

Sixth International Symposium on Snow Removal and Ice Control Technology

DETAILS

0 pages | null | PAPERBACK

ISBN 978-0-309-43723-3 | DOI 10.17226/17602

AUTHORS

Transportation Research Board

BUY THIS BOOK

FIND RELATED TITLES

Visit the National Academies Press at NAP.edu and login or register to get:

- Access to free PDF downloads of thousands of scientific reports
- 10% off the price of print titles
- Email or social media notifications of new titles related to your interests
- Special offers and discounts



Distribution, posting, or copying of this PDF is strictly prohibited without written permission of the National Academies Press. (Request Permission) Unless otherwise indicated, all materials in this PDF are copyrighted by the National Academy of Sciences.

TRANSPORTATION RESEARCH
CIRCULAR

Number E-C063

June 2004

Sixth International Symposium on

**Snow Removal and
Ice Control Technology**

June 7–9, 2004
Doubletree Spokane City Center
Spokane, Washington

TRANSPORTATION RESEARCH BOARD
OF THE NATIONAL ACADEMIES

TRANSPORTATION
RESEARCH
E-CIRCULAR

Number E-C063, June 2004
ISSN 0097-8515

Sixth International Symposium on Snow Removal and Ice Control Technology

June 7–9, 2004
Doubletree Spokane City Center
Spokane, Washington

Sponsored by

COMMITTEE ON WINTER MAINTENANCE (AHD65)

In Cooperation with

WASHINGTON STATE DEPARTMENT OF TRANSPORTATION
AMERICAN ASSOCIATION OF STATE HIGHWAY AND TRANSPORTATION OFFICIALS
FEDERAL HIGHWAY ADMINISTRATION

Wilfrid A. Nixon, *Chair*

Russell G. Alger
Joe Brett Althouse
Richard M. Balgowan
John P. Burkhardt
Torgrim Dahl
Rand Decker
Graham B. Gilfillan
Stephen N. Goodman

Richard L. Hanneman
Yasuhiko Kajiya
Dennis Kroeger
George Levasseur
Mikko Malmivuo
Jere E. Meredith
L. David Minsk
Richard J. Nelson

Jan Olander
Max S. Perchanok
Paul A. Pisano
Leland D. Smithson
Gregory E. Thompson
Alfred Obiora Uzokwe
David Vieth
Donald M. Walker

Program Committee

Richard M. Balgowan
Edward Boselly
John P. Burkhardt

Graham B. Gilfillan
Richard L. Hanneman
Yasuhiko Kajiya
Wilfrid A. Nixon

Paul A. Pisano
Leland D. Smithson
Donald M. Walker

Frank N. Lisle, *TRB Staff Representative*

TRB website:
www.TRB.org

Transportation Research Board
500 Fifth Street, NW
Washington, DC 20001

The **Transportation Research Board** is a division of the National Research Council, which serves as an independent adviser to the federal government on scientific and technical questions of national importance. The National Research Council, jointly administered by the National Academy of Sciences, the National Academy of Engineering, and the Institute of Medicine, brings the resources of the entire scientific and technical community to bear on national problems through its volunteer advisory committees.

The **Transportation Research Board** is distributing this Circular to make the information contained herein available for use by individual practitioners in state and local transportation agencies, researchers in academic institutions, and other members of the transportation research community. The information in this Circular was taken directly from the submissions of the authors. This document is not a report of the National Research Council or of the National Academy of Sciences.

Ann E. Petty, Managing Editor; Cathy Hamann and Kristen M. Sawyer, Editors; Jennifer G. Corroero and Jennifer J. Weeks, Senior Editorial Assistants; and Juanita Green, Production Manager.

Preface

The Sixth International Symposium on Snow Removal and Ice Control Technology was held in Spokane, Washington, on June 7–9, 2004. The symposium was conducted by the Transportation Research Board Committee on Winter Maintenance in cooperation with the Washington State Department of Transportation, American Association of State Highway and Transportation Officials, and the Federal Highway Administration. The objective of the Symposium was to provide a forum for the exchange of information about the state of the art and the state of the practice in research and technology applications to improve snow removal and ice control operations in transportation systems. This symposium included papers and presentations on winter weather (information, models, and data quality); winter maintenance (policy, management, and performance); customers' perspectives on winter operations; environmental stewardship; winter maintenance vehicle advancements; bridge support systems; winter pavement temperatures and road conditions; material distribution, performance and residual; and, large-volume snow control. Maintenance managers, engineers, and researchers from the following countries presented their papers: Canada, Denmark, Finland, Japan, New Zealand, Norway, Sweden, the United Kingdom, and the United States. The papers have not been subjected to the TRB peer review process.

Contents

WINTER WEATHER: INFORMATION, MODELS, AND DATA QUALITY

Winter Road Maintenance Decision Support System Project:	
Overview and Status (04-005)	3
Paul A. Pisano, <i>Federal Highway Administration</i> ; Andrew D. Stern, <i>Mitretek Systems, Inc.</i> ; William P. Mahoney III and William L. Myers, <i>National Center for Atmospheric Research</i> ; and Dennis Burkheimer, <i>Iowa Department of Transportation</i>	
Development of an Advanced Winter Road Management Support System for Greater Sapporo (04-039)	
18	
Yuji Yamagiwa, Yasuhiko Kajiya, and Tatsuya Uemura, <i>Civil Engineering Research Institute of Hokkaido</i>	
Guidelines for Snow and Ice Control Materials and Methods (04-059)	
31	
Robert R. Blackburn, <i>Consultant</i> ; Duane E. Amsler, Sr., <i>AFM Engineering Services</i> ; and Karin M. Bauer, <i>Midwest Research Institute</i>	
Finnish Road Administration's Web Road Weather Project (04-008)	
50	
Kimmo Toivonen and Jouko Kantonen, <i>Finnish Road Administration</i>	
Development of ARROWS: Automated Real-Time Road Weather System (04-010)	
58	
S. Edward Boselly, <i>Washington State Department of Transportation</i>	
Projected State of Road Weather Monitoring in Finland in 2007 (04-021)	
70	
Yrjö Pilli-Sihvola, <i>Finnish Road Administration</i> ; and Jukka Lähesmaa, <i>SysOpen, PLC</i>	
The Winter Model: A Winter Maintenance Management System (04-015)	
83	
Carl-Gustaf Wallman, <i>Swedish National Road and Transport Research Institute</i>	
Forecasting Terrain-Dependent Weather Conditions:	
Details of a Model Chain Sequence (04-051)	
95	
L. R. McKittrick and E. E. Adams, <i>Montana State University–Bozeman</i> ; P. Gauer, <i>Norwegian Geotechnical Institute</i> ; J. Mewes, <i>Meridian Environmental Technology, Inc.</i> ; and A. R. Curran, <i>ThermoAnalytics, Inc.</i>	
Verification of the Road Weather Forecast System Run During the 2003 Demonstration at the Iowa Department of Transportation (04-003)	
109	
Ben C. Bernstein, Jamie K. Wolff, Seth Linden, and William Myers, <i>National Center for Atmospheric Research</i>	
Quality Management for Road Weather Data (04-026)	
127	
Tuomo Iivanainen and Matti Pettersson, <i>Intrinsic Ltd.</i>	

WINTER MAINTENANCE: POLICY, MANAGEMENT, AND PERFORMANCE

Research on the Level of Winter Road Management (04-037).....	139
Takashi Yamada, <i>Hokuriku Construction Association</i> ; Akira Sugimura, <i>Hokuriku Regional Development Bureau</i> ; and Teruhiko Maruyama, <i>Nagaoka University of Technology</i>	
Proactive Snow and Ice Control Toolbox (04-061)	153
Leland D. Smithson, <i>Iowa Department of Transportation</i>	
Planning Blowing-Snow Control Facilities According to Danger Assessment: Development of a New Highway Snowstorm Countermeasure Manual (04-042).....	158
Yasuhiko Ito, Masaru Matsuzawa, and Yasuhiko Kajiya, <i>Civil Engineering Research Institute of Hokkaido</i>	
Indiana Winter Severity Index (04-014)	167
Bob McCullouch, <i>Purdue University</i> ; and Dennis Belter, Tom Konieczny, and Tony McClellan, <i>Indiana Department of Transportation</i>	
Quality Improvement of Winter Service in Denmark (04-052)	179
Freddy Knudsen, <i>Danish Road Directorate</i>	
Analysis of Road Weather Information System Use in California and Montana (04-060).....	190
Lisa Ballard, <i>Montana State University–Bozeman</i>	
Implementing Snow and Ice Control Research (04-056).....	208
Leland D. Smithson, <i>Iowa Department of Transportation</i>	

CUSTOMERS' PERSPECTIVE ON WINTER OPERATIONS

Importance of Winter Urban Traffic Issues and Performance Indicators as Rated by Businesses (04-045).....	219
Chigako Yamamoto, Kunihiro Kishi, and Keiichi Sato, <i>Hokkaido University</i> ; and Fumihiko Hara, <i>Hokkaido Development Engineering Center, Inc.</i>	
Conjoint Approach as Customer-Based Measurement for Winter Walkway Maintenance in the Snowiest City of Japan (04-011).....	237
Roberto A. Tokunaga, Naoto Takahashi, and Motoki Asano, <i>Civil Engineering Research Institute of Hokkaido</i>	
Study on Effects and Evaluation of Winter Road Information (04-023).....	248
Yasuhiko Kajiya, Takehiko Suzuki, Masaru Matsuzawa, and Tatsuya Uemura, <i>Civil Engineering Research Institute of Hokkaido</i>	

ENVIRONMENTAL STEWARDSHIP

- Icy Road Management with Calcium Magnesium Acetate to Meet Environmental and Customer Expectations in New Zealand** (04-050).....267
 Alan Burkett, *Transit New Zealand*; and Nick Gurr, *Opus International Consultants*
- Reducing Salt Consumption by Using Road Weather Information System and Mesan Data** (04-058).....278
 Dan Eriksson, *Swedish National Road Administration*
- Washington State Department of Transportation’s 2002–2003 Salt Pilot Project** (04-044).....282
 Enrico V. Baroga, *Washington State Department of Transportation*
- Modeling Exposure of Roadside Environment to Airborne Salt: Case Study** (04-018).....296
 Mats Gustafsson and Göran Blomqvist, *Swedish National Road and Transport Research Institute*
- Regulating Deicing Runoff from Highway Operations** (04-033).....307
 Richard S. Davis, *Beveridge & Diamond, P.C.*

WINTER MAINTENANCE VEHICLE ADVANCEMENTS

- Business Case for Winter Maintenance Technology Applications: Highway Maintenance Concept Vehicle** (04-034)323
 Dennis A. Kroeger and Reggie Sinhaa, *Iowa State University*
- Needs Assessment and Cost–Benefit Analysis of the RoadView™ Advanced Snowplow Technology System** (04-006).....332
 David Kack and Eli Cuelho, *Montana State University–Bozeman*
- GIS-Based Analysis of Intelligent Winter Maintenance Vehicle Data** (04-029)348
 Alan Vonderohe, Teresa Adams, Carola Blazquez, and Justin Maloney, *University of Wisconsin–Madison*; and Thomas Martinelli, *Wisconsin Department of Transportation*

BRIDGE WINTER SUPPORT SYSTEMS

- Implementation of Conductive Concrete Overlay for Bridge Deck Deicing at Roca, Nebraska** (04-002)363
 Christopher Y. Tuan, *University of Nebraska–Lincoln*; and Sherif A. Yehia, *Western Michigan University*

State-of-the-Art Fixed Automated Spray Technology (04-001).....379
 Jerry R. Waldman, *Surface Systems, Inc.–Quixote Transportation Safety, Inc.*

Bridge Frost Occurrence and Prediction (04-048).....391
 Tina M. Greenfield, Eugene S. Takle, Brian J. Tentinger, and Jose J. Alamo, *Iowa State University*; and Dennis Burkheimer and Diane McCauley, *Iowa Department of Transportation*

WINTER PAVEMENT TEMPERATURES AND ROAD CONDITIONS

Effect of Blowing Snow and Snow Fences on Pavement Temperature and Ice Formation (04-030)401
 Ronald D. Tabler, *Tabler & Associates*

Road Surface Temperature Forecasting: Case Study in a Mountainous Region of Japan (04-019)404
 Noriyuki Sato, *Indiana University–Bloomington*; J. E. Thornes, *University of Birmingham*; Teruhiko Maruyama, *Nagaoka University of Technology*; Akira Sugimura, *Nagaoka National Highway Office*; and Takashi Yamada, *Hokuriku Construction Association*

A First Principles Pavement Thermal Model for Topographically Complex Terrain (04-035).....422
 E. E. Adams and L. R. McKittrick, *Montana State University–Bozeman*; P. Gauer, *Norwegian Geotechnical Institute*; and A. R. Curran, *ThermoAnalytics, Inc.*

Winter Road Condition Model (04-016)433
 Staffan Möller, *Swedish National Road and Transport Research Institute*

Inverse Estimation of Friction Coefficient of Winter Road Surface With Vehicular Motion Data Measured by GPS-Equipped Probe Vehicles (04-043).....442
 Takashi Nakatsuji, *Hokkaido University*; and Akira Kawamura and Tikakuni Maeda, *Kitami Institute of Technology*

Using Taxi GPS to Gather High-Quality Traffic Data for Winter Road Management Evaluation in Sapporo, Japan (04-036).....455
 Naoto Takahashi, Syuji Miyamoto, and Motoki Asano, *Civil Engineering Research Institute of Hokkaido*

MATERIAL DISTRIBUTION, PERFORMANCE, AND RESIDUAL

Implementation of New Sanding Method in Norway (04-025)	473
Torgeir Vaa, <i>SINTEF Roads and Transport</i>	
Alberta’s Benchmark Model for Maintenance Winter Service Delivery (04-057)	487
Steve Otto, <i>Alberta Transportation</i>	
Anti-Icing and Material Distribution Performance Measures for Achieving Level of Service Through Mobile Data Collection (04-004)	503
Gregory E. Thompson, <i>ThomTech Design, Inc.</i>	
Norwegian Experience with Use of Magnesium Chloride (04-024)	516
Torgeir Vaa, <i>SINTEF Roads and Transport</i>	
Assessment of Safecote: New Deicer Product (04-064)	529
Marilyn Burtwell, <i>Transportation Research Laboratory Limited</i>	
Development and Evaluation of Nonchloride Antifreeze Admixture (04-038)	541
Toshiya Takeshi, Kazuharu Kobayashi, and Seishi Meiarashi, <i>Incorporated Administrative Agency of Public Works Research Institute</i>	
Agricultural By-Products for Anti-Icing and Deicing Use in Michigan: Summary (04-009)	552
Steve Kahl, <i>Michigan Department of Transportation</i>	
Role of Performance Specifications in Developing a Quality Control System for Winter Maintenance (04-046)	555
Wilfrid A. Nixon, George Kochumman, Ju Qiu, Lin Qiu, and Jing Xiong, <i>University of Iowa</i>	
Deicing Trials on UK Roads: Performance of Prewetted Salt Spreading and Dry Salt Spreading (04-063)	564
Marilyn Burtwell, <i>Transportation Research Laboratory Limited</i>	
Laboratory Melting Performance Comparison: Rock Salt With and Without Prewetting (04-032)	585
Craig Luker, Barry Rokosh, and Timothy Leggett, <i>Forensic Dynamics Inc.</i>	
Patterns of Residual Salt on Road Surface: Case Study (04-017)	602
Göran Blomqvist and Mats Gustafsson, <i>Swedish National Road and Transport Research Institute</i>	
Field Persistence of Anti-Icing Sodium Chloride Residuals (04-049)	609
Christopher L. Hunt, Gayle F. Mitchell, and Wallace Richardson, <i>Ohio University</i>	

LARGE-VOLUME SNOW CONTROL

GIS-Based Three-Dimensional Snow Drift Computer Model (04-007)	625
Robert B. Haehnel, <i>U.S. Army Corps of Engineers Cold Regions Research and Engineering Laboratory</i> ; and Glen Liston, <i>InterWorks Consulting</i>	
Development of Advanced Snowbreak Fences (04-020)	636
Masaru Matsuzawa, Yasuhiko Ito, and Yasuhiko Kajiya, <i>Civil Engineering Research Institute of Hokkaido</i> ; Shinya Fujiwara, <i>Sekisui Jushi Corp.</i> ; and Masayuki Murakami, <i>Sanei Kogyo Co., Ltd.</i>	
Avalanche Hazard Reduction on US-89/191 With Snow Sails (04-062)	645
Rand Decker, <i>Northern Arizona University</i> ; Robert Rice, <i>University of California–Merced</i> ; and Leroy (Ted) Wells and Jamie Yount, <i>Wyoming Department of Transportation</i>	
APPENDIX: Author Contact List	657

Winter Weather: Information, Models, and Data Quality

WINTER WEATHER: INFORMATION, MODELS, AND DATA QUALITY

Winter Road Maintenance Decision Support System Project
*Overview and Status***PAUL A. PISANO***Federal Highway Administration***ANDREW D. STERN***Mitretek Systems, Inc.***WILLIAM P. MAHONEY III****WILLIAM L. MYERS***National Center for Atmospheric Research***DENNIS BURKHEIMER***Iowa Department of Transportation*

For several years, the U.S. Federal Highway Administration (FHWA) Office of Transportation Operations Road Weather Management Program has been involved in the development of a guidance tool for winter road maintenance decision makers. The tool, known as the maintenance decision support system (MDSS), is the culmination of work by a consortium of national laboratories, directed by FHWA with feedback from both the state departments of transportation and the private sector. The MDSS combines advanced weather and road condition prediction with automated rules of practice to produce a customized and optimized set of treatment recommendations for winter road maintenance managers. The potential payoff is higher mobility and safety on roadways, and more efficient and cost-effective use of staff, equipment, and chemicals. The latter would produce a reduced impact on the environment. This paper describes the history, development, and status of the MDSS project. Preliminary results and lessons learned from a field demonstration, future development efforts, and the technology transfer plan is discussed.

INTRODUCTION

With tight budgets and the high expectation of the public for keeping roads clear of snow and ice, today's maintenance manager has to be able to handle multiple tasks or risk getting behind the onslaught of winter weather. All of the regulations about chemical applications, environmental impacts, and multiple, often contradictory weather forecasts can lead to information overload.

The Federal Highway Administration (FHWA) recognized this problem in the late 1990s. Generally speaking, there were plenty of weather forecasts, along with a few companies that issued road-specific forecasts, but there was a lack of linkage between the information available and the decisions made by winter maintenance managers. It was this weak link that became the genesis for the winter maintenance decision support system (MDSS) project.

Since 2000, the MDSS has evolved from a conceptual framework into a functional prototype. During the winter of 2002–2003, the prototype was deployed at several maintenance garages in central Iowa for a field demonstration. This paper will document the implementation of the demonstration, a summary of lessons learned, verification statistics, and technology transfer activities. It will also describe plans for a longer, more comprehensive demonstration during the winter of 2003–2004.

SYSTEM OVERVIEW

The MDSS is a research and development project that is funded and administered by the FHWA Road Weather Management Program. Five national laboratories have been participating in the development and implementation of the project. Participating laboratories include

- Army Cold Regions Research and Engineering Laboratory (CRREL),
- National Center for Atmospheric Research (NCAR),
- Massachusetts Institute of Technology–Lincoln Laboratory (MIT/LL),
- National Oceanic and Atmospheric Association Forecast Systems Laboratory (NOAA /FSL), and
- NOAA National Severe Storms Laboratory.

Each laboratory brings unique capabilities and expertise to the project. Much of the software used in the core MDSS modules has been reused from other projects and tied together via interprocess communications.

The MDSS project takes state-of-the-art weather forecasting and data fusion techniques and merges them with computerized winter road maintenance rules of practice. The result is a set of guidance aimed at maintenance managers that provides a tailored forecast of surface conditions and treatment recommendations customized for specific routes. A description of the prototype MDSS can be found in Mahoney and Myers (1).

Figure 1 shows a high-level flow diagram for the MDSS functional prototype that was used in the winter 2002–2003 demonstration. The top box in the left column represents data received from the National Weather Service (NWS). These data include both surface observations, statistical guidance, and numerical model output from both the Eta and GFS (global forecast system, formerly known as the aviation model) models.

The lower box in the left column represents supplemental mesoscale numerical weather prediction models that were provided and run by FSL. These models were the Mesoscale Model 5 (MM5), the regional atmospheric modeling system (RAMS), and the weather and research forecasting model (WRF). In order to provide diversity into the data fusion module, FSL used the NWS models to provide lateral boundary conditions to initialize each mesoscale model. Hence, four times per day, FSL generated six model solutions for the forecast domain (Figure 2).

Different from the standard NWS models, the FSL mesoscale models used a new initialization routine to add realistic distributions of moisture and clouds to the model atmosphere. This method, called “hot-start” (2), allows the mesoscale models to have a more realistic and accurate initial representation of clouds and moisture, which is critical for road condition prediction. Forecast output from these six models, plus surface observations from state

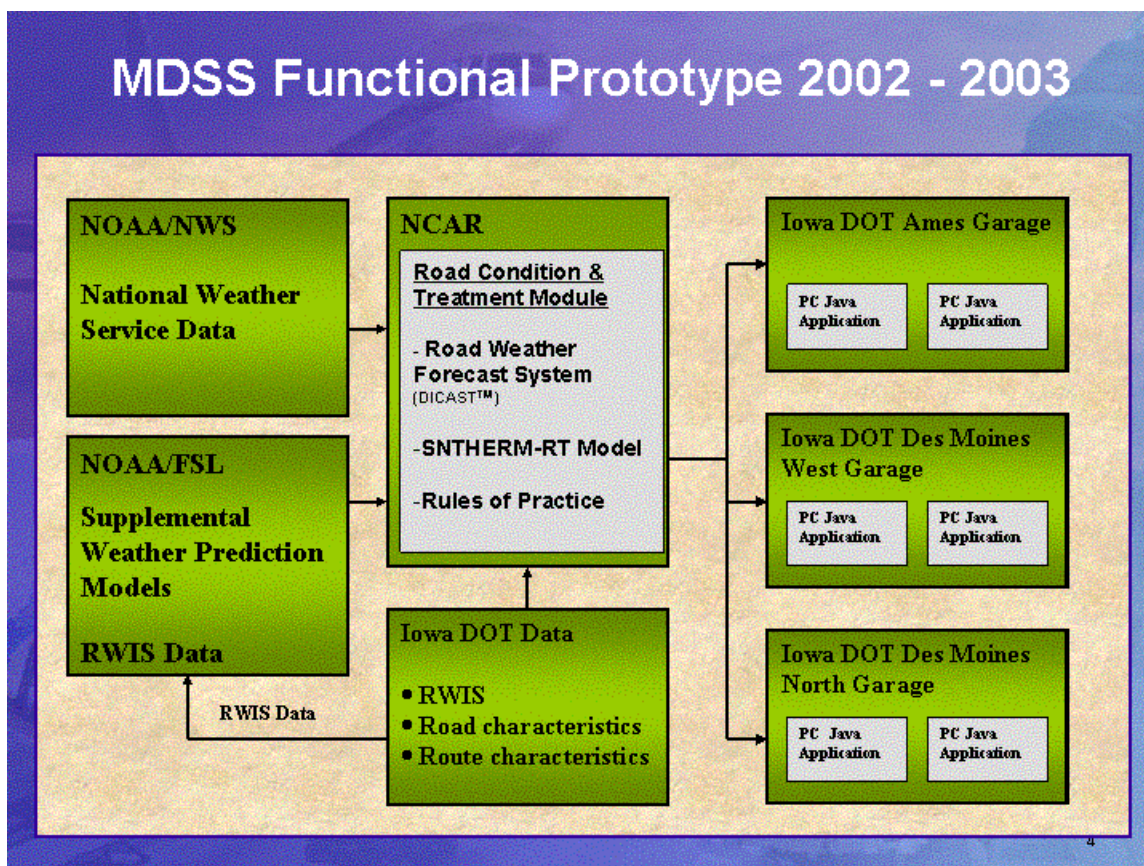

FIGURE 1 High-level flow diagram of the MDSS functional prototype.

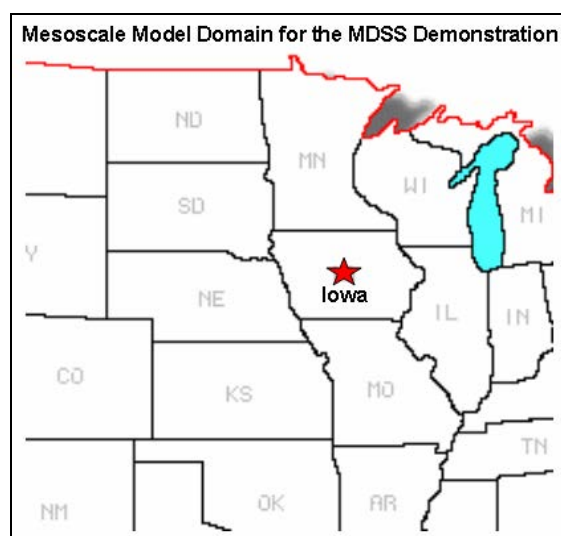

FIGURE 2 Model domain for the MDSS demonstration. Area under the star represents the approximate demo area.

departments' of transportation (DOTs') road weather information systems (RWIS) was forwarded to NCAR's data fusion engine (Figure 1, top center box, or Figure 3) called the road weather forecast system (RWFS). The RWFS module uses a fuzzy logic ensembling scheme that has the ability to generate more accurate forecasts than any individual model input by applying bias corrections and weighting the forecast modules that have higher skill.

Once forecasts have been generated by the RWFS, a number of algorithms are queued for execution. These include the road temperature forecast module and the road condition and treatment module. The former generates temperature forecasts for the state and condition of the road surface and contains algorithms for estimating chemical concentration and dilution.

The final module in the system contains the rules of practice algorithms. The rules of practice are customized rules and techniques for effective anti-icing and deicing. These rules tend to be different for each state and in many cases are different for each garage. Hence, this module has the ability to customize many of its inputs so that it can be portable between garages.

Output from the rules of practice module includes treatment recommendations for the DOT garage supervisor. Treatment recommendations include

- Timing of initial and subsequent treatments,
- Type of treatment (plowing, chemical, etc.), and
- Chemical amounts.

Figure 4 is an example from the MDSS prototype main display. The top left panel shows a summary table with color-coded bars showing forecast weather and road conditions for the next 48 h. The panel at the left center provides access for displaying weather parameters or treatment routes. The bottom section controls the forecast time selection and animation. The main map (top right) can show either an entire state view or a zoomed-in route view (Figure 5).

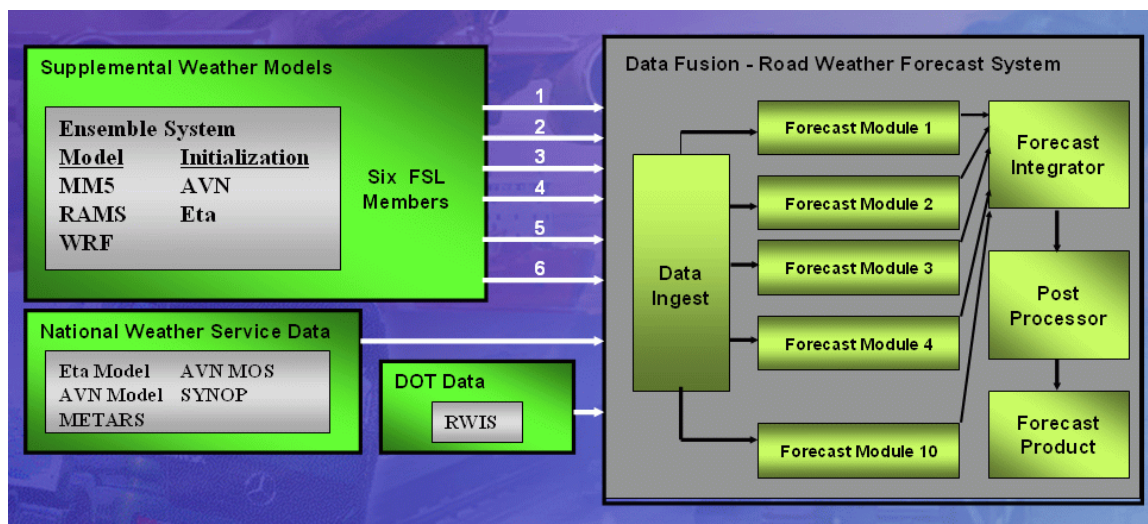

FIGURE 3 Detailed data flow from sources into the RWFS data fusion module.

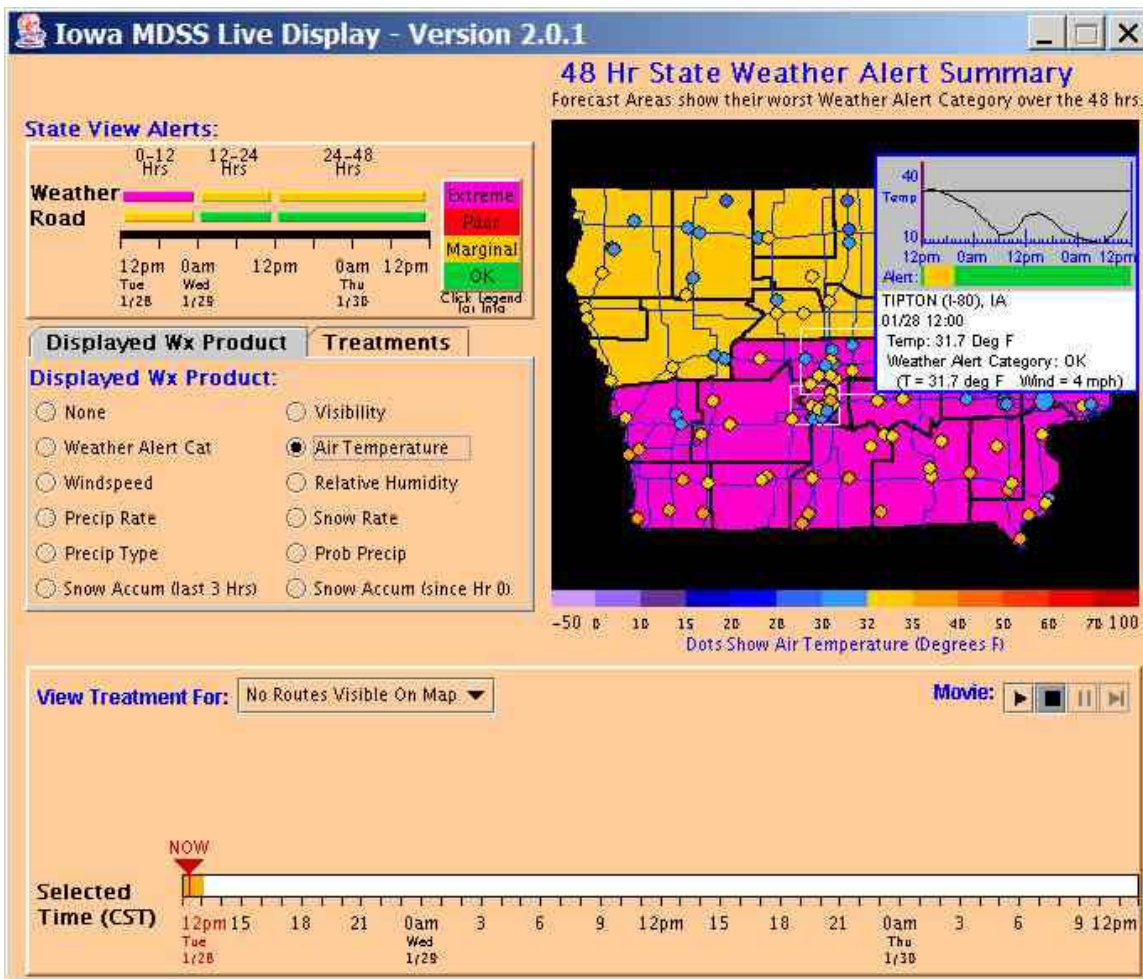

FIGURE 4 MDSS functional prototype main user screen (from the 2002–2003 demonstration).

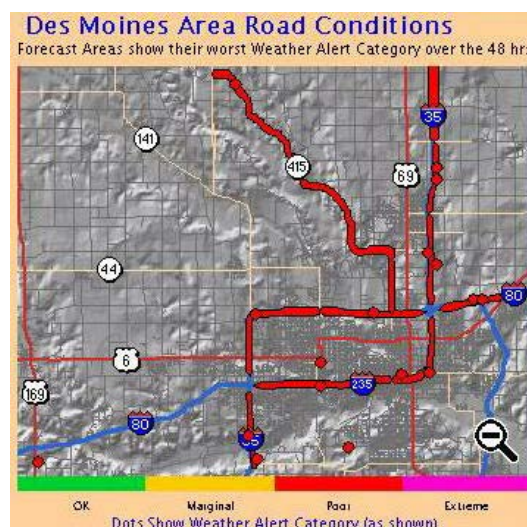

FIGURE 5 Des Moines area MDSS routes and forecast points.

Each dot on the main map represents an observation and forecast point. Forecasts for routes with no observations are generated using interpolation techniques. Moving a cursor over any point brings up a trace of the selected forecast parameter plus additional site specific details.

The MDSS contains a what-if scenario treatment selector. This means that the user is able to modify the recommended treatment times, chemical types, or application rates and view the results of the user-defined treatment plan.

In Figure 6, a chemical concentration display shows the results of two scenarios. The green trace shows the dilution rate of sodium chloride on the road surface if no additional treatments of chemicals are applied. In this case, given the forecast weather conditions, the chemical concentration on the road surface would fall to 10% or less within 24 h. With one application of sodium chloride (at a rate of 300 lbs per lane mile), the red trace indicates that the chemical concentration would stay about constant through the 48-h forecast period.

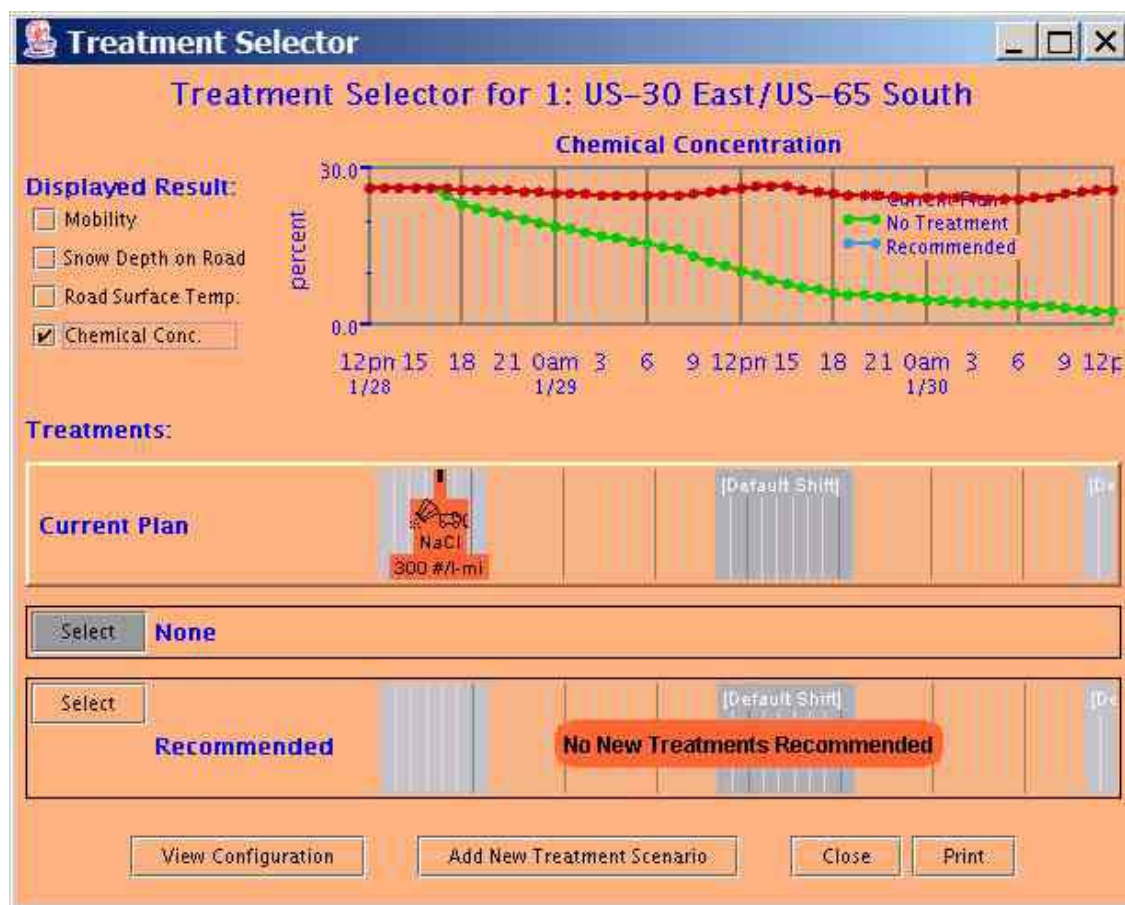

FIGURE 6 MDSS treatment selector screen. The red trace (top line, top window) shows the predicted chemical concentration if the treatment application is followed. The green trace (bottom line) shows the chemical dilution rate if no chemicals were applied.

FIELD DEMONSTRATION 2003

During the summer of 2002, half a dozen states competed to win the opportunity to host the MDSS project. While there were several very good candidates, the Iowa Department of Transportation (IADOT) was selected. Determining factors included their progressive maintenance programs, the availability of high-speed communications and computers at maintenance garages, and a willingness of the DOT personnel to participate in training and verification activities. Iowa also was surrounded by a dense network of surface observations and did not have complex terrain issues.

In all, 15 routes and three maintenance garages around Des Moines and Ames, Iowa, were selected to participate in the demonstration (Figure 7).

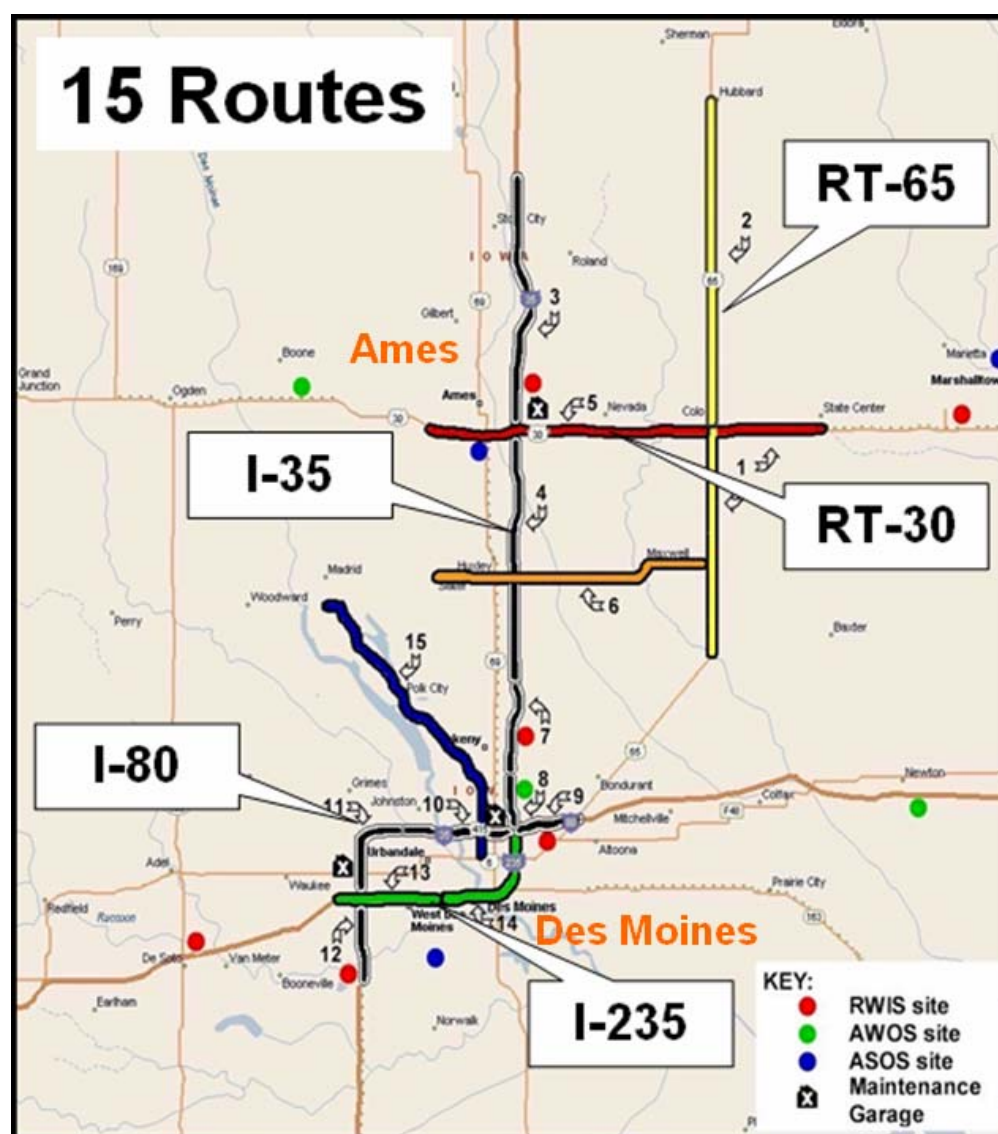

FIGURE 7 The 2002–2003 MDSS Winter Demonstration route map.

The Des Moines West garage is located just to the west of I-80 and is responsible for portions of I-80 and I-235. The Des Moines North garage is located near the intersection of I-80, I-35, and I-235. This garage is responsible for the expressways through and north of downtown including secondary roads to the north of the city. The Ames garage is located about 40 mi north of Des Moines near the intersection of I-35 and US-30. The Ames garage is responsible for longer but less-traveled routes through the rural areas of central Iowa.

The colored dots along the roadways represent automated surface observing stations that were either operated by NWS, the state, or the DOT. These stations provide observational data that is used for forecast initialization and verification.

The demonstration period began on February 3, 2003, and concluded on April 7, 2003. During that time, five light snow events (3 in or less accumulation), three heavy snow events (accumulations of greater than 3 in) and one mixed rain/snow/ice event occurred.

Verification

A detailed verification report was conducted by the national labs (3, 4) after the field demonstration. This section provides highlights from this report.

Establishing Data Quality

A study was performed to determine the quality of the NWS automated surface observation system (ASOS), the state DOT–operated automated weather observing system (AWOS), and RWIS within the demonstration domain. Both ASOS and AWOS instrumentation are located at airports, which typically have no obstructions. RWIS, on the other hand, are generally located along roads or near bridges and often have terrain or obstruction issues. All three systems are maintained and calibrated; however, each is of a different quality and capability.

Table 1 shows overall results of comparisons between the automated airport observations and the roadside observations. For air temperature, most observations were within 2.5°C (4.5°F). However, compared with ASOS, the Ames RWIS tended to be 1°C to 2°C (2°F to 4°F) warmer, and the Ankeny AWOS (I-35 north of Des Moines) tended to be about 1°C (2°F) cooler.

TABLE 1 Comparisons Between Automated Airport and Roadside Observations

Parameter	Comparison
Air Temperature	Most within 2.5°C (4.5°F)
Relative Humidity	Most within 10%
Wind Speed	Most within 4 knots
Cloud Cover	Not available
Precipitation	Not available
Road Temperature	Cloudy <2°C (<4°F) Sunny 4°C to 5°C (7°F to 9°F)

Most relative humidity readings were within 10%. However, some differences were noted because ASOS reports dew points in whole degrees Celsius while RWIS uses tenths of a degree Celsius. A possible calibration problem was also noted at the Ankeny AWOS as it consistently reported relative humidity 10% to 15% too high when the RWIS reported humidity of less than 50%.

In general, wind speeds were within 4 knots of each other. Probably due to better exposures in airports, ASOS reported higher winds than RWIS especially at speeds less than 12 knots. The only exception was found at the Ankeny AWOS, where the RWIS reported higher winds.

No comparison was possible for cloud cover since RWIS has no cloud sensing capability and ASOS only approximates coverage. RWIS also does not have a heated precipitation gauge, winter precipitation quantity (e.g., liquid equivalent) cannot be measured by the IADOT RWIS network.

Interestingly, it was confirmed that the NWS ASOS system has major problems reporting winter precipitation (especially liquid equivalent), even though it employs a heated tipping bucket type of gauge. During the evaluation period, most of the snow accumulations from ASOS were underreported when compared with human observed ground truth. In 7 of the 11 significant periods of ice or snow, a value of zero liquid equivalent was reported for the entire event. The biggest snowstorm of the demonstration period produced 13 in. of snow at the Des Moines airport. ASOS reported zero liquid equivalent precipitation for the entire storm.

This very poor ability to measure and disseminate winter precipitation can have a deleterious effect on systems such as the MDSS. One of the advantages of the MDSS logic is that it has the ability to forward correct its forecasts based on observations that are supposed to be ground truth. These grossly underreported precipitation observations produced a marked dry bias in the forecast. Hence, some of the precipitation observations (both ASOS and RWIS) were removed from the forward correcting scheme to overcome this deficiency.

Verification of the Supplemental Weather Models

The supplemental FSL mesoscale models were run four times per day, providing data in 3-h increments to the RWFS. The initial requirements when the ensemble scheme was constructed was to focus on the “planning” or 12- to 24-h time span as being the most critical for maintenance managers. However, as the demonstration progressed, it became evident that more “tactical” (2- to 12-h) forecasts were also very important. Note that the results in this section are for the mesoscale models and do not represent the results of the output from the RWFS, which improves the predictions using bias correction, forward error correction and dynamic weighting techniques.

Table 2 provides some statistics on the performance of each mesoscale model. Both the root mean square (RMS) error and the statistical bias are provided.

Temperature forecasts had an error of about 2.5°C (4.5°F) during the first 24 h with RMS errors increasing to around 3°C (5°F) for both the WRF and MM5 models for the entire 48-h forecast period. This error was close to the measurement uncertainty of the ground truth observations. Errors for the RAMS model were much higher. Also, all of the models showed a cool bias, forecasting temperatures colder than what was observed.

Wind speed forecasts had an error of around 2.5 m/s (5 knots), and all models displayed a high bias. This means that wind speeds were forecast to be somewhat stronger than what was

observed. Forecasts of dew point had larger errors. For the 48-h period the average RMS error was 6°C (almost 11°F). This resulted in relative humidity forecasts being off by $\pm 20\%$. This type of error could pose problems for fog or frost deposition forecasting.

Cloud cover forecasts (not shown in Table 2) were generally one category of observed conditions. The forecast showed an overall bias toward more cloudy conditions. This type of error can produce problems with road temperature forecasts since the forecast energy fluxes would contain errors.

The models generated conditional probabilities of snow (CPOS), rain (CPOR), and ice (CPOI). Table 3 highlights some of the results.

The CPOS was most successful when values reached 70%. The same level of success was reached by CPOR when it reached 80%. However, middle range forecasts (20% to 80%) showed much more of a variety of forecast precipitation types. Very few cases of ice were reported during the demonstration period and the probability value never exceeded 0.4.

TABLE 2 Verification Statistics for the MDSS Mesoscale Models (2002–2003 Demonstration)

	Temperature (°C)		Wind Speed (m/s)		Dew Point (°C)	
	RMS	Bias	RMS	Bias	RMS	Bias
MM5-GFS	3.1	-0.7	2.5	+0.8	5.6	+1.5
MM5-Eta	3.0	-0.5	2.5	+0.8	5.5	+1.6
RAMS-GFS	5.8	-1.1	2.6	+1.6	6.5	-0.9
RAMS-Eta	5.9	-1.1	2.6	+1.7	6.9	-1.0
WRF-GFS	3.1	-0.4	2.4	+1.1	5.7	+1.4
WRF-Eta	3.1	-0.4	2.4	+1.0	5.7	+1.3

TABLE 3 Conditional Probability of Snow (CPOS), Rain (CPOR), and Ice (CPOI)

CPOS	CPOS > 0.7 snow occurred 95% of the time.	0.2 < CPOS < 0.7 snow occurred 15% to 60% of the time. Remainder was a variety of precipitation.	CPOS < 0.1 rain occurred 95% of the time.
CPOR	CPOR > 0.8 rain occurred 95% of the time.	0.3 < CPOR < 0.8 rain occurred 20% to 30% of the time. The remainder was snow.	CPOR < 0.3 rain rarely occurred. Snow dominated.
CPOI	CPOI > 0.3 rain fell 85% of the time.	0.2 < CPOI < 0.3 rain, snow and unknown precipitation occurred with equal frequency.	CPOI < 0.2 snow dominated.

Road Temperature Predictions

The MDSS makes road temperature predictions for each plow route regardless of whether there is an RWIS along the route. The prediction points for routes with and without RWIS are near the center of the route and not at the RWIS site. It was felt that weather and road temperature predictions at the route center point would be more representative of the predominant condition of the entire route. Because there is no alternative, the RWIS data were used for verification even though the MDSS was not explicitly predicting the road temperatures at that site. In addition, the MDSS road temperature predictions used in the analysis assumed that the DOT performed the recommended treatments, meaning that the roads were generally clear of snow and ice, which can affect road temperatures. Because of these caveats, care must be taken when interpreting the results.

Average RMS errors for road temperature forecasts were about 2.5°C (4.5°F) with a slight cool bias regardless of temperature range. Errors were maximized during the daytime under clear skies. Under these conditions forecasts were too low by 5°C to 10°C (9°F to 18°F). Handheld radiometer tests showed the biggest discrepancies with the pavement sensors under these conditions (~5°C or 9°F). Hence, there may also be some pavement sensor error involved. Forecasts under cloudy, nighttime, and precipitating conditions were much more accurate. The majority of road temperature forecasts were within 1.8°C (3.3°F) when precipitation was falling, especially snow. Additional tuning of the road temperature model will be performed to improve its overall skill.

Rules of Practice Module

The treatment recommendations that are provided by the MDSS are generated by the rules of practice module. During the demonstration period, both garage supervisors and plow operators were asked to fill out storm evaluation forms so that verification of the recommendations and a comparison with what treatments were actually performed could be tabulated.

Overall, it was found that given the forecasts from the RWFS, the recommendations were reasonable. The following section provides some insight to the rules of practice verification.

Case of February 3–4, 2003–Ames This event was a short lived 5- to 7-h event that deposited about 1 in. of snow (0.1 liquid equivalent) over both the Ames and Des Moines routes. The MDSS recommended a pretreatment of liquid brine followed by two successive treatments of sodium chloride with an application rate of 150 lbs per lane mi.

The actual IADOT treatments consisted of one treatment of 300 lbs per lane mi. However, due to a rapid drop in air and road temperatures before the melted snow could dry, IADOT had to provide several more applications to keep the roads from refreezing.

It was determined that the MDSS recommendations were reasonable. However, the strong winds (>18 knots) prior to the storm caused IADOT not to pretreat the roads. The initial treatments of the roads were similar. However, the lateness of the day and the blowing snow kept the road surface wet as temperatures dropped. The MDSS did not recommend additional treatments because the snow had stopped and it was believed that the applied chemicals were enough to last until the roads were dry.

Case of February 14–15, 2003–Des Moines This event provided the heaviest snowstorm of the demonstration with nearly a foot of snow deposited over the region. In Des Moines, the event started as rain, then changed to snow that lasted almost 20 h.

The MDSS recommended a pretreatment of liquid brine several hours before the onset of precipitation because the MDSS forecast called for a period of freezing rain, which did not materialize. The Des Moines West garage did not perform a pretreatment since they recognized that the initial period of rain would have reduced the effectiveness of the brine.

The MDSS then recommended 12 chemical treatments ranging from 100 to 350 lbs per lane mile. The overall treatment recommendation was about twice the tonnage that was actually applied by the Des Moines West garage. However, it did supplement its treatments with “plow only” operations (something supported by the MDSS, but due to a software bug, not recommended for this case).

As a result of the case studies, many algorithms within the rules of practice module will be updated with information collected during the winter 2003 demonstration. A more complete set of rules of practice verification examples can be found in NCAR and Wolff (3, 4).

Summary of Lessons Learned

The following list contains lessons learned or confirmed from the 2002–2003 MDSS field demonstration:

- The MDSS requires highly specific forecasts of precipitation, which is pushing the limits of predictability.
- The rules of practice module needs additional development to handle a wider variety of weather and road condition scenarios and treatment responses.
- The availability and quality of real-time precipitation rate data from NWS and RWIS stations are very poor.
- Light snow events and intermittent events are critical to DOT operations and were difficult to predict given the MDSS configuration used during the demonstration and lack of quality precipitation observations.
- More research is needed to account for the impact of travel, chemicals, compact snow, and blowing snow on road temperature prediction.
- In addition to planning decision support, users have a strong desire for tactical (0- to 2-h) decision support.
- Because weather will not soon be predicted perfectly at road scales, probabilistic products should be developed.

In addition to lessons learned, several shortcomings in the system were noted:

- The MDSS prototype is not designed to provide explicit treatment recommendations for blowing snow conditions (after precipitation has ceased).
- The MDSS does not contain explicit algorithms that identify road segments that may need treatments due to frost.
- Users indicate that a measure of overall forecast confidence would be highly beneficial.

Testimonials

Since the beginning of the MDSS concept, a large group of interested individuals and organizations have participated in the shaping and refinement of the project. Members of the road maintenance community, private-sector vendors, and academia have constituted a stakeholder group. Each year, the stakeholders gather to review past progress and to discuss and shape the future plans of the project.

Results from the 2002–2003 winter demonstration were presented at the 2003 annual stakeholder meeting. After the summary of lessons learned was discussed, a panel of participants was asked if the overall concept of the MDSS makes sense. The following are some responses:

- “Absolutely. At first, some of the operators were really apprehensive that this tool was going to take away jobs. Then, it became like a video game and a discovery tool. Just don’t take the ultimate decision away from the end user.”
- “Very valuable—even if it wasn’t totally accurate—getting people down to the surface and away from aviation weather was very important.”
- “There will be a drastic reduction in guard rail repairs, and this will save lives. This is very good for the IADOT. It provides an opportunity to try new things. We constantly have to do more with less.”

The members of the stakeholder group were pleased with progress made by the MDSS project and were looking forward to further refinements in 2004.

PLANS FOR DEMO II, WINTER 2004

After evaluation of the performance of the MDSS during the first demonstration, it was determined that the system was not yet mature enough to survive on its own in the private sector. Hence, the FHWA decided to fund another round of development and field demonstration. It will again take place in central Iowa and extend from December 29, 2003, until March 19, 2004.

Numerous enhancements will be engineered and implemented prior to the start of the demonstration. These include the following:

- Continuing to develop, refine, and tune the road temperature forecasting module.
- Creating a treatment recommendation to alert when blowing snow conditions are likely (in the absence of an actual blowing snow model).
- Continuing to expand, refine, and test the coded rules of practice to better reflect actual treatment plans.
- Continuing to work with Iowa State University on adding frost deposition forecast support.
- Deploying real-time snow gauges to obtain better liquid equivalent information for demonstration verification.
- Revising the RWFS to process and output hourly forecast data (rather than data over 3 h interpolated to hourly).
- Generating probabilistic information for selected data fields.

- Adding the ability of the users to reset the road conditions to zero for both road snow depth and chemical concentration on a route or network basis.
- Reconfiguring the FSL ensemble modeling system to run the MM5 and WRF models every hour and use a “time-lagged” ensemble.
- Updating the display application based on user feedback.

Even after all of these changes are implemented, there will still be many challenges to overcome to create a truly comprehensive MDSS. However, the spirit of cooperation between the public and private sectors will move the entire industry closer to this goal.

TECHNOLOGY TRANSFER

During the course of the MDSS project, the system technologies (software and documentation) have been made available publicly through software releases. Two software releases have been made thus far. Once the second field demonstration is complete, the laboratories will begin to compile new verification statistics and evaluation reports. The FHWA will also continue the process of outreach and technology transfer. In 2004, the focus will be on identifying organizations that can assist in the technology transfer process. One such organization is the AASHTO Technical Implementation Group. The MDSS project will be submitted to this group as a new and promising technology during the spring of 2004. It is anticipated that components of the MDSS will be integrated into the product lines of private companies so that the technology can be used to raise the level of service for all state DOTs.

The sixth meeting of the MDSS stakeholder group will be held in July 2004 in Boulder, Colorado. At this meeting, the laboratories will be holding a workshop to provide a detailed engineering overview of the MDSS and exchange technical information with any company that is interested in exploring the MDSS technology. In addition, CDs with all of the software and documentation associated with the winter 2004 demonstration (MDSS Release 3) will be distributed to interested parties during the fall of 2004 via the NCAR MDSS website.

SUMMARY

The FHWA has been funding and directing a team of national laboratories to create and refine a decision support system for the winter road maintenance community. A demonstration of the MDSS prototype was conducted in central Iowa during the winter of 2003. Reviews from this first demonstration were mixed. The system showed consistent improvement as the season progressed. However, there were some problems with obtaining ground truth observations both from automated stations and from DOT maintenance log forms. There were problems with the weather models capturing some of the “light” precipitation events. Also, because some of the weather forecasts were not as accurate as desired, some of the treatments recommended were not appropriate.

However, in a postdemonstration presentation, the participating IADOT maintenance supervisors all agreed that the system had tremendous promise and was worth the effort to continue to work with the laboratories to make the system better.

ACKNOWLEDGMENTS

The authors would like to acknowledge some of the major contributors to the MDSS project. This project would not be possible without the continuing support and leadership from the FHWA Office of Operations, the Joint Program Office, and the Highway Research Division. These individuals include Jeff Paniati, Shelley Row (now of the Institute of Transportation Engineers), Mike Freitas, James Pol, Toni Wilbur, Rudy Persaud, and Henry Lieu. Major contributors from the laboratories include Ben Bernstein, Jamie Wolff, Seth Linden, and Bill Myers of NCAR; Robert Hallowell of MIT/LL; Paul Schultz of NOAA/FSL; and George Koenig and Gary Phetteplace of CRREL.

Contributors from the IADOT include Dennis Burkheimer, Paul Durham, Edward Mahoney, and Richard Hedlund. Verification support was lead by Dennis Kroeger of the Iowa State University's Center for Transportation Research and Education.

REFERENCES

1. Mahoney, W. P., and W. L. Myers. Predicting Weather and Road Conditions: An Integrated Decision Support Tool for Winter Road Maintenance Operations. In *Transportation Research Record: Journal of the Transportation Research Board, No. 1824*, TRB, National Research Council, Washington, D.C., 2003, pp. 98–105.
2. McGinley, J., S. Albers, D. Birkenheuer, B. Shaw, and P. Shultz. The LAPS Water in All Phases Analysis: the Approach and Impacts on Numerical Prediction. 5th International Symposium on Tropospheric Profiling, Adelaide, Australia, 2000.
3. National Center for Atmospheric Research. *The Maintenance Decision Support System Project*, Technical Performance Report, Iowa Field Demonstration Winter 2003, Version 1.1. Sept. 12, 2003, Boulder, Colo.
4. Wolff, J. K., B. C. Bernstein, and S. Linden. Case Study Verification of the Maintenance Decision Support System (MDSS) During the 2003 Operational Demonstration, Preprints. 20th Conference on Interactive Information and Processing Systems, Seattle, Wash., *American Meteorological Society*, Vol. 18, No. 5, 2004.

WINTER WEATHER: INFORMATION, MODELS, AND DATA QUALITY

Development of an Advanced Winter Road Management Support System for Greater Sapporo**YUJI YAMAGIWA****YASUHIKO KAJIYA****TATSUYA UEMURA***Civil Engineering Research Institute of Hokkaido*

In the Greater Sapporo Area of Japan, road administrators spend large sums on winter road maintenance, which includes snow removal and antifreezing agent application. For this reason it is important to improve the efficiency of such maintenance. The Advanced Winter Road Management Support System is being developed to support decision-making in which snow removal and antifreezing agent application operations are conducted with due consideration of weather conditions. A system prototype was tested from January to March 2003 by five snow removal contractors on national highways. This system features a weather and road surface condition forecast, a road-icing index (probability of ice formation on road), an index for very slippery road surface emergence (occurrence probability of very slippery road surface), snow removal operation support guidance, anti-icing operation support guidance, and an emergency notification system. It provided information via Internet at 18:00 every day. In a questionnaire survey, trial users gave the system a somewhat low rating (2.4 on a 5.0-point scale, with 5.0 as the best). This means the accuracy of road surface forecasts and the content of the provided information require improvement. All the test users expressed a desire to obtain current conditions of road and weather and accurate forecasts for efficient and appropriate winter road maintenance operations. Improvement and expansion of the system will be sought.

INTRODUCTION

The Greater Sapporo Area has a population of about 2 million and about 5 m of snowfall per year. In winter, snow and ice on the road surface cause traffic congestion and reduce driving safety, thus significantly affecting road traffic. Additionally, winter road management entails great costs, including labor costs, for operations to remove snow, apply anti-icing agents, and conduct other work. It is crucial to enhance the efficiency and quality of winter road management.

To solve these problems, the authors have been developing an advanced winter road management support system. This system compiles information that supports snow removal and anti-icing operations using forecasts on weather and road surface conditions, and provides such support information via a website. This paper reports on efforts to estimate ice formation on roads in Greater Sapporo and on the development status of the advanced winter road management support system.

FORECASTING ICE FORMATION ON ROADS

Categorization of Winter Road Surface Conditions

Pursuant to the Law on the Prevention of Generation of Particulates from Studded Tires, which took effect in 1990, in 1991 the city of Sapporo and its six neighboring municipalities imposed a ban on the use of metal-studded tires. In the winter from 1991 to 1992 when penalties under the Law began to be applied, almost 100% of the vehicles in Greater Sapporo were equipped with nonstudded tires, which buffed the ice on roads to a mirror-like slipperiness. Deterioration of driving conditions caused major concern.

Before the ban on studded tires, the Hokkaido Development Bureau, the national highway administrator, identified six surface conditions: ice sheet, compacted snow, fresh snow, slush, wet pavement, and dry pavement. “Very slippery road surface” did not fall under any of these, although it was critical to road management.

In 1994, Akitaya and Yamada (1) proposed a method for categorizing snow and ice on roads, which made it easier to determine road surface conditions and slipperiness by visual observation. Based on this method, the Council for Improved Winter Road Management Planning, consisting of road administrators in Hokkaido, reviewed the categories of winter road surface conditions to be used by those administrators so as to best suit the “studless era.” Eventually, winter road surface conditions were divided into 13 types.

The Hokkaido Development Bureau of the Ministry of Land, Infrastructure, and Transport issued the *1997 Winter Road Management Manual* (draft) that contained descriptions of the 13 road surface conditions and a classification of road surface evaluations in terms of slipperiness. These categorizations have been in effect to date.

Development of Road Ice Forecasting System

Forecasting of road ice in Greater Sapporo started in the winter of 1993–1994 when the Civil Engineering Research Institute of the Hokkaido Development Bureau [the current Civil Engineering Research Institute of Hokkaido (CERI)] installed a road ice forecasting system that had achieved satisfactory results in other regions at two places in the city for experimental forecasts of road ice. Observations and forecasts obtained with the system were used in designing a model for forecasting ice on roads during the winters of 1993–1994 and 1994–1995. This study made it clear that it would be necessary to develop a new forecast model for Greater Sapporo, where winters are characterized by low temperatures and heavy snowfall (2).

Based on the results above, the current forecast model has been developed and tested since the winter of 1995–1996. In the winter of 1999–2000, trials by CERI were completed, and the road ice forecasting system was put into practical use for winter road management by road offices in Sapporo and Otaru under the jurisdiction of the Hokkaido Development Bureau of the Ministry of Land, Infrastructure, and Transport, which administers national roads in Hokkaido.

Technique for Collecting Road Ice Forecast Information

The current forecasting system predicts at 18:00 every evening what the road surface conditions will be at 0:00 and 8:00, because the forecasts are used in deciding appropriate snow removal and anti-icing operations, which are carried out from late at night to early the following morning.

To produce a forecast, the initial surface conditions observed by patrolling snow removal contractors at 16:00 are combined with information on air temperature (at 16:00) and forecasts (air temperature, cumulative snowfall, and other weather phenomena), after which a flowchart for forecasting road surface conditions is used to predict the road surface conditions. The forecast road condition is modified by a weather forecaster based on weather forecasts, for provision as road ice forecast information. Road surface conditions and ice on roads are predicted in accordance with the 13 road surface conditions, and road ice forecasts are given for the two most probable conditions. In addition, such forecasts are given for two cases: one with anti-icing agent application before the forecast times and the other without such application.

To develop a forecast flowchart, the relationship between the weather elements and the road surface conditions observed at 16:00 every day in the past, and the surface conditions observed at 0:00 and 8:00 were analyzed. Then, patterns in which certain road surface conditions and weather forecast preceded certain road surface conditions were identified. However, the current road ice forecasts are evaluated only in terms of hit ratios, and any accuracy measured in this way is bound to have its limits. Therefore, other indicators are needed to support winter maintenance against ice on roads.

DEVELOPMENT OF ADVANCED WINTER ROAD MANAGEMENT SUPPORT SYSTEM

On the basis of the road ice forecasts described above, we have been working on developing an index of road ice forecasts, toward providing greater support for decision making and road management operations done by road administrators and snow removal contractors. At the same time, an advanced winter road management support system is under development. This system uses a website and e-mail to supply information, such as guidance to support snow removal and anti-icing operations and automatically send emergency notifications by e-mail.

Road-Icing Index and Index for Very Slippery Road Surface Emergence

Two types of forecast information were examined. The “road-icing index” gives a quantitative estimate of the possibility that ice will form on the road. The “index for very slippery road surface emergence” gives a quantitative estimate of the possibility that ice on the road will become very slippery.

The road-icing index and the index for very slippery road surface emergence are shown below with regard to the data on the forecast and observed surface conditions at 0:00 and 8:00 a.m. on National Highway 5 (at Kita-5 Higashi-1, Chuo-ku, Sapporo), where research was conducted in the winters of 1996–1997 and 1997–1998. Thirteen winter road surface conditions were used, and the occurrence rates were calculated for three ranks of surface conditions: very slippery road surface, slippery road surface, and relatively easy-driving road surface. The 13 road surface conditions and the 3 ranks are compared in [Table 1](#). The predicted and the observed surface conditions are compared for the conditions that snow removal and anti-icing agent application operations were done and were not done.

[Figure 1](#) shows the road-icing index and the actual occurrence rates of ice formation on roads (very slippery or slippery road surface: road surface slipperiness Ranks 1 and 2). When the road surface forecast calls for very slippery compacted snow, the road-icing index is 70, from

which road administrators can judge that a slippery road surface is very likely to appear. When the road surface forecast calls for compacted snow or moist grainy snow, the road-icing index is 30. Although 30 is not high, it can be interpreted as an indication that the road surface might become slippery.

TABLE 1 Surface Conditions Comparison by Rank

	Surface Category	Rank
1	Very slippery compacted snow	1—Very slippery road surface
2	Very slippery ice sheet	
3	Very slippery ice film	
4	Ice sheet	2—Slippery road surface
5	Ice film	
6	Powder snow on ice	
7	Granular snow on ice	3—Relatively easy driving road surface
8	Compacted snow	
9	Powder snow	
10	Granular snow	
11	Slush	
12	Wet	
13	Dry	

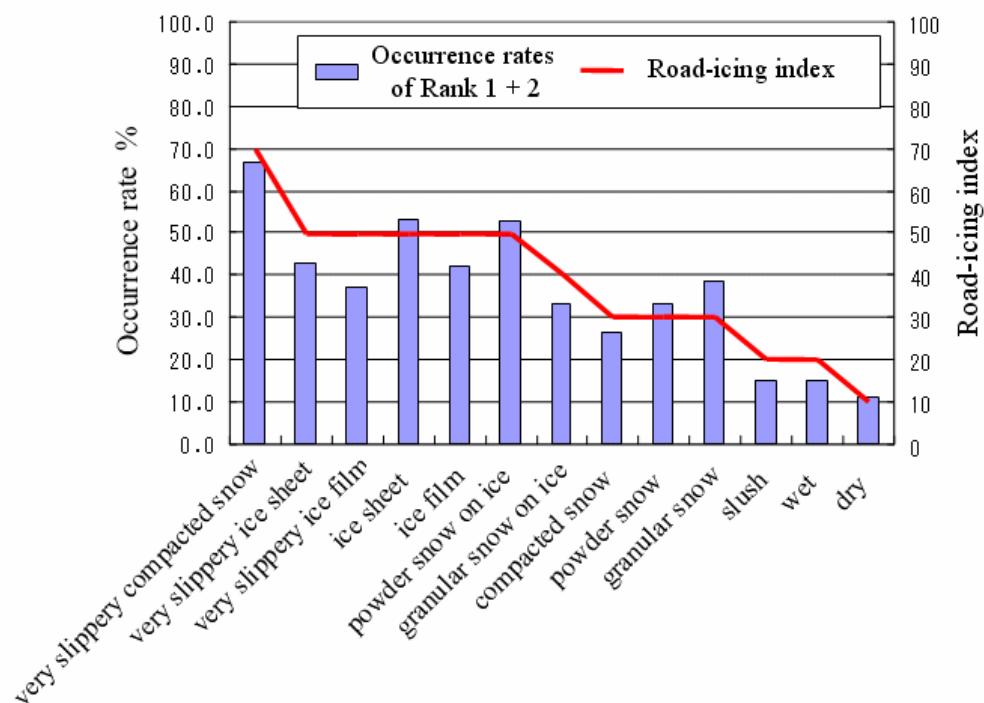

FIGURE 1 Occurrence rate of road surface slipperiness rank 1 + 2, and the road-icing index versus forecast surface condition.

Figure 2 shows the index for very slippery road surface emergence and the actual occurrence rates of such surface (Rank 1). When very slippery compacted snow is forecast, the index for very slippery road surface emergence is 50, but when powder snow is forecast the index is 0.

Snow Removal Support Guidance

To supply information that increases the effectiveness of snow removal operations, an investigation was made on how snow removal operation had been conducted. The relationship between the type of snow removal operations and the cumulative snowfall between those operations was analyzed. This provided a basis for examining snow removal support guidance.

Snow removal is done over an extended time period, so its operations need a plan that is more carefully worked out than that of anti-icing agent application operations. Snow removal operations should be started at around midnight, because heavy traffic makes it difficult to remove snow in the daytime. Snow removal operations take between 7 and 8 h to complete, and such operations should be finished before morning. Additionally, snow that accumulates both at night and during the day must be removed. Snow removal support information was evaluated to see whether it meets these conditions.

Snow removal operations are planned as follows: when it has snowed much in the daytime but little at night, it is possible to start the operation early and to apply anti-icing agent to prevent the surface from becoming slippery. However, when the forecast calls for snow to fall between night and early morning, snow removal is completed by early morning. The operations are intensified when the forecast calls for heavy snowfall.

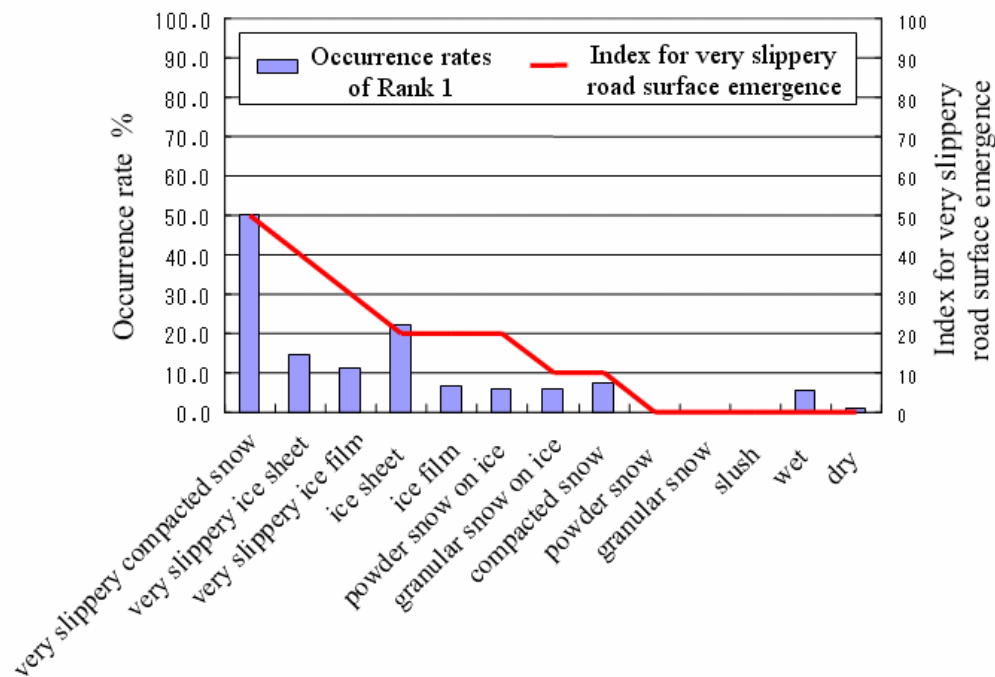

FIGURE 2 Occurrence rate of road surface slipperiness Rank 1 and the very slippery road surface occurrence index versus forecast surface condition.

To facilitate decision making on snow removal, snow removal support information was arranged from data on the cumulative snowfall during the immediate past 12 h before 18:00 (when support guidance is provided) and on the cumulative snowfall forecast for 18:00 to 0:00 and for 0:00 to 8:00. Figure 3 shows the relationship between snow removal operation hours and the cumulative snowfall during 6:00 to 18:00, 18:00 to 0:00, and 0:00 to 8:00, and Figure 4 shows a flowchart of snow removal support guidance. The text provided as guidance consists of weather information and operations expected to be necessary.

An example of the snow removal support guidance follows. When Rank 1 + Rank 2 ≥ 5 cm and Rank 3 ≥ 5 cm and Rank 2 + Rank 3 < 20 cm, the cumulative snowfall between 6:00 and 18:00 was 5 cm, and the cumulative snowfall forecast for 18:00 to 0:00 and 0:00 to 8:00 was 0 cm and 7 cm, respectively.

Heavy snow is forecast to fall at night. It is possible that snow removal operations will need to be repeated several times.

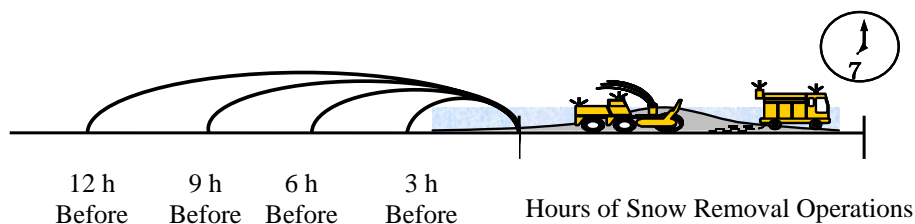

FIGURE 3 Relationship between snow removal operation hours and the cumulative snowfall from 6:00 to 18:00, 18:00 to 0:00, and 0:00 to 8:00.

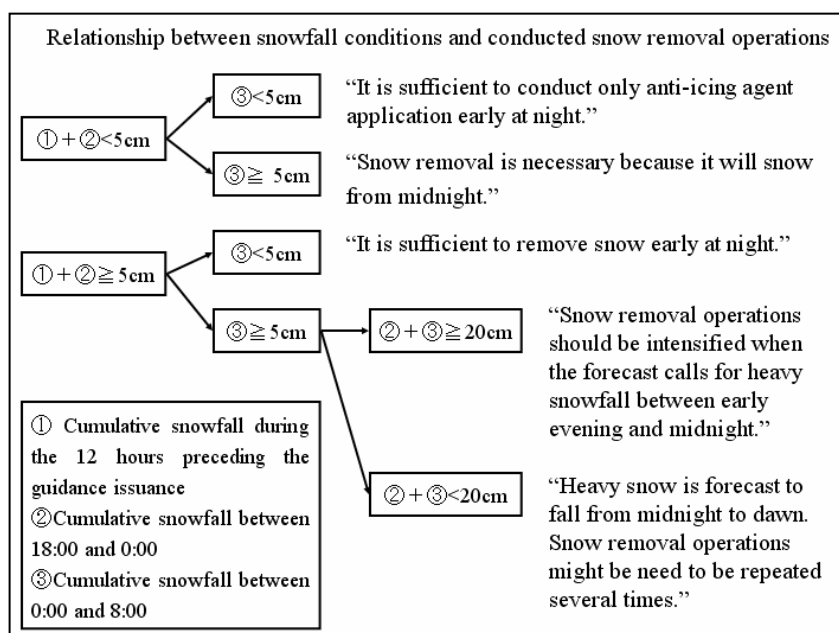

FIGURE 4 Flowchart of snow removal support guidance.

Guidance for Support of Anti-Icing Agent Application Operation

To supply information that helps to increase the effectiveness of anti-icing agent application operations, an investigation was made on how anti-icing agent has been applied. The relationship between anti-icing agent application operation and the road surface conditions was analyzed. This provided a basis for examining guidance for support of anti-icing agent application operation. Based on the surface conditions observed at 16:00 and also on cumulative snowfall forecast to fall between 0:00 and 8:00, anti-icing operation support takes the form of information on three levels of application: (a) a greater amount than the standard application amount; (b) slightly less than the standard application amount (i.e., spot application); and (c) less than the standard application (i.e., spot application at fewer sites than in b). The flowchart is shown in Figure 5.

The following is an example of guidance for support of anti-icing agent application operation when the surface condition observed at 16:00 is “compacted snow” and the forecast calls for 5 cm cumulative snowfall (0:00 to 8:00).

Information provision at 18:00 follows.

- The surface observed at 16:00 was “compacted snow.”
- It was forecast that the cumulative snowfall between 0:00 and 8:00 would be 5 cm.
- Without anti-icing agent application operations, the surface condition forecast for 0:00 was “compacted snow.”
- Without anti-icing agent application operations, the surface condition forecast for 8:00 was “very slippery.”
- It was forecast that snow would fall late at night, so application of anti-icing agents was necessary after plowing of fresh snow.

In comparison with the standard application amount of anti-icing agents (applied to the entire route in a shuttle operation), the application amount needs to be ⊙ = greater, ○ = slightly less or △ = less.			
*Cumulative snowfall between 0:00 and 8:00			
Surface conditions observed at 16:00	Snowfall ≤ 1cm	1cm ≤ Snowfall < 5cm	5cm ≤ Snowfall
Very slippery road surface	⊙	⊙	⊙
ice	⊙	⊙	⊙
Compacted snow	⊙	⊙	⊙
Loose snow	○	⊙	⊙
slush	○	○	○
wet	○	○	○
dry	△	○ ~ ⊙	○

FIGURE 5 Guidance for support of anti-icing agent application operation (flowchart).

- It was highly probable that anti-icing agents would be necessary for places other than priority application sections. Operations for anti-icing-agent application needed to be intensified based on the patrol report.

Trials of Advanced Winter Road Management Support System

Between January and March 2003, a prototype system was experimentally used by five snow removal contractors operating on national roads in Greater Sapporo. The system functions included weather forecast, road surface condition forecast, snow removal support guidance, guidance for support of anti-icing agent application operation, and an emergency notification system, toward supporting accurate decision making of winter road management in response to various weather conditions. The system is outlined in Figure 6.

Currently, road patrol is done on national highways at 8:00 and 16:00 to observe the road surface and weather conditions at 14 sites. The prototype system provided the support information described above via a website with regard to these 14 locations.

The emergency notification system automatically produces and sends out e-mails to users' cell phones or personal computers according to a preset emergency criterion of weather forecast, an observed value from road weather telemeters, or a road-icing forecast. This assists initial actions, and surveillance can be modified in response to sudden weather changes.

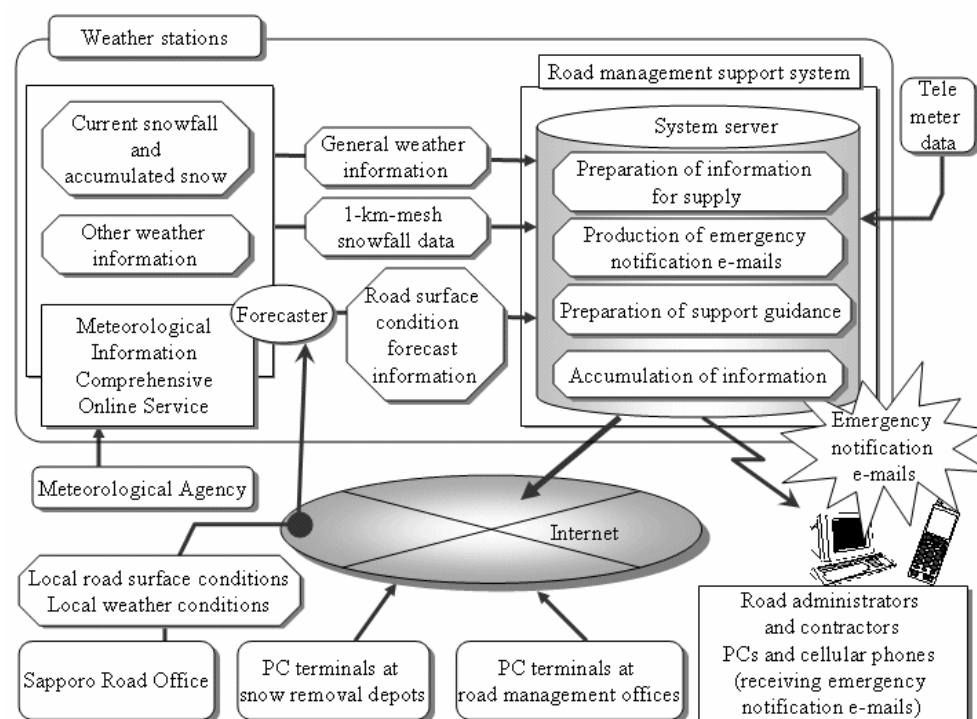

FIGURE 6 Flowchart of the advanced road management support system.

VERIFICATION OF ACCURACY OF SUPPORT INFORMATION

Verifying the Accuracy of Road Surface Condition Forecasts

The accuracy of road surface condition forecasts was verified by comparing the forecasts with the observed surface conditions in the period from January 27 to March 15, 2003. The data were compared between the surface conditions observed at 8:00 and the forecasted road surface conditions for both the cases of “with/without ice and snow control operations.” Although the surface conditions are divided into 13 types for both forecasts and observations, these were simplified into 3 ranks (Table 1). This rougher classification was sufficient for our purposes: verification of whether the necessity of ice and snow control operations was predicted accurately.

Based on the report of the road management operations compiled by the Sapporo Road Office, the days when ice and snow control operations were conducted and were not conducted were identified. Then, hit ratios were obtained as follow: when ice and snow control operations were done, the resulting road surface conditions were compared with the forecast road surface conditions that were forecast with ice and snow control operations; when ice and snow control operations were not conducted, the resulting road surface conditions were compared with the road surface conditions that were forecast without ice and snow control operations.

Figure 7 shows the hit rate at 14 forecast sites. The figure gives the forecast road surface conditions, the hit rate of the most probable forecast road surface conditions, as well as the hit rates of the most probable and the second most probable forecast road surface conditions. At most of the forecast points, the hit ratios were 60% to 70%, and the average ratio was almost 70%.

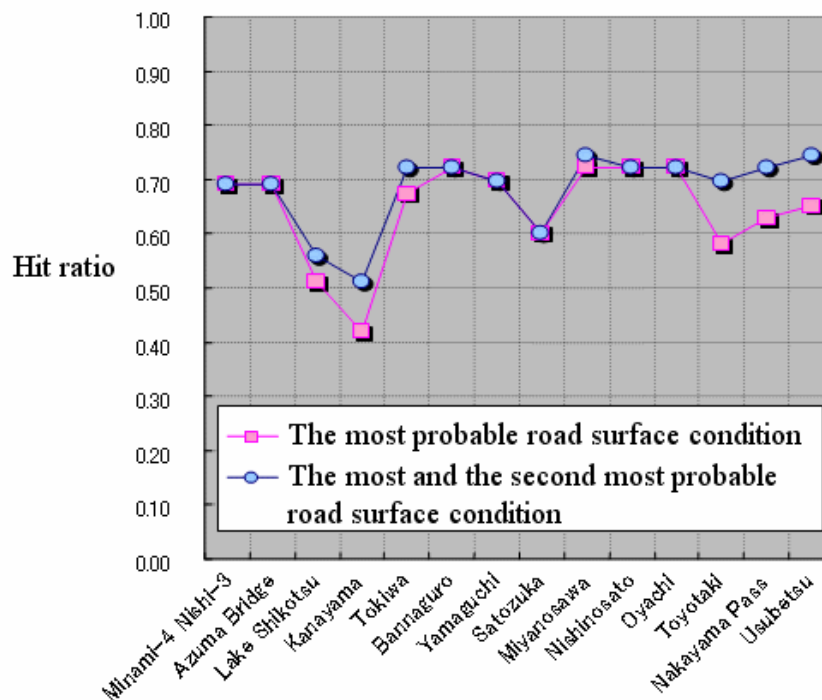

FIGURE 7 Hit ratios of road surface condition forecasts according to the three ranks of surface conditions.

One possible reason for the failed forecasts is that the forecast of cumulative snowfall used for forecasting surface conditions tended exceed the observed values. The forecasting logic used in the system to judge snowfall produces a forecast of “compacted snow” in most cases. In reality, however, there were many instances for which there was little or no snowfall and the observed surface conditions were not as bad as forecast. For example, when slippery road surface conditions of Rank 2 were forecast, the actual conditions were often Rank 3, or the surface for relatively comfortable traveling due to little snowfall. Additionally, it is necessary to take into account the fact that very few cases of “very slippery road surface” and “ice formation on road” were observed, because observations were done at 8:00 in the morning.

It is probable that the current ice and snow control operations and observation technique differ from those of the days when the relevant forecast technique was developed. To keep pace with such changes, improvement of the forecast technique needs to be updated.

Verifying Accuracy of Road-Icing Index and Index for Very Slippery Road Surface Emergence

The index for very slippery road surface emergence indicates the occurrence rate of very slippery road surface, and the road-icing index shows occurrence rate of either thick ice sheet or very slippery road surface. The accuracy was verified on the basis of all the road surface indices and the surface conditions observed at 8:00 at 14 sites between January 27 and March 15, 2003. In the verification, the roadside environment (topographic conditions) were divided into three types—flat urban, flat suburban, and mountainous (Table 2)—and the surface indices were divided into five ranks of 0–20, 20–40, 40–60, 60–80, and 80–100. The number of cases was counted for each rank, and the number and the occurrence rates of very slippery road surface or either very slippery road surface or thick ice sheet observed at 8:00 were also counted for each rank.

During the period under examination, in the mountainous area, very slippery road surface occurred only once; thus, most of the very slippery road surface indices fell in the rank of 0–20, corresponding to the observed values. The indices fell in the ranks of 20–40 and 40–60 144 times, but very slippery road surface did not appear. As for the road-icing index, because only a few occurrences of thick ice sheet were observed in the flat urban and flat suburban areas, the occurrence rate of thick ice sheet was also low in each rank. In the mountainous area, relatively many instances of thick ice sheet were observed, whereas very slippery road surface appeared once. The occurrence ratio of thick ice sheet in the rank of 0–20 was 30.4%. The ratio was quite high and greatly exceeded expected values for the rank.

As mentioned in the verification of the road surface condition forecasts, the forecast surface conditions were not observed sometimes partly because the observation data used for the verification were only those taken at 8:00. It is also presumed that the current road management technique used in flat urban and flat suburban areas differs from those used when the surface forecasts and various indices were developed. In the future, the logic used to forecast road surface conditions and the calculation indices should be updated to better suit the current situation. This will improve the accuracy of each index.

TABLE 2 Index for Very Slippery Road Surface Emergence, Road Icing Index, and Observed Surface Conditions

Roadside Environment (Topographic Conditions)	Index for Very Slippery Road Surface	Very Slippery Road Surface			Road Ice Index	Very Slippery Road Surface + Ice		
		1 No. of Times Conditions of This Rank Occurred	2 Occurrences	3 Occurrence Rate		1 No. of Times Conditions of This Rank Occurred	2 Occurrences	3 Occurrence Rate
Flat Urban Sections	0~20	191	0	0.0%	0~20	79	1	1.3%
	20~40	26	0	0.0%	20~40	107	8	7.5%
	40~60	34	0	0.0%	40~60	49	6	12.2%
	60~80	0	0	—	60~80	16	1	6.3%
	80~100	0	0	—	80~100	0	0	—
Flat Suburban Sections	0~20	137	0	0.0%	0~20	54	2	3.7%
	20~40	7	0	0.0%	20~40	77	3	3.9%
	40~60	24	0	0.0%	40~60	25	5	20.0%
	60~80	0	0	—	60~80	12	2	16.7%
	80~100	0	0	—	80~100	0	0	—
Mountainous Sections	0~20	113	1	0.9%	0~20	46	14	30.4%
	20~40	17	0	0.0%	20~40	63	14	22.2%
	40~60	36	0	0.0%	40~60	32	12	37.5%
	60~80	0	0	—	60~80	25	9	36.0%
	80~100	0	0	—	80~100	0	0	—
Total	0~20	441	1	0.0%	0~20	179	17	9.5%
	20~40	50	0	0.0%	20~40	247	25	10.1%
	40~60	94	0	0.0%	40~60	106	23	21.7%
	60~80	0	0	—	60~80	53	12	22.6%
	80~100	0	0	—	80~100	0	0	—

Evaluation of Advanced Winter Road Management Support System

After the trial operation of the Advanced Winter Road Management Support System, a questionnaire sheet was posted to the trial users. The questions focused on how useful the users found the information to be and on how they used the information. Responses from all 5 contractors were obtained, and these numbered 11. Regarding frequency of use, 7 respondents (64%) answered “Checked the provided information on some days, but not every day,” and 4 respondents (36%) answered, “Checked the provided information about once a day.”

The questionnaire also asked about the level of satisfaction with each item of the information provided via Internet and e-mail. The questions for each item included those regarding comprehensibility and usability of the provided information. Then the questionnaire asked for the overall level of satisfaction. The respondents answered according to a five-point scale of very satisfactory (5), satisfactory (4), somewhat satisfactory (3), somewhat unsatisfactory (2), and unsatisfactory (1). For each item, the percentages of these answers were used to calculate an average rating for the level of satisfaction (Table 3).

The level of satisfaction with the road-icing index was found to be 1.9 (somewhat unsatisfactory). Some respondents said that this index did not quite relate to the actual road conditions. The content and accuracy of the information needed to be reassessed. More than half the responses indicated that this index was necessary. As for road-icing index, some respondents

TABLE 3 Level of Satisfaction with the Provided Information

	Very Satisfactory (5)	Satisfactory (4)	Somewhat Satisfactory (3)	Somewhat Unsatisfactory (2)	Unsatisfactory (1)	Average
Road Weather Information	0	20	50	10	20	2.7
Snowfall mesh	0	10	70	20	0	2.9
National highway mesh	0	10	40	40	10	2.5
Road-icing index	0	0	30	30	40	1.9
Snow removal support guidance	0	0	50	40	10	2.4
Anti-icing agent application operation support guidance	0	0	40	40	20	2.2
Emergency notification e-mail	0	10	50	20	20	2.5
Total	0	50	330	200	120	2.4

said that snow removal support guidance and anti-icing agent application operation support guidance did not correspond to the real road conditions. They also needed to be revised to support snow removal.

The level of satisfaction was fair for road weather information (road surface, temperature, snowfall, wind, and other factors at a particular location), as well as for snowfall mesh (snowfall distribution on a plane basis). The emergency notification e-mails, the service in which e-mail is transmitted, had a low level of satisfaction. This low rating can be attributed to the small number of observation sites. More sites would make this service more useful.

Also, the system will become more usable if it is improved such that it better meets the needs of personnel in the field.

CONCLUSIONS

For winter road management, road weather and surface information is essential. In the questionnaire survey on the Advanced Winter Road Management Support System, nearly 90% of respondents said that road surface information and snowfall information are particularly important. During operations for snow and ice control, the patrol report is the most important information, but information from other media, such as TV and radio, is also used. The Internet enabled the construction of a system that provides offices with real-time weather information. This system is in use at many offices. For our system to provide effective support information the accuracy of the provided information needs to be improved and its content reexamined.

It is important to offer information at the start of snow removal operations. Information on the beginning, peak, and end times of snowfall can be of great assistance to snow removal operations. Personnel performing snow removal seem to have a great need for special information when heavy snowfall is forecast. The provision of real-time information is needed to

complement patrol reports. We must examine what types of information collected by the sensors of pertinent organizations can be made available.

Toward optimization of snow and ice control measures, necessary information must be compiled and continuously provided in a visually comprehensible manner. Upon completion, our system will enable quick and efficient road management, reduction of road management costs, and enhancement of the level of service for road users.

REFERENCES

1. Akitaya, E., and T. Yamada. Categorization of Snow and Ice on the Road by Visual Observation and Its Usage. *Proc., 10th International Symposium on Cold Region Development*, 1994, pp. 63–69.
2. Fukuzawa, Y., Y. Kajiya, and T. Kobayashi. Development of Road Freezing Forecast Method. *Proc., 52nd Annual Conference of Japan Society of Civil Engineers*, Part 4, IV-121, 1997, pp. 242–243.

WINTER WEATHER: INFORMATION, MODELS, AND DATA QUALITY

Guidelines for Snow and Ice Control Materials and Methods

ROBERT R. BLACKBURN

Consultant

DUANE E. AMSLER, SR.

AFM Engineering Services

KARIN M. BAUER

Midwest Research Institute

Snow and ice control strategies and tactics (S&Ts) that employ solid and liquid chemicals, abrasives, and mechanical methods—individually or in combination—have been used by many different highway agencies throughout the world. Research by the Strategic Highway Research Program, the Federal Highway Administration, the National Cooperative Highway Research Program and other organizations in the United States and other countries has addressed many of the issues associated with snow and ice control treatments. However, widely accepted guidelines for selecting level-of-service driven roadway S&Ts for specific weather, site, and traffic conditions have not been developed. Without this information, the process of selecting treatment S&Ts that meet highway agencies level of service objectives is difficult.

The results of a multiyear study conducted under NCHRP Project 6-13 are described. Five snow and ice control strategy and tactic combinations were tested and evaluated under various ranges of weather, site, and traffic conditions found in North America. A pavement ice condition index was developed for determining the overall effectiveness of a given snow and ice control strategy and tactic combination as well as effectiveness of within-storm and end-of-storm winter maintenance operations. The field test results were used to develop a set of guidelines for selecting roadway S&Ts for a range of winter maintenance operating conditions. The results were also used in developing snow and ice control material application rate guidelines.

INTRODUCTION

Research by the Strategic Highway Research Program (SHRP), FHWA, AASHTO, NCHRP, and other organizations in the United States and other countries has addressed many of the issues associated with snow and ice control treatments (1–4). However, widely accepted guidelines for selecting level-of-service (LOS) driven roadway strategies and tactics (S&Ts) for specific climatic, site, and traffic conditions have not been developed. Without this information, the process of selecting treatment S&Ts that meet highway agencies' LOS objectives is difficult.

This paper describes a set of guidelines for selecting roadway S&Ts for a wide range of climate, site, and traffic conditions found in the United States. These guidelines apply to both state and local highway agencies. The term “roadway” refers to any highway, road, street, or other paved surface that carries motor vehicles. The guidelines were developed under NCHRP

Project 6-13 from appropriate existing documentation plus data collected from field testing of selected S&Ts over multiple winters. Detailed information from that multiyear study is presented in the final report *Guidelines for Snow and Ice Control Materials and Methods* (5). For the purposes of this paper, S&Ts refer to the combination of material, equipment, and methods, including both chemical and physical, that are used in snow and ice control operations to achieve a defined LOS.

LEVEL OF SERVICE

LOS, in the context of roadway snow and ice control operations, is a set of operational guidelines and procedures that establish the timing, type, and frequency of treatments. The maintenance actions are directed toward achieving specific pavement condition goals for various highway sections. Examples of LOS for highways, roads, and streets under snow and ice control conditions are given in AASHTO's *Guide for Snow and Ice Control* (4). How highway agencies characterize LOS, how they assign LOS goals, and how they measure the performance of maintenance operations in achieving the LOS goals are very important topics.

LOS Goals

Highway agencies may use two fundamental approaches when assigning their LOS goals. The first is to evaluate existing resources and direct them toward providing a balanced LOS on a priority of treatment basis. This is the more common approach. The second approach is to assign pavement condition goals at certain times in a "design storm" of "X" inches of snow per hour to the various priority elements of the highway system. Using this, and production rate (lane-miles per hour) of equipment (including deadheading and reloading) in both the plowing and materials spreading modes, the necessary personnel and equipment can then be determined to provide the desired LOS.

When defining LOS goals, two time frames relative to a winter weather event should be considered:

- Within-winter weather event and
- After-end-of-winter weather event.

Higher LOS are associated with "better" within-event pavement snow and ice conditions (PSICs) and more rapid achievement of "better" or "bare" pavement conditions after the event ends.

A within-winter weather event LOS has two intertwined components: the amount of loose snow/ice/slush allowed to accumulate between plowing cycles and the condition of the ice/pavement interface in terms of bond and packed snow/ice.

The after-end-of-event LOS is usually expressed as a time to achieve particular pavement surface conditions in terms of ice or snow coverage, or PSIC level.

Performance-Based LOS

A variety of performance measures relative to LOS are being tried. These include (in order of popularity) pavement conditions (visual) at various points in time (some agencies use pictorial

reference templates as an aid to condition observers); performance indices that relate the amount of time pavement areas are snow/ice covered to total storm time (visual); report cards (customer satisfaction surveys); and friction measurements at various points in time and rating slipperiness at various points in time based on vehicle handling characteristics.

The visual approach appears to be gaining in popularity both in the U.S. and abroad. Examples of visual characterization of roadway surfaces include

- Centerline bare,
- Wheel path bare,
- Loose snow covered (percent area and depth),
- Packed snow covered (percent area and depth),
- Bare (percent area),
- Thin ice covered (percent area),
- Thick ice covered (percent area),
- Dry,
- Damp,
- Slush (percent area and depth),
- Frost, and
- Wet.

Using these descriptors together with traffic flow and other visual information, a PSIC index can be established for any point in time. Various PSIC indices are described in [Table 1](#).

Whatever performance measure is chosen, it must be part of a continuing evaluation plan that addresses individual winter weather events, subwinter seasons, and full winter seasons. This allows for critical judgment about resource levels, S&Ts, materials choices, and materials application rates.

Snow and Ice Control Operational Considerations Relating to LOS

The primary snow and ice control operational considerations relating to LOS are cycle time, available material treatments, climate, weather, site conditions, and traffic. Each has a profound effect on some aspect of operations.

Cycle time is primarily a function of the number of personnel and the amount of equipment available to treat the assigned roadway system or route. Other factors, including traffic volume or speed, traffic control devices, roadway geometry or complexity, and the location of material stockpiles, also contribute to achievable cycle time.

LOS and cycle time of maintenance treatment operations are clearly interconnected. The LOS and cycle time for a facility will largely be determined by the importance or functional classification of the road, which may be strongly related to the roadway's average daily traffic volume (4). High winter maintenance LOS requirements are often described as "bare pavement" policies. Anti-icing strategies with appropriate tactics have been shown to be consistent with the requirements of a high-LOS facility (2).

TABLE 1 Description of Pavement Snow and Ice Conditions (PSIC)

Condition 1: All snow and ice are prevented from bonding and accumulating on the road surface. Bare/wet pavement surface is maintained at all times. Traffic does not experience weather-related delays other than those associated with wet pavement surfaces, reduced visibility, incidents, and “normal” congestion.

Condition 2: Bare/wet pavement surface is the general condition. There are occasional areas having snow or ice accumulations resulting from drifting, sheltering, cold spots, frozen melt-water, etc. Prudent speed reduction and general minor delays are associated with traversing those areas.

Condition 3: Accumulations of loose snow or slush ranging up to 5 cm (2 in.) are found on the pavement surface. Packed and bonded snow and ice are not present. There are some moderate delays due to a general speed reduction. However, the roads are passable at all times.

Condition 4: The pavement surface has continuous stretches of packed snow with or without loose snow on top of the packed snow or ice. Wheel tracks may range from bare/wet to having up to 4 cm (1.5 in.) of slush or unpacked snow. On multilane highways, only one lane exhibits these pavement surface conditions. The use of snow tires is recommended to the public. There is a reduction in traveling speed with moderate delays due to reduced capacity. However, the roads are passable.

Condition 5: The pavement surface is completely covered with packed snow and ice that has been treated with abrasives or abrasive/chemical mixtures. There may be loose snow of up to 5 cm (2 in.) on top of the packed surface. The use of snow tires is required. Chains and/or four-wheel drive may also be required. Traveling speed is significantly reduced, and there are general moderate delays with some incidental severe delays.

Condition 6: The pavement surface is covered with a significant buildup of packed snow and ice that has not been treated with abrasives or abrasives/chemical mixtures. There may be over 5 cm (2 in.) of loose or wind-transported snow on top of the packed surface due to high snowfall rate and/or wind. There may be deep ruts in the packed snow and ice that may have been treated with chemicals, abrasives, or abrasives/chemical mixtures. The use of snow tires is the minimum requirement. Chain- and snow tire-equipped four-wheel drive is required in these circumstances. Travelers experience severe delays and low travel speeds due to reduced visibility, unplowed loose or wind-compacted snow, or ruts in the packed snow and ice.

Condition 7: The road is temporarily closed. This may be the result of severe weather (low visibility, etc.) or road conditions (drifting, excessive unplowed snow, avalanche potential or actuality, glare ice, accidents, vehicles stuck on the road, etc.).

The type of material treatments an agency is capable of delivering has a major impact on achievable LOS. Agencies capable of providing appropriate liquid and solid chemical treatment will achieve higher LOS than those who provide only mixtures of chemicals and abrasives or no material treatment at all.

Climate can be defined as the weather that occurs averaged over a specified period of time, normally 30 years. Climate is an issue that is primarily of importance in the planning phase of snow and ice control operations. LOS goals are to some extent climate driven in terms of what is and is not possible. S&Ts that support LOS goals are similarly climate driven. In any climate, the achievable LOS is limited by the rate of precipitation, cycle time capability, sustainability of the maintenance effort, site conditions that may cause road closure, and material options.

Field winter maintenance personnel in a given area are mostly concerned with anticipated winter weather conditions and not with climate considerations. “Weather” usually refers to the measurable or identifiable meteorological events that occur at a given site or in a given area at a particular point in time. Weather can be characterized by describing the meteorological elements associated with those events, for example, precipitation type and amount, visibility, wind speed and direction, temperature, and relative humidity or dew point.

Precipitation is arguably the most important weather condition. Equally important is the distribution of precipitation types associated with winter weather events. Winter maintenance forces need to be prepared to treat a wide variety of precipitation types, even within a given winter weather event.

The ability to forecast and recognize the various types of precipitation is extremely important. This influences to a large degree the types of treatment, material choice, and material application rate.

Site conditions are those local situations that impact how snow and ice control operations are conducted. They influence type of equipment needed, material choices and associated application rates, and type and sequence of maintenance treatment. Certain recurring site conditions (microclimates) are climate driven and require specific recurring operational responses. These include cold spots, high humidity locations, and persistent windy areas.

The three site conditions of major importance are pavement temperature, the amount of snow or ice remaining on the roadway after plowing or before chemical treatment, and most important, the presence or absence of ice or pavement bond.

Traffic considerations include those relating to operational difficulty (slow- and fast-moving traffic, stranded blocking vehicles, etc.), timing (rush-hour, congestion, etc.), and influences on treatment effectiveness and longevity.

Vehicular traffic can affect the pavement surface in several ways. Tires compact snow, abrade it, displace, or disperse it. Heat from tire friction, engine, and the exhaust system can add measurable heat to the pavement surface. Traffic can also result in applied chemicals and abrasives being blown from the pavement surface particularly when applied before precipitation. Thus, traffic can have both positive and negative influences on the effectiveness of snow and ice control operations.

SNOW AND ICE CONTROL STRATEGIES

Roadway snow and ice control strategies used in winter maintenance operations can be classified into six general categories:

- Anti-icing,
- Deicing,
- Mechanical removal of snow and ice together with traction enhancement,
- Mechanical removal alone,
- Traction enhancement, and
- Combinations of strategies.

Anti-icing is a snow and ice control strategy of preventing the formation or development of bonded snow and ice to a pavement surface by timely applications of a chemical freezing-point depressant. Tactics employed during anti-icing operations consist of chemical applications coordinated with plowing.

Deicing is a snow and ice control strategy of removing compacted snow or ice already bonded to the pavement surface by chemical or mechanical means or a combination of both.

Mechanical removal of snow and ice together with traction enhancement is a strategy in which abrasives or a mixture of abrasives and a chemical are applied to a layer of compacted snow or ice already bonded to the pavement surface that may or may not have been partially removed by mechanical means (plowing and scraping). This strategy provides an increase in the coefficient of friction for vehicular traffic, although this increase may be short lived. Abrasives, by themselves, are not ice control chemicals and will not support the fundamental objective of either anti-icing or deicing.

Mechanical removal alone is a strategy that involves the physical process of attempting to remove accumulated snow or ice by means such as plowing, brooming, blowing, and so on, without the use of snow and ice control chemicals. This strategy is strictly a physical process that has some merit during or after frozen precipitation has occurred at very low pavement temperatures.

Other techniques enhance the traction of snow and ice surfaces. For example, mechanical roughening, grooving, or texturing provides a small level of traction and directional stability enhancement. This technique, however, is not suitable for higher-volume roads as its effect is short lived, but may provide an option in environmentally sensitive areas with low traffic volume.

The most common technique for enhancing friction on a snow or ice surface is to apply abrasive materials such as sand, cinders, ash, tailings, and crushed stone. These materials may be applied straight or with varying amounts of ice control chemical in a mixture.

Traction enhancement's primary role is limited to lower-volume roads, to situations where ice control chemicals will not likely "work," and in environmentally sensitive situations in which the use of ice control chemicals must be limited.

Combinations of strategies are almost always used. Many winter weather events present a variety of weather and pavement conditions. To deal effectively with these changes, S&Ts need to be adapted.

Achieving stated LOS goals may require using different S&Ts during a single winter weather event. An example is where an agency wants a low within-winter weather event LOS

and a high LOS at or after the end of a winter weather event. In this case, the agency may initially do anti-icing with ice control chemical, use only mechanical removal techniques during the event, and utilize deicing at the end of the event. The early anti-icing treatment makes the later deicing treatment more effective.

A list was developed of ten potential combinations of S&Ts for further field evaluation, based on a literature review and telephone contacts with state and local highway agencies. Five of the ten snow and ice control strategy and tactic combinations were ultimately tested and evaluated during three winters under various ranges of weather, site, and traffic conditions found in North America. The five combinations are

1. Anti-icing strategy with appropriate chemical forms (e.g., solids, prewetted solids, and possibly liquids) on lower-volume primary highways and local roads followed by a subsequent strategy of mechanical removal of snow and ice together with friction enhancement, if necessary;
2. Anti-icing strategy with appropriate chemical forms (e.g., solids, prewetted solids, and liquids) at selected highway locations such as hills, curves, intersections, grades, or selected bridge decks;
3. Anti-icing or deicing strategy with appropriate chemical forms on lower-volume primary highways and local road systems;
4. Anti-icing strategy with liquid chemical applications on bridge decks to prevent preferential icing; and
5. Mechanical snow and ice removal strategy with abrasives prewetted with liquid chemicals.

A total of 24 highway agencies (13 state, 1 provincial, 4 county, and 6 city or town) made an attempt at testing the five S&T combinations at a total of 51 site locations over the three-winter period. Three highway agencies were able to provide test data for the same location over all three winters.

FACTORS INFLUENCING THE CHOICE OF MATERIALS, THEIR FORM, AND ASSOCIATED APPLICATION RATES

The major factors to consider when choosing a snow and ice control materials treatment are the dilution potential of chemical treatments and the performance characteristics of the materials.

Dilution Potential

“Dilution potential” is a term that relates precipitation, pavement conditions, pavement surface conditions, and operational conditions to the choice of snow and ice control material and application rate that will generally produce a “successful” result. For simplicity, dilution potential is divided into three levels: low, medium, and high.

Precipitation dilution potential is the contribution to overall dilution potential caused by the type and rate of precipitation of a winter weather event in progress. The higher the moisture content of the event per unit or time, the higher the dilution potential.

Pavement conditions are the properties of the pavement itself that influence snow and ice control operations. The most important of those is pavement surface temperature as it has a major effect on how ice control chemicals perform and ultimately, on the treatment decision itself. As pavement temperatures decline below about 12°F, most ice control chemicals become very inefficient in terms of the amount of ice melted per unit of chemical applied. Pavement temperature therefore drives the decision to plow only, plow and apply chemicals, or plow and apply abrasives (depending also on LOS goals). Unpaved or gravel roads are not suitable for chemical treatment.

Pavement surface conditions describe any accumulations of snow and ice that may remain on the pavement at the time of treatment (after plowing). These include loose snow, packed snow, and ice. A critical surface condition is whether the snow or ice is bonded to the pavement surface. Any remaining snow or ice on the roadway surface after plowing will cause chemical treatments to dilute more quickly (in addition to the dilution caused by precipitation). If the snow or ice is bonded to the pavement, considerably more chemical will need to be applied to achieve an unbonded condition.

The most important operational conditions influencing dilution potential are treatment cycle time and traffic. Longer cycle times allow more precipitation to accumulate on the roadway between treatments. For equivalent effectiveness, more chemical must be applied for longer cycle times.

The two traffic characteristics thought to influence dilution potential are traffic volume and traffic speed. Higher speeds and higher volume will displace ice control chemicals from the roadway.

Properties of Ice Control Materials

The four basic types of ice control materials are abrasives, solid ice control chemicals, prewet solid ice control chemicals, and liquid ice control chemicals.

Abrasives

Abrasives are a vital part of most snow and ice control programs. They support lower LOS and can provide at least some measure of traction enhancement when it is too cold for chemicals to work effectively. They are suitable for use on unpaved roads and on thick snow pack or ice surfaces that are too thick for chemicals to penetrate.

When mixed with enough ice control chemical, abrasives will support anti-icing and deicing strategies; however, this is very inefficient and costly as the abrasives for the most part are “going along for the ride” while the chemical portion of the mix is doing the “work.”

Solid Ice Control Chemicals

Solid ice control chemicals are a very popular treatment option for most highway maintenance agencies. They support high LOS and both anti-icing and deicing strategies. When anti-icing, they are most effective when applied early in a winter weather event, before ice or pavement bond has a chance to develop. Some snow, ice, or water on the pavement will minimize bouncing and scattering of the chemicals. They may be used as a pretreatment, but only when applied at traffic speeds under about 30 mph and traffic volumes under 100 vph.

Solid chemicals, particularly those with a coarser gradation or particle size distribution, are well suited to deicing operations. The larger particles are able to melt through snow and ice on the surface and continue to cause melting at the ice or pavement interface until the ice/pavement bond is broken and the snow and ice can be removed mechanically.

Prewet Solid Ice Control Chemicals

Prewet solid ice control chemicals are used like solid chemicals except they are generally not mixed with abrasives. They consist of solid ice control chemicals that have been coated with liquid ice control chemicals by a variety of mechanisms. The water in the liquid ice control chemical starts the process of allowing the solid chemical to generate brine more quickly than uncoated solid chemical. The coating also allows the solid chemical to stick better to the surface. This reduces bounce and scatter and accelerates deicing.

Liquid Ice Control Chemicals

Liquid ice control chemicals are generally a solution of solid ice control chemicals with water being the predominant component. They support high LOS and anti-icing and limited deicing strategies. They are particularly well suited to pretreating for anticipated frost, icing, or black ice situations. Here, the water evaporates, and the residual dry chemical is relatively immune to dispersal by traffic. Liquid chemicals are also used to pretreat roadways before a general snow or ice event. This is an effective way to initiate the anti-icing strategy.

Since liquid ice control chemicals are mostly water, they are already fairly well diluted. They are not well suited to general deicing operations as they have little ability to penetrate thick snow and ice. They may be used for limited deicing if the treatment is immediately followed by an application of solid chemicals or the process is reversed. This is a variation of prewetting.

Liquid chemicals are probably not a good choice at pavement temperatures below about 20°F. Here, the limited ice melting ability of most chemicals would make application rates excessive and potentially cause refreeze if the pavement were not dried by traffic or other atmospheric mechanisms.

Liquid chemicals, as a within-winter weather event treatment, should be limited to lower moisture content events, pavement temperatures above 20°F, and cycle times less than about 1.5 h. This will minimize the risk of ice/pavement bond formation. It is not advisable, however, to use liquid chemical during moderate or heavy snow, sleet, and freezing rain events.

At pavement temperatures higher than about 28°F, liquid chemicals are a very effective treatment for thin ice in the absence of precipitation. The ice-melting process in this situation is almost immediate.

LOS EXPECTATIONS FROM VARIOUS SNOW AND ICE CONTROL PRACTICES

In general, higher within-event LOS can be produced with an anti-icing strategy and relatively short operational cycle times of less than 1.5 h. As cycle times increase, there are opportunities for higher accumulations of snow and ice on the roadway before plowing and retreating. Thus, maintaining an unbonded pavement, snow, or ice interface becomes increasingly more difficult as cycle times increase.

For the purpose of the following discussion we will divide pavement condition LOS into three categories of low, medium, and high and relate them to PSICs that appear in Table 2 in the following way:

<u>Pavement Condition LOS</u>	<u>PSIC</u>
Low	5 and 6
Medium	3 and 4
High	1 and 2

With respect to after-event LOS, most agencies provide treatment until bare pavement is achieved. The measure of LOS then becomes the time, in hours, needed to reach a high LOS (a PSIC of 2 or 1). Again, for the purpose of this discussion, after-end-of-event LOS is divided into the three categories of low, medium, and high in the following way:

<u>After-Event LOS</u>	<u>Time (h) to Achieve a PSIC of 2 or 1</u>
Low	> 8.0
Medium	3.1-8.0
High	0-3.0

Table 2 shows the expected LOS levels achievable within- and after-winter weather events from various snow and ice control strategies and from tactics. These results were derived from the multiyear field tests of the five strategy and tactic combinations described earlier. It must be recognized that these are general approaches and changing conditions within an event often necessitated changes in S&Ts.

TABLE 2 Strategies and Tactics and LOS Expectations

Strategies and Tactics	<u>Within-Event LOS</u>			<u>After-Event LOS</u>		
	Low	Medium	High	Low	Medium	High
Anti-icing ^a			X			X
Deicing ^a	X	X		X	X	
Mechanical alone	X			X		
Mechanical and abrasives	X			X		
Mechanical and anti-icing ^a			X			X
Mechanical and deicing	X	X		X	X	
Mechanical and prewetted Abrasives	X			X		
Anti-icing ^a for frost/black ice/ icing protection			X			X
Mechanical and abrasives containing > 100 lb/lane-mile of chemical	X	X	X	X	X	X
Chemical treatment before or early in event, mechanical removal during event, and deicing at end of event	X				X	

^a With appropriate chemical treatments.

RECOMMENDED OPERATIONAL GUIDELINES FOR WINTER MAINTENANCE FIELD PERSONNEL

General recommended operational guidelines for winter maintenance field personnel are presented. The guidance focuses on the selection of appropriate snow and ice control materials and associated application rates for various combinations of operating conditions.

The snow and ice control materials include solid chemicals, liquid chemicals, prewetted solid chemicals, abrasives, abrasive and chemical mixtures, and prewetted abrasives including abrasive and chemical mixtures. Plowing and other mechanical removal methods are necessary to support LOS goals and allow material treatments to be more effective. If needed, plowing and other mechanical removal methods should precede any material applications so that excess snow, slush, or ice is removed and the pavement is left wet, slushy, or lightly snow covered when treated.

The guidance presented is based upon the results of three winters of field testing various S&T combinations by 24 highway agencies. These results are reported in NCHRP No. 6-13 *Guidelines for Snow and Ice Control Materials and Methods* (5).

Solid Ice Control Chemicals

Solid ice control chemicals serve a number of functions in snow and ice control operations. They are used in anti-icing, in deicing, in mixing with abrasives, and in the production of liquid ice control chemicals.

Anti-Icing with Solid Ice Control Chemicals

Solid chemicals, used for many years in anti-icing operations, are typically applied early in an event before ice/pavement bond forms and then periodically throughout the event. The first application is made when there is just enough precipitation on the roadway to minimize bounce and scatter and displacement by traffic.

Dry solid chemicals can be used to pretreat roadways before a snow or ice event if applied at traffic speeds below 30 mph and with traffic volume less than about 100 vph. Prewetting a solid chemical before spreading can improve its effectiveness and help the granules adhere better to the road surface. In practice it has been found that 10 to 12 gallons of a NaCl solution will be sufficient for 1 ton of dry chemical of coarse gradation (2). Some agencies have used two to three times this quantity so that the material is applied as a slurry to reduce losses by traffic action. Prewetted finer gradations of a solid chemical will also adhere better to the road surface and may be successfully applied at traffic speeds below 40 mph and with traffic volumes below about 250 vph.

Deicing with Solid Ice Control Chemicals

With the exception of very thin ice situations, solid chemicals are the most effective treatment for packed or bonded snow and ice. Prewetting dry solid chemical with a liquid ice control chemical further enhances performance. Coarser graded chemicals do a better job of deicing thicker snow and ice accumulations.

Mixing Solid Ice Control Chemicals with Abrasives

The mixing of solid chemicals with abrasives has been a popular practice for many years, mostly to keep stockpiles of abrasives from freezing or chunking. The amount of chemicals in stockpiles is usually less than 10% by weight.

Liquid Ice Control Chemicals

Liquid chemicals serve a number of functions in snow and ice control operations. They are used to prewet solid ice control chemicals, abrasives, and abrasive or solid chemical mixtures to make those applications more effective. Liquid chemicals are used to pretreat and treat colder highway spots for frost, black ice, and localized icing. They are used as a pretreatment for general storms to facilitate higher LOS in the initial storm phase and to buy time until treatments with solid chemicals can be made. They may be used also as a treatment within certain low-moisture winter weather events. Liquid chemicals should generally not be used for freezing rain and sleet events or as a treatment when pavement temperatures are expected to fall below about 20°F during the period of treatment effectiveness.

Prewetting with Liquid Ice Control Chemicals

Most commercially available liquid ice control chemicals can be used for prewetting solid ice control chemicals, abrasives, and abrasive or solid chemical mixtures. The primary function of the liquid in prewetting is to provide the water necessary to start the brine generation process for the solid chemicals. When used on abrasives, they help them adhere to the ice surface and provide some ice control chemical to the roadway that may at some point improve LOS. Organic-based chemicals provide some corrosion protection properties and environmental friendliness.

Pretreating and Treating Frost, Black Ice, and Icing with Liquid Chemicals

This tactic provides arguably the best use of liquid ice control chemicals. A 23% solution of liquid NaCl applied at 40 to 60 gal/lane-mi (or equivalent effective amount of other chemical) has proven to provide protection from these conditions that are nonprecipitation events. In the absence of precipitation, these treatments are effective for at least 3 days and possibly up to 5 days depending on traffic volume. If the liquid treatment is allowed to dry before the event, it will be slightly more effective.

Treating frost, black ice, and icing that has already occurred with liquid chemicals is an excellent tactic. Using application rates for NaCl found in the next section for a low adjusted dilution potential and bonded condition will provide almost immediate results.

Pretreating and Treating General Snow and Ice Events with Liquid Chemicals

The use of liquid chemicals during general snow and ice events requires more caution and information in order to achieve satisfactory results. Liquid chemicals are more sensitive to pavement temperature, dilution, and ice or pavement bond than solid chemicals. Analytical results were generated during the study to define the time to freeze of chemical brines as a

function of application rate, pavement temperature, and rate and moisture content of precipitation.

Relationships Between Time to Freeze of a Chemical Brine and Controlling Variables

The nature of the relationships between the time to freeze of a chemical brine and the controlling variables can be summarized as follows:

- The time to freeze increases linearly with chemical application rate for a given pavement temperature and rate of precipitation;
- The time to freeze decreases nonlinearly with increasing rate of precipitation for a given chemical application rate and pavement temperature; and
- The time to freeze decreases nonlinearly with decreasing pavement temperature for a given chemical application rate and rate of precipitation.

Sample plots of the time to freeze of liquid NaCl versus snowfall precipitation rates in terms of meltwater equivalent (WE) in inches per hour and snowfall rate in inches per hour were generated to illustrate the second point above. The times to freeze for a 23% concentration of NaCl versus snowfall rate are presented in Figures 1 and 2. An application rate of 100 lb/lane-mi equivalent dry NaCl was used in both figures. Figure 1 applies to a pavement temperature range

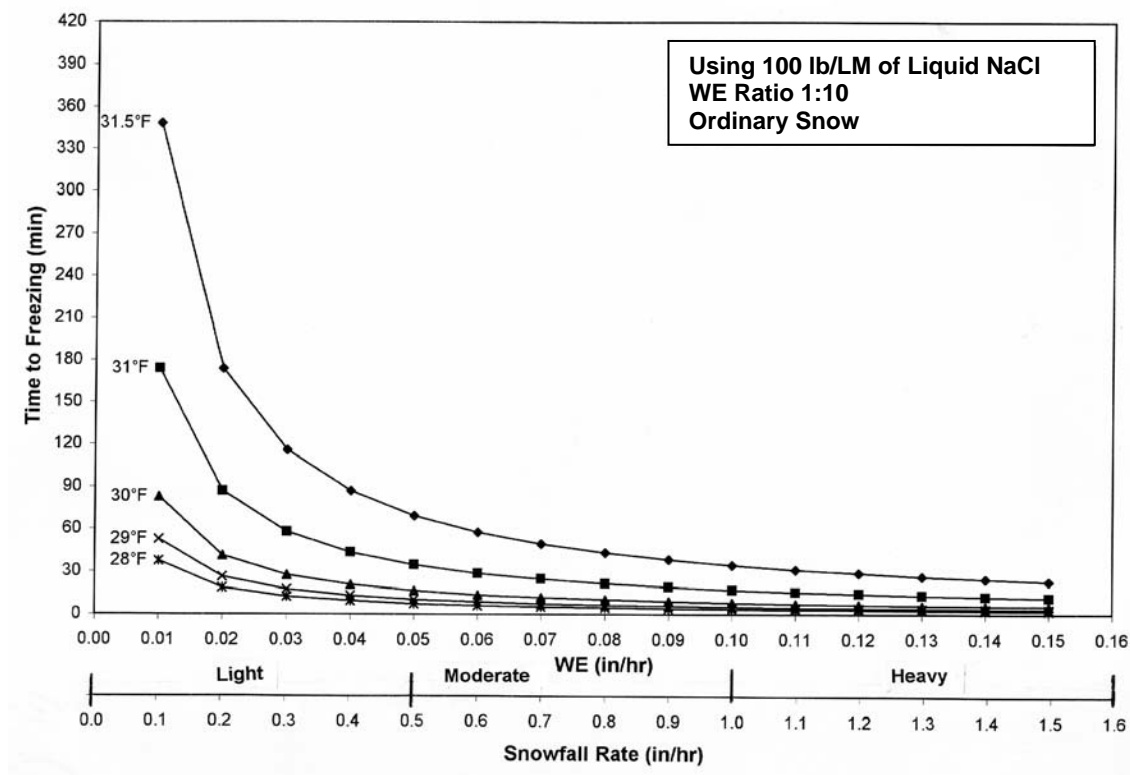

FIGURE 1 Time to freezing versus WE/snowfall rate for a pavement temperature range of 28°F to 31.5°F using liquid 23% concentration NaCl.

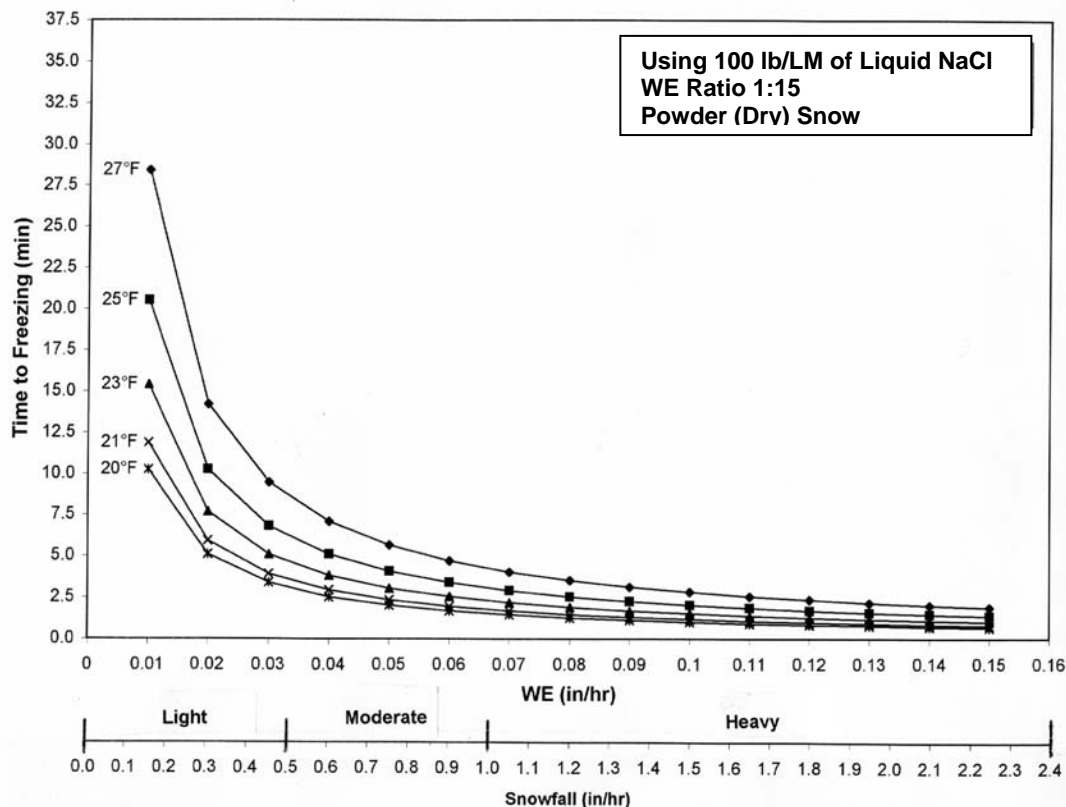

FIGURE 2 Time to freezing versus WE/snowfall rate for a pavement temperature range of 20°F to 27°F using liquid 23% concentration NaCl.

of 28°F to 31.5°F. Figure 2 applies to a pavement temperature range of 20°F to 27°F.

Figures 1 and 2 clearly show the limiting role that liquid chemicals play in snow and ice control operations as the pavement temperatures drop and application rates associated with anti-icing are used. The role of liquid chemicals for a given pavement temperature also diminishes as the snowfall rate increases.

Applying Liquid Chemicals to Roadway Surfaces

Liquid chemicals are usually applied to the highway with spray bars or spinners. Spray bars may simply have holes in them or nozzles having various spray patterns. When using chemicals other than liquid NaCl, it is recommended that streamer or pencil nozzles or just holes in the spray bar be used to apply strips of chemical to the surface. The spacing of nozzles or holes should be in the range of 8 in. In rare circumstances, using a liquid chemical has resulted in slippery conditions in the absence of precipitation or freezing pavement temperature.

Abrasives

The primary function of abrasives is to provide temporary traction (friction) improvement on snow and ice surfaces. Note that snow- and ice-covered roadways that have been treated with abrasives provide friction values that are far less than bare or wet pavement. The application rate for abrasives varies considerably among maintenance agencies. Application rates for most agencies fall within the 500 lb/lane-mi to 1,500 lb/lane-mi range with the overall average centering around 800 lb/lane-mi.

SNOW AND ICE CONTROL CHEMICAL APPLICATION RATES

A recommended step-by-step procedure is presented that winter maintenance field personnel can follow in determining an appropriate snow and ice control chemical treatment action to take in response to a variety of conditions. Appropriate application rates for solid, prewetted solid, and liquid NaCl are given as a function of pavement temperature range, adjusted dilution potential level, and the presence or absence of ice and pavement bond. The adjusted dilution potential level accounts for precipitation type and rate, snow and ice conditions on the road, and treatment cycle time and traffic volume conditions. The recommended snow and ice control material application rates depend on atmospheric and pavement conditions at the time of treatment and on how these conditions are expected to change over the time window prior to the next anticipated treatment.

Implicit in the treatment guidelines is the requirement that plowing, if needed, should be performed before chemical applications are made. This is necessary so that any excess snow, slush, or ice is removed and the pavement surface is wet, slushy, or lightly snow covered when treated.

The first step in the procedure is to determine the pavement temperature at the time of treatment and the temperature trend after treatment. A judgment, either estimated or predicted by modeling techniques, of what the pavement temperature will be in the near term (1 to 2 h after treatment) is necessary. This is one aspect of what is commonly called “nowcasting.” This will result in the determination of the pavement temperature and trend.

The next step is to establish the dilution potential that a chemical treatment must endure before another treatment is made during a winter weather event, or produce a satisfactory result in the absence of precipitation at the end of an event. The establishment of the dilution potential for each treatment includes consideration of precipitation type and rate (including none), precipitation trend, the presence of various wheel path area conditions, treatment cycle time, and traffic speed and volume.

The dilution potential for the precipitation at the time of treatment and its anticipated trend in the short term is determined from [Table 3](#). The level of precipitation dilution potential will be either low, medium, or high. The definitions of the different types and rates of snowfall are given elsewhere (5). In the absence of precipitation, the dilution potential is determined from the wheel path area condition and is also shown in [Table 3](#).

In the next step, an adjustment to the precipitation dilution potential shown in [Table 3](#) may have to be made for various wheel path area conditions. These adjustments are given in [Table 3](#) as well.

Next, an additional adjustment to the precipitation dilution potential may have to be made for treatment cycle time. This is the time between anticipated successive treatment passes. In the case of pretreating, it is the time between the onset of precipitation and the next anticipated treatment. These adjustments are given in [Table 3](#).

TABLE 3 Precipitation Dilution Potential and Its Adjustments

Precipitation Type	Precipitation Rate			
	Light	Moderate	Heavy	Unknown
1. Snow (powder)	Low	Low	Medium	Low
2. Snow (ordinary)	Low	Medium	High	Medium
3. Snow (wet/heavy)	Medium	High	High	High
4. Snow (unknown)	—	Medium	—	—
5. Rain	Low	Medium	High	Medium
6. Freezing rain	Low	Medium	High	Medium
7. Sleet	Low	Medium	High	Medium
8. Blowing snow	—	Medium	—	—
9. Snow with blowing snow		(Same as type of snow)		
10. Freezing rain with sleet	Low	Medium	High	Medium
11. None				
If wheel path area condition is				
– Dry or damp		Not applicable		
– Wet		Low		
– Frost or black ice (thin ice)		Low		
– Slush or loose snow		Medium		
– Packed snow or thick ice		High		
Adjustments to Precipitation Dilution Potential				
a. Wheel path area condition when precipitation is present		Increase precipitation dilution potential above by number of levels		
Bare		0		
Frost or thin ice		0		
Slush, loose snow, packed snow, or thick ice		1		
b. Cycle time				
0–1.5 h		0		
1.6–3.0 h		1		
Over 3.0 h		2		
c. Traffic volume at traffic speeds > 35 mph				
Less than 125 vph		0		
More than 125 vph		1		

Finally, an adjustment to the precipitation dilution potential may have to be made for traffic speeds greater than 35 mph and traffic volume greater than 125 vph. These adjustments are also given in Table 3. No adjustment is made for traffic volume when traffic speeds are 35 mph or below.

When making additional level adjustments to the precipitation dilution potential, an adjustment level of 1 would change a low level to a medium level or a medium level to a high level. An adjustment level of 2 would change a low level to a high level. The end result of adding various factor adjustment levels to the precipitation dilution potential is termed “adjusted dilution potential.” The final adjusted dilution potential level cannot exceed “high.”

The final step in the procedure is to make a judgment of whether an ice or pavement bond condition exists. This determination (yes or no) is made based on field observations or sensor data.

The appropriate application rates for solid, prewetted solid, and liquid NaCl can then be determined from Table 4 using the results from the previously described steps.

Analytical work was conducted to develop application rate data for calcium chloride (CaCl₂), magnesium chloride (MgCl₂), potassium acetate (KAc), and calcium magnesium acetate (CMA), that were normalized with respect to the application rate data for NaCl. The application rate data for each of the five chemicals are given in Table 5 for various pavement temperature ranges.

TABLE 4 Application Rates for Solid, Prewetted Solid, and Liquid Sodium Chloride

Pavement Temperature (°F)	Adjusted Dilution Potential	Ice Pavement Bond	Application Rate	
			Solid (1) lb/LM	Liquid (2) gal/LM
Over 32	Low	No	90 (3)	40 (3)
		Yes	200	NR (4)
	Medium	No	100 (3)	44 (3)
		Yes	225	NR (4)
	High	No	110 (3)	48 (3)
		Yes	250	NR (4)
30–32	Low	No	130	57
		Yes	275	NR (4)
	Medium	No	150	66
		Yes	300	NR (4)
	High	No	160	70
		Yes	325	NR (4)
25–30	Low	No	170	74
		Yes	350	NR (4)
	Medium	No	180	79
		Yes	375	NR (4)
	High	No	190	83
		Yes	400	NR (4)
20–25	Low	No	200	87
		Yes	425	NR (4)
	Medium	No	210	92
		Yes	450	NR (4)
	High	No	220	96
		Yes	475	NR
15–20	Low	No	230	NR
		Yes	500	NR
	Medium	No	240	NR
		Yes	525	NR
	High	No	250	NR
		Yes	550	NR
10–15	Low	No	260	NR
		Yes	575	NR
	Medium	No	270	NR
		Yes	600	NR
	High	No	280	NR
		Yes	625	NR
Below 10°F	A. If unbonded, try mechanical removal without chemical.			
	B. If bonded, apply chemical at 700 lb/L-M. Plow when slushy. Repeat as necessary.			
	C. Apply abrasives as necessary.			

NR = not recommended; LM = lane-mile.

Specific notes:

1. Values for “solid” also apply to prewet solid and include the equivalent dry chemical weight in prewetting solutions.
2. Liquid values are shown for the 23-percent concentration solution.
3. In unbonded, try mechanical removal without applying chemicals. If pretreating, use this application rate.
4. If very thin ice, liquids may be applied at the unbonded rates.

General notes:

5. These application rates are starting points. Local experience should refine these recommendations.
6. Prewetting chemicals should allow application rates to be reduced by up to about 20% depending on such primary factors as spread pattern and spreading speed.
7. Application rates for chemicals other than sodium chloride will need to be adjusted using the guidance in Table 5.
8. Before applying any ice control chemical, the surface should be cleared of as much snow and ice as possible.

TABLE 5 Equivalent Application Rates for Five Ice Control Chemicals

Temperature Range (°F)	NaCl		CaCl ₂		MgCl ₂		KAc		CMA	
	23%		32%		27%		50%		25%	
	Solid	Liquid	Solid	Liquid	Solid	Liquid	Solid	Liquid	Solid	Liquid
	lb/LM	gal/LM	lb/LM	gal/LM	lb/LM	gal/LM	lb/LM	gal/LM	lb/LM	gal/LM
30–32	50	22	56	16	47	17	79	15	82	35
	100	44	111	32	94	33	158	30	164	70
	150	66	167	47	141	50	237	44	246	105
	200	87	222	63	188	66	316	59	328	140
	250	109	278	79	235	83	395	74	410	174
28–30	50	22	53	15	45	16	75	14	85	36
	100	44	106	30	90	32	150	28	169	72
	150	66	159	45	135	48	225	42	254	108
	200	87	212	60	180	64	300	56	338	144
	250	109	265	75	225	80	375	70	423	180
26–28	50	22	51	14	43	15	71	13	87	37
	100	44	102	29	86	30	142	27	174	74
	150	66	153	43	129	46	213	40	261	110
	200	87	204	58	172	61	284	53	348	148
	250	109	255	72	215	76	355	66	435	185
24–26	50	22	49	14	41	14	67	13	90	38
	100	44	98	28	87	29	134	25	179	76
	150	66	147	42	123	43	201	38	269	114
	200	87	196	56	164	58	268	50	358	152
	250	109	245	70	205	72	335	63	448	191
22–24	50	22	47	13	39	14	63	12	92	39
	100	44	94	27	78	28	125	23	184	78
	150	66	141	40	117	41	188	35	276	117
	200	87	188	53	156	55	250	47	368	157
	250	109	235	67	195	69	313	59	460	196
20–22	50	22	45	13	37	13	59	11	95	40
	100	44	89	25	74	26	117	22	189	80
	150	66	134	38	111	39	176	33	284	121
	200	87	178	51	148	52	234	44	378	161
	250	109	223	63	185	65	293	55	473	201

NaCl: Sodium chloride

CaCl₂: Calcium chlorideMgCl₂: Magnesium chloride

KAc: Potassium acetate

CMA: Calcium magnesium acetate

LM: Lane mile

CONCLUSION

A pavement snow and ice condition (PSIC) index was developed to evaluate the effectiveness of snow and ice control strategies and tactics. The index was used to evaluate both within-event and end-of-event LOS achieved by winter maintenance treatments. Field test results were also used in developing snow and ice control material rate guidelines that apply to both state and local highway agencies engaged in snow and ice control operations on highways, roads, and streets. Appropriate application rates for solid, prewetted solid, and liquid NaCl were developed as a function of pavement temperature range, adjusted dilution potential level, and the presence or absence of ice or pavement bond. The adjusted dilution potential level accounts for precipitation type and rate, snow and ice conditions on the road, and the treatment cycle time and traffic volume conditions. Application rates for four other snow and ice control chemicals were developed from analytical work.

ACKNOWLEDGMENTS

The work reported in this paper was conducted under NCHRP Project 6-13. Dr. Amir N. Hanna was the NCHRP senior program officer.

REFERENCES

1. Blackburn, R. R., E. McGrane, C. C. Chappelow, D. W. Harwood, and E. J. Fleege. *Development of Anti-Icing Technology*. Report SHRP-H-385, TRB, National Research Council, Washington D.C., 1994.
2. Ketcham, S., L. David Minsk, R. Blackburn, and E. Fleege. *Manual of Practice for an Effective Anti-icing Program: A Guide for Highway Winter Maintenance Personnel*. Report FHWA-RD-95-202. FHWA, U.S. Department of Transportation, 1996.
3. Ketcham, S., L. David Minsk, and L. Danyuk. *Test and Evaluation Project 28, Anti-Icing Technology*. Field Evaluation Report. U.S. Army Cold Regions Research and Engineering Laboratory, Hanover, New Hampshire, 1996.
4. *Guide for Snow and Ice Control*. AASHTO, 1999.
5. Blackburn, R. R., K. M. Bauer, D. E. Amsler, S. E. Boselly, and A. D. McElroy. *Guidelines for Snow and Ice Control Materials and Methods*. Final Report of NCHRP Project 6-13. Midwest Research Institute, Kansas City, Missouri, 2002.

WINTER WEATHER: INFORMATION, MODELS, AND DATA QUALITY

Finnish Road Administration's Web Road Weather Project**KIMMO TOIVONEN****JOUKO KANTONEN***Finnish Road Administration*

The Finnish road weather information system has been gradually developed into an aid to winter maintenance. Recently, winter maintenance of the road network, especially in commissioning of maintenance, has undergone major changes in Finland. Winter maintenance is being opened to competition, and the goal is that by the end of 2004 winter maintenance on all the public roads in Finland will be done by contractors selected through a bidding process. The new method of operation put pressure on the Finnish road weather information system (RWIS). It became necessary to make the RWIS and the information it contains available to all the contractors doing winter maintenance as easily and reliably as possible. To satisfy this need, a Web Road Weather project was started in the beginning of 2000, which resulted in a new web-based application for users of road weather information.

Technically the web server retrieves the information desired by the user application from the database and image product servers and sends it to the user. Thus, the user does not have a direct connection to the Finnish Road Administration's data banks. Web Road Weather is part of the Finnish Road Administration's extranet solution. The extranet provides user identification and better information security. The user and the user's Web Road Weather application communicate only with a separate extranet server. The extranet server sees the Road Weather web services as its own and provides them as its own services to identified users with the correct user rights.

With this new application it is possible to monitor ten different kinds of weather images, camera images from 240 road weather cameras, and road weather information from 320 road weather stations. The application is currently being used by both the Finnish Road Administration and external contractors. Total user amount is already almost 300.

INTRODUCTION

Since the 1970s, the Finnish road weather information system has been gradually developed into an aid to winter maintenance. Recently, winter maintenance of the road network, especially in commissioning of maintenance, has undergone major changes. The former Finnish National Road Administration (Finnra) has been divided into the Finnish Road Administration (also Finnra), which takes care of administrative tasks, and the Finnish Road Enterprise, which does contracting. Winter maintenance is being opened to competition, and the goal is that by the end of 2004 winter maintenance on all the public roads in Finland will be done by contractors selected through a bidding process. The new method of operation put pressure on the road weather system. It became necessary to make the road weather system and the information it contains available to all the contractors doing winter maintenance as easily and reliably as

possible. To satisfy this need, a Web Road Weather project was started in the beginning of 2000 and resulted in a new web-based application for users of road weather information.

BRIEF HISTORY OF ROAD WEATHER INFORMATION

From the late 1970s on, road weather service systems have been developed to aid winter maintenance in various parts of Europe. Finland has actively participated in this development work right from the beginning. Testing of a road weather system began in Finland in the early 1980s. The system proved to be beneficial, and in 1987 Finnra assumed primary responsibility for the development of the system. At the same time, development of the system was speeded up significantly.

The first microcomputer-based road weather system was taken into use in parts of Finland at the end of the 1980s, at which time 66 road weather stations were in use. In 1990 the central stations that gathered information were converted into Unix-based systems. With this change the entire country has been included in the system since 1992. The first road weather cameras were put into use the same year. The number of road weather stations grew rapidly; in the winter of 1994–1995 there were already 200 road weather stations.

The next major steps to improve the usability of the system were taken in the middle of the 1990s. An Image Product application was introduced in the beginning of 1995, which made it possible to monitor images of the weather and driving conditions. During the following year, storage of road weather information was centralized in one database server that covered the entire country. A Road Weather Windows workstation application and a new data collection application for the WindowsNT operating system were put into use in 1997. Both applications have been developed further since then.

In 2000, Finnra needed to acquire a new road weather application that would enable viewing of a wide range of images of weather and driving conditions and monitoring of conventional road weather information. The application also needed to be easily applied as a tool for external contractors.

MOVE TO A MULTIPLE CONTRACTOR MODEL

In the early 1990s, winter maintenance was solely the job of Finnra. At first, road master areas in the districts took care of winter weather monitoring and winter maintenance quite independently, but as the road weather system evolved, monitoring began to be centralized. The districts' weather centers monitor the weather, driving conditions, and changes in conditions and, if necessary, alert supervisors to take charge of maintenance work.

In 1994 the first regional contract handled by an external contractor was implemented as a pilot project in the Kirkkonummi area. The following year pilot projects were set up in the areas of Loppi and Luopionen. In 1998 the maintenance of five areas for the following 3 years was subjected to actual bidding. Five additional areas were subjected to bidding the year after.

Area bidding contests were suspended for a year because of the operational separation implemented at Finnra in 2000, but when Finnra was divided into the Finnish Road Administration and the Finnish Road Enterprise, 23 areas were subjected to bidding in 2001. The contractors that were chosen had overall responsibility for maintenance of the road network and

the traffic surroundings. Contracts that were not included in the bidding are being implemented as negotiated contracts with the Finnish Road Enterprise.

Twenty-five to 30 new areas per year will be subjected to bidding in 2002–2004, so by the end of 2004 all 100 areas in Finland will be maintained by contractors chosen on the basis of competitive bidding.

While previously there was only one maintenance agency, in the winter of 2003–2004 there are already eight. A couple of years from now there will most likely be a few more.

When winter maintenance was taken care of within Finnra, it was quite straightforward to arrange the installation and use of the road weather system for its users. Now that Finnra and the Finnish Road Enterprise have been separated and several other entrepreneurs have also begun to take care of winter maintenance, road weather information, road weather forecasts, images of weather and driving conditions and other related information need to be easily accessed and viewed also outside Finnra. This requirement introduced new challenges to the technical architecture of the road weather system.

Today, Internet and extranet-based systems are one solution for making it easy to distribute applications and information between different companies and their telecommunications networks.

CONVENTIONAL DISTRIBUTION OF ROAD WEATHER INFORMATION

Finland's road weather system is a typical client/server application. Users' workstations are located in a fixed telecommunications network. A road weather application in the workstation queries a database for information, and the database sends the requested information to the workstation that asked for it. The information is presented in graphical form in the workstation's road weather application. The application functions well and its response times are very short. The system has a centralized database for road weather information. On the basis of user feedback, the application is very easy to use, but its technical architecture is not the best possible in light of Finnra's present operating idea, where several different contractors take care of winter maintenance.

PROBLEMS WITH "OLD" SYSTEM IN MULTIPLE CONTRACTOR ENVIRONMENT

Fixed Network Address/Connection

The old road weather system requires a user (contractor) outside the Finnish Road Administration to have a fixed network address, which in Finland typically means the telecommunications connection must be fixed. A fixed network connection with a fixed network address is usually a more costly solution than a connection in which the network address is retrieved each time a connection is made. Finland offers very inexpensive, quick Internet connection modes in which the network address may change each time a connection is made. For example, a generally available ADSL connection with a bit rate of 512 kbit/s costs €50 to €90 (\$60 to \$100) a month.

Local Installation

The application must always be installed locally: thus version updates, configuration, and troubleshooting are more difficult. The old road weather application always requires separate installation at the workstation end. In addition, the database connection has to be installed in the workstation. The road weather application only runs on WindowsNT4 and Windows 2000 operating systems. If the features of the application need to be changed after installation, the modification has to be done locally at the workstation. New versions of the application must be installed locally at the workstation. Local installations can be avoided by standardizing the workstations and automating the distribution of new versions. However, standardization of the structure and content of the workstations does not fit into the environment of most contractors. Different environments may also cause problems in the operation of the road weather application.

Changes in Contractors

The fact that the competitive bidding of the new operating model may result in changes in contractors also poses a problem from the standpoint of the application. New installation requirements arise each time a new workstation is added to the road weather system. Old connections have to be shut down, and the application has to be removed from the previous contractor's workstations. Connections have to be opened for the new contractors, and the application and necessary related software have to be installed. The workstation architecture of the new contractor also has to be matched with the road weather workstation application. The workstation's operating system may also be a limiting factor.

Two Separate Applications

Finland's road weather system still requires two separate applications in the user's workstation. One application is used to examine road weather information, and the other application is used to view different types of image products. Therefore, the addition of new workstations requires the installation and commissioning of two separate applications. Connections have to be established to both the road weather system database and the image product server.

Access to Internal Network and Information Security Risk

In the old model the workstation has to be directly connected to the database and image product server. This solution is not good from the standpoint of information security, because the servers in question are in Finnra's internal telecommunications network. Breaking into either server would provide access to all the computers in Finnra's network.

NEW WEB-BASED DISTRIBUTION OF ROAD WEATHER INFORMATION

To make the road weather information more readily accessible to the winter maintenance contractors than it was in the old system, in the spring of 2000 Finnra began developing a new web-based solution for distributing road weather information. The project progressed quickly through the specification phase to implementation by the end of the year. The Web Road Weather application was ready in the spring of 2001 and the commissioning phase got underway in the autumn of the same year. With the new application it is possible to monitor ten different kinds of weather images, camera images from 240 road weather and traffic cameras, and road weather information from 320 road weather stations. The application is currently being used by both the Finnra and external contractors.

Web Road Weather is a road weather application that runs on an Internet browser. When prompted by the user, the workstation application retrieves desired information from a road weather system web server especially set up for this purpose and displays the information in graphical form. Technically speaking, the information retrieval happens in such a way that the web server retrieves the information desired by the user from the database server and the image product server and sends it to the user. Thus, the user does not have a direct connection to the data banks. Web Road Weather is part of Finnra's extranet solution. The extranet provides user identification and better information security. The user and the user's Web Road Weather application communicate only with a separate extranet server. The extranet server sees the Road Weather web services as its own and provides them as its own services to identified users with the correct user rights.

HOW HAVE THE PROBLEMS BEEN SOLVED?

The user needs nothing more than an Internet connection. Because this is a web-based application that is used with a browser, the user needs only a browser and an Internet connection to use the service. According to the requirements of an extranet solution, the user needs a user name and a password with which the user can be identified. After being identified, the user is provided access to certain services. Winter maintenance contractors make an agreement covering the winter maintenance contract and are given a password allowing them to use the service.

Web Road Weather is a web-based Java application that is automatically downloaded the first time it is used. The new Web Road Weather application is easy to install. While the application is downloading, it checks the user's workstation and browser for necessary components and, if necessary, offers the possibility to download them. Each time, the application also makes sure the latest version is being used. It is very easy and quick to add new workstations into the road weather system. Today an Internet connection and browser are standard features on nearly all workstations. No separate installation visits are needed to install the road weather application, because everything is taken care of automatically the first time the user visits the home page of the road weather application.

It is not necessary to make separate connection agreements between two companies; all the user needs is an ordinary Internet connection. An Internet connection can be obtained quickly and its operation is reliable (at least at the present time in Finland). The client also saves time and trouble because no separate monitoring of connection agreements, routers, or firewalls is needed.

Viewing of road weather information and image products now takes place within the same application. The new web-based road weather application integrates viewing of road weather information and different kinds of image products related to road weather. This possibility of viewing different forms of information with the same application is one of the biggest functional improvements of the road weather application from the user's point of view.

In the new solution the road weather application and the user's workstation only have access to Finnra's extranet server. The extranet server provides the services of the road weather system to a user external to Finnra as if the services were the server's own. Naturally, from the standpoint of information security this solution is excellent and significantly better than the old system. In the new solution only the extranet server is able to penetrate Finnra's firewall to retrieve road weather information, while in the old system all the users had access to the road weather service servers in Finnra's internal network (intranet). The extranet server also checks the users' identification and approves them as legitimate road weather information users.

With the new solution Finnra's internal users will also gradually begin using the new web-based road weather application. For now, though, they also have the possibility of using the old client-server-based road weather application because all its features have not yet been incorporated into the new road weather application. So far, the conventional client-server application is also a little quicker than the new web-based solution. From here on, though, system development resources will focus on the new web-based solution.

USER INTERFACE OF THE NEW SYSTEM

Large Desktop

Because it is necessary to simultaneously view different windows containing several different kinds of images from rainfall radar and road weather cameras and road weather information, the user's computer should have a sufficiently large desktop to permit effective monitoring of different types of information and images related to weather and driving conditions. For this reason, the workstation should have several displays. This way it is possible to increase the size of the desktop and view several images at one time. Like all other applications, the Web Road Weather application is able to utilize a large desktop completely. Of course, it is possible to use the application with one display, but active monitoring requires several large displays. It is normal to use three or four 21-in. displays, which usually gives a desktop resolution of 3,600 to 4,800 x 1,024 pixels.

Possibility to Save Desktop Settings

The Web Road Weather application allows the user to save his or her own desktop settings. This way windows that are carefully placed on different screens can be quickly displayed again later. Thus, the next user can easily return the desired desktop by restarting the application, and time is not wasted in opening windows and placing them on the different displays of the desktop.

Menu Structure

Different types of images and road weather information in the Web Road Weather application are clearly divided into separate menu groups. Each group contains one to three clear subdivisions, depending on the number of different selectable items there are. This makes it easy for the user to pick the information to be displayed.

Information and its Presentation

Radar and Satellite Images

Several different kinds of weather images can be obtained from Finland's and Scandinavia's rainfall radar and Meteosat and National Oceanic and Atmospheric Administration satellites. Different-sized satellite images of clouds and radar rainfall images, rainfall summation images, rainfall state images, and rainfall movement prognoses can be viewed as individual images or time-based animations. Animations make it easier to detect the movement and development of rainfall areas than it would be by just viewing a single latest image. The images in the Web Road Weather application have a time bar at the bottom showing the time when they were captured. The animation is easy to interrupt, and by manually using the time bar it is possible to view the areas of rain at different times in the same window at the desired speed and in the desired order.

Road Weather Camera Images

There is such an abundant number of road weather and traffic cameras that by using subdivision they can be divided into submenus according to district, for example. Contractors may divide them up differently, for example, by monitoring area. The camera images often make use of time animations. Another new feature of the Web Road Weather application is the possibility to view a master animation of the latest images of several cameras in one window. This saves desktop space, and the camera animation of a given camera can be opened for closer examination if necessary.

Road Weather Information

Road weather information can be examined using graphs, tables, and maps just like the old Road Weather Windows application. Because the response times of the map server are too long in the current version of the application, the map displays cannot be zoomed yet. The graphical display may have several X-axes and sets of bars for the presentation of different sensor information. The graphical display is used to examine sensor information of one station over different time intervals, which makes it easy to spot any trends in the values. Tables are generally used to monitor the latest measurement information of several stations.

PRACTICAL EXPERIENCES

New techniques and infrastructure cause new kind of problems. So, the users and IT personnel must be trained properly to be able to use and maintain the system. Against anticipation, amazingly few throughput problems have arisen.

The extranet server is a very important link. So, it must be continuously available, reliable, and highly secured. It is in the Internet! The web server for Road Weather application, road weather database, and image server are, of course, also very important. They must be monitored continuously and maintained, if needed.

Some new development ideas have arisen. The most important one is the single-sign-on feature—for example, users need sign only once. At present they have to sign first on the extranet and then again on the application.

It has been proved in practice that Web Road Weather is a suitable and easy way to disseminate road weather information also to the Finnish Emergency Response Centers. By fall 2003, the Web Road Weather had almost 300 users.

WINTER WEATHER: INFORMATION, MODELS, AND DATA QUALITY

Development of ARROWS

Automated Real-Time Road Weather System

S. EDWARD BOSELLY

Washington State Department of Transportation

Weather impacts nearly all highway maintenance activities. Consequently, maintenance managers and operators need accurate and reliable weather information in order to manage their resources effectively and efficiently. In addition, these decision makers need to have weather information presented in a user-friendly manner so that they are not forced to try to integrate information from many sources in order to make decisions. Under contract to the Washington State Department of Transportation (WSDOT), researchers at the University of Washington (UW) developed a capability to gather data from the many networks of weather instrumentation around the state. They integrated these data into a user-friendly format and developed a website for data display. The original website, called rWeather, is available on the Internet for public viewing, as well as for use by maintenance personnel. The second generation of this product is available as the WSDOT Traffic and Weather page, also on the Internet. However, neither rWeather nor the Traffic and Weather websites provide key forecast information needed by decision makers. The UW researchers developed a new capability for maintenance operations decision making. The product, the Automated Real-Time Road Weather System, takes numerical weather prediction output and presents the forecast information in a format for easy use and understanding by maintenance personnel. The high-resolution modeled output, the integration of other weather information sources, and the development of the presentation format are described. Initial results from the first winter's operational use by WSDOT personnel are also discussed.

INTRODUCTION

The weather and the climate in the state of Washington are as varied as the terrain. Washington State Department of Transportation (WSDOT) highway maintenance workers face year-round challenges ranging from decisions for snow and ice control strategies and tactics in the winter to vegetation control, for instance, in the summer. In addition, the highway travelers face weather-related challenges.

Under contract to WSDOT, researchers at the University of Washington (UW) Department of Atmospheric Sciences developed a website to allow WSDOT personnel and travelers to access current weather and forecasts. This site, the Real-Time Road and Weather Traveler Information Web site, referred to as rWeather, became operational in 1999 (Figure 1). The site provides access to over 400 observing locations around the state, area forecasts, and road information such as construction, accidents, and closures.

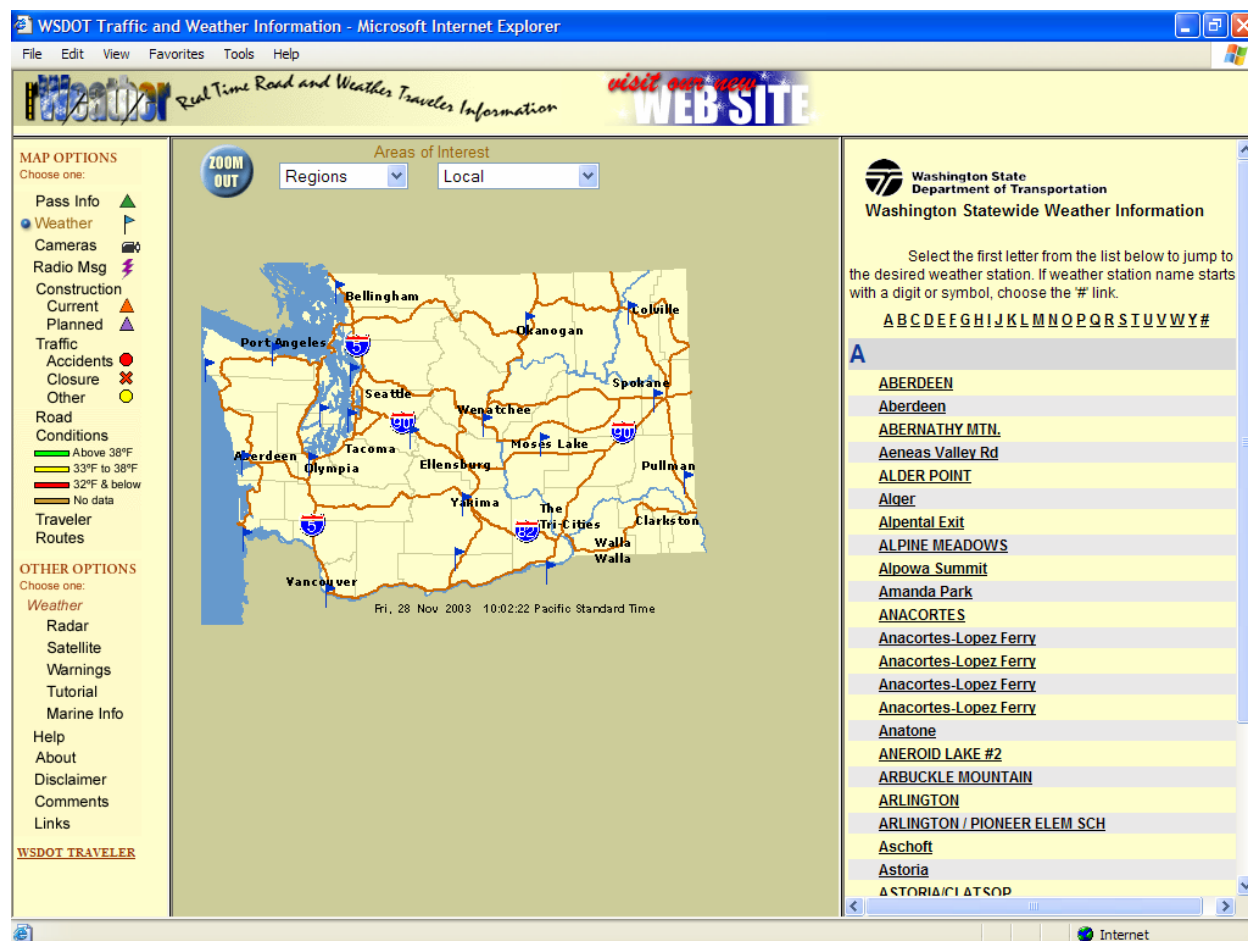

FIGURE 1 WSDOT's rWeather website.

An effort to develop a new website was undertaken as the WSDOT Office of Information Technology developed standards for WSDOT Internet displays. In 2001 the new traffic and weather website appeared on the Internet (Figure 2). This site requires access to the latest Internet browser technology in order to display the frames properly. As a consequence, the rWeather website remains active for users with older computers and browsers. The UW personnel enhanced the road weather information display capabilities on the new traffic and weather website by developing profiles of certain road segments, such as Interstate 90 over the Cascade Mountains, by providing visual clues to current weather and pavement temperatures.

During this same time frame, a pooled-fund effort, called the Northwest Regional Modeling Consortium, funded the development of fine-scale forecasting capability at the UW. The UW began running the Pennsylvania State University's MM5 mesoscale model to produce forecasts for air quality. WSDOT participated in the consortium as an associate member. It became apparent that WSDOT could benefit from the high-resolution forecasting capabilities being developed.

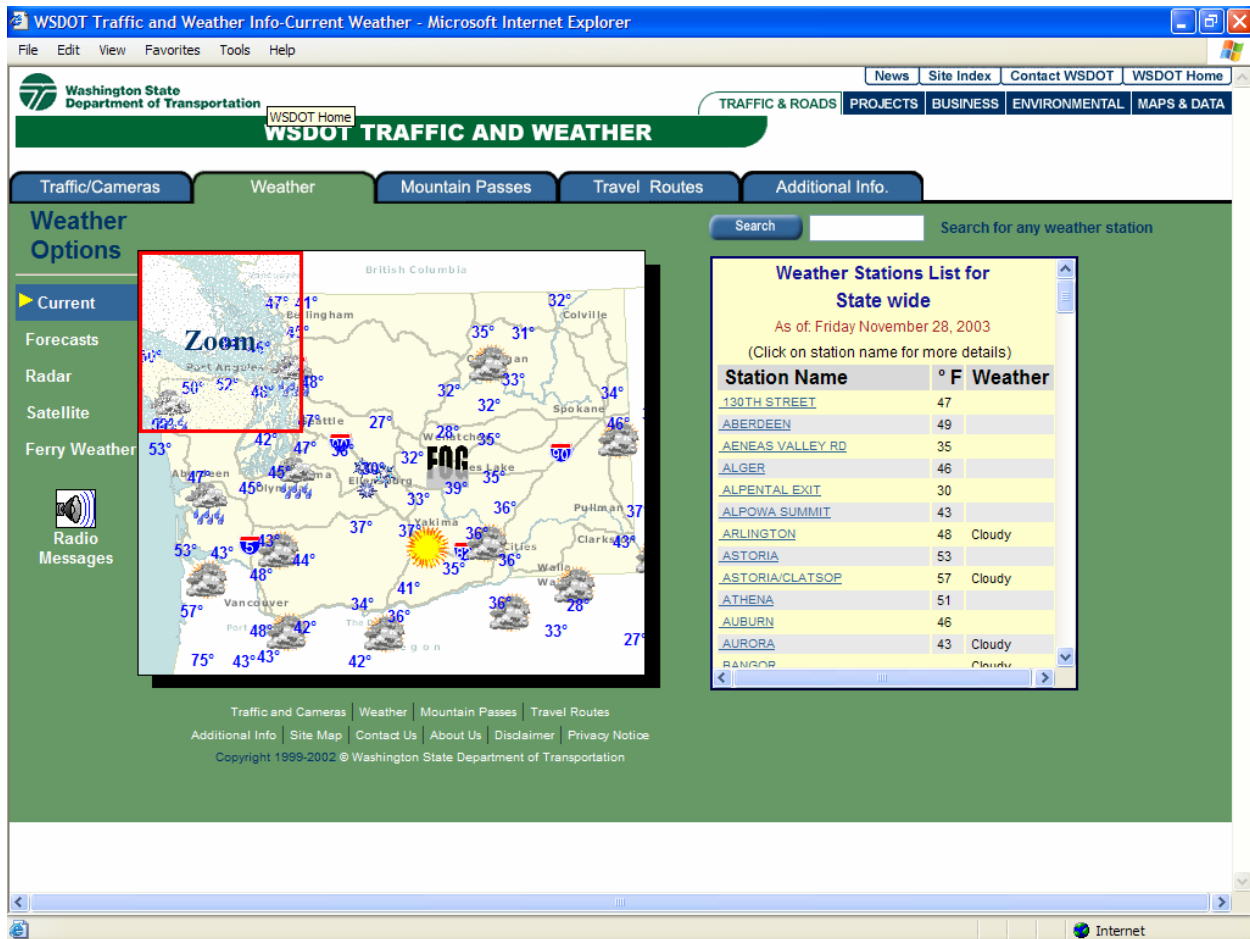

FIGURE 2 WSDOT's current traffic and weather website.

In 2002 a meeting was held between WSDOT highway maintenance personnel and UW researchers to begin the development of a weather information product that could be used by WSDOT for operational decision making. This focus group defined the WSDOT needs for the developers who used the information to build a product that could meet the needs.

The UW created a beta-test version and dubbed it the Automated Real-Time Road Weather System (ARROWS). It released this version in the early spring of 2003 for comment by the focus group members. Approximately 10 WSDOT people used the product for the first two weeks of April. Another focus group meeting was held, and comments, mostly very favorable in terms of utility, accessibility, and so on, were provided to the UW researchers. One set of negative comments related to the display of the state road network. No highway numbers, WSDOT region boundaries, or locations of towns and cities appeared on the maps and information was difficult to locate for specific road segments.

The UW researchers took the comments and worked for another five months to put together Version 1.0 of ARROWS. This version became operational in the middle of September 2003. WSDOT Headquarters Maintenance provided the Internet address to all maintenance superintendents and suggested widespread use. This new product is shown in Figure 3.

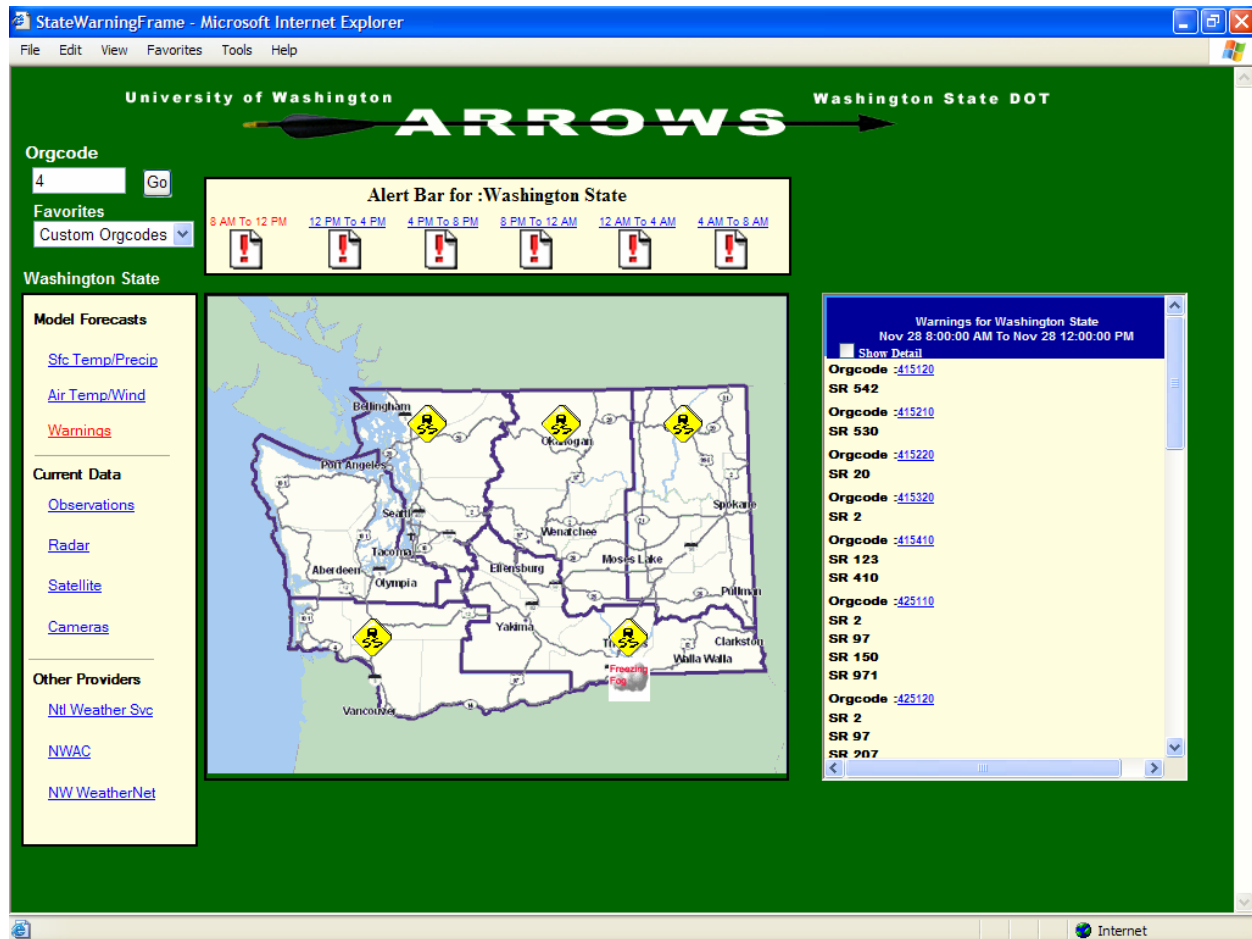

FIGURE 3 WSDOT's ARROWS website front page.

ARROWS DESCRIPTION

ARROWS provides forecasts of weather and pavement conditions for the entire state highway network. The MM5 output runs through a land-surface model to produce pavement temperature forecasts. MM5 and the land surface model product output at 4 km resolution. The background terrain for the model runs is also 4 km. This allows for very site-specific forecasting for the road network.

The MM5 model uses output from eight national and international global meteorological models. The model output is used in MM5 with three different parameterizations each plus one other MM5 run for a total of 25 sets of modeled output. The output is averaged and the mean of the ensembles is selected for generating ARROWS output. Besides the mean, the system calculates the standard deviation in order to generate a confidence level for the forecasts. If all the model runs are in general agreement, confidence is high.

ARROWS Forecast Displays

The primary intent of ARROWS is to provide information quickly to decision makers in a useful format. The front page for ARROWS (Figure 3) is a warning page that provides indications of the existence of warnings for a 24-h period. The 24-h period is divided into six 4-h time blocks. If a warning exists for any location in the state during any one of the time periods, an exclamation point icon appears under that time block above the state map. In addition, icons for various warnings appear in any one of the six WSDOT regions where a warning exists during that time block. The user can click on any one of the time periods to check where warnings exist.

In addition to the region icons, a table to the right of the state map identifies down to the maintenance shed level (six-digit organizational code) and state route the locations of warnings. The user can click on any one of the organizational codes with a warning and a screen of detailed road maps appears (Figure 4). Any locations where warnings exist during that 4-h block are highlighted in red. The user can move the cursor over any one of the red marks, and the type of warning (snow, freezing fog, frost, etc.) appears. If the user then clicks on the red mark, a 24-h forecast for that location appears (Figure 5).

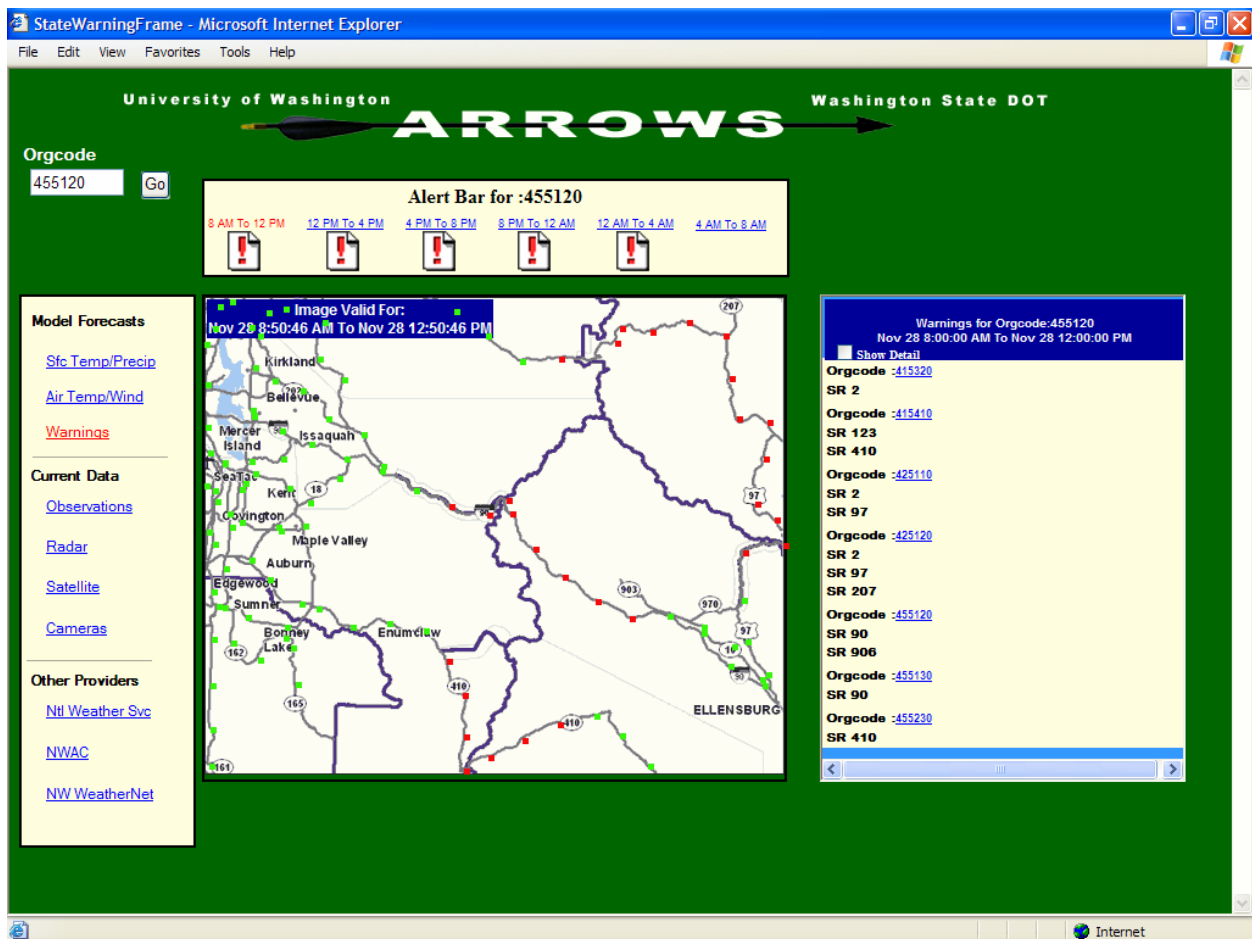

FIGURE 4 ARROWS detailed close-up view of roadways and warning in effect.

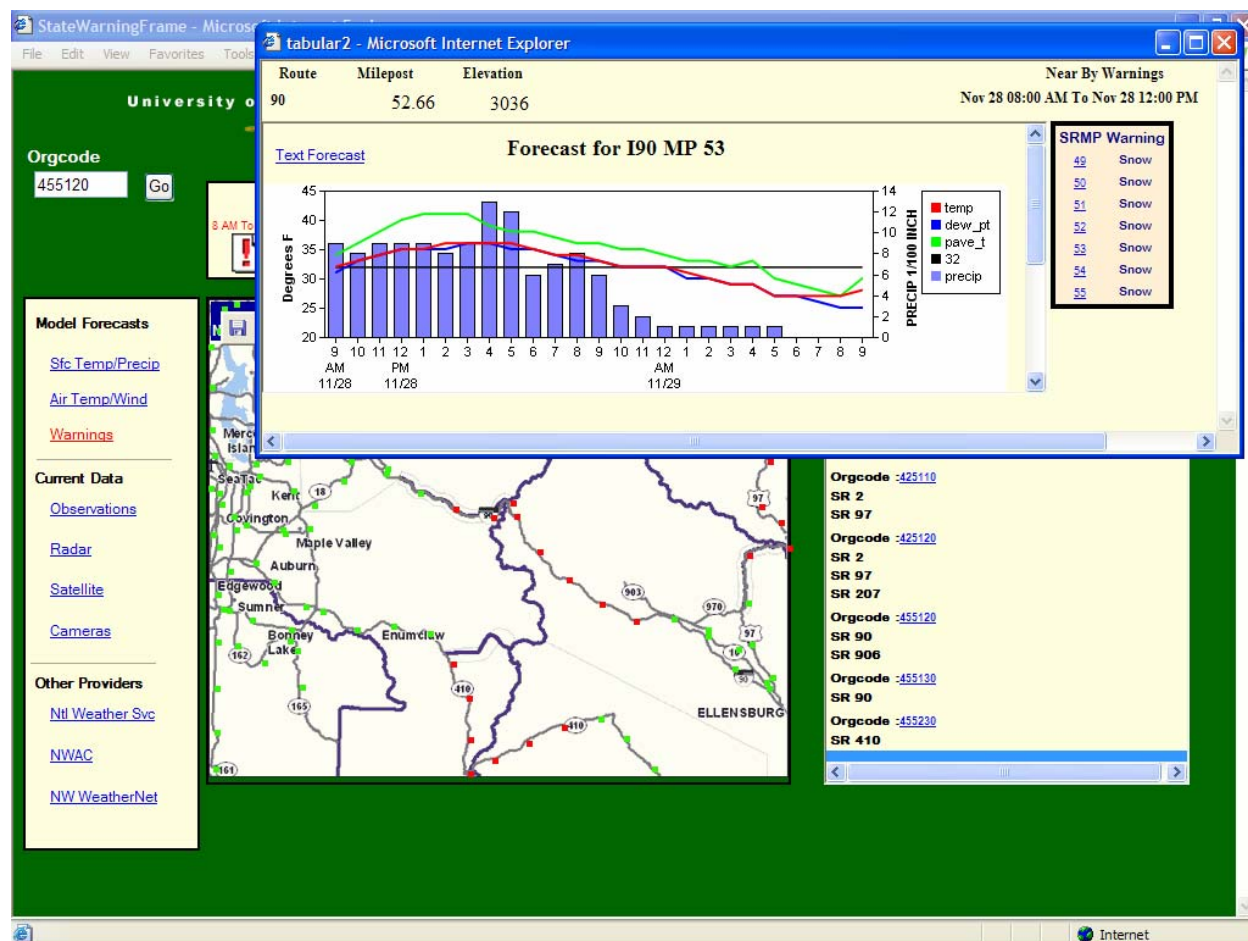

FIGURE 5 ARROWS display of a 24-h forecast for a specific location.

This 24-h forecast is particularly valuable to the maintenance decision makers. It provides a 24-h forecast of pavement temperature, air temperature, dewpoint, and precipitation. The pavement temperature is critical information for maintenance decision makers. This is especially true for winter maintenance. Nearly everything that happens on the pavement surface is related to pavement temperature. The dewpoint is also critical for the forecast of frost or black ice. The precipitation forecast is obviously helpful in determining the intensity of precipitation expected. As of this writing, the user must infer the type of precipitation. The UW researchers will be working to try to specify, for instance, whether the precipitation may be liquid or frozen. Also in this view, any warnings in existence in the vicinity of the forecast location are identified in a box to the right of the forecast legend. These nearby warnings are listed by milepost. Theoretically, depending on the weather situation, the user could see warnings for every milepost along a highway for many miles by clicking on adjacent red marks. Forecasts can also be obtained for each of the forecast locations identified by green marks. The locations of these marks can be adjusted to suit maintenance needs.

Besides the warning views, other modeled output can be viewed. Figure 6 provides a regional view of forecast pavement temperatures and precipitation. The roadways are color coded to show the minimum temperature expected in the selected 4-h block. Pavement

temperatures forecast at 32°F (0°C) or below appear red. Pavement temperatures greater than 33°F to 37°F (0.5°C to 3°C) appear yellow, and temperatures greater than 37°F (3°C) appear green. The color-coding represents identified thresholds of concern. This affords the decision maker the opportunity to view road segments that perhaps need to be monitored closely, compared with those that need not be a concern.

Figure 6 also shows the type and intensity of precipitation expected during the 4-h block. The example shown shows rain from light (light green) to heavy (dark green), snow from light (light gray) to heavy (black), and freezing rain (red). The legend showing precipitation amounts for the intensity always appears. In this and all forecast modes, the warnings for the time period appear in the table to the right. As in the case of the warning mode in Figure 5, the user can click on any one of the blue dots shown and obtain a 24-h forecast for that location. At the six-digit organizational code view, rather than show the precipitation color-coded over an area, the individual forecast locations will have a green “R” for rain or red “S” for snow. The area color coverage could overwhelm the display.

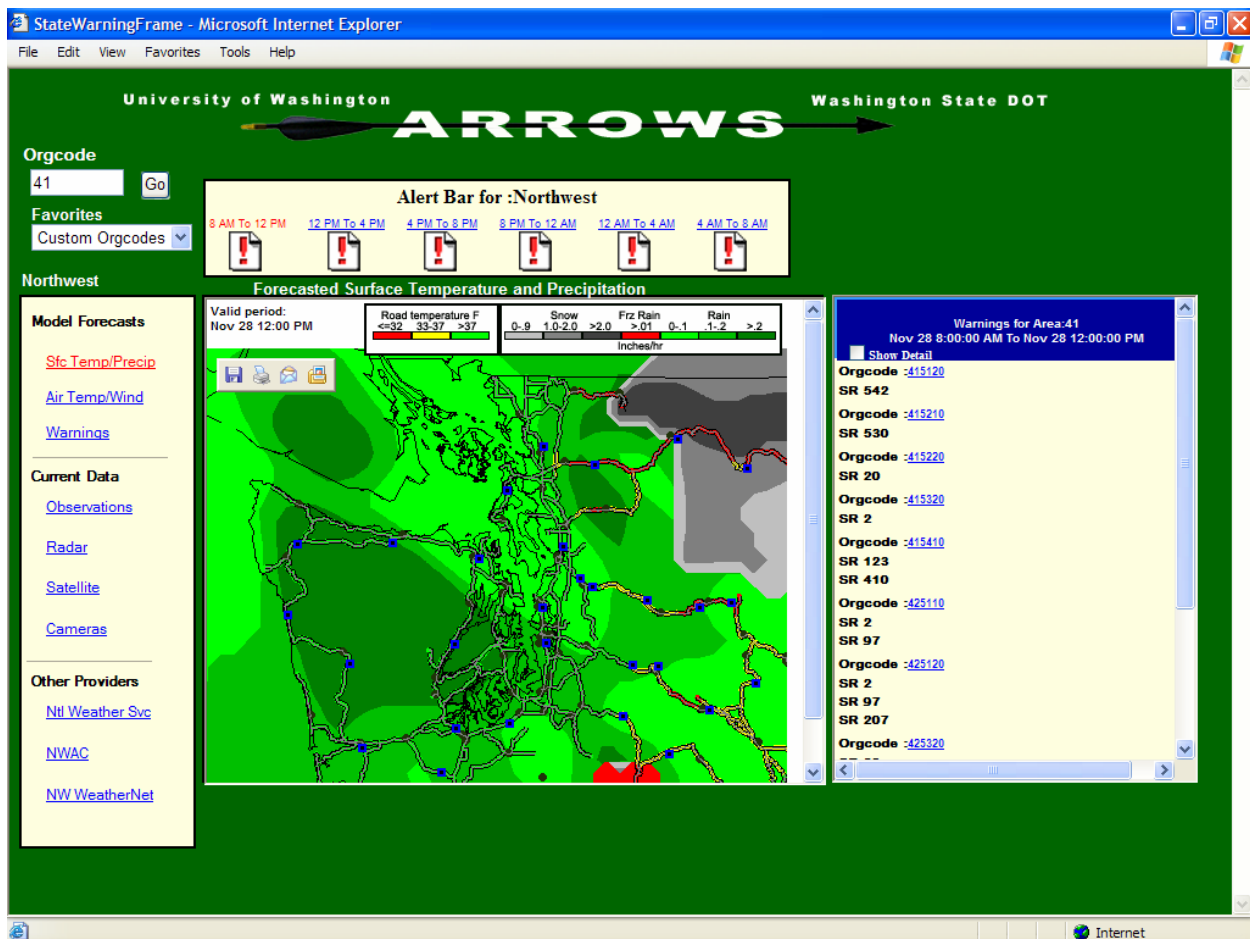

FIGURE 6 ARROWS regional display of roadway surface temperature and precipitation forecast.

The forecast displays are dynamic in the sense that every 4 h a new set of 4-h time blocks appears and the 24-h forecast adjusts to match the new 24-h period. In addition, the warning process is dynamic in that observations can nudge the warning process. If snow begins to fall at a location where it was previously not forecast, an icon warning for snow will appear in the various warning views, marks will change from green to red, and the warning table on the right is updated.

Figure 7 shows the final forecast product. This regional product provides forecasts of air temperature, color-coded by temperature. A similar view appears on the statewide view. Red depicts the areas expected to be at 32°F (0°C) or below and the yellow depicts areas where the temperature is expected to be 33°F to 37°F (0.5°C to 3°C). This again depicts concern thresholds. Along with the air temperature forecasts, modeled wind forecasts are also shown. At the six-digit organizational code view, as is the case with surface temperature and precipitation view, the areal color-coding disappears, and the maximum and minimum temperature expected appear numerically and the maximum wind expected is given in miles per hour. If the wind is expected to be 10 mph (16 km/h) or greater, it is color-coded red. Temperatures expected to be freezing or below are also color-coded red.

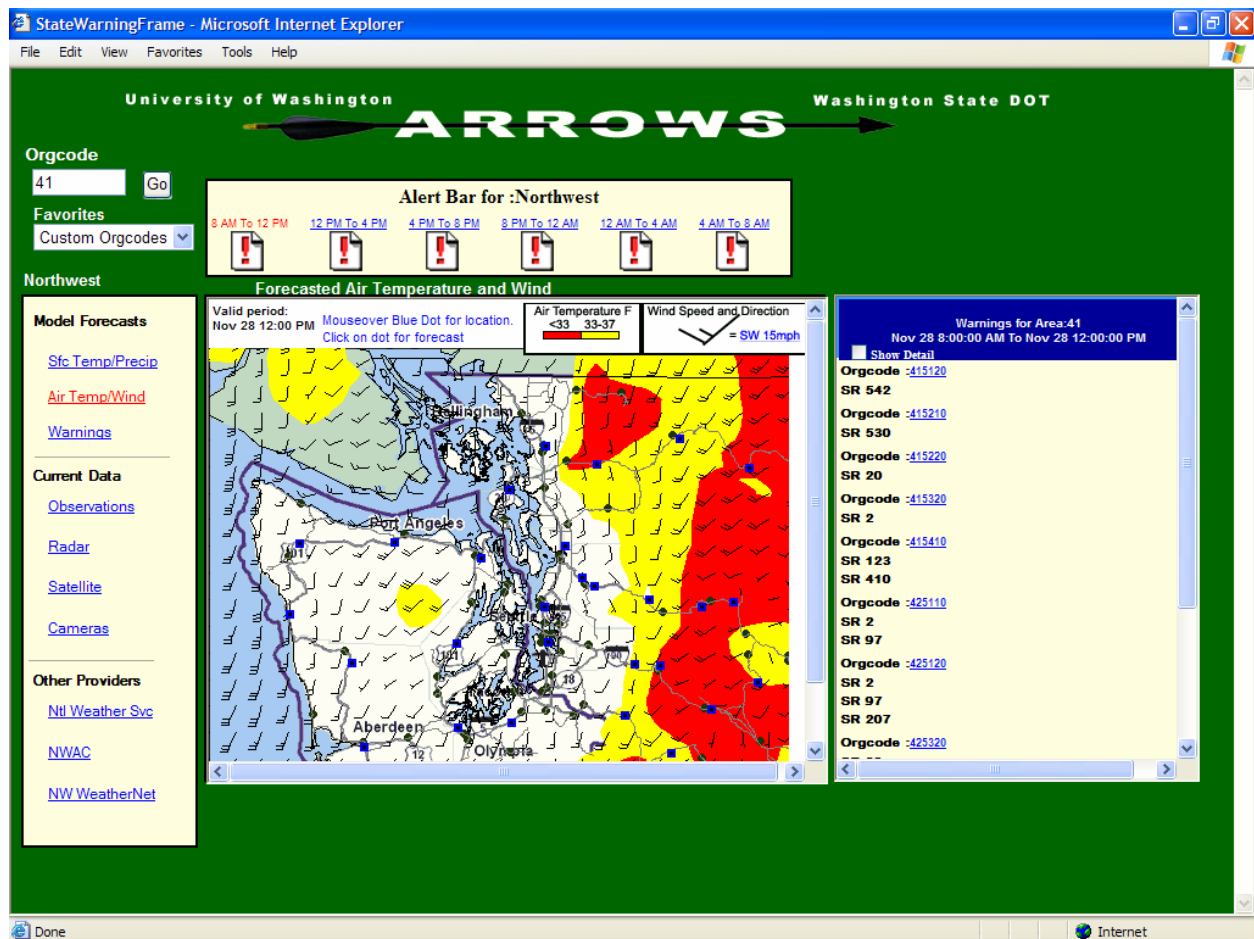

FIGURE 7 ARROWS regional display of air temperature and wind forecast.

ARROWS Observation Displays

One of the ideas from the start when developing ARROWS was to help the maintenance forces find ancillary weather information. ARROWS is therefore a one-stop shop for weather information.

The same surface observation database used to generate the tables in the WSDOT rWeather and traffic and weather web pages is displayed in ARROWS. This is both in a numerical format on the map displays and in tabular form (Figure 8). Observations from roadside Road Weather Information System environmental sensor stations appear on the map. The numbers are air temperature and pavement temperature, respectively. Temperature 32°F (0°C) or below appear red. All surface observations in the local area will appear in the table to the right if the data are 2 h old or less. This precludes having decision makers view old data and perhaps make bad decisions. NA means data are not available.

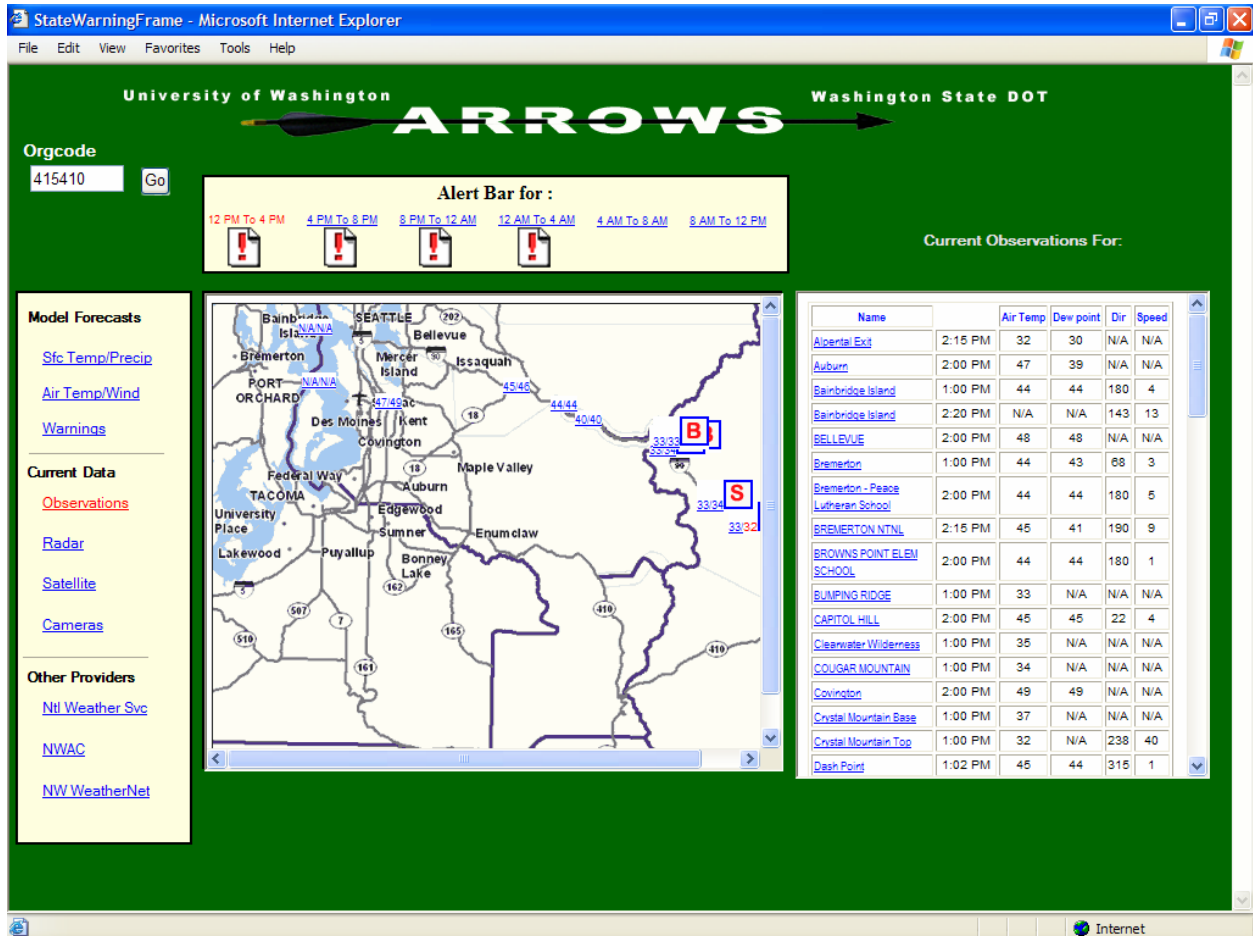

FIGURE 8 Current observations displayed by ARROWS.

In addition to surface observation, users can access radar data at the click of a mouse. The UW researchers take radar data from the four National Weather Service (NWS) WSR-88D radars that provide coverage of Washington and create a composite product (Figure 9). Radar data can be viewed in either the statewide view or the regional view. Users can also put the data into motion by clicking on the little green arrow button in the upper left had corner of the radar data window. Radar data for up to about 3.5 h will be looped.

Users can also access satellite data; however, the UW researchers created no new products for this view. Following the beta test of ARROWS, users and UW personnel felt that there was no way to create better satellite data products than those already created by the NWS. Clicking on the satellite link on the left takes the user to the NWS satellite data access webpage.

The final observation link is for cameras. WSDOT has access to over 100 cameras statewide, most along state highways. The maintenance personnel frequently use these cameras to check road conditions. When the user clicks on the camera link, a listing of cameras by state route appears in a table on the right side of the page.

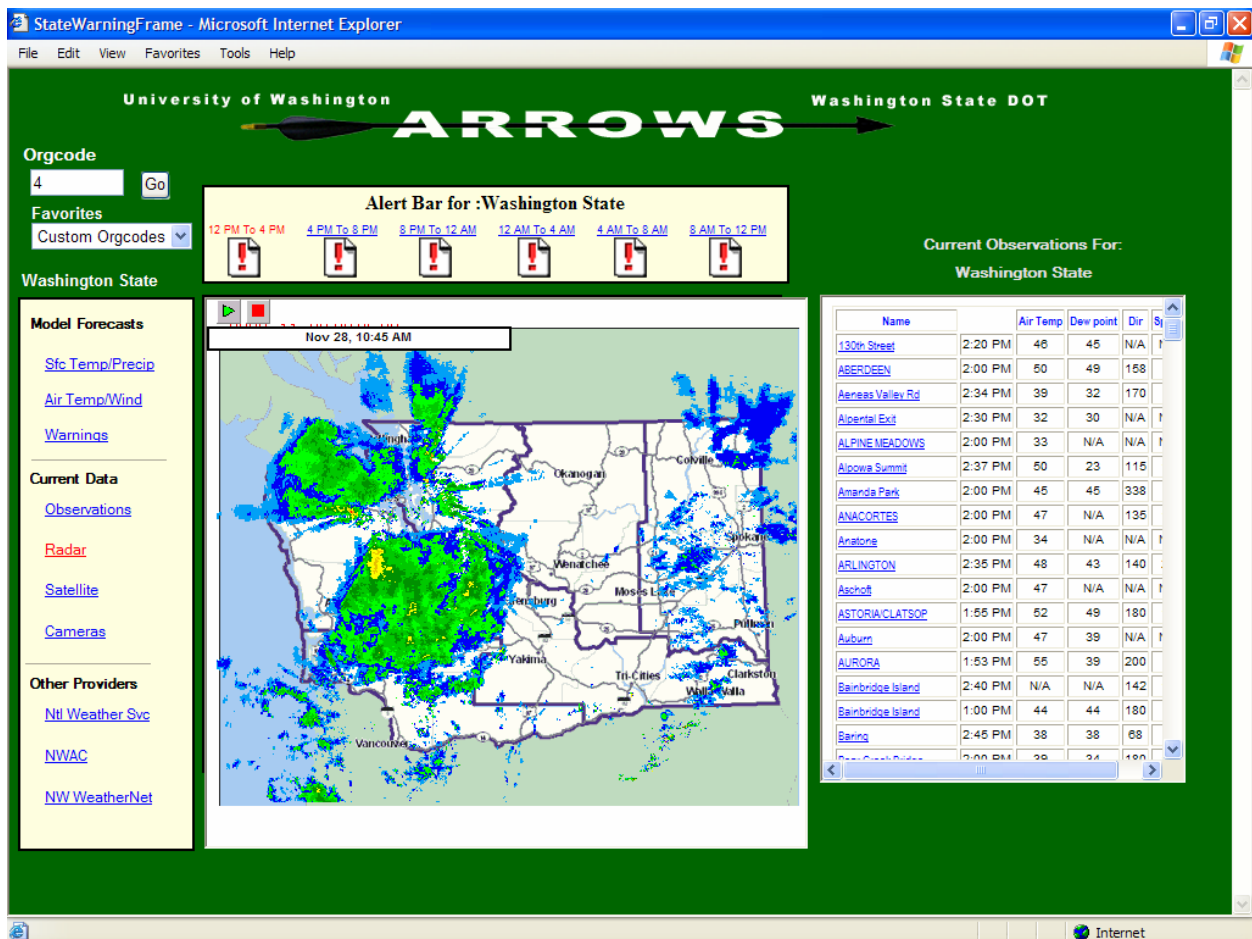

FIGURE 9 Composite radar data image for the statewide view.

Other Weather Information Access

ARROWS is strictly a computer-generated product. There is no weather forecaster to talk with regarding the forecast products. The ARROWS page provides access to other sources of weather information. This is conceptionally, again, the one-stop shop for weather information.

First, users can click on a link to the NWS. If the user clicks on this link from the statewide view, the system automatically links to the national weather warning map on the NWS home page. The user can then click on the area of interest in Washington. However, if the user is in the regional view or the shed-level view, clicking on this link will take the user to the NWS office that provides operational weather support to that region. Just as there are four NWS radars providing coverage, there are four NWS offices providing forecast support. These offices are located in Seattle, Portland, Pendleton, and Spokane. The user can then access products for the region of interest.

Next, users can obtain information and forecasts from the Northwest Weather and Avalanche Center. This center provides forecasts for backcountry avalanches. The forecasts can be very useful for mountain highway concerns, although the forecasts are generated for virgin snowfall areas rather than along highways, where frequently avalanche hazards are physically removed.

Finally, if a region or maintenance shed uses a private weather service, or value added meteorological service (VAMS), a link to the VAMS will allow the user to access the forecasts directly via the Internet. The forecasts sometimes are sent via facsimile or e-mail and timely distribution is not always possible to the decision maker who might be away from the office. This VAMS access plus all of the other information is available to any maintenance person who has Internet access at home or away from the office. The information does not reside on the WSDOT Intranet and therefore more use can be made of the important information.

ARROWS EVALUATION

The plan for the 2003–2004 winter is to conduct a formal evaluation of ARROWS in order to determine direction for the future. To date, only an informal evaluation had been undertaken. This informal evaluation has pointed to some notable successes and some problems.

From a success standpoint, ARROWS forecasts identified very isolated locations where snow would occur. Separate success included three successive days in April 2003: each day one red mark appeared in different locations on State Route 101 on the Olympic Peninsula. In each case, snow did occur during the 4-h time block forecast. Forecasts also identified two instances of unusual snow expected on Stevens Pass in the Cascade Mountains, one in June and one in September. Results from the early 2003–2004 winter point to continued general success. In fact, the WSDOT Headquarters maintenance office sent a message to the field indicating that in all probability there would be failures and to remember that even though ARROWS is demonstrating great success, it is only one tool in the toolbox for decision makers.

In addition to precipitation forecasting success, ARROWS appears to provide relatively accurate pavement temperature forecasts for the morning hours. Initial analysis showed $\pm 2.5^{\circ}\text{F}$ ($\pm 1.5^{\circ}\text{C}$) degree accuracy based on comparisons over 3 days at 10 locations around the state. It is hoped that the accuracy will continue to get better. The computer process of forecast issuing

includes bias checking, and if biases seem to occur at certain locations, the processing applies to bias correction.

On the problem side, afternoon pavement temperature forecasts can be difficult. This is due in part to a lack of important solar radiation data input and also to the fact that the interaction between pavement and solar radiation is very complicated. In addition to temperature forecast problems, some precipitation forecasting problems have and will occur. This is due to the fact that frequently shower-type activity cannot be resolved properly with the 4-km MM5 resolution. Radar information, though, helps correct this problem in the near term.

CONCLUSIONS

Data from the 2003–2004 winter were not available for inclusion in this paper. However, anecdotal evidence from maintenance personnel in the field indicates a high level of satisfaction with ARROWS. They believe money has been saved and resources managed more effectively and efficiently by being able to make more informed decisions.

The use of ARROWS also appears to be a function of training. Although ARROWS is intuitive once people begin using it, it is initially a bit foreboding to some of the people in the field. The WSDOT Headquarters maintenance office provides tailored hands-on training or group training sessions at field units' requests.

WSDOT believes ARROWS will become an important tool in its maintenance and operations decision processes. One more year of development should bring ARROWS to the level of routine operations. Questions concerning how that operational implementation will take place will also be addressed.

WINTER WEATHER: INFORMATION, MODELS, AND DATA QUALITY

Projected State of Road Weather Monitoring in Finland in 2007

YRJÖ PILLI-SIHVOLA

Finnish Road Administration

JUKKA LÄHESMAA

SysOpen PLC

The aim of the projected road weather data monitoring project is to define the objective state of weather and road weather data monitoring for 2007. The data in this context include road weather station data and camera pictures, satellite and radar pictures, weather forecasts in different forms, as well as data on road conditions and road weather forecasts. The definition of the objective is a tool for developing the monitoring system.

Six use cases of the monitoring system defined the requirements for the intended state. The most important new requirements came from road maintenance quality control use case. The most detailed requirements came from the traditional maintenance realization. In addition the traffic control has its own requirements for those road sections with variable speed limits and information boards.

The present monitoring system meets many of the future requirements. The projected state is illustrated by defining the new and enhanced parts of the system in 2007. All together nine new parts were defined, including issues like enlarged and better-equipped road weather stations and camera network, improvements to data storages, processing, and presentation, and also a new centralized data transmission system for receiving and delivering road weather data.

In addition to the implementation projects a number of development ideas were proposed. The most important future development items are road weather models and forecasts as well as floating car road weather monitoring.

INTRODUCTION

The history of the road weather information system (RWIS) in Finland dates from the early 1970s. First conceptions of the system were set out in connection with the European COST 30 project, Electronic Aids on Major Roads. Finland's responsibility in the project was to develop ice warning systems on black spots. In the late 1970s, a pilot road weather information system that was tested both in the Hague, the Netherlands, and in the Finnish capital, Helsinki, was developed. Due to the good test results, RWIS was installed in the beginning of the 1980s in a somewhat wider area in Finland, including the capital, its neighboring areas, and a few other major cities. In the late 1980s and the beginning of the 1990s, the system was totally renewed and expanded to cover the whole country, from the southern coast to Lapland.

The techniques used in road weather monitoring, weather radar, and road weather forecasting have improved enormously during the past few decades. In the 1970s, data transmission was very difficult and slow whereas today all real-time information is available both on the Internet and even by mobile communication means.

During the entire history of RWIS the acquired information has helped road authorities or winter maintenance operators improve their service or make it more effective or cost-efficient. Nowadays the information has become more and more important for everyday road users as well so that they can drive more safely and comfortably to their destination. The latest solutions make use of the information to show the suitable speed limit to road users via variable message signs. In 2002, the Finnish Road Administration (FinnRa) started a project to ensure the quality of road weather information by developing a quality management system for the road weather information system in Finland. By the end of 2003, the project was in the implementation phase.

OBJECTIVES AND BACKGROUND

The aim of the project is to define the projected state of the Finnish weather and road weather data monitoring system for 2007. The project also aims to make an implementation plan for the actions needed to realize the objective. Finnra is the owner of this road weather system (1).

The description of the objective aims to deal with the coverage of monitoring, different means for monitoring and data procurement of data from different partners, data processing and analyzing and data delivery to the Finnra's own utilization, as well as to other companies. The data mean road weather station data and camera pictures, satellite and radar pictures, and weather forecasts in different forms, as well as data on road conditions and road weather forecasts.

The objective state description is a tool for developing the monitoring system. It forms a common understanding about the present state of the road weather system and on the desired functionality. The implementation plan includes the most important actions needed to realize the objective state and work plans for each of these actions.

The most important need for making the study came from the recent organizational change in Finnish road maintenance. The former Finnish National Road Administration that both built and maintained the public roads in Finland was reorganized into two different organizations. The new Finnish National Road Administration is now ordering the road construction and maintenance from private markets. The other part of the former Finnish National Road Administration, the Finnish Road Enterprise, is a publicly owned company that provides the road building and maintenance services to the administration, among other companies.

As the road weather system has been traditionally used mainly to support directly winter maintenance planning and operation, this organizational change caused urgent need to rethink the road weather system utilization and functionality.

METHODOLOGY

The objective was realized in three phases achieved as illustrated in the [Figure 1](#).

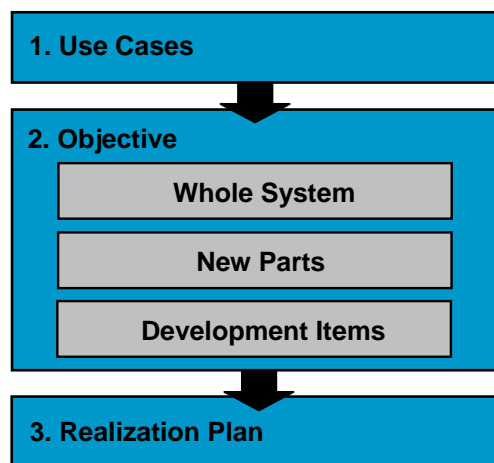

FIGURE 1 Phases of the project.

Identifying and describing the use cases for which road weather information is needed started the work. For example, road maintenance quality control and information services are use cases. The needs of road weather data and requirements for its delivery to each use case were investigated by interviewing experts of different use cases. In addition, needs for new road weather stations and cameras were investigated with an extensive questionnaire to the road maintenance people working in the field.

The description of the objective was made after describing the use cases. The present was first described as a process to form a background for the future development. The objective description includes three parts:

- A process description of the whole road weather monitoring system at year 2007,
- A more precise description of the new parts at the completed state, and
- A description of the development ideas. Development ideas are parts that will not present at the operational system in 2007 but an aspect that has to be further developed in order to be utilized later.

The last phase of the project was creating the implementation plan. In this phase, a number of projects and their work plans were planned to realize the new or changed parts of the objective state road weather system. The projects were scheduled for 2003–2006. Development ideas were also converted into development projects.

The description of the system objective and the implementation plan were done by a group of road weather experts, based on the needs and requirements that the use cases provided. The work was mainly done at workshops during the project.

OBJECTIVE STATE

Present State

The projected state road weather monitoring system is mainly based on the present state system. The present system answers in many respects the needs and requirements of the year 2007. The

description of the projected system shows the new and improved parts of the present system that makes the present system fulfill the needs.

Description of Use Cases

The weather and road weather information is needed in the use cases described in [Table 1](#). The use cases are functions of Finnra or other organizations that utilize this information.

The use cases have needs and requirements for the projected road weather monitoring system, such as what kind of information has to be produced and how. The monitoring system has traditionally been used for road maintenance planning and control. This function gives the most detailed requirements for the road weather system development. Based on the new role of Finnra as the contractor of road maintenance, it has to be able to monitor and control the quality of the maintenance. This function creates the most urgent and extensive need for the development. Based on both road maintenance (U1) and its quality control (O1), more effort is needed on the extension of the monitoring network as well as the quality of the data. In this kind of environment it is highly important that each road maintenance area has a proper and equal coverage of the road weather stations and weather cameras. It was also noticed that there must be means for monitoring the conditions outside the main road network. The results from these use cases were also compared with the results from the road maintenance field experts' questionnaire. The results from each approach gave similar type of needs for extending the weather station and especially the weather camera monitoring network.

TABLE 1 Use Cases of the Road Weather Data

Number	Name	Description
Use Cases of Road Administration		
O1	Road maintenance quality control	Real time monitoring and quality control of winter maintenance actions as well as analysis afterwards of the quality and operation models
O2	Traffic control	Automatic and manual control of variable message signs based on current weather conditions
O3	Information services	Information on the weather and road conditions to the road users through administration's own distribution channels
Use Cases of Other Organizations		
U1	Road maintenance	Planning of the maintenance actions and online management of the actions
U2	Traffic and weather information services	Production of weather forecasts and value-added information services based on the information from the administration
U3	Freight and fleet management	Planning and online management of the transport of goods, especially in the forest sector

Traffic control (O2) with variable message signs (VMS) has the toughest requirements for monitoring at the road sections where VMS is used. At the road sections where there are major changes in the weather, there should be road weather stations approximately after every fifth kilometer. However, road sections where the weather does not change so rapidly can have stations at longer intervals. The weather cameras are needed to support the automatic VMS control manually. The operator should have the possibility to get a total picture of the road section, and therefore the coverage of weather cameras should be one per 15 km. The current VMS road sections mainly meet these requirements.

Traffic information (O3) and production of value added information services (U2) had one major requirement for having easy access to the existing information. This kind of road weather information is not utilized much in freight and fleet management (U3), and this function did not have any additional requirements.

Whole System

The whole projected state road weather monitoring system was illustrated by adding the new or improved parts to the process description of the present system. Figure 2 presents the whole system planned for 2007.

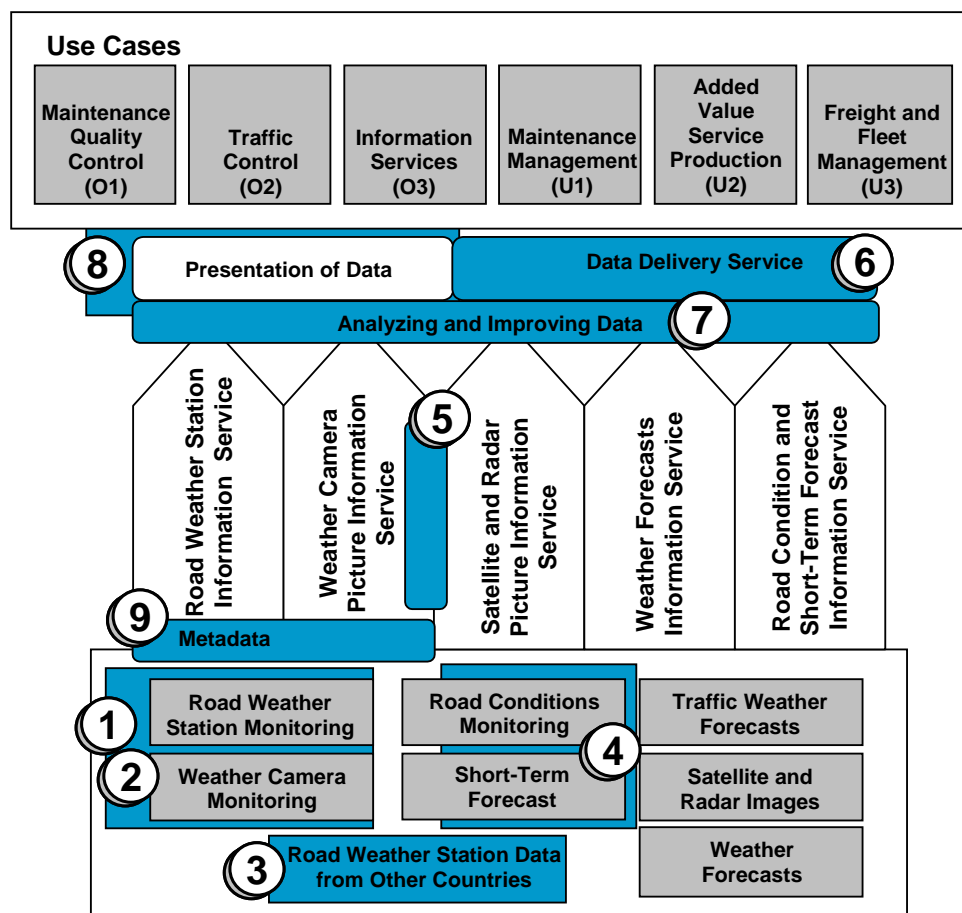

FIGURE 2 Simplified illustration of the road weather monitoring system for 2007.

The model of the whole system consists of three parts. In the figure the lowest part shows the different means that the Road Administration has for monitoring the conditions and for gathering information from other parties. The Road Administration's own monitoring means are road weather stations and weather cameras. Descriptions of road conditions and short-term road weather forecasts come first from the maintenance contractors, but after that the administration modifies and improves this information. The weather forecast companies produce the traffic weather forecasts for the next 24 h. These companies also provide weather forecasts in the form of text, tables, and pictures to the administration as well as the satellite and radar images. The second part in the middle of [Figure 2](#) shows the five road weather information services that the system produces. The information services are Finnra's means for storing and delivering the information. The information services of the road weather monitoring system are road weather station data, road weather camera pictures, satellite and radar pictures, and weather forecasts and road conditions with short-term road weather forecasts. The third part of the total system is the use cases at the top of [Figure 2](#).

The new or improved parts of the road weather monitoring system follow. The new parts are numbered in the order of the data production chain. All the new parts are significant to the objective system and therefore are not listed according to any priority:

1. Number and locations of road weather stations and cameras,
2. Equipment of road weather stations and cameras,
3. Road weather station data from neighboring countries,
4. Road conditions and short term forecast data from the contractors to the administration,
5. Storage of weather camera pictures,
6. Data delivery service for all road weather information services,
7. Means and methods for analyzing the data,
8. Means for presenting the data to the users, and
9. Road weather station and camera metadata.

New Parts

The new or improved parts of the whole system and the need for them are discussed in the following sections.

Number and Locations of Road Weather Stations and Cameras

The number of road weather stations and weather cameras has to be increased to meet the requirements of road maintenance quality control in particular and also maintenance management. There should be more than one road weather station and weather camera in each of the Finland's 90 winter maintenance areas. In addition, weather cameras and light-equipped road weather stations should be maintained outside the main road network. All together, Finnra needs 60 to 70 new road weather stations and approximately 110 weather cameras. The number of stations was 290 and cameras totaled 205. These objectives are also in line with the estimations within the VIKING monitoring guidelines (2).

Equipment of Road Weather Stations and Cameras

The equipment of all road weather stations has to be improved and equalized so that all the stations have similar rain sensors and fiber sensors for measuring road surface conditions and coverage. Also, a new sensor to measure the height of snow is needed for some of the stations.

For the road network outside of the main roads in particular, a new type of lighter road weather station is needed. This lighter station does not need normal road surface sensors as the road surface is most likely to be covered with ice and snow all the time during the winter on these road classes.

The weather cameras should be programmed to take pictures after certain intervals from predefined angles, such as the road surface, and general pictures of the entire road section. The traffic center operators should also have the ability to control the movement and zooming of cameras. At the locations where there is a camera, the air temperature and other basic data should also be measured.

During situations in which road maintenance is needed, the data from road weather stations and pictures from weather cameras are updated every 15 min on the main road network. On the lower level, road network, the updating interval can be longer. On the road sections where there are VMS, monitoring and updating must happen in real time.

Simultaneous with this objective state project was another project going on regarding the quality management of the road weather system. That study dealt with the accuracy and reliability of the system and data.

Road Weather Station Data from Neighboring Countries

It is important for road maintenance planners to see what kind of weather and road conditions there are outside Finnish borders in order to predict the forthcoming conditions and actions needed. Therefore the road weather station data from some stations in Sweden, Norway, Estonia, and Russia should be collected for the Finnish system. The data should be integrated in the system so that the planners can see it in the same manner as the data from the Finnish stations.

Road Conditions and Short-Term Forecast Data from Contractors to the Administration

During the project it was noticed that the process and applications for delivering road conditions and short-term forecast data from the contractors to the administration are not working well. However, the situation was found to be so complicated that it was impossible to define a final objective for this matter. Therefore, it was suggested that this issue be further investigated in a new project. However, there were some preliminary statements made regarding how this process should work.

Finnra has to receive reliable data on the current road conditions and short-term road weather forecasts from the contractors. The contractors can deliver this information to the road weather system directly with an interface application provided by the administration or from their own systems to an open data exchange interface.

The contractors operating at areas where there are road sections with VMS are obliged to report how the traffic control system is working. They should inform the administration's traffic centers if the speed limits and other information shown on roadside are not inconsistent with their opinion on the current conditions.

Storage of Weather Camera Pictures

The weather camera pictures are stored for at least a week after the picture is taken. During that time it is easy for the users to pick up the needed picture from the storage. This gives enough time for the road maintenance quality control to make a quality analysis of different situations. In addition to that short-term storage, all the pictures are permanently stored to a mass memory.

Data Delivery Service

All the road weather information is delivered to the users through the Road Administration's new integrated data delivery service. The road weather system will be integrated into the data delivery service. This will make it possible for the user applications inside and outside Finnra to access all existing data easily.

Means and Methods for Analyzing Data

Summaries and analysis will be produced from different weather and road weather data. One need for this is in the area of road maintenance management. There is a need for calculating summaries from different sources of data. For example, the rain data from road weather stations can be combined with the radar images in order to capture the most reliable information and the best coverage of the current road weather situation. Another example is the estimation of slipperiness based on the road weather station data about road surface and air temperatures, change in the dew point, and wind speed.

More advanced analysis is also needed for road maintenance quality control. Based on the data from road weather stations, alarms can be produced to notify in real time quality control personnel or the persons analyzing the performance afterward in certain situations. By processing the data, it must also be made sure that the weather data can be combined with the road maintenance data at quality control.

Means for Presenting Data to Users

This new part is closely connected with the previous section on data analysis. The improved information has to be presented to the users in a way that is easy to understand and that supports their work.

The summary information and illustrations are presented mainly to the road maintenance planners. At the road weather web interface the planners will have more choices to select for themselves what kind of summaries will be presented. For example, pictures and text information can be combined in the same image.

The road weather information needs for maintenance quality personnel are different from those of road maintenance management personnel. As the information presentation has traditionally been developed for management purposes, the presentation does not fully meet the requirements of quality control. Therefore, new forms of presenting the information have to be developed. In addition, the road masters responsible for real-time quality control need mobile access to the weather information. Also, education on the usage of road weather information is needed, especially for quality control personnel.

Road Weather Station and Weather Camera Metadata

More and improved metadata is needed from both road weather stations and weather cameras. Metadata are background information on the data that the stations and cameras produce. The metadata are needed especially for road maintenance quality control. Examples of the most important metadata needed are the locations of stations and cameras, descriptions of the environment of the road weather station, and a classification of different weather camera pictures based on the camera angle. The metadata must be stored in databases so that user applications can utilize it.

IMPLEMENTATION PLAN

General

The implementation plan includes the projects needed to realize the new or improved parts of the objective state of the road weather monitoring system. The objectives, preliminary work plan, responsible parties, timetable, and rough cost estimate of each project were made. Figure 3 shows the projects, their overall time schedules, and cost estimates.

Improvement of Road Weather Stations and Camera Network

The aim of the project is to coordinate and follow the development of road weather stations and camera networks to the desired state. The project has two parts: (1) improvement of the road weather and camera network and (2) enhancement of the road weather station equipment.

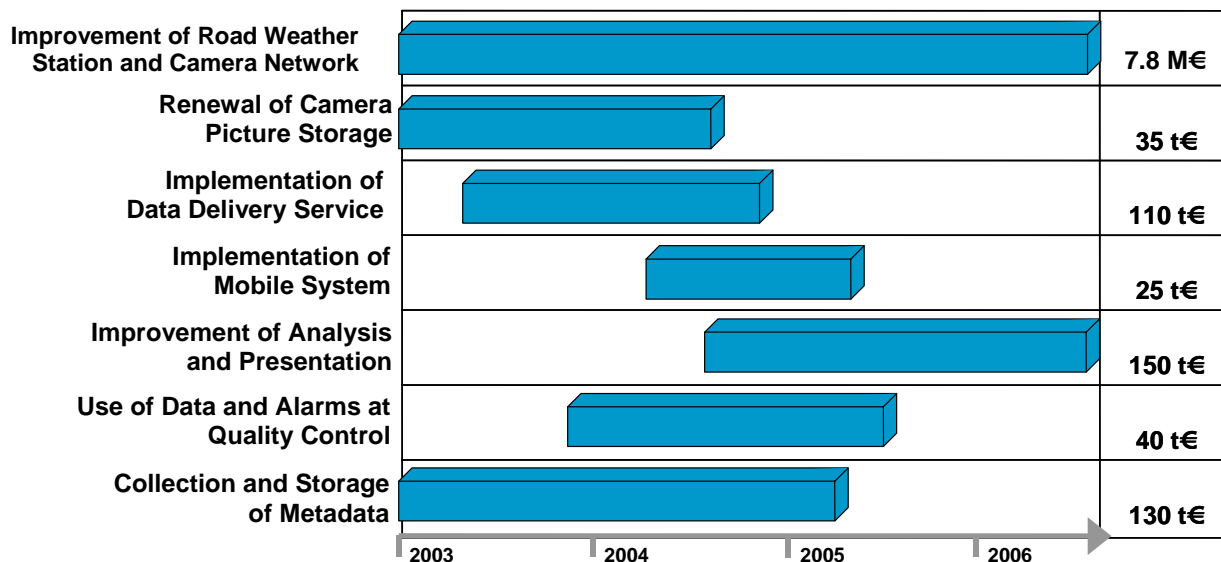

FIGURE 3 Implementation projects.

The actual development and enhancement happens at road districts of the administration. This project forms a cooperative forum for this work. The project also forms a common line for the development and follow-ups on progress.

The cost of the new road weather stations is €1.4 million, and the development of the equipment costs an additional €500,000. The cost of the new weather cameras is €1.3 million. Adding the air temperature measurement equipment to the weather cameras costs approximately €430,000. The enhancement of the network costs all together €3.6 million.

Currently, 210 road weather stations have old-version equipment. Updating the equipment to meet the objective state costs about €20,000 per station. Totally, this improvement costs €4.2 million.

The project will start immediately and progress so that the improvement of old versions will be completed by the end of 2005, and the projected coverage of monitoring will be reached by the end of 2007.

Renewal of Weather Camera Picture Storage

The aim of the project is to lengthen the storage time of road weather camera pictures to one week. This storage provides easy access to the pictures. The other aim is to implement permanent data storage for the pictures.

The project will be done in two phases. First, a functional and technical definition of 1-week and permanent storage will be made. Based on this, the storage will be implemented. This project is connected to the metadata development project and utilizes the data delivery service.

The cost estimate for the project is €35,000. The project started in 2003 and will be finished in early 2004.

Implementation of Data Delivery Service

The aim of the project is for all road weather data to be delivered centrally through the data delivery service of Finnra. The data delivery service is also used to collect road weather data from neighboring countries.

The project will be started with a functional definition phase that describes the functionality and implementation model for the road weather data based on this objective state definition. The road weather system will be then integrated with the data delivery service. The assumption is that the data will be collected from the present databases and data from other countries will be stored in the present databases.

The cost estimate for the project is €10,000. The project was to start during 2003, and the data delivery service will be operational by mid-2004. Additional resources have to be allocated for cooperation with neighboring countries.

Implementation of Mobile Service

The aim of the project is that road weather data can be delivered through mobile service to maintenance quality control field personnel. This project will utilize the data delivery service platform realized in the previous project.

The cost estimate for this project is €25,000. The project will be carried out simultaneously with the data delivery service definition phase, and the mobile communication will be implemented by the end of 2004.

Improvement of Analysis and Presentation

The aim of the project is to implement the objective concerning the analysis and presentation of road weather information.

The project will be started with a definition phase that describes data, analysis, and presentation. During the definition phase, which changes can be directly implemented by using the present system are defined, and which ones need further development of the system itself will be noted. This project will also give feedback to the road weather modeling and forecasting development project that will further investigate future possibilities.

The preliminary cost estimate is €150,000. The project will be started during 2004, the definition phase will finish by the end of 2004, and the project will end during 2005.

Use of Data and Alarms at Quality Control

The aim of the project is to tailor the information presentation and alarms produced from road weather station data to meet the needs of road maintenance quality control.

The project will start with a definition phase that sets the operational principles and describes how the data and alarms will be used in quality control. Based on the definitions, the alarms needed will be produced for the road weather system, and a new user interface will be implemented in the road weather web application. If major changes are needed to the road weather system they will be made with the improvements of the analysis and presentation project. The cost estimate is €40,000. The project will be done during 2004.

Collection and Storage of Metadata

The aim of the project is to collect and store the needed metadata from road weather stations and cameras.

The projects will be started by listing more precisely the needed metadata based on this study. The data will then be collected and produced for the road districts. At the same time, the metadata storage will be defined and implemented. The metadata should be stored to the same data systems as road weather station data and camera pictures so that the metadata can be also easily accessed through the data delivery service.

The preliminary cost estimate for this project is €30,000. The project should be realized so that the metadata could be utilized from the beginning of 2005.

Road Conditions and Short-Term Forecasts

In addition to the actual implementation projects, there is a need for a new study that defines the objective of road conditions data and short-term forecasts production. At the same time, the data needed about road maintenance actions should also be considered.

Development Projects

In addition to the implementation projects a number of development projects were proposed. The development projects will further investigate the issues that are not included in the objective but might become important to monitoring in the future. The most important future development items are road weather models and forecasts as well as floating car road weather monitoring.

The development of road weather models will lead to more reliable and precise forecasts needed especially for road maintenance management. Also, the effects of different road maintenance actions should be considered in the models. The possibilities to utilize a neural network in the models will be investigated. This development will be done in close cooperation with the weather forecast companies and the international community in the COST project. The development costs of modeling are estimated to €500,000.

The aim of floating car monitoring is to produce data that supplement the other sources and provide a wider picture of the conditions of the entire road section. This information is needed by road maintenance management and quality control as well by the information services. The floating car data would be needed especially during bad road conditions. However, the needs for these kinds of data are not yet precisely known. Finnra will study the needs and possibilities for the data in the future. From 2004 to 2007, the number of experimental floating cars also will be increased. The development costs for this area are estimated to be some €900,000.

The other development issues to be covered by making feasibility studies are

- Production of slipperiness estimates based on road weather station data;
- Measurement of cloudiness;
- Utilization of traffic speed and volume data at weather monitoring; and
- Automatic picture analysis to produce data and alarms from weather camera pictures.

CONCLUSION

This project defined the projected state of weather and road weather data monitoring for 2007. Also, an implementation plan was created to illustrate the actions needed to achieve the monitoring system.

In the study, we found that six main functions utilize the road weather data. These use cases defined the requirements for the objective. The most important new requirements to enlarge and improve the monitoring network came from the winter maintenance quality control use case. The most detailed requirements came from the traditional maintenance realization use case. In addition, the traffic control use case had its own requirements for those road sections with variable speed limits and information boards.

The present monitoring system meets many of the future requirements. The projected state is illustrated by defining the new and enhanced parts of the system at 2007. The new parts are the following:

- Enlarged and better-equipped road weather station and camera network,
- Receipt of and utilization system for road weather data from neighbor countries,
- Renewed storage system for road weather camera pictures,

- Centralized data transmission system for road weather data,
- Processing system to realize summaries and analyses as well as to produce alarms to road maintenance quality control,
- Improved information presentation system for analyses and road maintenance quality control, and
- System to process road weather station and camera metadata.

The estimated cost of the road weather station and camera network enlargement and improvement project is €7.8 million. The total costs of other realization projects are €490,000.

The most important future development items are road weather models and forecasts as well as floating car road weather monitoring. The development costs for these are together about €1.5 million.

The definition of the implementation plan are tools for developing the monitoring system. After this project Finnra has started planning a road maintenance Tema program, in which one of the themes is improvement and enlargement of traffic and road weather monitoring. This program will help to fund the most important part of the projected system. Also, the integration of the road weather system to the centralized data delivery system is ongoing. This will also help in receiving road weather station data from neighboring countries.

ACKNOWLEDGMENT

The project has been granted European Community financial support in the field of trans-European networks–transport.

REFERENCES

1. Lähesmaa, J., and J. Levo. *Tiesäaseurannan tavoitetila* [Objective state of road weather monitoring]. Finnish Road Administration, Kouvola, Finland, 2003.
2. Kulmala, R., and S. ja Luoma. *VIKING Monitoring Guidelines 2002*. Euro-Regional Project VIKING Version 0.7. Commission of the European Union, Directorate General for Energy and Transport, September 2002.

WINTER WEATHER: INFORMATION, MODELS, AND DATA QUALITY

The Winter Model

A Winter Maintenance Management System

CARL-GUSTAF WALLMAN

Swedish National Road and Transport Research Institute

Road users are concerned with ice and snow on roads and streets. The main problems are increased accident risk and impaired accessibility. To prevent—or at least decrease—the difficulties, road administrators perform various maintenance actions. The actions are advantageous for road users but involve costs for the road administrators and negative effects for the environment. To optimize maintenance efforts, the use of management systems should be applied. The winter model project will result in a model for assessing the most important effects and the monetary value of alterations to winter maintenance strategies and operations in Sweden. The effects are assessed for road users, road administrators, and the environment.

For road users, the main effects concern accessibility (in terms of vehicle speed and flow) and safety. By using simultaneous monitoring of road surface conditions and traffic, the relationship between speed and different roadway conditions has been established. The speed reductions due to seven specified roadway conditions (moist, wet, ice, or snow) relative to the speed at dry bare conditions are generally significant. The reduction can be as great as 20%. No relationship for traffic flow could be established.

The average accident rate (accidents per million vehicle kilometers) during a winter season can be 16 times larger in black ice conditions than in dry road conditions. The accident rate in ice and snow conditions has an exponential relation to the duration of the condition—for example, the shorter the duration, the higher the accident rate.

INTRODUCTION

Every year road users are concerned with ice and snow on roads, streets, and pedestrian and cycle lanes. The main problems are increased accident risk and impaired accessibility. To prevent, or at least decrease, the difficulties, road administrators perform various maintenance actions, such as snow plowing or skid prevention.

The actions are advantageous for road users but involve costs for the road administrators and negative effects for the environment. To optimize maintenance efforts (or at least enable making sufficiently good choices), the use of management systems should be applied.

Investment planning of highways and streets has long included models for estimating different effects: beside costs for planning and construction, changes in traffic generation, travel times, accident risks, and so on have been modeled.

The field of road maintenance and operations is in this respect very neglected, being a weakness when competing for funds within a limited budget. This is valid not least for winter maintenance and operations.

The winter management of Swedish national roads is governed by technical directives, by “Drift 96” until the winter season of 2001–2002 (1) [the previous description “Drift 94” also in

an English version, “Operation 94” (2)], and from now on by “Vinter 2003” (3). The documents state strict, functional requirements for lanes, shoulders, bus stops, and so on, associated with prevailing snowfall, slipperiness, and other circumstances.

One deficiency of the regulations is that the effects of the actions can be estimated only for the road administrator (at least the direct costs), while the effects for road users and the environment can be accounted for to a very limited extent. Doubtless, the rules are established on estimations of road user and environmental effects acquired by experience, but since winter road maintenance is financed in competition with other public activities, it should be motivated by objective, socioeconomic arguments. In addition, the maintenance measures are undertaken to improve the conditions for the road users, making well-founded effect assessments still more important.

The winter model project, cofinanced by the Swedish National Road Administration (SNRA) and the Swedish Agency for Innovation Systems, was realized in cooperation between VTI and Klimator AB (a knowledge corporation at the University of Gothenburg). The project will result in a model for assessing the most important effects and the monetary value of alterations to winter maintenance strategies and operations. The effects are assessed for road users, road administrators, and environment.

STRUCTURE OF THE WINTER MODEL

The structure of the model appears in [Figure 1](#). The relations between weather, traffic, maintenance actions, and road conditions are illustrated.

The winter model consists of submodels for assessing the state of the road—which is the key to all other models—the effects and their monetary value, and the optimization. For some of these submodels, relevant variables and effect relations are known, but there are many areas in which far more knowledge is required, knowledge that can be attained only by assiduous effort.

In the model, the weather throughout a whole winter season is defined by the Road Weather Information System (RWIS) and other data on an hourly level. The data may be derived from any real winter or be estimated for an average winter. Thereafter, the roadway condition can be calculated for every hour, influenced by the prior roadway condition, weather, actions, and traffic. Subsequently, the effects for road users, road administrator, and the environment can be assessed and valued in the respective models.

In this paper, the accessibility model and the accident risk model are treated.

DEFINITIONS AND EXPLANATIONS

Road traffic accessibility denotes

- Mean speed by the hour (km/h) and
- Flow (number of vehicles per hour).

With respect to the lengths of the winters in different parts of the country, Sweden is usually divided into four climate zones: Southern, Central, Lower Northern, and Upper Northern Sweden. See [Figure 2](#).

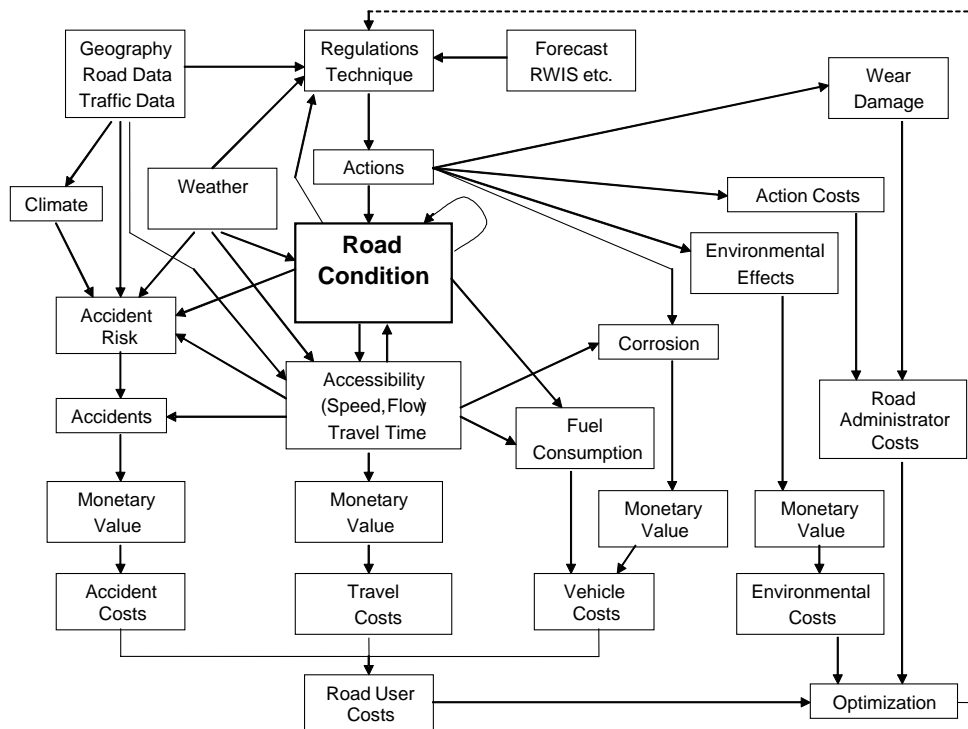

FIGURE 1 Flowchart of the winter model.



FIGURE 2 The four climate zones of Sweden.

The roadway conditions are divided into 18 categories (for the accessibility model), described as follows:

- Dry, moist, or wet bare ground; whenever applicable with a strip of snow or ice in the middle of the road;
- Temporary conditions: hoarfrost (HF) or black ice (BI);
- Stable conditions: hard-packed snow (HP) or thick ice (THI);
- Variable conditions: loose snow (LS) or slush (SL);
- Rutted conditions: with bare ground in the ruts R(B) (three cases, outside the ruts: stable, variable, or other/mixed layers); and
- Rutted conditions: with black ice in the ruts R(BI) (three cases, as above).

Rutted conditions develop when ice or snow layers are worn down to the pavement in the wheelpaths; then the only possible conditions in the ruts are either bare ground or black ice.

Accident rate (also called accident risk) is expressed as the number of accidents per million vehicle kilometers. All accidents reported by the police are used, with the exception of accidents including wildlife. Assessments of accident rates distinguish between the following five road conditions (according to the police reports):

- Dry bare ground,
- Moist or wet bare ground,
- Hard-packed snow or thick ice (unsteady),
- Black ice or hoarfrost, and
- Loose snow or slush.

The duration of a certain icy or snowy road condition refers to its share of the total vehicle mileage throughout the winter season.

Six standard levels for operation are defined by SNRA: A1–A4, and B1–B2 (1). For skid control, the A-level road network is salted, while, as a rule, the B-level network is not salted. A1 is the highest standard on salted roads, and B1 is the highest standard on unsalted roads.

ACCESSIBILITY MODEL

The model describes the relationship between weather, traffic, maintenance actions, road condition, and vehicle speed and flow. The model was presented in a paper to the Ninth Maintenance Management Conference in Juneau, Alaska, July 2000 (4).

Data Capture

The effect of ice and snow on the roadway on traffic speed and flow is not well understood, mainly because conditions vary or may exist only for a short period. A successful assessment of the effects calls for very close monitoring of the state of the road and of the weather.

Vehicle speed and flow were recorded as average values by the hour. The measuring equipment included inductive loop sensors, to ensure good performance under any road surface condition. Three vehicle categories were distinguished: passenger cars, trucks with no trailer (including buses), and trucks with a trailer.

Weather data were captured from road weather information system stations and slightly processed. The following data were acquired hourly: air temperature, road surface temperature, precipitation quantity, wind direction and force, and weather situation—fair, rainfall, snowfall, blowing snow, and risk for slipperiness due to freezing rain or frost.

Road conditions were monitored by visual observations, from twice a day up to once per hour. The state of the road was defined as either changeable or steady. Changeable conditions prevailed when there was precipitation or when the road was wet, moist, or covered with loose snow, slush, hoarfrost, or black ice. Under these circumstances, observations were made every hour (from 6 p.m. to 8 a.m.). Steady conditions prevailed in fair weather and with dry, bare road, or if the roadway was covered with hard-packed snow or thick ice. In this case only two observations per day were necessary.

Data were obtained at 11 sites in all climate zones except Southern Sweden. The widths of the roads were between 6 and 9.5 m (20 to 31 ft). The annual average daily traffic for the roads varied between 1,000 and 3,300 vehicles. Six roads belonged to the salted network, and five belonged to the unsalted.

As a rule, each site was studied for two winter seasons.

Data Processing and Analysis

A custom-made database manager was developed for loading traffic, weather, and observed data into a database.

Instead of relying on the usual regression analysis, a new method of evaluation was developed. The underlying concept was to match pairs of hours in which only the weather and surface conditions differed. For dry road conditions, both members in a pair should have close to equal traffic conditions (speed level and number of vehicles). Consequently, daily, weekly, and seasonal variability was taken into account.

Briefly, the statistical analysis comprised a regression analysis of the result of all matched pairs, and relating the differences to the speed and flow at dry bare surface conditions. The statistical method is published in Wiklund (5).

Results

The outcome of the analysis shows significant speed reductions for icy and snowy roadways and also different reductions for the various ice and snow conditions defined above. Generally, moist or wet conditions give less reduction than ice or snow conditions. Concerning variations in the traffic flow, no relation could be established with the roadway conditions.

The results for the speed reductions are shown in [Tables 1](#) through [3](#). The data from all sites are aggregated and generalized to ensure more reliable and consistent results. In the tables, the reductions are related to (1) the climate zones, (2) salted or unsalted roads, and (3) the width of the roads, in two categories. Thus, the results may be used under different assumptions.

The speed reductions are expressed as percentages of the speed on dry bare roadway.

TABLE 1 Decrease in Speed for Different Road Conditions and Different Climate Zones, Relative to Dry Bare Roadway

	Central Sweden			Lower Northern Sweden			Upper Northern Sweden		
	PC	TNT	TWT	PC	TNT	TWT	PC	TNT	TWT
Moist	1	1	1	1	1	1	1	2	2
Wet	2	2	2	2	2	2	2	3	3
HF/BI	10	9	8	8	7	6	6	5	4
PS/THI	20	19	15	16	15	7	9	8	5
LS/SL	17	16	9	14	13	6	11	11	5
R(B)	8	8	6	6	6	5	5	5	4
R(BI)	12	11	10	10	8	7	7	5	4

NOTE: PC: passenger car; TNT: truck without trailer; TWT: truck with trailer.

TABLE 2 Decrease in Speed for Different Road Conditions on Salted and Unsalted Roads, Relative to Dry Bare Roadway

	Salted Roads			Unsalted Roads		
	PC	TNT	TWT	PC	TNT	TWT
Moist	1	1	1	3	3	3
Wet	2	2	2	4	4	4
HF/BI	9	8	8	6	5	5
PS/THI	19	18	16	12	12	10
LS/SL	16	15	10	11	11	7
R(B)	7	7	5	5	5	4
R(BI)	11	9	9	7	6	5

NOTE: PC: passenger car; TNT: truck without trailer; TWT: truck with trailer.

TABLE 3 Decrease in Speed for Different Road Conditions on Roads with Different Widths, Relative to Dry Bare Roadway

	Width 6–7.9 m (20–26 ft)			Width 8–9.5 m (26–31 ft)		
	PC	TNT	TWT	PC	TNT	TWT
Moist	2	2	2	1	1	1
Wet	3	3	3	2	2	2
HF/BI	8	7	7	7	6	6
PS/THI	19	18	15	15	14	10
LS/SL	16	15	11	13	12	7
R(B)	7	6	6	6	5	5
R(BI)	10	8	8	9	7	7

NOTE: PC: passenger car; TNT: truck without trailer; TWT: truck with trailer.

THE ACCIDENT RISK MODEL

The underlying hypotheses for the accident risk model are that the risk varies between the different ice and snow road conditions specified above and that it differs between the climate zones of Sweden, because the more common wintry conditions are, the better drivers adapt to the situation. A subsequent hypothesis is that the less duration a certain ice or snow condition has throughout the winter season, the higher the risk (6).

Another hypothesis is that the accident rate is higher for early and late parts of the winter, compared with the rate for the midwinter (7).

To estimate the accident rate in a specific ice or snow condition for a certain road network, two data must be known: the number of accidents in the road condition in question and the vehicle mileage in that condition. There is a major problem in collecting data for the vehicle mileage: the duration of icy and snowy conditions is often very short, and calls for close observations of the road network throughout the winter season.

Data Capture

SNRA monitored the roadway condition all over Sweden in the four winter seasons of 1993–1994 to 1996–1997. The intention was to check the performance of the winter maintenance contractors. The observations were made at about 2,000 sites on the national road network with a frequency of about one observation per site and week. From the data it was possible to estimate the distributions of the different roadway conditions under the four winter seasons. Roadway condition data were aggregated for road networks: grouped into the four climate zones and into

the different standard levels of operation. Finally, the vehicle mileage in each roadway condition could be estimated.

The accidents reported by the police during the four winter seasons were used, grouped into the reported roadway condition at the accident. The accidents were linked to the same road networks as the roadway conditions.

Results

The average accident rates vary between the different ice and snow conditions and between the climate zones, as was stated in the first two hypotheses. However, the differences between the climate zones also apply for the rate for dry bare roadway. An explanation for this could be that the extents of police reports vary between the climate zones; for example, Upper Northern Sweden is very sparsely populated, and one may suspect that the police have difficulties in traveling many miles for reporting a distant, minor accident.

As an example, the accident rates for the salted and unsalted road networks in Central Sweden are displayed in [Figure 3](#).

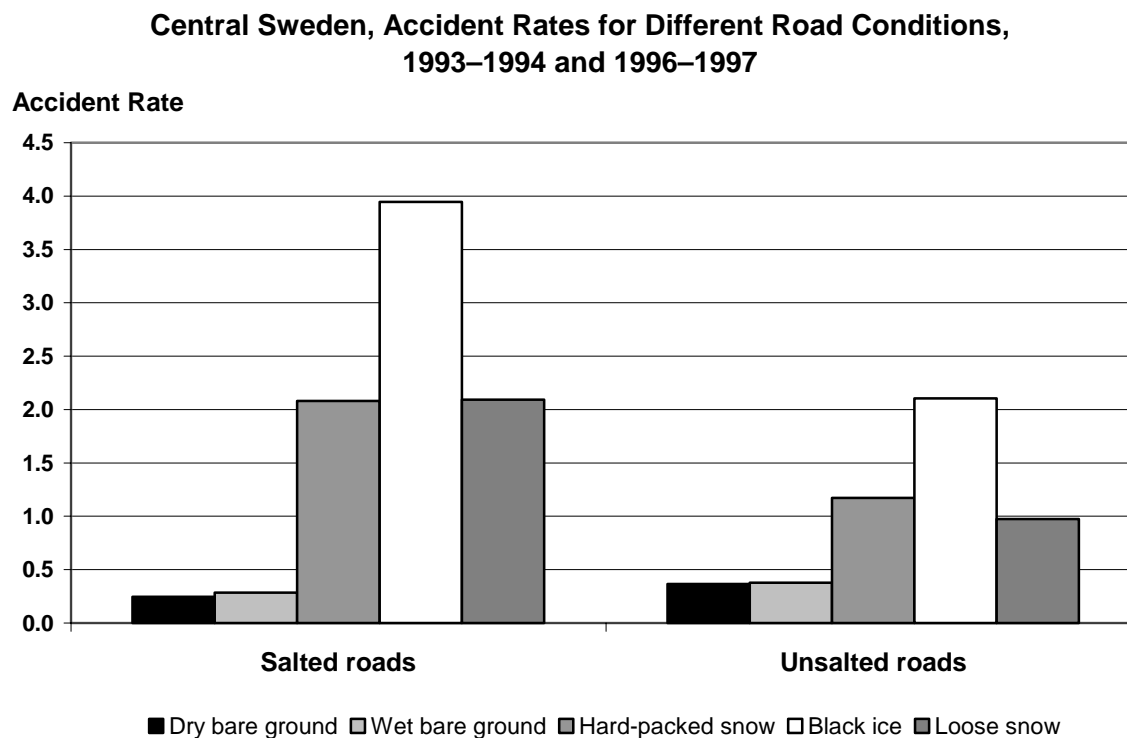

FIGURE 3 Average accident rates (accidents per million vehicle kilometers) for different road conditions, salted and unsalted roads.

The accident rates for ice and snow conditions are much larger for the salted network and still larger if the rates are related to the rate at dry, bare ground. For example, black ice is 16 times more dangerous on salted roads, but “only” about 6 times on unsalted roads.

An interesting question is whether the accident risk is always the same for each ice and snow condition or if the risk varies with the duration of the conditions (the third hypothesis mentioned above).

Assume that the accident rate has two levels, one for ice and snow and another for bare ground conditions. Some part of the vehicle mileage during the winter season runs on ice and snow, and some runs on bare ground. What will happen if the maintenance effort is improved?

The striped area in [Figure 4](#) shows the effect of improved maintenance. The vehicle mileage is decreased on ice and snow. The optimistic model states that the accidents decrease by a number, corresponding to the area of the striped square. Conversely, the accident rate on ice and snow may increase, because drivers will have fewer occasions and less time for adapting their driving behavior to icy and snowy conditions. If this is the case, the accidents increase on ice and snow corresponding to the striped area in [Figure 5](#).

A possible hypothesis is that improved maintenance will result in fewer accidents but not to the full extent like in [Figure 3](#).

For testing this hypothesis, the same set of data as before can be used. The result shows an exponential relation between the accident rate and the duration for each of the three different ice and snow conditions. Like the average accident rates, this result varies between the climate zones. [Figure 6](#) displays the result from Central Sweden.

The relative duration denotes the vehicle mileage on the particular ice and snow condition related to the total vehicle mileage throughout the winter season. Roughly, the number 0.01 corresponds to the duration of about 2 days of the winter season.

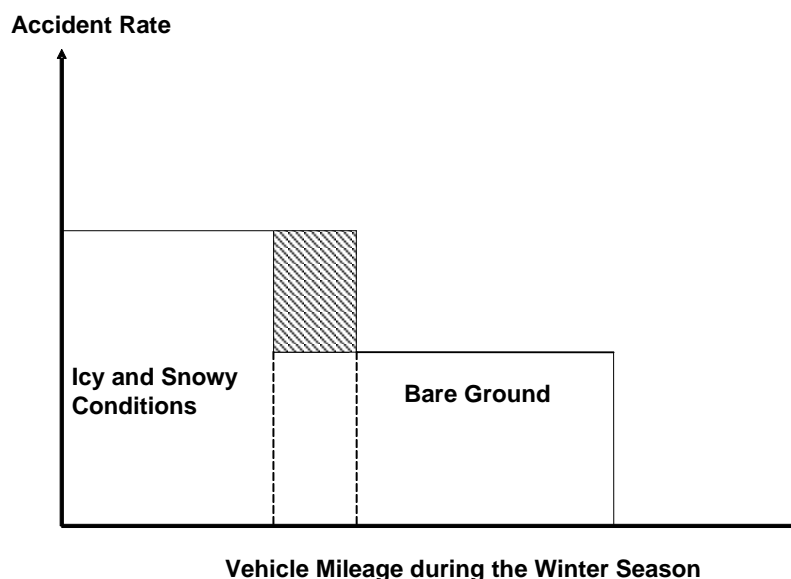

FIGURE 4 The optimistic model.

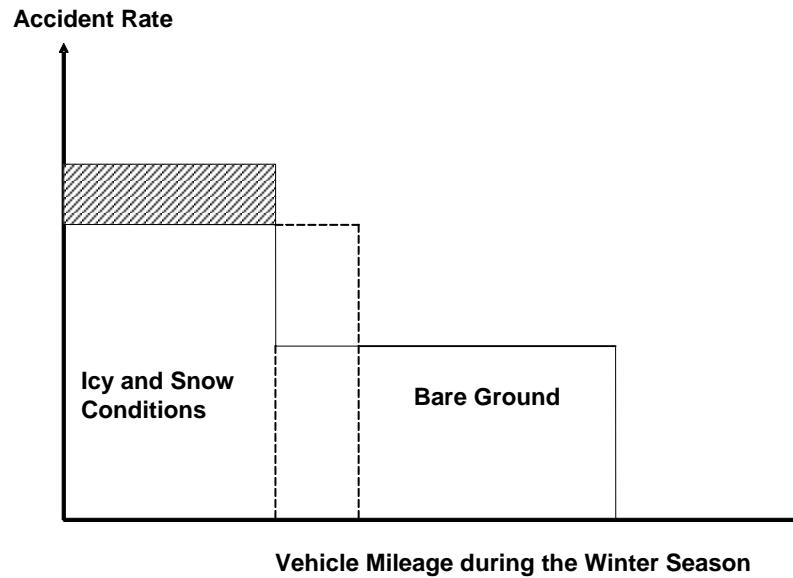

FIGURE 5 The pessimistic model.

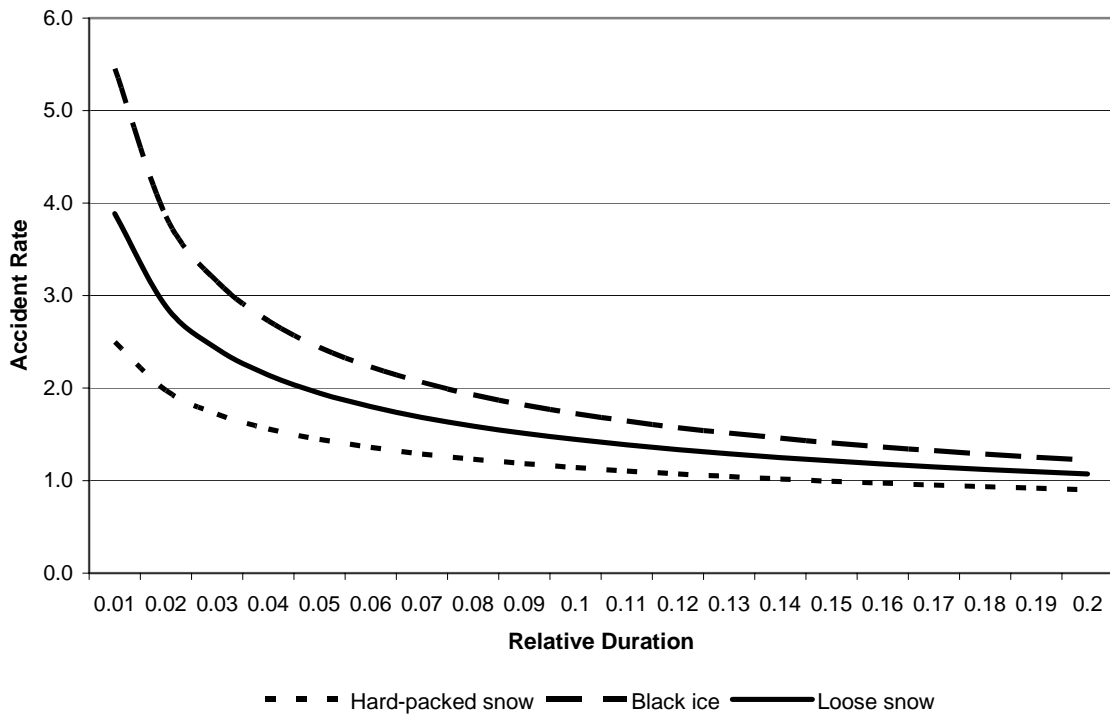

FIGURE 6 The accident rate (accidents per million vehicle kilometers) as a function of relative duration for three ice and snow conditions.

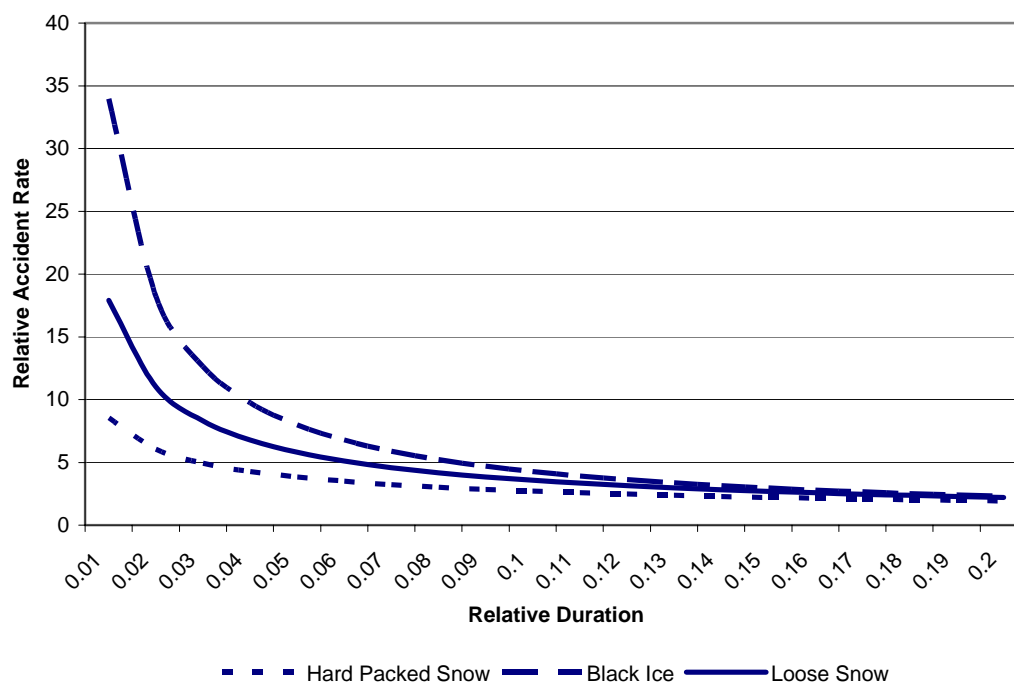

FIGURE 7 The relative accident rate (relative to the rate at dry bare road) as a function of relative duration for three ice and snow conditions.

If the accident rate functions are related to the rate at dry bare conditions, the relations are found to be valid for all climate zones. In Figure 7, the relative accident rates are shown and valid for all of Sweden.

The fourth hypothesis, if the accident rates at early and late winter periods are larger than that for the midwinter, was tested by assessing accident rates for early and late winter periods, with varying length—2, 3, and 4 weeks respectively. Generally, the results show considerably increased accident rates at early as well as late winter periods, and the earlier and later, the higher the rates. However, the variations were so large between the climate zones and between the different road conditions that no average values seemed to be relevant.

ACKNOWLEDGMENT

The development of the Winter Model is cofinanced by the National Swedish Road Administration and the Swedish Agency for Innovation Systems.

REFERENCES

1. Vägverket (Swedish National Road Administration). *Drift 96: Allmän teknisk beskrivning av driftstandard*. Publ.1996:16. Borlänge, Sweden, 1996.
2. Vägverket (Swedish National Road Administration). *Operation 94: General Technical Description of Operation Service Levels*. Publ.1994:100. Borlänge, Sweden, 1994.
3. Vägverket (Swedish National Road Administration). *Vinter 2003: Val av vinterväghållningsstandard*. VV Publ 2002:147. Borlänge, Sweden, 2002.
4. Wallman, C. G. Vehicle Speed and Flow in Various Winter Road Conditions. In *Conference Proceedings 23: Proceedings of the Ninth Maintenance Management Conference*, TRB, National Research Council, Washington, D.C., 2001, pp. 159–166.
5. Wiklund, M. *Pair Comparing Method*. VTI rapport 495A, Linköping, Sweden, 2003.
6. Wallman, C. G. *Tema Vintermodell: Olycksrisker vid olika väglag*. VTI note 60-2001, Linköping, Sweden, 2001.
7. Bergström, A. *Tema Vintermodell: Olycksrisker under för-, hög- och senvinter*. VTI note 19-2003, Linköping, Sweden, 2003.

WINTER WEATHER: INFORMATION, MODELS, AND DATA QUALITY

Forecasting Terrain-Dependent Weather Conditions*Details of a Model Chain Sequence***L. R. MCKITTRICK****E. E. ADAMS***Montana State University–Bozeman***P. GAUER***Norwegian Geotechnical Institute***J. MEWES***Meridian Environmental Technology, Inc.***A. R. CURRAN***ThermoAnalytics, Inc.*

To forecast terrain-dependent weather conditions with a focus on hazardous road conditions (such as icing and high winds), a model chain has been developed. In this chain, a series of three weather modeling programs have been linked together, successively nesting the mesh of one regional model inside another. The three programs in use are Eta, with computational analysis provided by the National Center for Environmental Prediction (NCEP); ARPS (Advanced Regional Prediction System), with computational analysis provided by Meridian Environmental Technology; and RadTherm/RT, with computational analysis provided by Montana State University (MSU).

Once Eta data are available, they are downloaded from NCEP servers to Meridian servers and used to run a sequence of ARPS models, to represent terrain-dependent changes in the meteorological conditions down to resolutions of 1 km. As each analysis progresses, successive forecast conditions are written to files and passed to computational servers at MSU. At MSU, these meteorological files are used to define environment conditions (such as long- and short-wave radiation, cloud cover, precipitation, and convective effects) in RadTherm. Successive downloads are then used to run RadTherm models somewhat in parallel with, though slightly behind, each ARPS forecast.

As successive forecast models become complete, forecast data are graphed alongside real-time measured data and posted on the Internet. To allow viewers to evaluate the validity of the current forecast, graphs corresponding to weather station sites are updated hourly, typically by extracting measured data from websites associated with the given station. These same data sets can then be compared on a weekly basis for long-term performance evaluation and improvement.

INTRODUCTION

With improvements in technology, traveler's expectations have increased. These expectations include improved winter road maintenance and road weather information. To meet these expectations in mountainous terrain, forecast models have to be refined to include terrain-dependent aspects of weather and storm behavior. Examples of features that create terrain-dependent behaviors are mountain passes and canyons. These features can create significant changes in wind magnitude and direction along with changes in available longwave and shortwave radiation. Due to the significant variations in road weather often associated with these terrain features, mountain passes and canyons both have the tendency to serve as bottlenecks for highway travelers. To mitigate hazards and delays, both maintenance personnel and travelers need to be forewarned of likely road weather hazards.

The focus of this project has been on the development of a model chain that can both be run in forecast mode, and can provide forecasts of terrain-dependent weather hazards (see paper by Adams, McKittrick, Gauer, and Curran in this circular on pages 424-456). Because such weather models will always have some inaccuracies, it is also necessary to provide a source of real-time validation. With the intent of improving these models, it is also necessary to archive data for postcast analysis of bias and trends. These postcast analyses can then be used to establish levels of certainty (or uncertainty) and possible sources of error in the forecasts (to be used for model improvements).

Because local terrain dependent forecasts should not be created without accounting for larger scale weather systems, data must be passed from larger-scale forecast models to the smaller-scale models. Correspondingly, each model must be nested inside the area modeled by the previous larger-scale model in the chain. To accomplish this in an accurate fashion, the change in resolution (size of grid element) from one model to the next cannot be too large. At the same time, the number of models in the model chain must be minimized in order for each analysis to be completed in a timely fashion and yield a forecast.

For 2003, the following sequence of programs was used for this model chain. Eta, with computational analysis provided by the National Center for Environmental Prediction (NCEP), served as the first link. The Advanced Regional Prediction System (ARPS), with computational analysis provided by Meridian Environmental Technology, was used for the second and third links. RadTherm/RT (RTRT), with computational analysis provided by Montana State University (MSU), was used for fourth link in this computational modeling chain. Eta provides a continental scale forecast, ARPS a mesoscale forecast, and RadTherm a microscale forecast. Notice that each program in the chain requires a different expertise and is therefore, more or less by necessity, run by a different provider. The next section provides a detailed overview of the sequence used for generating these road weather forecasts.

FORECAST SEQUENCE

For the spring of 2003, NCEP provided Eta forecasts every 6 h, starting at 00Z, 06Z, 12Z, and 18Z each day. Using the 24-h (military) convention, these times refer to the hour of the day in the coordinated universal time (UTC) zone, also known as the Greenwich mean time (GMT) zone or the Zulu (Z) time zone. As an example, 18Z refers to 6 p.m. in GMT and 11 a.m. in mountain standard time (MST). Due to availability of more accurate data for the initialization of

the 00Z and 12Z analyses, these forecasts were typically considered more reliable. At the same time, 12-h updates were deemed sufficient for the road weather forecasts. With this configuration (presented in Figure 1), NCEP gathers and compiles meteorological data (M) for the first 1.5 h of the forecast period (fcp), and uses the data to initialize Eta. The mesh for the Eta model covers the North American continent, extending well into the Pacific and Atlantic oceans. Eta then runs from 0130Z to 0300Z of a 00Z forecast. Eta is run using a 12-km resolution or cell size. This data set was too large to be downloaded in a reasonable amount of time with standard T1 Internet connection. The output data were then mapped (interpolated) onto a transfer grid (Lambert conformal transfer grid Eta 218) with a 20-km resolution. Results for this transfer grid were then downloaded and used to initialize the ARPS 20-km resolution model (ARPS20) at Meridian. The ARPS20 model then ran from approximately 0300Z to 0530Z for the 00Z forecast. Though this may seem like a redundant step, this ARPS20 analysis was used to smooth out errors both from the grid transfer and from the corresponding transfer of data into the ARPS model. Because the ARPS model includes additional principles that account for smaller-scale turbulent effects and terrain features, the resulting output is assumed to be more accurate. Output from this model is then used to initialize the ARPS 3 km resolution (ARPS3) model, which runs from roughly 0530Z to 1200Z. This analysis was the most time-consuming component in the chain.

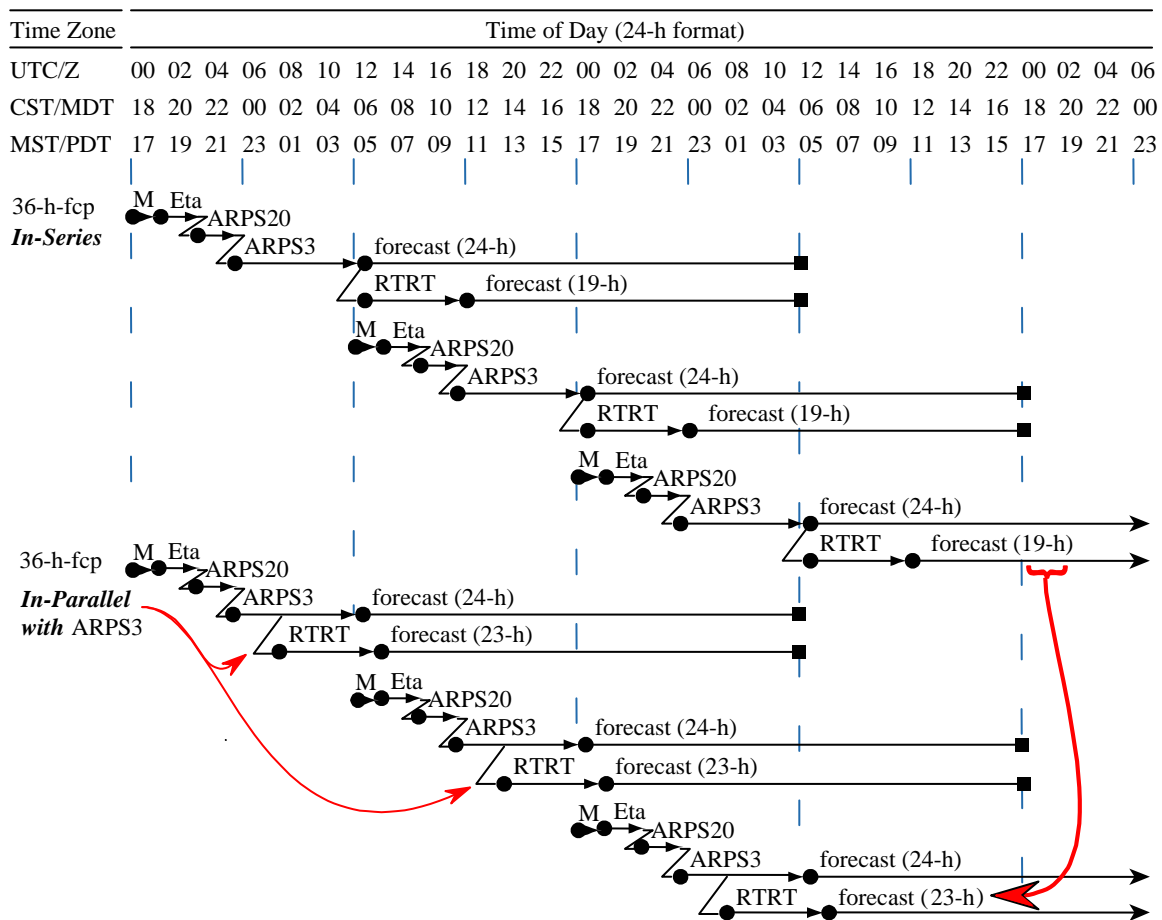

FIGURE 1 Model chain sequences for 2003 road weather forecasts.

For the in-series sequence used in the spring of 2003, data were not passed to the last model in the sequence, RTRT, until the ARPS3 run had been completed. Unfortunately, because each model waited until the previous model had completed before starting, the resulting forecast was at best 19 h into the future and at worst (just before the next forecast completed), about 7 h into the future.

To extend the pavement temperature forecast (starting in the fall of 2003), routines were modified to allow data to be passed successively from Meridian to MSU's Western Transportation Institute and used as input for RadTherm while the ARPS3 model was running. By passing data periodically, the RTRT model was typically able to start at 0800Z, stopping to wait periodically for additional data, and finishing typically at about 1300Z. By running the two models in parallel, the pavement forecast finished approximately 4 h earlier, extending the pavement temperature forecast from ~19 h to ~23 h. At the same time, because the model forecast analysis was broken up into shorter segments, much of the forecast data was available before the model had completed. Therefore, the worst case forecast was typically 12 h or more into the future, a big improvement over the 7 h in the previous sequence. One unfortunate consequence of these model chains is when one model in the chain generates an inaccurate forecast or fails, the rest of the models in the chain are affected. Again, this requires a balance between the quest for accuracy and need for a timely solution. In each of these forecast models, analysis step sizes were set to yield generally stable solutions under typical weather conditions, while setting them as large as was deemed reasonable to shorten run times. Periodically, extreme weather conditions introduced nonlinearities that led to instabilities and hence nonconvergent solutions. Unfortunately, when such instabilities do occur, that model and hence all subsequent models in the sequence yield no usable output or forecast for that forecast period. Fortunately, these failures were minimized with experience. Each forecast sequence is executed in an ordered progression and monitored for errors via a set of Practical Extraction and Reporting Language (PERL) scripts. These scripts have been written to work with run-time delays, which are often due to model convergence problems from highly nonlinear forecast conditions. Various strategies have been used to keep the forecast sequence as robust as possible.

For completed forecasts, the dominant question becomes, How much faith can the user put in the data? This question can be divided into two parts. First, in the short term, how well does the early part of the forecast match current conditions? Second, in the longer term, how well does this model perform in general? Tools for answering these questions are discussed in the following sections.

SHORT-TERM VALIDATION TOOLS

Because forecast models are initialized from measured meteorological data, in the time it takes the model to run, the time period corresponding to the initial part of the forecast overlaps with now measured data. If the forecast models have each in turn been properly initialized and are able to forecast current conditions, then modeled data should match measured data for this initial time period reasonably well.

PERL scripts are used to download measured data that are posted on the Internet for different stations in the forecast area. In the process, some measured data are filtered to remove

noise or unreasonable values. In 2003, stations used for validation included road weather information station (RWIS) sites, along with sites administered by the National Weather Service, airports, ski areas, and the Gallatin National Forest Avalanche Forecast Center. At the beginning of every hour, measured data are downloaded and graphed along side forecast data, when available. As an example, consider comparisons shown in Figure 2. In Figure 2a, forecast temperatures are compared with measured temperatures for an RWIS site at the top of Bozeman Pass, which is just east of Bozeman, Montana. In this case, the forecast extends approximately 21 h beyond current conditions. In this graph, the forecast air temperatures and dew-point temperatures are based on the ARPS3 forecast. The road surface temperature forecast is based on results from the RTRT model. The measured data for this graph are updated at the beginning of each hour, as with all other graphs corresponding to sites with measured data. The next forecast set is then updated as the analysis of the next model chain progresses.

In Figure 2b, forecast estimates of shortwave (solar) and longwave radiation are measured incoming radiation for the same RWIS site. Here, the forecast components of incoming radiation are all taken from the ARPS (ARPS3) forecast. Note that measured components of incoming radiation are not available at most meteorological sites. These sensors have been added to the Bozeman Hill RWIS site primarily to provide data for this project. Differences in the incoming shortwave and longwave radiation, not too surprisingly, can cause large differences in the forecast surface temperatures. Additionally, variations in radiation due to changes in cloud cover are difficult to forecast accurately. By viewing these comparisons, particularly with a little experience, it is not difficult to identify possible sources of error. Additional data that are made available for evaluating forecast performance includes wind speed and direction, cloud cover fraction, relative humidity, precipitation rate, precipitation accumulation, and atmospheric pressure. Unfortunately, very few meteorological stations provide each of these items for validation, but they are all available from the forecast models and can be used to understand sources of error when measured data are available for comparison. Also, trends in the data serve as helpful indicators for more experienced weather watchers.

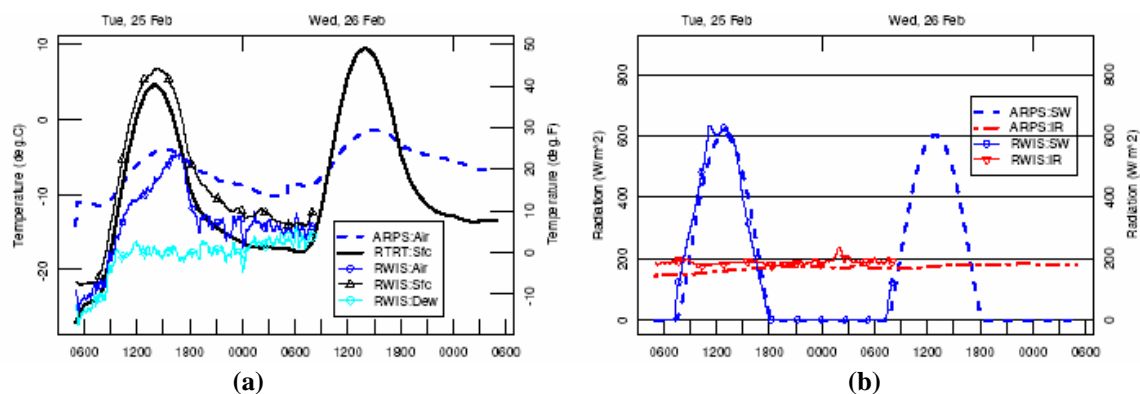

FIGURE 2 Comparison of forecast and measured data, to evaluate forecast initialization: (a) temperature comparisons and (b) radiation comparisons.

LONG-TERM VALIDATION TOOLS

To evaluate long-term performance when sufficient data were available, outcomes were evaluated on a weekly basis, as displayed in Figure 3. Unfortunately, because this project was still in the development phase in 2003, there were days when the forecast was flawed or measured data were not available from key meteorological sites. For the first day (Sunday, February 23), one of the mesoscale models did not run to completion. Therefore, no forecast was available for Bozeman Pass for February 23, 2003. Each forecast is typically initialized from the previous forecast, when it is available. Because the Sunday forecast was not available, the Monday RTRT forecast had to be initialized using the assumption of a “steady-state” thermal balance. Because this initialization took place in the early morning, the model started out with a road surface temperature forecast that was rather low. After the initialization phase, the model started to catch up and gave a reasonable forecast of road surface temperatures by midday.

Unfortunately, simple side-by-side comparisons of data are not very useful for evaluating repeated errors or biases in forecast models. In this case, it is more useful to evaluate the differences in forecast and measured data via statistical measures. Also, because some of these differences are driven by assumptions built into the forecast models that might become manifest only under certain conditions, it is necessary to be able to isolate these conditions as much as possible. An obvious example is the difference between daytime and nighttime temperature variations. Daytime temperatures are in large part driven by variations in incoming shortwave radiation. Nighttime temperatures are driven more by variations in long wave radiation. As a consequence, it is necessary, at the minimum, to be able to distinguish errors that occur during the day from those that typically occur at night.

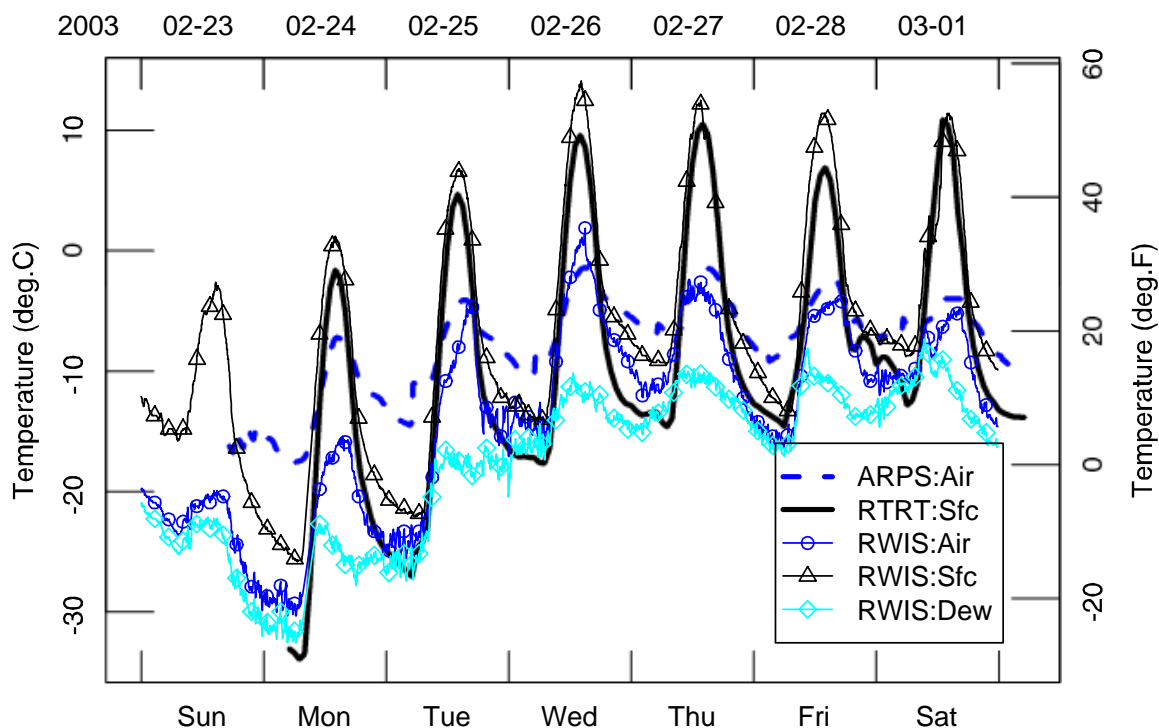

FIGURE 3 Weekly temperature comparisons, for long-term validation.

One approach for distinguishing these differences is to plot modeled outcomes against measured outcomes for 1 week at a time. When applied to temperatures, low temperatures can be assumed to occur predominantly at night, while high temperatures can be assumed to occur primarily during the day. By graphing data in this manner, it is possible to establish a level of correlation between the modeled outcomes and the measured outcomes.

Unfortunately, because measured outcomes are rarely recorded at consistent times, it is necessary to use an interpolation scheme to match data from one set to the other. The easiest approach is simply to use linear interpolation. This approach works well if the reference data set and interpolated data set are measured on nearly the same time intervals. However, if one data set is recorded on an hourly basis (as with some measured data sources) while the other is recorded on a minute-by-minute basis, then comparisons can be misleading, as variations from hour to hour typically do not occur in a linear fashion. Similarly, if hourly data are to be compared to data recorded at a much higher frequency that contains “noisy” variations, comparisons may also be misleading. Also, higher-frequency variations in the data will typically have a much weaker influence on roadway maintenance and travel. Therefore, it was deemed appropriate to smooth data sources to eliminate higher-frequency variations and then evaluate lower-frequency variations or trends in the differences between measured and modeled outcomes, particularly since, in most cases, the data recorded at the lower frequency intervals had already been averaged in some manner. Also, by smoothing data sets, the comparisons become more robust and less dependent on the frequency of the recorded outcomes.

To smooth and interpolate data recorded at a higher frequency (~1 to 3 min), for comparison with data recorded on at a lower frequency (~15 to 60 min), a Loess weighted average was used. For the Loess weighted average, a polynomial is fit to the local data, weighting the data near the point of interest much higher than that further away. The interpolated point is then based on the corresponding point on the Loess-based polynomial. Using this approach, the difference between modeled and measured outcomes can be displayed as a function of time (e.g., [Figure 4](#)). Notice that in this case, on the first 2 days, when the measured air temperatures dropped below -20°C , the ARPS3 model forecasted air temperatures approximately 10°C higher. This may illustrate a weakness in either the Eta or ARPS components of the modeling chain. At present, data are only extracted from the ARPS3 model for evaluation. Extraction of data from links further up the modeling chain may be required in order to isolate the source of such errors. Though the ARPS model starts out high, the surface temperature RTRT forecast, which uses the ARPS data to initialize, yields a low road surface temperature forecast. This low forecast is due, in part, to the lack of a preceding forecast, which could be used to initialize the Monday (February 24) forecast.

To view these differences from another perspective, forecast temperatures were also graphed relative to corresponding measured temperatures, as displayed in [Figure 5](#). In [Figure 5a](#), the solid line corresponds to a perfect correlation. In other words, all data points would lie on this solid line if the forecast air temperatures matched exactly with measured air temperatures. The model correlation coefficient (r_{mod}) provides a measure of the correlation with the measured data, such as relative to the solid line. The model coefficient of determination (r_{mod}^2) expresses the proportion of variation in the measured data that is represented by the forecast. If y_i represents the forecast value and x_i represents the measured value, the coefficient of determination (r_{mod}^2) can be determined using

$$r_{mod}^2 = 1 - \frac{SSE_{mod}}{S_{xx}} \quad (1)$$

where

$$S_{xx} = \sum_{i=1}^n (x_i - \bar{x})^2 \quad \& \quad SSE_{mod} = \sum_{i=1}^n (y_i - x_i)^2 \quad (2)$$

Notice that SSE_{mod} is the sum of the squared error between the measured data and the forecast data.

The sample correlation coefficient (r_{fit}) provides a measure of the correlation between the data and the fitted regression (dashed) line while r_{fit}^2 expresses the proportion of variation in the data that is represented by the linear fit (I). This coefficient of determination (r_{fit}^2) can be written as

$$r_{fit}^2 = \frac{S_{xy}^2}{S_{yy} S_{xx}} \quad (3)$$

where

$$S_{yy} = \sum_{i=1}^n (y_i - \bar{y})^2 \quad \& \quad S_{xy} = \sum_{i=1}^n (x_i - \bar{x})(y_i - \bar{y}) \quad (4)$$

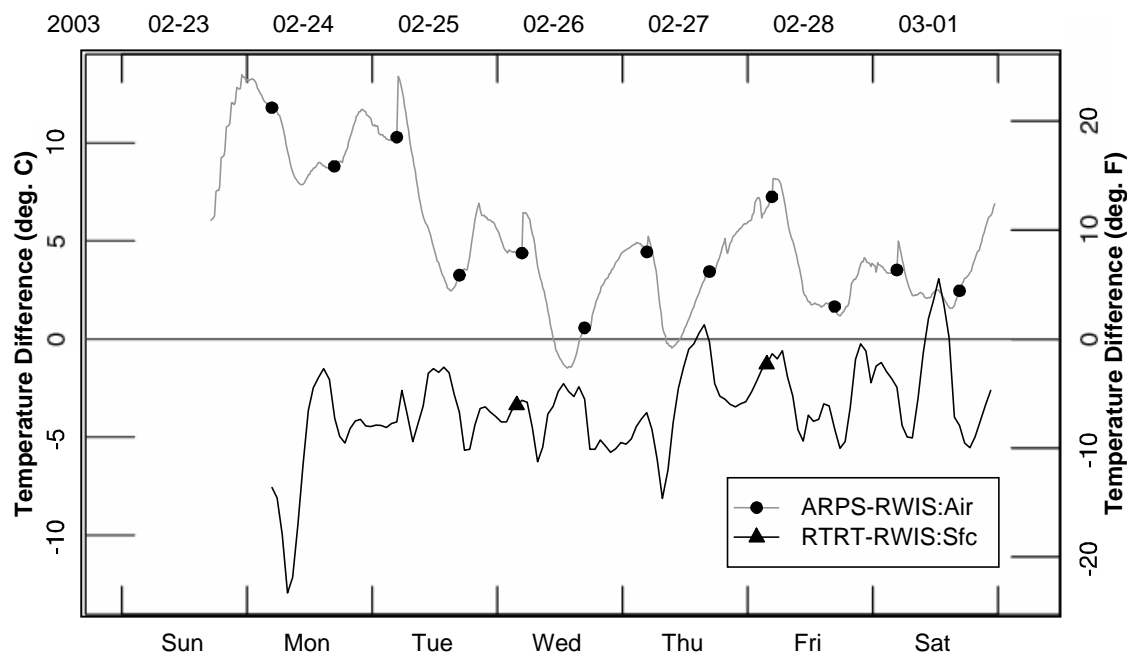

FIGURE 4 Temperature difference, forecast temperature minus measured temperature.

The dashed line is included only to provide an estimate of expected values from the forecast model, based on results from that week. Comparing the two lines provides an estimate of the temperature dependence of the expected forecast temperature relative to the measured temperature. If there is no bias in the temperature forecasts, the dashed line should lie nearly on top of the solid line. To provide a qualitative measure of the differences between the expected forecast temperature and the measured temperature at the high and low extremes, two values are displayed in the lower right corner of the plot (Figure 5a). First is the temperature difference between the highest measured temperature and the expected forecast value, based on the linear fit (dashed line), denoted by uppercase ΔT . Second is the temperature difference between the lowest measured temperature and the corresponding forecast value (again based on the dashed line) denoted by lowercase δT .

The equivalent of the dashed line in Figure 5a is also shown in Figure 5c. Figure 5c displays the residual or the difference between the forecast and measured temperature as a function of the measured temperature. The difference between the dashed and solid lines on the left hand side of the plot is δT and on the right-hand side ΔT , as in Figure 5a. In both of these graphs (Figure 5a and 5c), the data should be randomly distributed about the solid line that passes through both graphs. If this is the case, then many of these differences can be attributed to fluctuations in the weather that occur in a shorter time span that the model is set to track. If the points are not randomly distributed about the line, then the model has a bias that may be due to an improperly set parameter or an error in the energy balance that the model was based on. In this case, the comparison indicates that for this week the forecast was typically 1.6°C low and 5.8°C low in forecasting the daily highs and lows, respectively.

Similarly, Figure 5b and Figure 5d display statistical measures of the differences in the measured versus RTRT forecast surface temperatures. These statistical measures cannot be considered as measures of fit, but instead as displays of variation that may provide a measure of biases in the model behavior or as a measure of uncertainty in the forecast temperatures. Figure 5b displays a histogram based on data points used to compare the modeled and measured differences in temperature. On top of each histogram is a normal distribution, based on estimates of the sample mean (μ) and standard deviation (σ) for each data set. The intent of this overlap is to illustrate that the data points are not normally distributed. However, the distributions are considered close enough that the measures of mean and standard deviation are considered useful. In this case, the mean ($\mu = -3.6^\circ\text{C}$), indicates that on average the road temperature forecast was 3.6°C low, with a standard deviation of 2.9°C.

Figure 5d displays a Q-Q normal plot, which displays the difference between the quantiles of a normal distribution and the quantiles of the sample distribution. The horizontal axis is based on the theoretical normal distribution and assumes that the distribution has a mean of zero and a standard deviation of 1. If the sample distribution were well represented by a normal distribution, the sample points would be expected to lie very near the displayed line, which passes through the upper and lower quartiles ($\mu \pm \sigma$) of the sample and theoretical normal distributions. As displayed in these Q-Q plots, the sample distribution diverges from the line near the edges of the plot, indicating that the errors are not normally distributed about the mean. The divergence at the low end of the plot can be attributed to the error associated with “steady-state” initialization of the February 24 RTRT forecast (Figure 3).

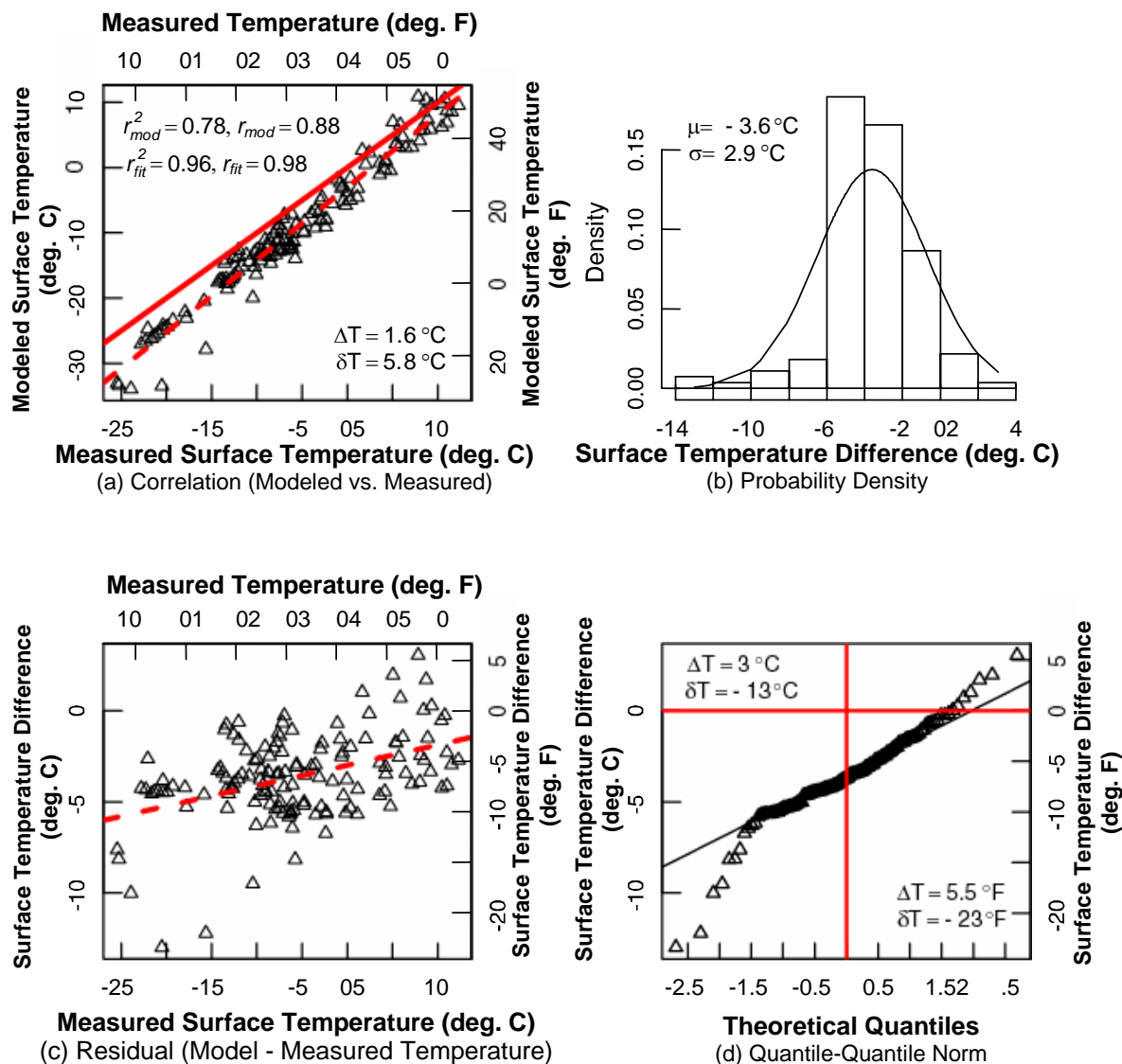

FIGURE 5 Performance statistics.

EVALUATION OF MESOSCALE FORECAST/INPUT DATA

One of the final goals in these road weather forecast models is an accurate forecast of road surface temperatures. In the previous section, a set of tools was discussed for evaluating the accuracy of these road surface temperature forecast models. When these models show inaccuracies, the next question is, What was the source of these inaccuracies? The following discussion will focus on input data that are used to generate these surface temperature forecasts and how the accuracy of the input data can be evaluated. Recall that all input data for road temperature forecast (RTRT) models are derived from mesoscale forecast models (ARPS). As mentioned previously, long wave and shortwave radiation are considered significant drivers for nighttime and daytime road surface temperatures, respectively. To evaluate the accuracy of these

models, both shortwave and longwave sensors were installed at the Bozeman Hill RWIS site. The data was then logged by the Montana Department of Transportation and forwarded to a federal test procedure site, then downloaded for comparisons with forecast model results. An example of such a comparison is displayed in Figure 6a. If both of these sources are available, then cloud cover (Figure 6c) is not used. However, both of these radiation sources are influenced by cloud cover. Therefore, cloud cover forecasts are evaluated as a source of error in the radiation forecasts. Unfortunately, RWIS sites do not typically provide cloud cover estimates. However, the cloud cover forecast can be used to understand the variations in the radiation forecast. As an example, notice that in Figure 6a, the ARPS shortwave forecast reaches a high of approximately 600 Wm^{-2} , on every day except Saturday, March 1, when the maximum barely exceeded 500 Wm^{-2} . By comparing this with the cloud cover forecast (Figure 6c), it is clear that the reduction is most likely due to the increased cloud cover that was forecast for that day. Similarly, the incoming long wave radiation typically increases with increases in cloud cover, as cloud temperatures are typically warmer than temperatures in the outer atmosphere. Also, though cloud cover estimates are not typically available at RWIS sites, they are available at many airports. Therefore, these estimates can also be downloaded and used to evaluate the accuracy of the cloud cover forecast at least at those locations.

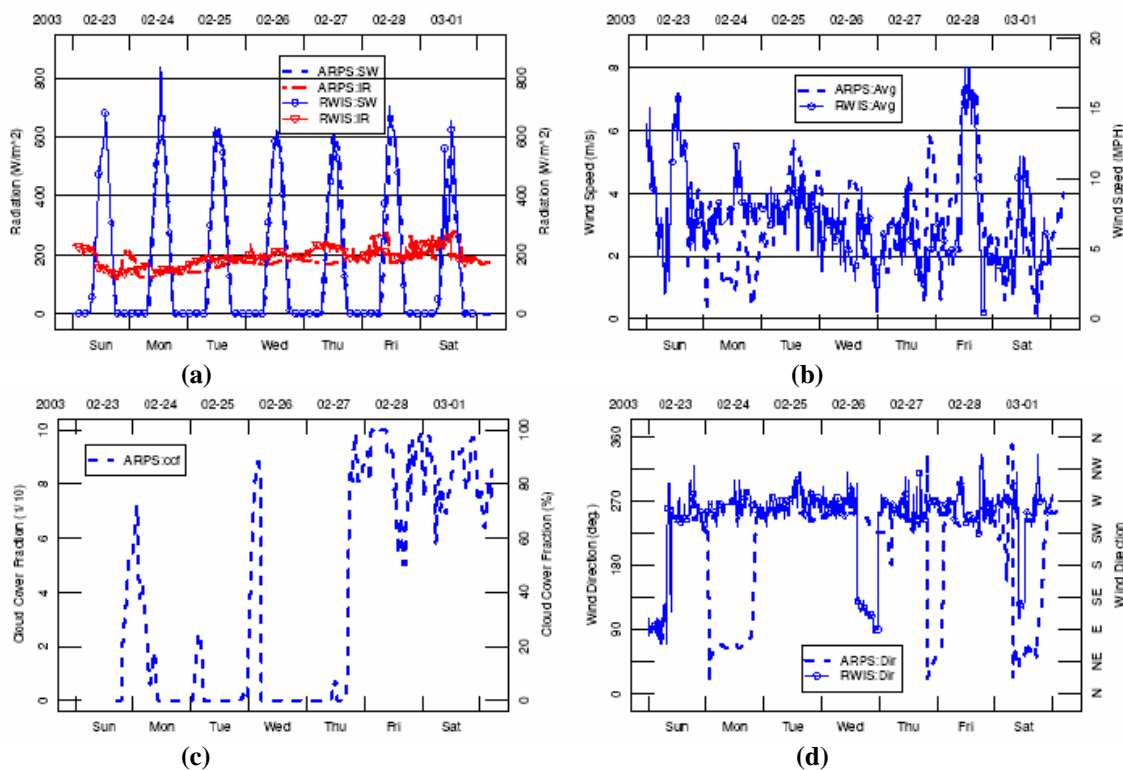

FIGURE 6 Evaluation of radiation and convective heat sources: (a) radiation comparisons, (b) wind speed comparisons, (c) cloud cover comparisons, and (c) wind direction comparisons.

Similarly, to evaluate convective modes of heat transfer, wind speed and direction are compared with measured data (Figure 6b and 6d, respectively). Of course, wind speed becomes significant primarily when the surface temperature is significantly different from the air temperature (Figure 3). Wind direction is important to verify that the wind is properly oriented relative to the terrain surface, that is, to verify that the wind speed tangent to sloping surfaces is accurate.

Fortunately, forecast models appear to do a fairly accurate job of estimating the variations in radiation and wind (Figure 6). Factors that can be just as significant are precipitation and the associated conduction to the road surface, condensation or evaporation at the road surface, and melting or freezing on the road surface. Data for these outcomes are also compared and evaluated relative to the road weather forecast (e.g., Figure 7). To evaluate the accuracy of precipitation forecasts, slight errors in the timing can lead to indications of large errors, particularly in the evaluation of precipitation rate (Figure 7a). A better evaluation of accuracy is the difference in the accumulation of precipitation (Figure 7c) during the forecast period. Measured accumulation rates must be integrated because RWIS sites do not typically record accumulations. As mentioned in Adams et al., precipitation is assumed to reach the road surface with a temperature equal to that of the air temperature. For the models used in the 2003 forecasts, the phase of precipitation and heat transfer due to condensation or evaporation was poorly accounted for. Therefore, in these cases, relative humidity served more as an indicator of the likelihood of precipitation and the corresponding dew-point temperature as an indicator of events when condensation might occur on the road surface, keeping the surface from cooling to the same degree as it would otherwise. The road condition evaluation (Figure 7d) is based on sensor measurements at the RWIS site. These sensors are typically designed to measure chemical composition and from that freezing the freezing point of water. Unfortunately, these sensors can not be considered accurate for any point along the roadway except possibly in the immediate vicinity of the sensor. Therefore the road condition identification numbers (numeric IDs) are used to indicate when the temperature is above or below 0°C. Positive road condition numbers indicate that road surface temperatures were above 0°C, while negative numeric IDs indicate that the sensor evaluations were for surface temperatures below 0°C. A numeric ID of 0 refers to dry road conditions at the sensor. An ID of -1 indicates that for the measured chemical composition, any precipitation on the road is expected to melt, even though temperatures are below 0°C. For a road condition ID of -2, the temperature is close to the phase transition point, and uncertainty in the measurements indicates that precipitation on the roadway is likely to take either melted or frozen forms. For an ID of -3, precipitation is likely to be frozen.

RESULTS

The primary purpose of the present paper is to present the modeling process and validation tools. Detailed performance evaluations will be provided in future papers. However, as an example performance evaluation, a sequence of 4 weeks was selected from the spring of 2003, for the period from February 16 through March 16. During this time frame, the roads were periodically covered with snow and ice (e.g., Figure 7d). Due to human factors (snow plows, application of deicers, traffic, etc.), it was not possible to accurately forecast the existence of melted or frozen precipitation on the roadway. Therefore as a general rule, it was assumed that the roadway was dry. The following statistics are taken from forecast models that used this assumption.

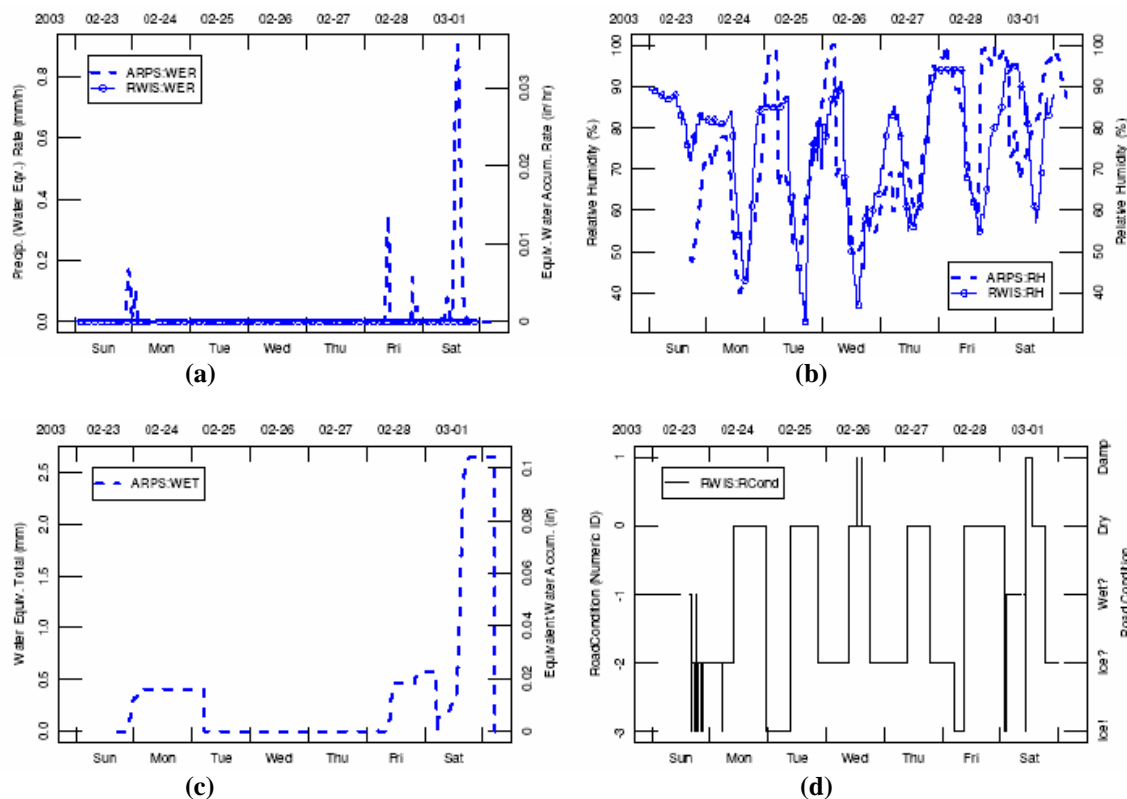

FIGURE 7 Evaluation of precipitation and latent heat sources: (a) precipitation rate comparisons, (b) relative humidity comparisons, (c) precipitation accumulation comparisons, and (d) road condition evaluation.

Using the ARPS3 forecast data as input, the road surface temperature forecast had an average (μ) that was 2.2°C low, with a standard deviation (σ) of 4.9°C . The expected low temperature (δT) forecasts were low by 1.1°C and expected high temperature (ΔT) forecasts were low by 3.3°C . These comparisons assume that the Bozeman Hill RWIS sensor is accurate. This accuracy has not been confirmed.

The worst case underestimates for nighttime lows occurred when the RTRT model had to be reinitialized from a steady-state estimate. Over the 4-week span, the worst case was an underestimate of 13°C ; however, several hours after the initialization phase, the model bounced back to yield a forecast that was within 3°C of the measured outcome.

The worst overall estimate occurred as a 16°C underestimate of a daytime high. In this case, the measured surface temperatures rose from 0°C to a high near 30°C . This appeared to be a relatively cloudless day and the ARPS forecast was reasonably accurate for most meteorological parameters. In particular, forecast estimates of solar and longwave radiation (e.g., Figure 6a) were less than 100 W/m^2 different from measured values, which was considered quite accurate. However, the ARPS forecast did underestimate air temperatures throughout the day by roughly 6°C to 7°C . In combination, wind speeds were overestimated with forecast wind speeds on the order of 10 m/s , while measured wind speeds were near 2.5 m/s . This combination of errors would provide a significant cooling effect, via convection (Adams et al.), which was considered sufficient to explain the low estimate of the surface temperature. As a check, the RTRT model was rerun using RWIS data as input at that site for the same time period. For this

case, with input data based on measured data, the model yielded road surface temperatures that were within 4°C throughout the day and that were within 1°C at the daytime high. To clarify, surface temperature was not an input value.

To evaluate the accuracy of the energy balance terms included in RadTherm, the model was run using RWIS data from March 9 through March 15. For this 1-week period, the average surface temperature forecast was low by 1°C, with a standard deviation of 2.4°C. In this case, the correlation coefficient r_{fit}^2 had a value of 0.97 and r_{mod}^2 had a value of 0.96. Though the road condition indicated melted and frozen precipitation on the road periodically, there was no record of precipitation (e.g., Figure 7a) for this week. These comparisons assume that all of the Bozeman Hill RWIS sensors are accurate. This accuracy has not been confirmed.

CONCLUSION

A chain of models has been organized to provide forecasts of terrain-dependent road temperatures and weather. Though three different providers run the models, the most time-consuming components have been organized to run in parallel to provide 23-h forecasts every 12 h. Short-term validation tools have been provided as graphs, which allow the user to compare the initial phase of the forecast with measured data to evaluate the accuracy of the forecast initialization. Long-term validation tools have been constructed to allow researchers to evaluate and improve model performance over the longer term.

Based on a 4-week evaluation from the spring of 2003, the road surface forecast temperature appears to be on average -2.2°C low, with a standard deviation of 4.9°C. However, this evaluation is based on the assumption that the Bozeman Hill RWIS sensor is accurate. This accuracy has not been confirmed.

ACKNOWLEDGMENTS

The authors thank the Federal Highway Administration, the Montana Department of Transportation, and Montana State University's Western Transportation Institute for support of this research project.

The Advanced Regional Prediction of Storms, which was utilized in part of this study, was developed by the Center for Analysis and Prediction of Storms (CAPS), University of Oklahoma. CAPS is supported by the National Science Foundation and the Federal Aviation Administration.

REFERENCE

1. Press, W. H., S. A. Teukolsky, W. T. Vetterling, and B. P. Flannery. *Numerical Recipes in Fortran*, 2nd ed. Cambridge University Press, Cambridge, United Kingdom, 1992.

WINTER WEATHER: INFORMATION, MODELS, AND DATA QUALITY

Verification of the Road Weather Forecast System Run During the 2003 Demonstration at the Iowa Department of Transportation**BEN C. BERNSTEIN****JAMIE K. WOLFF****SETH LINDEN****WILLIAM MYERS***National Center for Atmospheric Research*

The Road Weather Forecast System (RWFS) was developed by the National Center for Atmospheric Research (NCAR) for the FHWA's winter road maintenance decision support system (MDSS) project. The RWFS, which is based on a data fusion technology that NCAR previously developed for general weather forecast applications, was reconfigured to generate specific forecasts for winter road maintenance routes by supplying this information to the U.S. Army Cold Regions Research and Engineering Laboratory's road temperature prediction system and a road condition treatment module developed by Massachusetts Institute of Technology's Lincoln Laboratory.

For such a system to provide useful information to road maintenance personnel, it must provide accurate forecasts of the weather and translate that to a reasonable representation of its impact on the road surface. The RWFS attempts to objectively maximize forecast accuracy (minimize error) by blending output from standard and research numerical models with surface observations and statistical regressions. Tuning of the system is done through comparison of model output with surface observations from National Weather Service meteorological aeronautical report (METAR) sites and Iowa Department of Transportation (DOT) road weather information system (RWIS) sites to provide optimized forecasts of both standard weather and extended highway parameters (e.g., road temperature) for departments of transportation.

Overall verification results from the first Iowa DOT RWFS demonstration are presented. Accuracy of RWFS forecasts of air temperature and precipitation type are examined through comparison with METAR and RWIS observations. Road temperature forecasts resulting from the application of MDSS recommended road treatments (plowing, salting) are compared with RWIS measurements of road temperature. A case study from a light snow event is presented to demonstrate some error sources and to compare MDSS recommended and actual Iowa DOT treatments.

INTRODUCTION

The maintenance decision support system (MDSS) was tested in an operational setting during the winter of 2003 in the Des Moines and Ames, Iowa, area. The road weather forecasting system (RWFS) (1), which is the forecasting component of MDSS, was developed by the National Center for Atmospheric Research for the MDSS project. RWFS ingests data from a variety of numerical models [i.e., Eta, aviation model (AVN), nested grid model] and observational platforms [meteorological aeronautical reports (METARs), road weather information system (RWIS)] to provide optimized forecasts of both standard weather and extended highway parameters for

departments of transportation (DOTs), by supplying this information to SNTHERM and the road condition treatment module (RCTM).

In this paper, results from objective and subjective verifications of winter 2003 MDSS forecasts and road treatment recommendations are presented. First, observation quality will be assessed through coincident observations of state and road parameters. Differences apparent in the observations themselves set a lower bound for the accuracy one can expect from the MDSS forecasts, for if the observations can only be trusted within a certain tolerance, then differences between such observations and the MDSS forecasts can be partially attributable to the uncertainty in the observations.

Objective verification is achieved through direct comparisons of RWFS forecasts and observations from National Weather Service (NWS) and RWIS stations, using scatter diagrams, and calculated values of root-mean-square error (RMSE) and bias for state parameter fields (e.g., air temperature, wind speed) as well as road temperature. The complexity and subjective nature of the verification of road treatment recommendations lend themselves well to a case-study approach. This places the recommendations into the necessary context of the forecast itself, as well as the actual weather and road conditions that occurred. Contrast between the forecast and reality are often at the root of differences between the recommended and actual treatments. Several case studies were performed and results from a single light snow event will be presented here to highlight several aspects of the RWFS forecasts and MDSS-recommended treatments. The synoptic situation will be briefly described, and RWFS forecasts of standard meteorological parameters (air temperature, wind speed, and precipitation type and amount) and road temperature are compared with observations. MDSS-recommended road treatments are compared with actual treatments recorded by Iowa DOT road maintenance personnel for two highway segments. Finally, lessons learned from this event are discussed.

OBSERVATION QUALITY

Before comparing forecasts with observations, it is important to assess the quality of the observations themselves. To achieve this, coincident observations of a variety of fields from NWS METAR stations and Iowa DOT RWIS sites near Ames, Des Moines, and Ankeny, Iowa, were compared. Among state parameters, only air temperature results are discussed here. Road temperature quality was assessed through comparison of two separate but nearly collocated sensors. The Ames RWIS site was located along I-35, just to the north of the NWS site and the city of Ames, as well as to the north of the I-35/US-30 interchange. The Des Moines RWIS site was also located along I-35, just to the southwest of the METAR site and the city, as well as to the south of the I-80/I-35 interchange. The Ankeny site was located along I-35, roughly midway between Ames and Des Moines, near the town of Ankeny (Figure 1).

Air temperature is important for correctly forecasting precipitation type and for thermal interactions with the road surface, especially bridges. In general, METAR and RWIS observations matched quite well, with most coincident observations being within 2.5°C. Some stations were biased from one another by 1°C to 2°C, but neither observation platform showed consistent warm or cold biases. Local differences may be attributable to slight differences in location (geographic, elevation, low/high spots for air temperature), instrument type and instrument quality. Comparisons between METAR air temperature observations at all three locations showed good agreement.

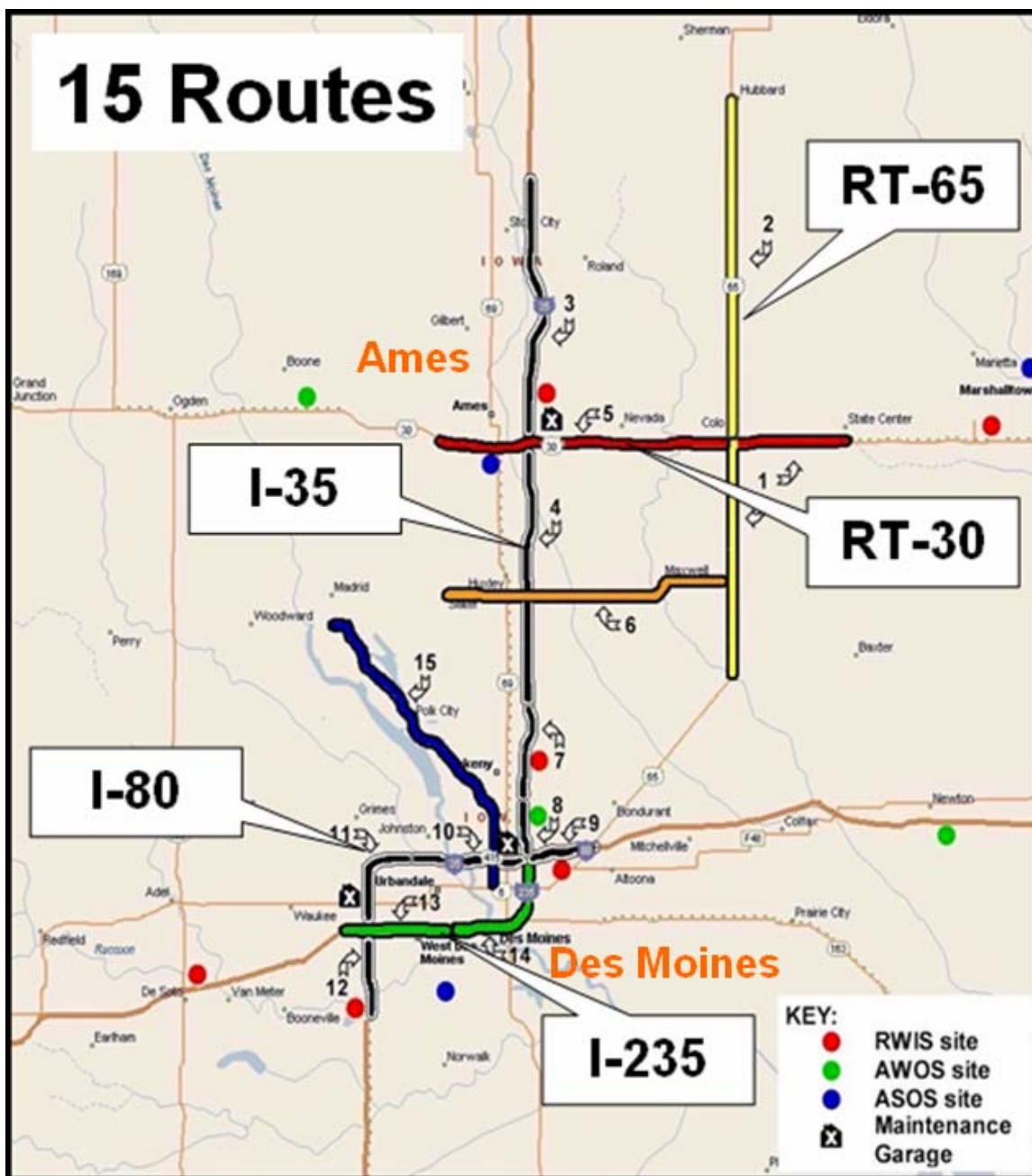

FIGURE 1 The 2002–2003 MDSS winter demonstration route map. Road segment numbers 1–15 are indicated along each segment, while observation site locations and types are noted with dots (AWOS: automated weather observing system; ASOS: automated surface observing system).

Road temperature is, of course, one of the most important parameters to forecast correctly, yet it is also one of the most difficult to measure and forecast. It is measured using temperature sensors (hereafter referred to as pucks) embedded within the pavement. Reported expected errors in these measurements are on the order of a few degrees Celsius. At most RWIS sites, multiple pucks are used to measure pavement and bridge temperatures, often on multiple roads at an interchange. One site within the demonstration area had two pucks embedded within the same pavement type, in nonbridge situations, along the east- and westbound lanes of I-80, at the Altoona interchange with US-65. Time-series charts for the demonstration period show that the two pucks track each other very closely, and a scatter plot shows that most observations are well within 2°C of one another, though the I-80 eastbound sensor appears to read a bit warmer than the westbound sensor (Figure 2). There do not appear to be any significant differences in the measurements with changes in cloud cover, occurrences of precipitation, or its type. The sensors do appear to match most closely when temperatures are around or below freezing, which is the range of particular interest for this program. Overall, the puck-to-puck comparison is quite good.

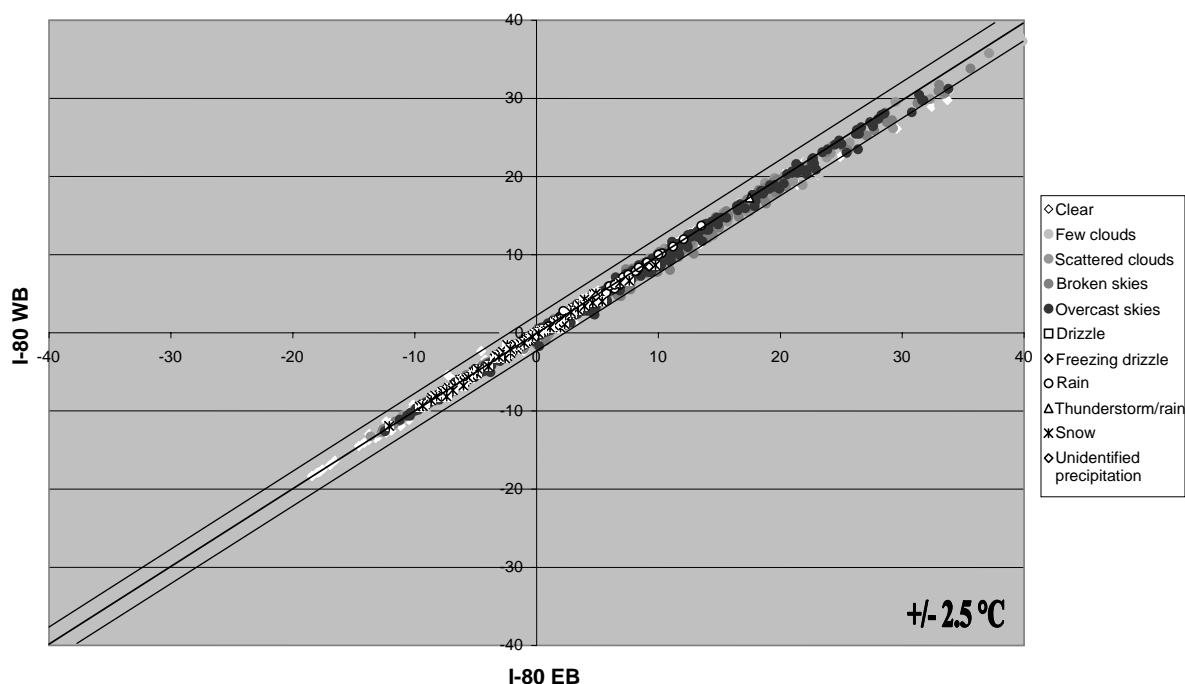

FIGURE 2 Time-series and scatter plots for I-80 east- and westbound road temperature measurements. Coincident cloud cover or precipitation are indicated by the symbol shape.

OBJECTIVE VERIFICATION OF RWFS FORECASTS

In this section, the 1- through 24-h MDSS forecasts of air temperature, cloud cover, and precipitation (including precipitation type) forecasts from each day's 1800 coordinated universal time (UTC) forecast run were compared with observations made at the RWIS (air temperature only) and METAR sites between February 3 and April 8, 2003. Additional comparisons of the precipitation type forecasts are made only at the NWS sites. Note that bias values are the reverse of standard convention. Positive (negative) bias indicates that the forecasts were too low (high).

Air Temperature

For tests including all NWS and RWIS stations within the state of Iowa, air temperature forecasts were accurate within $\sim 2.5^{\circ}\text{C}$ in the first 24 h. RMSEs gradually increased with forecast length (Figure 3). These values are similar to the measurement uncertainties in the observations, indicating that MDSS air temperature forecasts were quite accurate. A slight cool bias ($<0.5^{\circ}\text{C}$) was present in the forecasts. Scatter plots and time-series plots for individual sites (not shown) indicated very good correlation. Some slight over- and underforecasting of relatively low and high temperatures, respectively, was evident at Ames and Ankeny, usually in relatively cloud-free situations. In general, temperatures were most accurate during precipitation and very cloudy periods and least accurate during cloud-free periods. This may reflect some issues in the quality of the radiation budgets in the upstream model forecasts or poor forecasts of the cloud-free conditions (cloud cover was predicted when none existed).

Cloud Cover and Precipitation

Cloud Cover

The cloud cover and precipitation fields are quite important for correctly forecasting the energy balances at the road surface and for downstream buildup of precipitation (and its type) on the road and for subsequent treatment recommendations. Cloud cover observations are recorded categorically by the RWFS, using a fixed number of octants of sky cover for each category. The categories and coverage values are as follows: clear skies (CLR/FAI; 0 octants, 0.00), a few clouds (FEW; 1 octant, 0.1875), scattered clouds (SCT; 3 octants, 0.4375), broken skies (BKN; 6 octants, 0.75), and overcast skies (OVC; 8 octants, 1.0). Cloud cover forecasts are floating point values ranging from 0.0 (completely clear) to 1.0 (completely overcast). Differences between forecasts and observations may not be smooth, because of the categorical nature of the observations.

Cloud cover results are in terms of RMSE and bias values for all stations combined. Overall, the RMSE for cloud cover forecasts was on the order of 0.3–0.35 and trended slightly upward with forecast length, as expected. A comparison of results for the Eta model's direct model output statistics (DMOS) and the AVN model's DMOS forecasts indicated that the RWFS postprocessing forecast was comparable with the Eta DMOS forecasts throughout the first 24 h. The RWFS had slightly lower errors in the first few hours, then slightly larger errors in the hours beyond. Both forecasts had much better accuracy than the AVN DMOS forecasts. Overall, the 0.3 to 0.35 forecast errors indicate that both the Eta and RWFS forecasts tended to be about one

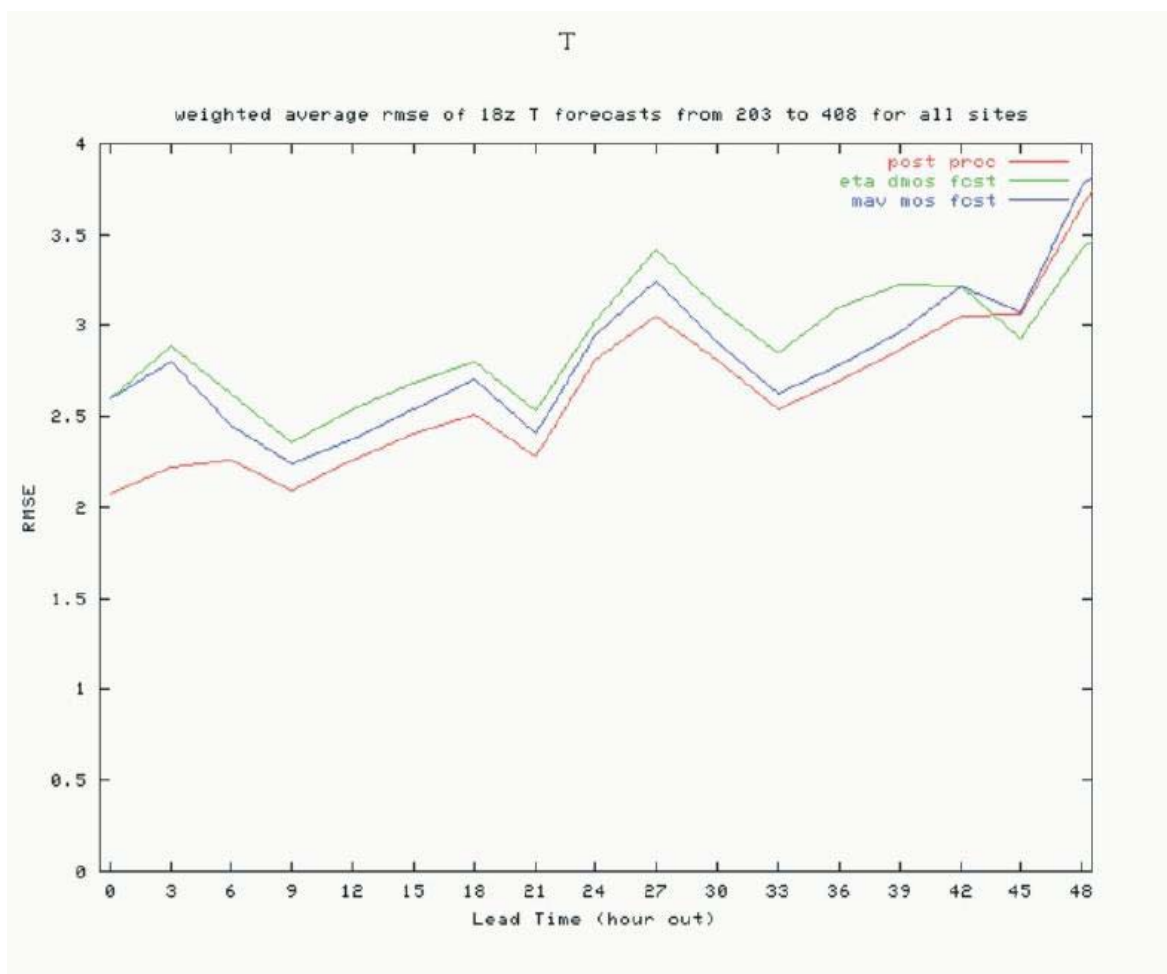

FIGURE 3 RMSE for air temperature at all sites combined. The RWFS postprocessing, NWS, Eta model DMOS, and NWS Aviation (MAV) model MOS forecast values are indicated using the light gray, medium gray, and dark gray lines, respectively.

category off. This can be significant for air and especially road temperature forecasts, since the shortwave and longwave energy fluxes are very important for these fields. This is a common problem in all models and a continuing topic of research in the model community. Until the models themselves make better moisture (and thus, cloud-cover) forecasts, the only likely way to improve upon these forecasts is with a forward correction scheme, such as that planned for future upgrades to the RWFS. Bias results show that there was a slight negative bias (absolute value was less than 0.1) in the cloud-cover forecasts, indicating that the forecasts were slightly too cloudy, overall.

Another way to examine the cloud-cover forecasts is to show the distribution of predicted cloud coverage (tenths) for each cloud-cover category (Figure 4). When clear skies were observed (FAI) the predicted cloud cover was usually less than 0.3. The most frequent cloud coverage predicted was in the 0.21 to 0.30 range. Greater cloud coverage was predicted at other times, but CLR skies occurred with decreasing frequency with increasing forecast cloud cover. CLR skies never occurred when the cloud cover forecast was for >0.9 coverage. The reverse trend was found for OVC skies, with forecast cloud cover >0.7 most of the time, peak frequency

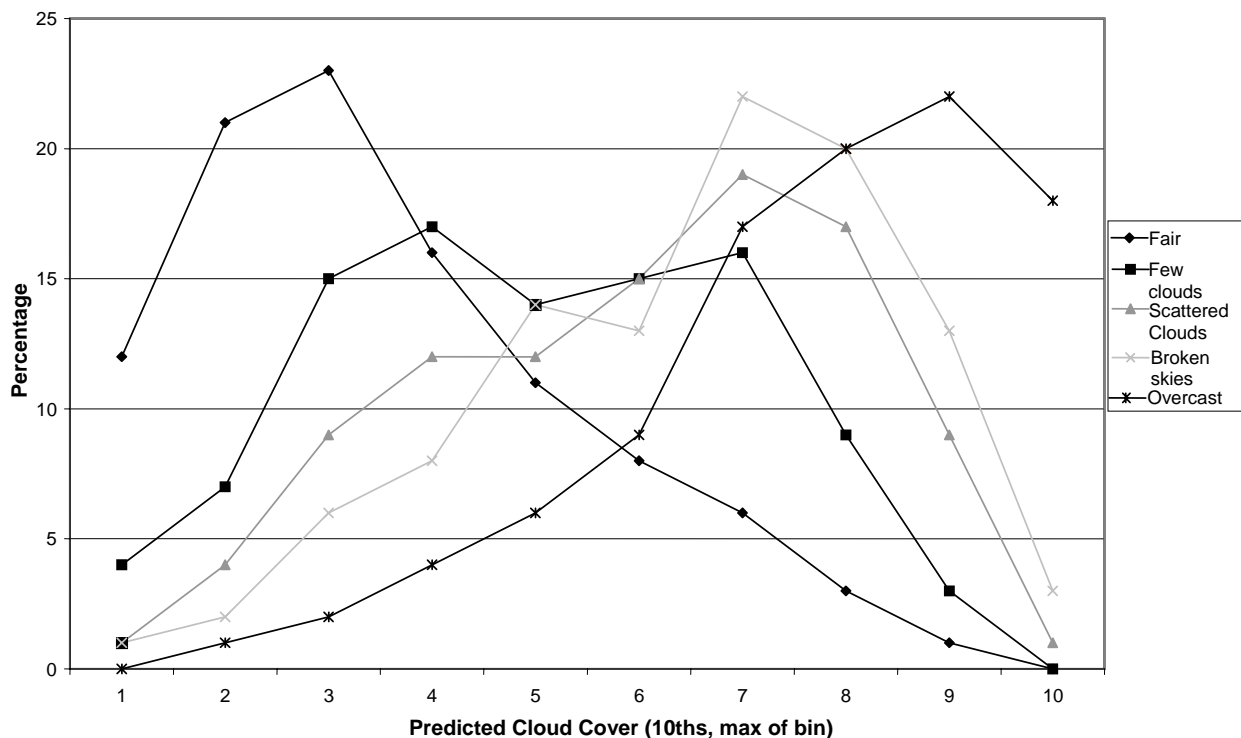

FIGURE 4 Percentage of all observations of different cloud cover amounts (colored lines) matched to predictions of cloud cover in tenths at Ames Municipal Airport and Des Moines Airport.

in the 0.81 to 0.90 range, and no OVC skies observed when the predicted cloud cover was <0.1. BKN skies had their peak frequency when the cloud cover forecast was 0.61 to 0.7, which is very good. However, the same was true for SCT skies, where we should expect the peak in the 0.41 to 0.50 range. Overall, there was good discrimination among the extreme cloud coverage categories (FAI, OVC) and reasonable discrimination in the partial cloud cover categories (FEW, SCT, BKN).

Precipitation Occurrence

The occurrence of precipitation at a given station is a tricky thing to diagnose. Reports of liquid in heated tipping bucket gauges can be useful, but the NWS ASOS stations have serious problems during snowfall, often reporting no liquid equivalent during snow events. The “present weather” field indicates the presence of precipitation and its type. Both fields can normally be used as a simple on/off flag, indicating that precipitation is occurring (probability of precipitation, POP = 1.0) or it is not (POP = 0.0). RWFS forecasts indicate POP in terms of a floating-point number. For example, the RWFS may indicate a POP of 0.68, meaning that the probability of precipitation is 68% during the period. If precipitation did or did not occur, then the errors associated with this POP forecast are 0.32 (absolute difference between 1.0 and 0.68)

and 0.68 (absolute difference between 0.0 and 0.68), respectively. The only opportunity for a perfect POP forecast is when the POP forecast is 1.0 and precipitation does occur or 0.0 and it does not occur. These combinations are rather unusual, so significant errors are expected in the POP field.

RMSE values for all stations combined were on the order of 0.3 to 0.35 for POP, with a slight upward trend with forecast length, as expected. Such errors are quite reasonable, as described above. No significant biases were present, so the MDSS forecasts were predicting precipitation at about the correct frequency, overall. An examination of results for individual stations sometimes indicated slight biases. For example, the bias was somewhat positive (on the order of 0.1) at Des Moines Airport (DSM), indicating that the system was consistently under-forecasting the POP by about 10%.

Precipitation Type

Precipitation type is forecast in terms of a conditional probability (CP), indicating the chance of a particular type of precipitation, given that precipitation will occur. The values are floating point, from 0.0 to 1.0, for each of three categories: rain (CPOR), snow (CPOS), and ice (freezing rain; CPOI). At all times, $CPOR + CPOS + CPOI = 1.0$. For example, if precipitation is expected, and the temperature is expected to be near freezing, the forecast could have the following conditional probabilities: $CPOR = 0.4$, $CPOS = 0.4$, $CPOI = 0.2$. As the CPOS rises, for example, the system expects a better chance that the precipitation will fall as snow. If the probabilistic forecasts are calibrated, then snow should fall 30% of the time when the CPOS is 0.3, and it should be some other type 70% of the time. In this section, results are discussed for each category. For each range of CPOx (e.g., 0.71 to 0.8), the percentage of precipitation that fell in each category was calculated (see [Figures 5 through 7](#)), based on observations taken at Ames Municipal Airport (AMW) and DSM.

Snow

When the CPOS was greater than 0.7, the precipitation type was nearly always snow (~95% of the time), and “UP” (unknown precipitation type) was reported almost all of the rest of the time. In the middle ranges ($0.2 < CPOS < 0.7$), a variety of precipitation types occurred, and snow fell 15% to 60% of the time. The correlation was poor, but there were relatively few cases, so the results are not very robust. For very low CPOS ranges (< 0.1), snow essentially never occurred, and rain fell ~95% of the time.

Rain

High CPOR values were nearly always associated with reports of rain, with almost all of the remaining precipitation falling as (above-freezing) drizzle. In the middle CPOR ranges (0.3 to 0.8), rain typically fell 20% to 30% of the time and much of the rest of it fell as snow. Little correlation may again be attributable to the relative lack of forecasts of CPOR in this range. At low CPOR values (< 0.3), rain rarely occurred, and it never occurred when the CPOR was less than 0.1. Snow dominated at the low CPOR values.

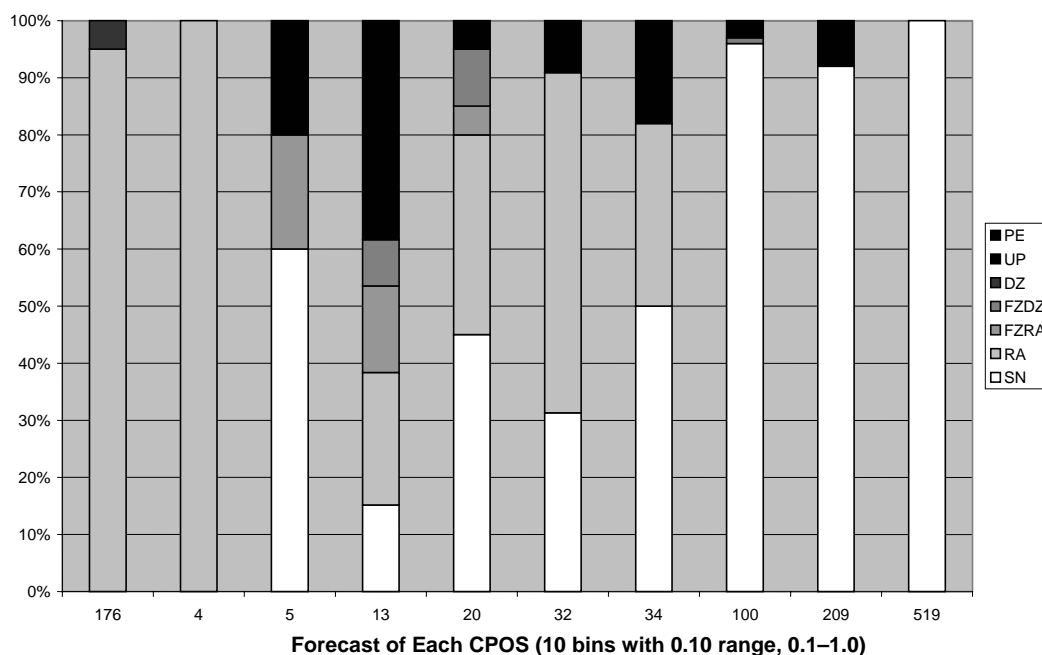

FIGURE 5 Distribution of precipitation-type occurrences for snow (CPOS).
Note: Stacked columns are for each 0.1 range of CPOx (e.g., 0.11–0.20 for the 2nd set of stacked columns). Total number of forecasts within each CPOx bin range is shown at the bottom of each column.

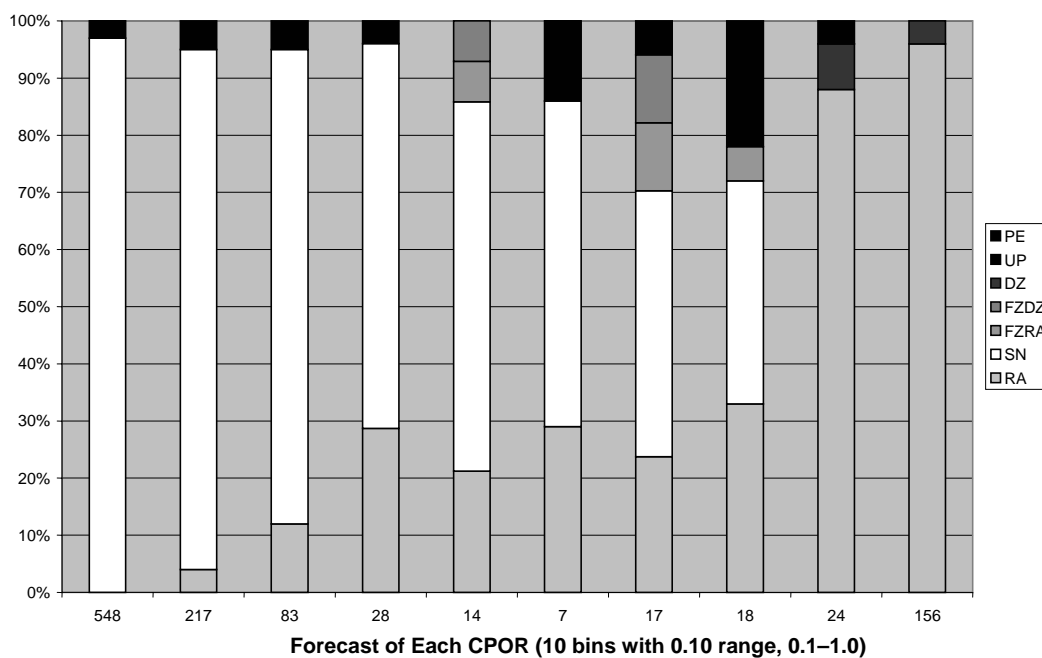

FIGURE 6 Same as Figure 5, but for rain (CPOR). Distribution of precipitation-type occurrences. Note: See note for Figure 5.

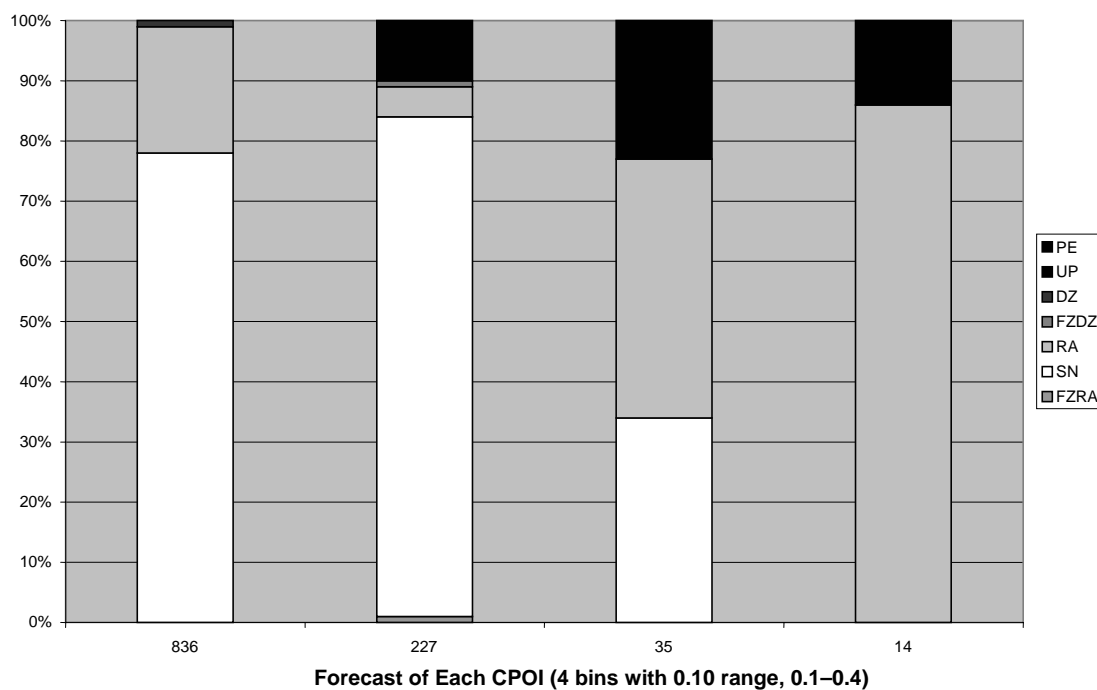

FIGURE 7 Distribution of precipitation-type occurrences for ice [freezing rain (FZRA); CPOI]. Note: For CPOI, no forecast values exceeded 0.40, so only 4 sets of columns are shown. Also, see note to Figure 5.

Ice (Freezing Rain)

There were very few situations during the field demonstration when freezing precipitation was expected. In the few forecast runs with freezing precipitation a real possibility (mostly during the February 13–15 case), the CPOI never exceeded 0.4, and it only exceeded 0.2 in 49 out of over 1,000 forecasts. Freezing rain never did occur during that or any other event, and freezing drizzle only occurred once. During the few times that CPOI was greater than 0.3, rain fell ~85% of the time and UP fell the remainder of the time. This was because the air temperature forecast was incorrectly low during the expected period of freezing rain. When CPOI was in the 0.21 to 0.3 range, rain, snow, and UP fell about an equal amount of time. Snow dominated when CPOI was less than 0.2. The winter of 2003 did not provide an adequate test for the CPOI field, since freezing rain did not occur over the test domain. Note that the CPOI field was designed to catch freezing rain, rather than freezing drizzle (FZDZ).

Road Temperature

MDSS provides three sets of road temperature forecasts for each segment of road: untreated, suggested treatment, and current treatment. The untreated forecast is the forecast road

temperature given that the weather occurs (snowfall on the road, etc.) and no treatments are inserted into the system (the road is left as is). Suggested treatment is the forecast road temperature, given that the treatment suggested by the MDSS is applied (e.g., the road is plowed at 13 Zulu, as suggested by the system). Current treatment is the forecast road temperature, given the treatment that was entered into the system by Iowa DOT personnel during the event.

The untreated forecast is the most unrealistic, since treatment nearly always takes place. The current treatment forecast was not always captured well, as Iowa DOT personnel sometimes became far too busy during snow events to enter the actual treatments for all 15 road segments they covered, despite their best efforts. The best field to verify is the suggested treatment field, since it is designed to keep the roads clear of snow and ice, which is the same strategy used by DOT. Results for that field are discussed here for two road segments, 4 and 12, that were located close to the Ames and Des Moines (I-35, to the southwest of DSM) RWIS sites (see [Figure 1](#)). All forecast data are based on the 1800 UTC RWFS/MDSS runs. It is important to note that the RWFS road temperature prediction is made for a segment of roadway that is roughly covered by a single Iowa DOT plow route. The pavement parameters (type, substrate) are representative of the entire route, and the forecast is made for the center point along that route, rather than at the RWIS site. It was felt that such a forecast would be more representative of the conditions along the entire route, rather than at one point. Since verification can only be made at the RWIS site, this can result in additional differences between forecasts and observations (2).

A scatter plot of the RWFS forecasts and RWIS observations of road temperature for highway segment 4 (Ames; [Figure 8](#)) shows that most of the forecasts were within $\pm 2.5^{\circ}\text{C}$ of the observations, and that the forecast road temperatures tended to be slightly lower than those reported by the RWIS. Errors were maximized during clear sky situations, where they were under-forecast by 5°C to 10°C . Some of these large errors may be attributable to RWIS measurement uncertainties when the sun shines on the pucks. Forecasts appeared to be more accurate under cloudy and precipitating conditions, when the measurements themselves may be more credible. The forecasts were most accurate (the vast majority within 2°C) when precipitation was falling, especially snow. RMSE results for Ames show a baseline error on the order of 2.5°C and spikes of error up to 5.5°C during times of peak heating (0- to 3-h and 24- to 27-h forecasts, equivalent of 1800–2100 UTC; [Figure 9](#)). Again, this may be partially attributable to instrument error, but errors in cloud cover forecasts and sensitivity of the road temperature calculation schemes to insolation may also have contributed. Forecast accuracy was best at night and during the morning, when these factors are minimized. Bias calculations indicated an overall cold bias to the forecasts, on the order of 2°C during most of the day, but near 3°C during peak heating periods. The cold bias is evident on the scatter plot. Rarely were forecasts more than 2°C too warm, but they were more than 2°C too cold on many occasions.

Results for highway segment 12, located near Des Moines (not shown), were fairly similar except that the cold bias was not as evident in the scatter plot or bias plot. Errors were on the same order, and the diurnal pattern was still present in the RMSE and bias results. However, the entire plot was shifted downward, with overforecasts (negative bias) on the order of 2°C during the peak heating periods and underforecasts (positive bias) on the order of 1°C during the night. Accuracy did not appear to be as dependent on cloud cover as they were at Ames, perhaps indicating less puck sensitivity to insolation at DSM.

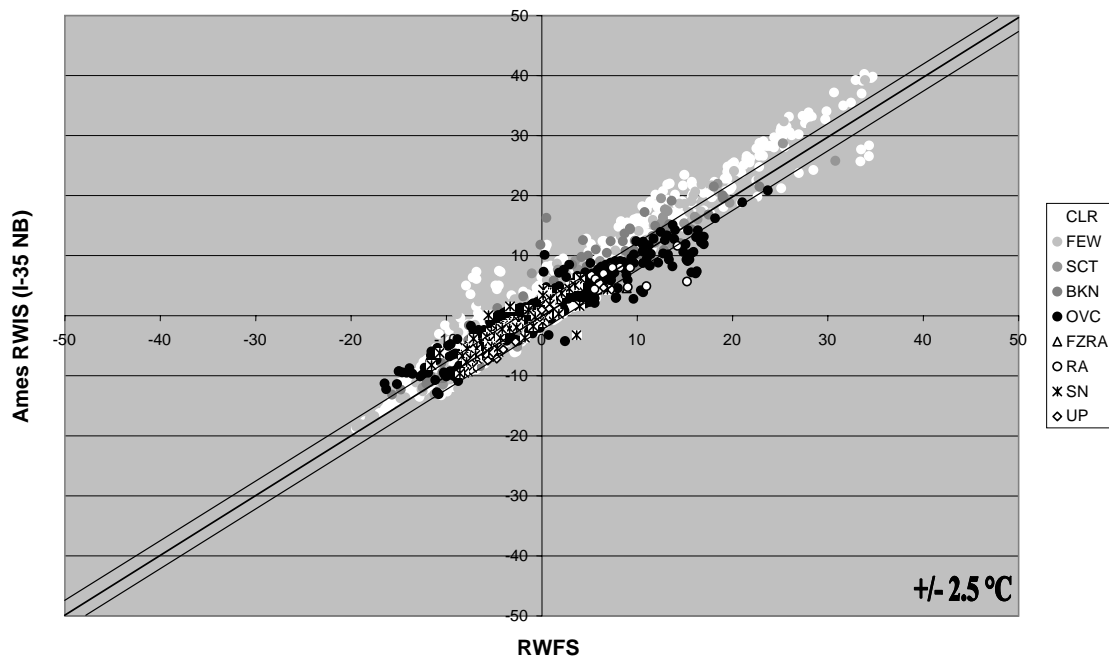

FIGURE 8 Scatter plots for air temperature at AMW. Coincident cloud cover or precipitation is indicated by the symbol shape.

CASE STUDY OF LIGHT SNOW EVENT

In this section, a light snow event is subjectively examined to determine the accuracy of precipitation start and stop times, as well as how closely suggested treatments matched actual treatments made during the event. Iowa DOT personnel recorded actual treatments performed on survey forms jointly created by National Center for Atmospheric Research, Iowa DOT, and Mitretek. Forecasts and observations of the overall precipitation amounts and patterns are also discussed, for RWFS/MDSS runs made 6 to 12 h before the event, both with and without the supplemental Forecast Systems Laboratory (FSL) models. In the RWFS, precipitation was considered to be falling if the POP was 0.25 or greater and the quantitative precipitation forecast (QPF) was 0.1 mm/3 h or greater. These thresholds were used to determine the start and stop times of the predicted event, while actual observations of precipitation in the METARs were used to determine actual start and stop times. For intermittent events, the earliest and latest precipitation was considered to be the start and stop time.

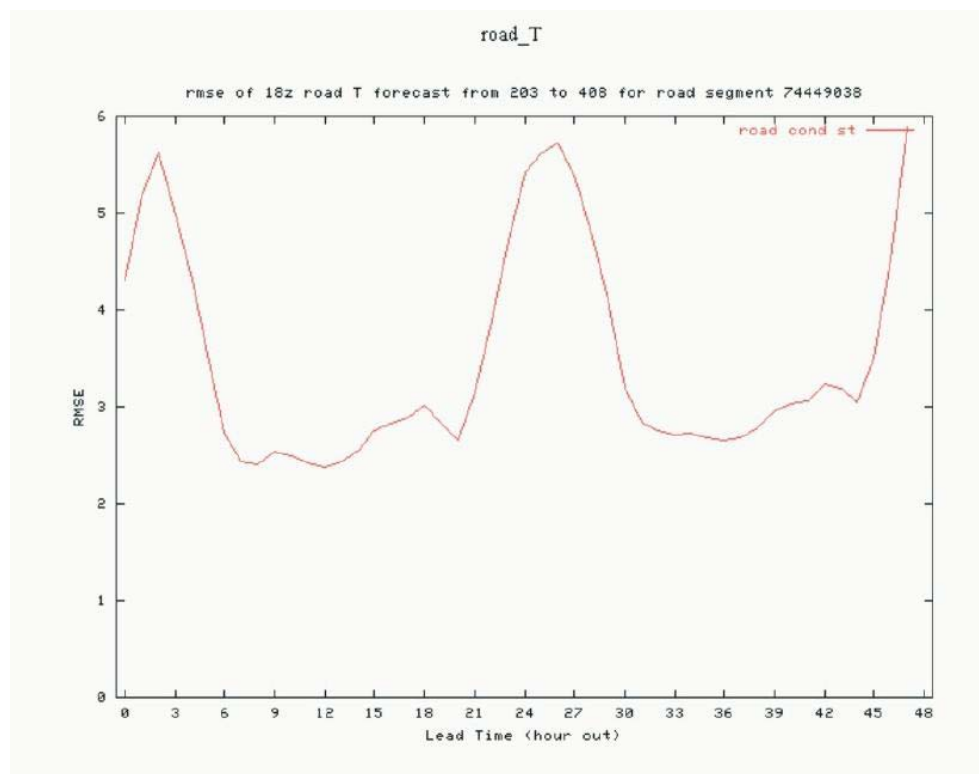

FIGURE 9 RMSE of road temperature forecasts at AMW, using suggested treatments.

Snowfall Amounts and Event Timing

During this event on February 3–4, 2003, about 2.5 cm (1 in.) of snow fell across the project domain, while up to 7cm (3 in.) fell elsewhere in Iowa. Liquid equivalents were on the order of 0.1 to 0.6 cm (0.05 to 0.25 in.). The snow was associated with the passage of a strong cold front that caused temperatures to fall sharply during and following the snowfall. This feature was very important to the treatments applied late in the event.

The overall precipitation and snowfall predictions from the 6 UTC, February 3, 2003, MDSS run were of the right magnitude, with liquid equivalents of less than 0.5 cm (0.2 in.) and snowfalls of less than 5 cm (2 in.) forecast. The precipitation amounts were roughly correct, and the geographic distribution of the precipitation across the state was quite good. Highest values were expected in the northeast corner, with more moderate snow in the southwest corner and lowest values in the northwest and southeast corners of Iowa. In reality, the heaviest snows fell in both the northeast and southwest corners, while lowest values fell in the northwest and southeast corners, as expected.

Snow started and ended at DSM at 1830 (February 3) and 0423 UTC (February 4), respectively (Figure 10). The initial snow came over a 5-h period, followed by a 4-h break, then another short period of snow. QPF and POP thresholds indicated that precipitation should have begun and ended at ~16 and ~03 UTC without the FSL models and ~17 and ~03 UTC with the FSL models. In both cases, the forecasts started and ended the precipitation too early, but the “with FSL” version was slightly better on the start time. Neither system indicated a break in the precipitation during the middle of the event, but both did indicate peak POP and QPF values

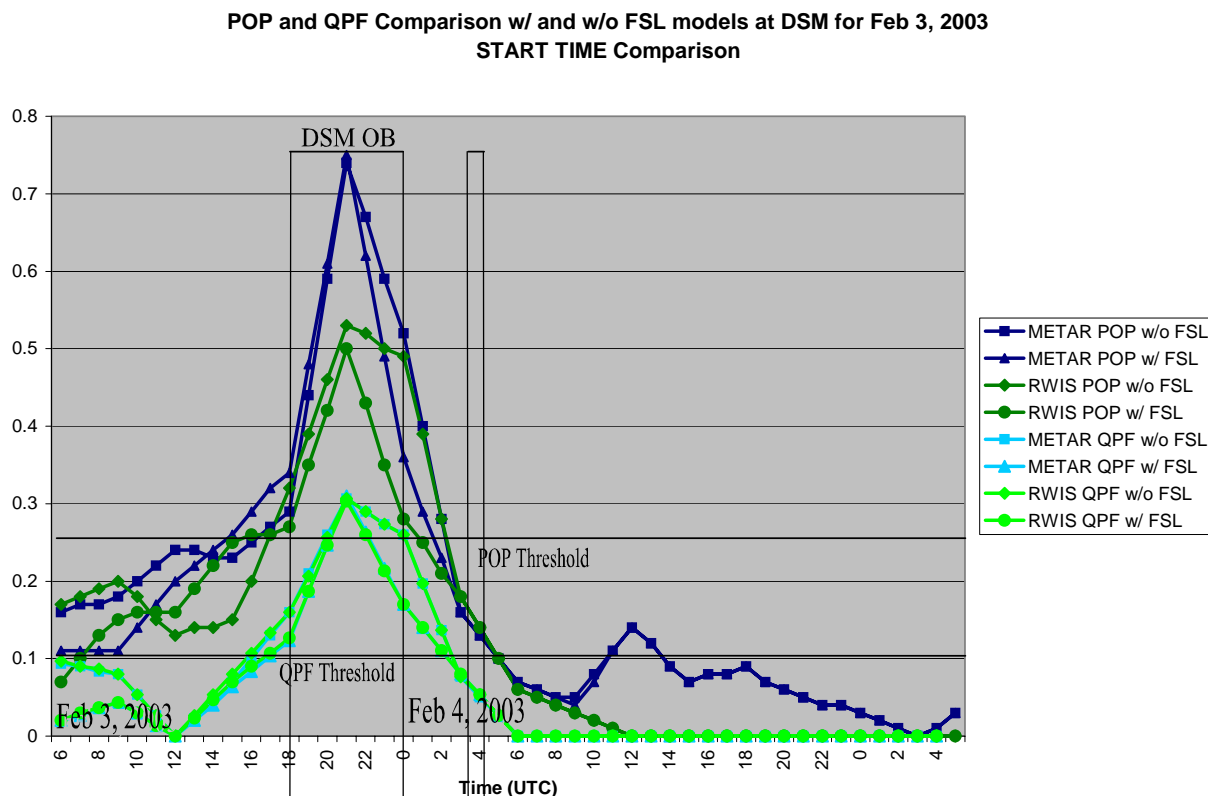

FIGURE 10 Time series of POP and QPF forecasts at DSM for February 3–4. Vertical black boxes marked with DSM OB indicate periods of snow observed at DSM.

during the period where nearly all of the snow fell. At Ames (not shown), the snow was again predicted to start a bit too early, but the end of the event was captured nicely.

Temperature and Winds

The temperature time series shows that the forecasts were quite accurate before and during the early part of the snowfall (through 2000 UTC), forecasting temperatures that were slightly too low (Figure 11). After 2000 UTC, temperatures fell quickly at DSM. The models were slow to catch this trend, resulting in forecast temperatures that were 4°C too warm for the latter part of the snowfall and the cold, windy period that followed it. This same trend was observed at Ames, but the temperature drop was associated with the beginning of the snowfall.

Suggested and Actual Road Treatments

With good precipitation timing, type (all snow), and amounts, the weather was well predicted, overall. Such light precipitation prompted the system to suggest a pretreatment of brine at ~17 UTC (not shown on the charts), followed by a single plowing and treatment cycle (150 pounds per lane mile) at both Des Moines and Ames, with treatments beginning

at ~20 UTC and ending at ~22 UTC (Figure 12). This matched the timing of the snow buildup on the road and should have allowed enough chemical to melt the snow that fell after the plowing was complete. Actual Iowa DOT treatments near Ames and Des Moines did not include any pretreatment. Plowing and salt application started an hour or so earlier near Ames (not shown) and later at Des Moines than the suggested plowing and treatment. The amount of salt applied was 300 pounds per lane mile. The problem with both the suggested and actual treatments was that the sharp temperature drop was not expected and the salt put down caused the snow to melt, but there was inadequate time for the roads to dry before the water refroze to form ice, due to the rapid temperature drop. Also, winds were on the order of 5 ms^{-1} to 10 ms^{-1} , causing blowing snow, something the current version of the MDSS does not try to handle. Because of the ice and blowing snow, garages in the area had to continue treatments throughout the night and into the morning, until the sun came out the next day and helped to melt the ice and snow. These overnight and morning treatments were not suggested by the MDSS because of the combination of the lack of blowing snow treatment logic and the poorly forecast sharp temperature drop.

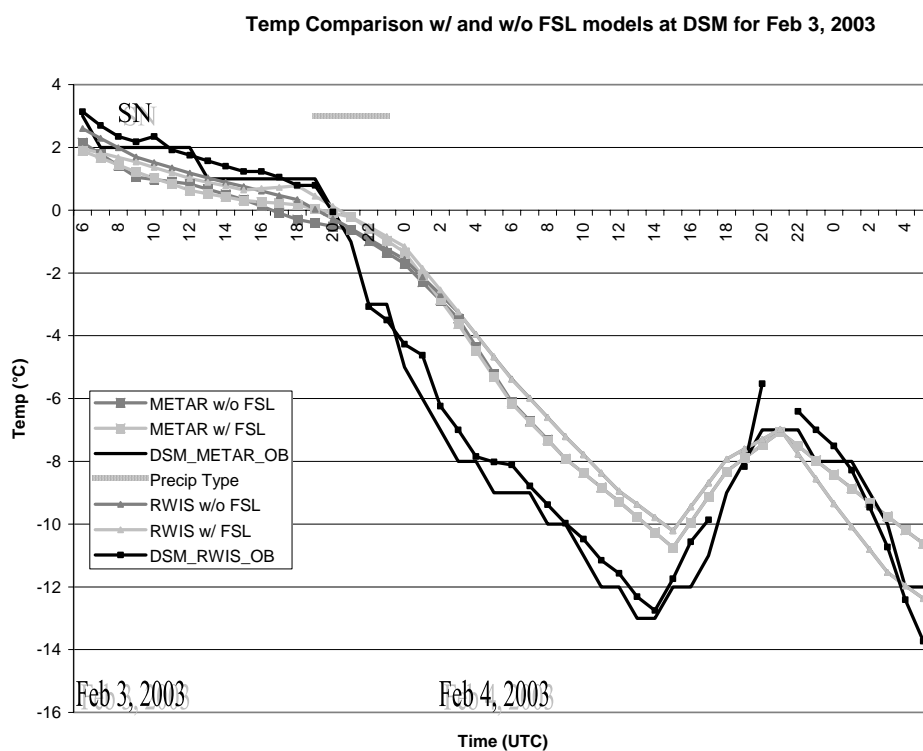

FIGURE 11 Time series of forecast and observed air temperatures at DSM for February 3–4. Horizontal bar at the top denotes the period of snowfall at DSM.

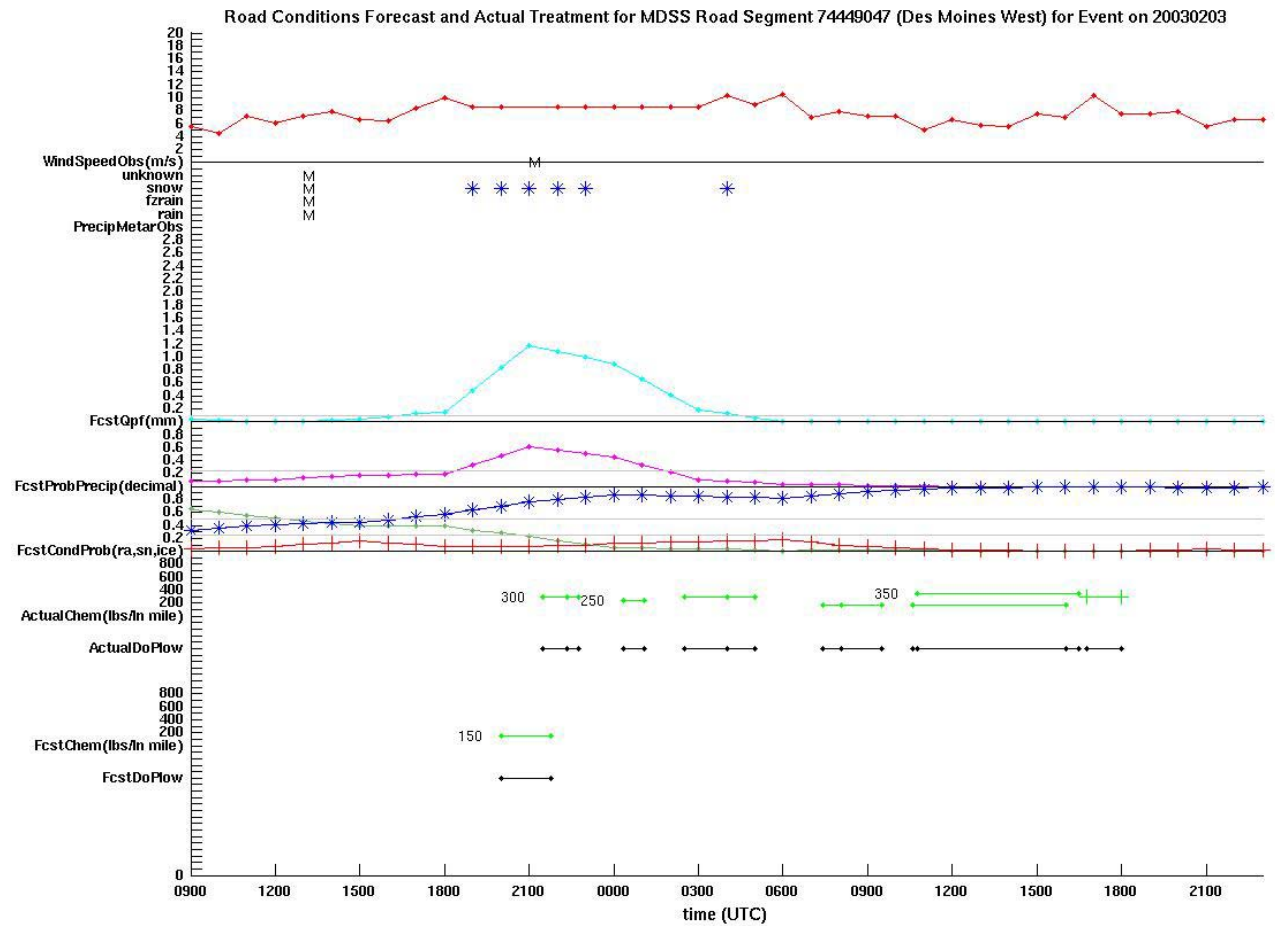

FIGURE 12 Forecast of road conditions and actual treatment for MDSS road segment, Des Moines west, for February 3–4, 2003.

Summary and Lessons Learned

From this case study a few lessons have been learned that would help the MDSS system capture this type of event better in the future. The first is the recognition of the need for a blowing snow module in the system. Some method for alerting on conditions with the potential to cause blowing snow would be very useful. Such a module that takes into account, among other things, wind speed and direction and the freshness of the snow has been developed and will be implemented for the 2004 demonstration. One key issue for the

maintenance personnel will be local knowledge of the surrounding area, such as which segments of road are along open fields, valleys, or forested areas. These different types of areas can greatly affect blowing snow. The second lesson learned is that the system needs to evaluate the entire event before making road treatment recommendations in order to avoid a situation like this case where the snow was melted by chemicals and did not have time to dry before it got too cold and refroze.

CONCLUSION

Overall, the RWFS did a good job at predicting both state and road weather parameters, given that this was the first attempt at completely automated forecasting for this application. Forecast accuracies were typically on the order of the measurement uncertainties estimated from station to station comparisons. With reasonable forecasts of these fields in hand, the MDSS was able to produce reasonable treatment recommendations, given the weather predicted. Differences between the forecast and actual weather, as well as difficulty in capturing road treatment rules of practice and the nuances of storm-to-storm treatments resulted in significant differences between suggested and actual treatments in some cases, however. The case study of the relatively simple light snow and blowing snow event of February 3–4, 2003, demonstrates this, including the importance of handling blowing snow.

During the winter of 2004, there will be another operational demonstration of the MDSS/RWFS over the same domain. System upgrades for 2004 include a blowing snow warning system (though no treatments will be suggested based on blowing snow alone) and forward error correction of many parameters, including temperature, precipitation occurrence and even precipitation type. In addition, a new mesoscale model ensemble will be employed. Following the demonstration, additional in-depth verification is planned.

ACKNOWLEDGMENTS

The FHWA Office of Transportation Operations Road Weather Management Program sponsors this project. The MDSS development team is grateful for the leadership provided by Shelley Row, Paul Pisano, Rudy Persaud, and Andy Stern (Mitretek). More than 20 state DOTs have been active participants and their feedback has been very useful.

The development of the MDSS functional prototype is a team effort involving several U.S. national laboratories including Cold Regions Research and Engineering Laboratory, MIT Lincoln Laboratory, National Oceanic and Atmospheric Administration (NOAA) FSL, and NOAA's National Severe Storms Laboratory. Each national laboratory has contributed by providing technologies that support MDSS objectives.

Thanks to Bill Mahoney for his constructive review of this document.

REFERENCES

1. Myers, B., M. Petty, and J. Cowie. An Automated Road Weather Prediction System for Road Maintenance Decision Support. *Preprints, 18th International Conference on Interactive Information and Processing Systems for Meteorology, Oceanography and Hydrology*. American Meteorological Society, 2002, pp. 40–41.
2. Mahoney, W. P., and W. L. Myers. Predicting Weather and Road Conditions. Integrated Decision-Support Tool for Winter Road-Maintenance Operations. In *Transportation Research Record: Journal of the Transportation Research Board, No. 1824*, TRB, National Research Council, Washington, D.C., 2003, pp. 98–105.

WINTER WEATHER: INFORMATION, MODELS, AND DATA QUALITY

Quality Management for Road Weather Data

TUOMO IIVANAINEN

MATTI PETTERSSON

Intrinsic Ltd.

Accurate road weather data are a prerequisite for cost-effective winter maintenance and reliable information services. Road weather data quality depend on several factors including properties of the road weather measuring device in use, as well as placement, assembly, and maintenance of the device. The purpose of the project described is to ensure the quality of road weather information by developing a quality management system for the road weather information system in Finland. The project started in the autumn of 2002. From the very beginning, the quality standard ISO 9001:2000 was taken as a frame of reference for the work, as it serves a generally accepted framework for quality. A project group was formed, members of which came from the Finnish Road Administration, winter maintenance organizations, measuring equipment assembly and maintenance service providers, the Finnish Meteorological Institute, and the authors as quality experts. In the first phase of the project, from autumn 2002 through spring 2003, a quality manual for road weather system was prepared. The second phase, started in autumn 2003, is an implementation phase. To ensure that the activities within the system are carried out as described in the manual. Moreover, some new software tools are introduced to support quality management.

INTRODUCTION

Road weather data quality has several characteristics. These include the following:

- How exactly do the data describe the road conditions (validity)?
- How well can the data be generalized?
- How comprehensively do the data cover the road network?
- Are the data available all the time?

Validity of data is further affected by several factors, including

- Properties of the road weather measuring device in use,
- Assembly of the device, and
- Maintenance of the device.

The goal of the project described is to ensure the quality of road weather information by developing a quality management system for the road weather information system in Finland. [Figure 1](#) shows an overview of the road weather information system. Road weather data are

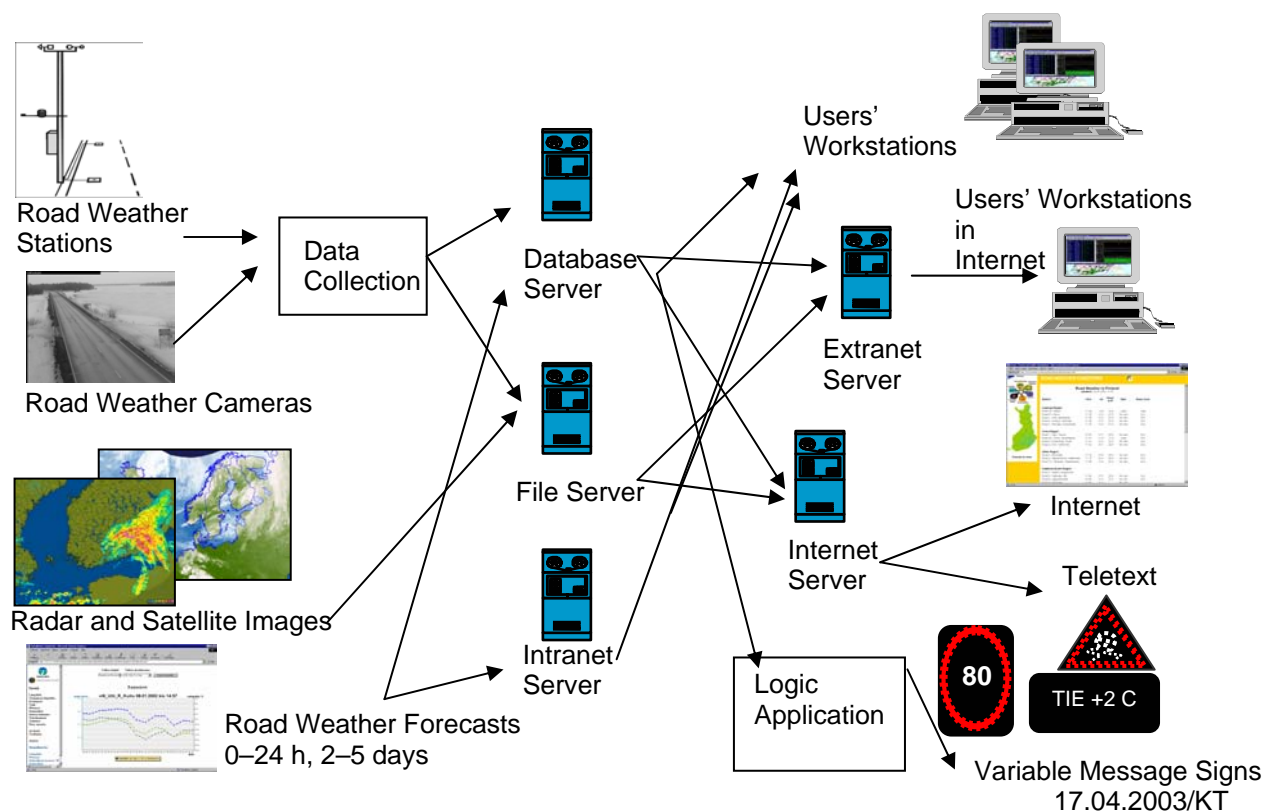

FIGURE 1 An overview of the road weather information system.

collected from about 300 road weather stations and images from about the same number of closed-circuit television cameras (CCTV). Weather forecasts and radar and satellite images are also passed through the system from weather service providers to supplement data collected by the Finnish Road Administration [(Finnra); for a more detailed description of the system see (1)].

The system was initially built up to provide data for the planning of winter maintenance operations, but nowadays data is also used to inform road users about driving conditions and to control variable message signs.

The project was initiated by Finnra, and it started in autumn 2002. A project group was formed, members of which come from Finnra, winter maintenance provider organizations, measuring equipment assembly and service providers, the Finnish Meteorological Institute, and the authors as quality experts. The group worked from autumn 2002 through spring 2003 to build a quality manual for the road weather information system.

MOTIVATION FOR THE PROJECT

Road weather information is used while optimizing performance or while defining an acceptable risk level. Car drivers, for example, use information to find an optimal course or timing for their trip. Variable message signs are used to control speed in challenging road weather conditions in

such a way that risk is acceptable. Winter maintenance operators optimize their use of resources—for example, their use of salt to prevent freezing.

To be useful for the intended purposes, the quality of road weather data must be good enough. Otherwise optimization and risk management fails. Data quality has always been an important topic while developing the road weather system, but there are several reasons why quality should be considered in a more systematic way than before.

Outsourcing Winter Maintenance and Data Use

Some years ago road administration in Finland was reorganized, and as a result winter maintenance operations are now carried out by independent service providers. This outsourcing has changed the role of the road weather information system, which remained within Finnra. Information is now used by independent organizations, whereas earlier it was mainly used within Finnra itself. Moreover, one of the future goals in Finland and elsewhere is that commercial information services be built based on road weather data. Most of the users of data now and in the future are outside Finnra.

This outsourcing of data use means more formal relations between producers and users of data. As part of the formality, a need to define a quality level for the information becomes more explicit. At the moment, the winter maintenance contracts include a general statement of the availability of information. However, particularly those looking for new business opportunities would also like to get more detailed information about accuracy of measurement and about possible breaks in the flow of data. Besides this, they would like to see some evidence, such as facts about the quality of the data.

Data Use in Automated Systems

There are several areas in Finland where speed limits and information signs are controlled by road weather data, and the number of such areas is increasing. Data used in these systems must be highly accurate, so that speed limits and informational signs reflect real driving conditions. Drivers seem to be sensitive to the justification for a speed limit; if they get the feeling that limits are often too low, they tend to disregard them.

Another example of automated systems is Internet pages: currently, data from some road weather stations are shown on Finnra's website, and the pages are widely used. Here the requirement of accuracy is not exactly that high, but there is another common feature: data are used immediately. There is no possibility for human control until afterward. This means that actions to ensure data quality must be mainly preventive in nature and be taken beforehand.

VIKING Guidelines

One of the long-term goals in the VIKING project is to achieve a harmonized and consistent level for road weather monitoring within Nordic countries. For that purpose, a set of guidelines has been prepared for monitoring (2). The guidelines include a set of common minimum quality requirements for monitoring road weather. The guidelines are an important step in assuring the quality of information. Still, it is only the first step: having defined a set of standards, we must also make sure that the whole system all the time (or most of the time) complies with the standard.

Quantity and Quality

The overall coverage of road weather stations and CCTV cameras is quite good in Finland—at least on main roads—and the data collection applications are quite reliable. However, while the size of the system is increasing, at the same time the number of personnel responsible for monitoring and maintaining the system decreases, so there is a risk of lowering quality. This stresses the need for preventive actions as well as the need for straightforward routines for detecting and handling problem situations, supported by automatic tools.

THE APPROACH

As a conclusion, there was a need to

1. Define a quality level for road weather data,
2. Ensure that the level is achieved,
3. Continuously monitor the level, and
4. Collect evidence of quality.

From the very beginning, quality standard ISO 9001:2000 was taken as a frame of reference for the work, as it serves a generally accepted framework for quality and covers all the aspects (1 through 4) above. Moreover it has an explicit customer focus, which is one of the leading principles of Finnra.

In the quality standard, quality is not considered in absolute terms. Quality is defined as the “degree to which a set of inherent characteristics fulfills requirements.” Thus, the first task in the project was to define the requirements. Interviews were used to determine needs and expectations of data users and other interested parties. Invaluable information was also received from a concurrent project on future visions of road weather system (3). The needs and expectations were then analyzed to establish a set of requirements for road weather data quality. The resources available for road weather information system were taken into account, so that unrealistic expectations were not accepted in the set of requirements. The VIKING monitoring guidelines were accepted where applicable.

The requirements include statements about

- Density and placement of stations and camera installations,
- Accuracy of measurements, and
- Availability of data and video images.

The next task was to consider how to fulfill quality requirements. It is evident that data quality is determined when the measurement is done. Afterward one can search and filter out clearly incorrect data, but the accuracy of an individual measurement cannot be increased. Thus actions to ensure data quality must be taken mostly before the measurement.

The method used to find the actions needed to ensure data quality was risk analysis. The whole process of producing road weather data was analyzed step by step. At each step it was considered what factors might risk the ability to produce high-quality data. Actions were then planned to eliminate the risks. The actions include

- Careful planning while selecting a place for a station or camera,
- Careful assembly of devices, and
- Maintenance operations accomplished according to a plan before the start of season.

In the quality standard this approach is referred to as quality assurance. Quality assurance is also related to quality control. The main difference is that quality control is reactive in nature whereas quality assurance is preventive.

Quality control uses techniques such as inspections and monitoring to assess quality. In principle, road weather data can be validated by conducting an independent measurement and comparing the results. Unfortunately, this is seldom possible, and we must mostly rely on quality assurance. Quality assurance aims at preventing any problems from happening. Of course, it is not a complete guarantee of quality. It is a way to provide reasonable confidence that the requirements will be met.

Quality control is used in road weather information system to find device malfunctions and to assess the effectiveness of quality assurance. For that purpose data can be verified against older data from same point or against current data originating from neighboring stations. However, this method reveals only considerable deviations. To find minor deviations we must rely on human judgment: the user of the data may detect even small deficiencies by comparing road weather data to information from other sources and by monitoring data for a longer period of time.

Collecting data describing quality achieved or activities performed is an important part of quality management. To be able to improve quality, one must have facts about the current state. Collected data is also used as evidence while showing the quality.

PROJECT RESULTS

Evidently, the most important result of the project is better quality. However, it is still too early to make an assessment whether this was achieved. In a project like this, the general increase of competence is another important result. The competence of the personnel was increased by arranging several courses on quality; some members of the project group even passed a quality auditor exam during the project.

The first visible outcome from the project was a quality manual, the first version of which was accepted in May 2003. In autumn 2003, several software tools were implemented both for personnel for quality management and for road weather data users. In the following section, we take a closer look at the new tools.

Tools for Users

The most important goal while designing new tools for road weather data users was that of adding the overall transparency of the system. New features were integrated into the existing viewing tools to show the users as much background knowledge of each station and camera installation as possible. The motivation for this was that the background knowledge helps the user in interpreting the measurement results correctly; clearly a quality goal in itself. Earlier, background data was not that necessary because there were fewer stations, and users typically monitored the weather within a smaller area. They knew their stations. Nowadays, there are more

stations and in many cases one person monitors the whole country area. It is impossible to master all the details without an easy access to background information. The background information includes

- Technical details of the device itself, types of detectors, and so forth;
- Photos of the surrounding landscape;
- Any special arrangement used in the assembly of the station; and
- Details of any repair or maintenance operations done on the station including cleaning, polishing, or calibrating the detectors.

The users also have access to the current status of station or camera installation. If there is a problem detected at the station, users get information about it alongside the measurement data. In Figure 2, status is shown as third column (VIKA) in the measurement data table in a viewing application. The first column contains station names (ASEMA), and the second shows the time (AIKA) of the latest measurement. The rest of the columns contain measurement data like air and road surface temperatures.

ASEMA	AIKA	VIKA	Ilm.	DIlm	Tie1	Tie2	DTie1	DTie2	Maa1	Maa2	KastP	KpEro	JääPI1	JääPI2	Koste	Sade	S-Int	S-Sum
vt1_Nupuri	30.10.15:59	SER	3,1	-0,3	4,7	4,7	0,1	-0,3	4,6	4,5	1,9	2,8	0,0	0,0	92	Pouta	0,0	0,0
vt1_Palojärvi_R	30.10.16:00	---	3,2	-0,1	3,1	3,3	-0,2	-0,3	3,3	3,6	2,0	1,1	0,0	0,0	92	Pouta	0,0	0,5
vt1_Palojärvi_O	30.10.16:00	---	3,2	-0,1	3,7	2,9	-0,1	-0,3	3,6	3,5	2,0	1,7	0,0	0,0	92	Pouta	0,0	0,5
vt1_Myllylampi	30.10.16:00	---	3,0	-0,1	4,4	4,2	0,0	-0,1	4,1	4,5	1,8	2,6	0,0	0,0	92	Pouta	0,0	0,2
vt2_Salkola	30.10.15:35	---	3,1	-0,2	3,6	3,7	-0,3	-0,2	3,3	3,4	2,6	1,0	0,0	0,0	97	Pouta	0,0	0,3
vt1_Koikkala_R	30.10.16:01	---	3,1	-0,1	3,8	4,0	-0,1	-0,2	4,2	4,5	2,4	1,4	0,0	0,0	95	Pouta	0,0	0,6
vt1_Hyrsylän-suora_R	30.10.16:01	---	3,5	-0,1	4,6	3,6	-0,2	-0,2	4,2	4,1	2,5	2,1	0,0	0,0	93	Pouta	0,0	0,2
vt1_Hyrsylän-mutka_R	30.10.16:01	---	3,4	-0,2	4,3	4,2	-0,2	-0,3	4,2	4,5	2,7	1,6	0,0	0,0	96	Pouta	0,0	0,2
vt1_Hyrsylän-mutka_O	30.10.16:01	---	3,4	-0,1	4,4	3,9	-0,2	-0,3	4,5	4,3	2,8	1,6	0,0	0,0	96	Pouta	0,0	0,2
vt1_Saukkola_R	30.10.15:57	---	3,1	-0,2	4,2	4,3	-0,2	-0,2	4,4	4,4	2,4	1,8	0,0	0,0	95	Pouta	0,0	0,3
vt1_Sysimetsä_R	30.10.15:59	---	3,5	-0,2	4,0	3,8	-0,2	-0,2	4,0	4,1	3,0	1,0	0,0	0,0	96	Pouta	0,0	0,2
vt1_Oinola_R	30.10.16:01	---	3,4	-0,2	3,7	3,9	-0,3	-0,3	4,3	4,3	3,0	0,7	0,0	0,0	97	Pouta	0,0	0,2
vt1_Oinola_O	30.10.16:01	---	3,4	-0,2	3,8	3,6	-0,2	-0,3	4,3	4,2	3,0	0,8	0,0	0,0	97	Pouta	0,0	0,2
vt1_Leppäkorpi_R	30.10.16:01	---	3,4	-0,3	3,8	3,7	-0,3	-0,4	4,1	4,0	2,7	1,1	0,0	0,0	95	Pouta	0,0	0,2
vt3_Pirkkola_R	30.10.15:38	---	3,6	0,1	4,9	3,8	-0,1	-0,3	4,3	3,9	1,7	3,2	0,0	0,0	87	Pouta	0,0	0,0
vt1_Leppäkorpi_O	30.10.16:01	---	3,4	-0,3	3,7	3,5	-0,3	-0,3	4,1	4,2	2,7	1,0	0,0	0,0	95	Pouta	0,0	0,2
vt3_Keimola_2_R	30.10.15:48	---	3,5	0,0	5,1	4,6	0,0	0,1	4,5	4,1	1,7	3,4	0,0	0,0	88	Pouta	0,0	0,0
vt3_Keimola_2_O	30.10.15:48	---	3,5	0,0	4,7	3,9	-0,3	-0,3	4,7	4,0	1,7	3,0	0,0	0,0	88	Pouta	0,0	0,0
vt3_Karhunkorpi	30.10.16:00	---	3,2	-0,2	3,5	3,5	-0,5	-0,4	3,7	3,8	2,1	1,4	0,0	0,0	93	Pouta	0,0	0,1
vt4_Jakomäki	30.10.15:59	PRB	3,7	-0,2	5,2	4,7	-0,3	-0,4	4,8	5,1	1,4	3,8	0,0	0,0	85	Pouta	0,0	0,0
vt4_Kerava	30.10.15:56	OK	3,7	-0,2	4,7	3,9	-0,3	-0,6	4,2	4,3	2,1	2,6	0,0	0,0	92	Pouta	0,0	0,1
vt4_Ohkola	30.10.15:55	---	3,4	-0,5	3,0	3,6	-0,9	-0,9	3,8	3,9	1,3	1,7	0,0	0,0	93	Pouta	0,0	0,3
vt4_Levanto	30.10.16:00	---	2,8	-0,4	2,8	2,8	-0,8	-0,6	3,5	3,1	1,9	0,9	0,0	0,0	93	Pouta	0,0	0,3
vt7_Sipoonlahti	30.10.16:04	---	3,3	-0,3	4,3	4,9	-0,2	-0,6	4,5	4,9	1,6	2,7	0,0	0,0	88	Pouta	0,0	0,0
vt7_Porvoo	30.10.15:58	OK	3,1	-0,5	3,9	4,2	-0,4	-0,6	4,2	4,2	1,3	2,6	0,0	0,0	88	Pouta	0,0	0,0
vt7_Koskenkylä	30.10.15:58	TST	2,1	-0,3	4,4	4,2	-0,6	-0,5	4,3	4,3	0,8	3,6	0,0	0,0	86	Pouta	0,0	0,0
vt7_Lovisa_R	30.10.15:55	---	3,1	-0,2	3,4	4,2	-0,5	-0,7	3,9	4,2	0,7	2,7	0,0	0,0	84	Pouta	0,0	0,0
vt25_Hanko	30.10.15:56	---	4,5	0,0	5,7	5,8	-0,8	-0,9	5,3	5,4	2,0	3,7	0,0	0,0	84	Pouta	0,0	0,0
vt25_Tammisaari_R	30.10.15:57	---	4,8	0,0	4,6	5,0	0,0	0,0	4,4	4,8	2,8	1,8	0,0	0,0	87	Pouta	0,0	0,2
vt25_Karjaa	30.10.15:57	---	3,7	-0,3	4,4	4,4	-0,5	-0,6	3,7	4,2	2,4	2,0	0,0	0,0	91	Pouta	0,0	0,4

FIGURE 2 Stations' status shown as third column of a measurement data table.

By a mouse click or by a menu selection, users can open a web page for more detailed information, such as the fault history of a station (see Figure 3), where each line in the table is either a status change (e.g., error detected) or an action taken (repair service ordered). Through the same page any user can himself give feedback about possible malfunctions or errors he has detected in any of the system's components.

Tools to Support Quality Management

With the aid of the new tools, problem situations will be detected more quickly. The system itself collects data about problem situations and stores data to the database. Moreover, the system collects feedback from the users. All the data can be viewed by the supporting personnel as well as by the user. The system makes it easier for the supporting personnel to send maintenance requests for device maintenance service providers, helping to shorten the time while data is not available. Figure 4 shows a map where personnel can see if there are any new problem situations at any of the stations.

Päiväys	Kellonaika	Ilmoittaja	Vikatunnus	Anturi	Tapahtuma	Selite	Kommentit
28.10.2003	12:57	super	25	Koko asema	Kunnossa.	Selite	Kommentit
28.10.2003	12:56	super	25	Koko asema	KorjausLempäälä	Huoltoraportti	Kommentit
28.10.2003	12:55	super	25	Koko asema	Korjauspyyntö vastaanotettu	Selite	Kommentit
28.10.2003	12:53	super	25	Koko asema	Vika vahvistettu, korjauspyyntö lähetetty.	Selite	Kommentit
24.10.2003	15:31	super	25	Koko asema	testivirhettä	Selite	Kommentit
08.09.2003	14:25	JV	6	Koko asema	Kunnossa.	Selite	Kommentit
08.09.2003	14:25	JV	5	ILMA	Kunnossa.	Selite	Kommentit
08.09.2003	14:25	JV	5	ILMA	Korjattu.	Huoltoraportti	Kommentit

FIGURE 3 Status history of a road weather station. Each line in the table is either a status change (e.g., error detected) or an action taken (e.g., maintenance service ordered).

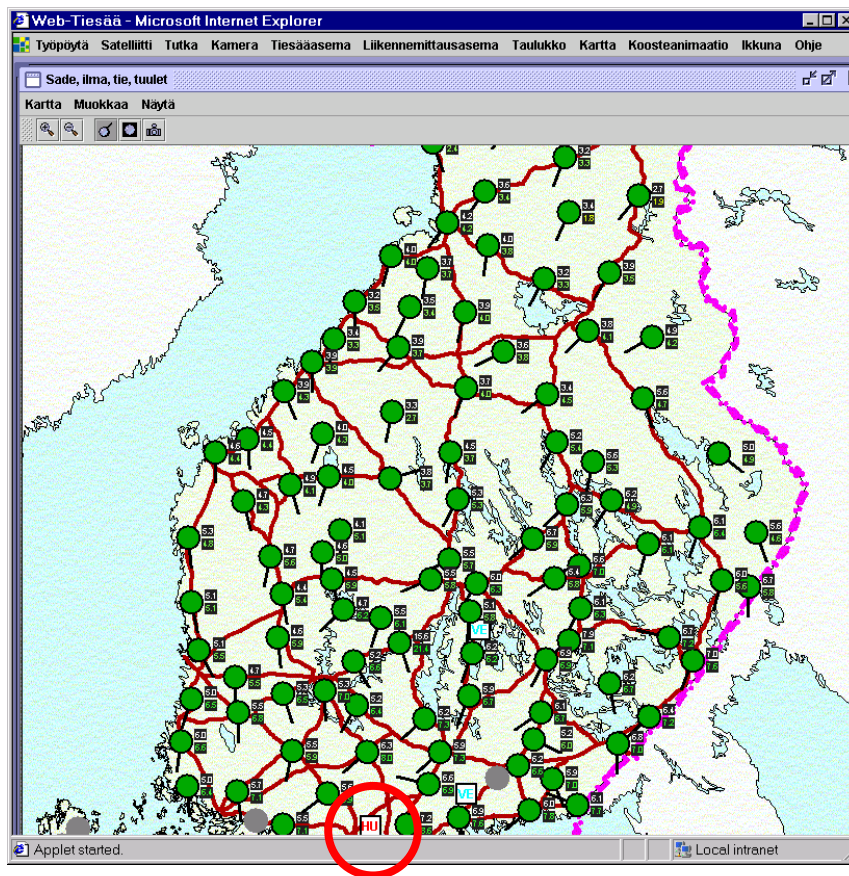

FIGURE 4 Finnra personnel can view possible problems on any of the stations on a map.

Frequently done maintenance operations on stations and camera installations are a key in maintaining the accuracy of data. With the new tools the personnel can track that the maintenance operations are carried out as intended, making their management easier. Data recorded can also be used for auditing purposes.

Current Status

At the moment (November 2003), the project is in the implementation phase. We are working to ensure that all the activities are carried out as described in the quality manual. The new tools described above are partly implemented, too. The project continues through spring 2004.

ACKNOWLEDGMENTS

The authors wish to thank the Finnish Road Administration and all the parties involved in the project. The project has also been granted European Community financial support in the field of Trans-European Networks-Transport.

REFERENCES

1. Toivonen, K., and J. Kantonen. Road Weather Information System in Finland. Presented at 5th International Symposium on Snow Removal and Ice Control Technology, 2000, Roanoke, Va.
2. Kulmala, R., and S. Luoma. *VIKING Monitoring Guidelines 2001. Euro-Regional Project VIKING Version 1.0*. Commission of the European Union, Directorate General for Energy and Transport, August 2001.
3. Lähesmaa, J., and J. Levo. *Tiesääseurannan Tavoitetila* [Objective State of Road Weather Monitoring]. Finnish Road Administration, Kouvola, 2003.

Winter Maintenance: Policy, Management, and Performance

WINTER MAINTENANCE: POLICY, MANAGEMENT, AND PERFORMANCE

Research on the Level of Winter Road Management**TAKASHI YAMADA***Hokuriku Construction Association***AKIRA SUGIMURA***Hokuriku Regional Development Bureau***TERUHIKO MARUYAMA***Nagaoka University of Technology*

This study focuses on the level of winter road management and analyzes regional characteristics, snow removal cost, and degree of road-user satisfaction to study the level of winter road management that should be provided in a heavy snow region.

The analysis revealed that, in the region studied, road surface snow cover had a great impact on driving speed and that driving speed differs between snow removal work sections. It also showed that snow removal was adequate and economically efficient and that road users were not dissatisfied with road surface management. The results demonstrated that it was appropriate for driving speed to be an index of the level of road management in a heavy snow region and that local rules must be established for each snow removal section. It has been proposed that it would be suitable to set this index on the premise that the present service level would be maintained. It is assumed that it would be possible to achieve effective and efficient winter road management by setting this driving speed as the target for management of winter roads and by removing snow in order to provide specified benefits to road users.

In the future, many-sided analyses such as detailed traffic analysis including traffic accident analyses and interview surveys of road users must be performed to complete the data.

INTRODUCTION

Snow removal is an essential road service in heavy snow zones in Japan, not only to guarantee safe, smooth road traffic but also to stabilize social life and to contribute to regional economic growth. In today's mature society, the needs of these regions have grown and become diversified, and the people demand service improvement. However, road managers must meet these demands under severe budget restrictions.

The Nagaoka National Highway Office (NNHO) is responsible for the Yuzawa District, which is one of the heavy snow zones. In an attempt to meet the service needs and demands as well as the restricted budget, NNHO has studied road performance management, which is intended to provide management that satisfies regional needs through a partnership between the public and private sectors. This approach is based on regional characteristics and road-user views. It is implemented for winter road surface management by setting goals that address the most important challenges facing the region, performing management based on these goals, evaluating

management effectiveness, and, according to circumstances, working cooperatively with road users to improve service.

The research that has been undertaken in response to the above circumstances is a study of the winter road management level suitable for a heavy snow region. The research focuses on the management goals and analyzes regional characteristics, snow removal costs, and the degree of road-user satisfaction (Figure 1). The conclusions presented in this report do not directly reflect the views of the NNHO.

RESEARCH OUTLINE

A variety of analyses were performed using meteorological and traffic data obtained from reference documents and from the findings of a fixed observation system installed beside National Highway No. 17, which passes through the town of Yuzawa in Niigata Prefecture and is managed by the NNHO. Figure 2 shows the district studied and the snow removal sections on National Highway No. 17.

WINTER ROAD MANAGEMENT LEVEL INDEX

It is necessary to establish an index suitable for regional characteristics in order to set the level of winter road surface management. The authors studied an index for the level of winter road surface management by analyzing meteorological characteristics, traffic characteristics, and the state of snow removal.

Meteorological Characteristics

Figure 3 shows changes of the cumulative snowfall in the Yuzawa District, and Figure 4 shows winter meteorological conditions in the Yuzawa District. The cumulative snowfall—exceeding 10 m every year except 1996 and 1997—shows how heavy snowfall is in this district. The temperature begins to fall in early November, hits its minimum from January to mid-February, and begins to rise in late February. In the district, climatic conditions cause extreme variability of road surface conditions. Specifically, a daily temperature differential reaches approximately as much as 10°C, with the daily maximum and minimum temperatures above and below 0°C, which is the road surface freeze–thaw boundary from late December to mid-February (a period of extremely heavy snowfall).

Another feature of this heavy snowfall district is its high population concentration: 20,000 in Shiozawa and 9,000 in Yuzawa.

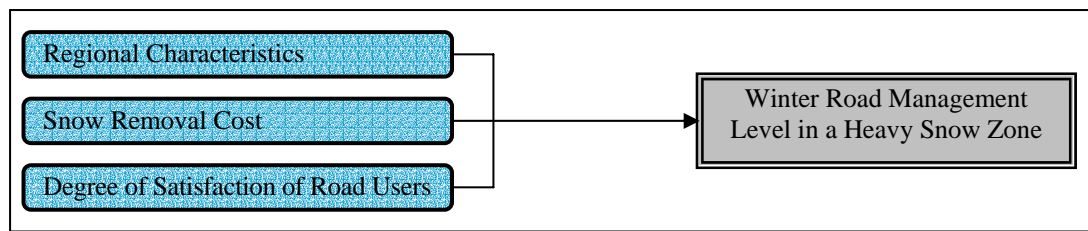

FIGURE 1 The research approach.

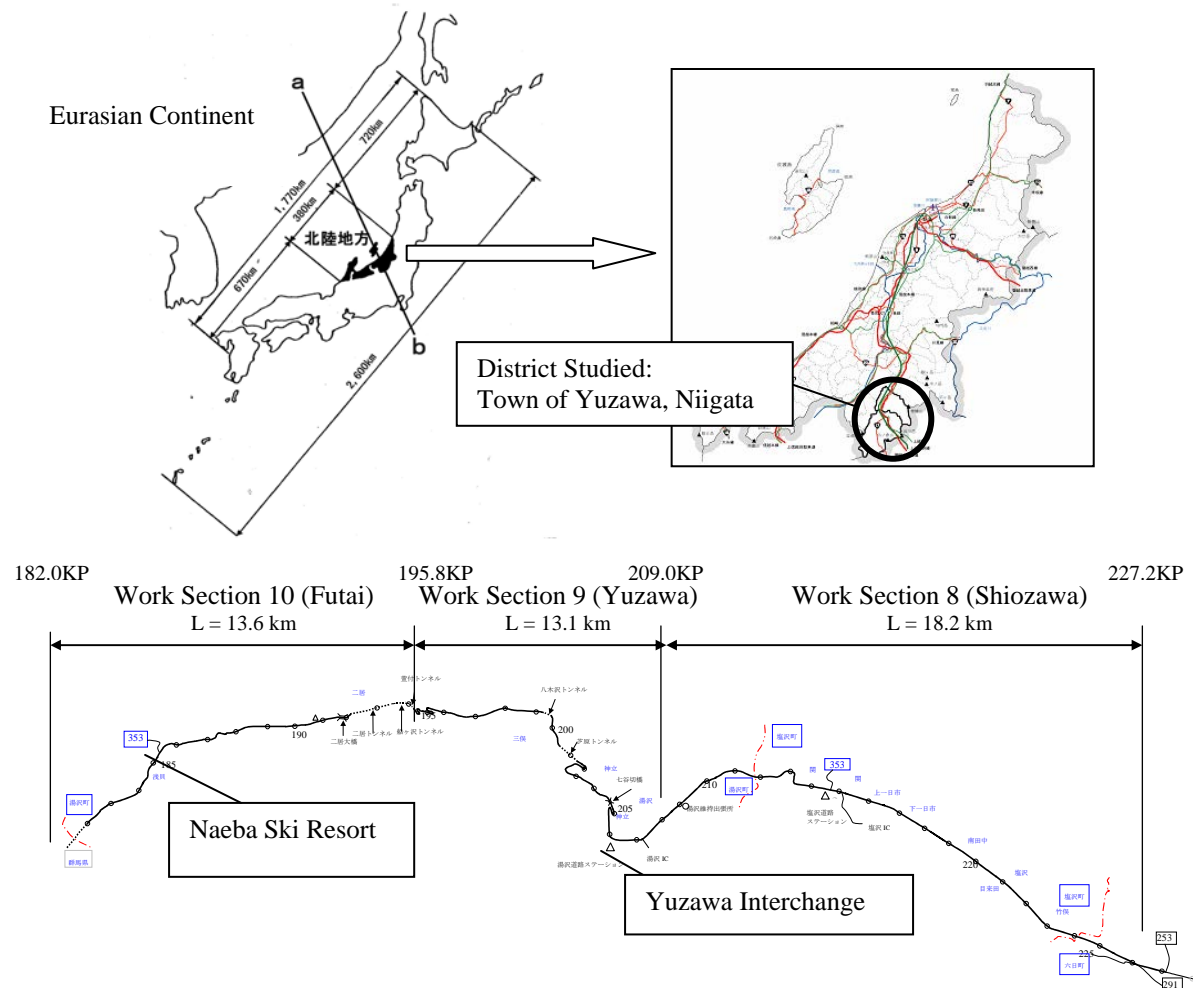

FIGURE 2 District studied and the snow removal sections on National Highway No. 17 in the Yuzawa District.

Traffic Characteristics

Figure 5 shows the monthly average traffic volume by snow removal work section, and Figure 6 shows the average monthly driving speed by snow removal work section in the winter. In the Shiozawa work section, the traffic volume exceeds 10,000 vehicles in both autumn and winter; that is far heavier than in the Yuzawa and Futai work sections. By day of the week, the autumn traffic is heavier on weekdays than on holidays, but in the Futai and Yuzawa work sections, winter traffic is heavier on holidays than on weekdays. In the Shiozawa section, the driving speed on weekdays is slowest at 30 km/h, and the degree of congestion is highest at approximately 2, but the degree of congestion on holidays is highest in the Futai work section (Figure 6).

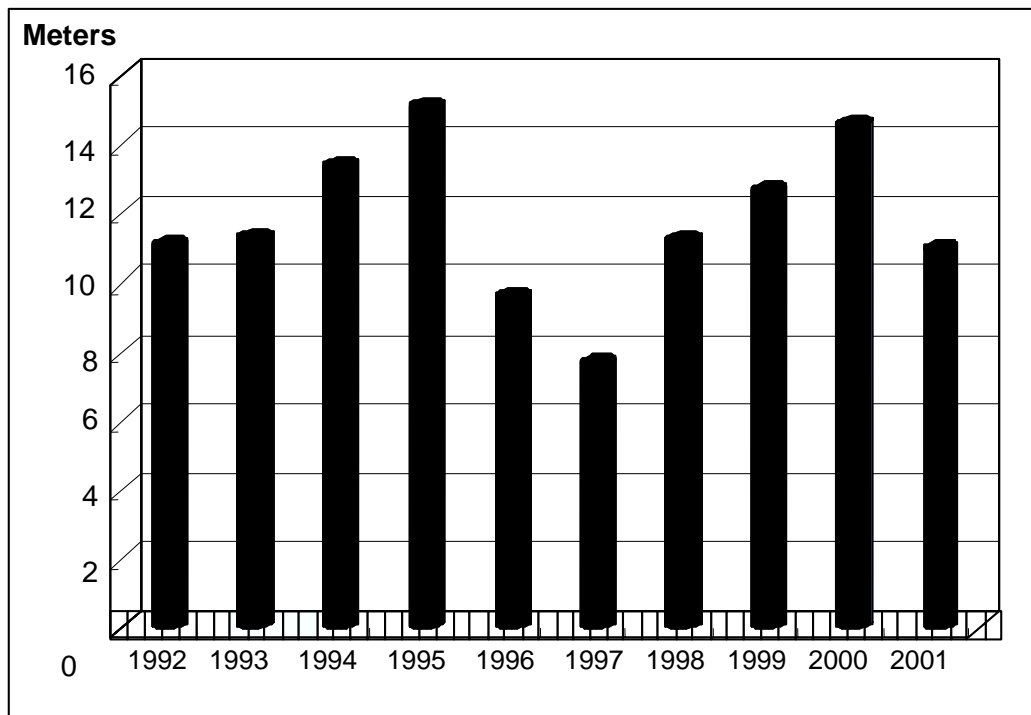

FIGURE 3 Changing cumulative snowfall in the Yuzawa District (average for Futai, Mitsumata, Yuzawa, and Shiozawa).

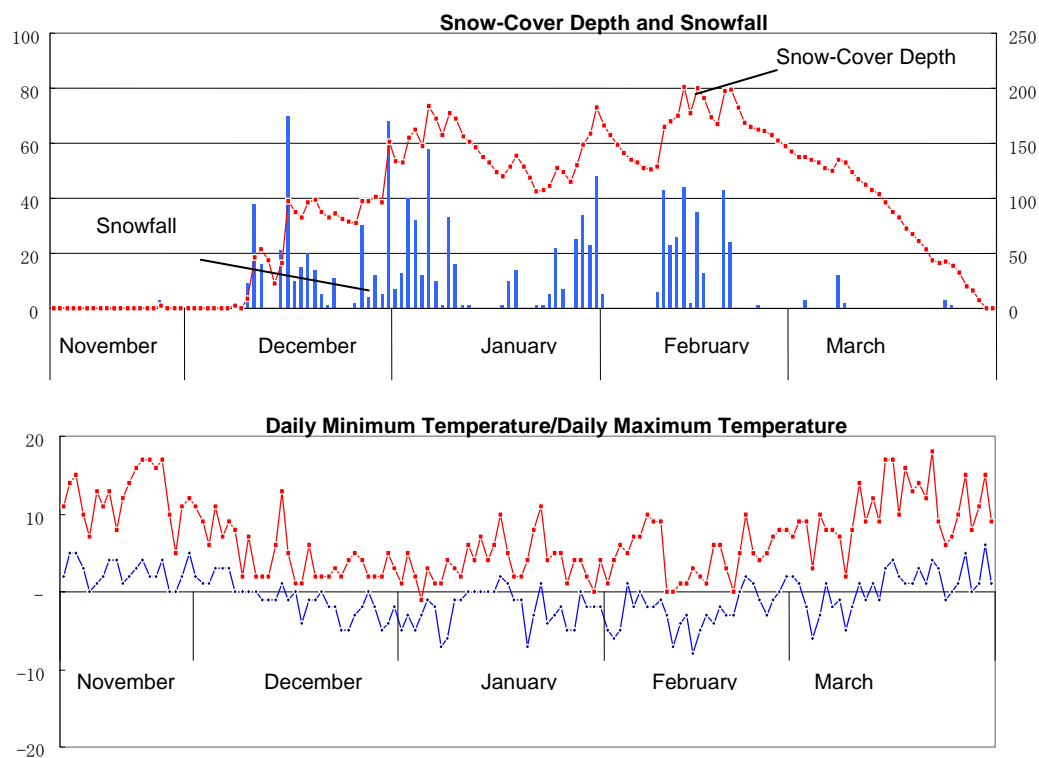

FIGURE 4 Winter meteorological conditions in Yuzawa District (November 2002 to March 2003).

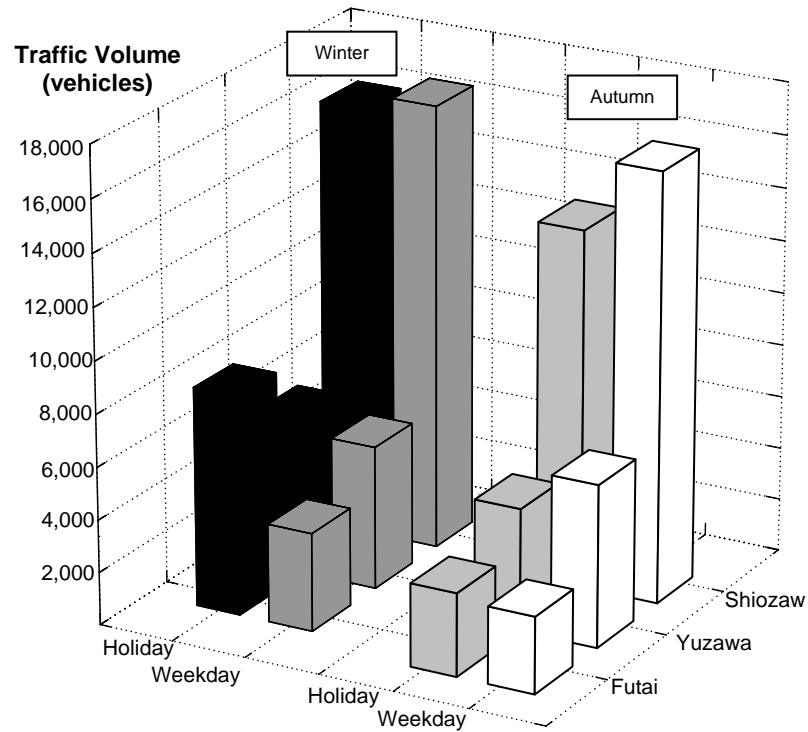

FIGURE 5 Average monthly traffic volume by snow removal work section (2003).

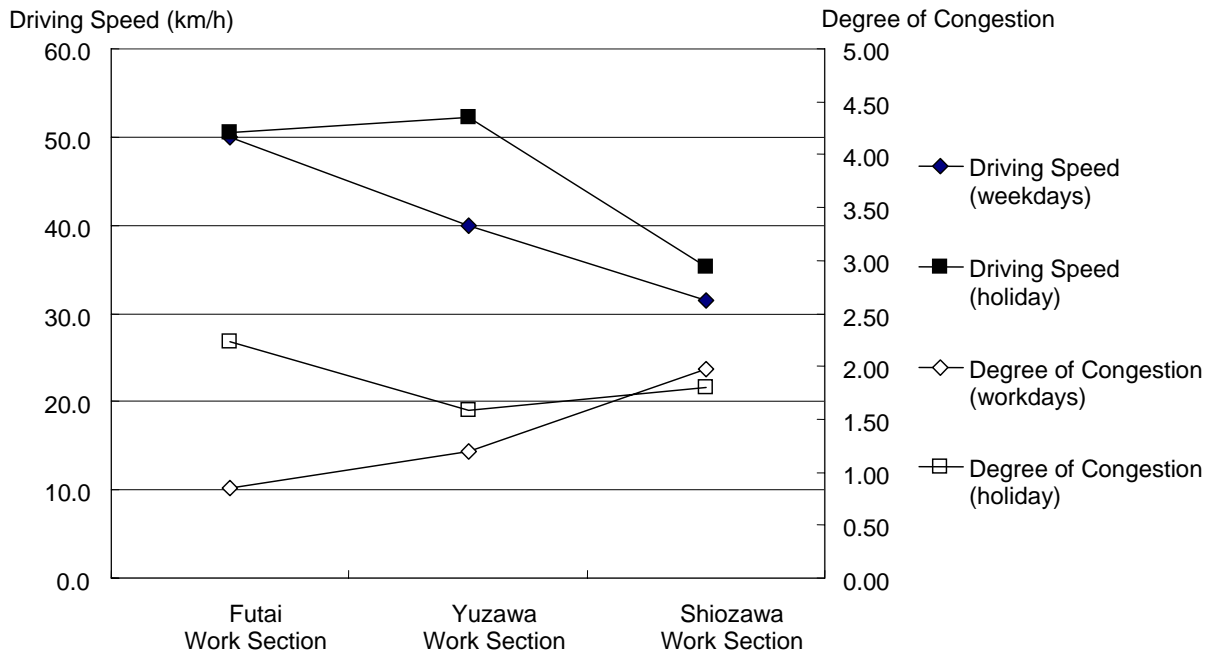

FIGURE 6 Monthly average driving speed by snow removal work section (winter 2003).

It can be hypothesized that because there are ski resorts, hot springs, and numerous other tourist facilities that attract many winter visitors to Futai, the traffic volume rises and falls complexly according to the number of visitors. Therefore, it is necessary to carry out more prompt and more reliable winter road surface management in this district.

State of Snow Removal

Figure 7 illustrates the operating hours by type of snow removal machine, and Figure 8 illustrates the rate of occurrence of each road surface condition in the Yuzawa work section. The total operating hours of the snowplow-equipped graders, snow removal trucks, snowplow-equipped tractors, rotary snowplows, small snow removal vehicles, and small snow removers account for approximately 70% of all operating hours, showing that snow removal and disposal is a very time-consuming and costly part of snow and ice measures.

The state of the road surface shows that 51% of the time the road surface is snow free (it is either dry or wet), while 43% of the time it is snow covered (either slush or compacted snow). It is frozen 6% of the time.

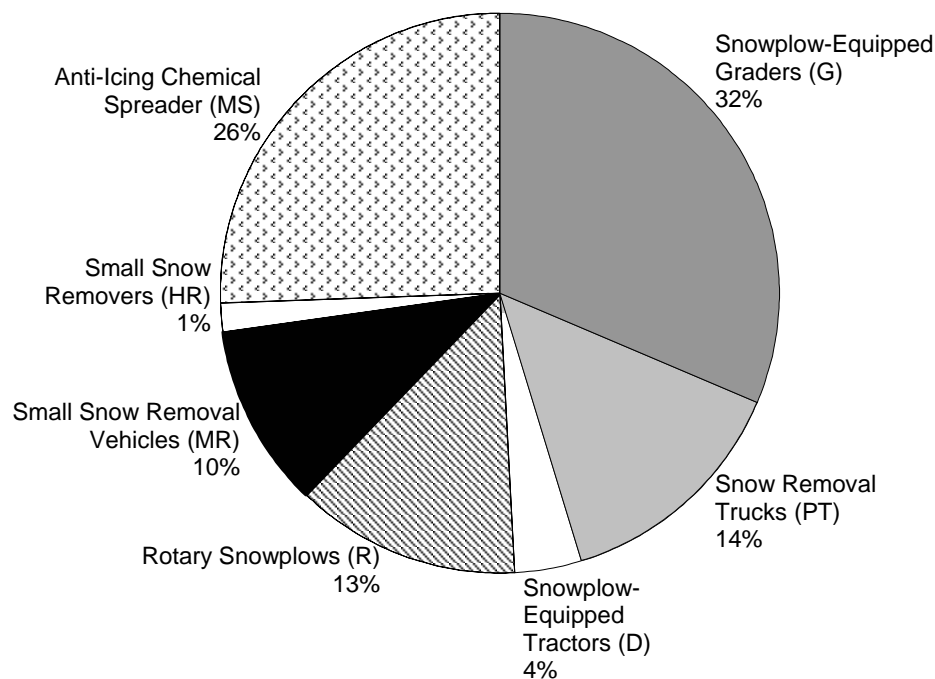

FIGURE 7 Operating hours by type of snow removal machine (average operating hours from 1989 to 1999).

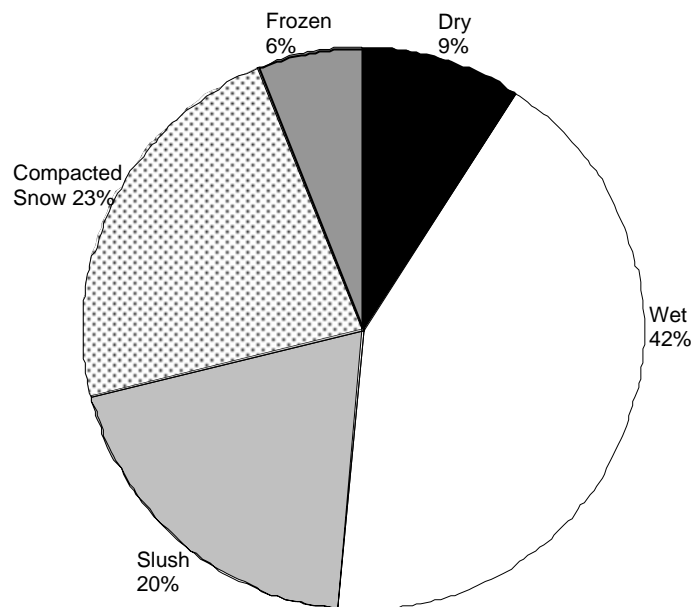

FIGURE 8 Road surface condition occurrence rate (8:30 a.m. data, December 1, 2000, to March 31, 2001).

Impact of Road Surface Snow Cover on Road Traffic

Because the removal and the disposal of snow account for most of the time and the cost of road management in the Yuzawa District, the impact of road surface snow cover on road traffic was analyzed.

Figure 9 presents the distribution ratio of the time headway by road surface snow cover depth. An increase of road surface snow-cover depth shifts the distribution ratio to the right, increasing the time headway. The time headway on dry roads is generally assumed to be between 2 and 3 s, but snow cover increases this by about 1 s. The relationship between the time headway and the traffic volume is represented by the following equation, revealing that a rise in the road surface snow cover lowers the traffic volume.

$$t = 1/Q \quad (1)$$

where t = time headway (second) and Q = traffic volume (vehicles/h).

Figure 10 shows the road surface snow cover depth–time headway relationship and the 95% reliability zone. The range of the 95% reliability zone is large, and scattering of the time headway to the road surface snow-cover depth is large. Considering the fact that at a road surface snow-cover depth of 6 cm or more, the data are extremely few in number and include many abnormal values, and if the road surface snow-cover depth rises, the time headway tends to fall. The relationship of the time headway with the traffic volume, traffic density, and driving speed

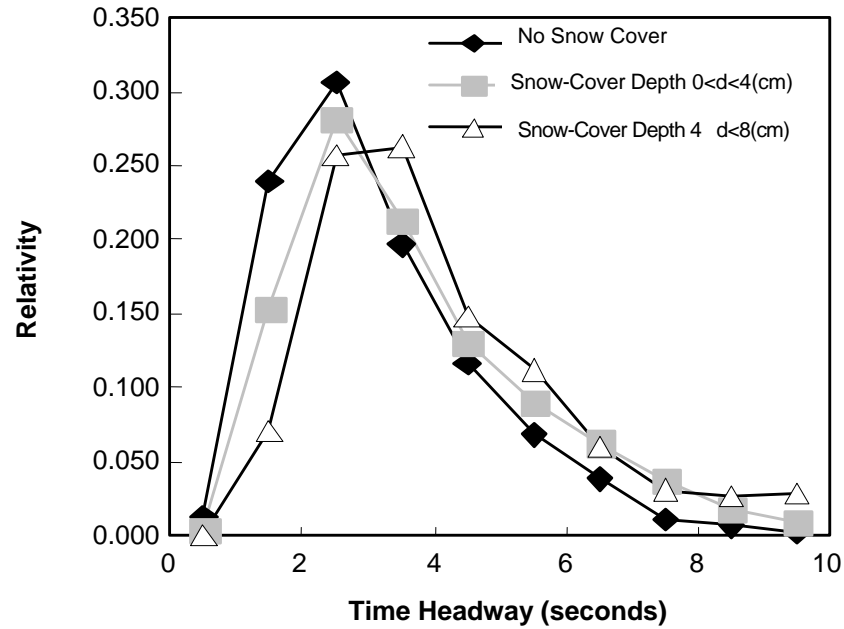

FIGURE 9 Distribution ratio of time headway.

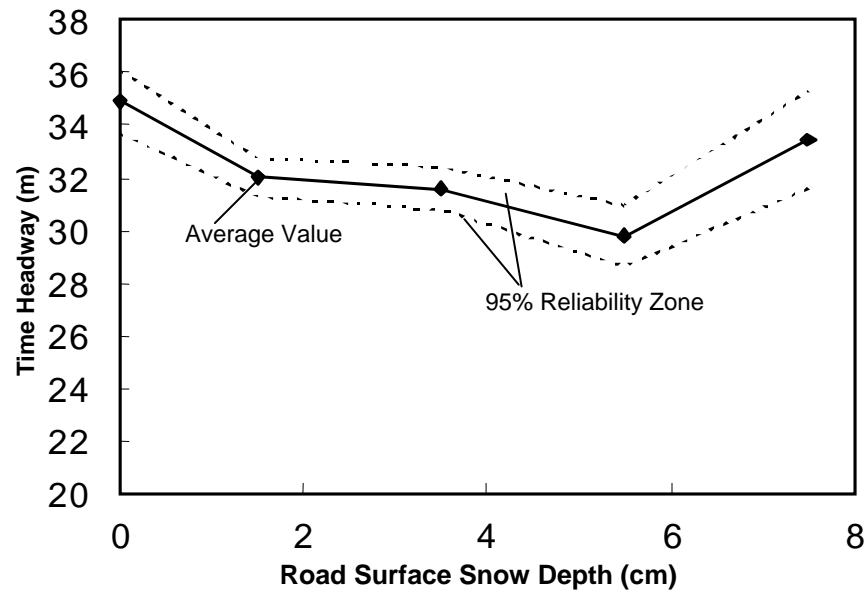

FIGURE 10 Road surface snow depth, time-headway relationship.

is represented by the following equation, but the small time headway signifies large traffic density.

Therefore, an increase of the road surface snow-cover depth lowers driving speed, increases traffic density, reduces traffic volume, and causes the traffic flow to fall in congested flow zones.

$$s = l/K = v/Q \quad (2)$$

where

s	= average time headway (m)
K	= traffic density (vehicles/km)
v	= driving speed (km/h)
Q	= traffic volume (vehicles/h)

For the above reasons, roads are managed in the winter by setting management goals with driving speed as one of the indices for the service level in a district where snowfall is heavy, snow removal and disposal account for more than half of road surface management, and road surface snow cover remarkably reduces the driving speed. Because the characteristics of traffic in different snow removal work sections differ, it is necessary to set the driving speed separately for each snow removal work section.

LEVEL OF PRESENT WINTER ROAD MANAGEMENT

When driving speed has been hypothesized to be an index of service level, road management is performed considering the level of service to be guaranteed. Figure 11 shows the rate of driving speed decline from the Yuzawa Interchange to the Naeba Ski Resort. When the road is dry, the average driving speed falls by approximately 10% on the outbound lanes and by approximately 15% on the inbound lanes. The present level of winter road management when the road is dry guarantees a service level between 85% and 90%.

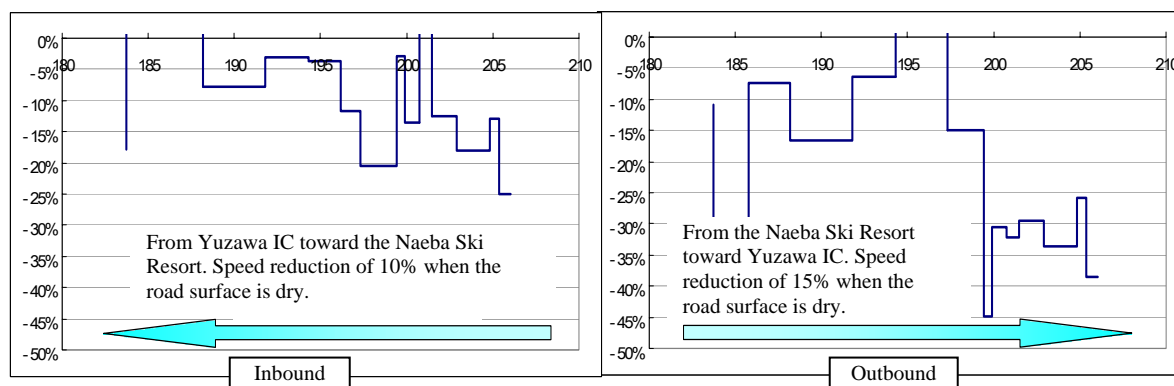

* Driving speed reduction rate = dry road speed/compacted snow speed x100%

FIGURE 11 Driving speed reduction rate.

SNOW REMOVAL COST ANALYSIS

Winter Road Management Level and Snow Removal Cost

Winter road management must provide appropriate road services under strict budget restrictions. So the relationship of snow removal cost and snowfall with the road surface management level (driving speed) is analyzed.

Figure 12 shows the relationship of daily snowfall with snow removal cost in the Yuzawa district in 2001. The snow removal cost is calculated by multiplying the operating time of snow removal machines by the snow removal cost per unit of time based on past performance. As the snowfall rises, the snow removal costs rises, with a high coefficient of determination of 0.94. By predicting the snowfall, it is possible to set the snow removal cost and plan the target budget.

Figure 13 shows the relationships of driving speed and daily snowfall with snow removal cost. As the snowfall rises, the snow removal cost rises, but the driving speed inevitably falls. The driving speed when snowfall is heavy (35 cm/day) is about 20% less than it is during a light snowfall (0 cm/day) and about the same level as the road surface management stated above. Considering that present snow removal is performed by full operation of snow removal machines for road surface management, it is difficult to seek significant improvement of the service level using only snow removal machinery.

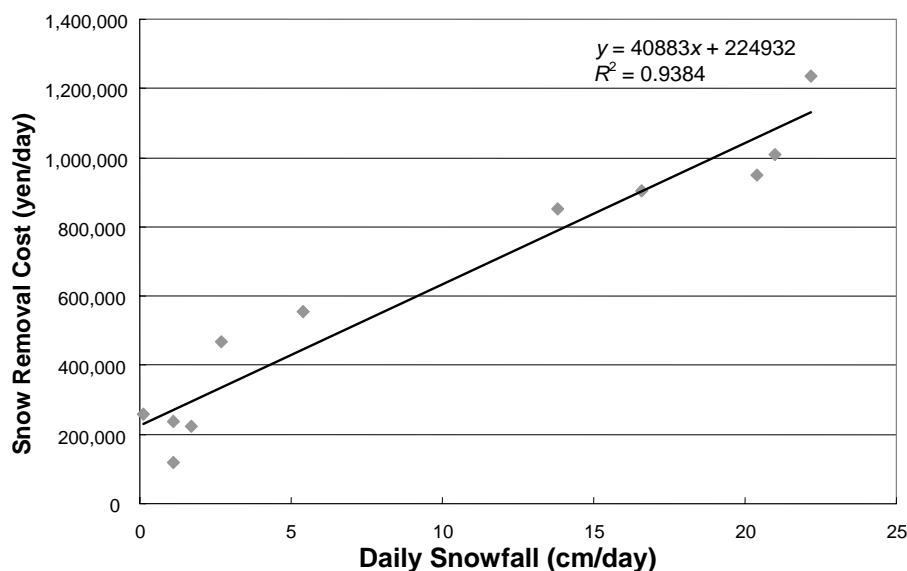

FIGURE 12 Daily snowfall–snow removal cost relationship.

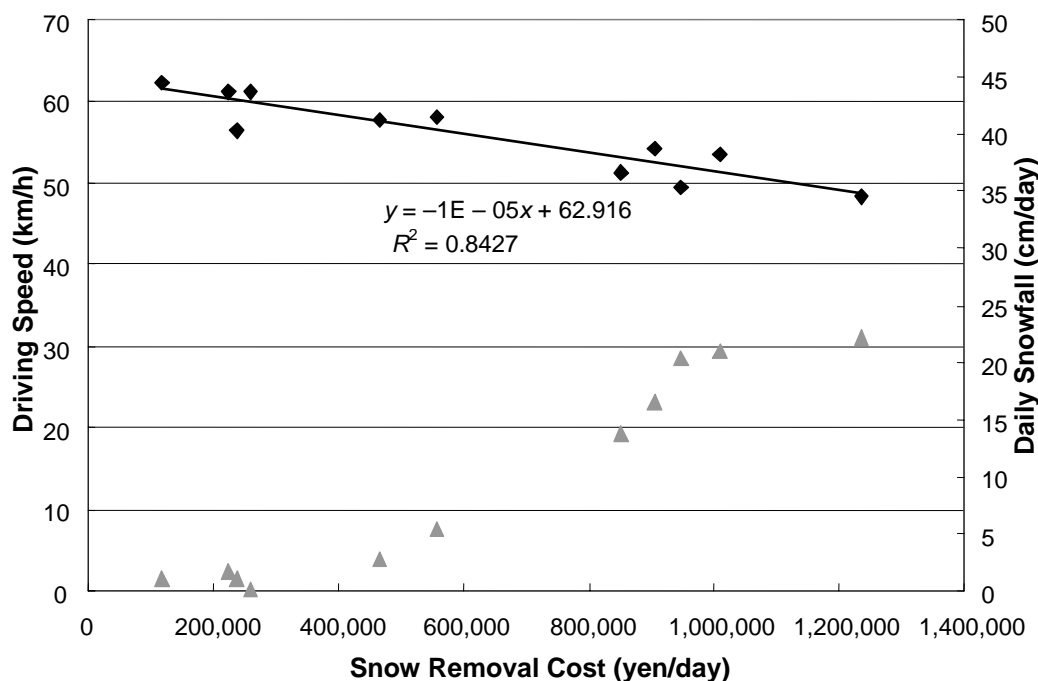

FIGURE 13 Snow removal cost, driving speed, and daily snowfall relationship.

Note: Snow removal cost is ordinary snow removal work + snow bank treatment work + anti-icing work + sidewalk snowfall removal.

Cost–Benefits

A cost–benefits analysis of present snow removal was performed based on the prerequisite conditions presented in Table 1. The analysis obtained the driving time reduction to measure this as the snow removal effects based on the difference between the driving speed with and without snow cover on the road surface.

As a result, the cost-benefits ratio is 1:4, and a measurement based only on the driving time reduction benefits satisfies the efficiency standard. Because the total benefit presumably includes driving expense benefits, traffic accident reduction benefits, and more, the benefits of actual snow removal are probably several times larger than shown here.

TABLE 1 Prerequisite Conditions

Work Section	Traffic Volume	Large Vehicle Percentage	Traveling Speed	Time Value
Kandatsu–Mikuni (23.8 km)	6,400 vehicles/day	27.3%	With snow: 49.19 km/h Without snow: 53.88 km/h	Normal vehicles: 67.27 yen/min Trucks: 101.39 yen/min

NOTE: Traffic census data for 1997.

TABLE 2 Content of Complaints About Snow and Cold Submitted to the Road Consultation Office (Jurisdiction of the Yuzawa Maintenance Office)

Related Item	Number of Cases	Content of Complaints	Number of Cases
Snow/cold related	25		
Snow cornice treatment	1	Treatment of snow cornices	1
Snow removal	4	There are cases where snow is not removed at the same time according to the section.	1
		Do not leave snow at intersections.	1
		Please remove snow from bus stops.	1
		Snow removal broke my paddy field drainage pipe.	1
Snow bank treatment	1	If you remove snow only to the outside line of the road, skiers have to walk in the dangerous traffic lane.	1
Snow blowing	9	Please do not blow snow on paddy fields.	4
		Please do not blow snow in front of houses and shops.	2
		Please do not blow snow in side ditches or on driveways.	2
		Please do not blow snow on sidewalks cleared by the town.	1
Snow banks	5	Snow banks are obstructions that reduce visibility so that entering the roadway is dangerous.	2
		Do not form snow banks in front of shops.	1
		Snow banks make crossing the street dangerous for old people.	1
		Snow banks on sidewalks are dangerous because people cannot see cars.	1

DEGREE OF SATISFACTION OF ROAD USERS

The setting of the winter road management level must reflect not only the views of the road manager but also those of road users. The degree of satisfaction of road users with present road surface management was analyzed based on the content of requests and comments received by the Road Consultation Office (Table 2). The complaints concerning snow and cold include many complaints of problems closely related to daily life, requests for snow blowing, and post-processing of snowbanks, but few complaints about winter road surfaces.

CONCLUSIONS

This research was a study of the road management level that is required in heavy snow regions based on the results of various analyses. The following is a summary of knowledge obtained from the study.

1. Removing and disposing of snow accounts for about 70% of the time and expense of winter road management.
2. Road surfaces are snow free (dry or wet) 51% of the time, snow covered (including slush and compacted snow) 43% of the time, and iced over 6% of the time.
3. Characteristics of traffic such as the traffic volume and driving speed vary between snow removal work sections.
4. Considering that present snow removal is performed by full operation of snow removal machines for road management, it is difficult to seek significant improvement of the service level using only snow removal machinery.
5. The cost and benefits of present snow removal satisfy efficiency standards, even if only the time reduction benefits are included in the calculation. It can be concluded that the present service is at an appropriate level, even from the perspective of economic efficiency.
6. Complaints concerning snow and cold include few complaints about winter road surfaces, indicating that people are satisfied with the present level of road management.
7. Considering the fact that the level of road management in heavy snow regions is impacted by meteorological characteristics, traffic characteristics, the state of snow removal, and the snow cover on the road surface, it is appropriate to set driving speed as an index, and it is necessary to establish local rules for each snow removal section.

It also is appropriate to set the winter road management level based on the fact that the present service level will be maintained in order to guarantee economic suitability and the degree of satisfaction of road users. It is assumed that it is possible to achieve effective and efficient winter road management by setting this driving speed as the target for management of winter roads and by removing snow in order to provide specified benefits to road users. Driving speed can be used beneficially by both road managers and road users, for example, by allowing a road manager to provide an index or pass-through time in order to help road users more easily understand the benefits of snow removal.

FUTURE CHALLENGES

Managing roads with the driving speed as a road service index guarantees road users speed and on-time arrival at their destinations, but there have not been adequate surveys of the psychological state of road users and their concern with safety and comfort. It also is necessary to set detailed management goals such as the range of permissible driving speeds.

In the future, many-sided analyses such as detailed traffic analysis including traffic accident analyses and interview surveys of road users must be performed to complete the data.

ACKNOWLEDGMENTS

The authors thank Mr. Sugimura and Dr. Maruyama for their valuable comments and suggestions.

REFERENCES

1. Japan Society of Traffic Engineers. *Traffic Engineering Handbook*. Gihodo Shuppan Co. Ltd., 1984.
2. Wada, J., Y. Masuda, and M. Okuzumi. Study of Winter Road Management Level. *Traffic Engineering*, Vol. 21, No. 1, 1986.
3. *Snow Protection Technology Handbook* (D. M. Gray and D. H. Male, eds.; M. Masuda, translator). Tsukiji Shokan Publishing Co., Ltd., 1990.
4. Hayakawa, A. Ichinose: Research on the Enactment of Winter Road Surface Management Level. In *Report on the Fifteenth Symposium on Cold Region Technologies*, 1999, pp. 622–627.
5. Ministry of Land, Infrastructure, and Transport Road Bureau. *Cost–Benefits Analysis Manual* (draft), 1999.
6. Yamada, T., T. Maruyama, and A. Kuramata. Increasing the Efficiency of Road Surface Management and Winter Road Management by CS-type Information Provision. *Proc. of the Eighteenth Niigata Research and Survey Conference of the Kanto Branch of the Japan Society of Civil Engineers*, 2000, pp. 121–124.

WINTER MAINTENANCE: POLICY, MANAGEMENT, AND PERFORMANCE

Proactive Snow and Ice Control Toolbox**LELAND D. SMITHSON***Iowa Department of Transportation*

Winter weather conditions adversely affect the nation's surface transportation system. Safety, mobility, and the economy take a dramatic hit during winter storms. A staggering 1.5 million vehicular accidents occur annually during adverse weather. These accidents result in approximately 800,000 injuries and 7,000 fatalities costing an average of \$42 billion annually (www.ops.fhwa.dot.gov/Weather). Adding to these negative impacts, loss of mobility puts a strain on commerce, especially businesses that rely on just-in-time delivery. To counter these impacts of winter, state and local governments annually spend more than \$2 billion on snow and ice control operations and more than \$5 billion for infrastructure repair because of snow and ice control damage. However, use of snow and ice control chemicals puts an added stress on the environment. Environment Canada's recent declaration that chloride-based chemicals should be considered toxic to the Canadian Environmental Protection Agency adds a sense of urgency for the snow and ice community to focus on the proper handling, storage, and application of commonly used anti-icing and deicing chemicals.

The current state of the practice of snow and ice control is building on the solid elemental foundation laid in the early 1990s by the Strategic Highway Research Program (SHRP) and the winter maintenance international scanning tours conducted in 1994, 1998, and 2002. The state of the art has moved from reactive snow and ice control (initiating operations after the snow or ice begin to form) to a focus on proactive snow and ice control (beginning operations before the storm to prevent the bonding of ice or snowpack to the pavement). The proactive assault on winter is being launched simultaneously on three fronts:

- Innovative interactive road weather information systems and anti-icing (RWIS/AI) training lead by AASHTO,
- Maintenance decision support systems (MDSS) lead by FHWA, and
- Development and evaluation of the next-generation snow and ice control equipment led by a consortium of state departments of transportation (DOTs) with the Iowa DOT.

These three things—innovative training to better understand modern road weather forecasts, MDSS to assist in bringing all the elements into consideration for an optimized snow and ice control strategy, and advanced technology equipment—are powerful and effective tools in the winter maintenance toolbox.

INNOVATIVE TRAINING

Results from SHRP seemed straightforward and relatively uncomplicated. Most DOT leadership felt the benefits of the research were so obvious that the field maintenance crews would implement the new processes with little effort or guidance. Lead states that experienced early

success tried to help other states get started but soon realized a national RWIS/AI training program needed to be developed.

Snow and ice control managers and supervisors needed a better understanding of meteorology and energy balance in order to determine when a road weather forecast was reliable or when it was going bad. They needed to understand how to work cooperatively and how to effectively talk to their weather service provider to correct the situation. They also needed a better understanding of snow and ice control chemicals, effective brine-making techniques, optimal application rates, dilution caused by weather and traffic, pavement temperatures, and seasonal effects. Some ad hoc training was being developed by agencies, but the reduction in agency staffs and the increased use of contractor workforces resulted in a less experienced and smaller workforce attempting to meet the increasing demands of the motoring public, who wanted a higher level of mobility.

To meet these training needs, the lead states team developed an outline of user-based training needs for understanding and implementing an RWIS/AI snow and ice control program. They further requested that AASHTO take the lead in raising the necessary funding and administering development of the training program. AASHTO then developed the computer-based, interactive, RWIS/AI training program. Since more than 90% of the snow belt states and the Association of Public Works Association and the National Association of County Engineers are using this training program, there should be a more consistent approach to optimizing snow and ice control, and the road conditions during winter weather should be more uniform. Because this training was based on previously identified user needs, it has been well accepted by the maintenance workforce, and the principles taught have been integrated into their operational practices.

IMPROVED WEATHER FORECASTING

Providing snow and ice control managers and the motoring public more accurate and accessible road weather information can improve snow and ice control operations and reduce accidents. A project called FORETELL, funded in part by FHWA, is being evaluated in the upper Mississippi valley. FORETELL collects, forecasts, and distributes on the Internet highly specific road weather information that is needed by the motoring public and snow and ice control decision makers. System features include

- Detailed weather forecasts generated four times each day and 24 h into the future;
- Data provided at 10-km gridded resolution, increasing the ability to pinpoint which areas are being affected by winter weather conditions;
- Grid atmospheric weather forecasts and nowcasts mapped to Interstates and U.S. and state highways to predict pavement conditions;
- Gathered and translated atmospheric and road condition information from specific road points to generate easily understood descriptions of the road and weather conditions; and
- Road and weather event descriptions distributed on demand with fax, pager, and e-mail notification.

After three seasons of test and evaluation, most elements of the program are working well, but forecast accuracy needs some improvement to be able to meet users' high expectations.

A brief video demonstrating the value of the FORETELL RWIS is available at itspubs@fhwa.dot.gov. This system combines intelligent transportation and weather prediction systems to create an advanced highway maintenance management and traveler information system. The video explains how FORETELL integrates road and weather observation data to provide a web-based, one-stop information source for maintenance crews and travelers.

DEVELOPMENT OF MAINTENANCE DECISION SUPPORT SYSTEM

Snow and ice control managers, now armed with more road weather information, realized the difficulty of fitting this multiplicity of factual information into an operational response. Building on the new proactive snow and ice control approach, FHWA developed a new tool for these RWIS/AI decision makers. MDSS is the new package for the RWIS for winter maintenance decision makers. The MDSS inner workings assemble weather conditions throughout a wide area, predict the potential of deteriorating conditions, plan treatment scenarios, and provide decision makers with treatment recommendations based on the proven rules they were taught in the RWIS/AI computer-based training program. Project details can be found at FHWA's website: www.ops.fhwa.dot.gov/weather/MDSSRollOut.htm.

ADVANCED EQUIPMENT TECHNOLOGY

In the final analysis, the results of all of the previously described training and of MDSS need the correct equipment accurately performing the right operations in order to optimize snow and ice control operations. This next-generation snow and ice control equipment is being developed and field-tested at the Iowa DOT. A consortium of snow belt states led by the Iowa DOT has developed and field-tested a new generation of snowplow.

The Highway Maintenance Concept Vehicle (HMCV) project had its beginning in 1995 following the results of the 1994 FHWA/AAHSTO/TRB international scanning tour. The pooled-fund study envisioned using international and domestic technologies to improve snow and ice control equipment and provide travelers with the level of service defined by policy during the winter season at the least cost to taxpayers. The approach was to bring technology being used in other industries and apply them to snow and ice control equipment. The project encompassed four phases over a 7-year period:

- Phase 1 of the project focused on describing the desired functions of the HMCV and evaluating feasibility. This phase began with a literature search of winter-related materials. Focus groups consisting of equipment operators, mechanics, area supervisors, and resident and central office maintenance engineers were formed. Focus group meetings were held in three snow belt states to identify the desired capabilities of the future HMCV. More than 600 ideas were combined into 181 desired capabilities to be explored. Private-sector equipment and technology providers were invited to join the pooled fund effort. The private-sector partners provided equipment and expertise for the duration of the study.
- Phase 2 project objectives were to build three prototype concept vehicles. One prototype HMCV was built for each of the three consortium states, integrating subsystems into a working system, conducting proof of concept evaluations, and preparing field evaluations for

Phase 3 of the project. Functional areas integrated into the prototype HMCV included an air and pavement temperature sensor; a Global Positioning System (GPS); real-time data communications; an engine power booster; anti-icing equipment to apply brine, pre-wetting material, or dry material spreading; back-up sensors; and a pavement friction measuring device.

- Phase 3 objectives included extensive field-testing and evaluation and producing data flow and decision process maps to integrate the HMCV functionality into management systems.
- Phase 4 built on the accomplishments of the previous three phases. Several functionalities were redesigned to improve durability and operational efficiency and effectiveness. Also, a newly discovered functionality—a mobile chemical sensor—was added. Following the completion of Phase 4 field evaluations, a business case for implementing the technologies was added to the project.

This truck uses off-the-shelf technology that takes real-time GPS-correlated measurements of road temperature, surface chemistry, and surface friction, and can customize (through onboard computers) application rates to predicted road conditions. This information is displayed onboard and downlinked to the garage, so that both the operator and the supervisor can monitor real-time operations. These automated features let the operator concentrate on driving the truck and allow the supervisor to monitor the entire fleet rather than following a snowplow and deciding what the appropriate action should be for the remainder of the fleet. Vehicle description and project details and evaluations can be found at www.ctre.iastate.edu/research/conceptv/index.htm. The open architecture of the HMCV makes it an ideal mobile test platform for technologies to be evaluated in an actual operational field environment.

FUTURE DIRECTIONS

So far this paper has addressed only improvements for the winter maintenance community. Achieving improvements in safety and mobility will be a partnership effort involving motorists and the winter maintenance community. Motorists could benefit from the improved road weather forecasting being purchased by governmental agencies. Further, motorists could improve their trip planning if they knew which roads had been plowed and treated and how effective that treatment has been.

Some governmental agencies are allowing the public to access their websites to view data from environmental sensor stations. This information includes pavement temperature, air temperature, wind speed and direction, road surface condition, and cameras. Some websites even show the status of snow and ice control operations, such as what routes have been plowed and treated as well as the current location of snowplow equipment. Although some governmental agencies are reluctant to release this information, others are displaying all their operational data and are delighted with the positive response they have received from taxpayers. The agencies have fewer phone calls from the public, which results in improved operational efficiency.

Accurate and timely road weather information, including current observations and forecasts, can help the motoring public make better decisions with regard to travel plans and react properly when faced with potentially compromised conditions. The motoring public has shown high interest in road weather information. The 511 system tested in several snow belt states during the 2002–2003 winter had call-in and web page hits that exceeded design capabilities. Ed Boselly, Road Weather Program Manager, Washington State DOT, reported in a

message on the AASHTO SICOP List Serve that Washington State DOT's traffic and weather website set a record on November 19, 2003, with more than 6.8 million page views. The number dropped to 5.8 million the next day. One of their cameras on Snoqualmie Pass (Interstate 90, 53 mi east of Seattle) had more than 377,000 views on November 19, 2003.

The message from the motoring public is clear: they are interested in keeping out of harm's way and are looking for ways to become better-informed motorists. The push from the auto industry for telematics and smart cars that will be able to detect and respond to road weather conditions means that drivers will be informed of suboptimal conditions and will have the ability to operationally respond and find other optimal routes for travel. The proactive snow and ice control toolbox has many unique tools that are working well now, and there will be many more tools added in the near future.

WINTER MAINTENANCE: POLICY, MANAGEMENT, AND PERFORMANCE

Planning Blowing-Snow Control Facilities
According to Danger Assessment
Development of New Highway Snowstorm Countermeasure Manual

YASUHIKO ITO

MASARU MATSUZAWA

YASUHIKO KAJIYA

Civil Engineering Research Institute of Hokkaido

To maintain road traffic flow and safety in cold regions, it is particularly important to mitigate the visibility reduction and snowdrift formation induced by blowing snow. The *Highway Snowstorm Countermeasure Manual*, which was first published in 1990, addresses snowy roads in Japan, but it has neither included specific planning guidelines for blowing-snow countermeasures nor addressed blowing-snow countermeasures for new roads in the road planning stage. In an effort toward developing systematic and efficient installation of blowing-snow control facilities, a planning method has been devised in which the degree of blowing-snow-induced danger is assessed numerically, plans for blowing-snow control measures are formulated according to a new procedure, the proper countermeasures are selected according to a detailed flowchart, and surveys for snow- and ice-related facilities are specified. This method is included in the newest revision of the *Highway Snowstorm Countermeasure Manual*, where it is expected to be instrumental in helping road administrators in Hokkaido and other snowy regions of Japan to select and implement blowing-snow countermeasures for roads.

INTRODUCTION

Ensuring winter road safety is important for cold, snowy regions in Japan, including Hokkaido. Blowing-snow control measures (poor visibility mitigation and snowdrift prevention) are especially important. Traditionally those measures have been planned according to daily patrols, the needs of road users, and assessment by road engineers. No specific planning method has been established, and the measures do not address specific needs for newly constructed roads. For systematic and efficient installation of blowing-snow control facilities, we have devised a planning method for snow control measures on roads. This method consists of assessment of the degree of blowing-snow-induced danger, a planning procedure for blowing-snow control measures and control facility selection, and snow- and ice-related surveys for facility planning.

The *Highway Snowstorm Countermeasure Manual* was first published in 1990. It includes guidelines on the design of blowing-snow control facilities in Hokkaido. Snow control facilities have been installed based on the manual's recommendations. The revised manual consists of three volumes: the general guide volume, snowbreak woods volume, and snow fence volume. The first of these is completely new and includes the method mentioned above. The other two volumes are revisions of existing volumes. The newly revised *Highway Snowstorm Countermeasure Manual* was published in 2004. This paper describes the concept of the new manual and the background of its development.

METHOD OF ASSESSING DEGREE OF BLOWING-SNOW-INDUCED DANGER

Conventional Assessment Method and Points To Be Improved

The manual uses the assessment of the degree of blowing-snow-induced danger in the early phases of planning toward identifying sections that require blowing-snow control. The assessment method has been made more concise and has been designed to allow the existing data to be used and the survey time and labor to be reduced as much as possible.

The *Road Disaster Prevention Measure Survey and Design Guideline (1)* and *Road Disaster Prevention Guideline (2)*, which were published in 1978 and 1996, respectively, have been used to assess the degree of blowing-snow-induced danger. Because the former focuses exclusively on countermeasures against snowdrift, which was regarded as the main problem at the time of its drafting, the reference is inadequate with respect to poor visibility. The *Comprehensive Inspection Guideline for Road Disaster Prevention* is aimed at assessment of existing snow control facilities but not those along new roads. The focus, methods, and objectives of these documents are different. A new method was considered necessary to assess the degree of blowing-snow-induced danger and the needs for control measures. To develop a new assessment method, the following improvements have been implemented:

- Focus—In addition to snowdrift, poor visibility is regarded as important.
- Concept—Danger factors and safety factors are incorporated into the basic concept of degree of danger assessment. The existing method provides a 3-scale rating. For a more specific assessment, the new method adds “Countermeasure not needed” to provide a 4-scale rating.
- Assessment items—
 1. Blowing-snow-induced road closures, traffic hindrances, and accident history are assessed. Whether any winter-specific accidents had occurred is incorporated, since poor visibility is the focus.
 2. Poor visibility caused by high embankment is assessed.
- Safety factor—
 1. Land use on the upwind side is considered in assessing the safety factor.
 2. Gentle slope snowdrift-control fill are given a positive score in assessing the safety factor.
 3. Snowdrift-control fill is assessed in terms of snowdrift prevention and poor visibility effects.

Concept Behind New Flowchart for Degree of Danger Assessment and Scoring

The new flowchart for degree of danger assessment divides degree of blowing-snow-induced danger assessment into degree of snowdrift-caused danger assessment and degree of poor-visibility-induced danger assessment (Figure 1). Based on these assessments, countermeasures are selected for blowing-snow control.

The degree of danger is based on the sum of the scores of snowdrift factors or poor visibility factors, whichever are higher, and the history factors (e.g., traffic accident records) of the road subject to assessment (Figure 2). Consideration of past traffic circumstances (history factor) incorporates the effects of factors other than snowdrift and poor visibility factors. This enables objective assessment. When no past information is available (e.g., the road is new), the flowchart

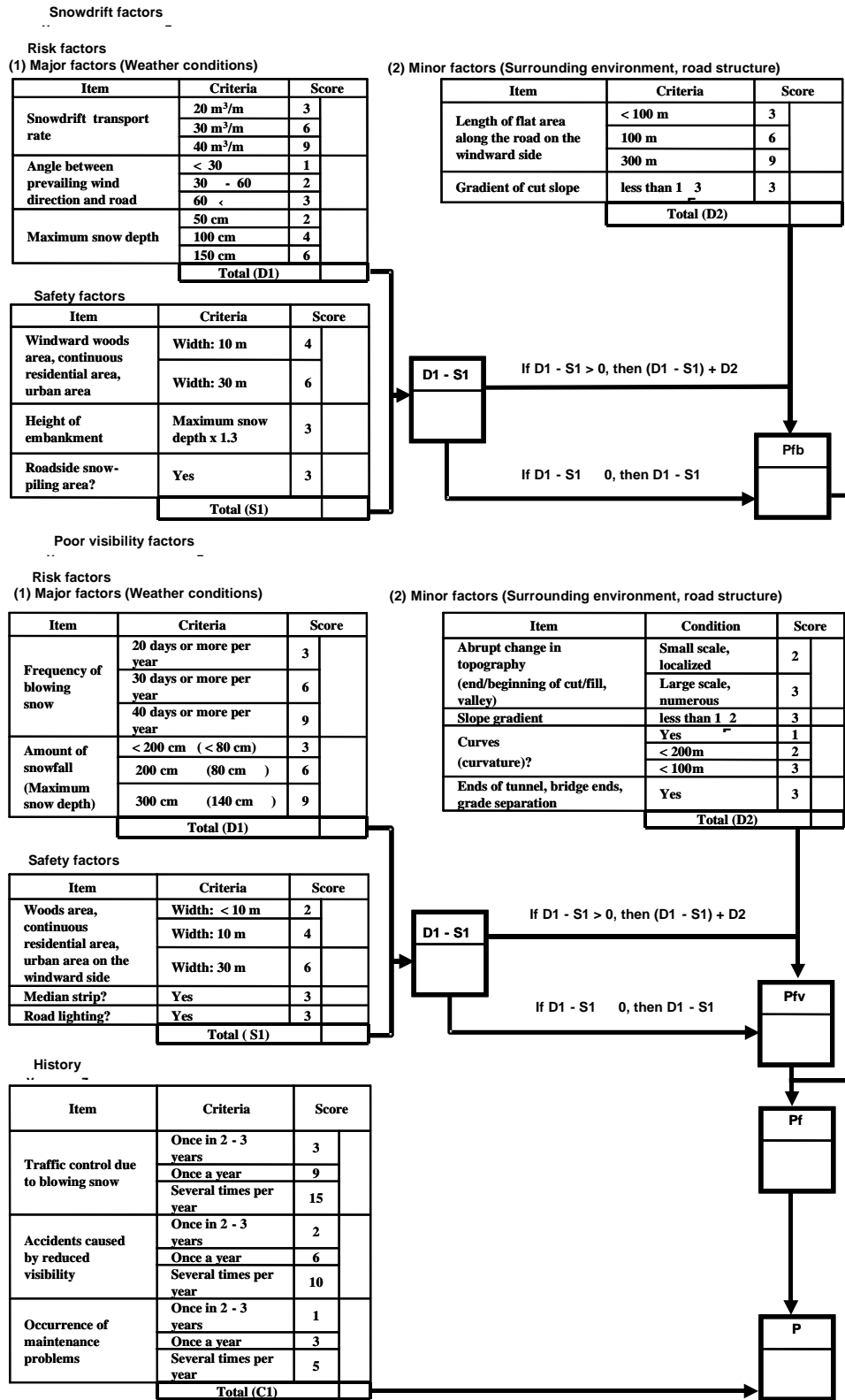

FIGURE 1 Degree of blowing-snow-induced danger assessment.

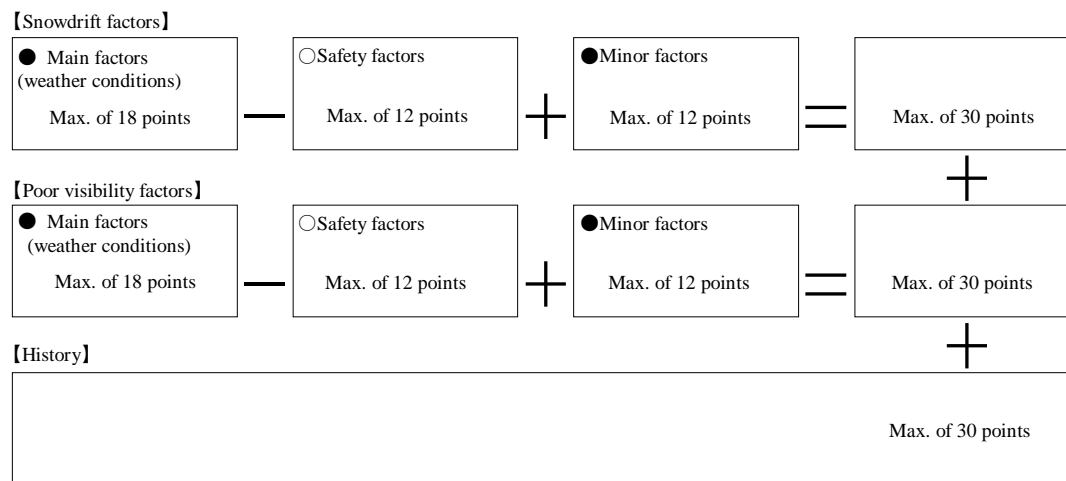

FIGURE 2 Concept of scoring for each factor.

uses only snowdrift and poor visibility factors.

The factors employed in the flowchart are safety factors and danger factors. Danger factors are subdivided into main factors and minor factors. The main factors are weather conditions, and the minor factors include the roadside environment and the road structure. This categorization is based on the idea that danger is mainly caused by the main factors (weather) and that the level of danger is amplified by the minor factors. Also, the danger is mitigated by the safety factors.

The maximum scores for danger factors (main plus minor) is 30 points for snowdrift factors, 30 points for poor visibility factors, 12 points for the minor factors, and 12 points for the safety factors. The maximum score for the main factors is 18, which is 50% greater than that for the minor factors and that for the safety factors. The maximum score for history is 30 points, the same as that for snowdrift and that for poor visibility.

Table 1 shows the scoring system for assigning degree of danger. In the case of maximum score, for instance, the procedure is as follows:

1. The score of the main factors for snowdrift and poor visibility totals 36. This is rounded to 35. A rating of *A* is given to any score that equals or exceeds 35 points.
2. The lowest point score for *B* is calculated by dividing 35 by 2 and rounding it down to 15 points to maintain a margin of safety.
3. A rating of *C* is given to a situation with a lower risk of blowing snow than the tank of *B*, which may need attention.
4. When the combined score of the safety factors exceeds that of the main factors, there is no danger from snowdrift or poor visibility. A rating of *D* is given to negative scores (meaning that blowing-snow control measures are unnecessary).

Inclusion of history in the rating procedure requires these rules:

1. Nine points are awarded for traffic controls for each year the road is in service.
2. Ten points are awarded for accidents attributed to visibility hindrance for each year the road is in service.

TABLE 1 Scores and Ratings of Degree of Danger

Ratings	Total Points		Remarks
	When History Is Included	When History Is Not Included	
A	44 points or more	35 points or more	Degree of blowing-snow-induced danger is extremely high.
B	21–42 points	15–34 points	There is blowing-snow-induced danger.
C	0–21 points	0–14 points	Need to be aware of possible blowing-snow-induced danger.
D	0 points or below	0 points or below	Blowing-snow countermeasures are not needed.

3. Five points are awarded for occasional maintenance problems for each year the road is in service, with 3 additional points if there is a history of traffic control (5 + 3 = maximum 8 points).

4. Three points are awarded for maintenance problems occurring an average of once a year, with an additional 6 points if accidents induced by visibility hindrance occur every year (3 + 6 = maximum 9 points).

In these instances of rules 1 through 4, the degree of blowing-snow-induced danger is high. The maximum score for history (9 points) is added to 35 points (the lowest score for an *A* rating without the history) to obtain the lowest *A* score.

To set the lowest score for *B*, 6 points are added to the lowest score for *B* without the history. The reason for adding 6 points is that it is the total of the lowest scores of occurrence of maintenance problems (1 point), accident induced by visibility hindrance (2 points), and history of traffic control (3 points).

Numerical Assessment and Comparison of Snowstorm Danger

The necessity of blowing-snow control measures for eight sections in northern and central Hokkaido was assessed. Weather conditions, roadside environment, and road structure were considered. The assessment shows that sections prone to blowing snow have high ratings. The degree of danger of such sections is well demonstrated. Also, ratings are proper for mountainous areas with heavy snowfall and areas with little snowfall.

PROCEDURE TO FORMULATE SNOWSTORM COUNTERMEASURES

Blowing-snow control facilities used to be examined during road construction or in response to problems occurring after the start of service. However, at these stages, control facilities could not always be installed due to restrictions related to roadside land use and weather environment (e.g., direction of prevailing winds). Also, on some occasions, the most appropriate facility could not be

selected, and the selected facility was not always efficient and economical because of engineering restrictions.

One cause of these problems is that examination of blowing-snow control facilities was not included in road planning, construction, or maintenance. Table 2 summarizes the procedure for formulating a blowing-snow control measure plan at each stage of road design, road planning, construction, and maintenance.

There are four types of surveys for blowing-snow control measures: schematic, preliminary, detailed, and follow-up.

The schematic survey is the first survey in the planning of blowing-snow control measures for new roads. Existing weather data, such as distribution amount of snow settled in snowdrifts in Hokkaido (3), and records of blowing-snow disasters on nearby roads are collected in order to generally understand the winter weather conditions and degree of blowing-snow-induced danger. Based on this understanding, the necessity of blowing-snow control measures is studied, and routes are selected (by measures such as providing detours of blowing-snow-prone sections or taking advantage of the ability of natural woods to provide break up of snow).

The preliminary survey of new roads is carried out between route determination and preliminary design using an aerial-photography-based map. Materials on weather statistics, environmental conditions, road structure, and other factors relevant to blowing snow are collected, and fixed-point weather observation is conducted. Necessity of blowing-snow countermeasures and degree of blowing-snow-induced danger are assessed, and then the additional width of right-of-way required for the blowing-snow measures is studied and incorporated into the design. The survey on existing roads uses records of road closures and accidents during blowing snow and records of road patrols in addition to the survey items on the new road in order to identify problems. When snowbreak woods are a possible blowing-snow countermeasure, the sufficiency of the available width needs to be determined, so onsite surveys are conducted to find the growth conditions of nearby trees. If they are in a gusty area, land is secured for protective woods.

A detailed survey is conducted for new roads between land survey and the end of road construction and for existing roads between the formulation of plans for blowing-snow control measures and countermeasure installation. A section to be installed with a blowing-snow control countermeasure is selected, final inspection on the countermeasure selected in the preliminary survey is conducted, and design values of the countermeasure are set. A snow survey, fixed-point weather observation, and other surveys are conducted to include specific local conditions of blowing snow in the design values. When selecting snowbreak woods, it is necessary to know what environmental conditions are favorable to forest growth. Those conditions are surveyed at the installed site to determine the planting method.

The follow-up survey is conducted in the maintenance stage. It is divided into a survey to understand the snow control effects and a survey to understand other installation effects.

The survey on snow control effects examines the blowing-snow control effects of the countermeasure. Records of blowing-snow troubles, such as road closures and accidents, are summarized from time to time, and onsite surveys and weather observations are conducted as needed. At each growth stage of snowbreak woods, surveys are made on growth conditions and on selecting trees to be thinned.

In the survey on other installation effects, the cost-benefit ratio is calculated by comparing the investment in blowing-snow countermeasures to the benefits.

TABLE 2 Surveys for Blowing-Snow Control Measures

Survey	Main Objectives	Stage		Design Stage and Use of the Survey Results
		Survey on New Roads	Survey on Existing Roads	
Schematic	<ul style="list-style-type: none"> • Understanding of winter weather conditions • General understanding of degree of blowing-snow-induced danger • Examination of necessity for blowing-snow control measures • Route selection to avoid blowing-snow-prone sections 	Construction plan formulation, schematic design (1/2,500)		<ul style="list-style-type: none"> – General design – Necessity of blowing-snow control measures – Route selection
Preliminary	<ul style="list-style-type: none"> • Understanding of blowing-snow conditions • Degree of blowing-snow-induced danger assessment • Assessment of necessity for blowing-snow control measures • Identification of sections requiring blowing-snow control measures • Determination of a blowing-snow countermeasure • Calculation of width for snowbreak woods zone 	Route determination, aerial survey, and preliminary design	Occurrence of problems, formulating a plan for a blowing-snow control measure	<ul style="list-style-type: none"> – Preliminary design – Calculation of the forest woods zone width – Road construction method (cut, snowdrift-control fill, etc.)
Detailed	<ul style="list-style-type: none"> • Confirmation and revision of a blowing-snow countermeasure • Determination of sections to be installed with blowing-snow control measures • Determination of design values for blowing-snow countermeasure • Understanding of the environmental conditions required for the growth of snowbreak woods 	Land survey, road completion	Blowing-snow control measure planning, when constructing a blowing-snow countermeasure	<ul style="list-style-type: none"> – Preliminary design and execution design – Determination of ancillary structures – Determination of design values for blowing-snow countermeasure – Determination of zone width for snowbreak woods
Follow-up	<ul style="list-style-type: none"> • Examination of the effects of a blowing-snow countermeasure • Understanding of cost-effectiveness of a blowing-snow countermeasure 	After entering service	After construction of a blowing-snow countermeasure	<ul style="list-style-type: none"> – Repair of a blowing-snow countermeasure – Revision of a blowing-snow control plan

SELECTION OF BLOWING-SNOW CONTROL FACILITY

The indices used to select a blowing-snow control facility are the main objective of the facility, ease of securing land, road structure, and prevailing wind direction. Figure 3 shows the flowchart used in selecting blowing-snow control facilities.

THE HIGHWAY SNOWSTORM COUNTERMEASURE MANUAL

The *Highway Snowstorm Countermeasure Manual* (4) was published by the Hokkaido Development Bureau in 1990. It has been used for blowing-snow control measures on trunk roads in Hokkaido.

Now that 10 years have elapsed, the focus of blowing-snow control measures in Hokkaido has shifted from traffic hindrances by snowdrift to assurance of traffic safety by mitigation of poor

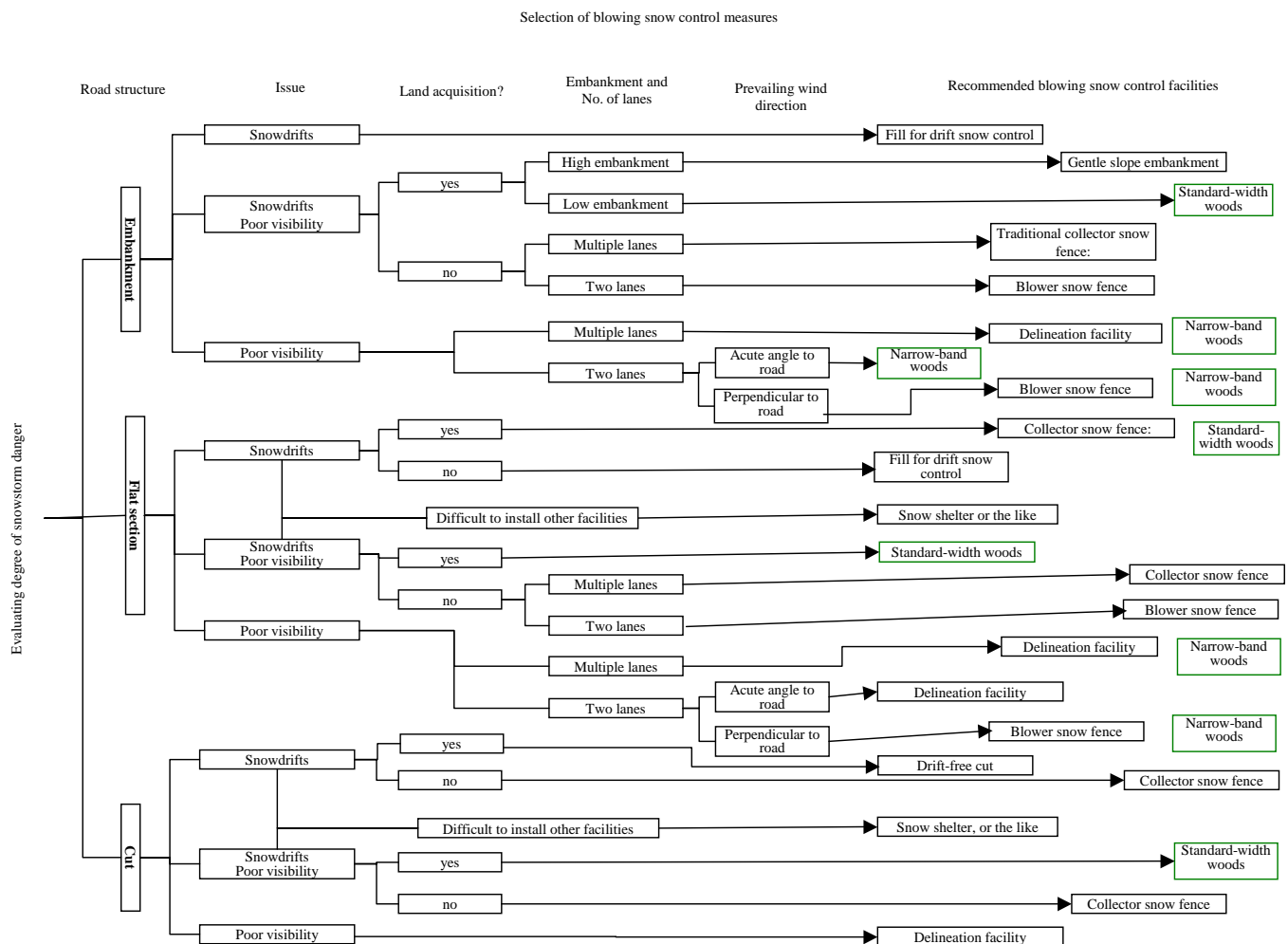

FIGURE 3 Selection of blowing-snow control measures.

visibility. New blowing-snow control techniques have been proposed, surveyed, and researched, and much knowledge has been accumulated. The revision of the initial edition began in 2000 and has recently been completed.

The assessment of the degree of blowing-snow-induced danger, the procedure to formulate plans for blowing-snow control measure, and the flowchart used in selecting a blowing-snow control facility are described in the general guide. In addition to addressing blowing-snow control facilities and measures, this new volume describes basic knowledge on blowing snow for road engineers. The snowbreak woods section was revised according to the survey results. The revised edition proposed an increase in the tree interval to facilitate maintenance, and explanations were added regarding tree growth and maintenance. The snow fence section presents the revised criteria for wind velocity on fins with holes and a method of calculating the collector snow fence height with respect to the amount of snowdrift.

The new edition of the *Highway Snowstorm Countermeasure Manual* is expected to be used in implementing blowing-snow countermeasures for roads in Hokkaido and elsewhere in Japan. This manual, available only in Japanese, can be downloaded for free from the website of the Civil Engineering Research Institute (www.ceri.go.jp/).

CONCLUSIONS

This paper has described numerical assessment of the degree of blowing-snow-induced danger, a procedure for formulating plans for blowing-snow control measures, and a flowchart for selecting blowing-snow countermeasures. All of these are included in the new edition of the *Highway Snowstorm Countermeasure Manual*. What the new edition describes is general knowledge that has been accumulated thus far. As new survey results, knowledge, and techniques are obtained, the manual will be revised. To assure winter road traffic safety in an economic and efficient manner, information collection and research and development will continue.

ACKNOWLEDGMENT

The authors thank Masao Takeuchi and others for their valuable cooperation in revising the *Highway Snowstorm Countermeasure Manual* as well as for their contributions to this paper.

REFERENCES

1. *Road Disaster Prevention Measure Survey and Design Guideline*. Construction Department, Hokkaido Development Bureau. March 1978, pp. 7–33.
2. *Road Disaster Prevention Guideline (heavy rain, heavy snow, etc.)*. Road Management Technology Center. August 1996.
3. Fukuzawa, Y., Y. Kajiya, T. Kobayashi, and T. Tobeji. Estimate of Snowdrift in Hokkaido, *Snow and Ice*, Vol. 62, 2000, pp. 291–300.
4. *Highway Snowstorm Countermeasure Manual*. Hokkaido Development Bureau and Hokkaido Engineering Development Center. 1990.

WINTER MAINTENANCE: POLICY, MANAGEMENT, AND PERFORMANCE

Indiana Winter Severity Index**BOB McCULLOUGH***Purdue University***DENNIS BELTER****TOM KONIECZNY****TONY McCLELLAN***Indiana Department of Transportation*

The Indiana Department of Transportation (DOT) created the Winter Operations Team (WOT) committee to address issues associated with winter activities. Some of WOT's past activities have included developing its *Total Storm Management Manual* (TSM) and studying the effectiveness of several chemicals used by Indiana DOT.

WOT determined that a winter severity index (WSI) would be helpful for several reasons. A WSI could be used to compare the efforts of snow and ice removal between the different climatic zones in Indiana and to compare and analyze mild and severe winters. It could also provide a quantitative method for determining what relationships exist between different weather events and snow and ice removal. A subcommittee of the WOT was put together to study existing indices and to determine if one or a combination of indices could be used for Indiana DOT. The recommendation was that if other WSIs did not work, then an index for Indiana DOT should be developed. During development, the intent was to derive an index that did not require cumbersome and time-consuming data collection.

EXISTING INDICES

One of the first actions was to look at previously developed winter severity indices (WSIs). Several indexes have been created by different organizations and are summarized below.

Wisconsin

The Wisconsin index uses the following weather factors:

- Snow events (SE),
- Freezing rain events (FR),
- Snow amount (AMT),
- Storm duration (DUR), and
- Incidents (INC—drifting, cleanup, and frost runs).

The winter index (WI) is

$$WI = 10 \times \frac{SE}{63} + 5.9 \times \frac{FR}{21} + 8.5 \times \frac{AMT}{314} + 9.4 \times \frac{DUR}{1125} + 9.2 \times \frac{INC}{50}$$

Wisconsin uses the WI to measure the type of winter in Wisconsin. Since the counties perform the snow and ice removal, it will be used to evaluate their performances and expenditures. A value is calculated for each county; this requires that the above weather data be recorded in each county. One future plan for the WI is to incorporate it into a level of service model that will be used to allocate operations funding and could be used to distribute winter reserve funding. Wisconsin has developed reports to show the correlation between the severity index and salt use and a graph showing the relationship between WI and cost per lane mile (1, 2).

Washington State

Washington State DOT developed a frost index (FI), which is a severity index less the snowfall factor. Washington State DOT found the FI relates directly to performance measurement in the winter activities. It plans to use the FI when an overrun occurs in the snow and ice budget and a supplemental funding request is made to the state legislature (3).

Modified Hulme Index

The modified Hulme index has been used by some international organizations. It uses three weather factors; the equation follows:

$$WI = 10T - F - (18.5S)^{1/3} + C$$

where

- | | |
|---|--|
| T | = mean maximum air temperature, |
| F | = total number of ground frosts, |
| S | = number of days with snow cover at 9:00 a.m., and |
| C | = constant. |

Strategic Highway Research Program Index

The Strategic Highway Research Program (SHRP) (4) index uses the following weather factors:

- Average daily temperature index (TI),
- Mean daily snowfall (S),
- Proportion of days with air frosts (N), and
- Temperature range (R).

The TI equals 0 if minimum air temperature is above 32°F, TI equals 1 if maximum air

temperature is above 32°F while minimum air temperature is at or below 32°F, and TI equals 2 if the maximum air temperature is at or below 32°F.

$$WI = a(TI)^{0.5} + b \ln\left(\frac{S}{10} + 1\right) + c \frac{(N)^{0.5}}{R + 10} + d$$

where

- N = number of air frosts (days with maximum air temperature at or below 32°F),
 R = temperature range (mean monthly maximum minus the mean monthly minimum), and
 a, b, c, and d = constants.

Kansas and Minnesota DOTs have adopted the SHRP index. Minnesota calculates by location and month. Ontario Province, Canada, modified the SHRP equation to include freezing rain. The equation is

$$WI = -a(TI)^{0.5} - b \ln\left[\frac{S}{10} + 1\right] - c [\text{frz}]^{0.5} + 50$$

where frz equals number of freezing rain days.

The SHRP index was tried with weather data from South Bend, Indiana, for four winters (Figure 1). The figure is a plot of the SHRP index and the cost per mile for the South Bend maintenance unit. The cost per mile is the total labor, equipment, and material cost divided by the lane miles within the unit. The figure shows no correlation between the two.

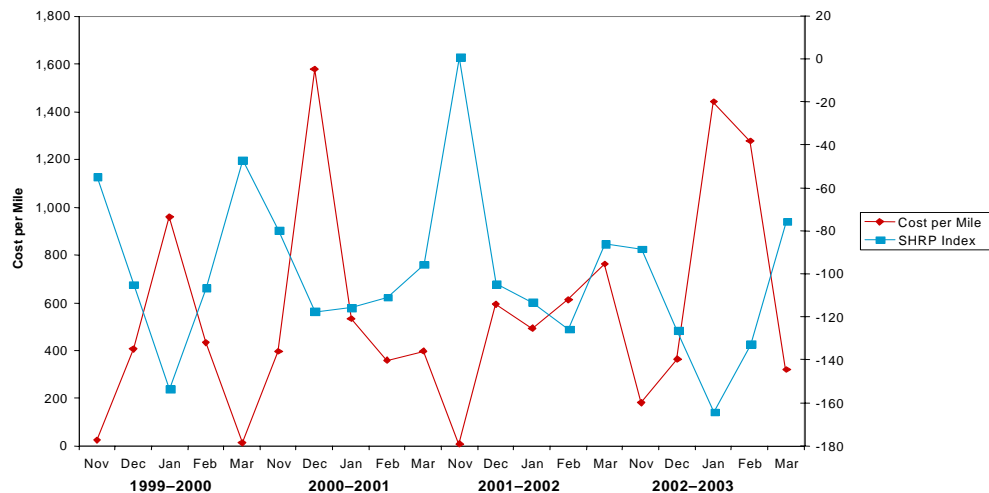

FIGURE 1 South Bend, Indiana, SHRP index and cost per mile.

Feeling uncomfortable with this result and looking at the other indexes and their missing weather influences, Indiana DOT decided to develop its own index by using the total cost per mile as the dependent function in the equation. Weather data for Indiana had to be found and evaluated first.

WEATHER DATA

Indiana has basically four different winter climatic zones (Figure 2). The southern zone has milder winter weather and a considerably shorter winter season. The central zone is somewhat colder and experiences more snow. The northern zone is noticeably harsher in temperature and receives greater snowfall. Also, the northern zone can be further divided into two distinct regions, one being the northwest corner that typically receives Lake Michigan–effect snows that drive up the average to twice the snowfall of the rest of the northern region. Because these four zones are different, winter weather data were collected for each of these areas.

The National Oceanic and Atmospheric Administration (NOAA) records weather conditions at various locations in the United States. There is an online store where weather data can be purchased. The address is www.ncdc.noaa.gov/oa/ncdc.html. There are four Indiana locations available: Evansville, Fort Wayne, Indianapolis, and South Bend. Each one represents one of the four climate zones—Evansville for the southern zone, Indianapolis for the central zone, Fort Wayne for northeast Indiana, and South Bend for northwest with lake-effect snow.

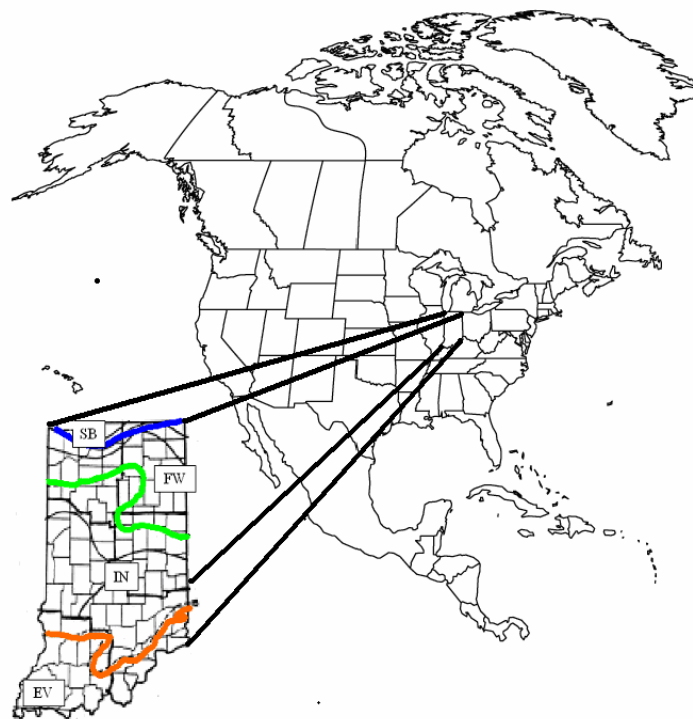

FIGURE 2 Indiana map.

The cost for the online weather data is \$3 per month at each location. Weather data were obtained for four winters (November through March 2002–2003, 2001–2002, 2000–2001, and 1999–2000). The data can be downloaded in either a text or .pdf file. Figure 3 shows the first page of monthly weather data available at these locations.

Weather factors that can be obtained from these data are

- Number of freezing rain events,
- Number of snow events,
- Amount of snow,
- Average maximum temperature,
- Average minimum temperature,
- Storm duration,
- Average wind velocity,
- Number of frost days, and
- Number of days with snow cover.

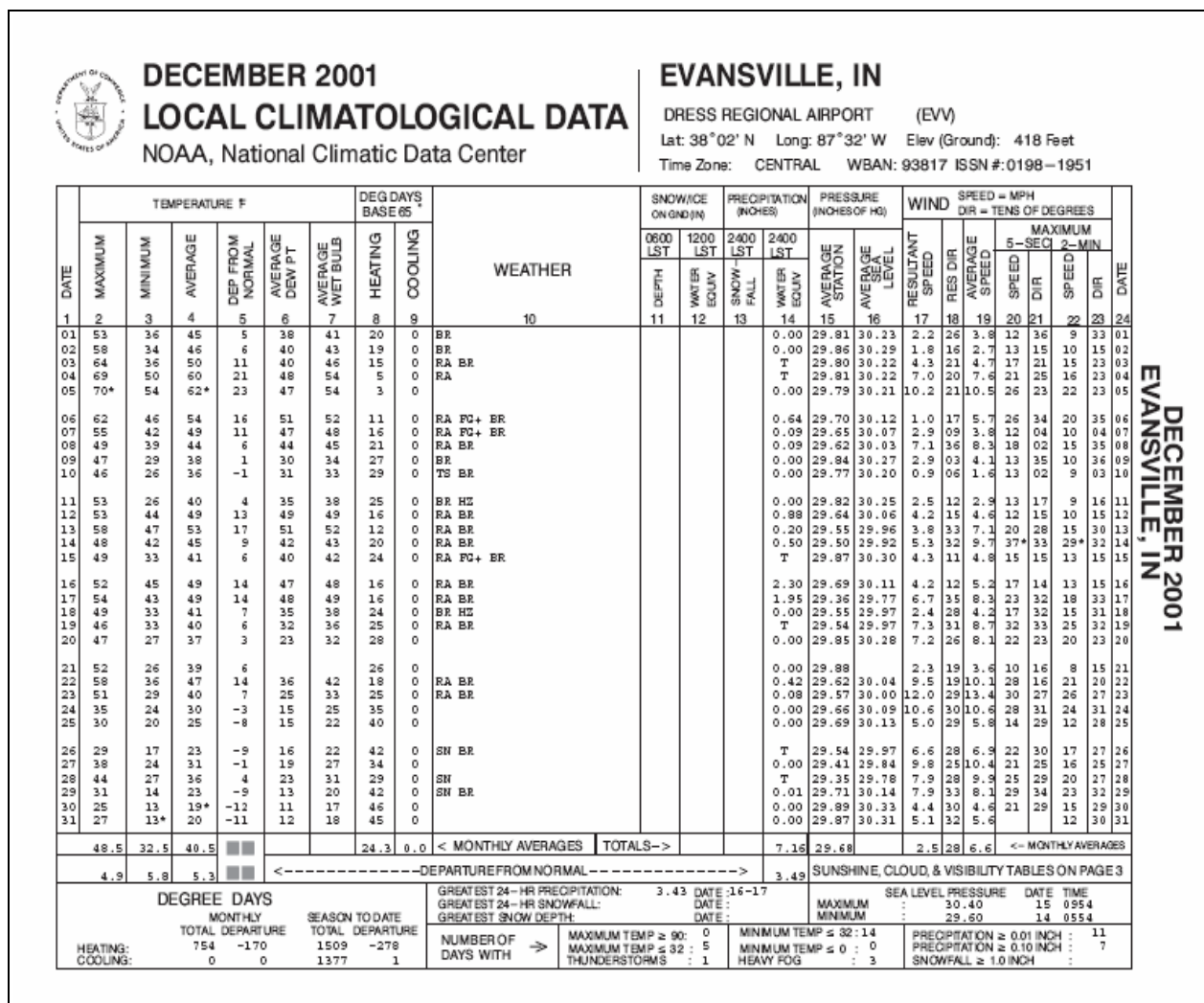

FIGURE 3 NOAA monthly weather data.

Weather data in text format can be imported into an Excel spreadsheet, and macros can be written with parameters defined to automatically calculate the number of certain weather events. Some of these events are counted manually by scanning the weather data. For each month and location seven weather events were tabulated. They were

1. Frost day,
2. Freezing rain,
3. Drifting,
4. Snow,
5. Snow depth,
6. Storm intensity, and
7. Average temperature.

FORMULATING THE EQUATION

Field Factors

The first equation developed was based on input from field operations. The input came through surveying field crews and talking with employees involved in the snow and ice removal effort. This group identified four weather factors with the most influence. So the first equation's basic form was

$$WI = a(\text{frost day}) + b(\text{freezing rain}) + c(\text{snow vent}) + d(\text{drift day})$$

A snow event is affected by the amount of snow, the duration of the event, and the temperature during the event. These factors were used to define the snow event. The coefficients a , b , c , and d are weight values. These values were determined by surveying field operations. The survey asked to distribute 100 points between the four weather events. Based on the survey results the values became $a = 0.06$, $b = 0.29$, $c = 0.38$, and $d = 0.27$.

This relationship is now shown in equation format with a mathematical description of each factor.

TABLE 1 Four Most Influential Weather Factors

Events	Symbols	Definitions
Frost	FrD	Number of days with minimum temperature \leq to 32°F and a minimum dew point \leq 32°F
Freezing rain	RfD	Number of days with freezing rain and/or drizzle and minimum temperature \leq 32°F
Drifting	DrD	Number of days with wind speeds >15 mph and snow on ground or a snow event
Snow	(SnD)*In/AvT	Number of days with minimum temperature \leq 32°F times the snowfall intensity divided by the average temperature during the event

The original equation looked like the following:

$$WI = 100* [.06(FrD) + 0.29*(RfD) + 0.38*(DrD) + 0.27*(SnD)*In/AvT]$$

The next step was to validate the equation. The equation uses weather data to calculate a severity index value. This was done for the various locations and months. Initial analyses looked at index values by locations. Figure 4 shows index values by location for three winters. Some of the values look acceptable while others don't. For example, in winter 2000–2001 Indianapolis had a higher index than Fort Wayne.

One possible validation is to graph WI values with lane-mile snow removal costs. Figures 5 and 6 show these plots. In Figures 5 and 6, the line graphs do not correlate well between WI and cost per lane mile. With these results it is difficult to validate the equation.

The coefficients used were established by the number of survey responses. After a review, it was felt that there might have been too much bias and that the results were skewed. For example, some locations use anti-icing to prevent frost and do not consider it as an important factor in the effort, although other locations respond to frost callouts in the middle of the night, giving it a high priority. Therefore a more scientific statistical approach was taken, similar to what some of the other indices took.

Statistical Approach

With multiple factor relationships and with lane mile costs as the controlling (or forecast) variable, this problem is solved best using regression analysis. Since there are multiple weather (or explanatory) variables, a multiple regression analysis is needed.

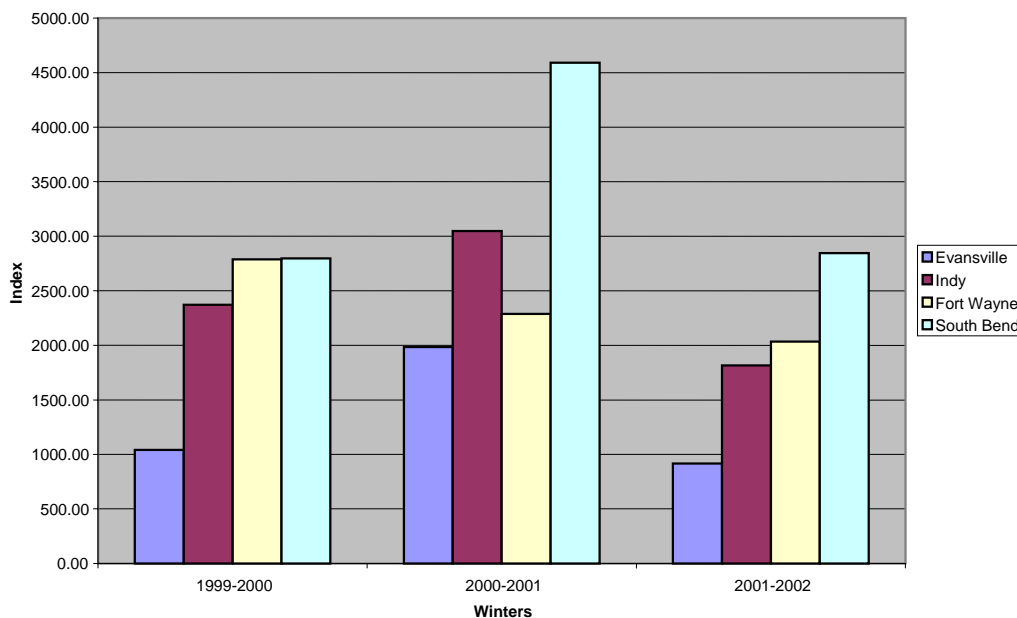

FIGURE 4 Severity index, original WSI (for 3 years).

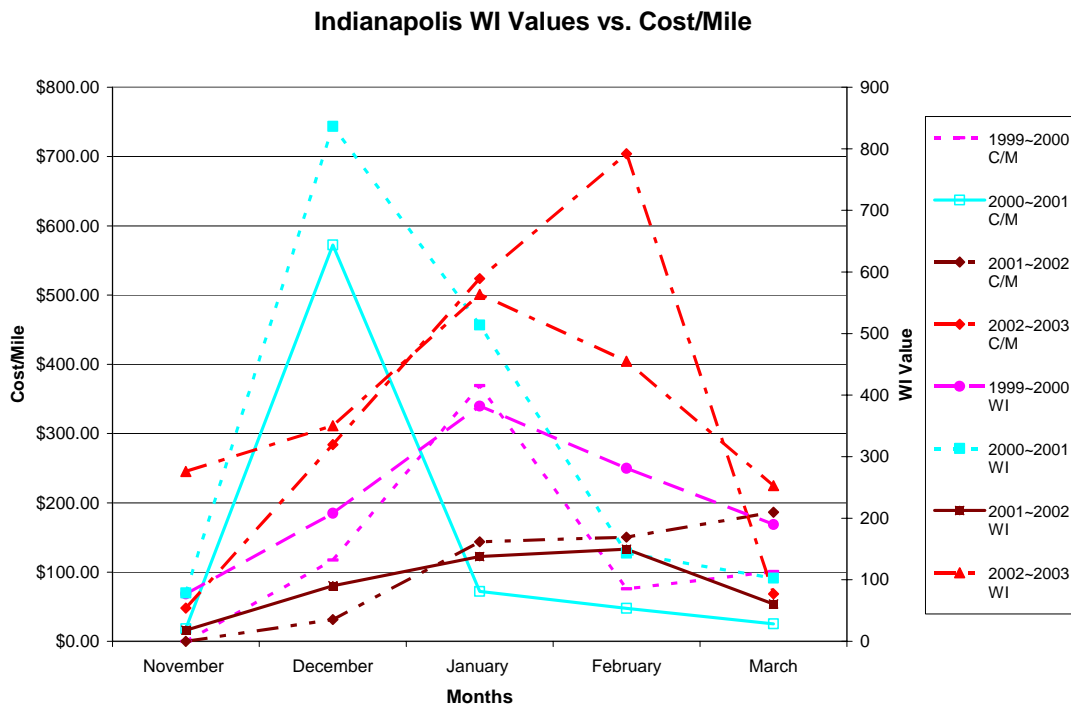

FIGURE 5 Indianapolis WI values versus cost per mile.

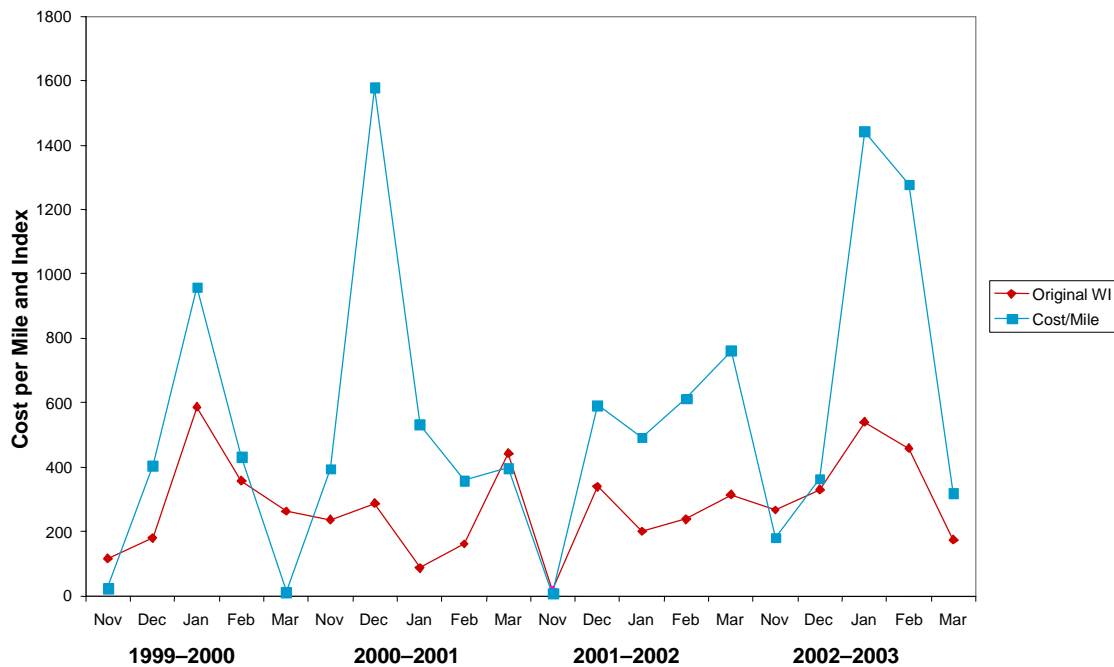

FIGURE 6 South Bend Index and cost per mile.

The tool used to perform the multiple regression analysis was SAS (Simultaneous Analog Stimulation), an interactive and batch programming environment that provides modules for basic data analysis, statistics, and report writing. The software is easy to use, and making modifications to variable data is easy. The software allows for multiple equations to be produced with validation.

Because of SAS, it was decided to start with the original WI equation's four weather factors. Figure 7 shows this equation. Notice it correlates significantly better than the original equation shown in Figure 6. Additional weather factors were analyzed with SAS and compared with the controlling variable. As more factors were included in the analysis, the two line graphs moved closer to each other. Figure 8 shows the five-weather-factor index (original factors + snow depth) graph. This is an improvement over Figure 7. The final SAS analysis included all seven main weather events experienced in Indiana listed previously. From SAS the following equations were generated and validated with the lane-mile costs. Figure 9 shows the graph for Indianapolis. Figure 10 a comparison of WI for the four locations using the statewide equation.

The equations below were created from the multiple regression analysis based on regional weather data. Also, a statewide equation was generated.

South Bend

$$WI = -5.98483 * \text{Frost} + 13.73518 * \text{Freezing rain} + 12.57288 * \text{Drifting} + -25.18103 * \text{Snow} + 28.78145 * \text{Snow depth} + 4.29121 * \text{Hour} + 6.77877 * \text{Average temperature}$$

Fort Wayne

$$WI = 7.05832 * \text{Frost} - 16.21024 * \text{Freezing rain} + 6.31394 * \text{Drifting} + 31.24970 * \text{Snow} + 25.36240 * \text{Snow depth} + 1.23828 * \text{Hour} - 6.95440 * \text{Average temperature}$$

Indianapolis

$$WI = 3.42152 * \text{Frost} + 7.96888 * \text{Freezing rain} + 7.24260 * \text{Drifting} + 14.044284 * \text{Snow} + 16.63333 * \text{Snow depth} + 1.50251 * \text{Hour} - 3.90486 * \text{Average temperature}$$

Evansville

$$WI = 0.01116 * \text{Frost} + 23.68383 * \text{Freezing rain} + 43.46891 * \text{Drifting} - 18.77938 * \text{Snow} + 63.02214 * \text{Snow depth} + 0.23399 * \text{Hour} - 0.32291 * \text{Average temperature}$$

Statewide

$$WI = 0.71839 * \text{Frost} + 16.87634 * \text{Freezing rain} + 12.90112 * \text{Drifting} - 0.32281 * \text{Snow} + 25.72981 * \text{Snow depth} + 3.23541 * \text{Hour} - 2.80668 * \text{Average temperature}$$

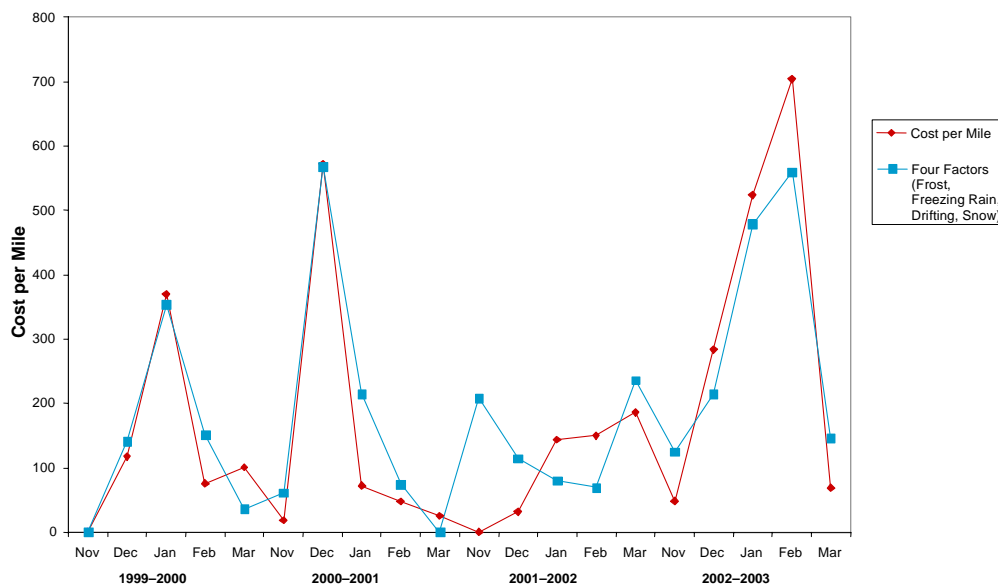

FIGURE 7 Indianapolis Four-Factor Index and cost per mile.

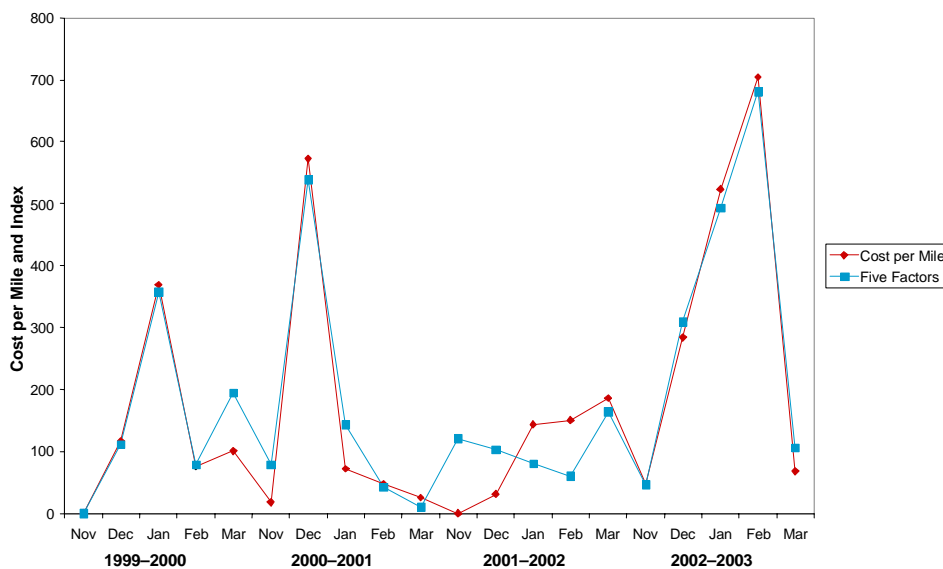

FIGURE 8 Indianapolis Five-Factor Index and cost per mile.

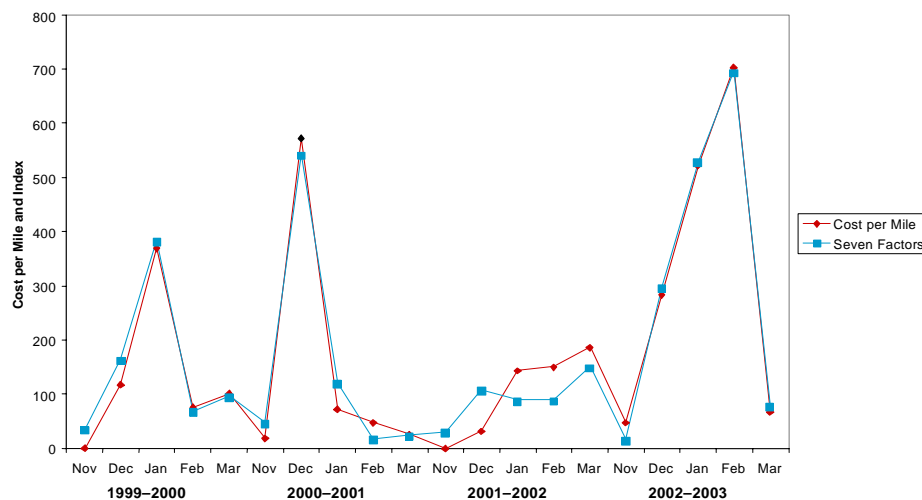

FIGURE 9 Indianapolis Seven-Factor Index and cost per mile.

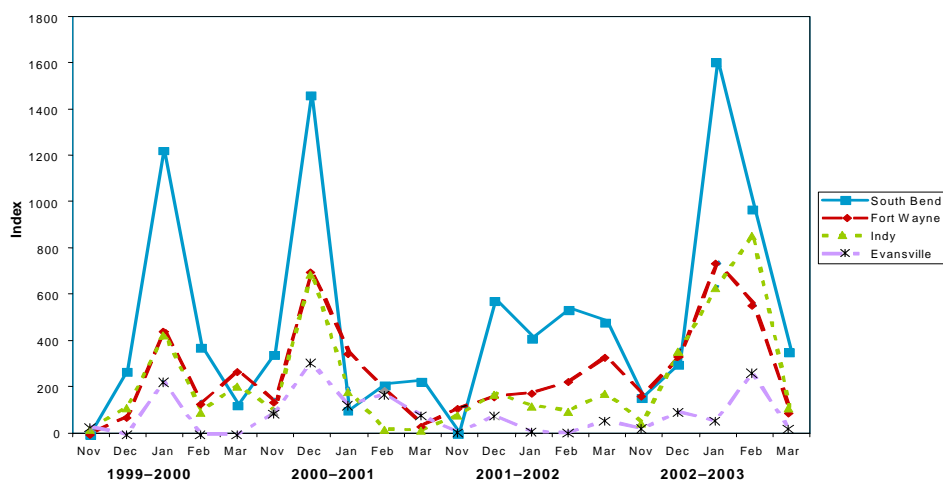

FIGURE 10 Statewide equation at four locations.

CONCLUSION

The equations derived from SAS correlate well with the lane-mile cost. Only one is shown in this paper.

What can be done with the WSI? One possibility is to use it to verify snow and ice removal expenditures. It may answer questions such as, Are new technologies reducing costs? The new technologies may include proactive snow fighting measures, additional higher-tech training, improved weather service information, and a higher overall winter priority.

Another possibility is to use it for resource allocation. Are funds being spent where they are needed? Comparisons may be made between the WI and expenditures by climatic zones. Materials are easy to quantify, but do some zones need more money for manpower and equipment to provide comparable levels of service? The WI may also be used to justify expenditures or the need for additional funding.

There are several things that need to be looked at in further detail as a result of this research. How do the removal costs of heavy snowfall compare with small snowfall events and freezing rain? Does the severity index capture these effects accurately? As the index is implemented, other, similar issues will be scrutinized by using the WI.

By obtaining and analyzing future winter data, the equations can be further refined and validated and will become more trusted and useful.

REFERENCES

1. Adams, M. J. Winter Severity Index. Wisconsin Department of Transportation, internal document, 2001.
2. Martinelli, T. Wisconsin Department of Transportation, personal interview, 2001.
3. Perry, A. H., and L. J. Symons. *Road Weather Information Systems*. Vol. I, Highway Climatology.
4. Andrey, L., and Mills. A Winter Index for Benchmarking Winter Road Maintenance Operations on Ontario Highways. In 80th Annual Meeting Compendium of Papers CD-ROM, Transportation Research Board, Washington, D.C., January 7–11, 2001.

WINTER MAINTENANCE: POLICY, MANAGEMENT, AND PERFORMANCE

Quality Improvement of Winter Service in Denmark

FREDDY KNUDSEN

Danish Road Directorate

Denmark, a small country of just 44,000 km², is situated in Northern Europe as part of Scandinavia. Denmark is a flat country where the most elevated point is just 173 m. The climate is typically coastal where the Gulf Stream affects the climate in a way that it is rarely extremely cold in the winter. During a winter season the usual number of days with snow is from 5 to 10, with a total snowfall of 30 to 50 cm. A typical winter day will see a temperature of around 0°C, with thawing in the daytime and a slight frost at night. This temperature pattern often creates a risk for a white frost on the roads in the early hours together with freezing wet road surfaces. Thus on the main roads there is a yearly average of 95 salting actions, with a variation from season to season from 60 to 140 actions.

In Denmark the roads are administered by three different authorities:

- The state is responsible for 1,600 km of main roads, primarily motorways.
- 13 counties are responsible for 10,000 km of county roads.
- 271 municipalities are responsible for the remaining roads, 60,000 km.

Among the municipalities in Denmark the standard for winter services varies a lot; however, on the state and county roads ([Figure 1](#)) service is being provided throughout the country according to the following principles:

- Decision of a call out is taken at county winter centrals. The decision includes both county and state roads in a given area. Today there are 13 winter centrals manned all hours to handle this task.
 - Private contractors carry out the salting and snow clearing, and they normally provide the drivers and the equipment. The spreaders and snowplows are owned by the road authorities.
 - The service objective always is to have “black road surfaces” (i.e., either dry surfaces or wet surfaces). Thus, preventive salting actions are carried out on the basis of prognoses for slippery roads.

[Figure 2](#) illustrates the tasks and tools at a winter central. The task of the winter centrals is to survey the road conditions and the weather and to start appropriate actions in order to avoid slippery roads. The centrals have two essential tools, the road weather information system (RWIS) and Vinterman.



FIGURE 1 Map of state and county roads in Denmark (state roads are shown in red and the county roads in green).

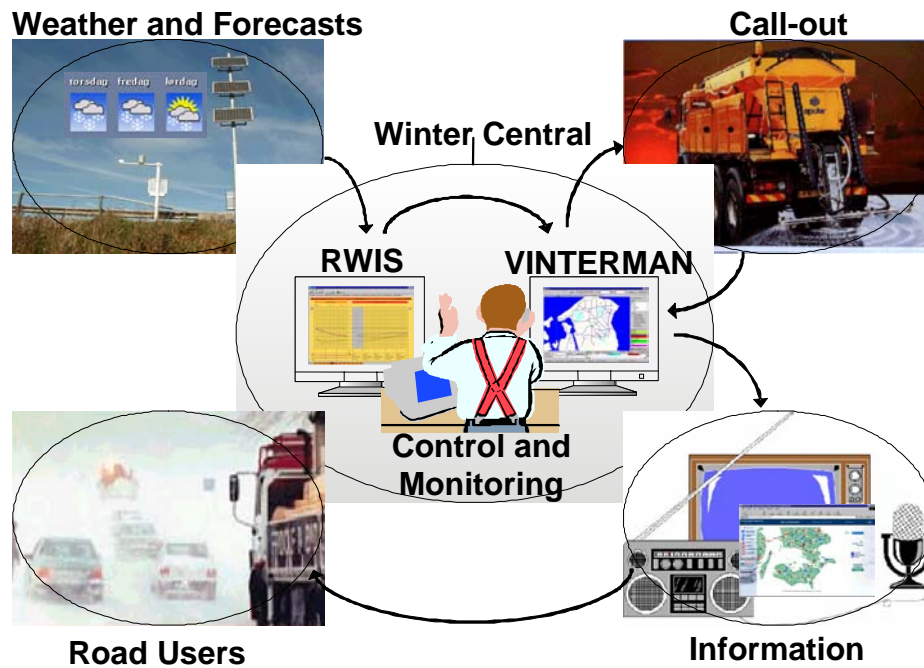

FIGURE 2 Tasks and tools at a winter central.

The operator at winter central uses the countrywide RWIS to survey the development in the weather and the road conditions. The tool is essential in connection with call outs for salting and snow clearing. When the decision is made, Vinterman is used for starting, surveying, managing, and following up on the call out. At the same time, the system issues information to the traffic information center and the media so that road users can be updated on the situation.

In the development of the Danish RWIS and Vinterman systems great emphasis has been placed on enabling the systems to ensure the best possible quality in both decision and implementation of a call out.

RWIS

The Danish RWIS gives access to data from approximately 300 measuring stations scattered throughout the roads. All measuring stations deliver observation data every 10 min on road temperature, air temperature, humidity, and road conditions. Some stations deliver addition information on precipitation, visibility, wind direction and speed, residual salt, water thickness, and the freezing point.

In order to avoid misunderstandings in different interpretations and presentation of data by different manufacturers of measuring stations, all measurements are presented consistently in one system. Further, the Danish Meteorological Institute (DMI) prepares specific prognoses for the development in road temperature, air temperature, and the dewpoint based on information from all the stations and other weather sources (Figure 3).

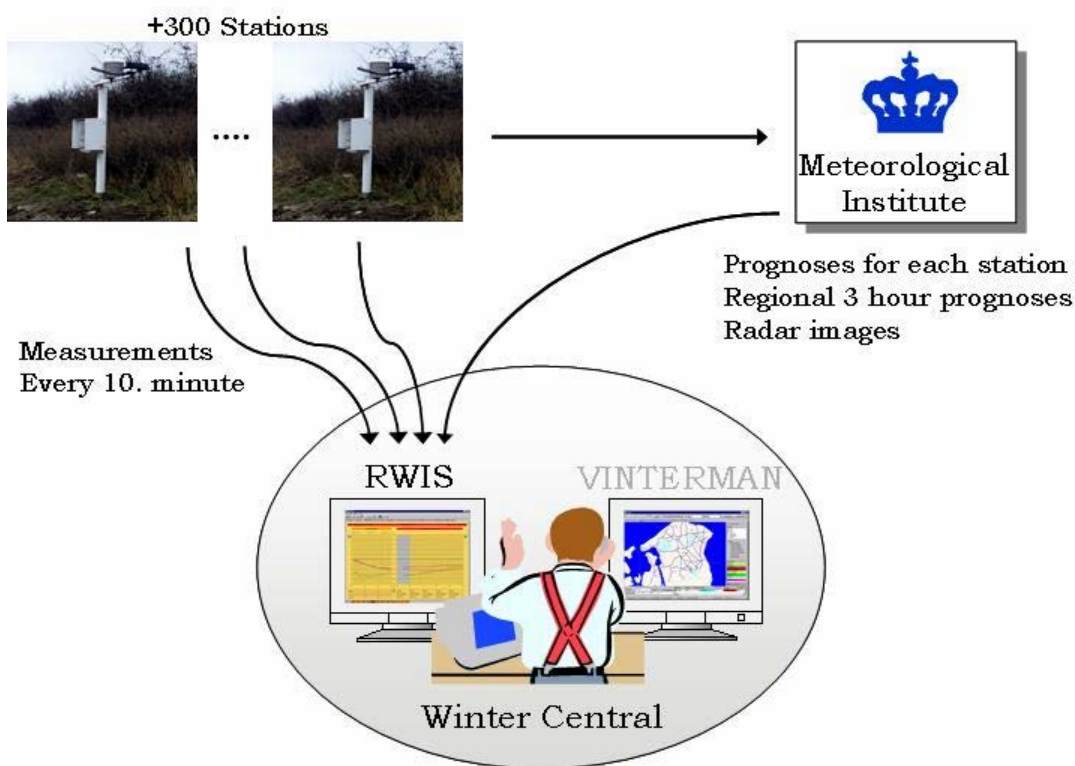

FIGURE 3 Data for RWIS is received from the measuring stations and the Danish Meteorological Institute.

The structure of the Danish RWIS permits the operator at the station to have access to both observations as prognoses applying to the individual stations. The information in the system is the main basis for a decision to salt or clear snow. The operators on duty also have access to a web camera and, for supplementary information, have the possibility to send patrols out on the roads to inspect situations. As a further support for judging the situation, the duty operator always can contact the duty officer at the DMI to discuss the prognoses. Also, written comments on the development in the weather situation can be obtained from the meteorologist.

The development of the Danish RWIS was started in the 1980s; however, it is still developing, especially the models behind the prognoses, which are being refined and expanded in order to improve the exactness—and thus to allow a better basis for better decisions. Normally the duration of a salting action from decision to the last route salted is 3 h. Consequently the decision to salt must be made 3 h before the slippery roads occur.

To ensure that the personnel at the winter central possess the proper skills, the system includes a training module, where interesting weather situations are stored as exercises. This module gives the participants the possibility to experience a weather situation of 12 to 24 h in the pace that they find suitable. The system will ask a number of questions and will follow up on the participant's answers and decisions. Before the winter season it is important to ensure proper training of the staff with realistic situations in order to improve the quality of the decisions whether to start a salting action or not.

VINTERMAN

When the decision of a call out is taken, the man on duty at the winter central will switch to another computer, where he can operate Vinterman (Figure 4). Vinterman is used not only during the call out, it has a wider scope:

- It handles all administrative information about contractors, drivers, phone numbers, routes, equipment, contracts, duty rosters, and more.
- It helps the operator during a call out for salting and snow clearing. It is supposed to facilitate an easy and safe call-out and still ensure registration of all necessary events etc.
- It documents every decision and action on the winter central.
- It is the basis for various reports and statistics on the winter season.
- It ensures the distribution of information about the road conditions to police, rescue services, the traffic information center, radios, and the Internet.

By letting the system assist with all these tasks, it ensures a structured and well-documented way of handling winter service operations. All the above mentioned tasks have a positive impact on the quality of how winter service is provided. In the following sections focus will be on a few of the tasks where Vinterman now does and in the future will improve the overall quality of the provided winter service.



FIGURE 4 The winter central in Ribe County is normally operated by one person.

Operating Vinterman During a Call Out

The principle behind the design of Vinterman is to store as much knowledge as possible about winter operations within the system before the season and in between each call out. When a snowstorm arrives, it is extremely busy at the winter central. It is therefore important that the system has the maximum information about the needed actions.

When initiating a call out the operator selects an action plan from a predefined set of action plans. These plans cover everything involved in solving a specific task, for example, salting or snowplowing within a district. The plan will contain not only all the routes but also all necessary additional activities as salt-loading staff, patrol cars, information to other authorities, and more.

By selecting a predefined action plan, the operator gets a to-do list of everything needed. If the predefined plan isn't adequate, the operator can adjust the activity list by adding or removing activities. Usually there is no need to add activities, because the plans cover everything within a district. It is much safer to let the operator remove activities that he considers irrelevant in the actual situation. In most situations the plan is adequate with no need for adjustments.

During a call out Vinterman knows up front what events need to be registered for every activity on each route. An example is a salting action on route X:

- Vinterman knows who operates the route and with which truck, spreader, and plow. The first step will be calling a driver, who is found by Vinterman in a specific duty roster for this route.
- Some spreaders are parked at the drivers' homes, others are at a depot where the drivers need to pick up the spreader and salt. Vinterman will know this already for each route.
- The next step can be that the driver will call back when he is on the route. We especially would like to hear from him if he is coming directly from home. This registration is also often used as billing information.
- The last step could be that the driver returns to the depot for reloading and finishing up the activity.

Vinterman also knows the duration of each step. If the time is exceeded, Vinterman will prompt for missing action and the operator can call the driver. A typical salting action is initiated at 3 a.m., and at this hour we have to incorporate the risk that a driver has fallen asleep again.

All of this seems like a lot for the Vinterman operator to handle, but as most registrations are made by just one click with the mouse, it goes very smoothly. Normally the operator uses a headset and leaves all the calling and controlling to Vinterman. Some larger road authorities are using a voice response system for the initial call to most of the drivers.

During the call out the operator works with Vinterman on one computer, but normally there is also at least one extra monitor with a status map. [Figure 5](#) illustrates the status of each route (coded by color), and all equipment with on-line data collection is also presented. Using the map gives a good overview, and it is very easy to identify missing routes if something is forgotten. On routes with data collection it is also possible to see the entire action in detail. In situations where redirection of equipment is needed it is very helpful to know the location of each piece of equipment.

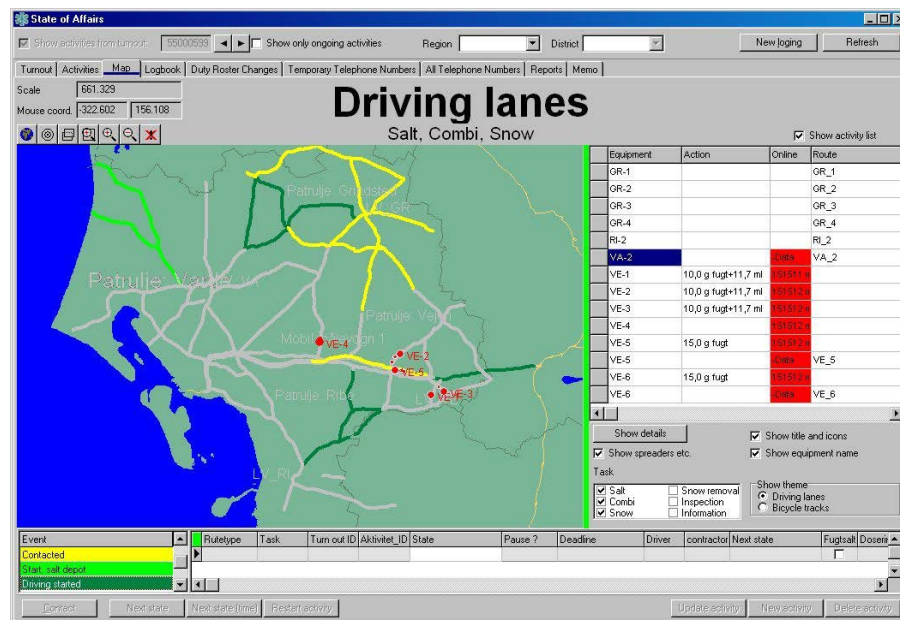

FIGURE 5 Presentation of routes and online spreaders.

On all spreaders with online data collection Vinterman is able to see when the driver is starting and finishing the route without the need for phone calls. At the same time Vinterman receives data about dosage at salting actions, and it can warn the Vinterman operator about wrong settings and faults on the equipment during the action. A typical example is that the driver has been using a dosage that is much too low. This can be identified early during the action instead of afterwards, when he returns to the depot.

Vinterman assists the operator on the winter central by handling the call outs. Together, a better quality process is established, and there is full documentation of every action that has taken place.

First Step on Intelligent Spreaders: Online Data Collection

In the 2003–2004 season there are more than 200 pieces of equipment in Denmark from different suppliers with online data collection and presentation within Vinterman. Most of this equipment is salt spreaders, but there are also 4 patrol cars and approximately 35 trucks and tractors with plows and sweepers. The data coming from this equipment can be analyzed during or after an action (Figure 6). This enables a follow-up on the quality of the driver's work.

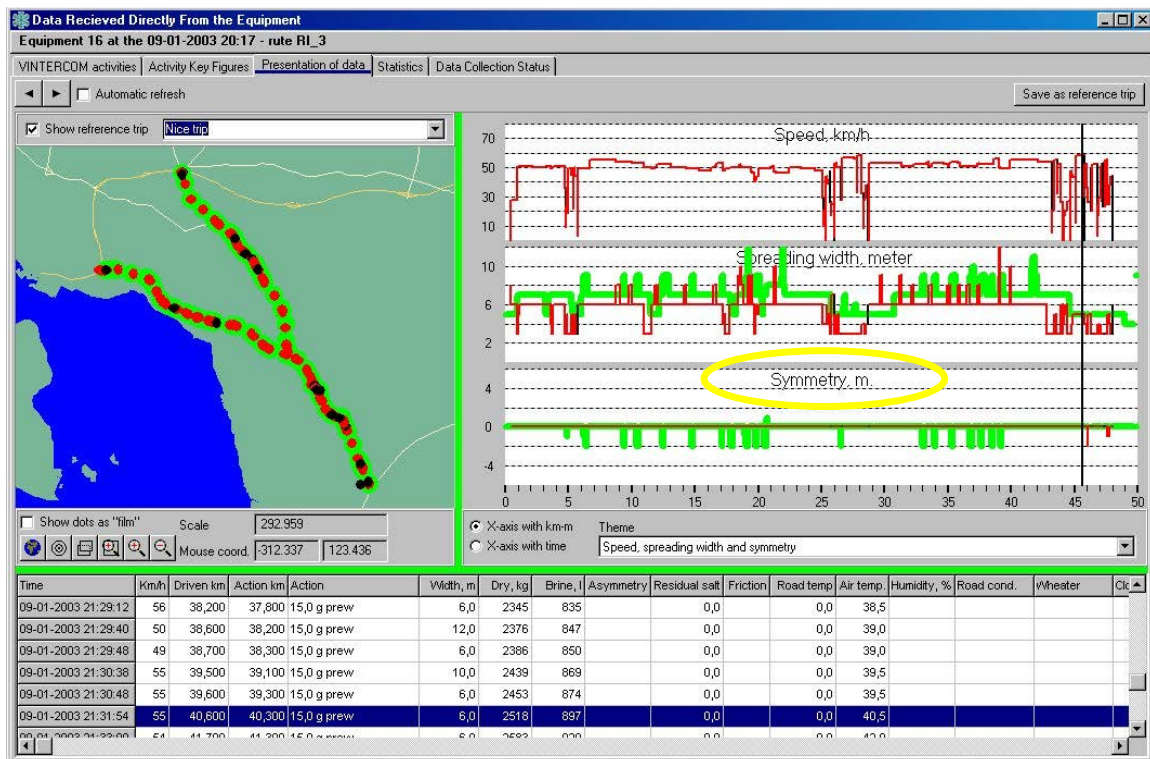

FIGURE 6 Presentation of one activity with red and black spots. The lime color is a reference activity.

The standard presentation within Vinterman shows an activity on a map, graphically and as a detailed data list. The system has a facility where you can get a reference map of the optimal situation on the route to compare with the actual situation. This presentation gives the following benefits:

- On the map you can quickly identify missing parts of the route—there will be a green line without any black or red bullets.
- With the graphics, it is easy to identify wrong adjustments of the dosage, spreading width, symmetry, and more.
- There always is access to all detailed data received from the spreader.

Generally, a 1-m smaller spreading width is used, and the button for spreading symmetry is almost never touched. By making an analysis with Vinterman on a series of existing salting actions the conclusions are

- Handling spreading width is a problem from time to time. A good driver normally has no problems.
- Spreading symmetry is rarely used. On routes in urban areas this should be used more often.
- Initial dosage settings according to the order are normally handled well. But special routes where higher dosages need to be applied at some parts of the route are in generally not observed. An example could be a section with open asphalt.
- Spreading with too high speed seldom occurs. The drivers know that it is easy to see afterward.

This is the result based on analysed routes in the season 2002–2003. This is even after the

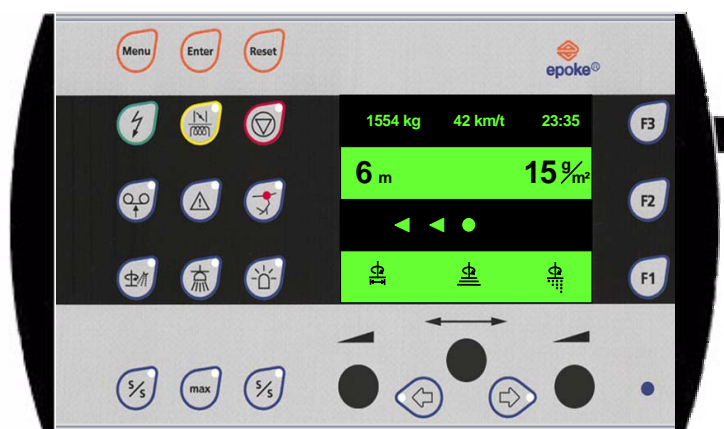

FIGURE 7 Example of a spreader control box.

drivers have been through a comprehensive formalized training program to ensure that they had the skills to drive with a spreader (Figure 7).

The conclusion is that online data collection has improved the quality of the result on the roads, but at the same time it has documented that the quality can be further improved. It also shows that it is difficult to drive with an advanced spreader, take care of the traffic, and make comprehensive adjustments to the control box at the same time.

Next Step for Intelligent Spreaders: Global Positioning System–Controlled Spreading

Based on the fact that the spreading actions could distribute the salt better, a project on Global Positioning System (GPS)–controlled spreading has been initiated. The idea is that the road geometry, surface, and dosage are known before the action starts and should therefore be handled automatically without the need for the driver to adjust the control box (Figure 8). The driver will still be able to override the automatic adjustments, for example, changing of the spreading symmetry in windy situations.

Implementation of GPS-controlled spreading will be good for traffic safety and can improve the quality of the salting actions.

The project was initiated in the spring of 2003 and has included the Danish road authorities and the suppliers of salt spreaders on the Danish market. In 2003 a general standard for communication of all needed information between the spreader and Vinterman has been established.

The *Standard for Communication Between VINTERMAN and the Road Clearing Equipment* initially covered only the monitoring of information but is now expanded with control information to handle GPS-controlled spreading (Figure 9). The standard is based on the German DAU-protocol for mobile data collection.

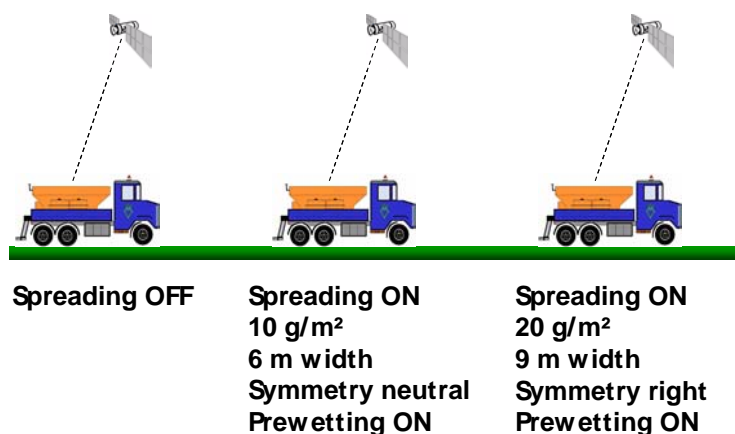

FIGURE 8 Example of how spreader settings can change automatically during a route.

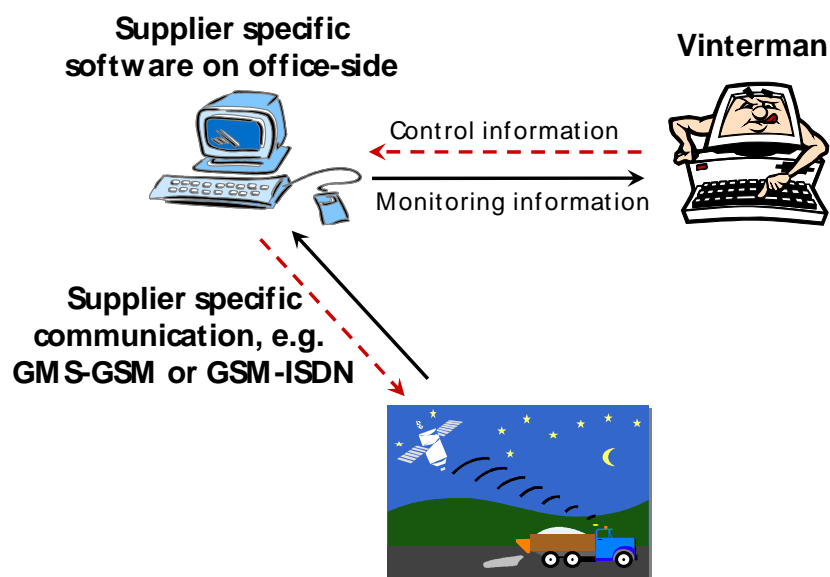

FIGURE 9 Communication of monitoring and control information between spreaders and Vinterman.

In the winter of 2003–2004 the manufacturers are trying to implement GPS-controlled spreading on their spreaders. The first steps are to provide the equipment with a facility to replay a tour collected by the same spreader, but later they should be able to receive a reference tour directly from Vinterman.

Expectations of this project are high; however, it must be accepted that there will be several steps ahead before GPS-controlled spreading is working smoothly.

GPS-controlled spreading is also a necessary basis to benefit from section based prognoses. When the meteorological people are ready with section-based prognoses, GPS-controlled spreading is necessary for implementing the usage of these prognoses.

Salting Methods

Methods to prevent slippery roads during hoarfrost and snow situations on the major road system in Denmark have moved from the spreading of dry salt to the method predominantly used today, namely, the spreading of prewetted salt. But the use of pure brine is also interesting at least in hoarfrost situations.

In order to test the methods, the Danish Road Directorate, the county of Funen, and the machine manufacturer Epoke have carried out studies on the motorway across the island of Funen (E20) during the winters of 2000–2001 and 2001–2002.

The Danish Ministry of Environmental Protection has subsidized these studies, which consisted of comparisons of slippery roads control using prewetted salt and brine, respectively.

An important study parameter was the ability to determine residual salt quantities when using either method. Unfortunately, the sensors for measuring residual salt proved unable to provide reliable data.

Therefore, the results are based on picture recordings from stationary cameras from various road sections as well as personal observations of the conditions made by individual committee members.

The conclusion is that in hoarfrost situations the use of brine instead of the traditional method of prewetted salt enables salt savings of at least 30%. According to the study, salt savings do not seem to be possible in snow situations, which may claim up to 50% of the salt consumption used for winter road maintenance in Denmark. There is reason to believe, though, that potential salt savings may be obtained, although to a much more limited extent.

The involved parties intend to continue their efforts of trying to reduce the salt consumption, which is why the advantages and disadvantages of the two methods will be registered over the coming winters.

CONCLUSION

In Denmark we have focused on improving the quality of the winter service. This paper describes how the common RWIS and Vinterman system have been implemented, and ensure that the work on the winter central is carried out using well-proven procedures and with access to the best weather prognoses.

There also has been much effort on implementing a nationwide training program for drivers with spreaders and plows; but here it is obvious that there are still some steps to go. Using the GPS-controlled spreading technology should help in the future.

There also is focus on the environmental impact of the usage of salt. Therefore, there is a move to combi-spreaders, which in some weather situations can use pure brine and still be able to use traditional salt, for example, in snow situations. There is hope to benefit someday from section-based weather prognoses and GPS-controlled spreading in order to save salt.

WINTER MAINTENANCE: POLICY, MANAGEMENT, AND PERFORMANCE

Analysis of Road Weather Information System Users in California and Montana**LISA BALLARD***Montana State University–Bozeman*

A road weather information system (RWIS)—a network of weather stations, forecasting services, and the supporting infrastructure—has been used widely in the United States and Canada since the late 1980s. Through separate projects with Montana Department of Transportation (DOT) and California Department of Transportation (Caltrans), Western Transportation Institute (WTI) collected information from road weather information users through surveys and interviews. Montana DOT's survey, completed in September 2000, received responses from 89 Montana DOT maintenance personnel. WTI conducted the Caltrans study in January 2002, and received responses from maintenance and traffic operations staff representing 11 of the 12 districts. Although not identical, the surveys included questions in similar categories, including training; current use, methods, and data; station siting; and accuracy.

For the new analysis, WTI will once again interview representatives from state DOTs concerning changes made to the states' RWISs since the survey and their possible effect on future survey response. WTI will then compile and summarize the states' operations and structures, highlighting any changes made following the original surveys. RWIS use will be compared with that of other states contacted through the interview process.

The objective of this analysis is to identify trends or improvements that are applicable on the national level. This information will be of interest and benefit to transportation officials wishing to gain a better understanding of the users' perspective on RWIS, identify areas of improvement for a state's RWIS system, and learn about applicable experiences from other states.

BACKGROUND

A road weather information system (RWIS) is a network of weather stations, forecasting services, and the supporting infrastructure. Generally, RWIS refers to the entire system used to obtain data, including the roadside equipment, the remote processing unit that obtains data from the site, the central processing unit that receives the data, the communication systems that send the data, and any site-specific weather forecast service using the weather station data and public forecasts. The roadside equipment used in weather information sites, also defined as environmental sensor stations (ESS), is compatible with the National Transportation Communications for ITS Protocol (NTCIP) and the National ITS Architecture. Unlike ESS, RWIS systems are not necessarily NTCIP compliant. This document will use the term "RWIS" with reference to the entire system and the term "RWIS stations" to refer to roadside sensor stations.

Transportation managers use the information from RWIS to make maintenance and advisory decisions that help reduce the number of incidents during severe weather conditions. RWIS has been used widely in the United States and Canada since the late 1980s, when the development of accurate sensors made it possible to determine pavement surface temperatures, and the maintenance community began using a more proactive approach to snow and ice removal (1). These systems are used most commonly to detect snow and ice, aid in efforts to remove it from roadways, and help alert motorists to dangerous driving conditions. RWIS is a critical component in supporting the following traveler services (among others):

- Maintenance decisions,
- Alert messages on roadside changeable message signs (CMS) (automated or manual),
- Automated de-icing systems on bridge decks, and
- Phone or web traveler information systems.

RWIS is one of many sources of weather information used by department of transportation (DOT) staff. The camera images available from many sites provide the visual cue of the current conditions. Users also access forecasts from multiple sources available via subscription [such as the National Weather Service (NWS) and value-added meteorological services (VAMS)] to complement the RWIS information. Finally, the Internet augments the information available through the subscription services.

This paper summarizes the RWIS operations and user opinions in California and Montana and compares them with those reported by Wyoming DOT in 1998. Specifically, this analysis will discuss

- RWIS user profiles,
- Station siting and networking,
- Weather information improvement ideas,
- Perceived current and potential usefulness,
- Training, and
- Traffic operations and maintenance usage.

The objective of this analysis is to identify nationally applicable RWIS trends or improvements. The information in this paper will be of interest and benefit to transportation officials who wish to gain a better understanding of users' perspectives on RWIS, identify areas of improvement for a state's RWIS system, and learn about related experiences from other states.

Between July 2000 and June 2002, Western Technical Institute (WTI) at Montana State University–Bozeman executed two studies evaluating RWIS use by state DOTs. WTI conducted the first study for Montana DOT; the purpose was to identify improvements in the use of decision-support tools for winter road maintenance (2). The second study, completed for the California DOT (Caltrans) in June 2002, attempted to increase the use and improve the effectiveness of Caltrans' RWIS (1). Much like the Wyoming study conducted by Tabler and Associates (3), both studies included a survey of potential RWIS users and interviews with people responsible for the maintenance and operations of state highways.

The Caltrans and Montana DOT surveys included several questions that were similar in wording and intent. Some of these questions were developed initially from the Tabler survey of Wyoming RWIS users published in 1998. On these similar questions, responses could be

compared across the three states. For questions where responders were asked to rank their agreement with a statement, the scale for the responses differed among surveys between a three-point scale and a five-point scale. To compare across surveys, this paper mathematically adjusted responses to a five-point scale.

While the small sample sizes on all three surveys prevent any statistically significant conclusions, an analysis and comparison of results highlights some possible trends. Some differences should be kept in mind when comparing responses to the survey:

1. Surveys were taken during different years. As technology and its use have improved over the years, all else being equal, the most recent surveys should be most positive.

2. The Caltrans survey included people with a wider variety of responsibilities, including traffic management center operators, winter maintenance staff, system support, district management, and headquarters staff. Montana and Wyoming responses were exclusively from winter maintenance staff.

3. California is a diverse state with many climates, including mountainous regions with heavy snowfall. Overall, though, it has a milder climate than Montana and Wyoming. Some respondents to the Caltrans survey work in very mild climates where the need for snow and ice information is far more limited than in Montana and Wyoming. All else being equal, this should decrease the positive responses related to need of RWIS by Caltrans.

4. The high population and heavy traffic in metropolitan areas decreases the priority of weather information for Caltrans headquarters and metropolitan districts as compared to traffic management.

METHODOLOGY

In addition to surveys, WTI interviewed users and facilitated meetings for the data collection process. The Caltrans survey was created and sent to Caltrans RWIS users to assess attitudes about RWIS, how each district uses its system, and the problems involved with using RWIS. The project's technical advisory committee (TAC) identified 37 potential users of RWIS in California. On January 10, 2002, Caltrans' New Technology Division (now Division of Research and Innovation) sent the electronic survey, with a request to complete it, to those identified by the TAC. TAC members also were given the option of forwarding the survey to others as they deemed appropriate. The identified survey respondents include winter road maintenance, traffic and operations personnel, district management, and headquarters personnel. Of 47 requests for responses, 38 surveys were returned and evaluated. For analysis purposes, respondents from districts without RWIS (District 5, San Luis Obispo, and District 12, Orange County) were removed from the pool of returned surveys; the analysis used a total of 33 surveys. The four respondents from headquarters were removed from analysis for questions related to training, because they are not expected to use weather information in day-to-day road operations.

The Montana survey, developed by WTI and made available to Montana DOT maintenance personnel, was conducted exclusively online. The survey focused on the sources of weather information that personnel accessed to understand current weather conditions and to

make maintenance decisions in response to the weather. It also addressed what weather information was most helpful and how it influenced the type and timing of response. A total of 87 responses was received. All respondents worked in the field of winter road maintenance. The Wyoming survey had 69 respondents, all working in winter maintenance as well.

The most recent updates on the use of RWIS were obtained through interviews, informal discussions, and interactions provided by current projects. In the fall of 2003, the operations manager at Montana DOT was interviewed to get the most recent perceptions of changes in technology and road weather maintenance and their impact on the use of weather information (4).

USE OF ROAD WEATHER INFORMATION SYSTEM

Before understanding users' perceptions, it is important to identify who the users are. The following paragraphs provide a more detailed description of the various RWIS locations and users in California and Montana.

In 1990, Caltrans began using RWIS for the first time when District 7 installed three sites on the Grapevine between Los Angeles and the Central Valley. Since then, 10 of the 12 districts have begun to use RWIS. As of July 2003, there were 81 RWIS sites throughout California with plans to install 179 more sites (Figure 1).

Caltrans districts are responsible for the procurement, siting, operations, and maintenance of RWIS with minimal input from Caltrans headquarters. In general, neighboring districts can access the RWIS data if they use the same vendor, but there is no statewide network of Caltrans RWIS. Most of the stations are placed strategically to address specific problems. In regions where snow is not prevalent, sites are situated to help monitor frost, ice, wind, or fog. In the Cascades, Sierra Nevada, and southern California mountain ranges, the primary purpose for placing RWIS is for snow and ice control. Some districts choose to cluster their sites around specific problem areas (Districts 3, 8, 10, and 11), while the pattern of placement in other districts is distributed more evenly (Districts 2 and 6).

Winter maintenance staff constitute the majority of the RWIS data users, although an increasing number of users are in the transportation management centers (TMC) or maintenance dispatch. For example, District 8 (San Bernardino and Riverside Counties) has seven sites tightly spaced along Cajon Pass primarily to monitor the winds. TMC operators receive an audible alarm whenever the winds exceed a threshold speed. District 6 (Fresno and portions of the Sierra Nevada) plans a network of stations across the southern Central Valley to be able to monitor heavy fog conditions from their TMC. At the time the Caltrans analysis was completed, data from only a limited number of sites were available to anyone outside of Caltrans.

As of June 2001, Montana DOT's RWIS network included 59 stations throughout the state. Montana DOT placed their sites in a relatively even pattern across the state (Figure 2), with all sites falling within the Interstate system or the primary route system. No RWIS is on urban state routes or secondary state routes. The density of stations is about the same on the two systems, but the Interstate system has a higher density of cameras. Four of five mountain passes on the Interstate system have RWIS, and two of seven passes on primary routes have stations (Table 1).

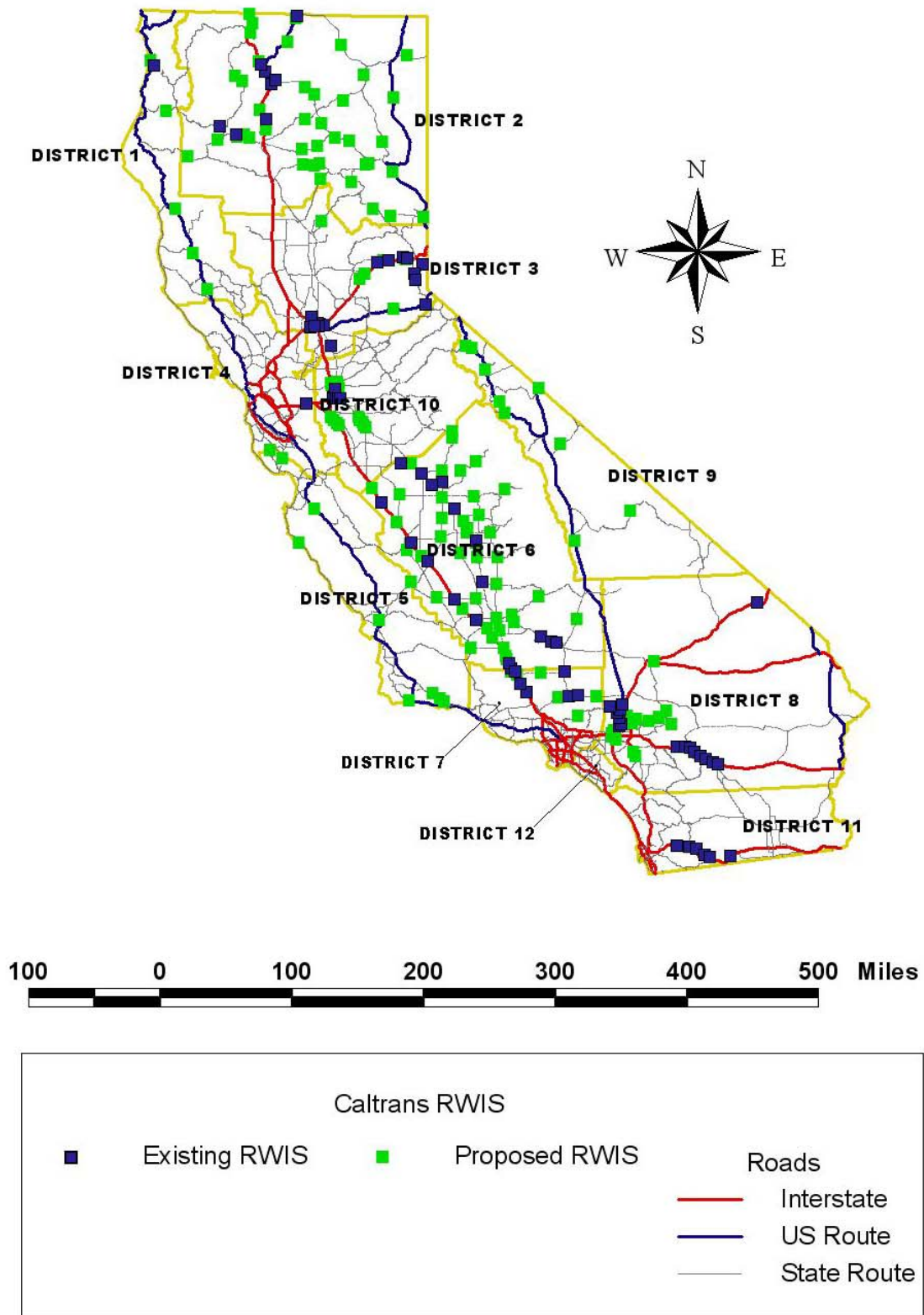

FIGURE 1 Caltrans RWIS locations and district boundaries.

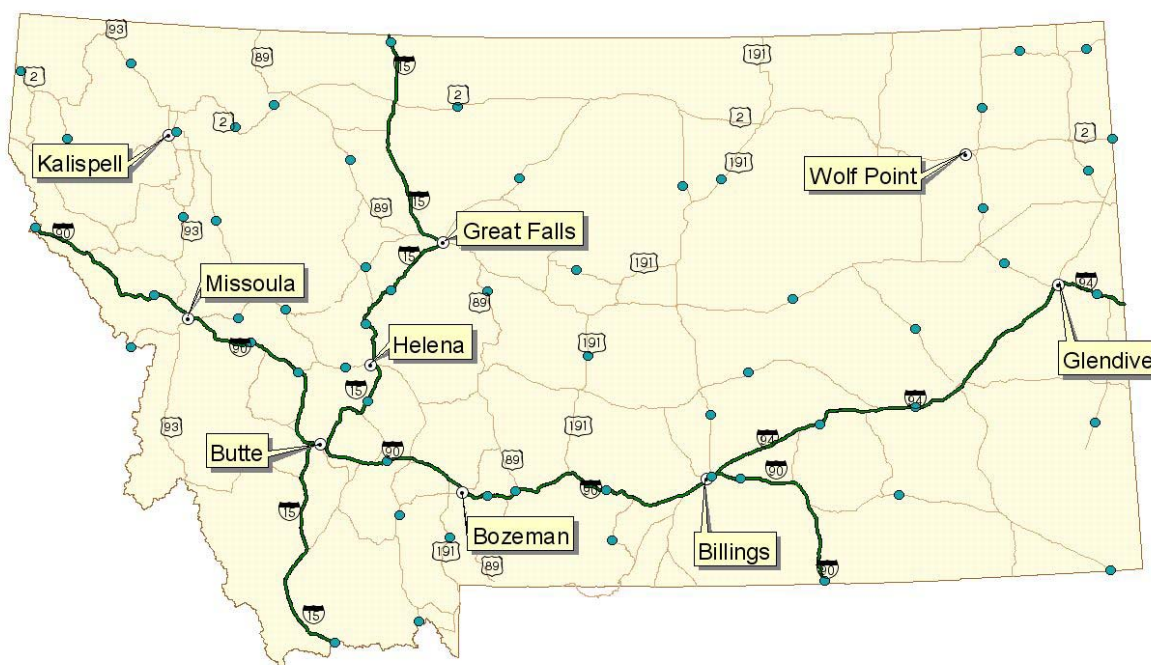

FIGURE 2 Montana RWIS locations.

TABLE 1 Montana RWIS and Camera Locations by Road Type

Road Type	Miles	RWIS Sites		Cameras		Passes	
		Number	Density	Number	Density	Number	With Sites
Interstate	1,200	19	1:63 mi	4	1:300 mi	5	4
Urban	160	0		0		No data	0
Primary	2,760	40	1:69 mi	3	1:920 mi	7	2
Secondary	2,340	0		0		No data	0
Total	6,460	59	1:109 mi	7	1:922 mi	12	6

Managing the RWIS from headquarters, Montana DOT linked all 59 stations into one system. Primary users are Montana DOT maintenance staff, but information is available to the general public from the Montana DOT website. In addition to RWIS data, maintenance staff members also have access to specialized forecasts that can help in making winter maintenance decisions. The station data are linked to the MesoWest Mesonet of surface weather stations used by meteorologists. Finally, the forecast models used for the Montana 511 Traveler Information phone number use the RWIS data as one input.

USER PERCEPTIONS

A review of the survey results will provide an indication of users' perception. As the surveys in California, Montana, and Wyoming had a limited number of responses, it is important to note the characteristics of the survey responders. In California, 14 of the 33 responses indicated a primary job function of winter maintenance; 9 were from traffic operations, 6 from management, and 2 from RWIS system maintenance. All of the 87 Montana responses were from the maintenance division. Seventy-five percent of the responses were field supervisors; 15% were superintendents, 7% maintenance chiefs, and 3% indicated other job functions. While this breakdown was not available from the published Wyoming survey results, that effort targeted the Wyoming DOT maintenance staff.

A second respondent characteristic is the method of accessing the RWIS data. When asked, "How do you usually obtain information from RWIS?" 93% of Montana DOT respondents access it from a computer they operate, as compared with 62% of Caltrans respondents and 61% of Wyoming respondents (Figure 3). These differences may be a reflection of the types of people who responded to the surveys (Caltrans responders were more diverse). The lower number of responders who access information from their own computer from Wyoming could reflect advancements in technology experienced since the time of the survey.

How do you usually obtain information from RWIS?

Verbally, by notes, or by printout, from a computer operated by someone else

From a computer that I operate

I usually do not obtain this information

Other:

RPU's page when conditions are ice or snow

Tell someone to show me the data. Data is currently not available.

	Caltrans	Wyoming	Montana
Verbally, by notes, or by printout, from a computer operated by someone else	9	37	4
From a computer that I operate	21	61	79
I usually do not obtain this information	2	2	2
Other:	2		

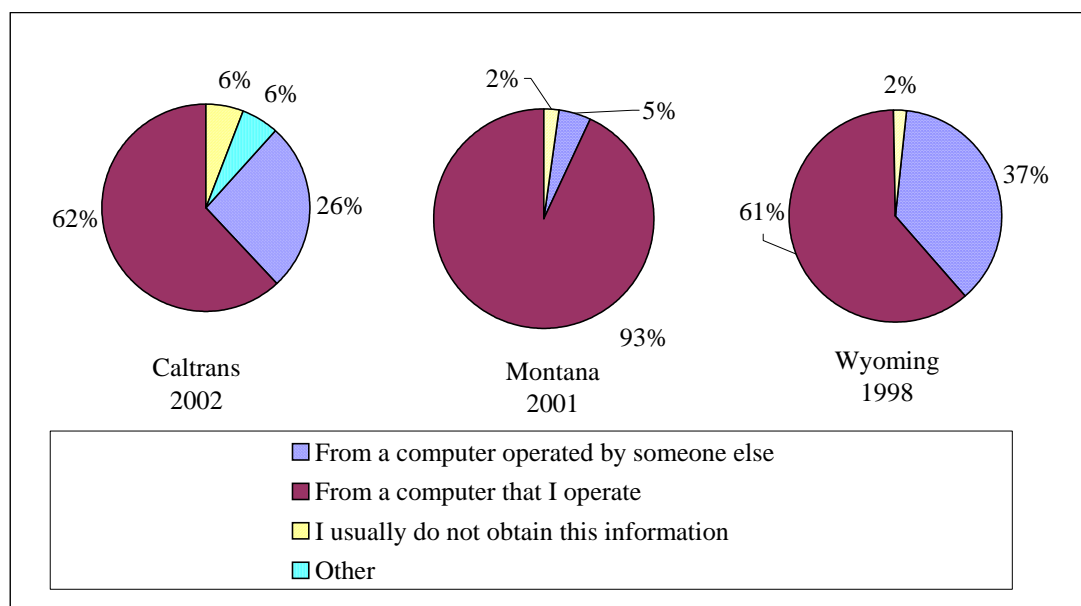

FIGURE 3 Access to RWIS data in three states.

A third respondent characteristic is related to the method of obtaining weather information. The Montana and Caltrans survey included a question asking how often they used different sources of weather information in making weather-related decisions on their job (Figure 4). The use of RWIS was about the same for both states and was used less than television weather reports and the Internet. However, the Caltrans responders' use of RWIS ranked second of the provided choices while Montana responders' use ranked sixth. Overall, Montana responders indicated a higher use of all forms of weather information than Caltrans responders. The responses indicated that Montana responders were more likely to use more traditional methods of obtaining weather information, such as television, weather radio, and commercial radio.

As previously discussed, Caltrans currently does not have a statewide RWIS network. When asked what other delivery methods were desirable, more than 70% of the Caltrans responders agreed that statewide data available over the web was desirable (Figure 5). Among the other choices for new delivery methods, there were pronounced differences in perceptions between the two states for the Internet (preferred by Caltrans) and the radio (preferred by MDT).

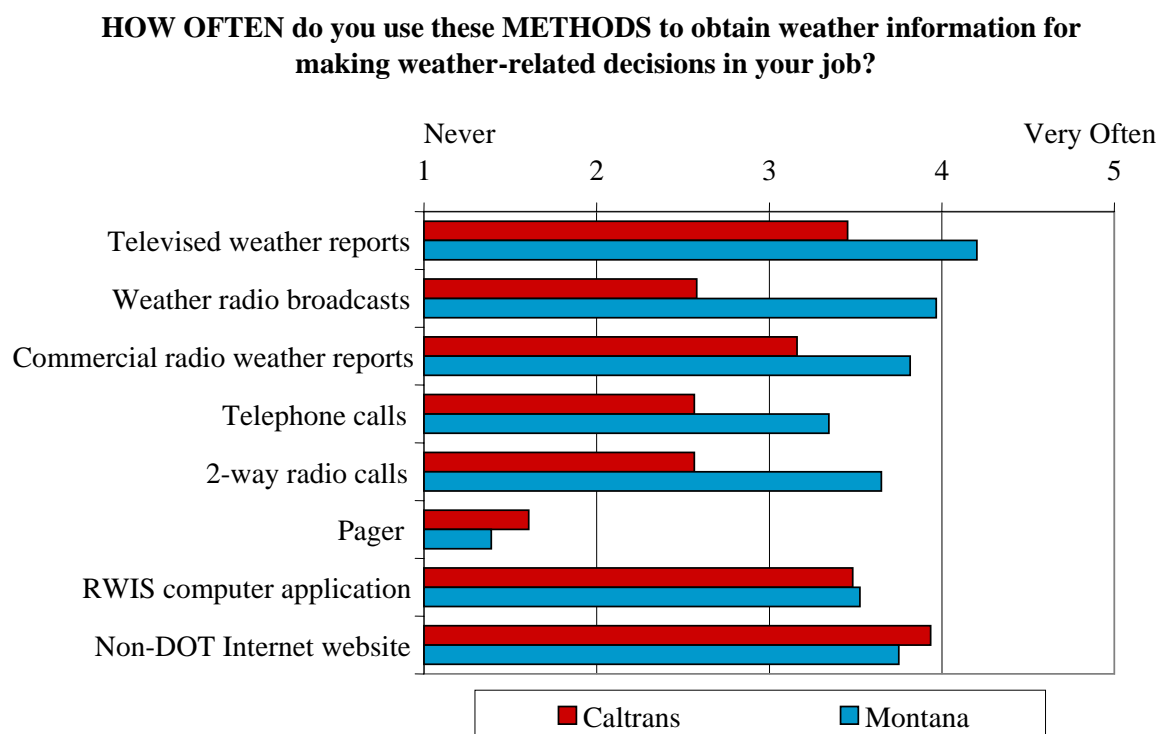

FIGURE 4 Methods of obtaining weather information (Caltrans and Montana).

If other methods for delivery of weather information were provided, which would be desirable?

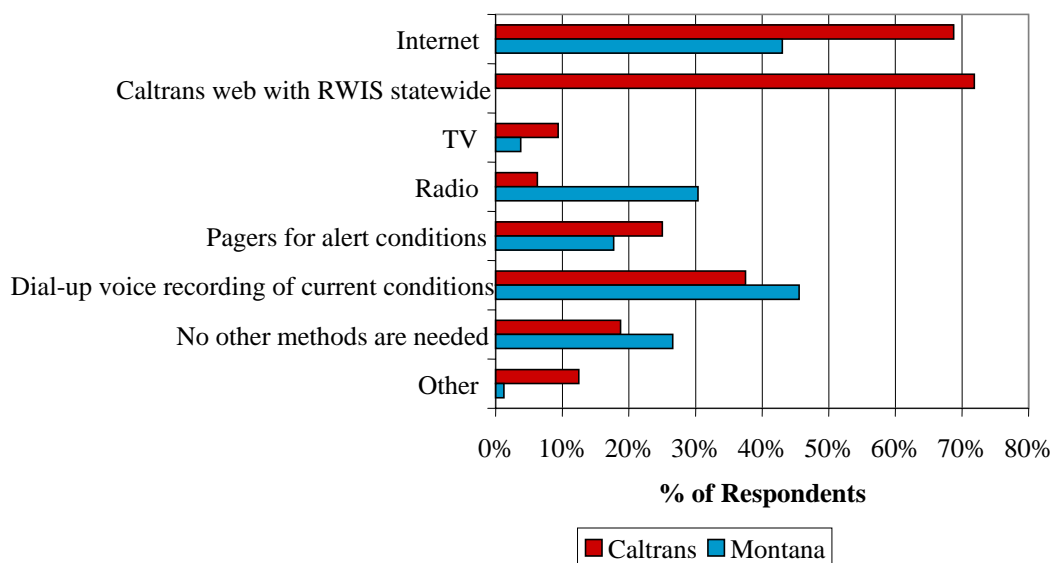

FIGURE 5 Other desirable delivery methods (Caltrans and Montana).

Usefulness

The Caltrans survey included a question addressing the potential of RWIS for differing purposes: “Rate the potential usefulness of RWIS and VAMS for the following functions.” Among the functions provided, responders ranked only the potential usefulness of RWIS and VAMS below the median value only for intense rain traveler information. Among the other functions that responders ranked, they ranked the potential for snow and ice traveler information highest, ahead of snow and ice control (Figure 6).

The Montana survey asked for suggestions to improve the usefulness of the RWIS systems. Many of the comments were related to more accurate forecasts and more stations. Others reflected issues with slow Internet connections and infrequent update periods. Some responders indicated that more cameras were desirable. Other common comments requested making the systems easier to use or making it easier to understand how to use the information. Finally, some comments requested a system that could provide accurate weather information over a terrain of around 50 mi.

Finally, all three of the surveys asked the responder to rate the usefulness of different site-specific information for winter maintenance (Figure 7):

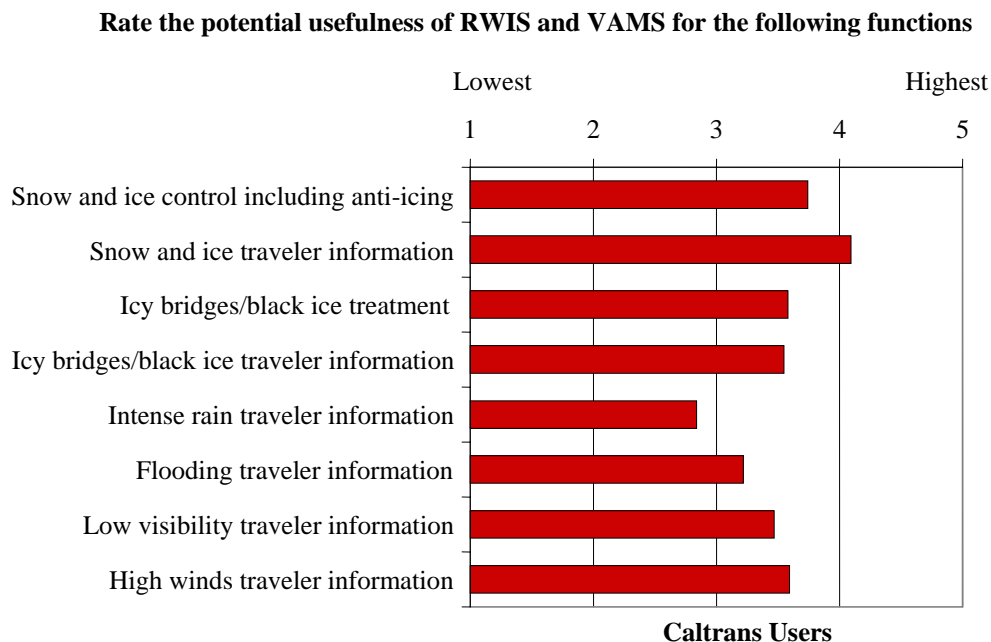

FIGURE 6 Potential usefulness of RWIS and VAMS (Caltrans only).

- Air temperature,
- Wind speed and direction,
- Pavement temperature,
- Road subsurface temperature,
- Dewpoint and relative humidity,
- Precipitation and snowfall,
- Road surface condition,
- Freezing-point depressant (Caltrans and Montana),
- Visibility data,
- Video image (Caltrans and Montana), and
- Forecasted conditions (Wyoming and Montana).

While each of the measurements was rated above the middle value for all three states, there were some differences among choices. The usefulness of wind was rated higher for Montana and Wyoming than California. Aside from the question on higher impact of wind on winter maintenance in Montana and Wyoming, the Caltrans survey had a separate question on the usefulness of these measurements for traffic operations and traveler warnings that wasn't on the previous two surveys. Another noticeable difference between the states' responses related to the usefulness of road subsurface temperatures, where Wyoming rated it lower.

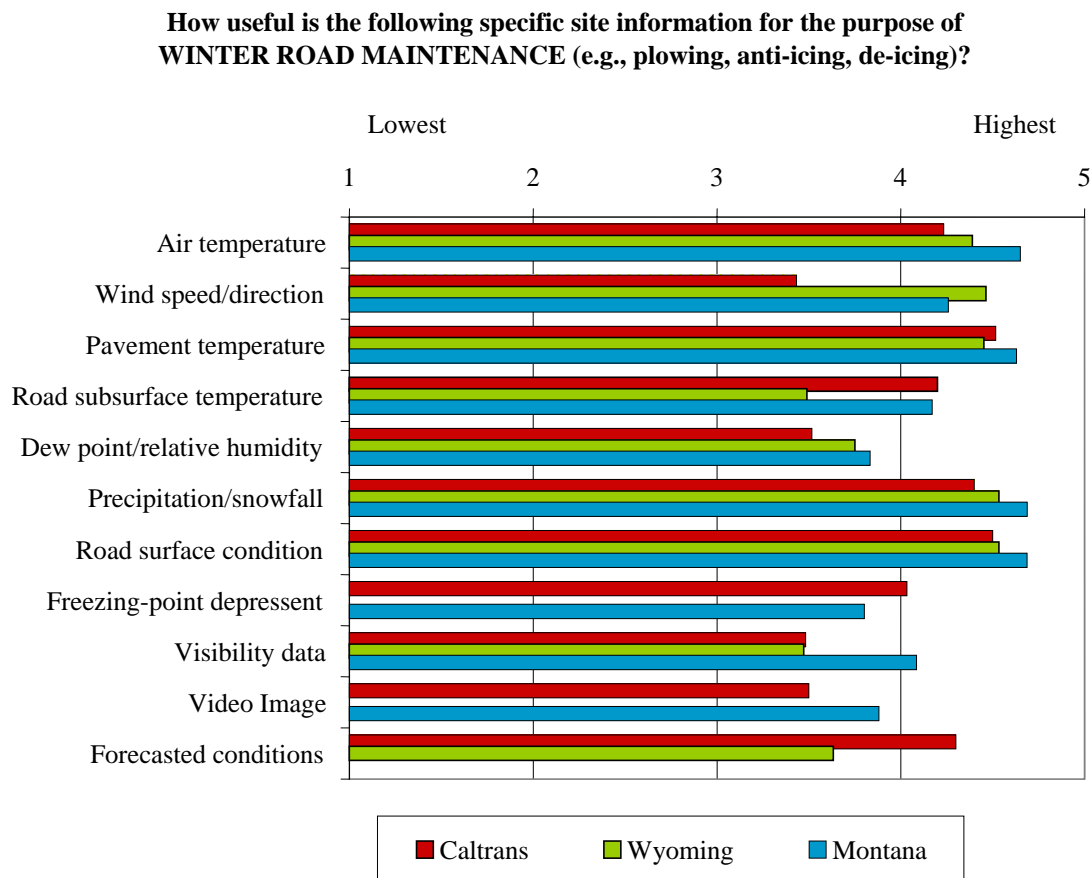

FIGURE 7 Perceived usefulness of reported station data (Caltrans, Wyoming, and Montana).

Training

All three surveys had questions regarding the amount of RWIS training received and the desire, for additional training to improve RWIS usage (Table 2). In all three states, responders indicated a limited amount of training. For Caltrans, 88% indicated they had received less than 8 h of training in the past 2 years. Montana and Wyoming responders were asked to classify how much training they had received. Montana responders were given four choices—considerable amount, some, minimal amount, or none. Wyoming responders were given three choices—considerable amount, some, or none. Eighty-six percent of Montana users indicate less than a considerable amount of training. For Wyoming, that amount was 83%. Although the questions differed between the surveys, the amount of training correlates.

When asked if more training would lead to better use of RWIS or if the amount of training received was adequate, the Montana and Caltrans respondents agreed that it was not adequate. Only 21% of Montana respondents answered that additional training would not help

TABLE 2 Survey Responses to Training Questions in Three States

Caltrans					
In the past 2 years, how many hours of training have you received in obtaining, interpreting, and using RWIS information?			How would you classify this amount of training?		
Over 40 hours	<u>0%</u>		Excessive	<u>0%</u>	
20–40 hours	<u>3%</u>		More than adequate	<u>17%</u>	
8–20 hours	<u>13%</u>		Correct amount	<u>21%</u>	
Under 8 hours	<u>50%</u>		Less than adequate	<u>29%</u>	
None	<u>33%</u>		Minimal	<u>33%</u>	
Montana & Wyoming					
How much training have you received in obtaining, interpreting, and using the RWIS information?			Do you think that you could use the RWIS to better advantage if you received more training?		
	Montana	Wyoming		Montana	Wyoming
Considerable amount	<u>14%</u>	<u>16%</u>	Yes	<u>56%</u>	<u>30%</u>
Some	<u>48%</u>	<u>73%</u>	No	<u>21%</u>	<u>53%</u>
Minimal amount	<u>26%</u>	NA	Don't know or not sure	<u>23%</u>	<u>17%</u>
None	<u>12%</u>	<u>10%</u>			

them use RWIS to better advantage. No Caltrans responder felt the training received was excessive, and only 38% felt they received sufficient, or more than sufficient, training. Wyoming respondents did not agree with their counterparts; 53% of Wyoming responders felt more training would not help.

Two conclusions were drawn from these series of questions. First, few respondents across all three states felt they had received too much training. Second, responses indicated that RWIS users in Montana and California, at the time the survey was taken, wanted more training. Finally, the author concluded that the training and overall situation within Wyoming DOT in 1998 left their users with less desire to learn more about RWIS usage. Although many factors may have contributed to the situation in Wyoming, one or more of the following also may have been responsible:

1. An improvement in American society as a whole between 1998 and 2001 in the quality, ease of use, and acceptance of technology;
2. A training program provided in 1998 in Wyoming that was perceived as less useful than training programs attended by Montana or Caltrans users;
3. More acceptance of technology by winter maintenance staff over time;
4. Better knowledge of how RWIS, in particular, can help winter maintenance staff do their jobs; and
5. A better RWIS, including station sensors, communications, and user interface.

STUDY RECOMMENDATIONS

The fundamental conclusion of the Caltrans report is that RWIS provides many benefits and has great potential. Therefore, Caltrans should continue to pursue and develop its system and other weather-related features for managing California roadways. There are numerous institutional issues that prevent Caltrans from moving towards its goal of a fully realized, linked RWIS. Given these issues and the vision for RWIS in Caltrans and input from project participants, the researchers identified key recommendations for improvement and asked the TAC to prioritize these recommendations. The prioritized recommendations, including indications of implementation costs, are listed in [Table 3](#). Details on these recommendations can be found in the Caltrans RWIS report.

The Montana road weather study recommended a continued improvement on the use of weather information. In particular, it highlighted four areas of focus:

- RWIS planning,
- Improved forecasts,
- Integrated decision support system, and
- Training.

With reference to the survey and focus group, users highly prioritized the desire for additional RWIS deployments and relocation of some of the existing RWIS, and emphasized the need for reliable weather information. Although the focus group did not rank the planning of a complete RWIS network highly, a number of comments during the activity indicated that this seemed implied in the new deployment and relocation activities. Furthermore, the need for relocation of existing RWIS indicates that better planning for initial placement would be beneficial. All of these issues point to the genuine need for an RWIS planning effort that

- Defines the need, location, and priority of additional RWIS sites;
 - Determines the optimum locations and relocation strategies for existing RWIS sites;
- and
- Defines the required capabilities of each existing and proposed site.

In addition, such a planning effort would allow the necessary coordination with national level requirements to ensure compatibility within the larger ITS network.

Many of the problems encountered by Montana RWIS users could be addressed through an integrated decision support system. Focus group discussions pointed out the importance of easy access to, and timely merging of, multiple types of weather information. Another issue discussed during the meeting was the difference in responses by various decision makers to similar weather events. Although different road segments may require different treatments for a given weather or pavement condition, this difference is generally subtle in comparison with the

TABLE 3 Assess Caltrans RWIS Recommendations for Institutional Improvements

Category	Recommendations	Priority	Cost
General	Continue pursuing RWIS and weather-related features for managing Caltrans roadways.	4	Medium
	Assess sensor capabilities to address trade offs of cost, accuracy, and reliability; develop performance specifications for sensors.	4	Medium
	Conduct benefit-cost analysis of RWIS development.	4	Medium
	Update headquarters electrical maintenance inventory with RWIS stations.	4	Medium
	Identify deployment locations based on safety and relevant other criteria.	5	Medium
MDSS	Identify Caltrans representative to participate and track national MDSS efforts.	3	Low
Traveler Information	Include RWIS information and road conditions in Caltrans-designed traveler information sources: <ul style="list-style-type: none"> • Web page, • Phone systems including 511, and • California Highway Incident Network. 	4	Medium
	Conduct detailed requirements and design to provide information in a manner most useful to the traveling public.	4	Medium
	Include the ability to incorporate forecasted conditions into traveler information systems.	3	Medium
Traffic Management Systems	Include RWIS in requirements for upgrades to ATMS.	4	Medium
	Include ability to incorporate site-specific forecasts.	3	Medium
	Include user-settable operational alarms.	4	Medium
Statewide Coordination and Assistance	Establish a statewide RWIS coordinator.	4	Medium
	Encourage each district to utilize existing headquarters staff and experts in other districts.	4	Low
	Hold an RWIS user group meeting every other year <ul style="list-style-type: none"> • Include training and • Invite partners. 	4	Medium
	Require roadside equipment to be NTCIP compliant; require software to be compliant with National ITS Architecture and regional architectures.	4	Medium
	Validate NTCIP compliance through independent contractor.	4	Low
	Require that data from RWIS and forecasts be owned by Caltrans and can be housed on Caltrans servers.	5	Low
Product Selection	Procure equipment through competitive bid process or request for proposal process.	4	Low
	Establish one statewide contract for each chosen vendor.	3	Low
Partnerships	Provide Caltrans RWIS data to MesoWest.	3	Low
	Develop relationship with the local NWS and other identified potential partners.	4	Low
	Initiate an effort to form or join a California meteorological consortium.	4	Low
	Identify potential partners from which to collect meteorological data and exchange information.	4	Low
Access to Data from Field	Interested districts should pursue products that provide access to data via pager, Internet, or mobile phone.	4	Medium
	Create opportunities to develop and deploy “push” technology (e.g., e-mail alerts) to assisted partner organizations.	4	Medium

Note: Priority ranked from 5 (very important) to 1 (not important).

need for motorists to experience relatively consistent roadway maintenance conditions from one maintenance area to the next. A decision support system can provide recommendations to decision makers, thereby creating a more consistent approach to statewide winter maintenance. Planning for such a system is imperative to ensure acceptance and use among personnel.

Finally, the data collected indicated a need for improved training. Winter maintenance decision makers need to have a thorough understanding of the information sources available, how to access the information, and how to interpret the information. In addition, a more thorough understanding of how the systems, such as RWIS, work will help these personnel to recognize malfunctions, lack of calibration, or bogus information. Training in these and other topics, as additional systems come into use, is necessary to provide the greatest benefits from the technology applications.

CHANGES SINCE STUDIES

Due to the economic and political issues that the state of California has been facing in the 17 months since the completion of *Assess Caltrans RWIS*, the author is unaware of any recent, significant changes in the use or procurement of RWIS by Caltrans. An additional contributing cause could be the lack of a staff person available to take the lead on this issue. Caltrans District 2, located near Redding in northeastern California, has implemented some changes that were already under way during the project. The district has posted their RWIS data, along with camera images, on their website's traveler information page. This is the first and only district in the state to post RWIS information (5).

The Montana RWIS survey was completed in 2001. Since that time, Montana DOT has seen better communications infrastructure, improved software, and the initiation of just-in-time anti-icing. These changes have impacted the use of RWIS by making the system more useful and by decreasing the need for the information.

According to Montana DOT's operations manager, the implementation of just-in-time anti-icing is the biggest impact on RWIS use. Instead of placing chemicals hours or days before the onset of a storm based on the forecast, as prescribed in the anti-icing methodology that has been recommended over the past few years, just-in-time anti-icing waits for treatment until the first snowflake falls. This change was implemented because of situations where Montana DOT used anti-icing liquids (magnesium chloride) before the start of a forecasted storm that never hit the forecasted location. With this philosophy in road treatment, there is less priority on tracking a storm and precisely forecasting when a storm will start. For a just-in-time approach, there is a need for forecast as well as personal observation. Although Montana DOT is happy with the just-in-time approach, it would return to the more traditional anti-icing techniques if it had highly accurate forecasts.

As the DOT continues to try new approaches, they experience changing weather data needs. There is not a one-size-fits-all approach that works in Montana. To address this, Montana DOT is trying different VAMS in one of its districts. The concept of this VAMS forecast differs from other contracted VAMS works in that it is oriented to provide a forecast across a larger area, for segments of roads and for regions of the state. The other type of forecast is tied more closely to the precise location of the RWIS station and the pavement temperature sensor. The data from the sensor initiate and verify the forecast for that location.

Another change that has improved RWIS use is the continued upgrade of the software and systems used to access RWIS data. Montana DOT recently purchased upgraded computers for staff access to the system and improved the Internet connection from a weak to a strong land-line. Montana DOT also is researching direct-services lines and high-speed wireless connections for its section houses. Increased use of RWIS also can be tied to maintenance staff's greater confidence in the use of computer applications.

In identifying the cost-benefit of an RWIS and VAMS forecast system, the Montana DOT operations manager felt that an expenditure of \$100,000 per year for the state of Montana for forecasts and RWIS maintenance would be a good deal if the service were good, if Montana DOT people were properly trained in the use of the information, and if the information was presented in a format that Montana DOT winter maintenance staff wanted.

When discussing the use of RWIS, Montana DOT indicated that people outside of the transportation industry use the RWIS information. For example, Montana RWIS data have been used to assist in siting a wind farm. Also, Montana DOT RWIS is part of the MesoWest Mesonet and thus is incorporated into other weather models that improve forecasts from NWS and other forecast providers and hence improve information for everyone including Montana DOT. Finally, the operations manager noted that the traveling public utilized the RWIS information quite a bit through the Montana DOT traveler information website. (4).

CONCLUSIONS

Despite the potential of weather information to make our roadways safer, it is not clear how much the local maintenance decision makers use even the most basic observations, such as RWIS. The use appears to be based somewhat on individual preference but is also related to training, the perceived accuracy of the data, and the influence of senior staff. In many cases, a maintenance decision maker simply reads the current situation from the plow truck instead of reviewing forecasts.

Users recognize the limited usefulness of the point-source data provided by RWIS. Maintenance staff relate stories of how one RWIS is placed to detect the location that ices first while another RWIS is placed to represent the average conditions at a site. Others will say a certain location does not report pavement temperatures anymore because the puck has been paved over. While proper placement and maintenance increase the usefulness of the sensor, it is still impossible for sensors to estimate pavement temperatures economically through complex terrain.

When users are trying to get weather information, they are using every source they can access. They are just as likely to use publicly available resources as they are to use the products designed for highway weather information. The Caltrans survey and the Montana survey both asked, "How often do you use these methods to obtain weather information for making weather-related decisions in your job?" The highest used sources were non-Caltrans Internet websites and televised weather reports, with the RWIS computer application ranking in the middle of the list.

In discussing how weather information is used, national, state, and local decision makers should recognize the importance of road and weather information to travelers. In a rural, cold-region environment, this information is more important to travelers than construction information, traffic conditions, travel times, public transit information, or incident information.

With accessibility to RWIS data, road-weather forecasts, governmental forecast agencies, private meteorological conditions, and research or experimental applications, through television, radio, web, telephone, page, or subscription satellite service, it is easy to understand if the maintenance or traffic management user does not know how to best use all of that information.

Despite the current availability of abundant weather information, the quality is not good enough for the most proactive and innovative responses. Montana DOT is moving away from anti-icing and toward just-in-time anti-icing partially because inaccurate forecasts have led to the placement of liquid chemicals when no storm occurs or vice versa. If maintenance decision makers felt they had timely, reliable, and accurate forecasted conditions, MDT would reconsider an earlier anti-icing treatment policy. At this point, this quality of forecast data has not been developed. Furthermore, computer-based decision support tools and full access to a meteorologist can assist greatly in improving the interpretation of weather information.

Another opportunity for access to a larger network of weather information is to work with other interested parties. Incident response agencies and personnel, such as fire fighters, highway patrol, and emergency medical services, must travel in all weather conditions and have their own sets of needs that should be incorporated into a national policy. The trucking industry and transporters of hazardous materials also can contribute.

Overall, given the differences in population and climate, snow and ice control impacts a larger percentage of travelers and of roads in Montana than in California. As such, from a statewide perspective, Montana DOT seems to place a higher priority on snow and ice control than Caltrans. Users in both states are finding that RWIS is a useful tool in managing winter road conditions, with Caltrans showing innovative uses for high wind and low-visibility monitoring. RWIS and other weather information tools are perceived to be useful, but institutional and technical issues need to be addressed to reach the full potential. In particular, RWIS use can be optimized if the following items are addressed:

- Better training;
- Better forecasts;
- Appropriate siting and coverage;
- Appropriate maintenance of the systems;
- Always improve the manner in which the information is provided to the user;
- Shortcomings of RWIS and other technologies for providing current and forecasted conditions;
 - Access to other networks' data, especially in California where data are not shared statewide; and
 - Sharing of information with partner agencies and the public while addressing liability concerns.

ACKNOWLEDGMENTS

Caltrans and U.S. DOT's Research and Special Programs Administration sponsored research reported in this paper. The author thanks Mike Bousliman of Montana DOT and Alyssa Begley of Caltrans for their input into this paper and into the original research.

REFERENCES

1. Ballard, L., A. Beddoe, J. Ball, E. Eidswick, and K. Rutz. *Handbook and Summary Report: Assess Caltrans Road Weather Information Systems Devices and Related Sensors*. Prepared for Caltrans New Technology and Research by Western Transportation Institute, Montana State University, Sacramento, Calif., July 2002.
2. Allemeir, R., and L. Ballard. *Montana Weather and Road Report*. October 2003. www.coe.montana.edu/wti/wti/display.php?id=12. Accessed November 15, 2003.
3. Tabler & Associates. *Improving the Wyoming Road Weather Information System*. Report FHWA-WY-98/02F. Wyoming Department of Transportation and FHWA, U.S. Department of Transportation, 1998.
4. Montana Department of Transportation. Interview between author and Mike Bousliman, Operations Manager, November 20, 2003
5. Caltrans District 2 Road Weather Information System website. www.dot.ca.gov/dist2/rwis/rwissites.php. Accessed December 1, 2003.

WINTER MAINTENANCE: POLICY, MANAGEMENT, AND PERFORMANCE

Implementing Snow and Ice Control Research**LELAND D. SMITHSON***Iowa Department of Transportation*

The user demand for year-round, all-weather mobility has created a great need to bring about change and improve the effectiveness of snow and ice control programs at state and local government levels. The function of end-to-end snow and ice control research is to discover ways to bring about that change. The term “end-to-end research” is used to describe a process that includes identification of research needs, the research, peer evaluation, and finally application of the research and validation of it in an operational setting. This paper illustrates and documents how an important element of snow and ice control research progressed on this arduous trail and is now the state of the practice.

During the past decade, research has made great strides in providing new materials, methods, and equipment for improving the maintenance and safety of transportation facilities. Topping the list of accomplishments is the way governmental agencies are approaching snow and ice control operations. The 1988 to 1993 Strategic Highway Research Program (SHRP) began the research process with nearly \$20 million being spent in a maintenance operations research program. Due to the short time span of the program the major resources were directed at accomplishing the research, and little effort was spent on technology transfer and implementation. The feeling was that the state and local agencies would see the good in the research and simply adopt it.

An international technology scanning tour program followed the sunset of SHRP in 1994 with a winter maintenance operations scan of Japan, Germany, and Austria; followed by a 1998 scan of Switzerland, France, Norway, and Sweden; and finally the latest winter operations and intelligent transportation systems (ITS) applications scan in 2002 revisited Japan.

This tremendous influx of new research knowledge and technological advances brings a concomitant societal obligation for government to increase the efficiency and effectiveness of private and public winter maintenance of transportation facilities. Environment Canada’s recent declaration that chloride-based chemicals should be considered Canadian Environmental Protection Agency–toxic adds to this sense of urgency for the snow and ice community to focus on the proper handling, storage, and application of commonly used anti-icing and deicing chemicals.

Training for supervisors and field operators in understanding the new processes and equipment used in these proactive snow and ice control techniques has been slow in developing. Lack of effective and scientifically based training has hampered progress in the implementation of anti-icing (AI) and road weather information system (RWIS) technologies discovered from SHRP and the international scanning tours.

AASHTO, recognizing these educational needs, established a pooled-fund study to provide the necessary financial support to develop a national computer-based, AI/RWIS training

program for state and local governments. Nearly all of the Snow Belt states, the American Public Works Association (APWA), and the National Association of County Engineers (NACE) contributed to this pooled fund.

IMPLEMENTATION APPROACH

After completion of SHRP, FHWA realized that the states were not recognizing the value of this completed research. The major products of the snow and ice control research, RWIS and AI were being implemented only in a few Snow Belt states. A Lead States program was put in place to accelerate the implementation process. At the end of the Lead States program it was concluded that both RWIS and AI are complicated systems and require initial and refresher training to achieve understanding and maintain skills of the users. The Lead State team determined this training could be accomplished best with the development of an interactive computer-based, stand-alone, training (CBT) program.

When the Lead States program was ended, the responsibilities for developing and implementing the CBT program were handed off to the AASHTO Snow and Ice Cooperative Program (SICOP). The Aurora Consortium, an RWIS research consortium, had training as one of its top program priorities. The Aurora Consortium and AASHTO SICOP agreed to partner in the development of a national AI/RWIS training program with Aurora taking the lead in developing the scope of work and obtaining a contractor to build the CBT program. AASHTO was designated to be the lead agency in establishing a pooled-fund program to provide the necessary financial support and technical guidance to develop an innovative national RWIS/AI CBT program for state and local governments. SICOP was charged with raising the necessary funding and coordinating the project. APWA, NACE, and more than 90% of the Snow Belt states have contributed to the pooled-fund program.

THE PRODUCT

Two versions of the CBT program, one generic and the other customized, are the end products of this pooled-fund effort. Each version is a menu-driven, hyperlinked, interactive program manager. The student (once logged in) can work through this stand-alone training from beginning to end, as with a book, and return to the menu at intervals, as desired, to select another path. The content includes photographs, illustrations, text, video, charts, animation, interaction, narration, and other means of communications. There are opportunities at various points to assess the progress the user is making educationally, including quizzes, scenario-based problem cases, and exercises. The training can be administered individually or used in a group setting and can be the foundation for a certification program.

The beta version of the generic CBT was been completed and distributed to the states on April 30, 2003. Some states used the beta version as a stand-alone training program during the winter of 2003–2004 for training during inclement weather when outdoor operations were not possible. Others are integrating it into existing academy programs for both initial and refresher training.

COURSE CONTENT

The course consists of seven lessons containing a total of 38 units. The content outline is listed below:

- Lesson 1. Introduction to Anti-Icing and Winter Maintenance
 - Unit 1. The New World of Anti-Icing
 - Unit 2. Benefits of Anti-Icing
 - Unit 3. Anti-icing in a Nutshell
 - Unit 4. Units of Measure
- Lesson 2. Winter Road Maintenance Management
 - Unit 1. Components of a Successful Anti-Icing Program
 - Unit 2. Preparing for the Winter Season
 - Unit 3. Level of Service
 - Unit 4. Data Collection and Record-Keeping
 - Unit 5. Anti-Icing Communications and Legal Matters
- Lesson 3. Winter Roadway Hazards and Principles of Overcoming Them
 - Unit 1. Water and its Winter States
 - Unit 2. Road Surface Heat
 - Unit 3. Condensation and Dew Point Temperatures
 - Unit 4. Pavement Temperature—It's the Key!
 - Unit 5. Snow, Ice and the Roadway
 - Unit 6. Snow/Ice Bonds and Freezing-Point Depressants
 - Unit 7. Dilution of Solution
 - Unit 8. Chemical Concentrations and Application Rates
 - Unit 9. Friction
- Lesson 4. Weather Basics
 - Unit 1. Weather and Winter Road Maintenance
 - Unit 2. Air, Atmosphere, Heat, and Humidity
 - Unit 3. Weather Systems
 - Unit 4. Regional Weather Influences
 - Unit 5. Precipitation Hazards
 - Unit 6. Nonprecipitation Hazards
- Lesson 5. Weather and Roadway Monitoring for Anti-Icing Decisions
 - Unit 1. Radar
 - Unit 2. Weather Observation and Data Gathering
 - Unit 3. An Introduction to RWIS
 - Unit 4. The Importance of VAMS
 - Unit 5. Eight Critical Questions
 - Unit 6. Combining Anti-Icing and the Traditional Approach
- Lesson 6. Computer Access to Road Weather Information
 - Unit 1. An Introduction to the RWIS Screens
 - Unit 2. Navigating Through the System
 - Unit 3. Other Online Resources
- Lesson 7. Anti-icing Practice in Winter Maintenance Operations
 - Unit 1. Preparing for the Season

- Unit 2. Equipment Types, Preparation and Maintenance
- Unit 3. Material Preparation and Storage
- Unit 4. Chemical Application Rates
- Unit 5. End-of-Season Tasks

COURSE DOCUMENTATION

- *AI/RWIS CBT Setup Guide* is a manual describing how to set up the CBT on the user's computer. The guide is written for the information technology staff.
- *AI/RWIS CBT User Guide* is the primary reference manual for the CBT. This manual is meant for the CBT users. The *User Guide* explains in detail how to use the software and provides a detailed description of each of the CBT's features and functions.
- *Training Manager Guide* is a guide for training managers. It details the Training Manager Tool.
- *Course Editor Guide* details the use of the Course Editor Tool. The Course Editor is designed for training managers.
- *Implementation Guide* is written particularly for training managers. It explains how to roll out the CBT and how to best monitor student performance both with the CBT and on the job.

USING CBT

- A splash screen appears each time the CBT is launched. It is a composite of small images reflecting training program content. As the images appear, music plays in the background. The splash screen requires about 15 s to build. If the student desires to bypass this screen, pressing the space bar or enter key will advance to the log-in screen.
- The log-in screen must be completed each time so student progress can be recorded. Log-in requires first name, last name, password, and job title. Thereafter the Microsoft® Agent Jake, an online assistant, addresses the student by their first name. Jake is an animated conversational personality that walks the student through the tutorial (discussed below) and provides assistance when the student needs help. In addition to assuming the role of a guide, Jake appears on occasion to drive home a point or sometimes just to entertain.
- The welcome video presents a brief video introduction to the course. The welcome video plays the first time the student uses the CBT.
- The tutorial familiarizes the student to the features and functions of the CBT. The full tutorial requires 31 min. The student can go through the entire tutorial or select tutorial topics. When the student logs back into the program for a subsequent session, he or she can revisit the entire tutorial, select topics, or skip the entire tutorial.
- The Road Map appears once the student exits the tutorial. The Road Map illustrates the student's progress and directs him or her to units within each lesson. Each road sign on the screen represents a lesson in the course. Lessons must be completed in order. Completed lesson signs are checked off as soon as the student works through all of the lesson content and earns a passing score on the postassessment quiz and scenario.

- Each lesson begins with a video introduction to the content in that lesson. The main topics discussed in the forthcoming lesson are displayed on the screen as a real person host mentions them.
- A preassessment quiz is administered after the lesson introduction. The purpose of the preassessment is to evaluate what the student knows before going through the lesson so it can be compared with what he or she knows after going through the lesson. The quiz contains questions in a variety of common formats (multiple-choice, true/false, and fill-in-the-blank). On the last question of the preassessment a Check My Score button will appear. Clicking that button will display a score panel with student results.
- The lesson content in each lesson is organized into units. Each unit is broken down into screens. Lessons contain anywhere from three to nine units. Each unit has as few as five or as many as 40 to 50 screens. The lesson content is presented using multimedia elements, including
 - Text;
 - Bullets (key points);
 - Photographs;
 - Illustrations;
 - Charts, graphs, or tables;
 - Screen element highlighting;
 - Narration;
 - Animation;
 - Digital video;
 - Sound effects;
 - Mouse- or keyboard-controlled (or both) interactive exercises and simulations;
 and
 - Review questions.

Interactive exercises engage the student and topic being discussed. Review questions are presented about every 5 to 10 screens. These are designed to check the student's understanding of the topic being discussed over the past few screens. Review questions are presented in a variety of formats, such as multiple choice, fill-in-the-blank, true/false, or drag-and-drop. Feedback will be provided so that the student can see how he or she did (and if a question was missed, what the correct answer is).

- Knowledge Base is a warehouse of information related to AI/RWIS. The student should think of it as an online encyclopedia. Material in Knowledge Base is arranged in tab groups and discussion topics by subject or area or in an alphabetical index. In addition to text, Knowledge Base discussions may include photographs, diagrams, tables, website links, and digital videos. Some discussions include links to other discussions. These are identified with blue underlined text. The student can click on these hot terms (links) to jump to those discussions in the Knowledge Base.
 - The glossary contains a list of AI/RWIS terms and their definitions.
 - A postassessment quiz is used to evaluate what the student knows after going through the lesson. On the last question of the postassessment a Check My Score button appears. Clicking that button brings results of the postassessment quiz and preassessment scores, so the

student can compare what he or she now knows after going through the lesson compared with what he or she knew beforehand.

- While the postassessment quiz evaluated the student's knowledge of AI/RWIS facts, the scenario evaluates his or her understanding of the lesson content by asking for the newly acquired knowledge to be put into practice. It is well known that working with theories is one thing; working within the constraints of the real world can be quite different. The scenario room gives hands-on practice in a simulated winter maintenance facility so that winter maintenance decision-making skills can be developed and refined. The scenario room is set up to look like a field maintenance garage office. It includes the tools most maintenance facilities have in some form or other to learn of an impending winter weather event. The student should be able to research the particular nature of the event and make operational decisions based on that research. Everything the student does in the Scenario Room is tracked and evaluated. The student is encouraged to strive to use pertinent tools available, yet not to waste time clicking on objects that will not aid in the particular event. Detailed feedback will be provided once an operational decision has been made. If the student does not pick the optimal solution to the problem, the optimal solution is explained. The results of the student's decision are compared with the results of the optimal solution. This way the student can learn the consequences of making a less-than-optimal operational decision. The feedback also lists each step taken, the order of each step, and the time needed to complete the step. There are two scenario modes: practice and evaluation. Practice mode lets the student work through the scenario without being graded. A student can take up to three practice scenarios before tackling the evaluation or graded scenario.

- The AI/RWIS CBT continues to be a valuable tool even after the student completes the course. When the student finishes the CBT, a new feature is activated—the Electronic Performance Support System (EPSS) Mode. The student can access this feature through the Road Map icon on the Road Map screen. The EPSS Mode screen is divided into two main panels. The panel on the left includes a scrolling alphabetical list of discussion topics in the CBT. The student locates the topic he or she wishes to review, highlights the topic by clicking on it, and then clicks on the Go to Selected Topic button to jump to the first screen of that discussion. Above the alphabetical list of topics there is a search field. Rather than scroll through the extensive list, the student can type the first few characters of the topic of interest, and the list will scroll automatically to the first topic matching the characters the student typed in. On the right-hand side of the screen, topics are organized into a content tree. If the student needs help, the Help button is available. Jake appears and provides the assistance needed.

PRODUCT IMPLEMENTATION AND CUSTOMER SATISFACTION

Two versions of the CBT program, one generic and the other customized, were distributed in the spring of 2003. APWA and NACE selected the generic version while all but two states desired the customized versions. Some states promptly began the customization process, while others reviewed the generic content and found it satisfactory for immediate implementation. Those states delaying customization felt that they could do a more complete customization after their maintenance workers had a chance to become familiar with the program content and determine how well the generic material fit their particular snow and ice control operations and learning processes.

Each state department of transportation (DOT) formed a customization team generally consisting of supervisors, equipment operators, and training personnel. Customization included tailoring to specific methods, equipment, policies and procedures, and chemicals used in snow and ice control operations. Training managers working with the teams selected lessons or portions of lessons they wanted presented to the various job classifications in their organization and set the thresholds for minimum passing test scores. Some states had photos of snow and ice control equipment to include in the customization, others had to obtain the photos during the winter of 2003–2004.

Unanimous feedback from state DOT maintenance personnel and trainers has been that the CBT exceeded their expectations. The CBT was installed easily on their computers and fit well into their training program. The CBT will work well in either the group or individual training mode. The individual training mode is the most popular use. Students find the CBT engaging and challenging. Most find 2 h at a session fits best into the daily work schedule and does not wear them out. Depending on student experience and ability, the time required to complete all seven lessons varies from 20 to 40 h.

A metric version of the CBT has been prepared for use in the Canadian provinces. Converting to metrics was more than just doing the mathematics. Maintenance field jargon and techniques were needed for gaining field acceptance. Also maps and radar had to be extended northward to provide adequate coverage of the Canadian provinces.

INTEGRATION WITH MAINTENANCE DECISION SUPPORT SYSTEM

The CBT lays the basic educational foundation for snow and ice control decision makers to assess the various road weather elements leading to an operational storm treatment strategy. This multifaceted problem is changing constantly so an optimum treatment strategy is usually a moving target. An optimal solution can best be achieved with the assistance of a computer-based decision support system.

FHWA recognized the complexity of the problem and developed a prototype winter maintenance decision support system (MDSS). The objective of the MDSS effort is to produce a prototype tool for decision support for winter road maintenance managers. The MDSS is based on diagnostic and prognostic weather research and road condition algorithms, which have been a follow on from the SHRP and subsequent Test and Evaluation (TE-28) project efforts. The components of the MDSS prototype were developed by the Cold Regions Research and Engineering Laboratory, National Center for Atmospheric Research, Massachusetts Institute of Technology, Lincoln Laboratory, National Severe Storms Laboratory, Environmental Technology Laboratory, and the Forecast Systems Laboratory.

The MDSS was tested in several states during the winters of 2001–2002 and 2002–2003. Neither winter produced a sufficient number or variety of storm events to test the system thoroughly. The project is in its final year (winter 2003–2004) of evaluating selected prototype components in an operational environment. The MDSS goal is to provide on a single platform a display on the state of the roadway and recommended courses of action together with anticipated consequences of action or inaction. The principles and operational techniques found in the final version of the MDSS must be consistent with those being taught in the AASHTO AI/RWIS CBT. Since both programs were built on SHRP and TE-28 results, they are currently parallel.

However, as field evaluations continue and more experience with existing and new chemicals is acquired, program content in the CBT is likely to need some minor revision.

NEXT STEPS

Modern snow and ice control is a dynamic and continuously changing field. Discussion on the quest for new equipment, chemicals, and techniques to solve looming operational problems appears daily on the AASHTO SICOP List Serve. Customer expectations for better mobility and improved winter driving safety provide the challenge and political momentum necessary to drive the road weather research process. As new knowledge becomes available, program content in the AI/RWIS CBT needs to be revised so that improvements from snow and ice control and road weather research can be implemented and optimized. The basic structure of the CBT has been developed so that these revisions can be accomplished in an economical and timely manner. The AASHTO Winter Maintenance Technical Service Program has the primary responsibility for future maintenance and revision of the CBT.

Customers' Perspective on Winter Operations

CUSTOMERS' PERSPECTIVE ON WINTER OPERATIONS

Importance of Winter Urban Traffic Issues and Performance Indicators as Rated by Businesses**CHIGAKO YAMAMOTO****KUNIHIRO KISHI****KEIICHI SATO***Hokkaido University***FUMIHIRO HARA***Hokkaido Development Engineering Center, Inc.*

Despite the huge sums budgeted by Sapporo for snow-related works, citizens express a high demand for improved winter road maintenance. Citizens include various segments, and understanding the needs of each segment helps to improve overall satisfaction. This study focused on businesses, essential to the economic strength of any city. Businesspeople were surveyed regarding winter traffic problems and desired outcomes for snow and ice control. The survey examined the importance of winter traffic issues; investigated winter–summer comparisons of vehicle-related costs, numbers of visits to clients, time taken to deliver merchandise, and number of visits by customers; and found winter traffic accidents in the past 5 years.

Rankings of winter traffic issues were clarified by the expanded contributive rule for all respondents and for each business category. Despite some differences in ranking due to unique features of each business category, three problems ranked high for businesses of all categories: “risk of increased traffic accidents,” “decline in visits to clients for meetings/sale,” and “increase in time to deliver merchandise.” The performance indicators that address these issues are “securing skid-resistance of winter road” and “securing effective road width.” These indicators coincided with those ranked high by businesspeople in the opinion survey. Obtaining the achievement rates of indicator targets can enable us to measure outcomes of winter road maintenance.

Public services aim to fulfill the needs of citizens, and organizing winter maintenance operations according to desired outcomes can promote this objective. We propose a logic model of winter road maintenance that incorporates the outcome indicators desired by businesses.

INTRODUCTION

Sapporo is the capital of Hokkaido, Japan’s northernmost prefecture. There are 1.84 million residents in the city, and 2.5 million in Greater Sapporo. The city receives more snowfall (10-year average of 1994–2003 is 5 m) than any other metropolitan area of its size in the world. The population density is high, and the business sector is vibrant. Although the city budgets great sums for winter road maintenance, there is still a high demand among citizens for snow clearing and hauling on roads. It is thought that increasing the overall snow removal level uniformly will not increase citizen satisfaction.

To improve the overall satisfaction of citizens with winter road maintenance, it is important to identify and satisfy the needs of each segment of the citizenry. Although the city has been surveying the citizens each year on winter road maintenance, few surveys have targeted businesspeople. In this study, an opinion survey was given to businesspeople, because the business sector is important to a thriving city.

The opinion survey focused on the importance of winter traffic issues, quantitative comparison of road traffic issues between winter and summer, importance ranking of winter traffic issues as evaluated by businesses, and performance indicators for winter road maintenance based on the needs of businesses. After analyzing the survey results, we proposed a logic model that fulfills the needs of businesses for winter road maintenance.

OPINION SURVEY

Sapporo

In the 30 years ending in 1995, the population of Sapporo more than doubled from 820,000 in 1965 to 1.75 million in 1995. This increase continues, although it is largely confined to the elderly demographic [see [Figure 1](#), (1)]. Vehicle ownership grew from 830,000 vehicles in 1993 to 940,000 vehicles in 1998 and continues to grow. In contrast, the city's gross product and tax revenue peaked in 1996. The city's budget has been expanding because of high demand for public services. Efficient and effective public services are very important for the city.

The snow and ice control budget for Sapporo was 15.7 billion yen (US\$ 157 million) in FY 2003. Even with such a large allocation, annual opinion surveys show that citizens have considered snow removal and hauling to be the most important public service issues for 25 consecutive years. Annual snowfall fluctuates between 3 m and 6 m, with a typical winter producing 5 m ([Figure 2](#)). Citizen demand for snow and ice control is always high.

Survey Outline

Interview Survey

In January 2001, an interview survey was made by telephone and fax. The questions addressed what winter traffic issues are considered important by businesses. The 19 respondents were companies that were members of Sapporo Chamber of Commerce and Industry. The survey outlined winter traffic-related problems with respect to business activities.

Questionnaire Survey

Based on the results of the initial interview survey, a detailed questionnaire on urban commercial traffic in winter was developed and conducted among members of Sapporo Junior Chamber, Inc. Members of this organization were businesspeople younger than 40 who worked for companies with offices in Sapporo. Because they managed small and medium-sized businesses or were independent professionals (dentists, lawyers, accountants, financial planners, and the like) and their opinions reflected those of their businesses, Sapporo Junior Chamber members were considered to be representative of the business community.

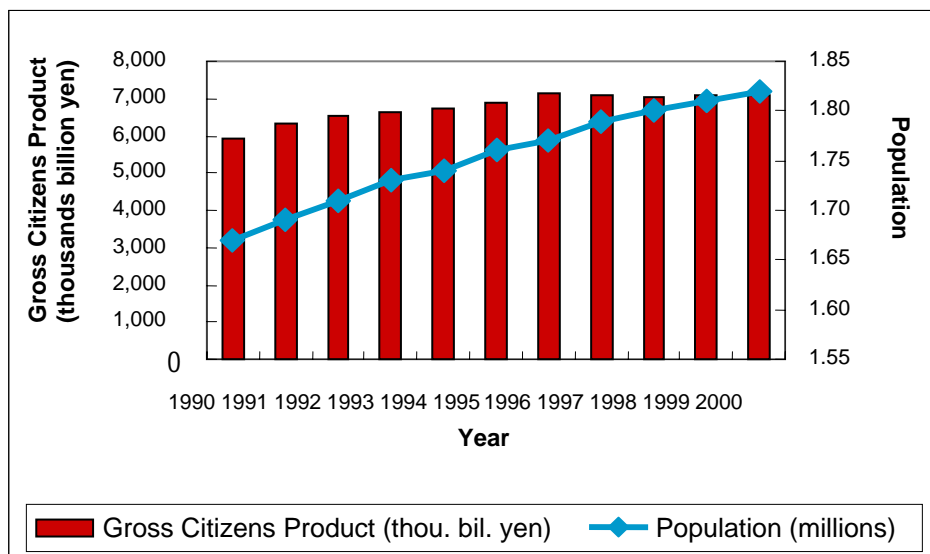

FIGURE 1 Population and gross product of Sapporo.

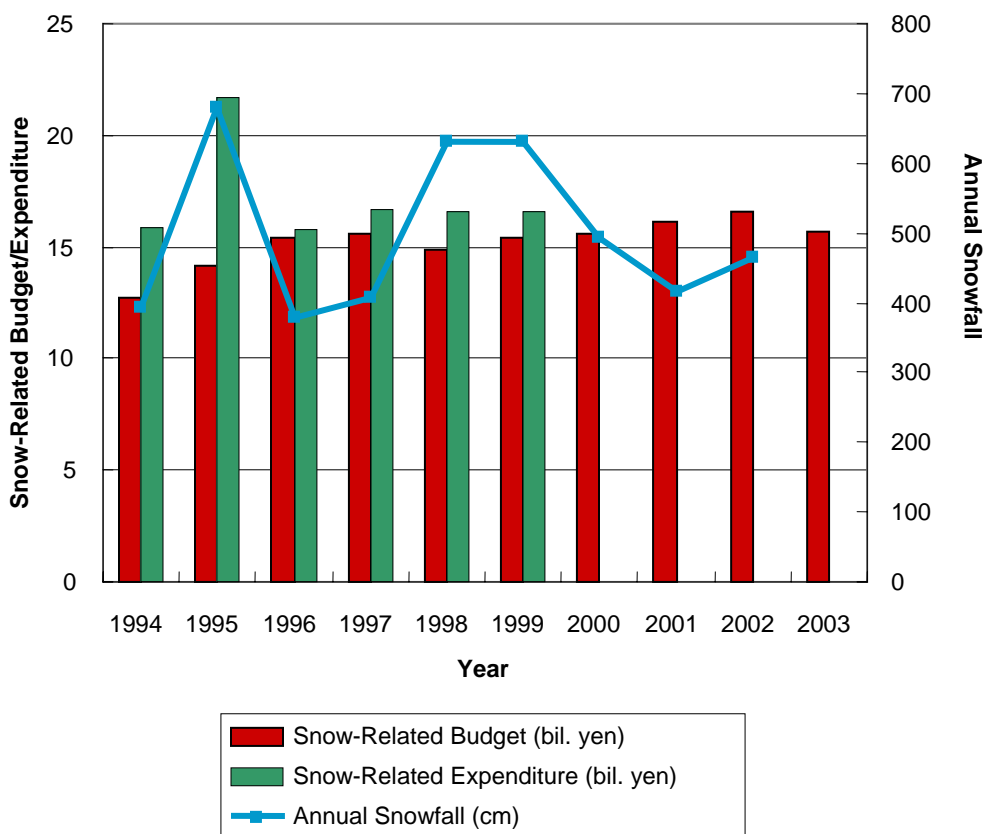

FIGURE 2 Snow and ice control outlays and annual snowfall.

The questionnaire was distributed by hand at the regular meeting of the Sapporo Junior Chamber on July 10, 2001. Collection was made immediately after the meeting and later by post. Of 104 questionnaires handed out, 65 were collected.

The survey aimed to compare summer and winter traffic conditions. In addition, the order of importance (problem severity) of 10 winter road traffic problems selected based on the above interview was assessed by the expanded contributive rule (ECR). The aim was to clarify the importance ranking of the winter road traffic issues that had been cited as problematic.

SURVEY RESULTS

Importance of Winter Traffic Issues

Respondents were businesspeople who were asked to answer in their capacity as commercial road users, rather than as individuals. We asked the respondents to evaluate the importance of winter traffic issues in terms of their business activities. They were asked to rank winter traffic issues as (a) very important (problematic), (b) somewhat important (somewhat problematic), or (c) unimportant.

The businesses were categorized into 10 industries, according to the standard Japanese industrial categories. Because “agriculture, forestry, and fishery,” “mining,” and “electricity, gas, heating, and water supply” each accounts for only 0.1% of the city’s industries in terms of number of businesses and there were no respondents from such businesses, these industrial categories were excluded. Both “finance and insurance” and “real estate” had only two valid responses each, so they were combined into one category. Consequently, respondents were categorized into the six business categories of “service,” “finance, insurance, and real estate,” “retail, wholesale, and restaurant,” “transport and telecommunications,” “manufacturing,” and “construction.”

Figure 3 shows evaluation of winter traffic issues [choice of either (a), or (b) or (c)] by all respondents as well as by each businesses category. Obviously, winter traffic issues differ in importance evaluation according to industrial category. The rate of companies who regarded winter traffic issues as “very important” was highest for the “construction” industry, followed by “retail, wholesale, and restaurant.” A majority of respondents (54%) evaluated winter traffic issues as “very important,” followed by “important” (41%) and “unimportant” (5%). Because 95% of respondents evaluated winter traffic issues as important or very important, the issues were confirmed to be a critical matter for businesses in the city.

Increase in Vehicle-Related Cost in Winter and Winter Traffic Accidents During the Past Five Winters

Figures 4 and 5 show the percentages of businesses that indicated an increase in vehicle-related cost in winter and that were involved in winter traffic accidents during the past five winters for all respondents and for each industry.

Forty-three percent of respondents indicated that vehicle-related costs are greater in winter than in summer (Figure 4) compared with 57% who said they remain similar in the two seasons. No one answered that costs decrease in winter.

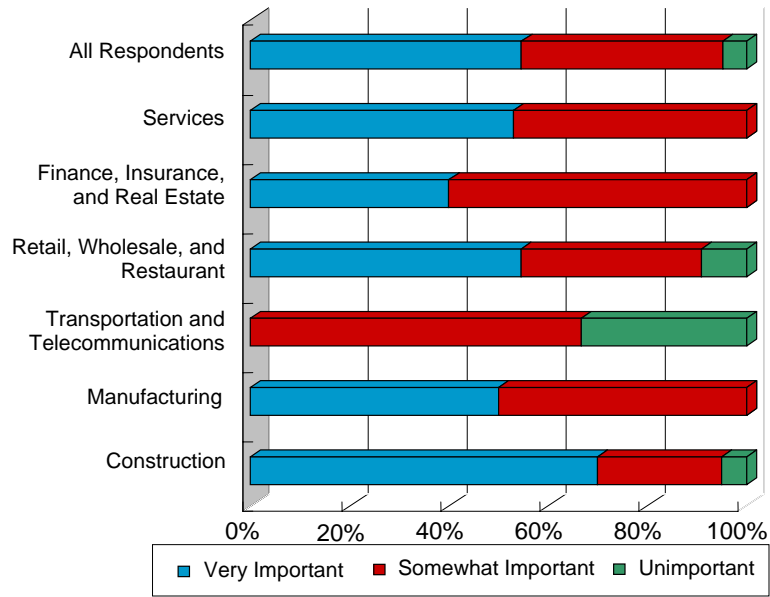

FIGURE 3 Importance of winter traffic issues as evaluated by business.

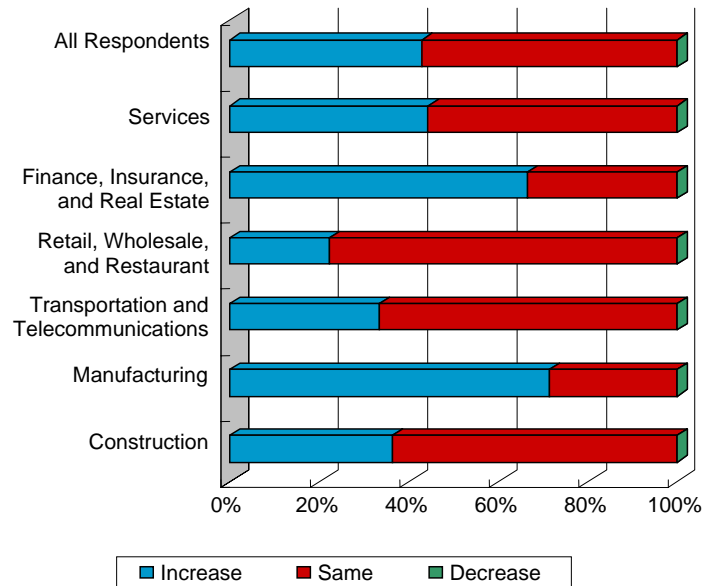

FIGURE 4 Winter vehicle-related costs relative to those for summer.

The respondents were asked whether their company had experienced any winter traffic accidents for the past five years. Such accidents were reported by 65% of the companies (Figure 5). Of the businesses that indicated an increase in vehicle-related costs in winter, 82.4% also reported having had winter traffic accidents in the past 5 years. This shows that winter traffic accidents greatly increase vehicle-related costs in winter.

Decline in Visits to Clients for Meetings/Sales

The respondents were asked how many visits they make to clients for meetings or sales per day in winter and in summer. Valid responses numbered 41. The results (Figure 6) show three peaks for winter and three for summer. The maximum was 30 visits per day in summer, which declined to half that in winter. The summer average was 8.3 visits per day. The first peak was 10 visits per day (17 respondents, or 41.5%), which was the mode, and the second and third peaks were 5 and 6 visits per day, respectively. The winter average was 4.7 visits per day. The first peak was 5 visits per day (15 respondents, or 36.6%), which was the mode, and the second and third peaks were 3 and 7 or 8 visits per day, respectively. The number of visits to clients for meetings and sales in winter declines to about half that in summer.

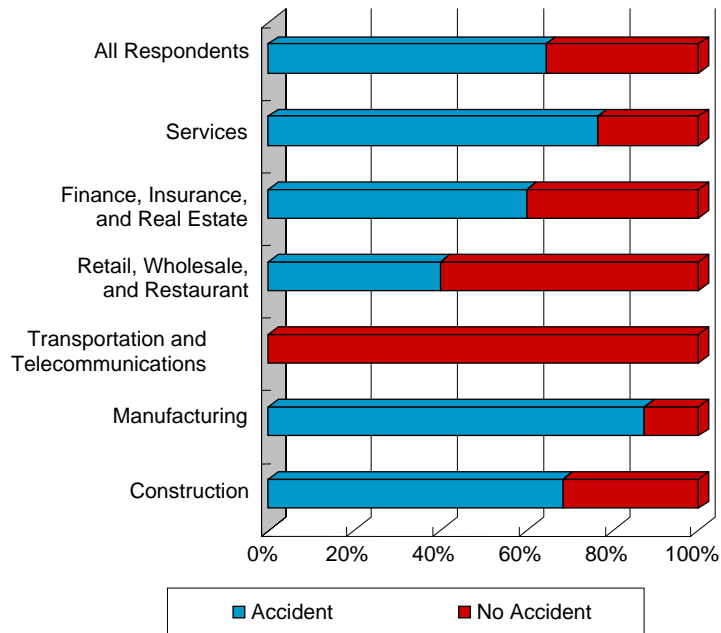

FIGURE 5 Winter traffic accidents reported by businesses for the past five winters.

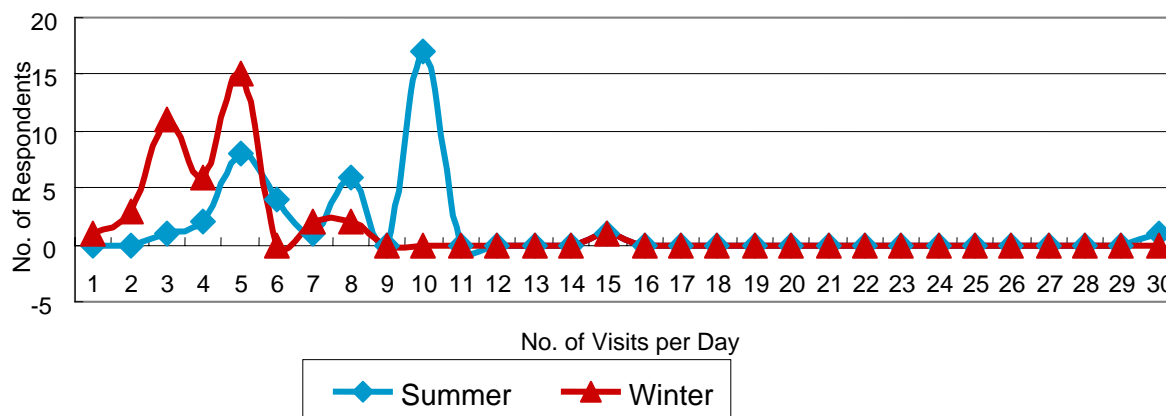

FIGURE 6 Visits to clients for meetings or sales in winter versus summer.

Increase in Merchandise Delivery Time

Businesses that delivered merchandise to clients on the same route all year round were asked how much more time this took in winter than in summer. The winter delay rate was calculated as a percentage: $\text{winter delay rate} = (\text{delivery time taken in winter} - \text{delivery time taken in summer}) / \text{delivery time taken in summer} \times 100$. Valid responses numbered 33. When road and traffic conditions were good, the winter delay rate averaged 48.8%, a 48.8% increase over summer. When road and traffic conditions were normal or very poor, the rates averaged 89.9% and 212.4%, respectively (Figure 7). Because delivery time was the sum of time taken to drive to the destination and time taken to load and unload, the delay was not entirely because of traffic delays. Finding places for loading or unloading and the loading or unloading itself also took more time in winter. Therefore, delivery time in winter was considerably greater than in summer, and this decline in efficiency of workers incurred great business costs.

Decline in Customer Visits and Sales

Businesses were asked whether they saw a decline in their numbers of customer visits and sales on winter days without snowfall and on winter days with snowfall, compared with visits and sales in summer. A decline in customer visits was reported by 14 respondents. This decline averaged 29.9% on winter days without snowfall, with an additional decline of 37.5% on winter days with snowfall. A decrease in sales figures was reported by 17 respondents. This decrease averaged 37% on winter days without snowfall, with an additional decrease of 47.4% on winter days with snowfall. Businesses that relied on visits by clients were clearly affected by winter.

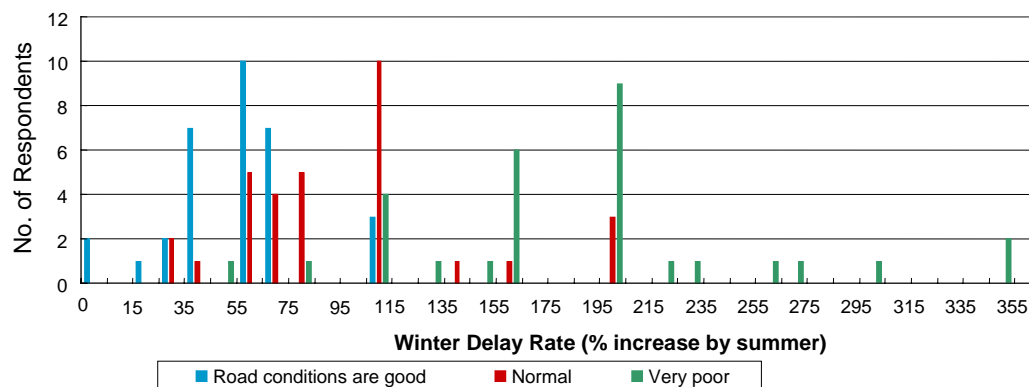

FIGURE 7 Merchandise delivery delay rate (increase rates of time taken in winter relative to summer when winter road and traffic conditions are good, normal, and very poor).

USING ECR TO ANALYZE ISSUES OF WINTER URBAN TRAFFIC AS EVALUATED BY BUSINESSES

Outline

ECR was originally proposed as a system to support group decision making (2). It gives the order of preference of a group when the group makes a decision to select the best or the worst from several items, based on each group member's order of preference. The products of ECR are the group's preference order of items and a map that illustrates the group's preference of items.

ECR has been applied to transport user opinion surveys. For example, it has been used in preference surveys on road reconstruction routes given to residents of different coastal villages following a tunnel collapse and closure of the access road (3) and on attractions in downtown Sapporo (4).

The present study aims to identify the order of importance (problem severity) of winter urban traffic issues for businesses from the order of importance indicated by each business. The results allow us to rank the problems in order of importance.

Simple Contributive Rule

The method of using the ± 5 points method relies on the simple contributive rule (SCR) and on a special case of the contributive rule (5). When there are items to be selected concerning an issue, 5 points are given to the most preferred item and -5 points to the least preferred item, with the points in between awarded for preferences that fall between the two extremes. SCR as used in this study is illustrated by the following example.

Equation 1 defines the contribution function c^l that gives the degree of contribution for each business (or company) to the group's preference.

$$a_i R^l a_j \text{ iff } c^l(a_i, a_j) \geq 0 \quad (1)$$

where, a_i and a_j are two items of winter urban traffic issues and where R is the order of problem of the group. $a_i R^l a_j$ means that item a_i is as problematic or more problematic than item a_j for a business l . The order is given from the least to the most problematic items (partial order). Therefore, $a_i R^l a_j$ gives degrees of problems a_i over a_j for business l . Hereafter substitute c^l_{ij} for $c^l(a_i, a_j)$.

When functions of real variables c^l and g defined by Equation 2 exist and the number of businesses is m , the mapping from the order of problem severity of items for each business to the order of problem severity of items of all respondents is called CR .

$$a_i R^l a_j \text{ iff } g(c^l_{ij}, -c^m_{ij}) \geq 0 \quad (2)$$

When G gives the sum of c^l_{ij} of each business, $\sum_{i=1}^m c^l_{ij}$ is SCR, and it is expressed by Equation 3.

$$g(c^l_{ij}, -c^m_{ij}) = \sum_{i=1}^m c^l_{ij} \quad (3)$$

When cardinal utility of business l on item a_i is expressed by $u^l(a_i)$ and the differences of utility between a_i and a_j are given by Equation 4, SCR gives Equation 5.

$$c^l_{ij} = u^l(a_i) - u^l(a_j) \quad (4)$$

$$g(c^l_{ij}, -c^m_{ij}) = \sum_{i=1}^m u^l(a_i) - \sum_{i=1}^m u^l(a_j) \quad (5)$$

The order of items obtained by Equation 4 is from least to most problematic.

ECR

The order of items given by SCR is obtained by incorporating the order of problem severity of items of each business to the same extent. However, when a business identifies a problem as much more or less problematic than do other businesses, even though the order of problem of the item is the same, SCR does not work. ECR is an extension of SCR, and the function g that corresponds to c^l_{ij} in Equation 4 is given by Equation 6.

$$g(c^l_{ij}, -c^m_{ij}) = \sum_{i=1}^m \omega^l u^l(a_i) + \lambda \sum_{i=1}^m \omega^l \text{Min}(0, c^l_{ij}) - m\theta \quad (6)$$

where $\lambda, \theta \geq 0$, and ω^l is the weight of business l .

The second term of Equation 6 additionally incorporates opinions opposed to $c^l_{ij} < 0$ as much as λ . When the value of λ is increased, even when the value of the first term (degree of

problem in the group) remains the same, items that are evaluated as having a different severity of problem are ranked as if they had the same severity of problem.

The third term has θ as its threshold value defining the lower limit of average for the total of the first and second terms of all respondents in the group. θ causes items of different rank to appear to have the same rank. This occurs when the difference in the group's average utility for two items is small.

The order of items given by ECR conforms to the transitive principle but not to the connectivity principle; thus, it gives a partial order. This suggests that when the difference in severity of problem between two items is very large or very small, the order of two such items cannot be determined definitively. Further examination should be made to decide the order between such items.

Generally, values of λ and θ are chosen arbitrarily. The structure of the problematic order of items is illustrated by a line graph used in interpretive structural modeling.

WINTER TRAFFIC ISSUES AND THEIR RELATIVE IMPORTANCE AS EVALUATED BY BUSINESSES

Questionnaire Survey

To clarify the specific hindrances that winter traffic poses to businesses, we selected 10 winter traffic issues identified by businesses (Table 1) by the affinity diagram, or KJ method, created by Jiro Kawakita, from the interview survey described above. A questionnaire (Figure 8) of the ± 5 points method for ECR analysis was included in the questionnaire given to Sapporo Junior Chamber members, to identify the ranking of relative importance of these issues for businesses in Sapporo.

TABLE 1 Winter Traffic Issues Identified by Business

Item	Issue
1	Increased risk of traffic accident
2	Disruption in delivery of raw materials and merchandise
3	Decline in visits to clients for meetings/sales
4	Decline in visits by customers
5	Decline in sales on snowy days
6	Financial penalty for late delivery
7	Increase in overtime payment due to late arrival of raw materials
8	Employee tardiness
9	Increase in fuel and other vehicle-related costs
10	Increase in time to deliver merchandise

In Sapporo, winter traffic delays occur often in winter due to heavy snowfall or poor road conditions. Which of the items from (a) to (j) does your business consider the most problematic?

**Please give +5 points to the most problematic item,
and -5 points to the least problematic item.**

Then, give points from -4 and +4 for each item, such that the points total **zero (0)**.

1	Increased risk of traffic accident	<input type="text"/>	points
2	Disruption in delivery of raw materials and merchandise	<input type="text"/>	points
3	Decline in visits to clients for meetings/sales	<input type="text"/>	points
4	Decline in visits by customers	<input type="text"/>	points
5	Decline in sales on snowy days	<input type="text"/>	points
6	Financial penalty for late delivery	<input type="text"/>	points
7	Increase in overtime payment due to late arrival of raw materials	<input type="text"/>	points
8	Employee tardiness	<input type="text"/>	points
9	Increase in fuel and other vehicle-related costs	<input type="text"/>	points
10	Increase in time to deliver merchandise	<input type="text"/>	points
Total			<input type="text" value="0"/> points

FIGURE 8 Questionnaire for ECR analysis.

ECR Analytical Results

Ranking of Issues for All Businesses

Valid responses for ECR analysis numbered 48. First, the ranking of winter traffic issues was analyzed for all respondents while setting $\lambda, \theta = 0$. **Figure 9a** shows the results in a graph with arrows. “Increased risk of traffic accident” ranked highest, followed by “decline in visits to clients for meetings/sales” and “increase in time to deliver merchandise.” Ranked fourth was “increase in fuel and other vehicle-related costs.”

Ranking of Issues by Business Category

ECR analysis was made for each business category. Obviously, the rankings of issues differed by business category, and they depended on the characteristics of the businesses in each category (**Figures 9b to 9g**). The following describes features of rankings and business characteristics.

Businesses Highly Concerned About Increased Risk of Traffic Accident Businesses in categories that require driving to meet clients or deliver goods showed great concern about winter traffic safety. For example, construction businesses who built structures at the client’s site ranked “increased risk of traffic accident” highest, whereas businesses whose customers came to visit (e.g., retail, wholesale, restaurant) ranked this issue much lower.

Businesses Highly Concerned About Reduced Mobility of Businesspeople Businesses that made sales only when services were delivered to clients showed great concern about the decline in mobility of people. Businesses that sold services rather than merchandise ranked “decline in visits to clients for meetings or sales” as the most important issue.

Businesses Highly Concerned About Delay in Delivery of Goods Businesses that cannot make sales unless they delivered merchandise to clients ranked “increase in time to deliver merchandise” as the most important issue. For example, manufacturers who had to deliver products and retailers and wholesalers for which delivering goods meant sales showed great concern about increased time for transport of goods in winter.

Businesses Highly Concerned About Increase in Vehicle-Related Costs Businesses whose vehicle-related costs were high all year round ranked “increase in fuel and other vehicle-related costs” high. Transportation businesses whose main activity was transporting goods indicated “increase in fuel and other vehicle-related costs” as particularly problematic.

As noted above, although there were differences by business category, the items ranked high by all respondents (traffic safety, decline in visits to clients for meetings or sales, and increase in time to deliver merchandise and provide services) also ranked high in each business category. We can say that addressing these three issues will improve satisfaction of businesses regarding winter road maintenance.

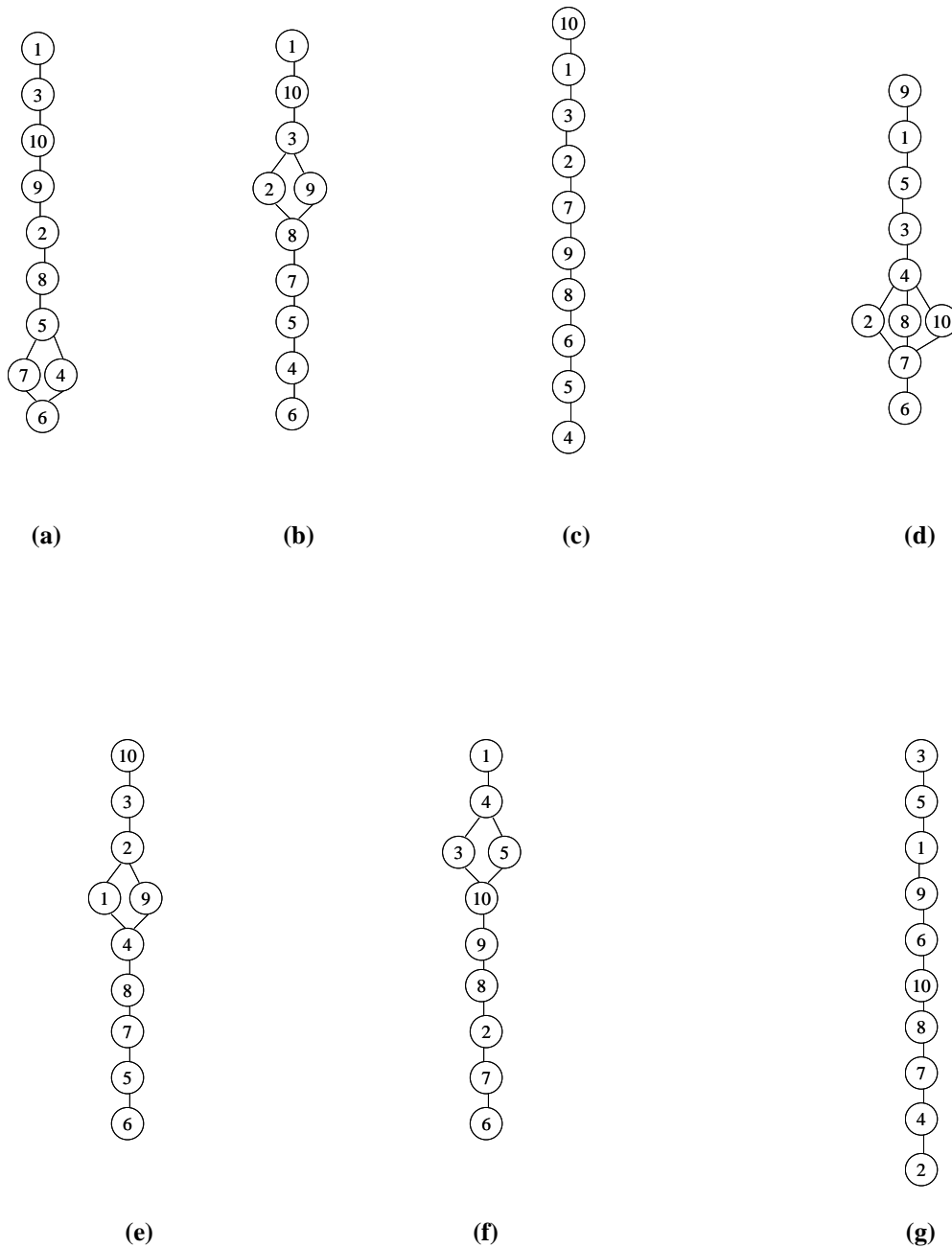

FIGURE 9 Winter traffic issues evaluated by businesses and ranked by ecr ($\lambda, \theta = 0$):
 (a) all respondents; (b) construction; (c) manufacturing; (d) transport and telecommunications; (e) retail, wholesale, and restaurants; (f) finance, insurance, and real estate; and (g) services.

PERFORMANCE INDICATORS AND LOGIC MODEL

Performance Indicators Addressing Business-Related Issues of Winter Road Traffic

The top three winter road issues are associated with winter road maintenance. We obtained these relationships:

1. “Increased risk of winter accidents” is largely influenced by the skid-resistance coefficient of the winter road surface;
2. “Increase in time to deliver merchandise” is strongly influenced by reduced traffic capacity from narrowed road width; and
3. “Decline in visits to clients for meetings or sales” is strongly influenced by both the increased risk of accident and the increased time required to drive to clients. Addressing this issues means improving the skid-resistance coefficient of winter road surface and maintaining the road width.

From these relationships, we can conclude that the issue of “decline in visits to clients for meetings or sales” can be addressed by winter maintenance operations, which will also address “increased risk of winter accidents” and “increase in time to deliver merchandise.” The maintenance operations are those to maintain the road width and increase the skid-resistance coefficient of the winter road surface.

Performance Indicators as Rated by Businesses

In the questionnaire survey, respondents were asked to choose the most important of five indicators of winter road maintenance: road surface conditions (i.e., unevenness, rutting, and slipperiness), road width, sight distance at intersections, pedestrian safety, and provision of traffic congestion information.

The indicators ranked as most important by each respondent are shown in [Figure 10](#). Road width ranks as most important (35%), followed by road surface conditions (28%). This result agrees well with performance indicators that addresses needs of businesses (skid-resistance coefficient of winter road surface and maintained road width), shown in the section above regarding performance indicators.

Outcome Indicators

The role of administration is to meet the needs of citizens. Therefore, winter road maintenance operations should be based on the needs of road users. To meet the needs of businesses, winter road maintenance should address issues of “increased risk of traffic accident” and “increase in time to deliver merchandise.” Output targets for operations need to be set according to the desired outcomes. Outcome indicators show the social effects of projects. Numerical goals allow the achievement rate of such goals to be outcome indicators.

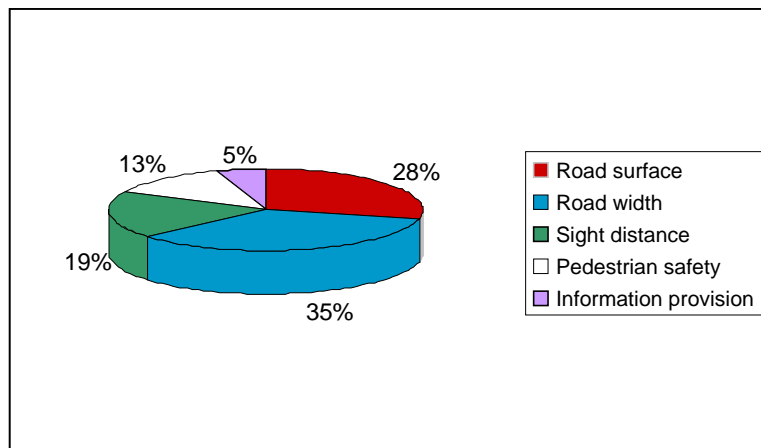

FIGURE 10 Performance indicators of winter maintenance rated most important by businesses.

In this study, we selected the maintained road width and the skid-resistance coefficient as outcome indicators. Their measurements were indicators of winter maintenance and their outcome indicators could be set and used as follows. First, set quantitative goals for road width and skid-resistance coefficient; second, set targets of fulfillment rates, such as the number of days when such targets must be met during days with snow cover (135 day per winter on average); third, compare target achievement rates with actual achievement rates. In this way, the effects of winter maintenance operations could be measured based on road width and skid-resistance coefficient. In addition, the number of winter traffic accidents that did not involve injury or casualty, and “winter delay rate” defined in the subsection on the increase in merchandise delivery time were outcome indicators that addressed issues of winter traffic to businesses.

Logic Model

A flow chart showing program operation from “input,” “activity,” “output,” to “outcome” is called a logic model. In performance measurement, a logic model provides useful information by clearly indicating causes and results. A logic model developed to promote project objectives helps to organize activities or operations to attain output levels that are neither excessive nor inadequate.

This study clarified which outcome indicators addressed the needs of businesses. A logic model that incorporates such outcome indicators suggests appropriate outputs of winter maintenance. Figure 11 is an example of a logic model that incorporates business-related winter road traffic issues as goals and outcome indicators.

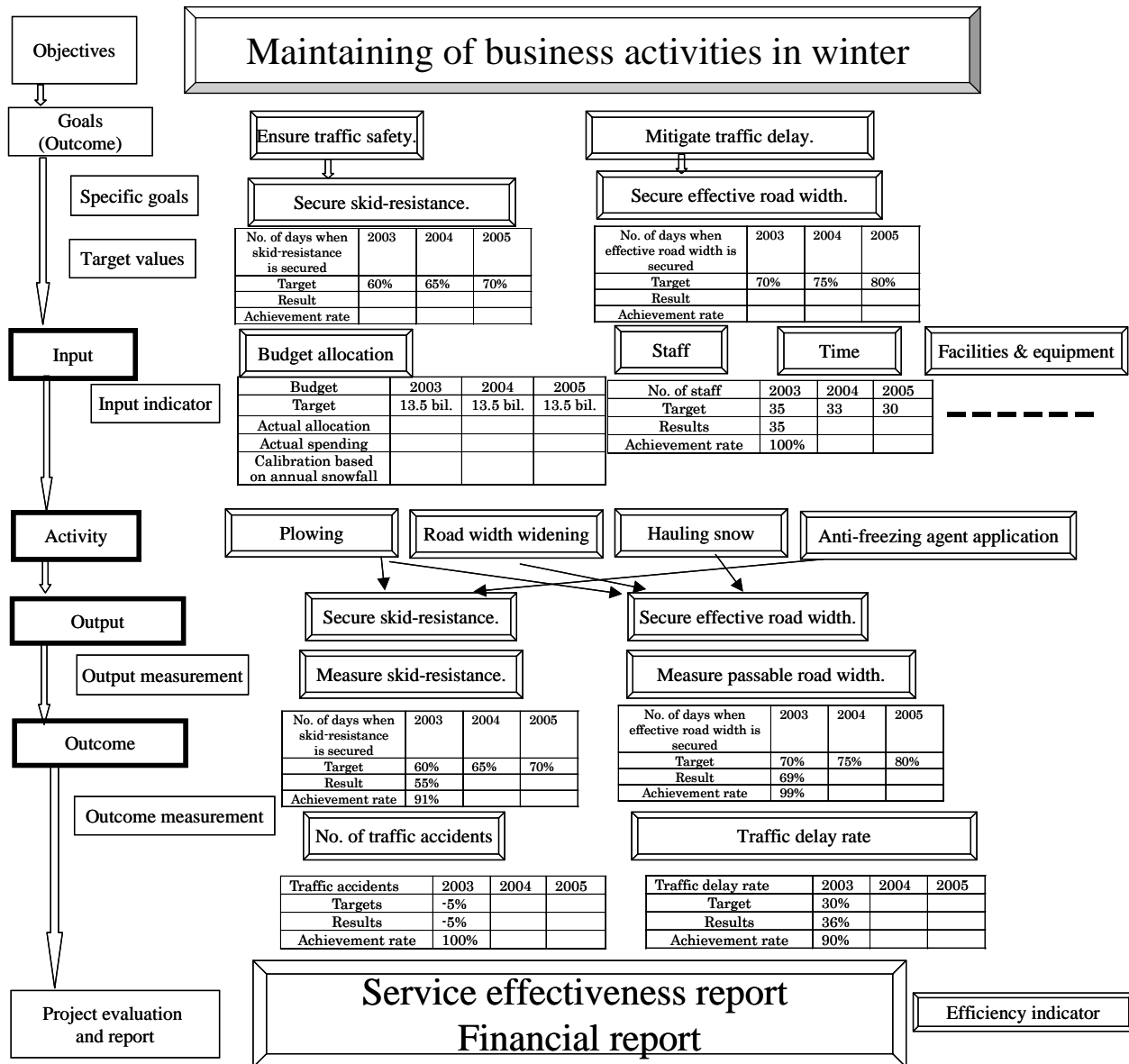

FIGURE 11 Logic model of winter road maintenance that incorporates the outcome indicators desired by businesses.

SUMMARY

Importance of Winter Traffic Issues

Ninety-five percent of the respondents (i.e., 95% of businesses in the city) judged winter traffic issues to be important or very important. The following data were found:

1. Forty-three percent of businesses see increased vehicle-related costs in winter over summer.
2. Sixty-five percent of respondents have been involved in winter traffic accidents in the past 5 years.
3. Winter visits to clients for meetings or sales decreased to about half the figure for summer.
4. Time taken to deliver merchandise to clients in winter increased 48.8% over summer when road and traffic conditions were good and 89.9% and 212.4% when road and traffic conditions were normal or very poor, respectively.
5. Businesses whose customers must come to them saw sales decrease by 47.4 % on winter days with snow, compared with winter days without snow.

These findings show that winter road traffic issues greatly affected businesses in the city.

Ranking of Winter Traffic Issues Analyzed by ECR

The relative importance of winter traffic issues was analyzed by ECR. ECR analyses were made for all businesses and their respective business categories. Despite slight differences in ranking depending on the characteristics of businesses, “increased risk of traffic accident,” “decline in visit to clients for meetings or sales” and “increase in time to deliver merchandise” consistently ranked as very important.

Performance Indicators and Logic Model

Winter road management that addressed issues considered important by businesses was narrowed to “securing the road width” and “securing skid-resistance of winter road.” Operation outputs should be measured for these output indicators. Then, outcomes are measured by using achievement rates. Also, other outcome indicators of the numbers of winter accidents and the winter delay rate indicate achievements of winter maintenance operation in terms of social effects. A logic model that addresses business-related issues of winter traffic can suggest appropriate winter operations that are neither excessive nor inadequate.

The results of this study can be used in planning winter maintenance. However, future study needs to address the relationship between the actual road and traffic conditions and the satisfaction of businesses with winter road maintenance.

REFERENCES

1. *Citizen Opinion Survey 2001* (in Japanese). City of Sapporo, 2001.
2. Sawaragi, G. et al. System to Support Group Decision Making (in Japanese). *Operations Research*, Nov. 1980, pp. 720–728.
3. Kishi, K., et al. Research on the Function of a Road System in a Coastal Community and Issues in Preparing for Disaster Road Closure (in Japanese). *Proc. of City Planning Institute of Japan*, Vol. 33, 1998, pp. 121–126.
4. Liu, Z., et al. A Study on Consensus-Formation in Sapporo City Center Regeneration by Using the Extended Contributive Rule (ECR). *Journal of the Eastern Asia Society for Transportation Studies* (CD-ROM), Vol. 5, Eastern Asia Society for Transportation Studies, Oct. 2003, pp. 3158–3168.
5. Saposnik, R. Social Choice with Continuous Expression of Individual Preferences. *Econometrica*, Vol. 43, No. 4, 1975, pp. 683–690.

CUSTOMERS' PERSPECTIVE ON WINTER OPERATIONS

Conjoint Approach as Customer-Based Measurement for Winter Walkway Maintenance in the Snowiest City of Japan

ROBERTO A. TOKUNAGA

NAOTO TAKAHASHI

MOTOKI ASANO

Civil Engineering Research Institute of Hokkaido

A primary goal of our study was to identify residents' preference among a wide variety of walkway features in order to suggest an evaluation method for winter pedestrian mobility in Sapporo, the metropolitan city in Japan that receives the most snowfall. The approach is basically about answering the following two questions: How can transportation engineers recognize residents' diverse needs for pedestrian settings in winter? How can professionals evaluate the quality of maintenance service resulting from the increase of public participation?

To answer these questions involved a critical reflection of the meaning of winter livability in Sapporo, and what it meant for the urban landscape to be a pedestrian-friendly winter environment.

Pedestrians' satisfaction level with different sidewalk conditions in winter was gauged through a self-administered survey based on the conjoint approach. Conducted at Sapporo's two main railroad stations, the study found that icy, uneven surfaces between crosswalks and sidewalks without antislipping procedures were the most difficult portions to walk for pedestrians. Additionally, our results showed that pedestrians considered an icy or snowy sidewalk as the most important among a wide variety of winter walkway features; with or without antislipping procedures ranks the second. This indicated that pedestrians would have liked to have antislipping procedures set on the sidewalk when walkways become slippery. Thus, our demonstrative finding can be thought as an explanation for the potential rewards of the conjoint approach to determine customer satisfaction in winter walkway maintenance.

INTRODUCTION

Hokkaido prefecture, with a population of 5.7 million in 2003 (this is only 4.6% of Japan's total population), is located at the northernmost island of Japan with the Sea of Japan in the west, the Pacific Ocean in the south, and the Sea of Ohotsuk in the northeast. Unlike other portions of Japan that are the densely populated, Hokkaido is a sparsely populated region. However, approximately 40% of Hokkaido's population is concentrated in the Sapporo metropolitan area, consisting of the city of Sapporo—the prefecture capital of Hokkaido and one of the five major cities of Japan—and its neighboring municipalities, even though the area accounts for only 2% of land space in the prefecture. The two most distinguishing features of Sapporo are: (1) it is one of the few metropolises in the world with heavy snowfall reaching up to approximately 1 m and (2) an excessive concentration of functions, such as administrative and commercial, in the

downtown and subcenter leads to an extreme daytime population in the areas.

Like other northern cities, Sapporo's severe, snow-covered winter greatly affects the mobility of pedestrians. Especially if the walkway surface is icy, walking becomes difficult and unsafe (see [Figure 1](#)). Although various studies have been conducted in enhancing pedestrian mobility in Japan, these studies are mostly focused on a summer setting, not on winter (1, 2).

In order to encourage pedestrian mobility in winter, Japanese governments at all levels have made great improvements, including a pavement-heating system that melts snow on the sidewalks and is called "Road-Heating." Nevertheless, in recent years, the pedestrian activity in the downtown and subcenter has been threatened by extremely slippery surfaces, as shown in [Figure 2](#) (caused by the automobiles with studless tires). It has also been threatened by the government's attention to keeping pathways clear of snow and ice for automobiles, rather than for pedestrians. Moreover, despite the increase of public participation in recent years, few studies have addressed customer-based measures in a winter pedestrian setting.

The aim of this study was to contribute to improving the content of the Management Guideline for Sidewalks in metropolitan snowfall by quantifying the needs of pedestrians and level of service that the road managers offer. In this study, therefore, we tried to understand pedestrians' satisfaction depending on different winter walkway features in quantitative manner in order to adopt it as guideline for winter mobility. To specify, we have tried to recognize pedestrians' satisfaction with different sidewalk conditions and management levels in winter by applying the conjoint approach widely used in marketing research because we considered winter sidewalk management to be one of the road manager's services.

METHODOLOGY

Feature of Conjoint Analysis

Conjoint analysis is the research method widely used in the marketing field for estimating the value people place on the attributes or features that define products and services. To use a specific service, this method is suitable with the research that we have done to see what attributes pedestrians will compromise on in case we cannot meet all their needs. In other words, individuals jointly consider levels of walkway maintenance features so that the relative importance of the levels can be determined as the meaning of winter pedestrian mobility. The main functions of conjoint analysis are the following (3):

1. Demonstrates which attribute is most significantly considered among many attributes;
2. Determines primary attributes having the most influence on judgment in order to select a certain matter;
3. Determines whether the attribute's level negatively or positively influences the choices by identifying the absolute-value magnitude of "utility value" and its plus or minus sign; and
4. Creates a simulation model by putting levels of all attributes together. This allows us to recognize how each combination is being satisfied for the users.



FIGURE 1 Icy sidewalk in Sapporo.



FIGURE 2 Extremely slippery crosswalk caused by studless tires.

Summary of Research Method

Theoretically, it is relatively simple to maximize the quality of the winter pedestrian setting; a Road-Heating system could just be installed on all sidewalks. In Sapporo's financial situation, however, it is out of the question. Therefore, we need to consider the next possible measures for

improvement in winter sidewalk quality, for instance, seeing where antislipping procedures should be placed and iced bumps should be smoothed and by taking a survey based on conjoint measurement. The information that could be collected through this survey are

- Among winter walkway attributes, which attribute is the most significant in deciding whether sidewalk in winter is walkable?
 - Under which situation is the evaluation of winter mobility the highest or the lowest?
- and
- Which combination of walking locations and surface conditions do the pedestrians feel are the most effective place for antislipping procedures (i.e., sanding)?

The first step of the research design was to define those variables that should be analyzed, after taking into account the essence of the research project. Based on various studies and literature review, we define attributes and levels of winter walkway, as shown in Figure 3. All the possible combinations of profiles were 72 in this study, but asking respondents to evaluate all 72 profiles would have led to an ineffective survey design because it would have been harder for respondents; consequently, it was worse data quality. Therefore, the second step was to identify a minimum number of appropriate profiles that should be asked in the study: this could be generated by Statistical Package for the Social Sciences (SPSS) software easily. As a result, the survey had 18 sets of winter walkway situations with a five-point Likert scale, and in each scenario respondents were asked to choose a highly valued level of combined attributes (see Table 1 and Figure 4). Otherwise, respondents compared various combinations of winter sidewalk features in order to indicate the strength of their preference.

The survey was conducted at two main railroad stations in the city, one downtown and the other in the subcenter; both had been designated as the priority improvement districts to be barrier-free by the city government (4). A convenience-sampling method was utilized in this survey because the respondents were available or easy to find out on the street. In addition to this sampling method, the questionnaire had been distributed to several condominiums around the station in the subcenter (not in the downtown) since a collecting rate from the first method would have been lower than expected. The sampling units were 1,750 randomly selected pedestrians and residents at each station (collecting rates were 13% downtown and 7% in the subcenter).

ATTRIBUTES	LEVELS			
Walking Location	Sidewalk	Boundary Between Sidewalk & Crosswalk	Crosswalk	
Icy/Snowy	Extremely Slippery	Compacted Snow	Snow or Slush over Compacted Snow	Powder Snow
Evenness	Somewhat Even	Little Bump	Bumpy	
Sanding	With Sanding	Without Sanding		

FIGURE 3 Attributes and levels of winter walkways.

TABLE 1 Eighteen Profiles Used in the Study

	WALKING LOCATION	ICY/SNOWY CONDITION	EVENNESS	SANDING
1	Crosswalk	Compacted Snow	Somewhat Even	Without
2	Sidewalk	SS over CS	Somewhat Even	Without
3	Crosswalk	Extremely Slippery	Bumpy	With
4	Sidewalk	Extremely Slippery	Somewhat Even	Without
5	BB S & C	Powder Snow	Somewhat Even	With
6	BB S & C	Compacted Snow	Somewhat Even	With
7	Sidewalk	SS over CS	Somewhat Even	With
8	Sidewalk	Extremely Slippery	Somewhat Even	With
9	Crosswalk	Powder Snow	Somewhat Even	Without
10	BB S & C	SS over CS	Bumpy	Without
11	Sidewalk	Compacted Snow	Little Bumpy	Without
12	BB S & C	Extremely Slippery	Little Bumpy	Without
13	Sidewalk	Powder Snow	Bumpy	Without
14	Sidewalk	Powder Snow	Little Bumpy	With
15	Crosswalk	SS over CS	Little Bumpy	With
16	Sidewalk	Compacted Snow	Bumpy	With
17	BB S & C	Extremely Slippery	Somewhat Even	With
18	Sidewalk	SS over CS	Bumpy	With

BB S&C=Boundary Between Sidewalk & Crosswalk

SS over CS=Snow or Slush over Compacted Snow

<p>8</p> 	<p>On Sidewalk Extremely Slippery Evenness With Sanding</p>				
	Very Hard to Walk	Hard to Walk	Neither	Less Hard to Walk	Not Hard to Walk
<p>どれかに○をつけてください</p>					

FIGURE 4 Five-point Likert scale used in the questionnaire.

RESULTS

Respondent Characteristics

Downtown (Sapporo Station)

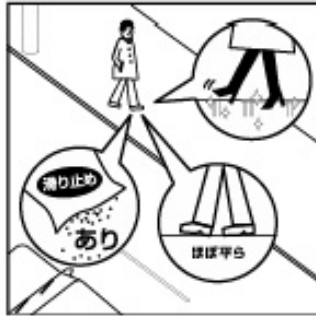
Of the people we surveyed at the Sapporo Station, most people were from the surrounding wards. Many people were also residents from outside of Sapporo because the survey took place at the central station, which was the city's main transit stop including an interurban railroad station, subway stations, and inter- and intra-urban bus terminals, located nearby the city's central business district and high priority commercial district. People in their 40s were the most common age group (about 25%), followed by the 30s, 50s, and the 60s. The percentage of male and female response to this survey is approximately the same. Physically disabled persons surveyed account for approximately 1%.

Subcenter (Shin-Sapporo Station)

Since we have surveyed through the posting method in addition to the convenience sampling, 85% of the respondents were from the ward where the station was located. The most common age group was the 60s (about 25%) followed by the 30s, 40s, and the 50s with approximately 20% each. It is interesting to note that 70% of the respondents were women and 12% were physically disabled; those results significantly exceeded the percentage of the downtown. This might have resulted from the different survey distribution method from that of downtown.

Findings

Downtown

The most significant factor among four attributes was “snowy/icy pavement condition” which showed approximately 40 points of the averaged importance score, while “use of antislipping procedures (sanding)” and “sidewalk evenness” ranks next; “place of walking” was not considered important (see [Figure 5](#)). However, we did not see much significant difference among these four attributes. Moreover, as for “utility value,” we found the strongest connection between winter mobility and “snowy/icy sidewalk,” and then “use of antislipping procedures.”

Since Pearson's correlation coefficient (0.988) was significantly high (5), the conjoint model predicted corresponded with the survey result well; however, a little low value of Kendall's rank correlation coefficient [0.879 (5)] showed a possibility of the respondents' varied preference. Furthermore, as a result of calculating the relative importance based on the range of utility value, the relative importance of “location of walking” showed lower than the averaged, which suggested pedestrians' response varied by issues of location.

[Table 2](#) shows the result of the simulation model indicating the score of the first, second, fourth, fifth, seventh, and eighth situations were relatively high: this score specified utility value under each situation. The model computerized here has implications that, even if the sidewalk is slippery, using antislipping procedures on a somewhat even or little bumpy surface, rather than a difference of walking location, is relatively effective for pedestrians to walk without considerable

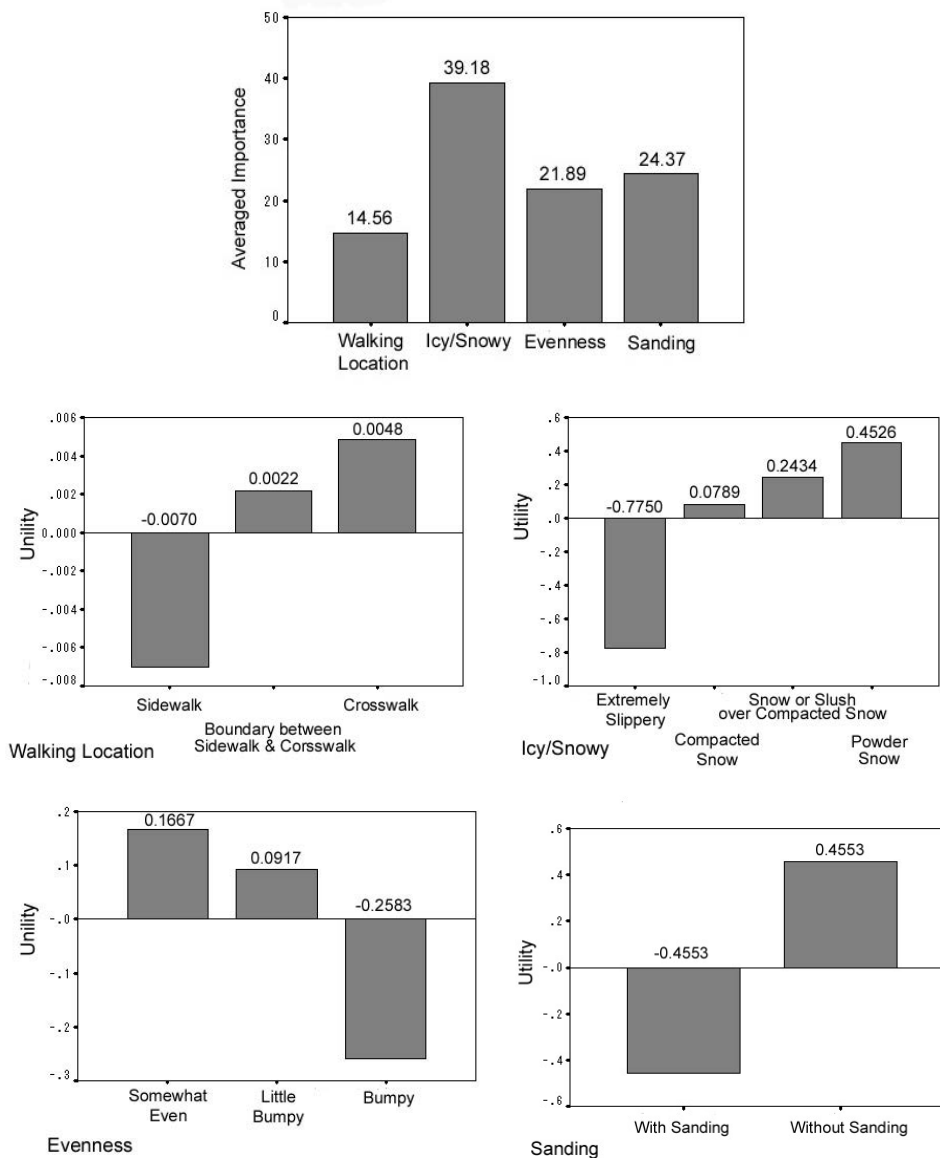

FIGURE 5 Averaged importance utility value for each level.

TABLE 2 Simulation Model Result (Downtown)

	WALKING LOCATION	ICY/SNOWY CONDITION	EVENNESS	SANDING	SCORE	MAX UTILITY	BLT	LOGIT
1	Sidewalk	Extremely Slippery	Somewhat Even	With	2.5	11.65	12.01	12.46
2	Sidewalk	Extremely Slippery	Little Bumpy	With	2.5	12.18	11.51	11.7
3	Sidewalk	Extremely Slippery	Bumpy	With	2.1	5.12	9.79	8.72
4	BB S & C	Extremely Slippery	Somewhat Even	With	2.5	19.02	12.06	12.09
5	BB S & C	Extremely Slippery	Little Bumpy	With	2.1	10.47	11.56	11.71
6	BB S & C	Extremely Slippery	Bumpy	With	2.1	6.04	9.84	9.02
7	Crosswalk	Extremely Slippery	Somewhat Even	With	2.5	18.71	11.98	12.92
8	Crosswalk	Extremely Slippery	Little Bumpy	With	2.5	8.58	11.48	11.61
9	Crosswalk	Extremely Slippery	Bumpy	With	2.1	8.23	9.76	8.88

BB S&C=Boundary Between Sidewalk & Crosswalk
 SS over CS=Snow or Slush over Compacted Snow

difficulty. In order to identify the preference probability of each category listed on the model, we explored “max utility” that assumed highest preference was always chosen. The model’s max utility showed that the fourth value read the highest; namely the fourth condition was evaluated as the best walkable, as opposed to, the third condition which ranked the lowest.

The survey asked the respondents, as an additional question, about the direction of measures to improve winter pedestrian mobility. The result showed that all age groups gave diametrically opposed answers: “installing road-heating system as much as possible” or “providing less costly actions as much as possible” (see Figure 6). That was partly because the residents recognized that the installing of a road-heating system on all pedestrian paths was out of the question in the city’s financial situation and that the road-heating system had a profound negative effect on the environment.

Subcenter

Overall importance of the four attributes to the pedestrians ranks the same as the survey taken downtown. The most significant factor among the four attributes was “snowy/icy pavement condition” with 40 points of the averaged importance score, and then “use of antislipping procedures,” “sidewalk evenness,” and “walking location” came in order (see Figure 7). Moreover, we found that, as for utility value, the strongest connection between winter mobility and “snowy/icy sidewalk” and then “use of antislipping procedures.”

As well as the downtown’s Pearson Value, its correlation coefficient (0.991) was significantly high; therefore, it reported the conjoint model predicted corresponds with the survey result well. Conversely, unlike the Kendall’s Value in the downtown study, its correlation coefficient in the subcenter study (0.912) was slightly high enough to conclude that the study result was faithful. Furthermore, as a result of calculating the relative importance based on the range of utility value, the relative importance of “location of walking” showed lower than the average, which suggested that pedestrians’ response varied on the issue of location.

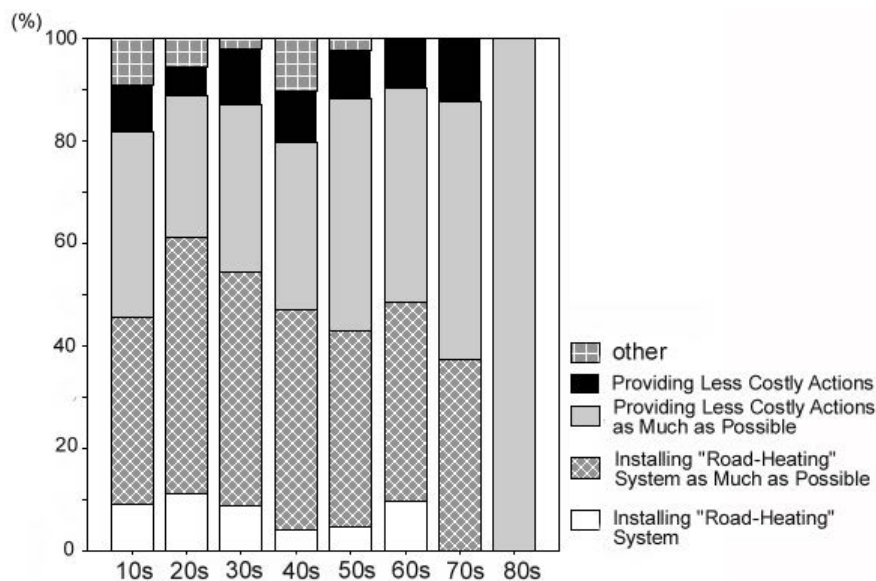

FIGURE 6 Desired direction of measures for winter mobility improvement (downtown).

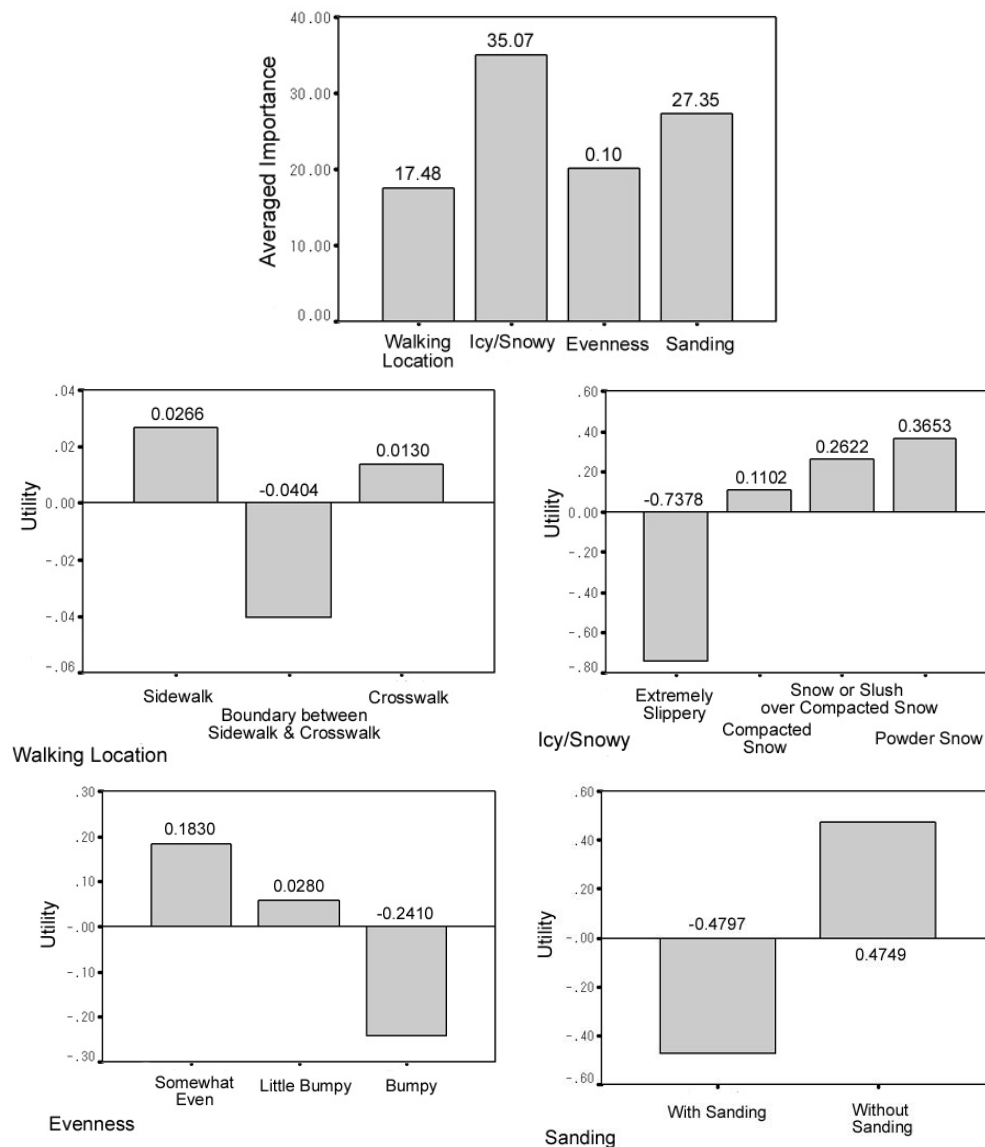

FIGURE 7 Averaged importance utility value for each level.

Table 3 shows the result of the subcenter study's simulation model. It indicates that the score on the first situation was the highest (2.6), followed by the fourth and the seventh situation (2.5). However, the max utility indicator showed that the seventh mobility approach was the highest. As well as the result in the downtown study, the model implied that using antislipping procedures on somewhat even or little bumpy surface, rather than a difference of walking location, was relatively effective for pedestrians to walk on slippery sidewalks. Incidentally, the sixth mobility approach was proven to be the lowest.

Additionally the survey inquired of the respondents regarding the direction of measures to improve winter pedestrian mobility, and as shown in Figure 8 we got the same result as in the downtown: all age groups gave the diametrically opposed answers of installing road-heating system and providing less costly actions as much as possible. Therefore, this can be thought of as

TABLE 3 Simulation Model Result (Subcenter)

	WALKING LOCATION	ICY/SNOWY CONDITION	EVENNESS	SANDING	SCORE	MAX UTILITY	BLT	LOGIT
1	Sidewalk	Extremely Slippery	Somewhat Even	With	2.6	10.68	12.38	13.03
2	Sidewalk	Extremely Slippery	Little Bumpy	With	2.4	18.16	11.74	12.05
3	Sidewalk	Extremely Slippery	Bumpy	With	2.1	5.7	10.05	8.97
4	BB S & C	Extremely Slippery	Somewhat Even	With	2.5	15.32	11.83	12.72
5	BB S & C	Extremely Slippery	Little Bumpy	With	2.4	7.07	11.19	10.88
6	BB S & C	Extremely Slippery	Bumpy	With	2.1	4.41	9.5	8.45
7	Crosswalk	Extremely Slippery	Somewhat Even	With	2.5	26.4	12.1	13.5
8	Crosswalk	Extremely Slippery	Little Bumpy	With	2.4	7.07	11.46	11.51
9	Crosswalk	Extremely Slippery	Bumpy	With	2.1	5.18	9.77	8.88

BB S&C=Boundary Between Sidewalk & Crosswalk

SS over CS=Snow or Slush over Compacted Snow

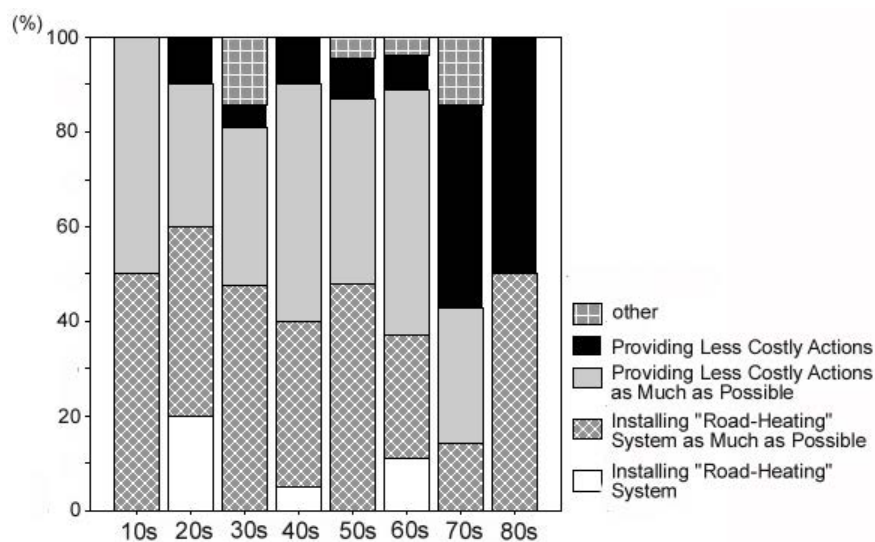
**FIGURE 8 Desired direction of measures for winter mobility improvement (subcenter).**

an increase in financial and environmental consciousness. It is interesting to note that, unlike the downtown study, almost 50% of people in their 70s and 80s sought a less costly management for winter mobility improvement, instead of road-heating system installation.

CONCLUSION AND FUTURE STUDY

Throughout the course of this study, we tried to identify pedestrians' preference among a wide variety of winter walkway features by using conjoint analysis. Even though more data are required to support our demonstrative findings, they can be thought of as an explanation for the potential rewards of the conjoint approach, instead of a simple-designed survey, to determine customer satisfaction in winter walkway maintenance. In the case of Sapporo, we have found that using antislipping procedures made pedestrians satisfied with the evaluation of mobility, not

only on certain walking locations but also on any snowy or icy sidewalks. Furthermore, the result of the additional study showed that all age groups not only demanded installing road-heating system for winter mobility improvement but also were worried about environmental damage or initial cost and money used to run the road-heating system.

In this research project, we made an in-depth study of recognizing residents' diverse needs for the pedestrian setting in winter. This might lead to suggest maintaining walkways for winter use in the heavy snowfall of a metropolitan city like Sapporo. Throughout the future study, demonstrative findings obtained by this study will be further refined to determine customer satisfaction in winter walkway maintenance in a more effective manner with the conjoint approach. To be concrete, in this study the residents have evaluated winter pedestrian mobility based on an imaginative pedestrian setting; however, we believe that monitoring actual places or visiting to see what pedestrians observe from their perspective will make our evaluation more efficient. We will try to continue in our research accordingly.

REFERENCES

1. Hokkaido Arterial Committee. *Guideline for Sidewalk Maintenance (Draft)* (in Japanese). Sapporo, Japan, 1997.
2. Ministry of Land, Infrastructure, and Transport, and Japan Institute of Construction Engineering. *Guideline for Maintenance to Smooth Travel Movement on Road* (in Japanese). Taisei-Shuppan, Tokyo, 2003.
3. Okamoto, S. *Conjoint Analysis: Marketing Research Using SPSS* (in Japanese). Nakanishi-Shuppan, Tokyo, 1999.
4. City of Sapporo. *City of Sapporo: Implementation Committee Documentation* (in Japanese). Sapporo, Japan, 2002.
5. Sanagi, T. *Conjoint Analysis Using SPSS (Practical Use in the Field of Education, Psychology, and Social Welfare)* (in Japanese). Tokyo-Tosho, Tokyo, 2001.

CUSTOMERS' PERSPECTIVE ON WINTER OPERATIONS

Study on Effects and Evaluation of Winter Road Information

YASUHIKO KAJIYA
TAKEHIKO SUZUKI
MASARU MATSUZAWA
TATSUYA UEMURA

Civil Engineering Research Institute of Hokkaido

In Hokkaido, Japan, there are many conditions that affect winter road traffic. These include slipperiness from snowy or icy road surfaces and poor visibility induced by snowstorms. Proper provision of information is essential. The effects of winter road information provision on users, and their evaluation of that information, were analyzed. The analysis and discussion were based on the results of two questionnaire surveys, one regarding the Northern Road Navi website conducted via that website and the other regarding the provision of regionwide snowstorm information conducted via face-to-face group interview.

When asked whether the information posed on the Northern Road Navi website was useful in enhancing safety and a sense of security, 90% of respondents answered affirmatively. The items of road information and mountain pass information were given positive evaluations. All the respondents said that they would continue to use these two types of information. Of the items of mountain pass information, many respondents answered that real-time information, such as mountain pass road images, weather forecasts, and snow and frost duration, is useful in enhancing safety and a sense of security.

We conducted a customer satisfaction analysis to find out how the mountain pass information contributed to enhanced winter driving safety and a sense of security. The analysis results found that "topographical information on mountain passes (elevation, gradient, and so on)" was the mountain pass item that ranked highest in priority of requests for improvement. "Road image" ranked highest in customer satisfaction.

We asked the respondents whether they would use a regionwide snowstorm information service that allowed unlimited access via personal computer and mobile phone to weather and road information on roads they selected. The contingent valuation method was employed in the questionnaire survey to estimate how much one household would be willing to pay for such a service per winter. This question was asked in a face-to-face group interview. The willingness to pay for such an information service was found to be ¥581 per household per winter. Our survey results quantitatively verified that provision of winter road information prompted proper route selection and departure time adjustment, and thereby contributed greatly to enhanced safety and sense of security.

INTRODUCTION

Cities are widely distributed in Hokkaido. In summer, tourists have to drive for long durations. In

winter, drivers have to drive through mountain passes that are prone to sudden weather changes. Road information needs to be properly provided. Many difficult driving conditions occur, particularly on winter roads, such as slipperiness from snowy or icy road surfaces and poor visibility induced by snowstorms.

This paper presents the results of a web-based questionnaire survey conducted via the Northern Road Navi website, which offers Hokkaido-wide road information, and a customer satisfaction (CS) analysis. We examined user needs for Internet-based road information provision in Hokkaido and the effects of information provision on road traffic safety and driving comfort. We discussed the effects of winter road information provision on users and their evaluations of that provision based on the results of a questionnaire survey on regionwide snowstorm information provision by face-to-face group interview.

NORTHERN ROAD NAVI QUESTIONNAIRE SURVEY

Pervasion of Internet in Japan

The Ministry of Public Management, Home Affairs, Posts and Telecommunications of Japan released Communications Usage Trend Survey in 2002 (1). According to this report, at the end of 2002, Internet users numbered 69.42 million, which is 54.5% of all Japanese. It was the first year for the figure to exceed 50%. Also, 81.4% of households are connected to the Internet. It is becoming an important element of the information infrastructure. Since Hokkaido has many depopulated areas, it lags behind the national average in Internet pervasion rate. However, the pervasion growth rate is roughly the national average.

Opening and Operation of Northern Road Navi

Northern Road Navi is a website that offers Hokkaido-wide road information (Figure 1). The Civil Engineering Research Institute of Hokkaido operates this website under the general editorship of major road administrators in Hokkaido: the Hokkaido Development Bureau, the Hokkaido government, the city of Sapporo, and the Hokkaido Headquarters of Japan Highway Public Corporation. It opened in July 1999, and the cumulative number of visits reached 1 million about 4 years later. The monthly average of daily visits was 1,846 between April and September 2003. The day Typhoon 10 struck Hokkaido on August 10, visits numbered 6,994. Shortly after the Tokachi-oki earthquake of September 26, the daily visits numbered 4,204.

In November 2002, a web page with mountain pass information was added to the Northern Road Navi website. This page posts information on 25 mountain passes in Hokkaido. It includes mountain pass section length, maximum elevation, road alignment, road images, and weather forecast (Figure 2). This information has been integrated into information returned by query for travel time and distance. When a user specifies the trip and destination and submits a query, the query function displays information on the passes along the user's travel route. To examine the usage and usefulness of the Northern Road Navi website, we conducted one questionnaire each in summer and winter.



FIGURE 1 Northern Road Navi (<http://northern-road.jp/navi/>).

■ Sekihoku Pass			
Route Name	Length	Elevation	Duration of Snow (Frost)
National Highway Route 39	24.5 km	1,050m	1 2 3 4 5 6 7 8 9 10 11 12
Road Width (Min)	Radius (Min)	Gradient (Max)	Spaces for Tire-chain On and Off
6.5m	50m	6.6%	Kamikawa Town - Rubeshibe Town
Road Map	Live Camera	Detail Information	Other Links
East Hokkaido		Mountain Pass Guide HRDB-Abashiri Office	Mountain Pass Weather Forecast (JWA Hokkaido)

FIGURE 2 Northern Road Navi mountain pass information.

Outline of Questionnaires

Summer Questionnaire

A 2-month summer questionnaire regarding the Northern Road Navi website was conducted via that website from September 9 through November 4, 2002. The questionnaire contained 27 questions. They addressed how the information posted on Northern Road Navi was used, how useful it was, and how the information provided related to selection of routes for car travel. Among the respondents, those who had used the query function for travel time and distance received an additional questionnaire by post.

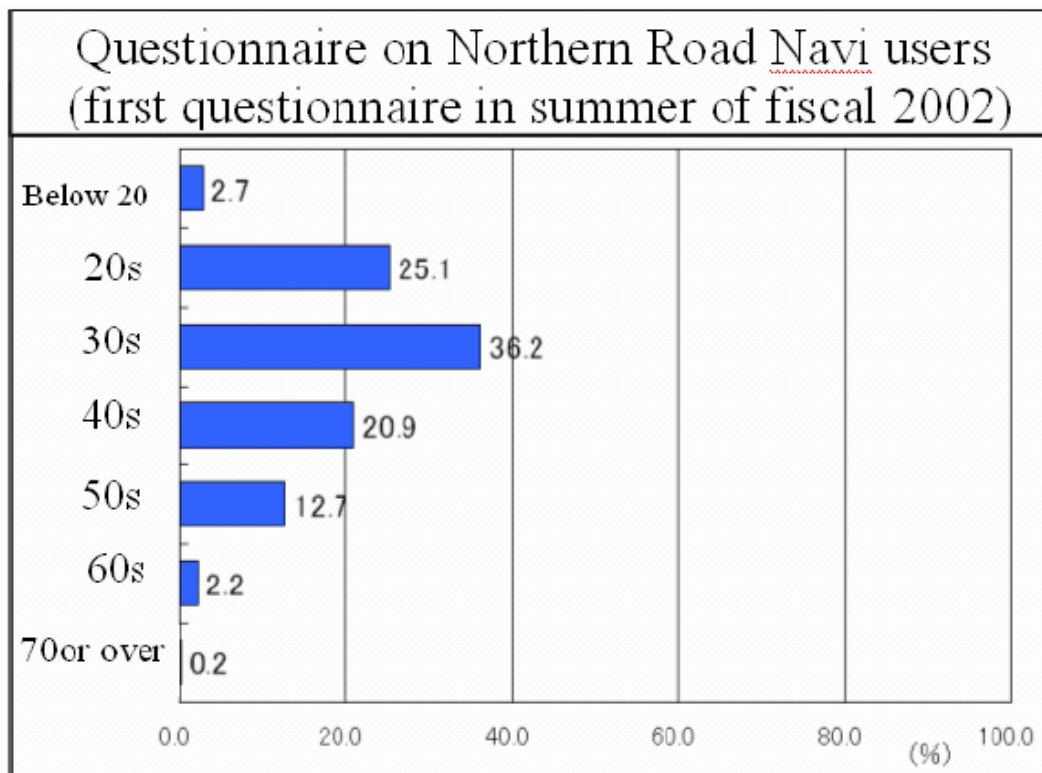

FIGURE 3 Respondents of the summer questionnaire by age group.

This questionnaire consisted of 15 questions about how the query results influenced actual travel.

Winter Questionnaire

A winter questionnaire was conducted via the Northern Road Navi website for the month from February 14 through March 14, 2003. The questionnaire consisted of 20 questions. They were about how the information posted on Northern Road Navi was used and how useful it was and about “mountain pass information,” the provision of which was launched in late November.

The mountain pass information web page gives pass section length, maximum elevation, snow duration, road alignment, road images, and weather forecast for 25 mountain passes in Hokkaido. This information has been integrated into information returned by query for travel time and distance. When a user specifies the trip origin and destination and submits a query, information on the mountain passes along the specified route is displayed.

Questionnaire Results

Summer Questionnaire

The valid responses to the web-based summer questionnaire numbered 589, 80% of them from men and 77% from Hokkaido. Of the respondents, 82% were between ages 20 and 40, with 36% in their 30s (the highest percentage for any decade) (Figure 3). The web-based summer questionnaire results are as follows:

- The respondents came to learn of Northern Road Navi through search engines such as Yahoo!
- The website was used mainly for tourism, leisure driving, and other recreation. This tendency was more noticeable among the non-Hokkaido respondents.
 - The frequently used content was road information, distance and time query, and tourist information. Non-Hokkaido respondents tended to use the site for tourist information.
 - Types of information on Northern Road Navi often seen and evaluated positively were map information, distance and time query, and road information. Many respondents requested improvement of the distance and time query function (Figure 4).
 - Approximately 80% of the respondents were satisfied with the information provided on the Northern Road Navi website. Also, 97% wanted to keep using the site.
 - More than 80% of the respondents were satisfied with the method of navigating the website. Many respondents suggested that an index of purposes would improve the aspects that earned negative evaluations.
 - About 80% of the respondents used the distance and time query function. The leading purpose of use was tourism.
 - Many responses pointed out that “travel distance” and “required travel time” were important information items. Also, many said that information on roadside rest facilities such as Michi-no-eki (roadside station) was important. Many non-Hokkaido respondents regarded roadside scenery and tourist attractions as important items.

The questionnaire on the time and distance query function was sent by regular mail to 468 people who answered in the web-based questionnaire that they had used this function. The valid responses number 171. As in the case of the web-based questionnaire, most respondents were men (86%), and Hokkaido residents accounted for 77%. Of the respondents, 86% were between ages 20 and 40, with 41% in their 30s (the highest percentage for any decade) (Figure 5).

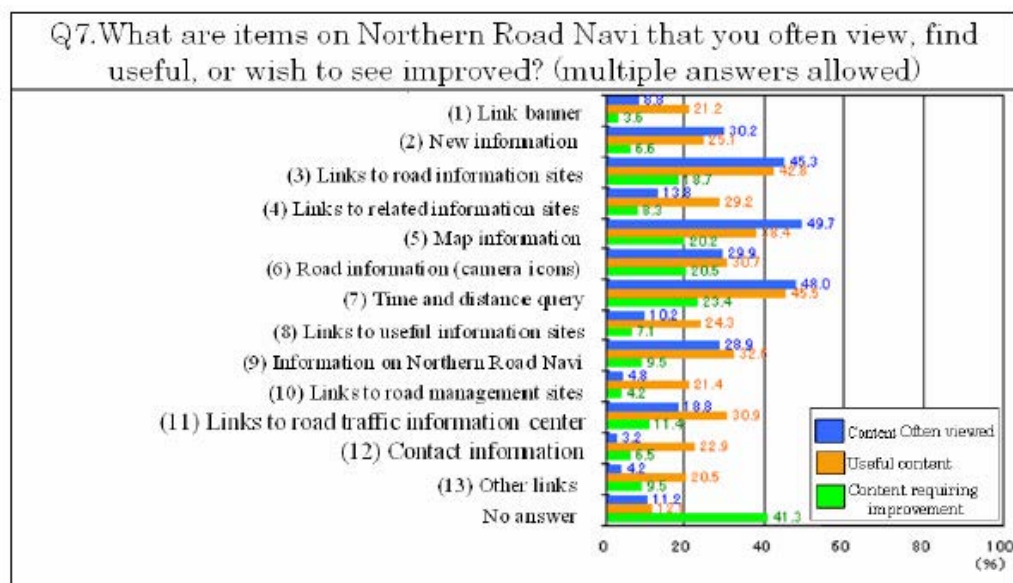

FIGURE 4 Content of Northern Road Navi: often viewed, useful, and requested to be improved.

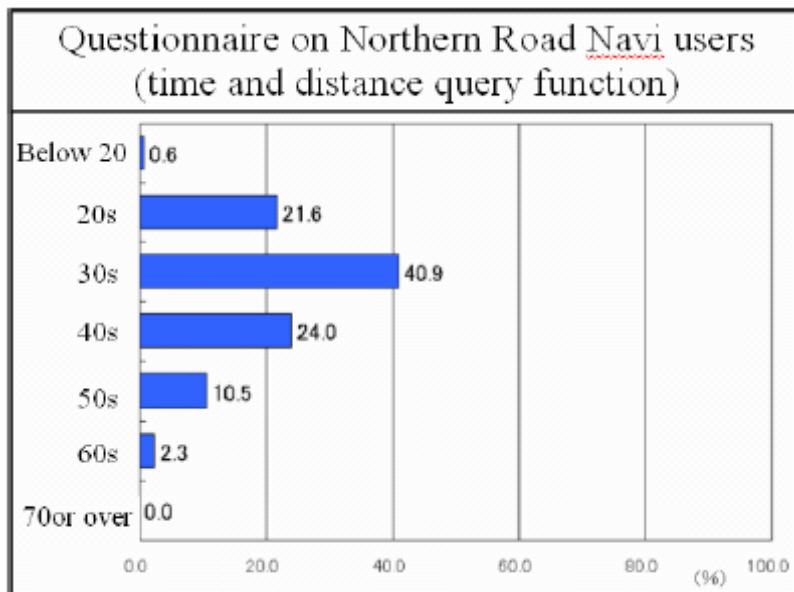

FIGURE 5 Respondents to the questionnaire on time and distance query function by age group.

The questionnaire had yielded the following results:

- For travel route search, the majority of Hokkaido residents used road atlases whereas non-Hokkaido residents tended to use maps in pamphlets and guidebooks.
- To the question on how the query results were used, about half the respondents said that they took notes or printed the page to carry while traveling.
- Non-Hokkaido residents wanted to see landscape information in the query results.
- Regarding terminal devices providing this service, many respondents wanted to use devices at roadside rest facilities, such as Michi-no-eki, and Internet-accessible mobile phones.

Winter Questionnaire

Valid responses to the web-based winter questionnaire numbered 207. Men accounted for 81%, and Hokkaido residents for 78%. Of the respondents, 87% were between ages 20 and 40, with 34% in their 30s (the highest percentage for any decade) (Figure 6).

The web-based winter questionnaire results are as follows:

- The majority of respondents had at least 10 years of driving experience, and 88% had driven on winter roads in Hokkaido. More than 60% of respondents drove almost every day. To the question “How many times do you drive through a mountain pass in a month?” the largest response was “once.”
- The leading purposes of using the Northern Road Navi website were tourism, leisure driving, and other recreation. The percentage for business use was greater in winter than in summer, particular for the mountain pass information.
- Not only the road information and the time and distance query functions

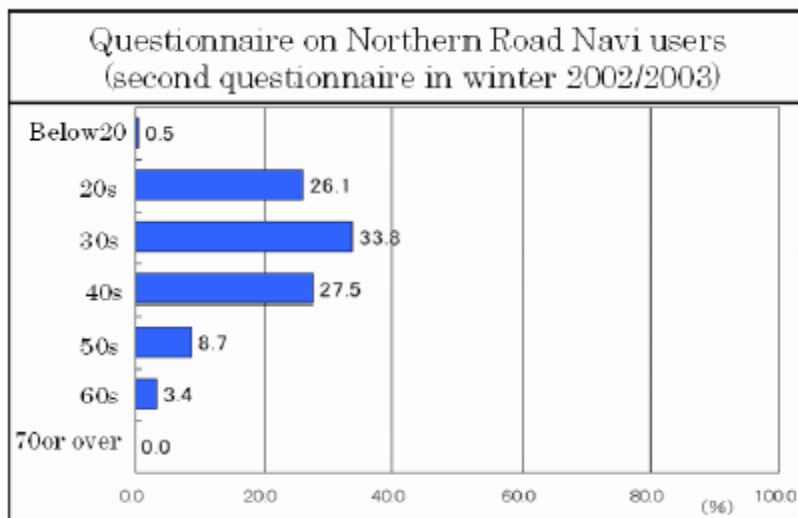

FIGURE 6 Respondents to the winter questionnaire by age group.

were frequently used. The newly added mountain pass information also was used often. Use for tourism was much less frequent.

Effects of Information Provision

The survey on the effect of information provided through Northern Road Navi showed the following:

1. Questionnaire on time and distance query function
 - The time and distance query function was useful in travel planning. A particularly great number of non-Hokkaido residents said that this function contributes to enhanced sense of security while driving.
 - More than 50% said that the time and distance query function would make them more likely to stop at tourist facilities, such as Michi-no-eki. The usefulness of Northern Road Navi to travel has been proved.
2. Winter questionnaire
 - To the question, “Do you think that information posted on Northern Road Navi is useful in enhancing our safety and sense of security on winter roads?” 90% answered “yes.” The items that were evaluated most positively in enhancing such safety were road information and mountain pass information (Figure 7). All the respondents said that they wanted to continue using these two information items.
 - Regarding the items of mountain pass information, many respondents said that real-time information (road image and weather forecast) as well as information on the snow and frost duration helped increase safety and a sense of security while driving (Figure 8).

Also, we adopted the CS analysis method in the questionnaire survey. There was a question asking how useful the mountain pass information was in enhancing safety and a sense of security for winter drivers. From the relationship between this usefulness and the overall

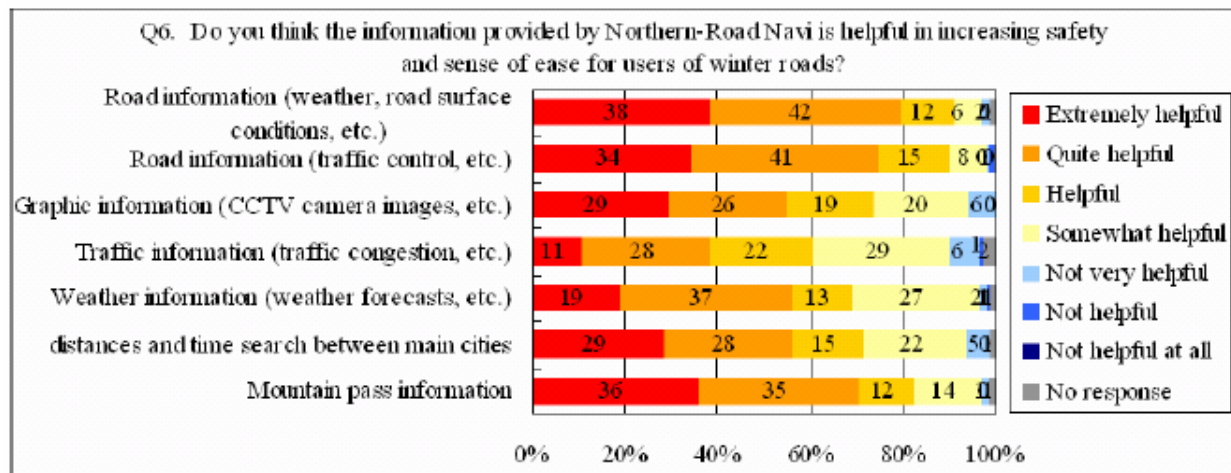

FIGURE 7 The Northern Road Navi information item most useful in enhancing winter driving safety and sense of security.

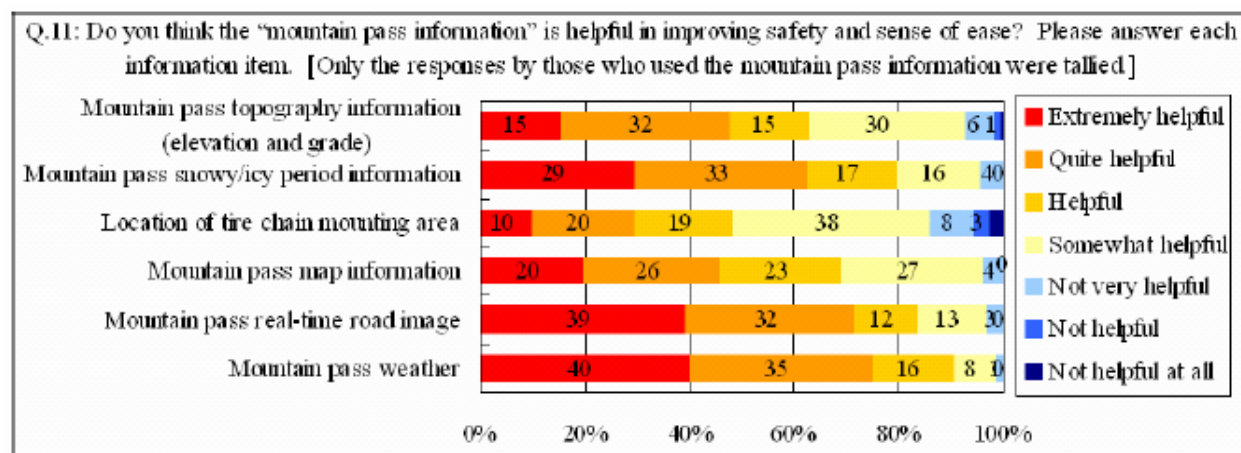

FIGURE 8 The mountain pass information item most useful in enhancing winter driving safety and sense of security.

evaluation of the mountain pass information, the needs for improvement were calculated for each item.

The results have revealed that the item ranked at the top for priority in improvement was topographical information on mountain passes (elevation, gradient, and so on), followed by mountain pass weather information (Figure 9). The level of satisfaction was high for the road image of mountain pass.

In view of these analysis results, we improved the representation of topographical information. For example, we considered addition of a cross-sectional figure in the table. Such an improvement should enable intuitive understanding of mountain pass section length, elevation, and other kinds of topographical information. Also, links to road images were changed to small live-image, so that users can more easily know that clicking will bring up a large image. We enhanced usability through these improvements.

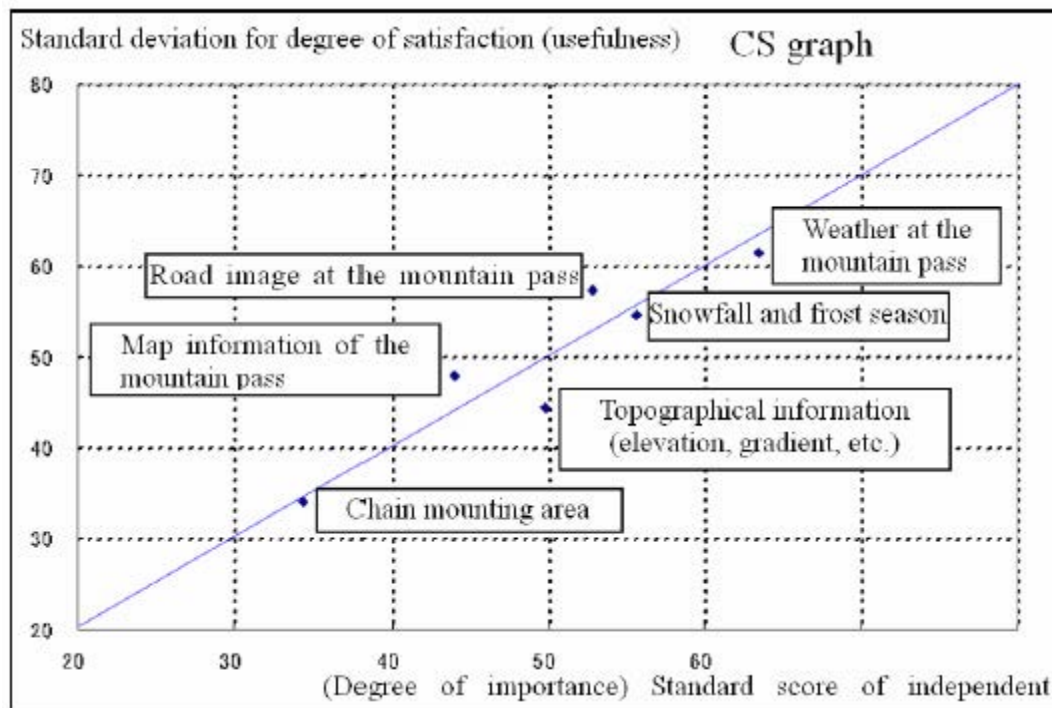

FIGURE 9 CS graph of the mountain pass information.

CONTINGENT VALUATION METHOD SURVEY ON PROVISION OF REGIONWIDE SNOWSTORM INFORMATION

Advanced Information Provision System for Winter Road Traffic

The advanced information provision system for winter roads delivers snowstorm information by regionwide information service (Figure 10a) and roadside information service (Figure 10b). The regionwide information system provides drivers with detailed weather and road conditions of the travel route beforehand. The roadside information system employs light-emitting delineators for delineation and for flashing in warning to following cars of the danger ahead. This section discusses a survey based on the contingent valuation method (CVM) on the regionwide information service with regard to its nonmarket values for enhancement of driving comfort and a sense of security.

Needs for Examination of Nonmarket Values

Cost-benefit analysis typically seeks to measure traffic-volume-dependent “travel time reduction benefit,” “travel cost reduction benefit,” “traffic accident reduction benefit,” and “environmental improvement benefit” (2).

As stated above, poor visibility on the winter road, which is induced by snowstorms and other factors, results in direct losses from traffic accidents and adverse psychological effects, such as anxiety and tension. According to the results of level of satisfaction survey on long-distance winter travel, which was conducted in 2001, approximately 70% of road users were dissatisfied, 70% of whom said, “Snowstorm and drifting snow generates a sense of danger.” Solving or mitigating problems arising from these phenomena will bring positive psychological effects.

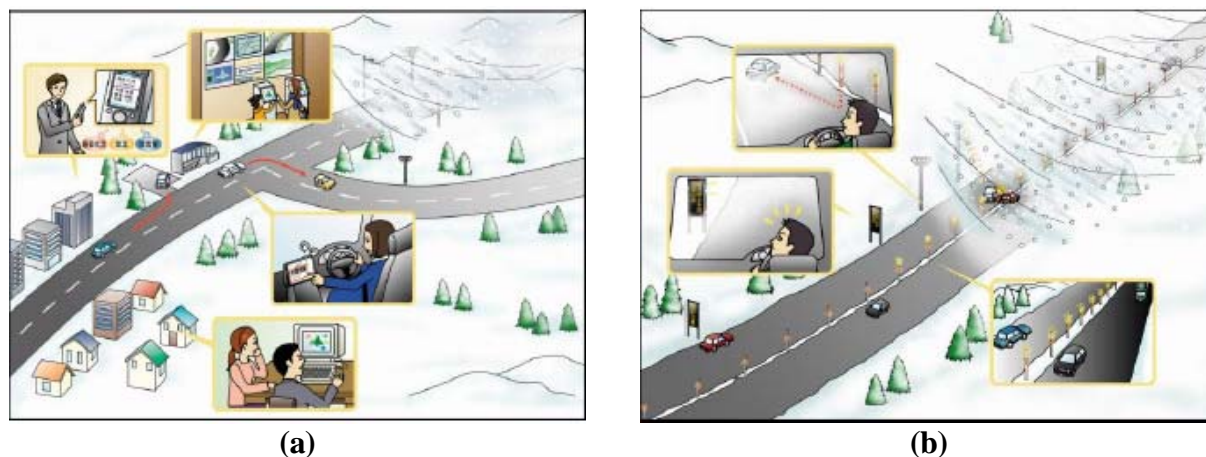

FIGURE 10 Provision of (a) regionwide snowstorm information and (b) roadside snow storm information.

ITS-based services can have numerous effects, including enhancing a driver's sense of security, if information is appropriately provided. Other potential effects include modifying transportation behavior, including avoidance of travel to areas suffering severe weather and danger avoidance.

To evaluate a new system properly for countermeasures against snowstorm-induced poor visibility, it is essential to understand the traffic-volume-dependent benefit and the nonmarket values of enhanced driving comfort and sense of security (3).

Outline of CVM-Based Survey

Table 1 presents the outline of the CVM-based survey.

Sample Selection, Distribution, and Recovery

To secure a large enough respondent sample size, to avoid miscommunication, and to make the hypothetical system and its services understood by the respondents, a CVM-based survey was conducted by a face-to-face group interview. Respondents were randomly selected from residential areas of road users who frequently traveled sections and routes where snowstorms are frequent. Six areas were selected:

1. The northern part of Kita Ward in Sapporo;
2. The eastern part of Higashi Ward in Sapporo;
3. Ebetsu;
4. The Horomui and Kamihoromui districts of Iwamizawa;
5. Ishikari; and
6. Tobetsu.

Postcards were mailed to about 500 households, and 111 replied. We asked them to come to a questionnaire site for the CVM-based survey.

TABLE 1 Outline of CVM-Based Survey

Item	Details
Objective	Estimation of willingness to pay for regionwide information service roadside information service.
Survey Area	Northern Sapporo (Higashi and Kita Ward), Ebetsu, and other areas
Sample	111 (47 men and 64 women)
Survey Method	Face-to-face group interview
Questioning Method	Dichotomous choice

Questionnaire Sheet Design and Questions Regarding Willingness to Pay

The questions and hypothetical situations of the CVM-based survey are presented in [Table 2](#) and [Figure 11](#).

The questions were asked in double-bound format for dichotomous choice, since it tended to be unbiased. To estimate the prices to be offered, a preliminary survey was conducted. Then we showed videos, slides, and other items of the regionwide information service and of the roadside information service of the advanced information provision system for winter road traffic ([Figures 12](#) and [13](#)). Attributed of respondents and their attitude toward snowstorm information were surveyed in the interview.

TABLE 2 Hypothetical Questions Regarding Regionwide Information Service

	Regionwide Information Service	Roadside Information Service
Hypothetical Situation	<ol style="list-style-type: none"> 1. On the road you usually take, poor visibility often occurs due to heavy snowfall and blowing snow in the winter. 2. At times of poor visibility, it is very difficult to know the road gradient and curves ahead, as well as where you are driving. 3. In the area in which you live, a system has been made available to provide weather and snowstorm information in winter to your mobile phone or personal computer. 	<ol style="list-style-type: none"> 1. On the road, poor visibility often occurs due to heavy snowfall and snowstorms in winter. 2. During poor visibility, it is very difficult to know road gradient and curves ahead as well as where you are driving. 3. A roadside information service systems has been constructed. This system helps you to recognize the road alignment (fluctuations on the curved section) and warns you of the existence of parked cars and other obstacles ahead.
Question	<ul style="list-style-type: none"> • If you were to pay a membership fee, you would have unlimited access to such information from your mobile phone or personal computer. The membership would be on a household basis, meaning all members of your family could use this service. The collected fee would be used solely to manage the system. • If membership were valid for one winter (December to March), would you pay ¥1,000 to subscribe as a member? 	<ul style="list-style-type: none"> • On the road you usually take, the system described in 3 above would be available in a 1-km-long snowstorm-prone section. When visibility is low, this system would offer service only to drivers who have paid the service fee. You pay the fee by pressing a button in your car. The collected fee would be used solely to manage the system. • If the fee for this service were ¥100 per use, would you pay for it?

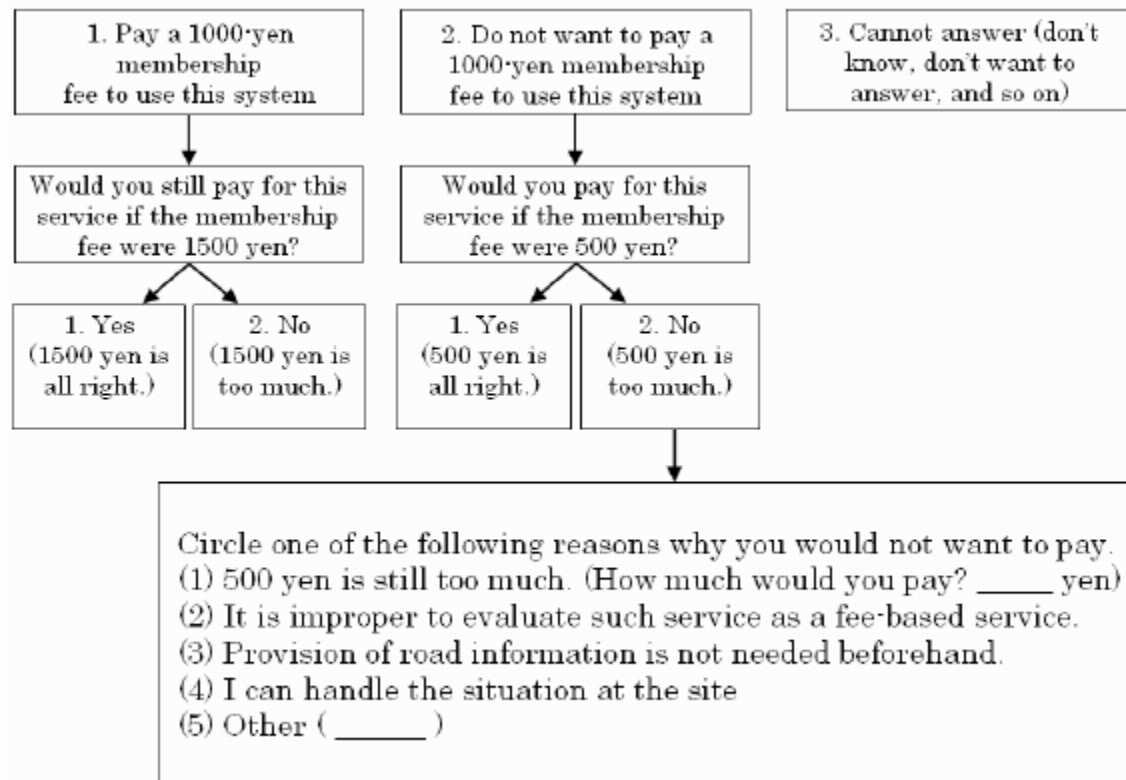

FIGURE 11 Flow of questions regarding the regionwide information service system.



FIGURE 12 Explaining the questionnaire survey to the subjects.

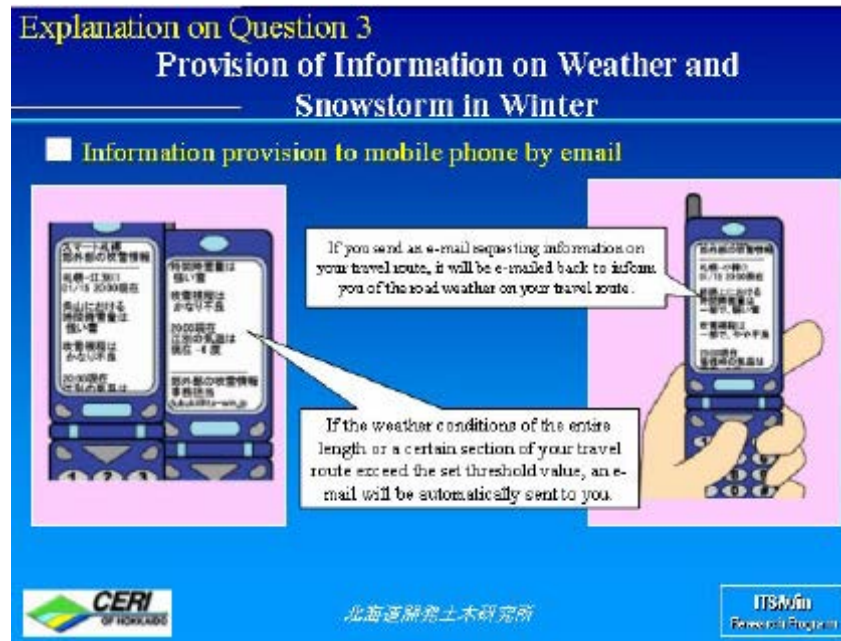

FIGURE 13 Slide presenting the nationwide information provision service system.

Attributes of Subjects

The subjects numbered 111. Figure 14 shows the number by gender and age group. Women exceed men. Of the respondents, 29% were in their 30s. All the other age groups were mutually similar in numbers.

According to the results of a survey on snowstorm consciousness, about 80% of the subjects drove either almost every day or 3 or 4 days a week in both winter and summer. They are not professional drivers. Over 90% of the subjects experienced snowstorm-induced poor visibility (Figure 15).

Estimate of Nonmarket Values of Nationwide Snowstorm Information Provision

The questionnaire assumed a nationwide snowstorm information provision system that offers unlimited access to information on winter weather and road conditions. One question was “Would you pay to use the service if the membership fee were ¥1,000 per winter (December–March)?” Figure 16 shows the answers.

In this survey, we estimated the WTP using a logit model in the form of dichotomous choice. The logit model was a random utility model (4). According to the estimates, the median and average values were ¥438 and ¥581, respectively. Approximately 60 subjects gave protest responses (Figure 17), such as “Even ¥500 is too expensive” and “It is improper to evaluate such service as a fee-based service (i.e., it should be covered by tax).”

To measure the nonmarket values, the WTP and beneficiaries must be set. The beneficiaries to be surveyed were households directly affected by road traffic and users of the survey roads.

The nationwide snowstorm information provision service offers snowstorm-related

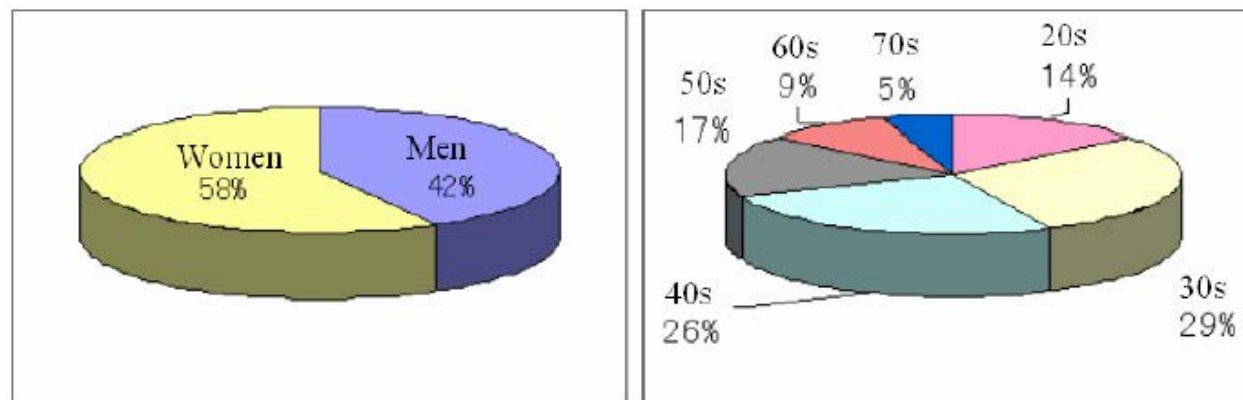

FIGURE 14 Subjects by gender and age group.

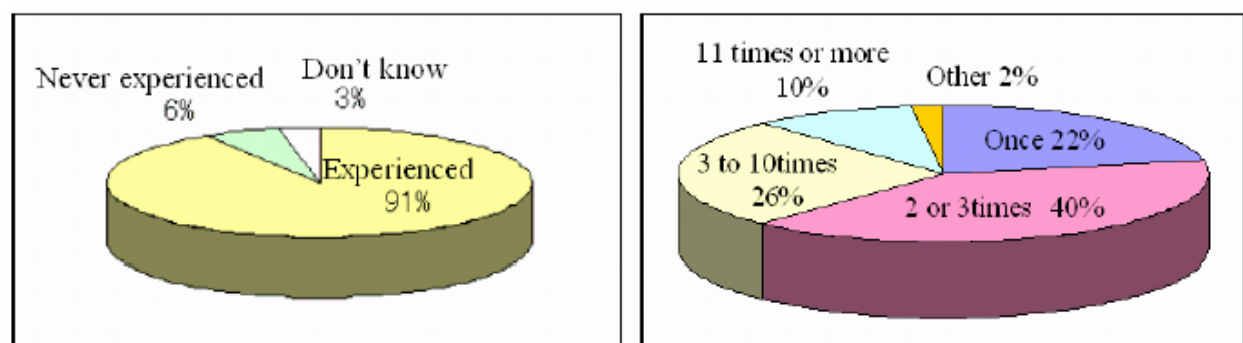

FIGURE 15 Experience of encountering snowstorm-induced poor visibility and the number of times the subjects encountered poor visibility in one winter.

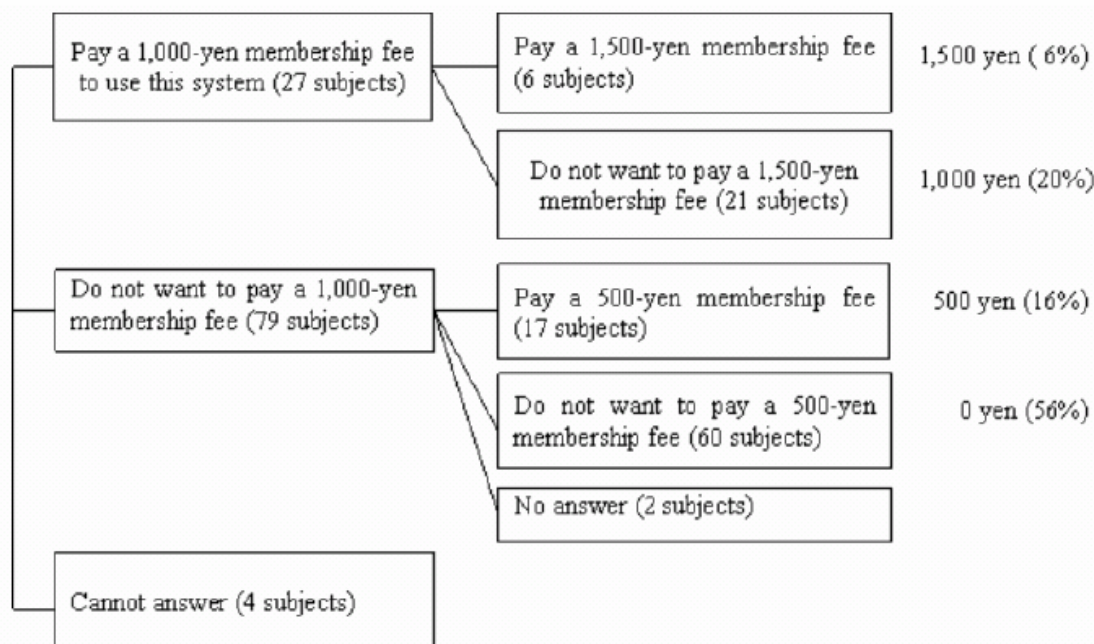

FIGURE 16 Results of questionnaire on regionwide information system.

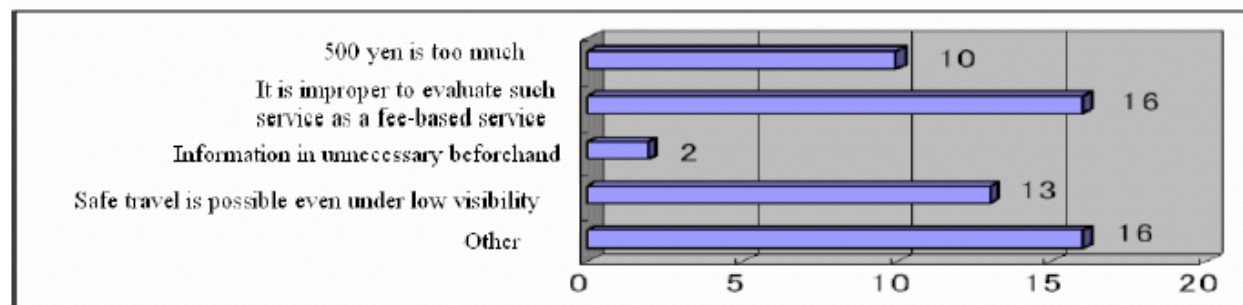

FIGURE 17 Protest responses in the questionnaire on the nationwide information provision service.

weather and road information via mobile phone and personal computer. The information must be carefully examined in determining the beneficiaries. In this survey, the beneficiaries were households in snowstorm-prone areas of Greater Sapporo. The number of these households was multiplied by the car ownership rate (number of vehicles per household). The purpose was to find the number of car-owning households in particular need of snowstorm information. To exclude households unable to receive the service, the number above was multiplied by the Internet pervasion rate. Based on the calculations, we estimated the economic value.

The economic value was calculated by the following equation:

$$B = b \times \text{car ownership rate (vehicles per household) (\%)} \times \text{Internet pervasion rate (\%)} \\ \times \text{the number of households in the survey area}$$

Where B equals the benefit of providing service for one winter (¥/year) and b equals the monetary value of the service per household (¥581)

Suppose the survey area consists of Ishikari and Tobetsu (approximately 29,000 households) and the average WTP is ¥581; the economic value is ¥11.7 million per year (Table 3).

In the information provision experiment, ¥3 million to ¥5 million was added as the cost for the system and its operation. For full-scale introduction of the system, operation and management must be improved, and Internet security measures well implemented. Although the cost is expected to be higher, its benefit is expected to justify the cost.

TABLE 3 Benefit Calculated for the Area of Ishikari and Tobetsu

Survey Area	Households ¹	Car Ownership Rate per Household ²	Internet Dissemination Rate in Households ³	Benefits (¥ million/year)
Ishikari Tobetsu	28,987	85%	81.4%	11.7

¹ Basic Resident Register Network (January 2003)

² National Survey of Family Income and Expenditure (1999)

³ Communications Usage Trend Survey (2002)

CONCLUSIONS

This paper presented the results of the questionnaire survey conducted on the Northern Road Navi website and conducted on the regionwide snowstorm information provision service by face-to-face group interview. The paper has discussed user evaluation of winter road information and the effects of such information.

Northern Road Navi was found by 90% of the respondents to enhance safety and a sense of security. The road information and the mountain pass information were the main contributors to this high rating. All the respondents said that they wished to continue using these two information items. For items of the mountain pass information webpage, high evaluations were given for real-time information (mountain pass road image and weather forecast) and snow and frost duration. Many respondents said that these items would help enhance safety and sense of security.

According to the CS analysis, we measured usefulness of the mountain pass information in enhancing driving safety and a sense of security on winter roads. The topographical information on mountain passes (elevation, gradient, and so on) was the item for which the improvement priority ranked the highest. The level of satisfaction was high for mountain pass road images. In light of these results, we will add a cross-sectional figure in the table to enable intuitive understanding of mountain pass section length and elevation, and we will add other kinds of topographical information. Also, we will improve links to road images, so that users may more easily know that clicking will bring up an image. Through these improvements, we will attempt to enhance usability of the mountain pass information webpage.

The regionwide snowstorm information provision service was assumed to permit users unlimited access, via mobile phone and personal computer, to weather road information on the road they selected. Under this assumption, a CVM-based questionnaire survey was conducted in a face-to-face interview with a group of people regarding the WTP per household in one winter. It was found to be ¥581.

The winter road information service has been proved to contribute to enhanced safety and sense of security of drivers by prompting proper route selection and departure time adjustment. The survey results have confirmed this quantitatively.

Once improvements are made to the mountain pass information of the Northern Road Navi website, another questionnaire survey will be conducted. In addition, for the regionwide road snowstorm information service, road users will be provided with snowstorm information so that they may evaluate its effects.

ACKNOWLEDGMENTS

In the questionnaire survey conducted via the Northern Road Navi website, Naotoshi Kanemura of Sapporo Information Network was of tremendous help. In the questionnaire survey on regionwide snowstorm information provision, Toshiyuki Naito of Docon Co. Ltd. provided a great deal of assistance. In addition, we extend our appreciation to the respondents of the questionnaire survey, as well as to staff of the Hokkaido Society for the Study of Road Information, for their assistance in operation of the Northern Road Navi website.

REFERENCES

1. Ministry of Public Management, Home Affairs, Posts and Telecommunications. Communications Usage Trend Survey in 2002. Mar. 2003.
2. Committee for Examination of Guidelines for Evaluation of Investment in Roads. *Guidelines for Evaluation of Investment in Roads* (Draft, in Japanese). June 1998.
3. Committee for Examination of Guidelines for Evaluation of Investment in Roads. *Guidelines for Evaluation of Investment in Roads* (Draft, in Japanese). Vol. II, Overall Evaluation, Jan. 2000.
4. Kuriyama, K. *CVM Guidebook for Value of Public Works and the Environment* (in Japanese). Nov. 1997.

Environmental Stewardship

ENVIRONMENTAL STEWARDSHIP

Icy Road Management with Calcium Magnesium Acetate to Meet Environmental and Customer Expectations in New Zealand

ALAN BURKETT
Transit New Zealand

NICK GURR
Opus International Consultants

Because of public concerns, the use of salt as a deicer for roads in New Zealand was discontinued more than 20 years ago, and icy roads have been managed since without the use of chemical deicers. In more recent years however, increasing customer expectations have demanded improvements to icy road management beyond the application of just grit or sand.

A proposal to reintroduce salt as a deicing chemical was rejected by road users and environmental groups.

Following investigations of alternatives, calcium magnesium acetate (CMA) was chosen as a suitable deicer and anti-icer that could meet the environmental concerns and be accepted by the road user.

CMA has been introduced gradually in various parts of the country and has been closely monitored for any effects on the environment. In particular, monitoring has taken place over the past 5 years in the central North Island, where operations are within a national park and world heritage area. During that time extensive testing of streams, soil, and vegetation has been carried out, and no significant effect has been observed.

CMA is a high-cost product, and so ice prediction technology is now being introduced to assist with managing its use on a just-in-time and in-the-right-place philosophy to ensure it is cost-effective, improves safety and efficiency for the road user, and minimizes any environmental concerns.

This paper summarizes the environmental monitoring of CMA in the central North Island, the results obtained, the benefits and costs involved, and management practices.

INTRODUCTION

New Zealand's temperate climate provides winter temperatures that generally do not remain below freezing during the day. This climate provides sometimes daily freeze-thaw cycles during the winter season with temperatures hovering around 0°C.

In 1995 storms closed a section of State Highway 1, the main north-south highway, in the central North Island for 9 consecutive days due to snow and ice. This section of highway is known as the Desert Road, and although closures each winter are common, the extended length of this closure raised substantial public concern. The previous winter,

because of a fatality caused by ice, criticisms were leveled on the basis that the Desert Road was not closed soon enough.

Traffic volume on the main highways continues to increase, and more goods are being transported by road as a result of reducing regulation in the transport industry. Consequently, road users and communities have in recent times increased their expectation for higher levels of service on the country's highways.

Transit New Zealand's ability to manage winter storms better has been constrained by its existing ice management practices. Salt had been used in past years in some areas, although not extensively. However, its use was stopped in the late 1970s or early 1980s as a result of concerns, mainly from motorist groups.

Ice management practices were therefore restricted to the use of mechanical means to remove snow and cut down the ice layer as far as possible to the road surface. Abrasives in the form of grit or sharp sand were applied to improve traction until rising temperatures were able to melt the ice.

Gritting, however, has its own limitations in its effectiveness. There have been concerns over safety issues; under some circumstances this material can be just as dangerous as ice on the road to unsuspecting motorists.

As a result of public concerns following the mid-1990 storms, investigations into winter maintenance operations for the Desert Road were commenced and included a study of overseas practices. Among other things, this investigation recommended the use of a chemical deicer as being the most effective method of managing ice.

Consequently the reintroduction of salt was recommended. However the various motoring organizations expressed total opposition to the use of any chloride-based salt. The location of the Desert Road within a national park and world heritage area also meant that there was significant concern for the environment.

Following extensive research in to the various deicing chemicals available, it was found that calcium magnesium acetate (CMA) was the best suited because of its reduced effect on the environment and its noncorrosive properties.

New Zealand's environmental law (*I*) meant that formal consents were necessary to allow the use of a chemical for deicing purposes on the highway. The process also requires recognition of any cultural and spiritual concerns of indigenous Maori. Natural waterways and landforms are particularly significant to Maori.

Consents, covering discharge to water and land, were granted in October 1997 for a 5-year period covering five sites on the Desert Road. These were the most prone to icing and were frequently the sites that caused problems for motorists. The consents were to enable trials to be carried out, including extensive field monitoring, to determine the effects on the streams, soils, and vegetation. Further consents have been obtained since for extensive areas in the South Island based on the work undertaken on the Desert Road.

This paper outlines the environmental monitoring undertaken on the Desert Road over the 5-year trial period and discusses the results obtained.

CMA is a relatively high-cost, imported product. To ensure that it is used effectively and improves safety and efficiency for the road user and that the environmental concerns are minimized, managing its use on a just-in-time and in-the-right-place basis is important. The directions being taken and the technology being introduced also are reviewed.

POTENTIAL EFFECTS

In order to support the application for consent to use a chemical deicer, extensive investigations and consultation were carried out and an effects assessment was prepared. This work highlighted the following potential effects.

Soils and Groundwater

In normal agricultural soils, there are usually high levels of calcium and magnesium but in contrast, the generally volcanic soils of the Desert Road region have low levels of calcium and magnesium. The Desert Road soils also are low in organic matter and phosphorous and are acidic. CMA could therefore be expected to increase soil fertility with increases in calcium and magnesium as well as potentially increasing phosphorous levels. [Production-grade CMA is contaminated with phosphorous (2).] In addition there could be an expected increase in phosphorous and soil organic matter. Overall the effects of CMA on soils could be expected to be beneficial; however, the effects of any increased soil fertility on vegetation existing in the lowly fertile Desert Road alpine areas were unknown.

Terrestrial Vegetation

The Desert Road area experiences a relatively windy climate and therefore makes vegetation potentially susceptible to damage by airborne contaminants. It had been reported that CMA application on a number of plant species showed no discernible effects (2, 3). It was considered that CMA applications at the levels expected were unlikely to cause any detrimental effects on roadside vegetation.

Streams

The depletion of dissolved oxygen (DO) from the degradation of the acetate component of CMA was the major water quality concern. Studies had shown that CMA decomposition exerted a significant biochemical oxygen demand on receiving waters (3). Stream life could be affected by depleted DO, and there was also concern about potential bacteria and fungi growth that could smother the streambed and increase the oxygen demand. This was of concern as the streams are nearly pristine and feed an internationally acclaimed trout fishery.

Although there was some concern over the potential effects on both soils and vegetation in the area, monitoring over time to determine cumulative effects was considered to be the most appropriate method for determining changes due to CMA application. The more significant concerns, however, were the apparent risks to streams.

DISSOLVED OXYGEN MODELING

As a consequence of the possible adverse effects identified by the investigation, a simple DO modeling exercise was carried out to determine stream responses for the five areas identified on the Desert Road for chemical applications. There are various guidelines available that discuss DO levels in natural waters. In particular, environmental legislation requires that for water

classified to be managed for aquatic ecosystems, fishery, or fish-spawning purposes, the concentration of dissolved oxygen shall exceed 80% of saturation concentration (1).

The streams in the national park have not been classified under the legislation, but because of their particular location it was considered that this level of protection was appropriate.

The results of the modeling suggested that at lower rates (10 gm/m²) of CMA delivery to streams, the risk of DO depletion causing adverse effects on aquatic biota was negligible. However, with higher application rates, the model indicated that severe oxygen depletion might occur (4).

As a consequence of this assessment, further work was necessary to refine the inputs of the model.

Four streams on the Desert Road were chosen for the refined modeling study and site-specific information on temperatures, DO, stream depths, velocities, and background biological oxygen demand (BOD₅) was obtained.

The worst-case theoretical scenario providing the greatest risk to the streams was considered to be where multiple applications of chemical had been applied and was followed by a relatively short-duration, high-intensity rainfall event. The resulting runoff would then tend to slug dose the streams giving the greatest potential for any effect.

The total mass of chemical that would cause a 20% drop in DO under this scenario was determined as the critical burden. When the cumulative critical burden was reached, a significant run-off event would need to occur before further CMA applications could resume.

The smallest stream with a base flow less than 0.05 m³/s indicated some risk of significant DO reductions with an estimated critical burden of just 35 gm/m² (4).

There was however a high uncertainty of two critical model parameters:

- The proportion of CMA applied to the road that washes into the stream and
- The time taken (duration) for the CMA to reach the stream.

To obtain realistic estimates of these criteria and to calibrate the DO model further, field-testing involving the application of CMA directly on the road was necessary. At this point a consent was required for on-road trials.

It was considered that with a precautionary approach adopted by commencing testing on the catchments of the larger streams, monitored information could be gathered to estimate the crucial model parameters. The testing also would monitor DO response in the streams and the results used to calibrate the model. Further model simulations could then be made to set safe application limits for the smaller streams and allow full-scale trials to be carried out on all catchments.

CONSENT APPROVAL

On the basis of the investigation and specific modeling analysis, consents were sought to initially carry out model calibration tests followed by a controlled trial at the five identified sites. Accepted as an integral part of the consent approval, an environmental management plan was prepared to cover the test and trial procedures, including the monitoring and operational requirements. In addition a community liaison group was established with representation invited from the major interest groups, including the Maori.

The purpose of the group was to receive information of the testing and trial monitoring results and provide feedback. This provided a forum for discussion of important issues, so that the interested parties could gain a greater understanding of the trial and appreciate others points of view. The consent was granted for a 5-year period to carry out model calibration tests initially and then full-scale on-road trials based on critical burdens derived from the modeling.

FIELD CALIBRATION

The calibration test criteria required that ground temperatures be below zero (freezing) to minimize the loss of chemical due to infiltration into the soils on the flow paths to the stream. CMA was then to be applied over a measured road area at a predetermined rate and then washed from the road by water tankers simulating a short high intensity rainstorm.

Stream samplers and DO probes were placed downstream of the test site, and measurements were taken following the washing of CMA off the road (Figure 1). The measured drop in DO as a result of the CMA inflow would be used to calibrate the model and then refine the determination of the critical burden for each stream catchments. Should the test not provide the required results, then—based on the precautionary approach—the stream with the next lowest flow rate would be the subject of testing and so on until a result was achieved and the model able to be calibrated.

The tests on the larger streams indicated that the prediction of critical burden was conservative. As a result the smallest stream was then tested but with changes to the test procedure. To avoid having to spread the CMA on the road and then wash it off, the CMA was poured directly into the stream.

Testing began with 5 kg of solid CMA discharged directly to the stream over a 30-min period. Monitoring was unable to detect any discernible decrease in DO within the stream (5). A second test was carried out with 12 kg over a 30-min period. Again there was no evidence of DO depletion.

Two further tests were carried out. The first involved 15 kg of dissolved CMA applied over a 15-min period, and the second, 32 kg of dissolved CMA applied over a 10-min period. Neither test indicated any effect on stream DO (6).

All four direct tests on the stream were carried out in the summer period, stream bacterial populations normally would be expected to be at their highest and with the greatest effect on oxygen demand.

The tests carried out did not provide the results required to enable the DO model to be calibrated and therefore provide a confident assessment of the CMA critical burden that would ensure that the DO depletion in each stream would not exceed the 20% limit set by the resource consent.

With the lack of results it was thought that there were insufficient bacteria in the streams to consume the CMA to the extent required to affect DO. The streams are of pristine nature with relatively cool water temperatures measured at a maximum of 12 degrees during midsummer and therefore suppressing the BOD₅ decay rate.

Feedback from the liaison group, however, gave the opinion that the bacteria needed to acclimate to the introduction of CMA as a food source, and the tests so far were insufficient in duration to allow this to take place.

The model was then refined assuming that an actual DO depression in the final test of 5% was reached given that the DO probes were accurate to $\pm 3\%$. The BOD₅ decay rate was altered in the model to force it to predict a DO depression of 5% for the test.

The revised model then was used to predict the critical burden for the smallest stream. This resulted in a total application of 500 kg, equivalent to a rate of 110 gm/m² on the road, which could be applied safely before requiring a significant runoff event to wash the accumulated CMA from the road and surrounding soils. This maximum rate allowed realistic CMA applications on this area for the full-scale trials. The larger streams could therefore receive proportionally larger critical burdens.

This provided confidence that the risk of significant effect on the streams for the full-scale trials would be negligible.

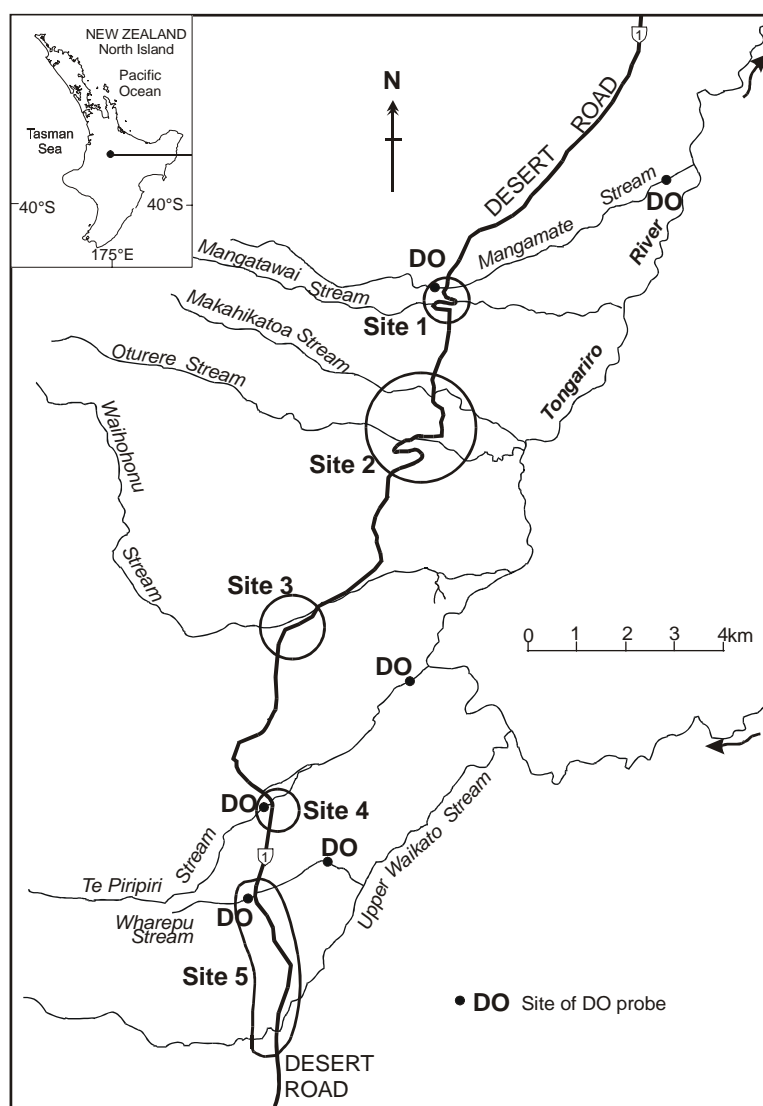

FIGURE 1 Locality plan, showing CMA trial areas (sites 1 through 5) and location of DO probes.

FULL-SCALE ROAD TRIALS

Stream Monitoring

The first full-scale trials of CMA began in the winter of 1999. When snow fell or ice formed on the road, CMA was applied to the five trial sites. A range of monitoring was carried out, including the following:

- Continuous DO and phosphorous measurements upstream and downstream from the road on three different streams,
- TOC measurements in two streams during three separate rainfall runoff events (to provide further information on the concentrations of CMA entering the streams),
- Monthly assessments of invertebrates and periphyton and heterotrophic film cover on three streams upstream and downstream from the road, and
- Ancillary information gathering, including rainfall and stream flow recording.

Relatively mild winters were experienced in 1999 and 2000, and CMA was applied only on three and four occasions per year, respectively. Colder winters were experienced in 2001 and 2002, and a total of 13 and 12 applications were made each year, respectively (average application rate of 30 gm/m²; total mass of 23 tons and 22 tons applied each year, respectively).

It was concluded that in the monitored streams over the trial period there were

- No reductions in DO below the consent limit of 80% of saturation (DO concentrations remained above 90% of saturation throughout the study period). A typical result is shown in [Figure 2](#).
- No detectable effects on benthic growths.

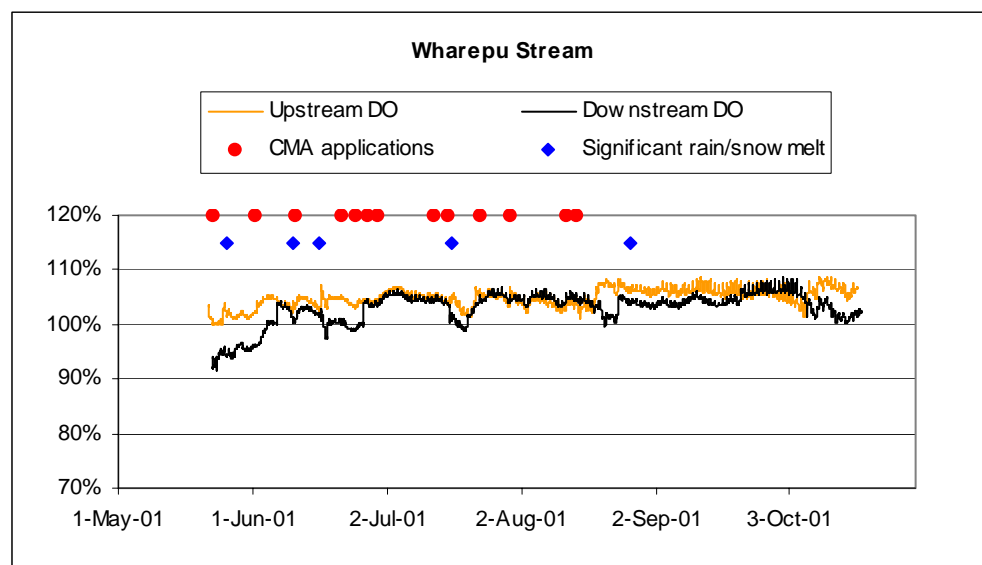

FIGURE 2 Typical result of DO monitoring at the smallest stream.

- No ecologically significant effects on aquatic invertebrates.
- Some short-term increases in TOC concentrations downstream from the road after rainfall (7).

Vegetation and Soils Monitoring

Vegetation monitoring involved the establishment of 30-m transects at right angles to the highway on both sides of the road with one site in each of the four distinct vegetation areas within the trial areas, including beech forest, shrub-grassland, and fernland vegetation. The vegetation was checked monthly during the trial, and photographic records were kept. Soil samples were analyzed annually for physiochemical changes.

No consistent pattern of change was evident in measured parameters in beech or tea tree forest or in fernland or grassland. Changes found in some plots in beech and tea tree forests were likely to reflect natural dynamic processes rather than the application of CMA to the adjacent highway. There has been no evidence that the application of CMA to the highway since 1999 has affected the health of the four monitored plant communities or of the individual species monitored within them (8).

No significant effect has been found in the soil chemistry. Increases in phosphorous and exchangeable calcium and magnesium were insignificant and decreases in values were as common as increases (9).

COSTS AND BENEFITS

The use of CMA provides substantial benefits over the traditional use of grit in terms of safety and effectiveness. Grit application is relatively inexpensive (US\$63 per lane km per application), but there have been concerns raised regarding its use as it can create hazardous situations and expose motorists to additional or unnecessary risk. It also requires multiple applications to overcome the disbursement by vehicles and wind and the embedment into ice as the surface re-freezes.

CMA, conversely, is a high-cost, imported product. Application cost is about five times the cost of grit. CMA does, however, have the ability to maintain a residual effect; therefore the number of applications and the amount applied reflect this.

To provide a comparison of the cost and benefits of using CMA against grit, an assessment of the relative economic differences has been undertaken using a 25-year analysis period.

In the case of CMA these benefits are obtained through

- Reduction in accidents. The analysis of accident reductions is difficult because of the variability of the winters. To allow for this in a benefits analysis, the effectiveness of CMA at reducing ice-related accidents was treated as a variable.
- Decrease in travel time. The replacement of grit with CMA results in a net decrease in travel time when icy conditions are prevalent because of increased speed. Skid-resistance tests indicated a 24% increase in grip when CMA was used in place of grit and therefore provided a safer surface for motorists.

- Reduction in road closure durations. The most significant benefit to the road users is obtained through reductions in road closures. A network model to determine the effects on road users when the Desert Road is closed has been developed (10). The model considered
 - Vehicle operating costs,
 - Vehicle occupant time, and
 - Benefits lost because of canceled trips.

The reduction in road closures due to the use of a deicer or anti-icer is difficult to quantify, and so this factor also was adopted as a variable.

The benefit–cost ratio (BCR) of CMA is the ratio of the combined benefit streams (travel time reductions, accident reductions, and reductions in road closure durations) over the differential cost of CMA compared with gritting. In looking at the BCR of using CMA as a replacement for grit (Table 1), it is evident that CMA's greater costs can be offset by the increased benefits to the road users with just a small reduction in accidents or closures.

MANAGEMENT PRACTICES

The demand for improved levels of service and the use of a high-cost, imported deicer, necessary to meet the environmental and motorist concerns, has driven the need to introduce better management practices. As the affected areas of highway in New Zealand are dispersed widely throughout the network, varying levels of service are appropriate taking the use and remoteness of the highways into consideration.

The focus will be to keep high-volume tourist routes and strategic state highways open as a first priority level of service. It has been considered that because of the cost in terms of resources and consent compliance monitoring for the use of the deicer, only the first priority routes will receive chemical treatment. Other routes will continue with the traditional grit applications.

TABLE 1 Benefits–Cost Ratio Matrix

		Reduction in Ice and Snow Accidents with the Road Open										
		0%	10%	20%	30%	40%	50%	60%	70%	80%	90%	100%
Reduction in Closures	0%	0.38	0.42	0.49	0.57	0.64	0.72	0.79	0.87	0.94	1.02	1.09
	10%	2.18	2.21	2.29	2.37	2.44	2.52	2.59	2.67	2.74	2.82	2.89
	20%	3.97	4.01	4.09	4.16	4.24	4.32	4.39	4.47	4.54	4.62	4.69
	30%	5.77	5.81	5.89	5.96	6.04	6.11	6.19	6.27	6.34	6.42	6.49
	40%	7.57	7.61	7.69	7.76	7.84	7.91	7.99	8.06	8.14	8.22	8.29
	50%	9.37	9.41	9.49	9.56	9.64	9.71	9.79	9.86	9.94	10.01	10.09
	60%	11.17	11.21	11.29	11.36	11.44	11.51	11.59	11.66	11.74	11.81	11.89
	70%	12.97	13.01	13.09	13.16	13.24	13.31	13.39	13.46	13.54	13.61	13.69
	80%	14.77	14.81	14.89	14.96	15.04	15.11	15.19	15.26	15.34	15.41	15.49
	90%	16.57	16.61	16.69	16.76	16.84	16.91	16.99	17.06	17.14	17.21	17.29
	100%	18.37	18.41	18.49	18.56	18.64	18.71	18.79	18.86	18.94	19.01	19.09

Getting resources to the right place at the right time is also an important factor in improving the levels of service. All highway maintenance services have been contracted out since 1989, and there has been a reliance on the experience and judgment of the contractors to determine when and where treatment was required. The specification for snow and ice treatment traditionally has been method-based. The use of a chemical also means that advantage can be taken of its ability as an anti-icer to improve safety and route availability in a more efficient and effective manner.

To assist road managers, road weather information stations, thermal mapping, and ice prediction forecasting now are being introduced.

Using such systems will provide road managers with real-time information about their network, an analysis of the various factors that give rise to icy conditions, and specific predictions for the network. This knowledge ensures that better-informed decisions will be made as to where and when to act and that the appropriate treatment will be applied at the right time at the right place.

These systems will be applied not only to the management of chemical application but also to gritting use, thereby minimizing the exposure of motorists to hazards.

Variable message signs and automated road open and close signs also have been installed to provide motorists with accurate and timely road condition information.

CONCLUSIONS

Environmental monitoring of CMA use on the Desert Road has indicated that there have been no discernable effects on DO concentrations or biological attributes in the streams during the 5-year trial period.

There has been no evidence that the application of CMA has affected the health of vegetation and no significant effect has been found in the soil chemistry.

The environmental liaison group has not raised any significant issues of concern, and the success of the trial has been acknowledged through the granting of a further consent for an 11-year period.

In that time monitoring for an additional 5 years on a much-reduced scale will be undertaken to ensure that there will be no long-term cumulative effects.

So far the changes to management practices have been well received by the contractors and supported by the motorist organizations.

For the future every opportunity to stay informed about various initiatives in operations, products, research studies, and trials should be taken and every opportunity to keep aware of changing customer expectations should be implemented.

Benchmarking with others and applying best practices suitable for the New Zealand situation should contribute to obtaining acceptance by customers and society as a whole that this management of snow and icy roads is reasonable and effective and saves lives.

REFERENCES

1. Resource Management Act. New Zealand Government. 1991.
2. Horner, R. R. *NCHRP Report 305: Environmental Monitoring and Evaluation of Calcium Magnesium Acetate*. TRB, National Research Council, Washington, D.C., 1998.
3. Horner, R. R., and M. V. Brenner. Environmental Evaluation of Calcium Magnesium Acetate for Highway Deicing Applications. *Resources, Conservation, and Recycling*, Vol. 7, 1992, pp. 213–237.
4. Scarsbrook, M. R., R. J. Wilcock, J. C. Rutherford, J. L. Hawken, and R. Henderson. *Effects of Calcium Magnesium Acetate on Dissolved Oxygen Levels in Desert Road Streams: A Modelling Study*. Consultancy Report, National Institute of Water and Atmospheric Research Ltd., New Zealand, 1996.
5. Ray, D. E. *Desert Road Deicing Tests—Wharepu Stream Calibration*. Client Report, National Institute of Water and Atmospheric Research Ltd., New Zealand, 1998.
6. Ray, D. E. *Desert Road Deicing Tests—Second Wharepu Stream Calibration (February 1999 Tests)*. Client Report, National Institute of Water and Atmospheric Research Ltd., New Zealand, 1999.
7. Ray, D. E., and M. R. Scarsbrook. *Desert Road Deicing Trials: Winter 2002 Monitoring Results*. Client Report, National Institute of Water and Atmospheric Research Ltd., New Zealand, 2002.
8. Smale, M. C., and N. B. Fitzgerald. *Changes in Vegetation After Five Years of CMA Trials on the Desert Road (State Highway 1)*. Landcare Research Contract Report LC203/163, Landcare Research New Zealand Ltd., 2003.
9. Rijkse, W. *Soil Analyses of Desert Road Monitoring; Chemical De-icing Trials (2002 Results)*. Landcare Research Contract Report 0203/058, Landcare Research New Zealand Ltd., 2002.
10. Dalziell, E. P., A. J. Nicholson, and D. L. Wilkinson. *Risk Assessment Methods in Road Network Evaluation*. Transfund New Zealand Research Report No. 148, 1999.

ENVIRONMENTAL STEWARDSHIP

Reducing Salt Consumption by Using Road Weather Information System and Mesan Data

DAN ERIKSSON

Swedish National Road Administration

In today's road administrations it is important to keep track of the spread amount of chemicals used in winter road maintenance. Variations in snow and ice conditions from year to year make it difficult to compare figures. In order to tackle this problem, the Swedish National Road Administration (SNRA) has developed a new salt index.

The salt index is based on data from SNRA's 700 road weather information system (RWIS) stations as well as on data provided by the Swedish Meteorological and Hydrological Institute (SMHI) and on the total amount of salt. SNRA uses RWIS data for information on air and road surface temperatures, humidity, wind, and type of precipitation and SMHI data for the amount of precipitation.

$$\text{Saltindex} = \left(\frac{\left(\frac{\sum \text{Salt_förbrukning_kg}}{\sum \text{salt_väglängd_km}} \right)}{(\text{HR1} * 24) + (\text{HR2} * 36) + (\text{HT} * 48) + (\text{HN} * 60) + (\text{SNÖ1} * 36) + (\text{SNÖ2} * 90) + (\text{SNÖ3} * 120) + (\text{DREV1} * 24) + (\text{DREV2} * 24)} \right)$$

In calculating the salt index in [Figure 1](#), the length of road treated with salt, type of road (standard class), and guidelines for salt are used. A salt index of 1.0 indicates that the contractor (or county, regional, or national road manager) has used the optimum salt dosage.

The weather index provides data on slippery roads, snowfall, and snowdrifts expressed in number of occasions; for example, two icy road surface occasions will be registered if it is

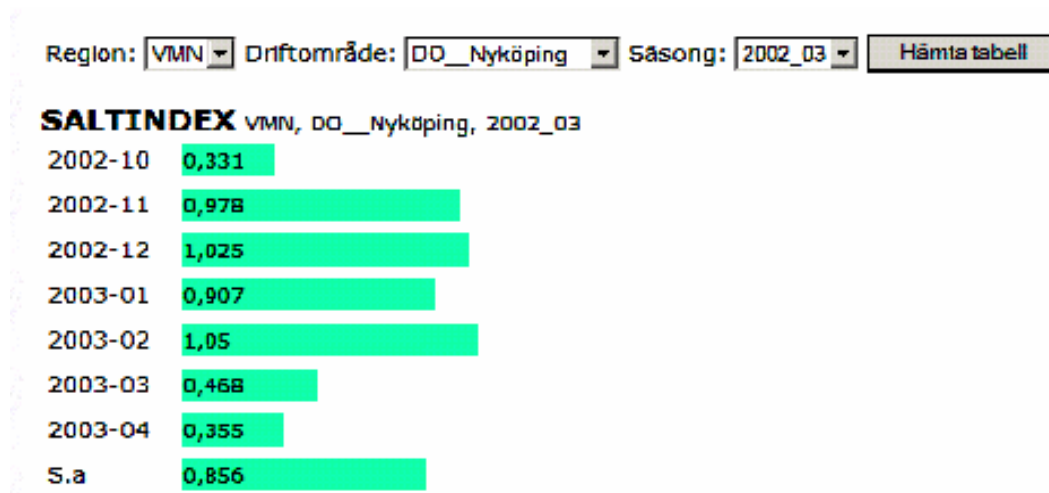

FIGURE 1 Example of salt index.

known that a skid control measure will be effective for 5 h and the RWIS data show that there still is a risk of slippery roads after 6 h. The same principle applies to snowfalls and snowdrifts.

The weather index can detect four kinds of slippery surfaces ranging from light frost to freezing rain (HR1, HR2, HT, HN) and three kinds of snowfall and snowdrift ranging from light to heavy (SNO1-3, DREV1-2) (Figure 2).

The RWIS data are collected every half-hour and the SMHI data every hour. To calculate the amount of precipitation, SMHI uses a model called Mesan, which is an operational mesoscale analysis system. This model subdivides Sweden into a 22- by 22-km grid net, and calculations are performed for each grid individually (Figure 3).

VÄDERINDEX

Teckenförklaring: ■ = Halka ■ = Snö ■ = Drev -tilfällen

2002-10	6,6	3,1	0,8	Tot: 10,5
2002-11	14,3	8,6	0,3	Tot: 23,2
2002-12	24,4	12,3		Tot: 36,7
2003-01	49,4		7,1 0,5	Tot: 57
2003-02	11,8	14,6	1,1	Tot: 27,5
2003-03	6,1	1,3		Tot: 7,4
2003-04	3,8	12,3	0,8	Tot: 16,9

FIGURE 2 Example of weather index.

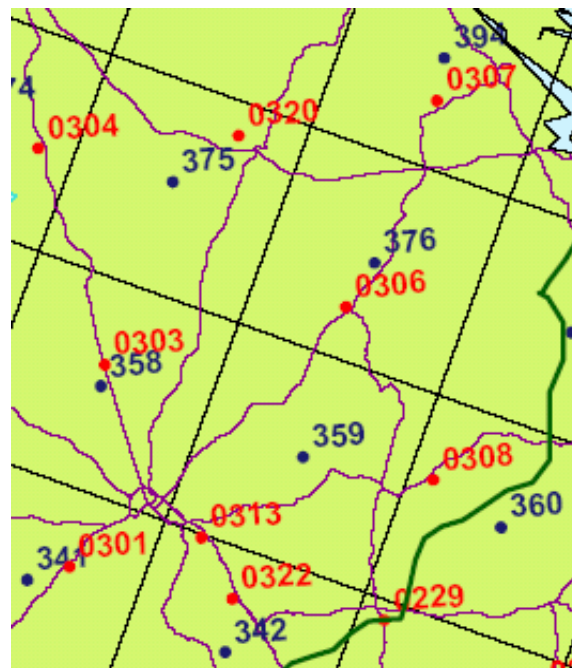

FIGURE 3 Example of Mesan grids and RWIS.

Weather Index Calculations

Slippery	= HR1 + HR2 + HT + HN	Slippery occasions
Snow	= Sno 3_10 + Sno 10_25 + Sno 25_	Snow occasions
Drift	= Drev 0_3 + Drev 3_10	Drift occasions

Recommended Amount of Salt (kg/km)

HR1	Number of slippery occasions – light hoarfrost	24
HR2	Number of slippery occasions – severe hoarfrost	36
HT	Number of slippery occasions – falling surface temperature	48
HN	Number of slippery occasions – wet precipitation on cold surface	60
Sno 3_10	Number of snow occasions between 3–10 mm	36
Sno 10_25	Number of snow occasions between 10–25 mm	90
Sno 25_	Number of snow occasions between > 25 mm	120
Drev 0_3	Number of snow occasions between 0–3 mm	24
Drev 3_10	Number of snow occasions between 3–10 mm	24

The amount of salt used compared with the weather situation involved is entered in the final step of the calculation. This provides a good basis for comparing salt consumption from year to year and a possibility to find areas with too much salt use compared with the weather. This index is a tool for benchmarking maintenance quality.

For those maintenance areas that were found to have a salt index much higher than acceptable, there was the question of why. The answer was found in the way the contractors were compensated for their maintenance activities. When there was a compensation model based on incentive, the salt index was close to 1.0 or lower.

An incentive-based compensation to contractors gives the following results shown in Figure 4.

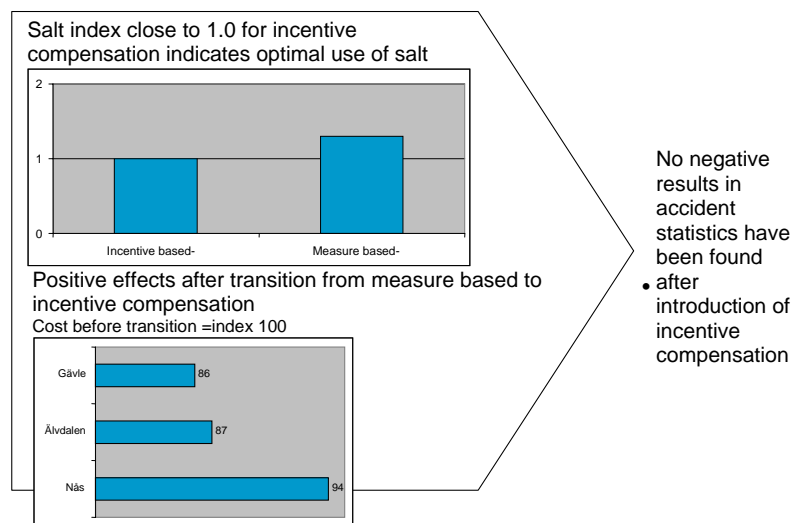

FIGURE 4 Results of incentive-based compensation to contractors.

The use of an incentive-based compensation model built on RWIS and MESAN-data gives as a result a reduced use of salt compared with a compensation model based on measures.

The results were so obvious that SNRA is making preparations for changing the whole compensation system before the next winter season 2004–2005.

An incentive-based compensation to contractors has the advantages shown in [Figure 5](#).

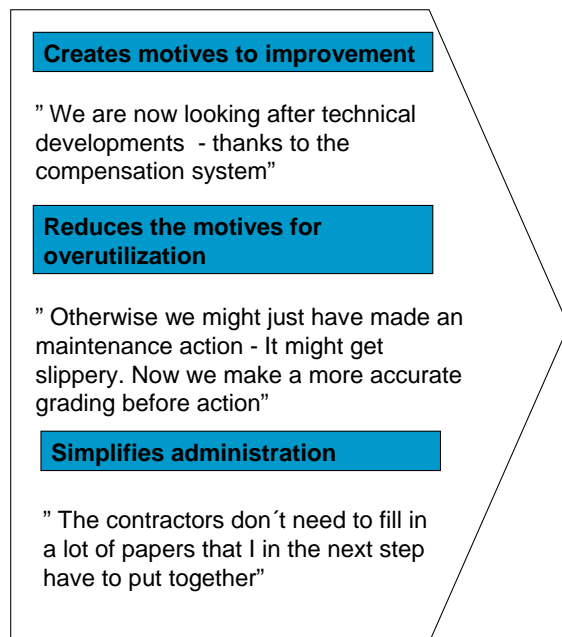

FIGURE 5 Advantages of incentive-based compensation to contractors.

ENVIRONMENTAL STEWARDSHIP

**Washington State Department of Transportation's
2002–2003 Salt Pilot Project****ENRICO V. BAROGA***Washington State Department of Transportation*

During the winter of 2002–2003, the Washington State Department of Transportation (DOT) conducted a field evaluation that compared several aspects of using sodium chloride for highway snow and ice control and corrosion-inhibited snow and ice control chemicals. Sections of highway were designated in which salt products (salt brine and rock salt) were the sole chemicals used. Similar sections of highway were designated in which corrosion-inhibited chemicals (corrosion-inhibited liquid calcium chloride, corrosion-inhibited liquid magnesium chloride, and corrosion-inhibited rock salt) were the sole chemicals used.

The cost of materials, equipment, and labor for sections in which salt was used was significantly less than like costs for those sections in which corrosion-inhibited chemicals were used. The results, in terms of average roadway condition during inclement winter weather, were similar between highway sections where salt was used and highway sections where corrosion-inhibited chemicals were used.

The corrosion evaluation provided varied results based on different scenarios. Corrosion was evaluated by exposing samples of steel, sheet aluminum, and cast aluminum to either salt or corrosion-inhibited chemicals and comparing corrosion rates on them. Exposure of the metal samples was accomplished by attaching them to maintenance trucks, maintenance supervisor pick-up trucks, and roadside guardrail posts. The basis to which the corrosion results are compared is a performance specification used by Washington State DOT and several other road maintenance organizations. Washington State DOT specifies that corrosion-inhibited chemicals must be at least 70% less corrosive than salt. A laboratory test that simulates environmental exposure to snow and ice control chemicals has traditionally been used to verify chemicals meet this specification. Steel is typically the metal of choice in conducting this lab test. The corrosion-inhibited chemicals generally come close to, meet, or exceed the 70% specification when tested on steel using the laboratory analysis. Use of the corrosion-inhibited chemicals in the field evaluation did not meet the 70% specification in any comparison scenarios. In some scenarios, the use of corrosion-inhibited chemicals resulted in some reductions in corrosion, and in other scenarios, their use resulted in more corrosion compared with the use of salt.

In the environmental evaluation, chloride levels found in roadside soils, surface water, and underlying groundwater were found to be generally low and well below any applicable regulatory standards or guidelines. No pattern was evident from this evaluation of increased contribution of chlorides to the roadside environment dependent on whether salt was used or corrosion-inhibited chemicals were used.

BACKGROUND

The Washington State Department of Transportation (DOT) discontinued the use of rock salt in the late 1980s in favor of alternative, corrosion-inhibited chemicals. In the years since this policy change, Washington State DOT personnel have noticed continued corrosion on maintenance trucks and have received complaints from road users regarding corrosion. Conversely, Washington State DOT bridge personnel have noticed a general decrease in the amount of rehabilitation work needed on bridge decks due to corrosion in the underlying rebar. This conflicting information has caused Washington State DOT maintenance personnel to raise the question of how much reduction in corrosion is actually occurring in the roadway environment from the use of corrosion-inhibited chemicals compared with the use of salt. The only documentation of relative corrosion rates from exposure to sodium chloride and corrosion-inhibited chemicals under like circumstances has been from tests conducted under controlled, laboratory conditions. It seemed plausible that differences between the controlled laboratory environment and the variable roadway environment might lead to different rates of relative corrosion.

In addition to the questions about corrosion from snow and ice control chemicals, it was felt that an overall evaluation of sodium chloride as a highway maintenance tool in Washington State was needed. Factors that led to this include sodium chloride's cost-effectiveness, changing anti-icing chemical application practices, other road maintenance organizations' extensive, continued use of sodium chloride, and improved corrosion protection practices in the truck and automobile manufacturing industry as well as in bridge construction. The use of liquid anti-icers (i.e., salt brine) in a preventive manner results in much lower levels of chlorides being applied to the roadway. Application of chloride-based liquids typically equates to approximately 100 lbs of salt, or chlorides, per lane mile. Contemporary application rates for solid chemicals (i.e., rock salt), when used for accumulated snow or compact snow and ice, are typically between 200 and 300 lbs per lane mile.

RESEARCH OBJECTIVES

The general objective of this research project was to carry out a multifaceted comparison of sodium chloride and corrosion-inhibited chemicals under real-world roadway conditions. Specific objectives included the following:

1. To compare snow and ice control costs of using sodium chloride with like costs by using corrosion-inhibited chemicals;
2. To compare the results (i.e., road conditions) of snow and ice control activities carried out by using sodium chloride products with like results from the use of corrosion-inhibited chemicals;
3. To compare corrosion of metal exposed to sodium chloride with metal exposed to corrosion-inhibited chemicals; and
4. To compare chloride levels in roadside soils, surface water, and underlying groundwater in areas using sodium chloride with chloride levels in areas by using corrosion-inhibited chemicals.

TEST LOCATIONS

Washington State DOT initially selected two test locations where salt brine and rock salt would be the sole snow and ice control chemicals used. Two other sections were selected where corrosion-inhibited chemicals were the sole snow and ice chemicals used. Plowing and sanding activities also were conducted as needed in both salt and corrosion-inhibited chemical sections.

After the initial planning of the pilot project commenced, maintenance personnel from Washington State DOT's southwest region expressed an interest in participating in the project. State Route (SR) 6 between Chehalis and Raymond was selected as a section for salt use. A specific section of highway on which corrosion-inhibited chemicals were to be applied was not selected in the southwest region for the purpose of comparing data with the salt section. Instead, two maintenance trucks that applied corrosion-inhibited chemicals on several highways in the general vicinity of SR 6 were selected for data comparison purposes (Figure 1).

COSTS

Snow and ice control operational costs incurred during the pilot project were tabulated for each project section (Table 1). The primary objective of documenting these costs was to be able to generate a general comparison of the operational costs of a maintenance program that was reliant on salt products for snow and ice control with a maintenance program that was reliant on corrosion-inhibited chemical products for snow and ice control. Cost items included in this tabulation were materials, labor, and equipment expenditures.

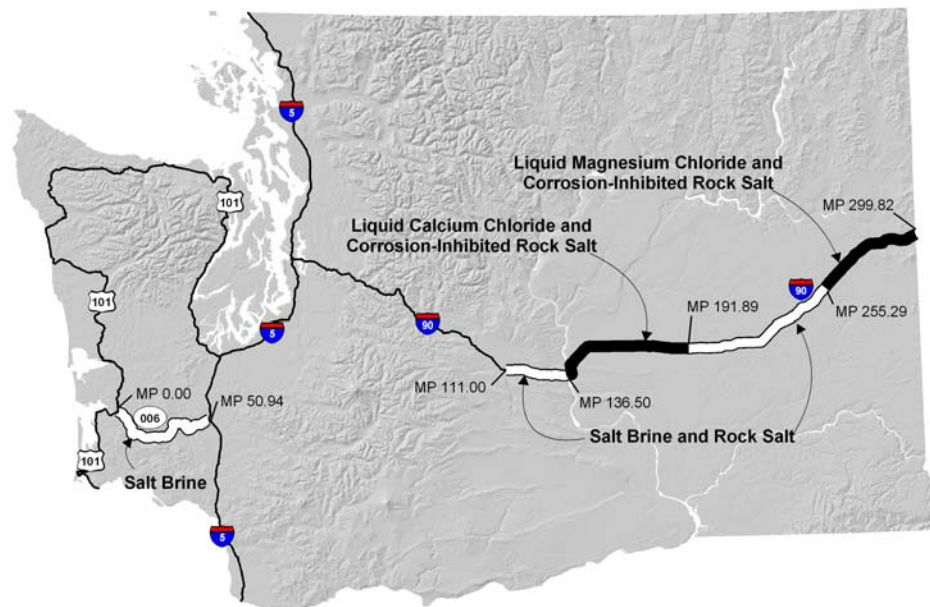

FIGURE 1 Salt and corrosion-inhibited chemical test sections.

TABLE 1 Salt Pilot Project Costs per Lane Mile

Location	Labor	Equipment	Materials	Lane Miles	\$/Lane Mile
SC Region Salt	\$10,467	\$4,731	\$54,479	102	\$683.10
NC Region Corrosion-Inhibited Chemicals	\$24,347	\$12,564	\$117,501	222	\$695.55
Eastern Region Salt	\$30,090	\$13,886	\$66,385	253	\$436.21
Eastern Region Corrosion-Inhibited Chemicals Control	\$41,492	\$18,954	\$286,670	210	\$1,652.93
SW Region Salt	\$4,042	\$1,784	\$5,914	103	\$113.98

Several variables must be considered when assessing the costs of delivering a winter maintenance program. An example of this is in regard to costs per unit and application rates of anti-icing chemicals. Unit costs vary, but so do required application rates. Although the unit cost of a certain chemical may be only half of another chemical, the total costs actually may be more if the chemical has to be applied at a much higher rate. Another example is related to the roadway area of responsibility. Total monetary costs between two sections may be similar, but significant differences in miles of roadway maintained provide important information about program efficiency. A simple way to improve the fairness of cost comparisons is to put total costs into terms of costs per lane mile over an entire winter season. Although this doesn't factor in every possible variable, it generally does provide a good medium of comparison.

SNOW AND ICE CONTROL RESULTS AND PERFORMANCE

Washington State DOT measures performance for a variety of maintenance activities using a program known as the maintenance accountability process (MAP). Performance measures are focused on customer-oriented outcomes or the results of maintenance work with which highway users can identify. Results are determined typically by field evaluations that assess the condition of highway system features. Results are identified in terms of level of service (LOS). LOS is communicated in terms of a letter-grade scale similar to school report cards. An LOS of *A* is the best LOS, and an LOS of *F* is the poorest LOS.

Several roadway segments within the project sections were utilized for field evaluations and LOS calculation. A summary of the LOS ratings for each project section is shown in [Figure 2](#). The LOS rating for each section represents the average condition in which the subject roadway was maintained during the winter season.

CORROSION STANDARDS

Washington State DOT is a member of a consortium of northwest state DOTs and Canadian provinces known as the Pacific Northwest Snowfighters (PNS). One of PNS's functions is to

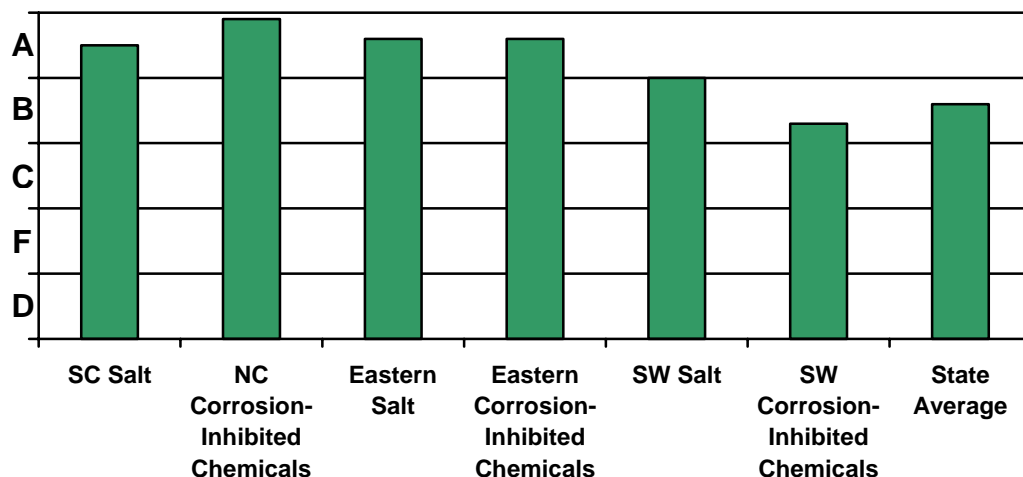

FIGURE 2 Level of service ratings for project test sections.

develop anti-icing chemical specifications that all member organizations utilize. The PNS specification for corrosion is that a corrosion-inhibited anti-icing chemical must be at least 70% less corrosive to a given type of metal than sodium chloride is corrosive to that same type of metal. This reduced level of corrosion is determined by a laboratory test.

Generally, the lab test consists of immersing and removing separate metal washers into a sodium chloride solution and a corrosion-inhibited chemical solution. Over a 72-h period, the metal samples are immersed for 50 min and removed from the solution for 10 min. This immersion and removal process is done hourly for the 72-h period. After the test period is complete, the metal samples are weighed. If the metal sample exposed to corrosion-inhibited chemicals has at least 70% less weight loss compared with the weight loss of the metal sample exposed to the sodium chloride solution, the corrosion-inhibited chemical meets the PNS specification.

MEASURING CORROSION IN ROADWAY ENVIRONMENT

The field replication of the laboratory corrosion analysis consisted of attaching samples of metal to Washington State DOT maintenance trucks working on highways where the only anti-icing chemical they would be exposed to is sodium chloride. Similar metal samples were attached to Washington State DOT maintenance trucks working on highways where the only anti-icing chemical they would be exposed to is a corrosion-inhibited product. Selected trucks were assigned to specific routes for winter maintenance to ensure that they would be exposed only to one type of either anti-icing chemical. While the laboratory test uses metal washers, larger pieces of metal were used for the roadway corrosion test. With longer exposure times and more potential corrosion, it was felt that the smaller washers would be inappropriate for this use. The pieces of metal used—called coupons—are approximately 4 in. by 6 in. in dimension. Three types of metal were selected by their common use in the automobile and truck manufacturing industry. Mild steel was selected because of its common use on a wide variety of motor vehicle components. A sheet aluminum alloy (type #5182) was selected

because of its use in a variety of car and truck body panels. A cast aluminum alloy (type # A356) was selected because of its use in housings (i.e., transmission housings) of certain car and truck parts.

Each coupon was cleaned, prepared, and weighed. Two coupons of each of the three types of metal were attached to a rack that was in turn attached to Washington State DOT maintenance trucks. The racks were made of galvanized and painted steel. Coupons were attached to the rack with stainless steel nuts and bolts. Each rack (with mounted coupons) was then mounted on a truck that was used to conduct snow and ice control activities on the project sections. The coupon racks were fitted between the truck chassis rails above the truck's differential. The coupons and rack were marked for tracking purposes. Racks and coupons were fitted to 31 maintenance trucks for this evaluation. These were either dump trucks that applied solid chemicals or sand, or both or spray trucks or tank trucks that applied liquid chemicals.

Coupons and racks also were fitted onto four supervisor pickup trucks for a similar evaluation. Supervisor trucks were driven on a variety of highways in the course of daily work. In the evaluation, supervisor trucks in the test areas were driven on highways where they were exposed to both sodium chloride as well as corrosion-inhibited chemicals. Supervisor trucks in the corrosion-inhibited chemical sections would be driven on highways where they would be exposed only to corrosion-inhibited chemicals since no salt was used anywhere in these maintenance areas.

One set (steel, sheet aluminum, cast aluminum) of coupons was also fitted onto guardrail posts at select locations in each of the project sections. While they did not have the extensive exposure to anti-icing chemicals that Washington State DOT maintenance trucks did, they had some exposure from storm water splash by vehicles driving on the highways. The guardrail along the project sections of I-90 was typically 10 ft from the nearest travel lane. SR 6 did not have a similar, wide-paved shoulder. At the location where the coupons were attached to the guardrail, they were 7 ft from the nearest travel lane.

CORROSION RESULTS

Getting Corrosion Results

Because of the number of coupons used in the corrosion evaluation, average weight loss amounts were calculated by using all coupons of each metal type from each project section. The charts separate corrosion based on the type of metal coupon evaluated. The respective magnitudes of corrosion are significantly different. Weight loss in the steel coupons was on the order of grams. Weight loss in the sheet aluminum and cast aluminum coupons was much less—on the order of tenths of grams. The charts and narrative for the eastern and western Washington components of the pilot project were reported separately due to the differences in winter weather and snow and ice control methodology.

Interpreting Corrosion Results

To be included on a Washington State DOT contract, anti-icing chemical vendors must submit samples of their anti-icing chemical, which must pass the corrosion-inhibition test (at least 70% less corrosive than sodium chloride, corrosion being measured in weight loss) as well as tests for other impurities such as heavy metals.

The charts used to depict corrosion rates compare amounts of corrosion in metal samples exposed to corrosion-inhibited chemicals with amounts of corrosion in metal samples exposed to sodium chloride. The target level of reduced corrosion (70% less than salt) also is shown on each measure for corrosion-inhibited chemicals. This way, the reader learns of the target and actual rates of corrosion.

CORROSION COMPARISON

SC Region Salt and NC Region Corrosion-Inhibited Chemicals

Figure 3 shows corrosion in steel coupons mounted on maintenance trucks, supervisor trucks, and guardrail in the SC salt and the NC corrosion-inhibited chemical sections. The maintenance truck-mounted coupons exposed to corrosion-inhibited chemicals had 53% less corrosion than similar coupons exposed to salt. The supervisor truck-mounted coupons exposed to corrosion-inhibited chemicals had 60% less corrosion than similar coupons exposed to salt. The guardrail-mounted coupons exposed to corrosion-inhibited chemicals had 17% more corrosion than similar coupons exposed to salt.

Figure 4 shows corrosion in sheet aluminum coupons mounted on maintenance trucks, supervisor trucks, and guardrail in the SC salt and the NC corrosion-inhibited chemical sections. The maintenance truck-mounted coupons exposed to corrosion-inhibited chemicals had 180% more corrosion than similar coupons exposed to salt. The supervisor truck-mounted coupons exposed to corrosion-inhibited chemicals had 13% more corrosion than similar coupons exposed to salt. The guardrail-mounted coupons exposed to corrosion-inhibited chemicals had 100% more corrosion than similar coupons exposed to salt.

Figure 5 shows corrosion in cast aluminum coupons mounted on maintenance trucks, supervisor trucks, and guardrail in the SC salt and the NC corrosion-inhibited chemical sections.

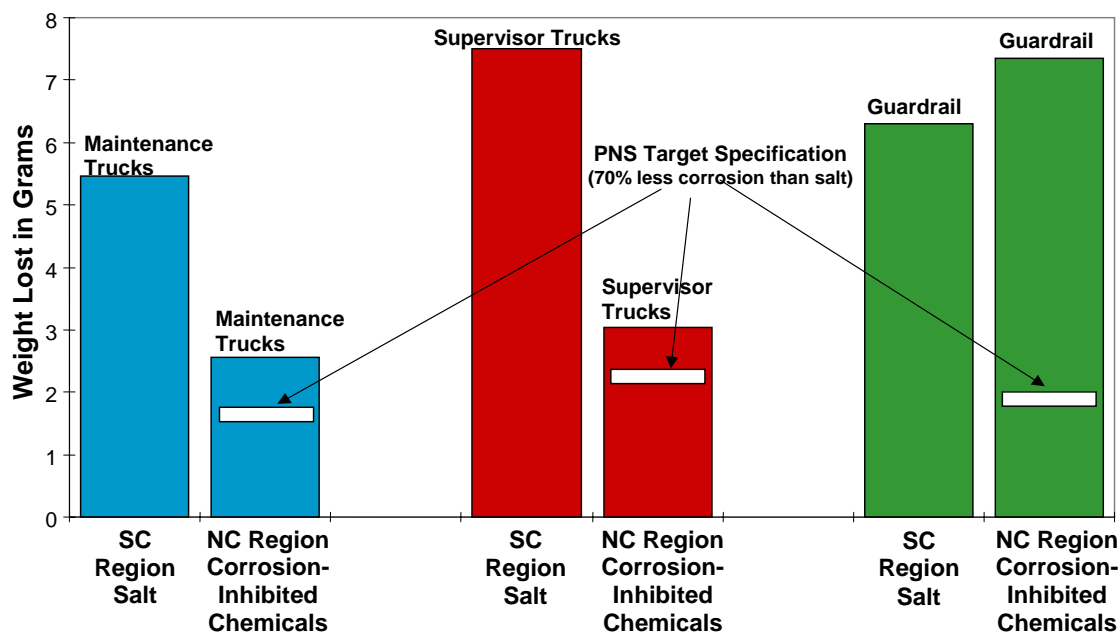

FIGURE 3 Steel coupon corrosion in SC and NC region test sections.

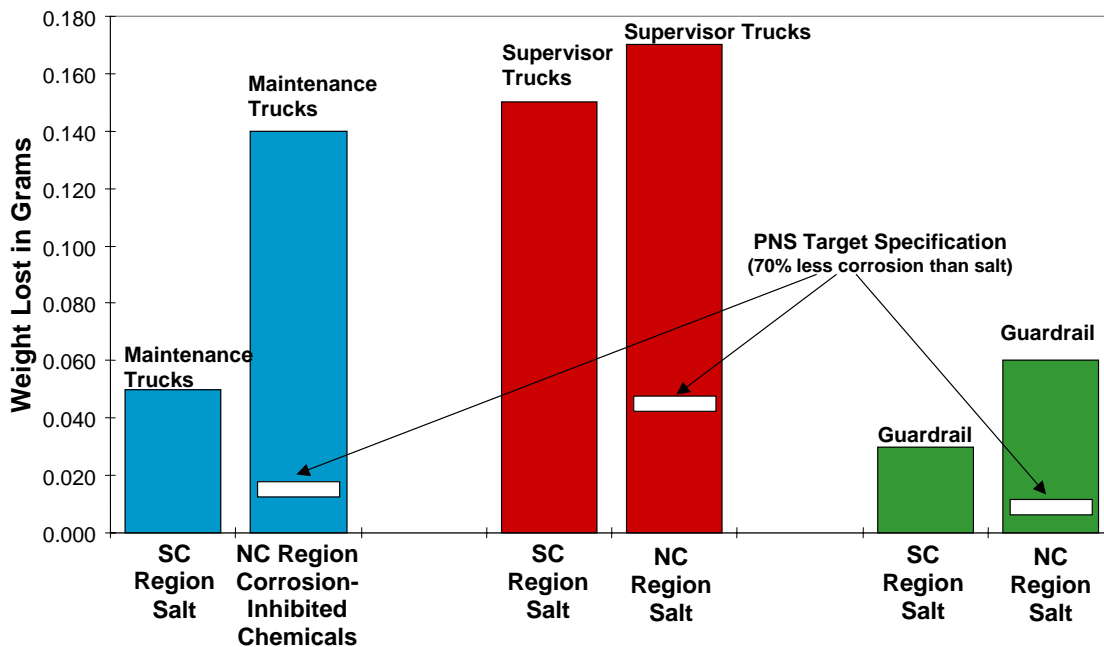

FIGURE 4 Sheet aluminum coupon corrosion in SC and NC region test sections.

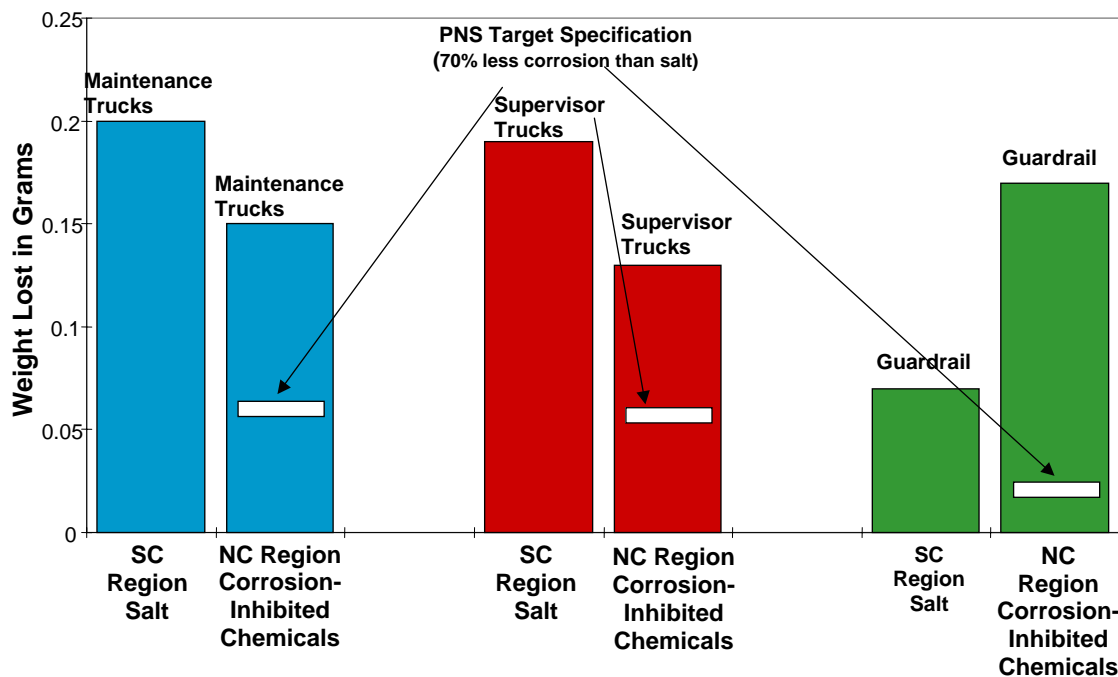

FIGURE 5 Cast aluminum coupon corrosion in SC and NC region test sections.

The maintenance truck-mounted coupons exposed to corrosion-inhibited chemicals had 25% less corrosion than similar coupons exposed to salt. The supervisor truck-mounted coupons exposed to corrosion-inhibited chemicals had 32% less corrosion than similar coupons exposed to salt. The guardrail-mounted coupons exposed to corrosion-inhibited chemicals had 143% more corrosion than similar coupons exposed to salt.

Eastern Region Salt and Corrosion-Inhibited Chemicals

Figure 6 shows corrosion in steel coupons mounted on maintenance trucks, supervisor trucks, and guardrail in the eastern region salt and corrosion-inhibited chemical sections. The maintenance truck-mounted coupons exposed to corrosion-inhibited chemicals had 30% less corrosion than similar coupons exposed to salt. The supervisor truck-mounted coupons exposed to corrosion-inhibited chemicals had 27% less corrosion than similar coupons exposed to salt. The guardrail-mounted coupons exposed to corrosion-inhibited chemicals had 9% more corrosion than similar coupons exposed to salt.

Figure 7 shows corrosion in sheet aluminum coupons mounted on maintenance trucks, supervisor trucks, and guardrail in the eastern region salt and corrosion-inhibited chemical sections. The maintenance truck-mounted coupons exposed to corrosion-inhibited chemicals had 140% more corrosion than similar coupons exposed to salt. The supervisor truck-mounted coupons exposed to corrosion-inhibited chemicals had 162% more corrosion than similar coupons exposed to salt. The guardrail-mounted coupons exposed to corrosion-inhibited chemicals had 50% less corrosion than similar coupons exposed to salt.

Figure 8 shows corrosion in cast aluminum coupons mounted on maintenance trucks, supervisor trucks, and guardrail in the eastern region salt and corrosion-inhibited chemical

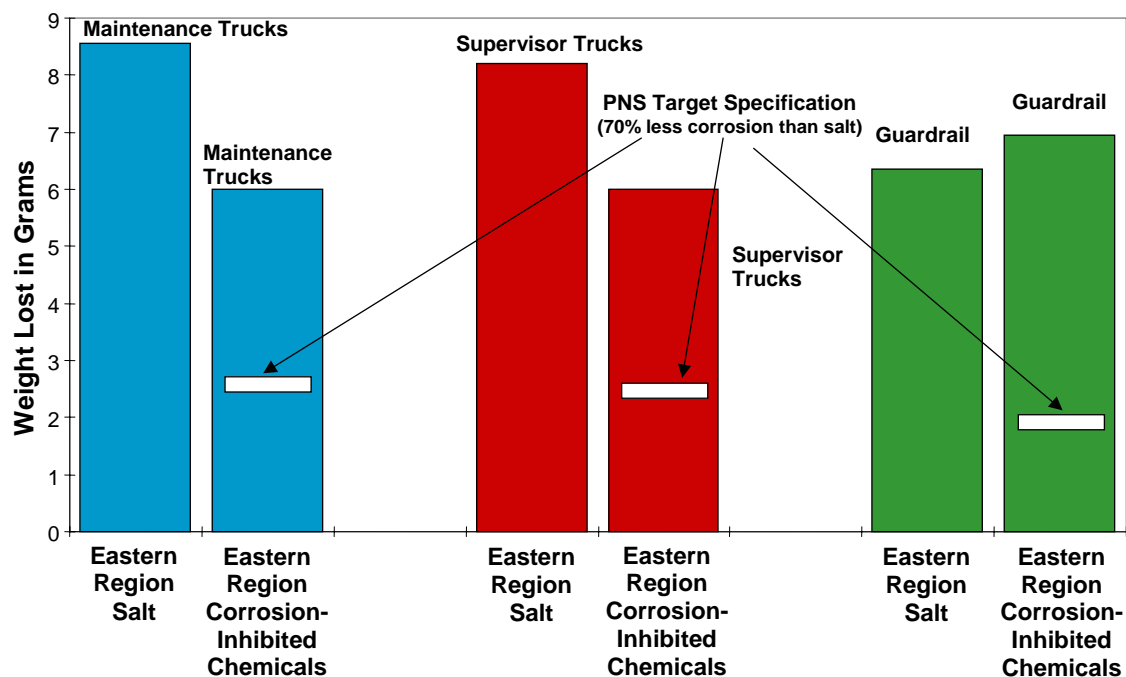

FIGURE 6 Steel coupon corrosion in eastern region test sections.

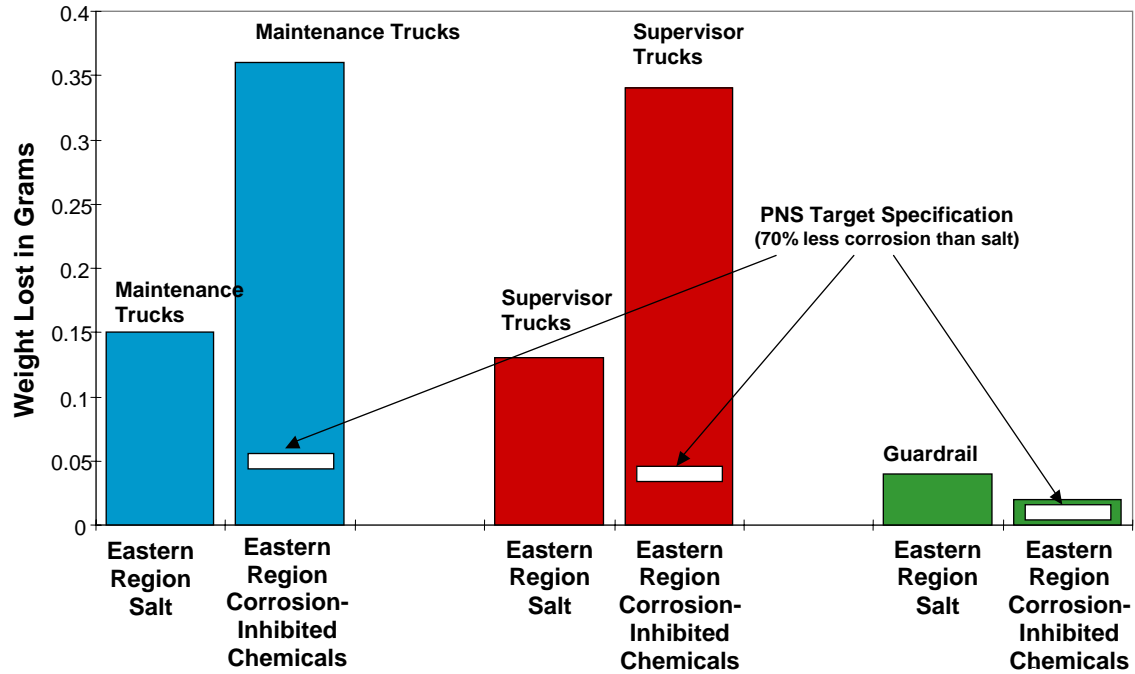

FIGURE 7 Sheet aluminum coupon corrosion in eastern region test sections.

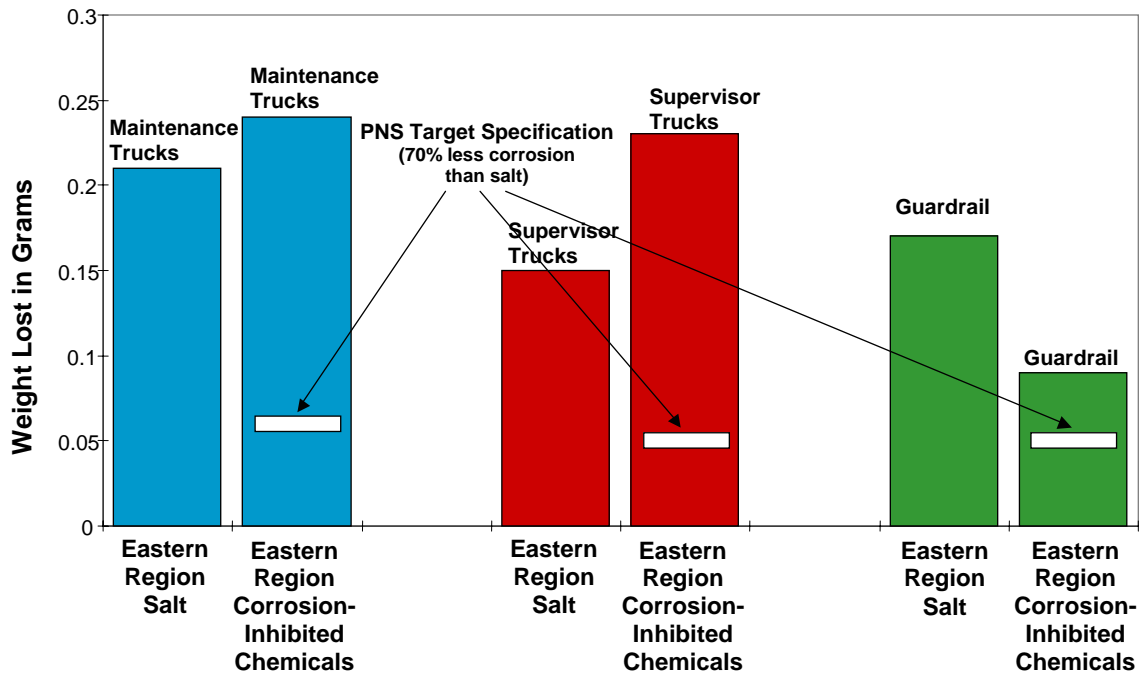

FIGURE 8 Cast aluminum coupon corrosion in eastern region test sections.

sections. The maintenance truck-mounted coupons exposed to corrosion-inhibited chemicals had 14% more corrosion than similar coupons exposed to salt. The supervisor truck-mounted coupons exposed to corrosion-inhibited chemicals had 53% more corrosion than similar coupons exposed to salt. The guardrail-mounted coupons exposed to corrosion-inhibited chemicals had 47% less corrosion than similar coupons exposed to salt.

Discussion

The steel coupons that were attached to maintenance trucks indicated that corrosion-inhibited chemicals provided some reductions (53% and 30%) to corrosion rates compared with corrosion rates of sodium chloride. These reductions fell short of comparable results from laboratory corrosion analysis as well as the PNS corrosion specification. Of the two corrosion-inhibited liquid chemicals used in the corrosion-inhibited chemical sections, the section using the liquid, calcium chloride product showed better corrosion reduction than the section using the liquid magnesium chloride product in both lab analysis as well as corrosion in the truck-mounted, steel coupons.

In most cases with both types of aluminum coupons that were attached to maintenance trucks, the corrosion rates from exposure to corrosion-inhibited chemicals were actually higher than rates from exposure to sodium chloride. Once again, the actual corrosion rates were significantly different from the PNS corrosion specification. The PNS corrosion specification and accompanying laboratory test were developed with corrosion to steel in mind. The information on the sheet and cast aluminum coupons indicates that the PNS specification has little to no relevance to actual corrosion of aluminum.

Both the steel and aluminum coupons mounted on the supervisor pickup trucks showed similar corrosion rates, as did those coupons from the maintenance trucks. For steel coupons, corrosion in the corrosion-inhibited control sections was less than that in the salt sections but far short of the PNS specification level. For the aluminum coupons, corrosion in the corrosion-inhibited chemical sections was either in excess or slightly less than in the salt sections and fell far short of the PNS specification level.

While the corrosion-inhibited chemicals resulted in some levels of reduced corrosion to steel coupons on maintenance and supervisor trucks, this was not the case with steel coupons mounted on guardrail posts. There was more corrosion on guardrail-mounted steel coupons exposed to corrosion-inhibited chemicals than those exposed to salt. Additionally, the total amount of corrosion on these coupons was greater than the total amount of corrosion on the truck-mounted coupons. While the reasons for this disparity are unknown, it does raise the question of whether corrosion inhibitors are providing any actual corrosion reduction in bridges. If corrosion rates associated with corrosion-inhibited chemicals increase as they migrate 10 ft from where they are applied to the roadway, do they also increase as the chemicals migrate into bridge decks through pavement cracks or drip down onto structural components of the bridge below the bridge deck? This corrosion information indicates that the PNS specification and accompanying laboratory procedure lack a direct and predictable relationship to corrosion rates that actually occur in the roadway and roadside environment.

Corrosion results in the SW region test area were generally similar to those reported above. As such, they are not reported separately in this paper.

ENVIRONMENTAL IMPACTS

As part of this pilot project, Washington State DOT environmental staff conducted field sampling and laboratory analysis to assess the level of chloride residue in the roadside environment.

Sampling Methodology

Within each of the four designated sections along I-90 (two sections using corrosion-inhibited chemicals and two sections using sodium chloride), four sample locations were identified. These locations generally were chosen for the potential for chlorides from highway snow and ice control activities to enter nearby waters. However, due to the semi-arid nature of the Columbia River basin, some sections did not have any water bodies nearby that were suitable for sampling. Two sample locations along SR 6 had standing water present. All sample locations were recorded into a Global Positioning System. A total of 40 soil, 8 surface water, 10 sediment, and 4 drinking water samples were taken during the prewinter and postwinter sampling efforts.

Surface soil samples were collected from each location adjacent to the edge of the pavement, 10 ft from the edge of the pavement, and in the sediment at the bottom of a roadside ditch or pond if present. Samples were taken at an approximate depth of 3 in. below the surface. Surface water bodies were sampled only if they were considered nonflowing (e.g., ponds and lakes). Flowing water bodies were not selected because of the dilution factor. Several past studies have shown that in flowing water, chlorides are rapidly diluted and leave little or no detectable chlorides. A ground water sample was also obtained from each I-90 section from water fountains located at safety rest areas. Each of the rest areas was served by a Washington State DOT–owned well that serves that specific rest area only.

The prewinter sampling event (sample 1) occurred during the summer and fall of 2002. The postwinter sampling event (sample 2) occurred during spring of 2003. The prewinter and postwinter samples were collected within 1 ft of each other.

Results and Discussion

Chloride levels in all mediums tested were fairly low (below 250 parts per million). There are several variables that make comparisons of chloride levels in environmental compartments difficult. Sodium chloride and the corrosion-inhibited chemicals both contain chloride ions. Another variable is that calcium chloride and magnesium chloride both have twice the number of chloride ions as sodium chloride. The information does not reveal significant differences in chloride levels resultant of the application of corrosion-inhibited chemicals compared with sodium chloride. The information indicates that Washington State DOT's application of deicing chemicals, either corrosion-inhibited or sodium chloride, is not resulting in chloride levels that are above any state or federal standard or guideline.

The information indicates that chloride concentrations in the soil are highest at the roadside and in the sediment and somewhat lower at the 10-ft sampling stations. This may be due to the fact that in most places along this stretch of I-90, the 10-ft station tends to be on a fairly steep slope. The drinking water data indicate no chloride influence from the anti-icing operation. No significant differences in chloride levels were identified at the end of winter compared with

before winter commenced. Since no midwinter snowmelt events were measured, it is unknown if short-term changes in chloride levels occurred during winter

SIGNIFICANT PROJECT FINDINGS

This evaluation indicated that the use of corrosion-inhibited chemicals was not resulting in the levels of reduced corrosion for which these chemicals were specified, tested, and purchased. In some scenarios, use of the corrosion-inhibited chemicals resulted in less corrosion than did the use of salt. However, the use of corrosion-inhibited chemicals did not meet the specification target in any of the scenarios evaluated. In other scenarios, the corrosion-inhibited chemicals resulted in more corrosion than did the use of salt. The significant differences in relative corrosion rates and the consistent pattern of not meeting the reduced corrosion specification strongly indicated that the current corrosion specification and related laboratory testing protocol lacked a direct and predictable relationship to corrosion rates that actually occurred in the roadway and roadside environment.

The corrosion-inhibited chemicals used in this evaluation generally appeared to be more aggressive in corroding the sheet and cast aluminum alloys tested than did salt. It was not known whether this was caused by the chloride compound itself or the corrosion-inhibiting additive. The project findings seemed to support the increasing complaints from motorists (including a significant amount of complaints from the trucking industry) about corrosion to aluminum. The focus of the development of the PNS corrosion specification was on corrosion to steel. The project findings indicated the specification did not address impacts to sheet and cast aluminum.

The project findings showed some interesting variations in corrosion rates from the use of corrosion-inhibited chemicals. The chemicals met, or came close to meeting, the corrosion specification when they were delivered to Washington State DOT maintenance yards. The chemicals' effectiveness (related to reduced corrosion) appeared to be reduced after they are applied to the roadway and motor vehicles were exposed to them. As the chemicals were splashed off the roadway or otherwise migrated to the roadside, the findings indicated some significant changes in corrosion rates. In some cases, corrosion rates on the guardrail-mounted coupons were less than on the truck-mounted coupons. In other cases, corrosion rates were more than twice as high at the guardrail location than they were on trucks. This could have significant ramifications to corrosion issues related to bridges, steel re-bar in concrete pavement, and other metal-containing highway features. This is an area on which additional research should focus.

The general performance of salt was found to be favorable in comparison with the corrosion-inhibited chemicals tested. The maintenance crews using salt were able to deliver an LOS comparable with that delivered by crews using corrosion-inhibited chemicals. The primary limitation of salt is the relatively limited temperature range in which it will work. The mild winter during the pilot project was well suited for the use of salt. The lack of significant snowfall and black ice events during the pilot project resulted in limited opportunities for a full operational evaluation of salt.

The materials costs of using salt brine and rock salt were significantly less than comparable costs of using corrosion-inhibited chemicals. Use of a factory-built brine maker turned out to be a cost-effective method of supplying maintenance crews with liquid anti-icers. There are indications that the cost of using salt could be less than that incurred during this evaluation. In looking at costs other than for materials, labor and equipment costs were

comparable between those sections using salt and those sections using corrosion-inhibited chemicals. In evaluating environmental costs (impacts), there appeared to be little to no difference in impacts between salt use and the use of corrosion-inhibited chemicals. They both were applied in a similar fashion, and they both contain comparable levels of chlorides. In evaluating corrosion costs, the evaluation did not provide enough information for a definitive comparison. Although the use of corrosion-inhibited chemicals appeared to reduce corrosion of steel in motor vehicles (and hence some level of potential, eventual cost savings), the findings indicated the possibility of less corrosion reduction (and hence some level of potential, eventual cost increases) as chemicals moved from the roadway to the roadside. Also although the use of corrosion-inhibited chemicals appeared to reduce corrosion costs related to steel, it appeared to increase corrosion related to aluminum. Some costs also were associated with these impacts.

ENVIRONMENTAL STEWARDSHIP

Modeling Exposure of Roadside Environment to Airborne Salt *Case Study*

MATS GUSTAFSSON**GÖRAN BLOMQVIST***Swedish National Road and Transport Research Institute*

A field study was performed in order to investigate the relationships between the salt use, the mechanisms affecting the salt emission and dispersion, and the salt exposure in a modeling approach. The salt was collected on gauze filter salt vanes at distances of 2.5 to 100 m from the road, allowing a time resolution of 30-min to 24-h exposure time. The results will be implemented in a winter maintenance management model under development by the Swedish National Road and Transport Research Institute. The results showed that the roadside exposure to airborne salt was related strongly to the wind direction. The road conditions of packed snow and thin ice seemed to abate the roadside exposure temporarily by capturing the salt on the road surface. Even at a distance of 100 m from the road, a positive relation of the wind sum and chloride deposition showed on days with strong winds. The modeling approach indicates the importance of residual salt, traffic, road surface characteristics, and wind for roadside exposure but also indicates that there are several aspects of these variables that need further investigation.

BACKGROUND

Salt has been widely used for decades in order to maintain road safety and accessibility of the road network at acceptable levels also during the winter season. The use of sodium chloride for deicing and anti-icing purposes started in the 1940s in the United States and has increased ever since, as motoring has developed (1). In the Nordic countries the use of deicing salt started in the mid-1960s. Already at an early stage, it was recognized that the use of salt had not only the desired effect of improved traffic safety and accessibility but also several negative impacts. Numerous investigations of impacts on vegetation, soil, and groundwater have been presented, and the matter is still of great concern in North America, Europe, and Japan. Recent studies made in Sweden have been examining the problem in relation to damage to roadside vegetation (2) and in relation to damage to groundwater aquifers (3).

The transport of salt from the road to the roadside environment is the main environmental concern of winter maintenance. The basic mechanisms determining the salt exposure are salt dose to the road, road conditions, traffic characteristics (type, intensity, and speed), and meteorological parameters, such as wind. Salt use is the origin of salt exposure and naturally affects the deposition in the roadside environment. Salt use in combination with wind can result in the kind of patterns seen in Figure 1 (4). The deposition follows the salt use, and the lee side of the road receives markedly higher amounts of salt than the upwind side. The importance of wind as the main transport mechanism was shown by Blomqvist (4) by studying the percentage of winds with a road perpendicular wind component toward the road in relation to the percentage of chloride deposition into containers placed on the downwind side of the road (Figure 2). The

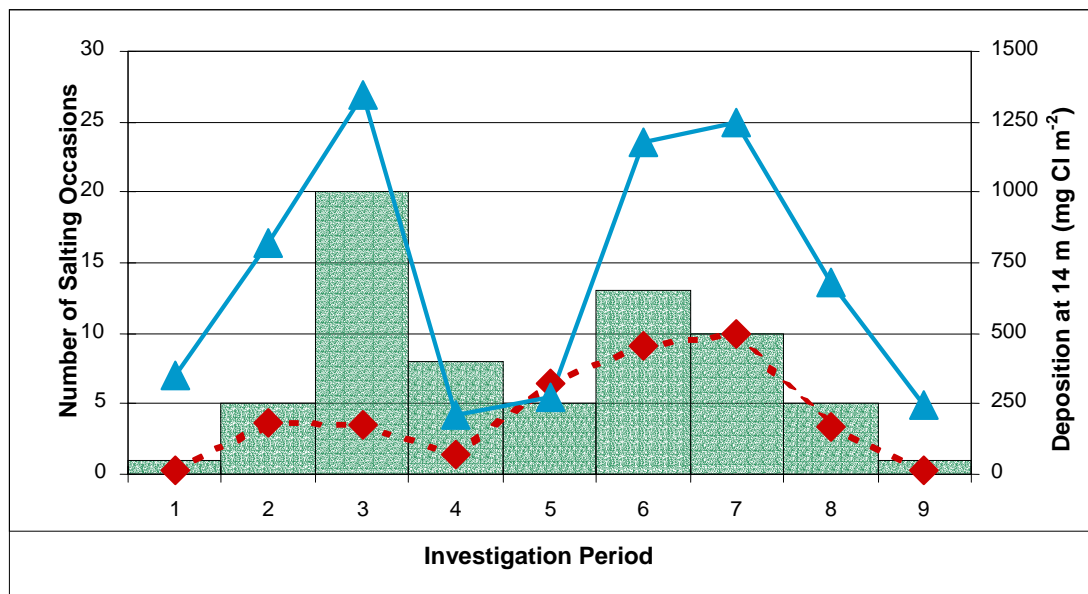

FIGURE 1 Relation between the salt use and the deposited amount of chloride on the southeastern (triangles) and northwestern (squares) side of the road, at 14-m distance during the nine investigated periods (4).

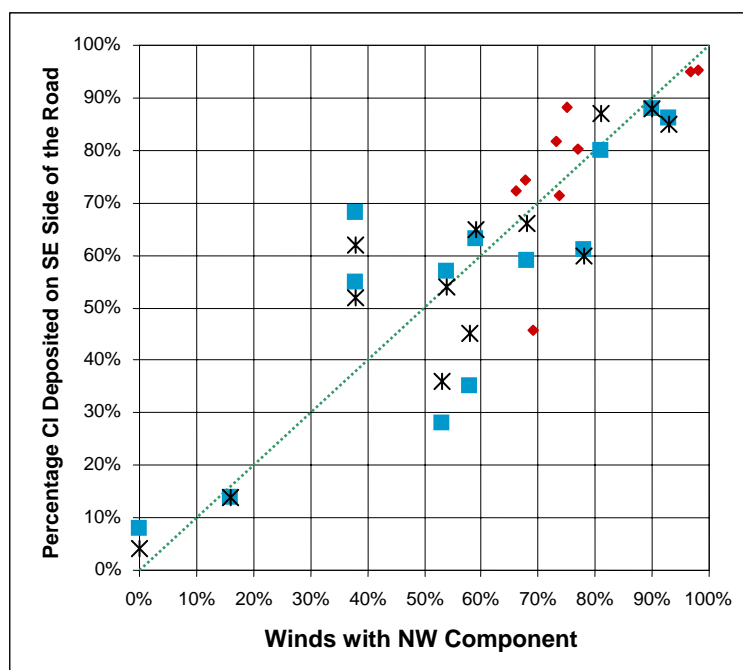

FIGURE 2 Percentage of Cl deposited on the southeastern side of the road as related to the percentage of winds with a NW component (4)
(□ = 12 m, * = 20 m, ◆ = 14 m).

correlation was good especially when the wind was blowing almost exclusively from one side. In between these extremes the divergence was somewhat larger.

Few investigations have related the roadside salt exposure to the deicing action itself, to the road-surface and traffic characteristics during the action, or to meteorological conditions. Knowledge of these relationships would aid the road administrator in managing the deicing action so as to minimize undesired consequences.

At the Swedish National Road and Transport Research Institute (VTI) a winter maintenance management system (winter model) is under development. The winter model consists of submodels for assessing the state of the road, its effects, and their appraisalment [see State-of-the-Art Fixed Automated Spray Technology (FAST) by Jerry R. Waldman on pp. 379–390 in this circular]. One of the submodels is describing the environmental effects by modeling the roadside exposure to salt. The aim of this paper is to investigate the relationships between the salt use, the mechanisms affecting the salt emission and dispersion, and the salt exposure in a modeling approach.

METHOD

Two field sites were equipped with salt vanes—constructions holding gauze filters perpendicularly aligned toward the wind (Figure 3) (5). The vanes also were equipped with a roof to protect the filter from precipitation. The use of such filters at distances of 2.5 to 100 m from the road allowed a time resolution of 30-min to 24-h exposure time, depending on the rate of roadside exposure. The field sites were equipped with instruments for the registration of traffic characteristics (type and volume) at 1-h resolution and wind (speed, direction) at 30-min resolution.



FIGURE 3 Salt vane at the Vimmerby field site.

Although the salt vanes are not comparable to a natural surface like a tree, they have many practical advantages. The filters are clean from salt, they each have the same surface area and structure, and the washing procedure to extract the collected salt is easy to standardize. Salt vanes are therefore suitable for empirical modeling. The salt content on the filters is washed off the filter by de-ionized water in an ultrasonic bath for 2 min. The washed-off salt solution is then investigated for its concentration of chloride.

At the Vimmerby field site, one salt vane was placed on each side of the road, 10 m from the outer road markings. At the Klockrike field site, both sides of the road were equipped with salt vanes at 2.5, 5, and 10 m. An additional salt vane was placed at 100 m from the road to serve as a background measurement. The salt vanes were exposed in 24-h periods from noon to noon.

At Vimmerby, traffic data were acquired from a magnetic induction traffic counter installed in the pavement and weather data from a road weather information system (RWIS) station at the same location. Road surface conditions and salting occasions were registered visually. At Klockrike traffic data were collected by a rubber tube traffic counter. Weather data were acquired from a nearby RWIS station. Residual salt measurement in a transect across the road was used to follow up the salt content on the road surface after salting.

In the empirical modeling attempt the road perpendicular wind component was used together with salt use, road conditions, and traffic data.

RESULT AND DISCUSSION

One-hour salt vane data from Vimmerby during a period with a relatively constant wind direction and several salting occasions (Figures 4 and 5) showed how the resulting salt exposure on the lee side of the road directly reacted on the salting during a morning hour snowfall. As the road condition (Figure 5) was characterized as packed snow or thin ice, the salt exposure fell, probably because of very little splash and spray production during these road conditions (see hours 10, 15, and 16 in Figure 4). The exposure rose again when the road condition turned to snow slush. During this large variation in exposure on the lee side, the exposure on the windward side of the road was constantly low, a finding emphasizing the importance of the wind direction.

At the Klockrike field site a 24-h salt vane sampling was used. The results from the salt vane transect at both sides of the road showed that salt exposure rapidly decreased with distance from the road (Figure 6). It also is obvious how the relative level and decrease of the exposure profiles on both sides of the road followed the direction of the road perpendicular wind component (Figure 7). The deposition on both sides of the road was low until the February 16, when a rise in the deposition on the south side of the road became clear. The salting of the road actually took place already in the morning of the February 15 and also was seen in the amount of residual salt in the wheel tracks (Figure 7). But probably due to the lower traffic on the Saturday and Sunday and the relatively low wind speeds, the increase in the roadside exposure was not seen until the northerly winds and the increase in traffic took place in the Monday morning of February 17. The main part of the salt migrated to the southern part of the road during the 24-h measurement from noon to noon, February 16–17, because of the prevailing northerly winds.

The residual salt, however, increased already on February 13 (Figure 7, top). Surprisingly no salting occasion occurred on this date. The increased residual salt probably was a result of a light snowfall causing accumulated, dried-up salt on the road margins to dissolve and migrate into the driving lane, where it was emitted by passing vehicles. This situation is further discussed by Blomqvist

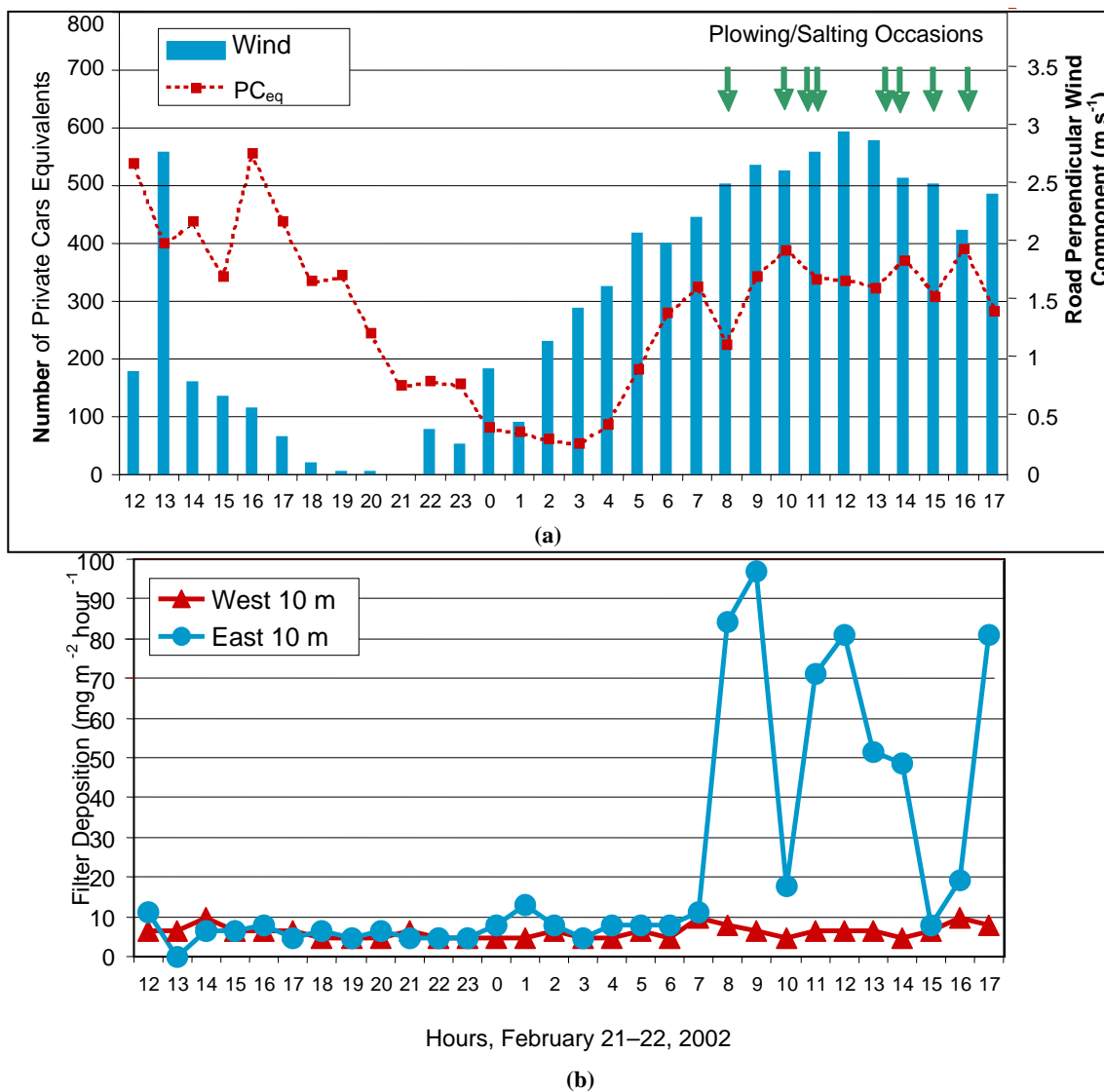

FIGURE 4 Field data from Vimmerby field site: (a) wind and traffic characteristics during the investigation period (the plowing and salting passages are marked by arrows, pointing out their occasions in time) and (b) the amount of chloride deposited on the salt vane filters on each side of the road.



FIGURE 5 Road surface observations in Vimmerby field study.

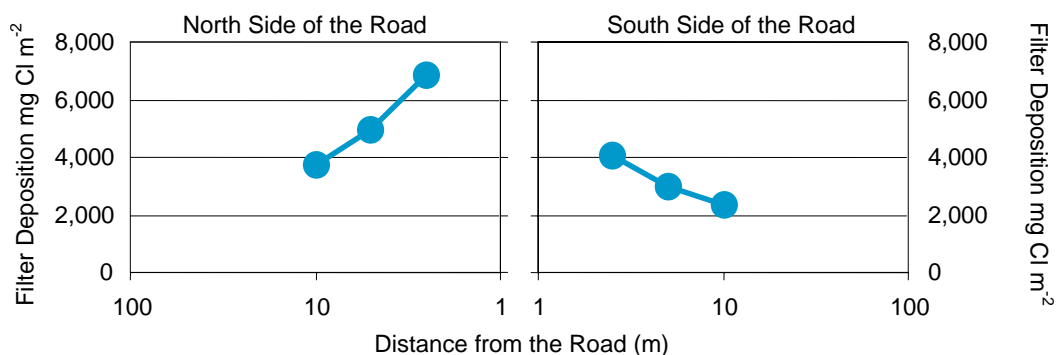

FIGURE 6 The accumulated deposition of chloride on the salt vane filters during the 25-day investigation period in Klockrike field site.

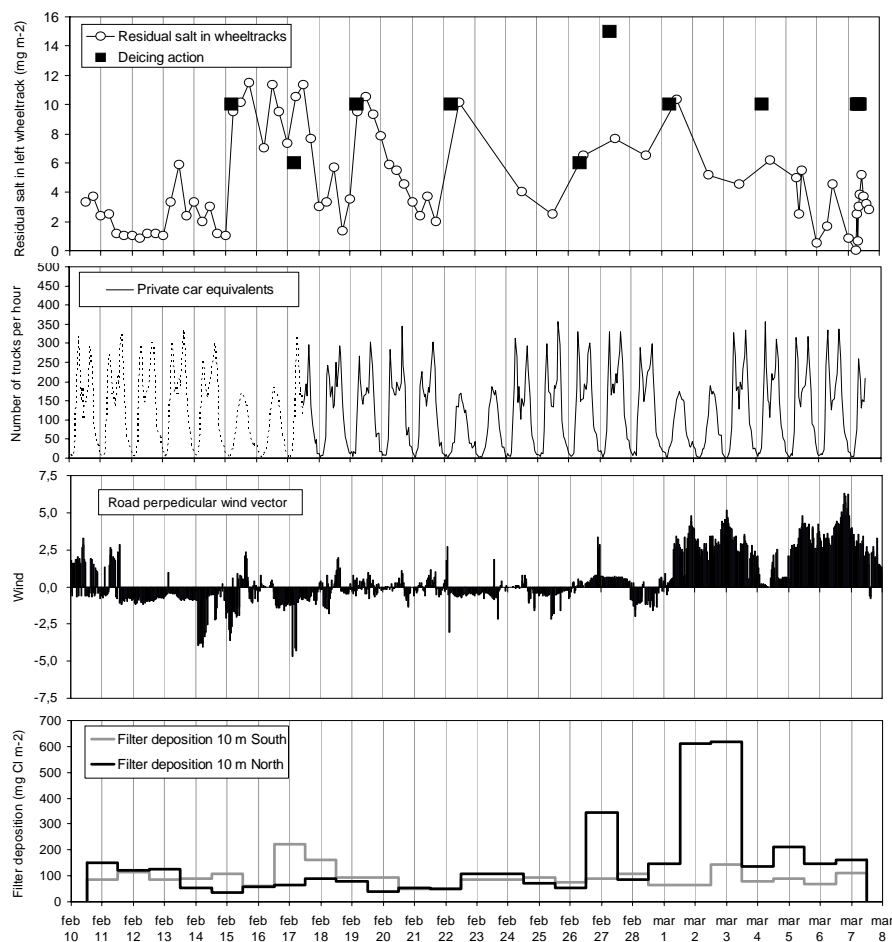

FIGURE 7 Field data from Klockrike field site. From top: Salting occasions and measured residual salt in the left wheel tracks, traffic characteristics as calculated private car equivalents, wind characteristics as calculated road perpendicular wind vector, and chloride deposition on salt vane filters 10 m from the road.

and Gustafsson in *Patterns of Residual Salt on Road Surface: Case Study*, pp. 602–608.

The highest exposure levels were found on March 1–3. This episode was triggered by a salting occasion on March 1, causing rather high residual salt levels. Traffic in combination with a high road perpendicular wind component resulted in high exposure levels on the leeward road side (Figures 7 and 8). A similar situation with high salt exposure levels could be seen during February 26 and 27. In contrast to the situation of March 1–3, the winds were aligned more with the road orientation. This could cause a high turbulence, which could be reflected by the gradients on both sides of the road and also a more rapid decrease with distance from the road (Figure 8). The road perpendicular wind component may not have been good enough to describe the actual wind situation, since the same perpendicular wind factor could represent totally different wind situations regarding the direction and speed. Therefore, there was an obvious need to develop a more efficient way to use the wind data for modeling purposes.

Also the salt vane at 100-m distance from the road received salt from the road. This was seen clearly when the southerly wind components were summed up for each 24-h measuring period and compared with the amount of chloride deposited (Figure 9). This showed a positive relationship for higher wind sums, implying that the exposure at 100-m distance was influenced when the wind was strong enough toward that direction.

MODELING APPROACH

The exposure of salt can in its roughest form be seen as a function of residual salt available for emission, traffic volume, wind, and road surface conditions. In another paper presented at this symposium (*Patterns of Residual Salt on Road Surface: Case Study*, pp. 602–608) by Blomqvist and Gustafsson, an empirical modeling approach for residual salt has been presented. In the suggested model the decline of the residual salt on the road surface can be described as

$$RS = S \cdot e^{-k \cdot PC_{eqacc}} \quad (1)$$

where

RS = residual salt,
 S = salt use, and
 PC_{eqacc} = accumulated private car equivalents.

The basic empirical approach can be described as

$$E = f(RS, PC_{eq}, W_{PC}, RSF)$$

where

E = emission,
 RS = residual salt available,
 PC_{eq} = private car equivalents
 W_{PC} = perpendicular wind component, and
 RSF = road surface condition factor.

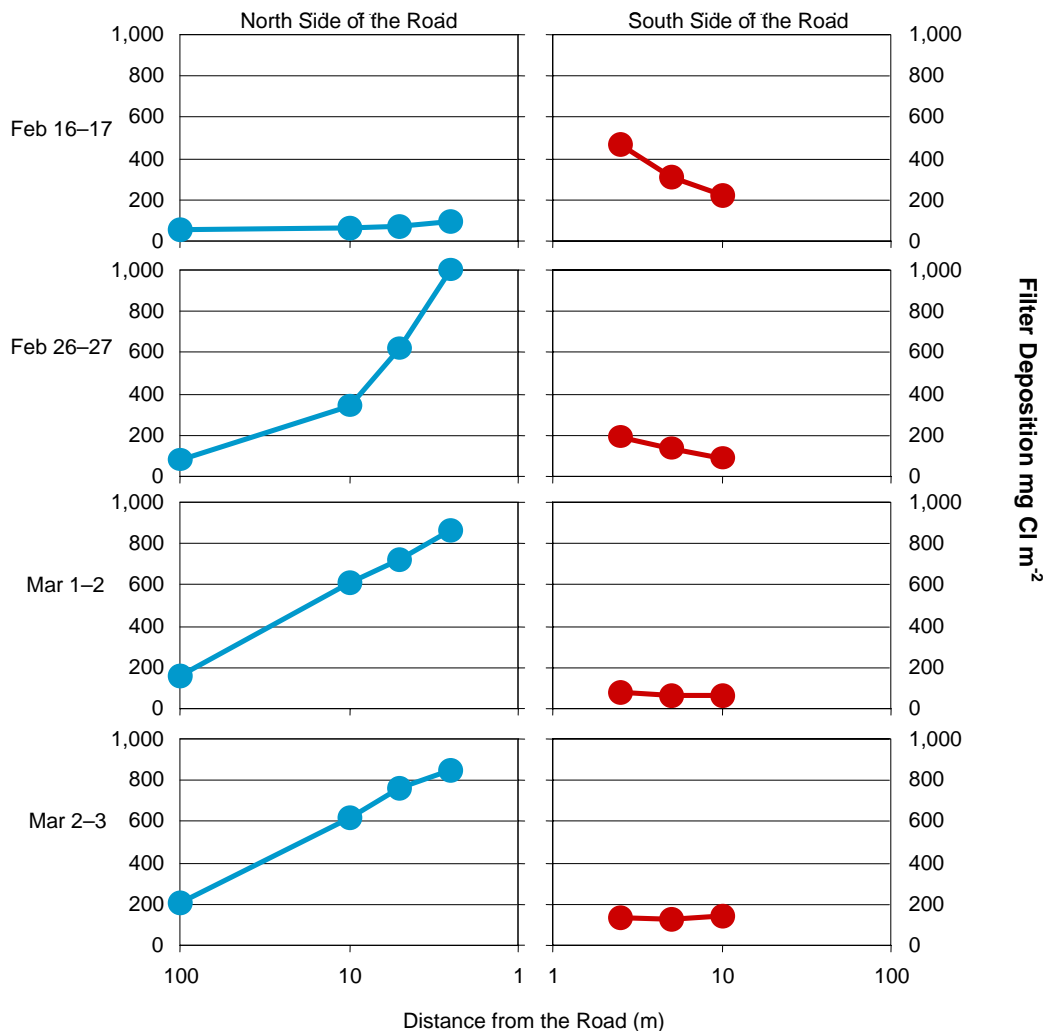

FIGURE 8 Examples of different deposition patterns from Klockrike field site.

A modeling attempt was made with data from Vimmerby (Figures 4 and 5). The same approach was used regarding the decline of residual salt as in Blomqvist and Gustafsson (in this circular). The model tested was

$$EXP = RSF \cdot RS \cdot W_{PC}^2 \cdot Cl + EXP_B \quad (2)$$

where

EXP = chloride exposure on filter,
 Cl = factor for converting NaCl to Cl, and
 EXP_B = background exposure.

In order to test this model approach with the data collected in Vimmerby, the following

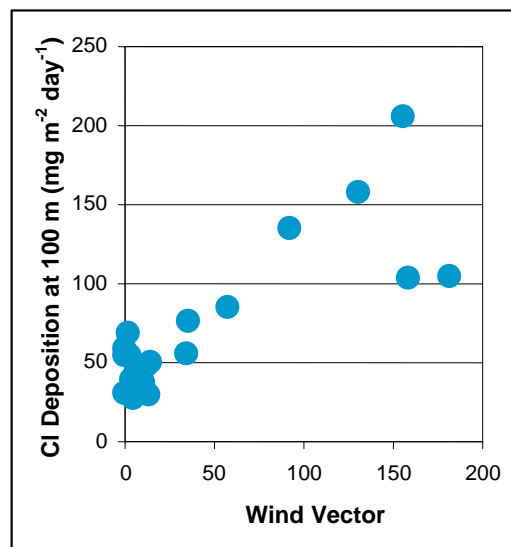

FIGURE 9 The relation between the wind vector (accumulated 30-min measurements for 24 h) and the amount of chloride deposited 100 m from the road.

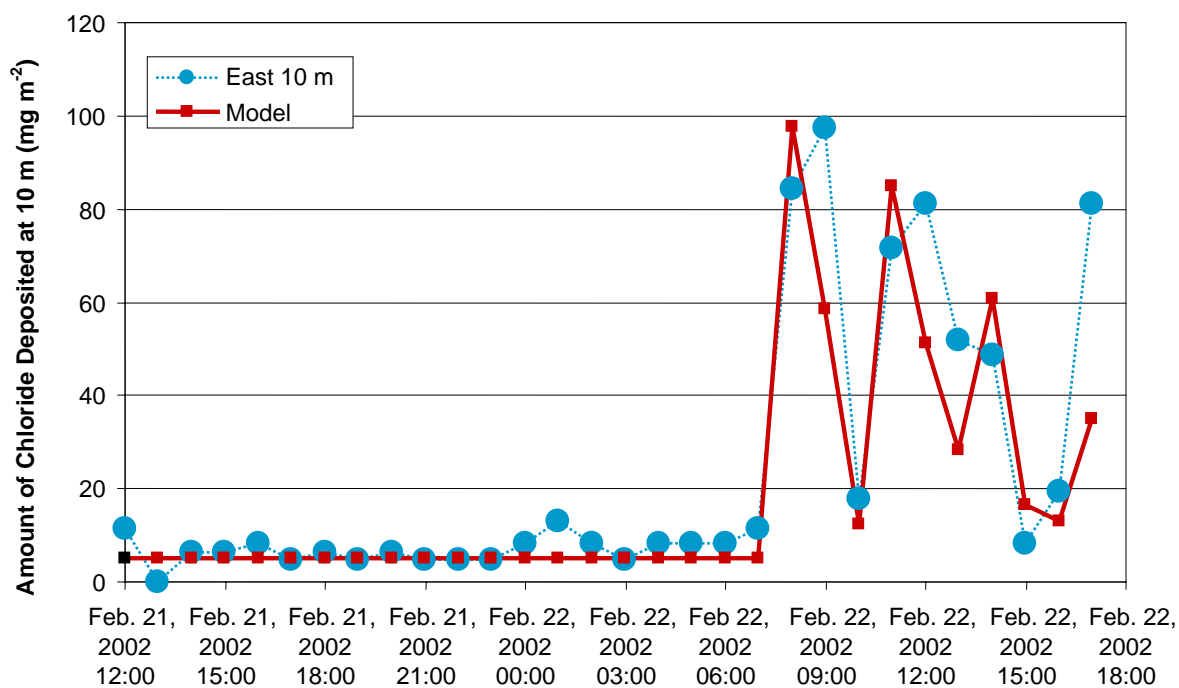

FIGURE 10 A model of the amount of chloride deposited on a salt vane filter 10 m from the road as compared with the measured amount.

assumptions were made regarding the road surface condition factor: when the road conditions were wet asphalt and loose snow, the *RSF* was set to 3; when the road condition was slush, the *RSF* was set to 1; and when the road conditions were packed with snow and thin ice, the *RSF* was set to 0.2. At each passage of the salting and plowing vehicle it was assumed to spread 10 gm^{-2} . The rate of decline was assumed to be 10 times faster in Vimmerby than in the residual salt model from Klockrike (Blomqvist and Gustafsson, pp. 48) because of the expected faster decline due to the much wetter road surface conditions in the Vimmerby field test. So far the model seemed to be fairly adequate (Figure 10), but with so many assumptions that have not yet been verified, the validation of the model required more field data. The winters of 2003–2004 and 2004–2005 will be used in order to collect data so that the model assumptions can be better elaborated.

Issues that need to be addressed during the upcoming field studies are

- How should road surface conditions be incorporated into the model?
- How should the different parts of wind data (direction and speed) be used to describe better the influence of wind on the resulting roadside exposure patterns?
- How does traffic composition affect the roadside exposure?

ACKNOWLEDGMENT

This study was made as part of the winter model project that is conducted at VTI and is financed by the Swedish National Road Administration and the Swedish Agency for Innovation Systems.

REFERENCES

1. *Special Report 235: Highway Deicing: Comparing Salt and Calcium Magnesium Acetate*. TRB, National Research Council, Washington, D.C., 1991.
2. Blomqvist, G. *De-icing Salt and the Roadside Environment: Airborne Exposure, Damage to Norway Spruce and System Monitoring*. Ph.D. thesis. Royal Institute of Technology, Stockholm, Sweden, 2001.
3. Thunqvist, E.-L. *Estimating Chloride Concentration in Surface Water and Groundwater due to Deicing Salt Application*. Ph.D. thesis. Royal Institute of Technology, Stockholm, Sweden, 2003.
4. Blomqvist, G. Patterns of Chloride Deposition Next to Roads as Influenced by Salting Occasions and Winds. Presented at 82nd Annual Meeting of the Transportation Research Board, Washington, D.C., 2003.
5. Gustafsson, M. E. R., and L. Franzén. Dry Deposition and Concentration of Marine Aerosols in a Coastal Area. SW Sweden, *Atmospheric Environment*, Vol. 30, No. 6, 996, pp. 977–989.

ENVIRONMENTAL STEWARDSHIP

Regulating Deicing Runoff from Highway Operations**RICHARD S. DAVIS***Beveridge & Diamond, P.C.*

This paper describes the increasing regulatory pressure on the runoff of roadway deicing chemicals projects future trends in the permitting of those discharges.

In recent years, increasing attention has been paid to the environmental consequences of pavement deicing activities. With the advent of the Clean Water Act's storm water permitting program in 1987, the U.S. Environmental Protection Agency was given an express mandate to control storm water discharges through federal wastewater discharge permits. Deicing discharges from roadways were excluded largely in the first phase of that program. Phase II of the storm water program brings a new focus on the potential water quality impact of highway deicing runoff. With this focus comes the increased likelihood that dischargers adjacent to impaired waters will be subjected to stringent permit terms.

As these trends mature, states may conclude that the issuance of permits for highway deicing runoff should be the rule rather than the exception. To meet this challenge, state departments of transportation and other entities responsible for roadway deicing activities should begin to think through the options with which they will be presented. Working with regulatory agencies early on to ensure that potential water quality impacts will be fairly and accurately characterized will be critical. Equally important will be advance work with permitting agencies to frame permitting strategies that would not unduly burden roadway deicing operations.

TWO PERSPECTIVES ON ROAD SALT RUNOFF***“Is Highway Runoff a Serious Problem?”***

Not necessarily. . . . When applied heavily and frequently, deicing chemicals can pollute receiving waters, but . . . [h]ighway runoff is generally not harmful.”
(Reproduced from U.S. Federal Highway Administration Technology Brief)

“Science Assessment Finds Road Salts Toxic to the Environment

In 1995, an expert advisory panel made up of scientists, environmentalists, health organizations, industry and other governments agreed on a list of 25 substances to be assessed for their toxicity to the environment and to human health under the Canadian Environmental Protection Act (CEPA). . . . The scientific assessment was carried out to determine the exact effects road salts were having on the environment.

The conclusion is that road salts are toxic to the environment

especially to streams, small lake ecosystems and to groundwater because of their widespread use and should be added to the List of Toxic Substances under CEPA.
(Reproduced from News Release by Environment Canada)

INTRODUCTION

Different observers often have starkly different assessments of the environmental implications of the road salt runoff from highway deicing operations. These somewhat edited, but fundamentally representative excerpts from Canadian and U.S. publications seem to reflect differences in perspective on this subject across the shared border. In Canada, with colder temperatures and a longer average icing season, concerns about the environmental effects of road salt runoff have crystallized into scientific assessment and regulatory action. In the United States, where the climate results in widely varying degrees of reliance on road salt to keep highways passable and safe, highway deicing runoff has received less focused attention, and both science and regulatory control have been less evident. That laissez-faire climate is about to change—perhaps radically.

Historically, U.S. environmental laws placed little emphasis on the regulation of any kind of storm runoff, including runoff from highway deicing operations. As those regulatory programs have matured, however, the importance of controlling storm water runoff has gained greater prominence. Today, an entire wing of the federal Clean Water Act's¹ National Pollutant Discharge Elimination System (NPDES) is devoted to managing pollutants borne by storm water.²

As the storm water permitting program continues to evolve, it promises to expand federal involvement in and control over roadway deicing discharges. Among other things, it will bring discharges from an increasing number of road-miles into the permitting system; it will establish and evaluate a database describing the impact of those discharges' potential to affect the quality of surface waters adversely; and it will provide the basis for further, more stringent regulation.

Perhaps equally important is what entities other than the U.S. Environmental Protection Agency (EPA) and the states may do with the information developed under this unfolding system. Private environmental groups will, for the first time, have access to information that characterizes the quality and impact of deicing runoff. They also will have the procedural tools, through the permitting process, to become involved in the development of storm water permits for new and existing highways drainage systems. That level of day-to-day citizen involvement in highway operating practices will present a multitude of new challenges for state highway managers.

From sources both public and private, then, it is reasonable to expect a major increase in the intensity with which highway deicing runoff is regulated in the United States. Whether it is in the need for permits, the need for the first time to assess the applicability of stringent numeric water quality-based discharge limitations, or the challenge of citizen participation in the regulatory and compliance enforcement arenas, state highway managers will see their environmental challenges begin multiply over the next 5 years.

This article provides a survey of the development of the regulatory systems that are beginning to control highway deicing discharge and the consequences of that growing control. It also discusses actions that the industry might consider to manage and direct the oncoming surge of regulatory and enforcement activity.

SOURCES AND CHARACTERISTICS OF DEICING RUNOFF

Runoff from highway deicing results from the co-mingling of deicing materials used with pavement runoff of storm water and snowmelt. A number of substances are used for treating and deicing roadway surfaces, including calcium magnesium acetate (CMA), potassium acetate (KAc), sodium chloride (NaCl), calcium chloride (CaCl₂), and magnesium chloride (MgCl₂). CMA and KAc are understood commonly to be the deicing chemicals with the smallest environmental footprints. The salts, NaCl, CaCl₂, and MgCl₂, leave residues of chloride ions that can be swept up in storm water runoff or snowmelt and carried into adjacent drainage ditches to be discharged into downstream surface waters. It is these deicing compounds that are the focus of the most intense environmental scrutiny.

Chloride concentrations from roadway deicing can be substantial. Although natural background concentrations in water may be only a few parts per million, roadway runoff during deicing operations has been measured as high as 18,000 mg/l. Resulting chloride concentrations in the environment also can be significant. Values measured in lakes can vary from 15 to 300 mg/l in rural settings to 2,000 to 5,000 mg/l in urban impoundments. Streams have been documented to carry concentrations as high as 4,300 mg/l.³

These values become important because of the relatively low thresholds at which chlorides can do harm to freshwater aquatic species. Acute toxicity (i.e., mortality) can result for half of the exposed *Ceriodaphnia dubia* at concentrations as low as 1,400 mg/l. Chronic toxicity is present at much lower concentrations, with about 10% of freshwater aquatic species affected adversely by concentrations at and above 240 mg/l.⁴ It is against this backdrop that the regulatory control of highway deicing runoff has developed.

HISTORY OF REGULATION IN THE UNITED STATES

There have been three distinct eras of storm water regulation in the United States. The pre-1987 period, when the NPDES program was originally established by the Clean Water Act, was in effect the first. Following that came the Phase I period of the federal storm water program, which was designed to issue discharge permits to the highest priority sources of contaminated storm water. Finally, today, there is Phase II of the storm water program, which addresses all other sources, including municipal separate storm sewer systems in so-called small municipalities. As we have passed from one era into the next, the degree of scrutiny focused on storm water discharges has increased, and ever more benign discharges have been required to obtain NPDES permits.

The development of this storm water regulatory program parallels, and in large measure drives, the expansion of the NPDES program into the permitting of roadway deicing discharges. For this reason, it is worthwhile for highway managers to take a few moments to understand how and why their discharges are coming under this new form of regulatory control.

Pre-1987 Period

From its enactment in 1972 until amendments made in 1987, the federal Clean Water Act contained a single standard for determining whether a discharge required a permit. When there was an addition of pollutants to waters of the United States through a point source, then there

was a discharge required to have a permit. Permits were issued initially by EPA and increasingly by delegated state agencies under what was known as the NPDES program.

Although countless storm water discharges, including many of those from highways during deicing operations, have always been required to have permits under that basic standard, it was rare for EPA or the states to issue an NPDES permit solely for storm water before 1987. In large measure this was because the permitting agencies were focused on controlling much more severe and visible sources of pollution in the process wastewater discharges from industry and the sanitary sewage discharges of municipalities. Permitting agencies committed their resources to bringing those discharges under control first and honored the requirement to permit storm water discharges only in the breach.

Phase I Storm Water Program

Once the major industrial and municipal discharges had been brought under some degree of control, EPA in the 1980s began focusing on the extent to which contaminants could be carried into surface waters by storm water. Following a number of studies variously addressed to urban runoff and nonpoint source discharges, EPA concluded that the lion's share of the pollution not yet permitted was being conveyed to the nation's streams and rivers by storm water runoff and snowmelt. With public attention beginning to focus on this previously ignored, but clearly jurisdictional set of discharges, Congress took action.

Phase I Program

In 1987, Congress passed substantive amendments to the 1972 Clean Water Act that among other things established a dedicated storm water permitting program for the first time.⁵ In the fine tradition of Washington, however, Congress jump-started storm water permitting by first outlawing it.

The 1987 amendments forbade EPA or the states to require permits for storm water *except* for storm water from certain high-priority industrial sectors. EPA was left to identify these presumably dirty industries, and it did so in a 1990 rulemaking. Permits were required of those sources of storm water by the early 1990s, and storm water pollution prevention plans were required of the newly permitted sources. The amendments and their implementing regulations also called for the permitting of storm water from municipal collection systems known as municipal separate storm sewer systems (MS4s) operated by large and medium-sized municipalities. Special pollution prevention and planning requirements were imposed on these municipal dischargers. In addition to these enumerated industrial and municipal storm water sources, any discharge of storm water that a permitting authority concluded had the potential to adversely affect water quality could be specially designated as requiring a permit, regardless of the industrial or municipal activity it might have arisen from.

Applicability to Highway Deicing Runoff

Highway runoff from deicing operations was not among the industrial activities from which storm water was required to be permitted under Phase I of the program. Moreover, state- or federally owned and operated highways generally did not fall into the definition of an MS4

operated by a large or medium-sized municipality. As a result, roadway deicing runoff was not, as a matter of course, drawn into the NPDES permitting program by the Phase I regulations.

Equally important, it was a rare case in which any storm water discharge was specially called out for permitting solely on the basis of its potential to harm water quality. On the relatively rare occasions that this occurred, the discharge usually was one that was so visible and notorious in its impact that local public opinion cried out for its control. Because deicing discharges most often occur in the dead of winter, and because chloride contamination is invisible to the naked eye, it is doubtful that more than a handful of highway deicing discharges were required to have permits under this first phase of the storm water program.

Phase II Storm Water Program

With the passage of time, the high-priority storm water discharges were brought into the permitting program. Now it was time to pursue the less important, presumably less damaging sources. Thus, Phase II of the federal storm water program was born in 1999.⁶

Phase II Program

Under Phase II, five major additions or changes to the program occurred. First, EPA determined that states would be responsible for designating additional industrial sources of storm water for permitting. As opposed to the approach taken in Phase I, second-tier industrial storm water dischargers would need to be affirmatively identified by state program offices rather than simply be identified on the basis of a nationally uniform federal regulation. Second, small municipal systems were covered by the permitting program for the first time. In general, these small MS4s needed to be in what were called urbanized areas in order to be designated automatically for permitting. Third, small MS4s not in urbanized areas could be designated specially under Phase II as requiring a permit if they satisfied criteria set out in the federal rule as applied by the states. Fourth, the threshold for permitting construction runoff was lowered from 5 acres in Phase I to 1 acre in Phase II. Finally, the new regulation provided that all storm water permittees (both under Phase I and Phase II) could be exempt from the obligation to maintain a permit if they certified (and maintained the certification) that storm water at the site did not come into contact with process materials.

The provisions governing small MS4s are of greatest interest to highway managers. On their face these regulations, which require permits of small MS4s, would seem not to apply to highway drainage ditches and the like. In fact, however, the reach of these requirements is very extensive.

The definition of MS4, for example, encompasses many structures and systems that are not the traditional, municipally owned and operated city storm water systems. An MS4 [40 C.F.R. 122.26(b)(8)] for purposes of Phase II is defined to include all separate storm sewer systems (i.e., systems that are used to convey only storm water) that are

a. Owned or operated by a state, city, town borough, county, parish, district, association, or other public body (created by or pursuant to state law). . . , including special districts under state law such as a sewer district, flood control district or drainage district, or similar entity, or an Indian tribe or an authorized Indian tribal organization, or a designated and approved

management agency that discharges into waters of the United States (under section 208 of the Clean Water Act);

- b. Designed or used for collecting or conveying storm water;
- c. Not a combined sewer; and
- d. Not part of a Publicly Owned Treatment Works (POTW) as defined at 40 C.F.R.

122.2.

Under this definition, many storm conveyances that are publicly owned by entities other than municipalities are included within the class of small MS4s that Phase II newly subjects to permitting.

Moreover, the term “urbanized area” is equally broadly defined under the new regulations. According to EPA’s Phase II guidance package, an urbanized area is

a land area comprising one or more places—central place(s)—and the adjacent densely settled surrounding area—urban fringe—that *together* have a residential population of at least 50,000 and an overall population density of at least 1,000 people per square mile. EPA Storm Water Phase II—Final Rule, Fact Sheet 2.1 (January 2000).

In combination, these two definitions require permitting of any publicly owned separate storm sewer system that happens to fall within the boundaries of an urbanized area. The systems need not be owned by a political subdivision specific to the urbanized area, and they do not need to be under the control of or operated by any such local political subdivision. Once a system is found to satisfy the definition of a Phase II MS4, it becomes subject to permitting simply by virtue of its location within an urbanized area.⁷

Similarly broad under Phase II are the states’ powers to specially designate MS4s that are not in urbanized areas. States were required to establish designation criteria by December 9, 2002 (or by December 8, 2004, if a watershed plan was in place) by which such out-of-area MS4s are to be identified. Designation criteria must include the following at a minimum:

- a. Discharge to sensitive waters,
- b. High population density,
- c. High growth or potential for growth,
- d. Significant contributor of pollutants to waters of the United States, and
- e. Ineffective protection of water quality concerns by other programs.

These criteria must be applied to jurisdictions with a population of at least 10,000 with a population density of at least 1,000 people per mi². They may, but need not, be applied to lesser population concentrations.

Applicability to Highway Deicing Runoff

Although there may be some academic potential to debate whether these new permitting requirements apply to public highway runoff structures, EPA and many state environmental departments clearly have concluded that they do apply. For example, EPA’s own guidance materials go out of their way to address the breadth of the definition of MS4 as follows:

What constitutes an MS4 is often misinterpreted and misunderstood. The term MS4 does not solely refer to municipally owned storm sewer systems, but rather is a term of art with a much broader application that can include, . . . State departments of transportation . . . An MS4 also is not always just a system of underground pipes—it can include roads with drainage systems, gutters, and ditches.⁸

This statement makes clear EPA's intention to require permits for otherwise jurisdictional discharges into (or, at least through) highway drainage systems, including drainage resulting from roadway deicing operations.

State officials also have acknowledged that the Phase II program is broad enough to require permitting of highway deicing runoff. A number of state environmental agencies have already developed extensive guidance on the need for Phase II permits and the most effective means of managing storm water from roadways in Phase II urbanized areas. The Mississippi Department of Environmental Quality, for example, has issued a lengthy and detailed guidance manual addressing both the department's understanding of the broad scope of the new permitting requirements and the various controls and practices that might be employed to satisfy certain expected permit terms.⁹ Similar excellent summaries of Phase II permitting requirements and available best management practices have been produced by the environmental agencies and departments of transportation (DOTs) of Michigan, Washington State, and California, among others. These states and others have concluded that the Phase II program will require permitting for the first time of highway deicing and other runoff that occurs in urbanized areas.

Consistent with this view, EPA offers a simplified means of determining whether a specific roadway falls within an urbanized area for purposes of the Phase II program. EPA maintains an excellent website dedicated to showing the areas that the agency understands to have been automatically designated as urbanized areas, within which small MS4s are required to obtain permit coverage.¹⁰ This website can produce both general land use and detailed road- and street-specific maps derived from the 2000 census. These maps allow state DOTs to identify those portions of the roadways within their states that are subject to permitting under Phase II.

In sum, then, the Phase II storm water program represents the first general mandate to obtain NPDES permits for highway runoff from deicing activities. Although limited geographically in most cases to urbanized areas, Phase II will bring numerous roadway discharge points into the permitting program for the first time. Some but by no means all of the consequences of the expansion on NPDES permitting into the transportation infrastructure are discussed below.

CONSEQUENCES OF NATIONAL POLLUTANT DISCHARGE ELIMINATION SYSTEM EXPANSION

The expanding reach of the NPDES permitting program into the nation's transportation infrastructure has come in two phases: the transition from the pre-1987 period to the Phase I program and the transition from the Phase I program to the more encompassing Phase II program. Consequences to the transportation system of this expansion are well known with respect to the transition to Phase I and can be fairly predicted for the transition to Phase II of the

program. Beyond the immediate impact of the Phase II regulation, however, lies a third class of consequences. These are the consequences that will be felt after transportation systems' initial exposure to the permitting program produces data that characterize (perhaps for the first time in the United States) the environmental impacts of deicing runoff. Each of these three types of consequences to the nation's transportation infrastructure will be explored briefly.

Consequences of Phase I

The Phase I storm water program had little tangible effect on state and federal transportation systems. Because roadway deicing was not identified as one of the high-priority sources of pollutants required to be regulated in that first phase, there was no systematic imposition of NPDES permits on these discharges. Similarly, it was only municipal governments that were subject to the Phase I permitting requirements imposed on large and medium-sized cities.

The only provision of Phase I that had any real potential to reach roadway deicing discharges was the grant to environmental agencies of the power to single out individual discharges that were believed to be a threat to water quality for permitting. Because of a lack of data on the chlorides concentrations in highway deicing runoff, a lack of systematic information on the environmental impact of chlorides, and a higher priority assigned to permitting storm water from the named Phase I industries, however, few, if any, permits were required on this basis. At most, Phase I of the storm water program may have caused state DOTs to begin systematizing their environmental stewardship activities.

Consequences of Phase II

The beginning of the Phase II program marked the beginning of systematic permitting of storm water (and deicing) runoff from highway operations. With this initial exposure to the NPDES program will come a number of obligations that highway managers may be unaccustomed to.

Permit Terms

For example, Phase II storm water permits require the development and implementation of a storm water management plan designed to reduce the discharge of pollutants to the maximum extent practicable (MEP) standard of performance. The program must include certain minimum control measures, including such novel requirements as public participation and outreach, public participation in plan development, elimination of all nonstorm water contributions, development of construction site runoff controls; and development of a post-construction storm water management program.¹¹ In addition, the permit will require the implementation of pollution prevention measures and the evaluation and assessment of the degree to which the controls developed pursuant to the permit have resulted in measurable progress in controlling pollutants.¹² Record-keeping obligations will apply as will an obligation to report annually on the progress of the program in reducing pollutant discharges.¹³

Possibility of Numeric Discharge Limitations

With these enhanced stewardship and record-keeping requirements comes a far more substantive, if less obvious, obligation. In addition to complying with the relatively flexible MEP standard that can be satisfied by applying best management practices, Phase II permittees may also be required to comply with any more-stringent effluent limitations necessary to protect water quality.¹⁴ Translated, this means that Phase II permittees may be required to comply with numeric, pollutant-specific effluent limits if necessary to meet water quality standards. While EPA's guidance recommends that permitting authorities not impose such additional requirements until after a systematic review of data collected under Phase II is conducted in 2012, it also suggests that more stringent limitations be imposed where there is concrete evidence that the discharge is responsible for an impairment of water quality.¹⁵ The United States Court of Appeals for the Ninth Circuit has taken a slightly different tack and ruled that (in the Ninth Circuit¹⁶ at least) permit writers have the discretion to impose numeric water quality-based limits on municipal storm water discharges but are not required by law to do so.¹⁷

Public Participation and Enforcement

Finally, permitting of highway runoff under Phase II will provide citizens with procedural opportunities to challenge both the permitting and the compliance records of highway discharge systems. Under the Clean Water Act, any interested party may become involved in permitting proceedings. Although EPA and many states had thought to avoid that involvement by permitting Phase II dischargers under so-called general permits,¹⁸ a case decided recently by the United States Court of Appeals for the Ninth Circuit has thrown that strategy into doubt by holding that even general permits must include a measure of public participation.¹⁹ EPA has recently issued guidance for EPA regions and states to follow in order to conform to the court's ruling,²⁰ but EPA acknowledges that corrective rulemaking would be required to define the form of public involvement and agency review of notices of intent (NOIs) that will be injected into the general permitting process.

Moreover, private individuals and groups are authorized to file suit under the Clean Water Act to enforce the provisions of NPDES permits. Private enforcement under the act can result in imposition of the same civil penalties as could be recovered by EPA, injunctive relief, and the assessment of an award directly to plaintiff organizations for their legal fees and expenses.

Consequences Beyond Phase II

It is apparent that Phase II of the storm water permitting program exposes many highway deicing dischargers to regulation under the NPDES program for the first time. The immediate consequences of that exposure are discussed above. In the longer term, however, there are serious potential consequences of which highway managers must be aware. While these consequences are hypothetical at this point in history, they represent an educated estimate of how the program may evolve to impose ever-tighter control over roadway deicing discharges.

Loss of Access to General Permits

In most states, general permits will be used to simplify permitting for Phase II dischargers. At present, general permits require only the filing of a simple form to obtain coverage, and need not be tailored to meet the demands of an individual discharger. In many states, however, as well as under certain EPA general permits, the availability of the general permit is limited to those discharges that do not constitute a threat to the water quality of the streams into which they flow. To the extent highway deicing runoff is demonstrated to produce an impairment in water quality (because of chlorides concentrations, for example), general permitting may become unavailable. The alternative to general permitting is to obtain an individual permit—a much longer, costlier, and more involved process.

Increased Monitoring Requirements

Where storm water from a Phase II discharger is suspected of causing a violation of water quality standards, the discharger can be subjected to substantially more burdensome monitoring requirements. These include monitoring of the discharge itself and of ambient conditions of the receiving waters, as well as a requirement to perform assessments of other kinds of the quality and integrity of the receiving waters.²¹ Such monitoring is both costly and intended to establish the basis for the imposition of numeric limitations on the discharge.

Numeric Effluent Limitations

Once the stage is set with sufficient data, Phase II storm water discharges may be subjected to numeric effluent limitations as needed to protect water quality.²² Achieving compliance with water quality–based effluent limitations for any storm water discharge would constitute a new serious challenge. The intermittent nature of the discharge makes traditional treatment both inefficient and often cost-prohibitive. Meeting numeric chlorides limitations for a highway deicing discharge would be especially challenging, as the chlorides in such discharges are already in solution and could be removed only by application of one of several costly treatment technologies. (Note, however, that the applicability of numeric water quality–based effluent limitations to municipal storm water discharges remains a question of much contention with at least one federal court of appeals holding that such limitations are not mandatory.)²³

Special Designation for Permitting Where Discharge Is into Impaired Waters

Even where a roadway storm sewer system is not located in an urbanized area, the regulations target it for permitting under Phase II if its discharge causes or contributes to an impairment of water quality in the receiving waters.²⁴ In many cases, storm water from highways will be discharged into one of the tens of thousands of surface waters listed by the states as impaired waters requiring special remedial attention.²⁵ Where the impairment identified by the state is related to the pollutants discharged from the roadway drainage system, the regulations suggest that permits will be required regardless of whether the site is within an urbanized area.²⁶ This element of the program may bring far more roadway deicing discharges into the system than originally anticipated by EPA.

Public Participation and Citizen Enforcement Actions

As noted above, along with NPDES permitting come public participation in the permitting process and susceptibility to private enforcement actions brought by individuals and citizens' organizations. Private environmental groups can be expected to begin to recognize that permitted road salt runoff provides them an opportunity to impose the most stringent form of Clean Water Act regulatory control—water quality–based effluent limitations—on discharges from the winter operations of highways. More important, local groups may begin to use these tools much as they use the Endangered Species Act, the National Historic Preservation Act, and the National Environmental Policy Act, to slow and even block roadway construction that they oppose for other reasons. Citizen challenges to general permits, participation in the development of individual permits, and enforcement actions for failure to obtain or comply with required permits can, thus, be expected to present new challenges to highway managers as a result of Phase II storm water permitting.

HIGHWAY INDUSTRY RESPONSE

Even if only a fraction of the consequences suggested above come to pass, highway departments and state DOTs around the country will be faced with a major new challenge. Managing highways to maximize safety in winter has always been the principal and arguably the only objective of responsible roadway maintenance operations. With the advent of NPDES permitting, those operations now also will be faced with the need to comply with largely foreign environmental controls and will be confronted by environmental and local interest groups with agendas only tangentially related to transportation. How the industry responds to and manages this challenge as it is forming is critical to the shape of highway operations in the next decade.

Some might argue that it is premature to consider industry options now because the Phase II program is still relatively new, and the challenges it presents are only beginning to crystallize. This author, for one, would disagree with such advice. Regulatory programs often take shape over the course of many years and in response to the combined input of all participating stakeholders. To wait until challenges become problems is to wait too long for an industry with such an enormous investment in its existing infrastructure. With all humility, then, the following potential courses of action are presented for consideration by those involved:

- Track EPA and state environmental agencies' efforts to refine and implement the Phase II program. This will allow the industry to recognize important opportunities and potential missteps by the agencies in time to provide the appropriate input. Remember also that state agencies' actions are important not just within their jurisdiction but also for the influence they exert on regulators in other states.
- Develop data that accurately characterize the fate and transport of chlorides in highway deicing runoff. Too little information on this subject has been developed under conditions found in the United States. Information of this kind can assist in establishing that deicing discharges are not problematic under certain circumstances and that certain management techniques are effective in controlling pollutants associated with highway deicing activities.
- Continue to aggressively explore alternative deicing technologies, application strategies, and runoff management strategies. New materials and practices often are the key to

managing evolving environmental responsibilities. Moreover, continued research will help to validate assertions that certain superficially attractive alternatives are not feasible. All the time that this research is ongoing, remember to keep the environmental regulatory agencies apprised of the seriousness of this effort and its tangible results.

- Systematically educate state environmental agencies as well as the EPA about the safety benefits derived from the use of deicing chemicals and the real efforts of state highway personnel to manage those discharges responsibly. Developing and maintaining an industry position as a credible and responsible partner with the regulatory agencies will pay dividends throughout the life of the program.

- Do not allow private environmental groups or local interest groups to dictate the ultimate form of regulation applied to highway deicing runoff. Although all stakeholders are entitled to be heard, the industry is the most knowledgeable and accountable party at the table. Do not surrender carelessly that position by assuming that the transportation industry's position is so well known that it needs no advocate.

- Work to develop Phase II permits that effectively manage highway deicing runoff without crippling the operations responsible for the maintenance of safe conditions on the nation's highways in winter.

- Monitor and, if necessary, become involved in the continuing debate over the applicability of water quality-based effluent limitations to municipal storm water discharges.

Advances in federal and state permitting of storm water discharges are reaching into the discharge of deicing runoff from highway operations. The pace at which that regulatory control is expanding will increase as more sites are permitted and as more information about the nature of deicing runoff becomes available. The industry can meet this challenge by working internally, with the Transportation Research Board, with private entities, and with the environmental agencies involved to ensure the protection of the nation's waters is achieved in a manner consistent with the safe and efficient management of winter weather.

NOTES

1. 33 U.S.C. 1251, et seq.
2. The NPDES program is established primarily under Section 402 of the Clean Water Act, with the portion of the permitting program addressing storm water situated at Section 402(p). 33 U.S.C. 1342(p).
3. Assessment Report—Road Salts. Environment Canada, 2001. Available at www.ec.gc.ca/substances/ese/eng/psap/final/roadsalts.cfm.
4. *Id.*
5. See 33 U.S.C. 1342(p).
6. 64 *Federal Regulation* 68722 (December 8, 1999).
7. It is important to note that while Phase II expands permitting for municipally owned systems only to the extent of including small municipalities, the new rule sweeps in highway systems in small, medium, and large cities—potentially any system located in an area that satisfies the definition of an urbanized area that is not already permitted. This expansion of the NPDES program is thus much broader as applied to state-owned highway storm water systems than it is when applied to municipally owned city storm water systems.

8. EPA Fact Sheet 2.1 at 1 (emphasis added).
9. Mississippi's Department of Transportation Phase II Storm Water Guidance Manual. General Permits Branch of the Office of Pollution Control, Mississippi Department of Environmental Quality, October 2002.
10. <http://cfpub1.epa.gov/npdes/stormwater/urbanmaps.cfm>
11. 40 C.F.R. 122.34(b).
12. 40 C.F.R.122.34(b) and (g)(1).
13. 40 C.F.R.122.34(g)(2) and (3).
14. 40 C.F.R. 122.34(e)(1).
15. 40 C.F.R. 122.34(e)(2).
16. The states within the Ninth Circuit are Alaska, Arizona, California, Hawaii, Idaho, Montana, Nevada, Oregon, and Washington.
17. *Defenders of Wildlife v. Browner*, 191F.3d 1159, 1166 (9th Cir. 1999). See also *Environmental Defense Center Inc. v. EPA*, 344F.3d 832 (9th Cir. 2003).
18. General permits under the Clean Water Act have been available historically upon the filing of a notice of intent (NOI). Once the minimal information on the NOI was submitted, the permit terms would apply automatically to the discharger without the need for a formal, and public, permitting process.
19. *Environmental Defense Center, Inc., et al. v. U.S. Environmental Protection Agency*, 344 F.3d 832 (9th Cir. 2003).
20. Memorandum from James Hanlon to EPA Water Management Division directors, *Implementing the Partial Reward of the Storm Water Phase II Regulations Regarding Notices of Intent and NPDES General Permitting for Phase II MS4s*, April 16, 2004.
21. 64 *Federal Regulation* at 68788, col. 2.
22. 64 *Federal Regulation* at 68787-68791. See also, note 15, supra.
23. See note 17, supra.
24. 64 *Federal Regulation* at 68789-68791.
25. States must list impaired waters (waters not expected to meet water quality standards after application of technology-based effluent limitations to all point sources). These listings are then the basis for evaluation under the total maximum daily load (TMDL) program, which determines the stream's tolerance for each pollutant of concern and then allocates that loading among permissible point sources, nonpoint sources of pollution, a reserve for growth, and a safety factor to account for any scientific uncertainty in the analysis. 33 U.S.C. 1313(d); 40 C.F.R. Part 130.
26. This special designation for permitting can be waived where the pollutants of concern are projected to be adequately controlled under wasteload allocations contained in a TMDL or where there is an affirmative finding that there is no adverse impact on water quality. 64 *Federal Regulation* at 68790-91. While this subject is beyond the scope of this article, it is worth noting that the exemption provided here is extremely narrow and in practice may be supported only in rare cases.

Winter Maintenance Vehicle Advancements

WINTER MAINTENANCE VEHICLE ADVANCEMENTS

Business Case for Winter Maintenance Technology Applications
*Highway Maintenance Concept Vehicle***DENNIS A. KROEGER****REGGIE SINHAA***Iowa State University*

The purpose of this paper is to demonstrate, from a business perspective, the benefits of using technology applications in winter maintenance operations. This paper documents the business case to be made for the technology applications on the Highway Maintenance Concept Vehicle project by examining the business implications of many benefits such as increased safety, reduced environmental impacts, and increased efficiency.

The use of commercial-off-the-shelf and prototype technologies to improve winter maintenance operations has been in practice for several years; however, it has been difficult to quantify the benefits achieved by adopting these technologies. A benefit–cost framework is established whereby the current methods of performing the analysis can be compared with other proposed winter maintenance technology improvements.

Applying new technology to winter maintenance operations can

- Reduce accidents,
- Reduce chemical use, and
- Provide return on investment.

The benefit–cost analysis demonstrated that the integration of the newer emerging technologies does indeed play a beneficial role in reducing accidents, increasing mobility, reducing adverse environmental impacts, and having a direct bearing on the economic impacts in the area.

INTRODUCTION

This paper updates the Highway Maintenance Concept Vehicle (HMCV) Phase IV report (Figure 1) by providing a business case for technology applications on the HMCV. The case to be made examines many benefits such as increased safety, reduced environmental impacts, and increased efficiency. A benefit–cost framework is established whereby the current methods of performing the analysis can be compared to other proposed winter maintenance technology improvements.

The objectives of applying new technology to winter maintenance operations are

- Reduction in accidents,
- Reduced chemical usage, and
- Return on investment.

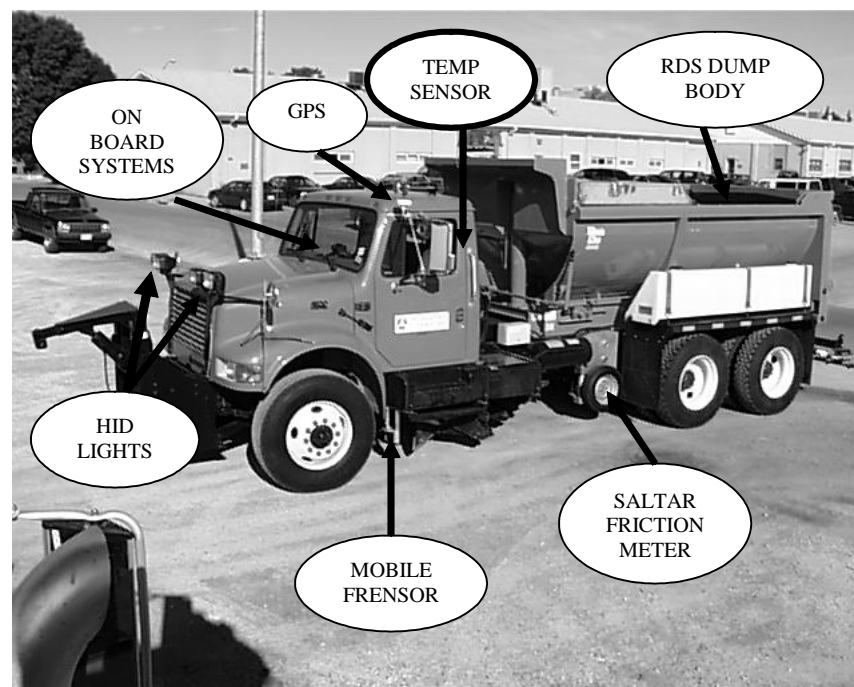

FIGURE 1 Phase IV HMCV (2001–2002).

A literature review available on winter anti-icing operations using advanced technology by different agencies indicates reduction or eliminating of accident rates by 73% to 80%. The Pennsylvania Department of Transportation (DOT) reported an accident reduction of close to 100% by using anti-icing techniques but, given certain allowances, a presumed 80% or a 0.2 resultant factor rate was used (1).

Reduced Chemical Usage

The benefit–cost ratio also suggests that although costs savings are definitely possible with the usage of anti-icing technologies, the level of service (LOS) to the travelers is increased with the same or less usage of materials. Some of the other benefits are less chemical usage, less time on equipment, and increase in the efficiency of the system.

A similar study was done in the city of Kamloops, British Columbia. The benefit–cost ratio also suggests that although costs savings are definitely possible with the usage of anti-icing technologies, the LOS to the travelers is increased with the same or less usage of materials.

Return on Investment

The sensitivity analysis parameters for accident reduction and elimination included a wide range of numbers—from the reported close to an 80% accident eliminated (Pennsylvania DOT and Kamloops, British Columbia, studies) to a range of 50% reduction. Even at the low 50% range, the benefit–cost ratio was still favorable at 2.31 and 2.37 and indicated a 131% and 137% (depending on the discount rate) rate of investment (ROI) return for the project.

The investigation also examined some of the secondary benefits and risks associated with these technology applications to winter maintenance operations.

BACKGROUND

The entire HMCV project encompassed four phases over a 6-year period. Phase I of this project focused on describing the desirable functions of a maintenance concept vehicle and evaluating its feasibility. Phase II was the proof-of-concept phase that included development, operation, and observation of three prototype vehicles. Phase III included conducting the field evaluation of three prototype vehicles and identifying methods and cost to integrate the data and information generated by the vehicle into the state's snow and ice control management process. The research quickly pointed out that investments in winter storm maintenance assets must be based on benefit–cost analysis (BCA) and related to improving LOS. If the concept vehicle and data produced by the vehicle are used to support decision making leading to reducing material usage and the average time by 1 h, a reasonable benefit–cost will result. In Phase IV, the Center for Transportation Research and Education (CTRE) at Iowa State University, as well as its partners at Iowa DOT, Wisconsin DOT, and Pennsylvania DOT, have long considered the benefits of advanced technology to enhance winter maintenance activities. The HMCV demonstrated near-term benefits of the technologies for winter maintenance operations.

Why a Business Case?

A business case is one way to organize, evaluate, and present information about the actions that governments take to improve public safety. In this report, all benefits and costs each year between 2000 and 2001 are included in the BCA, and all values are discounted back to 2000 with both a 4% and a 7% real discount rate to calculate the present values of the benefits and costs in 2002 dollars.

The benefit–cost ratio suggests that although costs savings are definitely possible with the usage of anti-icing technologies, the LOS to the travelers is increased with the same or less usage of materials.

Detailed Research

The first step in developing the business case was to analyze the data and information technology in the Iowa DOT maintenance operations and determine their impact on the cost of conducting those activities. Reductions in resource costs, labor, trucks, and materials are achieved by identifying cost factors and by taking actions to influence those factors. Certainly the severity of the winter affects winter maintenance costs. A bad winter is expensive and requires using a large amount of labor, trucks, and materials to achieve an acceptable LOS.

Every year, state agencies spend an estimated \$2 billion plowing snow, sanding, and spreading chemicals on icy roadways. Approximately 20 million metric tons of sodium chloride (road salt) are used annually for deicing. The demand for salt has doubled in the past 10 years. To keep roads clear and safe for travel, the Iowa DOT, for example, spends approximately \$35 million every year on winter maintenance spending an average of \$65,000 to \$70,000 per hour to fight the winter storms (2).

This BCA was conducted as part of the overall goal of the pooled fund study's HMCV project to “examine and test newly emerging technologies that have the potential for improving the LOS defined by policy during the winter season at the least cost to taxpayers.”

Benefits of anti-icing techniques have been summarized in [Table 1](#). Based on the perception of maintenance personnel, most benefits were related to improved safety and improved productivity (i.e., reduced maintenance costs) (3).

Methodology

The methodology for conducting the BCA is based on the guidelines outlined for generally accepted practices for federal projects and on the “Benefit/Cost Analysis of ITS Applications for Winter Maintenance” conducted by Stowe (*I*). With information obtained from DOT officials from the Washington and Arizona DOTs, it was established that the benefit–cost worksheet for collision reduction was an appropriate and a valid tool in computing the benefits and costs for collision reduction.

The BCA considered two different alternatives for this study.

1. The first alternative is the do-nothing alternative where the status quo approach of using traditional method of winter application was considered. Although this practice has worked successfully over the past years, this system is not very efficient in terms of safety, consumption of materials, and labor. This inefficient system uses the outdated reactive deicing approach in solving winter road surface conditions. A study by the Iowa DOT suggests that 30% of the salt is wasted with existing techniques. Also, excessive chemical run-offs contaminate soil and ground water contributing to environmental degradation. Although the do-nothing alternative has the advantage of low implementation cost, it carries high operational efficiencies and perhaps much higher costs in terms of societal benefits.

2. The second alternative considered was to study the BCA of deploying and integrating anti-icing strategies on HMCVs during winter applications. A comprehensive BCA would include quantification and monetization of various elements of the analysis: safety in terms of accidents reduced or eliminated, reduction in salt, chemical and labor usage, environmental equity, and savings in time due to increased mobility. Since no historical or relevant data on environmental, mobility, and labor usage were available, this BCA was conducted on two counts: safety and material usage (salt). The crash report was based on information available at the Iowa Traffic Safety Data Service and CTRE for crash severity data for years 1998–2000. Iowa DOT provided the salt usage data at the Des Moines North Garage.

One of the basic concepts of BCA is not to consider sunk costs. This appears to be consistent

TABLE 1 Benefits of Anti-Icing Techniques

Performance Measures	Anti-Icing Benefits
Mobility	<ul style="list-style-type: none"> • Reduced number of road closures • Improved traveler information
Safety	<ul style="list-style-type: none"> • Reduced accident frequency • Decrease in insurance claims
Productivity	<ul style="list-style-type: none"> • Less snow/ice bonding facilitated more efficient plowing • Reduced maintenance costs (overtime pay and materials) • Reduced time to clear snow/ice from roads • Less abrasives cleanup required
Environmental Quality	<ul style="list-style-type: none"> • Reduced impact on roadside vegetation, aquifers, and watercourses. • Improved air quality as a result of reduced abrasive usage
Other/Indirect	<ul style="list-style-type: none"> • Reduced asset damage (vehicles, equipment, etc.)

with one of the purposes of the HMCV, which is to determine whether to proceed with the project according to the plan outlay. Because this analysis is being done after the development costs have been incurred, the purpose of this BCA is not to determine development and operational costs of the system will be justified by the projected benefits, but rather to evaluate whether the projected costs and benefits (starting with fiscal year 2000) justify continuation of the project.

The BCA analysis undertaken in this study differs marginally from the original model envisaged in Task 3 of the Phase IV study Work Plan dated February 28, 2002, for the following reasons:

- a. **Discounting:** In the original model, discounting, where future cash flows are reduced to equivalent present-day values, is not addressed. Discounting is an important element of a BCA whereby the costs and benefits of each year of the system cycle is estimated and is then converted to a common unit of measurement to properly compare competing alternatives.
- b. **Start-up costs or sunk costs** are usually not part of the BCA analysis for an ongoing project.

Data were available on safety and materials, specifically, usage of salt. This provided the basis to conduct the BCA based on these data.

ASSUMPTIONS

BCAs should be explicit about the underlying assumptions used to arrive at estimates of future benefits and costs. For this analysis, these are some of the assumptions:

1. Wet conditions have been included in the element of surface conditions for winter driving conditions. Since anti-icing materials are applied to the roadway immediately before or at the beginning of a storm, the road becomes wet or slushy rather than icy. This wet road conditions are considered part of the surface condition under analysis.
2. The BCA time period should match the system life cycle. The system life cycle includes the following stages or phases:
 - a. Feasibility study,
 - b. Design,
 - c. Development,
 - d. Implementation, and
 - e. Operation.

The system life cycle or technological obsolescence is considered 5 years.

3. The BCA computation has been done on two factors: safety and salt usage. The Iowa DOT has specific information on crash severities. Literature reviews indicated that specific data were available for crash severities and value of life matrix. Not many data were available for the mobility, efficiency, productivity, and environmental quality of the areas under analysis.

4. Based on the data available, it was determined that accidents were eliminated by almost 80% when anti-icing techniques were used. This was the case in Pennsylvania and British Columbia, Canada. Resultant factor has been computed on different range of values: the first at 0.2 (80% accidents were eliminated) and the second at 0.5 (50% of the accidents were eliminated).

HMCV COSTS

A portion of the equipment used in this research was provided to the study, some had to be purchased, and some was included in the cost of upgrading the snowplow that was done during the normal course of normal vehicle replacement schedule at Iowa DOT. Table 2 lists the costs of the equipment, along with the vendors that supplied those equipment items.

BENEFIT-COST CALCULATIONS

All benefits and costs each year between 1998 and 2000 are included in the BCA, and all values are discounted back to 2000 with both a 4% and a 7% real discount rate to calculate the present values of the benefits and costs in 2000 dollars. Planners and economists traditionally have followed the use of 4% real discount rate in these benefit-cost calculations using the guidelines in the *Red Book* published by AASHTO (4). The 7% real discount rate is a federal Office of Management and Budget guideline for calculating a BCA for federal projects (5).

Discounting

Future cash flows need to be reduced to equivalent present-day values, because the value of a dollar in the future is less than the value of a dollar today. This is referred to as discounting. After the costs and benefits for each year of the system cycle have been estimated, it is converted to a common unit of measurement to properly compare competing alternatives. That is accomplished by discounting future dollar values, which transforms future benefits and costs to their present value (PV). The PV (also referred to as the discounted value) of a future amount is calculated with the following formula:

TABLE 2 Costs of HMCV

Equipment Item	Cost	Vendor
Chassis—International	\$65,500	Monroe Snow & Ice Control
RDS Dump Box	5,500	Same
Front Plow	4,000	Same
Sander/Salter	2,600	Same
Underbody Blade	6,600	Same
Added Features for HMCV		
Onboard Prewetting	2,500	Monroe
Anti-Icing Spray Bar	14,000	Monroe
Surface Temperature Sensor	800	Sprague
AMS 200 Data Management	2,500	Raven Industries
DCS 710 Ground Speed Controller	8,000	Raven Industries
Trakit AVL	13,000	IDA Corp
DGPS Antennae	1,400	Communications Systems International
HID Plow Lights	1,100	Speaker
Saltar Friction Meter	15,000	Norsemeter
Frensor Mobile Freeze Point Detection	10,500*	AeroTech-Telub
Total	\$153,000	

$$P = F [1 / (1 + I)^n]$$

where

- P = present value,
- F = future value,
- I = interest rate, and
- n = number of years.

Government policies or projects typically produce streams of benefits and costs over time rather than in one-shot increments. Commonly, in fact, substantial portions of costs are incurred early in the life of the project, while benefits may extend for many years. Yet, because people prefer a dollar today than 10 years from now, BCA typically discounts future benefits and costs back to present values. The system life cycle for this study is considered 5 years.

Sensitivity Analysis

At its most rudimentary, a sensitivity analysis demonstrates the impact of variations on the discount rate on the final analysis. But in a broader perspective, a sensitivity analysis tests the impact of changes in input parameters on the results obtained from the BCA. For example, how much change in the value of the benefits is required before the costs of the proposed system exceed the benefit.

An appraisal should always be subject to a sensitivity test to assess how robust the result is to changes in the assumptions used in calculating it. In particular, a range of expected accident reductions should be assessed, since one can never be certain as to what the actual outcome will be; using a low and a high estimate of possible and realistic outcomes is always good practice. In this case study, although literature review suggested that the resultant factor of 0.2 was safe to use (80% of accidents were eliminated), the range was expanded to include a conservative value of 0.5 resultant factor (50% of the accidents were eliminated).

If the outcome is favorable even with a pessimistic forecast, there can be confidence that the project is worthwhile. Conversely, if the outcome is unfavorable even with optimistic assumptions, there can be confidence that the project is unlikely to be worthwhile. The middle ground—favorable under optimistic assumptions and unfavorable under pessimistic assumptions—requires more work to get a better forecast.

CONCLUSIONS

The BCA demonstrates that the integration of the newer emerging technologies in the concept vehicle does indeed play a beneficial role in reducing accidents, increasing mobility, reducing adverse environmental impacts, and effecting the economic impact in the area. The sensitivity analysis parameters for accident reduction and elimination included a wide range of numbers—from the reported close to an 80% accident eliminated (Pennsylvania DOT and Kamloops, British Columbia, study) to a range of 50% reduction. Even at the low 50% range, the benefit–cost ratio was still favorable at 2.31 and 2.37 with a 131% and 137% (depending upon the discount rate) rate of investment (ROI) return for the project.

The benefit–cost ratio also suggests that although costs savings are definitely possible with the usage of anti-icing technologies, the LOS to the travelers is increased with the same or less usage of materials. Some of the other benefits are in less sand and chemical usage, less time on equipment, and increase in the efficiency of the system.

APPENDIX A

Benefit–Cost Worksheet

For Collision Reduction

Safety Improvement Location: Select Corridor I-35 Polk County, Iowa

Safety Improvement Description: Technology Add-ons on HMCV

1. Initial Project Costs, I:	\$50,691
2. Net Annual Operations and Maintenance Costs, K:	\$5,000
3. Annual Safety Benefits in Number of Collisions:	

Collision Type	Before (historic) Nos.	–	After (estimated) Yrs.	Rate	=	Resultant Rate Factor	Annual Benefits
a) Fatality	0		3	= 0.0	.2	0.00	= 0.00
b) Major Injury	4		3	= 1.33	.2	0.27	= 1.06
c) Minor Injury	17		3	= 5.67	.2	1.13	= 4.54
d) Possible Injury	18		3	= 6.0	.2	1.20	= 4.80
e) Property Damage Only	51		3	= 17.0	.2	3.40	= 13.60

1. Costs Per Collision:

5. Annual Safety Benefits by Costs of Collision

Collision Type	Cost				
a) Fatality	\$1,000,000	a)	(3a)(4a)	=	\$0
b) Major Injury	\$150,000	b)	(3b)(4b)	=	\$159,000
c) Minor Injury	\$10,000	c)	(3c)(4c)	=	\$45,400
d) Possible Injury	\$2,500	d)	(3d)(4d)	=	\$12,000
e) Property Damage Only	\$2,500	e)	(3e)(4e)	=	\$34,000
			TOTAL, B	=	\$250,400

6. Service life, n = 5 years

7. Salvage Value, T = \$1,000

8. Interest rate, I = 4%

9. Present Worth of Costs, PWOC:

Present Worth Factor of a Uniform Series, SPWin = 4.4518

PWOC = I + K(SPWin) – T(PWin) = 67,786

10. Present Worth of Benefits, PWOB = B(SPWin) = 1,114,731

11. Benefit/Cost Ratio, B/C = PWOB/PWOC = **16.45**

12. Net Benefit = PWOB – PWOC = **1,046,945**

Sensitivity Analysis based on (a) accident savings of 80% (0.2 resultant factor) and (b) interest rate at 4% (A Manual on User Benefit Analysis of Highway and Bus-Transit Improvements. 1977, p. 14). SPW in rates from appendix on p. 118.

ACKNOWLEDGMENTS

The authors acknowledge the financial support for this study provided by the DOTs in Iowa, Minnesota, Wisconsin, and Pennsylvania; their contributions to the work reported here are greatly appreciated.

REFERENCES

1. Stowe, R. D. Benefit–Cost Analysis of Intelligent Transportation System Applications for Winter Maintenance. Presented at the 80th Annual Meeting of the Transportation Research Board, Washington, D.C., 2001.
2. *Winter Maintenance Technologies and Processes*. PM 10-22-01. U.S. Department of Transportation. www.dot.state.ia.us/technology.pdf.
3. Johnson, K. Non-Chloride Deicers for Pavements. Presented at Winter Cities Forum, Session 2: Advanced Snow Removal and Ice Control Technology, Aomori, Japan, Feb. 7–10, 2002.
4. *A Manual on User Benefit Analysis of Highway and Bus–Transit Improvements*. AASHTO, Washington, D.C., 1977, p. 7.
5. *Circular A-94: Guidelines and Discount Rates for Benefit–Cost Analysis of Federal Programs*. U.S. Office of Management and Budget, www.whitehouse.gov/omb/circulars/a094/a094.html.

ADDITIONAL RESOURCES

1. Bapna, S., J. Zaveri, and Z. A. Farkas. *Benefit–Cost Assessment of the Commercial Vehicle Information Systems and Networks (CVISN) in Maryland*. National Transportation Center, Morgan State University, Baltimore, Maryland, Nov. 1998. www.itsdocs.fhwa.dot.gov/JPODOCS/REPTS_TE/78901!.PDF. Accessed August 21, 2002.
2. Boselly, S. E. *Benefit/Cost Study of RWIS and Anti-Icing Technologies*. Weather Solutions Group, Chesterfield, Mo. [www.sicop.net/NCHRP20-7\(117\).pdf](http://www.sicop.net/NCHRP20-7(117).pdf). Accessed July 18, 2002.
3. Brand, D., T. E. Parody, J. E. Orban, and V. Brown. Benefit–Cost Analysis of Commercial Vehicle Information Systems and Networks Program. Presented at the 81st Annual Meeting of the Transportation Research Board, Washington, D.C., 2002.
4. Lee, D., and A. Carroll. *Benefit–Cost Evaluation of a Highway–Railroad Intermodal Control System*. Volpe National Transportation Systems Center and American Society of Civil Engineering, Reston, Va.
5. Moore, J. L. *Cost–Benefit Analysis: Issues in Its Use in Regulation*. CRS Report for Congress, National Council for Science and the Environment, Washington D.C., June 28, 1995, p. 4.

WINTER MAINTENANCE VEHICLE ADVANCEMENTS

Needs Assessment and Cost–Benefit Analysis of RoadView™ Advanced Snowplow Technology System**DAVID KACK****ELI CUELHO***Montana State University–Bozeman*

The RoadView™ system was originally developed to determine the feasibility of implementing an advanced snowplow control system to improve the safety and efficiency of snow removal operations. As follow-on research, this evaluation was designed to determine the magnitude of the challenges faced by snowplow operators, particularly during low-visibility conditions. Both a needs assessment and a cost–benefit analysis (BCA) of the RoadView system are provided.

The analyses focused on data gathered primarily from four western states: Idaho, Montana, North Dakota, and Wyoming. The three main factors to be considered in the needs assessment and potential BCA were safety, mobility, and operational issues. Both quantitative and qualitative data were collected from participating departments of transportation, including a survey distributed to snowplow operators in the four designated states. The survey was designed to gain further insight into perceived problems with limited-visibility snow removal operations and to examine current methods being used by snowplow operators to improve their spatial and situational awareness during low-visibility conditions.

Results indicated the three methods most used by snowplow operators to maintain their lane position are visual. Operators had a high perceived usefulness of technology that would assist in detecting obstacles and provide lane position information. The BCA indicated that RoadView would be most beneficial on roadways with high traffic volumes associated with significant road closures due to winter weather conditions.

INTRODUCTION

Keeping roads open and passable in the winter is a fundamental public safety task, the importance of which is emphasized by newspaper articles with headlines such as “Storm Paralyzes Upper Midwest.” The details of this particular article describe the magnitude of the problem. “Minnesota snowplow crews parked their rigs Tuesday because they couldn’t keep up with blowing, drifting snow that closed schools for thousands of youngsters from the Plains to the upper Great Lakes” (1).

In addition to being an inconvenience to travelers, a major snowstorm can have a significant economic impact. A study conducted for the Salt Institute estimated that impassible roadways in a 12-state Midwest region would cost \$526.4 million per day in federal, state, and local taxes. In addition, it was estimated that such a storm would cost \$1.4 billion per day in unearned wages and \$600 million per day in lost retail sales (2).

Further, a major snowstorm has the potential to increase the number and severity of motor vehicle accidents. Researchers have explored the relationship between adverse weather and safety and found a significant decrease in crash rates after snow removal and deicing

activities (3). Studies also have found that the number and rate of highway fatalities and injuries increase on snowy days (4).

Recent projects have focused on utilizing and evaluating technology to allow snowplow operators to continue to work in reduced-visibility situations (5, 6, 7, 8, 9, 10). By utilizing a variety of technologies, it is hoped that snowplow operators will be able to continue clearing roads in low visibility conditions and thereby keep roadways open and reduce the economic impact of a storm. The RoadView™ system was initiated in response to these concerns as a means to facilitate snowplow operations in inclement weather.

PURPOSE OF THE STUDY

The purpose of this research project was to determine the need for the RoadView system and to perform a benefit–cost analysis (BCA) of the technology. Previous demonstrations have shown the potential success of RoadView deployments, although such demonstrations are limited in terms of the number of advanced technology-equipped vehicles and the amount of time these vehicles have been in operation. Theoretically, the technology utilized in the RoadView project is expected to increase safety by reducing erratic snowplow movements, run-off-the-road incidents and lane departures, snowplow accidents, damage to other vehicles and the infrastructure, and injuries to snowplow operators or other vehicle occupants. Increasing the speed or efficiency of snow removal tasks may potentially reduce road closures and travel delays and thereby improve both the operational aspects of snow removal activities and the mobility of motorists during adverse winter weather.

The needs assessment portion of this project discusses possible measures of effectiveness for the RoadView system and potential benefits that may be realized from more extensive implementation and deployment of the technology. Data for the study were gathered primarily from four states: Idaho, Montana, North Dakota, and Wyoming. Additional data collected as part of a RoadView evaluation in the Donner Pass area of California were included as supplemental information.

Quantitative data on winter weather-related accidents, as well as on the frequency and duration of winter road closures, were collected for descriptive purposes and to enhance the needs assessment. The qualitative data collected via the snowplow operator survey were used to determine equipment and route characteristics, perceived problems with limited-visibility snow removal operations, and current methods used to position the snowplow on the roadway during typical snowplow operations and particularly during periods of limited visibility.

The next section presents the needs assessment portion of the project, and the third section presents the BCA. The final section of this paper presents the conclusions of the research.

NEEDS ASSESSMENT

A needs assessment represents an attempt to identify and quantify, if possible, the potential benefits of a given accident countermeasure or safety improvement. This task often provides the justification for funding decisions and as such is a valuable tool for departments of transportation.

Based on previous research, RoadView and similar advanced snowplow technologies have been found to assist snowplow operators in determining their lane position as well as in providing a warning of objects and obstacles in front of and behind the vehicle (5, 6, 7, 8, 9, 10). Research in Minnesota (5, 7) focused on accidents and the related costs as the basis for continuing research

efforts on this topic, and two studies conducted in Iowa focused on the operational aspects of plowing snow (6, 8). The present study was designed to combine these two approaches in order to provide a detailed investigation into various issues associated with snowplow operations in low-visibility situations and to consider variables that might be used to measure system effectiveness and assess possible benefits associated with the technology.

Analytical Considerations and Limitations

Identification of the potential benefits of the RoadView system focused on data related to snowplow-related accidents and run-off-the-road incidents, delays to motorists, and perceptions and opinions of snowplow operators.

Data on accidents and incidents involving snowplows, as well as information on winter road closures, were used to describe the magnitude of problems that might be mitigated with the implementation of the RoadView system. Quantitative data confirmed the incidence of snowplow-related accidents, both with and without the involvement of other vehicles, on those roadways selected as study sites and statewide. Roadway closures due to severe winter weather and resulting in unspecified delays to travelers also were documented. Intuitively, any technology assumed capable of reducing accident-related costs or injuries would be perceived as beneficial. Furthermore, technology that has the potential to shorten or eliminate road closures would have appeal. As emphasized elsewhere throughout this document, the ability of the RoadView system to reduce accidents or road closures remains undetermined at this point.

In assessing whether a need exists for advanced snowplow technology, it was difficult to determine an appropriate threshold for each of the factors described above. In other words, at what point does each measure of effectiveness become a meaningful indication of need? How many snowplow-related accidents per year, for example, would have to be reported in order to establish a need for advanced technology? how many winter road closures? how many hours of delay due to road closures? Does the fact that snowplow operators perceive the proposed technology to be highly useful validate a need? There are no objective criteria for determining appropriate thresholds, and, often answers to these kinds of questions, by themselves, cannot establish whether the system is needed. Information concerning benefits to be accrued must be compared with the costs associated with the system in order to calculate the net value of the technology. Only then can a safety improvement program or technology be judged relative to other budgeted or proposed projects to establish funding priorities. Wider-scale deployment and field testing of the RoadView technology are necessary in order to collect empirical data to assess the system's effectiveness and quantify its benefits so that objective decisions can be made regarding the need for and cost-effectiveness of the system.

Given that empirical data were not available to evaluate system effectiveness as part of this research, it was necessary to incorporate other, more subjective, information into the needs assessment. Responses to the snowplow operator survey were used to more broadly define the potential need for the advanced snowplow technology. For example, operators were asked to assess the potential usefulness of technology that would assist them in various aspects of snowplow operations. The survey responses regarding the perceived usefulness of the system became surrogate measures of the technology's potential benefits. It was not possible, however, to meaningfully assign monetary values to these potential benefits, which were based on hypothetical examples of the system's technological capabilities.

Survey Results

The results of the operator survey highlighted several issues that may have implications regarding the need for advanced snowplow technology. One of the RoadView system's two primary purposes is to provide lane-positioning information to snowplow operators. When asked what methods operators currently use to maintain their position on the roadway, their three highest-ranked choices involved judging their distance from the following roadside features: guardrails, mileposts and delineators, and the centerline. In fact, 8 of the 15 most commonly used methods for maintaining lane position involved visual cues. By definition, these methods all rely on the operator's ability to see out of the vehicle, which may be severely hampered by a number of factors as discussed below.

Weather conditions, as expected, were ranked highest in terms of factors that contribute to poor visibility. In addition, certain driving conditions (e.g., meeting or being passed by other vehicles) can exacerbate the situation. Whereas these things cannot be controlled, there were other factors that might be addressed through design modifications or routine maintenance and repair. Specifically, three different placements of the vehicle's lights were believed to create visibility problems, and numerous comments on the survey described problems caused by wipers and defrosters that did not function properly.

The importance of maintaining their lane position was ranked fourth out of five factors related to safe snowplow operation, although the mean rankings were extremely close for all five choices. Operators acknowledged that road configuration and traffic volume determine to a large extent the risks involved with crossing into another lane of travel. Similarly, run-off-the-road incidents increase during low-visibility conditions; the incidents potentially can cause damage to the snowplow or the infrastructure, as well as injury to the snowplow operator. Survey responses described the magnitude of this problem, as well as provided information regarding what, if any, objects were struck when the snowplow left the road.

Operators were asked to rank the usefulness of technologies that would assist with four specific tasks, the first of which was providing lane position information. The remaining three tasks dealt with detecting obstacles to the front, rear, and side of the vehicle, respectively. It should be reemphasized that the operators had only a general written description of each technology (e.g., "If the technology existed that could tell you your lane position while plowing, how useful would it be to you?"). The operators indicated that technology with the ability to detect obstacles in front of their vehicle would be most useful, followed closely by technology to assist with lane position awareness.

Lastly, the frequency and duration of loss-of-visibility events may be considered relevant to the needs assessment. During an average snowstorm, operators estimated they typically lost sight of the roadway once every two hours, with each occurrence lasting four seconds or less. This finding was similar to results obtained by McGehee and Raby (6) when they surveyed snowplow operators in Iowa and Minnesota. Loss-of-sight occurrences did not happen frequently or for extended periods of time, but these events can cause stress for snowplow operators, as can snow removal activities, in general. Perhaps more importantly, such instances can affect the efficiency of snowplow operations. During reduced visibility conditions, operators may have to reduce significantly their speed or stop their vehicle altogether. Either action potentially affects the mobility of travelers and could have safety implications for both the snowplow operators and other motorists on the roadway.

Conclusions and Implications—Needs Assessment

This research identified ways in which advanced snowplow technologies may benefit snowplow operations, but operational testing on a wider scale and for extended periods of time are needed to

establish the effectiveness of the system. To date, advanced snowplow technologies have been utilized predominantly in proof-of-concept or proof-of-technology research. Minnesota and California have had early successes in demonstrating that certain technologies can provide lane position and obstacle detection warnings to snowplow operators. Ultimately, however, deployment of the technology in real-world situations will be necessary to provide quantifiable data on system benefits associated with reductions in accidents or delays.

There is evidence to support the continued research on and operational testing of advanced snowplow technologies. Historical data confirm snowplow-only and snowplow versus motor vehicle accidents on designated roadways in this research effort. Reductions in mobility caused by winter road closures also were documented. The ability of an advanced snowplow system to impact these factors directly has not been determined but should be investigated.

The results of the snowplow operator survey revealed the extent to which operators rely on their ability to see obstacles and vehicles in front of the snowplows and to utilize visual cues to maintain their lane position. Given the variety of circumstances in which visibility is severely restricted, advanced technology to assist operators by providing lane position information and obstacle warnings has obvious utility. The added potential benefit of reducing operator workload and stress was not addressed specifically in this study but should be examined in future research efforts.

As stated previously, in order to determine the feasibility of widespread use of RoadView or other advanced snowplow technologies, it is important to consider the costs, as well as the potential benefits, of the system. A discussion of variables that could be used in a BCA of RoadView is included in the next chapter, along with cost–benefit scenarios using the five designated study sites.

BENEFIT–COST ANALYSIS

For the BCA, an attempt was made to quantify the benefits of the RoadView system in terms of safety and mobility. For purposes of this analysis, the economic benefits associated with improved safety were related strictly to reductions in the number of snowplow-only accidents. Benefits associated with increased mobility were related solely to decreases in the time associated with road closures due to winter weather. Other benefits of the advanced technology may be related to increased effectiveness and efficiency of snowplow operations, which in turn may increase both mobility and safety. No attempt was made to quantify these variables for use in the calculations.

Quantification of the system's potential benefits was problematic because of a lack of empirical data. Advanced snowplow technologies have been used in demonstrations or proof-of-concept research but have not been deployed in sufficient numbers or for a sufficient length of time to enable a rigorous evaluation of the system's effectiveness. Thus, estimates of reductions in the frequency of snowplow-related accidents and the occurrence and duration of road closures were arbitrary. As discussed elsewhere in this report, previous demonstrations have concluded that the technology was useful in terms of providing snowplow operators with greater lane–roadway awareness during low-visibility plowing operations (9), but estimates of the accident-reduction capabilities of the system or the system's effect on road closures are unavailable. Thus, the results of the BCA should be interpreted with caution.

Overview of Analytical Technique

To perform the BCA, an equation was used to calculate the annualized benefits and costs associated with full deployment of the RoadView system and produce a benefit–cost ratio.

The costs associated with the advanced technology system include both in-vehicle and in-road elements. The in-vehicle costs of the RoadView system include the sensors, monitors, and support systems that allow the technology to provide lane positioning information and obstacle detection to the snowplow operator. The in-road costs are those associated with placing magnets in the roadway which, when read by sensors in the vehicle, provide lane position information.

The total system cost can be calculated by adding the in-road costs with the in-vehicle costs. The resulting total can then be divided by the expected useful life of the system to provide an annualized system cost. Finally, annual maintenance costs are added to calculate the total annual cost for the RoadView system.

It is hypothesized that full implementation of the RoadView system will produce certain benefits. Possible benefits include a reduction in the duration of road closures and a reduction in the frequency or severity of snowplow-only accidents. The monetary savings associated with these benefits also are annualized. Finally, the annualized benefits can be divided by the annualized costs to calculate a benefit–cost ratio. If the ratio is greater than 1.0, the RoadView system will be considered cost-effective.

A simplified summary of the calculations used to produce the benefit–cost ratios is provided below:

<u>Costs</u>	
In-road costs	\$ IR
In-vehicle costs	+ \$ IV
Total RoadView system initial purchase costs	\$ Tot Cost
Annualized cost (Total cost/N yrs. + maintenance)	\$ COST
<u>Benefits</u>	
Reduction of road closure duration (annual hours gained)	\$ CD
Reduction of snowplow-only accidents (annual number)	+ \$ SP
Annualized benefits from the RoadView system	\$ BENE
Annual gain (loss)	<u>\$ COST – BENEFIT</u>
Benefit–cost ratio	BENEFIT–COST

To illustrate the potential costs and benefits associated with implementing the RoadView system, five scenarios were analyzed. These scenarios pertain to the five areas that were targeted for data collection. The roadways represented in the scenarios have individual characteristics that distinguish them from one another, including variations in traffic volume, the number of lanes, road grade, and the frequency of road closures due to winter weather conditions. From a review of the scenarios, the factors that influence the benefit cost–ratio can be examined more fully.

Parameters Used in the Analysis

As previously discussed, the expected benefits of the RoadView system include increased safety and mobility. It is assumed that implementation of the RoadView technology will reduce the number and duration of road closures, as well as reduce the number of snowplow-only accidents. Operational benefits are anticipated, as well, but measures of the efficiency of plowing operations were not included in the analysis.

To calculate the economic benefits associated with the implementation of the RoadView system, the following data were used in each scenario: snowplow-only accident statistics, average annual daily traffic (AADT) and average daily truck traffic (ADTT), and the aggregate duration of road closures. The data used in Scenarios 1 through 4 were collected as part of this study, while the data utilized in Scenario 5 were collected by Ravani et al. (9).

The benefits of the RoadView system were quantified using the following factors:

- Travel delay cost for automobiles of \$12.20 per hour (11),
- Travel delay cost for commercial vehicles of \$25.30 per hour (11), and
- Cost of damage to snowplows per accident of \$2,450 (7).

The costs associated with the RoadView system pertain to placing magnets in the roadway (in-road costs), as well as outfitting the snowplow with the necessary radars, sensors, and control units (in-vehicle costs). Correspondence with Mr. Kin Yen, University of California–Davis, and Stephen Owen, Arizona Department of Transportation (unpublished data), identified the following costs associated with the RoadView project:

In-vehicle costs	= \$30,000/snowplow (includes installation),
In-road costs	= \$18,000/lane mi (includes installation),
Maintenance costs	= \$500/year/snowplow, and
In-vehicle and in-road equipment life expectancy	= 5 years.

The scenarios and the formula used constant dollars (not adjusted for inflation) and were rounded to the nearest \$10. It was assumed that the number of hours associated with road closures due to winter weather would be reduced by 5%. An average of 4 h per closure was used for the purposes of the scenarios. It was further assumed that snowplow-only accidents would be reduced by 15%. Finally, the number of snowplows to be equipped with the RoadView system for deployment on each roadway was established on the basis of the number of miles and lane miles to be plowed. Because of the cost associated with equipping the plows, it was assumed that a minimal number of plows would be equipped for each area and used primarily for that specific roadway. Because plows are often part of a gang-plowing operation, two plows were used for all but one of the scenarios. Four plows were used in the Idaho scenario because of the high number of lane miles for this example.

SCENARIO 1: US-12 IN IDAHO (BETWEEN LOLO PASS AND LOWELL, IDAHO)

The section of US-12 used in this analysis (Figure 1) begins at the Lolo Pass, located on the Montana–Idaho border, and flows to the southwest to the town of Lowell, Idaho. The majority of this section of roadway follows along the Lochsa River. This roadway segment consists of 76 mi of two-lane highway.

In-road costs (152 lane miles)	\$ 2,736,000
In-vehicle costs (4 snowplows)	<u>120,000</u>
Total RoadView system initial purchase costs	\$ 2,856,000
Annualized cost (including maintenance)	\$ 573,200
Reduction of road closure duration (Assumption 1)	\$ 0
Reduction of snowplow-only accidents (Assumption 2)	<u>3,310</u>
Annualized benefits from the RoadView system	\$ 3,310
Annual gain (loss)	<u>(\$ 569,890)</u>
Benefit–cost ratio	0.006

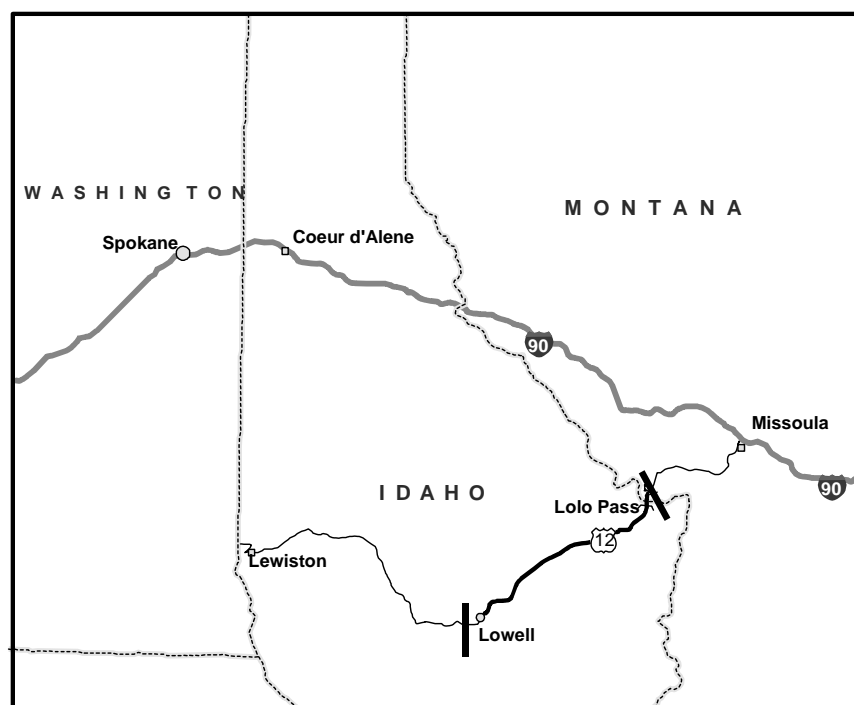

FIGURE 1 Idaho (US-12) scenario site.

The Scenario 1 assumptions follow.

1. Although Lolo Pass was closed during the 5-year timeframe examined in this study, the closures were due to forest fires and avalanche conditions, factors that would not be affected by RoadView technology. Thus, there could be no reduction in this variable.
2. Snowplow-only accidents would be reduced from 9 to 7.65 (15% reduction).

SCENARIO 2: HOMESTAKE PASS ON I-90 NEAR BUTTE, MONTANA

Homestake Pass is located on I-90 approximately 7 mi southeast of Butte, Montana (Figure 2). I-90 is a major east-west road connecting the West Coast to the Midwest. The area considered in this analysis consists of 14 mi of four-lane Interstate highway.

In-road costs (56 lane miles)	\$ 1,008,000
In-vehicle costs (2 snowplows)	<u>60,000</u>
Total RoadView system initial purchase costs	\$ 1,068,000
Annualized cost (including maintenance)	\$ 214,600
Reduction of road closure duration (Assumption 1)	\$ 1,780
Reduction of snowplow-only accidents (Assumption 2)	<u>1,470</u>
Annualized benefits from the RoadView system	\$ 3,250
Annual gain (loss)	<u>(\$ 211,350)</u>
Benefit–cost ratio	0.015

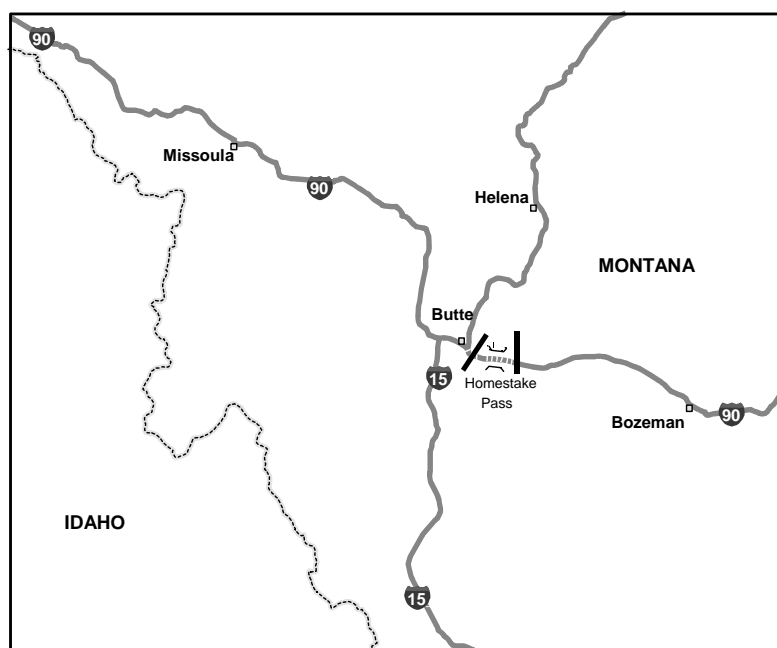

FIGURE 2 Montana (I-90) scenario site.

The Scenario 2 assumptions follow.

1. Reduction in closures equals 0.4 h per year (5% reduction).
2. Snowplow-only accidents would be reduced from 4 to 3.4 (15% reduction).

SCENARIO 3: I-94 IN NORTH DAKOTA NEAR BISMARCK

I-94 runs the entire length of North Dakota, approximately 360 mi. I-94 enters the state in the east at Fargo (the largest city in the state) and continues west through Bismarck (the capital) and then into Montana. The targeted 31-mi section of I-94 consists of a four-lane Interstate highway between Bismarck and Driscoll, North Dakota (Figure 3).

In-road costs (124 lane miles)	\$ 2,232,000
In-vehicle costs (2 snowplows)	<u>60,000</u>
Total RoadView system initial purchase costs	\$ 2,292,000
Annualized cost (including maintenance)	\$ 459,400
Reduction of road closure duration (Assumption 1)	\$ 2,230
Reduction of snowplow-only accidents (Assumption 2)	<u>1,100</u>
Annualized benefits from the RoadView system	\$ 3,330
Annual gain (loss)	<u>(\$ 456,070)</u>
Benefit–cost ratio	0.007

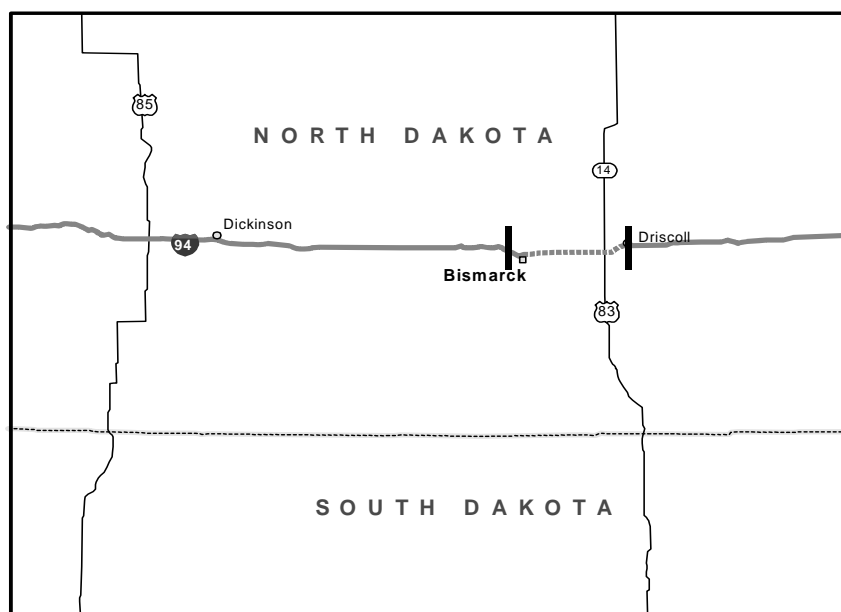

FIGURE 3 North Dakota (I-94) scenario site.

The Scenario 3 assumptions follow.

1. Reduction in closures equals 0.5 h per year (5% reduction).
2. Snowplow-only accidents would be reduced from 3 to 2.55 per year (15% reduction).

SCENARIO 4: I-80 IN WYOMING NEAR LARAMIE

I-80 runs the entire length of the state of Wyoming, approximately 400 mi. I-80 enters the state in the east near Cheyenne (the Capital and largest city in the state) and continues west into Utah. The targeted 12-mi section of I-80 consists of a four-lane Interstate highway, near Laramie, Wyoming, extending eastward to milepost 329 (Figure 4).

In-road costs (48 lane miles)	\$ 864,000
In-vehicle costs (2 snowplows)	<u>60,000</u>
Total RoadView system initial purchase costs	\$ 924,000
Annualized cost (including maintenance)	\$ 185,800
Reduction of road closure duration (Assumption 1)	\$ 11,370
Reduction of snowplow-only accidents (Assumption 2)	<u>1,470</u>
Annualized benefits from the RoadView system	\$ 12,840
Annual gain (loss)	<u>(\$172,960)</u>
Benefit–cost ratio	0.069

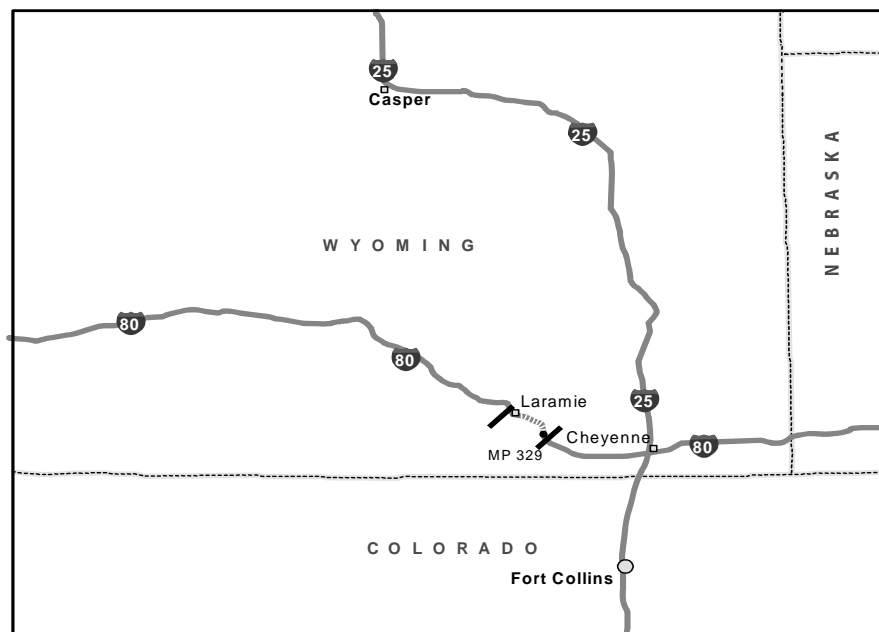

FIGURE 4 Wyoming (I-80) scenario site.

The Scenario 4 assumptions follow.

1. Reduction in closures equals 1.7 h per year (5% reduction).
2. Snowplow-only accidents would be reduced from 4 to 3.4 per year (15% reduction).

SCENARIO 5: DONNER PASS, CALIFORNIA

Donner Pass is located on I-80, to the west and southwest of Reno, Nevada. Although magnets were placed in just one lane for previous research (9), it was assumed that all lanes would receive magnets for purposes of this scenario. The targeted section includes approximately 4 mi of Interstate highway, part two-lane and part three-lane in configuration (Figure 5).

In-road costs (20 lane miles)	\$ 360,000
In-vehicle costs (2 snowplows)	<u>60,000</u>
Total RoadView system initial purchase costs	\$ 420,000
Annualized cost (including maintenance)	\$ 85,000
Reduction of road closure duration (Assumption 1)	\$ 106,740
Reduction of snowplow-only accidents (Assumption 2)	<u>6,250</u>
Annualized benefits from the RoadView system	\$ 112,990
Annual gain (loss)	<u>\$ 27,990</u>
Benefit–cost ratio	1.33



FIGURE 5 California (I-80) scenario site.

The Scenario 5 assumptions follow.

1. Reduction in closures equals 4.4 h per year (5% reduction).
2. Snowplow-only accidents would be reduced from 17 to 14.45 per year (15% reduction).

CONCLUSIONS AND IMPLICATIONS: BENEFIT-COST ANALYSIS

The RoadView system was found to be cost-effective in only one of the five scenarios: the Donner Pass area in California. Several characteristics that distinguished this site from the other locations should be highlighted. First, this location experienced the highest frequency of snowplow-related accidents among the study sites, as well as the highest 4-year average of winter road closures. In fact, road closures at this site were 6 to 10 times more frequent than at the other four locations. The AADT at Donner Pass was approximately six times greater than at the remaining sites, with ADTT figures ranking second only behind the designated roadway in Wyoming. Thus, it appears that the RoadView system may have the greatest impact on roadways that have a history of numerous winter road closures, with high volumes of automobile and truck traffic. Roadways with high accident experience (i.e., crashes involving only snowplows or snowplows compares with other motor vehicles) also should be considered for deployment of vehicles equipped with advanced snowplow technologies in order to maximize the opportunity to detect and measure the system's effect on snowplow-related crash and injury rates.

To further illustrate the impact that road closures, traffic volume, and the length of road have on the benefit-cost ratio, a break-even curve was created for each scenario (Figure 6). The break-even curve is defined as having a benefit-cost ratio of 1.0 at any point along its length. Points lying to the right of the curve have a benefit-cost ratio of greater than 1.0, while points to

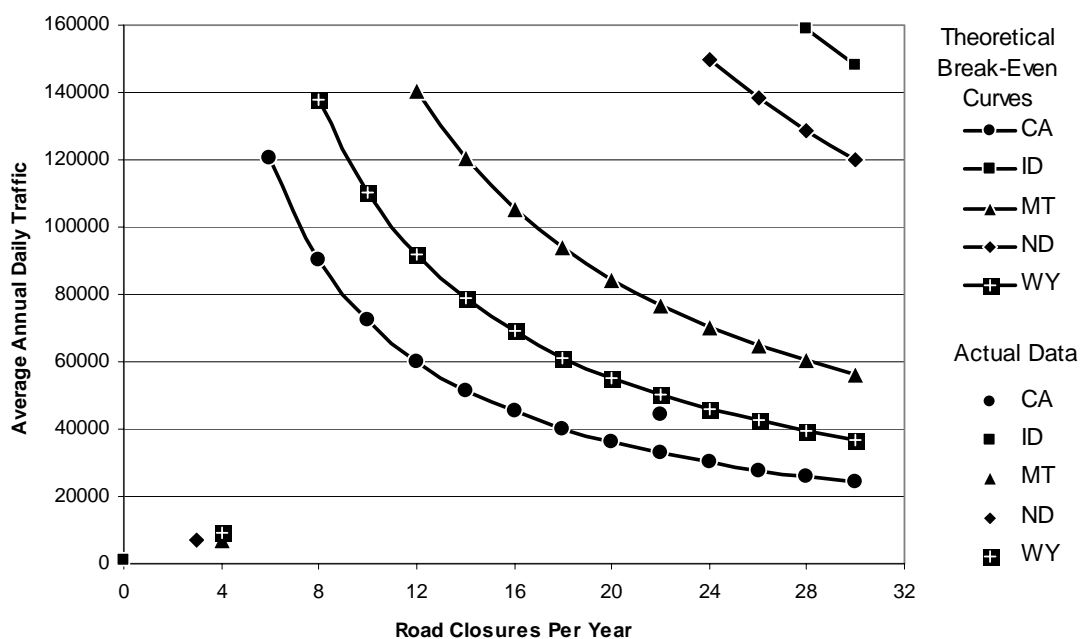

FIGURE 6 Break-even analysis of the RoadView system.

the left of the curve have a benefit–cost ratio of less than 1.0. Break-even curves were individually calculated for each of the five scenarios. It is important to note that the data point for each scenario should be compared against only its respective break-even curve.

From the analysis, it was found that the length of the roadway to be instrumented, the number of closures, and AADT are the three most significant factors in determining whether the RoadView system would be cost-effective in a particular area. The number of snowplow-only accidents had less effect on the analysis because of the relatively small cost of these incidents. Therefore, benefits realized from deployment are realized mostly through delay savings to the traveling public and, to a much lesser extent, snowplow only accidents. Bear in mind that this analysis was based on assumed estimates of benefits to be derived from the RoadView system.

At this stage of development, the costs associated with the RoadView system are extensive. Further testing or system modifications may reduce costs as well as could wholesale manufacture and product distribution. Correspondence with Yen discussed the equipment costs being reduced by up to 20% in a full-scale production and deployment scenario. The useful life of the in-road portion of the system (i.e., the magnets) is estimated to be at least 5 years; however, this estimate depends largely on the frequency of resurfacing activities on any given roadway. Extending the useful life of the RoadView components would increase the benefit–cost ratio, because the system costs could be amortized over a longer period of time. Assuming the estimates of system benefits used in the scenarios were reasonable, the costs currently associated with the advanced snowplow technology would have to be reduced significantly in order to make the system cost-effective. Once again, however, these results must be interpreted with caution because of the arbitrary estimates of system effectiveness used in the calculations.

SUMMARY

The goal of this project was to determine the feasibility of implementing an advanced snowplow guidance and warning system to improve the safety and efficiency of snow removal operations and to assess potential costs and benefits associated with combining conventional snowplow operations with intelligent vehicle technologies. The study was designed to determine the magnitude of the challenges faced by snowplow operators while they attempt to clear roadways of snow and ice, particularly during low visibility conditions. A needs assessment and a discussion of variables that could be used in a BCA of the RoadView system were provided, along with a detailed analysis of responses to a survey administered to snowplow operators. This study was not intended as an effectiveness evaluation of the system.

The quantitative and qualitative data that were collected for subsequent analyses were related to safety, mobility, and operational issues. Previous demonstrations have shown the potential success of RoadView deployments, although such demonstrations were limited in terms of the number of vehicles equipped with the advanced technology and the amount of time these vehicles had been in operation. Theoretically, the technology used in the RoadView project is expected to increase safety by reducing erratic snowplow movements, run-off-the-road incidents and lane departures, snowplow accidents, damage to other vehicles and the infrastructure, and injuries to snowplow operators or other vehicle occupants. Increasing the speed or efficiency of snow removal tasks may reduce road closures and travel delays and thereby improve both the operational aspects of snow removal activities and the mobility of motorists during adverse winter weather.

Historical data confirmed the incidence of snowplow-related accidents, both with and without the involvement of other vehicles, along those roadways selected as study sites. Roadway closures due to severe winter weather and resulting in unspecified delays to travelers also were documented. Presumably, any technology capable of reducing accident-related costs or injuries would be perceived as beneficial. Furthermore, technology that has the potential to shorten or eliminate road closures would have intuitive appeal. The task of determining the need for advanced technology without the benefit of empirical data was problematic. Therefore, subjective assessments of the perceived usefulness and potential benefits of the system, based on the responses to the snowplow operator survey, were used as additional measures or indications of the need for the technology.

The survey also provided information regarding difficulties encountered by snowplow operators while conducting operations in low-visibility conditions, current practices, and operational concerns, and the receptivity of operators to the advanced technology. During an average snowstorm, for example, snowplow operators estimated they typically lost sight of the roadway between one and six times for roughly 4 to 5 s per event. In terms of current operations, the three visual cues that snowplow operators relied on most frequently to maintain their position on the roadway included judging their distance from guardrails, mileposts and delineators, and centerlines. When asked to assess the potential usefulness of various advanced technologies, operators gave the highest ratings to those that would provide lane position information, followed by those that would provide obstacle detection capabilities. Despite these high ranking of potential usefulness, operators felt that there would be weather conditions in which snowplow operations should be suspended, regardless of the availability of advanced snowplow technology.

As with the needs assessment, the BCA was limited by the lack of empirical data to measure system benefits. Five scenarios that corresponded to the designated study sites were used to illustrate how benefit–cost ratios for the RoadView system could be calculated. It must be emphasized that until sufficient data have been collected to quantify the benefits of the advanced snowplow technology such hypothetical examples should not be considered statistical estimates of system effectiveness and should be interpreted with caution. In response to these concerns, what were believed to be conservative estimates of potential benefits associated with the RoadView system were used in the calculations. In comparison, Parsons Brinkerhoff Quade & Douglas, Inc. (7) utilized benefit levels of 10%, 20%, and 30% for reducing the number of snowplow crashes with other motor vehicles and fixed objects, reducing delays to commercial vehicles, and increasing the productivity of snowplow operations.

Of the five scenarios, only one produced a benefit–cost ratio greater than 1.0 (i.e., signifying benefits that outweighed the costs of the system). Overall, it appears that the potential cost-effectiveness of the RoadView system would be increased in areas with high traffic volumes and high probabilities of road closures due to winter weather and to a lesser extent in areas that have experienced a large number of snowplow-related accidents in the past.

ACKNOWLEDGMENTS

The authors thank the departments of transportation in Idaho, Montana, North Dakota, and Wyoming for their participation and support. In addition, the authors acknowledge the district

engineers, section supervisors, and maintenance chiefs in each of the states who helped in distributing nearly 2,000 surveys. The authors also acknowledge the dedicated efforts of the undergraduate and graduate students at the Western Transportation Institute who provided instrumental assistance in the completion of this research.

The authors also thank the Advanced Highway Maintenance and Construction Technology Center at the University of California–Davis for sponsoring this report, as well as the other partners in the RoadView project including the University of California–Berkeley’s Partners for Advanced Transit and Highways Center, the California Department of Transportation, and the Arizona Department of Transportation.

REFERENCES

1. *Bozeman Daily Chronicle*, Wednesday, November 28, 2001.
2. Salt Institute statement on Standard & Poor’s DRI Study. Winter 1999. Available online at www.saltinstitute.org/pubstat/s-p-dri.htm.
3. Hanbali, R. M. Economic Impact of Winter Road Maintenance on Road Users. In *Transportation Research Record 1442*, TRB, National Research Council, Washington, D.C., 1994, pp. 151–161.
4. Knapp, K. K., L. D. Smithson, and A. J. Khattak. The Mobility and Safety Impacts of Winter Storm Events in a Freeway Environment. *Mid-Continent Transportation Symposium 2000 Proceedings*.
5. Booz-Allen & Hamilton, Inc. *Evaluation of the Minnesota Department of Transportation’s Intelligent Vehicle Initiative Snowplow Demonstration Project on Trunk Highway 19. Winter 1998–1999*. Prepared for the Minnesota Department of Transportation, October 27, 1999.
6. McGehee, D. V., and M. Raby. *Operator Interface Design Rational for the 3M Lane Awareness System for Snow Removal Operations*. Draft Report, University of Iowa, July 3, 2000.
7. Parsons Brinckerhoff Quade & Douglas, Inc. *Snow Plow Vehicle Case Study Summary Report*. Submitted to the Minnesota Department of Transportation Office of Advanced Transportation Systems, September 21, 1998.
8. Raby, M., D. V. McGehee, G. E. Nourse, and S. Bartingale. *Operator Interface Design of a Lane Awareness System for Snow Removal Operations*.
9. Ravani, B., et al. *Advanced Snowplow Development and Demonstration: Phase I: Driver Assistance*. Advanced Highway Maintenance and Construction Technology Research Report, UCD-ARR-99-06-30-03, June 30, 1999.
10. Ravani, B., et al. *Development of an Advanced Snowplow Driver Assistance System*. Advanced Highway Maintenance and Construction Technology Research Report, UCD-ARR-00-06-30-02, June 30, 2000.
11. Texas Transportation Institute. Benefit-Cost Spreadsheet. Available online at http://tti.tamu.edu/austin/research/b-c_spreadsheet_6-00.xls.

WINTER MAINTENANCE VEHICLE ADVANCEMENTS

**GIS-Based Analysis of Intelligent
Winter Maintenance Vehicle Data****ALAN VONDEROHE****TERESA ADAMS****CAROLA BLAZQUEZ****JUSTIN MALONEY***University of Wisconsin–Madison***THOMAS MARTINELLI***Wisconsin Department of Transportation*

The Wisconsin Department of Transportation, in cooperation with eight Wisconsin counties, has embarked on a 4- to 5-year effort to implement advanced technologies in winter maintenance vehicles. The University of Wisconsin–Madison is assisting with data management aspects of the effort.

The winter maintenance vehicles are equipped with differential Global Positioning System (DGPS) receivers and numerous additional sensors that collect environmental data (e.g., pavement and air temperature), equipment status data (e.g., plow up/plow down), and material usage data (e.g., salt application rate). These data are telemetered to a dispatch center and recorded on magnetic media for later downloading. Data are transmitted and recorded as often as every 2 s. Data such as these, both in type and in quantity, have never before been available to Wisconsin transportation agencies.

A geographic information system application, dubbed “Wiscplow,” has been developed and initially deployed for testing within participating counties. Wiscplow combines vehicle data with manually entered data (e.g., storm durations, vehicle configurations, and labor and equipment cost rates) and with spatial data representing roadway centerlines attributed with functional class, number of lanes, patrol sections, and route systems. Outputs include reports on computed performance measures (e.g., cycle time and hourly average salt application rate by patrol section and storm) and decision management tools (i.e., charts, graphs, and maps) showing relationships among performance measures (e.g., salt application rate versus pavement temperature by patrol section and storm).

Both technical and institutional issues are being addressed. Technical issues include spatial data accuracy requirements, sensitivity of computed performance measures to error in the DGPS and roadway centerline data, temporal keys to uniquely identify vehicle data points, and advanced map-matching algorithms for resolution of spatial ambiguities between DGPS and roadway centerline data at intersections and on converging and diverging roadways (e.g., ramps). Institutional issues include responsibility for development and maintenance of the necessary spatial databases at the required level of accuracy and currency, installation and management of a new set of databases and applications within county highway departments, staffing and training, and mechanisms for technical support and maintenance of the application software.

INTRODUCTION

The Wisconsin Department of Transportation (DOT), in cooperation with eight Wisconsin counties, has embarked on a 4- to 5-year effort to implement advanced technologies in winter maintenance vehicles. The University of Wisconsin–Madison is assisting with data management aspects of the effort.

The winter maintenance vehicles are equipped with differential Global Positioning System (DGPS) receivers and numerous additional sensors that collect environmental data (e.g., pavement and air temperature), equipment status data (e.g., plow up/plow down), and material usage data (e.g., salt application rate). These data are telemetered to a dispatch center and recorded on magnetic media for later downloading. Data are transmitted and recorded as often as every 2 s. Data such as these, both in type and in quantity, have never before been available to Wisconsin transportation agencies.

A geographic information system (GIS) application, dubbed “Wiscplow,” has been developed and initially deployed for testing within participating counties. Wiscplow combines vehicle data with manually entered data (e.g., storm durations, vehicle configurations, and labor and equipment cost rates) and with spatial data representing roadway centerlines attributed with functional class, number of lanes, patrol sections, and route systems. Outputs include reports on computed performance measures (e.g., cycle time and hourly average salt application rate by patrol section and storm) and decision management tools (charts, graphs, and maps) showing relationships among performance measures (e.g., salt application rate versus pavement temperature by patrol section and storm).

WISCPLOW OVERVIEW

Figure 1 presents a conceptual overview of Wiscplow inputs, functions, and outputs. Inputs to Wiscplow include encoded sensor data recorded onboard the vehicles on magnetic media. Vehicle data files are in ASCII format. A new file is created each time the engine of a vehicle is started or when the vehicle operator initiates the data-recording process through the vehicle’s console. Typical data files range from a few hundred kilobytes to a few megabytes in size. Data files are downloaded from the magnetic cards after the vehicles return to the yard. A single card can contain many data files.

Wiscplow requires some data to be entered manually. These data include equipment configurations for individual vehicles, equipment charge-back rates, costs and types of materials, labor costs, time periods for normal and overtime labor costs, and types and durations of winter events. Users also must select performance measures to be computed and decision management tools to be generated.

The third primary input data component is a roadway centerline spatial database that includes a topologically structured network with delineated patrol sections and assigned route systems with traveled distance measures.

Wiscplow parses the vehicle data files and generates a core database of DGPS positions, times, and sensor data. The database includes relationships with the manually entered data on events, equipment configurations, materials, operators, and costs. The DGPS positions are used to create a shape file of vehicle locations (the vehicle track). Spatial functions are then used to relate these data to roadway centerlines, patrol sections, and route systems.

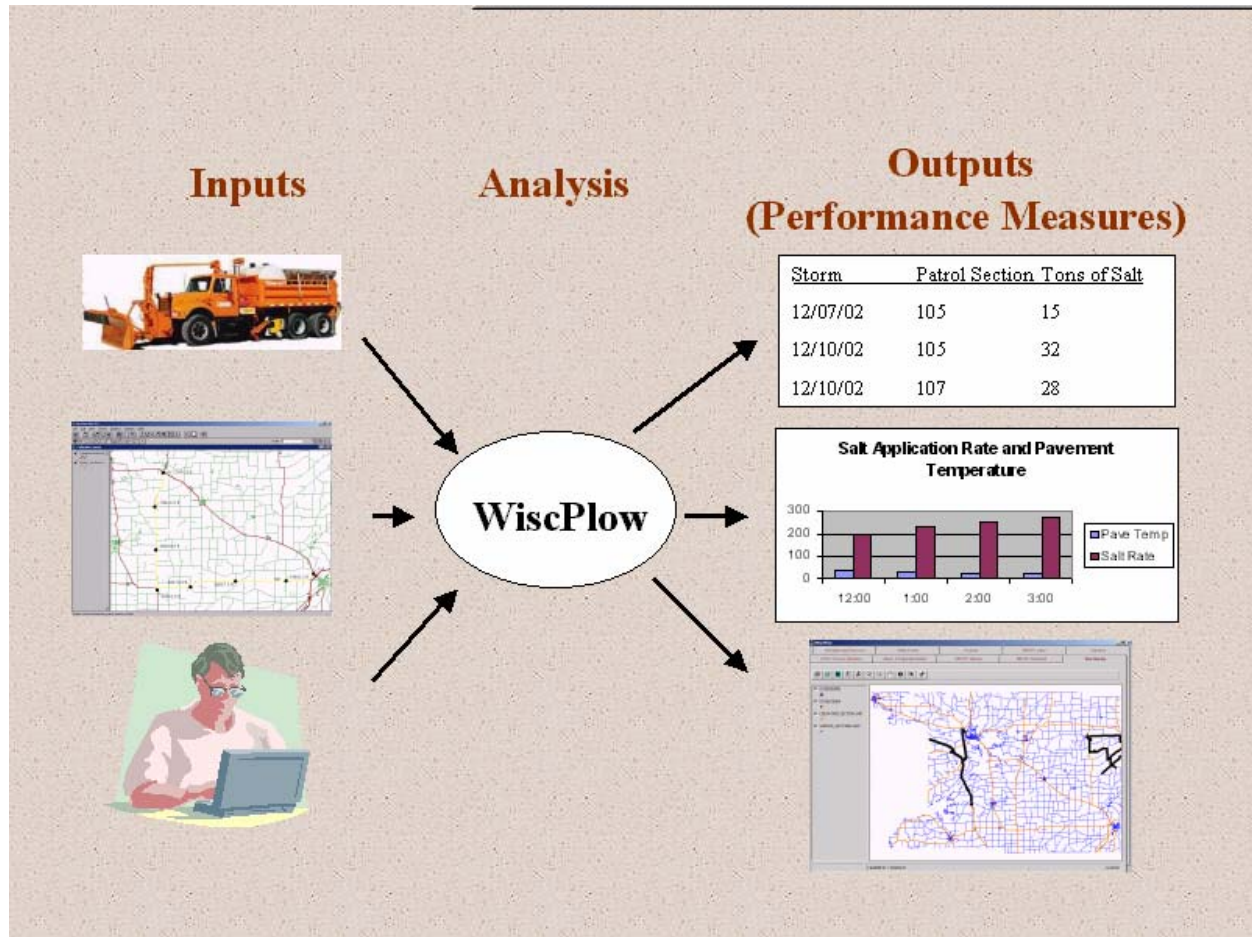

FIGURE 1 Conceptual overview of Wiscplow inputs, analysis, and outputs.

Preprogrammed queries then draw on these intermediate data to derive performance measures. The performance measures can be output as reports, combined together in charts for analysis, or displayed on maps. Figure 2 illustrates high-level data and program flows of Wiscplow.

APPLICATION ARCHITECTURE

Wiscplow is written in Visual Basic®. Spatial analytical functions, map displays, and cartographic functions and queries were developed with Environmental Systems Research Institute's (ESRI) Map Objects®. Wiscplow seamlessly links these spatial functions with Microsoft's Access® and Excel®. Wiscplow reports are in ASCII format, and its charts are embedded in Excel spreadsheets for easy portability. Its maps are ESRI shape files.

Wiscplow was designed as a stand-alone application to be used by county highway departments. It is not a multiuser system with concurrent access to its databases. This configuration was deemed appropriate for Wiscplow's intended uses and the level of sophistication in information technology across Wisconsin county highway departments.

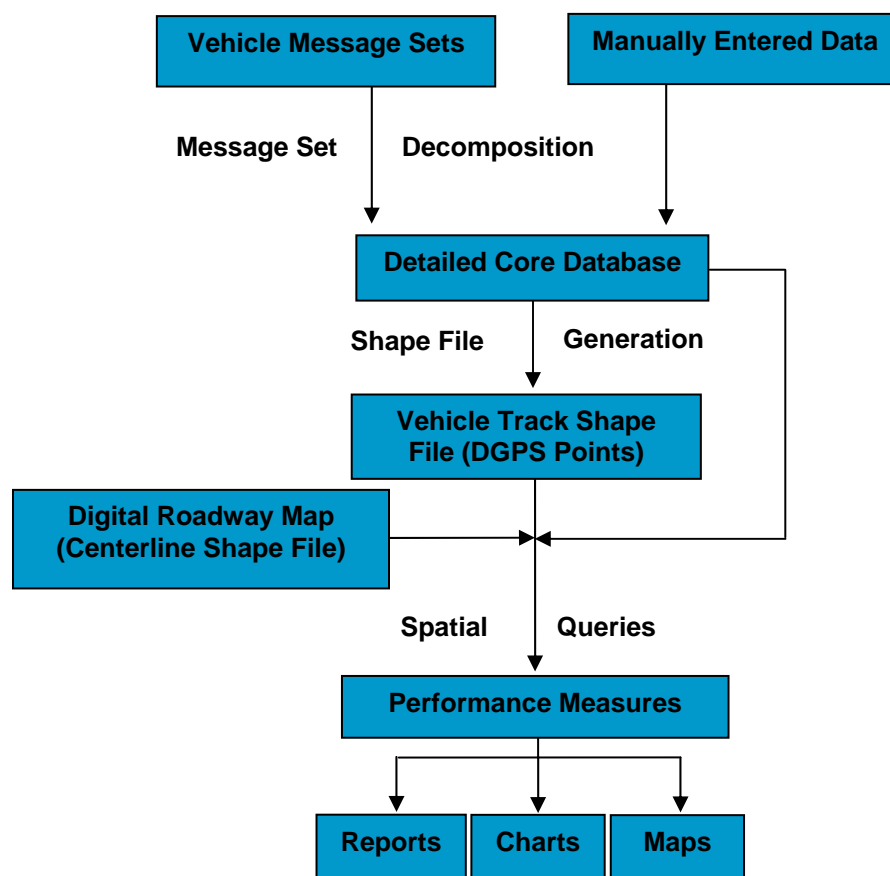

FIGURE 2 Wisplow data and program flow.

USER INTERFACE

The user interface was developed to be as intuitive as possible. Users are not required to have prior knowledge of or training in GIS. Users invoke functions by checking boxes. Some data must be entered manually.

Wisplow has 10 screens, selected by tabs that appear at the tops:

1. An initialization screen for entering a password and identifying the county (this function selects the appropriate roadway centerline spatial database and needs to be executed only once).
2. A winter events screen (Figure 3) for entering identifiers, precipitation types, and durations for storms, anti-icing events, and incidents.
3. An operators screen for entering vehicle operator names, labor rates, and operating day versus overtime periods.
4. An equipment configuration/rates screen (Figure 4) for entering identifiers and attachments for each vehicle and charge back rates for use of attachments.
5. A products screen for entering information and codes for dry and liquid agents.

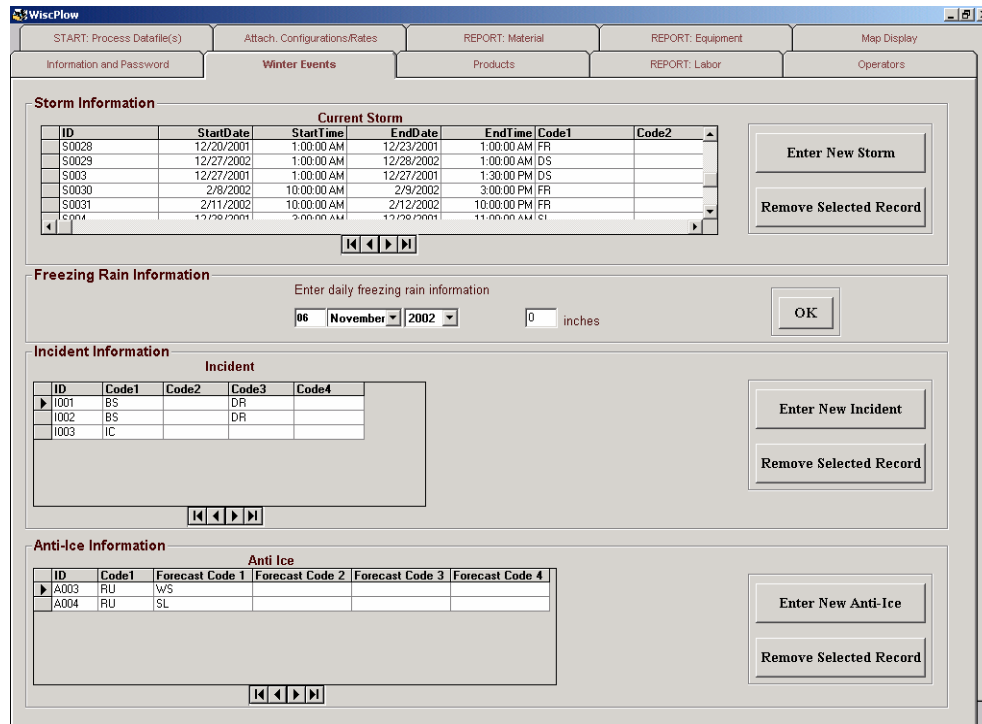

FIGURE 3 Winter events screen.

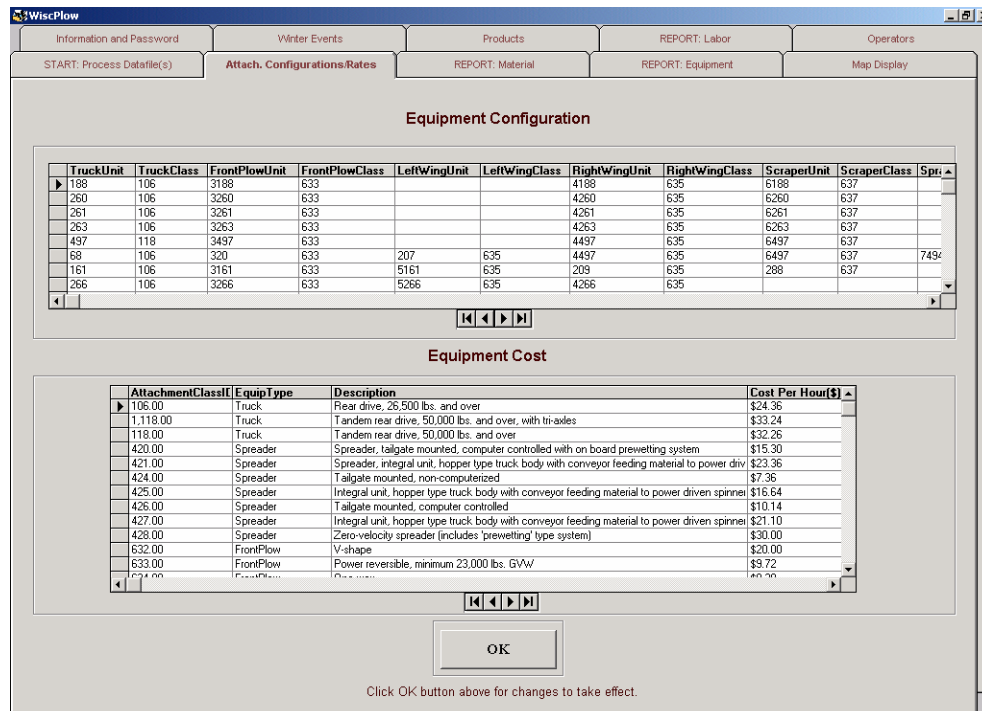

FIGURE 4 Equipment configuration/rates screen.

6. A process data files screen (Figure 5) for selecting vehicle data files for batch processing and associating data files with events, vehicles, operators, and liquid and dry agents. A number of data files (e.g., for all vehicles for 2 days) can be selected for overnight batch processing. The spatial operation of associating DGPS points with roadway centerlines is computationally expensive, and large data files, with perhaps more than 10,000 data points, can require significant processing time.

7. A material report screen (Figure 6) for selecting performance measures reports and decision management tools associated with usage of materials. A calendar is displayed for designation of the time period to be covered by the reports and decision management tools. Wiscplow displays the data files included in the designated time period.

8. An equipment report screen for selecting performance measures reports and decision management tools associated with usage of equipment. Again, a calendar is displayed for designation of the time period to be covered by the reports and decision management tools.

9. A labor report screen for selecting performance measures reports associated with operators and labor. Again, a calendar is displayed for designation of the time period to be covered by the reports.

10. A map display screen (Figure 7) that displays roadway centerlines, selected patrol sections, and selected vehicle tracks. Users can zoom, pan, and query these maps (see the following section). They are ESRI shape files and could be extracted for inclusion in other GIS applications.

Pathway	FileName	OperatorID	EventID	DryAgent	VehicleID	LiquidAgent
C:\columbiadata\02080217.004	02080217.004	256	S0030		170	
C:\columbiadata\02110217.003	02110217.003	278	S0031		170	

FIGURE 5 Process data files screen.

Application Rates

Average material application rate for each operator and event

Select from the following to include in the report:

Pounds/lane mile of salt
 Pounds/lane mile of sand
 Gals of prewetting liquid/ton of salt
 Gals of prewetting liquid/ton of sand
 Gals/lane mile of anti-ice liquid
 Check all

Hourly average material application rate for each patrol section

Select from the following to include in the report:

Pounds/lane mile of salt
 Pounds/lane mile of sand
 Gals of prewetting liquid/ton of salt
 Gals of prewetting liquid/ton of sand
 Gals/lane mile of anti-ice liquid
 Select all to include

Inventory

Quantity of material used for each event and patrol section

Tons of salt
 Cubic yards of sand
 Gals of prewetting liquid
 Gals of anti-ice liquid
 Check all

Quantity of material used for all events and each patrol section

Tons of salt
 Cubic yards of sand
 Gals of liquid material (prewetting and anti-ice)
 Check all

Analytical Decision Tools

Hourly application rate and pavement temperature by patrol section, vehicle ID, and winter storm event
 Seasonal cumulative salt use on each patrol section
 Average pavement temperature, salt, and sand rates by winter storm event for all patrol sections
 Pre-wet salt application guideline compliance by patrol section and winter storm event

Blasts

Number of blasts for each operator and event

Pavement Temperature

Hourly average patrol section pavement temperature

Date Information

Start Date: Jan 2001, End Date: Nov 2002

Sun	Mon	Tue	Wed	Thu	Fri	Sat	Sun	Mon	Tue	Wed	Thu	Fri	Sat
31	1	2	3	4	5	6	27	28	29	30	31	1	2
7	8	9	10	11	12	13	3	4	5	6	7	8	9
14	15	16	17	18	19	20	10	11	12	13	14	15	16
21	22	23	24	25	26	27	17	18	19	20	21	22	23
28	29	30	31	1	2	3	24	25	26	27	28	29	30
4	5	6	7	8	9	10	1	2	3	4	5	6	7

List of Datafiles

02110217.003
02110217.002
02030100.002
02030100.003

OK Generate Report

FIGURE 6 Material report screen.

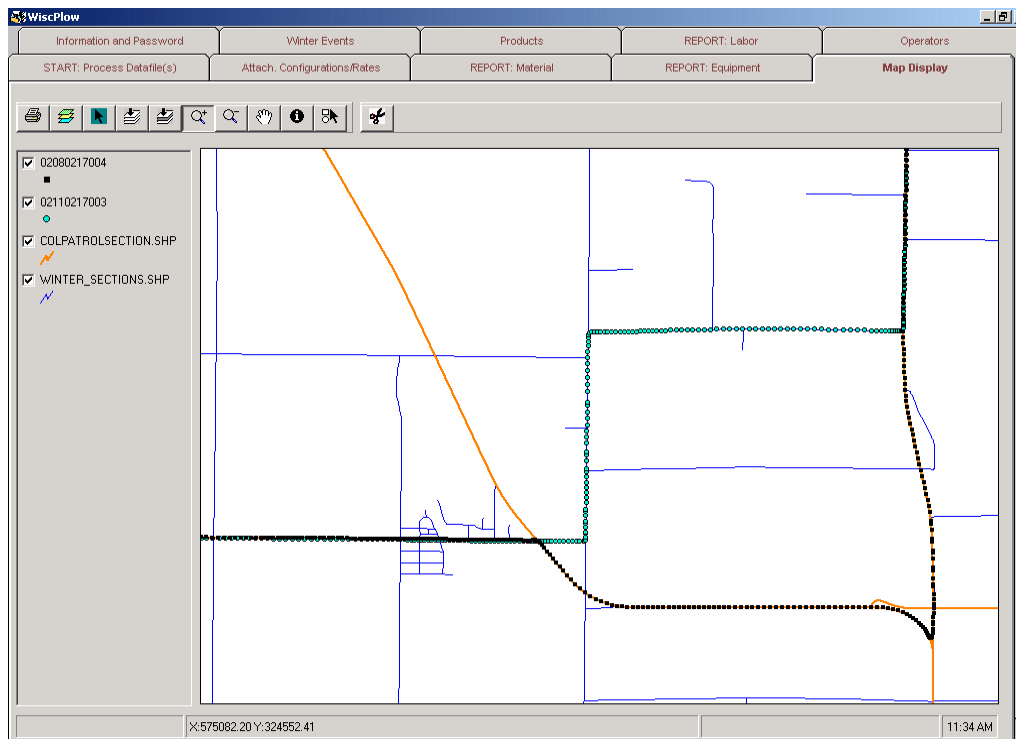

FIGURE 7 Map display screen with roadway centerlines, patrol sections, and two vehicle tracks.

PERFORMANCE MEASURES AND DECISION MANAGEMENT TOOLS

Winter operations performance measures and decision management tools were identified, defined, developed, and refined in an iterative process, with state and county transportation decision makers, that included a series of meetings, communications, and two workshops (1, 2).

Concerning material usage, Wisplow can generate up to 19 performance measures and four charts showing relationships among them (Figure 6). Sample performance measures include average pounds of salt per lane mile for each operator and event, hourly average for each patrol section of gallons per lane mile of anti-ice liquid, tons of salt used for each event and patrol section, and cubic yards of sand used for all events for each patrol section. Sample charts include average pavement temperature, salt, and sand application rates by patrol section for a winter storm event (Figure 8) and seasonal cumulative salt use on each patrol section (Figure 9).

Concerning equipment usage, Wisplow can generate up to 10 performance measures and three charts showing relationships among them. Example performance measures include cost for each attachment unit for each event and patrol section, cycle time for each patrol section and storm, and total operating distance, season-to-date, for each attachment unit. Example charts include production rates for equipment units by roadway class and cumulative operating hours for units of an attachment class.

Concerning labor, Wisplow can generate up to five performance measures. Examples include labor hours per lane mile for each patrol section and storm and percentage of labor costs attributed to clean-up for each storm.

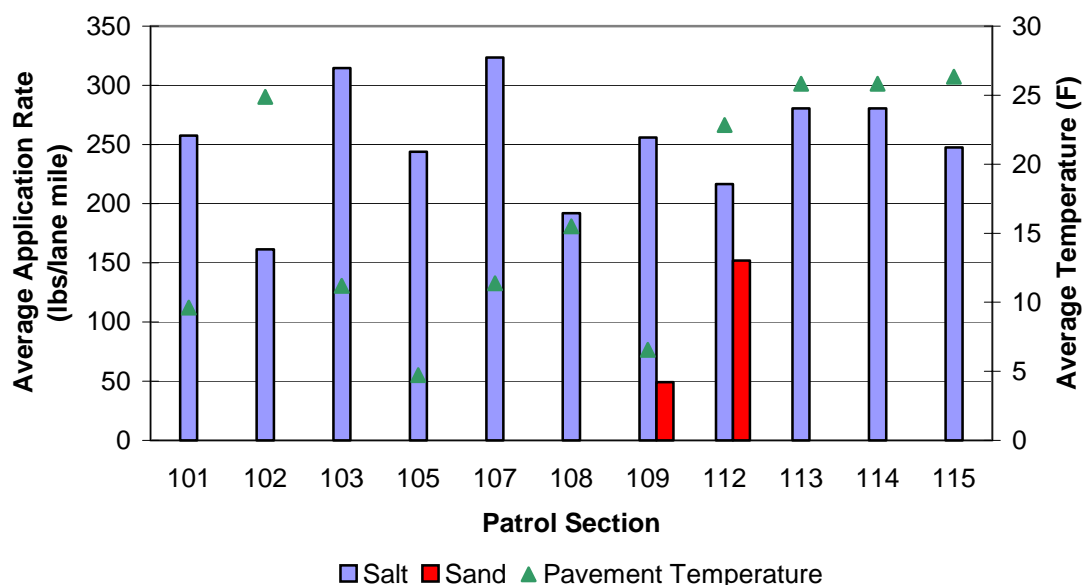

FIGURE 8 Average pavement temperature, salt, and sand application rates by patrol section for a winter storm event.

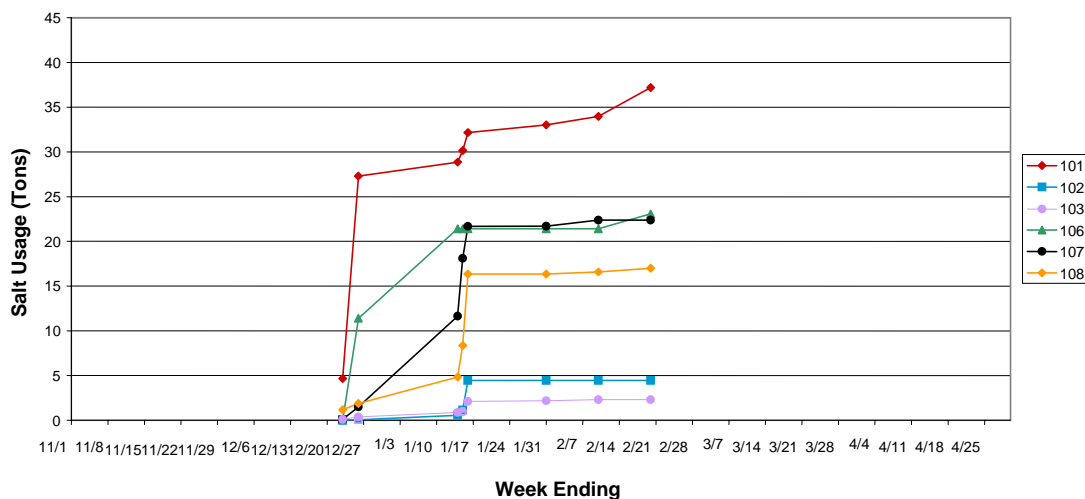

FIGURE 9 Seasonal cumulative salt use on each patrol section.

The map display can be queried by using the identify function. Identify displays the attributes of features that are selected on the map using the cursor. Attributes can be displayed for roadways, patrol sections, and each data point in a vehicle track. In Figure 10, a vehicle data point has been selected and some of its attributes are displayed. They include operator name, time, air temperature, pavement temperature, vehicle speed, front plow status, right-wing status, left-wing status, and scraper status. The user can scroll down to see material application rates, on which patrol section and route the vehicle is traveling, and the route measure of the vehicle's location.

TECHNICAL ISSUES

During development of Wisplow, a number of technical issues arose and were, or are being, addressed. These include aspects of the spatial versus temporal nature of the vehicle data, determination of appropriate values for proximity parameters, resolution of spatial ambiguities, propagation of error during transformation of DGPS coordinates to route measures (linear locations), and sensitivity of derived performance measures to spatial error and temporal resolution in the data.

In static GIS spatial databases (snapshots for which time is constant throughout the database), location is often thought of as a primary key that distinguishes individual features from one another. Conversely, in spatial and temporal databases, more than one thing can be at the same location. However, two or more things cannot be at the same location at the same time. Therefore, in Wisplow, it is the timestamp, together with the vehicle identifier, that gives uniqueness to individual DGPS data points.

The spatial operation that associates DGPS data points with roadway centerlines uses a buffer of specified size around each data point to find all roadway centerlines that are within proximity. If no centerline falls within its buffer, then a data point is not associated with a

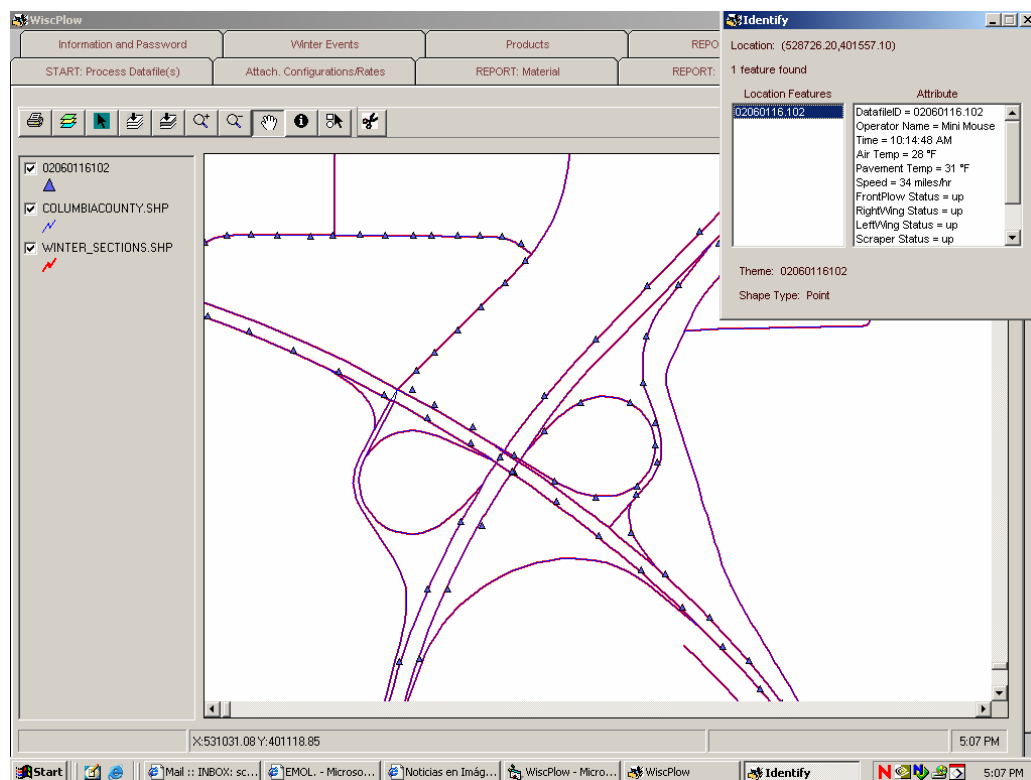

FIGURE 10 Attributes of a vehicle data point.

roadway and is excluded from the database. The assumption is that the vehicle is not traveling on represented roadways (e.g., it is in a parking lot). If more than one centerline falls within its buffer, then a data point is associated with the nearest one. For high-quality DGPS and map data, a buffer of 10 m appears to work effectively. However, experimentation is necessary to determine optimal buffer size as a function of spatial accuracies of the DGPS data points and of the roadway centerline map.

Even if both the DGPS data and the centerline map are of high accuracy, spatial ambiguities can arise when associating vehicle data points with roadways. Figure 11 is a large-scale view of very accurate DGPS and roadway centerline data. It can be seen that, in some cases [e.g., diverging or converging roadways (ramps)], the centerline nearest to a DGPS point is not that of the roadway on which the vehicle is traveling. In Wisflow, many of these problems are resolved by examining consecutive pairs of DGPS data points. The shortest path between each pair of data points is determined from the network topology (link directions and allowable turns). The shortest path is compared to the distance that the vehicle should have traveled, given its reported speed. If the difference falls within a specified tolerance, the association of the second data point with its roadway centerline is accepted. If the difference is greater than the specified tolerance, the next closest roadway centerline is tested. If no path is found that can be traveled at the vehicle's speed, then it is assumed that spatial error has overwhelmed the data and the second data point is excluded from the database. This approach has resolved all tested problems at ramps, without rejection of any data points. The tested data are of high quality, with the DGPS points having a positional accuracy of 2 to 5 m (rms) and the centerline map having a nominal scale of 1:2400. Even with high-quality data, and in a few cases, this method might not

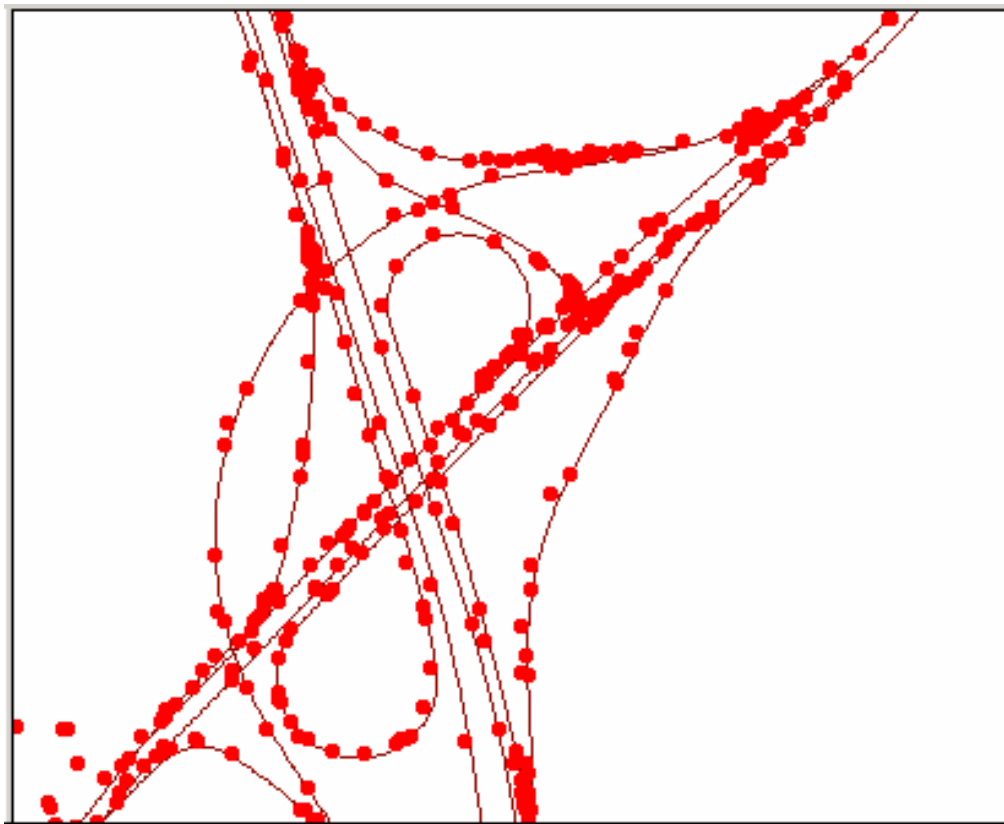

FIGURE 11 Accurate data including spatial ambiguities.

correctly resolve spatial ambiguities at T-intersections, where a given DGPS point is actually closer to the centerline of the cross road than to the centerline of the roadway on which the vehicle is traveling. In such cases, vehicle-tracking algorithms, such as those described by Kim et al. (3), Taylor and Blewitt (4), and Taylor et al. (5), might be effective. In future work, the authors intend to code these algorithms and test them against available data sets.

Even if all spatial ambiguities can be resolved, the data still contain errors that affect derived performance measures. Errors in the DGPS points and in the centerline maps propagate to produce errors in the computed route measures for the DGPS points. These errors then propagate further through the functions used to compute performance measures. Two studies are under way. The first is examining how errors in the DGPS points and the centerline map affect computed route measures for the points. The second study is examining the sensitivities of selected performance measures to both sources of error. The studies account for possible correlations between the errors in latitude and longitude for individual DGPS points and also for possible spatial autocorrelation of error in the roadway centerline map. The second study is also examining sensitivities of the performance measures to temporal resolution of the DGPS data. These data can be collected as often as every 2 s. However, if the sensitivities of the performance measures allow it, this frequency can be reduced with a subsequent reduction in file size and processing time. The ultimate objectives of these two studies are to determine an optimal temporal resolution for the DGPS data; the minimum required accuracy in the DGPS data and, more importantly, in the roadway centerline maps; and relationships between 1 and 2.

INSTITUTIONAL ISSUES

A number of institutional issues must be addressed for successful deployment, use, and extension of Wiscplow. Foremost is the issue of roadway centerline map database development. Only three of the participating counties have roadway centerline maps that are of 1:24,000 scale or larger. Maps at smaller scales cannot support Wiscplow. For example, divided roadways will be represented by a single cartographic line on such maps. So, Wisconsin DOT and the counties must address the issue of development and maintenance of roadway centerline maps that are accurate enough to support this application. All of the counties have land information offices that coordinate GIS efforts on a countywide basis. However, these offices typically have not worked closely with the highway departments because the highway departments have not implemented GIS applications. All Wisconsin DOT district offices have GIS expertise and the skills and technology for managing this task. However, they might not have the time and money to do so. Districts do not typically manage county data. Wisconsin DOT's central office also has the skills and technology but might lack other necessary resources.

The counties must also address the issue of installation of Wiscplow and the necessary databases within their existing information technology environments. A number of county-level management information systems offices require applications and server-based file systems to be installed and managed by them, not the end users. Counties highway departments must have staff trained in the use of Wiscplow and the management of data coming from the magnetic cards on the vehicles. These are new tasks for the counties.

Maintenance of the Wiscplow code is an issue. University environments, with their turnover in graduate students and their project-based activities, are not typically conducive to long-term technical support and maintenance of software. Wisconsin DOT is capable of maintaining GIS application source code but has a policy of not doing so for applications developed by others.

SUMMARY

Wiscplow is a GIS-based application for analysis of data coming from advanced winter maintenance vehicles. The application requires accurate roadway centerline maps that include patrol sections and route systems. Spatial analytical operations associate vehicle DGPS data points with roadway centerlines, yielding route measures for the data points. These data are combined with manually entered data on winter events, equipment configurations, materials, and labor to produce winter operations performance measures that can be reported in tabular form or visualized in decision management tools that include charts and maps.

Some technical issues, concerning refinements to and effective use of Wiscplow, are being addressed. These include questions about temporal identifiers, required spatial accuracies of both the DGPS and map data, optimal temporal resolution of the DGPS data, sensitivities of computed performance measures, and resolution of spatial ambiguities that cause vehicle data to be associated with the wrong roadways. Institutional issues that must be addressed before effective, long-term use of Wiscplow can be realized include responsibility for development and maintenance of accurate roadway centerline spatial databases, integration of Wiscplow and its databases with existing information technology environments at the county level, training and staffing, and long-term technical support and maintenance of the Wiscplow code.

ACKNOWLEDGMENTS

Development of Wiscplow and associated research was supported by Wisconsin DOT's Bureau of Highway Operations. Many persons within Wisconsin DOT and within the highway departments of the eight participating counties assisted with definition and development of Wiscplow's performance measures and decision-management tools. Others who assisted with coding of Wiscplow are Amit Malhotra, Gerald Stanuch, Mohamed Danijarsa, Kiran Manchikanti, and Vaishal Sheth.

REFERENCES

1. Adams, T. M., M. Danijarsa, T. Martinelli, G. Stanuch, and A. Vonderohe. Performance Measures for Winter Operations. In *Transportation Research Record: Journal of the Transportation Research Board, No. 1824*, TRB, National Research Council, Washington, D.C., 2003, pp. 87–97.
2. Adams, T. M., J. Maloney, A. Vonderohe, and T. Martinelli. Management Decision Tools for Winter Operations. In *Transportation Research Circular E-C052*, TRB, National Research Council, Washington, D.C., July 2003, pp. 52–68.
3. Kim, W., G. Jee, and J. Lee. Efficient Use of Digital Road Map in Various Positioning for ITS. In *Proceedings, IEEE Symposium on Position, Location, and Navigation*, 2000.
4. Taylor, G., and G. Blewitt. Road Reduction Filtering Using GPS. In *Proceedings, 3rd AGILE Conference on Geographic Information Science*, Helsinki, Finland, 2000.
5. Taylor, G., D. Steup, A. Car, G. Blewitt, and S. Corbett. Road Reduction Filtering for GPS-GIS Navigation. In *Transactions in GIS*, Vol. 5, No. 3, 2001.

Bridge Winter Support Systems

BRIDGE WINTER SUPPORT SYSTEMS

Implementation of Conductive Concrete Overlay for Bridge Deck Deicing at Roca, Nebraska

CHRISTOPHER Y. TUAN

University of Nebraska–Lincoln

SHERIF A. YEHIA

Western Michigan University

Conductive concrete is a relatively new material technology developed to achieve high electrical conductivity and high mechanical strength. In research sponsored by Nebraska Department of Roads, a conductive concrete mix specifically for bridge deck deicing was developed. In this application, a conductive concrete overlay is cast on top of a bridge deck for deicing and anti-icing.

This technology has been successfully implemented in a demonstration project at Roca, about 15 mi south of Lincoln, Nebraska. The Roca Spur Bridge has a 36-m (117-ft) long and 8.5-m (28-ft) wide conductive concrete inlay. Temperature sensors and a microprocessor-based controller system were installed to monitor and control the deicing operation of the inlay. The construction was completed and the bridge was opened to traffic in the spring of 2003. Data from the first deicing event showed that an average of 500 W/m^2 (46 W/ft^2) was generated by the conductive concrete to raise the slab temperature about 9°C (16°F) above the ambient temperature.

The details of the construction and deicing operation of the conductive concrete inlay are presented.

INTRODUCTION

Conductive concrete is a cementitious admixture containing electrically conductive components to attain stable and high electrical conductivity. Due to its electrical resistance and impedance, a thin conductive concrete overlay can generate enough heat to prevent ice formation on a bridge deck when connected to a power source.

In research sponsored by Nebraska Department of Roads, Yehia and Tuan developed a conductive concrete mix specifically for bridge deck deicing (1–6). In this application, a conductive concrete overlay is cast on top of a bridge deck for deicing and anti-icing. The mechanical and physical properties of the conductive concrete mix were evaluated in accordance with the ASTM and AASHTO specifications (7, 8). Two concrete slabs were constructed with a 9-cm (3.5-in.) conductive concrete overlay for conducting deicing experiments in the natural environment. Deicing experiments were conducted during the winters of 1998–2001 under two scenarios: deicing and anti-icing. The average power density of about 591 W/m^2 (55 W/ft^2) was generated by the conductive concrete to prevent snow accumulation and ice formation.

The Phase 1 findings of this research have shown that conductive concrete overlay has the potential to become the most cost-effective concrete pavement deicing method. The Phase 2

project was completed in the spring of 2003; the conductive concrete has been successfully implemented in a demonstration project at Roca, about 15 mi south of Lincoln, Nebraska. The Roca Spur Bridge has a 36-m (117-ft) long and 8.5-m (28-ft) wide conductive concrete inlay. In this paper, details of the construction of the conductive concrete inlay are presented.

RESEARCH OBJECTIVES

This research focuses on using the newly developed conductive concrete for bridge deck deicing and anti-icing. The implementation of this technology could eliminate the use of road salt and deicing chemicals, which cause concrete deck damage and rebar corrosion. It would also improve winter travel safety on Interstate highway bridges.

BACKGROUND

Conventional concrete is not electrically conductive. Conduction of electricity through concrete may take place in two ways: electronic and electrolytic (9, 10). Electronic conduction occurs through the motion of free electrons in the conductive medium, while electrolytic conduction takes place by the motion of ions in the pore solution. In fresh concrete and during hydration, conduction of electricity takes place by the motion of ions. However, in the hardened state, in which no moisture is available, conduction takes place by the motion of free electrons. In order for hardened concrete to be adequately conductive, metallic or other conductive particles must be added to the concrete matrix, and they must be in good electrical contact with each other. In this project, several conductive concrete mixtures were prepared with steel fibers, carbon and graphite products, and steel shaving.

Mix Design, Optimization, and Properties

Part 1: Conductive Concrete Mixes with Steel Shaving and Steel Fibers

In 1998, a conductive concrete mix specifically for bridge deck deicing was developed (1–5). In this mix, steel shavings with particle sizes ranging between 0.15 and 4.75 mm (0.007 to 0.19 in.) and steel fibers with four different aspect ratios between 18 and 53 were added to the concrete as conductive materials.

More than 150 trial mixes were prepared to optimize the volumetric ratios of the steel shavings and fibers in the mix proportioning. The evaluation criteria were mechanical properties (compressive and flexural strength), slab heating performance, power source (DC versus AC), size effect, electric resistivity, and electrode configuration. The optimized mix was evaluated in accordance with the ASTM and AASHTO specifications. The compressive strength, flexural strength, modulus of elasticity, and rapid freeze-and-thaw resistance of the conductive concrete mix after 28 days have met the AASHTO requirements for bridge deck overlay. Two concrete slabs, 2 m by 2 m and 1.2 m by 3.6 m (7 ft by 7 ft and 4 ft by 12 ft) and 15-cm (6-in.) thick were constructed with a 9-cm (3.5-in.) conductive concrete overlay for conducting the deicing experiment in the natural environment.

Slab Heating Tests

Slab heating tests were conducted under two different initial slab temperatures at 23°C (74°F) and -1.1°C (30°F). The slabs were 305 mm by 305 mm by 51 mm (1 ft by 1 ft by 2 in.). Average power of 516 W/m² (48W/ft²) was generated by the conductive concrete to raise the slab temperature from -1.1°C (30°F) to 15.6°C (60°F) in 30 min. This power level was consistent with the successful deicing applications using electrical heating cited in Henderson and Zenewitz (11, 12).

Part 2: Conductive Concrete Mixes with Carbon Products and Steel Fibers

During the research and development of the conductive concrete, several disadvantages to using steel shavings in the mix were noticed. First, there was no wide availability of supplies of steel shavings. Second, steel shavings acquired from metal fabricators are usually contaminated with oil and requires cleaning. And third, steel shavings pose a safety hazard for handling and requires a specialized mixing procedure to ensure uniform distribution.

In the spring of 2001, a conductive concrete mix utilizing graphite and carbon products to replace steel shavings was developed (6). Ten trial mixes with seven carbon and graphite products were included in the preliminary experimental evaluation. The evaluation criteria used for each trial batch were workability and finishability, compressive strength, heating rate, and electric resistivity. All mixes contained 1.5% of steel fibers per volume of conductive concrete, in addition to the carbon and graphite products used for conductive materials. The added carbon and graphite products amounted to 25% per volume of the trial mixes. The conductive concrete mix using 25% combined carbon and graphite products and 1.5% steel fibers per volume was tested extensively to evaluate its mechanical and physical properties. Material testing was conducted in accordance with the ASTM and AASHTO specifications. The compressive strength, flexural strength, and freeze and thaw resistance of the mix were determined. The test results are summarized in Table 1.

Field Applications and Durability Test

A conductive concrete patch was constructed on December 3, 1999, in one I-480 westbound lane over the Missouri River (near the Nebraska–Iowa border) for durability evaluation. The patch was 6.4 m by 3.65 m by 9 cm (21 ft by 12 ft by 3.5 in.), and the optimized mix design with steel shavings was used. The workability and finishability for the conductive concrete was similar to that of conventional concrete. The overlay was visually inspected every 6 months for 2 years. There was no fiber exposure, but reflective cracking developed in the overlay due to cracking of the substructure.

TABLE 1 Mechanical Properties of Conductive Concrete with Carbon Products

Tests	Results
Compressive strength	41–55 MPa (6,000–8,000 psi)
Flexural strength	5.3–5.9 MPa (770–850 psi)
Rapid freeze-and-thaw resistance	None of the specimen failed after 300 cycles
Modulus of elasticity	27,565 MPa (3.8 by 10 ⁶ psi)

Deicing and Anti-Icing Experiments

Several deicing and anti-icing experiments were conducted during the winters of 1998–2001. In the anti-icing experiments, the overlays were preheated 2 h to 10 h (depending on the initial temperature of the overlay) before and heated during the storms. In addition, deicing experiments, in which the overlays were heated only during the storms, were conducted to evaluate the heating rate of the conductive concrete.

In each experiment, the applied voltage current going through each overlay and the temperature distribution within each overlay were measured as well as the air temperature, humidity, and wind speed and direction. Figure 1 shows the 1.2 m by 3.6m (4 ft by 12 ft) slab during a deicing experiment. In the winter of 2000 most of the experiments were conducted with an initial overlay temperature -9°C (-15°F). At this temperature most deicing chemicals became ineffective. The heating rate was consistent with the winter 1998 experiments. The average heating rate was $0.56^{\circ}\text{C}/\text{min}$ ($1^{\circ}\text{F}/\text{min}$) during the snowstorms. The average energy cost was about $\$0.8/\text{m}^2$ ($\$0.074/\text{ft}^2$) per storm at a cost of 8 cents per kW-h.

IMPLEMENTATION PROJECT

Selection of Bridge Site

The findings of the Phase 1 research showed that the conductive concrete overlay had the potential to become the most cost-effective bridge deck deicing method. In 2001, Nebraska



FIGURE 1 Deicing experiment during the winter of 2000.

Department of Roads approved a demonstration project at Roca, about 15 mi (24 km) south of Lincoln, to implement a conductive concrete overlay on a highway bridge.

The Roca Spur Bridge has a 36-m- (117-ft-) long and 8.5-m- (28-ft-) wide conductive concrete inlay. A railroad crossing is located immediately following the end of the bridge, making it a prime candidate for deicing application, as shown in [Figure 2](#).

Bridge Construction

The Roca Spur Bridge is a three-span slab-type bridge has a 45.7-m (150-ft) long and 11-m (36-ft) wide concrete deck. The slab thickness is 0.3 m (12 in.). A 102-mm (4-in.) thick inlay of conductive concrete was taken into account during the design phase. [Figures 3](#) and [4](#) show a general plan of the bridge, cross-sectional elevation, and cross section of the slab. Polyvinyl chloride (PVC) conduits and junction boxes were embedded into the slab during construction, as shown in [Figure 5](#). The conduits had no effect on the structural integrity of the bridge. Conventional concrete with 30 MPa (4500 psi) compressive strength was used to cast the slab.

Conductive Concrete Inlay

The conductive concrete inlay is 36 m (117 ft) in length and 8.5 m (28 ft) in width. The inlay consists of 52 individual 1.2 m by 4.1 m (4 ft by 14 ft) conductive concrete slabs, as shown in [Figure 6](#). The slabs were divided into two groups separated by a 150-mm (6-in.) -gap along the centerline of the bridge to allow for the electrical connections.



FIGURE 2 A railroad crossing is located immediately following the end of the bridge.

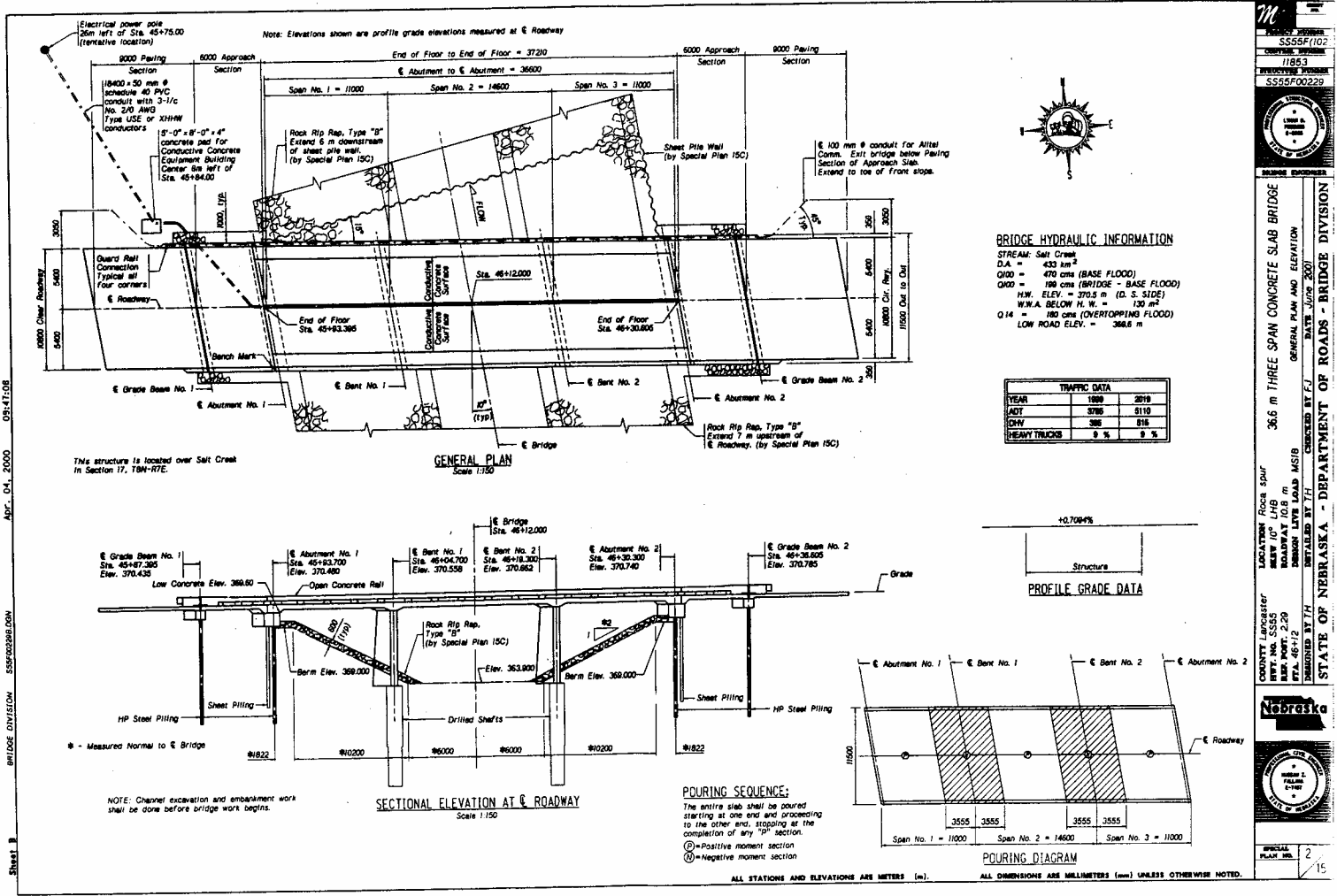

FIGURE 3 Roca Super Bridge: cross section and top view.

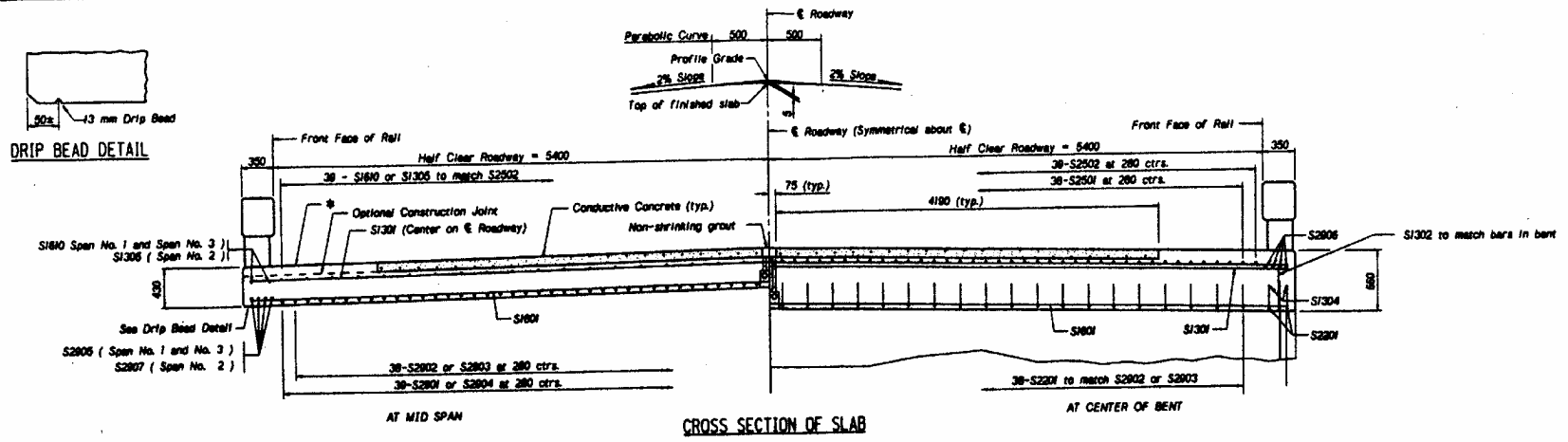

FIGURE 4 Cross section of slab.



FIGURE 5 First conductive concrete overlay during construction at Roca, Nebraska.

Electrode Configuration

In each slab, two 76 mm by 76 mm by 6 mm (3 in. by 3 in. by ¼ in.) angle irons spaced 1,067 mm (3.5 ft) apart were embedded for electrodes, as shown in [Figure 7](#). [Figure 8](#) shows the electrodes layout during construction. The angles had perforations greater or equal to the 13-mm (0.5-in.) maximum aggregate size to allow concrete to flow through to provide good conductivity. In addition, the angles were sandblasted to remove mill scale for better conductivity. Coupling nuts were welded to one end of the angle irons for making an electrical connection.

Instrumentation

Temperature sensors, thermocouple wires, type TX, were installed at the center of each slab at about 13 mm (0.5 in.) below the surface to measure the slab temperature. The sensors were installed before casting the inlay. Separate PVC conduits were used to house the thermocouple wires.

Casting Concrete

The conductive concrete mix with steel fibers and carbon and graphite products was used to cast the inlay. Several, 2 yd³ trial batches were prepared to examine the mixing procedure and travel time from the mixing plant to the job site. In addition, the contractor and the pouring and finishing crews practiced at a test site. On the casting date, the westbound lane was poured first and the eastbound lane next, as shown in [Figure 9](#). [Figure 10](#) shows that the workability and finish of the mix are similar to those of conventional concrete. After hardening, the

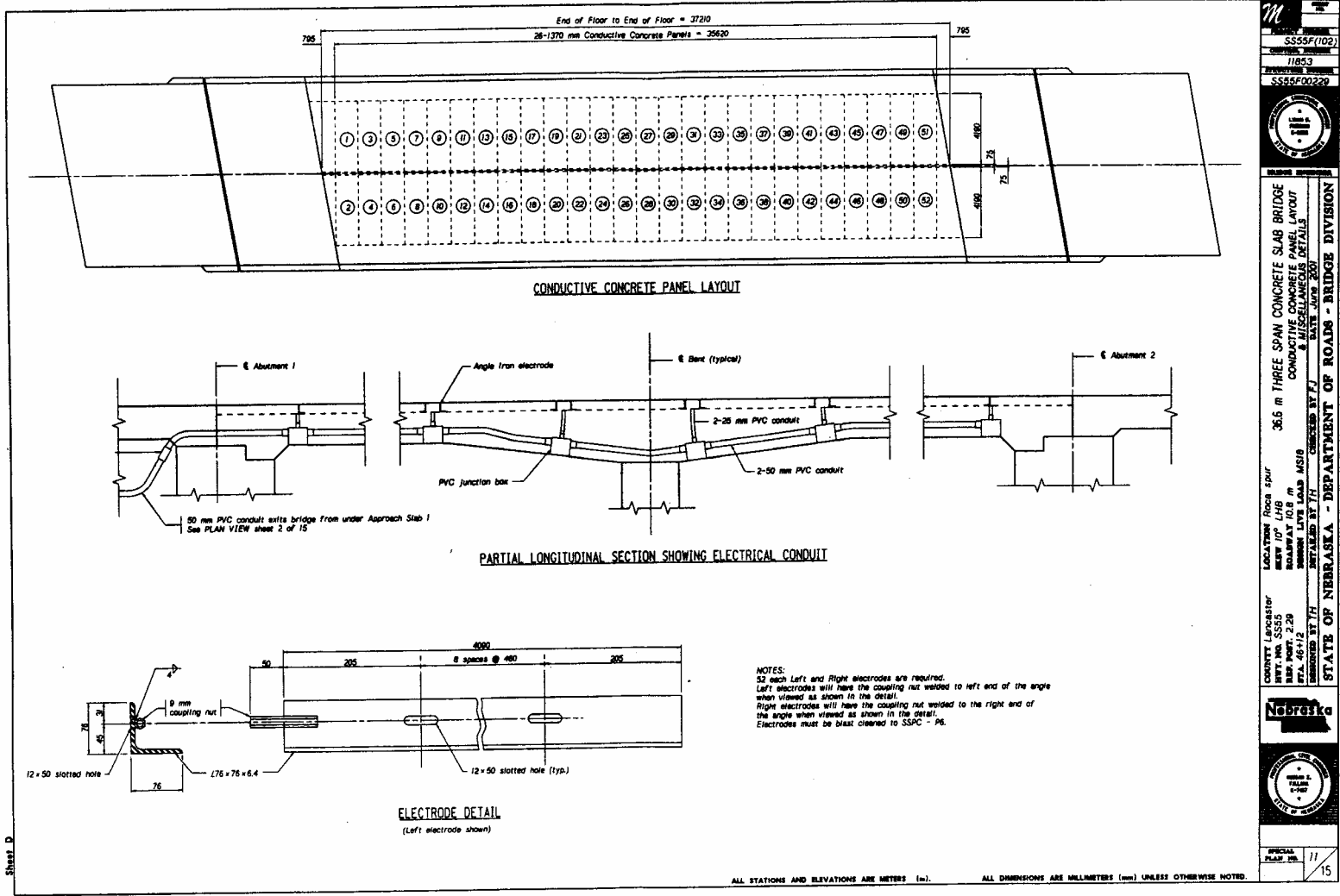

FIGURE 6 Conductive concrete panel layout.

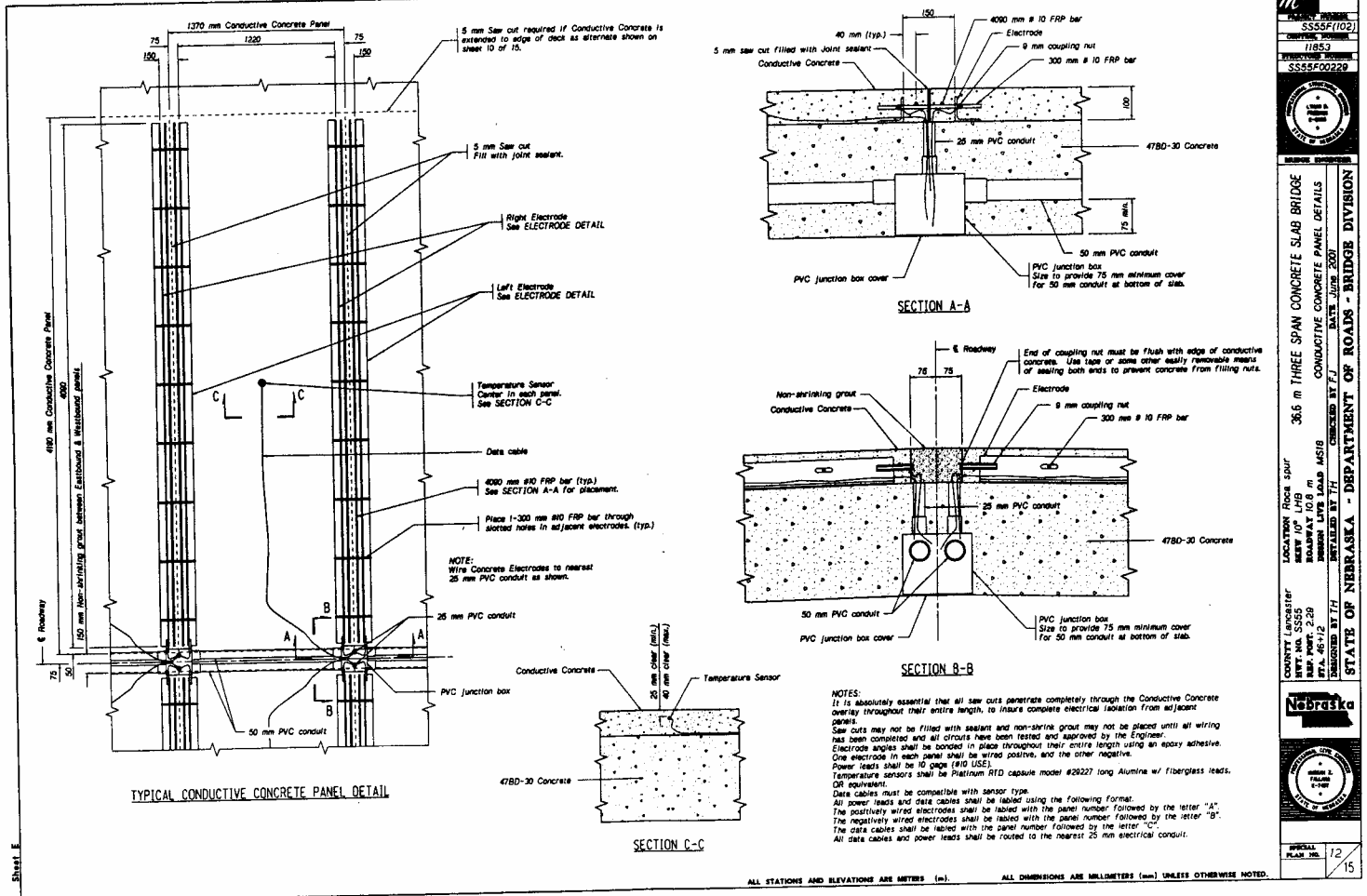

FIGURE 7 Electrode layout and sensors locations.

SS55F(102)
 11853
 SS55F00220

STATE OF NEBRASKA
 DEPARTMENT OF ROADS - BRIDGE DIVISION

DATE: June 2007
 CHECKED BY: FJ
 DESIGNED BY: TH

PROJECT: 36.6 m THREE SPAN CONCRETE SLAB BRIDGE
 COUNTY: LINCOLN
 LOCATION: ROCK SPUR
 BRIDGE NO. 140
 ROADWAY: U.S. 8
 BRIDGE LANE: MS18
 DRAWING DATE: 6-1-07
 COUNTY: LINCOLN

NEBRASKA
 STATE ENGINEER
 JOHN L. THOMAS
 P.E.

SPECIAL PLAN NO. 12
 15



FIGURE 8 Electrode layout during construction.



FIGURE 9 Casting the westbound lane with conductive concrete.



FIGURE 10 Finishing the conductive concrete inlay.

conductive concrete inlay was cut by saw to a 102-mm (4-in.) depth along the perimeters of the individual slabs, as shown in [Figure 11](#), and the gaps were filled with polyurethane sealant. The gap along the centerline of the bridge was then filled with a nonshrink, high-strength grout after finishing all the power connections to the individual slabs.

Power Supply, Sensors, and Control Circuit

A three-phase, 600 A and 220 V AC power is available from a power line nearby. A microprocessor-based controller system was installed in a control room to monitor and control the deicing operation of the 52 slabs. [Figure 12](#) shows the control circuit after installation. The system includes four main elements: a temperature-sensing unit, a power-switching unit, a current-monitoring unit, and an operator-interface unit. The temperature-sensing unit takes and records the thermocouple readings of the slabs every 15 min. A slab's power is turned on by the controller if the temperature of the slab is below 4.5°C (40°F) and turned off if the temperature is above 12.8°C (55°F). The power-switching unit controls power relays to perform the desired on/off function. To ensure safety, a current-monitoring unit limits the current going through a slab to a user-specified amount. The operator-interface unit allows a user to connect to the controller with a PC or laptop via a phone modem. The operator interface displays all the temperature and electrical current readings of every slab in real time. A user also has the option of using a PC or laptop to download the controller-stored data into a spreadsheet.



FIGURE 11 Total of 52 slabs after saw cut the inlay.

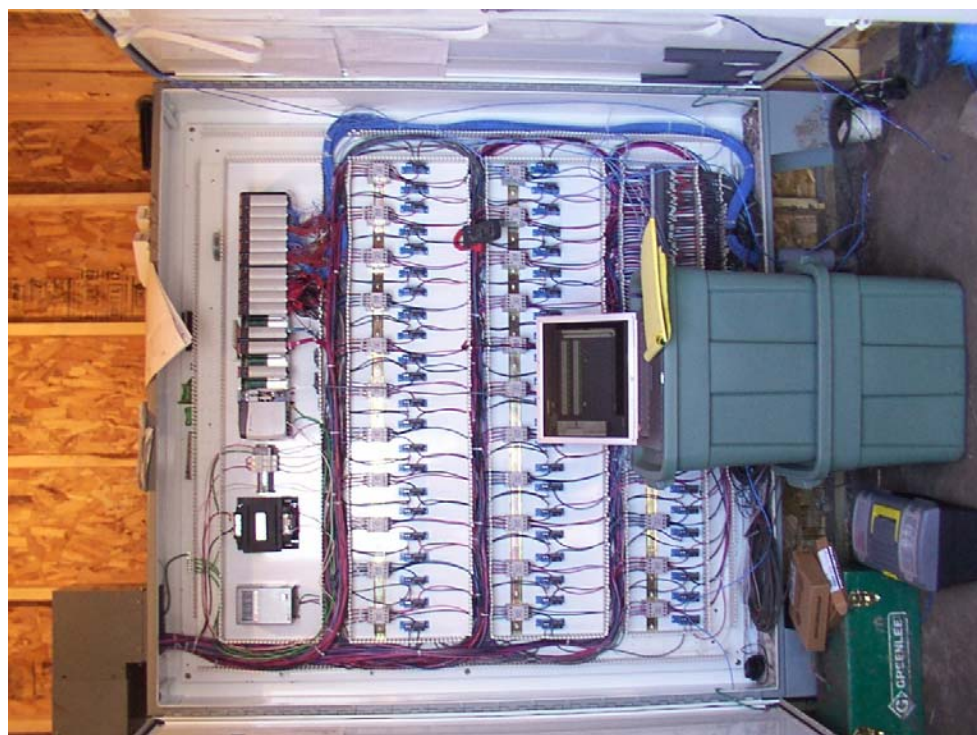

FIGURE 12 Microprocessor-based controller system.

Powering Scheme and Evaluation of Heating System

The conductive concrete heating system was fully operational in the spring of 2003, but by that time most of the winter storms were missed. However, the system was tested successfully under freezing temperature. The powering scheme is to divide the 52 slabs into 26 groups with each group containing two consecutive slabs. To avoid power surge, the odd-numbered groups were started up in turn at 3-min interval and energized at 208 V for 30 min before the even-numbered groups were started. This powering scheme was used in one event.

It was anticipated that a big snowstorm would occur on April 6, 2003. It was found from the results of Phase 1 that the anti-icing operation was more effective than the deicing (3, 4). Therefore, the system was turned on April 4. However, the snow band just missed Roca and produced less than 6 mm (0.25 in.) of sleet. As shown in Figure 13, there was snow or ice accumulation on the asphalt roadways and the bridge deck was wet during the storm period. The system was shut down early on the morning of April 7. The temperature distribution was very uniform across the bridge. The controller system kept the slab temperature about 9°C (16°F) above the ambient temperature. The maximum current recorded varied between 9 and 18 amps, with an average of 12.5 amps. The peak power density delivered to the slabs varied between 360 to 720 W/m² (33 to 67 W/ft²) with an average of 500 W/m² (46 W/ft²). The energy consumed by the conductive slabs during the 3-day period varied from 12.6 to 34.6 kW-h, with an average of 24 kW-h per slab. The total energy consumption was calculated to be 1,270 kW-h and would cost about \$100 based on the rate of \$0.08/kW-h.



FIGURE 13 No ice or snow accumulation during the first snowstorm—April 2003.

Construction Costs

Table 2 summarizes the actual construction cost of the conductive concrete inlay. The average cost per unit surface area of the conductive concrete was compared with that of other heating systems in Table 3. The initial construction cost was high compared with cost of the most recent propane-fired boiler heating system installed in the Buffalo River Bridge in Amherst, Virginia, in 1996 (15). It is expected that the construction costs of conductive concrete overlay or inlay will drop significantly when the technology becomes widely accepted. In addition, other factors such as life-cycle costs, including system maintenance costs, deck repair costs, and vehicle depreciation caused by deicing chemicals, should be used as the basis for cost-effectiveness comparisons between different deicing systems.

Long-Term Monitoring and Performance Evaluation

Nebraska Department of Roads has approved a 5-year plan for monitoring the conductive concrete overlay. The results will be shared with the engineering community for further evaluation of the new technology.

CONCLUSIONS

The heated bridge deck of Roca Spur Bridge is the first implementation in the world of conductive concrete used for highway bridge deicing. The new mix design containing carbon

TABLE 2 Construction Cost of the Conductive Concrete Inlay

Item	Cost
Placing, finishing, curing, and saw cutting conductive concrete	\$50,020
Conductive concrete materials	\$80,620
Building and installing control cabinet with sensors and power relays	\$43,685
Integrating and programming the deicing operation controller	\$18,850

TABLE 3 Initial Cost Comparison of Different Heating Systems

Heating System	Approximate Cost ^a
Infrared heat lamp, 1970 (12)	\$96/m ² (\$8.9/ft ²)
Electric heating cable, 1961 (11, 12)	\$54/m ² (\$5/ft ²)
Hot water, 1993 (13, 14)	\$161/m ² (\$15/ft ²)
Heated gas, 1996 (15)	\$378/m ² (\$35/ft ²)
Conductive concrete, 2002	\$635/m ² (\$59/ft ²)

^a Cost figures were quoted directly from the literature, and conversion to present worth was not attempted.

powder and particles is found to be superior to using steel shavings, in that the electrical conductivity and the heating rate are improved without the drawbacks. The construction costs and deicing performance of the heated bridge deck would demonstrate its cost-effectiveness as opposed to other existing deicing technologies. The conductive concrete deicing technology can be readily implemented at accident-prone areas such as bridge overpasses, exit ramps, airport runways, street intersections, sidewalks, and driveways.

ACKNOWLEDGMENTS

The authors thank Sam Fallaha, Terry Holman, Fouad Jaber, Gale Barnhill, George Woolstrum, Dalcyce Ronnau, Bob Traudt, and Mark Traynowicz of the Nebraska Department of Roads for their effort in the design and construction of the Roca Spur Bridge.

REFERENCES

1. Yehia, S., and C. Y. Tuan. Conductive Concrete Overlay for Bridge Deck Deicing. *ACI Materials Journal*, Vol. 96, No. 3, May–June 1999, pp. 382–390.
2. Yehia, S., and C. Y. Tuan. Conductive Concrete Overlay, Technical Article. *Concrete Engineering International*, Vol. 3, No. 1, January/February 1999, pp. 70–72.
3. Yehia, S., C. Y. Tuan, D. Ferdon, and B. Chen. Conductive Concrete Overlay for Bridge Deck Deicing: Mix Design, Optimization, and Properties. *ACI Materials Journal*, Vol. 97, No. 2, March–April 2000, pp. 172–181.
4. Yehia, S. A., and C. Y. Tuan. Thin Conductive Concrete Overlay for Bridge Deck Deicing and Anti-icing. In *Transportation Research Record: Journal of the Transportation Research Board*, No. 1698, TRB, National Research Council, Washington, D.C., 2000, pp. 45–53.
5. Yehia, S., and C. Y. Tuan. Conductive Concrete Overlay: An Innovative Solution for Bridge Deck Deicing. *Concrete International*, Vol. 24, No. 2, February 2002.
6. Tuan, C. Y., and S. Yehia. Evaluation of Electrically Conductive Concrete Containing Carbon Products for Deicing. *ACI Materials Journal*, July 2003 (submitted for publication).
7. *Significance of Tests and Properties of Concrete and Concrete-Making Materials*. ASTM, 1966.
8. *Standard Specifications for Transportation Materials and Methods of Sampling and Testing*, 17th ed. AASHTO, 1995.
9. Electrical Properties of Concrete. *Concrete and Construction Engineering*. London, 1963, p. 195.
10. Whittington, H., W. McCarter, and M. C. Forde. The Conduction of Electricity Through Concrete. *Magazine of Concrete Research*, Vol. 33, No. 114, 1981, pp. 48–60.
11. Henderson, D. J. Experimental Roadway Heating Project on a Bridge Approach. *Highway Research Record*, No. 14, HRB, National Research Record, 1963, pp. 14–23.
12. Zenewitz, J. A. *Survey of Alternatives to the Use of Chlorides for Highway Deicing*. Report FHWA-RD-77-52. FHWA, U.S. Department of Transportation, 1977.
13. Cress, M. D. Heated Bridge Deck Construction and Operation in Lincoln, Nebraska. In *Proc., IABSE Symposium*, San Francisco, 1995, pp. 449–454.
14. Ficenec, J. A., S. D. Kneip, M. K. Tadros, and L. G. Fischer. Prestressed Spliced I Girders: Tenth Street Viaduct Project, Lincoln, Nebraska. *PCI Journal*, September–October 1993, pp. 38–48.
15. Heated Pipes Keep Deck Ice Free. *Civil Engineering, ASCE*, Vol. 68, No. 1, January 1998, pp. 19–20.

BRIDGE WINTER SUPPORT SYSTEMS

State-of-the-Art Fixed Automated Spray Technology**JERRY R. WALDMAN***Surface Systems, Inc.—Quixote Transportation Safety, Inc.*

Applying anti-icing chemical at the optimum time is critical for an effective anti-icing program (1). The timing of anti-icing chemical applications is especially critical for bridge structures, where icing can occur in advance of icing on normal pavements. Additionally, other highway characteristics such as ramps and steep grades can require different treatment strategies as compared to anti-icing treatments for normal pavements.

Advances in technology have given highway operators a new tool to enhance the effectiveness and efficiency of their anti-icing program. This tool is the fixed automated spray technology (FAST) system.

The FAST system is a permanent installation of a pump, a tank, nozzles, and a controller that dispenses anti-icing chemicals directly on a predetermined area of pavement. These systems can initiate chemical applications either on manual command or be integrated with road weather information system (RWIS) to operate automatically based on detected highway conditions.

The FAST system permits timely, localized, and repeated anti-icing treatments with the optimum amount of anti-icing chemicals and without the deployment of typical winter maintenance equipment and personnel.

FAST systems are now in use in more than 20 U.S. states and in several locations in Canada.

SYSTEM CONFIGURATION

A FAST system generally consists of the following elements: a pump house, various outdoor components, a system controller, and RWIS.

Pump House

Weather-proof structure that houses

- Electrically powered pumps,
- Anti-icing chemical storage tank sized for the specific coverage area to be treated,
- Optional reservoir for water-flushing the system,
- Control valves to control the flow of liquid within the pump house,
- Programmable system controller, and
- Optional communication equipment.

Outdoor Components

Outdoor components include the following:

- Conduit raceways for housing the piping and control wiring between the pump house and valve boxes. The raceway material should meet agency and local noncorrosive specifications or codes for the anti-icing chemicals being used.
- Expansion joints for raceways and piping to prevent raceway or piping damage due to expansion and contraction caused by temperature.
- Nonmetallic, noncorrosive high-pressure piping to deliver liquid chemical from the pump house pump to the valve control boxes and spray nozzles.
- Electrical control wiring to permit the system controller to control the individual valves associated with each spray nozzle.
- Boxes to house individual control valves and a valve controller. These valves are installed to control the flow of anti-icing chemical to individual spray nozzles. Typically, a small controller is also located inside each valve control box. The valve control box material should meet agency and local noncorrosive specifications or codes.
- Nozzles to deliver the liquid anti-icing chemical in the form of a spray to the pavement surface. Two types of spray nozzles are typically used.
 - In-pavement, flush mount nozzle, or disk.
 - Parapet wall or guardrail-mounted nozzle.
 - Spray nozzles should be very durable and constructed of a noncorrosive material.
 - In-pavement, flush mount nozzles should be capable of disassembly after installation to permit economical repairs to be performed.

FAST System Control

The system control includes

- Programmable system controller with multiple inputs for initiating system activation and system monitoring outputs,
 - Manual pushbutton for on-site activation,
 - Control input for automatic activation by an on-site RWIS,
 - Pager control input for system activation,
 - Wireless (radio) control input for system activation, and
 - Optional communications port for direct communication with the system controller via phone, fiber optics, or wireless for remote manual activation and monitoring.

RWIS

The system's RWIS includes

- Pavement sensors, active or passive;
- Atmospheric sensors as required;

- Remote processor unit (RPU) to monitor pavement and atmospheric sensors, determine if FAST system activation is required, provide output to activate the FAST system, and monitor FAST system output parameters; and
- User configurable values to control the operation of an automated FAST system.

Optional equipment for the system are

- Still frame color or black and white video cameras,
- Traffic monitoring, and
- Dynamic message signs.

ANTI-ICING

Anti-icing is the winter maintenance practice of making timely application of a freeze point depressant chemical to prevent and minimize the snow and ice bond to the pavement surface.

Anti-icing provides the winter maintenance manager with two major benefits:

- Maintain the best possible pavement condition during a winter storm event and
- Reduce the amount of chemical required to maintain safer driving conditions.

As a result, anti-icing has the potential to provide increased traffic safety at the lowest possible cost.

BROAD APPLICATIONS

FAST systems have broad applications to improve transportation safety during winter weather conditions. A few of the typical applications for FAST systems are

- Bridges,
- Areas with high accident rates,
- Highway curves, ramps, and steep grades,
- Tunnel entrances,
- High-traffic city streets and intersections, and
- Airport runways and taxiways.

SPRAY NOZZLES

There are typically two types of spray nozzles available:

- In-pavement flush-mounted nozzle and
- Parapet wall or guardrail-mounted nozzle.

Each type of nozzle is more fully described below.

In-Pavement Flush Mounted Nozzle Disk

The in-pavement flush-mounted nozzle or disk has proved to be the nozzle of choice. The disk is a few millimeters below the flush level of the pavement. The disk is installed in the area where the anti-icing chemical needs to be applied. The height of the spray from a disk is typically 12 in. to 24 in. above the pavement surface. This low angle of spray minimizes the effect of the spraying operation on traffic movement. The disk maintains its fixed, low profile in the pavement and does not rise like a typical lawn sprinkler. When installed in the center of a roadway, the disk typically can provide coverage for three lanes of traffic. The only disadvantage of a centerline installation is that the installation and any maintenance require the closure of two lanes of traffic.

Disks can also be installed near the shoulder of a roadway to provide coverage for two lanes. In applications that require coverage of four traffic lanes, it is recommended that the disks be installed near both shoulders of the roadway, across from each other. The advantage to installing disks near the shoulders is that only one lane of traffic requires closure to perform installation and maintenance on the disk.

The piping that carries the anti-icing chemical from the control valve to the disk is typically high-pressure polyvinyl chloride piping. The disks are generally designed to permit the feed tube to connect either from the side or the bottom of the disk. The bottom entry feed is preferred if possible for a particular installation. The bottom entry feed is typically used on bridge applications where a small hole is bored through the deck for the feed tube. An installation that uses proper techniques can assure the bridge deck installation can be accomplished without any damage to rebar or the bridge's inner membrane. The use of a proper sealing technique for the installation of disks on a bridge deck can minimize, if not eliminate, the potential for liquid leaking into the deck's inner membrane.

A quality disk is manufactured from a durable, noncorrosive material such as stainless steel. Stainless steel provides the best long-term performance by being resistant to cracking and damage as well as being resistant to corrosion. The disk design should permit disassembly and easy access to the internal components enabling quick and easy repair or replacement. This capability also minimizes the cost maintaining the disks during overlays or resurfacing.

The layout and spacing of disks is custom engineered for each specific project. The traffic volume in the coverage area is a key factor in the disk-spacing design. For example, a roadway with low traffic at 3 a.m. will require a layout with closer spacing such as 40 ft to 50 ft. For installations on roadways with a high volume of car and truck traffic, such as an Interstate highway, a layout with disk spacing as much as 100 ft or greater can be considered. A significant factor in the layout on high-volume highways is the effect of traffic chemical tracking. Traffic chemical tracking is disbursement of the deicing chemical by the vehicles on the road. As is obvious, a high volume of traffic will result in a wider distribution of the chemical. A key factor in traffic chemical tracking is applying the anti-icing chemical at the correct time to assure that the chemical is distributed across the entire treatment area by the vehicles just before the start of snow or ice bonding to the pavement. Utilizing automated activation of the FAST by a RWIS can provide optimum results.

Parapet Wall and Guardrail-Mounted Nozzles

These types of nozzles are available in different designs for different applications such as bridge parapet walls, guardrails, ramps, parking garages, and other applications. For a parapet wall, the nozzles are typically installed in a hole bored through in the parapet wall. For a guardrail installation, the nozzle is mounted to a support post below the guardrail. One advantage of these nozzles is their reduced cost as compared to the in-pavement flush-mount nozzle. The cost reduction is a result of a simpler design that is not required to endure and survive the harsh physical wear and tear of an in-pavement nozzle, and provides easier access for maintenance.

Although less costly than the in-pavement nozzles, performance issues that are associated with these nozzles include

- Spraying from the side, requiring a vertically higher spray pattern to obtain the same coverage area on the pavement;
- Spray nozzles required on both sides of the road to provide coverage of three lanes of traffic;
- The impact on the motorist: the spray from these nozzles being more visible to the motorist and the spray contacting the windshield and side of the vehicle, causing alarm or concern; and
- A reduction in spray efficiency or complete blockage of the spray as a result of snow plowed against the parapet wall or guardrail.

NORTH AMERICAN INSTALLATIONS OF FAST SYSTEMS

There are currently 23 states and 2 Canadian provinces that have FAST systems installed and operating or are currently in the process of installing FAST systems. The spectrum of FAST system users is broad, including state and provincial highway agencies, city and county highway agencies, airports, toll authorities, and private industry. The majority of installations are on elevated bridge structures. However, installations also exist on roadway and street hills, curves, ramps, and airport taxiways.

Pump houses come in various sizes and shapes depending on the size of the FAST system and agency requirements. The price of the pump house varies significantly with quality of the structure and its installation requirements. Some installations utilize a vault below ground to house tanks and controls. Vaults are typically used where vandalism or aesthetics are of prime concern. Some installations require that a containment pit be incorporated into the pump house foundation in order to eliminate the environmental impact of any leaked or spilled anti-icing chemical.

Typically, one would not expect the installation of FAST systems outside the major snow and ice belt of North America. However, agencies in the southern United States have been deploying these systems. Agencies have realized the benefits that FAST systems can offer their unique winter weather conditions. For example, the infrequency and severity of winter weather conditions tend to more easily catch the motorist off-guard to hazardous road conditions. Also, areas in the South often experience many more “pavement temperature freeze-thaw cycles” than northern areas.

These conditions highlight the importance of providing a timely response to winter highway conditions. The FAST systems provide these agencies with the ability to improve highway safety significantly in the strategic areas where the FAST systems are installed.

AUTOMATION OF FAST SYSTEMS

An automated FAST system incorporates RWIS to monitor weather and pavement conditions at the site and activate the FAST system because of preprogrammed conditions occurring.

The two key elements to effective anti-icing are just-in-time chemical applications and the correct amount of chemical for the current and forecast conditions.

A fully automated FAST system addresses both key elements of anti-icing. An automated FAST system is always standing guard at the remote sites that have been identified as critical winter hazards to the traveling public. Once installed and operational, the automated FAST system can apply the anti-icing chemical to prevent the formation of the pavement–ice bond.

It must be recognized that an automated FAST system is not designed to be a snow- and ice-melting system. A FAST system is the first line of defense in preventing the pavement–ice bond. It can also alert the agency management to dispatch trucks to plow and perhaps re-treat the area being treated by the FAST system. Trucks still need to plow snow and slush off of the roadway where the FAST nozzles are installed. The activation of an automated FAST system can also be used as an early alert system. Automatic activation of a FAST system draws the attention of the using agency that conditions are deteriorating and that other areas, without FAST systems, may also need attention and treatment.

COMPONENTS OF AUTOMATED FAST SYSTEM

To provide the necessary information to the RWIS for FAST system control, certain sensing and control components are required. The major components are detailed below.

ROADWAY PAVEMENT SENSORS

Pavement sensors are one of the basic components for an automated FAST system. The pavement sensors need to be installed in the area that the FAST system will be treating. Pavement sensors will monitor pavement temperature, presence of moisture, detection of freezing, frost, black ice, chemical concentration, moisture depth, and the freeze point temperature of the liquid solution present on the pavement surface.

Two types of pavement sensors are available and can be used.

Passive Pavement Sensors

Passive pavement sensors have been standard in North America for some time and are used on the majority of deployed RWIS. This technology requires that the RWIS know the type of anti-icing chemical being used to treat the roadways where the sensors are located. Due to the adoption of anti-icing procedures, frequently multiple chemicals are applied to certain highway

segments such as bridge structures and hills. Additionally, with the deployment of FAST systems, it is quite prevalent that one type of liquid anti-icing chemical is used by the FAST system while a different, more economical chemical is applied to the roadways. This trend of using different chemicals or “chemical cocktails” in anti-icing practices can require additional sensing technology to improve the operation of automated FAST systems.

Active Pavement Sensors

Active pavement sensor technology can enhance the operation of FAST systems. This technology uses an electronic device called a “peltier junction” that allows for the artificial cooling of a small sampling area on the top of the sensor. This permits the cooling and heating of the moisture sample. When this technology is applied to pavement sensors, the following benefits are realized:

- Independence of the type anti-icing chemical used,
- Proper operation even with chemical cocktails,
- True freeze point temperature detection, and
- Detection of possible freezing problems before they occur by providing advance warnings.

The active pavement sensor can provide improved operation for automated FAST where a single chemical or multiple chemicals are applied or carried on to the FAST system target area.

REQUIRED SYSTEM FEATURES (TYPICAL)

As agencies gain experience with FAST systems, they are finding an increased need to customize the logic that is used by the RWIS to activate the FAST system. Customization is required because of variations in geographical location and terrain, local weather conditions, and differences in winter maintenance practices from agency to agency.

The following are some of features that agencies have found useful in controlling the operation of their automated FAST system.

Freeze Point Temperature Versus Roadway Pavement Temperature

A useful feature is a user-configurable value to activate the FAST system before freezing or re-freezing conditions. For example, a current freeze point temperature, as measured by an active or passive pavement sensor, that is 1°C below the current pavement temperature measured by a passive pavement sensor will activate the FAST system. This temperature difference can be altered to permit the FAST system to be activated with a smaller or larger differential between freeze-point temperature and measured pavement temperature.

Frost Event

Also useful is a user-configurable value to activate the FAST system before frost forms on the pavement surface. For example, a current pavement temperature that is below freezing and is

1°C below the current dew point temperature will activate the FAST system. This temperature difference can be altered to permit the FAST system to be activated with a smaller or larger differential between dew point temperature and measured pavement temperature.

Temperature Limits

Two user-configurable values that prevents the RWIS from activating the FAST system if the measured pavement temperature is above or below the configurable values also help control operations. The high temperature value is set to ensure that the FAST system is not activated when snow, ice, or frost conditions cannot occur because of warm pavement temperatures. A high temperature value of 1°C to 2°C is typical. The low temperature value is set to ensure that the FAST system is not activated when the pavement temperature is below a certain temperature value. This allows the system owner to prevent FAST system activation under cold temperature conditions. However, the owner could decide to activate the FAST system manually under these conditions. The low-temperature lockout is desirable when the pavement temperature is below the effective temperature of the anti-icing chemical that is being used. The system owner can also reset the low temperature lockout if the anti-icing chemical is changed to a lower temperature chemical.

Hold-Off Times

Hold-off times are user-configurable values of time. These time values set the amount of time after the FAST system has been activated, before it can be activated again. To maintain efficiency of operation, the time between FAST system activation permits traffic tracking the anti-icing material across the treated area and time for the RWIS pavement sensors to determine the effectiveness of the chemical application. Typically, there are two different hold-off timers, one for frost and one for icing conditions.

Wind Speed

This is a user-configurable value prevents the activation of the FAST system when the wind speed is above a certain value. From experience, agencies have determined it is undesirable to activate the FAST system when the wind speed is above a certain value and the pavement temperature is low. For example, if the wind is over 30 mph and the pavement temperature is below -5°C, then the FAST system should not be activated.

System Event Documentation

The following are RWIS software features that document events for analyzing the proper operation of the FAST system and can alert the system owner of problems or situations that need attention. The data are collected at the FAST system site by the RWIS RPU, and then forwarded to and stored in the RWIS server for display and analysis by the system owner. Some of the typical data collected and displayed by the RWIS are

- A record that RWIS has activated the FAST system;
- Time when the FAST system was activated by the RWIS;

- Duration of time the FAST system sprayed anti-icing chemical;
- When the FAST system stopped spraying anti-icing chemical;
- The RWIS parameters that caused the FAST system to be activated, highlighted on the user display;
- Reports of system faults;
- Anti-icing chemical flow malfunctions;
- Tank level alert, indicating the chemical storage tank should be refilled;
- Tank empty alert when the chemical tank is empty; and
- Record of manual FAST system activations through the RWIS, recording the system identification of the user that initiated the manual activation.

Variable Application Rates

Several agencies have voiced their desire for a FAST system feature that would permit them to vary the application rate of chemical applied by the system. This seems like a logical request—applying lesser chemical for an upcoming frost event than for a current heavy snow event. As experience and knowledge increase with the operation of the many FAST systems being deployed in North America, two important elements stand out for effective implementation and operation: just-in-time application, and the use of less anti-icing chemical.

Using proper RWIS instrumentation to automatically activate the FAST system provides the most benefit. RWIS instrumentation permits lower application rates, allowing the traffic tracking to occur, and then letting the RWIS instrumentation determine if sufficient freeze-point depression has occurred. If not, the RWIS can again activate the FAST system for another application of chemical.

This approach is especially beneficial when applying anti-icing chemical on a dry pavement surface. The FAST system should apply just enough chemical to dampen the surface and allow traffic tracking to take place. The RWIS instrumentation can then evaluate if the proper amount of chemical was applied; if not, it can reapply additional chemical.

SLIPPERINESS OF ANTI-ICING CHEMICAL APPLICATIONS

Ever since liquid anti-icing chemicals were first used, there has been considerable discussion about a possible reduction of roadway friction after the application of liquid anti-icing chemicals.

Research studies, such as those performed by Forensic Dynamics, Inc., of Kamloops, British Columbia, Canada, (2) have shown that slipperiness or reduced friction as a result of anti-icing is not as big a problem as some have indicated. It is estimated that the number of incidents due to chemical treatments is estimated at less than 1/1,000 of 1% of all treatments.

Problems are potentially possible when the chemical is drying out with humidity levels in the high 20s to low 30s.

However, with the fully instrumented automated anti-icing system, this potential problem is essentially eliminated because of the following:

- Low application rates are possible with the system instrumentation and logic;
- The system only anti-ices just in time;
- User-configurable values prevent anti-icing when not required; and

- Software logic could be added to monitor humidity levels for sites with specific concerns.

CONCLUSIONS AND SYSTEM ADVANTAGES

The use of FAST system technology offers several advantages over conventional methods of winter maintenance:

- Application of anti-icing chemicals just in time, usually immediately at the start of a critical event, maximizes safety but reduces the amount of chemical lost through traffic, as well as avoiding chemical applications when an event does not materialize;
 - Quantity of chemical applied is minimized by ensuring it is effectively and uniformly applied and takes advantage of vehicle tracking to the greatest extent possible;
 - Just-in-time applications of anti-icing chemical provide the greatest benefit to preventing the pavement–ice bond while reducing the resources (labor and material) required for winter maintenance practices;
 - System activity monitoring can alert agency staff to weather and pavement conditions in the geographical area of the system;
 - Reapplication to prevent refreezing conditions can be automated;
 - Cost savings by a reduction in resources (labor, equipment, and materials); and
 - Efficient use of more costly nonchloride anti-icing chemicals that minimize damage to the highway infrastructure typically associated with chloride anti-icing or deicing chemicals is permitted. Since the tracking of salt from the approach section of the highway is a concern, the FAST system is designed to also treat the approach to the structure.

Published Reports on FAST Systems

Minnesota Department of Transportation

A report published in July 2001 outlines the success of an automated FAST system installed on an eight-lane bridge structure over the Mississippi River on I-35 west in the Minneapolis–St. Paul area of Minnesota (3). The report included the following conclusions:

- 70% reduction of accidents on the structure;
- Yearly savings of \$100,000 because of reduced accidents;
- Return on investment of \$3.40 for every \$1.00 invested in the project; and
- Opportunity to use a more costly, nonchloride, anti-icing chemical because of the increased efficiency of application rates and thus reduced damage to the bridge structure steel and concrete.

Ontario Ministry of Transportation and Operations

A report published in May 2001 outlines the success of a FAST system installed on a high-speed, curved, and elevated structure maintained by the Ontario Ministry of Transportation and Operations

(MTO), on the northbound 416/401 interchange near Ottawa, Ontario, Canada (4). The structure experienced 14 snow- and ice-related accidents the first year the bridge was built (1999), and in the three winters since the installation of the FAST system, there have been no winter-related accidents on this bridge structure. The report's conclusions follow.

Reduced Environmental Impacts Environment Canada is reviewing whether road salts are hazardous to the environment and have proposed the following with respect to an amendment to the Canadian Environmental Protection Act:

Based on the available data, it is considered that road salts are entering the environment in a quantity or concentration or under conditions that have or may have an immediate or long-term harmful effect on the environment or its biological diversity and that constitute or may constitute a danger to the environment on which life depends. Therefore, it is proposed that road salts be considered “toxic” under Section 64 of the *Canadian Environmental Protection Act, 1999*. (CEPA 1999)

Potassium acetate is not on the proposed list as the deicing chemical. Other relevant advantages of the use of FAST system technology include

- Application of deicing chemicals just in time, immediately in advance of a critical event, to maximize safety but reduce the amount of chemical lost from passing traffic, as well as avoid application of chemical when an event does not materialize;
- Minimization of chemical applied by ensuring it is effectively applied, uniformly, as a mist, and takes advantage of vehicle tracking to the greatest extent possible; and
- Effective breaking of the pavement–ice bond through just-in-time application of deicing chemical in advance of a critical event in an anti-icing application and substantial reduction of the effort (labor and material) required for snow and ice removal.

Potassium acetate does not attack steel and concrete, and hence the use of FAST may extend structure life and potentially reduce future rehabilitation costs. Tracking of salt from the previous section of highway is a concern: the FAST system also covers the approach to the structure.

Conclusions The lessons learned from the previous section may be of interest to other road authorities considering a similar system. MTO is pleased with the FAST installation in terms of its success because weather-related accidents have not occurred since it has been in operation. In the upcoming year, MTO will require the contractor to interrupt application of deicing salts across the structure now that the results respecting the safety of the structure have been achieved and functioning of the FAST system has been confirmed. Also, MTO is currently reviewing additional applications at locations where it appears FAST may be warranted. *Washington State Department of Transportation*

A paper presented at the 80th Annual Meeting of the Transportation Research Board in January 2001, “Benefit–Cost Analysis of Intelligent Transportation System Applications for Winter Maintenance,” concluded that the automated anti-icing system located on I-90 over the Columbia River in Washington State would provide the following benefits:

- Benefit–cost ratio of 2.36 and
- Net benefit of the system costing under \$600,000 installed was nearly \$1,200,000.

The report was prepared by Washington State DOT Maintenance Manager Robert D. Stowe (5).

Pennsylvania Department of Transportation

A news article published in December 2001 by the *New York Times* outlines the success of six FAST systems installed by the Pennsylvania DOT over a 2-year period (6).

The article concludes that before the installation of the FAST systems, there were dozens of accidents on one bridge in western Pennsylvania. After the FAST system was installed, only one accident on the bridge has been attributed to winter weather.

The document was prepared by Roadway Programs Manager Douglas Schmitt.

ACKNOWLEDGMENTS

The author thanks Mark Pinet of Mark F. Pinet & Associated Limited and Todd Comfort and Michael Griff of MTO.

REFERENCES

1. *Manual for an Effective Anti-Icing Program*. FHWA, U.S. Department of Transportation. www.fhwa.dot.gov/winter/library/libindex.html.
2. *Temperature and Humidity Effects on the Coefficients of Friction Value After Applications of Liquid Anti-Icing Chemicals*. Forensic Dynamics Inc., Kamloops, B.C., Canada.
3. Minnesota Department of Transportation. www.wsdot.wa.gov/partners/.pns/pdf/slicknessrpt.pdf/.
4. *Ontario Ministry of Transportation and Operations Report*. www.magma.ca/~mfpinet/English/MTO_Article.htm#overview.
5. Washington State Department of Transportation. www.ait-llc.com.
6. Pennsylvania Department of Transportation. Report available from author. Douglas Schmitt, Roadway Program Manager, Pennsylvania Department of Transportation. 717-783-5075; fax at 717-783-7839; e-mail at DougPaDot@aol.com.

BRIDGE WINTER SUPPORT SYSTEMS

Bridge Frost Occurrence and Prediction**TINA M. GREENFIELD****EUGENE S. TAKLE****BRIAN J. TENTINGER****JOSE J. ALAMO***Iowa State University***DENNIS BURKHEIMER****DIANE MCCAULEY***Iowa Department of Transportation*

Frost on bridges can present hazardous conditions to motorists, particularly if it occurs when adjacent roadways are clear of frost. Minimizing materials cost, vehicle corrosion, and negative environmental impacts calls for strategic use of frost-suppression chemicals. Accurate forecasts of bridge frost onset times, frost intensity, and frost disappearance (e.g., melting or sublimation) are needed to help roadway maintenance personnel decide when, where, and how much frost-suppression chemical to use. We have developed a finite-difference algorithm (BridgeT) that simulates vertical heat transfer in a bridge based on evolving meteorological conditions at its top and bottom as supplied by a weather forecast model. This algorithm simulates bridge deck surface temperature at 1-min intervals and calculates volume per unit area (i.e., depth) of frost deposited, melted, or sublimed. From this we produce forecasts of frost onset time, frost “depth,” and duration of frost on the bridge. Evaluation of forecast methods for predicting frost on bridges and roadways is difficult because of a lack of observations of frost occurrences. Early morning observations of untreated bridges near Ames, Iowa, were made during two winter seasons to establish a database of bridge frost occurrences and non-occurrences. When frost was detected, observations were continued until the frost disappeared and thereby provided additional information on duration and timing of onset and demise of frost. Bridge frost predictions as well as predictions of air temperature, dew-point temperature, bridge-top surface temperature, and wind speed, are compared with observed and measured values to assess skill in forecasting bridge frost and associated conditions. Lack of agreement between forecasts of frost characteristics and visual observations on a particular (presumed chemical-free) bridge may arise from (1) inaccuracies in forecasts of meteorological variables by the weather forecast model at its model resolution, (2) spatial variability in meteorological conditions below resolution of the forecast model, (3) inaccuracies in simulation of heat transfer by BridgeT, or (4) an inability to detect frost visually.

INTRODUCTION

Frost on paved motorways can present hazardous conditions to drivers, particularly when it occurs in patches or on bridges when adjacent roadways are clear of frost. To minimize materials cost, vehicle corrosion, and negative environmental impacts, frost-suppression chemicals should

be applied only when, where, and in appropriate amounts needed to maintain roadways in a safe condition for motorists. Accurate forecasts of frost onset times, frost intensity, and frost disappearance (e.g., melting or sublimation) enable roadway maintenance personnel to decide when, where, and how much frost-suppression chemical to use. Accurate forecasts of bridge surface temperature, 2-m air temperature, humidity, and wind speed are needed for accurate bridge frost forecasts. All these factors, except bridge surface temperature, are routinely calculated by weather forecast models such as the Pennsylvania State University/National Center for Atmospheric Research (NCAR) mesoscale model (MM5) or the Road Weather Forecast System [RWFS, (1)]. A finite-difference algorithm (BridgeT) has been developed to simulate heat movement vertically in a bridge in response to evolving conditions (including surface long-wave and shortwave radiation) produced by a forecast model. A vapor flux calculation uses the bridge surface temperature from BridgeT and concurrent meteorological variables from the model to produce forecasts of incremental volume per unit area (i.e., depth) of frost deposited, melted, or sublimed.

Reliable observations of bridge surface temperature and frost occurrences on uncontaminated bridge surfaces are needed to verify the model. Bridge surface temperature and frost occurrences were observed on bridges in the vicinity of Ames to test the model. The present results are an update of results reported by Greenfield et al. (2).

FROST FORECASTING MODEL

Model Description

A one-dimensional finite-difference algorithm (BridgeT) has been developed by following the procedure used by Crevier and Delage (3); it simulates heat movement vertically in a bridge in response to evolving conditions (including surface long-wave and shortwave radiation and meteorological conditions at top and bottom of the bridge deck) produced by a weather forecast model such as MM5. The bridge temperature distribution is initialized with road weather information system (RWIS) wind speed, bridge temperature, and 2-m air temperature. BridgeT was tested with input from NCAR's RWFS and MM5 version 3.4 run at Iowa State University. The RWFS produces forecasts using an ensemble of several models. MM5 produces 48-h forecasts twice daily with 20-km resolution. BridgeT provides the surface temperature required for a water vapor flux calculation that uses, in addition, air temperature, wind speed, and specific humidity provided by forecast models to predict minute-by-minute changes in frost depth.

Thermophysical properties of the bridge construction materials are provided as input to BridgeT. Results reported herein were generated with properties characteristic of a concrete Interstate highway overpass similar to the type found at the Ames RWIS site. Other common types of bridge construction, such as concrete bridges with asphalt overlays, require separate input files of thermophysical properties.

Preliminary Results

BridgeT has been driven by MM5 and RWFS forecasts to produce preliminary results of bridge surface temperature. A 47-h forecast of bridge surface temperature for March 2003 (Figure 1) showed agreement with RWIS observations (after a few hours of model spin-up) during the first

40 h with modest departures thereafter. Air temperature showed less agreement during daylight hours. Better agreement for the bridge surface than the air temperature suggested that for this clear-sky event, the surface temperature was much more strongly governed by the radiation balance than by conductive heat gain or loss from air. In this example, the average difference between RWIS and BridgeT surface temperatures was 0.45°C , with a standard deviation of only 1.2°C . The RWIS and BridgeT values had a correlation of over 0.995. BridgeT surface temperature errors mirrored the MM5 air temperature errors (i.e., BridgeT overestimated surface temperature when MM5 overestimated air temperature and vice versa), so surface temperature errors could be closely attributed to errors in the driving forecast. BridgeT surface temperatures seemed to react appropriately to abrupt radiation changes that occurred during sunrise and decreased correctly during the gradual nighttime radiative cooling period; that suggested BridgeT was correctly configured to the thermal and physical traits of the Ames RWIS bridge. BridgeT's ability to capture the correct nighttime cooling rate is a valuable trait for accurately forecasting the onset time and accumulation rate of bridge frost.

Figure 2 reveals the difficulty BridgeT had in simulating surface temperature when it was supplied with inaccurate cloud information. During the first forecast day, MM5 had predicted clear skies when it was in fact cloudy and caused MM5/BridgeT to overestimate the surface temperature by nearly 5°C . MM5 air temperature was also too high and thereby contributed to insufficient nighttime cooling of the bridge surface. The forecast and observed minimum

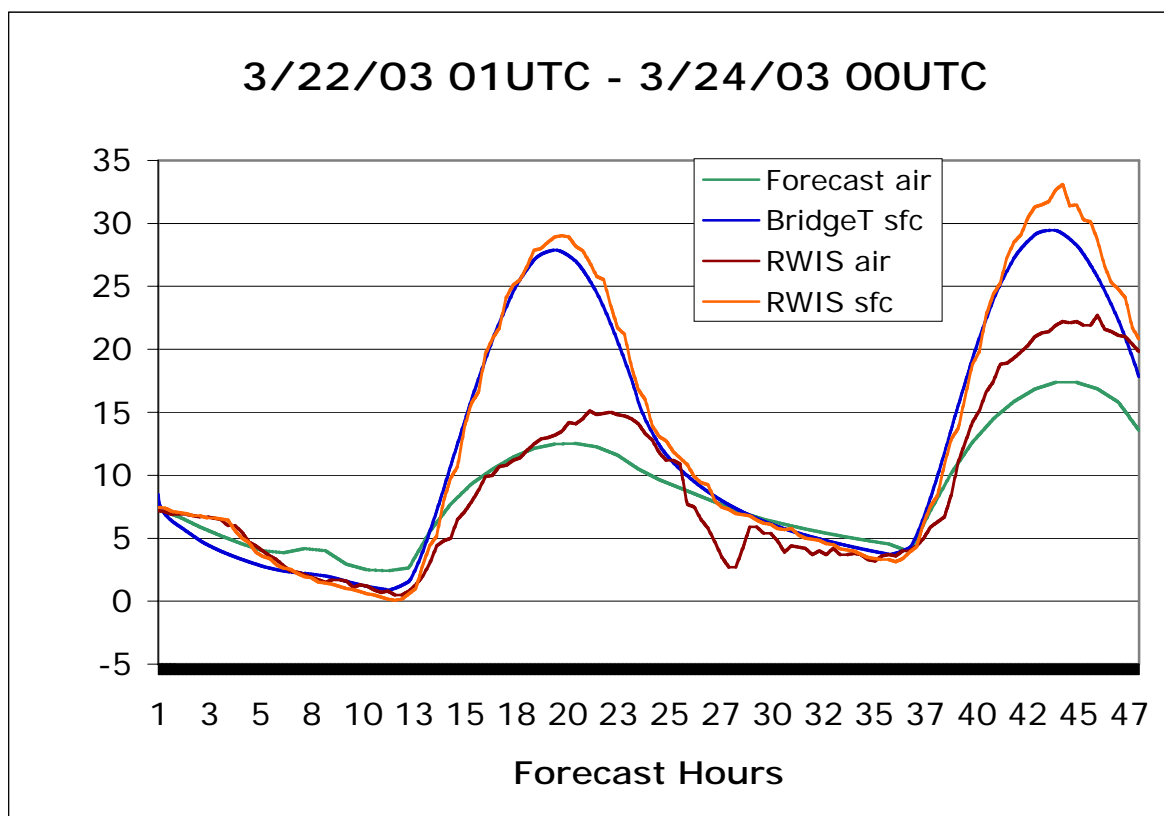

FIGURE 1 Air and bridge-surface temperatures produced by BridgeT with MM5 input during clear-sky conditions.

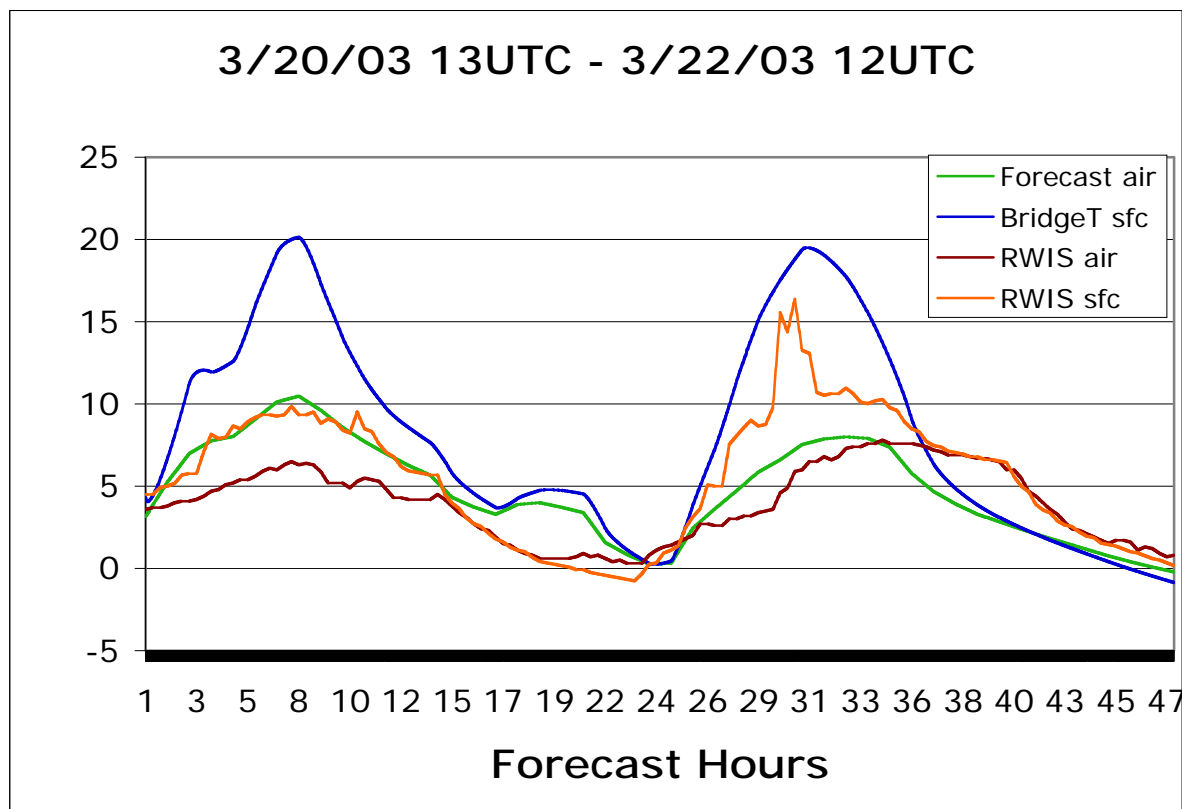

FIGURE 2 Air and bridge-surface temperatures produced by BridgeT with MM5 input during cloudy-sky conditions.

surface temperatures were only a few degrees apart, but MM5/BridgeT had forecast the minimum to occur later in the morning.

Erroneous MM5 forecasts caused BridgeT again to overestimate daytime surface heating by 3.7°C, and overestimate much of the nighttime cooling during the second forecast day. The MM5/BridgeT surface temperatures illustrated in Figure 2 were on average 2.5°C warmer than RWIS surface temperatures, with a standard deviation of 3.4°C. The RWIS and MM5/BridgeT surface temperatures had a correlation of only 0.88. The performance of BridgeT was obviously highly sensitive to the quality of meteorological data input.

NCAR's RWFS was used to drive BridgeT for a 64-day period from February 3, 2003, through April 8, 2003, for Ames. Statistical analysis of 48-h forecasts of the RWFS/BridgeT model runs compared with Ames RWIS observations showed that RWFS/BridgeT had a cold bias of 0.84 k and a root-mean-square (RMS) error of 2.72 k. It was notable that the RWFS 2-m air temperature cold bias was 0.92 k and its RMS was 2.68 k; that suggests that most of the error produced by the combined modeling system came from the meteorological model rather than the bridge model. This period overlapped two observed frost events, both forecast by BridgeT. When the forecast period was taken as the first 24 h of each run, BridgeT correctly forecast the only two observed frost events but predicted three false alarms for this 64-day period.

Real-time 2-day BridgeT frost and bridge temperature forecasts during the frost season in the upper Midwest can be found on the Iowa Environmental Mesonet webpage (4). These

forecasts use MM5 meteorological forecasts at 20-km resolution. Future reports will provide analyses of BridgeT forecasts compared with RWIS observations and frost observations taken during the 2003–2004 frost season.

FROST OBSERVATIONS

Objective

Observations of surface temperature and frost formation on untreated bridges are needed to evaluate the capability of frost accumulation algorithms used in BridgeT and other frost-forecasting systems. Observations of frost occurrence made by department of transportation (DOT) personnel are often compromised because bridges pretreated for frost suppression (or having residual chemical from previous treatments) respond differently from untreated bridges when meteorological conditions favor frost. Bridge surface temperature observations provide an additional means (i.e., in addition to frost verification) of evaluating the frost forecast procedure. They also provide quantitative information on the spatial variability of environmental conditions essential for frost formation. A nearby RWIS site offers additional opportunity for exploring spatial variability. We give an overview of the use of data collected for validation of the frost accumulation algorithm and BridgeT.

Observation Procedures

Bridge Selection

Frost occurrence was observed for the 2001–2002 winter on the State Avenue Bridge over Highway 30 (US-30) near Ames, Iowa. For the 2002–2003 frost season, County Line Road Bridge and South Dakota Avenue Bridge were added to the observations protocol and thereby allowed investigation of spatial variations in frost development. State Avenue, South Dakota Avenue, and County Line Road bridges were all north–south concrete bridges that allowed passage over US-30 at 1-mi intervals from east to west, respectively. Terrain in the vicinity of all bridges was quite flat, with embankments created for the bridge itself being comparable to or greater than natural terrain relief in the immediate area. Flat terrain between bridges minimized topographically induced influences (drainage flow, shading, wind-tunnel effects, etc.) and thereby allowed a cleaner study of natural variability of frost formation. Multiple bridges also allowed for the frost observations even if one of the bridges had been treated with deicing chemicals.

State Avenue Bridge and County Line Road Bridge were selected for close-up observation for this study because they are not routinely treated with frost-suppressing materials. They have no on or off ramps for possible turnaround points for Iowa DOT trucks and thus minimized the potential for inadvertent chemical spill from the frost-treatment vehicles. These bridges were typically not as heavily traveled as some other nearby bridges during early morning hours, so bridge observations on foot could be made more safely. The South Dakota Avenue Bridge was selected as a drive-over observation site because it was easily checked along the way while traveling between State Avenue and County Line Road and did not get frequent frost

suppression treatment because it was a new bridge. Traffic on the South Dakota Avenue Bridge was too high to allow observations on foot, but frost observations could be made from a vehicle.

Bridge frost and surface temperature observations were continued for the 2003–2004 frost season, with the addition of a fourth bridge 1 mi west of County Line Bridge over US-30. Results from the 2003–2004 frost season will be the subject of future reports.

Frost Observations

Observations began on November 28, 2001; continued through March 21, 2002; began again on November 15, 2002; and continued through March 21, 2003. Every day was considered a candidate for frost, unless there was a low probability of frost (e.g., nighttime temperatures were greater than 40°F). Some days were missed because of holidays and snowstorms. The observer visited the bridges beginning at 5 a.m. and observed frost conditions both from the car and close-up on foot. While on the bridge on foot, the observers carefully examined the surface for frost and measured the temperature of the bridge surface with an infrared thermometer. The time, date, bridge conditions, general weather conditions, frost characteristics, and surface temperature for each bridge were recorded. When frost was detected, the observer returned periodically until the frost dissipated for follow-up observations and measurements.

Temperature Observations

Measurements of bridge surface temperature were made with hand-held infrared thermometers. In the 2001–2002 frost season and the first 2 months of the 2002–2003 season, a Raytek thermometer was used; it required calibration before each use and required that the surface temperature be taken within a few inches of the bridge surface. Beginning in mid-January 2003 through the end of the season an Exergen thermometer was; it did not require continuous calibration but did require that the thermometer aperture be in contact with the surface. Temperature measurement precision (as judged from lack of sensor drift and uniformity across the bridge surface) and accuracy (as judged by comparison with nearby RWIS observations) were higher for the Exergen instrument.

Observation Results

Frost Occurrence

Winter of 2001–2002 observations were made on the State Avenue Bridge 47 days, and frost was observed 14 times, as presented in [Table 1](#).

Winter of 2002–2003 observations were made on 93 days, and frost was observed 10 times, as presented in [Table 2](#). Frequently the observer noted moisture on the bridge that could not be positively identified as frost. Dark or discolored patches or streaks covering various portions of the bridge often were observed, and occasionally the surface had patches of ice. These events were not considered frost events. Frost observation similarity among the bridges is given by the “Agreement” column of [Table 2](#). Agreement is found on slightly more than half

TABLE 1 Days When Bridge Frost Was Observed on State Avenue

Days When Bridge Frost Was Observed				
12/2/2001	12/30/2001	1/12/2002	2/3/2002	2/13/2002
12/6/2001	1/3/2002	1/24/2002	2/5/2002	2/17/2002
12/29/2001	1/7/2002	2/2/2002	2/7/2002	

TABLE 2 Frost Events for 2002–2003 Season

Date	Frost Occurrence			Agreement
	State Avenue	South Dakota	County Line	
11/12/02	Yes	—	—	—
11/23/02	No	Yes	Yes	No
12/06/02	Yes	Yes	Yes	Yes
12/11/02	No	No	Yes	No
12/19/02	Yes	Yes	No	No
12/26/02	Yes	Yes	Yes	Yes
12/27/02	Yes	Yes	Yes	Yes
01/07/03	Yes	Yes	Yes	Yes
02/18/03	Yes	Yes	Yes	Yes
02/26/03	No	No	Yes	No

the mornings with frost. It also may be noteworthy that the South Dakota Avenue bridge (located midway between the other two) never disagreed with both of the other bridges.

Therefore lack of agreement could be associated with an east–west frost gradient across all three bridges.

Temperature

For accuracy and consistency, all temperature comparisons herein reported were derived from observations taken with the newer Exergen thermometer.

County Line Road Bridge tended to be cooler than State Avenue by about 0.65°F at the 5 a.m. observation time; that was consistent with the tendency for County Line Road Bridge to have higher frost frequency. The largest temperature difference between the two bridges was 3.4°F. The disparity in temperatures and frost occurrence among the bridges suggested that spatial effects or bridge composition variations could be significant factors influencing the potential of frost formation between bridges.

Automated RWIS bridge surface temperature observations were taken from the Interstate 35 overpass over 13th Street on the east side of Ames. The distances from the RWIS site to the State Avenue and County Line Bridge awas approximately 5 mi and 7 mi, respectively. The differences and standard deviations of temperature between the RWIS site and the two bridges over US-30 at 5 a.m. shown in Table 3 indicated that RWIS surface temperatures were usually a few degrees lower than those taken at the observed bridges. Sensors 1 and 3 were located on the northbound overpass on the passing and driving lanes, respectively. Sensor 2 was located on the northbound passing lane. Instrument error and small-scale differences were possible causes of variations among RWIS temperature sensors.

TABLE 3 Observed Temperature Differences (Bridge Minus RWIS) and Standard Deviations at Initial Observation Time

County Line—RWIS			State Avenue—RWIS		
Sensor	Temperature Difference	Standard Deviation	Sensor	Temperature Difference	Standard Deviation
1	1.89	4.47	1	2.30	4.37
2	4.76	4.26	2	5.0	3.98
3	3.22	4.17	3	3.51	3.89

CONCLUSION

Human observations of bridge temperatures and frost occurrence on three bridges within a distance of 2 mi of each other offers a preliminary data set for assessing spatial variability of bridge frost and for testing bridge frost forecasts. A numerical model for heat transfer in a concrete bridge has been created to take values from a weather forecast model and calculate the bridge surface temperature. Preliminary comparisons of its results with measured surface temperatures from an RWIS station have demonstrated that the model was capable of supplying surface temperatures within 1°C of measured values over a 40-h forecast period if supplied with accurate weather information. The model was particularly sensitive to cloud forecasts because the bridge surface temperature was determined primarily from the radiation budget.

ACKNOWLEDGMENTS

The authors thank Daryl Herzmann, who archived and retrieved important data used in this study and in the construction of the BridgeT frost page; Bill Myers for the NCAR Road Weather Forecast System data; and Dave Flory for his help with MM5. This project was funded by the Iowa DOT and AURORA.

REFERENCES

1. Mahoney, W.P., III, and W. L. Myers. Predicting Weather and Road Conditions: Integrated Decision-Support Tool for Winter Road-Maintenance Operations. In *Transportation Research Record: Journal of the Transportation Research Board*, No. 1824, TRB, National Research Council, Washington, D.C., 2003, pp. 98–105.
2. Greenfield, T. M., E. S. Takle, B. J. Tentinger, J. J. Alamo, D. Burkheimer, and D. McCauley. Bridge Frost: Observations and Forecasts by Numerical Methods. Presented at Mid-Continent Transportation Research Symposium, Center for Transportation Research and Education, Iowa State University, Ames, 2003.
3. Crevier, L.-P., and Y. Delage. METRo: A New Model for Road-Condition Forecasting in Canada. *Journal of Applied Meteorology*, Vol. 40, Nov. 2001, pp. 2026–2037.
4. Iowa Environmental Mesonet, Iowa State University Department of Agronomy. <http://mesonet.agron.iastate.edu/frost>.

Winter Pavement Temperatures and Road Conditions

WINTER PAVEMENT TEMPERATURES AND ROAD CONDITIONS

Effect of Blowing Snow and Snow Fences on Pavement Temperature and Ice Formation**RONALD D. TABLER***Tabler & Associates*

Studies to identify specific causes of winter crashes in Wyoming indicated that the majority of crashes were associated with icy road conditions and that blowing snow was the dominant cause of icy roads in wind-exposed areas. The finding that 74% of all crashes over a 5-year period were associated with icy road conditions on a segment of Interstate 80 was illustrative and typical.

The mass of blowing snow falling on the pavement with a 10 m/s wind (22.4 mph) was equivalent to a snowfall rate of 7.8 cm (3.06 in.) per hour, assuming a snowfall water equivalent of 10%, and the mass flux of blowing snow at 20 m/s (44.7 mph) was approximately twice that amount. The energy required for melting the blowing snow associated with the 10 m/s wind speed was nine times the average daily radiation received at Cheyenne, Wyoming, in December, and four times that received in March.

The effect of blowing snow on pavement temperature can be quantified using vehicle-mounted infrared sensors applying the techniques described. Examples show that the melting of blowing snow constitutes a major heat sink and that areas protected by snow fences can be 6°C (10°F) or more warmer than adjacent unprotected road. These quantitative measurements explain the dramatic effect of snow fences on road surface conditions that have been previously reported, and they provide a compelling argument for mitigating blowing snow with roadside vegetation as well as fences.

INTRODUCTION

Studies to identify the specific causes of winter crashes in Wyoming indicated that the majority are associated with icy road conditions and that blowing snow was the dominant cause of icy roads in exposed areas. Over a 5-year period on a 10-mi (16.1-km) segment of Interstate 80 (I-80), 74% of all incidents were associated with icy road conditions (1). Crash reports filed by the Wyoming Highway Patrol contained separate categories for road and weather conditions, and a “ground blizzard” category was used to describe the presence of blowing snow with winds exceeding 25 mph (11 m/s). Figure 1 is a plot of the number of crashes associated with icy road conditions versus crashes in ground blizzard conditions, as determined for half-mile (0.8-km) locations in the aforementioned study. The strong correlation between this pair of road and weather conditions, significant at the 95% level, implied that blowing snow was an important cause of icy roads within the study area, and subsequent studies and observations suggested that this conclusion applied to most other locations in Wyoming as well. The key to ice prevention in windswept areas was reducing blowing snow.

This paper quantifies the effects of blowing snow on pavement temperature and illustrates the effectiveness of snow fences and other mitigation measures in reducing road ice. The methods used to measure pavement temperature, and the accuracy of the measurements, are also described.

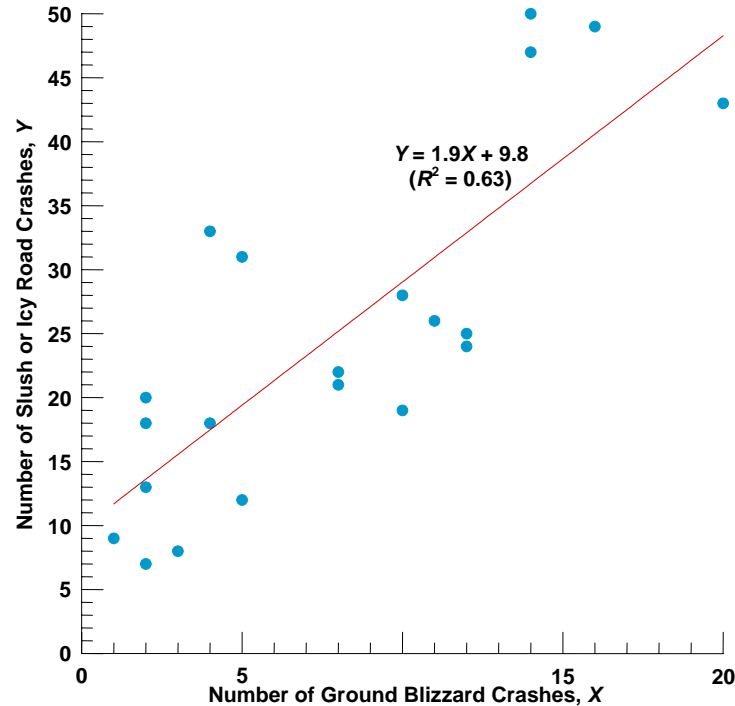

FIGURE 1 Correlation of crashes occurring with icy road conditions with blowing snow crashes as evidence that blowing snow is a significant cause of icy road conditions (1).

ROLE OF BLOWING SNOW IN PAVEMENT HEAT BALANCE

The dynamics of pavement temperature are complex because of the multitudinous combinations of factors and conditions affecting the energy balance. In general, however, the dominant source of incoming heat is solar radiation, and the dominant sink for heat during winter storms is the melting and evaporation of ice that comes in contact with the pavement. The mass flux of blowing snow contacting a road surface can equal or exceed that of even the most intense snowfall. An analysis of the vertical distribution of snow particle sizes and fall velocities (2) indicates that more than 99% of blowing snow particles contained in the first 20 cm (7.9 in.) or so of the surface fall to the surface within a period of 1 s. Assuming an unlimited supply of snow, the mass flux of blowing snow in the first 20 cm (7.9 in.) above the surface, per meter of width across the wind, is approximated by Tabler (3).

$$q = C(U_{10})^{3.25}/70 \quad (1)$$

where

- q = mass flux in $\text{g} \cdot \text{m}^{-2} \cdot \text{s}^{-1}$,
- C = coefficient varying with U_{10} , as given in Tabler (3), and
- U_{10} = wind speed (m/s) at 10-m (33-ft) height.

Table 1 presents the mass flux of snow impacting the pavement surface as a function of wind speed. To place these figures in perspective, the mass of blowing snow falling on the pavement with a 10 m/s wind (22.4 mph) is equivalent to a snowfall rate of 7.8 cm (3.06 in.) per hour, assuming a snowfall water equivalent of 10%. The mass flux of blowing snow at 20 m/s (44.7 mph) is approximately twice that amount.

The energy required to melt this much snow greatly exceeds the input of solar radiation, even on a clear day. As an illustration, **Table 2** shows the energy required to melt the total blowing snow received over a 24-h period compared with the average recorded daily solar radiation for Cheyenne, Wyoming (Latitude 41° 08' N), as reported in Martner (4). Assuming for simplicity that the snow particles are at a temperature of 0°C (32°F), the energy required for melting the blowing snow coming in contact with the pavement at a wind speed of 10 m/s (22 mph) is nine times the average daily radiation received in December and four times the radiation received in March. With a wind speed of 20 m/s (45 mph), the ratios of (energy required for melting/incoming solar radiation) are 15 and 8 for December and March, respectively.

TABLE 1 Mass Flux of Blowing Snow Within the First 20 cm Above the Surface per Meter of Width Across the Wind from Equation 1 and Rate of Deposition, in Relation to Wind Speed

Wind Speed (U_{10}) m/s (mph)	Coefficient C in Equation 1 (3)	Mass Flux (kg/m·h)	Mass of Deposited Snow (kg/m ² ·h)
10 (22.4)	0.85	77.74	7.77
15 (33.6)	0.58	198.12	13.21
20 (44.7)	0.36	313.22	15.66
25 (55.9)	0.24	431.24	17.25
30 (67.1)	0.16	519.96	17.33

NOTE: 1 kg/m = 0.67 lb/ft; 1kg/m² = 0.2048 lb/ft².

TABLE 2 Energy Required to Melt Blowing Snow Deposited Over 24-H Period at Indicated Wind Speed, Compared with Average Daily Solar Radiation at Cheyenne, Wyoming (4)

Wind Speed (U_{10}) m/s (mph)	Energy Required to Melt Blowing Snow over 24 h (MJ/m ²)	(Heat Required to Melt Deposited Snow) / (Total Daily Solar Radiation = SR)			
		December (SR = 7.20 MJ/m ²)	January (SR = 7.92 MJ/m ²)	February (SR = 11.52 MJ/m ²)	March (SR = 16.20 MJ/m ²)
10 (22.4)	62.49	8.7	7.9	5.4	3.9
15 (33.6)	106.17	14.7	13.4	9.2	6.6
20 (44.7)	125.89	17.5	15.9	10.9	7.8
25 (55.9)	138.66	19.3	17.5	12.0	8.6
30 (67.1)	139.33	19.4	17.6	12.1	8.6

NOTE: 1 MJ/m² = 89.49 BTU/ft².

Solar radiation is an important source of heat even on cloudy days. As shown in Figure 2, even with 100% cloud cover and the cloud base at ground level, radiation incident on the ground still averages 20% of that with clear skies (5, 6). Except for strong winds occurring with air temperatures below -6°C (20°F) or so, daytime solar radiation is usually sufficient to warm the pavement surface above freezing so that the onset of blowing snow results in the formation of ice. Because blowing snow conditions can persist long after a snowfall event has ended, it is intuitive that blowing snow is the dominant cause of road ice in wind-exposed areas and that the most important anti-icing strategy for such locations is to conserve the diurnal radiant heat stored in the pavement and substrata by minimizing the loss to melting blowing snow.

MEASURING PAVEMENT TEMPERATURES

Infrared Temperature Measurement

Before describing the effects of blowing snow on pavement temperature, it is necessary to describe the methodology and accuracy of the measurements. Because of their fast response and remote sensing capability, vehicle-mounted infrared (IR) temperature sensors can be used to measure pavement temperatures while the vehicle is moving at normal driving speeds. IR temperature measurement is based on the Stefan-Boltzmann law.

$$R = \varepsilon\sigma T^4 \quad (2)$$

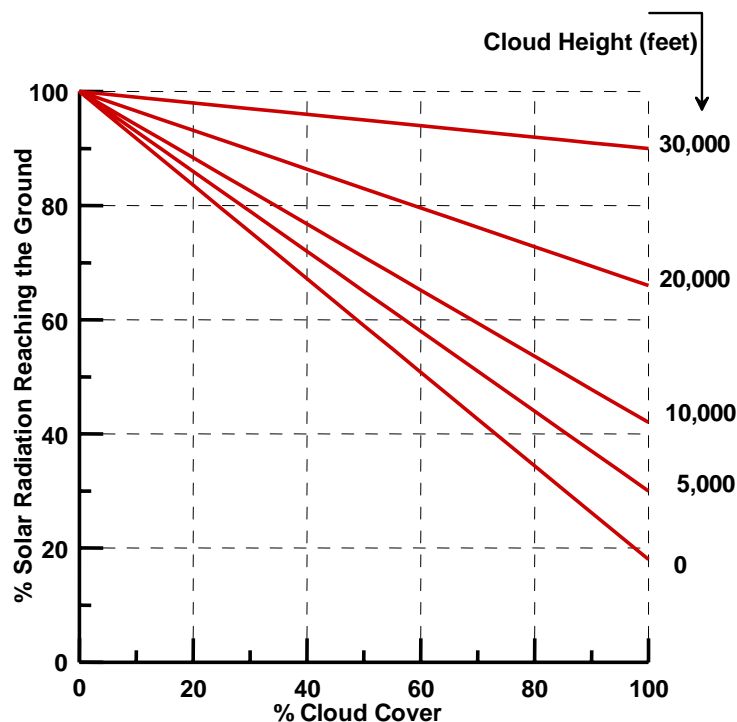

FIGURE 2 Solar radiation reaching the ground surface as a ratio of that on a clear day, in relation to cloud cover and height of cloud base above ground (6, 7).

where

- R = rate of radiant energy (radiance) per unit area (watts per m^2),
 σ = constant ($5.67051 \cdot 10^{-8} \text{ W} \cdot \text{m}^{-2} \cdot \text{K}^{-4}$),
 T = surface temperature in degrees Kelvin ($K = ^\circ\text{C} + 273$), and
 ϵ = emissivity, defined as the ratio of the radiance of a specimen to that of a blackbody at the same temperature as the specimen. Emissivity therefore ranges from 0 to 1.

Although the infrared portion of the electromagnetic spectrum extends from wavelengths of approximately 0.8μ to 1 mm , the spectral response of IR sensors used to measure pavement temperature is typically restricted to 8 to 14μ because this range is relatively free of absorption by water vapor and other atmospheric gases, and these wavelengths are also near the peak of radiant energy emission by the earth's surface at temperatures near 0°C (32°F). The emissivity of most organic substances is approximately 0.95 (7, 8), and this is true for most of the materials encountered in the road environment (Table 3). IR sensors used to measure pavement temperature are factory calibrated for an emissivity of 0.96 —that of ice at 0°C (32°F). The validity of this value over the 8μ to 14μ range is confirmed by the detailed measurements reported by Wan (9), shown in Figure 3. The emissivity of a road surface varies with albedo, surface roughness, and temperature, but the author's experiments have shown that such effects are relatively small—typically introducing an uncertainty of only 0.3°C to 1°C (0.5°F to 1.8°F), which is roughly within the range of instrument accuracy. The error in indicated temperature caused by the actual emissivity being different from the assumed value of 0.96 , shown in Figure 4 for a true temperature 0°C (32°F), suggests that an actual emissivity outside the range of 0.96 ± 0.02 can introduce significant error. A method for measuring the error arising from differential emissivity will be presented after describing the instrumentation.

Instrumentation and Methodology

The measurements reported here were obtained with a Control Products Model 999J IR sensor mounted forward of a vehicle with the detector at 62 cm (24.5 in.) above the pavement surface (Figure 5). According to the manufacturer, the diameter of the view area at this height was approximately 1.5 cm (0.5 in.). The nominal accuracy of this instrument was specified to be $\pm 1^\circ\text{F}$ (0.6°C), and this was true as long as the instrument read 0°C (32°F) over a mixture of water and ice

TABLE 3 Representative Total Emissivities for Selected Materials

Material	Temperature, $^\circ\text{C}$ ($^\circ\text{F}$)	Emissivity (ϵ)
Water (8)	20 (68)	0.96
Ice, smooth (8)	-10 (14)	0.96
Snow (8)	-10 (14)	0.85
Concrete, rough (7)	0 to 1093 (32 to 1999)	0.94
Asphalt pavement (7)	38 (100)	0.93
Steel, oxidized (8)	200 (392)	0.79
Rubber, hard (7)	23 (73)	0.94
Sand (8)	20 (68)	0.90
Skin, human (8)	32 (90)	0.98
Soil, dry (8)	20 (68)	0.92
Soil, saturated with water (8)	20 (68)	0.95

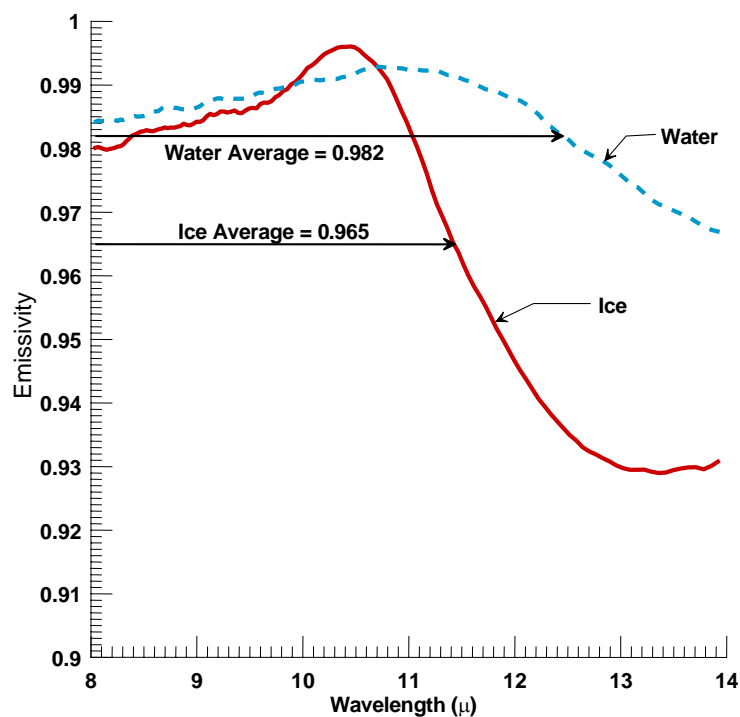

FIGURE 3 Spectral emissivity of water at 21°C (70°F) and ice at -9°C (15°F) (9).
(Copyright 2002, the Regents of the University of California.
Data presented with permission.)

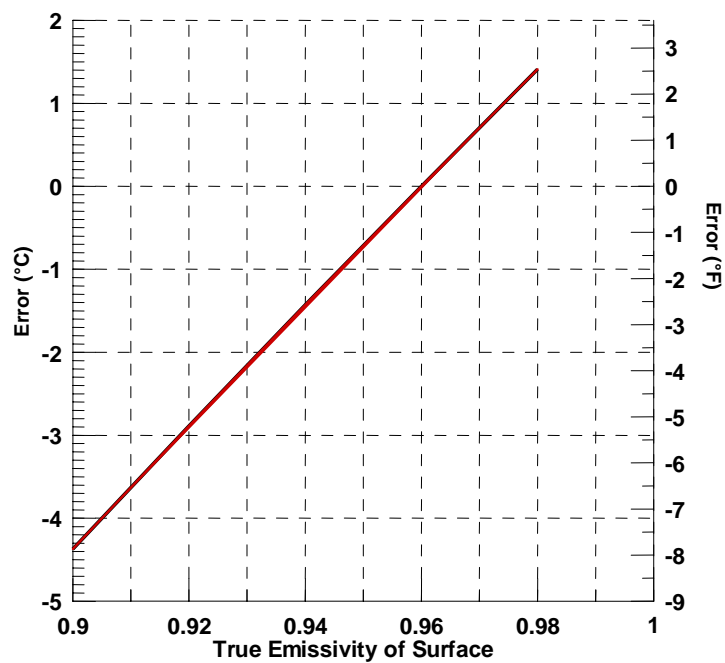

FIGURE 4 Error in indicated temperature caused by true emissivity being different from the assumed value of 0.96.

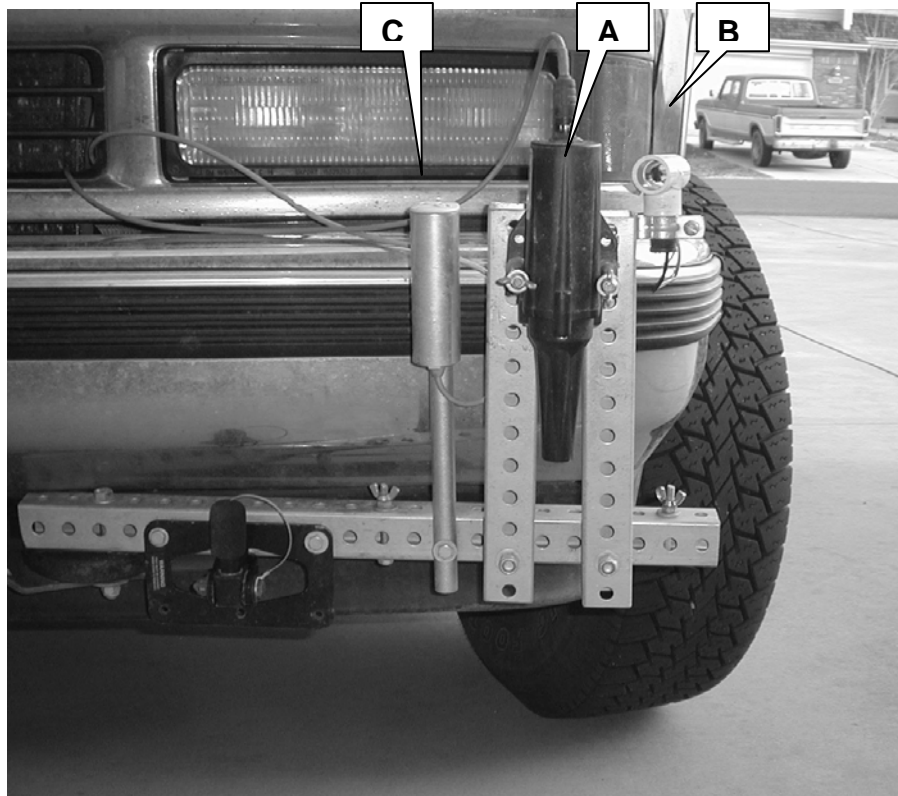

FIGURE 5 Mounting positions of (a) the Control Products IR sensor, (b) air temperature sensor, and (c) the Commercial Vehicle Systems RoadWatch IR sensor.

(hereafter referred to as an ice bath). The calibration changed somewhat with changes in the ambient temperature, and the absolute accuracy depended on the rate at which the air temperature changes. The accuracy appeared closer to $\pm 2^{\circ}\text{F}$ (1.1°C), as illustrated by an experiment in which an ice bath was suspended beneath the sensor while being driven and observe how the readings departed from the true value of 0°C (32°F) as variations of ambient temperatures were encountered (Figure 6). This particular experiment also compared the control products sensor with a Commercial Vehicle Systems RoadWatch sensor. It was concluded from this experiment that any abrupt change in pavement temperature recorded by the control products sensor was real, but that the same could not be said of the RoadWatch instrument.

The Germanium lens of the Control Products Sensor was recessed approximately 115 mm (4.5 in.) from the end of the conical housing, which effectively protected the lens from contamination by road spray. A fast-response sensor for air temperature, suspended inside a white polyvinyl chloride pipe “T” for shielding from solar radiation, was mounted at approximately the same height as the IR instrument near the end of the front bumper. Mounting locations were selected as optimal after testing alternatives over the course of several years. The IR sensor was intentionally mounted over a wheel track because this was the location where the actual pavement was most likely to be exposed on snow- and ice-covered roads. The sampling frequency of the infrared sensor was set at the fastest available rate, 10 measurements per second. At a vehicle speed of 80 km/h (50 mph), readings were therefore approximately 2 m (6.6 ft) apart.

The Control Products “minimapping” system which allowed temperatures and distance to be recorded on a laptop computer was used for data acquisition. The distance calibration

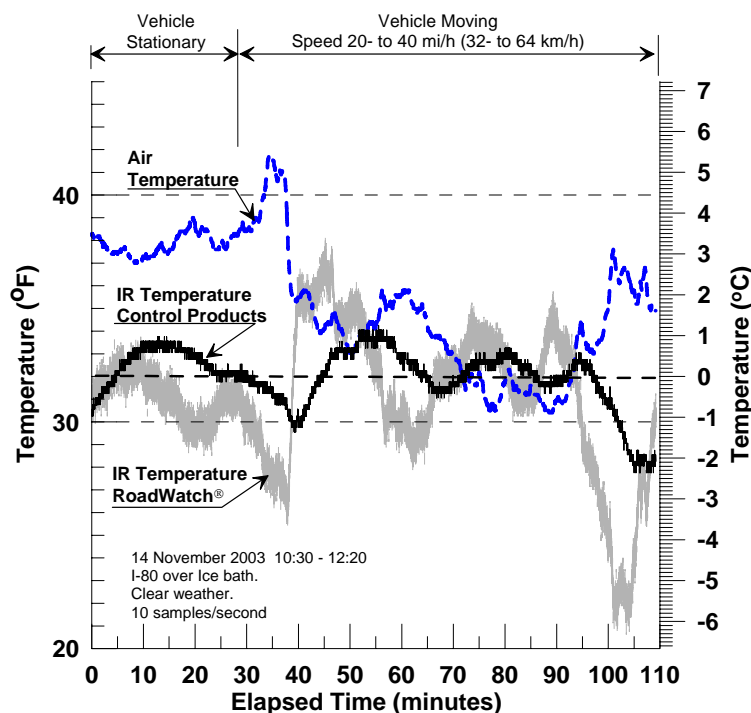

FIGURE 6 Experiment evaluating stability of the control products model 999J and the Commercial Vehicle Systems RoadWatch IR sensors in a dynamic environment by driving with an ice bath under the sensors.

program available in the minimapping software also provided more accurate distances than displayed by conventional distance measuring instruments. All data runs were started and stopped at known locations accurate to within ± 8 m (26 ft).

The calibration of the instrument was typically checked at the beginning and end of a run by inserting an ice bath known to be at 0°C (32°F) beneath the sensor. The calibration of the control products instrument could be reset in the field, but this was seldom necessary and was only done at night after the instrument and vehicle had equilibrated to air temperature.

Laboratory studies of sample cores, described below, used the same equipment, but the IR sensor was raised to a height of about 2 m above the samples to increase the view area to a diameter of approximately 5 cm (2 in.).

Validating IR Temperatures for Various Pavements

It can be assumed that the emissivity of a pavement will be close to 0.96 if it is uniformly covered with a thin film of water or ice. The key words here, however, are “uniformly” and “thin.” These requirements can rarely be met over a long section of road during winter conditions, especially in the blowing snow environment. The IR temperature is biased toward air temperature if the pavement is covered with blowing snow or a layer of snow or ice, and the bias increases with the mass flux of the blowing snow and the thickness of the snow or ice. For true pavement temperatures, measurements should be restricted to dry or moist conditions or to thin (< 1 mm = 0.04 in.) ice or snow cover. Readings on dry pavement can be validated in the field by

the simple but conclusive method of comparing the IR temperature of the dry surface at a below-freezing temperature with the temperature reading after lightly spraying the surface with water at 0°C (32°F) (Figure 7). The 3-in. (77-mm) thick, 4-in. diameter (102-mm) core sample was initially dry and at equilibrium with air temperature. The temperature measured by the embedded thermistor probe was within 0.1°F (0.06°C) of the IR temperature after being coated with a thin film of ice. Similar measurements can be performed before sunrise on core samples that have been left outside overnight to allow them to reach equilibrium with air temperature. The advantage of using core samples is that an independent measurement of the sample temperature can be obtained with a thermistor probe inserted into a hole drilled horizontally 2 mm or so beneath the surface. The effect of surface condition on IR temperature for the five asphalt samples is shown in Figure 8. IR temperatures of these asphalt pavement samples did not change significantly when sprayed with water at an air temperature of approximately 4.5°C (40°F). At temperatures near 29°F, however, the change in IR temperature was (for samples 1 through 5, respectively) +1.3, +0.7, +0.4, 1.0, and +0.5 °C (+2.3, +1.2, +0.8, +1.9, and +0.9 °F).

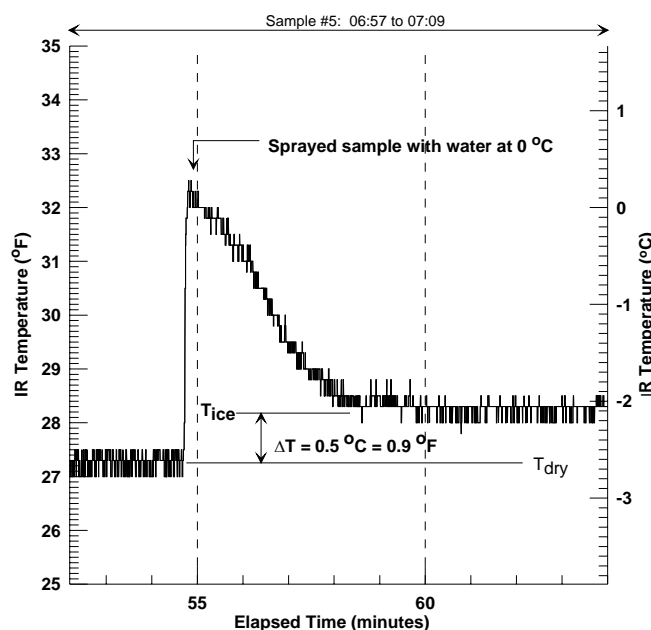

FIGURE 7 Example of method for quantifying effect of pavement condition on IR temperature (Sample 5 in Figure 8).

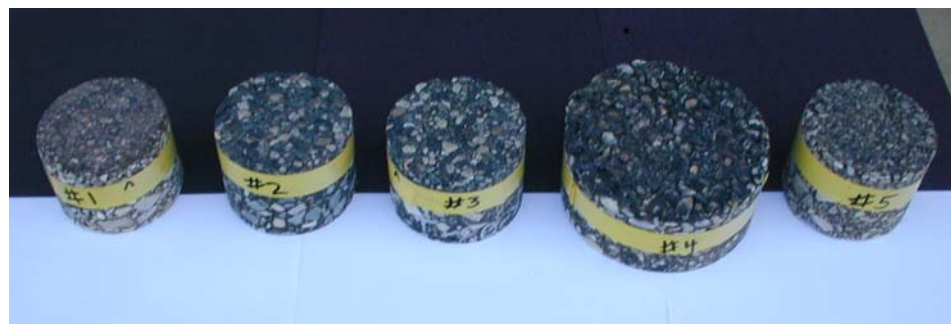

FIGURE 8 Effect of surface condition on IR temperature for the five asphalt samples.

TEMPERATURE EFFECTS OF BLOWING SNOW AND SNOW FENCES

During the last two winters, more than 8,000 km (5,000 mi) of temperature data have been recorded on 600 lane km (375 lane mi) of Wyoming highways for safety improvement studies. These data, in combination with the visual observations recorded during the measurements, constitute conclusive evidence of the dominant role that blowing snow plays in road temperature and ice formation, and provide a compelling mandate for mitigating blowing snow to improve highway safety.

There are two sources of blowing snow: “near snow” originating within or relatively close to the right-of-way and “far snow” that comes from distances hundreds or thousands of meters upwind. Although the total seasonal snow transport of near snow is relatively low, it can still be sufficient to cause localized areas of icy roads and high crash incidence, and this is particularly true on high embankments exposed to the wind and lacking trees and shrubs. Areas where vegetation has been denuded by construction activities are particularly prone to icing, and an increase in crashes is inevitable until vegetation becomes fully established. This is illustrated by the temperature plot in [Figure 9](#), which shows an area that is significantly colder than other locations in the vicinity as a consequence of reconstruction the previous summer that denuded vegetation within the right-of-way ([Figure 10](#)).

The effects of snow fences and other features on temperature and ice formation are illustrated by data taken on a two-lane road with some areas protected by terrain features and trees and at other locations protected with a few snow fences ([Figure 11](#)). The warmer

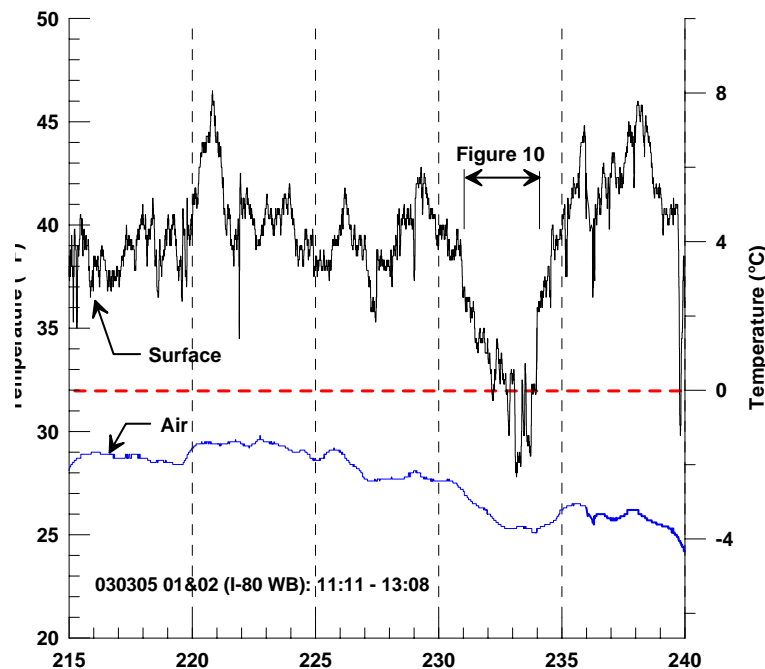

FIGURE 9 Effect of blowing snow on pavement temperature in reconstruction area shown in [Figure 10](#).



FIGURE 10 Blowing snow caused by absence of vegetation following reconstruction at I-80 mile 233 (January 15, 2003).

temperatures between mile 2.0 and 2.8 and from fence 5 to mile 4.3 were caused by the protection afforded by trees and terrain in these areas. The abrupt changes in pavement temperature from mile 4.4 to 6.7 coincided with transitions in blowing snow conditions downwind of the ends of snow fences or openings in the fence lines. The photographs in [Figure 12](#), taken at the time of the temperature measurements, show one such transition from icy to dry road conditions, the location of which is noted on the plot in [Figure 11](#).

These quantitative measurements explain the dramatic effect of snow fences on road surface conditions that have been previously observed and reported (*10, 11*), such as that shown in [Figure 13](#).

ACKNOWLEDGMENTS

The work reported herein was supported in part by the Wyoming Department of Transportation in cooperation with the FHWA.

The contents of this paper reflect the views of the author, who is responsible for the facts and the accuracy of the data presented herein, and do not necessarily reflect the official views or policies of the Transportation Commission of Wyoming, the Wyoming Department of Transportation, or the FHWA. Trade or manufacturer's names are cited only because they are considered essential to the objectives of the report. The U.S. government and the state of Wyoming do not endorse products or manufacturers.

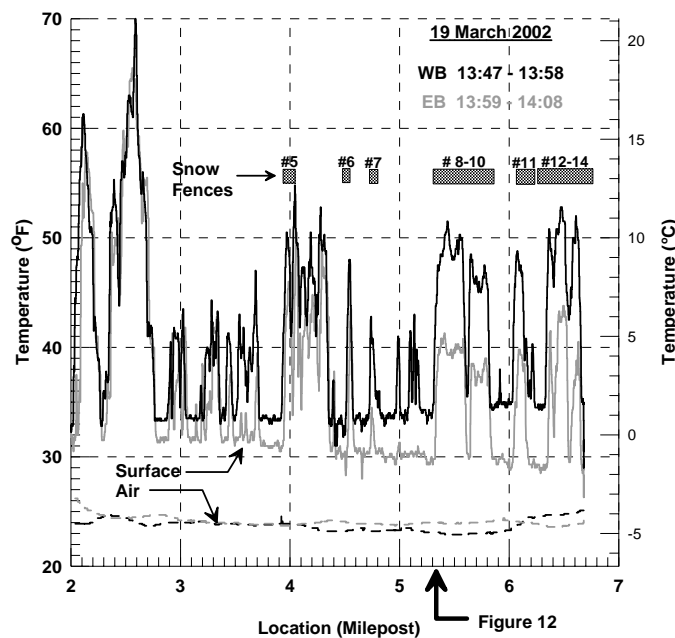

FIGURE 11 Pavement temperatures on a two-lane road showing effects of blowing snow and snow fences (1, 3) at the location of the photos in Figure 12; fence locations relative to the average wind direction during the measurements.

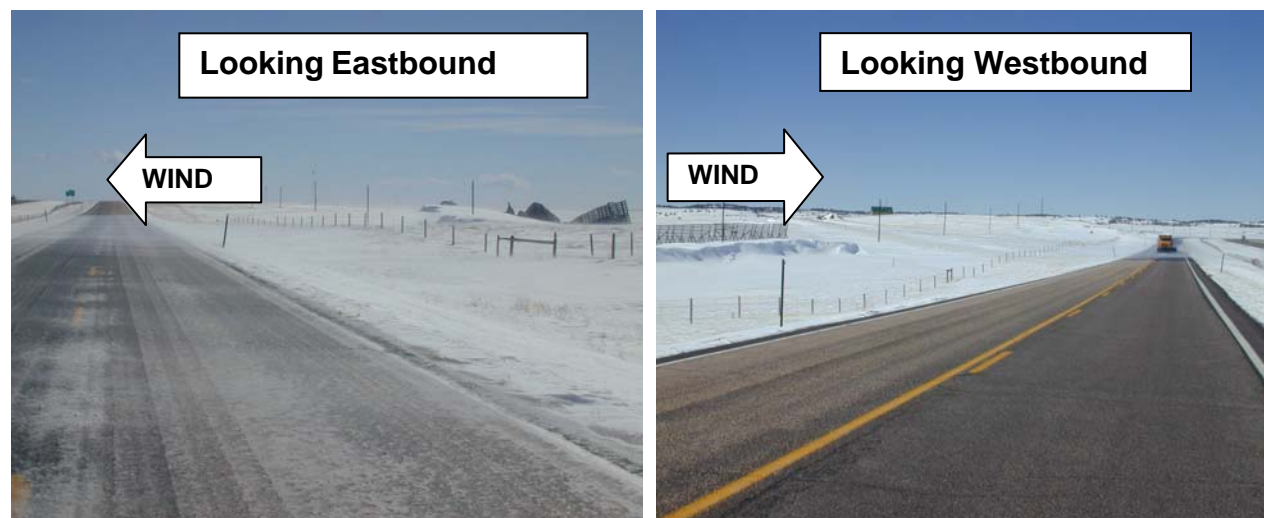

FIGURE 12 Road conditions at the time the data in Figure 11 were taken; pavement temperature differential of 6.7°C to 9.3°C (12°F to 15°F).



FIGURE 13 This transition from frozen slush to wet pavement corresponding to the beginning of the area protected by a 3.8-m-tall (12.4-ft) snow fence located about 150 m (500 ft) upwind.

REFERENCES

1. Tabler, R. D. *Safety Improvement Study: Interstate-80 Mile 325-335*. Final Report, Agreement No. 54839, Transportation Commission of Wyoming, 2002.
2. Budd, W. F. The Drifting of Non-Uniform Snow Particles. *Studies in Antarctic Meteorology, Antarctic Research Series*, Vol. 9. American Geophysical Union, 1966.
3. Tabler, R. D. Snow Transport as a Function of Wind Speed and Height. In *Proc., Cold Regions Sixth International Specialty Conference TCCP/ASCE*, West Lebanon, N.H., 1991, pp. 729–738.
4. Martner, B. E. *Wyoming Climate Atlas*. University of Nebraska Press, Lincoln, 1986.
5. *Snow Hydrology, Summary Report of the Snow Investigations*. U. S. Army Corps of Engineers, North Pacific Division, Portland, Oregon, 1956.
6. *Engineering and Design Runoff from Snowmelt*. Engineer Manual No. 1110-1406, U. S. Army Corps of Engineers, 1998.
7. Calnex Electronics Limited. *Temperature Handbook*, 12th ed. Bedfordshire, England. Undated.
8. Wolfe, W. L., and G. J. Sissis (eds.). *The Infrared Handbook*. Infrared Information Analysis Center, Environmental Research Institute of Michigan for the Office of Naval Research, Department of the Navy, 1985.
9. Wan, Z. University of California, Santa Barbara, MODIS Emissivity Library. Nov. 10, 1999. www.ices.ucsb.edu/modis/EMIS/html/em.html. Accessed Nov. 20, 2003.
10. Tabler, R. D. *Controlling Blowing and Drifting Snow with Snow Fences and Road Design*. NCHRP Project 20-7(147). TRB, National Research Council, Washington, D.C., 2003.
11. Tabler, R.D. *Design Guidelines for the Control of Blowing and Drifting Snow*. Report SHRP-H-381. TRB, National Research Council, Washington, D.C., 1994.

WINTER PAVEMENT TEMPERATURES AND ROAD CONDITIONS

Road Surface Temperature Forecasting
*Case Study in a Mountainous Region of Japan***NORIYUKI SATO***Indiana University–Bloomington***J. E. THORNES***University of Birmingham***TERUHIKO MARUYAMA***Nagaoka University of Technology***AKIRA SUGIMURA***Nagaoka National Highway Office***TAKASHI YAMADA***Hokuriku Construction Association*

This study examined a road surface temperature prediction model in a snowy, mountainous region in Japan. The road surface temperature varied from one segment of the road to another. This was mainly due to the fact that environmental factors were unique at each road segment. In general, the road surface temperature reached its maximum point in the midday and reached its lowest point just before sunrise. However, in a rugged mountainous environment, the road surface temperature does not follow a simple diurnal pattern. This study demonstrated the necessity of road surface temperature predictions at a local scale, rather than a regional scale, since regional forecasts may not depict any local-scale problems, such as road icing. Icy surface conditions may develop for a small area or patches of small areas, and regional forecasts may lead to all-or-nothing solutions for such local-scale problems. This study used both geographic information system (GIS) and Global Positioning System (GPS) as tools. Results from the road surface temperature predictions are illustrated visually using a GIS program so that any potentially problematic road segments can be identified geographically at different times. The use of GPS facilitates the compilation of various data with respect to their geographic coordinates. The outcome of the study will help highway maintenance authorities focus their efforts more carefully on potentially problematic road segments rather than on the entire road system. Moreover, they could narrow the time window for maintenance activities, thus saving resources while providing safe road conditions for the general public.

INTRODUCTION

Road surface conditions during winter months vary significantly and require much more attention than during any other time of the year in order to keep the roads open and safe for general public to use. While the severity of winter depends on geographic locations, those areas

requiring high-quality winter road maintenance tend to be the regions with adverse meteorological conditions. One approach to winter road maintenance is to predict the road surface temperature for an entire road segment and identify any problematic segments before any issues such as road icing arise. One of the difficulties of winter road maintenance is dealing with snow and ice. This study applied and introduced the road surface temperature prediction model (IceMiser model), which was developed at the University of Birmingham, U.K., to a snowy, mountainous region of Japan. Predicting the road surface temperature enables road maintenance activities to be planned in advance and carried out at the right time, and thus save resources. A challenge was that the topographic environment where the model was used was very different from that where the model was originally developed.

BACKGROUND

This study was conducted in the mountainous region of central Japan (approximately 200 km from Tokyo). There was an elevation difference of 675 m over a 25-km stretch of the highway in the study area, as shown in [Figure 1](#). The line segment depicted in the figure is a short stretch of National Highway 17, and it was the segment on which this study focused. The topography in the study area was highly rugged, and there were several tunnels, snow sheds, and snow shelters that protected the highway from natural hazards.

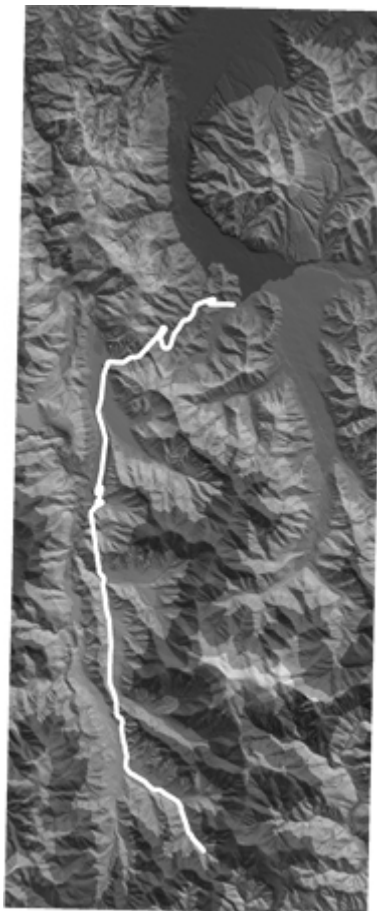

FIGURE 1 Overview of the study area.

Traffic to and from this study area is represented in Figure 2 (time in Julian date, from December 1 through March 31). The clusters of high-traffic volume were concentrated during certain short periods of the day, and the high-traffic volume had a clear weekly cycle. This latter traffic volume cycle corresponded to the demand of arriving and departing weekend skiers to and from the study area, mostly from the Tokyo region, which lacks snow.

Figure 3 illustrates monthly diurnal median air and road surface temperatures at a point location along the highway in the study area.

Figures 2 and 3 depict trends over time, but they are limited in a sense that data are collected at discrete points. Thus, it is difficult to compare the two figures, but a general interpretation can be derived. The peak times when arriving and departing traffic to and from the ski resort occurs inevitably correspond with the times when road surface temperature crosses 0°C. In a mountainous environment where there is not much shoulder space available along the highway, a single vehicle with lost traction may cause a major traffic backup and can become the starting point of a negative spiral in both traffic and road maintenance activities. When the road is congested, any snowplowing or chemical-spreading vehicles cannot do their jobs. Any delays in the road maintenance activities under adverse weather conditions may lead to more severe problems. In addition, this highway is a general trunk thoroughway for semi-trucks. And those trucks are more susceptible to adverse road conditions on a steep gradient highway than personal vehicles. It is necessary to be preventative rather than reactive when it comes to winter road maintenance. So far, it has been mostly within the realm of experienced maintenance crew and their knowledge to determine when to carry out road maintenance activities.

In order to plan efficient winter road maintenance in advance under adverse meteorological conditions, it is important to predict the road surface temperature with ample time before a critical point is reached. One of the critical points is the freeze-and-melt point of the road surface temperature. While the freezing point for the road surface can be modified with the use of an antifreeze chemical, it is important that a certain concentration of the chemical on the road surface be maintained. Early application of the chemical is not suitable because the chemical spread on the highway may disperse before the treated road encounters adverse

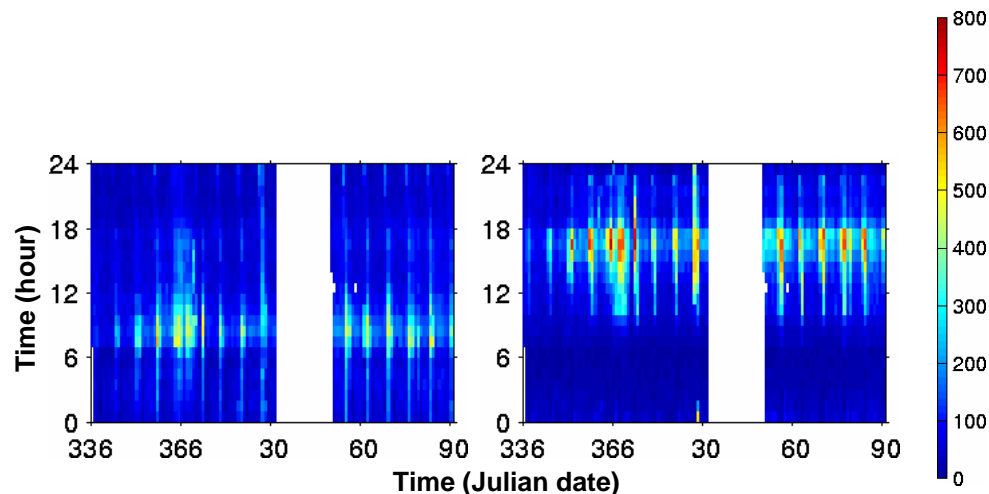

FIGURE 2 Traffic volume patterns throughout winter months.

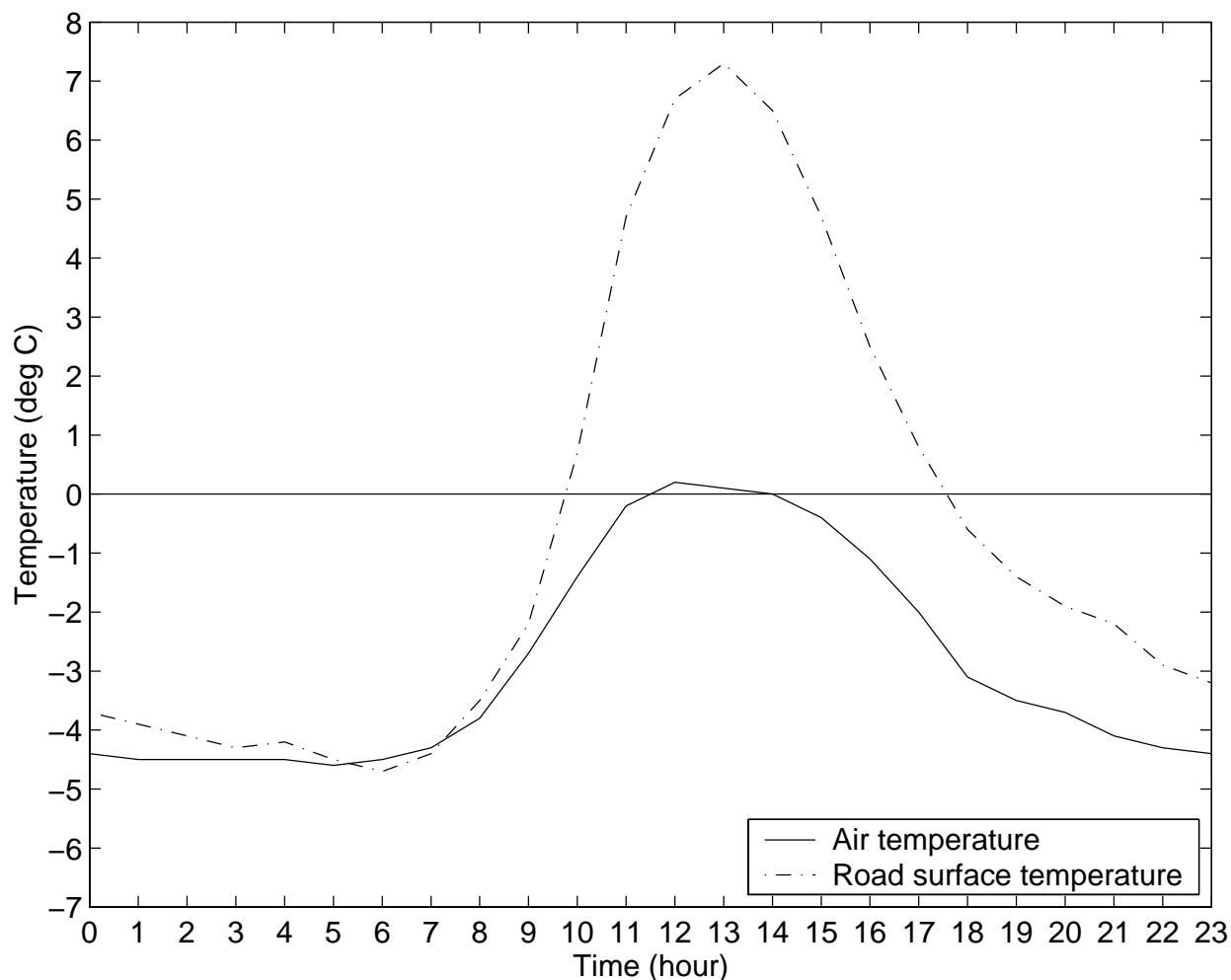

FIGURE 3 Median air temperature and road surface temperature in January.

meteorological conditions. Conversely, late application of the chemical is not effective because it will require more chemical to melt ice or snow once it has accumulated (1). A point or area forecast for the road surface temperature can indicate the onset of this critical point and thus provide the road maintenance crew with early warning signs, and this type of forecast may be suitable for a small area that is on flat terrain and has homogenous characteristics. However, the environment where the road surface of interest is located may not homogeneous, especially in a rugged, mountainous area. Several segments of the road surface are colder than others, as a thermal map in Figure 4 depicts.

Data from road weather information systems (RWIS) are helpful but are still a collection of information from discrete point locations. In order to utilize the information from real-time RWIS, the time interval of data transfer from remote sites needs to be short, and experienced personnel need to keep observing the trend when adverse meteorological conditions are expected. With the road surface prediction model, road maintenance can be planned in advance, and expert knowledge from the maintenance crew can be applied to a particular prediction that the model provides.

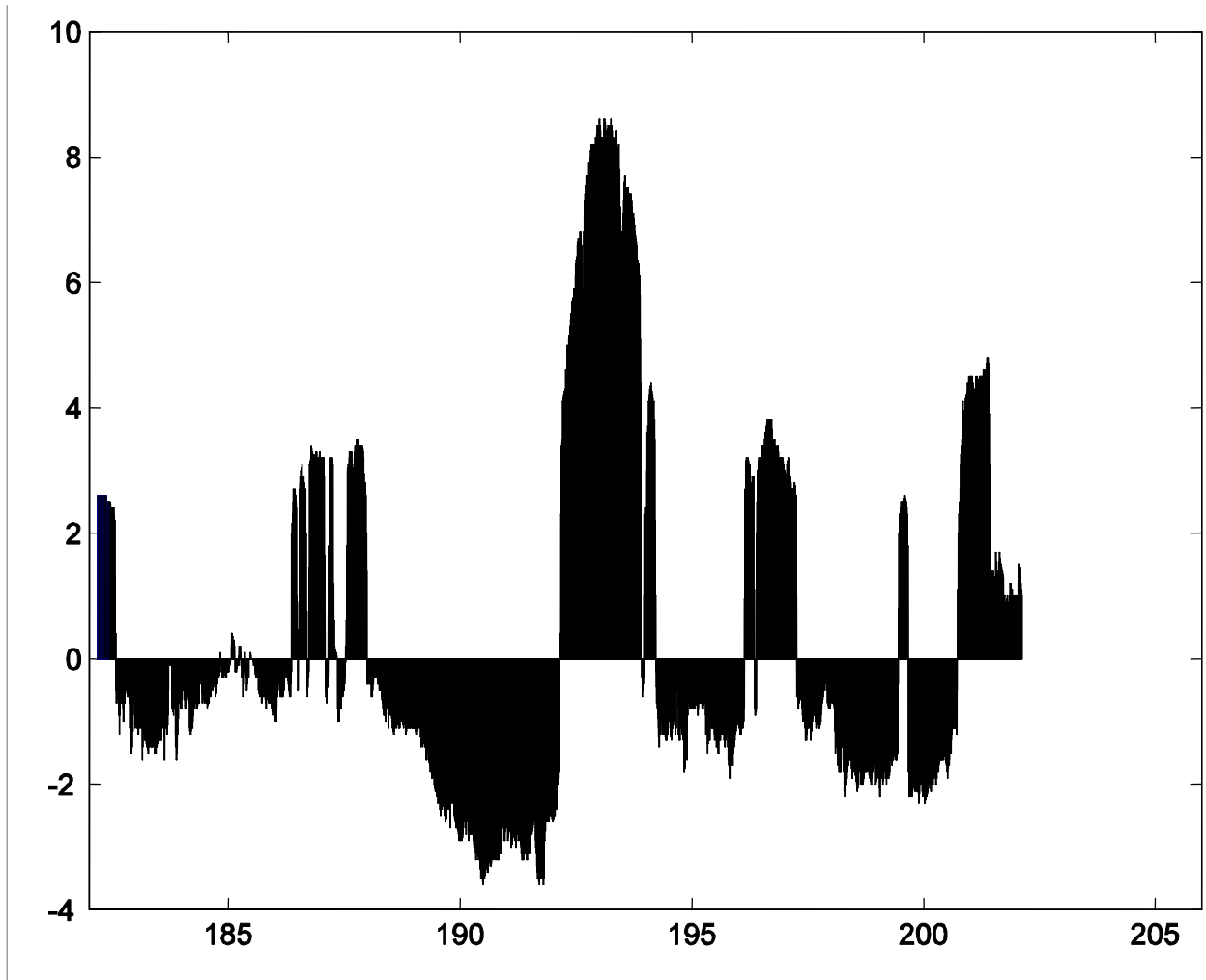

FIGURE 4 Thermal mapping of the study area.

PREDICTION MODEL

The IceMiser model requires both a geographic database and a set of meteorological forecast variables in order to produce a road surface temperature prediction for a 24-h period.

Mountainous environments vary in topography, and this variation affects the road surface temperature. As depicted in [Figure 1](#), the highway pierced through mountain ridges and ran parallel to valley lines. Both solar and emitted radiation and their interactions with the rugged topography affected the road surface temperature. Local sunrise and sunset or shadows dropped on the road surface affected the road surface temperatures (2). The radiation budget was clearly different in two point locations depicted in [Figure 5](#), which shows sky-view images at those locations.

Every point location along the highway has a different value of the sky-view factor. Thus, daytime and nocturnal radiation budgets vary from place to place. Determination of the sky-view factor for a given point location along the highway can be a cumbersome process, but it is necessary to quantify it in order to produce a road surface temperature prediction. [Figure 6](#)

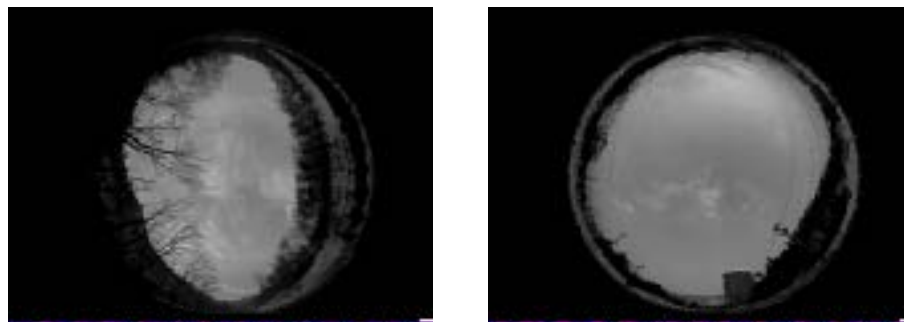

FIGURE 5 Different sky-view factors along the highway.

represents the sky-view factor for the entire study area. The segments with zero sky-view factor are those locations with tunnels, snow sheds, or snow shelters.

The use of a Global Positioning System (GPS) facilitated the development of a geographic database for the study area. GPS-provided geographic coordinates can be used as a series of anchors to compile different types of data at each discrete location. Although the accuracy of GPS degrades in a highly rugged area where usable signals from satellites cluster in one portion of the sky (i.e., low dilution of precision) (3), given that the resolution of digital elevation model (DEM) is 50 m it is assumed that any horizontal error in GPS-providing geographic coordinates can be contained within a correct DEM grid. Based on the anchors of geographic coordinates, road surface temperature predictions for a series of point locations (e.g., 15-m interval in between) can be performed.

PROPOSED STUDY METHOD

Meteorological forecasts for the winter of 2004–2005 were collected and archived. Based on the forecasts, the IceMiser model was run. This prediction model was evaluated from multiple viewpoints, mostly for its applicability to the study area. Specifically, the actual road surface temperature was measured with a vehicle equipped with an infrared thermometer multiple times during the winter season. Any topography-induced effects were identified and investigated, and results of the predictions were compared with an analysis of the meteorological forecasts and RWIS providing actual meteorological data. Figure 7 shows a series of road surface temperature predictions using average meteorological values, and it illustrates the potential for the IceMiser model.

CONCLUSION

Preventative maintenance is necessary and important so that the costs associated with the maintenance activities can be minimized while providing safe road conditions to the general public. The IceMiser model was evaluated in Europe, and it has a great potential for the study area in Japan which has different topographical and meteorological challenges. A full evaluation and appraisal of the model in the study area will be conducted during the winter of 2004–2005, and the results will be presented at the symposium.

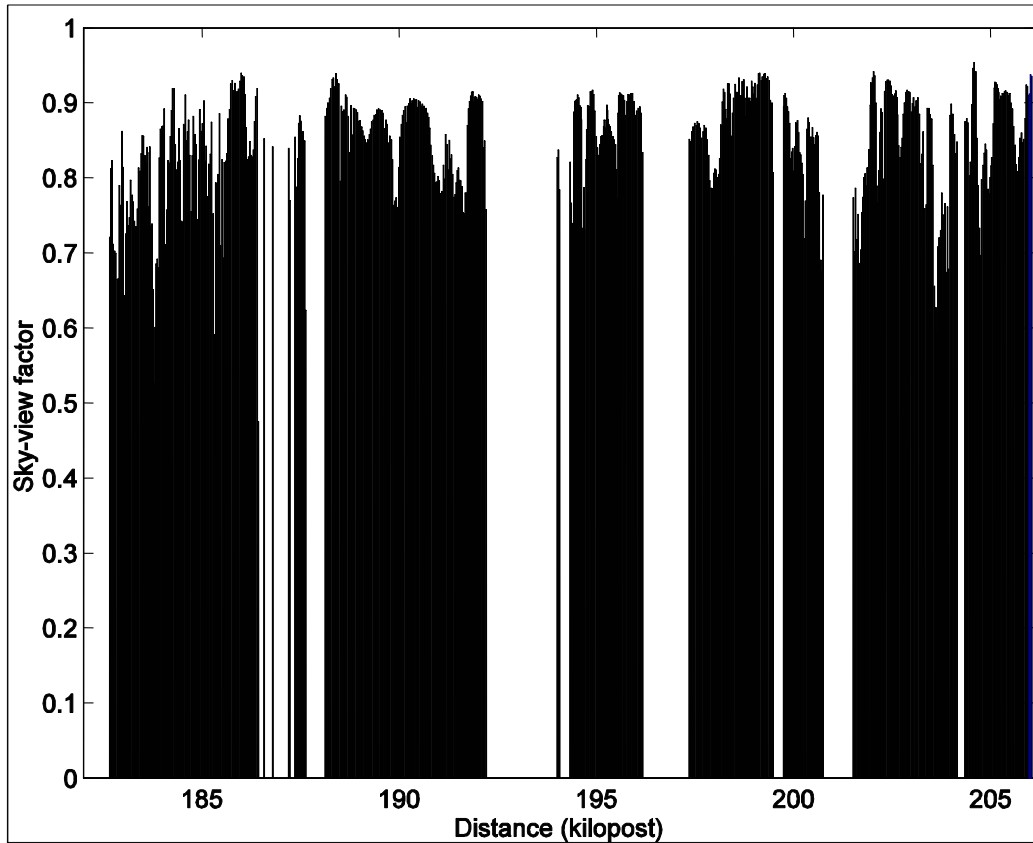
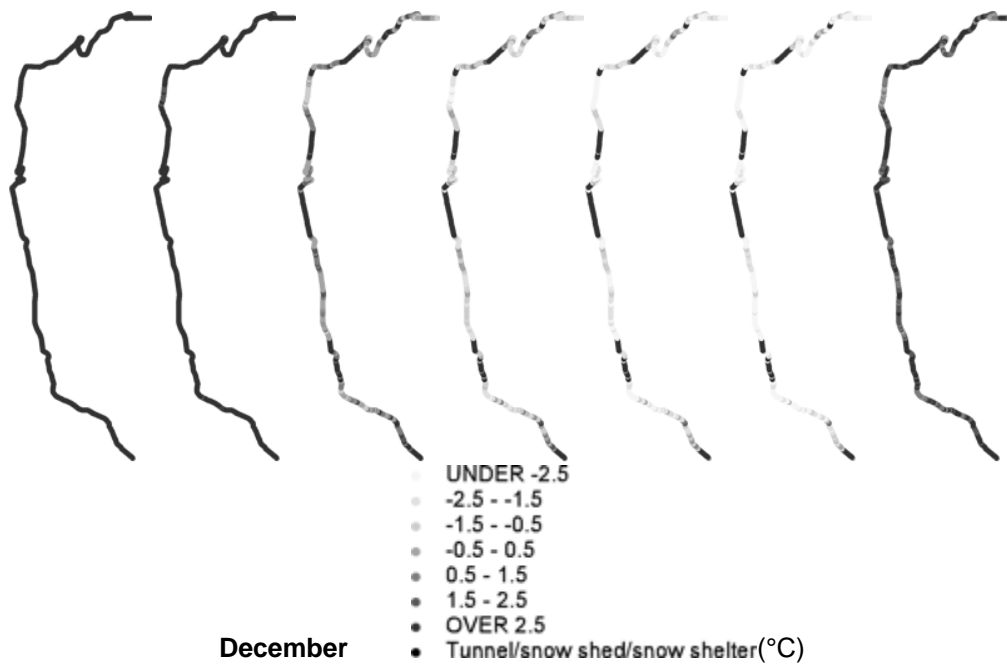

FIGURE 6 Sky-view factor along the highway in the study area.



December
(From left to right: 15:00, 18:00, 21:00, 00:00, 03:00, 06:00, and 09:00)

FIGURE 7 Sample IceMiser prediction output.

REFERENCES

1. Thornes, J. E. Thermal Mapping and Road-Weather Information System for Highway Engineers. In *Highway Meteorology* (A. H. Perry and L. J. Symons, eds.), E & FN Spon, London, 1991, pp. 39–67.
2. Bogren, J. Theoretical Background for Use of a Road Weather Information System. In *Conference Proceedings 16*, TRB, National Research Council, Washington, D.C., 1997, pp. 81–84.
3. Sigrist, P., P. Coppin, and M. Hermy. Impact of Forest Canopy on Quality and Accuracy of GPS Measurements. *International Journal of Remote Sensing*, Vol. 20, No. 18, 1999, pp. 3595–3610.

WINTER PAVEMENT TEMPERATURES AND ROAD CONDITIONS

**A First Principles Pavement Thermal Model for
Topographically Complex Terrain****E. E. ADAMS****L. R. MCKITTRICK***Montana State University–Bozeman***P. GAUER***Norwegian Geotechnical Institute***A. R. CURRAN***ThermoAnalytics, Inc.*

Pavement temperature in winter has a significant influence on highway maintenance and safety issues concerned with snow and ice management. A forecasting model chain for of pavement temperature in topographically varied terrain was developed and was being tested on Interstate 90 in Montana. The chain was initiated with the continental-scale meteorological forecast Eta model calculated on 20-km spacing. This was refined to a 1-km spacing using ARPS, a mesoscale model. Results were then interpolated to essentially provide a 30-m resolution weather forecast. Finally, Radiation Thermal model for Road Temperature (RadTherm/RT) was implemented to calculate terrain or pavement temperature. A Radtherm/RT grid was draped over a digital elevation map to provide a three-dimensional thermal topography, whereby each element or “facet” was given thermal characteristics appropriate to the material type. With the spatially calculated meteorological inputs, the energy balance of the terrain surface was calculated for each facet to forecast the surface temperature. Terrain surfaces took into account the influence of radiation exchange between facets as well as shadowing and sky view factors. Temporally animated surface temperature forecast maps were produced. Spatial variations were in clear evidence in the thermal signature of ridges compared with valleys and material properties. In order to simplify the information for more efficient utility by highway maintenance decision makers, a subset of the full terrain thermal map was provided to display only the highway temperature as a tricolor map. Comparisons of the pavement temperature calculated and measured at an road weather information system station were quite good when the meteorological forecasts were accurate.

INTRODUCTION

Weather forecasting, measurement, and communication technologies presently in development have the potential to greatly improve roadway safety for the commuting public. As these technologies mature, government entities responsible for transportation infrastructure

improvements must respond and work to implement systems that deliver anticipated results. It is typical for the commuting public to develop increased expectations of transportation infrastructure and information systems. With increased public expectations comes an increase in demands from providers of these services.

Ice formation on roads is an obvious safety issue on roadways in cold climates. In an ongoing effort to address the problem, state departments of transportation and meteorological services have established a network of automated meteorological stations on their ground transportation infrastructure systems. These networked stations deliver valuable real-time information to a central location where decisions regarding an appropriate course of action to ensure highway safety may be made. The usefulness of these stations is limited by their distributed geographical positions: any decisions made based on delivered data must include interpolation or guessing with regard to the conditions on road surfaces located between the fixed-positions stations.

A case in point is pavement icing, for which temperature and water sources determine the extent of icing. Thermal effects of sunlight, shadowing, and radiant heat exchange with the surrounding landscape in topographically complex terrain, such as mountainous and forested areas, cause significant differences in pavement temperature even on sections of road that are in close proximity to one another. However, it is virtually impossible to configure the entire highway system with sensors, so interpolation between sites is a necessity. It should also be noted that measurements are useful in providing a means to react to the current situation, but a forecast of the pavement conditions provides an added tool to help the highway operations manager be proactive.

To enhance the accuracy of this interpolation and to provide a pavement temperature forecast, a thermal model that has, as its genesis, a military application for the identification of the “infrared signature” of vehicles, is presented. The thermal contrast model (TCM) was originally developed for the U.S. Air Force (1, 2), and PRISM (Physically Reasonable Infrared Signature Model) was developed at Michigan Technological University’s Keweenaw Research Center in conjunction with the U.S. Army Tank-Automotive Command (3). An adaptation of this modeling to topographically complex terrain was advanced for a snow cover by Adams and McDowell in 1991 (4, 5). As a demonstration of the applicability of the concept, a relatively simple topography was presented. However, with the advent of readily available digital elevation maps (DEMs) and increasingly accurate mesoscale meteorological models, it is now practical to combine these elements in an operational setting. Radiation Thermal model for Road Temperature (RadTherm/RT) is a commercially available software product developed for structures using these same infrared signature principles (6, 7). A version of this program specifically developed for topographically complex terrain, with a specific emphasis on highway applications, in a collaboration between Montana State University and ThermoAnalytics Inc., was accomplished as a proof-of-concept study under the Montana Department of Transportation (MDT) research, development, and technology transfer program (8). Encouraged by these results, RadTherm/RT was developed in this subsequent research and is currently being tested to forecast pavement temperatures on a section of Interstate 90 through Bozeman Pass, Montana, with mesoscale meteorological forecast data as input.

RADTHERM/RT

Terrain and Topography

The first step in developing models for a particular locale is to describe the area in a format useful for the thermal calculations. Surrounding landscape features including aspect, elevation, and surface material properties (e.g., vegetation type, exposed soil, rock, or snow) all influence the pavement temperatures. The effect on pavement temperature due to the energy exchange is determined by topography and the thermal properties of the surrounding terrain.

From the outset, it was determined that for the most widespread utility the model must be readily transportable to new locations. Since DEMs and land cover maps (LCMs) are now readily available for many regions and since the thermal modeling presented here is based on application of well-established first principles, as outlined below, this approach achieves the goal of being highly portable for modeling additional areas. Accurate terrain models are generated from geographic information systems (GIS) to utilize the DEM and LCM information. Preprocessing programs are used to categorize GIS land cover types, defining appropriate material parameters for each element or facet that defines the landscape. A Radtherm/RT grid is effectively draped over the DEM to provide a three-dimensional thermal topography whereby each element or facet is given thermal characteristics appropriate to the particular material type. These thermal parameters (e.g., albedo, emissivity, thermal conductivity, and specific heat) are applied so that temperatures may be calculated based on environmental conditions.

Topography is currently input at a 30-m resolution since U.S. Geological Survey DEMs are readily available at this scale. From this are determined the geometric influences, including such things as slope and elevation, terrain self-shadow and obscurations, surface-to-surface reflections and emissions, and directional solar load on a sloped surface. The rectangular elements obtained from the DEM are further divided into triangular facet elements in order to maintain a continuously connected surface. Each facet has a view factor defined, which is in essence what it would “see looking out,” given its orientation with respect to the sky and the other facets representing the landscape. These view factors are used to incorporate shadowing, sun angle, and facet orientation for surface-to-surface radiation.

In order to account for radiation exchange between facets and with the sky, enclosure theory is employed to quantify each facet’s radiation view factor. This conceptually assumes a hemisphere centered over the facet, with the view factor F_{ij} , being the fraction of the hemisphere that the projection of facet j (or the sky) intercepts as viewed by facet i . Within RadTherm/RT, view factors are calculated for each facet with respect to all of the other facets and the sky using view factor rays. Between 512 and 4,608 rays (with trade-offs between efficiency and accuracy) may be prescribed as emanating from each facet. The DEM, in conjunction with the rays, is used to construct a view factor file. This process must be run only once for a particular location to construct a map, since it is a purely geometric relationship. However, an apparent area that each facet will have with respect to direct solar radiation must be updated at each time step in order to appropriately account for shadowing and the relative sun position. Similar to the ray casting for the facet to facet, or facet to sky view factor, from 1 to 48 rays may be cast from each element to the sun to determine the fraction of the facet that is in shadow at any given time and global location. Once the view factor terrain map has been constructed the terrain temperatures may be calculated (as described below), driven by the appropriate environmental conditions.

First Principles Utilized in RadTherm/RT

Computationally, one-dimensional, finite difference heat conduction equations are solved in the direction of the surface normal and determine the temperature profile through the thickness of each facet. Boundary conditions, used to solve the equations, assume a diurnal depth temperature for the lower bound and a flux condition for the energy exchange at the upper surface. The upper energy exchange includes radiation, convection, and phase change. Surface orientation is used to account for diurnal solar variations, including shadowing and reflection, and long-wave radiation calculations include facet-to-facet as well as facet-to-sky exchange.

The surface temperature of the pavement as well as the surrounding terrain is calculated in RadThermRT by accounting for the energy balance at every facet. Atmospheric input is provided at the upper surface in terms of energy flux, Q ,

$$Q = Q_{lw} + Q_{sw} + Q_{lh} + Q_{sh} \quad (1)$$

where

- Q_{lw} = long-wave radiation (6.8–100 μm , infrared),
- Q_{sw} = shortwave radiation (0.2–3 μm , solar),
- Q_{lh} = latent heat due to phase change, and
- Q_{sh} = convective or sensible heat flux.

The net long-wave radiation flux for each facet i is

$$Q_{lw_i} = F_{is} (Q_{li} - \sigma \cdot \varepsilon_i \cdot \theta_i^4) + \sigma \sum_{j=1}^n F_{ij} (\varepsilon_j \theta_j^4 - \varepsilon_i \theta_i^4) \quad (2)$$

where

- F_{is} = facet i to sky-view factor,
- F_{ij} = view factor from facet i to facet j ,
- $\varepsilon_i, \varepsilon_j$ = emissivity of facets i and j respectively,
- Q_{li} = incident long-wave sky radiation,
- σ = Stephan-Boltzman constant,
- n = number of other facets,
- θ_i = i facet temperature, and
- θ_j = j facet temperature.

Thus, this accounts for the exchange with the sky through the first term on the right-hand side and the exchange with all of the other facets through the second term. Somewhat similarly, the solar contribution, Q_{sw_i} , for the i^{th} facet is

$$Q_{sw_i} = \alpha \left(\frac{A_p}{A} \cdot I_n + F_{is} I_d \right) + \sum_{j=1}^n [B_{ij} (1 - \alpha_i) Q_{sw_j}] \quad (3)$$

where

- α = absorptivity (for nontransmissive terrains $\alpha = 1$ —albedo),
- I_n = direct solar radiation,
- I_d = diffuse solar,
- A = facet area,
- A_p = apparent area of the facet (i.e., that part of the facet projected toward the sun that is unshadowed), and
- B_{ij} = shape factor from the i to j facet.

Multiple reflections are accounted for, with the reflected solar considered diffuse.

Newton's Law for cooling is used for the sensible heat flux,

$$Q_{sh_i} = \bar{h}_c (\theta_a - \theta_i) \quad (4)$$

where \bar{h}_c is the average convective heat transfer coefficient over the facet, and θ_a is the air temperature. The flux due to phase change is calculated as

$$Q_{lh_i} = L_m \cdot \bar{h}_m (C_a - C_i) \quad (5)$$

where

- L_m = latent heat of phase change,
- \bar{h}_m = convective mass transfer coefficient, and
- C_a and C_i = the mass concentrations of water vapor.

The influence of liquid precipitation is handled by assuming no more than a 0.4-mm thickness will accumulate and that this film will eventually be removed through phase change. The influence of the phase change on the pavement temperature is taken into account through this equation; however, there is not yet a practical and accurate means to automatically update changing road surface conditions due to snowfall. This is not because of technical limitations within the modeling effort—for example, of adding snow accumulation based on snowfall rates—but rather the inability to handle the anthropomorphic influences, such as traffic and maintenance operations, in a forecast mode. RadTherm/RT in its current operational form is, by default, used to forecast road surface temperatures. The assumption with regard to the temperature calculations is that the road is dry and not snow covered. Snow-covered road conditions can be specified for a particular run, but these conditions are not updated as actual road surface conditions change during the course of that run and are not provided to the maintenance personnel in the operational test case.

The energy equation for a differential volume within the opaque terrain provides the time, t , rate of change of temperature, θ , as proportional to the divergence of the heat flux, \mathbf{q} ,

$$\nabla \cdot \mathbf{q} = -\rho \cdot c_p \left(\frac{\partial \theta}{\partial t} \right) \quad (6)$$

where ρ is the material mass density and c_p is the specific heat of the material. The heat flux, \mathbf{q} , through the terrain and pavement is primarily because of heat conduction and thus according to Fourier's law is represented as

$$\mathbf{q} = -k \cdot \nabla\theta \quad (7)$$

where k is the thermal conductivity. So that

$$\nabla^2\theta = \delta \left(\frac{\partial\theta}{\partial t} \right) \quad (8)$$

The thermal diffusivity, $\delta = \frac{\rho \cdot c_p}{k}$, is determined by the material properties. A fixed lower-boundary temperature is set at the diurnal depth as appropriate for the particular day as determined from measured historical data.

MODELING CHAIN

To utilize the terrain or pavement thermal model in an operational mode, a model chain was developed. This chain began with a continental-scale weather forecast that provided conditions to drive a mesoscale model, which in turn provided the meteorological input required for the pavement temperature calculation at the scale of the DEM, by using RadTherm/RT. This computational chain function as follows. Forecast weather data were taken from existing meteorological models (for forecasts in the United States, continental-, or synoptic-scale forecasts were first run by the National Center for Environmental Prediction using the Eta model), which were posted on a public file transfer protocol server. These results were then downloaded and used as input into a mesoscale modeling program, the Advanced Regional Prediction System (ARPS), which was designed to more accurately account for topographic and turbulent flow factors. Utilizing Eta input, ARPS models ran in two successively smaller scales to provide forecast data with resolutions on the order of 1 km. These values were subsequently interpolated to the scale of the DEM (30 m), essentially providing individual forecasts for each facet.

To model current conditions accurately, it should be mentioned that it is possible to use a mesoscale modeling tool such as the ARPS data assimilation system (ADAS). As the name indicates, ADAS can assimilate measured meteorological data throughout the entire modeling period and can be used to drive the responses near those measured points, by forcing or weighting a statistical minimization of the error between the model and the measured data. Data from either of these types of mesoscale programs can then be used as input into RadTherm/RT. RadTherm/RT inputs are air temperature, shortwave (solar) radiation, long-wave (infrared) radiation, wind speed, wind direction, humidity, and precipitation rate, as a function of time.

RESULTS

The information that had been calculated was presented on a website for the decision-making highway maintenance manager. Forecasts were run every 12 h, for 24-h periods; thus in general, the newest forecast overwrote the last 12 h of the previous. In addition to providing more current updates, this protocol ensured that if a forecast were late or there were some failure in the computer communication chain, there would still be a forecast in place. The process was further detailed in “Forecasting Terrain-Dependent Weather Conditions: Details of a Model Chain Sequence” by McKittrick, Adams, Gauer, Mewes, and Curran on pages 95–108 in this circular.

Data obtained from the LCM were adjusted to conditions appropriate to the winter during the period under consideration. Spatial surface temperatures, calculated using the first principles thermal model chain for the temporally varying terrain, were represented visually as a color-coded animation. In this instance all of the regions designated as grasslands were considered to be covered with 30 cm of fresh snow, rocky outcroppings were left exposed, deciduous trees were dormant and leafless, and conifer trees were also considered dormant. The highway was generally considered bare, as described above. An example snapshot of the output is shown in [Figure 1](#). Notice the influence of the topography and material properties on the image. The thermal signature of the highway, running east–west across the image was evident. The influence of both the topography and thermal properties were apparent in all of the terrain. Some of the hotter spots were the result of orientation to the sun but also their thermal properties. Since the highway was actually the area of interest, in order to increase computation efficiency a variable mesh size was developed in which facets further from the highway increase in area. While from a direct radiation exchange the more distant elements was less important, the influence of shadowing still might have been relevant. In particular, the highway was quite distinct from the surrounding terrain.

The information that had been calculated in the modeling chain was presented on a website for the decision-making highway maintenance manager. For each forecast period an e-mail was sent to provide the predicted maximum and minimum temperature and wind information. This notice also contained a link to a website to provide convenient access to more detailed information if the manager feels that the notification contained pertinent information warranting additional data.

While the information presented in [Figure 1](#) is available, it likely presents more information regarding the surrounding terrain than is likely needed with regard to highway operation decisions. The website is therefore organized in a manner such that the decision maker can access the data at a level of detail deemed most useful for a particular situation. Beyond the most basic level presented in the automatic email, a temporally varying tricolor plan view map keyed to the highway temperature is provided. The color code indicates the critical temperature; for example, close to freezing ($\pm 2^{\circ}\text{C}$), along with ranges above freezing and ranges below freezing. An example is demonstrated in [Figure 2](#). A similar presentation for average critical wind velocities calculated over each facet is also presented.

While the tricolor offers what may be sufficient to indicate where and when the critical pavement temperature and wind velocity values are to be anticipated, it does not provide particulars as to “how far” above or below the thresholds the values might be. This type of information may be important, for example, in deciding when a particular chemical might be effective. Consequently, a more detailed presentation is offered in the form of a continuous color-coded elevation view that includes both pavement temperature and wind velocity on the same figure ([Figure 3](#)).

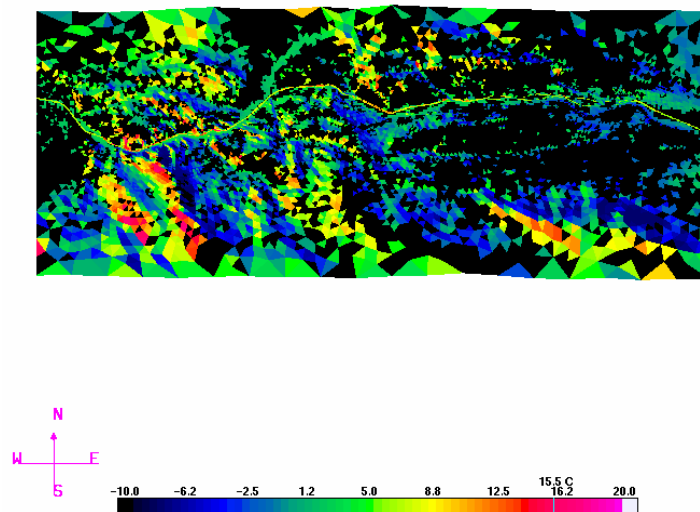

FIGURE 1 A thermal map “snapshot” of the terrain being modeled along I-90 between Bozeman and Livingston, captured at 13:00 on February 26, 2003.

As discussed, every facet essentially had a complete weather and terrain- or pavement-temperature forecast. This information was provided at each mile marker on a time versus variable plot. In addition, at the road weather information system (RWIS) meteorological station, the measured data were also plotted, as they came in, along with the predicted values. An example of this is demonstrated for the temperature plot in Figure 4. Also, the meteorological data used for the surface temperature calculation were similarly presented as plots, including shortwave and long-wave radiation, wind speed and direction, cloud cover fraction, relative humidity, precipitation, barometric pressure, and snow accumulation.

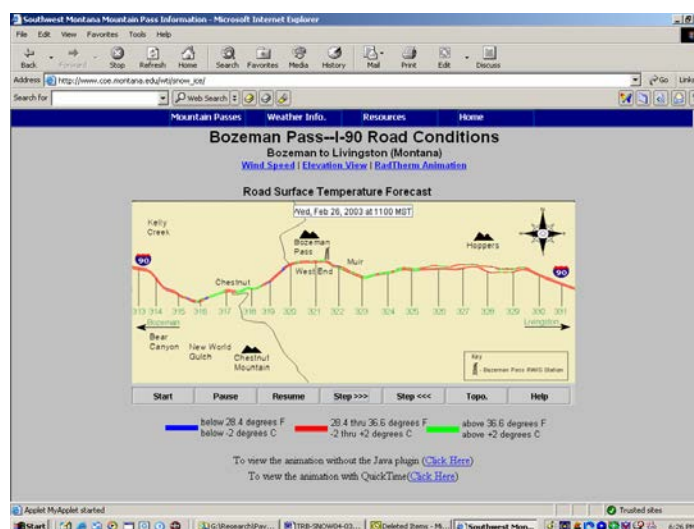

FIGURE 2 The basic tricolor map for highway maintenance decision makers, provided on the website as a time–temperature animation for the forecast period.

CONCLUSIONS

Statistical studies indicate that the pavement temperature model produces results that are quite good when the meteorological forecast is accurate. McKittrick et al., in the paper on pp. 95–108 in this circular, indicated that when the MDT RWIS measured data are used as input to the RadTherm/RT model the average error in pavement temperature is about 2°C, generally skewed low. The error when driving the model with the meteorological forecast models is closer to 5°C. It should be pointed out that the accuracy of RWIS, which is in place alongside the highway as part of the array of stations situated throughout the state, has not been validated in this study. There remain a number of areas in which improvements to the model can be made, such as improved values of material properties of the pavement and a reduction in the number of facets for which calculations are required and do not, perhaps, significantly influence the pavement temperature.

The model chain presented has been proved successful in being able to link together a complex series of models from the continental scale to the microscale. Increases in available computational tools have increased, even during the course of this study, to the point where the results achieved would not have been possible at the outset. The current approach is well positioned to continue to develop and grow along with technological advances. As the meteorological models continue to improve along with accuracy and efficiency gains anticipated for the surface temperature model, improved results and increased utility by the highway maintenance operations will proceed as well.

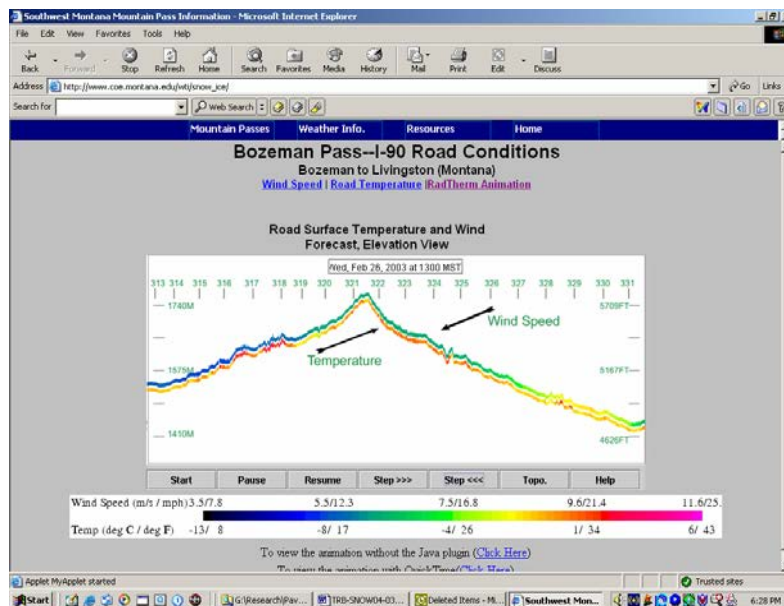

FIGURE 3 A “snapshot” of an elevation map providing a continuous temperature and wind-speed forecast across Bozeman Pass.

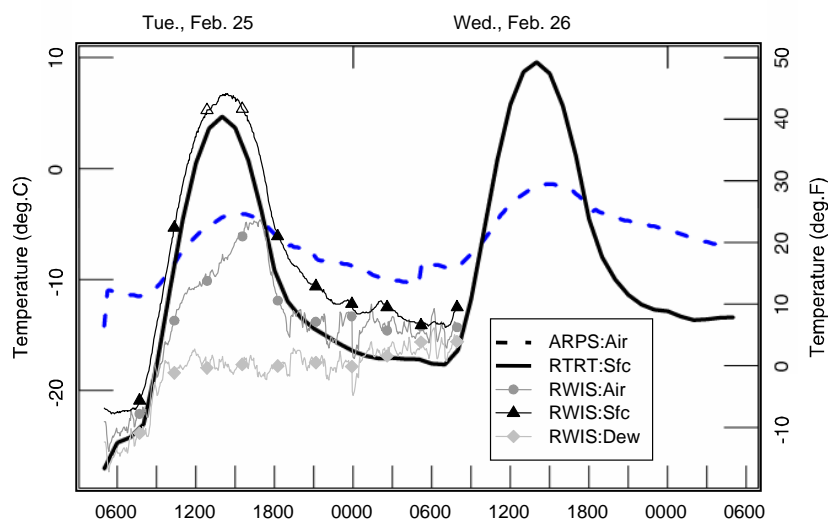

FIGURE 4 An example of plot presented at each mile marker, taken from the facet that includes the MDT RWIS. The measured data are continuously updated when available.

Plots at the other mile markers are similar, but without the measured data. All of the meteorological input required for the pavement temperature calculations is included on similar plots and provided on the website.

ACKNOWLEDGMENTS

The authors thank the FHWA, the MDT, and Montana State University's Western Transportation Institute for support of this research project.

The Advanced Regional Prediction of Storms, which was utilized in part of this study, was developed by the Center for Analysis and Prediction of Storms (CAPS), University of Oklahoma. CAPS is supported by the National Science Foundation and the FAA.

REFERENCES

1. Johnson, K. R. *Technical Reference Guide for TCM2*. Wright Laboratory Avionics Directorate, Wright-Patterson Air Force Base, Ohio, 1991.
2. Johnson, K. R., et al. *Phase 2 Development Tasks: Research to Enhance the Phillips Laboratory SIMLAB Capability for Simulating the IR Scene*. Phillips Laboratory, Hanscom Air Force Base, Massachusetts, 1996.
3. *Prism 3.0 User's Manual*, 3.0 ed. Keweenaw Research Center, Michigan Technological University, Houghton, 1991.
4. Adams, E. E., and S. A. McDowell. Thermal Model for Snow on Three Dimensional Terrain.

In Proc., Japan–U.S. Symposium on Snow Avalanche, Landslides, Debris Flow Prediction and Control, Tsukuba, Tsukuba-shi, Ibaraki-ken, Japan, 1991.

5. Adams, E. E., and S. A. McDowell. Influence of Topography on Mass Exchange at a Snow Surface. American Geophysical Union Fall Meeting, San Francisco, California, 1991.
6. Curran, A. R., et al. Automated Radiation Modeling for Vehicle Thermal Management. Presented at SAE International Congress and Exposition, Detroit, Michigan, 1995.
7. Johnson, K. R., et al. A Methodology for Rapid Calculation of Computational Thermal Models. Presented at SAE International Congress and Exposition, Underhood Thermal Management Session, Detroit, Michigan, 1995.
8. Adams, E. E. *Proof of Concept for Prediction of Pavement Temperature: A Tactical Decision Aid for Highway Safety*. Report FHWA/MT-99-003/8117, FHWA, U.S. Department of Transportation, 1999.

WINTER PAVEMENT TEMPERATURES AND ROAD CONDITIONS

Winter Road Condition Model

STAFFAN MÖLLER

Swedish National Road and Transport Research Institute

The large-scale winter model project resulted in a model for assessing the most important effects and the monetary value of changes to winter maintenance strategies and operations.

The winter road condition model was the central part of the winter model. The road condition model characterized the state of a winter in terms of a road condition description hour by hour. The road condition model provided input data for the other models assessing different effects such as accident risk, travel time, fuel consumption, and environmental effects. In the first stage, a model that described how road conditions were affected by weather, what maintenance measures were taken, and the volume of traffic on two-lane rural roads with a width of 7 to 9 m and speed limit of 90 km/h was developed.

To a great extent, the basis for developing the winter road condition model was data already collected from nine observation sites with the purpose of developing the accessibility model.

For several periods data from these observation sites contained information hour by hour regarding weather, traffic flow, initial road condition, maintenance measures taken, and specified types of road condition development mainly connected with snow ploughing and anti-icing measures. Additional information, such as development of ruts down to the pavement in hard-packed snow or thick ice caused by vehicles with studded tires and conditions for a wet or moist road to dry out, was collected by field studies during the 2002–2003 winter season.

INTRODUCTION

A large-scale winter model project resulted in a model for assessing the most important effects and the monetary value of changes to winter maintenance strategies and operations. The effects were assessed for road users, road administrators, and the environment.

The winter road condition model was the central part of the winter model. The model characterized the state of a winter in terms of a road condition description hour by hour. The road condition model provided input data for the other models assessing different effects such as accident risk, travel time, fuel consumption, and environmental effects. The model was limited to describing winter road conditions on two-lane rural roads.

MODEL DEVELOPMENT

In the first stage a model that described how road conditions are affected by weather, what maintenance measures were taken, and what volume of traffic existed on a road with a width of 7 to 9 m and speed limit of 90 km/h was developed. The model was limited to four cases concerning winter maintenance standard classes and traffic flow (Table 1). Standard class A3 was the second-lowest class of salted roads, and standard class B1 was the highest class of nonsalted roads (1).

To a great extent, the basis for developing the winter road condition model was data already collected from the nine observation sites, during one or two winter seasons, with the purpose of developing the accessibility model.

The observation sites represent the following variations:

- Climate zone: central, lower northern and upper northern Sweden;
- Standard class: A3, A4, and B1;
- Traffic flow: annual average daily traffic (AADT) 1,500 to 3,500;
- Road width: 6.5 to 9.2 m; and
- Speed limit: 90 and 110 km/h.

For several periods, data from these observation sites contained information hour by hour regarding weather, traffic flow, initial road condition, and maintenance measures taken. Also specified types of road condition development—mainly connected with snow ploughing and anti-icing treatment—could be studied. Additional information will be collected in special field surveys from the winter 2002–2003. One survey will cover the development of ruts down to the pavement in hard-packed snow or thick ice caused by vehicles with studded tires. Also, the mechanism for a wet or moist road to dry out was studied.

STRUCTURE OF WINTER ROAD CONDITION MODEL

The first version of the road condition model was constructed according to the following outline. The road condition for each of five strips of the lane was described (2). In [Figure 1](#), half of a carriageway is shown.

Starting from the center of the road, the lane, the shoulder, and the ditch areas shown. Snow covers the road except in wheel tracks. The lane is divided into the following strips:

- Edge of lane,
- Right wheel track,
- Between wheel tracks,
- Left wheel track, and
- Middle of the carriageway.

Input and output data to and from the road condition model are shown in [Figure 2](#). Input data included

- Road condition during the hour t (a 60-min period) for each of five strips of the lane.
- Amount of residual salt on the carriageway during the hour t , if possible.
- Weather from the road weather information system (RWIS) during the hour $t + 1$.

TABLE 1 Four Cases for the Road Condition Model

Winter Maintenance Standard Class	Traffic Flow (AADT)	
	A3	1,500
B1	1,000	3,000

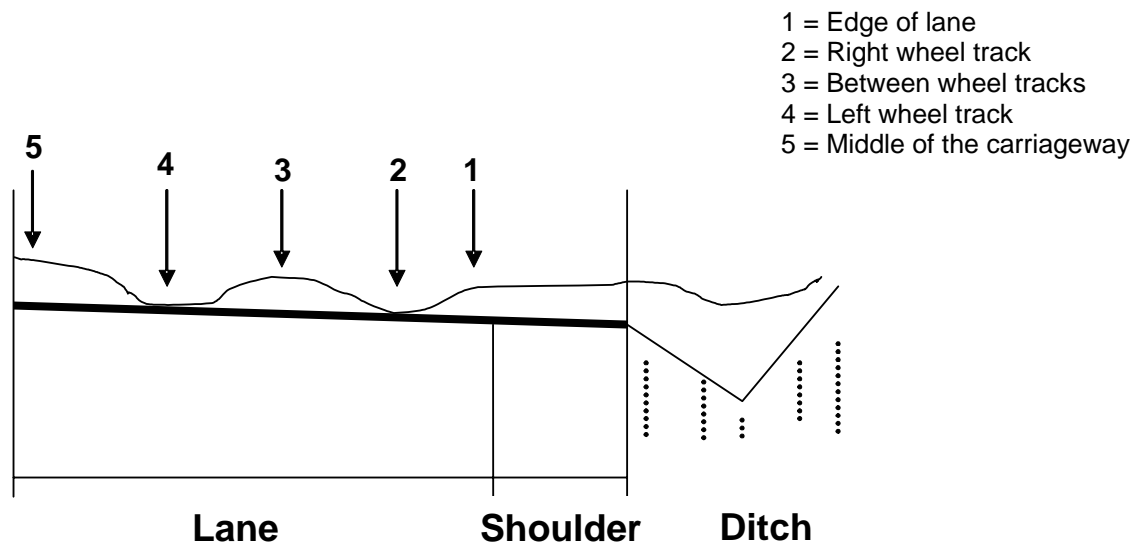

FIGURE 1 Lane divided into five strips.

Weather included air temperature, road surface temperature, dew point temperature, type and amount of precipitation, wind speed, and weather situation. Examples of weather situations were snowfall, rain, blowing snow, and risk of slippery surfaces due to, for example, frost formation on a cold carriageway.

- Traffic flow and average speed during the hour $t + 1$. Data were divided into cars using studded tires, cars not using studded tires, trucks with a trailer, and trucks with no trailer.
- Maintenance measures taken during the hour $t + 1$. These data were divided into snow ploughing, anti-icing treatment, snow ploughing combined with anti-icing treatment, gritting, and grading.

Output data included

- Road condition during the hour $t + 1$ for each of five strips of the lane.
- Road condition during the hour $t + 1$ at an aggregated level. For example, the following five types of road condition: dry bare ground, moist or wet bare ground, hard-packed snow or thick ice, black ice or hoar-frost, and loose snow or slush.
- Friction class in wheel tracks during the hour $t + 1$, if possible.
- Amount of residual salt on the carriageway during the hour $t + 1$, if possible.

FIRST ATTEMPT AT WINTER ROAD CONDITION MODEL

A first model attempt was designed as a basis for developing and testing the computer program that managed input and output data and made calculations in the winter model. The attempt consisted of three submodels:

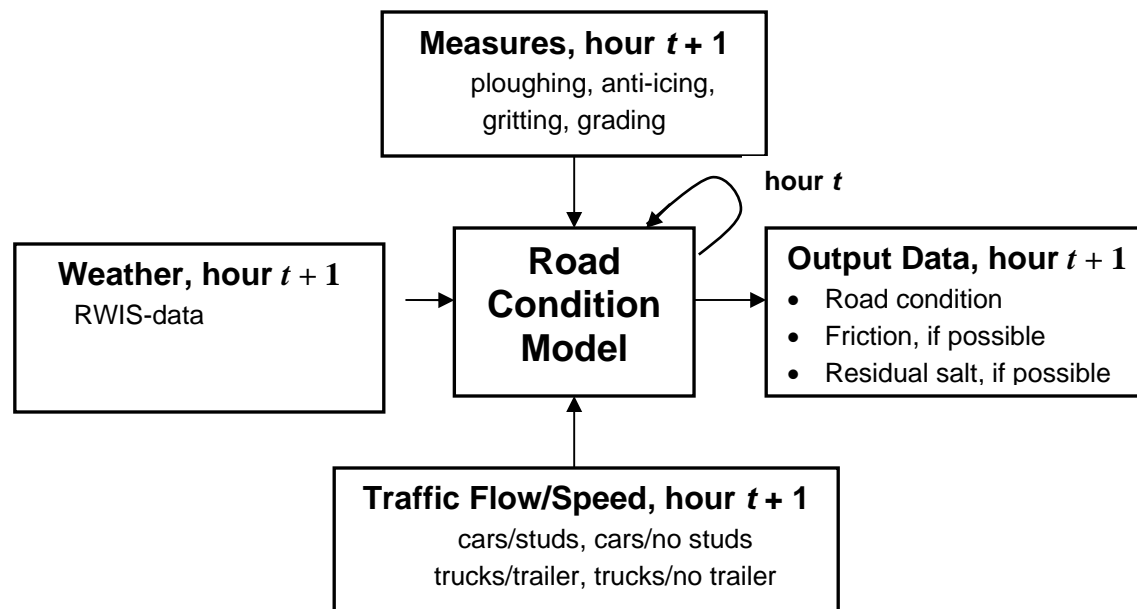

FIGURE 2 Input and output data to and from the road condition model.

1. One for a wet or moist road to dry out;
2. One for anti-icing treatment; and
3. One for snow ploughing combined with anti-icing treatment.

The submodels were still to a great extent intuitive and without accurate empirical foundation but contained some realistic relationships between different variables.

The following notation of the concept of time is used (Figure 3):

- Time t is an instant, for example 10:00 and 11:00.
- The hour t is a period of 60 min immediately after t . For example the hour 10 means the time period 10:00 to 10:59.

Drying Submodel

If the amount of water on the road is

- 50 g/m^2 , the road condition is wet bare ground;
- $50\text{--}5 \text{ g/m}^2$, the road condition is moist bare ground;
- $< 5 \text{ g/m}^2$, the road condition is dry bare ground; or

One mm of rain \leftrightarrow the amount of water on each m^2 of the road = $100 \times 100 \times 0.1 = 1,000 \text{ cm}^3/\text{m}^2 = 1000 \text{ g/m}^2$.

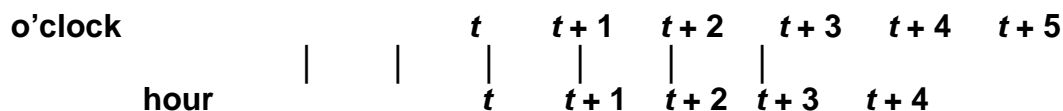

FIGURE 3 Notation of the concept of time.

If the amount of water on the road is $> 50 \text{ g/m}^2$, it is assumed that the amount of water is halved each time the traffic flow runs up to $100 \text{ pb}_{\text{ekv}}$, where pb_{ekv} is (the number of cars) $\times 1 +$ (the number of trucks with no trailer) $\times 3 +$ (the number of trucks with a trailer) $\times 7$.

If the amount of water on the road is $\leq 50 \text{ g/m}^2$, it is assumed that drying depends on dew point temperature, road surface temperature, and traffic flow. Also, wind speed and wind direction are important parameters that are included when empirical data are studied more closely.

Anti-Icing Treatment with Salt Submodel

Assumptions and Prerequisites

It is assumed that anti-icing treatment is carried out with brine and that a salting pass takes 2 h.

If icy conditions are indicated during hour t , action is ordered at $t + 1:00$. After the driver has reported for duty and the vehicle has been made ready, which takes 1 h, action on the road begins at $t + 2:00$ and is carried out during hours $t + 2$ and $t + 3$. This means that, as an average for the salting pass, salting is performed at $t + 3:00$. The change in road conditions as a result of salting, as an average for the salting pass, shall then refer to $t + 3:00$.

Model Attempt

The relationship between weather (HF = risk of hoar frost), activity (D + V = time for driver to report for duty and for the vehicle to be made ready; S = salting), time of salting as an average for the pass (\uparrow) and simplified description of road condition, is set out in Figure 4.

If slippery conditions persist, another salting pass must be carried out. When this is done depends on the type of slippery conditions in question.

Snow Plowing Combined with Anti-Icing Treatment Submodel

Assumptions and Prerequisites

It is assumed that snow falls over 5 to 7 h provides moderate amounts of snow (i.e., 2 cm to 4 cm of loose snow) and that only two passes of combined action are needed. Each pass takes 6 h. It is also assumed that a separate anti-icing treatment with moist salt is performed before the snowfall. Such an action is assumed to require 2 h.

O'Clock	t	$t+1$	$t+2$	$t+3$	$t+4$	$t+5$
Hour	t	$t+1$	$t+2$	$t+3$	$t+4$	
Weather	HF	HF	HF	—	—	
Activity	—	D+V	S	S	—	
Avg. time for pass				↑		
Road condition	DB	DB	DB	MB	drying	

FIGURE 4 Model attempt for anti-icing treatment with salt (DB = dry bare ground, MB = moist bare ground).

If the first snowfall is indicated during hour t_1 , salting is carried out during the hours $t_1 - 2$ and $t_1 - 1$. This means that the change in road conditions, as an average for the salting pass before the snowfall, should refer to $t_1 - 1:00$.

Combined action begins when ≥ 1 cm snow has fallen, aggregated by the hour. This is assumed to have occurred at $t_{2:00}$. The first pass is then run during the hours t_2 to $t_2 + 5$. This means that the change in road conditions, as an average for the first pass of snowplow combined with anti-icing treatment, should refer to $t_2 + 3:00$.

The second pass with combined action begins 6 h after the start of the first pass (i.e., at $t_2 + 6:00$). The change in road conditions as an average for the second pass should then refer to $t_2 + 9:00$.

Model Attempt

The relationship between weather (S = snowfall), amount of snow in cm/h, activities (S = salting, CA₁ and CA₂ = combined action of the first and second pass, respectively), time of salting and combined action as an average for the pass (↑), and simplified description of road conditions is set out in Figure 5.

o'clock	t_1-2	t_1-1	t_1	t_1+1	t_2	t_2+1	t_2+2	t_2+3	t_2+4	t_2+5	t_2+6
Hour	t_1-2	t_1-1	t_1	t_1+1	t_2	t_2+1	t_2+2	t_2+3	t_2+4	t_2+5	t_2+6
Weather	—	—	S	S	S	S	S	S	S	—	—
Amt. of snow	—	—	0.4	0.8	0.6	0.8	0.3	0.5	0.3	—	—
Activity	S	S	—	—	CA ₁	CA ₁	CA ₁	CA ₁	CA ₁	CA ₁	CA ₂
Ave. time for pass		↑ salt						↑ comb. action 1			
Road condition	DB	MB	SL/LS	SL/LS	SL/LS	SL/LS	SL/LS	SL	SL	SL	WB/SL

FIGURE 5 Model attempt for snow ploughing combined with anti-icing treatment with salt (DB = dry bare ground, MB = moist bare ground, WB = wet bare ground, SL = slush, LS = loose snow).

MEASUREMENT OF RUT DEVELOPMENT

At the end of January 2003 an attempt was made to measure rut development in hard-packed snow or thick ice caused by vehicles with studded tires. The measurement site was situated in upper northern Sweden. The road was covered by ice ~1-cm thick.

Development of ruts down to the pavement was examined using a special device, called the Primal (Figures 6 and 7).

The Primal is a small, self-propelled device, developed by the Swedish National Road and Transport Research Institute. It is normally used for measuring cross sections of paved roads in the summer. It is located at the starting point and aimed at the end point for the measurement.



FIGURE 6 Primal has just left the starting point in the middle of the road.



FIGURE 7 Primal toward the end point (by the stand) on the shoulder.

Then it travels across the road and measures the level of the surface on to the end point. The starting and end points are nails with a washer driven into the pavement. In this case the road condition was 1 cm of thick ice. The precision of the measurement was good. A cross section measured by the Primal is shown in [Figure 8](#).

A reference plane is defined by the starting point and the end point, and the cross section is drawn in relation to the reference plane. We can see the starting point (the nail in the pavement), 1 cm of thick ice on the pavement, left wheel track, between wheel tracks, right wheel track, shoulder, and down from the thick ice to the end point (the second nail).

Thirty-eight cross sections were measured over 4 days. By plotting these in the same diagram, the gradual development of ruts would be shown. Unfortunately, problems with data collection meant that rut development could not be evaluated in this simple way. Average cross sections from Days 1 and 4 were instead produced by manual methods. The results are plotted in [Figure 9](#).

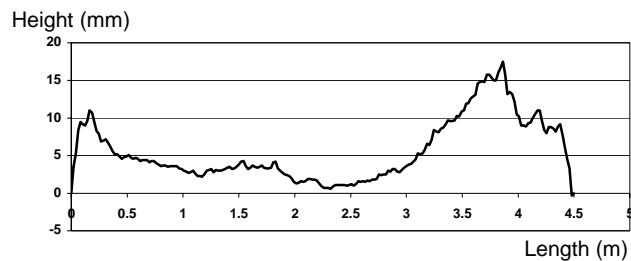

FIGURE 8 Cross section measured by the Primal (2003-01-27, cross section no. 8).

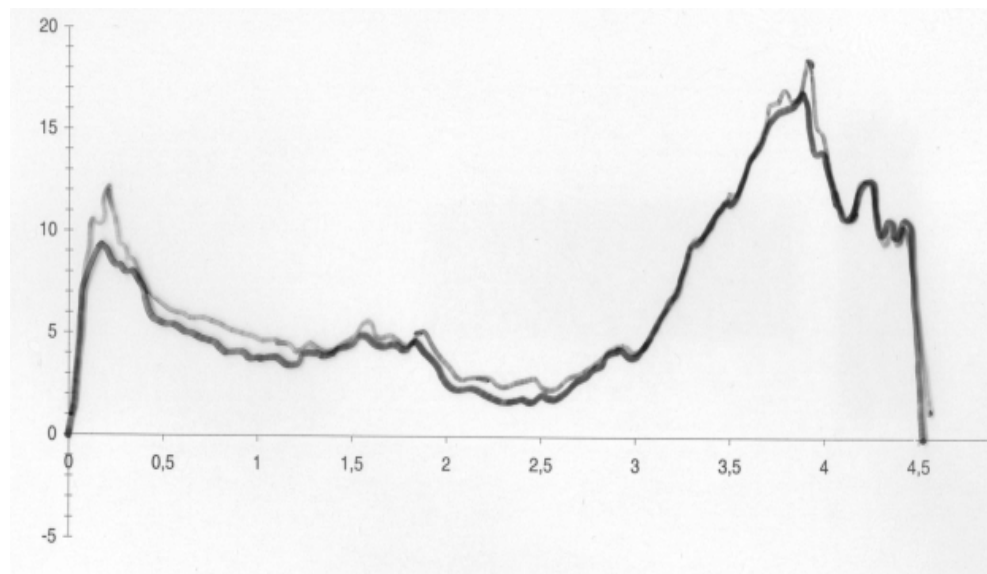

FIGURE 9 Average cross sections from Day 1 (light curve) and Day 4 (dark curve) superimposed upon each other.

It was estimated that the ruts deepened by a maximum of 1 mm between the first and last measuring event, over about 3 days. Because of the manual method, there is naturally quite a large uncertainty in this estimate. During the same period about 2,000 cars with studded tires, which abraded the thick ice, traveled over the road. The relative wear in the middle of the wheel track in thick ice can then be estimated as $1.0/2000 = 0.0005$ mm/car with studded tires.

In the present case, this would mean that the 1-cm thick ice would be worn away in the middle of the wheel track after ~20,000 cars with studded tires have passed. This represents traffic during approximately 1 month.

ACKNOWLEDGMENTS

The winter model project was cofinanced by the Swedish National Road Administration and the Swedish Agency for Innovation Systems. The financial support is gratefully acknowledged.

REFERENCES

1. Vägverket (Swedish National Road Administration). *Drift 96. Allmän teknisk beskrivning av driftstandard*. Publikation 1996:16. Vägverket, Borlänge, 1996.
2. Vägverket (Swedish National Road Administration). *Metodbeskrivning 105:1996. Bedömning av vinterväglag*. Publikation 1996:59. Vägverket, Borlänge, 1996.

WINTER PAVEMENT TEMPERATURES AND ROAD CONDITIONS

**Inverse Estimation of Friction Coefficient of
Winter Road Surface with Vehicular Motion Data
Measured by GPS-Equipped Probe Vehicles**

TAKASHI NAKATSUJI
Hokkaido University

AKIRA KAWAMURA
TIKAKUNI MAEDA
Kitami Institute of Technology

This study is concerned with a snow and ice control system based on a friction coefficient. A method was developed to estimate the friction coefficient on winter road surfaces indirectly from vehicular motion data. The interaction between tire and road surface was taken into account and integrated into a genetic algorithm. The friction coefficients estimated by the method were better fitted to the actual measured values, compared with those estimated by conventional physical formulas. More conveniently, the friction coefficients estimated were not sensitive to the parameters of the tire model that are difficult to measure in a real field.

INTRODUCTION

A snow and ice control system based on a friction coefficient (1–3) draws a great deal of concern from researchers and practitioners, but it still remains in a challenging stage. The difficulty lies in the fact that road surface conditions in winter are transient and vulnerable; that is, they can be quite different from those 30 min before and from those 100 m distant. It is almost impossible for a road agency to deploy as many devices needed to cover a whole city area and to measure the friction coefficients simultaneously even if advanced friction testers (4–6) are deployed in the real field.

Now, taxis are often equipped with a Global Positioning System (GPS) for more efficient operations. We are able to know exactly where they are on a real-time basis. In general, vehicular motions in winter are closely correlated with road surface conditions. If taxis were equipped with some vehicular motion sensors, it would be easy to find out what road surface conditions are like over a wider area. In this respect, vehicular motion sensors, such as the accelerometer and the angular velocity meter, are the best choice because they are small enough to be installed in a taxi, durable enough to withstand severe vehicular motions, and more important, inexpensive enough to deploy in large numbers.

This study aimed to establish a method estimating friction coefficient from vehicular motion data. Using the experiment data measured by probe vehicles that were equipped with motion sensors, we developed an inverse estimation technique, in which a tire model that represented the mutual interaction between tire and road surface was combined with a genetic algorithm (GA). The next section presents the theoretical background of the estimation method.

The description of data collection follows next, with a description of the probe vehicles that were designed for this study and the experiments conducted on a test track. The next section deals with some numerical analyses. The estimation method developed here is compared with some primitive methods that are based on elementary physical formula. The sensitivity of friction coefficient to some model parameters is also examined. Finally, some concluding remarks are presented for further study.

ESTIMATION METHODS

Rigid Body Model

Before formulating the equation of motion based on the tire model, a few simpler estimation equations assuming that the vehicle is in rigid body motion should be considered. That is, some elementary physical formulas for particle dynamics can be applied:

- If the longitudinal acceleration data, a , is available, the ratio to the gravitational constant, g , should correspond to friction coefficient:

$$f_1 = a / g \quad (1)$$

- In general, speed is easier to measure than acceleration. Although the numerical differentiation brings another difficulty, if the speed in the longitudinal direction v is measured, Equation 1 reduces to

$$f_2 = \left(\frac{dv}{dt}\right) / g \quad (2)$$

- If both speeds, v_1 and v_2 , at the beginning and end of vehicular motion as well as the distance S moving during the time period are available, the relationship between them yields the following equation:

$$f_3 = \frac{(v_2^2 - v_1^2)}{2gS} \quad (3)$$

Tire and Road Surface Interaction Model

Tire Model

Studless tires widely used in winter seasons are characterized by their high viscoelastic nature. Figure 1 depicts the displacement and force generated on a single tire under braking operation. The contact area between tire and road surfaces is divided into an adhesion region, where the friction force is proportional to the longitudinal displacement, and the sliding region, where the relative motion already occurred and the force is in proportion to vertical load. In order to evaluate the interaction between tire and road surface more precisely, the viscoelastic component in the adhesion region should be taken into account as well as the hysteresis component in the sliding

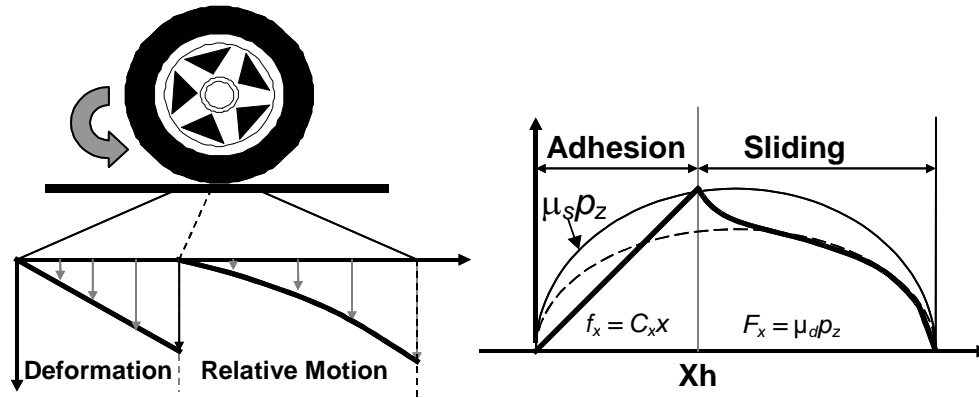

FIGURE 1 Conceptual drawing of friction force at contact area in braking operation: (a) distribution of displacement over the contact area and (b) friction force versus displacement.

region (7). The length of adhesion region l_h can be given as the solution of the following non-linear equation (8):

$$\frac{n+1}{n} \frac{2^n F_z \mu_s}{l^{n+1} w} \left[\left(\frac{l}{2} \right)^n - \left(l_h - \frac{l}{2} \right)^n \right] = s C_x l_h \quad (4)$$

where

- s = slip ratio,
- n = order of parabolic curve for contact pressure,
- l = contact length,
- w = contact width,
- μ_s = static friction coefficient,
- C_x = spring constant of tread base, and
- F_z = vertical load.

It should be noted here that the adhesion length is simply the function of the geometry of the contact area and the elastic constant of tire as well as the friction coefficient and the slip ratio. The vehicle speed has no influence on it.

The slip ratio in Equation 4 is an index that represents the relative discrepancy between vehicle and wheel speeds:

$$S_d = \frac{V_{bdy} - V_{whl}}{V_{vhl}} \quad (S_d \geq 0) \quad \text{when decelerating}$$

and

$$S_d = \frac{V_{bdy} - V_{whl}}{V_{vhl}} \quad (S_d \leq 0) \quad \text{when accelerating} \quad (5)$$

where V_{bdy} and V_{whl} are vehicle speed and wheel speed, respectively. The slip ratio S_d will be in the range of 0 to 1 while the slip ratio S_a will be from -1 to 0. In general, the slip ratio of the antibraking system (ABS) is designed to be 0.15 to 0.20. The adhesion length of a studless tire becomes 20% to 40% of the whole contact length for such a slip ratio. Once the length is determined, the longitudinal force applied to the whole contact area can be defined as the sum of the adhesion force in the adhesion region and the friction force in the sliding region:

$$F_x = sC_x w \frac{l_h^2}{2} + \frac{n+1}{n} \frac{2^n F_z \mu_d}{l^{n+1}} \left[\left(\frac{l}{2}\right)^n (l-l_h) - \frac{1}{n+1} \left\{ \left(\frac{l}{2}\right)^{n+1} - \left(l_h - \frac{l}{2}\right)^{n+1} \right\} \right] \quad (6)$$

Dynamic Friction Coefficient

Although the friction coefficient on winter road surfaces is not as dependent on speed as the one on wet surfaces, the speed dependency should be taken into account in the estimation model in order to evaluate the friction coefficient as precisely as possible. Suppose that the tread base is sliding at the speed of V' in the sliding region and the dynamic friction coefficient μ_d linearly decreases with speed:

$$\mu_d = \mu_0 - aV' \quad (7)$$

where μ_0 and a are regression coefficients. As shown in Equation 5, the relative speed of tread base to road surface is sV . Noting that the sliding occurs only in the sliding region, the average sliding speed in the region can be given as

$$V' = sV \frac{l}{l-l_h} \quad (8)$$

Accordingly the friction coefficient in the sliding region reduces to

$$\mu_d = \mu_0 - asV \frac{l}{l-l_h} \quad (9)$$

Driving Model

Once the forces applied to the vehicle are specified, vehicular motions can be described using a driving model. A two-wheel equivalence model was employed in this analysis (Figure 2). That is, by assuming that the vehicle is in two-dimensional motion and assembling the friction forces to the gravity center of the vehicle, we can set out the equation of motion for each direction:

$$\begin{Bmatrix} \frac{dx}{dt} \\ m \frac{dv}{dt} \end{Bmatrix} = \begin{Bmatrix} v \\ -2(F_x^f + F_x^r)g \end{Bmatrix} \quad (10)$$

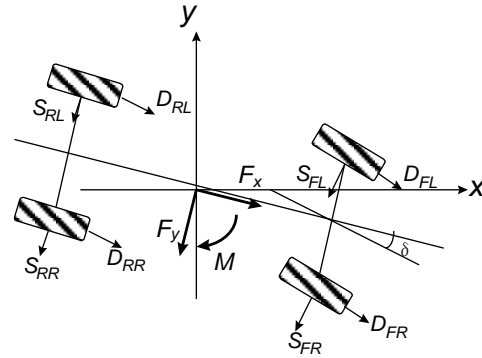

FIGURE 2 Two-wheel equivalence model.

where m is the mass of the vehicle. For simplicity, only the longitudinal force was considered in this study. The Runge-Kutta-Gill algorithm works well to solve the differential equation.

Inverse Estimation of Friction Coefficient

As shown in Equation 6, the longitudinal force F_x is the function of the adhesion length l_h . As shown in Equation 4, the length is also the function of both the friction coefficient μ_s and slip ratio s . Accordingly, the trajectory of the vehicle is closely related to the friction coefficient and the slip ratio. In turn, we can formulate the optimization problem in order to estimate them as

$$\text{Min } J(\mu_s, s_{fr}, s_{rr}) = \sum \left[\left(\frac{v_k - \tilde{v}_k}{\sigma_v} \right)^2 + \left(\frac{x_k - \tilde{x}_k}{\sigma_x} \right)^2 \right] \quad (11)$$

subject to

$$\mu_{\min} \leq \mu_s \leq \mu_{\max}, \quad s_{\min} \leq s_{fr} \leq s_{\max}, \quad s_{\min} \leq s_{rr} \leq s_{\max} \quad (12)$$

where

- s_{fr} and s_{rr} = slip ratio of front wheel and rear wheel, respectively;
- v_k and x_k = speed and position actually measured at time step k ; and
- \tilde{v}_k and \tilde{x}_k = estimates in Equation 11.

The speed and position in the objective function are normalized by the standard deviation σ_v and σ_x , respectively.

In general, since taxis in Japan are not equipped with an antilocking braking system (ABS), the slip ratio is not available in taxi vehicular motion data. In this analysis, considering the application to taxi data in the future, the slip ratios at both wheels were treated as an unknown variable although they were actually measured in the experiments. Instead, they were used to examine the validity of the estimation model. Moreover, the speed and position were averaged every 1 s in order to remove the noises included in the original measurement data.

Genetic Algorithm

The GA model adopted in this study is the GENECOP III program proposed by Michalewicz (9) and characterized by floating-point representations, flexibility in dealing with boundary constraints, the systematic application of mutations and crossovers, and the applicability to non-linear constraint problems. The fundamental concept of the GA model is a random search for the optimal solution. The technique is effective in circumventing local minima, in particular when the objective function has a lot of peaks. The algorithm consists of six genetic operators, three mutations and three crossovers: the uniform mutation allows it to move freely within the search space, the boundary mutation urges the optimal solution to lie either on or near the boundary of the feasible region, and the non-uniform mutation works for the fine tuning of the system. Conversely, the arithmetic crossover stimulates faster convergence to the global minimum and maximum, the simple crossover enhances the stability to the optimal solution, and the heuristic crossover contributes to the fine local tuning and promising direction finding. The parameters of the GA model used in this study were the same as in GENECOP III with the sole exception of the number of populations.

The estimation procedures are summarized as follows:

- Step 0: Set initial values of friction coefficient μ_s as well as slip ratios s_{fr} and s_{rr} . Specify constants: weight and geometry of vehicle, length and width of tire contact area, and spring constant of tire.
- Step 1: Set $k = 0$.
- Step 2: Update $k = k + 1$.
- Step 3: Calculate the adhesion length l_n with Equation 4 and longitudinal force F_x with Equation 6.
- Step 4: Solve Equation 10 and derive the speed \tilde{v}_k and position \tilde{x}_k .
- Step 5: Repeat Steps 2 to 4 until the vehicle stops or reaches a certain speed specified in advance.
- Step 6: Adjust the friction coefficient by following the GA operations; $\mu_s = \mu_s + \Delta\mu_s$.
- Step 7: Go to Step 1 if the objective function Equation 11 is still large. Otherwise, stop.

DATA COLLECTION

Vehicular Motion Sensors

We used the safety record (SR) sensors developed by Data Tech Co. Ltd. to measure acceleration in the longitudinal and lateral directions, the yaw rate (angular velocity) around the vertical axis, and the pulse rate of the driven wheel. The sensors were synchronized with a GPS device. The resolution of the accelerometer and the angular velocimeter were both 10 bits. The maximum frequency of the pulse meter was 1.5 kHz. The GPS was based on a point positioning system. The vehicular motion data were stored in either a peripheral component interconnect card or a memory stick every 0.1 s.

Probe Vehicles

Before fitting the SR sensors into taxis, we enhanced the measurement sensors in order to measure more extensive vehicular motions by adding acceleration in the vertical direction, pitching rate around the lateral axis, and pulse rate of both front and rear wheels. We equipped two probe vehicles with the enhanced device; one a Nissan Safari (Probe 1) owned by Hokkaido University and the other an Isuzu Big Horn (Probe 2) owned by Kitami Institute of Technology (KIT). Both vehicles were sport utility vehicles and had been specially fitted for this kind of driving test. The KIT probe vehicle was equipped with ABS while the Hokkaido probe vehicle was not.

Experimental Data

In order to collect the vehicular motion data on homogenous road conditions in winter, we conducted a series of driving tests on an isolated test track operated by the Civil Engineering Research Institute in December 2001. Before the experiments, we prepared two types of road surface: one lane was kept in an icy state and the other lane in a snow-compacted state. The friction coefficient was measured using a bus-type skid tester approximately every 2 h. The friction coefficient on the icy road surface ranged from 0.1 to 0.2, while that of the snow-compacted road surface was somewhat larger ranged from 0.3 to 0.5. Figure 3 exhibits the variation of the friction coefficient measured on both road surfaces.

The experiment was conducted by emulating driving patterns at intersections. The drivers were required to decelerate and accelerate in compliance with traffic signals. The speed before decelerating and after accelerating were set in advance but the timing of the signal turning to red was not told to the drivers in advance. The vehicles were driven singly without following other drivers. As shown in Figure 4, a few time periods with constant acceleration and deceleration were extracted from each data set, and the vehicular motion data were smoothed every 1 s. Table 1 lists the number of time periods extracted for each driving operation and each probe vehicle.

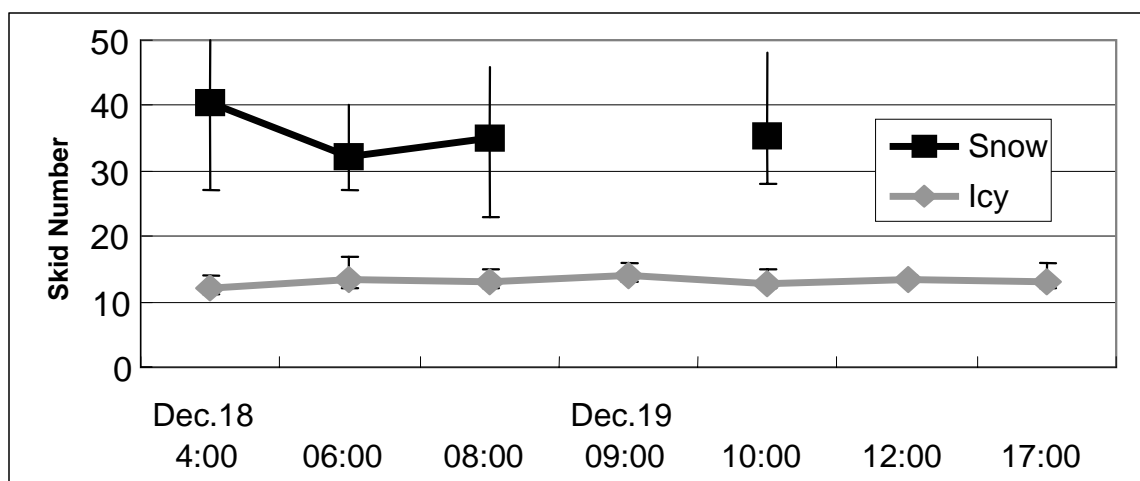

FIGURE 3 Variation of the friction coefficient measured on the test track.

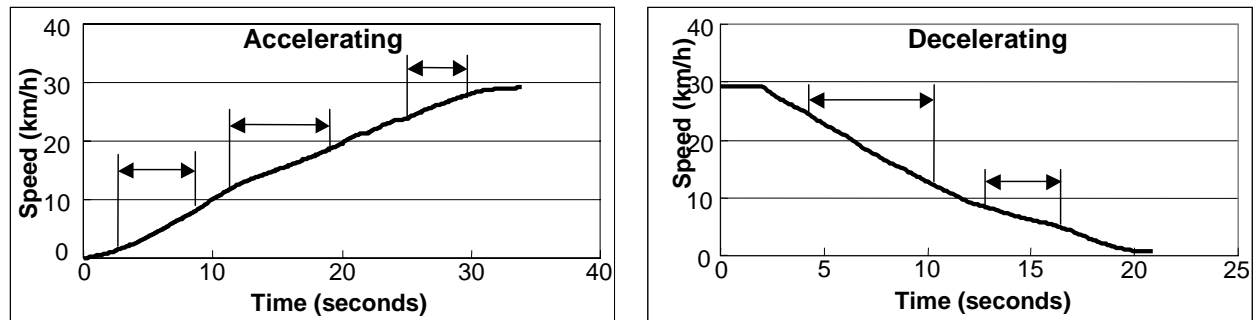

FIGURE 4 Accelerating and decelerating at intersection.

TABLE 1 Number of Datasets for Each Driving Operation, Each Road Condition, and Each Probe Vehicle

	Probe 1 (Safari)		Probe 2 (Big Horn)	
	Icy	Snow-Compacted	Icy	Snow-Compacted
Accelerating	12	11	11	11
Decelerating	8	6	10	7

NUMERICAL EXPERIMENTS

Rigid Body Model

Applying the rigid body models defined by Equations 1–3 to the test data sets in Table 1, we estimated the friction coefficient on both icy and snow-compacted road surfaces, as shown in Figure 5. The left sides are for Probe 1 and the right sides are for Probe 2. It can be seen that

- The friction coefficients estimated are much smaller than those actually measured regardless road condition, driving pattern, and probe vehicle.
- The friction coefficients in deceleration operation are somewhat closer to the actually measured ones, compared with those in accelerating operation. Even so, the difference is still large except some values for Probe 1.
- Little difference can be found in the friction coefficients estimated by Equations 1–3 except some values for Probe 1 in decelerating operation, in which the friction coefficients estimated by Equation 1 are somewhat larger than the ones estimated by the others.
- The friction coefficients for Probe 2 are distributed in a narrow range, compared with those for Probe 1. The ABS equipment in Probe 2 contributed to the stable distribution.

The rigid body model underestimates the friction coefficient not only on the icy road surface conditions but also on the snow-compacted conditions. This suggests that the vehicular motions in a real field are far from those of rigid body. Moreover, we can see some large difference in the friction coefficients for decelerating operation between Probe 1 and Probe 2. The vehicular motions of Probe 1, which was not equipped with ABS, were close to those of rigid body because both wheels were almost locked while braking. Conversely, the wheels of Probe 2, which was equipped with ABS, were not locked at all.

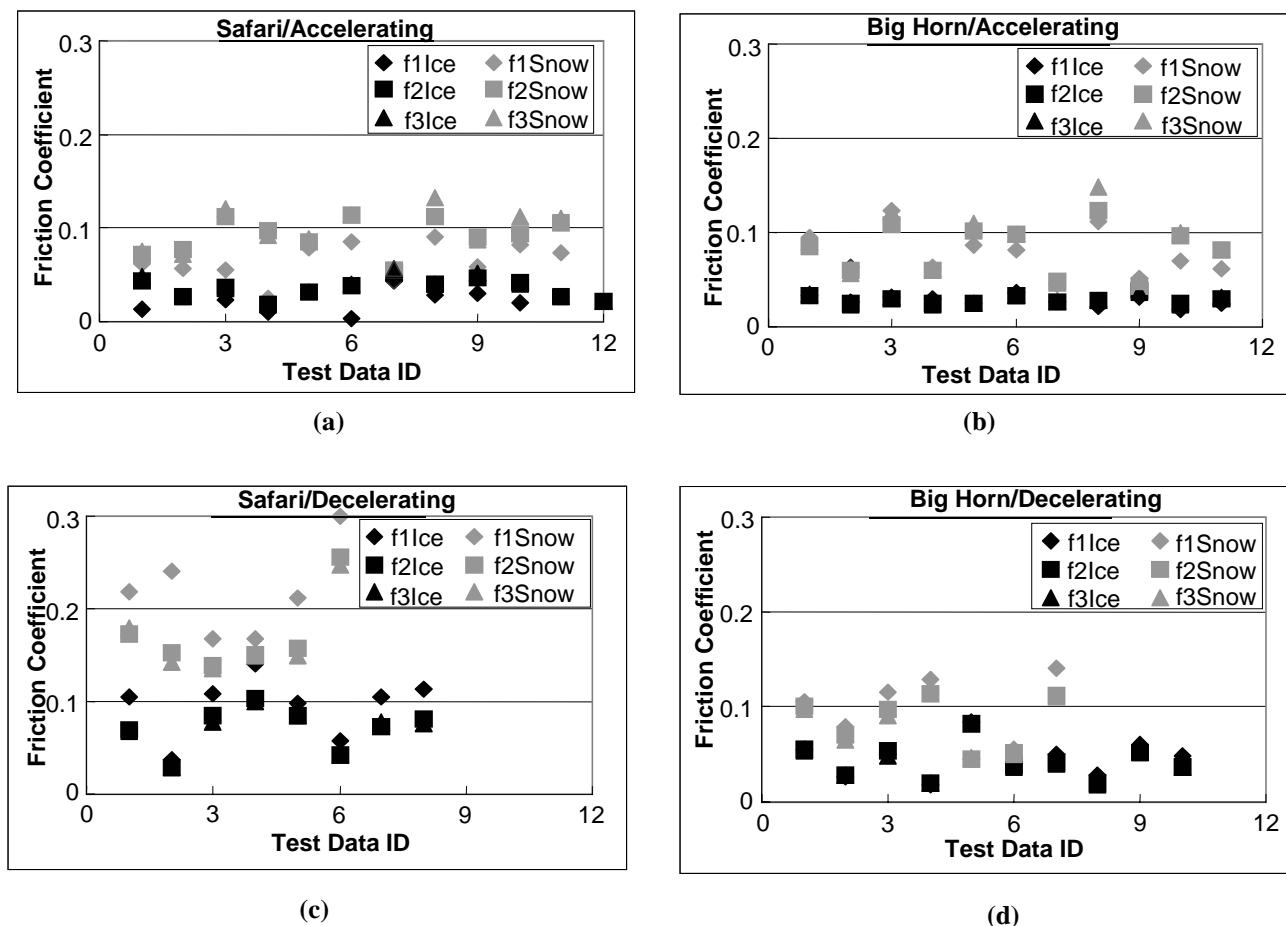

FIGURE 5 Friction coefficients estimated by the rigid body model: (a) Probe 1 while accelerating, (b) Probe 2 while accelerating, (c) Probe 1 while decelerating, and (d) Probe 2 while decelerating.

Tire and Road Surface Interaction Model

Friction Coefficient

As in the previous section, using the tire and road surface interaction model we estimated the friction coefficients for the same data sets in Table 1. They were compared with those estimated by one of the rigid body models Equation 1, as shown in Figure 6. We can see that

- The friction coefficients estimated by the interaction model are much larger than those estimated by the rigid body model. This tendency does not depend on the probe vehicle, road surface condition, or the driving operation.
- Some friction coefficients for Probe 1 are fairly close to the ones actually measured. Particularly, the values in the decelerating operation are distributed in almost the same range as the ones in the real field.
- Similar to the rigid body models, the friction coefficients for Probe 2 are less diverse than those for Probe 1 because of to the equipment of ABS.

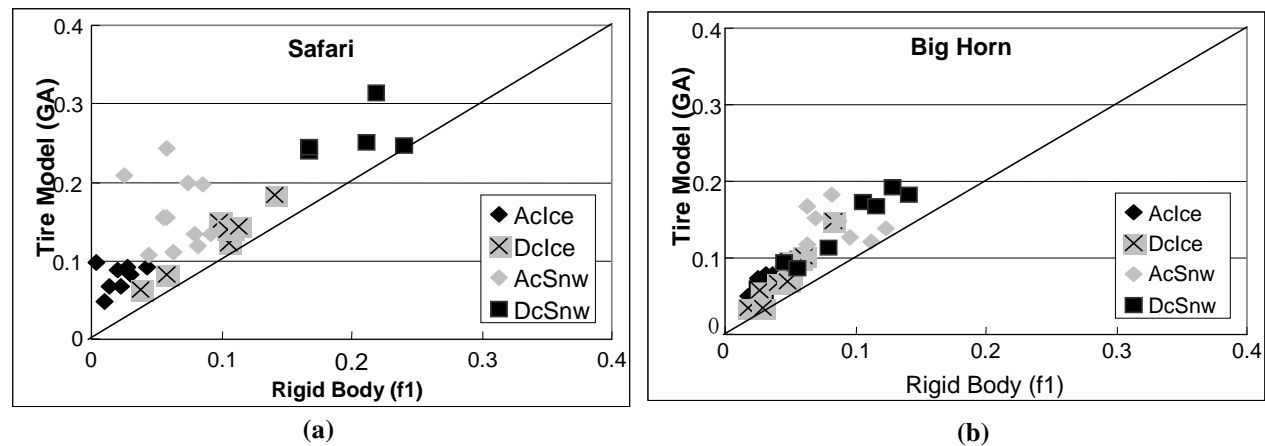

FIGURE 6 Friction coefficients estimated by the tire and road surface interaction model, compared with those estimated by the rigid body model: (a) Probe 1 and (b) Probe 2.

- Even so, the friction coefficients estimated by the interaction model are still in underestimation. Particularly, the values for Probe 2 are smaller regardless of road surface condition and driving pattern.

Slip Ratio

In the above analyses, we treated the slip ratios of front and rear wheels as unknown variables although we measured them in the experiments. In order to examine the accuracy of the estimation model proposed here, we compared the slip ratios estimated by the interaction model with those actually measured. Figure 7 exhibits the slip ratios of the rear wheel, which is the driving wheel for both probe vehicles. It can be seen that the slip ratios estimated by the interaction model are more widely distributed than those actually measured, particularly when in accelerating operation. Due to the ABS equipment, the ratios in decelerating operation for Probe 2 are comparatively distributed in a narrow range. Even so, the discrepancies in Figure 7 are too large to neglect. Further improvements are requisite in describing the interaction between tire and road surface more accurately.

Sensitivity

As explained in the previous section, the tire model includes some parameters that are almost impossible to measure in the field, including the spring constant and the geometry of contact area. If the friction coefficient estimated by the interaction model were sensitive to the change in these parameters, we could not put the estimation method into practice. Table 2 summarizes the sensitivity of the spring constant C_x , the contact length l , the contact width w , the order n of parabolic curve for contact pressure distribution, the vertical load F_z , and the regression coefficients μ_0 and a in the dynamic equation. For some parameters, we specified the ratio to the standard value (Std), which was actually used in the estimation analysis. Roughly speaking, the parameters on the left side in Table 1 are difficult to control because they are influenced by environmental factors, such as temperature and tire air pressure. It should be noted that the

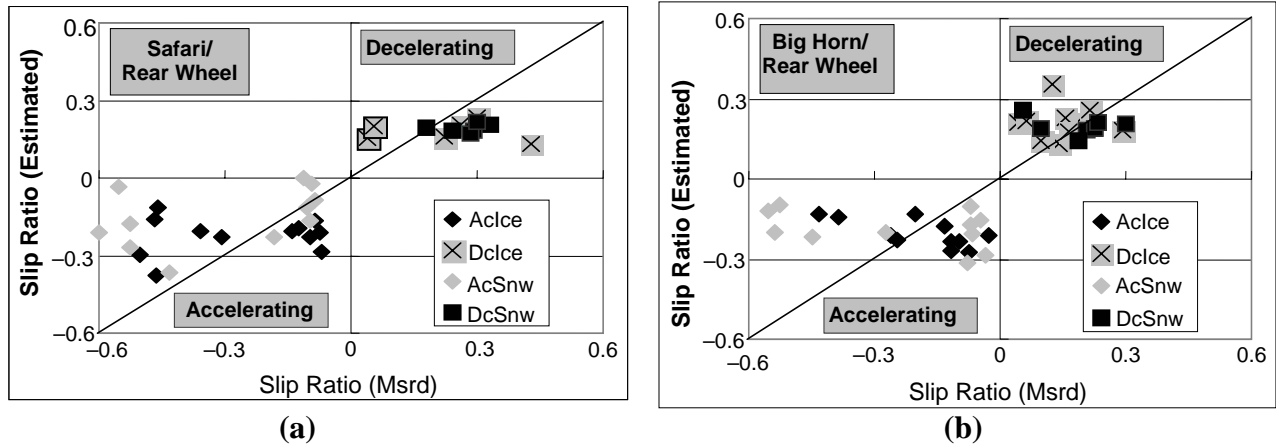

FIGURE 7 Slip ratios of rear wheel estimated by the tire and road surface interaction model, compared with those actually measured: (a) Probe 1 and (b) Probe 2.

TABLE 2 Sensitivity to the Tire Model Parameters (Probe 1 in decelerating operation, Test data 1)

Parameters	Ratio to Std	Ice	Snow		Ratio to Std	Ice	Snow
1) Spring Std: $C_x = 3000000$ (kgf/m ³)	0.5	0.132	0.326	5) Vertical Load Std: $F^z =$	0.8	0.160	0.406
	0.8	0.132	0.326		0.9	0.144	0.360
	1	0.132	0.326		1.0	0.132	0.326
	1.2	0.132	0.326		1.1	0.122	0.298
	1.5	0.132	0.326		1.2	0.113	0.275
Parameters	Ratio to Std	Ice	Snow		$\mu o / \mu St c$	Ice	Snow
2) Contact Length Std: $l = :270$ (mm)	0.8	0.132	0.326	6) $\mu o / \mu St c$	0.4	0.198	0.489
	0.9	0.132	0.326		0.5	0.158	0.391
	1	0.132	0.326		0.6	0.132	0.326
	1.1	0.132	0.326		0.7	0.113	0.279
	1.2	0.132	0.326		0.8	0.099	0.245
Parameters	Ratio to Std	Ice	Snow		a	Ice	Snow
3) Contact Width Std: $w = :216$ (mm)	0.8	0.132	0.326	7) Grad. in $\mu d a$	0.000	0.112	0.308
	0.9	0.132	0.326		0.001	0.122	0.317
	1	0.132	0.326		0.002	0.132	0.326
	1.1	0.132	0.326		0.003	0.142	0.335
	1.2	0.132	0.326		0.004	0.152	0.344
Parameters	n	Ice	Snow				
4) Order of Parabolic Curve $n:4$	2	0.132	0.326				
	4	0.132	0.326				
	6	0.132	0.326				
	8	0.132	0.326				
	10	0.132	0.326				

parameters on the left side do influence the estimation results at all. However, we must be careful in specifying the parameters on the right side in Table 1. The friction coefficient is fairly sensitive to a small change in these parameters. Regarding the vertical load F_z , it is not so difficult to determine it in advance from the vehicle handbook by adding the weight of occupants. The most difficult thing is the specification of the regression coefficients μ_0 and a . Although they are not as sensitive to environmental factors as the parameters on the left side in Table 2, they are not always available in the tire handbook, because tire companies sometime keep them secret. It is necessary to accumulate the experimental data for these parameters.

CONCLUSION

In order to estimate the friction coefficient on winter road surfaces, an inverse method based on vehicular motion data was developed; a tire model was integrated into a genetic algorithm. Before going to taxi data, we conducted a number of field experiments using probe vehicles equipped with vehicular motion sensors and a GPS device. The friction coefficients estimated by the new method were compared with those estimated by the physical formulas. Major findings were

1. The physical formulas underestimated friction coefficient regardless of road condition and driving pattern;
2. The new method improved the estimation precision to a great extent, but the friction coefficients estimated were still somewhat smaller than those actually measured;
3. The friction coefficients in decelerating operation fit better to actually measured value than those in accelerating operation; and
4. The friction coefficients estimated by the proposed method were not sensitive to the model parameters related to tire elasticity and contact area, but they were fairly sensitive to the parameters representing dynamic feature of friction coefficient.

The final goal of this project is to estimate friction coefficients in a whole city area simultaneously with taxi vehicular motion data. What has been achieved in this paper is still far from the goal. Much work has to be done to apply the method in practice, including the improvement of estimation precision of slip ratio and the extension of the equation of motion to a two-dimensional problem.

REFERENCES

1. Nixon, W. A. Friction as a Tool for Winter Maintenance. *Proc., Crossroads 2000*, Iowa State University, 1998, pp.86–89.
2. Perchanok, M. S. Friction Based Quality Assurance Measures for Snow Clearing Operations. 10th PIARC International Congress, 1998, pp.199–208.
3. Al-Qadi, I. et al. Feasibility of Using Friction Indicators to Improve Winter Maintenance Operations and Mobility. *NCHRP Web Document 53 (Project 6-14): Contractor's Final Report*. TRB, National Research Council, Washington, D.C., 2002.

4. Wambold, J. C., J. J. Henry, and Z. Rad. Friction Measurement Techniques for Snow and Ice Road Operations. *Proc., 11th PIARC International Winter Road Congress*, Japan, 2002.
5. Nordstrom, O. Development and Validation of BV14, a New Twin Track Fixed Slip Friction Tester for Winter Road Maintenance. *Proc., 10th PIARC International Winter Road Congress*, Sweden, 1998, pp. 741–754.
6. Ingulstad, A. New Friction Measuring Device for Safer Driving during Winter. *Nordic Road & Transport Research*, No.2, 2000, www.vti.se/nordic/.
7. Moore, D. F. *The Friction of Pneumatic Tyres*. Elsevier, 1975.
8. Sakai, H. *Tire Engineering* (in Japanese). Grand Prix Press, 1987.
9. Michalewicz, Z. *Genetic Algorithms + Data Structures = Evolution Programs*. Springer, 1992.

WINTER PAVEMENT TEMPERATURES AND ROAD CONDITIONS

Using Taxi GPS to Gather High-Quality Traffic Data for Winter Road Management Evaluation in Sapporo, Japan**NAOTO TAKAHASHI****SYUJI MIYAMOTO****MOTOKI ASANO***Civil Engineering Research Institute of Hokkaido*

How can we increase the quality of traffic data to provide effective and efficient winter road management in the city of Sapporo, Japan? In Sapporo, not only residents' daily activities but also business and industrial activities depend heavily on automobile mobility. The lack of winter road management is, however, the critical problem: it worsens traffic movement through the city. The problem is not simply that travel speed is remarkably reduced as a result of icy roads and street width narrowed by snow piles. The problem is that slowed traffic leads to ever-worsening traffic congestion; consequently, it results in economic losses and air pollution.

A primary goal is to identify the effective and efficient traffic data-gathering technique in order to develop winter road management measurement that might be implemented in the context of Sapporo. Throughout the course of this study, it has been demonstrated how cutting-edge technology has the potential to help solve the problems with existing traffic analysis methods and increase the quality of data to determine the unique traffic feature in winter.

The cutting-edge technology at issue is floating-car data, collected through Global Positioning Systems on taxis running through the city. Because of the advantage of covering the greater Sapporo area and running throughout the day, this would enable up-to-date traffic data to be supplied over a wide area. Besides, partnership with taxi companies provides cost-effective data collection solutions.

INTRODUCTION

The city of Sapporo is the prefectural capital of Hokkaido, the northernmost island of Japan, and it is Japan's fifth largest city with a population of approximately 1.8 million in 2003. The city is located on latitude 43 north and longitude 141 east, and cities at roughly the same latitude include Vladivostok, Russia; Chang Chun, China; Rome, Italy; Marseille, France; Boston, Massachusetts; and Chicago, Illinois. The city is one of the few metropolitan cities with severe, snow-covered winters in the world; indeed, the city has an annual cumulative snowfall reaching 5 m and the maximum depth of snowfall reaching 1 m (Figure 1). This is the city's most distinguishing feature.

In Sapporo, residents' daily activities depend heavily on automobile mobility. Automobile usage also provides an important means of transportation in business and industrial activities. Road traffic conditions in winter, nevertheless, are worse because of heavy snow cover and snowfall and declining temperatures (Figure 2). Although studded tires had been widely used in Japan, such use was regulated in the early 1990s to eliminate deterioration of the living environment caused by dust from studded tires. As a result of this regulation, air quality has been significantly improved, though, the regulation causes several traffic issues specific to winter (1).

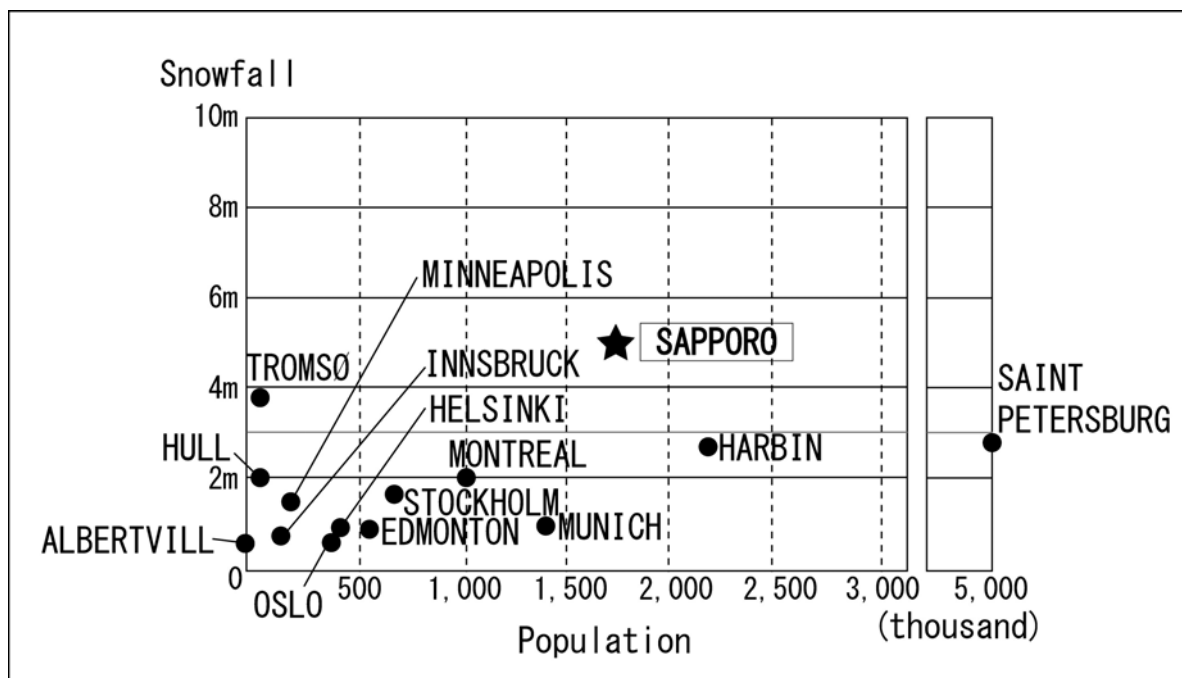

FIGURE 1 Snowfall and population [Source: City of Sapporo “Natural Environment of Sapporo: Weather Condition” (www.city.sapporo.jp/snow/outline/natural/natural.html)].



FIGURE 2 Traffic congestion on narrowed street caused by snow pile.

Especially a problem, as shown in Figure 3, are the increasing number of car accidents typical to winter, such as one slipped on icy path, the worsening traffic movement, and safety caused by extraordinarily slippery-roads (Figure 4). An increasing amount of antifreezing agents and abrasives are also critical problems.

Road administrations have taken some measures, including snow removal operation, to ensure that urban traffic functions in winter. Conversely, the total amount of winter road management cost has significantly increased for the past 15 years, as shown in Figure 5. This is mainly due to the ban on the use of studded tires from the late 1980s and the road users' growing demand for maintenance quality over the years. Indeed, the city government's fiscal year 2002 budget provided for carrying out the snow and ice control measures of more than ¥16.5 billion while delivering almost 70% of the budget for snowplowing and removal from streets and sidewalks.

It is also interesting to note huge economic losses caused by heavy snowfall and snow cover for Sapporo. Asano et al. calculated the direct and indirect economic losses before and after the ban on studded tires (2). The estimated annual economic losses were more than ¥18.5 billion in the greater Sapporo area caused by the increasing of driving time and costs, road accidents, and costs for maintenance and management. Considering that the decrease in traffic functionality was observed in summer even while the use of studded tires was permitted, there might be larger losses than before.

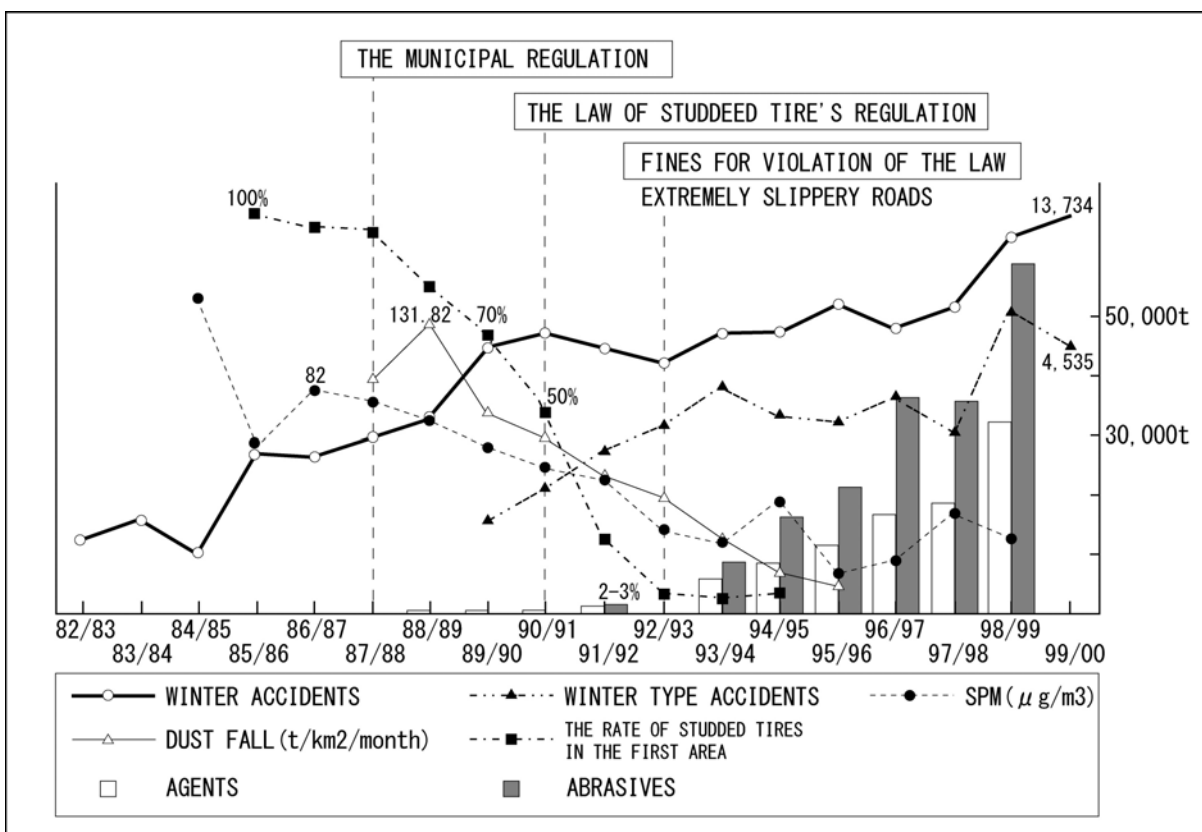

FIGURE 3 The several indices related to the rate of studded tires (I).



FIGURE 4 Extraordinarily slippery road.

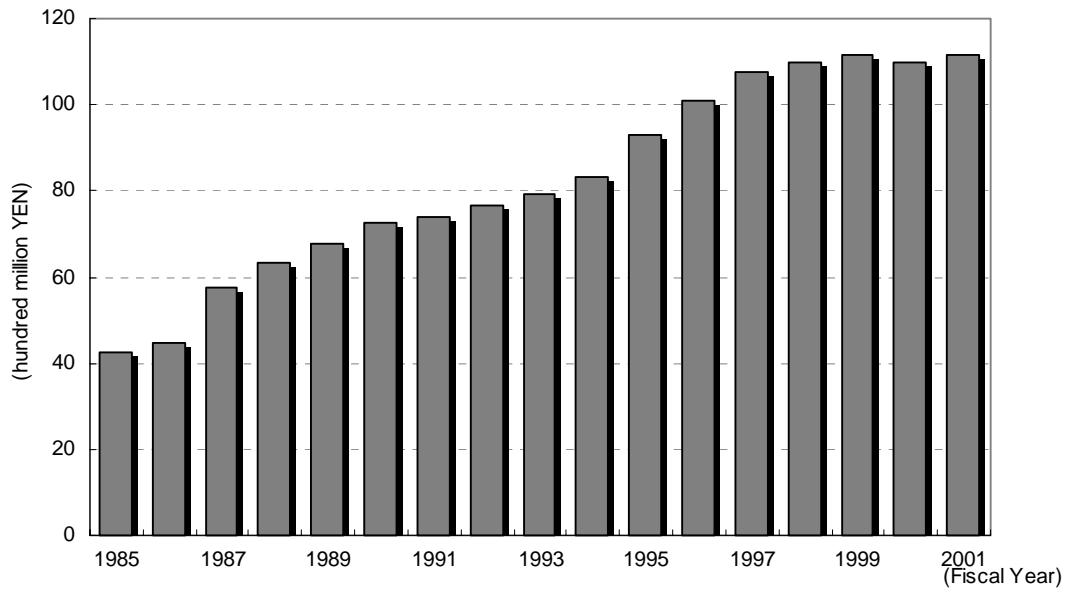

FIGURE 5 Growth of expense of road snow removal (Source: City of Sapporo).

STUDY METHODS

In order to study the traffic issue in winter, it is significantly important to understand the winter traffic feature in a quantitative manner. The traffic feature on weekdays notably differs from that on weekends and holidays. Especially, the traffic feature in winter seems to vary greatly from one specific weather condition to the other, such as snow cover and snowfall and declining temperatures; consequently, it is almost impossible to understand the varied traffic features by using the conventional study methods in which days and number of times for surveys are fixed. We therefore attempt to apply taxi floating-car data [taxi Global Positioning System (GPS) data] to analyze traffic situations on urban roadways as an advanced survey method. Before moving on to the description of the findings, we would like to discuss briefly characteristics of the survey with taxi GPS and the existing approaches. [Table 1](#) shows a comparison of these traffic data gathering techniques.

Winter Road Traffic Census

In Japan the road traffic information survey, known as the road traffic census, has been conducted all over the country once every few years in order to recognize the existing traffic conditions in summer. In Hokkaido the census has been conducted not only in summer but also in winter in order to collect baseline traffic data in winter.

Aerial Photograph Analysis

Conducted by our research institution experimentally, this data-gathering method takes aerial photographs of certain areas with lapping at intervals of few seconds ([Figure 6](#)). The collected information of two-dimensional images helps to analyze traffic conditions in and around Sapporo in a quantitative manner and at a regional level.

Satellite Photograph Analysis

Traffic information obtained through satellite photographs, as shown in [Figure 7](#), fills the same analytical role with aerial photographic analysis but covers a wider area.

Taxi GPS Data

Building a partnership with the taxi company has accumulated detailed information on taxi traveling throughout Sapporo by means of putting GPS on taxis; we attempt to apply data of their time instants and locations as floating-car data. [Figure 8](#) shows the system configuration of taxi GPS data. Locational data are recorded to memory cards after those data are confirmed with maps of car navigation systems operated by GPS installed inside the taxi. The GPS-based data are then compiled and analyzed after reconfirming processes of location and elimination of unusual values.

Partnership with the taxi company provides cost-effective data collection solutions. The partnership company has essentially obtained and accumulated data for supervising and effective running management. Therefore, we can obtain high quality and enormous amount of data at low cost by using secondary data collected through the taxi company for traffic analysis.

TABLE 1 Comparison Between Taxi GPS Data and Existing Approaches

Types	Summary	Survey Items	Methods and Analysis	Advantages	Disadvantages	Cost (¥) ¹
Winter Road Traffic Census	<ul style="list-style-type: none"> Apply nationwide survey done in summer only to winter 	<ul style="list-style-type: none"> Traffic volume (12- and 24-h) Average travel speeds during rush hours (on weekdays) 	<ul style="list-style-type: none"> Travel volume (manually observed from road side) Travel speeds (observed by a probe car) 	<ul style="list-style-type: none"> Commonly used across the county 	<ul style="list-style-type: none"> Conducted once in a few years Few survey points Surveyed at arterials only Not exact data because of only one probe car observing 	5 million
Aerial Photograph Analysis	<ul style="list-style-type: none"> Recognize the traffic features quantitatively with 2-D image 	<ul style="list-style-type: none"> The number of vehicles (travel volume and travel density can be calculated) Travel speeds 	<ul style="list-style-type: none"> Counting the number of vehicles on the photographs manually 	<ul style="list-style-type: none"> Possible to recognize traffic condition in quantitative manner and regional level at the same time period 	<ul style="list-style-type: none"> Can know only the instantaneous traffic condition Can't be conducted in bad weather (especially in winter it is impossible to conduct surveys when it is snowing) 	4 million
Satellite Photograph Analysis	<ul style="list-style-type: none"> Recognize the traffic features quantitatively with 2-D image 	<ul style="list-style-type: none"> The number of vehicles.(Travel volume and travel density can be calculated) Travel speeds 	<ul style="list-style-type: none"> Processing of data of photographs semi-automatically 	<ul style="list-style-type: none"> Possible to know traffic conditions in much wider area than aerial photographs 	<ul style="list-style-type: none"> Conducted only when satellite passing through the areas Survey time and days are fixed Can know only the instantaneous traffic condition Can't be conducted in bad weather (Not when the amount of cloud is more than 20%) 	4 million
Taxi GPS Data	<ul style="list-style-type: none"> Using traveling data of taxis (GPS) secondary 	<ul style="list-style-type: none"> Travel speeds 	<ul style="list-style-type: none"> Recording data on memory cards then processed by analysis systems 	<ul style="list-style-type: none"> Enormous amount of data (60,000 km per day) Possible to obtain data by day and night Possible to obtain data of any road As new equipments and workforce aren't needed, cost will be low 	<ul style="list-style-type: none"> Not sure of the traffic volume Traveling routes and frequency are not even Do not know where traveling on multistoried roads Different traveling characteristic between empty taxis and carrying passengers 	7,000

(US\$1 = ¥110)

¹ It is the estimated cost in the case of a survey conducted in and around the city of Sapporo per day (the costs of data analysis are not included.)



FIGURE 6 Aerial photograph for traffic analysis.

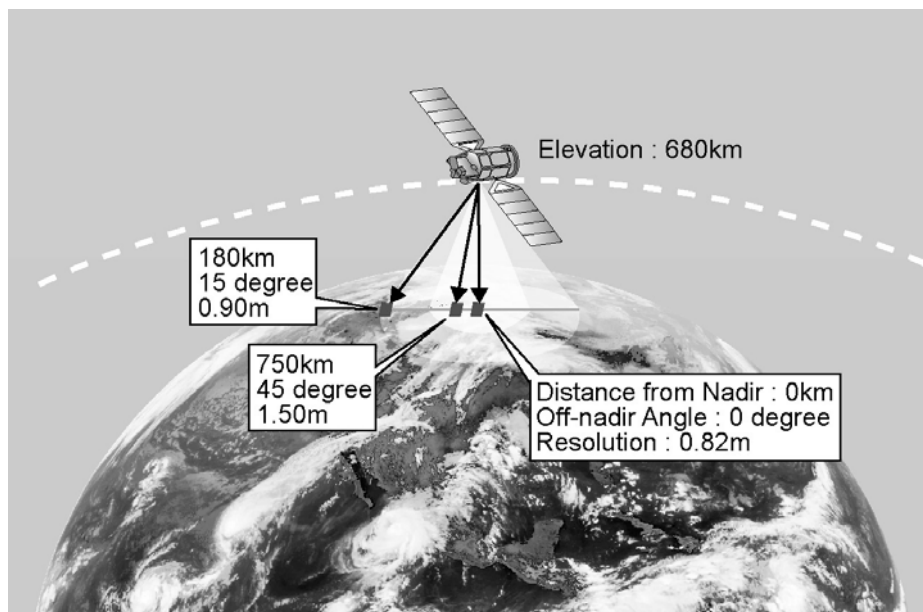

FIGURE 7 Satellite photograph analysis (image).

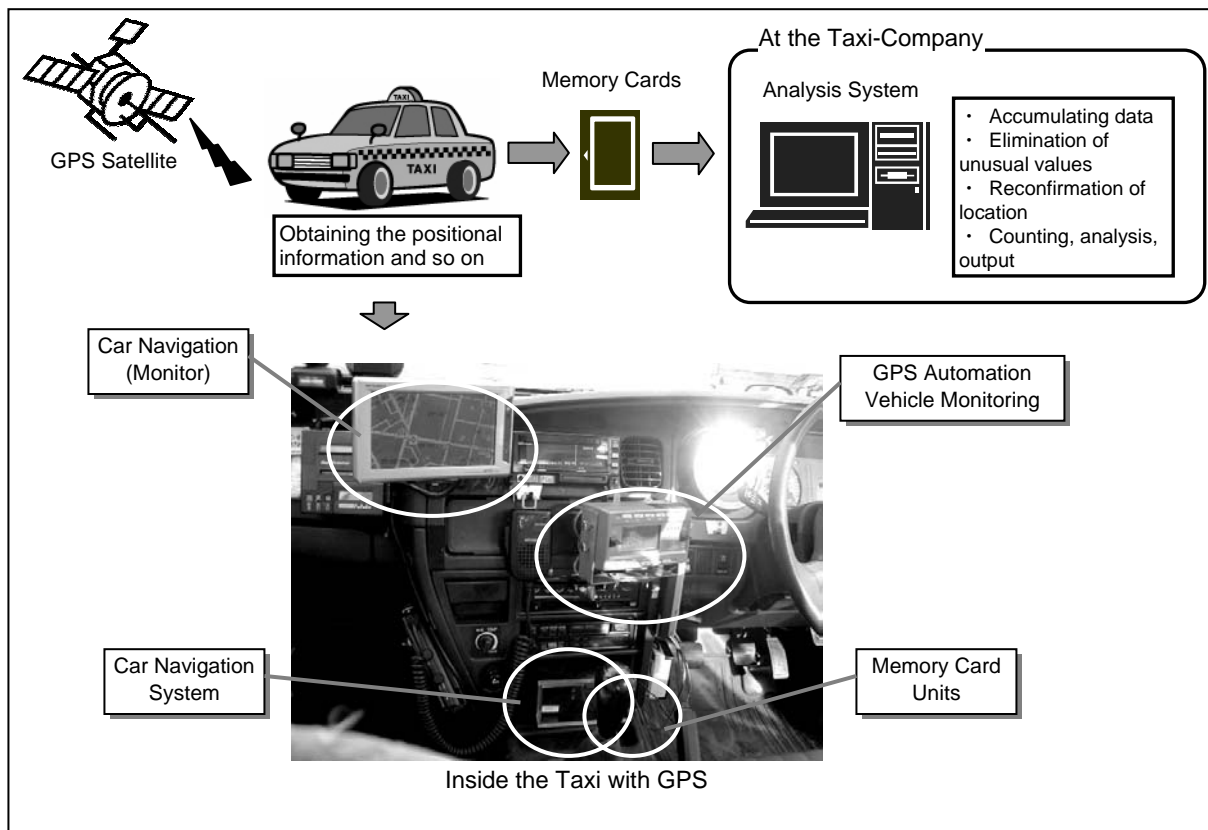

FIGURE 8 System configurations of taxi GPS data.

EMPIRICAL FINDINGS

This section describes winter road traffic conditions in the entire Sapporo area based on travel speed data in all of the road sections where traveling information of taxis was obtained (Table 2). The time range in which we calculated average travel speeds is between 7 a.m. and 7 p.m. the same used for the road traffic census. In Sapporo, snow removal and plowing have been operated in the nighttime when traffic densities are low to avoid influences on road traffic. Therefore, we select the best possible time range in which the study result might not be influenced by external factors such as traffic regulation for snow removal and plowing.

Weather Conditions in Winter 2001

Table 3 shows a variety of winter climatic conditions between October 2001 and April 2002. Even though a 200-cm snowfall was observed in December, which was nearly double the average year (the average of the 30 years between 1971 and 2000), Sapporo had light snowfall after January. The total amount of snowfall in the winter of 2001 was 415 cm: it was about 80 cm less than in the average year (496 cm on the average). The date of the first snow was November

TABLE 2 Summary of Taxi GPS Data

Number of Taxis with GPS	115 cars
Data Items	Date, time (second unit)
	Locations (latitude, longitude)
	Speed, traveling directions (16 directions)

TABLE 3 Winter Climatic Condition from October 2001 to April 2002

	Average Temperature (°C)		Highest Temperature (°C)		Lowest Temperature (°C)		Snowfall (cm)		Maximum Snow Depth (cm)	
Oct.	12.1	11.3	19.8	15.8	2.5	6.9	0	1	0	1
Nov.	5	4.6	16.4	8.1	-5.1	0.9	34	25	21	12
Dec.	-3.4	-1	5.3	2.1	-10.8	-4.4	200	109	81	44
Jan.	-2.5	-4.1	6.9	-0.9	-11.7	-7.7	71	158	76	73
Feb.	-0.6	-3.5	9.8	-0.3	-10	-7.2	73	132	83	98
March	2.5	0.1	12.8	3.5	-8.7	-3.5	37	67	66	81
April	9.6	6.7	20.3	11.1	1	2.7	0	8	0	22

Note: Shaded areas represent an average year.

Source: Meteorological Agency, Sapporo District Meteorological Observatory.

4, 2001, and this was about a week later than average year (on October 27 on the average). The average and the highest temperature of each were higher than in the average year, even if the lowest temperature of each month in the winter of 2001 was lower than the average year. Also, snow cover and snowfall are usually observed in April but not in 2002. Therefore, it could be said that the winter of 2001 was light in snowfall and mild.

Average Travel Speeds on Daily and Monthly Basis

Figure 9 shows the monthly and daily based average travel speeds based on traveling information from taxis with GPS (3). The average travel speed in April was just under the speed of 30 km/h and it slightly rose and fell at the speed of 30 km/h between in May and October. It started dropping in late November, and December had the lowest with the speed of 22.1 km/h. It rose slowly in January through February, and it almost recovered its April level in mid-March. It is interesting to note that the average travel speeds have risen periodically; those rises occur on Sundays and national holidays.

Average Travel Speeds, Snow Cover, and Temperatures

Figure 10 shows the relationship between average travel speed and snow depth (the maximum snow depth) on a daily basis, and Figure 11 shows the relationship between daily average travel speed and temperature on a daily basis.

The average travel speed dropped after November 27 in which the temperatures also dropped and snowfall was observed. November 27 was the first day on which the temperature dropped below 0°C in the winter of 2001 and heavy snowfall was observed.

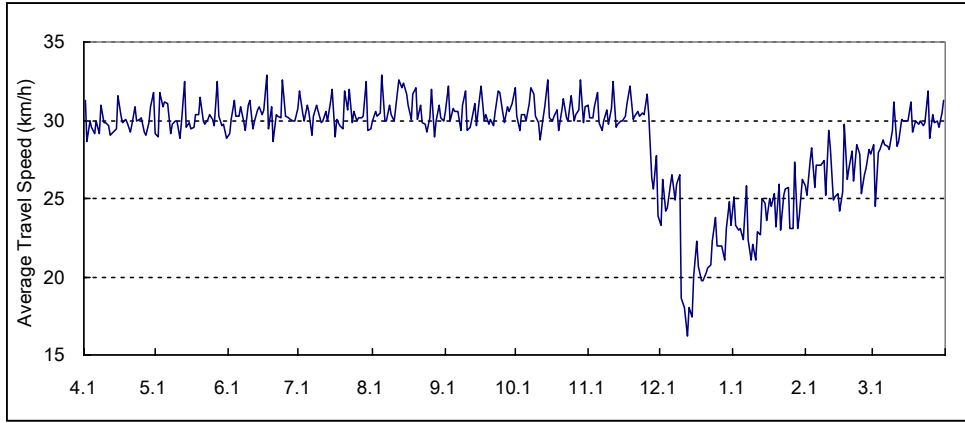

Average Travel Speed on a Monthly Basis (km/h)

April	May	June	July	Aug.	Sept.	Oct.	Nov.	Dec.	Jan.	Feb.	March
29.9	30.1	30.4	30.4	30.7	30.6	30.6	29.9	22.1	24.0	26.8	29.4

FIGURE 9 Average travel speed on a daily basis (2001).

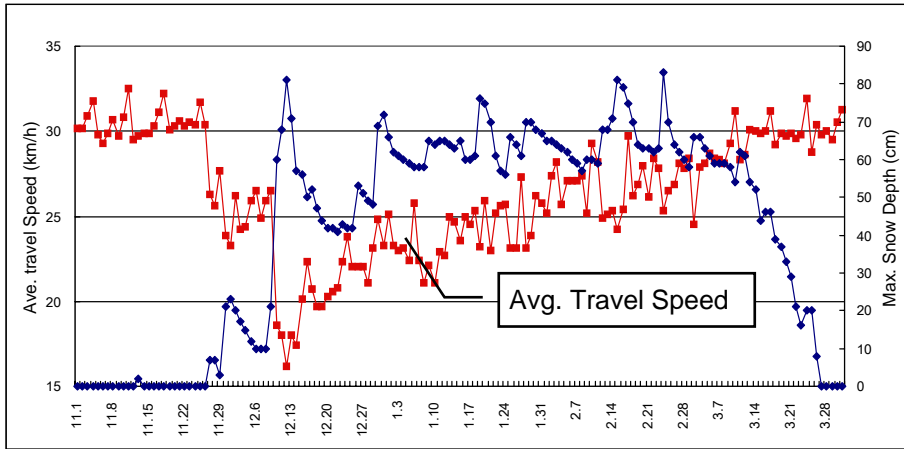

FIGURE 10 Average travel speed and maximum snow depth.

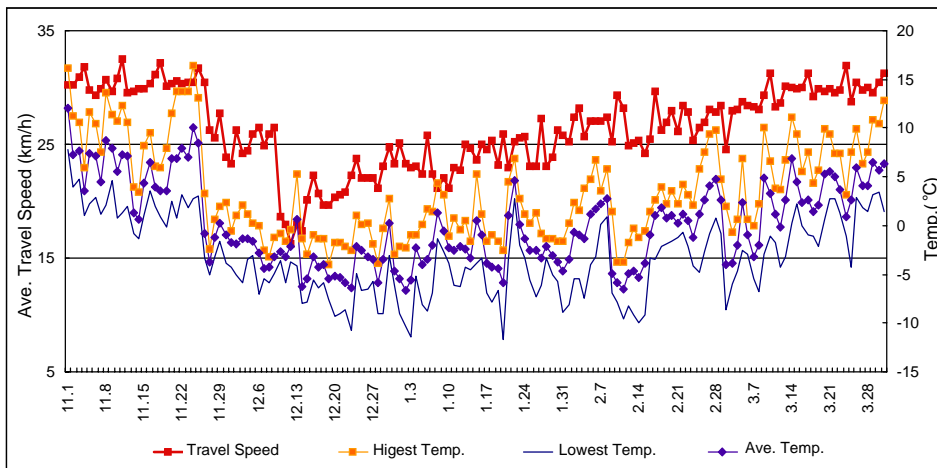

FIGURE 11 Average travel speed and temperature.

(Table 4 shows the meteorological data and the average travel speeds between November 24 and 30.)

Around December 10, the travel speed dropped again. This might be due to heavy snow for four straight days beginning December 9. It snowed 56 cm on December 10 alone, and it was the second-heaviest snowfall on record (4). Because of this heavy snow, the average travel speeds dropped to the level of the speed of 10 km/h between December 10 and 14, and the average travel speed in December 12 was the lowest of the speed of 16.2 km/h, though the average travel speeds slightly rose and fell at the speed of around 25 km/h in early December. (Table 5 shows the meteorological data and the average travel speed between December 8 and 14.)

FACTOR ANALYSIS

The previous section provides that winter weather conditions have a profound effect on declining average travel speeds in winter. In order to explore the effect of each weather factor in declining travel speeds in winter, a multiple linear regression (MLR) analysis has been conducted (5–7).

TABLE 4 Average Travel Speed and Winter Climatic Condition (November 14–30)

	Average Travel Speed (km/h)	Average Temperature (°C)	Highest Temperature (°C)	Lowest Temperature (°C)	Snowfall (cm)	Maximum Snow Depth (cm)
11.14	30.4	10.1	16.4	2.8	0	0
11.25	31.7	8.5	13.1	3	0	0
11.26	30.4	-0.8	3.3	-3.3	0	0
11.27	26.3	-3.7	-2.4	-5.1	5	7
11.28	25.6	-1.2	0.7	-3.2	8	7
11.29	27.7	0.3	2	-1.6	0	3
11.30	23.9	-0.9	2.4	-3.8	18	21

TABLE 5 Average Travel Speed and Winter Climatic Condition (December 8–14)

	Average Travel Speed (km/h)	Average Temperature (°C)	Highest Temperature (°C)	Lowest Temperature (°C)	Snowfall (cm)	Maximum Snow Depth (cm)
12.8	25.9	-4.3	-3.2	-5.8	0	10
12.9	26.5	-3.2	-1.2	-4.9	15	21
12.10	78.6	-2.7	-0.8	-3.6	56	60
12.11	18	-3.2	-1.6	-5.8	22	68
12.12	16.2	-2.2	-0.4	-3.7	23	81
12.13	18	0.6	5.3	-4.1	0	71
12.14	17.4	-6.2	-1.4	-8	12	57

Average Travel Speed in Summer

In order to analyze the declining travel speeds in winter, we first define and investigate average travel speed in summer. We define the time period from April 8 through November 3, 2001, in which temperature is over 0°C and snowfall and snow cover are not observed as “summer” in this study.

Figure 12 shows average travel speeds in summer according to day of the week. Meanwhile, national holidays are included as Sundays, as travel speeds are high. From Mondays to Fridays (weekdays), the average travel speed can be said to be approximately 30 km/h even if there is a slight fluctuation depending on day of the week. Saturdays are slightly high, and those on Sunday are about the speed of 2 km/h higher than those of weekday travel speeds. As a result, in this study we define the weekdays’ average travel speed of 30 km/h as the average travel speed in summer.

Defined Variables

The MLR analysis for declining weekday average travel speeds in winter and winter weather factors has been conducted with the following variables in Table 6.

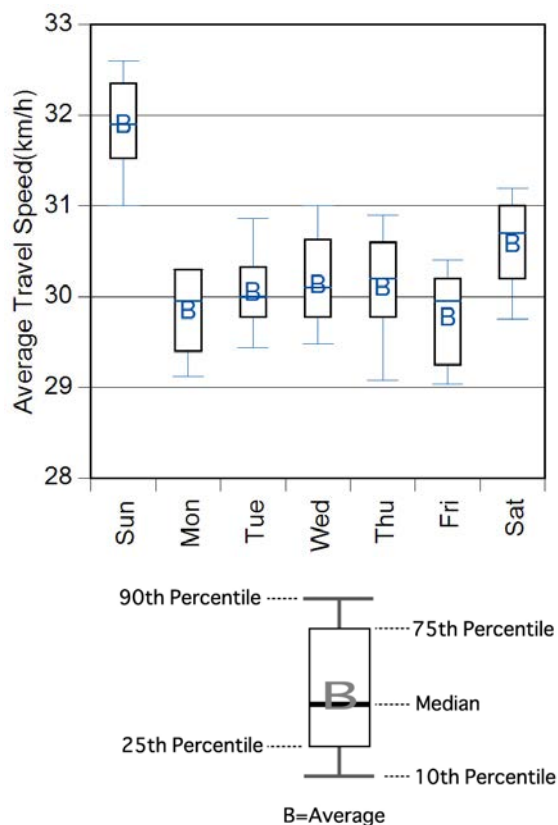

FIGURE 12 Average travel speed in summer (by day of the week).

TABLE 6 Defined Variables

Dependent Variable	Declining Average Travel Speed ATS) Compared with ATS in Summer (30km/h)
Explanatory Variable	Snow Depth, Snowfall Amount, Snowfall Amount on Previous Day, Average Temperature, Sunshine Duration

Multiple Linear Regression Analysis

Table 7 shows the results of the multiple linear regression analysis using the defined variables in Table 6. Multiple correlation coefficient was the high value of 0.831. As the result of conducting variance analysis, we got the level of significance^α = 0.05, and null hypothesis was dismissed: thus multiple regression equation is useful for predictions.

The MLR analysis shows that the dropping average temperature has the most profound effect on declining average travel speed in winter. It is interesting to note that the amount of a day's snowfall and that on the previous day has little effect on declining travel speed even though a popular idea exists nowadays that snowfall amount has marked effects on travel speed.

TABLE 7 MLR Analysis Results

MODEL						
Model		R	R-Square	Adjusted R-Square		
1		0.831	0.69	0.674		

ANOVA					
Model		Sum of Squares	df	Mean Square	F
1	Regression	908.883	5	181.777	43.619
	Residual	408.404	98	4.167	
	Total	1317.286	103		

COEFFICIENT						
Model		Unstandardized Coefficients		Standardized Coefficients	t	Sig.
		B	Std. Error	Beta		
1	Constant	3.416	0.484		7.059	0.000
	Snow Depth	0.025	0.009	0.019	2.74	0.007
	Snowfall Amount	0.084	0.032	0.167	2.598	0.110
	Average Temperature	-0.454	0.064	-0.501	-7.093	0.000
	Sunshine Duration	-0.234	0.075	-0.184	-3.113	0.002
	Snowfall Amount on Previous Day	0.078	0.031	0.161	2.563	0.012

CONCLUSION AND FUTURE STUDY

Throughout the course of this study, we have attempted to demonstrate how cutting-edge technology has the potential to help solve the problems with existing approaches and increase the quality of data to determine the unique traffic feature in winter. The main positive contribution of this study has been to show that using taxi GPS data is a useful survey method to understand and analyze Sapporo's unique traffic feature in winter. For instance, we find that it is possible to recognize variances in traveling speed on a daily basis, which is unrecognizable by the existing approaches, throughout the year by using floating-car data. Besides this, the study finds that snow cover, snowfall, and declining temperature have not much influence to declining travel speed, and unexpected events such as heavy snowfall have a profound effect on traveling speed.

Furthermore, a MLR analysis has been conducted to evaluate the effect of weather factors in declining travel speed in winter. The result of analysis shows that the declining temperature has a strongest effect in declining travel speed in winter while the amount of snowfall and that on previous day has less influence. This might be due to the consequence of little snow in the winter of 2001.

Most importantly, we find that traffic speed declines even after the road administration has conducted various winter road management measures such as removing snow, and plowing, and spreading antifreezing agents over roadways. This result suggests that winter road management activities might not be conducted as effectively as possible. Indeed, measures for winter road surface conditions, which are significantly affected by temperature, might be inadequate in comparison with measures for snow removal and plowing.

Even though we do not evaluate the effect on measures for winter road management in a quantitative manner at this time, in the future we will move on to recognizing the traffic characteristics of Sapporo's winters and considering the proper balance to conduct measures for winter road management and the standard for the measures while doing accumulations and analyses of data including the friction coefficient of road surface. Furthermore, by applying the method to calculate economic losses against winter road traffic, we hope that it might help in evaluating winter road management.

REFERENCES

1. Asano, M., S. Tanabe, F. Hara, and S. Yokoyama. Evaluation of the Ten Years Since Studded Tires were Banned in Hokkaido and Future Issues. Presented at 11th International Winter Road Congress, Sapporo, Japan, 2002.
2. Asano, M., S. Tanabe, F. Hara, and S. Yokoyama. Economic Evaluation of Banning Studded Tires Internalized Environmental Impacts (in Japanese). *Proc., 2001 Cold Region Technology Conference*, Asahikawa, Japan, 2001.
3. Ministry of Land, Infrastructure, and Transport. *New Road Study in IT-Society*. Ministry of Land, Infrastructure, and Transport, Road Bureau, Tokyo, 2000.
4. Miyamoto, S., K. Hayashi, and M. Asano. Study on Traffic Behavior on Heavy Snowfall Days in Sapporo City by Use of Taxi GPS Data (in Japanese). *Proc., 2002 Cold Region Technology Conference*, Aomori, Japan, 2001.

5. Horii, M. *Statistical Analysis on Traffic Flow Feature in Cold Cities* (in Japanese). Infrastructure Planning Research Publication. Infrastructure Planning Committee, Japan Society of Civil Engineers, Tokyo, 1991
6. Ishimura, S. *Analysis Process of Multivariate Data by SPSS* (in Japanese). Tokyo Tosho, 1998.
7. Kawaguchi, M. *Guide to Multivariate Analysis* (in Japanese). Morikita Shuppan, Tokyo, 1973.

Material Distribution, Performance, and Residual

MATERIAL DISTRIBUTION, PERFORMANCE, AND RESIDUAL

Implementation of New Sanding Method in Norway**TORGEIR VAA***SINTEF Roads and Transport*

One of the main achievements in the Winter Friction Project in Norway has been the development of a new sanding method based on a mix of hot water and sand. The most significant factors in this method are the sand quality, the amount of water, the spreading speed, and the water temperature. The sand should be of a specified quality corresponding to a 0 to 4-mm gradation. Hot water means that the water temperature is 90°C to 95°C.

The amount of water in the mixture of sand and water is approximately 30-weight percentage, and the normal dosage of sand used is equivalent to 200 g/m² as an average.

Scientific studies have revealed that measures carried out with the new sanding method last longer than traditional sanding methods. It has been proved that by adding warm water to the sand it is easy to maintain a friction level above the standard even after the passage of 2,000 vehicles. Under favorable road and weather conditions, satisfactory friction values have been maintained for up to 3 to 7 days on roads with annual average daily traffic of 1,500 vehicles.

The introduction of wet gritting means substantial improvement, both in regard to friction and in time of effect. The new method is expected to have a marked impact on winter road operations. In Norway there are now a total of approximately 30 trucks based on the new sanding method, and the method is being used on national roads, in municipalities, and on air fields.

BACKGROUND

Recognizing that there was a need for increased knowledge of all types of friction measure, the Norwegian Public Roads Administration started a research project in 1997 with focus on winter management (1). The goals for the project were to develop optimal methods that could be of practical use and devise recommendations for snowplowing techniques as well as the type and amount of salt and sand to be used during various conditions.

Aside from studying different salting methods, the project has dealt with different ways of applying abrasives. The challenge was to come up with a better method than the traditional sanding method as shown in Figure 1.

Both traditional and new sanding methods have been tested:

- Traditional methods—dry sand and sand with salt—and
- New methods—heated sand and warm wetted sand.

In particular, the method using a mix of hot water and sand produced promising results in the first winter test. Scientific studies conducted as part of the winter friction project in Norway have revealed that measures carried out with the new method lasted considerably longer than traditional sanding methods (2).



FIGURE 1 Traditional sanding method with dry sand.

DEVELOPMENT OF THE METHOD

Description of Warm Wetted Sand Method

The first truck based on the warm wetted sand principle in Norway was called Friction Maker. This equipment, which was tested the first time in the 1998–1999 winter season, was a reconstructed semitrailer spreader with a dropside body (Figure 2). A water tank holding 2.5 m³ and a heater with a water pump was mounted onto the lorry body. The first prototype was provided with a spreader towed behind the dropside body.

Field trials for the 1998–1999 and 1999–2000 winter seasons led to the conclusion that the further development of the method should be based on a spreader with a spinner and a heater system for water and material box and transport of the sand, ensuring a sufficient way of handling the sand. There has been a great change in the spreader concept and heater system during the project period. In the newest concept, the heater system and water tanks are separated (Figure 3). The new spreader type in combination with a spinner can be used for spreading sand and salt with or without adding liquid.

The warm wetted sand method is based on adding hot water to the sand and covering the sand particles with a film of water. When the sand that has been sprinkled with water leaves the spreader and lands on the roadway, the film of water has a short melting effect and then the mixture of sand and water freezes to the surface as lumps. This reaction gives the roadway a kind of sandpaper texture (Figures 4 and 5).

The most significant factors in the warm wetted sand method are the quality of the sand, the amount of water, the spreading speed, and the water temperature. The sand should be of a specified quality corresponding to a 0 to 4-mm gradation. Hot water means that the water temperature is 90°C to 95°C. The amount of water in the mixture of sand and water is



FIGURE 2 Swedish prototype for warm wetted sand.



FIGURE 3 New concept for warm wetted sand spreader.



FIGURE 4 Typical pattern using warm wetted sand: (a) roller distributor and (b) spinner.



FIGURE 5 Road surface textures: (a) roller distributor and (b) spinner.

approximately 30-weight percentage, and the normal dosage of sand used is equivalent to 200 g/m² as an average.

Testing Program During the Winter Seasons 2000–2001 to 2002–2003

In the period 2000–2001 to 2002–2003 focus was given to developing the spreader technique and testing new spreaders as well as to gaining experience with the new method in daily operations. The testing was conducted as scientific studies.

Figure 6 shows the design of a test section from one of the trials with different sanding methods. The section is divided into fields of 1-km length each. The same action is performed in each direction on the same field.

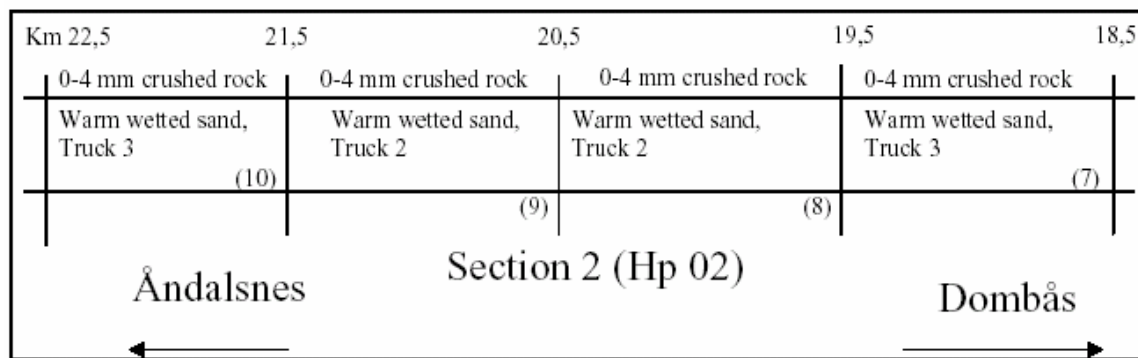

FIGURE 6 Design of a test section for sanding trials.

The effect has been measured in two ways: (1) by how much the friction is improved and (2) by how long the added improvement lasts. Two different friction-measuring devices (OSCAR and ROAR) have been used to determine the friction level. Both devices are continuous measuring types with a variable slip test wheel. The friction measurements are made until the friction level on the field with the most durable effect is back to the original standard or the trial is disrupted by change in weather conditions. The evaluation system also includes the possibility of simultaneous video images every 20 m together with the friction measurements. Road weather information is gathered, and the number of vehicles is counted.

Two comprehensive scientific studies were carried out through the winter season 2000–2001. These field studies comprised 35 road sections strewn in each direction with a length of 1 km. The total study consisted of 70 fields at a length of 70 km, and the main results are summarized in Figure 7.

Figure 7 tests during the 2000–2001 winter season showed that the method used in combination with a spinner type spreader gave almost as good results as the system combined with a roller distributor, even though the spreader pictures are quite different (Figures 4 and 5).

Figure 8 shows the results from one of the trials on E136 with different methods in January 2001. The annual average daily traffic (AADT) on this road is 1,200 vehicles with approximately 30% heavy vehicles per day. The second last friction measurement was made 5 days after sanding. Even if much of the sand had been worn away (Figure 9), there was still enough sand on the surface to raise the friction above the background level.

To evaluate the different sanding methods, a thermo camera was used in most of the scientific tests. The camera was an Inframetrics SC1000 that operated in temperatures from 10°C to +2,000°C. The sensitivity was 0.1°C. For picture analysis, the emissivity for a mixture of sand and water was set to 0.94.

One of the questions raised is how the spreading width influences the effect on the road; Figure 10 show three pictures taken with the spreader adjusted to 3, 4, and 5 m.

It can be seen from Figure 10 that the temperature loss increases rapidly with increasing spreader width. Even with the spreader set to 4 m, the drop in temperature will influence the effects with regard to friction improvement. Therefore, possible differences in spreader performance with regard to the temperature of the material leaving the spinner can result in different friction improvement gains.

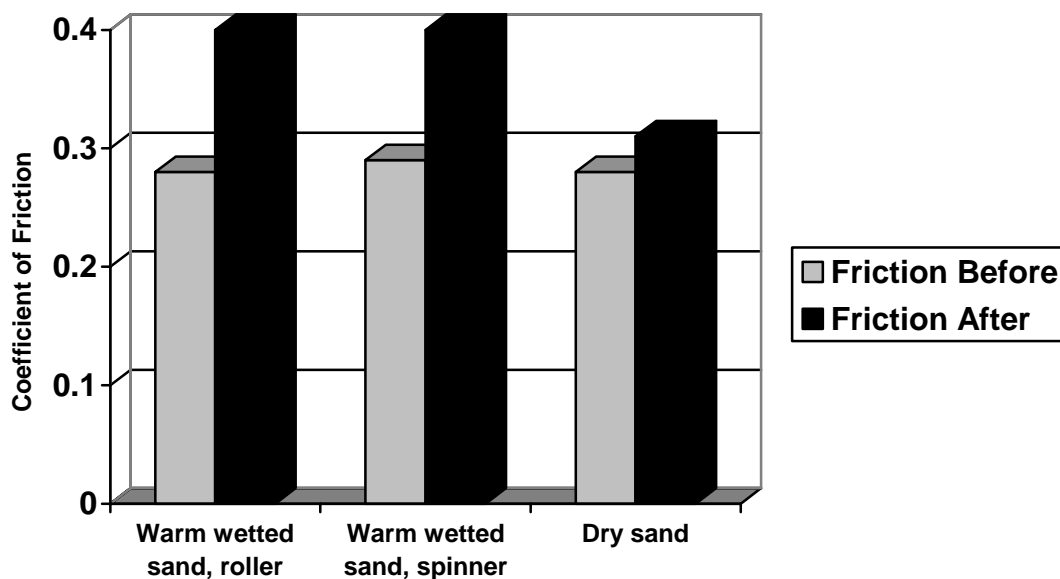

FIGURE 7 Comparing different sanding methods, data from winter season 2000–2001.

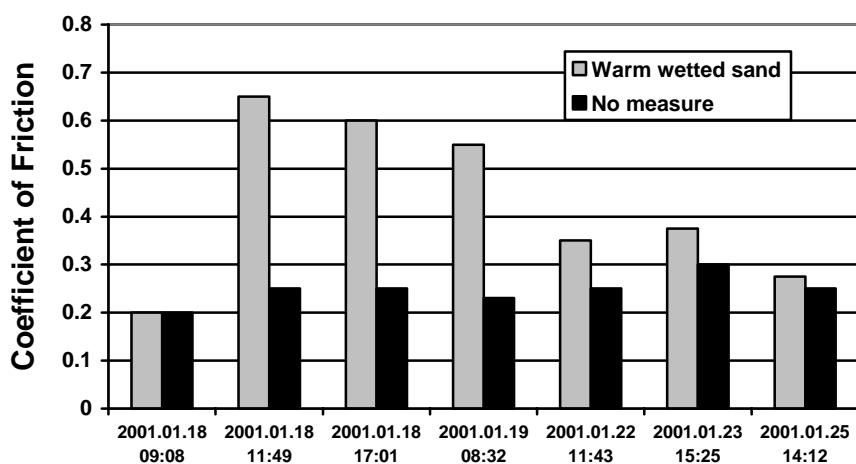

FIGURE 8 Results from field test with warm wetted sand.

Status on the Spreader Development

For the time being four suppliers are offering warm wetted sand spreaders on the Nordic market (Figure 11).

Figure 12 show the results from testing these spreaders against the first Norwegian prototype in January 2002.



**FIGURE 9 Test field strewn with warm wetted sand January 18, 2001.
Picture taken January 22.**

Only small variations were found between the different trucks except for one of them, which probably can be explained by a difference in the spreader concept. However, when it comes to the rise in the friction level, there were no significant differences between the first Norwegian prototype, Friction Maker, and the trucks with a spinner.

IMPLEMENTATION OF THE NEW SANDING METHOD

Summarizing the New Method

Under favorable road and weather conditions, satisfactory friction values have been found to be maintained for up to 1 week on roads with an AADT of 1,000–1,500 vehicles with the new method. Scientific studies have revealed that measures carried out with new sanding methods last longer than traditional sanding methods. Although the effect of using cold and dry sand can disappear after the passage of 50 vehicles, it has been proved that by adding hot water to the sand it is easy to maintain a friction level above the standard even after the passage of 2,000 vehicles.

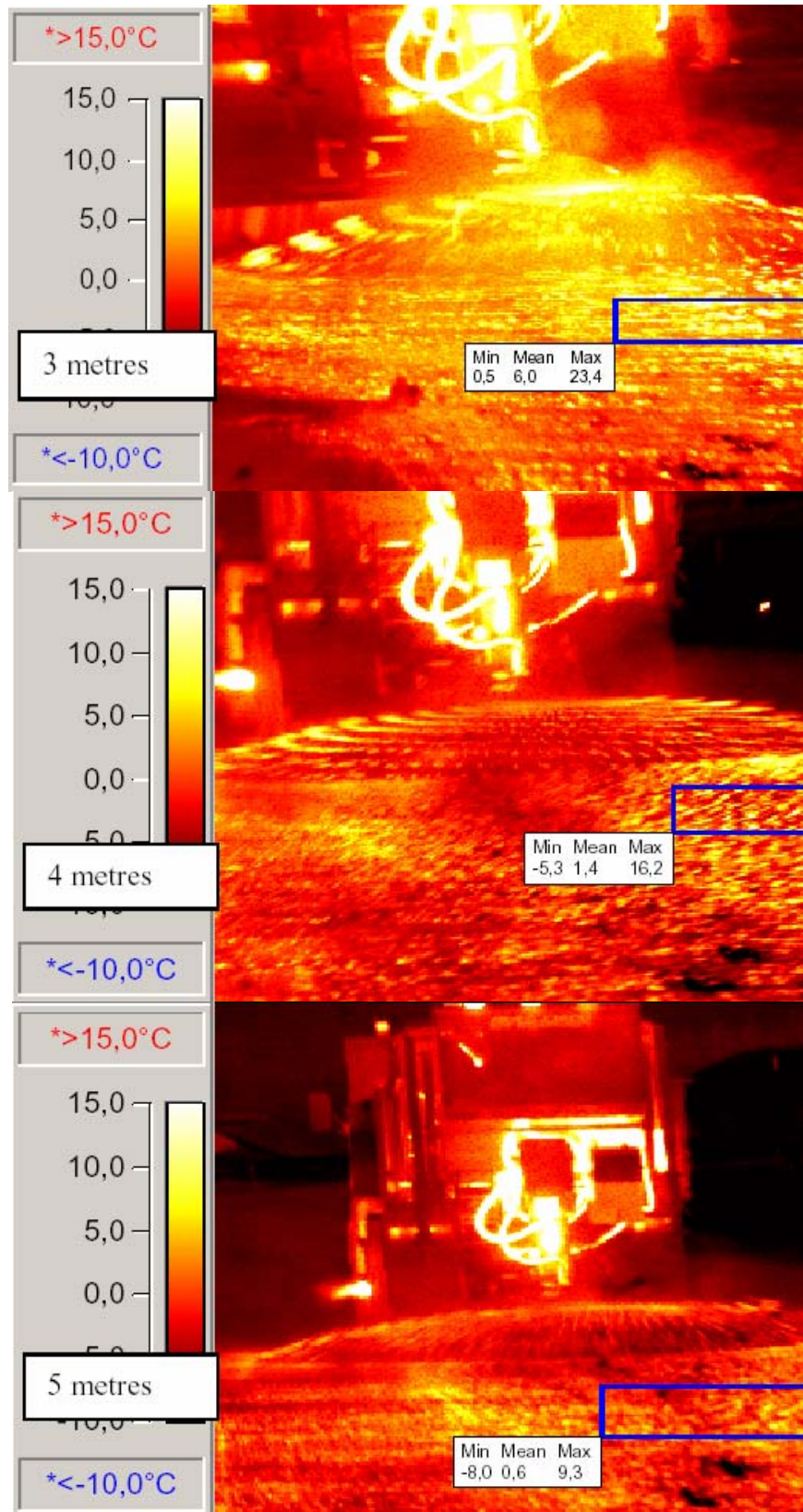

FIGURE 10 Thermo camera pictures taken February 20, 2002.

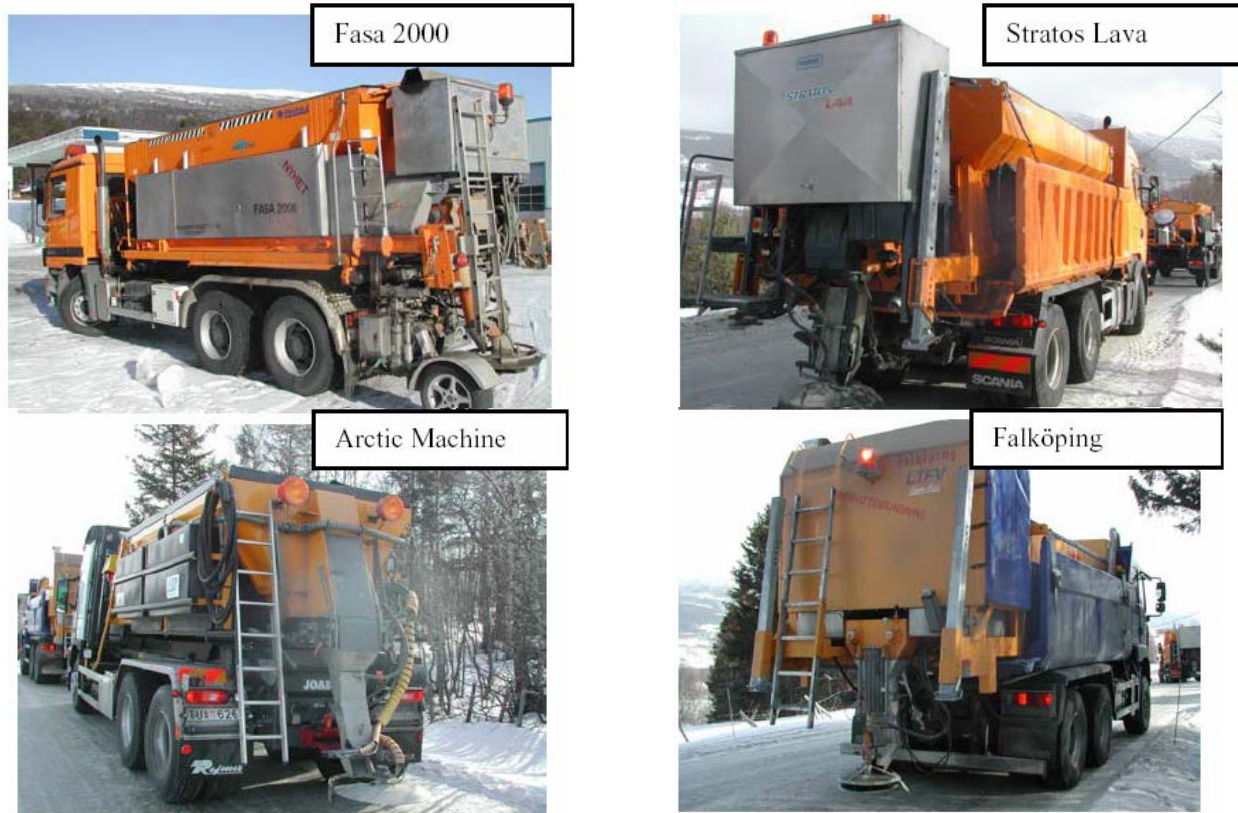

FIGURE 11 Warm wetted sand spreaders on the Nordic market.

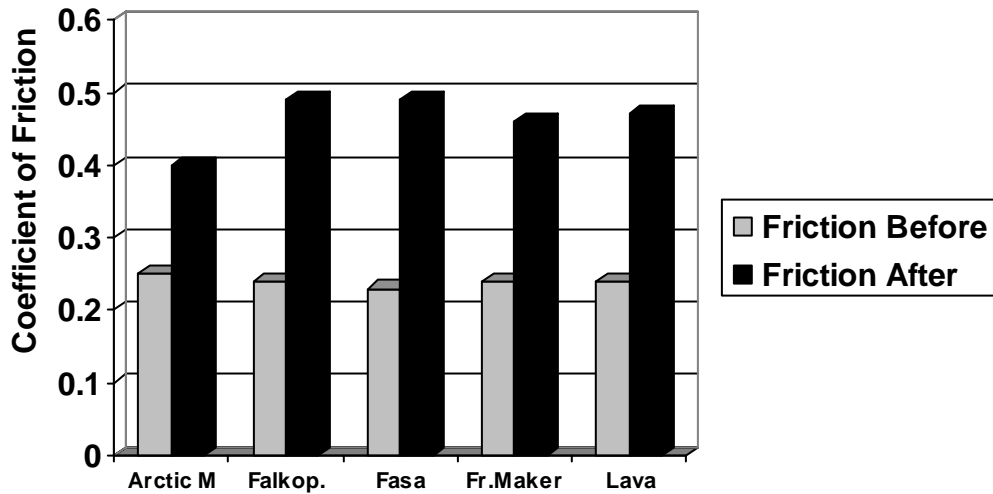

FIGURE 12 Results from spreader testing in January 2002.
 (Note: Error bars show 95% CI of mean.)

Under favorable road and weather conditions, satisfactory friction values have been maintained for up to 3 to 7 days on roads with an AADT of 1,500 vehicles.

From the experiments carried out, it is concluded that the warm wetted sand method, in particular, has a broad range of applications and therefore can be recommended as a supplement to existing sanding methods. It is important to emphasize that the wet-sand method can be used under conditions for which traditional methods have little or no effect. This new method also makes it possible to maintain the friction standard under conditions for which it is normal to spread sand less frequently than necessary in order to maintain the friction standard.

The main aspect is the long-lasting effect and friction improvement. It is important to emphasize that the new sanding method can be used under conditions under which traditional methods have little or no effect:

- Hard blue ice,
- Roads with a high percentage of heavy vehicles, and
- Thin ice or frost on asphalt.

Both controlled tests and reports from the counties confirm the effectiveness by the new method. Under normal and stable conditions without precipitation, the effect of a measure with warm wetted sand will last 10 to 20 times as long as dry sand with the same traffic volume.

Description of Existing Organization and Standard Requirements

In Norway 88% of public roads (47,300 km) are operated using the so-called white winter road strategy. Large quantities of sand are spread to improve friction on ice and snow. The total in an average winter is 400,000 metric tons (8.5 tons of sand per km). The limitations of this method are well known: The friction improvement is modest, and the effect of gritting is reduced rapidly by the traffic. For both practical and economic reasons, it is not always possible to comply with the required friction standards.

The normal practice in Norway is to organize the national road network into operational sections of 30 km to 60 km for snow plowing, sanding, and salting. The road length is adapted to the standards, the higher the standard the shorter length of the section. In total the national and county public network is served by 1,200 sand spreader trucks. Of these 1,200, 120 machines are of the spinner type, the majority are of the trailer type with roller distributors.

On roads with winter road strategy, the standard differs between types of road and traffic volume (Table 1). Normally 20% to 30% of a road will be defined for spot actions (curves, hill climbs, junctions, over-complex private accesses). The main challenge is to meet with the standard requirements on trunk roads and other roads with a traffic volume of 500 vehicles per day (vpd) or higher. For spot actions on roads with an AADT above 1,500 vehicles, the sanding should be done within a 1-h period. For traffic of fewer than 500 vehicles per day the requirement is that the action shall be completed within a 2-h period.

The problem with the traditional sanding method has been that the sand is gone often after only a few vehicles have passed. In many cases, it is difficult to maintain the friction standard by use of traditional sanding methods because it is not practically possible to use the resources necessary to keep the standard. The sanding practice until now has been considered insufficient in three respects:

TABLE 1 Friction Requirements for Strategy Winter Road

Road Category	AADT	Spot Action		Continuous Action	
		Start at	Completed within	Start at	Completed within
Trunk Roads		$\mu < 0.30$	1.0 h	$\mu < 0.20$	2.0 h
Other Roads	Above 1,500	$\mu < 0.25$	1.0 h	$\mu < 0.20$	2.0 h
	501–1,500	$\mu < 0.25$	2.0 h	$\mu < 0.15$	3.0 h
	0–500	$\mu < 0.20$	4.0 h	$\mu < 0.15$	4.0 h

- The effect of traditional sanding is only short lasting,
 - Traditional sanding often fails to meet the time limit because of insufficient capacity,
- and
- The road users are not satisfied with standards/action time and lack of repeated gritting with the traditional sanding method.

Potential of the New Method

The introduction of wet gritting means substantial improvement with regard to rise in friction and to time of effect (Figure 13).

From the available documentation, it is known that on a road with 2,000 vpd approximately 12 to 40 measures of dry sand (as opposed to only 1 measure of warm wetted sand) will be needed in a 24-h period. The amount of actions with dry sand can be from 3 to 4 during a day with difficult driving conditions. It is obvious that it is beyond the available resources to carry through with the level of measures required for traditional methods. Both controlled tests and reports from the counties confirm the effectiveness of the new method. Under normal and stable conditions without precipitation, the effect of a measure of warm wetted sand will last 10 to 20 times as long as dry sand, with the same traffic volume. The method is so well documented now that it can be recommended as an alternative to traditional dry sanding. With fine gradation, the water and sand slurry evenly sticks to bare pavement if the surface temperature is below 0°C.

In addition to a better and more lasting effect, the warm wetted sand method will also have a favorable environmental impact by reducing in the quantity of sand used. Preliminary calculations indicate that it is possible to reduce the sand consumption by 40% to 50%. The new method is expected to have a marked impact on winter road operations, in respect to the following:

- Under certain conditions wet spreading can be carried out as a preventive measure, implying that the work can be planned ahead and, to a large extent, be completed during regular working hours, thus reducing readiness and labor costs;
 - The new sanding method will be the only sanding technique making it possible to meet with the standard requirements on trunk roads;
 - There will be a reduced number of actions and less sand consumption under stable climate periods; and
 - There will be improved friction and winter driving conditions.

These new characteristics call for a redesign of the gritting organization. Spreading that can be done in advance as a preventive measure will be done with new wet sand spreaders. In

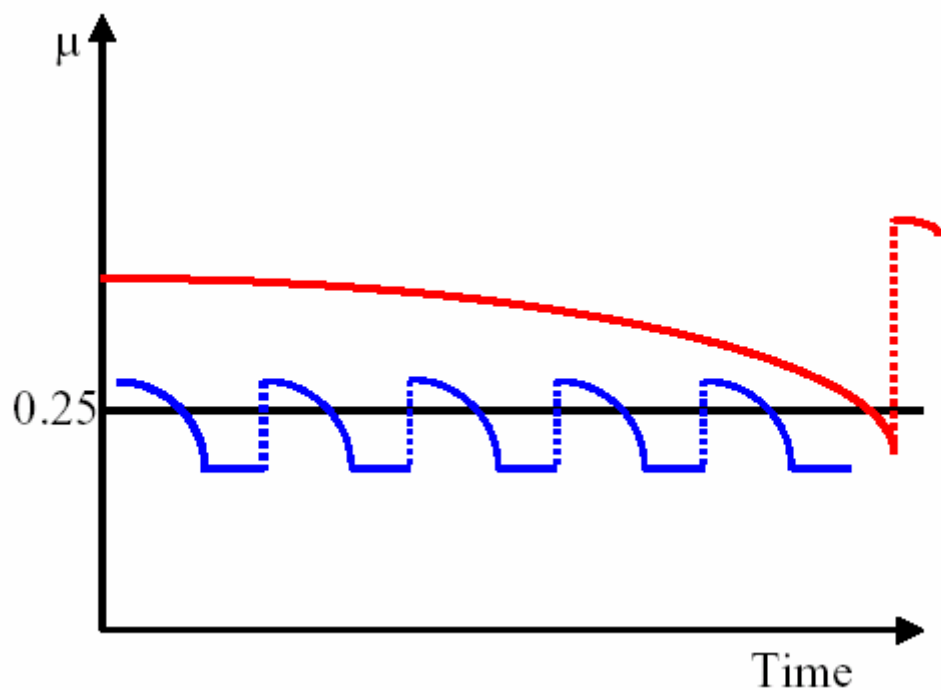

FIGURE 13 Diagram friction–time.

midwinter this is expected to be a significant part of the total spreading production. The long-lasting effect of warm wet gritting will reduce markedly the need for repeated spreading measures, and the wet sanding production will replace traditional sanding. The need for traditional spreading trucks will be reduced—how much depends on the rate of wet sanding possible as a preventive measure and the range a warm wetted sand spreader can cover. To take care of rapid weather changes, there will still be a need for a fleet of traditional spreaders, but the daily sanding with this equipment will be replaced by wet sanding to a large extent.

Status of the Implementation of the New Sanding Method

In 2000–2001, 4 out of 19 counties had taken the method into use. During the past 3 years, there has been a rapid growth in the number of spreaders, and there are now a total of 30 warm wetted sand spreaders in Norway. Most of them on national roads, but the method also was taken into use this winter in two municipalities and on two airfields in northern Norway. This is an important step towards a wider use of the method. However, further expansion of the warm wetted sand method depends not only on good working machines but also to a great extent on how the contractors value the economy in taking the method into use. The spreader manufacturers seem to have taken the challenge, and the equipment is well proven and stable. However, there is still a certain caution among the contractors from an economic point of view. At this moment it is therefore difficult to predict how many additional wet sand spreaders the market in Norway will absorb the coming years.

Outlook

Norway is still in an early phase of implementing the warm wetted sand technique in the daily winter operations.

The current main challenge is to convince the contractors that there is a good economy in taking the method into use. This is a question of objective documentation and spreading information. There is also a continuous need for focusing on the spreader equipment and the user experience to catch up with potential obstacles for the implementation of the method.

During the 2003–2004 winter season all of these aspects and others are addressed by a follow-up study on trunk roads in two different climate zones (inland and cost climate) and one study in the municipality of Trondheim. In all three areas there is a warm wetted sand spreader with an automatic data recording system based on Global Positioning System/GSM technology. One of the trucks has a friction device mounted, enabling continuous friction measurements (see Figure 14).

A part of the study during the 2003–2004 winter season is to look into the multiple uses of the spreaders and to utilize the possibility for alternating between sand and salt. One interesting option is to prewet salt with hot water to speed up the chemical process. Alternative use of the spreaders will be a part of the economic calculation.



FIGURE 14 Warm wetted sand spreader with friction device.

REFERENCES

1. Dahlen, J., and T. Vaa. Winter Friction Project in Norway. In *Transportation Research Record: Journal of the Transportation Research Board, No. 1741*, TRB, National Research Council, Washington, D.C., 2001, pp. 34–41.
2. Vaa, T., and T. Dahl. Development of a New Sanding Method Based on a Mix of Sand and Hot Water, and Implementation and Consequences for the Organization of the Gritting Operations. 11th International Winter Road Congress, Sapporo, Japan, January 28–31, 2002.

MATERIAL DISTRIBUTION, PERFORMANCE, AND RESIDUAL

Alberta's Benchmark Model for Maintenance Winter Service Delivery

STEVE OTTO

Alberta Transportation

In 1996, the provincial government of Alberta, Canada, outsourced highway maintenance for the provincial highway network. Private contractors were hired to perform maintenance activities under a 5-year, geographically based unit-price contract. The 1996 contracts specified the minimum number of trucks for each area, and the old Alberta Transportation (AT) shops were leased to the successful contractors.

Starting in 1998, the government began selling AT maintenance shops, and by 2000 most properties were no longer under government control. Then, in the fall of 2000, the government began to transfer road authority for secondary highways from the municipal governments (i.e. counties) and more than doubled the length of the network under provincial jurisdiction. Prospective contractors for contracts tendered after 2001 were required to propose new shop locations and the shop size and number of trucks to be provided in their new contract area.

AT's tasks were to

- Benchmark the existing (2000) winter maintenance service on the existing network,
- Predict the requirements for the number of trucks needed to meet provincial standards on the new (expanded) network and provide the same level of performance, and
- Evaluate contract proposals when shop locations and number of plow trucks were not specified.

The department's solution was a spreadsheet model of plowing and sanding–salting times with the total calculated time to complete one pass of the entire network as the benchmark. The model was used to determine how many trucks to add within each district as the secondary highways were transferred to provincial control. Contract proposals from prospective contractors were evaluated on whether their proposals showed equal to or slightly better than benchmark parameters. In broad terms, the benchmark model was developed by breaking the highway network into areas with similar traffic volumes, calculating the paved area (2-lane equivalent km) per plow truck, adding the newly transferred highways to the network, and determining the number of new trucks needed to complete work on the whole network within allowable times.

This paper gives details of the benchmarking process, including assumptions used, how highway topography and geometric characteristics were used to affect the length of highway each plow truck can be assigned before it was fully allocated, the business rules chosen to model actual work habits, calculations used to determine the time required to plow and spread sand or salt over each segment, and the improvements made over three successive rounds of tendering.

INTRODUCTION

Description of Winter Highway Maintenance in Alberta

Alberta is a western Canadian province, immediately north of the border with Montana. It has an area of 61,185 km² (23,620 mi²) and a population of about 2.7 million. In 1996 it had a provincial highway network of 13,562 centerline km (8,420 mi). Winter weather is typically cold and dry, with short, light snowstorms that are rarely last more than 48 h. Annual winter precipitation averages 50 to 70 mm (2 to 3 in.), and it is unusual to have more than a meter of snow accumulation by the end of the winter. Typical winter daytime highs are around -9°C (16°F); daily lows can easily reach -35°C (-31°F); and normally there are several times each winter when the temperature stays below -20°C (-4°F) for a week or longer.

The provincial network generally has a rural cross section and light traffic volumes, with the network's annual average daily traffic (AADT) of 2,600 vehicles. The busiest highways are close to large urban areas with traffic volumes never higher than 40,000 AADT. About half of the truck hours used for winter highway maintenance work is plowing fresh or drifting snow from the road, with the rest of the time spreading sand or salt and sand mixtures. Very few shops have more than one operator per plow truck, and most shops do not try to operate on a 24-h per day basis. Public weather forecasts and informal communications between shops give adequate warning of incoming winter storms, except in unusual conditions.

Outsourcing Highway Maintenance

Before 1995, the province delivered highway maintenance in the traditional way, with government employees and equipment. In 1995 the Minister of Transportation directed that all highway maintenance service delivery would be outsourced, and by October 1996 private contractors had been hired to do highway maintenance activities under a 5-year, geographically based unit-price contract. AT employees issue work orders to the contractor, who does the work and returns an invoice based on the units of work completed. The main exception to this system is dispatching plow trucks during winter storms. Since there are too few government employees to inspect the road network on an around-the-clock basis, the contractors have been given the responsibility to decide when to start plowing, salting, or sanding based on the weather forecast and actual road conditions. In the first round of contracts in 1996, AT specified the minimum number of trucks in each area and offered to lease the government-owned maintenance yards for the duration of the contract.

Issues with Retendering Maintenance Contracts in 2001

The highway maintenance contracts signed in 1996 expired after 5 years. In 2000, before starting the second round of tendering, AT decided that the resources allocated for highway maintenance had to be rationalized within the province to provide maximum efficiency and productivity. There had been two other major changes that affected the retendering process for the new contracts. In 1998, the provincial government decided to sell most of the government-owned maintenance yard properties on the open real estate market, with provisions that the existing

leases to the maintenance contractors were to remain in effect until the end of their current contracts. This meant that the second round of tenders would require prospective contractors to determine the number and location of their own maintenance yards.

Concurrently, the provincial government agreed with all municipal governments to transfer the responsibility for the secondary highway network back to the province. In the past, each municipal government had been designated the highway authority for secondary highways and had provided highway maintenance as it saw fit. Because of differences between municipalities, the level of service (LOS) delivery and the resources used on the secondary highways varied widely across the province. One of the main points of negotiation before the transfer was the commitment by the province to provide a consistent LOS on all highways, regardless of what the municipality had done previously. This meant that highways in some municipalities would have an increased level of maintenance service, while other highways would see a decreased level. To complicate the issue further, the secondary highway network would be transferred over a 2-year period that spanned the retendering period. Table 1 shows the distribution of the primary and secondary highway networks in the province.

Because of these two major changes, the department faced two related problems in late 2000 and early 2001:

1. How to determine and justify the number of additional plow trucks to add to the contractor's fleet in order to cover the increased network when the secondary highways were transferred to provincial control?
2. How to evaluate contract proposals where shop locations and number of trucks were not specified to the prospective contractor?

The solution that AT developed to address the first problem was to

- Benchmark the winter service on the existing primary highway network using the existing number of trucks and shops,

TABLE 1 Network and Resource Level Changes over Time

Time Period	Primary Highways (2LEKm under Provincial Jurisdiction)	Secondary Highways (2LEKm under Provincial Jurisdiction)	Number of Maintenance Shops	Number of Snowplow Trucks
Pre-1996	15,350	0	104 shops (plus 31 satellite stockpile sites without shops)	405
1996–2001	15,700	0	116 (plus 6 satellite stockpile sites without shops)	416
2002 to present	16,342	15,211	138	535

1.0 2LEKm = 1.25 lane mi

- Rationalize the regional differences in winter service delivery by the province that had existed up to 2000, and
- Apply the rationalized benchmark parameters to the expanded highway network, using the existing provincial maintenance shop locations.

Solving the first problem gave a base-case benchmark, which could be compared with contract proposals. In addition, the benchmark gave AT a tool to estimate the cost of delivering winter maintenance on the expanded network, which also would be used when evaluating proposals. Prospective contractors would have to demonstrate that their proposal met or slightly exceeded the base-case benchmark standards.

BENCHMARKING PROCESS

Creating Homogenous Highway Sections

The first step in the benchmarking process was to define short sections of highway that received a similar level of winter highway maintenance. Long stretches of highway were split into shorter sections that fit in one of eight classes based on AADT (Table 2). AADT was chosen as the defining characteristic of a homogenous highway section from the department's historic

TABLE 2 Highway Class by Annual Average Daily Traffic

Highway Class	AADT Range	Range of Factors (2LEKm/Truck)	Average Factor (2LEKm/Truck)	Maximum Time to Complete One Pass Plowing (Hours)	Maximum Time to Complete One Pass Sanding/Salting (Hours)
Class A	Over 15,000 AADT	25 to 32	29	2	4
Class B	7,000 to 15,000 AADT	28 to 35	34	2	4
Class C	5,000 to 6,999 AADT	32 to 37	35	2	4
Class D	1,800 to 4,999 AADT	33 to 46	37	3	4
Class E	850 to 1,799 AADT	44 to 60	48	3	6
Class F	425 to 849 AADT	77 to 95	86	4	8
Class G	85 to 424 AADT	85 to 105	93	5	10
Class H	Below 85 AADT	95 to 110	104	6	12

1.0 2LEKm = 1.25 lane mi

practice of providing shorter response times on high-volume highways compared with less-used roads. Because sections of highways that had climbing or passing lanes, interchanges, or hills required more time to plow or sand, these characteristics also were recorded for each section. To account for this additional work, sections were measured with 2-lane equivalent km (2LEKm) that included travel lanes, climbing, passing, acceleration, deceleration, and turning lanes (1.0 2LEKm = 1.25 lane mi). AT had divided previously the provincial highway network into 30 sub-areas to administer the highway maintenance contracts, so a separate Excel worksheet was created to enter the highway section data for each contract maintenance area (CMA). [Table 3](#) shows a typical CMA highway section table. The distance from each section to the nearest shop was measured using the existing provincial maintenance shop locations, and the number of existing plow trucks already in use on the primary highway network was recorded by CMA.

Calculating the Provincial Truck Factors

The second step in the benchmarking process was to establish a variable truck factor, which gave by class of highway the average number of kilometers that one plow truck could maintain under normal conditions. A higher class of highway (class A or class B) would need one plow truck for every 35 2LEKm. Lower-class highways (class G or class H) could be maintained within the specified response times even if there were only one plow truck for every 90 2LEKm. Even before starting to benchmark, it was common knowledge that there were truck factor differences across the province. Some differences were justified fully because of variation in local weather patterns, shop distribution, or traffic patterns. Other differences were less defensible, and dealt with public influence on level of service, past budgets, or even how stubborn the maintenance foreman had been when fleet changes were planned. No single truck factor could apply to a class of highway across the whole province, but a range of allowable truck factors could be developed. These truck factors then would be used to estimate how many additional plow trucks would be required when the secondary highway network was transferred to provincial control, while still accounting for regional differences in historic service delivery.

To establish the provincial range of truck factors, each of the 30 CMA worksheets was linked to a summary worksheet. The summary worksheet showed the actual number of trucks per CMA and the estimated number of trucks, as calculated using a set of cells containing the truck factors for each of the eight classes of highway. Then, by trial and error, the values of individual truck factor cells were changed manually until the range of truck factors shown in [Table 4](#) resulted in the following equation being true in each CMA (to the nearest integer):

$$\left[\sum_{i=1}^n \text{Section Length}_i / \text{Factor}_{\text{CLASS } x} \right] = \text{Actual number of trucks} \quad (1a)$$

where Section Length_i was the length of an individual section of highway in the CMA (2LEKm) and $\text{Factor}_{\text{CLASS } x}$ was the truck factor for the class of highway of Section_i (2LEKm/Truck).

TABLE 3 Example of CMA Highway Section Table

Section	Highway	Class	Description	2-Lane Equivalent Length (km)	AADT	Distance to Shop (km)	Unadjusted Factor (km/truck)	No. of Steep Gradient > 6%	No. of Mod. Gradient 4-6%	No. of Major Inter-sections	No. of Inter-changes	Adjusted Factor (km/truck)	No. Trucks Required for Section	Allow-able Plowing Time (hours)	Allow-able Sand/Salt Time (hours)
1	11 02 & 11 04	G	Park Bdy to Jct. 734	81.7	390	44.2	100.0	0	4	0	0	93.0	0.9	5	12.5
2	11 04 & 11 06 & 1108	E	Jct. 734 to Pipeline Approach Road	53.23	930	26	50.0	1	0	0	0	46.0	1.2	3	6
3	11 08 & 11A 02	E	Pipeline Approach Road to Rocky	50.15	1,300	24.5	50.0	1	0	2	0	50.0	1.0	3	6
4	11 10	D	Jct. 756 to Hwy 22 North	7.02	3,000	6.7	38.0	0	1	1	0	38.0	0.2	3	4
5	11 10	C	Hwy 22 North to Oras Road	18.15	5,001	9.2	36.0	1	0	2	0	36.0	0.5	2	4
6	11 10	D	Oras Road to SH 766	38.61	3,900	32.2	38.0	0	0	4	0	36.0	1.1	3	4.5
7	22 20	E	James River Jct. 587 to Hwy 54	20.24	1,740	14.9	50.0	0	3	1	0	50.0	0.4	3	6
8	54 06 & 54 08 & AR 114	E	Hwy 22 South to SH 781	42.63	1,400	26.1	50.0	0	0	4	0	48.0	0.9	3	6
9	54 06	D	Hwy 22 North to Hwy 22 South	14.14	2,700	7.1	38.0	0	1	3	0	38.0	0.4	3	4
10	22 22	D	Hwy 54 to Hwy 11	25.12	2,250	20.8	38.0	0	1	0	0	38.0	0.7	3	4
11	22 24 & 22 26	D	Hwy 11 to Medicine Lake Rd	47.21	2,456	11.4	38.0	4	0	3	0	38.0	1.2	3	4.5

1.0 2LEK_m = 1.25 lane mi

Note: Clear cells in the worksheet have manual data entry, shaded cells are calculated automatically.

TABLE 4 Adjustments to Truck Factor

	Section Characteristic	Adjustment to Truck Factor
1a	Distance to nearest shop, sections in Class A through Class E <ul style="list-style-type: none"> • Less than 25 km • 25 to 35 km • 35 to 45 km • More than 45 km 	<ul style="list-style-type: none"> • Reduce truck factor by 0 km • Reduce truck factor by 2 km • Reduce truck factor by 3 km • Reduce truck factor by 6 km
1b	Distance to nearest shop, sections in Class F through Class H <ul style="list-style-type: none"> • Less than 25 km • 25 to 35 km • 35 to 45 km • More than 45 km 	<ul style="list-style-type: none"> • Reduce truck factor by 0 km • Reduce truck factor by 3 km • Reduce truck factor by 5 km • Reduce truck factor by 15 km
2	Slopes greater than 6% (max. 2 per section)	Reduce truck factor by 2 km, each instance
3	Slopes of 4 to 6% (max. 2 per section)	Reduce truck factor by 1 km, each instance
4	Major intersections (max. 7 per section)	Reduce truck factor by 1 km, each instance
5	Interchanges (max. 2 per section)	Reduce truck factor by 2 km, each instance

1.0 km = 0.6 mi

Another layer of complexity was added when the physical characteristics of each section were included in the calculation of the number of trucks required per CMA. The extra work caused by increasing distance from the nearest shop, hills, major intersections, or interchanges within the section was compensated for by reducing the truck factor in that section—in effect, each section would seem to be longer (and require more effort for winter maintenance) because of these physical characteristics. Figure 1 shows a flowchart of the adjustment to the truck factor; this adjustment was done for each section in every CMA. Once the truck factor adjustment was added, the range of truck factors was slightly less than the original trial-and-error results. Using the adjusted truck factor, Equation 1 becomes:

$$\left[\sum_{i=1}^n \text{Section Length}_i / \text{AdjFactor}_{\text{CLASS}_x} \right] = \text{Actual number of trucks} \quad (1b)$$

where Section Length_i is the length of an individual section of highway in the CMA (2LEKm) and $\text{AdjFactor}_{\text{CLASS}_x}$ is the adjusted truck factor for the class of highway of Section_{*i*} (2LEKm/truck).

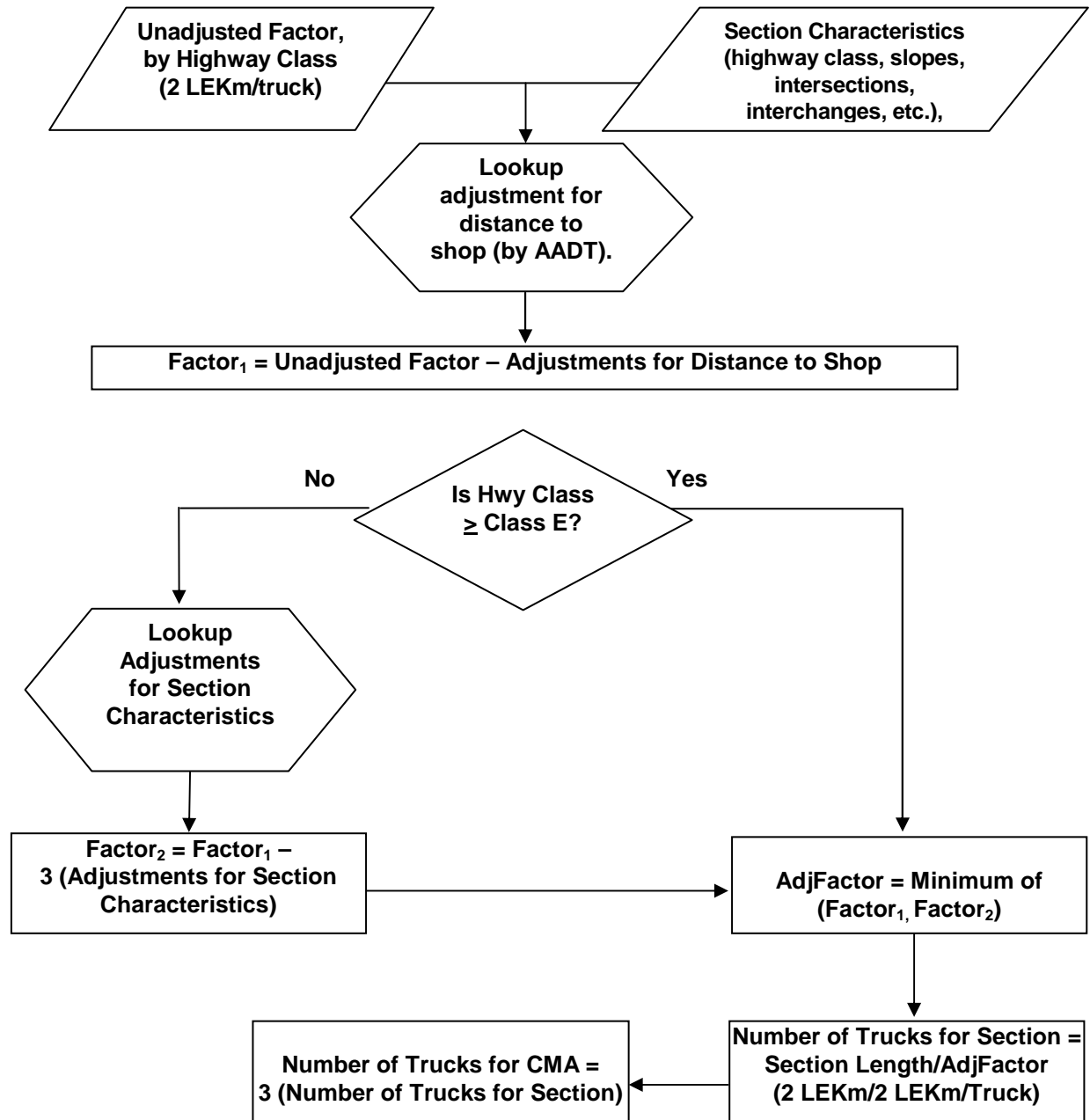

FIGURE 1 Adjusting the truck factor for section physical characteristics.

Benchmarking the Expanded Highway Network

Once the range of truck factors had been determined for the existing provincial network, they were used to determine the number of trucks that would be required when the secondary-highway network was transferred to provincial control. The secondary highways were broken into homogenous sections using the same process as the primary highways, and the new sections were added to the CMA spreadsheets. The truck factors that had been developed for the primary highway network were used without change for the expanded network, and an initial estimate of the total number of trucks needed in each CMA was calculated. This initial estimate assumed that the same maintenance shops would be used without adding or moving any for the larger network. In some CMAs where the geographic distribution of the secondary-highway network was similar to the distribution of the primary highways, this assumption was valid. But in other CMAs, the initial estimate would have been low because of time lost traveling to and from the new highway sections. [Figure 2](#) is a conceptual representation of the problems with geographical distribution of the added secondary-highway sections.

To validate the initial estimate of the number of trucks needed for a CMA, a new process of assigning trucks to work on each section was developed. Another worksheet was created for each CMA where individual plow trucks were assigned to work on sections or partial sections until that truck was fully allocated.

- For example, if a truck worked exclusively on Class A highway sections that had a truck factor of 35 2LEKm/truck, then that truck could work only until it was assigned to sections or partial sections equal in length to 35 2LEKm. Of course, most trucks would work on several sections in different highway classes, and it was easier to look at how the truck was allocated as a percentage of the total amount that the truck could work.

- For example, in a CMA that had a truck factor of 32 2LEKm/truck for Class A highways and 80 2LEKm/truck for Class F highways, a truck with its first assignment to a Class A 16-2LEKm-long section was 50% allocated ($16/32 = 50\%$ allocated).

- If the next section assigned to the truck were a Class F section, the truck could work only on 40 2LEKm before it was 100% allocated ($50\% + 40/80 = 100\%$ allocated). If the length of that Class F section were only 20 2LEKm, then the truck was only 75% allocated, and it could be assigned to work on another section ($50\% + 20/80 = 75\%$ allocated).

The sequence of assigning trucks to work on sections is similar enough to how maintenance foremen actually dispatch plow trucks that it caused some problems during the benchmarking process. AT district staff, drawing on their experience with actual winter maintenance operations, usually had to be reminded more than once that the sequence of work assignments for each truck didn't have to make sense.

Each truck was assigned to work on highway sections or partial sections until the truck was allocated fully. This process was followed until all of each section was allocated to at least one truck. In order to avoid ending up with a fraction of a truck needed for the last section(s), individual trucks were allowed to be slightly overallocated. When a truck in a CMA was overallocated, other trucks in that CMA's fleet had to be underallocated to balance. Since the new contracts would require the prospective contractor to choose where shops were located, it

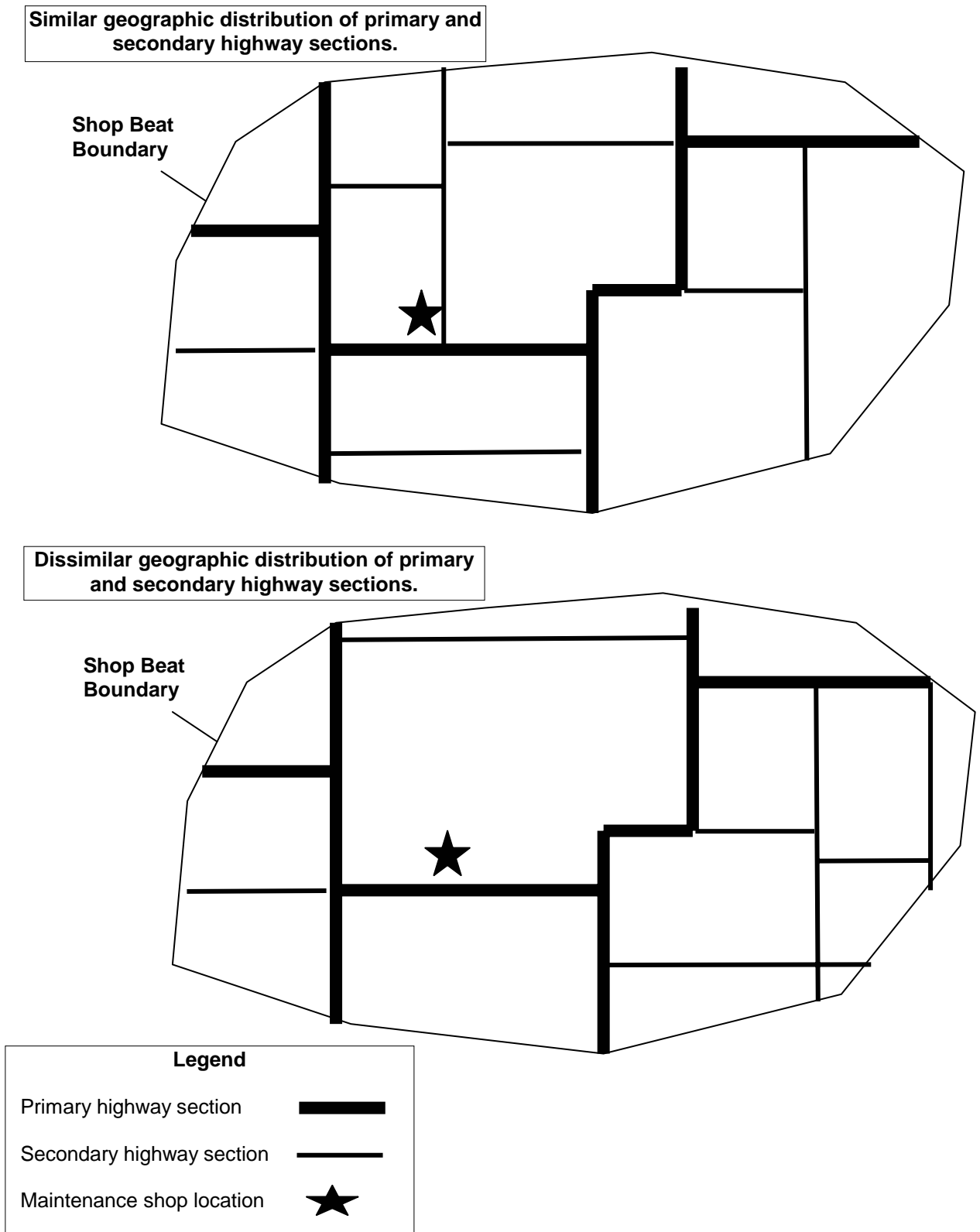

FIGURE 2 Conceptual model for problems with the initial estimate of trucks required.

would be possible to place the new shops in locations that gave greater efficiencies and did not need as many trucks as the base-case benchmark. To accommodate this scenario, alternative truck factors for each CMA were calculated on a proportional basis so that fewer trucks could still work on the same number of 2LEKms in the local network without being overutilized. AT provided these other ranges of truck factors in the request for proposal, along with a minimum number of trucks that would be provided by the contractor regardless of how well his shops were located. In keeping with AT's promise to deliver consistent highway maintenance across the province, the alternative truck factors were always fit within the range of truck factors developed previously for the primary highway network.

Using this benchmarking process, AT could justify the number of plow trucks to add to the contractor's fleet to respond adequately to the increased network when the secondary highways were transferred to provincial control.

Benchmarking Response Times

Using truck assignments for each highway section and the truck factors developed to this point, AT was able to establish the size of the plow truck fleet needed with the existing shop locations. The department expected each prospective contractor to find the most strategic locations for resources when developing proposals, which meant that widely different but equally acceptable proposals had to be expected. But, using the benchmark process that had been developed to this point, it would be very difficult to compare two proposals if one had many small shops spread throughout a contract area, while the other proposal had only a few, large shops in central locations. Obviously, the response times would vary depending on how much traveling the plow fleet had to do to cover the full network. So another benchmark criterion—the time to complete one cycle of work—was introduced to the benchmarking process.

The first step to develop a “time to complete” benchmark was to establish the maximum allowable times to do one cycle of work (one pass of a plow truck or one pass distributing sand or salt) for each highway class. [Table 2](#) gives the default time in hours by class of highway. The “maximum allowable time to complete” became a contractual requirement, and AT has grounds for payment adjustments if the contractor does not complete consistently his first response within the allowable time for any section of highway. Within any CMA, there were always some areas that needed to be plowed, sanded, or salted before any others. Sections containing these spots were identified as hot spots and had a shorter “time to complete” than other sections in the same highway class. Hot spots had to be defined with care, though, since the historical response times depended on where the maintenance shops had been located in the past; too many hot spots would constrain the prospective contractors when they were planning where to put their new maintenance shops. Most CMAs, averaging about 1,300 2LEKm (1,600 lane mi) in the expanded network, would have only two or three hot spots.

The CMA spreadsheets were set up to calculate the time to complete one pass over all of the travel lanes in each assignment and accumulate these times as the truck was assigned to more sections of highway. Regardless of how many sections a truck had been assigned to previously, the work had to be completed within the maximum allowable time for the section. Plow trucks were assumed to work at an average of 46 kph (28 mph), based on an analysis of contract records over the 1997–1999 winters. Sanding or salting operations were assumed to use a 8.5 m³ (10.7 yd³) capacity frame-mounted hopper at a rate of 330 kg per lane km (450 lb per lane mi),

meaning that one truckload of material would spread for 25.8 lane km (16.0 lane miles). The equations to calculate the time to complete work on a section follow:

Time to plow Section_{*i*}:

$$t_i = \frac{[TD_i + (2 * D_i)]}{46 \text{ km/hr}} \quad (2)$$

Time to spread sand or salt on Section_{*i*}:

$$t_i = \frac{\left(TD_i + \left[2 * \left(DH_i + \frac{D_i}{2} \right) * \left(\frac{2 * D_i}{25.8 \text{ km}} \right) \right] \right)}{46_{\text{km/hr}}} \quad (3)$$

where

- t_i = time to complete one pass over the section (all lanes) (hours),
- TD_i = travel distance to Section_{*i*} from the previous location (kms),
- D_i = length assigned from Section_{*i*} (kms), and
- DH_i = dead haul from stockpile location to closest point on Section_{*i*}.

Note that the equation to calculate the time to complete sanding or salting includes the time needed to dead haul back to the stockpile and refill the hopper spreader. Equation 3 does not account for the fact that dead haul distances increase as the truck works further from the stockpile, that trucks usually travel faster when dead hauling than when they are spreading, or that different size hoppers will treat more or less highway. Equation 3 was changed in later tenders to give a more realistic estimate of the time to complete one pass using the following sequence of equations:

$$t_i = \frac{[Mob + DH_i + (NL_i^2 * MH) + (2 * NL_i * DH_i)]}{dhaulspd_{\text{km/hr}}} + \frac{(2 * D_i)}{spreadspd_{\text{km/hr}}} \quad (4)$$

$$MH = \frac{\left(\frac{Hopsize}{0.33 \text{ m}^3 \text{ per lane km}} \right)}{2} \quad (4a)$$

$$NL_i = \text{rounddown} \left(\frac{D_i}{MH} \right) \quad (4b)$$

where

- MH = maximum length of highway that can be treated with a full hopper (2LEKm),
- $Hopsize$ = capacity of hopper spreader on the truck (m³),
- NL_i = number of hopper load refills needed to treat the assigned length D_i ,
- Mob = mobilization distance from the truck storage facility to the stockpile where it

loads up (km),
dhaulspd = average dead hauling speed (usually 70 km per hour), and
spreadspd = average working speed when spreading material (usually 46 km/h).

The CMA spreadsheets were set up to calculate the quantity of material left in the hopper at the completion of work on a section, and this quantity was taken into account when calculating the NL for the next highway section assignment.

With the calculation of the work times, benchmark truck assignments in some CMAs had to be redone to complete the work within the maximum allowable time. Because the calculated time to complete work on any section will change depending on where the maintenance shop is located, the benchmark adopted by AT was the cumulative time by class of highway in a CMA. [Table 5](#) shows a typical CMA spreadsheet showing the cumulative time for the benchmark condition on the expanded network.

Using these benchmarks, AT could evaluate proposals for future contracts. Each prospective contractor would

- Determine where maintenance shops would be located;
- Using the location of the shops, calculate the initial estimate of the number of trucks required for the local network;
- Using the initial estimate of the number of trucks needed, choose the truck factors that apply within the local network;
- Assign trucks to work on each section until all sections had been allocated without overutilizing the trucks;
- Check that each section is completed within the maximum allowable time to complete; and
- Check that the sum of cumulative time to complete work was equal to or less than the cumulative base-case benchmark times.

If the proposal did not meet the requirements of steps 5 and 6, the prospective contractor had to reevaluate his choice of locations for shops or add more trucks to his proposal until it did.

Applications of the Benchmarking Process

With the benchmarking process, AT had a tool to compare contract proposals for outsourced highway maintenance services. The trucks, shop, and stockpile locations that were detailed in the proposal would become part of the contract with the preferred highway maintenance contractor. It has been AT policy to provide a mobilization period of up to 1 year before a contract would be activated, and there have been times when the maintenance shop locations listed in the proposal could not be developed. In these cases, it is the prospective contractor's responsibility to propose alternative locations and show, using an updated winter service delivery spreadsheets, that the service delivery times in their proposal were still equal to or slightly less than the base-case benchmark.

AT also has used this benchmarking process to evaluate the impact of adding trucks or closing shops to the service delivery in existing contracts.

TABLE 5 Sample of CMA Spreadsheet Showing Cumulative Work Time by Class of Highway

Base Plow Cumulative Time by Class								
Class	A	B	C	D	E	F	G	H
Total Time	4.20	2.34	4.12	17.63	19.07	11.92	5.08	

Base Plow Time by Section					Truck Number								
Section	Road/Hwy	Class	Allow	Time	1	2	3	4	5	6	7	8	9
1	2 22 & 2 24	A	2	1.46	1.43	1.34	1.46						
2	2 24	A	2	1.26				1.24	1.26	0.57			
3	2 26	A	2	1.48						1.48	1.33	1.35	0.65
4	11 12	B	1.5 (hot spot)	1.20									
5	11 12 & AR 164	D	3	1.52									
6	11 14	D	1.5 (hot spot)	1.08									
7	11 16	E	3	1.88									
8	12 08	D	3	1.35									
9	12 10	C	2	1.17									1.17
10	12 10	D	3	0.92									
11	20 02	D	3	2.10									
12	11A 04	E	3	2.41									
13	11A 04	C	2	1.42									
14	11A 04 & 2A 18	B	2	0.65									
15	42 08	E	3	2.11									
16	2A 14	B	2	0.49									
17	2A 16	D	3	2.06									
18	2A 18 & 2A 20	C	2	1.53									1.53
19	2A 22	D	3	1.89									1.89
20	54 08	D	3	0.94									
21	587 02	E	3	1.89									
22	587 03	G	5	2.53									

FUTURE IMPROVEMENTS TO THE BENCHMARKING PROCESS

As noted previously, the equations used to calculate the work times for spreading sand or salt have been changed since the first contract tenders. Other changes already made to the benchmarking process include

- Using sections based on one-way, single travel lanes for benchmarking a high-speed, high-volume, multilane urban expressway in the city of Calgary, Alberta;
- Allowing the use of different capacity sand and salt hoppers, automatically adjusting the length of highway that can be treated before refilling the hopper; and
- Allowing the use of satellite stockpiles, where material is stored but there are no trucks stationed.

Any change to the benchmarking process must balance the improvement to the modeling of the actual services delivered and the additional effort that prospective contractors will have to make to understand the new process. Most contractors have found that it takes the full time efforts of one or two persons to complete the plow truck assignment process during the preparation of their contract proposals, and AT does not want to needlessly make a complex and time-consuming task more difficult than it must be.

Future improvements to the benchmarking process that are being considered by AT include

- Changing the equations that calculate the time to plow a section to reflect the improved productivity of side-mounted wings or plow extensions on plow trucks,
- Changing the criteria used for highway classifications from AADT to the service classification system developed by AT in 2001, and
- Developing a new benchmark for the application of anti-icing chemicals, in preparation for department anti-icing pilot projects in selected locations around the province.

While this benchmarking process has been used only with metric measurements, it could easily be converted to Imperial (U.S.) measures by changing some of the conversion factors in the CMA spreadsheets. And the benchmarking process developed by AT for a provincial highway network would not need any modification to be applied to any other sized highway network.

CONCLUSION

The benchmarking process developed by AT is not a perfect model of winter highway maintenance, but it has been used to justify the number of trucks required for network expansion and to evaluate proposals where the number of trucks and location of maintenance shops is not specified. This benchmarking process could be used by any size highway agency to document the service delivery differences within the agency, to benchmark service at existing resource levels, or to investigate the effects of changing resource levels or network changes on winter service delivery.

ACKNOWLEDGMENTS

The development of the AT benchmarking process was neither as straightforward nor as simple as this paper describes. The two people most responsible for taking the process from its initial stages to the final product are Alan Griffith and Gerry Pyper. Their full-time development work from the Red Deer District office in the months leading up to the first contract retenders in 2000 has never been recognized adequately within AT, and any competence that the author has in working with this benchmarking system is built largely on their innovative thinking and professional determination to make a robust, objective, and fair process.

MATERIAL DISTRIBUTION, PERFORMANCE, AND RESIDUAL

Anti-Icing and Material Distribution Performance Measures for Achieving Level of Service Through Mobile Data Collection**GREGORY E. THOMPSON***ThomTech Design, Inc.*

Recent events have shaped the world's approach to transportation safety and the marshaling of resources to respond to several potentially damaging scenarios. Paramount to successfully managing these situations is the rapid movement of emergency personnel and vehicles, the control of vital transportation arteries, and the ability to react in real-time over a wide geographic area using a variety of communications means and a host of emergency and environmental services. This results in the overtreatment of roadways and bridge decks that might otherwise achieve the desired level of service (LOS) with the use of less anti-icing materials.

The Alaska Department of Transportation and Public Facilities (DOT/PF) and ThomTech Design, Inc., sought to determine the effectiveness of the material distribution methods employed during the snow and ice removal process in the Juneau, Alaska, area. Accomplishing this task required accurate data collection procedures, LOS estimation, and analysis. The partners intended to develop particular performance measurements using a variety of in-vehicle sensors and post material distribution techniques that are subjective and objective in nature.

The Alaska DOT/PF Southeast Region configured the snowplows in the Juneau area with data collection equipment tied to several types of vehicle sensors. The evaluation vehicle was the key vehicle and included a touch-screen computer, digital camera, and a mobile weather station. Several recommendations for integrating with road weather information systems' stations to introducing a friction (grip) meter on the evaluation vehicle were suggested by the project participants. The project was scheduled for completion on January 1, 2004.

UNDERSTANDING

The Alaska Department of Transportation and Public Facilities (DOT/PF) and ThomTech Design, Inc., sought to determine the effectiveness of the material distribution methods employed during the snow and ice removal process in the Juneau, Alaska, area. In addition, the partners investigated objective and subjective performance measures for the achievement of level of service (LOS) requirements within the desired timeframe. Accomplishing these tasks required accurate data collection procedures, reliable LOS estimation, and creative data analysis. The partners intended to develop particular performance measurements using a variety of in-vehicle sensors and post material distribution techniques that are subjective and objective in nature.

The purpose of the study was to analyze the effectiveness of the snow and ice removal process in the Juneau, Alaska, area. [Figure 1](#) provides a block diagram description of the three objectives to support the project goal.

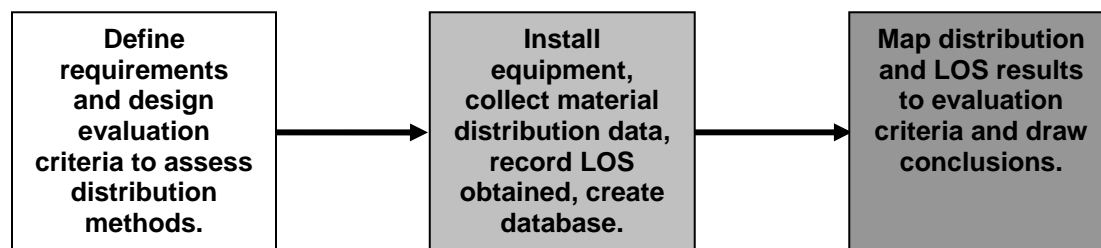

FIGURE 1 Proposed study objectives.

Design Description

General

The project was subdivided into three broad functional areas. [Figure 1](#) provides a block diagram of the three areas. The first part of the study defined the requirements, determined the method of data collection, and described the equipment and system parameters necessary to compare material distribution to LOS results. The second part of the study involved the system installation, data collection, and LOS estimation. The final part of the study recorded the data to a database, analyzed the results, and drew conclusions relative to the effectiveness of the snow and ice removal process.

The study was designed to be accomplished as a partnership between the systems integration company (ThomTech Design) and the public agency (Alaska DOT/PF). ThomTech accomplished the majority of the tasks, however the actual data collection and LOS estimation was prepared by Alaska DOT/PF personnel. Alaska DOT/PF selected five snowplows presently assigned to the Southeast District in Juneau. These snowplows were used to gather data about the snow and ice removal process. An additional vehicle (not necessarily a snowplow) was required to estimate the effectiveness of the snow and ice removal based on the material distributed on the route. Data collection equipment was installed into the snow and ice removal vehicles to automatically record events tagged with date, time, and location information.

The next two sections provide a description of the proposed tasks necessary to complete the study.

Project Flowchart

[Figure 2](#) provides a block diagram of the proposed project flow. The first two blocks (white in color) denote the two tasks for part one of the study. The light gray blocks illustrate the tasks for data collection and recording. The dark gray blocks highlight the tasks of the final part of the study.

Tasks

[Table 1](#) provides a task list and short description of each task. [Figure 3](#) provides a screenshot for the evaluator vehicle that records date, time, location, temperature, road temperature, humidity, barometric pressure, and other weather elements.

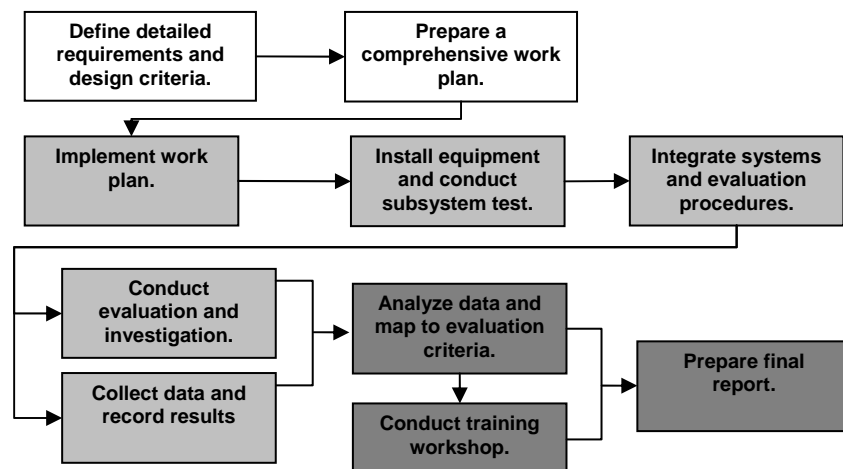

FIGURE 2 Project flowchart.

TABLE 1 Proposed Task and Description List

Proposed Task	Description Response
Define Detailed Requirements & Design Criteria	Establish the baseline parameters of the study by gathering information about how the snow and ice removal process is presently employed. This includes routes, material used, effectiveness, costs, and personnel requirements. A majority of this data has already been collected. Design a system of evaluation criteria that can reflect accurately the LOS provided during the snow and ice removal process. Also determine the parameters that will vary during the study to determine their effectiveness, such as material amount, type of material, when applied, where applied, and type of equipment.
Prepare Comprehensive Work Plan	Develop a detailed work plan to accomplish the goals and objectives of the study. The purpose of the work plan is to assign tasks, to schedule installation, and to describe how data is collected, recorded, and stored.
Implement Work Plan	The study team begins executing the work plan.
Install Equipment and Conduct System Test	ThomTech will install new equipment on the snowplows. This includes new controllers that accurately log snow and ice removal events such as salter on/off, pounds per lane mile, and gallons per ton. In addition, a mobile data computer with embedded Global Positioning System receiver will record the events and tag them with date, time, and location information. The events will be stored on a PCMCIA card and downloaded after the storm.
Integrate Systems and Evaluation Procedures	This task ensures that the subsystems are working successfully and that the evaluation procedures (estimating LOS) are collecting the information necessary to complete the analysis.
Conduct Evaluation and Investigation	This task is accomplished by observing the effectiveness of the snow and ice removal material by driving the route at selected periods after the material has been distributed. The methods for completing this are determined in Task 1. An accurate method of determining the LOS through observation is required.
Collect Data and Record Results	Actual collection of the detailed data from the snowplows during the snow and ice removal procedures. Data is downloaded periodically and stored in a database.
Conduct Training Workshop	Prepare a training workshop and presentation to train Alaska DOT/PF personnel in data collection and analysis and associated equipment and tools.
Analyze Data and Map to Evaluation Criteria	Conduct an analysis of the snow and ice process by evaluating the results of the data as they pertain to the LOS estimation.
Prepare Final Report	Prepare a comprehensive documentation of the study, draw conclusions, and provide suggestions and recommendations.

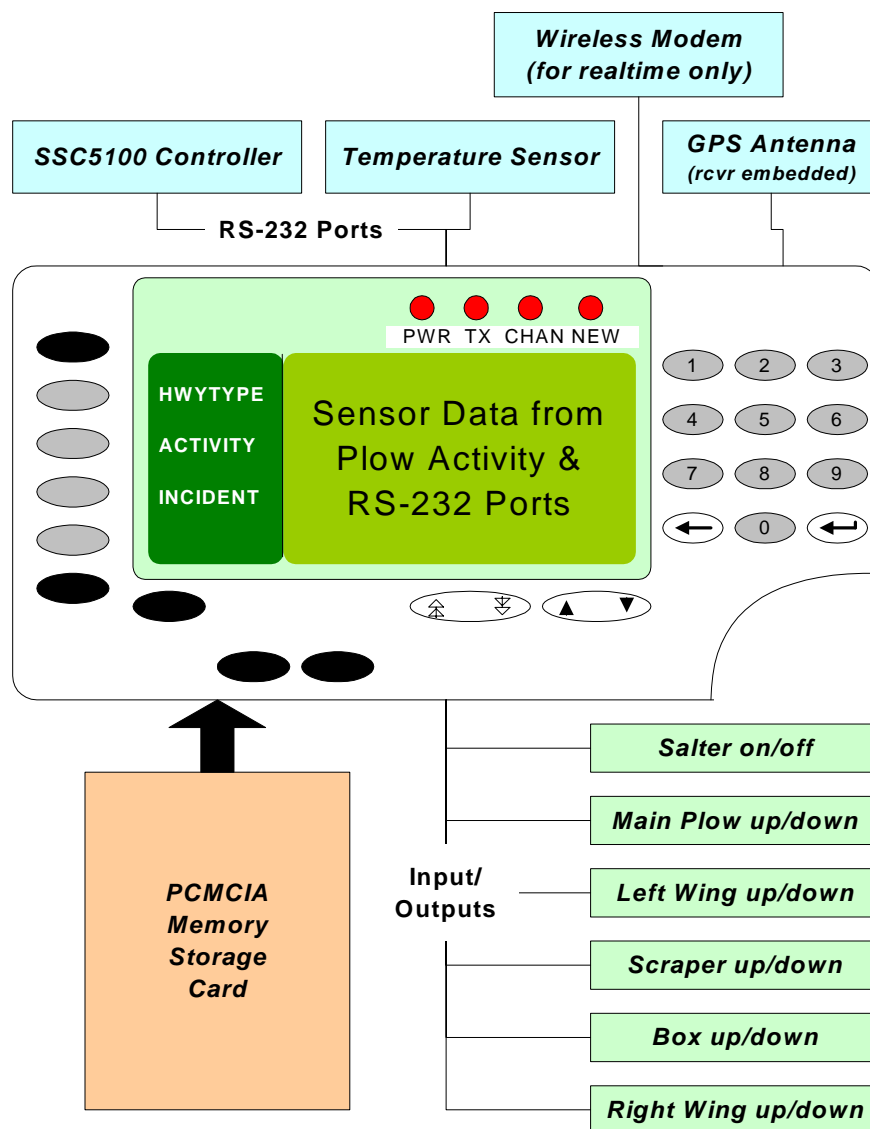

FIGURE 3 MDC block diagram with sensor connections.

Equipment

The collection of material usage and equipment usage data is provided by a mobile data computer (MDC) and several sensors. Figure 3 provides an illustration of the maximum number of sensors that the MDC can accommodate. For this project, only the front or main plow, the salter/controller, and the temperature sensor will be used. The data will be recorded and stored to an embedded PCMCIA card. This card is removed at the end of day, end of shift, end of week, or end of storm. The data are downloaded to a database on a desktop computer. ThomTech will install an MDC, plow sensor, pavement/air temperature sensor, and state-of-the-art controller into five snowplows. Detailed instructions and interface connections are provided in the work plan. The data file consists of records (a recording of each event), and each record consists of several data fields. An example of the data records is provided in Table 2.

TABLE 2 Evaluation Criteria of Roadway Surface After Material Application

Abbreviation	Name	Description
SN	Snow cover	Snow present; vehicles haven't driven over the roadway.
CS	Compact snow	Snow present; vehicles have packed the snow.
I	Ice on surface	Visible ice on the road surface.
BW	Bare and wet	Pavement is bare but wet.
SL	Slush on surface	Pavement is covered with slush of snow, ice, and water.
BWt	Bare and wet tracks	Snow present, however, tracks on pavement are bare/wet.
BI	Black ice	Ice on pavement, invisible or difficult to detect.
FD	Freeze dried	Pavement is dry; surface temperature is below freezing.
O	Other	Other descriptions not consistent with above criteria.

A list of the main components of the in-vehicle equipment is provided below:

- MDC,
- Infrared temperature sensor,
- Proximity sensor for main plow, and
- Salter/controller.

PROBLEM STATEMENT AND RESEARCH OBJECTIVE

The Alaska DOT/PF uses liquid magnesium chloride (MgCl) and other chemicals to maintain roads in a bare and wet condition. Alaska DOT/PF determines the timing of application and application rate of deicing and anti-icing chemicals by subjective judgment in response to many dynamic variables. Increased road maintenance needs in conjunction with stable or declining maintenance budgets have emphasized the need to optimize the cost effectiveness of anti-icing and deicing activities. Alaska DOT/PF believes that using subjective judgment may not lead to the most cost effective use of anti-icing and deicing chemicals.

Anti-icing and deicing operations in southeast Alaska's maritime climate are especially challenging given the extensive range of precipitation and temperature during the winter months. Although strategically placed road weather information systems can provide valuable information to road maintenance decision makers, this infrastructure is not yet in place in southeast Alaska. In this region, Alaska DOT/PF maintenance forces use exclusively subjective criteria developed from operator experience to determine quantity and timing of chemical use for anti-icing activities.

While several dynamic variables impact the effectiveness of road treatment activities during the snow and ice season, this research effort sought to examine the relative impact of the following variables:

- Type of chemical [e.g., MgCl, calcium chloride (CaCl), sodium chloride (NaCl)],
- Amount of chemical used in each application (e.g., direct liquid of 35 gal per mi, granular of 300 lbs per mi, prewet of 20 gal per ton, etc.),
- Type of snow and ice on roadway (e.g., packed snow, slush, black ice),
- Amount of traffic on roadway (e.g., high, medium, low),

- Weather conditions (e.g., temperature, dew point, humidity, pavement temperature, precipitation), and
- Timing (e.g., time of day, when evaluated, LOS achieved in certain number of hours).

The research sought to answer the following questions:

- Was the remote data collection technology useful for optimizing chemical usage?
How?
- How cost-effective was the technology for optimizing chemical use?
- How can Alaska DOT/PF use remote data collection technology to improve the effectiveness and economy of deicing and anti-icing operations?
- Other objective observations or recommendations to help maintenance and operations (M&O) decision makers decide whether or not to invest further in this technology.
- What operational and procedural improvements are necessary for successful implementation of remote data collection technology in Alaska?

SCOPE OF STUDY

There are several other factors that may contribute to the overall LOS achieved, such as weather forecast, equipment availability, time of day, and more. The number of combinations of variables can become quite cumbersome; however, by putting limits on the possible configurations, the study becomes manageable. The elements of each configuration consisted of air temperature, pavement temperature, humidity, dew point, barometric pressure, Global Positioning System (GPS) location data (latitude, longitude, speed, heading, date, time), and hydraulic controller information (plow up/down, material distribution rate).

The study also requires a control segment. This is a segment of road that is representative of the test roadway and is treated the same way each time.

For this study, the roadway study section was Egan Drive (State Highway 7) in Juneau. The routes of interest for the evaluation are #296001 and #296002. This is the route that encompasses Egan Drive from Otter Way to the AML Road in Thane. The road encompasses approximately 21 mi of highway that is treated with MgCl ([Figure 4](#)).

The study was conducted during the winter season of 2002–2003. The weather was unusually mild and limited the number of days that data could be collected. Nevertheless, 4 days of complete data have been collected—January 31, February 6, February 14, and February 17, 2003.

Equipment, Procedures, and Methodology

The project was subdivided into three parts. The first part of the study defined the requirements, determined the method of data collection, and described the equipment and system parameters

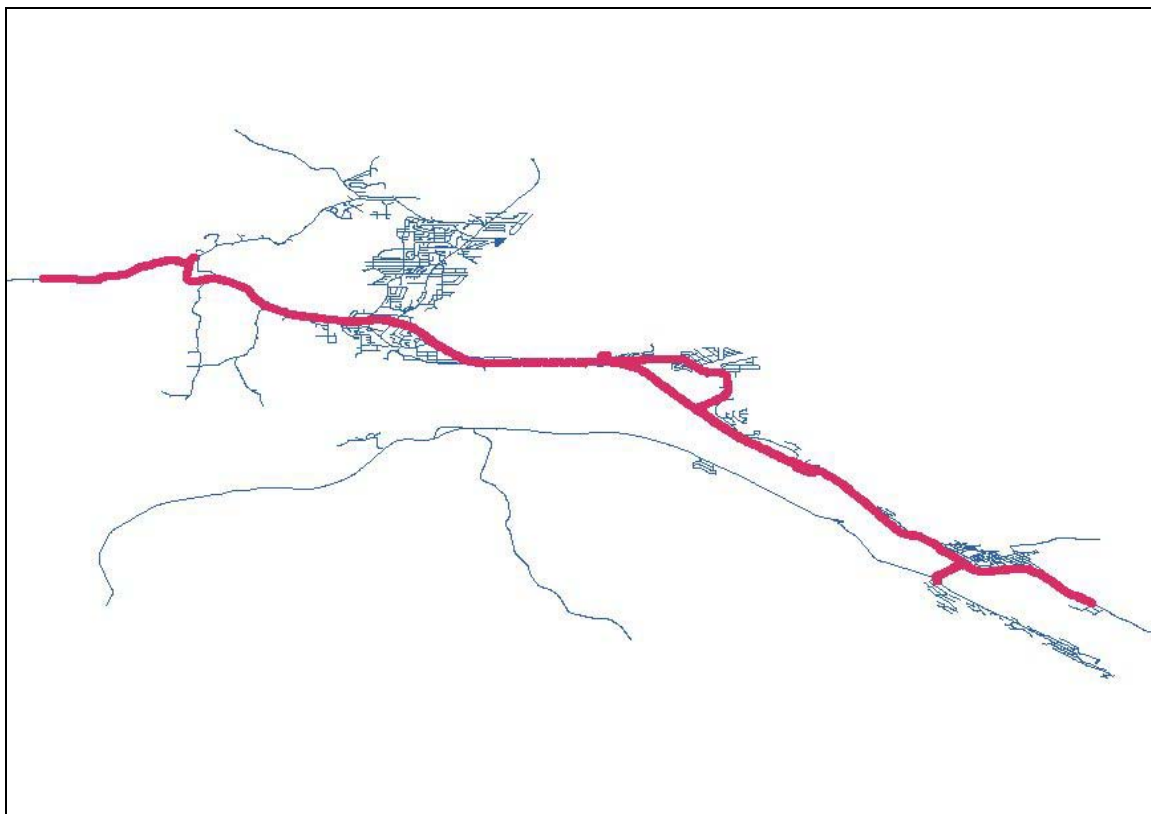

FIGURE 4 The route (Egan Drive) of interest for this study.

necessary to compare material distribution to LOS results. The second part of the study involved the system installation, data collection and recording, and LOS estimation. The final part of the study analyzes the results and draws conclusions relative to the effectiveness of the snow and ice removal process.

The study was designed to be accomplished as a partnership between ThomTech Design, Inc., and Alaska DOT/PF. ThomTech accomplished the majority of the tasks, however, Alaska DOT/PF M&O personnel collected the actual data and prepared the LOS estimation. Alaska DOT/PF M&O selected five snowplows presently assigned to the southeast region in Juneau. These snowplows were used to gather data about the snow and ice removal process.

Alaska DOT/PF M&O provided an additional vehicle for use in estimating the effectiveness of the snow and ice removal based on the material distributed on the route. ThomTech installed data collection equipment into the snow and ice removal vehicles to automatically record events (distribution rate) tagged with date, time, and location information. Although data were collected from other snowplows that were used for granular distribution, this document focuses on the truck that is dedicated to the distribution of MgCl on Egan Drive.

Routes and Evaluation Procedures

Routes

The route of interest for the evaluation is #296001 and #296002. This is the route that encompasses Egan Drive from Otter Way to the AML Road in Thane.

Evaluation Criteria

The evaluation criteria that were used to measure the effectiveness of the material distribution are consistent with the chart that has been used in previous seasons.

Evaluation Tools

Route Evaluation Software

The route evaluation software was developed for this project. Its function was to be a tool for the route evaluation team in determining the effectiveness of the material (MgCl and sand) distribution on selected roadways in southeast Alaska. The purpose was to develop a tool that made the evaluation process as objective as possible and thereby provided a clearer comparison of the material distribution process between seasons, roadways, type of material, when material is applied, and amount of material. Figure 5 provides a screenshot of the evaluation software application package. Figure 6 illustrates the snapshot feature that records a snapshot of the road surface and stores it in the database.



FIGURE 5 Screenshot of performance evaluation screen.



FIGURE 6 Example photos from evaluation camera.

Report Generator

The report generation software provided the evaluator with report preparation options that include material usage and equipment usage reporting. The reports have a standard format or can be tailored. Each report can be created by truck, start and end time, or sensor information. The report generation software was not used for this study.

Mapping Display Software

The data files recorded by the evaluation truck and the mobile data collection (distribution) trucks are comma delimited ASCII text (Table 3). As such, it can be imported into most mapping display software packages. The examples in the work plan are using Microsoft's MapPoint software. However, the data are best displayed using ArcView 3.2. Alaska DOT/PF provided the road data for mapping and the additional shape files are available on the Alaska State website.

Each data field can be used to color the route, such as plow up/down, speed, road temperature, material used, and more. ThomTech provided a copy of Microsoft MapPoint software for this purpose. ArcView 3.2 is a more capable software application package that is

TABLE 3 Sample Data

ID	Date & Time	Latitude	Longitude	SPD	HDG	IN1	IN2	IN3	IN4	IN5	IN6
688	9/21/01 12:06	39.6044	-82.9519	26	194	0	0	1	0	0	1
688	9/21/01 12:06	39.6044	-82.9519	26	194	0	1	1	0	0	1
688	9/21/01 12:06	39.6041	-82.952	26	194	0	1	1	0	0	1
688	9/21/01 12:06	39.6027	-82.9525	37	194	0	1	1	0	0	1
688	9/21/01 12:06	39.6011	-82.9531	37	194	0	1	1	0	0	1
688	9/21/01 12:06	39.5996	-82.9536	37	194	0	1	1	0	0	1
688	9/21/01 12:06	39.5982	-82.9542	32	194	0	1	1	0	0	1
688	9/21/01 12:07	39.5958	-82.9547	32	194	0	1	1	0	0	1
688	9/21/01 12:07	39.5955	-82.9551	32	190	0	1	1	0	0	1
688	9/21/01 12:07	39.594	-82.9552	35	180	0	1	1	0	0	1
688	9/21/01 12:07	39.5926	-82.955	32	170	0	1	1	0	0	1
688	9/21/01 12:07	39.5911	-82.9547	35	174	0	1	1	0	0	1
688	9/21/01 12:07	39.5899	-82.9545	22	170	0	1	1	0	0	1
688	9/21/01 12:08	39.5896	-82.9544	0	354	0	1	1	0	0	1
688	9/21/01 12:08	39.5896	-82.9544	2	170	0	1	1	0	0	1
688	9/21/01 12:08	39.5895	-82.9544	6	170	0	1	1	0	0	1
688	9/21/01 12:08	39.5891	-82.9544	15	170	0	1	1	0	0	1

ID	Date & Time	RTEMP	ATEMP	ACT	INC
688	9/21/01 12:06	84	77	0	0
688	9/21/01 12:06	84	77	2	0
688	9/21/01 12:06	84	77	0	0
688	9/21/01 12:06	81	77	0	0
688	9/21/01 12:06	83	77	0	0
688	9/21/01 12:06	83	77	0	0
688	9/21/01 12:06	83	77	0	0
688	9/21/01 12:07	82	77	2	0
688	9/21/01 12:07	82	77	0	4
688	9/21/01 12:07	83	77	0	0
688	9/21/01 12:07	82	77	0	4
688	9/21/01 12:07	82	77	0	0
688	9/21/01 12:07	83	77	0	0
688	9/21/01 12:08	84	77	0	8
688	9/21/01 12:08	84	77	0	0
688	9/21/01 12:08	84	77	0	2
688	9/21/01 12:08	83	76	0	0

(continued)

TABLE 3 (continued) **Sample Data**

ID	Date & Time	MSG_ID	Material	Units	Spinner	Auger	Rate	Liquid
688	9/21/01 12:06	%ST	GRANC	E	SP11	F	200	P050
688	9/21/01 12:06	%ST	GRANC	E	SP11	F	200	P050
688	9/21/01 12:06	%ST	GRANC	E	SP11	F	200	P050
688	9/21/01 12:06	%ST	GRANC	E	SP11	F	200	P050
688	9/21/01 12:06	%ST	GRANC	E	SP11	F	200	P050
688	9/21/01 12:06	%ST	GRANC	E	SP11	F	200	P050
688	9/21/01 12:06	%ST	GRANC	E	SP11	F	200	P050
688	9/21/01 12:07	%ST	GRANC	E	SP11	F	200	P050
688	9/21/01 12:07	%ST	GRANC	E	SP11	F	200	P050
688	9/21/01 12:07	%ST	GRANC	E	SP11	F	200	P050
688	9/21/01 12:07	%ST	GRANC	E	SP11	F	200	P050
688	9/21/01 12:07	%ST	GRANC	E	SP11	F	200	P050
688	9/21/01 12:07	%ST	GRANC	E	SP11	F	200	P050
688	9/21/01 12:07	%ST	GRANC	E	SP11	F	200	P050
688	9/21/01 12:08	%ST	GRANC	E	SP11	F	200	P050
688	9/21/01 12:08	%ST	GRANC	E	SP11	F	200	P050
688	9/21/01 12:08	%BT	GRANC	E	SP11	F	1000	P050
688	9/21/01 12:08	%BT	GRANC	E	SP11	F	1000	P050

compatible with the data collection formats. ArcView 3.2 was used for analysis for this phase of the project.

EVALUATION TRUCK DATA, COLLECTION, AND EMPLOYMENT

LOS Evaluation Vehicle

The LOS evaluator is provided with a laptop computer, GPS receiver, humidity sensor, and pavement temperature sensor. The laptop computer has a software application tailored to meet the data collection needs of the evaluator. The software application assists the evaluator by providing menu choices and definitions of pavement and roadway observations made by the evaluator. The in-vehicle laptop is a Panasonic Toughbook (CF-28) with touch-screen capability. Thus, the route evaluator has several items of data collected automatically that support the subjective portions of the evaluation. The evaluation data collection effort is instrumented with the onboard sensors as much as possible. Initially, the evaluator is required to provide a subjective evaluation of the effect of the material distribution by selecting from nine different road conditions (e.g., black ice) (Table 2).

Components

A list of components for the service evaluation vehicle equipment is provided below:

- Laptop computer (Panasonic Toughbook, CF-28) with touch screen;
- GPS receiver and antenna;
- Sprague infrared air/pavement temperature sensor;

- Humidity/dew point sensor;
- Barometric pressure sensor;
- Camera, Logitech video camera, mounted on dashboard; and
- Mount, cables, and power cords.

Route Evaluation Software

The route evaluation software was developed for this project. Its function is to be a tool for the route evaluation team in determining the effectiveness of the material (MgCl and sand) distribution on selected roadways in southeast Alaska. The purpose was develop a tool that makes the evaluation process as objective as possible and thereby provided a clearer comparison of the material distribution process between seasons, roadways, type of material, when material is applied, and amount of material. [Figure 5](#) provides a screenshot of the evaluation software package. One addition is the dew point calculation, which will provide a warning to the driver of fronts danger.

FINDINGS

1. Successful optimization of snow and ice control treatments requires a comprehensive understanding of the interaction between meteorological and treatment variables.
2. Several aspects of this study have never been attempted before. Many government agencies are struggling with evaluating LOS from the several methods of treatment. This study is the first of its kind to attempt to optimize objectively and subjectively a selected snow and ice control treatment (in this case MgCl) and then examine ways to improve effectiveness, increase efficiency, and reduce costs.
3. Results to date include limited evaluation over a single winter season. The mild winter and initial equipment problems prevented collection of a comprehensive set of data from which to draw definitive conclusions. The researchers recommend ongoing data collection and analysis.
4. The data exist to make objective and subjective comparisons between treatments. The mapping and reporting power present in Alaska DOT/PF is extensive, and the data manipulation skills are outstanding.
5. The evaluation data collected were done smartly, and the data are valuable and useful. Great care was taken to ensure that the software and hardware worked to their satisfaction.
6. Greater communications between the research members would have been helpful earlier in the season; the process seemed to run smoothly only towards the end of the season.
7. The cost of the research was in line with the results and findings. The resources required to collect and analyze data in the future are available, affordable, and practical.
8. The cost per snowplow for the data collection equipment is approximately \$1,850 per plow. The cost for the evaluation equipment is \$7,500 per truck (one per fleet). The analysis costs are difficult to assess; average cost in engineering and technical labor is approximately \$800 per storm.
9. A modest estimate of 10% reduction of MgCl applied to the 21-mi stretch of Highway 7 (Egan Road) in Juneau results in a savings of \$8,543 per year. The improvement in

safety (operator and motorist), the reduced impact on the environment, the increased efficiency by route, and the decreased equipment maintenance and storage costs are not included.

RECOMMENDATIONS

1. Prepare a detailed procedure roadmap that describes each step and method in the data collection process for the MgCl dispersion and the evaluation truck.
2. Expand the evaluation runs to include preapplication and postapplications at sufficient intervals for as long as it takes to determine when the MgCl breaks the ice and how long it is effective.
3. Establish a log for recording ancillary information such as weather before the treatment, weather forecast, number of gallons used, number of miles the truck traveled, how the decision was made to treat the roadway, and other descriptions that may impact the collection of data for that treatment and evaluation period.
4. Appoint a person to be in charge of the data collection effort, one who can assemble the data and examine the data set soon after the treatment and evaluation period. If a consultant is used, send data to team members after each storm to look for completeness, accuracy, and adjustments.
5. Continue this research for an additional season, anticipate a representative winter weather season, and incorporate the suggestions and recommendations from the research team members.
6. Highlight the three parameters that seem to have the largest effect on the MgCl treatment: weather, traffic, and application rate. Another suggested parameter is time of day in relation to the temperature/dew point/pavement temperature for choosing when to treat.
7. Extend the study to other portions of the southeast region; if necessary, use the data collection equipment for summer maintenance activities.
8. Modify the evaluation software to include the run number and traffic flows.
9. Expand the study to include granular material distribution and other routes within the Juneau area.
10. Replace the existing MgCl liquid dispensing equipment with data-enabled controller and equipment for more accurate and comprehensive recording of liquid treatment use.
11. Use a friction-measuring device to improve evaluations of treatment effectiveness.

MATERIAL DISTRIBUTION, PERFORMANCE, AND RESIDUAL

Norwegian Experience with Use of Magnesium Chloride**TORGEIR VAA***SINTEF Roads and Transport*

The Norwegian study on the use of magnesium chloride started in 2001–2002 and has been going on for two winter seasons. The project will be reported finally in 2004 after the 2003–2004 season.

The main goal of the magnesium chloride project was to verify how the amount of salt was affected by alternative salting methods and to study which possibilities magnesium chloride gave for operation at temperatures for which sodium chloride did not work. In addition it was an aim of the project to investigate the duration of an action and time to dry the road surface after salting with different chemicals. Solid sodium chloride prewetted with magnesium chloride liquid has been compared with the standard method, which is to use liquid sodium chloride as agent to solid salt.

One of the hypotheses was that magnesium chloride in some circumstances resulted in slippery road conditions, because it is a hygroscopic salt. One of the purposes was therefore to study how different methods effect friction and friction development under varying winter road conditions. The development in friction can be an indicator on the effects that can be expected on the road conditions by use of different salting methods.

The results after two winter seasons show some interesting tendencies toward less salt consumption with the method based on prewetting with magnesium chloride. However, there is some uncertainty in what way the friction is affected.

BACKGROUND

One of the main activities in the Norwegian Winter Friction Project was to carry out a testing program (scientific studies) to document performance of different friction improvement methods. The goal was to come up with a recommendation on what is the best method under different conditions. An important part of the Winter Friction Project has been to study the use of chemicals.

The project on the use of magnesium chloride (MgCl_2) was initiated by Public Roads Administration in Oslo on the background of observations during the winter season of 2000–2001 in connection with some salting actions with MgCl_2 in solid form. Even if they were not documented in a scientific way, the results indicated a longer lasting effect compared with the use of sodium chloride (NaCl), and thereby indicated that transfer to more use of MgCl_2 can affect the total salt consumption.

In Norway it is most common to use NaCl in the winter maintenance both as a preventive action and as a deicer. Sea salt is the most common salt in Norway, and rock salt is also common to some extent. Spreading of salt can be done with different methods according to a recommended salt table. This table is a guide to support the choice of method and the appropriate amount of salt for the prevailing road and weather conditions.

Even if salting by use of NaCl has a broad application in Norway, it is well known that NaCl has some limitations. These limitations are first and foremost due to the chemical performance implying that NaCl can not be used below -10°C . The normal temperature limit for application of NaCl is -6°C .

Aside from studying the deicing effect and consequences on the friction, it also has been given focus to the environmental issue. From an environmental point of view it will be of importance to reduce the amount of salt. Longer time before the road surface dry up can result in less dust, and MgCl_2 can reduce the negative impact on organisms and vegetation along environmentally exposed surroundings like parks in cities.

PROJECT DESCRIPTION

Alternative Chemicals

It is well known that there are alternatives to NaCl with other properties in regard to the temperature range for application as a deicing agent and the effects on binding dust on the road surface during the winter time (not only on gravel roads in the summer time). So far this has not been documented under Norwegian conditions.

The price of MgCl_2 in solid form is three times the price as NaCl in Norway, and because of the price difference MgCl_2 will not be used as a deicing agent in solid form or as a pure liquid. The method considered as the most actual alternative is to prewet solid NaCl with an MgCl_2 liquid. Another option would have been to use a liquid based on calcium chloride (CaCl_2).

Figure 1 shows the phase diagram for different types of salt (1). Figure 1 illustrates that the phase diagrams for the three chlorides dissolved in water differ from each other especially at temperatures below -10°C . For a given pavement temperature below 0°C but above the eutectic temperature of NaCl, a MgCl_2 solution will refreeze at a lower concentration than the corresponding concentrations of either CaCl_2 or NaCl at the same temperature. For example, the refreeze concentration of MgCl_2 at -10°C is about 11% while the refreeze concentrations of CaCl_2 and NaCl at that temperature are about 12.5% and 13.5%, respectively. This means that MgCl_2 brines can be diluted more than CaCl_2 and NaCl before refreezing at a given temperature.

However, once the dilution process starts, the slope of the MgCl_2 curve rises faster than the refreeze temperatures of CaCl_2 and NaCl. The slope of the MgCl_2 curve to the left of its eutectic concentration is steeper than the slope of either the CaCl_2 or NaCl curves until the three brine concentrations reach about 5% or a corresponding temperature of about -3°C . Between this temperature and 0°C , all three brines have about the same refreeze characteristics.

Figure 1 also illustrates that it is natural to test the properties of MgCl_2 related to NaCl, since the difference in freezing characteristics is greatest for these two chlorides within the actual temperature range.

Figure 2 shows the result from a calculation of the content of different elements in solid NaCl and liquid based on MgCl_2 and NaCl, respectively.

As one can see from Figure 1, there is only a marginal difference in the quantity of chloride between the two types of prewetting methods. It is only with a real reduction in the quantity of salt that the choice of liquid will have an impact on the environment.

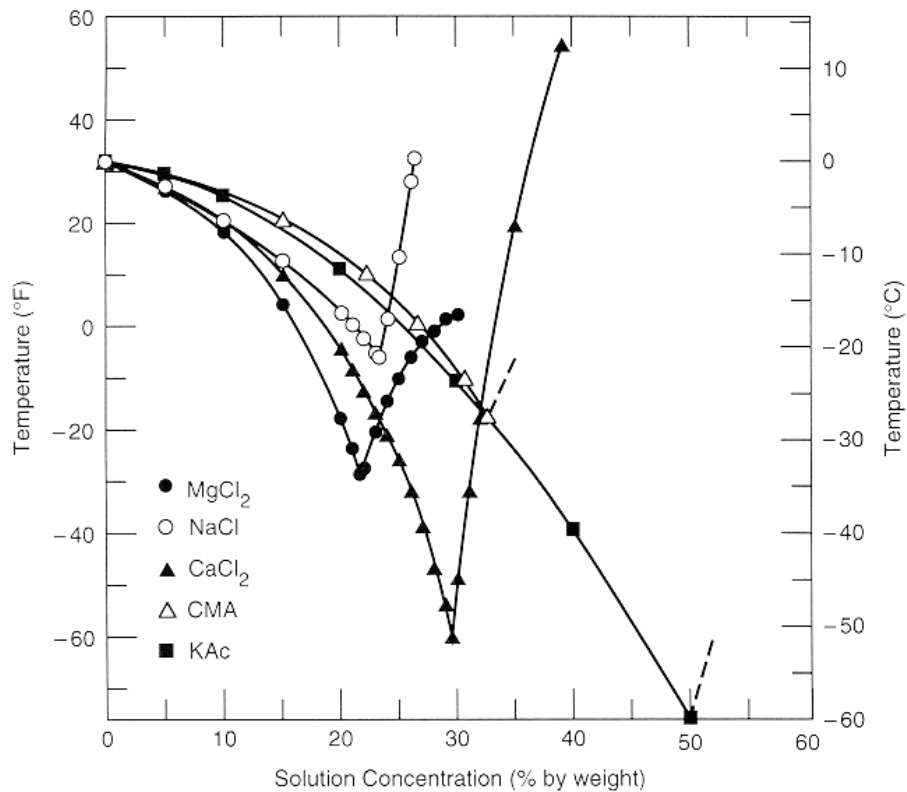

FIGURE 1 Phase diagram for different chemicals.

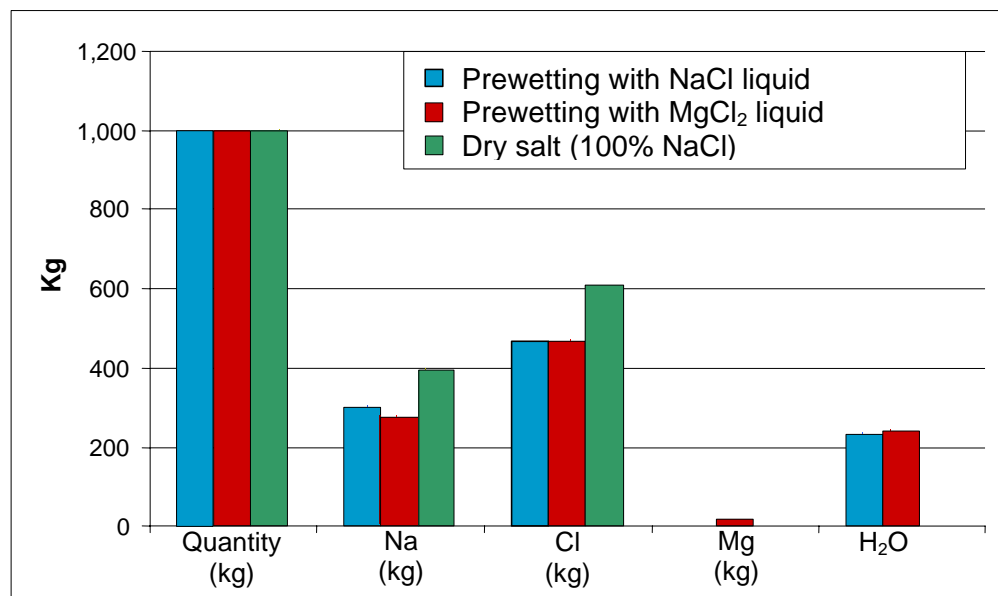

FIGURE 2 Content of elements in different salting methods.

Test Area and Salting Method

The total road network in the test area consists of 42 km of national roads in the inner city of Oslo. [Figure 3](#) shows a part of the road network within the test area.

On these roads a 20% $MgCl_2$ solution is used to prewet solid NaCl after a standard proportion by weight between solid material and liquid, 30% by weight of liquid and 70% solid material. The roads in the test area are treated with this method with exception of a road section where solid NaCl is prewetted with a NaCl solution. This road section is used as a reference for the standard salting method.

[Figure 4](#) shows the truck and spreader used in the test area. To ease the change between the two different liquid solutions, the spreader has been modified by mounting an extra tank for



FIGURE 3 Part of the test area in Oslo.



FIGURE 4 Spreader used in the $MgCl_2$ project in Oslo.

the NaCl solution. The change between the two tanks is controlled by a button on the control panel giving a signal to a valve shown in [Figure 5](#).

Data Recording

The following data have been registered:

- Operational data from the truck,
- Friction measurements by a friction trailer,
- Road weather information system data, and
- Traffic volume.

Operational Data from the Truck

The operational data for the road network in the test area are registered by use of an automatic data recording system on the truck based on Global Positioning System/Global System for Mobile Communications function.

Friction Measurements by a Friction Trailer

Friction measurements were made by use of a Roar Mark I friction trailer with a standard ASTM measuring wheel (see [Figure 6](#)).

Normally the Roar device is driven with an operating speed of 60 km/h and braking every two seconds; the distance between each measurement is approximately 40 m. Roar is designed to record the entire friction curve. The Roar Mark I can measure only variable slip and for purposes of the Winter Friction Project, the peak friction coefficient was chosen to be used as an expression of the friction level.



FIGURE 5 Valve system on the salt spreader in Oslo.



FIGURE 6 Roar friction trailer.

The friction measurements are used as the main data to evaluate the effect from the different salting methods in the Oslo project. Two road sections were chosen to compare the $MgCl_2$ method (marked with a green line in Figure 3) with the $NaCl$ method (marked with a red in line Figure 3) (see Table 1).

Both roads are four-lane roads. On parts of the road sections where friction measurements are made, there was resurfacing with new asphalt during the summer 2002. This makes it possible to study to what extent the type of asphalt has influence on the friction measurements. The principle for numbering the lanes is shown in Figure 7.

Road Weather Information System Data

The main source for climate data is a road weather information system station at Maritim. The data are recorded every 20 min, and a routine has been set up to convert the data to 1-h intervals.

Traffic Volume

Traffic data are gathered as support in evaluating the results from the friction measurements.

TABLE 1 Road Sections Where Friction Measurements Are Made with Roar Mark I

Road	Section	Lane	Start Section	Start km	End Section	End km	Length in km
NR ¹ 161	Uelands gt – Vigs gt	1	2	4.00	2	6.00	2.00
NR 168	Majorstua – Smestad	1, 2	1	1.90	1	4.00	2.10
Sections Resurfaced in Summer 2002							
NR 161	Sums gt – Vigs gt	1, 3	2	5.50	2	6.00	0.50
NR 168	Diakonvn – Smestad	1, 2, 3, 4	1	2.70	1	3.90	1.20

¹ NR = National road

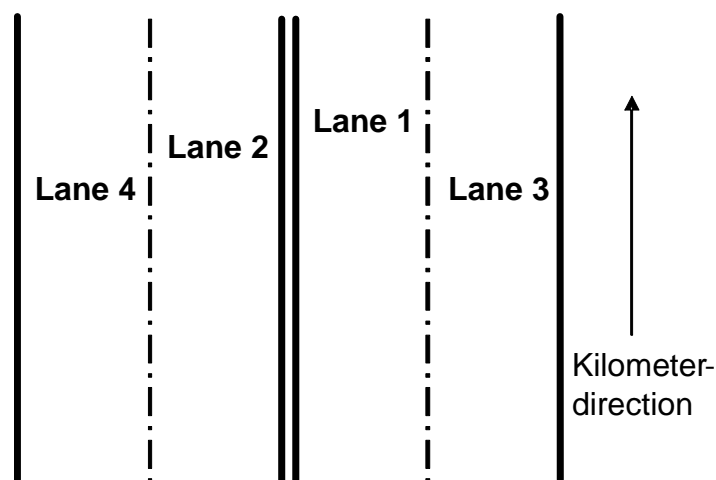

FIGURE 7 Principle for numbering lanes.

Chemical Analysis

Chemical analysis will be conducted as a part of the project to study the effects on plants, earth organisms, and fresh water biotopes.

RESULTS

Climate Data

Figure 8 shows an example of the climate data at Maritim for November 2002.

If the temperature limit for the use of NaCl is set to -6°C , the portion of the time when the air temperature was falling below this limit is as shown in Table 2.

From Table 2 it can be seen that the potential for use of MgCl_2 varies from month to month. For the 2002–2003 winter season as a whole; 19% of the time the air temperature was below -6°C .

Traffic Volume

Figure 9 shows the traffic variation during a typical day in February 2003 for the three lanes with friction measurements.

As can be seen from Figure 9, there is a difference in the daily traffic variation between the two road sections that in some situations can influence the development in the road condition.

Operational Statistics

To obtain a direct comparison with the results from the friction measurements, the operational

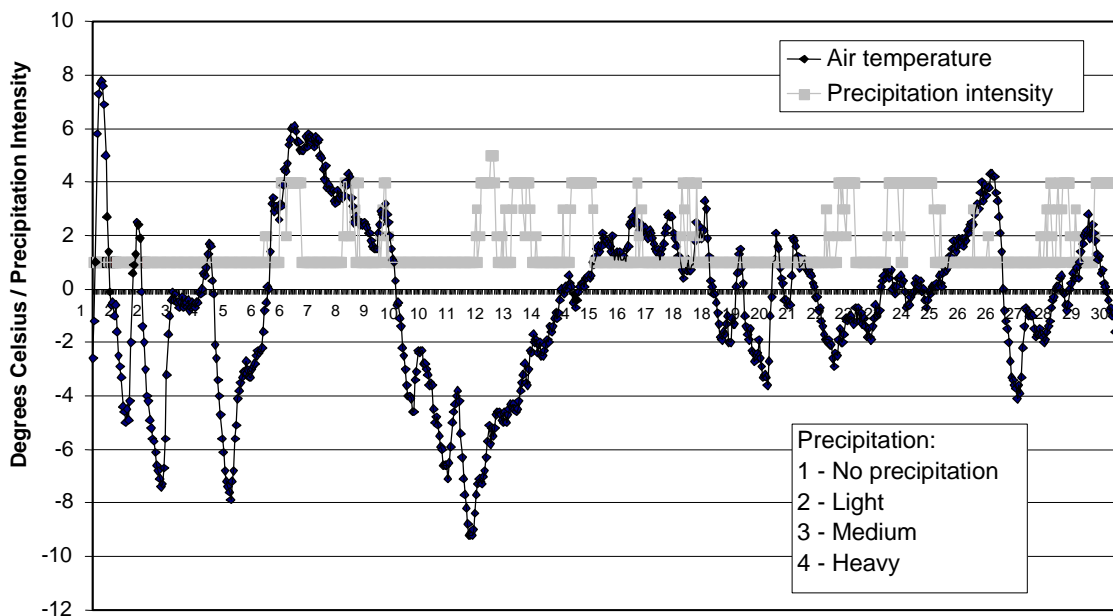

FIGURE 8 Climate data from E-18 in Maritim for November 2002.

TABLE 2 Portion of the Time with Air Temperature Falling Below -6°C

Month	Portion of the Time Below -6°C
November	5%
December	39%
January	41%
February	15%
March	1%
November–March	19%

statistics are withdrawn for the same road sections as shown in [Table 1](#). The operational data includes the following:

- Date and time,
- Program (automatic or manual dosage),
- Amount of solid salt and liquid (kilo),
- Surface temperature,
- Amount of spreading kilometers,
- Amount of driven kilometers,
- Treated area, and
- Amount of solid salt and liquid per m^2 .

[Figure 10](#) shows the distribution on different types of action. There is no significant difference between the two road sections with regard to the cause for the salting actions undertaken.

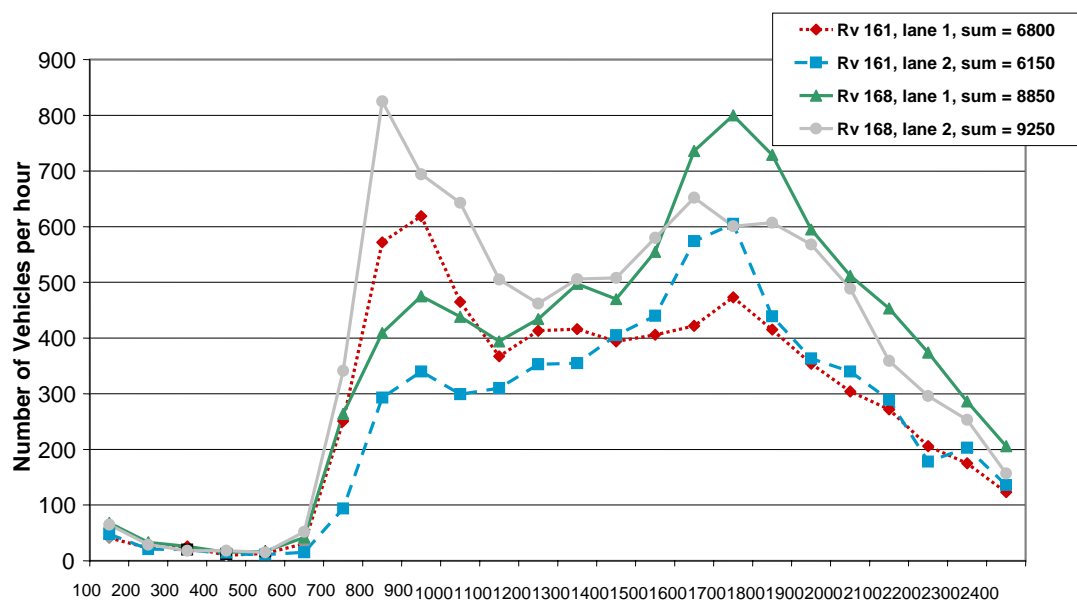

FIGURE 9 Traffic variation curves.

Figure 11 shows the salt consumption as an average dosage per month during the 2002–2003 winter season. The amount of solid salt is almost equivalent on the two road sections, but it seems that less liquid was added on the NaCl section than on the MgCl₂ section.

There were a total of 86 days with salting on NR 161 (MgCl₂ liquid) and 103 days with salting on NR 168 (NaCl liquid). Table 3 also shows the number of salting actions. A new action is defined if the time exceeds 2 h between one passage to the next passage with the truck. The total number of actions was 135 on NR 161 and 154 on NR 168, corresponding to a difference of 14% more actions on NR 168.

The total amount of salt used on the two road sections was 15.7 tons on NR 161 and 38.9 tons on NR 168. Conversion to salt consumption per m² showed that 0.67 kg salt/m² was spread on Kirkeveien and 1.45 kg salt/m² on Sørkedalsveien. This is equivalent to a difference of 216%, through the 2003–2004 winter season double the amount of salt/m² was used on Sørkedalsveien with NaCl liquid compared with Kirkeveien with MgCl₂ liquid. It is known in detail how much the traffic is affecting on the salt consumption locally in the study area, but from the traffic volume it does not seem that the difference in the total amount of salt used can be explained by traffic differences. How the traffic is working along with the chemicals will be studied more in detail after the 2003–2004 winter season.

Friction Measurements

The friction measurements do not give a complete picture of the friction standard during the whole winter season. Even if it would have been desirable to have had more measurements,

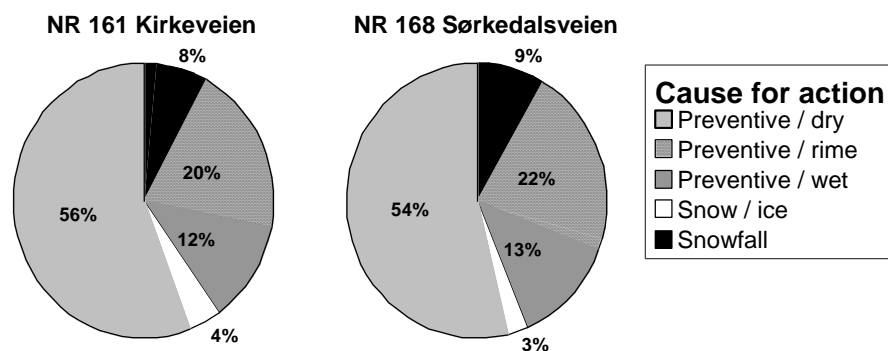

FIGURE 10 Distribution on different types of action.

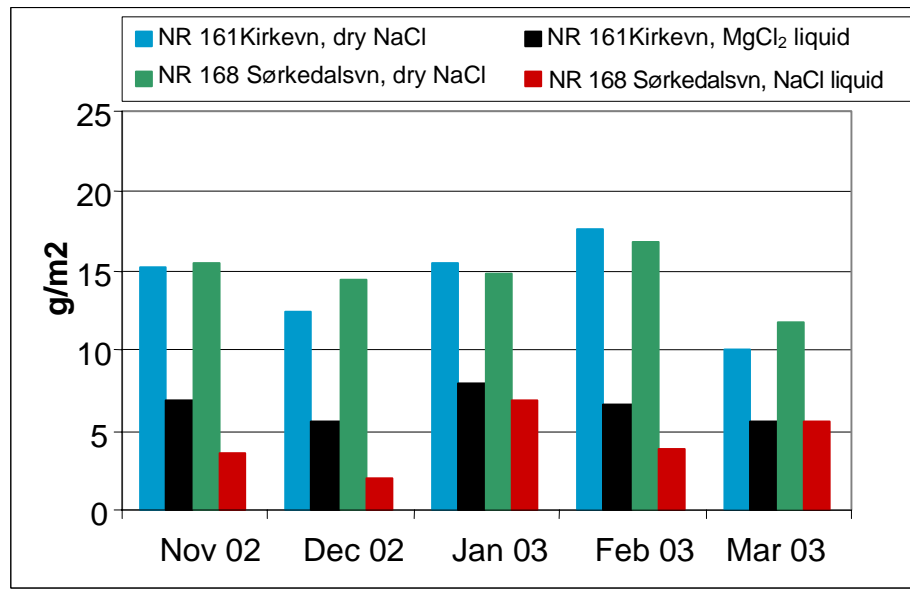

FIGURE 11 Salting actions the winter season 2002–2003, average dosage of solid salt and liquid per action.

TABLE 3 Number of Days with Salting Actions and Number of Actions During the 2002–2003 Winter Season

Road Section	Days and Number of Actions	Month				
		Nov	Dec	Jan	Feb	March
Rv 161 Kirkevn	Days with actions	19	20	20	17	10
Rv 161 Kirkevn	Number of actions	34	35	30	24	12
Rv 168 Sørkedalsvn	Days with actions	20	21	22	23	17
Rv 168 Sørkedalsvn	Number of actions	41	36	35	28	14

especially in connection with precipitation, the friction measurements still give a foundation for comparison between the $MgCl_2$ road section and the reference road section with regard to possible tendencies to a connection between the salting method and the friction standard.

In Figures 12 and 13 there is a comparison between the friction values from Roar Mark I on the two road sections. Even if the material is limited to 20 measurements series, the result does not indicate in general that the friction level is higher on the road section where liquid $MgCl_2$ is added to solid $NaCl$. However, one cannot draw the opposite conclusion either even if the road section with $MgCl_2$ comes out with the lowest friction value in several cases.

With respect to the temperature variations, the friction measurements in the period January 2–6 show interesting results, especially January 6. That day the temperature went down to $-16^\circ C$, and the friction level was significant higher on NR 161 with $MgCl_2$ than on NR 168 with the combination of solid $NaCl$ and liquid based on $NaCl$. This gives interesting indications to the effect on friction when the temperature is very low and clearly under the temperature limit for using $NaCl$.

There are no significant differences between Kirkeveien and Sørkedalsveien when comparing mean values from all the friction measurements. However, there are interesting tendencies in the data material when looking at observations made under temperatures below $-6^\circ C$. The difference in average friction level between the two salting methods was especially evident on the road sections with new asphalt at temperatures below $-6^\circ C$ (see Figure 14). Even if the difference is not significant statistically, the mean value for the coefficient of friction is highest for Kirkeveien, where $MgCl_2$ liquid is used as a prewetting agent.

CONCLUSIONS

In November, December, January, and February and the first days of March the air temperature was below $-10^\circ C$ for shorter periods of time, and there were longer periods with temperatures in

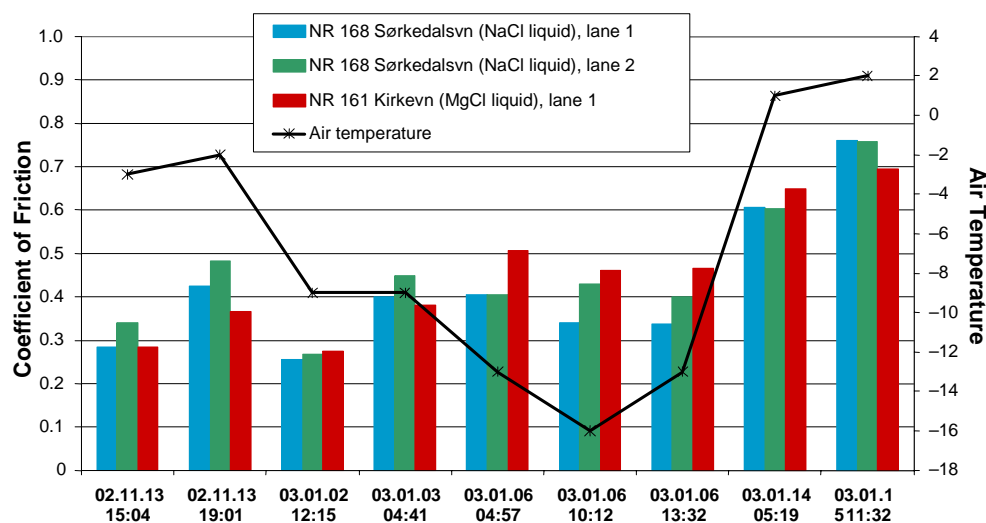

FIGURE 12 Results from friction measurements. (Testing $MgCl_2$ liquid as a prewetting agent to dry $NaCl$, the 2002–2003 winter season.)

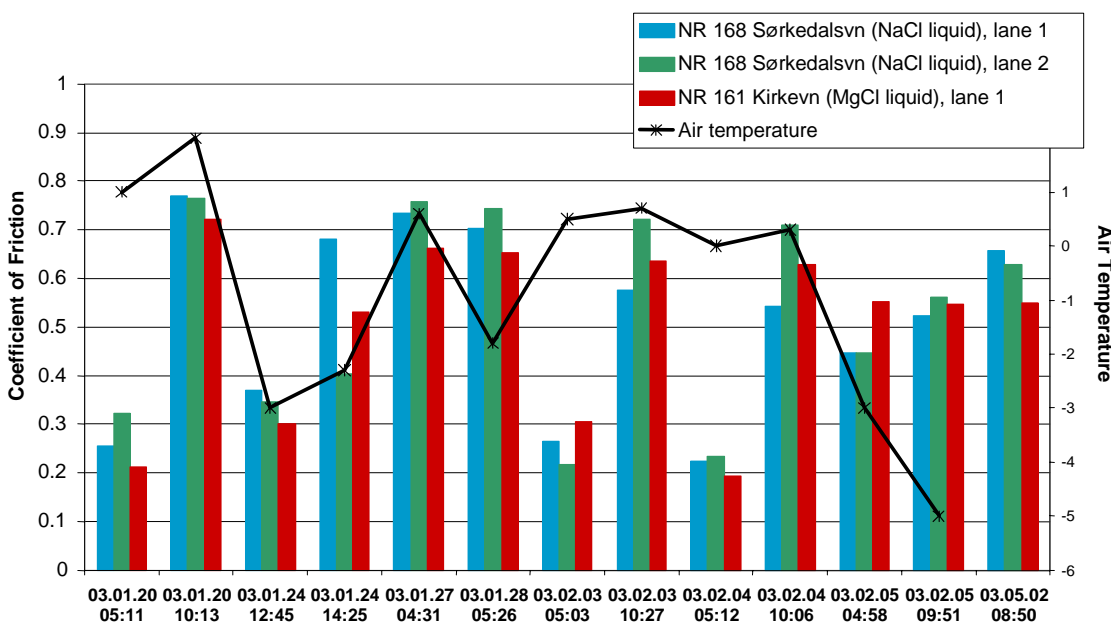

FIGURE 13 Results from friction measurements. (Testing $MgCl_2$ liquid as a prewetting agent to dry $NaCl$, the 2002–2003 winter season.)

the range $-5^{\circ}C$ to $-10^{\circ}C$. This indicates several cases with salting actions beyond the temperature range for $NaCl$ the 2002–2003 winter season. For the season as a whole the air temperature was below $-6^{\circ}C$ for 19% of the time.

Summarized over the whole winter season, there were 135 salting actions on Kirkeveien and 154 salting actions on Sørkedalsveien. The total amount of salt converted to consumption per m^2 showed that $0.67 \text{ kg salt}/m^2$ was spread on Kirkeveien and $1.45 \text{ kg salt}/m^2$ on Sørkedalsveien. This is equivalent to a difference of 216% through the 2003–2004 winter season; double the amount of salt/m^2 was used on Sørkedalsveien compared with Kirkeveien.

The difference in the number of actions and total amount of salt per area unit for a greater part should be claimed as a result of the salting methods and indicates that prewetting with $MgCl_2$ solution can lead to a reduction in the number of salting days and actions and reduced salt consumption.

From the friction measurements one occasion especially gave interesting results. During a snowfall from January 2 through 6, the temperature was $-16^{\circ}C$, and the friction was markedly higher on NR 161 with $MgCl_2$ liquid than on NR 168 with solid $NaCl$ prewetted with a $NaCl$ liquid. This gives an interesting perspective for the use of the $MgCl_2$ method at very low temperatures with regard to keeping the friction requirements.

It is too early to draw final conclusions after two winter seasons with the trials with prewetting $NaCl$ with $MgCl_2$ solution in Oslo. The results so far, however, are promising and underline that it is important to continue the project at least one more season to verify the findings with regards to the salt consumption and to how suitable the method is under extreme weather conditions with low temperatures.

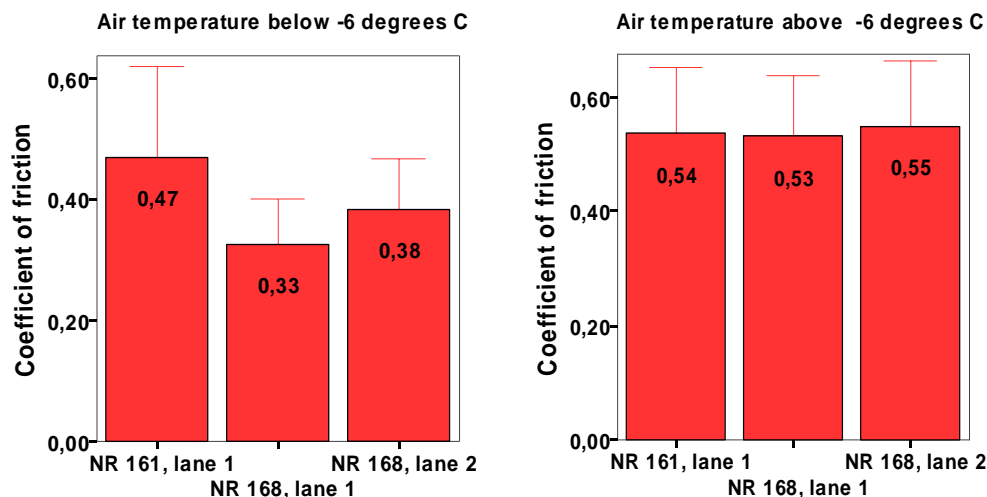

FIGURE 14 Mean friction values on resurfaced pavement on the test road sections.

REFERENCE

1. *Manual of Practice for an Effective Anti-icing Program: A Guide for Highway Winter Maintenance*. Personnel Publication No. FHWA_RD-95-202, June 1996.

ADDITIONAL RESOURCES

- Amrhein, C., J. E. Strong, and P. A. Mosher. Effect of Deicing Salts on Metal and Organic Matter Mobilization in Roadside Soils. *Environmental Science and Technology*, Vol. 26, 1993, pp. 703–709.
- Blomqvist, G. 1998. *Impact of Deicing Salt on Roadside Vegetation: A Literature Review*. VTI report 427A, 1998.
- Fitch, G. M., and D. S. Roosevelt. Environmental Implications of the Use of “Ice Ban” as an Ice Prewetting Agent for Sodium Chloride. *Transportation Research Record: Journal of Transportation Research*, No. 1700, TRB, National Research Council, Washington, D.C., 2000, pp. 32–37.
- Jarvinen, H.-L. *Technical Characteristics and Environmental Impacts of Deicing Chemicals*. Engineering Geology, Tampere University of Technology, Tampere, Finland, 1995.
- Labadia, C. F., and J. M. Buttle. Road Salt Accumulation in Highway Snow Banks and Transport Through the Unsaturated Zone of the Oak Ridges Moraine, Southern Ontario. *Hydrological Processes*, Vol. 10, 1996, pp. 1575–1589.
- Mengae, K., and E. A. Kirkby. *Principles of Plant Nutrition*. 4th ed. International Potash Institute, Bern, Switzerland, 1987.
- Minner, D. D., B. R. Bingaman, and J. A. Gall. The Effect of Deicing Chemicals on Turfgrass. In *Proc., 10th Piarc International Winter Road Congress*. VTI report, Vol. 2, 1998, pp. 529–537.

MATERIAL DISTRIBUTION, PERFORMANCE, AND RESIDUAL

Assessment of Safecote
*New Deicer Product***MARILYN BURTWELL***Transportation Research Laboratory Limited*

Ideally, a deicer used on pavements for winter maintenance should be effective, safe, and a good value for money. It should demonstrate quantifiable benefits for the community and the environment in keeping roads free of ice and snow while ensuring that the mobility and safety of the public are maintained and that environmental standards are met.

The Highways Agency's Environmental Strategy for England's Main Roads (1) and the United Kingdom Environment Agency's policy encourage best practice and the use of products that reduce the input of pollutants such as chloride into the natural environment. The use of more environmentally friendly deicer products could also help to provide a cost-effective solution to mitigate against structural damage.

Safecote Ltd, a company based in the United Kingdom, introduced a new deicer product based on extensive experience of its application in the United States and with the potential to help reduce chemical contamination of the environment. In 2000, Transportation Research Laboratory (TRL) Limited was commissioned to investigate the effect of this deicer product, when used in precautionary salting, as an additive or prewetting agent for salt products. As a prewetting agent to salt, the primary aims are to reduce the chloride component of the treatment in order to mitigate against the damaging effects of salt to the environment and to reduce the level of damage that occurs to both concrete and steel when chloride-based deicers are used for winter maintenance.

The study was carried out in the two phases and various properties of Safecote were evaluated:

- Phase 1
 - Freeze/thaw damage to concrete
 - Skid resistance and binder stripping of asphalt surfacing
 - Corrosion of steel and aluminium coupons
 - Environmental impact
- Phase 2
 - Freezing point temperature (FPT) depression
 - Environmental assessment: highway runoff and leaching
 - Skid resistance of asphalt surfacings
 - Application and spreading characteristics
 - Ice melt, ice penetration, and ice undercutting

This paper summarizes the findings from both phases of the study.

DAMAGE CAUSED BY CHLORIDE IN SALT

For comparison purposes, the properties of indigenous rock salt, which is the predominant deicer used on pavements for winter maintenance in the United Kingdom, were evaluated against those of Safecote and salt pretreated with Safecote (see section on deicing formulations). Rock salt is used extensively because it is inexpensive, easy to spread, and effective in keeping pavements safe in the winter. Damage to vegetation, soil, water quality, vehicles, and infrastructure is the known negative impact of rock salt, although it should be noted that most deicers have some of these environmental impacts (2).

Salt is transported onto highway verges either directly from salt spreaders or with the assistance of wind and bounce from the pavement surface. This “salt mist” has an impact on the local soil and vegetation, with the greatest concentration of salt found within 3 m of the pavement edge and within the top 1 m or so of soil. Salt can also reach the natural environment as a result of runoff from stockpiles and from highway runoff into drainage systems, which then discharges into watercourses.

A survey of 200 concrete highway bridges carried out by Maunsell & Partners (3) found that many of the bridges had reinforcement corrosion because of the high chloride content in the concrete caused by the use of salting for winter maintenance. The study confirmed that leakage through bridge joints occurred frequently. Consequently, areas of the abutments, piers, and deck soffits became stained and contaminated with chloride. Other areas were affected by spray from passing vehicles. Since this survey, low-permeability concrete mixes, silane impregnation, and new designs to minimize the number of joints have been successfully used to control the damage and reduce the incidence of severe chloride attack.

Whether a reduction in the quantity of salt entering the terrestrial environment could be accomplished more effectively by the use of prewetted salt or brine only or by improving the control of the rate of spread of dry salt during spreading operations is currently the subject of investigation. This research has been commissioned for Motorways and Trunk Roads by the HA and for local roads by the National Salt Spreading Research Group (NSSRG) and is being carried out on their behalf by TRL Limited.

The environmental impact as a consequence of using dry salt as a precautionary treatment in the United Kingdom has been estimated to be £100 million (4) per winter. This includes damage to vehicles, pavement structures, and the environment. Thornes (5) reported that the total cost of corrosion in the United Kingdom was £157 million and that, for every £1 spent on winter maintenance in the United Kingdom, approximately £8 is saved in the reduction of winter-related traffic accidents and delays. While technological improvements in materials and paints have reduced the corrosive effects of rock salt, there still remain considerable infrastructure and vehicle damage and costs of maintenance.

Vitaliano (6) reported that the true cost of salt used for deicing roads is estimated at more than US\$800 per ton (approximately £511 per ton at 2003 exchange rate) in the United States. He estimated that bridges exposed to deicing salt had an average life expectancy of 15 to 18 years, although bridges in low-salt or no-salt environments had an average life of 100 years or more.

If the overall chloride content reaching the environment were to be reduced, there would be many benefits to be gained, not least a reduction in the cost of structural repairs, a reduction in the contamination of highway runoff, reduced concentrations in watercourses, and reduced effects on flora and fauna.

DEICING FORMULATIONS

In general, the following formulations were evaluated in the study, but, at the request of the client, not all the formulations were considered in every phase of the work:

1. S1: Safecote added as a prewetting agent/admixture to solid rock salt (NaCl) at 33.3 litres of Safecote to 1,000 kg of rock salt;
2. S2: Safecote added as a prewetting agent/admixture to NaCl at 22.2 litres of Safecote to 1,000 kg of NaCl;
3. C32: a Safecote/calcium chloride (CaCl_2) deicing liquid at a 32% solution of CaCl_2 (by weight) added to Safecote in a 1:1 ratio (by volume);
4. M30: a Safecote/magnesium chloride (MgCl_2) deicing liquid at a 30% solution of MgCl_2 (by weight) added to Safecote in a 1:1 ratio (by volume); and
5. Safecote: the undiluted product.

Also, where requested by the client, these formulations were compared with the effects of various other deicers, which included NaCl, Urea, ApClear KA1 (potassium acetate), ethylene glycol, prewettted salt (NaCl with a CaCl_2 prewetting agent), and MgCl_2 . With the exception of the latter chemical, these deicers are actively used in the United Kingdom.

SUMMARY OF THE RESULTS

Freeze/Thaw Damage to Concrete

The effect of the M30 and C32 formulations on the level of freeze/thaw damage to concrete mixes was assessed and compared with the effect of NaCl. The tests were carried out on two types of pavement-quality concrete (PQC): one for use on highways (designated Mix PQ) and one for use at airports (designated Mix A), under the test method given in prEN 1338 (7).

After a 28-day period of 24-h freeze/thaw cycles with 3% solutions of the various deicers, the specimens were assessed visually and by collection of loose material from the concrete test surface. Table 1 shows the weight loss from each specimen expressed in kg/m^2 .

The Safecote-based formulations caused no visual damage to either of the concrete mixes whereas damage was caused by NaCl. Loose material was collected from the surface of the majority of the specimens, but in the case of M30 and C32 it did not appear to be scaled concrete. The most likely reason was that a reaction occurred between some component of the deicing solution and the soluble alkalis in the concrete causing a precipitate to form. Where NaCl had been used, the recovered material from the specimens was scaled concrete.

Specimen A8 had a high weight loss, which was because of a large piece of aggregate close to the surface that was severely scaled. In general, the Mix A concrete specimens showed more damage than the Mix PQ specimens when exposed to the 3% NaCl salt solution.

The experimental test program was designed to investigate the effect of two formulations of the Safecote family of deicing products on concrete under carefully controlled laboratory freeze/thaw conditions. It cannot be guaranteed that the same general results will be obtained if the products are used in the field where deicer concentrations will vary and will be applied to a wide range of different concrete types. Both magnesium ions and, to a lesser extent calcium ions,

TABLE 1 Freeze/Thaw Test Results

Cube No.	Solution	Surface Area (mm ²)	Weight of Solid Material Collected		Mean Weight of Solid Material Collected (kg/m ²)
			(mg)	(kg/m ²)	
A1	C32	8560	420	0.0491	0.0588
A2	C32	8560	540	0.0631	
A3	C32	8560	550	0.0643	
A4	M30	8560	0	0.0000	0.0000
A5	M30	8560	0	0.0000	
A6	M30	8560	0	0.0000	
A7	NaCl	8560	2510	0.2932	0.3989
A8	NaCl	8560	8750	1.0222	
A9	NaCl	8560	940	0.1098	
A10	NaCl	8560	1460	0.1706	
PQ1	C32	8560	410	0.0479	0.0230
PQ2	C32	8560	80	0.0093	
PQ3	C32	8560	100	0.0117	
PQ4	M30	8560	30	0.0035	0.0058
PQ5	M30	8560	40	0.0047	
PQ6	M30	8560	80	0.0093	
PQ7	NaCl	8560	80	0.0093	0.0167
PQ8	NaCl	8560	230	0.0269	
PQ9	NaCl	8560	120	0.0140	

can cause deterioration of concrete by chemical, as opposed to physical (i.e., freeze/thaw) means. Where freeze/thaw attack is known to be most prevalent at low concentrations, chemical attack usually occurs more rapidly at higher concentrations. Evaluation of this aspect would require further testing.

Skid Resistance and Binder Stripping of Asphalt Surfacing

In Phase 1, the effect of the formulations on the skid resistance of asphalt surfacing materials was investigated with a portable skid-resistance tester (8) (Figure 1). Two different materials were used: a fine-textured and an open-textured asphalt surfacing. The effects of the deicers were evaluated for a range of concentrations. For normal road sites, a minimum skid-resistance value (SRV) of 45 was considered to be adequate, but for high-speed roads and sites such as roundabouts, values of 55 and 65 were required.

Solutions were prepared by weight using deionized water and were

- a. 3%, 10%, and 20% NaCl (allowance made for insoluble material);
- b. 3%, 10%, and 20% MgCl₂;
- c. C32 diluted to give 3%, 10%, and 16% CaCl₂ (C32 diluted 1:4.3, 1:0.6, and 1:0 with water);



FIGURE 1 Portable skid resistance tester

- d. M30 diluted to give 3%, 10%, and 15% MgCl_2 (M30 diluted 1:4, 1:0.5, and 1:0 with water);
- e. S1 diluted to give 3%, 10%, and 22.5% NaCl solution (S1 diluted 1:6.5, 1:2.5, and 1:0 with water);
- f. Prewetted salt brine [(2.1% NaCl + 0.9% CaCl_2 solution), (7% + 3% and 14% + 6%)];
- g. 3%, 10%, and 20% urea;
- h. 3%, 10%, and 20% potassium acetate (ApClear KA1);
- i. 3%, 10%, and 20% ethylene glycol; and
- j. Deionized water.

Note: C32 is 32% calcium chloride brine (by weight) mixed in equal volumes with Safecote. M30 is 30% magnesium chloride brine (by weight) mixed in equal volumes with Safecote. S1 is 0.8% Safecote in brine (225g/l NaCl). ApClear KA1 is a 50% solution of potassium acetate

The different solutions were used to wet the surface of the specimens in place of the water that would normally be used for the standard skid-resistance test.

At all the concentrations tested, the S1 formulation had no detrimental effect on the skid-resistance value (SRV), but the undiluted C32 and M30 formulations reduced the SRV. As a consequence, their use may not be suitable as a precautionary deicer on surfaces close to the minimum permitted skid resistance. Their use might be acceptable where immediate dilution of the product can be expected (i.e., when used on snow and ice already present on the road surface) or on surfaces with an SRV well above the minimum permitted skid resistance.

In general, as the concentrations of all the deicing solutions increased, the SRVs decreased (Figures 2 and 3). The decrease was most pronounced with the M30 and C32 Safecote-based formulations when used at the highest concentrations. With the surfacing materials used, the values obtained were below the minimum permitted value of 45.

The SRV values of the S1 solutions—3%, 10%, and 22.5% rock salt solutions—were as good as the 3%, 10%, and 20% concentrations of NaCl on the fine-textured surfacing and

slightly better than the NaCl solutions on the open-textured surfacings at all concentrations. This is encouraging as it suggests that S1 could be used with no detrimental effect on the SRV.

In Phase 2, skid-resistance tests were carried out using the S2 formulation. The effective skid resistance of the S2 formulation was compared with NaCl on the same test surface with the TRL SCRIM machine (9). S2 formulation and salt (grade 6.3mm) were applied with a typical spreader at rates of 10g/m^2 and 20g/m^2 .

Under dry conditions, consistent high values were obtained for the S2 formulation and for NaCl at both spread rates. The S1 and S2 formulations showed no detrimental effect on the skid resistance of the road surfaces tested.

Tests in Phase 1 were undertaken to investigate whether the S1 formulation would lead to binder stripping of the aggregate in asphalt surfacing materials. The method employed was as given in MoD Specification 040, Appendix B (10). There was no evidence of binder stripping for the aggregate/binder combination tested.

Corrosion of Steel and Aluminium Coupons

The effect of a range of Safecote and non-Safecote-based deicing chemicals on the corrosion of steel and aluminium coupons was investigated using a modified version of the neutral salt spray test as given in BS 7479 (11).

Steel coupons were tested with the following solutions:

1. 5% NaCl (allowance was made for insoluble material and the solids were removed before use),
2. 5% MgCl_2 ,

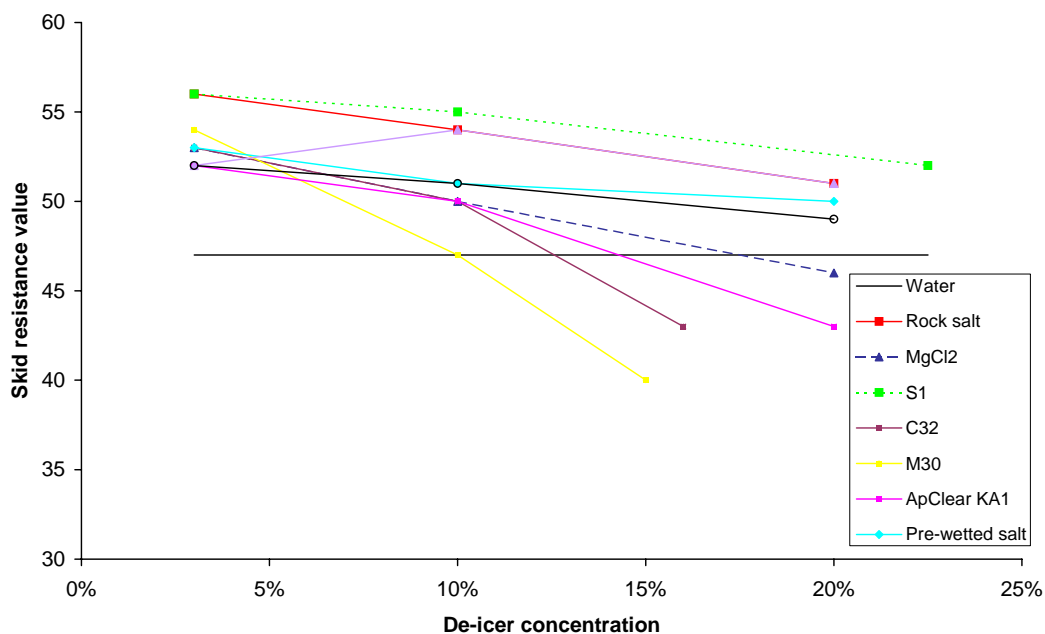

FIGURE 2 Effect of deicer concentration on the skid resistance of an open-textured asphalt surfacing.

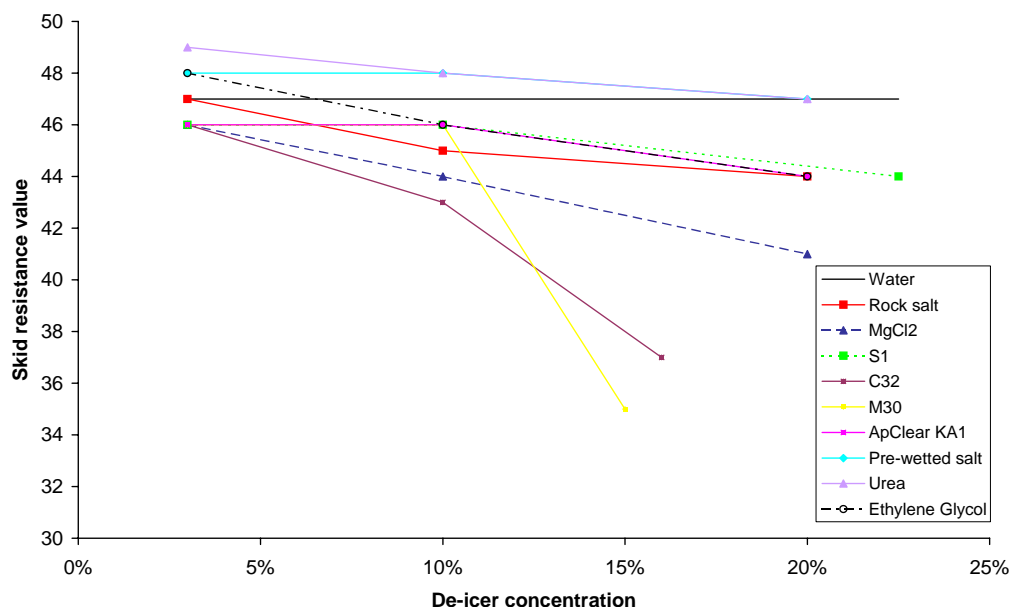

FIGURE 3 Effect of deicer concentration on the skid-resistance of a fine-textured asphalt surfacing

3. C32 diluted to give 5% active material (C32 diluted 1:7.2 with water),
4. M30 diluted to give 5% active material (M30 diluted 1:7 with water),
5. S1 diluted to give 5% active material (S1 diluted 1:3.7 with water),
6. Prewetted salt brine (3.5% NaCl + 1.5% CaCl₂ solution),
7. 5% urea,
8. 5% potassium acetate (10% ApClear KA1),
9. 5% ethylene glycol, and
10. Deionized water.

The corrosion products were removed from the steel coupons by using Clarke's Solution. This is an established method that uses hydrochloric acid (HCl) with additions of antimony trioxide (Sb₂O₃) and stannous chloride (SnCl₂·2H₂O); these additions inhibit the action of the acid on the steel while allowing the corrosion products to be dissolved.

Aluminium coupons were tested with the following solutions:

1. 5% Safecote,
2. 5% NaCl,
3. 5% potassium acetate (10% ApClear KA1), and
4. Deionized water.

The procedure adopted to remove corrosion products from the aluminium coupons was that given in American Society of Testing Materials (ASTM) G1-90 (12) and the *Handbook of Test Methods for Evaluating Chemical Deicers* (13). The average 7-day weight losses are given in Table 2 together with a relative corrosion rating.

Prewetted salt brine and rock salt produced the most corrosion on steel with weight losses after 7 days of 3.1 g and 2.5 g, respectively. The weight losses with deionized water and M30

were low, at less than 0.5 g. All the other materials tested fell between these limits with C32 giving approximately 0.8 g loss of weight.

The S1 formulation only caused 55% of the corrosion seen with rock salt and was approximately comparable with ApClear KA1 and Urea. This suggested that the Safecote may have a beneficial effect on chloride-induced corrosion of bare steel. As a further comparison, prewetted salt caused 127% of the corrosion seen with rock salt alone.

The weight loss from all of the aluminium tests was low compared with steel with the deionized water causing the most weight loss of 0.07 g at 7 days. The rock salt caused less than half the corrosion seen with deionized water with a weight loss of 0.027 g. Both Safecote and ApClear KA1 caused barely measurable weight loss, while Safecote caused slightly more corrosion than ApClear KA1 although the difference was minimal. Prewetted salt was not tested on aluminium samples.

FPT Depression

Tests were undertaken in a climate chamber to determine the FPT depression of an S2 formulation as a deicer. The S2 formulation was compared with solutions of rock salt, a 23.3% saturated solution of brine, undiluted Safecote and Safecote with brine. Deionized water was used as a control. The test data were transformed into graphs of cooling curves. At other points on the curves, the data were extrapolated to obtain the FPTs.

The results showed that for 3% and 5% solutions of the S2 formulation, the FPTs were at least as good as rock salt alone. There is no evidence however that the addition of Safecote improves the FPT.

Environmental Impact

Based on the chemical analysis of the Safecote product and information supplied by the client, an assessment of the environmental effects of using Safecote-based deicers was carried out.

TABLE 2 Average 7-Day Weight Loss and Relative Corrosion Rate (RCR)

Solution	Steel		Aluminium	
	Weight Loss (g)	RCR (%)	Weight Loss (g)	RCR (%)
Rock salt	2.453	100	0.0273	100
MgCl ₂	1.878	77	—	—
C32	0.822	34	—	—
M30	0.452	18	—	—
S1	1.356	55	—	—
Prewetted Salt	3.115	127	—	—
Urea	1.376	56	—	—
ApClear KA1	1.310	53	0.0002	1
Ethylene Glycol	1.609	66	—	—
Deionized water	0.230	9	0.0729	267
Safecote	—	—	0.0028	10

Note: RCR is percentage weight loss relative to rock salt.

In Phase 1, it was determined that the Safecote product had a high biological oxygen demand (BOD), appreciable amounts of various heavy metals, and possibly a high phosphorus content. As a consequence, the use of large amounts of Safecote over a winter maintenance period could have significant negative impact on the environment. However, Safecote is primarily intended for use in conjunction with rock salt or other deicers for UK highway applications. Therefore, to determine the overall environmental effect of using a Safecote-based deicer, further evaluation was carried out in Phase 2. The results are given in the following sections on highway runoff and leaching.

Highway Runoff

Guidelines from the *Design Manual for Roads and Bridges (14)* suggest a basic methodology for calculating dilution factors and subsequent contribution as a concentration to the downstream watercourse. Calculations were made for two theoretical scenarios for a stream along a 1-km length of carriageway comprising four lanes with no camber. Scenario A had high dilution, a high runoff rate, and rapid discharge into watercourses. Scenario B had low dilution, less precipitation, and a smaller runoff rate.

It was found that the S2 formulation complies with the UK water quality standard and the current UK Environment Agency standards for highway runoff for heavy metals and other chemicals.

The results showed that, as an additive to rock salt, Safecote was likely to be far less damaging to the environment than rock salt alone. Safecote may be best suited to highway deicing when used at a recommended application ratio of 3% weight for weight to rock salt.

Leaching

It was concluded that the addition of Safecote to salt should not cause a leaching problem at highway depots that were adhering to environmental standards for storage facilities and proper management of stockpiles.

Application and Spreading Characteristics

Spreading trials were carried out to compare the performance of the S2 formulation with virgin 6.3-mm rock salt in order to assess whether the addition of Safecote to rock salt enhanced the spreading performance and whether it improved the distribution of rock salt into the desired target spread area.

Spreading trials of the S2 formulation compared with virgin 6.3-mm rock salt were undertaken with a Foden/Telstar dual spinner spreader at the TRL Research Track. The experiment comprised eight runs at 50 km/h along a simulated three-lane motorway in accordance with BS 1622 (15). This combination was designed to deliver salt to three lanes and the hard shoulder. The S2 formulation (ratio of 22.2 liters per ton of rock salt) was applied at spread rates of 10g/m² and 20g/m².

The mean results of the 10g/m² spread showed that more salt was spread into the target zone with the S2 formulation than with rock salt alone. The target spread was achieved in most of the hard shoulder, Lanes 1 and 2, and the nearside of Lane 3. Underspreading occurred in Lane 3, although this was also true for rock salt. Overspreading beyond the target zone also

occurred, but this was less for the S2 formulation than the rock salt and suggested that the addition of Safecote to rock salt gives improved salt control. The mean results of the 20g/m² spread indicated that the S2 formulation gave similar improved performance in the target area.

Dry spreading normally results in longitudinal snaking effects with nonuniform spread patterns whereas prewetted salt spreading normally tends to reduce this effect. The addition of the S2 formulation to the rock salt reduced the longitudinal snaking effect.

SHRP Tests: Ice Melt, Ice Penetration, and Ice Undercutting

The S2 formulation was tested against the Strategic Highway Research Program (SHRP) methods for evaluating chemical and solid deicers (13). The S2 formulation was dissolved in demineralised water to give a 25% solution by weight. For comparison, the same tests were also carried out on a 25% solution of rock salt.

The following SHRP set of tests were specified:

- SHRP H-205. I test method for ice melting of solid deicing chemicals,
- SHRP H-205.3 test method for ice penetration of solid deicing chemicals, and
- SHRP H-205.5 test method for ice undercutting by solid deicing chemicals.

The results showed that the test solutions of both products are equally effective in an initial 30-min period during the ice melt and ice penetration processes at the test temperatures of -2°C, -6°C, and -10°C. However, the S2 formulation is slightly more effective than salt over the 1-h test period.

The S2 formulation is slightly more effective in the ice undercutting process at test temperatures of -2°C, -6°C, and -10°C than rock salt for the solution concentrations tested.

CONCLUSIONS

With its good corrosion inhibitor properties, its nonstripping properties of binders from asphalt surfacings, its reduced concrete spalling to structures compared with rock salt, and its nondetrimental effect on the skid resistance of the road surfaces tested, Safecote has the potential to be used as a prewetting agent for wetted salt treatments. Hence, this could reduce the adverse effects on the environment and transport structures and the quantity of salt used.

The addition of Safecote to salt should not cause a leaching problem at highway depots that are adhering to environmental standards for storage facilities and proper management of stockpiles.

From the results, it appears that the S2 formulation is slightly more effective than rock salt in the ice melt, ice penetration, and ice undercutting processes over a period of at least 1 h. However, similar properties are demonstrated by both products in an initial 30-min period during the ice melt and ice penetration processes for the solution concentrations tested.

The dissolving rate of salt is dependent on the particle size of the salt used. The larger the particle size, the longer the salt takes to enter solution. The addition of Safecote to salt appears to speed up the dissolving process compared with rock salt alone. For safety reasons in particular, it is important that a deicer melts the ice layer quickly in order to expose the pavement surface.

Based on the range of tests carried out, Safecote may be best suited to pavement deicing when used as an additive to salt at the standard application ratio of 3% weight for weight.

RECOMMENDATIONS

A number of recommendations emerged from the study, and it is planned to follow them up in a further testing program.

1. A rigorous cost–benefit analysis for the use of Safecote formulations should be carried out to determine whether real monetary gains could be realized for the deicing of UK roads. This is particularly relevant in demonstrating the “holdover” times of Safecote formulations in order to reduce the number of applications required.
2. The long-term benefits offered by Safecote formulations to the environment, through reduced chloride content, should be compared with salt products. The component benefits to highway runoff, soil contamination, corrosion of steel reinforcement, and aluminium and spalling of concrete structures should be fully quantified.
3. The long-term cost reduction as a consequence of mitigation of infrastructure damage due to chloride attack, although clear from the test results of concrete, asphalt, and corrosion damage mitigation, cannot be financially quantified at this stage and will vary according to regional infrastructure characteristics and climatic conditions. It is therefore recommended that winter maintenance practitioners take a view as to how they might quantify the possible benefits based on their own operational experience, and the type and nature of their infrastructure assets.

In the case of the environmental aspects, the UK Environment Agency has shown an interest in testing the BOD, COD levels of Safecote in water courses, soil, and vegetation so further data will be available. It is thought that setting threshold levels of different contaminants found in the environment may be one way of controlling the impact associated with winter deicing.

ACKNOWLEDGMENTS

The author wishes to thank Safecote Ltd for its support and encouragement during the studies and Tracy McKeown, Phil Henderson, and Richard Bowen of the UK Environment Agency for their guidance. An example of leachating data was obtained with permission from Matthew Lugg and David Groom of Cambridgeshire County Council. Finally, the author wishes to thank Adine Hird and Malcolm McKenzie of TRL Ltd for their valuable contributions to the research.

NOTE

Copyright TRL Limited 2004. All rights reserved. Published with permission

The information contained herein is the property of TRL Limited and does not necessarily reflect the views or policies of the customer that sponsored this paper. While every effort has been made to ensure that the matter presented in this paper is relevant, accurate, and

up-to-date at the time of publication, TRL Limited cannot accept any liability for any error or omission.

REFERENCES

1. *Business Plan 1998–1999*. UK Highways Agency, London, 1998.
2. Mangold, T. *Road Salt Use for Winter Maintenance: A Review of Impacts, Alternatives and Recommendations for the St. Paul Campus Stormwater Management Plan*. 2000, www.cnr.umn.edu/sci/StudProj/5061Mangold.pdf.
3. Wallbank, E. J. *The Performance of Concrete Bridges: A Survey of 200 Highway Bridges*. Department of Transport, London, 1989.
4. Thornes, J. E. An Estimate of the Economic Benefits of Winter Road Maintenance in the UK. In *Proc., Cold Comfort: 4th Annual Winter Maintenance Conference and Exhibition*. Nottingham, UK, 1995.
5. Thornes, J. E. Road Salting—An International Benefit/Cost Review. In *Proc., 8th World Salt Symposium*, Elsevier, Amsterdam, Netherlands, 2000, pp. 787–792.
6. Vitaliano, D. F. An Economic Assessment of the Social Costs of Highway Salting and the Efficiency of Substituting a New Deicing Material. *Journal of Policy Analysis and Management*, Vol. 11, No. 3, 1992, pp. 397–418.
7. *Concrete Paving Block, prEN 13381*. British Standards Institution, London, 1993.
8. Instruction for Using the Portable Skid-Resistance Tester. In *Road Note 27*, 2nd ed., Road Research Laboratory, HMSO, London, 1969.
9. *Methods for Measuring the Skid Resistance of Pavement Surfaces. Part 1: Side-Way Force Coefficient Routine Investigation Machine*. BS 7941-1. British Standards Institution, London, 1999.
10. *Porous Friction Course Surfacing for Airfields*. Specification 040. Defence Estate Organisation, Ministry of Defence Stationery Office, London, 1998.
11. *Method for Salt Spray Corrosion in Artificial Atmospheres*. BS 7479:1991. British Standards Institution, London, 1991.
12. *Standard Practice for Preparing, Cleaning and Evaluating Corrosion Test Specimens*. ASTM G1-90, 1999.
13. Chappelow, C. C., A. D. McElroy, R. R. Blackburn, D. Darwin, F. G. de Noyelles, and C. E. Locke. *Handbook of Test Methods for Evaluating Chemical Deicers*. TRB, National Research Council, Washington, D. C., 1992.
14. Assessment Methods and Worked Examples. In *Design Manual for Roads and Bridges*, Vol. 11, Section 3, Part 10, Annex III. Department for Transport, London, 1998.
15. *Spreaders for Winter Maintenance*. BS 1622: 1989, British Standards Institution, London, 1989.

MATERIAL DISTRIBUTION, PERFORMANCE, AND RESIDUAL

Development and Evaluation of Nonchloride Antifreeze Admixture

TOSHIYA TAKESHI
KAZUHARU KOBAYASHI
SEISHI MEIARASHI

Incorporated Administrative Agency of Public Works Research Institute

The Law for the Prevention of Spiked Tire Dust was announced in June 1990 to solve the problem of dust produced by spiked tires. The use of chloride antifreeze admixture for control of winter road surface in cold snowy regions has shown since then a tendency to increase year by year. The percentage of total snow removal costs spent on antifreeze admixture spreading has been increasing steadily. Currently the majority of antifreeze admixture used in Japan is a chloride type (calcium chloride, sodium chloride, etc.). Concern with its effects on roadside environments and structures also has appeared. This report presents the state of development of nonchloride antifreeze admixture that inflicts little salt damage. It also reports on the result of laboratory evaluations of various compounds and on the results of field test spreading of antifreeze admixture. Simultaneous spreading of chloride antifreeze admixture (calcium chloride) and the nonchloride one (sodium acetate) was done. The comparison of the effect was carried out by the skid friction coefficient and a questionnaire of operators driving snow graders and snow removal trucks. Though the calcium chloride spreading section generally exceeded slightly the sodium acetate section, in a few cases the sodium acetate showed better results. It is necessary to improve nonchloride antifreeze admixture and carry out research toward proposed spreading techniques.

INTRODUCTION

Approximately 60% of the land in Japan that is in special, cold, snowy regions is home to approximately 20% of the country's population. These regions are subject to road disasters and traffic accidents caused by accumulated snow and road icing. The Law for the Prevention of Spiked Tire Dust was announced in June 1990, and the use of spiked tires by all motor vehicles including large trucks was prohibited in restricted districts beginning in April 1993 to solve the problem of dust produced by spiked tires. Although the dust was reduced, the law has resulted in the appearance of slippery road surfaces. Antifreeze admixtures are spread as a measure to deal with this problem, but the volume of winter traffic has risen and, in response to public needs, the quantity of antifreeze admixture spread also has increased. This measure now accounts for a large portion of snow removal costs. Currently the majority of antifreeze admixture used in Japan is a chloride type (calcium chloride, sodium chloride, etc.). Concern with its effect on roadside environments and structures also has appeared. Development of new environmentally friendly antifreeze admixtures that inflict little salt damage and establishment of more effective and more efficient spreading methods are hoped for (1). This report presents the change over a period of years in the quantity of antifreeze admixture spread on the main roads of Japan. It also

reports on the results of laboratory evaluation of various compounds and the results of the test spreading of antifreeze admixture in some model regions.

CHANGE IN THE QUANTITY OF ANTIFREEZE ADMIXTURE SPREAD

Figure 1 shows the quantity of antifreeze admixture spread on the main roads of Japan in 1990 and from 1997 until 2001. A countermeasure for road surface freezing in cold, snowy regions of Japan began in earnest in 1964 and increased by less than 150,000 tons up to 1990. The quantity of antifreeze admixture used after 1990 has been increasing, as shown in Figure 1. The quantity of antifreeze admixture use has tripled, up to 490,000 tons in 2000. Figure 1 also shows that chloride type antifreeze admixture, such as sodium chloride and calcium chloride, accounted for 90% of total chemical spreading.

RESULT OF LABORATORY EVALUATION

Quantity of ice melted tests and steel plate corrosion tests were done to evaluate nine kinds of chemical compounds as antifreeze admixture in the laboratory. The sodium chloride and calcium chloride types also were tested for comparison.

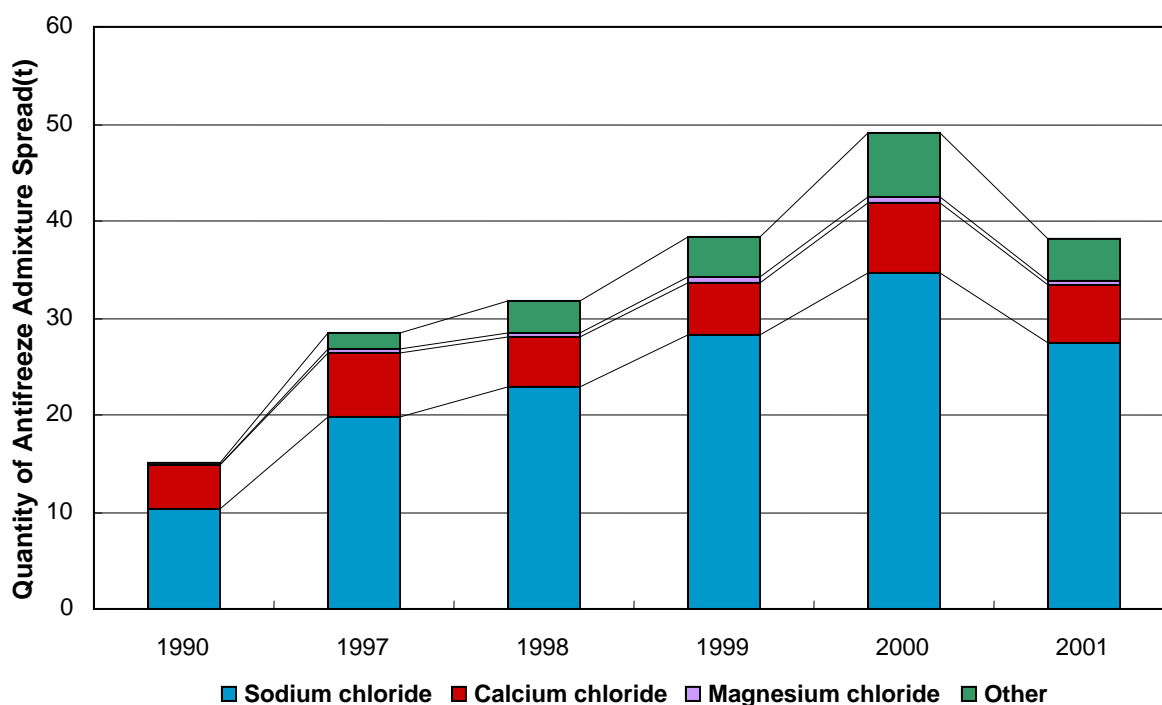

FIGURE 1 Change in the quantity of antifreeze admixture spread.

Quantity of Ice Melted Test Result

The results of quantity of ice melted measurements in a test conducted at -5°C are shown in Figure 2. Among the nonchloride chemicals, sodium formate provided the best ice-melting capability, considered equal to that of the chloride compounds. The next best melting capability was that provided by mixtures containing chloride compounds. The results confirmed that the ice-melting capability of sodium acetate, potassium acetate, and calcium magnesium potassium acetate are all equivalent to compounds including chloride. This test showed that the ice-melting capability of urea and of calcium magnesium acetate (CMA) are both relatively low.

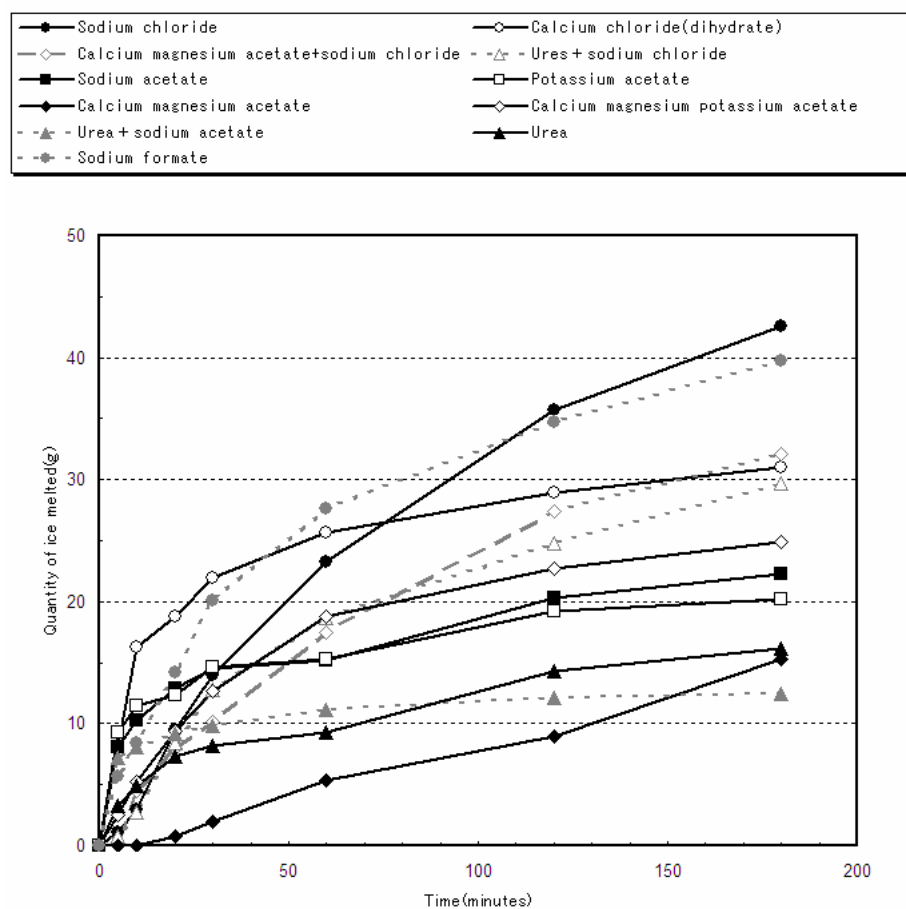

FIGURE 2 Results of measurement quantity of ice melted (-5°C , 5 g).

Steel Plate Corrosion Test Results

Corrosion testing using steel plate (JIS G 3141 cold rolled steel plate) was performed, and steel plate corrosion rates were obtained (Figure 3). The corrosion rates of the sodium chloride and calcium chloride were between 80 and 90 mdd. Among the mixtures including a chloride substance, the corrosion rate of the mixture of urea and sodium chloride was highest at 130 mdd. The corrosion rate of the sodium formate was about 40 mdd, which is equal approximately to that of the chemical made by mixing CMA with sodium chloride. Those containing only an acetate compound caused almost no corrosion.

Evaluation of the Prototype

According to these results, it was determined that, among the nonchloride types, an acetic acid compound was suitable as a nonchloride antifreeze admixture regarding its metal corrosion, environmental safety, and stability of supply of this chemical. The nonchloride antifreeze admixture, made with sodium acetate, was manufactured on a trial basis and was evaluated for the skid friction coefficient using a simple skid friction measurement device in the laboratory. The outline of this device is shown in Figure 4. A slider was pulled by a linear motor at a constant speed and this device detects a load by the load cell. A rubber board (length and width: 10cm; thickness: 1 cm) made of the same material as a tire was fixed under the slider. The measurement of the skid friction coefficient is shown in Figure 5. The skid friction coefficient of the sodium acetate antifreeze admixture was found to be marginally lower than the calcium chloride one. However, the actual effectiveness is expected to be equal.

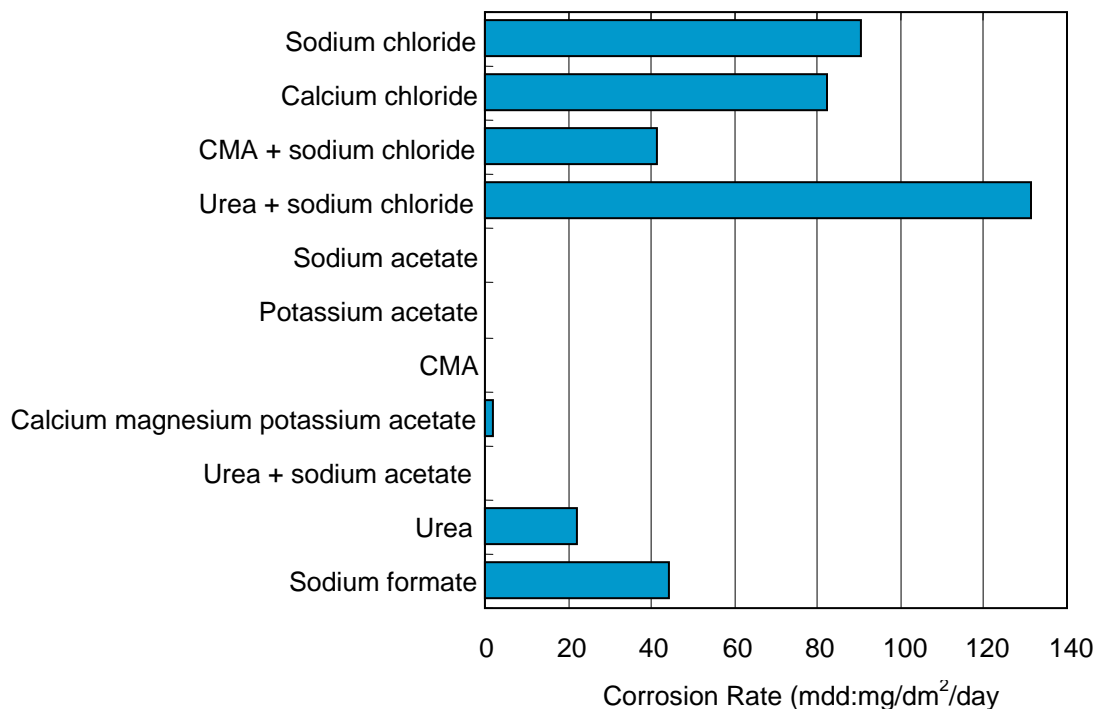

FIGURE 3 Steel plate corrosion test results.

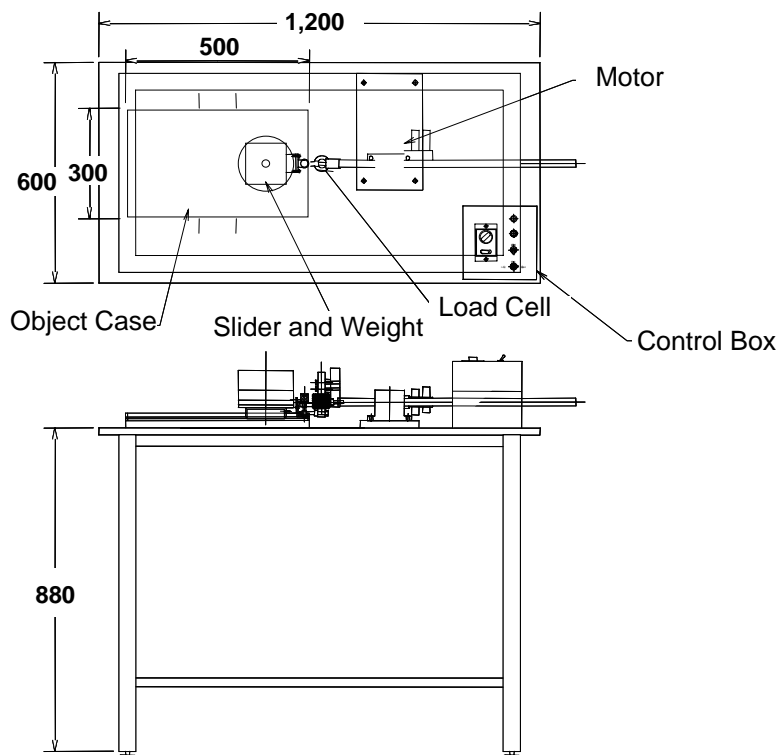

FIGURE 4 Outline of a simple skid friction measurement device in the laboratory.

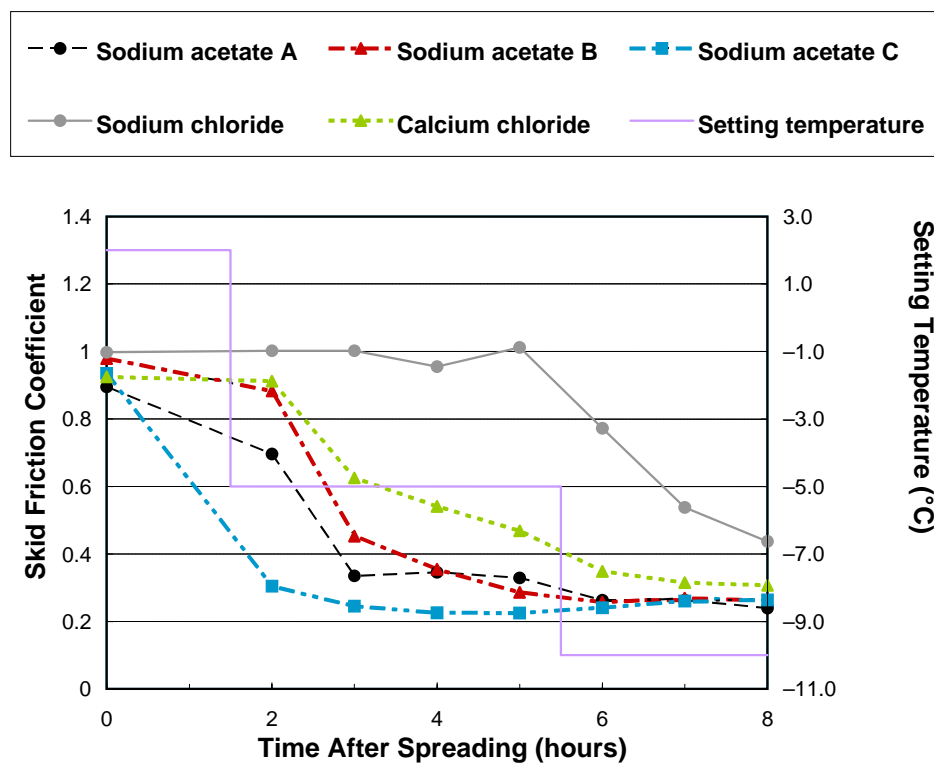

FIGURE 5 Results of measurement of skid friction coefficient in the laboratory.

FIELD VERIFICATION TEST OF NONCHLORIDE ANTIFREEZING ADMIXTURE

Outline of the Test

The test was performed in January–February 2003 at National Highway No.18 (Shinano town, Nagano Prefecture). The spreading section ($L = 1.8 \text{ km}$) of the nonchloride antifreeze admixture (sodium acetate) was set up on the highway (see Figure 6). Spreading of chloride and nonchloride-type antifreeze admixture (dry type, solid $20\text{g}/\text{m}^2$) was done at a time when a road administrator was actually spreading it. The effects of spreading antifreezing admixture were evaluated based on the results of measurements of skid friction coefficient by a road surface skid measurement vehicle and on the results of measurements by field observers (of snow and ice surface temperature, concentration of the residual chemical on the road surface, appearance of the road surface, etc.; see Table 1). This effect verification was done seven times for a total of 69 h. A questionnaire for operators driving snow graders and snow removal trucks was done about the effect of both antifreezes.

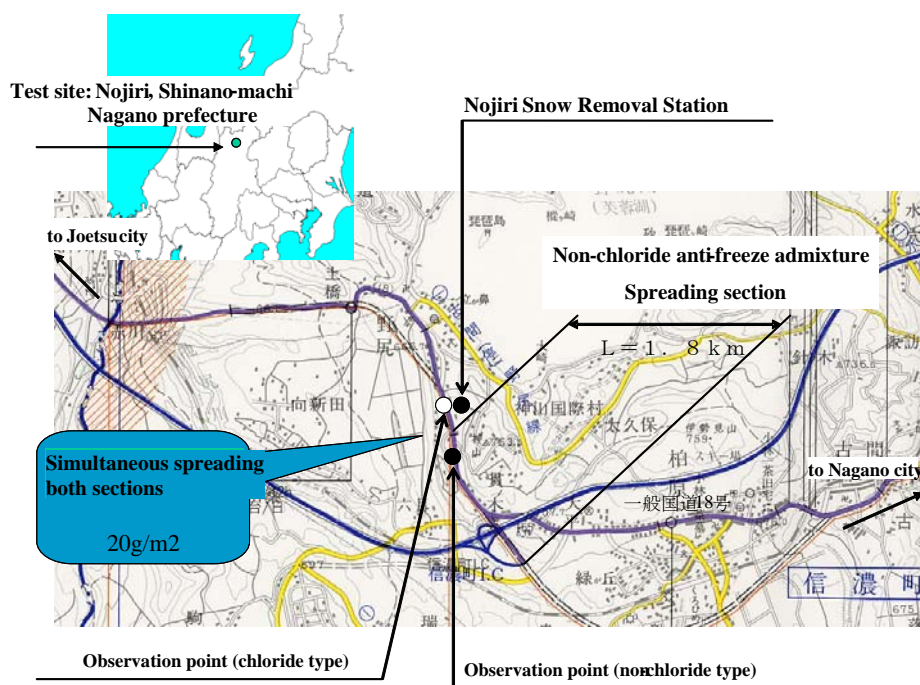

FIGURE 6 Measurement locations and spreading sections for the field verification test.

TABLE 1 Items of Measurements by Field Observers

Air temperature	Measurement at 1 point
Road surface temperature	Measurement at 3 points in rutted
Thickness of snow and ice	Measurement at 3 points in rutted
Concentration of residual	Measurement at 3 points in rutted
Snowfall	Measurement at 1 point
Traffic density	Measurement at 1 point
Appearance	Measurement at 3 points in rutted

Test Results

This section reports on the third field verification test (January 30–31, 2003) to confirm the effects of advance spreading. Road surface temperature, air temperature, snowfall, and traffic are shown in Figure 7. Appearance of the road surface and skid friction coefficient are shown in Figure 8. The thickness of the snow and ice on the road surface and concentration of the residual chemical on the road surface are shown in Figure 9.

Meteorological Conditions

Total snowfall was little, at 8mm, though light snow fell intermittently from the test start (21:00, Jan. 30) to the test end (6:30, Jan. 31). It was expected that road surface conditions changed to snow and ice cover with these meteorological conditions.

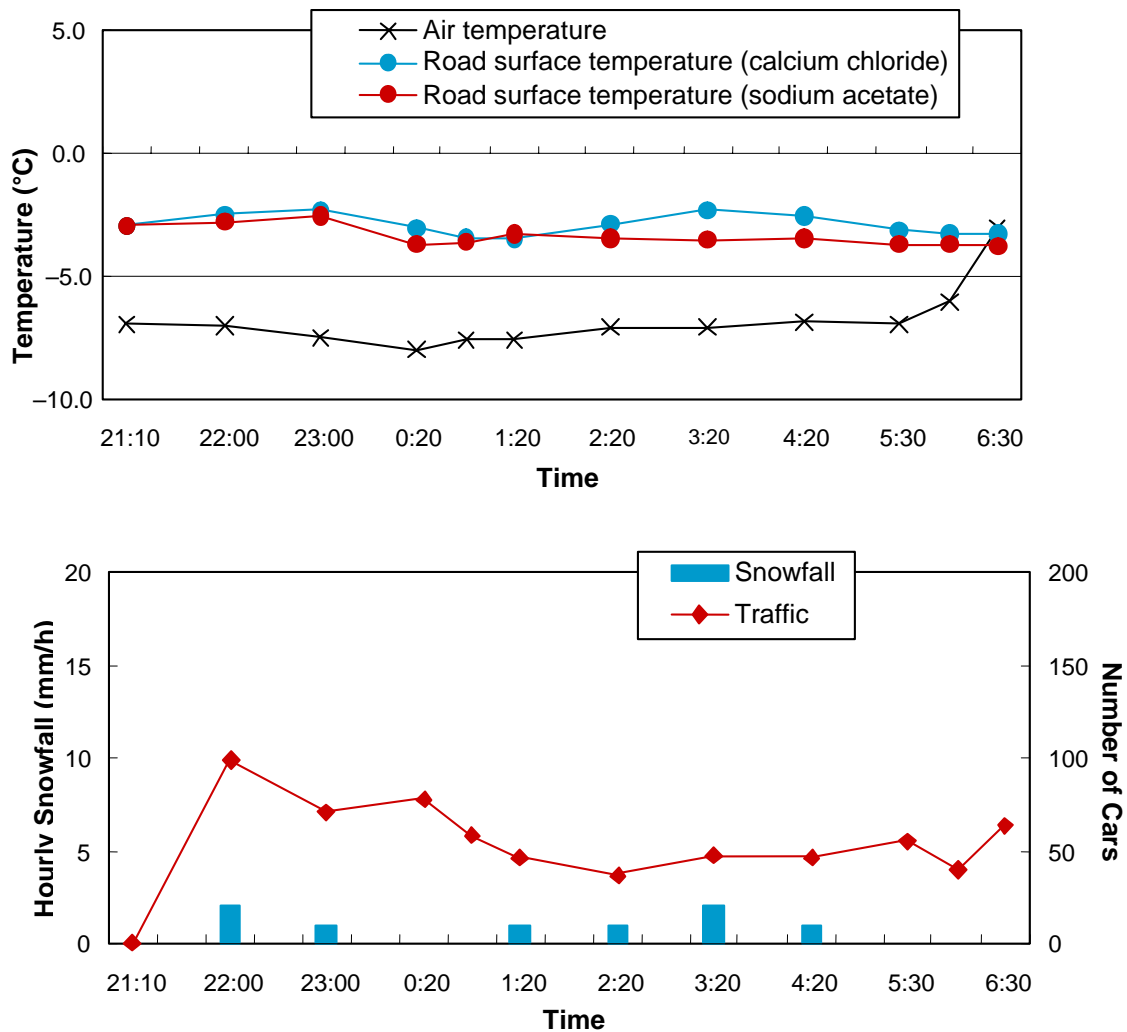

FIGURE 7 Change of air temperature, road surface temperature, snowfall, and traffic.

		21:10	22:00	23:00	0:20	0:50	1:20	2:20	3:20	4:20	5:30	6:30
Appearance	Calcium chloride	Black slush										Wet
	Sodium acetate	Black slush										Wet

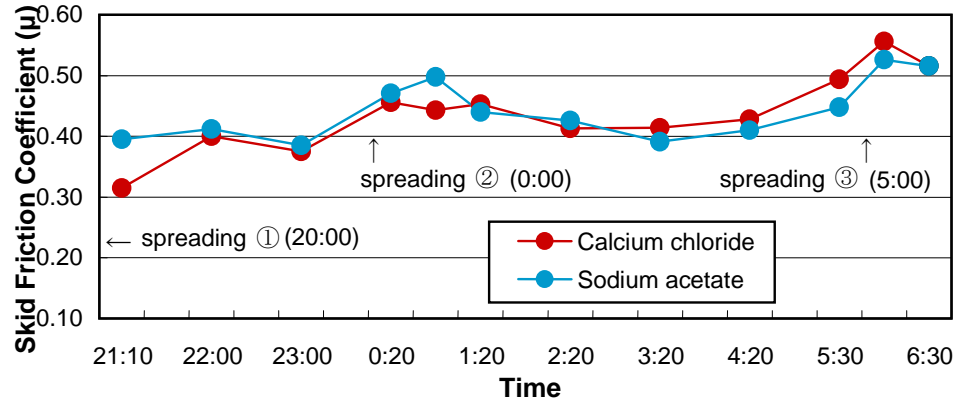

FIGURE 8 Change of appearance of the road surface and skid friction coefficient.

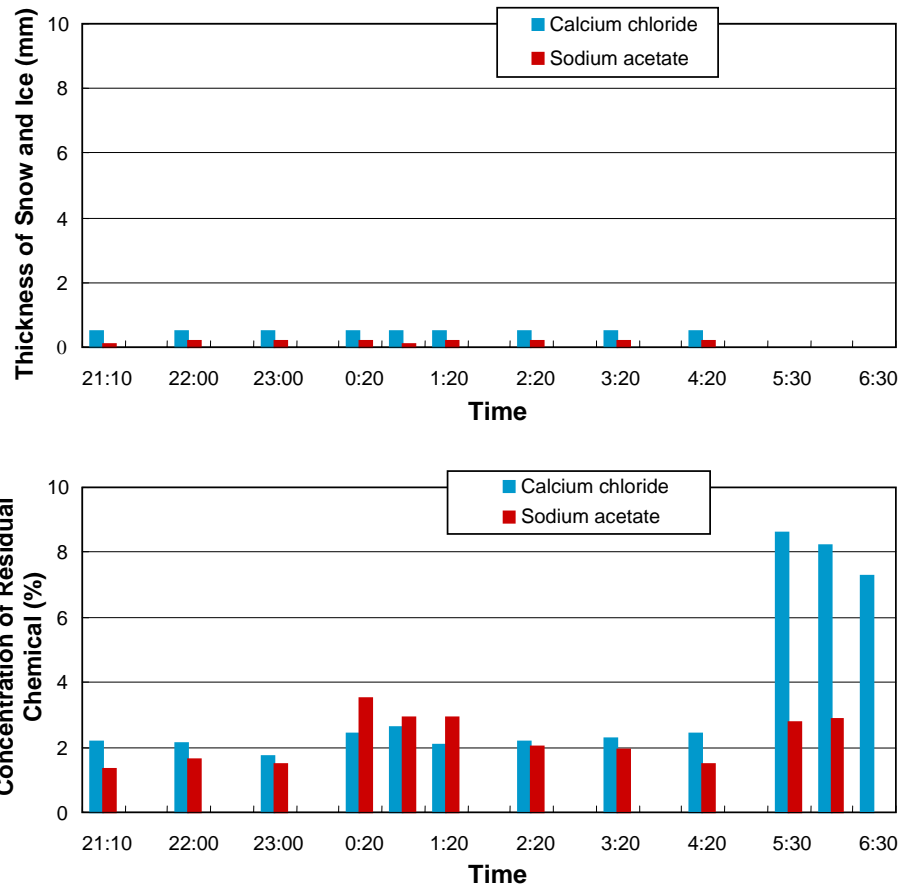

FIGURE 9 Change of the thickness of the snow and ice on the road surface and concentration of the residual chemical on the road surface.

Road Surface Conditions

Road surface temperatures in both spreading sections were similar with no significant difference observed. The road surface temperature was about -3°C in both spreading sections and apparently followed the change in the air temperature. Black slush conditions tended to continue from the first spreading to the third one, and conditions changed to wet on rutted areas in both spreading sections by the appearance of the road surface measurement by field observers. Both admixtures were seen to be effective. The thickness of snow and ice on the road surface was less than 1 mm in both spreading sections. The skid friction coefficient was comparatively low at $\mu = 0.32$ in the calcium chloride spreading section when the test started, but as time passed and number of times of spreading was piled up, it reached a high of $\mu = 0.56$ at 6:00. Conversely, it was 0.40 in the sodium acetate spreading section when the test started, and it reached a high of $\mu = 0.53$ as well as the calcium chloride spreading section at 6:00. Concentration of the residual chemical on the road surface was about 2% with some dispersion in both spreading sections from the first spreading to just before the third spreading.

Comparison of Both Chemicals

As for the road surface temperature, appearance of road surface, thickness of snow and ice on the road surface, skid friction coefficient, and concentration of the residual chemical on the road surface, a remarkable difference couldn't be confirmed from the results of the third field verification test. When skid friction coefficient by both chemical in the test from the first to the seventh was compared simply, the effect of both chemical was thought to be equivalent (see Figure 10).

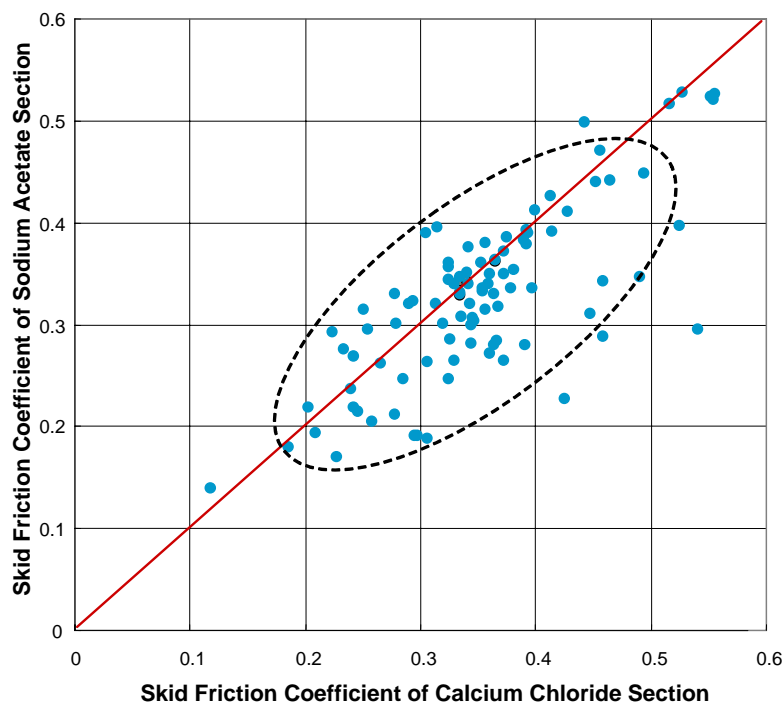

FIGURE 10 Skid friction coefficient by both chemical in the test from the first to seventh.

Evaluation of the Immediate Effect and Long-Lasting Effect

The immediate effect and long-lasting effect were defined by Equation 1 and Equation 2. As for the immediate effect, the mean skid friction coefficient of sodium acetate from just after spreading to 1 h later was divided by the mean skid friction coefficient of calcium chloride in the same time.

$$\text{immediate effect} = \frac{\mu(\text{sodium acetate section})}{\mu(\text{calcium chloride section})} \quad (1)$$

(mean from just after spreading).

For the long-lasting effect, the mean skid friction coefficient of sodium acetate from 2 h after spreading to 4 h after spreading was divided by the mean skid friction coefficient of calcium chloride in the same time.

$$\text{long - lasting effect} = \frac{\mu(\text{sodium acetate section})}{\mu(\text{calcium chloride section})} \quad (2)$$

(mean from 2 h after spreading to 4 h after spreading).

Though the calcium chloride spreading section generally exceeded the sodium acetate section slightly, in a few cases the sodium acetate showed better results (see [Table 2](#)).





Results of the Questionnaire

A questionnaire was carried out for the operators driving snow graders and snow removal trucks in this field test. The results are shown in [Table 3](#). As for the effect of advance spreading, 70% of operators answered that there was not much difference between sodium acetate and calcium chloride and that the effect lasted about 2 hours for both chemicals. As for the effect of post-spreading, 60% of the operators answered that the calcium chloride spreading section was quicker than the sodium acetate one, and 40% of them answered that effect of both chemicals was equivalent.

TABLE 2 Immediate Effect and Long-Lasting Effect

Test	Immediate Effect	Long-Lasting Effect
1	0.95	0.90
2	0.85	0.96
3	1.02	1.00
4	0.96	0.99
5	0.73	0.82
6	1.02	0.90
7	0.89	1.08
Mean	0.92	0.95

TABLE 3 Results of Questionnaire

Questionnaire			Results				
Q1. Which is longer, the calcium chloride or the sodium acetate, as for effect of spreading in advance, when the quantity of spreading is the same? 1. A calcium chloride spreading section is longer. 2. A sodium acetate spreading section is longer. 3. Both are not so much difference.			20%				
			10%				
			70%				
			Q2. How many hours does the effect last each sections in the case of spreading in advance when there is no new snowfall? Lasting time of calcium chloride spreading section 1. 1 h 2. 2 h 3. 3 h Lasting time of sodium acetate spreading section 1. 1 h 2. 2 h 3. 3 h			0%	
70%							
30%							
						0%	
						70%	
						30%	
Q3. Which is quicker, the calcium chloride or the sodium acetate, as for the post spreading, effect of melting snow and ice after snow and ice covers road surface? 1. A calcium chloride spreading section is quicker. 2. A sodium acetate spreading section is quicker. 3. Both are not so much difference.			60%				
			0%				
			40%				

CONCLUSION AND FUTURE RESPECT

Both laboratory evaluations and field tests showed that nonchlorinated antifreeze (sodium acetate) was as effective as chlorinated antifreeze (calcium chloride). Laboratory tests also showed that sodium acetate results in significantly less corrosion when compared to chlorinated antifreeze admixtures. However, field-testing was limited and did not explore effective and efficient spreading techniques.

REFERENCE

1. Mori, N., S. Meiarashi, T. Nakamura, M. Irasawa, and K. Hayashi. Snowy and Ice Road Countermeasures Using Antifreezing Admixture. 11th PIARC International Winter Road Congress, Japan, Sapporo, January 2002.

MATERIALS DISTRIBUTION, PERFORMANCE, AND RESIDUAL

Agricultural By-Products for Anti-Icing and Deicing Use in Michigan

Summary

STEVE KAHL

Michigan Department of Transportation

Keeping Michigan highways and roads clear of snow and ice during the winter can be a significant challenge to an agency's resources and personnel. The widespread use of rock salt (sodium chloride) to remove snow and ice and facilitate a "bare pavement" level of service has provided for the increased safety of motorists for some time. However, deicing salt use has some detrimental side effects. The damage to the ecosystem from chloride ions has been documented along with the corrosive effects to metals.

Several strategies have been suggested to deal with the effects of using rock salt. One approach has been direct substitution with chloride-free chemicals. Another idea is to use salt with added corrosion inhibitors to offset or delay the effects of corrosion, this is usually less expensive than complete substitution of chloride-based deicers. Unfortunately, alternatives to salt can be expensive and may require additional applications to obtain the same result.

In recent years anti-icing compounds developed from agricultural by-products (ABP) have been introduced. Manufacturers claim that ABPs perform better, are environmentally friendly, and are less corrosive than conventional anti-icing and deicing materials. These products have shown promise in trial applications within Michigan and elsewhere in the nation. Their primary use is for anti-icing operations, but improved performance of deicing chemicals used in conjunction with ABPs also has been documented.

A research advisory panel (RAP), composed of personnel from several Michigan Department of Transportation (DOT) regions and the C&T Division in Lansing, was formed to receive input and guidance on the ABP evaluation project and to disseminate information quickly. However, in order to evaluate ABPs used for anti-icing, the anti-icing methodology itself required further study. Therefore this report combines evaluating anti-icing as a winter maintenance tool and the use of ABPs for anti-icing. Evaluation included application of ABPs on trial roadways, analysis of cost-effectiveness, ABP prewetting effect on salt usage, use of ABPs for anti-icing and deicing operations, and accident statistics review. Because ABPs are supplied from different manufacturers they are subject to variability in composition, and therefore specifications for ABPs were developed.

This report summarizes the Michigan DOT anti-icing experience using ABPs during 1999–2002 winters in the southwest region. The southwest region is located in southwest lower Michigan and typically experiences heavy lake-effect winter precipitation. Several major routes pass through this region, namely Interstate 94 (I-94), I-69, U.S. Route 12 (US-12), US-31, and US-131.

Anti-icing is a snow and ice control strategy designed to prevent the formation of an ice-pavement bond by timely application of a chemical freezing point depressant. Fewer chemicals are needed to prevent ice from forming than to remove it, and less plowing effort is needed to remove unbonded ice and snow from the pavement. Once applied, the chemical remains on the pavement and

works for the next storm event until it is diluted out by precipitation. Liquids usually are suited best for this purpose as the pavement is generally dry and traffic action will disperse other materials (for example, if rock salt were used for anti-icing).

In contrast to anti-icing operations, traditional snow and ice control practice is to wait until the snow accumulates on the pavement before beginning to plow and treat the highway with chemicals or abrasives. A consequence of traditional practice is formation of a compacted snow layer that is tightly bonded to the pavement surface. A subsequent deicing of the pavement is then necessary and usually requires a large quantity of chemical to work its way through the snow pack to reach the pavement and destroy or weaken the bond. Although requiring less information and training than for anti-icing, deicing may provide less safety as a result of the inherent delay.

Repeat applications of chemicals were necessary for both anti-icing and deicing. In most cases, the anti-icing liquids were applied before the onset of precipitation, and the deicing salts applied after accumulation on the roadway surface had occurred. Initial application rates for anti-icing were 35 gal per lane mi. However, inexperience with anti-icing compounds in 1999–2000 led to application of rock salt immediately following anti-icing liquid placement. The dark-colored appearance of applied ABP on the highway was mistaken for black ice because of the dark brown color.

As more experience was gained, anti-icing methods became more efficient. Application rates for anti-icing were lowered to 25 gal per lane mi. For the 2000–2001 winter, the ABP used was a clear color, and thus the appearance as sprayed on the roadway did not resemble black ice and therefore prevented unnecessary applications of deicing salts.

One Michigan DOT maintenance garage used APBs exclusively for deicing operations at a cost of \$30.22 per lane mile. The application rate of 25 gal per lane mi for deicing corresponded to a dry weight of 97 lb per lane mi. Compared with the prewetted salt rate of 250 lb per lane mi, the environmental impact of salt is reduced 61%, albeit at considerable expense. However, chloride-free deicers would have cost considerably more; using calcium magnesium acetate (CMA) at 400 lb per lane mi (application rate needs to be increased to match performance of salt) at a unit cost of \$600 per ton would have cost \$120 per lane mi. The pilot program serves to emphasize that ABP liquids should be used for anti-icing operations and prewetting rock salt, rather than for deicing.

Costs for the cleanup of compacted snow and ice vary but reportedly are reduced in terms of man-hours and equipment. Further, the corrosion-inhibiting APBs reduce equipment maintenance by preventing or minimizing rusting of the truck hoppers, spinners, and other parts. Cost-effectiveness of APBs is sometimes difficult to determine, as many highly variable local costs (e.g., unit materials cost, labor rates, storage) need evaluation. Indirect costs (e.g., travel delay costs) should also be considered.

Overall highlights of the southwest region pilot program include

- Anti-icing led to overall decreased material costs the past three winter seasons;
- Prewetting rock salt reduced its use by 28% to 38%;
- Prewetted rock salt used for traction control reduced abrasives (sand) use by 78%;
- Cost savings of prewetting rock salt averaged \$1.69 per lane mi for materials;
- ABP liquids should be used for anti-icing and prewetting rock salt, but not for deicing;
- Anti-icing practices maintained bare pavements longer, which bought response time in storm events, up to an hour in some cases; and
- Anti-icing practices in 2001–2002 helped to reduce the frequency of winter accidents on I-94 as compared with previous years with similar numbers of storm events.

When ABP liquids are used appropriately for anti-icing, they can be a powerful tool in providing safer roads to the traveling public at less cost. The following are recommendations for anti-icing to be adopted as a strategic tool for winter maintenance operations in Michigan, based on the benefits of using anti-icing:

- It is recommended that Michigan DOT and local agencies responsible for winter maintenance operations on trunkline routes consider implementing anti-icing. Anti-icing is an effective tool to use for responding to higher level of service expectations from the traveling public.
- Agencies considering implementing anti-icing should contact those agencies currently practicing anti-icing to determine how to get started. Issues to address include what equipment, budget, and materials are required; the process of dealing with the public; and training needs for its own agency personnel. A successful anti-icing program needs the buy-in of all participants.
- It is recommended that an anti-icing training program be developed for operators and managers of agencies conducting or considering anti-icing. The training should explain when anti-icing is appropriate, incorporate decision-making scenarios, and familiarize staff with the *Manual of Practice for an Effective Anti-icing Program: A Guide for Highway Winter Maintenance Personnel* (FHWA-RD-95-202).
- It is also recommended that agencies adopt a benefit–cost methodology to formally track and document the costs and benefits of anti-icing. This can entail use of TAPER (Temperature, Application rate, Product used, storm Event, Results) logs, assignment of task-specific time sheet coding, and other means of tracking costs.

Editor's Note: The full report, *Agricultural By-Products for Anti-Icing and Deicing Use in Michigan*, Research Report R 1418, November 25, 2002, is available from the Michigan Department of Transportation

MATERIAL DISTRIBUTION, PERFORMANCE, AND RESIDUAL

Role of Performance Specifications in Developing a Quality Control System for Winter Maintenance

WILFRID A. NIXON
GEORGE KOCHUMMAN
JU QIU
LIN QIU
JING XIONG
University of Iowa

Effective winter maintenance makes use of freezing point depressant chemicals to prevent the formation of the bond between snow and ice and the highway pavement. In performing such winter maintenance, the selection of appropriate chemicals for the bond prevention task involves consideration of a number of factors, as indicated by Nixon and Williams (1). The factors are, in essence, performance measurements of the chemical, and as such can be incorporated easily into a specification document to allow for selection of the best chemicals for a given agency to use in its winter maintenance activities.

Once performance measures for deicing or anti-icing chemicals have been specified, this allows the creation of a quality control program for the acceptance of those chemicals. This paper presents a series of performance measurement tests for chemicals and discusses the role that they can play in such a quality control program. Some tests are simple and rapid enough that they can be performed on every load of chemicals received, while for others a sampling technique must be used. An appropriate sampling technique is presented in this paper. Further, each test is categorized as to whether it should be applied to every load of chemicals or on a sampling basis.

However, applying quality control to the chemicals as received is only part of a much broader quality program. This paper explores how the quality control of chemicals can be extended into a program that applies quality measures throughout winter maintenance activities. Obviously, such an extension involves performance measures, and these issues also are considered.

INTRODUCTION

The presence of snow and ice on the roads during winter months poses a problem to road users. It can impact private motorists as well as industry. Delays caused by snow and ice can result in significant economic losses due to late delivery of goods, and severe snowstorms may result in lost wages due to business closings. Winter weather also poses a safety risk, and the societal costs of accidents can be very high. In a nutshell, clearing the roads of snow and ice is important from both the safety and the economic point of view.

Previous studies have shown that the number and severity of accidents increase during a winter storm (2). Additionally there is some evidence that winter weather significantly increases trip times (3). Industry representatives have indicated that a reduction in transit times between

two points is less beneficial than an increase in the predictability of travel times between two points (4). In short, a decreased standard deviation on travel time is preferable to a decreased mean travel time.

There are three standard methods to remove snow and ice from roads: scraping and plowing, application of chemicals, and application of abrasives. In this study, we are concerned with the second method. The effectiveness of deicing and anti-icing depends on the chemicals used and the quantity in which they are applied.

For winter maintenance chemicals to be used effectively and efficiently, their performance must meet certain specified standards. The purpose of this study is to examine and develop tests that can be used to determine whether a chemical meets certain standards. The study is ongoing and consists of five different tests on liquid deicing chemicals and developing those tests into a form in which they can be used easily for quality control. Similar tests could be used for solid deicing chemicals (although clearly not the test for viscosity). The five tests are freezing point measurement, viscosity, specific gravity, ice melting, and ice penetration. This paper presents the five tests briefly and then discusses the viscosity and specific gravity tests in greater detail.

PERFORMANCE TEST TYPES

Freezing Point

This method is used to determine the freezing point of aqueous solutions of deicer materials [based on method to determine freezing point of engine coolants (5)]. The test can be used to develop a eutectic curve or phase diagram for the liquid and can be used as a specification measure (1).

Viscosity

This test is used to determine the viscosity of aqueous deicer solutions (6). It can be used as a simple quality control measure to determine whether the chemical delivered is the right chemical. The short test provides useful information that indicates clearly what chemical concentration the liquid product is and is conducted easily in a maintenance shed.

Specific Gravity

This method is used to determine the specific gravity of deicer solution with respect to water. This method too can be conducted as a quick and simple product acceptance test and also is conducted easily in a maintenance shed.

Ice-Melting Test

The test provides data on the actual or time dependent quantities of ice melted by a deicer, so that these quantities can be compared to the theoretical or equilibrium quantities of ice and can be employed to estimate quantities melted under field conditions within reasonable lengths of time (SHRP H-205.1 and H-205.2, 7).

Ice Penetration Test

The test provides a measure of the time required for penetration through a given thickness of ice and gives a rough approximation of the fraction of melting capacity available for undercutting (SHRP H-205.3 and H-205.4, 5).

CHEMICALS TESTED

Seven different liquid products were used in these tests. The products were obtained from state departments of transportation (DOTs) and were tested as supplied by those agencies.

This was to ensure, as much as possible, that what was being tested was fully representative of what was being used in practice. [Table 1](#) lists the seven chemicals and the location from where they were obtained.

VISCOSITY TESTING

Summary of Method

The purpose of this test is to determine the viscosity of the sample, with the method specified in ASTM D 445-88. The Ford cup viscometer is used for the viscosity experiment. Samples of deicer (diluted to various ratios, if required)—300 ml in volume—are prepared. Suggested chemical to water ratios are 4:0 (all liquid chemical as supplied), 3:1 (three parts chemical to one part water), 2:2, and 1:3. The viscometer is mounted on a stand, and a fixed volume of liquid is made to flow under gravity through the capillary of the calibrated viscometer. The time for the liquid to flow is noted. The viscosities at room temperature and temperatures between 0°F to 30°F are noted.

Equipment

The Ford cup viscometer #2 cup is used to measure the viscosity of the deicers (see [Figure 1](#)). The time is recorded using a stopwatch.

TABLE 1 Anti-Icing Products Tested

Anti-Icing Product	Source of Product
Sodium Chloride Brine (23% concentration)	Oakdale Garage, Iowa DOT
Calcium Chloride Brine	Davenport Garage, Iowa DOT
Calcium Magnesium Acetate (CMA)	Burlington Garage, Iowa DOT
Potassium Acetate (KA)	Burlington Garage, Iowa DOT
Ice Ban Ultra (20% Ice Ban, 80% Salt Brine)	Ames Garage, Iowa DOT
Caliber M-1000	Michigan DOT
Mineral Brine	Michigan DOT



FIGURE 1 Viscosity measured with a Ford #2 cup viscometer.

Test Procedures

1. The deicer and water are measured using a graduated cylinder in proper amounts and transferred to a beaker
2. The solution is poured into the viscometer with the orifice closed. The orifice is opened, and at the same time a stopwatch is started.
3. The time it takes for the entire liquid to flow through the viscometer is measured. The experiment is repeated three times and the mean is determined.
4. The viscosity of the solution is taken from viscosity chart for #2 Ford cup viscometer (see ASTM D 445-97).

Results

The experiment was conducted at 0°F, 10°F, 20°F, and 30°F (in a temperature-controlled cold room) and at room temperature (70°F). Some of the solutions froze at lower temperatures, and the experiment was not done on those solutions at those particular temperatures. Figure 2 shows the viscosity chart for calcium chloride. From the figure, it is obvious that the viscosity increases with increases in the concentration of the chemical. Also, as the temperature decreases, the viscosity increases. The variation from the above noted characteristics can be attributed to manual error or variation in the environmental conditions, for example, liquid lost because of evaporation.

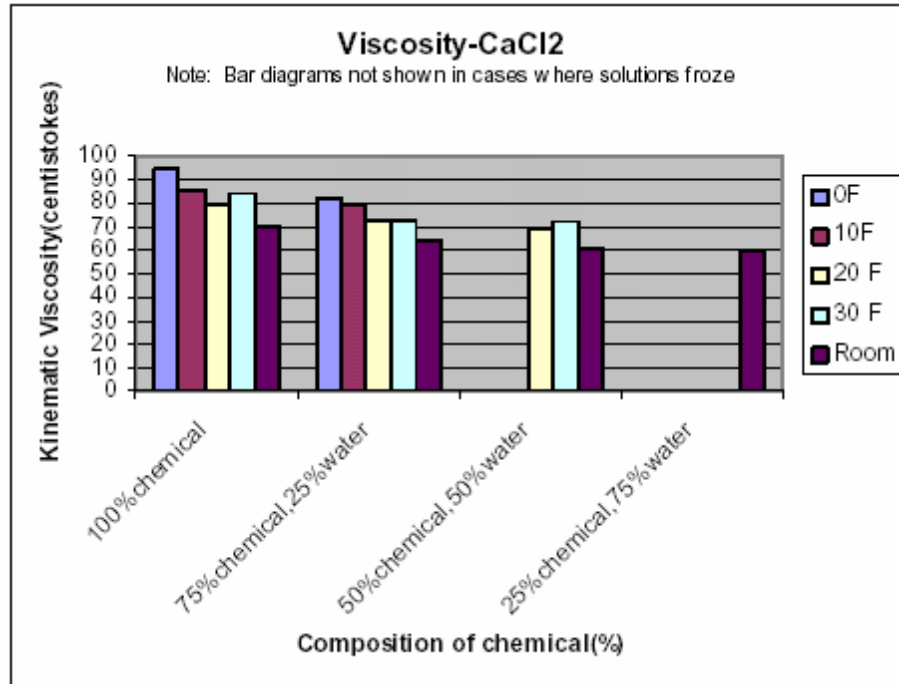

FIGURE 2 Viscosity chart for calcium chloride.

Figure 2 clearly shows two factors. First, viscosity decreases as chemical concentration decreases. Second, viscosity increases as temperature decreases. Figure 3 shows a comparison of viscosity for the seven products, as supplied, at 30°F. This demonstrates that viscosity can be a useful discriminant between products but is not perfect in this regard. For example, salt and Ice Ban Ultra have similar viscosities at this condition.

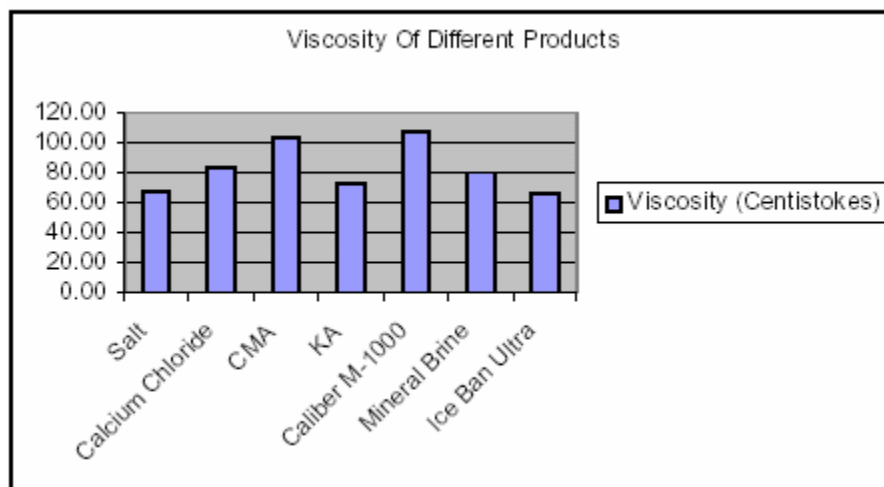

FIGURE 3 Viscosity of the seven products at 30°F.

SPECIFIC GRAVITY TESTING

Summary of Method

The purpose of this test is to determine the specific gravity of the sample. A hydrometer is used to measure the specific gravity (see Figure 4). The solution is taken in a graduated funnel, and the hydrometer is suspended into the solution. The readings are read directly from the hydrometer.

Equipment

Hydrometers that can measure specific gravity in the range from 1 to 2 are used.

Test Procedure

1. The deicer and water are measured with a graduated cylinder in proper amounts and transferred to a beaker.
2. The hydrometer is immersed in the solution, and the specific gravity value is noted.

Results

The experiment was done at 0°F, 10°F, 20°F, 30°F, and room temperature (70°F). Some of the solutions froze at lower temperatures, and the experiment was not done on those solutions at those particular temperatures. Figure 5 shows the specific gravity chart for calcium chloride. From the figure, it is obvious that the specific gravity of a solution remains essentially the same at different temperatures. It is also clear that diluting the mixture had a clear effect on the specific gravity.



FIGURE 4 Specific gravity measured with a hydrometer.

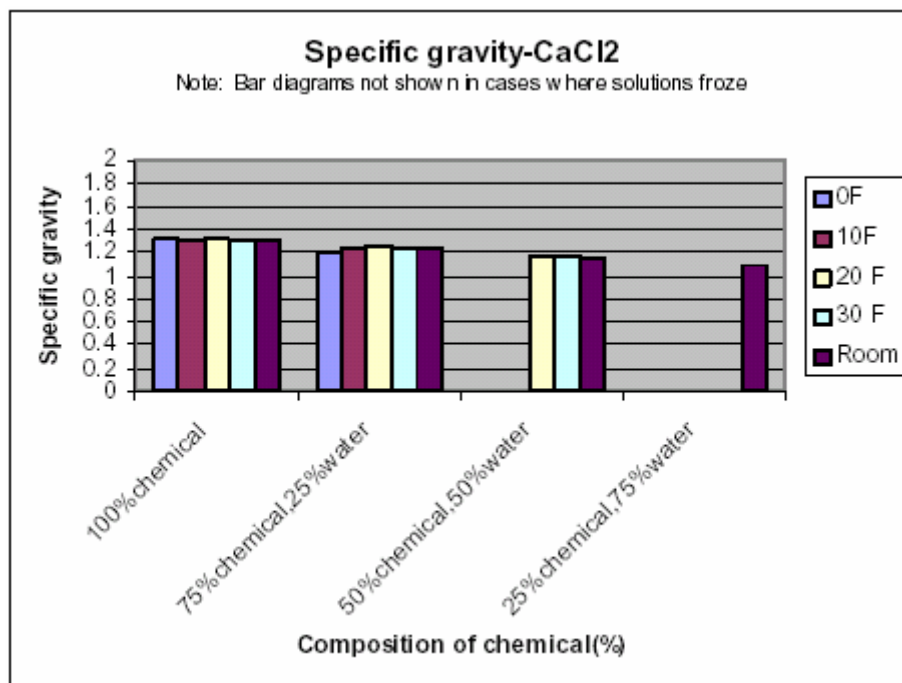

FIGURE 5 Variation in specific gravity of calcium chloride.

Figure 6 shows specific gravity for all seven products at 30°F. Like viscosity, specific gravity can be a useful discriminant, but also like viscosity not all products have different specific gravities.

Calcium magnesium acetate and potassium acetate exhibit, for example, have similar values of specific gravity. However, if the two tests are used in conjunction, then it becomes easy to tell the difference. Table 2 shows numeric values for the two tests for each of the products.

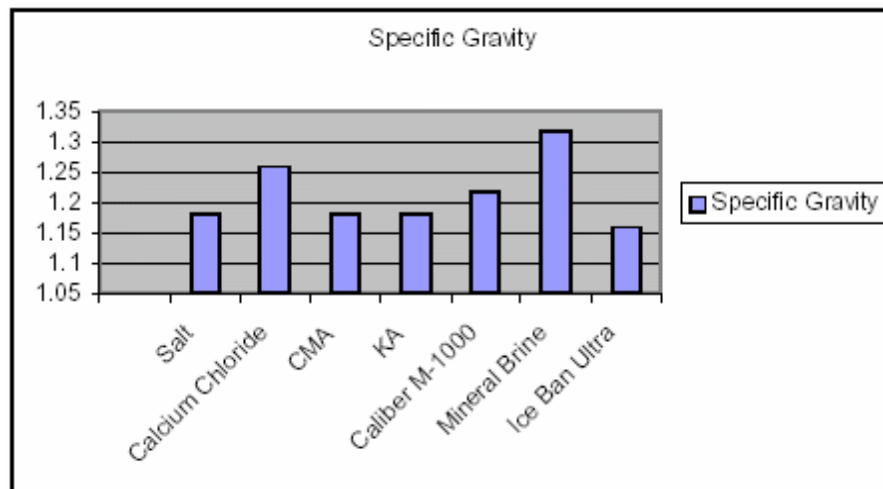

FIGURE 6 Specific gravity of the seven products at 30°F.

TABLE 2 Numerical Data from the Two Tests

Product	Viscosity (Centistokes)	Specific Gravity
Salt	67	1.18
Calcium Chloride	84	1.26
CMA	104	1.18
KA	73	1.18
Caliber M-1000	107	1.22
Mineral brine	80	1.32
Ice Ban Ultra	66	1.16

QUALITY CONTROL SYSTEMS AND PERFORMANCE MEASURES

The two tests (viscosity and specific gravity) considered in this paper provide a simple mechanism to ensure that the right chemical is being accepted at delivery and thus used by an agency. This is in some ways a stunningly obvious first step in quality control—yet such a simple step is far from being standard practice in winter maintenance around the United States. It clearly would be beneficial if such simple quality controls were instituted more widely.

However, the value of such quality control tests go far beyond the important but somewhat limited scope of these two tests. If winter maintenance is to adopt quality control as a means of measuring performance, then a range of tests must be applied at all steps of the winter maintenance process. Was the forecast accurate? Was the right amount of chemical applied? Was the road returned to a safe condition in a timely manner? Were the customers (the road users) satisfied? These questions are much harder to answer than the two simple ones addressed in this paper, but the answers to those two simple questions represent a first step along the way to answering the more complex and critical questions listed herein.

CONCLUSIONS

Two test methods have been presented that are suitable to be conducted in a maintenance garage when chemicals are received and are sufficiently discriminatory to differentiate between seven commonly used anti-icing liquids. Test results for those seven liquids have been presented, and the implications of those results have been discussed. One important implication is that tests such as these are the first steps toward developing more complex and complete quality control programs for winter maintenance.

REFERENCES

1. Nixon, W. A., and A. D. Williams. *A Guide for Selecting Anti-Icing Chemicals*. IIHR Technical Report No. 420, Version 1.0, October 2001.
2. Hanbali, R. M. Economic Impact of Winter Road Maintenance on Road Users. Presented at 73rd Annual Meeting of the Transportation Research Board, Washington, D.C., 1994.
3. Nixon, W. A. *The Potential of Friction as a Tool for Winter Maintenance: Iowa Department of Transportation Project TR 400*. IIHR Technical Report #392, February 1998.
4. Forkenbrock, D. J., N. S. J. Foster, and M. C. Crum. *Transportation and Iowa's Economic*

Future. Report prepared for U.S. Department of Transportation and the Iowa Department of Transportation. University of Iowa Public Policy Center, 1994.

5. *Standard Test Method for Freezing Point of Aqueous Engine Coolants*. ASTM D 1177-94, Volume 15.05, 2000.
6. *Standard Test Method for Kinematic Viscosity of Transparent and Opaque Liquids (Calculation of Dynamic Viscosity)*. ASTM D 445-97, Vol. 05.01, 2000.
7. Chappelow, C. C., A. D. McElroy, R. R. Blackburn, D. Darwin, F. G. de Noyelles, and C. E. Locke. *SHRP Report H-332: Handbook of Test Methods for Evaluating Chemical Deicers*. TRB, National Research Council, Washington, D.C., 1992.

MATERIAL DISTRIBUTION, PERFORMANCE, AND RESIDUAL

Deicing Trials on UK Roads

Performance of Prewetted Salt Spreading and Dry Salt Spreading

MARILYN BURTWELL

Transportation Research Laboratory Limited

The UK Highways Agency and the National Salt Spreading Research Group (NSSRG) commissioned Transportation Research Laboratory (TRL) Limited to evaluate the applicability and costs of introducing prewetted salt on both the motorway and all-purpose trunk road (APTR) network and local road network in England and to verify the claims made by users and salt suppliers about prewetted salting technologies. The project work is in two stages: (1) a report on the use and effectiveness of prewetted salt and the environmental issues, costs, benefits, and safety issues associated with the use of prewetted salt technologies and (2) design, implementation, monitoring, and reporting of comprehensive tests on the research track at TRL and on in-service motorways. Performance trials and road trials have enabled direct comparisons to be made between dry salting techniques and prewetted salting techniques. The rate at which undissolved salt grains enter into solution is being monitored together with the amount of salt reaching the target area, the optimum grain size of salt, the wastage to the roadside shoulder, and longitudinal snaking. The trials and the results have enabled the efficiency of the two salt systems to be better understood for both symmetric and asymmetric spreading and the distribution of salt on the carriageway to be quantified for different spreaders and salts. The results of these trials should provide the UK Highways Agency and NSSRG with evidence on which to base a decision concerning the use of prewetted salt on their road networks. Further information from a cost–benefit analysis would enable an informed decision to be made as to whether a change to prewetted salt is justified in economic terms.

INTRODUCTION

In the UK the primary method of preventing the formation of ice on road surfaces is to spread rock salt with purpose-built spreaders that regulate both the rate of spread and spread pattern. The cost of such measures in the UK is currently in the region of £157 million per annum (1). Thorne states that for every £1 spent on winter maintenance in the UK, approximately £8 is saved in the reduction of winter related traffic accidents and delays. While technological improvements in materials and paints have reduced the corrosive effects of rock salt, there still remain considerable infrastructure and vehicle damage and costs of premature maintenance.

Over the past two decades, basic application methods for salting have changed little. Traditionally in the UK, application of dry rock salt at or close to its natural moisture content of about 3.5% has been commonly used. Now, prewetted technology involving the combination of high-purity salt or 6.3 mm rock salt with a saturated brine is being slowly adopted on motorways and trunk roads by some UK maintaining agents under contract to the UK Highways Agency and on minor roads by local authorities in England and Scotland.

The UK Highways Agency and the National Salt Spreading Research Group (NSSRG) have commissioned Transportation Research Laboratory (TRL) Limited to evaluate the applicability and costs of introducing prewetted salt on the motorway and all-purpose trunk road (APTR) network in England and to verify the claims made by users and salt suppliers about prewetted salting technologies (i.e., the performance of prewetted salt is better than dry salt) and to evaluate prewetted salting operations.

The project work is in two stages: (1) a report on the use and effectiveness of prewetted salt, the environmental issues, costs, benefits, and safety issues associated with the use of prewetted salt technologies and (2) design, implementation, monitoring, and reporting of performance trials on the research track at TRL and on in-service motorways and local roads. Road trials are enabling direct comparisons to be made between dry salting techniques and prewetted salting techniques. The rate at which undissolved salt grains enter into solution is being monitored. The extent of the salt deficiency at the boundary between a thin surfacing with a relatively high surface void content and a dense surfacing, in both directions, is also being determined by experimentation for both dry salt and prewetted salt. This is required in order to safeguard road users from ice formation in these areas.

The results of these trials will enable the efficiency of the two different salt systems to be better understood for both symmetric and asymmetric spreading and the distribution of salt on the carriageway to be quantified for different spreaders. The results of these trials should also provide the UK Highways Agency and NSSRG with evidence on which to base their decisions concerning the use of prewetted salt on their road networks and its efficacy compared with dry salt. Further information from the cost–benefit analysis should enable an informed decision to be made as to whether a change to prewetted salt is justified in economic terms and enhanced benefits.

BACKGROUND

In the UK, maintaining agents and highway authorities generally follow the standards, guidelines, and recommendations provided in nationally accepted codes of practice (2, 3). Such documents prescribe policies and systems of precautionary treatment and post treatment (where necessary) based on the use of granular rock salt.

Rock salt of 10-mm grain size to BS 3247 (4) has traditionally been used in the UK, but more and more highway authorities are tending to use a 6.3-mm grain size. The rock salt is required to contain no more than 4% moisture by weight and to have a sodium chloride content of not less than 90% of the dry mass. Salt is effective only if it can form a solution with the moisture on the road surface. If this moisture has already frozen before the salt is applied, the salt is much less effective in combating the slippery conditions. There are a number of associated problems and difficulties with the spreading of salt. The most significant follow.

- There is difficulty in calibrating salt spreaders so that a consistent and even salt spread pattern is achieved. There is a tendency for overspreading whereby some salt is spread beyond the edges of the carriageway.
- To prevent the formation of ice or frost or to melt existing snow, the salt must first form a solution. Therefore, after dry rock salt is spread, there is a time lag before the salting becomes effective. The length of the time lag is dependent on a number of factors, e.g., the size of salt particle, but where moisture and humidity levels are low, the time lag is increased.

- During the time lag before the salt enters solution, the salt granules are subject to the effects of wind and traffic, and a proportion of the salt granules will be removed from carriageway before they become effective, especially when salt is spread on dry road surfaces in advance of precipitation.
- Depending on whether precipitation is forecast, typical rates of spread of salt for pre-salting range from 10 to 20 g/m². In rare situations, where conditions are expected to be severe or when heavy snowfall is predicted, pre-salting can be undertaken at spread rates of up to 40 g/m².
- Postsalting applications undertaken to aid the breakup and removal of existing snow and ice from the carriageway surface are less efficient, and typical rates of spread are between 20 to 40 g/m².

After severe winters, in which great quantities of salt have been used, there is noticeable damage to roadside vegetation together with increasing concern about the increase in salt concentration in groundwater. Chloride ions originating from deicing salts are also the primary cause of reinforcement corrosion in bridge decks and buried structures. Such concerns are increasing the pressure to improve the efficiency of winter maintenance operations through the reduction in the amount of salt used for treating highways.

PREWETTED SALT TECHNOLOGY

In the most widely adopted prewetted salting technique, dry deicing salt is wetted as it leaves the spreading hopper and enters the cone feeding the spreading mechanism (distribution spinner) of the salting vehicle (see [Figure 1](#)). The prewetting agent can be either water or a suitable chemical solution, such as a sodium chloride (NaCl) or calcium chloride (CaCl₂) brine, in the proportions of 70% of dry salt to 30% of saturated brine (the prewetting agent) by weight.

Because salt readily dissolves in water, salt brines are relatively simple to produce. The maximum salt solubility is about 26% by weight, but because of the possibility that such a concentrated solution would result in blocked pipes, valves and nozzles on the salt distribution system, a 20% to 23.5% by weight solution is usually adopted.

The majority of prewetting techniques currently use salt with a purity greater (i.e., a higher NaCl content—up to 99.5% purity) than the indigenous rock salt presently used in the UK. Salting vehicles specifically designed to undertake prewetted salting operations are readily available (see [Figure 1](#)). Recent developments have also led to the production of combi-spreaders that can spread both dry and prewetted salt, in addition to brine only. All the vehicles require a traditional hopper for the dry deicing agent and integral tanks for the storage of brine. A saturator station is required to produce the brine solution—this is simply a semi-automated tank where a bulk quantity of the brining salt is manually added to a circulated water supply. Concentrated brine runs into a separate vessel in the tank to be drawn off, as required. A controlled, consistent quality of brine is assured and the whole operation is relatively low cost and maintenance free. In most cases, existing salting vehicles fitted for traditional dry techniques can be retrofitted with brine tanks, etc., to enable them to conduct prewetted operations.



FIGURE 1 A typical prewetting salt vehicle used in the UK.

PERFORMANCE TRIALS

The main objectives of the performance trials on the TRL research track were

- To undertake trials in controlled conditions to confirm the spread rate and spread patterns of dry salting and prewetting salting;
- To make comparisons between dry salt spreaders and prewetting salt spreaders in delivering to required standards in terms of coverage across the carriageway and the adjacent verges and in the uniformity in spread along the carriageway;
- To develop and evaluate techniques for the measurement of residual salt levels;
- To determine the optimum salt grade, purity, and moisture content for dry salting and prewetting applications;
- To determine optimum spread rates for different salting techniques and spreader types; and
- To identify the most cost-effective treatments and their benefits.

Trials were carried out on a section of the TRL research track with no longitudinal gradient where the crossfall did not exceed 1 in 40 and thereby avoided possible bias in the results caused by the rolling action of larger salt grains across the track surface.

Testing Requirements

The test area consisted of three rectangular strips, labeled A, B, and C, which occupied a width of 15 m and were arranged as shown in [Figure 2](#). The strips were laid out at 50-m intervals, parallel to each other, and were located transversely across the direction of travel of the spreader.

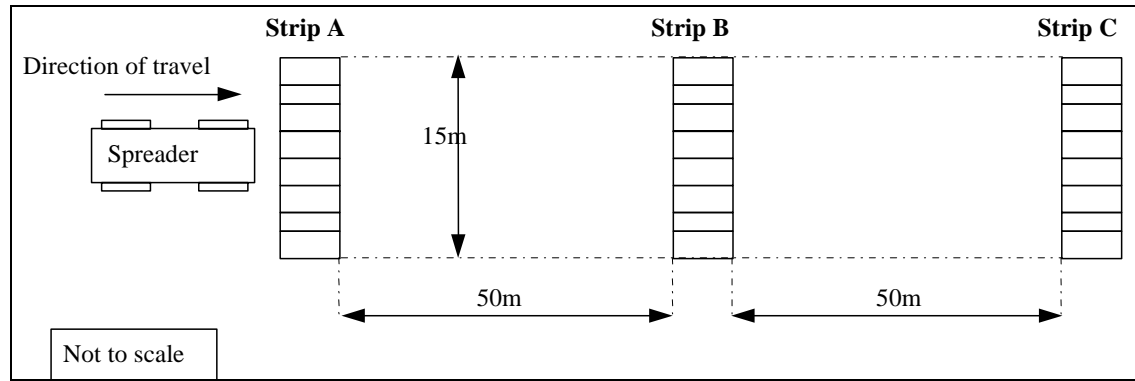

FIGURE 2 Schematic layout of the trial site on the track surface.

A distance of 175 m was provided for the spreaders to attain the correct speed before entering the test area. Typical dimensions for each of the strips are shown in Figure 3 for a three-lane layout. Each lane is made up of two zones. Zones 1 to 4 and Zone 6 are 2-m wide, with Zone 5 being 1.5-m wide.

Asymmetric spreading is used when salt is delivered from Lane 1 to cover Lanes 1 and 2 (and Lane 3 during a three-lane spread). Some spreaders also have the capability to use asymmetric spreading to cover the nearside hard shoulder, sidewalk, or lay-by.

Symmetric spreading is typically used when salt is delivered from Lane 1 to cover the adjacent sidewalk or lay-by. Salt is spread from the boundary of Lanes 1 and 2 within a dual carriageway to cover both lanes, or salt is delivered from Lane 2 within a three-lane motorway to cover all three lanes. For the purposes of the trials, the driver was required to drive directly over the boundary between main Zones 3 and 4 as shown in Figure 2.

Asymmetric spreading required that the left-hand side of the vehicle coincided with the left-hand edge of Zone 1 with a longitudinal line 300 mm inside the left-hand margin used as a marker.

Methodology

The methodology detailed in BS 1622 (5) required a total of eight runs to be carried out, depending on the speed of the spreader, the amount of salt in the hopper and the position of the spreader and the spread pattern. These permutations were modified by keeping the speed of spreading at 50 kph, the same as that used during field applications. Hence, spread rate was introduced as another parameter. The modified permutations are shown in Table 1. Before the road discharge performance trials could be carried out, a static discharge performance test was carried out on each spreader in accordance with BS 1622. For each of the test runs, the spreader driver was responsible for

1. Ensuring that the hopper loads corresponding to Table 1 were satisfied,
2. Ensuring that the spread rate provided in Table 1 was adhered to during each run, and
3. Maintaining the vehicle in the appropriate alignment for symmetric and asymmetric distribution.

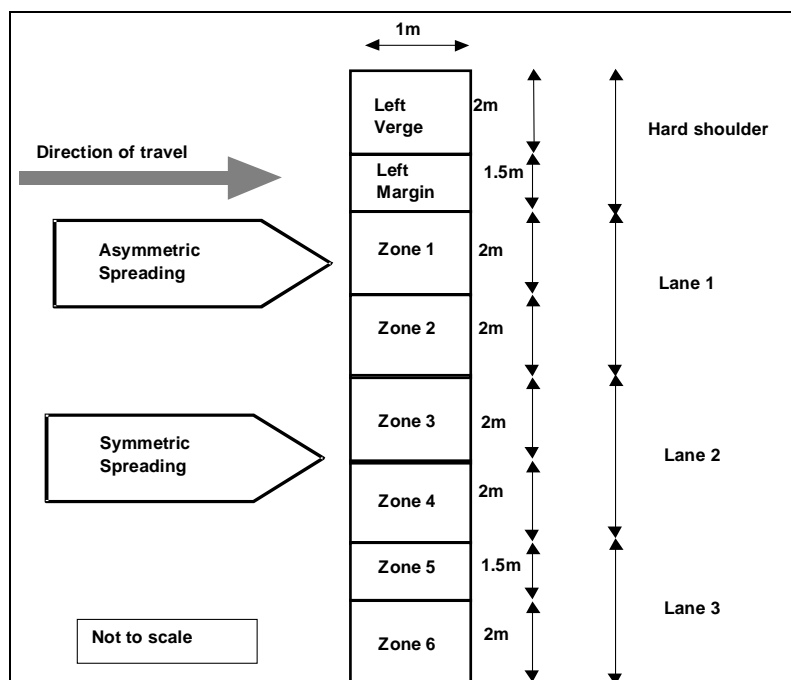

FIGURE 3 Schematic layout of the markings for a single strip for three-lane spreading.

TABLE 1 Permutations for Salt Spreading

Run Number	Spreader Configuration		
	Spread Rate (g/m^2)	Load	Distribution
1	10	Full	Asymmetric
2	20	Full	Asymmetric
3	10	Full	Symmetric
4	20	Full	Symmetric
5	10	10%	Asymmetric
6	20	10%	Asymmetric
7	10	10%	Symmetric
8	20	10%	Symmetric

The tasks required to complete each run were the same:

1. Prepare the test area,
2. Distribute salt by using the spreader, and
3. Collect the distributed salt within the various regions of the test strips.

The spreader was weighed initially and on completion of four and eight runs (i.e., on completion of full-load and 10% load tests) with calibrated weigh pads to obtain an approximate amount of total salt used during the trials.

The trials were designed to show whether the quantity of salt in the hopper had any effect

on the amount of salt that was delivered from the spreaders. Possible tunneling or clumping of the salt might have developed within the hopper as salt was discharged and hence might have affected the quantity delivered to the road surface. This was investigated by comparing the spread pattern between Test Runs 1 to 4 with those of 5 to 8, respectively.

Salt Recovery

Each area (zone) was divided into 1-m² quadrates. Because of the concerns regarding the inaccuracy of collecting the applied prewetted salt and brine by a hand-brush method, a new technique using a wet vacuum cleaner was developed and adopted for collecting the residual salt. It involved washing the surface of the 1-m² quadrates twice (running the vacuum cleaner up and down and then left to right) in 200-mm wide strips (i.e., the width of the vacuum cleaner's nozzle in contact with the pavement surface). The sequence of this operation is shown in [Figure 4](#). The chloride content and hence the salt content of the collected samples were determined by weight and chemical analysis and were considered appropriate for testing both dry and prewetted salt samples.



FIGURE 4 Wet washing of the test surfaces and transfer of the salt solution into a container.

Distribution of Salt on the Surface

To investigate the different patterns that develop when various-sized salt grains are scattered across the surface, a series of test panels, shown in Figure 5, were marked on the surface of the TRL track. Dry salt was spread at a rate of 20 g/m^2 in asymmetric mode, with the lane configuration similar to the main trial layout. The vehicle traveled over the panels several times to provide sufficient quantity of salt within each test panel for a grading analysis of the salt. The salt was then swept up from the individual panels, oven dried and graded according to BS 1377:Part 2 (6). This provided a measure of how different salt grains traveled across the width of the surface during spreading. The grading curves from each panel were then compared to the grading of the virgin salt. Under ideal conditions, as salt is spread outward from Lane 1 toward Lane 2, the proportion of larger grains is expected to increase further away from the spreader.

RESULTS

Overall Salt Discharge Rate

In order to check the static calibration of these spreaders against their dynamic calibration, the total amount of salt leaving the spreader has been calculated against the target rate as set on the spreader control box. For this purpose, the quantity of salt discharged over the 15-m width of the test panels (e.g., for a two-lane layout including a 3.5-m width of verge and margin to the side of the 2-m x 4-m lanes) was compared with the target rate set on the spreader box. The results are tabulated in Table 2 for both asymmetric and symmetric spreading for two quantities of salt (full and 10% full) in the hopper: This calculation ignores any discharged salt that landed outside the lanes but assumes that no salt is delivered beyond the 15-m test area (in two-lane and three-lane layouts). This is an approximation made during these tests because no further test panels were included beyond the 15-m width.

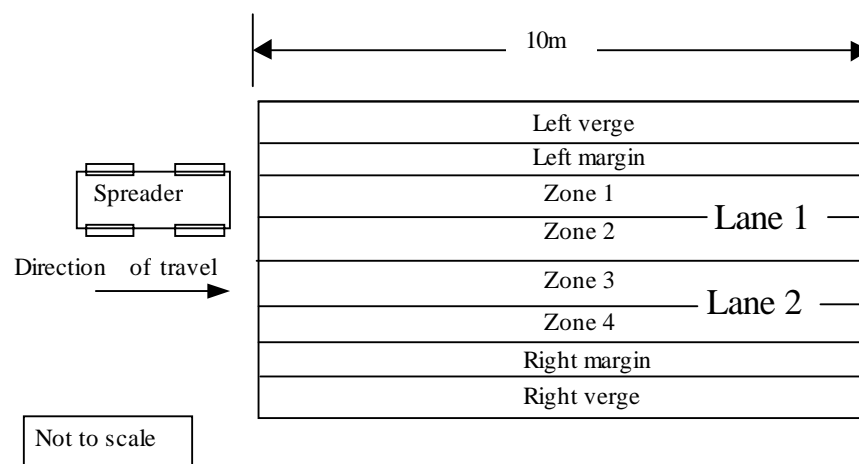

FIGURE 5 Test panels to estimate the distribution of salt grains.

TABLE 2 Overall Delivered Salt Against the Target Spread Rate

Test No.	Spreader No.	Type of Salting Operation	Quantity of Salt Leaving the Spreader as Percentage of Target Quantity to Cover the Specified Width (%)				Overall Average
			Full Hopper		10% Full Hopper		
			Asymmetric	Symmetric	Asymmetric	Symmetric	
1	1	Dry	63	67	70	51	63
2	2	Dry	58	71	75	80	71
3	3	Prewetted	60	94	76	122	88
4	3	Dry	83	91	93	82	87
5	4	Dry	99	100	104	100	101
6	4	Prewetted	83	125	93	111	103

The results, shown in [Table 2](#), indicate different discharge rates for each spreader, depending on the symmetry of spread as well as the salt load in the hopper. The results showed that three of the four spreaders tested were not able to discharge sufficient salt to match the target spread rate for the intended lane coverage. The undersalting ranged from 37% to 12%.

Achieved Spread Rates

The amount of salt spread on each lane has been compared to the target spread rate for each test and is discussed separately for asymmetric and symmetric operations and for full hopper and 10% full hopper loads.

Asymmetric Spreading

The percentage of target spread rate achieved within each lane is given in [Table 3](#). The data are based on the two salt spread rates, i.e., 10 and 20 g/m² for dry salting and 7.7 and 15.4 g/m² for prewetted salting. The specified 10 g/m² spread rate during the prewetted salt spreading is equivalent to 7.7 g/m² of salt, which is obtained from a 70:30 combination of salt to brine (with a 23.5% concentration).

Of the six tests carried out, three tests were carried out on a three-lane motorway layout, and the other three were carried out on a two-lane carriageway layout.

Symmetric Spreading

During symmetric spreading on a two-lane layout, the spreader was set to travel in between Lanes 1 and 2 to cover both lanes. For a three-lane layout, depending on whether any salt was to be spread to the hard shoulder the spreader was set to travel either at the boundary of Lanes 1 and 2 or inside Lane 2.

The percentage of target spread rate achieved within each lane is given in [Table 4](#). The data are based on two salt spread rates (i.e., 10 and 20 g/m² for dry salting and 7.7 and 15.4 g/m² for prewetted salting). Of the six tests carried out, three tests were on a three-lane motorway and three tests were on a two-lane carriageway.

TABLE 3 Percentage of Target Spread Rate Achieved in Different Lanes for Asymmetric Spreading

Test No.	Spreader No.	Type of Salting Operation	Percentage of Target Spread Rate (%)								Average of All Lanes
			Full Hopper				10% Full Hopper				
			Hard Shoulder	Lane 1	Lane 2	Lane 3*	Hard Shoulder	Lane 1	Lane 2	Lane 3*	
1	1	Dry		68	47			54	77		61
2	2	Dry		91	11			95	30		57
3	3	Prewetted		76	74	10		75	117	9	60
4	3	Dry		102	57			124	54		84
5	4	Dry	64	97	63	18	71	88	67	19	61**
6	4	Prewetted	38	94	113	44	39	107	120	53	76**

* shaded areas indicate that the areas were not covered by the target spread width

** including hard shoulder

TABLE 4 Percentage of Target Spread Rate Achieved in Different Lanes During Symmetric Spreading

Test No.	Spreader No.	Type of Salting Operation	Percentage of Target Spread Rate								Average of All Lanes
			Full Hopper				10% Full Hopper				
			Hard Shoulder	Lane 1	Lane 2	Lane 3*	Hard Shoulder	Lane 1	Lane 2	Lane 3*	
1	1	Dry		26	93			15	72		51
2	2	Dry		27	95			94	29		61
3	3	Prewetted		86	82	22		127	92	25	72
4	3	Dry		101	55			67	68		73
5	4	Dry	58	84	85	7	42	80	78	20	57**
6	4	Prewetted	66	115	193	68	80	133	127	71	107**

* shaded areas indicate that the areas were not covered by the target spread width

** including hard shoulder

Summary of the Results

During asymmetric spreading, none of the dry salt spreaders were able to achieve the target spread rate but achieved between 57% and 84% of the target spread rate to the main areas, on average (see Table 3). The performance of the spreaders during symmetric spreading was generally similar to that found during asymmetric spreading (see Table 4). Overall, the under-salting of the main areas was as much as 49%. The best performance was obtained from Spreader 4 during the prewetted operation when the hopper was only 10% full. For the asymmetric prewetted salt spreading, about 76% of the target spread rate was achieved between the three lanes (including the hard shoulder) despite the low delivery onto Lane 3 (see Table 3). For the symmetric prewetted salting, Spreader 4 exceeded the average target spread rate (107%) despite the three-lane spread width, which also included the hard shoulder (see Table 4).

Wastage to the Roadside Shoulders

Salt wastage to both left-hand and right-hand shoulders and margins during asymmetric and

symmetric spreading was investigated for both full and 10% full hopper loads of salt.

Asymmetric Spreading

Salt wastage outside the target spread width during asymmetric spreading is shown in [Table 5](#) for each test. The effect of the salt quantity in the hopper on the wastage to the nearside (N/S) and offside (O/S) shoulders and margins has been determined.

Symmetric Spreading

The salt wastage outside the main target spread width during symmetric spreading is shown in [Table 6](#) for each test. The salt wastage to the N/S and O/S verges and margins has been categorized for the full and the 10% full hopper.

**TABLE 5 Quantity of Salt Deposited Outside Lanes 1 and 2
During Asymmetric Spreading**

Test No.	Spreader No.	Type of Salting Operation	Amount of Salt Deposited Outside Lanes 1 and 2 (% by weight of overall spread)			
			Full Hopper		10% Full Hopper	
			N/S Verge and Margin	O/S Verge and Margin	N/S Verge and Margin	O/S Verge and Margin
1	1	Dry	7.3	3.4	4.7	3.4
2	2	Dry	13.4	1.2	15.0	4.4
3	3	Prewetted	13.8	Not tested	10.0	Not tested
4	3	Dry	2.8	1.5	4.2	1.3
5	4	Dry	6.6*	Not tested	10.5*	Not tested
6	4	Prewetted	6.4*	Not tested	9.6*	Not tested

* Wastage to 2 m of N/S verges and beyond the 1.5-m hard shoulders which were treated in addition to the two lanes.

**TABLE 6 Quantity of Salt Deposited Outside Lanes 1 and 2
During Symmetric Spreading**

Test No	Spreader No.	Type of Salting Operation	Amount of Salt Deposited Outside Lanes 1 and 2 (% by weight of overall spread)			
			Full Hopper		10% Full Hopper	
			N/S Verge and Margin	O/S Verge and Margin	N/S Verge and Margin	O/S Verge and Margin
1	1	Dry	3.9	9.0	3.4	13.2
2	2	Dry	4.6	12.5	21.6	4.1
3	3	Prewetted	34.6	Not tested	34.2	Not tested
4	3	Dry	13.7	2.9	17.2	2.8
5	4	Dry	8.2*	Not tested	11.6*	Not tested
6	4	Prewetted	11.3*	Not tested	10.8*	Not tested

* Wastage to 2 m of N/S verges and beyond the 1.5-m hard shoulders which were treated in addition to the two lanes.

Summary of Results

The overall results for asymmetrical and symmetric spreading modes indicated that salt was being lost to the verges and was dependent on the combination of salt and spreader type. The quantity of dry salt lost ranged between 4.3% and 19.4% during asymmetric spreading (see Table 5) and between 12.9% and 25.7% during symmetric spreading (see Table 6). The quantity of prewetted salt loss ranged between 6.4% and 13.8% during asymmetric spreading (see Table 5) and between 10.8% and 34.6% during symmetric spreading (see Table 6). However, in the case of prewetted salt, the salt deposited on the O/S verge and margin was not measured; these figures might have been lower than the salt actually deposited.

Snaking Effect

A qualitative comparison between the distributions of the salt spread across the test width of different strips along the trial site was made to provide some indication of the longitudinal snaking effects of the spreader. Selected salt distributions across the width of each test strip were assessed for six trials carried out with four spreaders. These covered the 10 g/m² spread rates during asymmetric and symmetric spreading with a full hopper load.

Longitudinal snaking appeared to be associated with both spreading modes during the dry salting operation. Two examples are shown in Figure 6 and Figure 7 for dry salt spreading and prewetted salt spreading, respectively. The results show that longitudinal snaking was more pronounced for dry salt than for prewetted salt. This may have been a function of the mechanics of the spreader, the salt particle size, or a combination of both. Further testing is needed to confirm which factor contributes most to the snaking effect.

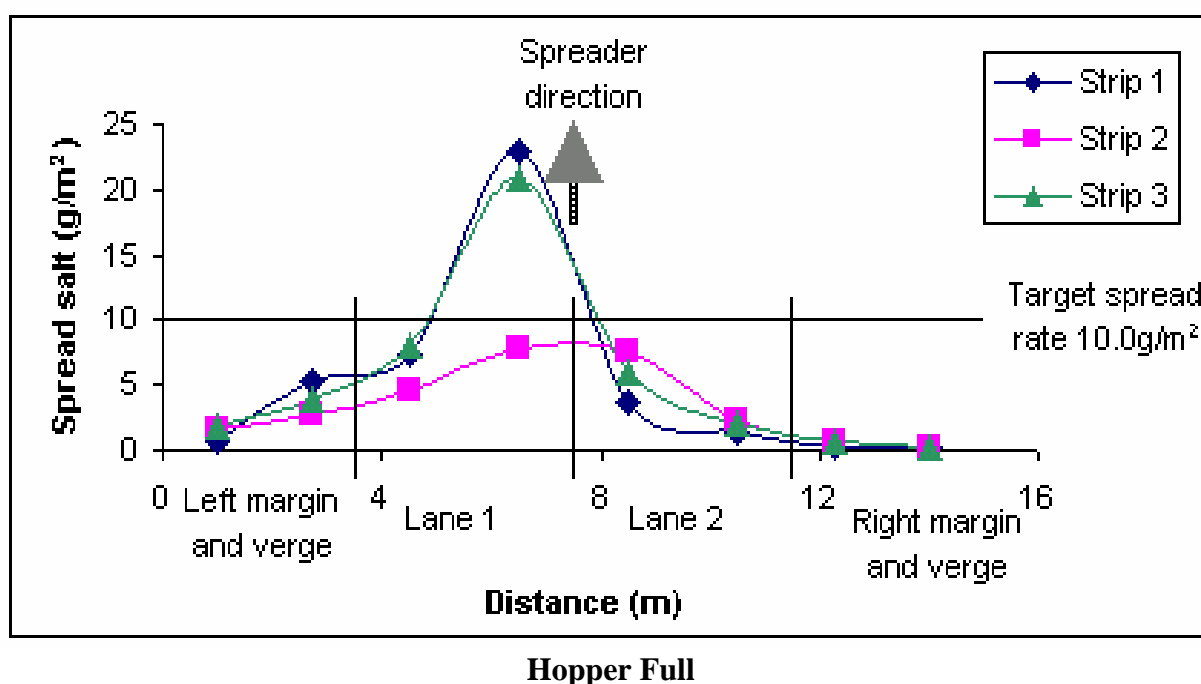
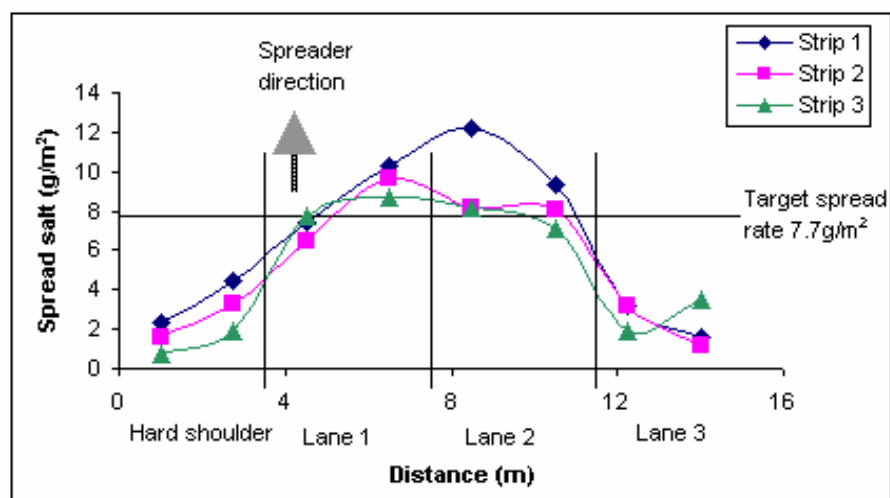

FIGURE 6 Example of symmetric dry salt spreading.



Hopper Full

FIGURE 7 Example of asymmetric prewetted salt spreading.

Effect of Grain Size on Salt Distribution

After the collection of dry salt from individual test panels, each sample was oven dried and graded. The grading curves from the individual test panels and the salt samples from the spreaders were plotted and showed that there was no consistent distribution pattern for each grain size with distance from the spreader. However, in certain circumstances, there were adverse effects in reducing the size of salt grains; the smaller grains could not be thrown as far as larger grains from conventional spinners, and they were more susceptible to the effects of wind. This was particularly significant for effective salting operations on multilane carriageways. It is also important to note that by reducing the size of salt grains used in traditional dry salting applications, some of the benefits of a shorter time lag might be realized. To date, almost all of the winter maintenance trials undertaken have found that the grading of deicing salt is one of the key issues affecting the effectiveness of both prewetted and traditional dry salting techniques. Any change in the salt grain size affects the amount of salt reaching the road surface—the heavier the salt grain, the further it travels. Moisture content has an effect on a salt grain by increasing the weight before distribution from the spinner. The ideal grain-size distribution for a particular salt grading requires further investigation for both dry and wetted salt applications.

ROAD TRIALS

Highways Agency Trial

The Highways Agency road trial took place on the northbound carriageway of the M6 motorway, located between Junctions 15 and 16, over two consecutive nights for each salting operation. The general weather conditions were broadly similar on both nights so that the dry and prewetted salting operations were undertaken in comparable conditions. The trial site was two sections: a 500-m section of hot-rolled asphalt (HRA) followed by a thin surfacing, Masterpave with a

relatively high void content, which had been laid 2 years previously. The site plan is shown in Figure 8. On each night, two teams of three working in parallel undertook the activities and measurements on the two trial sections. Similar salt recovery procedures were adopted to those used for the performance trials on the TRL track. The layout of the panels for salt recovery are shown in Figures 8 and 9 for the stages of salt recovery pre- and post-trafficking.

Both the dry salt spreader and the prewetted salt spreader traveled in Lane 1, and salt was spread in an asymmetric mode from this lane to cover Lanes 2 and 3. The staggered panels were used to determine whether there were real differences in salt deposits across Lane 2 over a length of 200 m.

Results for Dry Salting

No information on the spread pattern within Lanes 1 and 3 or the 1.2-m safety area within Lane 2 was available, so the spreader performance was based on the dry salt spread in the 2.5-m width of Lane 2. It was assumed that the residual salt after spreading remained constant in the longitudinal direction. This enabled the transverse residual salt level before trafficking to be compared with the post-trafficking data from the staggered measurements, spaced longitudinally every 50 m (Figure 10).

Figures 11 and 12 show the average spread for each surfacing material over the 2 nights. There was a good degree of consistency for both pre- and post-trafficking although the quantity of salt discharged from the spreader onto the Masterpave surfacing was more than twice that on

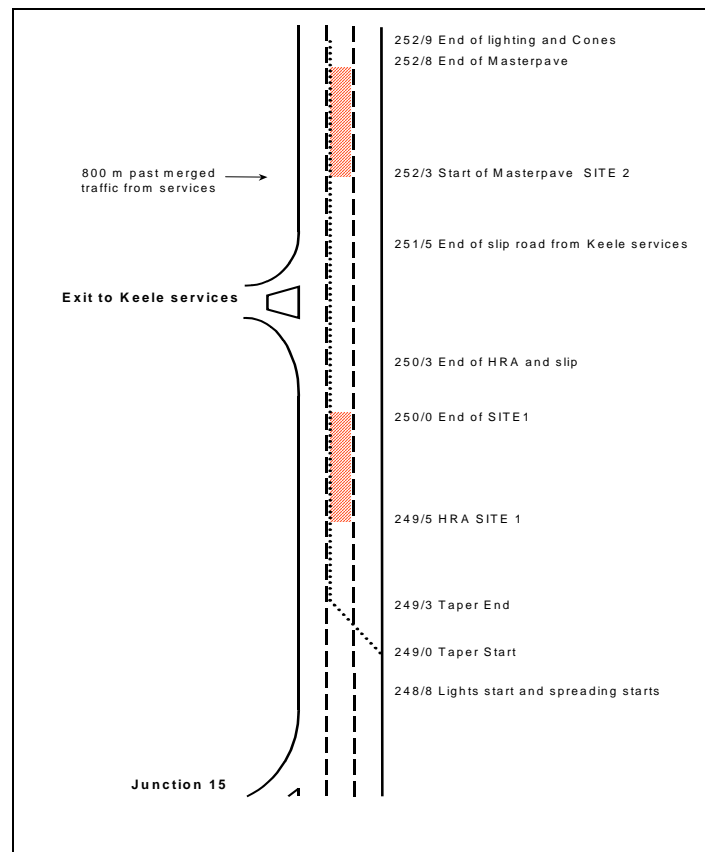

FIGURE 8 Schematic plan of M6 northbound carriageway between Junctions 15 and 16.

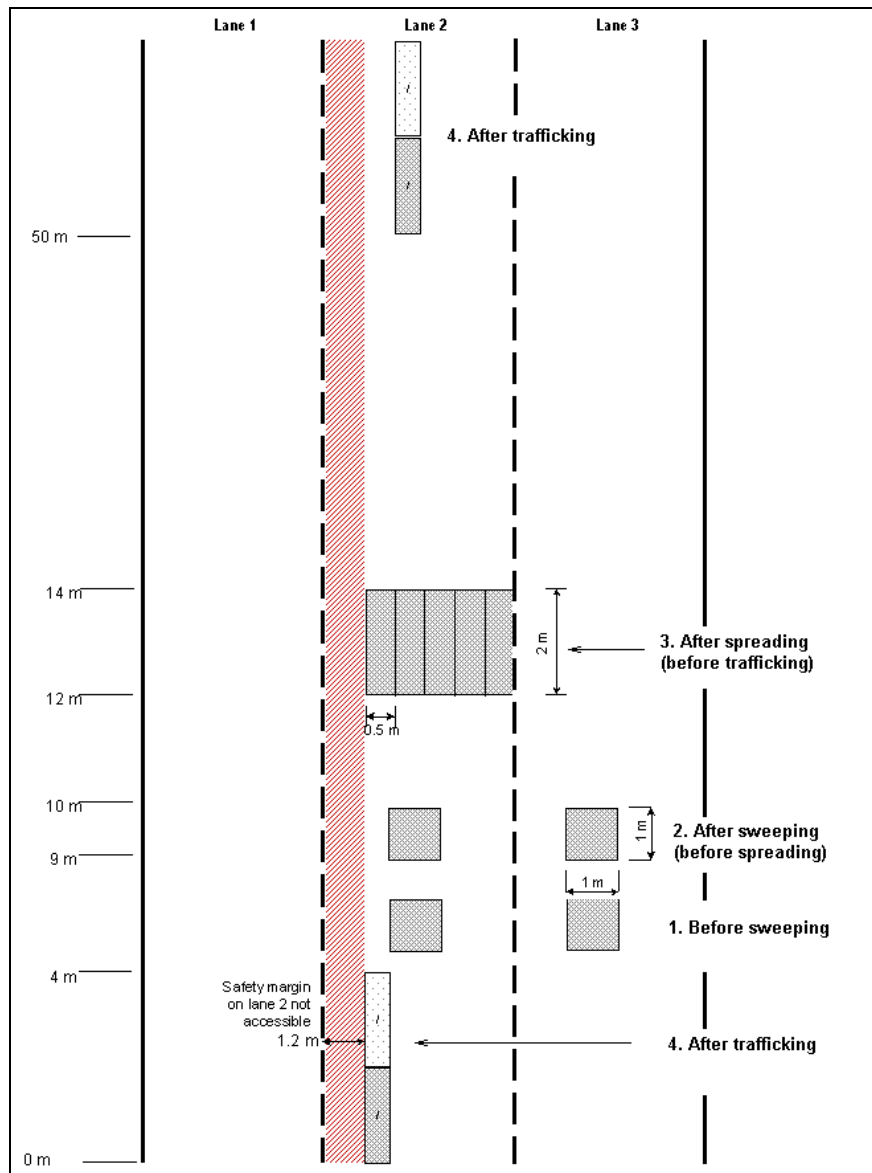

FIGURE 9 Stages of salt recovery from Lanes 1 and 2 pretrafficking.

the HRA surfacing. The trend in the pretrafficked residual salt distributions between the Masterpave surfacing and the HRA surfacing appeared to be related to the textural characteristics of the two surface types in retaining the salt in that the negative texture of Masterpave appeared to retain some of the smaller grains of the salt within the surface voids. This resulted in higher concentrations of the salt pretrafficking. The trafficking, however, played an important role in “pumping” the salt out of the voids and redistributing it to other lanes and in reducing residual salt level posttrafficking. Trafficking produced an increase in the residual salt level on the HRA surfacing of 75% (24% higher than the target level), while a reduction of residual salt level of 45% occurred on the Masterpave surfacing (just below the target level).

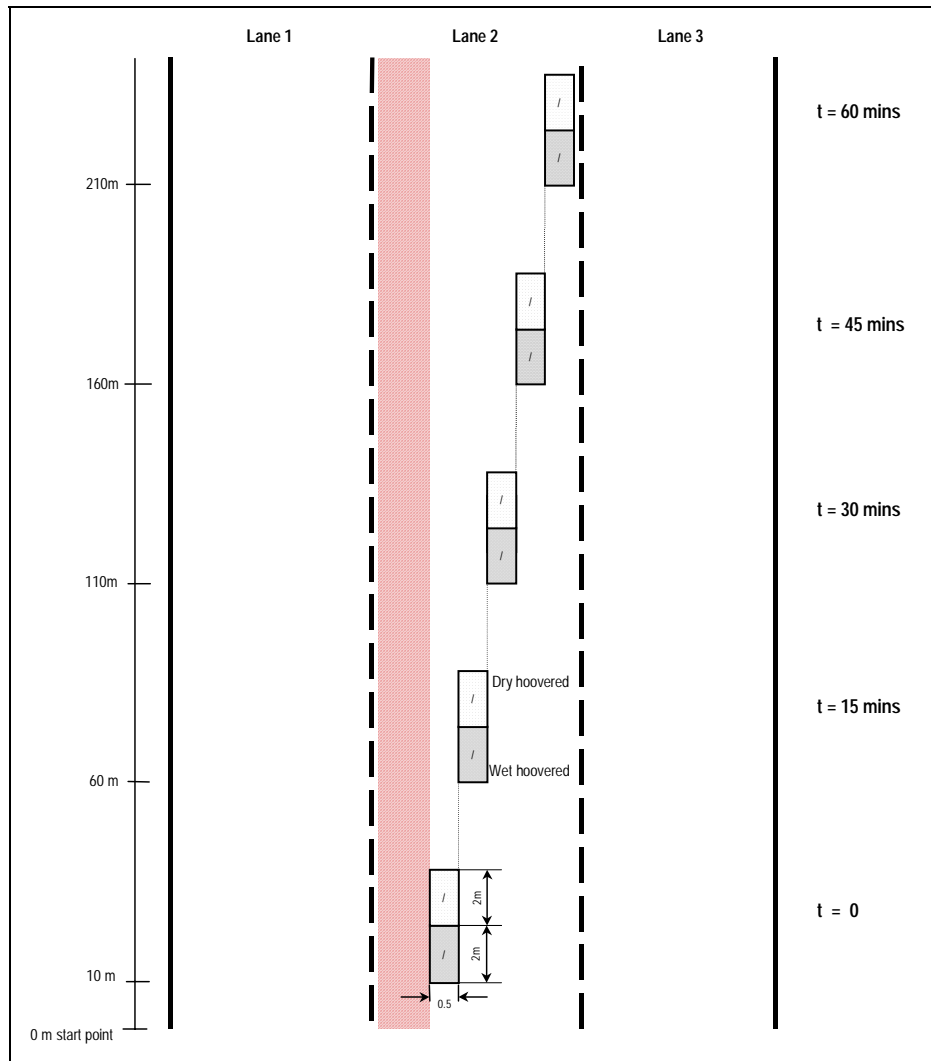

FIGURE 10 Salt recovery from Lane 2 after trafficking.

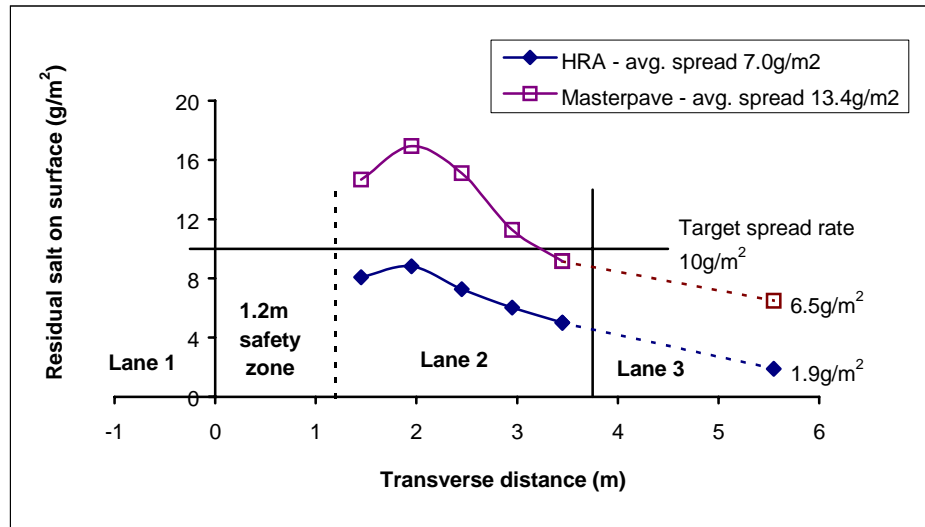

FIGURE 11 Average dry salt spread (over two nights) on both surfacing types pretrafficking.

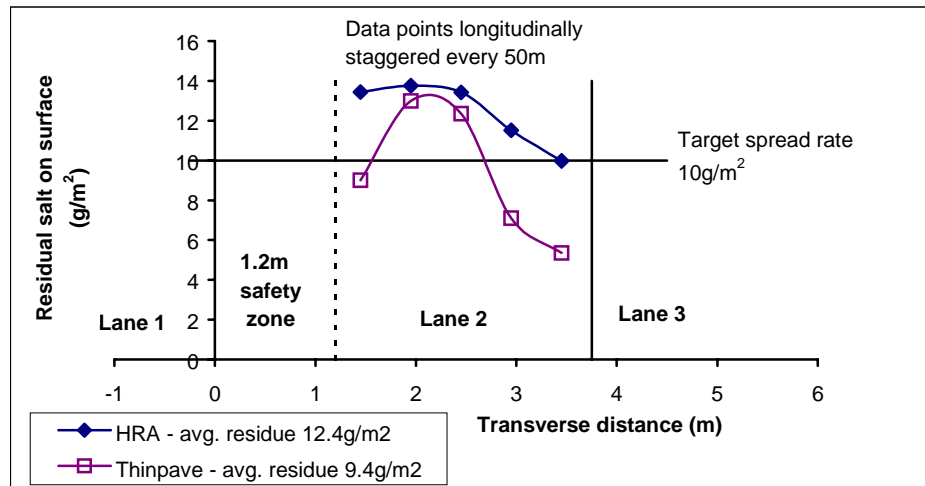

FIGURE 12 Average residual salt level (over two nights) on both surfacing types posttrafficking.

Results for Prewetted Salting

The prewetted salt methodology was extended to provide additional data on the post-trafficking residual salt levels across the carriageway. In the original methodology, the post-trafficking data came from the staggered panels on the assumption that there was no longitudinal variability on the residual salt level on any of the surface types. The addition of a transverse panel allowed the residual level across the carriageway pretrafficking to be compared with the post-trafficking level as well as the staggered measurements.

The overall prewetted salt spread rate was 5.11 g/m^2 compared with the target spread rate of 7.7 g/m^2 so that, on average, the spreader was underspreading across the three lanes by more than 60%. Trafficking reduced the residual salt level by 38%, measured both in the transverse

and the longitudinally staggered panels. As shown in Figure 13, a close correlation was found for the HRA surfacing between the spread patterns in the transverse panels and the longitudinally staggered panels with average values of 2.5 and 2.7 g/m^2 , respectively. The distribution of residual salt in Lane 3 pre- and post-trafficking reduced from 4.6 to 1.7 g/m^2 .

On the Masterpave surfacing the spread rate exceeded the target spread rate by about 15%. The results in Figure 14 show that the salt concentration on the longitudinally staggered panels was greater than that on the transverse panels. Post-trafficking, the salt concentration on the staggered panels decreased to less than 50% of the pretrafficking values. The salt concentration on the transverse panels showed an average concentration of around one-third of the target spread rate. It was possible that the difference might have been because of experimental variations. Further testing would be required to validate this.

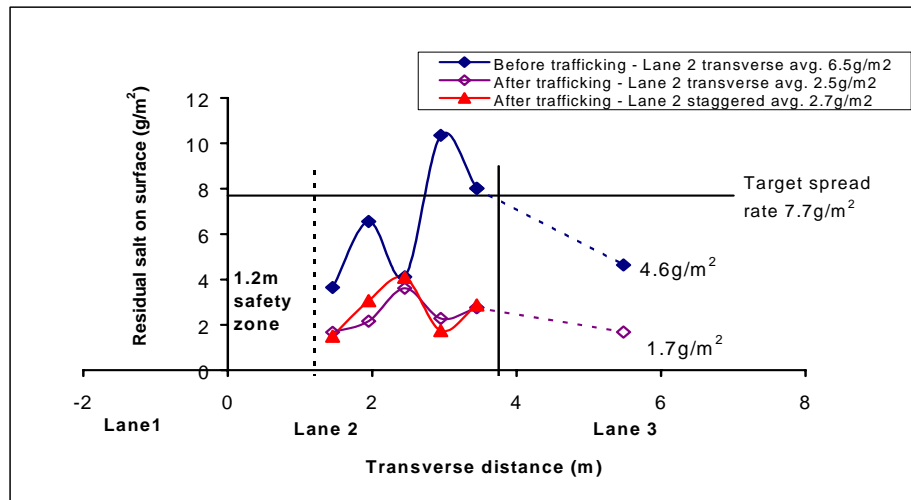

FIGURE 13 Residual salt on the HRA surfacing pre- and post-trafficking from the application of prewetted salt.

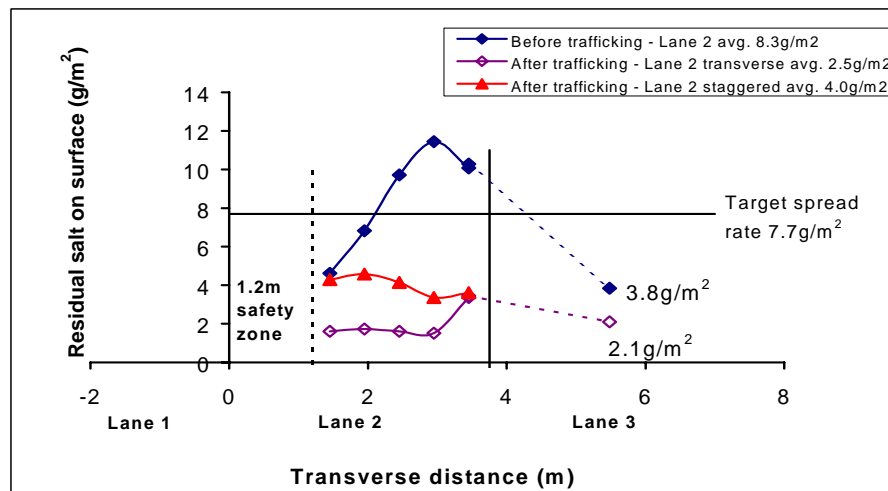

FIGURE 14 Residual salt on the Masterpave surfacing pre- and post-trafficking from the application of prewetted salt.

CONCLUSIONS

The following conclusions can be drawn from the trials:

- Prewetted salt is retained on dry roads better than dry salt because there is a tendency for most of the small salt grains to be dissolved before they are blown off the road.
- The results showed that prewetted salt spreading was better at targeting the target spread width with less overall wastage to the verges than dry salt spreading.
- The pretrafficked dry salt profiles on the Masterpave surfacing and the HRA surfacing appear to be related to the difference in the texture characteristics of the two surface types in retaining or dispersing the salt. The negative texture of Masterpave retains some of the smaller grains of the salt within the surface voids and results in higher concentrations of the salt pre-trafficking.
- For prewetted salting, the overall spread rate was 5.11 g/m² compared with the target spread rate of 7.7 g/m² so that underspreading exceeded 60% across the three test lanes. Trafficking reduced the residual salt level by 38% measured both in the transverse and the longitudinally staggered panels.

Other conclusions follow:

- European practitioners suggest that a salt saving of up to 25% is achievable through the introduction of prewetted technologies (7). Some local authorities have suggested that closer control of dry salting operations and increased attention to vehicle calibration could well yield savings similar to the estimated 25% from the use of prewetting. Prewetted salting might not be applicable in all adverse winter weather conditions.
- Reliable spreading equipment, designed and calibrated for the specific salt grade, is required to achieve an optimum distribution pattern. It is widely accepted by winter maintenance practitioners that salt-spreading equipment requires careful attention to achieve consistent calibration and hence accurate spreading.

POTENTIAL ADVANTAGES OF PREWETTED SALT

It has been claimed that the action of prewetting salt before it is spread can lead to advantages over conventional dry salting methods. These include the following:

1. The deicing effect of the salt spread onto the highway surface is achieved more quickly, with time lag significantly reduced.
2. A significant proportion of the salt spread by dry spreading techniques ends up in the channels of the highway or on the highway shoulder because of particle bounce and the action of traffic. This is particularly prevalent where 10-mm salt grains are spread. Prewetting techniques employ smaller dry salt particle sizes that can lead to more salt adhering to the road surface. It is also claimed that this may well increase the longevity of the salt action on the highway surface, with a direct result of possible reductions in salting frequency.
3. It is claimed that significant reductions (on average 25% but up to 33%) in the overall amount of salt usage can be realized. This may also have the effect of allowing salting vehicles

to run longer routes and thus have the potential to reduce the number of vehicles required. However, care is needed when calculating the cost savings because different salt types can be used for the base salt and wetting agent, as well as different proportions of dry salt to wetting agent, and these will change the costs and benefits.

4. As less salt can be used and more of it stays on the road surface, prewetting techniques can lead to significant environmental benefits compared with traditional dry salting techniques.

5. Damage to reinforced concrete structures is likely to lessen with high-purity prewettered salt although a calcium chloride wetting agent may cause more damage than a sodium chloride one.

POTENTIAL DISADVANTAGES OF PREWETTED SAND

The main disadvantages follow:

1. The spread width of prewettered salt may be reduced compared with that of dry salt because of the smaller particle sizes used.

2. High capital costs and installations costs will be incurred with the introduction of prewettered salt technologies.

3. The life expectancy of prewettered salt vehicles is shorter than that for dry salting vehicles.

4. In mild winters the use of prewettered salt may offer no additional benefits.

FUTURE TRIALS

Many of the claims made about the benefits and savings afforded by the use of prewettered technology have yet to be fully substantiated with data from road trials. Three trials are planned for the 2004–2005 winter on UK roads to determine the efficacy of prewettered salt compared with that of dry rock salt.

A number of factors will be considered in the trials: calibration of the spreaders with different salts, spread rates, width and pattern of spread, residual salt on the road surface after spreading, frequency of application, and wind, humidity, and temperature effects.

Until these trials have been completed, it is difficult to confirm the viability of adopting prewettered technologies across the UK.

ACKNOWLEDGMENTS

The work described in this paper forms part of the Highways Agency's research program and NSSRG's research program carried out by TRL Limited and is published by permission of the Highways Agency, NSSRG, and the chief executive of TRL Limited. The author wishes to thank the Highways Agency and the members of NSSRG for their encouragement and support and the members of the TRL project team for their contributions. The author also wishes to thank Richard Jordan of TRL for his quality review and audit of the paper.

NOTE

Copyright TRL Limited 2004. All rights reserved. PA/INF/4093/04. Published with permission. The information contained herein is the property of TRL Limited and does not necessarily reflect the views or policies of the customers that sponsored this paper. While every effort has been made to ensure that the matter presented in this paper is relevant, accurate, and up-to-date at the time of publication, TRL Limited cannot accept any liability for any error or omission.

REFERENCES

1. Thornes, J. E. *Road Salting—International Benefit Cost Review*. Final report. JET MET Services, Birmingham, England, June 1998.
2. *Trunk Road Maintenance Manual*. Vol. 3. *Routine and Winter Maintenance Code*. Version No. 3. Department of Transport, Network General and Maintenance Division, London, 1996.
3. *Delivering Best Value in Highway Maintenance: Code of Practice for Maintenance Management*. Institution of Highways and Transportation, Department of the Environment, Transport and the Regions, London, 2001.
4. *BS3247. Salt for Spreading on Highways for Winter Maintenance*. British Standards Institution, London, 1991.
5. *BS1622. Spreaders for Winter Maintenance*. British Standards Institution, London, 1989.
6. *BS 1377. Part 2: Soil for Civil Engineering Purposes: Classification Tests*. British Standards Institution, London, 1990.
7. Batchelor, D. The Salinity System™ Practical Trials in Surrey. Presented at Cold Comfort 99: 8th Annual Surveyor Winter Maintenance Conference and Exhibition, October 6, 1999, Nottingham, England.

MATERIAL DISTRIBUTION, PERFORMANCE, AND RESIDUAL

Laboratory Melting Performance Comparison *Rock Salt With and Without Prewetting*

CRAIG LUKER

BARRY ROKOSH

TIMOTHY LEGGETT

Forensic Dynamics Inc.

Prewetting road salt with liquid deicing chemicals has been suggested as a way to improve the melting performance of the salt and potentially reduce the amount of salt required to clear a roadway. Forensic Dynamics Inc. undertook this research to explore these possibilities.

A protocol for manufacturing repeatable compact snow and for trafficking this snow to simulate rolling tire compaction was developed following a literature review and experimentation. ASTM Standard D632-83 rock salt was prewetted with a liquid deicing chemical and applied to compact snow. The friction of a rubber tire on this sample was measured and provided friction versus time curves for dry rock salt and each of six prewetted salt mixtures. Tests were conducted at 4, 8, and 12 gal of liquid chemical per ton of rock salt, and at -1°C , -5°C , and -10°C . Three application rates were tested for most chemicals.

Prewetting salt slightly decreased its performance at -1°C and -5°C . However, all of the prewetted mixtures were effective at -10°C , unlike the dry rock salt. Melting was improved by increasing the ratio of liquid deicer to rock salt. Some mixtures had considerable variation in melting performance with temperature, but others remained quite consistent.

Attempts to use reduced amounts of prewetted salts to achieve the same performance as a greater amount of dry rock salt gave unexpected results. Specifically some mixtures performed better when less of them were applied at -1°C and -5°C . No explanation for this was found.

LITERATURE REVIEW

A thorough literature review was undertaken. The first objective was to obtain friction and density values for various snow conditions. A study by Perchanok et al. (1) of highway deicers reported density values for various types of snow as follows (g/cm^3):

New snow	0.10
Powder snow	0.27–0.41
Granular snow	0.28–0.5
Packed snow	0.45–0.75
Ice crust	0.75 and up
Slush	0.80–0.95

This paper further suggested automotive tire-to-road friction values for various conditions of ice and snow as follows:

Ice	0.10–0.20
New snow	0.20–0.25
Old snow	0.25–0.30
Refrozen snow	0.30–0.40

These friction values were confirmed by another Perchanok study (2). This paper also suggested that 25 vehicle passes were required to stabilize the friction value of packed snow. By this, it was meant that the friction value of packed snow was higher until it is worn in by traffic passing over top of it.

Typical salt application rates were then examined. Comfort provided the salt application rate used by the Ministry of Transportation Ontario as 130 kg per two-lane km (3). He further suggested at least 15% of the snow–ice layer’s thickness should be melted to prevent the salt–snow mixture from refreezing and forming an icy slush before which may have lower friction than prior to the application of salt.

Further research was reviewed with regard to the melting mechanism and expected performance of salt. Comfort suggested the mechanisms of salt and deicing fluids (4). The suggested mechanism involved initial surface roughening due to the burning in action of the salt. Gravity pulls the salt particles into the surface as the snow is melted beneath the particles. This action leads to the salt–snow brine mixture becoming deposited on the underlying asphalt or concrete. The brine then breaks the snow–ice-to-road bond. The effectiveness of salt is a direct result of this break in bond.

These studies showed clearly that traffic must be applied to the surface to remove the salt–snow mixture as melting progresses. This physical working of the melting layer helps break it up and moves the debris off the road as the road-to-snow bond is broken. It was decided to incorporate a means of trafficking the snow surface in order to recreate this action.

The literature also suggested that the reapplication or repeated applications of salt to compacted snow inhibited the bond of subsequent layers of snow pack (2). By this, it is meant that any further snowfall will not bond properly to the pavement layer or to the snow layer on top of the pavement if salt is already present.

METHODOLOGY

Environmental Chamber and Friction Sensor

The tests were conducted in Forensic Dynamics Inc.’s environmental chamber, which was capable of maintaining temperatures in the test range. Cooling was accomplished with a concrete slab with embedded cooling coils at the bottom of the chamber and a ceiling-mounted, evaporative style condensing section capable of air-cooling. The chamber had opening front glass windows that were fitted with through-wall gloves, permitting hands-on manipulation. The chamber was brought to temperature at least 2 h before each experiment to allow the test apparatus and sample plates to stabilize at the desired experiment temperature.

This research required measurements of the compacted snow surface at regular intervals to document the performance of each salt. Because of the limited size of the test chamber, it was

not practical to make large samples of compacted snow for use with a full-size vehicle tire or similar apparatus. A friction sensor currently being developed by Traction Technologies Inc. for InTransTech was provided for our use. This friction sensor consisted of a rubber wheel that was rotated across a sample plate area. A resisting spring torque was applied to the wheel until the wheel-to-sample friction could not overcome the resistance and the wheel stopped rotating. Potentiometer readings from the wheel rotation were then correlated to friction values and provided a wheel-to-sample friction for the test surface.

The friction sensor raised the sample plate to a limit switch-controlled height, ensuring that the top of the test surface was at the same elevation regardless of the amount of snow remaining on the plate. This ensured the sensor wheel was at the same horizontal angle for all tests.

For the purpose of this experiment, five sensor wheel passes were averaged to obtain one data point reading. During the course of this experiment, the friction sensor values were quite repeatable and varied less than 10% for each individual pass.

Snow-Making Protocol

A major challenge was identified as the production of consistent snow on each sample plate. Comfort's research suggested repeatable snow could be obtained by carefully monitoring the density of the final product (5). Comfort added liquid to harvested natural snow before compressing it to obtain the final desired density. The reported desired density was 0.6 to 0.7 g/cm³ (37 to 44 lb/ft³).

A snowstorm on January 4, 2003, resulted in compact snow forming on roads near our Kamloops, British Columbia, office. Samples were gathered from three locations (one major highway and two rural roads where they adjoined the highway). This snow was gathered 28 h after the storm began and had a uniform thickness of 8 mm (0.31 in.) and consistent average density of 0.71 g/cm³ (44 lb/ft³).

Through experimentation it was found that adding additional liquid was not workable for the sample size dictated by the friction sensor and resulted in compacted ice crystals rather than snow. After various attempts the final protocol was to obtain 80 g (2.8 oz) of snow and compact it with a hydraulic press to a thickness of 6 mm (0.23 in.) onto the 141 cm² (21.9 in.²) surface area of the concrete test samples. Compaction for each sample was done individually in a custom-fabricated press that ensured consistent snow thickness. Following compaction, some snow would overhang the concrete sample, and it was trimmed. Accounting for this reduced mass of snow gave a final, repeatable sample density of about 0.7 g/cm³ (44 lb/ft³).

The source of snow also was considered. Natural snow and Zamboni snow were compared; both were compacted in accordance with the above protocol. The Zamboni snow was essentially ice shaved from local hockey rinks in the course of routine maintenance. Although the mechanisms involved in the creation of natural snow and Zamboni snow are completely different, the end result after compaction appeared to be similar. Through repeated tests, the friction qualities and melting times of the Zamboni snow and natural snow were virtually identical. For this reason, and because the Zamboni snow had more consistent properties and was available year round, it was decided to use the Zamboni snow for the entire experiment.

There was concern that the Zamboni snow may have undesirable chemical properties and interactions with the tested salts, since it was made with treated city of Kamloops drinking water. However, as stated earlier, the Zamboni snow and natural snow exhibited similar melting and friction characteristics. This manufactured snow also was similar visually to the harvested storm compact snow.

Sample Trafficking

The procedure and methodology behind the traffic simulation of each sample was to simulate the actual road conditions. Comfort reported the friction of a compacted snow surface does not stabilize until it has been subjected to 25 tire passes (5). A small unit was fabricated with a trailer tire, which had a contact patch covering the sample and would fit inside the environmental chamber to simulate traffic on the snow samples. The Comfort study suggested that 3336 N (750 lb) of down force was required with a full-size vehicle tire to produce reliable results. Because of the smaller size and contact patch of the tire, the down force was reduced to 1134 N (255 lb) to replicate the same surface pressure.

Early experimentation confirmed 25 passes were required for the snow surface to stabilize at a consistent friction value. The traffic simulation action caused the snow surface to become polished and the friction to drop 10% to 15% from its starting value to the final stable value. For the 422 samples made for study, the friction of compact snow after 25 traffic passes averaged 0.310 with a standard deviation of 0.037.

Salt Application and Testing Protocol

The salt for each sample was shaken carefully onto each surface in an even distribution pattern. Four sample plates were used for each test salt and condition. Once the salt was applied to the compacted snow surface, it was allowed to sit for 5 min, enabling it to penetrate the surface. The sample was then submitted to an additional 25 trafficking tire passes.

Friction measurements were conducted at 20-min intervals. Samples were trafficked 20 times after each friction test. Each experiment was conducted until all four sample plates were within 10% of their starting wet friction value. The average time for each chemical to return the samples to a friction of 0.55 was used arbitrarily for performance comparisons. This was referred to as the friction recovery time.

Test Matrix

Testing was conducted in two phases. Phase 1 compared the melting performance of prewetted salts with the same 2 g (0.07 oz) mass of baseline rock salt (BRS). Phase 2 examined how 25% to 50% reduced amounts of prewetted salt could be used to match the melting performance of BRS.

ASTM D632 salt as supplied by the city of Kamloops was tested as the BRS. Prewetted salt was supplied by some manufacturers and otherwise was produced in our laboratory. Liquid deicer was added to the desired ratio, and then 2 g of the resulting mixture was used for testing. The test matrix is shown in [Table 1](#).

TABLE 1 Test Matrix

Mixture	Temperature (°C)			Prewet Ratio (gal/ton)			Mass of Mixture Applied (g)		
	-1	-5	-10	4	8	12	1.0	1.5	2.0
Dry BRS	-1	-5	-10	4	8	12	1.0	1.5	2.0
Distilled Water and BRS	-1	-5	-10	4	8	12	1.0	1.5	2.0
32% CaCl and BRS	-1	-5	-10	4	8	12	1.0	1.5	2.0
Ice Ban Performance Plus M and BRS	-1	-5	-10	4	8	12	1.0	1.5	2.0
Ice Ban Ultra M and BRS	-1	-5	-10	4	8	12	1.0	1.5	2.0
Liquid Corn Salt ¹	-1	-5	-10	—	8	—	—	1.5	—
Caliber M2000 LSW ¹	-1	-5	-10	—	8	—	—	1.5	—
Mineral Melt Elite ¹	-1	-5	-10	—	8	—	—	1.5	—

¹ Supplied by manufacturers as solid pretreated with deicing agent at a ratio of 8 gal/ton.

RESULTS AND DISCUSSION

General Findings

The melting mechanisms suggested in the literature were confirmed in this study. The crystals of salt sat on the snow surface for 30 to 60 s, by which time the melting action enabled the crystals to penetrate into the surface. The salt was drawn down, and the melting action moved the melted snow out of the way. Once the salt reached the roadway and snow interface, it spread and broke the snow-to-road bond.

Downward pressure on the snow as a result of traffic was required to remove the melted snow. Plates that were trafficked compared with plates that were not trafficked at the same salt application rate produced very different results. The plates that were not traffic simulated would develop a thick slush layer on top of the compact snow. The melting action of nontrafficked samples probably would not properly reflect the real world, since road traffic likely does help remove the melted snow. Subjecting snow samples to a complete test cycle without any salt applied revealed no change in the friction despite the repeated trafficking. Therefore the action of the salt and the traffic was required for effective melting.

Typically, the friction of the trafficked and salted samples initially increased and then substantially decreased below the original value for 2 to 3 tests (40 to 60 min); the friction then would rise as melting progressed. It is believed that the initial increase in friction was due primarily to the immediate melting of the salt, which caused a roughened, small-scale cratered surface. The subsequent decrease in surface friction is believed to have been caused by lubrication from a melted water film on the top of the compacted snow. After these surface effects subsided, the melting then continued deeper in the snow with a resulting generally steady friction increase over time.

Phase 1: Using Same Mass of Prewetted Deicer

The dry BRS was found to have little effect improving the friction at -10°C (14°F). [Figure 1](#) compares the data for dry BRS. As is shown, there was little or no effect at the lowest tested temperature. Despite having little effect at -10°C , BRS performed well at the higher two temperatures. In fact BRS was in the top half of the field and had a recovery time well faster than that of the median at -1°C (30°F) and had the fastest friction recovery time at -5°C (23°F).

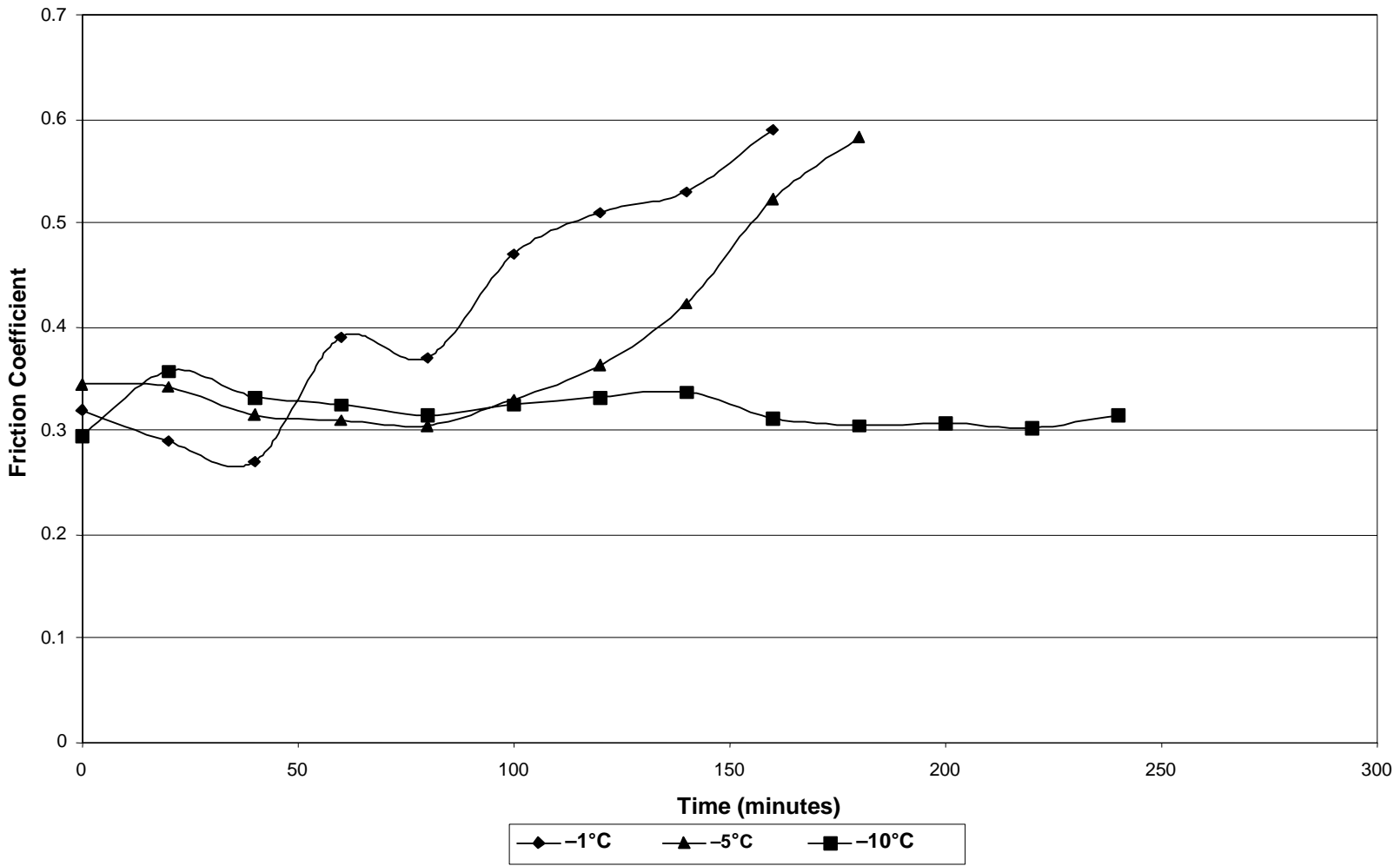

FIGURE 1 Baseline road salt (BRS) friction versus time.

Therefore the addition of a liquid deicer as a prewetting agent was much more effective at improving melting performance at lower temperatures than at warmer temperatures. For all temperatures, the friction initially increased faster for the prewetted salts than for dry BRS. This is consistent with other researchers' findings that prewetting enhances the salt's ability to burn into the snow layer.

The possibility that simply adding moisture improved the BRS performance by enabling it to dissolve more quickly was examined by prewetting BRS with distilled water at ratios of 4, 8, and 12 gal/ton (0.017, 0.033, and 0.050 l/kg). As shown in [Figure 2](#), the water inhibited the salts' performance because of dilution. Therefore, any improvement in melting performance by using liquid deicer as a prewetting agent likely would not be due simply to the presence of more moisture.

Melting was improved by increasing the ratio of liquid deicer to rock salt. For each tested prewetting agent and temperature, the mixture at a ratio of 12 gal/ton provided the fastest melting, whereas that at 4 gal/ton provided the slowest. The only exception in which this trend was reversed was the mixture of Ice Ban Performance Plus M and BRS at -5°C . However, the 15% difference in friction recovery time indicated the performance was essentially the same.

The products that were supplied as pretreated solids had been treated at 8 gal/ton. The provided liquid deicers were therefore added to BRS at that same ratio for direct melting performance comparisons between the agents. The time for each chemical to return the sample to a friction of 0.55 is presented in [Table 2](#).

The pretreated solids (Liquid Corn Salt, Caliber M2000 LSW, and Mineral Melt Elite) had consistent melting performance over the tested range of temperatures. This is shown in [Figure 3](#). Overall the recovery time for these chemicals increased 7% to 28% from -1°C to -10°C . In contrast, the supplied liquid deicers added to BRS experienced a 38% to 182% increase in recovery time, as shown in [Figure 4](#).

There was no single deicer and salt mixture that performed best at all temperatures. For instance, Ice Ban Performance Plus M performed best at -1°C and -5°C but was in the middle of the range at the lowest temperature. The 32% CaCl deicer was in the top two prewet mixtures at all tested temperatures, which may be because it was the only product without a rust inhibitor or because it was the only product mixture that was not based on MgCl, or both.

Phase 2: Using Reduced Mass of Prewetted Deicer

Reduced amounts of all 8 gal/ton prewet mixtures were compared to the melting performance of dry BRS at -1°C and -5°C . There were some unexpected results. Specifically, only 32% CaCl and Ice Ban Performance Plus M exhibited the expected behaviour by having slower recovery times when a smaller mass of mixture was used. Recovery time for these two products was substantially longer when 25% and 50% less mass of deicer and BRS mixture was applied. Only the complete 2-g application provided a melting performance better or similar to dry BRS.

The most unexpected results were that all three of the pretreated mixtures showed improved performance with a smaller application. All three had the best melting performance when 25% less was used (please see [Figures 5, 6, and 7](#)). That is, they achieved faster friction recovery times with a 1.5-g (0.05-oz.) application than with a 2.0-g application. In fact, although none of them outperformed dry BRS at -1°C or -5°C with a 2.0-g application, most bettered dry BRS with a 1.5-g application. The only exception was 1.5 g of Mineral Melt Elite at -5°C , which matched the dry BRS friction recovery until 0.52; then it paused briefly for one data point before increasing to full recovery. Therefore reduced amounts of all of the solid pretreated mixtures performed similar to, or better than, BRS and their own full mass results.

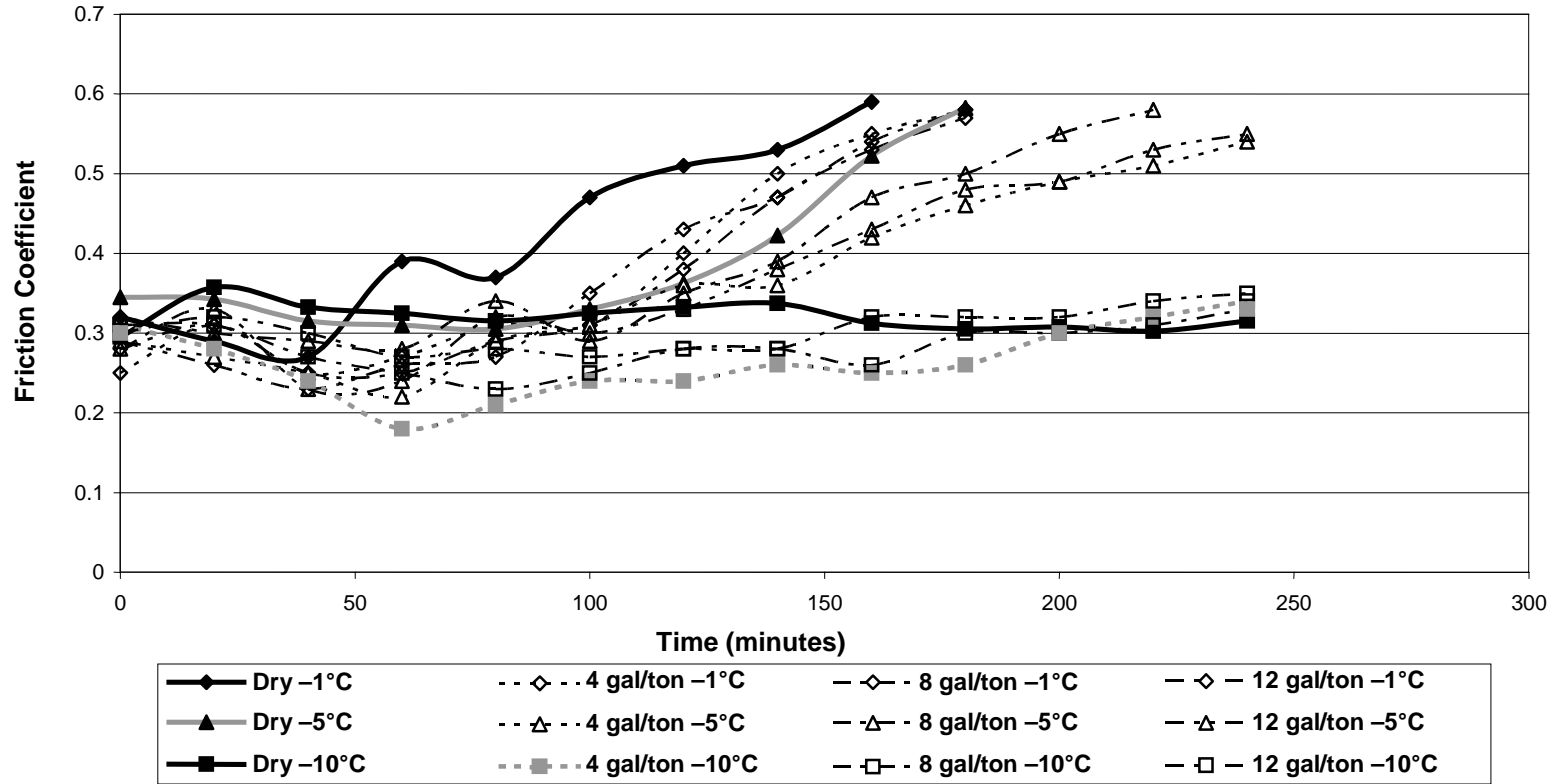

FIGURE 2 Water pretwet BRS and dry BRS friction versus time.

TABLE 2 Friction Recovery Times for 2 g of Mixture

Temperature		-1°C	-5°C	-10°C
Mixture	Ratio (gal/ton)	Time (min)	Time (min)	Time (min)
BRS	0	147	169	No Improvement
BRS with Distilled Water	4	160	247	No Improvement
	8	170	200	No Improvement
	12	165	240	No Improvement
	4	165	198	230
32% CaCl	8	107	180	208
	12	100	157	171
	4	96	193	293
Ice Ban Performance Plus M	8	95	173	268
	12	93	205	236
	4	193	228	264
Ice Ban Ultra M	8	180	245	249
	12	170	192	229
	8	220	190	235
Liquid Corn Salt	8	220	190	235
Caliber M2000 LSW	8	196	200	250
Mineral Melt Elite	8	190	200	217

No explanation for this result was found. There was only one test chamber temperature variation of more than 0.34°C (0.61°F) from the target value, and the mean temperatures were within 0.22°C (0.40°F) of the matching test's value. Relative humidity values showed no discernable pattern; some values were the same for the 2.0-g tests as for the reduced mass tests, some values were about 10% lower for the 2.0-g tests, and some values were about 10% higher.

Tests at -10°C demonstrated that the effective melting action, which all six prewetted mixtures exhibited, was only possible using the 2-g application. In [Figure 8](#), all of the 2-g tests displayed friction rising to 0.55, whereas no test with less than 2 g reached this level. The reduced salt amounts also caused a significant initial drop in friction (to levels below 0.2 in some cases), whereas none of the 2-g tests had this characteristic. This was likely due to an incomplete initial melting effect similar to that noted by Comfort (3).

DISCUSSION

This study was designed to measure the melting capacity of prewetted salts. That is why the performance of a 2.0-g mass of prewetted salt was compared with that of a 2.0-g mass of dry salt. It is this comparison that indicates the melting action of prewetted salt may be slightly less than that of dry salt for some prewetted salt mixtures. The authors recognize this disagrees with common practice, in which prewetting has been shown to be more effective in highway maintenance than not prewetting. There are several factors that could explain this apparent discrepancy.

For instance, in real-world maintenance tasks the prewetting agent is applied to the road in addition to the full amount of dry salt. For example, if a ton of dry salt would be used on a

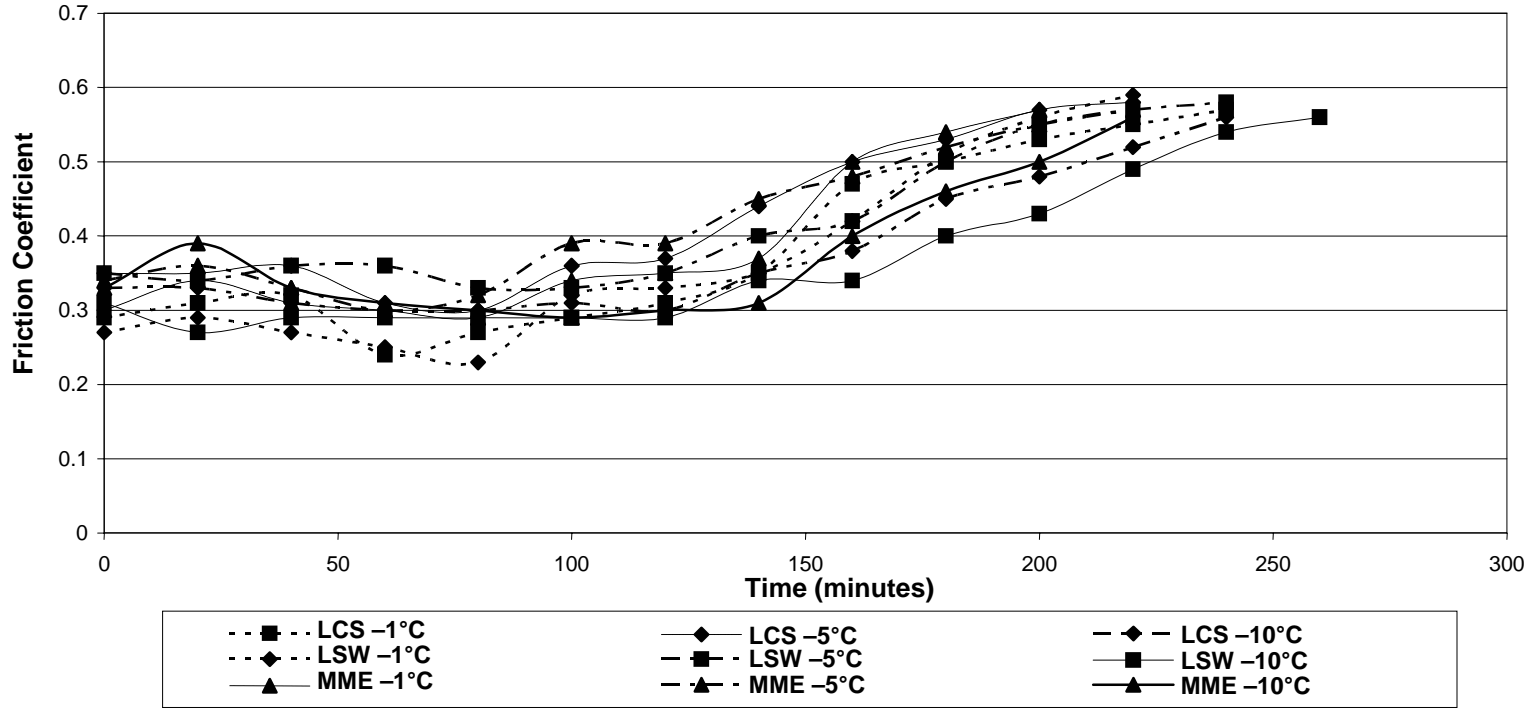

FIGURE 3 Pretreated solids friction versus time.

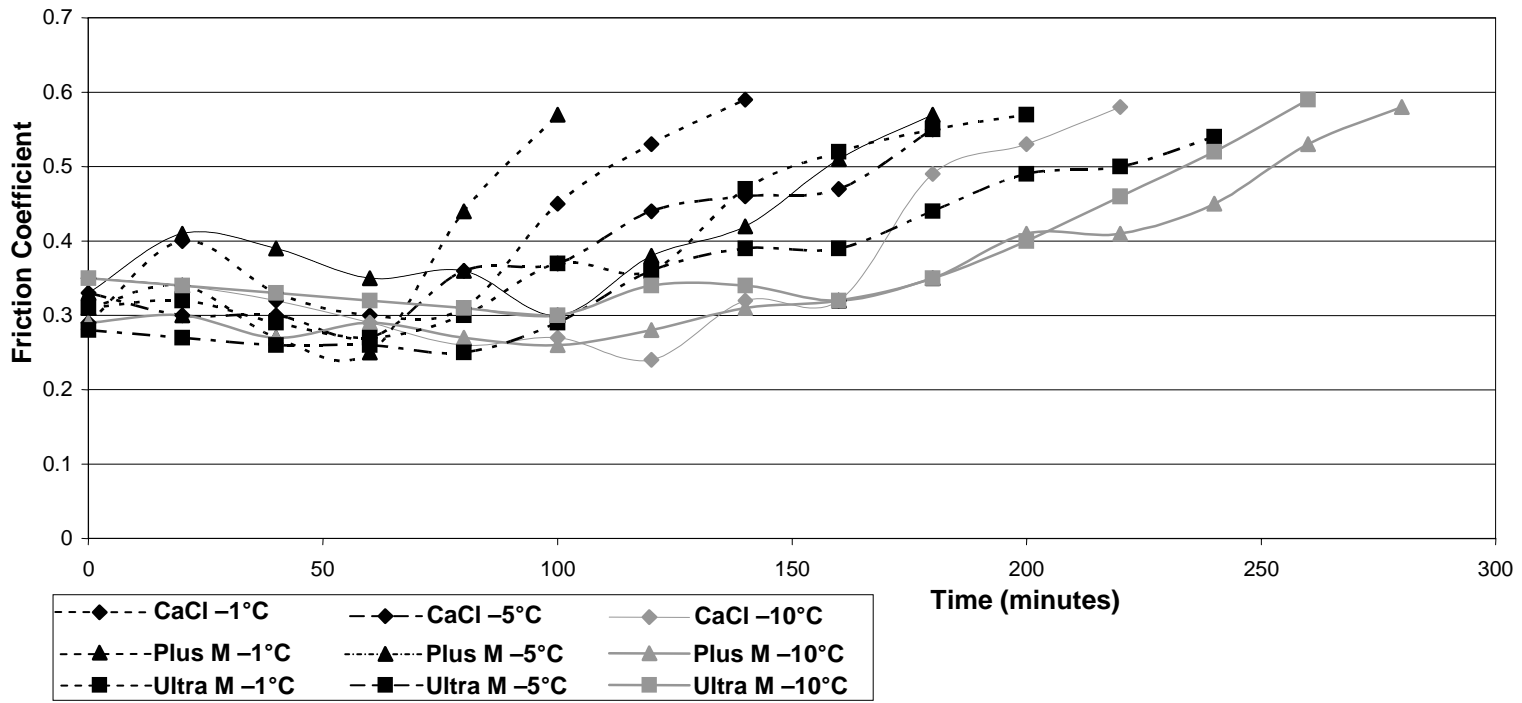

FIGURE 4 Eight gal/ton liquid chemical prewetted BRS friction versus time.

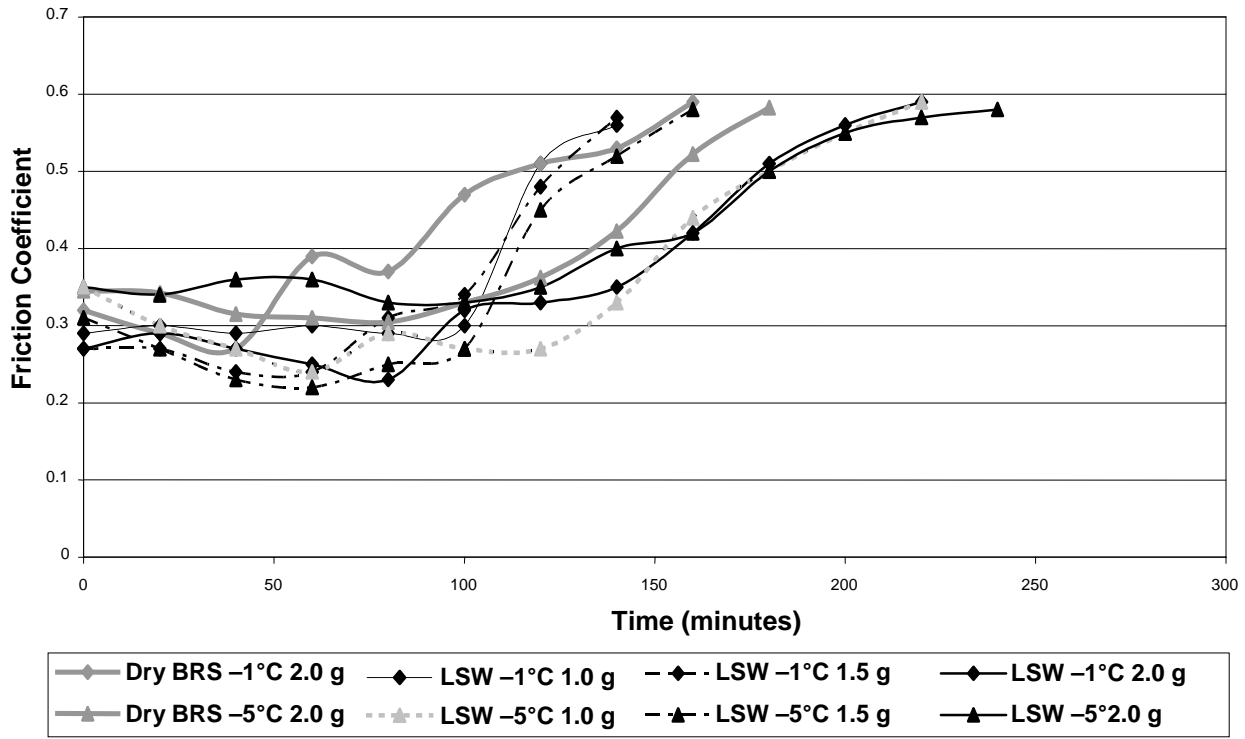

FIGURE 5 Caliber M2000 LSW friction versus time at -1°C and -5°C .

section of road, then a prewet application would involve the same ton of dry salt in addition to a further mass of prewetting liquid. Therefore more mass of salt overall (dry and liquid) would be placed on the road when used prewetted as opposed to a dry salt application alone. The possible reduced melting action of some of the prewet agent and BRS mixtures, compared with dry BRS, in this study may be due to these mixtures containing less total salt. By comparing the melting efficiency of 2.0 g of prewetted salt with 2.0 g of dry salt, the prewetted samples actually would contain less overall salt. That is, the prewetted salt would contain three basic ingredients: BRS, liquid salt (MgCl), and a rust inhibitor. The inhibitor likely would not be an effective melting agent, and therefore the portion of the 2.0 g taken by the inhibitor would not improve the melting action. There also could be a chemical interaction between the inhibitor and the other salts, which degrades performance to a small degree. In any event, the real world practice of adding the prewetting agent to the full amount of BRS would avoid this problem of effectively reducing the mass of salt.

Use of prewetting in the field has been shown to enable a reduction in the amount of dry salt required to achieve the same melting action. This is likely due to the well-documented improvement in the amount of salt that is retained on the traveled portion of the road when a prewetting agent is used (6). In other words, the real-world improvement gained by prewetting at warmer temperatures may be due largely to having most of the salt stay on the roadway. The same reference echoed this study's findings that prewetted salt had a definite melting performance improvement below -6°C (20°F), whereas there was minimal improvement above -3°C (27°F).

The finding that using a higher ratio of liquid deicing agent to dry BRS gives better melting performance may indicate a beneficial chemical interaction between the liquid and dry salts. With the higher ratios there likely would be a greater influence from this interaction. That would explain the results of having slightly worse melting for some mixtures at 4 gal/ton than for dry salt but better melting than 4 gal/ton when 8 and 12 gal/ton was used. For the mixtures with melting performance that was worse than dry BRS at warmer temperatures, there appear to be two opposing forces at work. A reduction in mass decreasing performance that may be partially offset by an inherent chemical benefit to using more prewetting agent is a potential explanation for this phenomenon.

In summary, the melting performance of dry salt appears to be improved by prewetting more at colder temperatures than at warmer ones. The actual melting performance of the same mass of prewetted salt may be slightly less than dry salt for some mixtures; however, this is likely more than compensated for by the improved retention of prewetted compared with dry salt in real-world driving environments. This study confirms a significant benefit in lowering the effective operating temperature of salt when prewetted with a liquid deicing chemical.

CONCLUSIONS

The current study confirmed earlier literature regarding the need to traffic snow samples. This replicates the action of passing vehicles in removing excess melted snow and stabilizes the underlying compact snow.

Tests comparing prewetting with liquid deicer and prewetting with distilled water indicated any melting performance benefit of prewetting likely is not due to the simple presence of additional moisture.

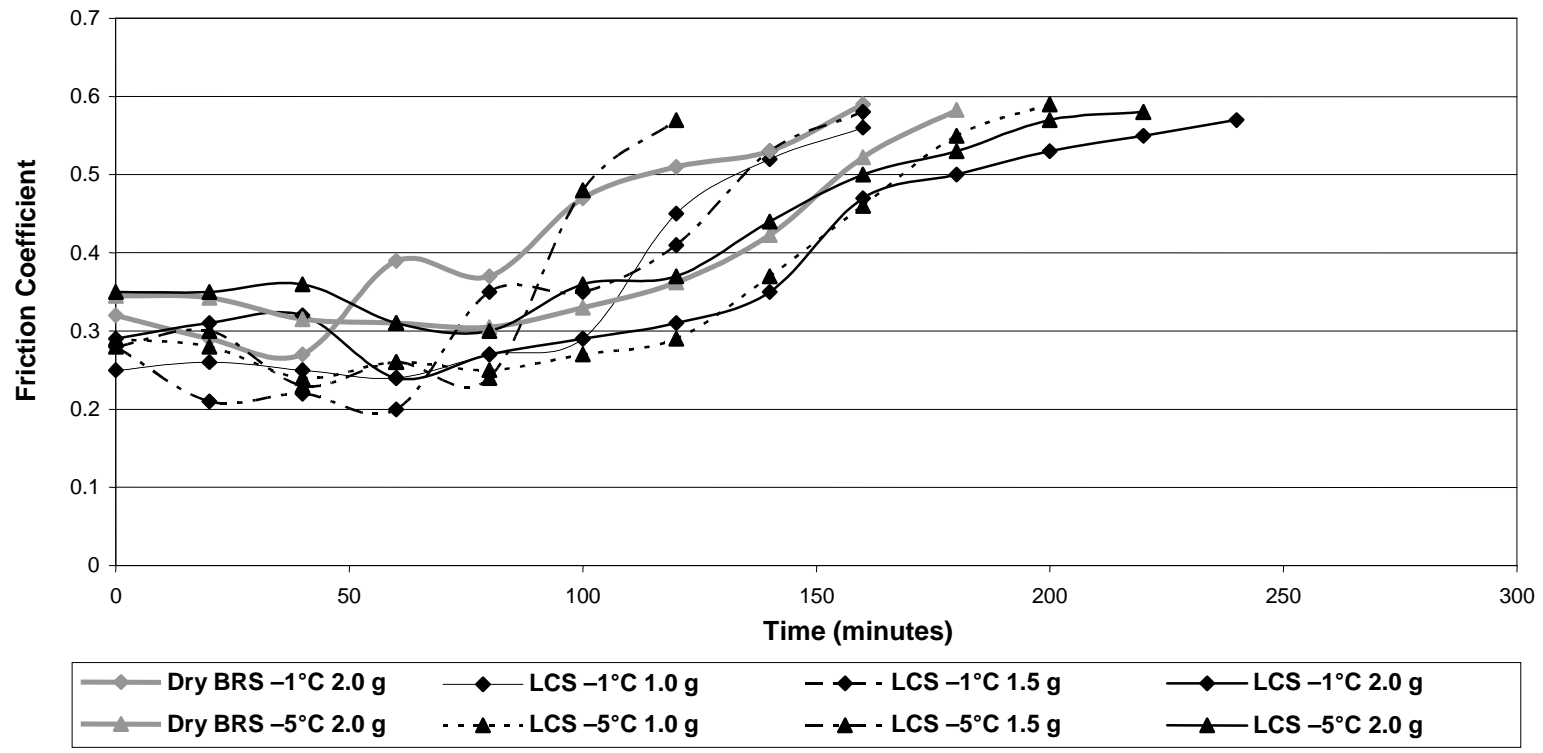

FIGURE 6 Liquid corn salt friction versus time at -1°C and -5°C.

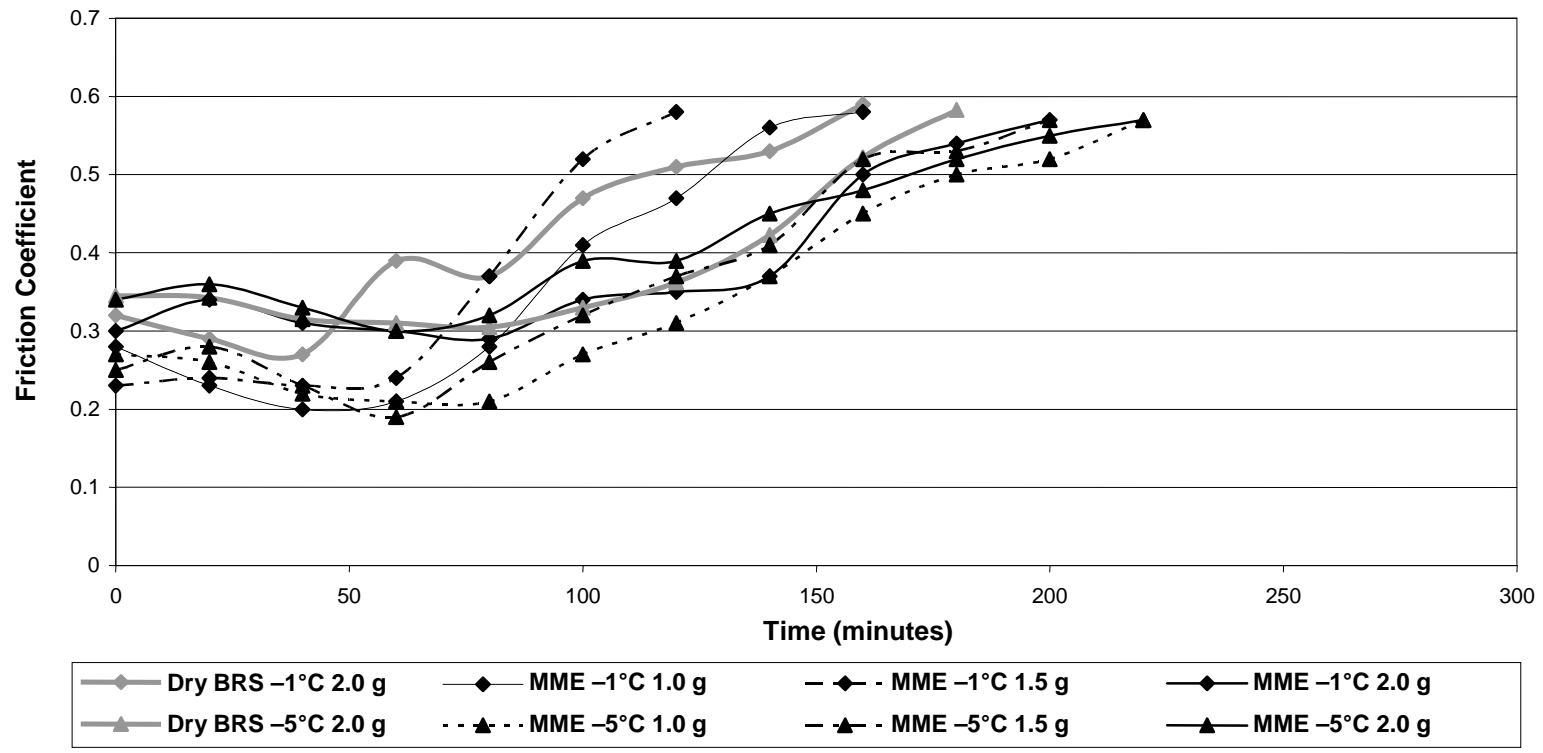

FIGURE 7 Mineral melt elite friction versus time at -1°C and -5°C.

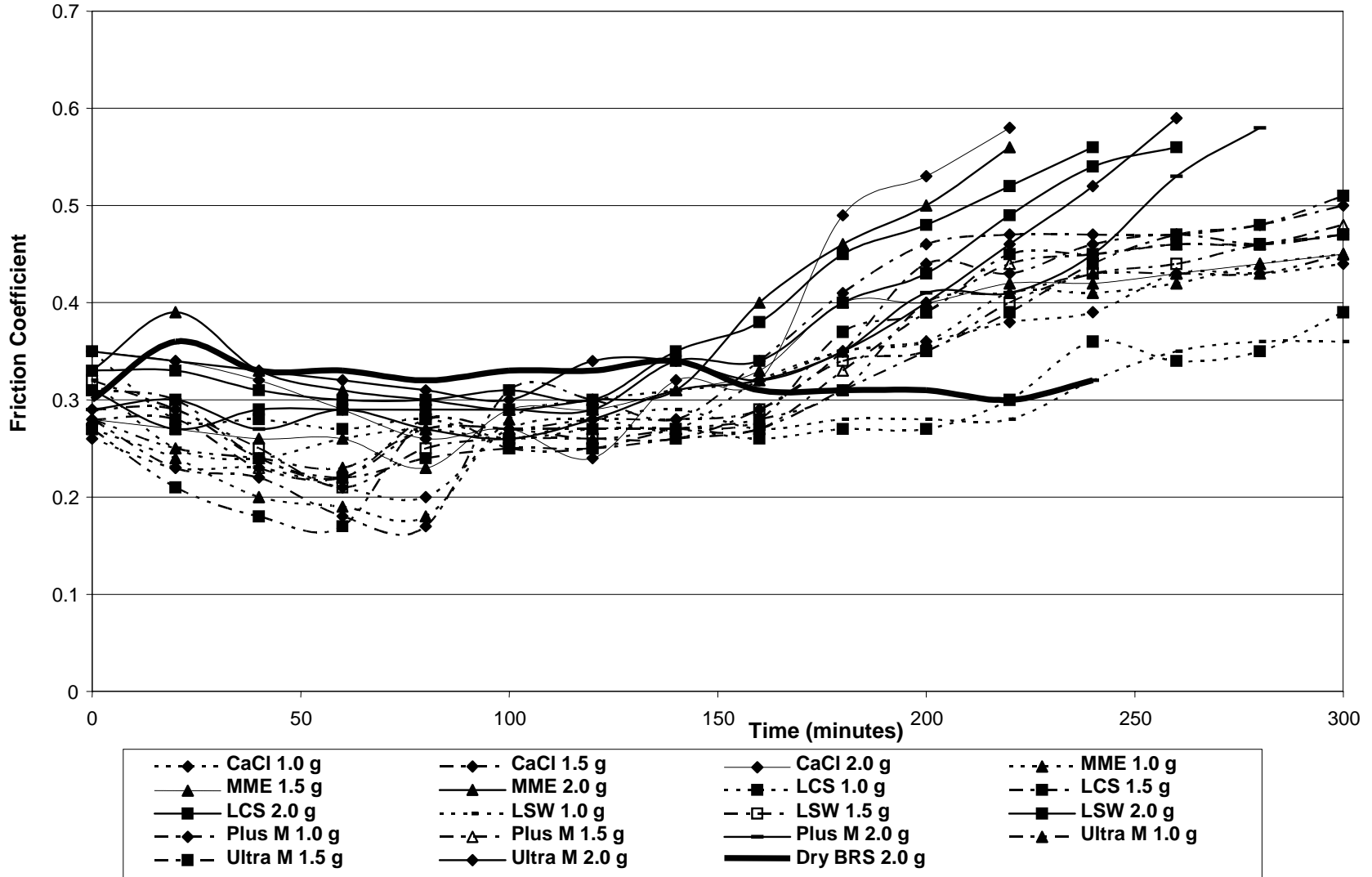

FIGURE 8 Eight gal/ton friction versus time summary at -10°C .

Prewetting was found to decrease slightly the melting performance of salt at relatively warm temperatures (-1°C and -5°C) for some prewetted mixtures and somewhat improve melting performance for other mixtures. All of the liquid deicer prewetted mixtures were effective at -10°C , whereas the BRS was not. The prewetted salts ceased to be effective at this temperature when a reduced mass of mixture was used.

Melting was improved by increasing the ratio of liquid deicer to rock salt. The products supplied for testing as pretreated solids had consistent melting performance across the tested temperatures. In contrast, the mixtures of liquid deicer and BRS made in the course of this study had their melting times increase substantially at lower temperatures.

Attempts to use reduced amounts of prewetted salts to achieve the same performance as a greater amount of BRS at -1°C and -5°C gave unexpected results. The supplied pre-treated solids matched or bettered the performance of dry BRS when applied at 1.5 g, although they did not perform as well when 2.0 g was applied. No explanation for this was found. The liquid deicer and BRS mixtures had more expected results, but none performed at 25% or 50% reduced applications sufficient to match the full application of dry BRS.

Overall, the melting performance of dry salt appears to be improved by prewetting more at colder temperatures than warmer ones. The actual melting performance of the same mass of prewetted salt may be slightly less than dry salt for some mixtures. However this likely is more than compensated for by the improved retention of prewetted compared with dry salt in real-world driving environments. This study confirms a significant benefit in lowering the effective operating temperature of salt when prewetted with a liquid deicing chemical.

ACKNOWLEDGMENTS

This study could not have been conducted without the kind assistance of many people. The authors specifically thank Ron McColl of the city of Kamloops Parks and Recreation, Brian Koronko of McArthur Island Sports Centre, Brian Silverson of the Ice Box Arena Corporation, and Trent Hammer of the University College of Cariboo Chemistry Department. The authors also thank Gerald Sdoutz, Dale Keep, and Graham Gillfilan for their assistance and advice.

REFERENCES

1. Perchanok et al. *Highway De-Icers: Standards, Practice, and Research in the Province of Ontario*. Report MAT-91-13, Ontario Ministry of Transportation, 1991.
2. Perchanok. *Field Trials of Pre-Wetted Sand for Winter Maintenance*. Report MAT-94-10, Ontario Ministry of Transportation, 1995.
3. Comfort and Dinovitzer. *Traction Enhancement Provided by Sand Application on Packed Snow and Bare Ice: Summary Report*. Report MAT-97-02, Ontario Ministry of Transportation, 1997.
4. Comfort. *Field Tests of Winter Sands on Packed Snow and Bare Ice*. Report MAT-96-01, Ontario Ministry of Transportation, 1995.
5. Comfort. *Laboratory Tests of the Performance of Highway De-Icing Chemicals and Winter Sand on Compacted Snow and Ice*. Report MAT-94-05, Ontario Ministry of Transportation, 1994.
6. Woodford et al. *1974–1975 Prewetted Salt Report*. Michigan Department of State Highways and Transportation, 1975.

MATERIAL DISTRIBUTION, PERFORMANCE, AND RESIDUAL

Patterns of Residual Salt on Road Surface *Case Study*

GÖRAN BLOMQVIST**MATS GUSTAFSSON***Swedish National Road and Transport Research Institute*

A field study was performed in order to investigate the patterns of residual salt on a road surface and the mechanisms involved in transporting the salt off the road into the roadside. The residual salt was measured in nine segments across a road and repeated in 2- to 24-h intervals, depending on the road surface conditions. The Swedish National Road and Transport Research Institute will implement the results in a winter maintenance management model under development. The results showed clearly that the vehicles were important for redistribution of the salt from wheel paths. A light snowfall increased the salt content in the roadway probably because of redistribution of salt from outside-the-road borderlines by passing vehicles because of increased wetness. The amount of residual salt in the wheel paths could be modeled rather well with an exponential function so that the amount of salt was depending on the accumulated number of vehicles after each salting occasion. A model constant was suggested to be related to the road surface conditions.

INTRODUCTION

Winter Maintenance Management System

Salt (mainly sodium chloride) is widely used in winter maintenance for deicing and anti-icing purposes. Because of the well-known environmental drawbacks of salt exposure to roadside vegetation and groundwater, the road keepers constantly strive to minimize the amount of salt used during the winters. In that context, knowledge of the content of residual salt remaining on the road surface is of great importance for the tactical decisions of whether another salting action is needed. The salt remaining on the road surface also will be transported sooner or later off the road by different means and, hence, expose the roadside to different amounts of salt. At the Swedish National Road and Transport Research Institute (VTI) a winter maintenance management system (WMMS or the winter model) is under development. The winter model consists of submodels for assessing the state of the road, its effects, and their appraisalment [see State-of-the-Art Fixed Automated Spray Technology (FAST) by Jerry R. Waldman on pp. 379–390 in this circular]. One of the submodels describes the environmental effects by modeling the roadside exposure to salt (see Modeling the Exposure of Roadside Environment to Airborne Salt: Case Study on pp. 296–306 by Gustafsson and Blomqvist in this circular). In order to model the roadside exposure to salt, knowledge of the amount of residual salt available on the road surface is a prerequisite. The purpose of the field studies described in this paper is to gather field data of the residual salt pattern on the road surface together with information on the factors influencing the transport of the salt off the road. In this paper these patterns and relationships are discussed in relation to how this knowledge should be used within the winter model. Also, a modeling approach to describe the decline of residual salt is made.

Residual Salt

Although there are numerous investigations performed on the environmental effects of deicing salt exposure to the roadsides, investigations of the mechanisms responsible for the transport of salt from the roads to the surroundings are rare.

In a Danish investigation, the amount of residual salt after a salting occasion was shown to be related linearly to the number of vehicle passages after the salting, at least when the traffic intensity was between 2,500 to 3,500 vehicles per day (*I*). The traffic intensity explained in the best cases 17% to 18% of the variation. On two of the four roads that were investigated the same relation between the residual salt and the traffic intensity could not be found. This was explained by the relationship maybe not being linear (*I*).

In a Swedish investigation, the residual salt decline showed to be related exponentially to time (*2*). A model was designed with the presumption that the salt will leave the road surface only by the transportation of liquids off the road. Another presumption was that the total amount of salt across the road surface can stay only at a constant level or decline by time (unless another salting action is taken). Locally, however, the residual salt may increase initially during precipitation because of salt relocation from the road center and other less trafficked areas.

FIELD WORK

The residual salt was measured by a chlorine meter (SOBO20, see [Figure 1](#)). This instrument worked by splashing a precise volume of measuring liquid (85% acetone) on an exact delimited road surface area. The electric conductivity and temperature were measured in the liquid, and thereby the amount of sodium chloride per square mile could be calculated. The measurements were separated by transect sections. The road was divided into nine segments from one edge of the road to the other: road edge (outside the white line), in the right wheel path, in between the wheel paths, in the left wheel path, at the road center, in the left wheel path, in between the wheel paths, in the right wheel path, and, finally, at the other road edge. Each measurement in the study was the mean value of three individual measurements, next to each other (see [Figure 1](#)). For each new measurement the three points were chosen next to the earlier measurement but shifted slightly toward the direction from where traffic came in order to avoid influence from the acetone solution already flushed out on the road surface. A similar procedure was taken in a Danish investigation with the same measuring equipment (*I*).

Two field sites were used to collect the data needed. At the first place, Vimmerby, an existing standard road weather information system was used hourly to gather data on the traffic amount and type. The traffic counter was installed in the pavement, and the traffic data were collected by magnetic induction. At the other field site, Klockrike, the traffic data were collected by a rubber tube, which needed to be disconnected when the plowing truck was passing the field site. The traffic data, salting occasions, and mean values of the residual salt in the left wheel tracks are presented in [Figure 2](#). The traffic data are calculated as the sum of the number of private cars, heavy trucks times 5, buses times 5, and heavy trucks with trailers times 7. The coefficients of 5 and 7 are not evaluated in this paper. The posted speed limits were 90 km/h⁻¹ at both field sites.

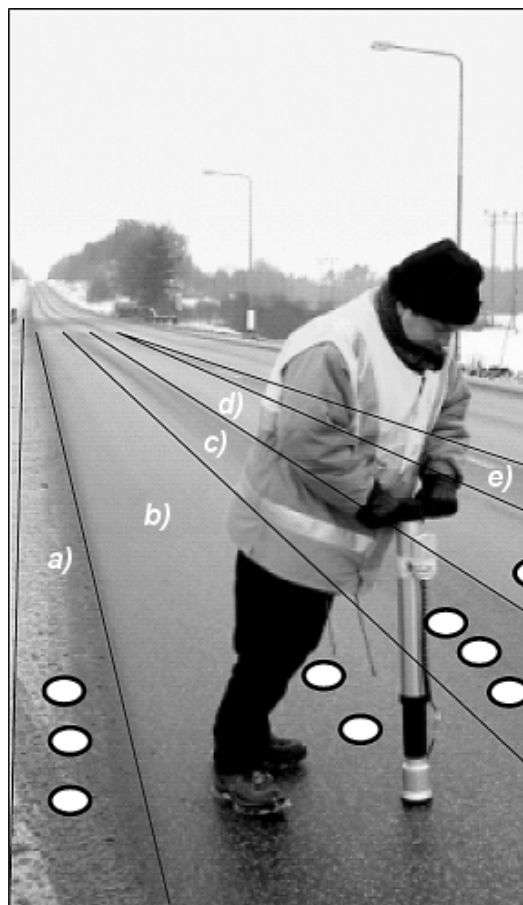

FIGURE 1 Measuring the residual salt on the road surface—note how the road surface is divided into segments: (a) road edge, (b) wheel track, (c) in between wheel tracks, (d) wheel track, and (e) road center. The measurements continue on the other half of the road.

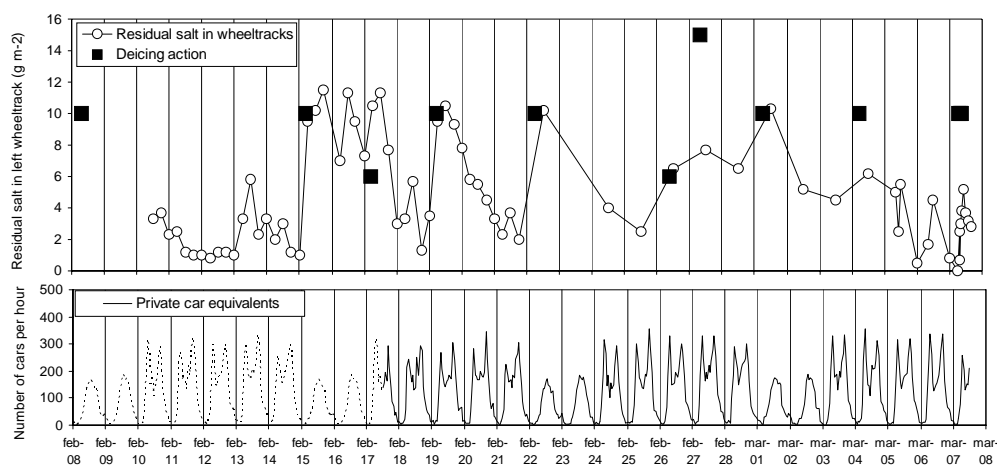

FIGURE 2 Residual salt in the wheel tracks, deicing actions, and traffic data. Traffic data are missing for the first 9 days. For that period the data used (dashed line) are compiled by the mean hourly data for the 2 consecutive weeks.

RESULTS AND DISCUSSION

The residual salt transects of the first 288 h of measurements at Klockrike field site are compiled in Figure 3, where the mean value of the residual salt amount in each segment of the road transect is presented along the vertical axis. The different repeated measurements are shifted along the horizontal time-axis. The space–time graph then is produced by linear triangulation of the data points. The amount of salt on the roadway, on the pavement inside the white lines of the road edges, is low for the first couple of days, but there seem to be high amounts of salt gathered on the road surface outside the white lines. For the first 18 h there also seems to be some salt remaining on the road surface from the salting occasion that took place in the morning of February 8 (72 h earlier). Usually the decline of the amount of residual salt on the road surface works faster than this, but one should bear in mind that the road surface conditions were dry to moist (with very low degree of wetness). These rather dry road conditions prevailed during the larger part of the investigation period that is illustrated in Figure 3.

There are two exceptions when the road surface got wetter because of a light snowfall. The first period was on February 13 and the second was on February 15. A small snowflake marks these snowfalls at each time of their observation in Figure 3. What can be seen as an effect

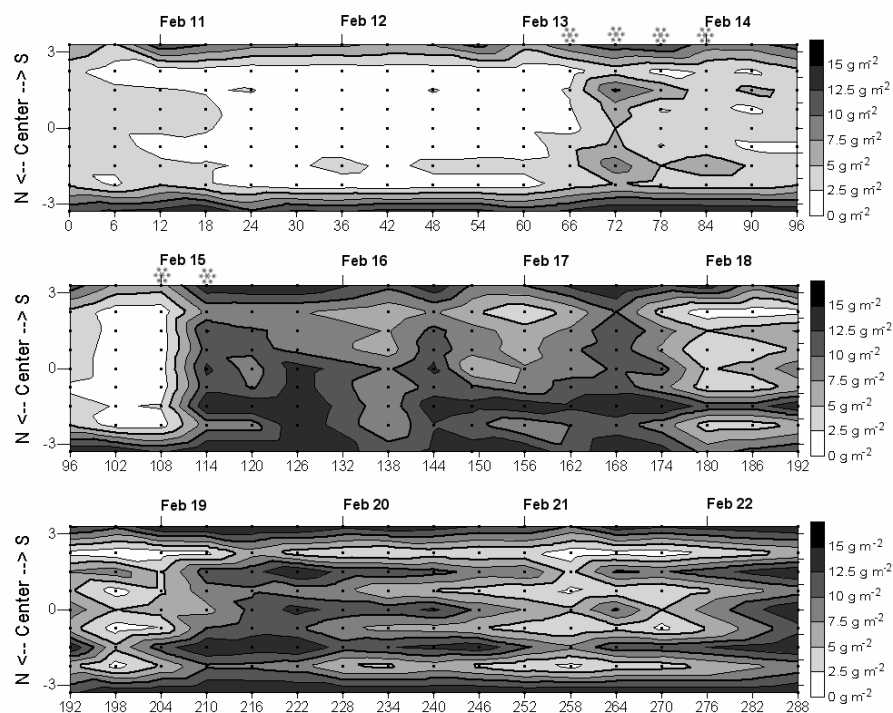

FIGURE 3 The development of residual salt pattern by time. X-axis is a timescale with the number of hours from start denoted on the lower axis and the dates on the top axis. The Y-axis is a transect across the road with each measurement in time and space marked as a black dot. Two periods of very light snowfall are marked by small snowflakes on the top axis.

of the higher degree of wetness of the road surface is an increase of residual salt starting in hour 66 and peaking in hour 72, especially in between the wheel paths in each direction of the road (see Figure 3). This is explained by redistribution of salt accumulated on the pavement outside the roadway into the driving lanes by passing vehicles. Similar effects have been discussed by Ericsson and Gustavsson (2). The first salting action after February 8 was taken on the morning of February 15 and can be seen as a major increase in the amount of residual salt. The salting was repeated in the morning of February 17.

During the latter half of the period illustrated in Figure 3, it became evident that the salt was gathering between the wheel tracks and in between the road halves. The standard deviation of a transect across the road was approximately twice as high (on February 20) as compared with the standard deviation of a 24-h time window during the same period (see Figure 4). The usefulness of residual salt measurements sometimes has been questioned. This study, however, showed that as long as one really was doing the repeated measurements within the same segment of the road, it was more likely to get a similar value several hours later than if moving to another segment of the road right after the first measurement.

For the modeling purposes in this study, the two inner wheel tracks (closest to the road center) were chosen to represent the amount of residual salt on the road surface available to roadside exposure. The reason for using the two inner wheel tracks in this first phase of modeling was that it was thought that this was the track that both private cars and larger heavy vehicles most often share and that the other two wheel tracks are more scattered in space. The mean value of the residual salt measurements in the two inner tracks is presented in Figure 2. In order to find out the rate at which the salt was leaving the road (or redistributed on the road), and since the pattern of salt distribution on the road seemed to be correlated strongly to the traffic, a model (function 1) was tested; it used the salt application as a start value and the accumulated traffic after the salt application as the factor influencing the rate at which the salt was leaving the wheel tracks. Testing equation 1, in which k is the rate by which the salt left the wheel track, used field data collected in Klockrike from the salting occasion in February 19 to the salting occasion in February 22, and gave the result that can be seen in Figure 5.

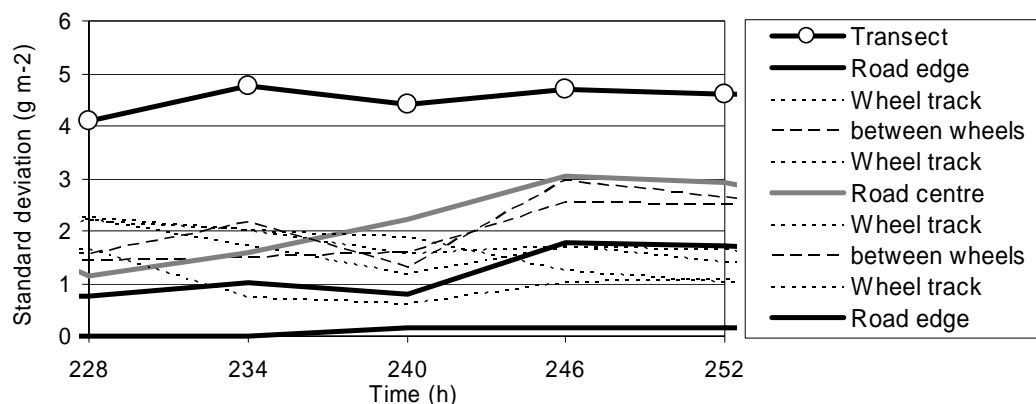

FIGURE 4 The standard deviation of the residual salt measurements in the transect across the road and in a time window of 24 h in each type segment: road edges, wheel tracks, between the wheels, and in the road center.

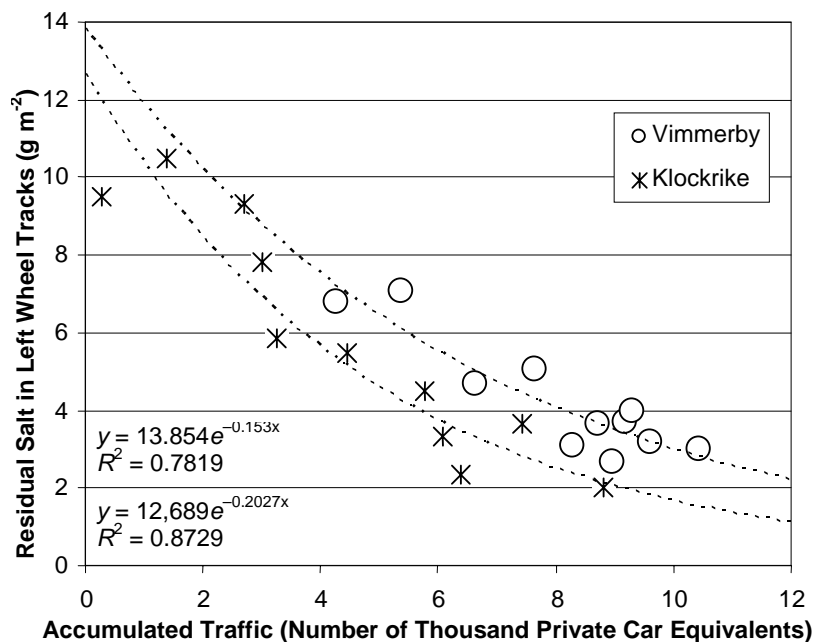

FIGURE 5 The relation between traffic and amount of residual salt in the wheel tracks in the two field sites, Vimmerby and Klockrike.

$$RS = S \cdot e^{-k \cdot PC_{eqacc}} \quad (1)$$

where

RS	= residual salt
S	= salt use
PC_{eqacc}	= accumulated private cars equivalents

This model suggests that the salt amount after the salting action in the morning of February 19 is 12.689 gm^{-2} and that the coefficient k describing the decrease is -0.2027 . Letting k , calculated from 3 consecutive days during the field experiment, represent the conditions during the entire 25-day-long field period gave the modeling results that can be seen in Figure 6. With exception of the two occasions when the light snowfall caused a suggested redistribution of the salt on the road (February 13 and 15), the model describes the residual salt surprisingly well until February 27. A reason for the good fit of the model to the measured data may be the fact that the weather situation during the investigation period was rather stable.

A value of the coefficient k was also calculated from the field data collected in the Vimmerby site (also seen in Figure 5). The Vimmerby k -value differs somewhat from the Klockrike k -value implies a somewhat slower rate of residual salt decrease in Vimmerby. However, whether this is a result of different wetness of the road surface during that time period, different road surface characteristics, a different composition of the traffic, or the use of another winter maintenance equipment in Vimmerby is not yet known.

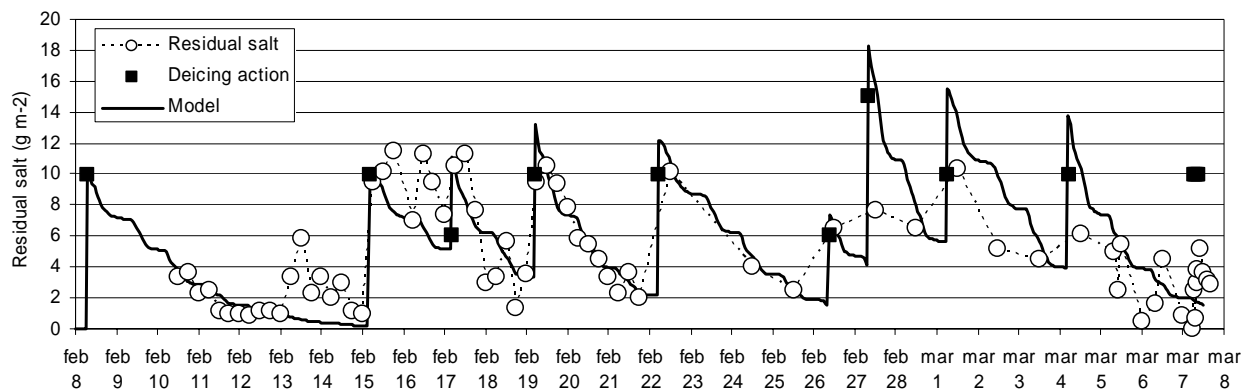

FIGURE 6 Modeling results as compared with the field measurements of the residual salt and the deicing actions.

Implementation in the winter model requires calibration of the model using data from field investigations under various conditions regarding the weather, traffic, and salting. Also, in order to be able to create a more generic model, different sites should be used to represent different pavements and different traffic compositions.

Issues that need to be addressed during the field investigations during the 2003–2004 and 2004–2005 winter seasons are

- What is the correct relation between a private car, a bus, a truck, and a truck with trailer regarding their potential to force the salt solution and salt-laden slush off the road surface into the surroundings?
- What is the influence of the different road surface states on the ability of the vehicles to force the salt off the road?
- How do climatic factors such as local wind speed and precipitation influence the decline of residual salt?
- How shall salt redistribution on the road surface be modeled?

ACKNOWLEDGMENTS

This study was made as part of the winter model project performed at VTI and is financed by the Swedish National Road Administration and the Swedish Agency for Innovation Systems.

REFERENCES

1. Fønnesbech, J. K., and K. B. Prahl. Saltlagespredning på trafikveje. Fyns Amt, Denmark, April 2000. (In Danish). www.fyns-amt.dk/wm103165. Accessed Dec. 1, 2003.
2. Ericsson, B., and T. Gustavsson. *Projekt Restsalt—Empirisk datormodell för beräkning av restsalt, vätskefilm och fryspunkt* (in Swedish). Bergab Klimatundersökningar, Göteborg, Sweden, July 1995.

MATERIAL DISTRIBUTION, PERFORMANCE, AND RESIDUAL

Field Persistence of Anti-Icing Sodium Chloride Residuals**CHRISTOPHER L. HUNT****GAYLE F. MITCHELL****WALLACE RICHARDSON***Ohio University*

Highway anti-icing programs strive to prevent the ice–pavement bond by preapplication of chemicals. An effective anti-icing program must estimate the time–traffic decay of the chemical residual on the highway surface. Sodium chloride solution (brine) is the most widely used chemical for anti-icing. Application rates for brine vary from state to state. The Ohio Department of Transportation (DOT) generally applies 23% sodium chloride brine at the rate of 40 gal per lane mile.

An extensive study of brine residual decay over time and traffic was completed on portland cement concrete (PCC), Nova-Chip asphalt cement (NCAC), Micro-Seal asphalt cement (MSAC), and open-grade asphalt cement (OGAC) pavements. During five sampling events in October and November 2002, brine residual, pavement temperature, traffic counts, and atmospheric conditions were monitored for up to 3 days after initial anti-icing on U.S. Routes 33, 23, and 50 in Ohio. All test sites were delineated into four test stations that were located on level, tangent sections of four-lane divided highways within the driving lane.

Ohio DOT units applied the brine from ten evenly spaced nozzles, producing brine lines longitudinally along the pavement surface. Samples of brine, obtained before application at each site, were consistently near 23% concentration. Two field measurement procedures designated as diagonal and nozzle tests were developed. The diagonal method allowed for a lane cross-section profile determination of salt residual over time. The nozzle procedure provided residual decay over time of a given brine line. Quality assurance and control were accomplished by obtaining duplicate and blank measurements at 25% and 5% frequency, respectively. A Boschung Megatronic instrument model SOBO-20 that measured the surface pavement concentration of sodium chloride by conductivity was utilized in field and laboratory residual tests. Laboratory tests on pavement specimens with various known brine concentrations provided SOBO adjustment factors for field data.

The pavement surface affected initial brine concentration from site to site with NCAC, PCC, and MSAC readings being the lowest, midrange, and highest, respectively. Initial concentrations on OGAC were highly variable. Decay occurred at nearly the same exponential rate for each pavement surface; however, decay rates for OGAC could not be determined because of data variability. Time and traffic depleted residuals during nonprecipitation periods could not be differentiated. NCAC was found to have negligible brine residual after about 10 h and 1,500 vehicles. Residuals on PCC were depleted within 25 h and 7,500 vehicles. MSAC provided the longest-lasting residual with a projected persistence to 750 h and 170,000 vehicles.

INTRODUCTION

State highway agencies, focusing on traditional winter road strategies such as plowing, salting, and gritting, spend about \$1.5 billion each year roads for winter maintenance (1). Recently emphasis has shifted toward prevention of hazardous conditions with anti-icing pretreatment along with weather forecasting, remote sensing, and thermal mapping. Anti-icing is a proactive winter road maintenance strategy in which chemicals are utilized to prevent the bond between ice or snow and the pavement surface from forming.

Field tests of anti-icing operations have indicated that anti-icing can reduce the amount of chemicals needed while effectively preventing black ice on bridge decks with periodic application and requiring less effort to return the pavement to its original condition after a storm (2, 3). Effective and efficient anti-icing operations require accurate weather forecasting, adequate pavement condition monitoring, and the ability to predict the persistence of pretreatment materials applied to the pavement.

Black Ice and Anti-Icing

Black ice can form from various types of precipitation events such as rain, freezing rain, drizzle, sleet, and snow when it comes in contact with a cold or cooling pavement. Dew, frost, mist, fog, or super-cooled water vapor (unfrozen in air down to -40°C) also can lead to the formation of black ice on surfaces (4, 5). The strategy of deicing involves the use of freezing point depressant chemicals to break the bond that forms between snow or ice and the pavement. The function of deicing products is to lower the freezing point temperature of liquid, expressed as the eutectic temperature. The freezing-point depression is dependent on the chemical concentration of the solution. The behavior of sodium chloride-water solutions at varying concentrations is described by the well-known eutectic diagram as presented in several texts [e.g. Kaufmann (6)].

In response to the need of agencies to control costs while enhancing snow and ice control, anti-icing technologies were investigated in the Strategic Highway Research Program project *Development of Anti-Icing Technology* (7). This study indicated that anti-icing could provide a higher level of service using the same or less material when predictive methods are used in the decision process. The project also recommended further study of weather, traffic, and other conditions with anti-icing.

In order to prevent black ice or frost, the *Manual of Practice for an Effective Anti-Icing Program* (8) recommends that the chemical should be applied in advance of the expected time of ice formation so that the water component of the brine will evaporate or be removed by traffic action. This will leave only the residual chemical on the road surface and thus result in the greatest concentration when frost or black ice conditions occur.

Anti-Icing Application

The most widely used chemical for anti-icing is sodium chloride (NaCl), either as salt brine, pre-wetted road salt, or dry road salt. Application rates for brine vary by agency but generally range from 94 to 117 L per lane kilometer (40 to 50 gal per lane mile) of 23% solution by weight (9).

The Ohio Department of Transportation (DOT) has used extensively salt or brine in its winter management strategy. Currently, Ohio DOT is applying brine at the approximate rate of about 40 gal per lane mile. A new winter maintenance directive specifies biweekly application of brine for anti-icing pretreatment when conditions warrant (10).

Residual Decay

Following the application of brine, factors affecting persistence are reported to be traffic volumes, speed, vehicle types, length of time since application, dispensing rate, road conditions, and weather as well as whether the salt has dried out and could have been trafficked or blown away (8).

A review of the literature did not indicate availability of predictive decay models for brine residual persistence on highways under field conditions. However, one study in Funen County, Denmark, during the 1998–1999 winter measured residual salt from the spreading of 20% saturated brine and prewet salt at 0.5 m, 1.5 m, and 2.5 m from the centerline of the road for a total of about 1,800 measurements using a conductivity device [SOBO-20 by Boschung Megatronic AG, Switzerland (11)]. Fønnesbech (2) reported salt residual from brine was active on the roadway during a precipitation event and degradation of residual salt is affected crucially by high traffic intensity.

The objective of this study was to develop a predictive model of brine residual decay as a function of time and traffic on various pavements.

METHODOLOGY

Laboratory Procedure

Surface Brine Residual

Surface brine residual was determined by utilizing a Boschung Megatronic instrument model SOBO-20, which measured the mass per unit area of salt on the road surface based on temperature-compensated conductivity measurements (11). A solution of acetone and water is sprayed from the instrument that dissolved the salt on a sealed-off portion of the highway surface. Conductivity in the pooled solution increased in proportion to the density of NaCl available on and dissolved from the surface. This instrument was utilized on portland cement concrete (PCC) and open-grade asphalt concrete (OGAC) samples within the laboratory, as well as in the field. More than 100 laboratory measurements were made for various brine concentrations throughout the analysis capability range of the SOBO (0–45 g/m²) on each surface. The results provided SOBO adjustment factors for field data. Another researcher found significant variability (15% to 50%) in individual SOBO measurements indicating verification of SOBO measurements was essential (2).

Brine Samples

Brine samples were collected at each highway application, and the percent NaCl by weight was determined directly or indirectly by total dissolved solids, atomic adsorption spectrophotometry (Na⁺), ion chromatography (Cl⁻), and salinometer. These methods also were used to validate prepared brine samples for laboratory investigations. *Standard Methods* (12) were followed except standard protocol was used with temperature correction for the salinometer.

Field Procedure

An extensive study of brine (NaCl) residual decay over time and traffic was completed on test sections of PCC, Nova-Chip asphalt cement (NCAC), Micro-Seal asphalt cement (MSAC), and OGAC (see [Table 1](#) for characteristics of the test sections). Selection was based on the diversity of pavement type and proximity of weather stations. During five testing sessions in October and November 2002, brine residual, pavement temperature, traffic counts, and atmospheric conditions were monitored for up to 3 days after brine application on U.S. Routes 33 (US-33), 23, and 50 in central and southeast Ohio. Driving lane traffic counts were obtained by using standard pneumatic traffic counters placed one-third and two-thirds the distance through the test section for most sites. Traffic was routed around the test sections while brine was applied. Bare surface pavement readings were taken before application of brine. All were zero.

Ohio DOT units applied 40 gal per lane mile, proportioned with speed by using automatic flow control of 23.3%, by weight, NaCl solution from 10 evenly spaced nozzles, producing brine lines longitudinally along the pavement surface. All test sites were on level, tangent sections of four-lane divided highways within the driving lane. Four evenly spaced test stations were demarcated within each highway section, and then readings were made. This provided four sets of data over time and traffic for analysis. Immediately after application, the brine line widths were measured at each of the four test stations at each field site. Samples of the brine were taken from the distributor at each site for laboratory assessment of salt concentration.

For each site, baseline SOBO readings were made to verify that the pavement was free of any conducting residual before Ohio DOT applied brine. Residual measurements were made on all stations in a test section at approximately 2-h intervals, while traffic was diverted to the passing lane. About 1 h was needed to complete each set of interval measurements; then the lane was re-opened to traffic for 1 h. Measurement usually ceased at the time of the afternoon traffic peak and then resumed the next day.

A field protocol was developed with two measurement techniques—the diagonal method and the nozzle method (see [Figure 1](#)). The nozzle method was used specifically to determine concentrations within the line, whereas the diagonal method determined brine concentration

TABLE 1 Characteristics of Field Sites

Test Site (direction)	Approx. SLM	Pavement	Dates (2002)	ADT	Exposure (# veh.)	Exposure (traffic hours)
ATH-50 (EB)	19.88	PCC grooved	Oct. 8–9	8560	3082	22:28
DEL-23 (SB)	13.86	AC open graded	Oct. 30–31	26820	6368	17:09
DEL-23 (NB)	13.86	PCC grooved	Oct. 31–Nov. 1	26820	6361	16:40
ATH-33 (EB)	5.18	AC Micro-Seal	Nov. 13–15	16730	11214	33:55
ATH-50 (EB)	24.94	AC Nova-Chip	Nov. 25–26	7500	3855	7:53

AC = asphalt concrete; SLM = Straight line mileage; ADT = Average daily traffic (all classes).

along the pavement diagonal, which provided a representation of concentration along the whole width of the pavement section. These two data sets (diagonal and nozzle data) were then combined to develop the durability functions for brine. The following provides a description of each measurement technique.

Diagonal Method

The SOBO instrument could make adjacent measurements spaced less than 7 cm apart, edge to edge. The diagonal method (see [Figure 1](#)) was introduced to remove this handicap and permit salt-density assessment of the entire lane width with no gaps in coverage, and thereby account for all the applied salt. Closely spaced measurements along a 20- or 30-ft diagonal line beginning at the edge of the lane and ending at the centerline formed an almost continuous profile of the concentration of salt across the whole lane when projected onto a line perpendicular to the centerline. [Figure 1](#) shows personnel completing measurements along a diagonal. Lines mark previous diagonal measurements. Measurements were made on the farthest downstream test section first and proceeded upstream against the traffic flow each time period, in order to minimize contamination due to tracking of SOBO test fluid residue.

Nozzle Method

The nozzle method entailed determination of salt residual on each of the 10 brine lines. Measurements were completed on each visually observed brine line during each time-traffic



FIGURE 1 Brine residual measurements along the pavement diagonal and on the brine lines.

interval. Figure 1 indicates nozzle readings by dots. As can be seen on the center brine line, a duplicate was performed by stepping down traffic of the original nozzle reading. Care was taken not to allow spent SOBO test solution to destroy the integrity of the lines by working from the berm to the centerline of the road. This technique allowed test solution to flow toward the previously analyzed lines.

DISCUSSION OF RESULTS

For each site, all baseline diagonal and nozzle values before brine application were zero. To simplify comparisons of profile (diagonal) data, the highest 10 readings from each profile were selected for evaluation. These 10 readings were considered to be the peak concentrations representing the true brine lines concentrations. When the top 10 diagonal readings were compared to nozzle data, the results were similar. Mean top 10 diagonal data and nozzle data for each site were chosen for overall data analysis.

SOBO Correction

SOBO readings were found to underrepresent the g/m^2 of surface salt at concentrations greater than 4 g/m^2 . Correlation functions to correct for the underestimation were developed for PCC and asphalt concrete (AC). Conversion of field SOBO readings to projected actual concentrations was accomplished using Figure 2. This graph was developed from regression analysis of laboratory data. The limitations of the SOBO instrumentation would not allow acquiring data above 45 g/m^2 . Therefore, the use of the graphs above 45 g/m^2 is not substantiated

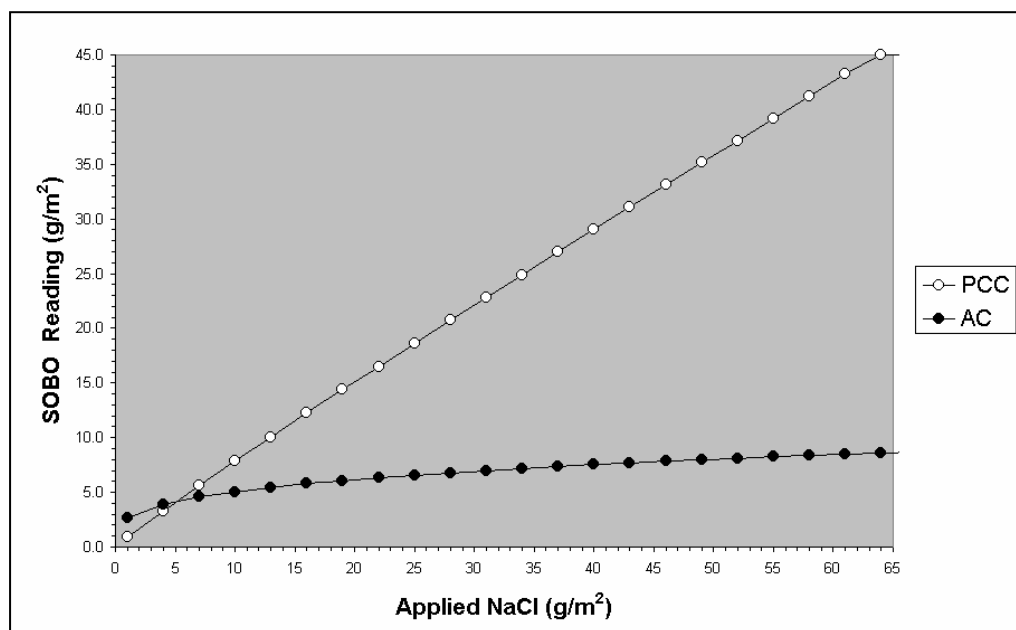

FIGURE 2 Regression lines to convert SOBO field data to applied NaCl concentrations.

by data. In addition, it should be noted that three different AC pavements were investigated in the field study; however, one AC pavement core that appeared less porous than OGAC and more porous than MSAC was utilized to develop the correction function.

Factors Affecting Residual Concentrations

Initial brine concentration on the pavement surface was found to be affected significantly by application method, pavement porosity, and surface roughness.

Application Method Affecting Brine Line Widths

In addition to the variability in pavement materials and brine concentrations, application equipment produced some variability in brine line widths. At each site, brine line widths were measured just after the initial brine application. Mean brine line widths at each site were not consistent. This variability could be attributed to the differing application equipment with changes in drip line hose lengths and speed of application, as well as environmental factors such as wind speed and direction.

For a given application rate (gallon per lane mile) and NaCl concentration (%), the pavement surface salt density in g/m^2 is a function of the brine line widths. As the sum of the widths of the ten lines increases, the peak density of NaCl residual in the brine lines decreases.

Pavement Variability

Porosity of pavement was a significant factor in initial brine losses. Pavements with highly porous surfaces such as OGAC had low initial residual concentrations, whereas low porosity pavements such as PCC and MSAC had high initial residuals. The contrasts in the initial brine concentrations at the five sites indicated the significance of porosity and roughness of the pavement material.

Both DEL-23 PCC and ATH-33 MSAC had initial average brine concentrations of about 16 to 18 g/m^2 . The ATH-50 PCC, followed by the ATH-50 NCAC, was next in order of concentration magnitude. These values of initial brine on the pavement were about half that found on the ATH-33 MSAC and DEL-23 PCC. The lowest initial residual brine concentration was measured on the DEL-23 OGAC. The porosity of the asphalt attributed to variability in the readings of the brine concentration, particularly for the OGAC.

Environmental Conditions

In an effort to detect any effects due to ambient conditions such as temperature and humidity on the decay of salt pavement concentration, environmental data for two test sites (DEL-23 PCC and ATH-33 MSAC) were evaluated with residual concentration data.

Figures 3 and 4 provide a graphical representation of the mean nozzle and the top 10 diagonal readings in g/m^2 versus hours of exposure for DEL-23 PCC and ATH-33 MSAC, respectively. Environmental conditions are plotted along with the residuals. Humidity was invariant for DEL-23 PCC and not plotted; however, it is illustrated for ATH-33 MSAC. The ambient data for DEL-23 were collected on site, but data for ATH-33, with the exception of the pavement temperature, were retrieved from a weather station approximately 10 mi from the application site.

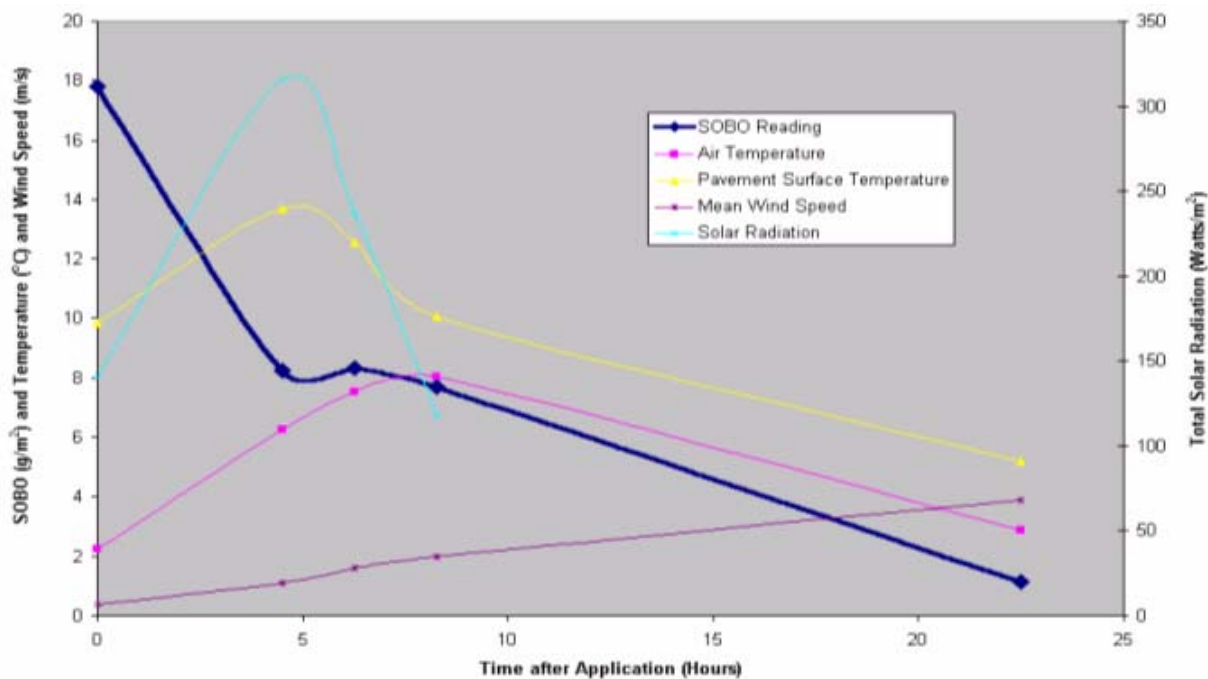

FIGURE 3 SOBO readings versus hours exposure with ambient conditions for DEL-23 PCC.

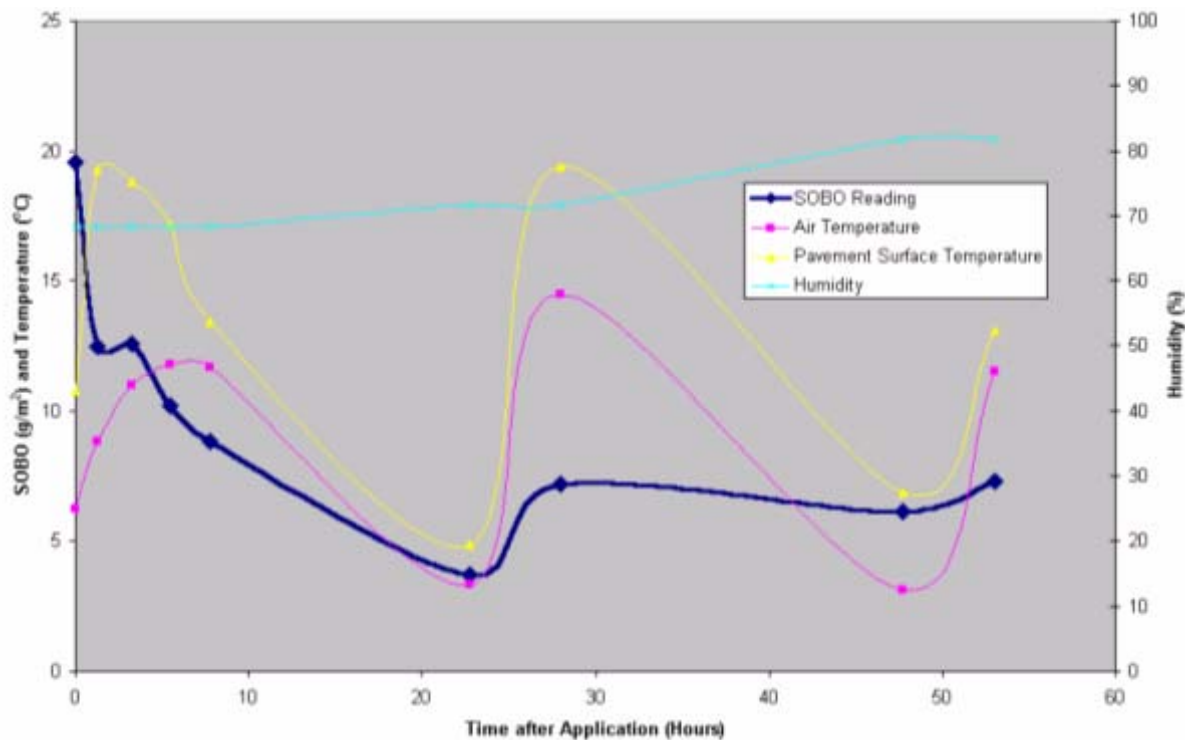

FIGURE 4 SOBO readings versus hours exposure with ambient conditions for ATH-33 MSAC.

Increases in brine concentrations or SOBO readings (at about the 7th h at DEL-23 PCC and at about the 3rd and 27th h at ATH-33 MSAC) accompanied by increases in pavement temperature, followed after some delay by an increase in air temperature. At DEL-23 PCC the rise in pavement temperature was about 5°C; at ATH-33 MSAC the amplitude was about 12°C. At DEL-23 the pavement temperature change followed promptly the change in solar radiation. The air temperature lagged behind. Wind speed increased steadily over the time of exposure. Overall, no apparent correlation to environmental conditions and residual decay existed during the nonprecipitation timeframe of the decay studies. Since the field investigations were conducted primarily during the fall season, the implications of the winter environmental conditions were undetermined.

Persistence of Residual on Pavements

The mean salt concentration data for all the stations at each pavement site were determined and plotted as a function of cumulative traffic and time. For DEL-23 PCC, Figures 5 and 6 present the equations of best fit for the means of the top 10 diagonal and nozzle concentrations as a function of time and traffic, respectively. Since the resulting exponential equations of best fit are similar for the diagonals and the nozzle lines, the two sets of data are combined and result in a more comprehensive data set and subsequent decay function with respect to time and traffic. A rapid decline in brine concentration occurs after about 7 h of traffic and corresponding accumulative traffic of about 1,500 vehicles.

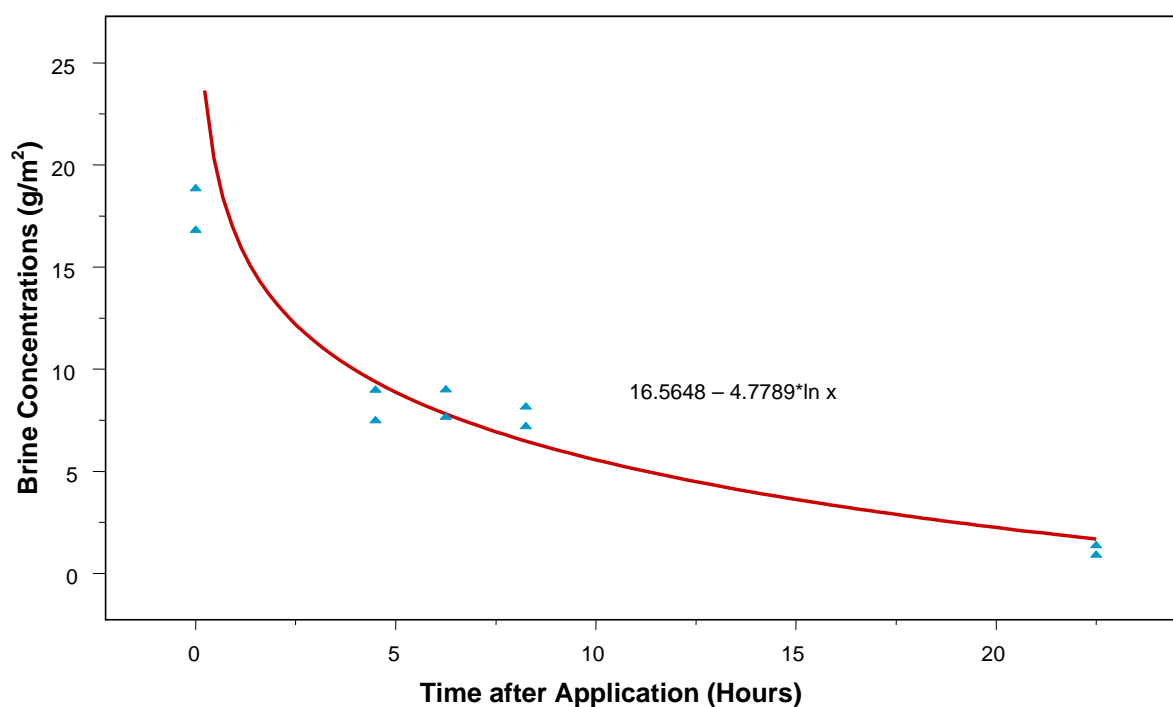

FIGURE 5 DEL-23 PCC decay of mean top 10 diagonal and brine line concentrations as a function of time.

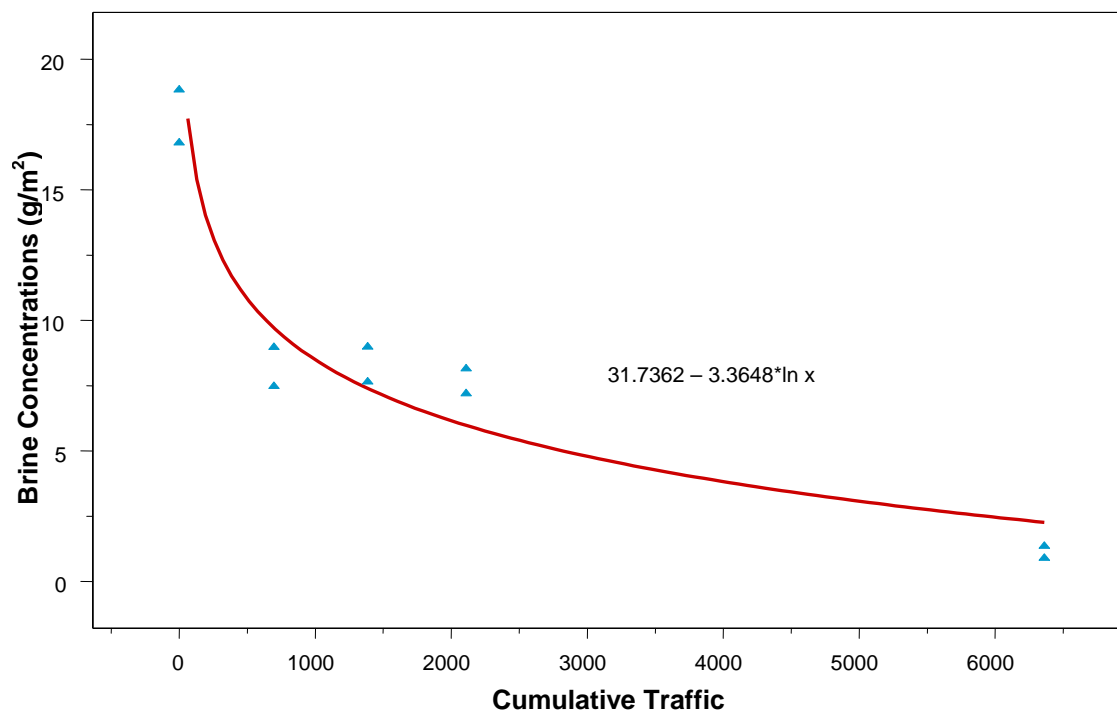

FIGURE 6 DEL-23 PCC decay of mean top 10 diagonal and brine line concentrations as a function of cumulative traffic.

The various asphalt surfaces produced significantly different results. The characteristics attributed to DEL-23 OGAC pavement (high porosity) caused extreme variability in brine concentration readings. Consequently, the combination of the station data for DEL-23 OGAC contained too much variability to be useful functionally. The results for ATH-50 NCAC are shown in [Figure 7](#) for time decay. The mean brine concentrations for all stations measured from the diagonal and nozzle methods as a function of time and traffic declined rapidly and approached 1 g/m² in a few hours and after a small volume of traffic. The mean of all stations and methods for ATH-33 MSAC, shown in [Figure 8](#) for traffic decay, also declined rapidly but remained above approximately 6 g/m² for up to 52 h and 11,000 vehicles.

Decay of brine concentrations for each site is represented in [Table 2](#) with functions developed from regressions of decay plots obtained from all the field data. Correlation coefficients for regressions are included in this table. The equations provide calculations of expected residual concentrations after a given time or traffic. Exponential regression functions were determined with mathematical analysis software (13). An initial concentration ratio of the applied value to the studied application rate of 98 g/m² is included in the equation to compensate for the potential variability of initial loss. SOBO readings as well as actual concentrations (corrected by use of [Figure 2](#)) are provided for ease of use.

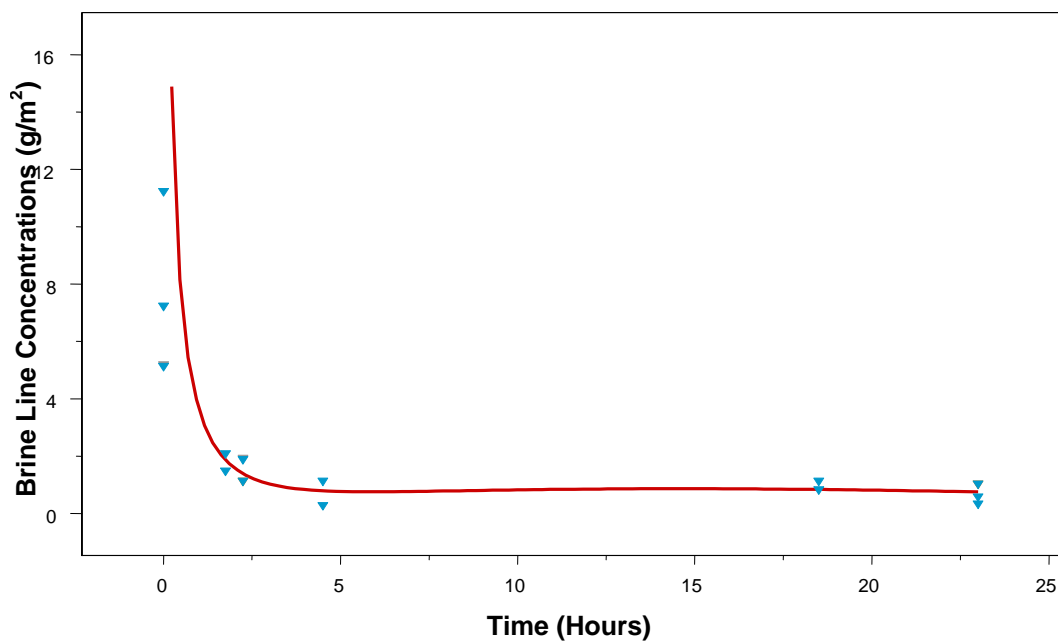

FIGURE 7 ATH-50 AC decay of mean top 10 diagonal and brine line concentrations as a function of time.

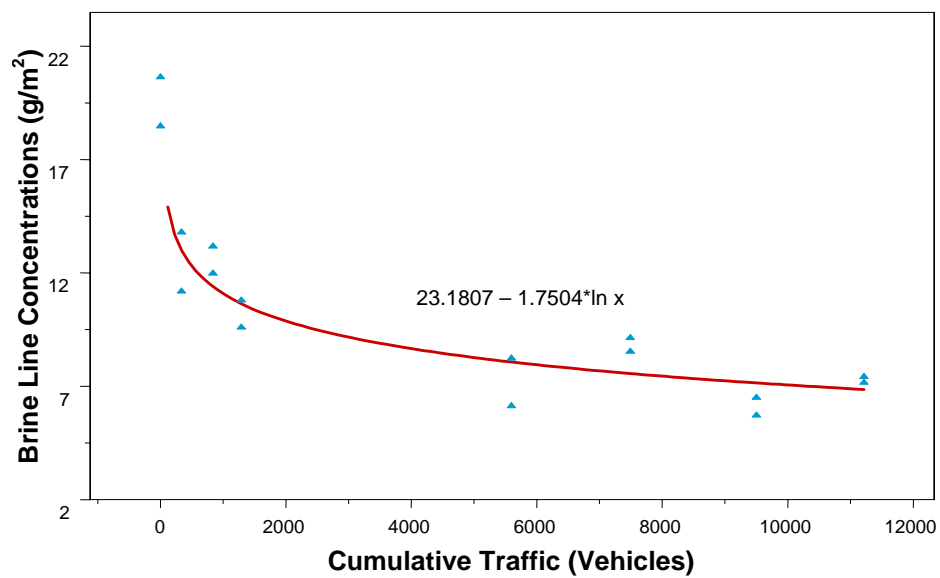

FIGURE 8 ATH-33 AC decay of mean top 10 diagonal and brine line concentrations as a function of cumulative traffic.

TABLE 2 Anti-Icing NaCl Residual Decay Functions

Decay Factor	Parameter	Pavement Material	Brine Concentration Decay	Correlation Coefficient
Time	Actual Concentration	AC - Microseal	$C_t = -6.93\ln(\text{Hours}) + 46.30(C_o / 98\text{g/m}^2)$	0.84
	Actual Concentration	AC - NovaChip	$C_t = -2.50\ln(\text{Hours}) + 7.77(C_o / 98\text{g/m}^2)$	0.54
	Actual Concentration	PCC	$C_t = -7.02\ln(\text{Hours}) + 23.64(C_o / 98\text{g/m}^2)$	0.77
Traffic	Actual Concentration	AC - Microseal	$C_t = -7.35\ln(\text{Vehicles}) + 88.64(C_o / 98\text{g/m}^2)$	0.81
	Actual Concentration	AC - NovaChip	$C_t = -2.53\ln(\text{Vehicles}) + 20.86(C_o / 98\text{g/m}^2)$	0.76
	Actual Concentration	PCC	$C_t = -5.60\ln(\text{Vehicles}) + 50.89(C_o / 98\text{g/m}^2)$	0.50
Time	SOBO Reading	AC - Microseal	$R_t = -2.08\ln(\text{Hours}) + 14.11(R_o / 98\text{g/m}^2)$	
	SOBO Reading	AC - NovaChip	$R_t = -0.75\ln(\text{Hours}) + 2.49(R_o / 98\text{g/m}^2)$	
	SOBO Reading	PCC	$R_t = -5.44\ln(\text{Hours}) + 18.00(R_o / 98\text{g/m}^2)$	
Traffic	SOBO Reading	AC - Microseal	$R_t = -2.21\ln(\text{Vehicles}) + 26.88(R_o / 98\text{g/m}^2)$	
	SOBO Reading	AC - NovaChip	$R_t = -0.76\ln(\text{Vehicles}) + 6.44(R_o / 98\text{g/m}^2)$	
	SOBO Reading	PCC	$R_t = -4.34\ln(\text{Vehicles}) + 39.14(R_o / 98\text{g/m}^2)$	

Note: C_t = Brine concentration at time t

C_o = Brine initial concentration

R_t = SOBO reading at time t

R_o = SOBO reading at time zero

CONCLUSIONS AND RECOMMENDATIONS

The purpose of this study was to determine the field persistence of anti-icing brine residuals on various pavement surfaces. A series of field tests, along with numerous laboratory tests, were conducted on brine residuals on various pavements. Influencing factors for decay such as time, traffic, and temperature were monitored in the study.

Three AC and two PCC pavements were investigated in the field. Initial residual concentrations seemed to be dependent significantly on porosity and roughness of the surface pavement as well as brine line widths. No correlation of environmental conditions and initial concentration reductions from site to site could be determined from data analysis.

The field studies yielded residual decay equations that provide an estimate of brine residual as a function of time or traffic for the various pavements investigated in the study. Only three of the pavements, MSAC, NCAC, and one transversely grooved PCC, provided sufficient data useful in developing decay equations. The porous OGAC attributed to highly variable data, limiting determination of decay. No differentiation between time and traffic as the major decay factor for any of the pavements could be determined from the data collected since traffic was highly dependent on exposure time.

Future work is needed to expand the study to obtain more data under a wider range of pavement types and winter field conditions. Further development and validation of the empirical relationships developed in this work should be completed. It would be desirable to incorporate surface roughness and porosity of the pavement material in the field persistence equations.

ACKNOWLEDGMENTS

This project was prepared in cooperation with the Ohio DOT Office of Maintenance Administration under State Job Number 14758(0). The authors are grateful for the assistance provided by Ohio DOT personnel from Athens and Delaware Counties who provided brine application and traffic control. Particular thanks go to Keith Swearingen and Diana Evans of the Office of Maintenance Administration, Central Office, Ohio DOT, for their support, input, and advice for this project.

Appreciation is also extended to Nida Ikiz, Ting Guo, and Yuming Su, who assisted in the field and laboratory studies and also with data analysis. Issam Khoury also is recognized for assisting with laboratory apparatuses as well as field site selection, project coordination, and data collection.

The contents of this report reflect the views of the authors, who are responsible for the facts and accuracy of the data presented herein. The contents do not reflect necessarily the official views or policies of the Ohio DOT or of FHWA. This report does not constitute a standard, specification, or regulation.

REFERENCES

1. Mergenmeier, A. New Strategies Can Improve Winter Road Maintenance Operations. *Public Roads*, Vol. 58, 1995, pp. 16–17.
2. Fannesbech, J. K. Ice Control Technology with 20 Percent Brine on Highways. In *Transportation Research Record: Journal of the Transportation Research Board*, No. 1741, TRB, National Research Council, Washington D.C., 2001, pp. 54–59.
3. Friar, S., and R. Decker. Evaluation of a Fixed Anti-Icing Spray System. In *Transportation Research Record: Journal of the Transportation Research Board*, No. 1672, TRB, National Research Council, Washington D.C., 1999, pp. 34–41.
4. Stull, R. B. *Meteorology for Scientists and Engineers*, 2nd ed. Brooks Cole, 2000.
5. Sumner, G. *Precipitation: Process and Analysis*. John Wiley & Sons Inc., New York, 1988.
6. Kaufmann, D. *Sodium Chloride: The Production and Properties of Salt and Brine*. Reinhold Publishing Corporation, New York, 1960.
7. Blackburn, R., E. McGrane, C. Chappelow, D. Harwood, and E. Fleege. *SHRP Report H-385: Development of Anti-Icing Technology*. TRB, National Research Council, Washington, D.C., 1994.
8. Ketcham, S., D. Minsk, R. Blackburn, and E. Fleege. *Manual of Practice for an Effective Anti-Icing Program: A Guide for Highway Winter Maintenance Personnel*. FHWA-RD-95-202, Office of Engineering Research and Development, FHWA, McLean, Va., 1996.
9. Mitchell, G., C. Hunt, and W. Richardson. *Evaluation of ODOT Roadway/Weather Sensor Systems for Snow and Ice Removal Operations, Part III: Optimization of Salt Brine Pretreatment Application Rates and Frequency*. Final Report, Ohio Research Institute for Transportation and the Environment, Russ College of Engineering and Technology, Ohio University, Athens, 2003.

10. *Snow and Ice Pretreatment Plan Draft*. Ohio Department of Transportation, Jan. 2, 2003.
11. *Instrumentation Manual Salt Quality Meter SOBO 20*. DV.00734.4. Boschung Mecatronic AG, Paccot, Switzerland, 1998, pp 1–8.
12. *Standard Methods for the Examination of Water and Wastewater*, 20th ed. American Public Health Association, American Water Works Association, and Water Environment Federation, 1998.
13. Axum. *Technical Graphics and Data Analysis*, 3rd ed. MathSoft, Inc., Cambridge, Mass., August 1996.

Large-Volume Snow Control

LARGE-VOLUME SNOW CONTROL

GIS-Based Three-Dimensional Snow Drift Computer Model**ROBERT B. HAEHNEL***U.S. Army Corps of Engineers
Cold Regions Research and Engineering Laboratory***GLEN LISTON***InterWorks Consulting*

The snowdrift transport model SnowTran-3D has been modified to work integrally with geographic information system (GIS) software. This allows use of the model with standard GIS tools and layers enabling direct display and analysis of drifts on roads and other features of interest. This is currently being developed as a planning tool for state and local departments of transportation and the U.S. Army for deployment of road maintenance equipment. Additionally it can be used as a forecasting tool for the maintenance decision support system and can work in conjunction with real-time meteorological forecasting, to allow posting of 48-h forecasts of drift formation on roads. Preliminary model validation data shows that SnowTran-3D is capable of correctly predicting drift location and volume for drifts deposited in the lee of a road or berm.

INTRODUCTION

Though snowfall in its own right degrades mobility on roads and traveled ways, drifting snow further exacerbates the problem. Drifting often continues well beyond the conclusion of the storm and poses a continued maintenance issue for days after the initial snowfall has been cleared. Furthermore, when roads are built or modified or roadside vegetation changes because of fires, logging, or plantings, the effects of drifting are seldom considered in advance, though their effects on drifting can be profound. Military operations can be negatively impacted by drifting snow when it accumulates on existing or planned routes, yet these missions are often carried out in areas where little is known about drifting history. Understanding the spatial and temporal variation in snow cover due to drifting enables effective route planning and design for new roads and allocation of maintenance equipment for existing roadways.

In many locales, long-time residents and seasoned highway crews know the key areas where drifting chronically degrades road conditions and requires continual maintenance. Though this information is invaluable, it is not useful for new construction and may not be available when deploying armed forces into new theaters of operation. SnowTran-3D is a computer model developed by Liston and Sturm (1) to compute the transport and deposition of snow on a gridded topographic domain. This model has been modified to work within a geographic information system (GIS) framework so that its output can be used in standard GIS software as a tool for route planning and maintenance decision support for state departments of transportation (DOTs) and the U.S. Army. This report outlines the model approach and presents model results and validation for use on roadways and other manmade features. Recommendations for future model improvements are given.

TRANSPORT MODEL

Once snow falls, it is often redistributed by wind; snow is scoured off highlands and windward slopes and deposited in low-velocity zones and wake regions. The dominant transport mechanisms are saltation and turbulent suspension. Their relative contribution to the overall transport is a function of the wind speed (2). The wind applies a shear force to the snow surface, and once the shear exceeds a threshold value, the snow begins to move. Initially particles roll over each other or creep across the snow surface. With increased surface shear, the particles hop off the surface and are carried by the wind for a short distance before splashing back into the snow surface, knocking other particles loose, perpetuating the process. This latter mechanism, known as saltation, is confined to a few centimeters above the snow surface (3). As the wind speed increases, snow particles are carried aloft from the saltation layer via turbulent diffusion. These particles are lifted several meters into the air and can travel many meters with the wind before they are lost due to sublimation or redeposited on the snow surface.

The change in snow depth, ζ , with respect to time depends on the water-equivalent snow precipitation, P , the sublimation flux, q_v , and changes in the horizontal saltation and suspension mass transport rates, Q_s and Q_t , respectively (1);

$$\frac{d\zeta}{dt} = \frac{1}{\rho_s} \left(\rho_w P - \frac{dQ_s}{dx^*} - \frac{dQ_t}{dx^*} + q_v \right) \quad (1)$$

where t is time and x^* is the coordinate direction defined by the wind vector. Equation 1 is solved for each grid cell in the domain and is coupled to the adjacent cells through the spatial derivatives. Liston and Sturm (1) give detailed discussion of the solution of Equation 1.

Due to variation in topography the wind direction and magnitude typically vary over a domain. Since measured wind information is typically reported on a spatial resolution of hundreds of kilometers, there needs to be a way to interpolate the available wind data to each grid cell in the domain. Though this can be done with regional atmospheric models, the computational overhead associated with the solution of the relevant momentum and continuity equations would yield model runs that are slower than real time. To simplify the interpolation of the observed wind speed, W , to the model grid, it is modified locally by multiplying it by a weighting factor, W_c :

$$W_c = 1 + \gamma_s \Omega_s + \gamma_c \Omega_c \quad (2a)$$

where Ω_s and Ω_c are the topographic slope and curvature, respectively, and γ_s and γ_c are constants that weight the relative influence of slope and curvature on modifying the wind speed (1, 4). The convention used is that lee and concave slopes produce negative values of Ω_s and Ω_c and thereby reduce the wind speed; windward and convex slopes increase the wind speed. Thus, the terrain modified wind speed, W_t , is

$$W_t = W_c W \quad (2b)$$

The wind direction, θ , is modified by a diverting factor, θ_d , according to Ryan (5);

$$\theta_d = -1/2 \Omega, \sin [2(\xi - \theta)] \quad (3a)$$

where ξ , the terrain slope azimuth, is defined as

$$\xi = \frac{3\pi}{2} - \tan^{-1} \left[\frac{\partial z / \partial y}{\partial z / \partial x} \right] \quad (3b)$$

with north having zero azimuth. This diverting factor is added to the wind direction to yield the terrain modified wind direction, θ_t

$$\theta_t = \theta + \theta_d \quad (3c)$$

Because of problems interpolating over the 360/0 direction line, the terrain modified wind speed and direction are converted to zonal, u , and meridional, v , components with

$$u = -W_t \sin (\theta_t) \quad (4a)$$

$$v = -W_t \cos (\theta_t) \quad (4b)$$

and are used to drive SnowTran-3D.

The wind-shear velocity, u_* , at the surface is then computed from the local wind velocity; u_r , at elevation, z_r , assuming a logarithmic variation of wind speed with height:

$$\frac{u_r}{u_*} = \frac{1}{k} \ln \left(\frac{z_r}{z_o} \right) \quad (5)$$

where z_o is the aerodynamic roughness height of the surface and k is von Kármán's constant.

Vegetation plays an important role in this transport process. It not only acts as a roughness element (thereby affecting surface shear) but also can provide sheltering from the wind. To account for this latter effect, Liston and Sturm (1) define a vegetation snow-holding capacity, C_v , which is the depth of snow the vegetation holds or can shelter from the wind. Once the accumulated snow depth exceeds the snow-holding capacity for a particular vegetation type, any additional snow is available to be transported by the wind. Since the vegetation roughness height decreases as the snow depth increases, the aerodynamic roughness height is approximated by

$$z_o = z_{o,veg} \frac{\zeta}{C_v} \left[1 + \left(\frac{z_{o,snow}}{z_{o,veg}} - 1 \right) \right] \quad \text{for } \zeta \leq C_v \quad (6)$$

$$z_o = z_{o,snow} \quad \text{for } \zeta > C_v$$

where *veg* and *snow* refer to initial values for the vegetation and snow cover, respectively. When the snow depth exceeds the holding capacity of the vegetation, and the wind speed is greater than the threshold velocity for the snow, saltation begins. The saltation layer's effect on wind shear is accounted for considering

$$z_o = 0.12 \frac{u_*^2}{2g} \quad (7)$$

where g is the gravitational constant (I).

Standard raster GIS data layers for topography and vegetation are used as model input (Figure 1). Additionally, information about the vegetation aerodynamic roughness height and snow capture depth needs to be provided. The required meteorological data are wind speed, wind direction, average air temperature, humidity, and precipitation (snow water-equivalent). This may be climatological or forecasted data specified at time intervals of hourly to daily.

MODEL VALIDATION

SnowTran-3D was originally developed to model the redistribution of snow due to drifting on the Arctic Tundra (I). The principle application there is estimation of seasonal snowpack water content for water resource management. In this work we have adapted the model to predict snowdrift accumulation on roads. Furthermore, the model has been updated to facilitate interfacing it with ESRI's ArcINFO, ArcView GIS software via an ASCII grid file (used for both model input and snow depth output). This allowed the model input to be prepared and the model output analyzed with off-the-shelf (OTS) GIS data layers and standard GIS tools already in

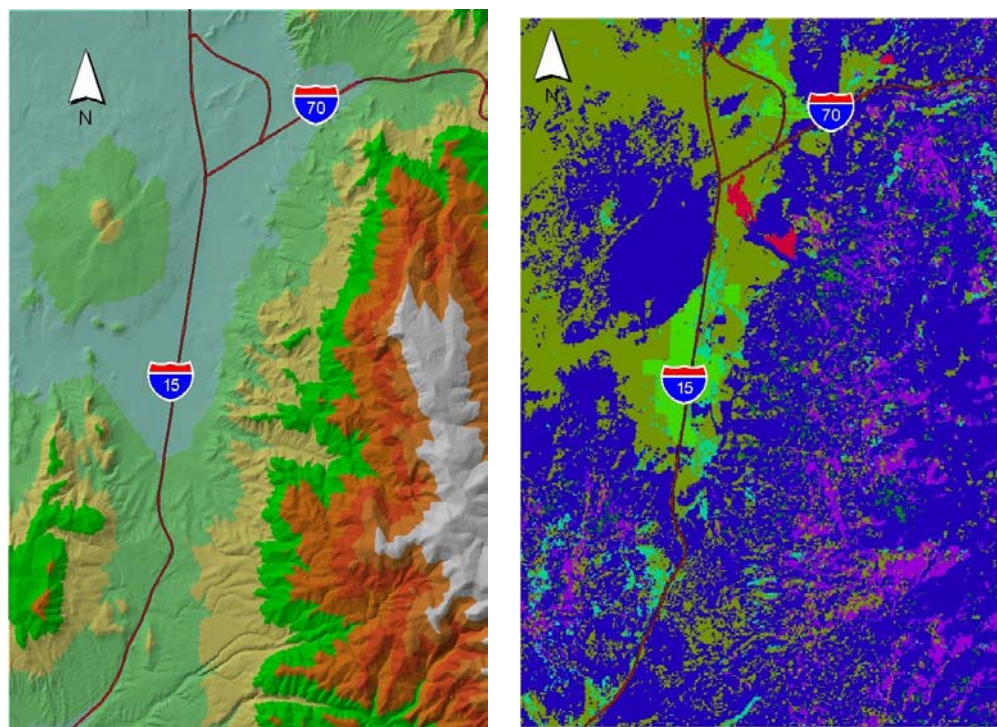

FIGURE 1 Topographic (left) and vegetation (right) data layers for the region surrounding Cove Fort, Utah (10-m grid resolution).

widespread use by the military and DOTs. Figure 1 shows topography and vegetation data obtained from the U.S. Geological Survey for Cove Fort, Utah. The Utah State DOT furnished the interstate data layer. Though OTS data such as these are preferred, they are not always available.

Figure 2 shows synthesized topographic data of a firing range located at Ft. Drum, New York, where we are validating the SnowTran-3D model for use on a road network. In this case the available topographic data predated the addition of the road network. Using the original topography and the electronic road design drawings, we generated an as-built topography of the domain in the GIS environment. The elevated roadbeds are readily identified in contrast to the surrounding topography in Figure 2.

The Ft. Drum site was chosen for validating the model because high-resolution digital elevation data were readily available, and they contained a road network that was not used during winter months facilitated measurement of snow accumulation without having traffic on the roads while measurements were being made. Meteorological equipment was installed at the site to measure wind speed and direction, snow depth, air temperature, and humidity. Additionally a networked video camera was set up at the site to monitor the snow conditions throughout the winter months.

After a substantial snowfall (at least 20 to 30 cm) and a subsequent drifting event, measurements of snow depth were taken throughout the study area. During the two winters spanning 1999 and 2001, we made three field measurements documenting the drift accumulation at the site. For two of these documented events, February 2, 2000, and December 31, 2000, the antecedent condition was bare ground. In this work we present some of the data for the

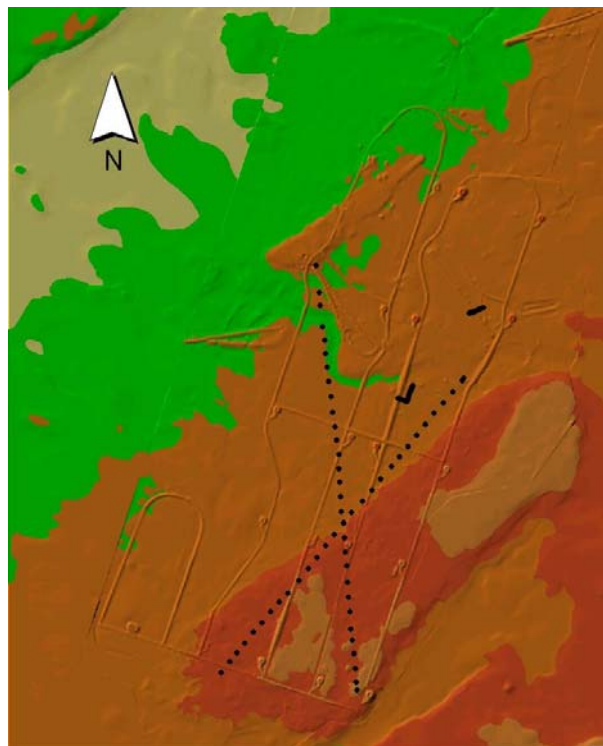

FIGURE 2 Synthesized topography of a firing range at Ft. Drum Military Reservation, New York (2-m grid resolution). Dots indicate the snow depth survey locations taken on January 4, 2001.

December 2000 event. In this event the snow ended on December 25, yet the snow continued drifting until the December 31. The measurements were made on January 4, 2001. The black circles in Figure 2 indicate where snow depth measurements were taken on January 4. The location of the snow depth measurements was surveyed by using a survey station (1-s theodolite). The snow depths were made with a MagnaProbe snow depth probe (6). The X pattern was chosen to capture the spatial variation in snow depth throughout the domain. The closely spaced measurements in the upper right of Figure 2 were cross sections taken through predominately 2-D topographic features.

Figure 3 shows the results of a model run simulating the documented event ending on December 31, 2000. In this figure the black indicates places where snow was scoured, and white indicates deposition. The remainder of the domain has a snow depth unchanged from the average precipitation depth (28 to 32 cm). The wind direction during this event was predominately out of the west-southwest.

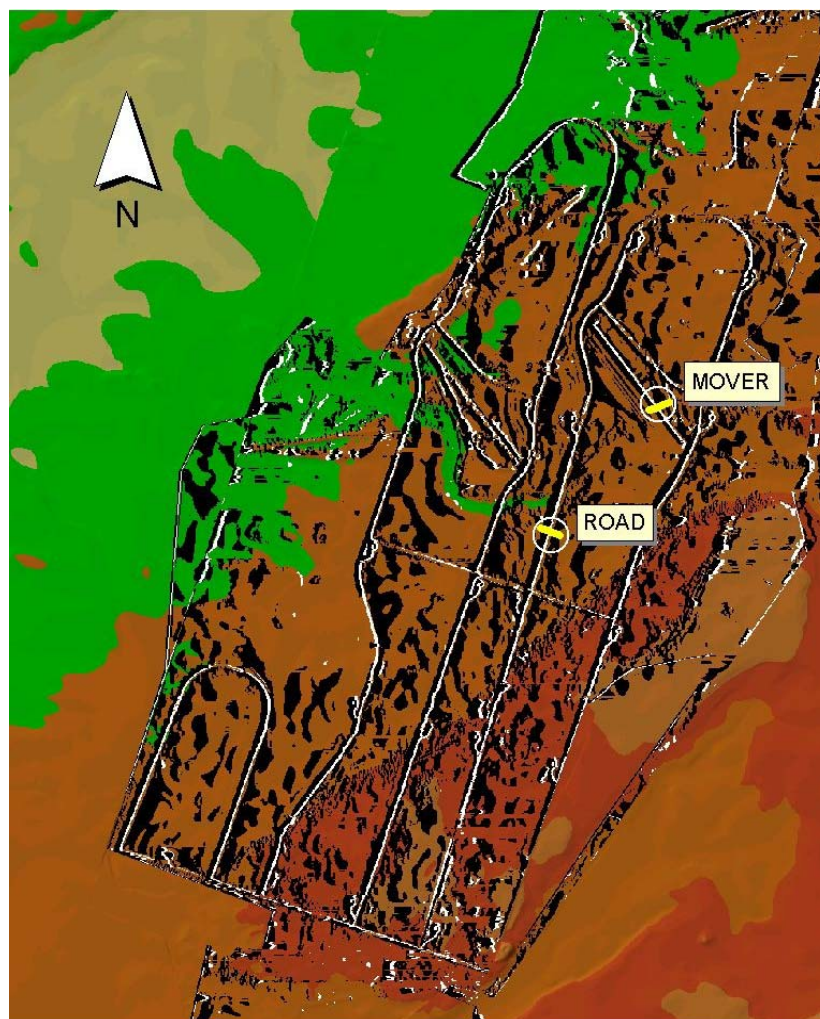

FIGURE 3 Simulated drifting on the firing range at Ft. Drum Military Reservation, New York. Average accumulated snow depth was 30 cm. White areas indicate deposition of the snow due to drifting, while black areas indicate wind-driven scour.

The drifting predicted by the model clearly outlines the roadbeds in the domain (Figure 3) with scour evident on the upwind side of the road and deposition on the lee. Figures 4 and 5 give a comparison of the measured and predicted snow depth over two of the 2-D cross sections taken in the field. The location of both of these features is indicated in Figure 3. The first is an elevated roadbed (road, Figure 3), and the second is a berm for a moving target (mover, Figure 3). In both Figures 4 and 5 we compare the actual topography and the representation of the topography given by the digital elevation model (DEM).

In Figure 4 both the measured and DEM representation of the topography for the roadbed are close. Differences at the road surface indicated that the surveyed points should have been closer together to properly capture the topography in that region. In general the predicted drift location agreed well with the field, though the shape of the drift differed. In the field and model the windward slope was scoured to the vegetation capture depth. On the leeward slope the field drift gradually tapered away from the crest of the road at first, and then there was a steep slip face and the snow surface fell away quickly. At the base of the slip face the snow depth was roughly equal to the precipitation depth. The predicted lee drift put essentially all of the snow in the first grid cell beyond the edge of the road even left the drift somewhat above the adjacent road topography. This “overshooting” of the drift depth was a result of the simplification in the surface wind model. Equation 2 adjusts the wind based on the slope and curvature of the local topography. Since the wind field is computed with the snow surface topography, and the leeward intersection of the road and the drift is concave, Equation 2 treats this as an area of reduced velocity, and the snow is not transported out of the grid cell as expected. A large overshoot in drift depth would increase the windward slope significantly and tip the scale in the other direction so that that grid cell would be given a higher velocity and the snow would be scoured off that cell and deposited in the adjacent cell.

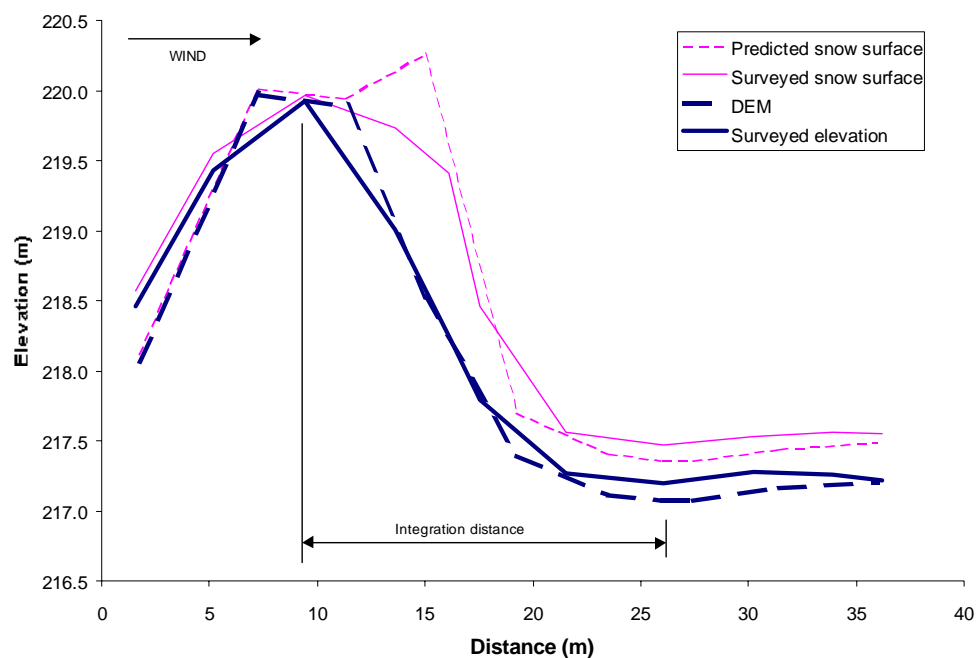

FIGURE 4 Comparison of field measurements and model results for an elevated road cross section.

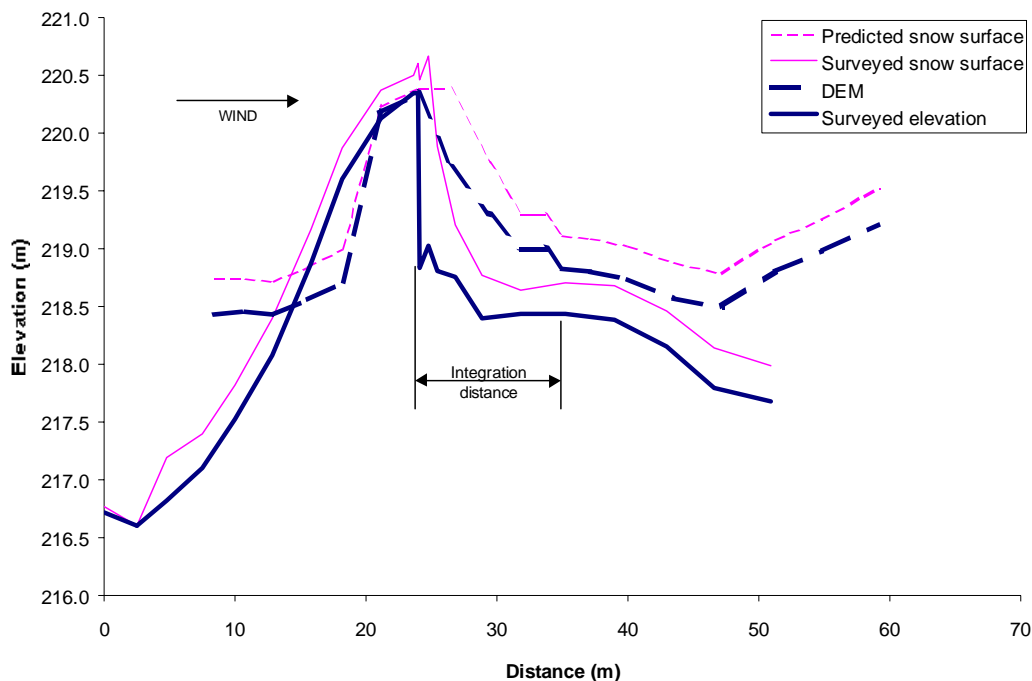

FIGURE 5 Comparison of field measurements and model results for a berm in front of a moving artillery target.

This is not the only limitation of the current wind model. Since Equation 2 merely adjusts the wind speed based on a contraction or divergence of the topography, separation zones are not identified at all in the current model. Though Equation 2 will do a reasonable job of depositing snow behind a leeward-facing stepped feature, such as the lee of the elevated road bed in Figure 4, it cannot predict a windward separation zone on a bluff face, for example, and the associated triangular drift that is deposited there. This deficiency is being addressed in ongoing model development. Regardless, at present the model does a fair job predicting drift location with a simple wind model.

Furthermore, a comparison of the drift area between the field and model reveals that the model does a good job of getting the right amount of snow deposited on the lee of the road. We computed the drift area between $x = 9.4$ m and $x = 26$ m (where x is the distance plotted in Figure 4). This integration distance is shown in Figure 4. Table 1 compares the drift area for the field and model. Despite the slight mismatch in the drift geometry we are encouraged by how well the model predicted the drift area.

In Figure 5, we compare the results for the mover. What is readily apparent is that the DEM does not accurately reproduce the actual topography we measured in the field. Though the overall shape is preserved, the DEM shows the height of the berm as being too small, and the leeward side of the berm is depicted as sloped, when in actuality it is a vertical face. This points out an important fact when working with DEM data: the ability to accurately predict the drift location and extent depends on the accuracy of the digital topography available. Despite the effort to integrate the design information into the existing DEM to produce an “as-built” DEM, there are clearly areas where our synthesized DEM doesn’t match the actual topography. For the

TABLE 1 Comparison of Drift Area Between Measured Field Data and Model Results

	Drift Area (m ²)	
	Road	Mover
Field	8.5	5.7
Model	9.5	4.6

road cross section in [Figure 4](#), our effort produced a good match but not so with this mover. Nevertheless, the drift location and depth seem reasonable for the actual geometry used by the model. Furthermore, the drift is similar to that measured in the field. Since the modeled mover is about two-thirds the height of the actual mover, we would expect the model to underpredict the leeward drift area. A comparison of the drift area given in [Table 1](#) shows this is indeed the case; regardless, the agreement is much better than expected. We also note that the actual snow capture depth on the upwind slope of the mover appears to be about four times that used in the model ([Figure 5](#)). Again, this illustrates the need for accurate input data to the model.

In the foregoing we have discussed the need for accurate DEM and vegetation data to generate accurate model predictions. Another important consideration is the spacial resolution of the grid and its impact on model accuracy. The model is capable of handling a wide range of grid increments (e.g., 10 cm to 5 km), and there is nothing in the physics of the model that is limited by spacial resolution per se. However, the grid resolution has to be chosen carefully to match the drift features of interest. For example, if the application is to predict snow distribution for snowmelt run-off predictions in a river basin, a 100-m or 1-km grid resolution may be appropriate for capturing the general location and extent of the large-scale drifts of interest. However, such a coarse grid would not be appropriate for predicting drift formation on a road network where the topography for the features of interest (e.g., a road cut) varies rapidly over short distances. In this later case we have found that a grid resolution on the order of 10 to 30 m or less is needed to sufficiently resolve the road network topography and thereby give a reasonable prediction of drift location and extent.

FIELD APPLICATIONS

In cooperation with FHWA, we adapted this model for forecasting snowdrift accumulation on roads. For this we use 48-h forecast data generated by the DICAST forecast model for meteorology input to the snow transport model (Bill Myers, Personal Communication, Jan. 2001, National Center of Atmospheric Research, Boulder, Colorado). This gives forecast points every 3 h out to 48 h. The Cove Fort region shown in [Figure 1](#) is one of the sites at which this model was demonstrated. For this simulation, the forecast is for a regional snowstorm that starts 18 h into the forecast and ends at hour 30. The wind persists to hour 33. [Figure 6](#) shows the forecasted drift-affected snow depth on the road for hour 20 and 24. The black double lines indicate the major roads through this region. The snow depth is coded in 3 bands to indicate a level of service for the road. White indicates snow depths greater than 15 cm, black is for snow depth between 7 and 15 cm, and clear (i.e., the underlying topography is visible) is for snow depths less than 7 cm.

From [Figure 6a](#) we see that at hour 20 (2 h after the snow starts accumulating) the forecasted snow depth throughout the domain is less than 7 cm, yet the black patches indicate

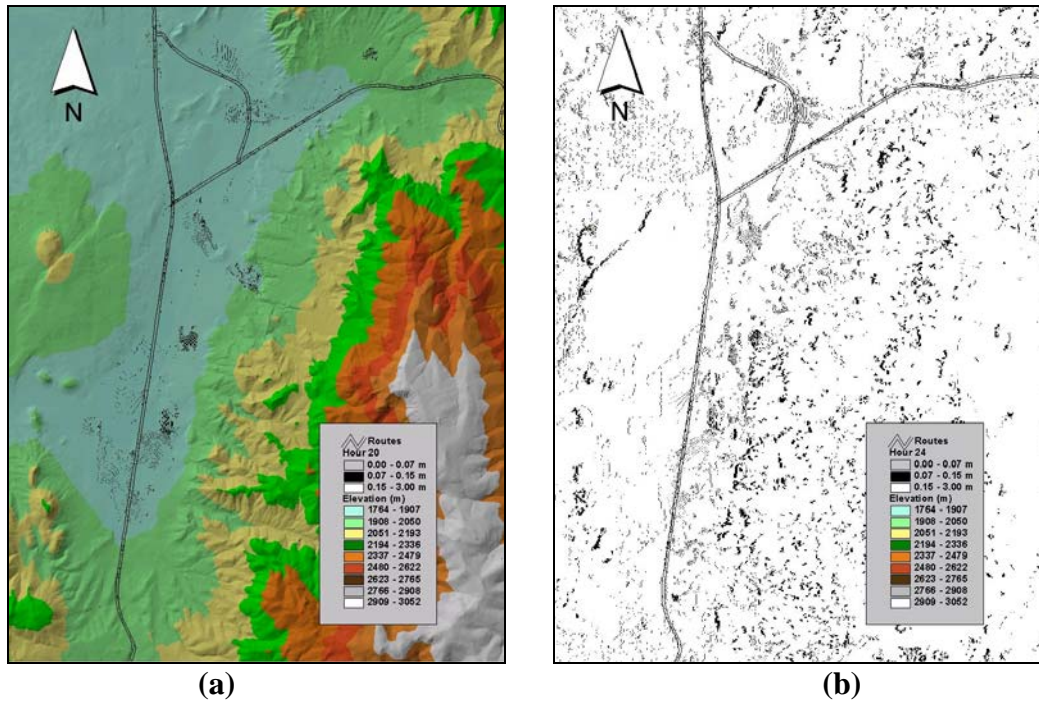

FIGURE 6 Predicted drift affected snow depth, Cove Fort, Utah, for (a) forecasted hour 20 and (b) forecasted hour 24.

that drifting along the road has increased the snow depth locally to greater than 7 cm. By hour 24 the prevailing snow depth throughout the domain is over 15cm (as indicated by the domain being almost completely white, [Figure 6b](#).) However, on some road sections drifting has actually reduced the forecasted snow depth by scouring the snow off the road, as evident by the black patches on the roadway in [Figure 6b](#).

Road maintenance personnel can use this information to plan when roads need to be plowed, and where road conditions are going to be the worst. [Figure 6a](#) shows that because of drifting, the snow is deeper on sections of the road than the forecasted precipitation would suggest and warrants increased maintenance in those areas. This model can be used, in conjunction with algorithms to predict road surface friction and applying standard rules of practice for road maintenance, to provide a forecast tool to support winter road maintenance decisions.

CONCLUSIONS AND RECOMMENDATIONS

Comparison of field measurements with model results of snow drifts on a road network at Fort Drum, New York, suggest that SnowTran-3D shows promise as a tool for predicting drifting on roads and other similar manmade features. Preliminary validation results suggest it is capable of capturing the approximate drift location and volume, yet it may not accurately predict drift shape. This later deficiency can be important when there is some question as to whether the spatial extent of the drift will overlap a road. In this case a difference of 10 m in location of the drift can mean the difference between having to plow or not. Nevertheless, the current model

shows promise in its capability to predict drift severity along road sections and identify areas where increased maintenance may be warranted.

Ongoing revisions to the SnowTran-3D are addressing the deficiencies in the current model. In particular, focus is being placed on developing an efficient method for improving the accuracy of predicting the location and extent of snow drift formations on small-scale topographic features such as roadways. As part of this work, more detailed model validation will be carried out over the entire modeled domain to confirm that the model can adequately predict drift formation over a varied topography.

ACKNOWLEDGMENTS

This work was funded by the U.S. Army AT42 work unit “Minimizing the impacts of winter storms on Lines of Communication,” FHWA Road Maintenance Decision Support Project, and the U.S. Army AT40 work unit “TE 008 Snowdrift Model Development for Tele-engineering Toolkit.” Special thanks go to Al Swark, Master Sergeant Greg Celesky, and Mike Earl at Ft. Drum for their support in obtaining the field measurements.

REFERENCES

1. Liston, G. E., and M. Sturm. A Snow Transport Model for Complex Terrain. *Journal of Glaciology*, Vol. 44, No. 148, 1998, pp. 489–516.
2. Pomeroy, J. W., and D. H. Male. Steady-State Suspension of Snow. *Journal of Hydrology*, Vol. 136, 1992, pp. 275–301.
3. Kobayashi, D. Studies of Snow Transport in Low-Level Drifting Snow. *Contributions from the Institute of Low Temperature Science*, Series A, No. 24, 1972, pp. 1–58.
4. Liston, G. E., and R. B. Haehnel. Simulating Complex Snow Distributions in Windy Environments (in press).
5. Ryan, B. C. A Mathematical Model for Diagnosis and Prediction of Surface Winds in Mountainous Terrain. *Journal of Applied Meteorology*, Vol. 16, 1977, pp. 571–584.
6. Holmgren, J. A., and M. Sturm. Snow Temperature and Depth Probe, U.S. Patent No. 5,815,064, 1998.

LARGE-VOLUME SNOW CONTROL

Development of Advanced Snowbreak Fences**MASARU MATSUZAWA****YASUHIKO ITO****YASUHIKO KAJIYA***Civil Engineering Research Institute of Hokkaido***SHINYA FUJIWARA***Sekisui Jushi Corp.***MASAYUKI MURAKAMI***Sanei Kogyo Co., Ltd.*

The blower snow fence is equipped with lateral fins attached obliquely to the vertical support so as to redirect incident winds downward. The redirected wind blows snow off of the road surface and secures visibility at the driver's sight level. The blower snow fence is most effective when the wind strikes perpendicularly and is known to be less effective against oblique winds. The authors are developing an improved blower snow fence that is effective in oblique winds. The new structure features modified fins that incorporate wind-straightening vanes. The improved structure can redirect oblique winds more effectively. Wind tunnel model experiments were conducted with wind-straightening vanes of different heights and intervals. The proposed blower snow fence proved about 10% more effective than the conventional blower snow fence.

INTRODUCTION

Drifting and blowing snow-induced poor visibility and snowdrift are major road traffic hazards in Japan's cold, snowy regions. The snowbreak fence is a countermeasure to these phenomena.

The blower snow fence is placed near the road on its windward side. Strong winds passing through the bottom gap of the fence blow snow off the road. The fence has been installed in Hokkaido and other cold, snowy regions, mainly to prevent poor visibility (Figure 1).

The blower snow fence is effective against perpendicular winds, but it has proved ineffective against oblique winds. Roads have curves, so blower snow fences along roads cannot always be at a right angle to incident winds. The snowbreak effects are low in some instances. The authors launched development of a blower snow fence effective against oblique winds. We discuss the experimental results.



FIGURE 1 Blower snow fence equipped with angled fins that redirect wind downward to prevent snow from suspending the driver's line of sight.

WIND TUNNEL EXPERIMENT ON EFFECTIVENESS OF CONVENTIONAL BLOWER SNOW FENCE AGAINST OBLIQUE WIND

Objectives

Quantitative indexes are needed to measure the effectiveness of the conventional blower snow fence against oblique wind. A wind tunnel experiment was performed to identify the snowbreak effect of the conventional blower snow fence.

Tests

Test Outline

In the wind tunnel, the wind velocity on the downwind side of the model snowbreak fence was measured by thermal-type anemometer to assess the blowing performance.

We used a large meteorological wind tunnel of the Hokkaido Northern Regional Building Research Institute (tunnel cross section: 1.8 m × 1.8 m).

The model blower snow fence was built on a scale of 1/30 (Figure 2). The wind angle of incidence was changed in increments of 5° from 0° to 25°. The blowing effect was tested at each angle.

The model snowbreak fence specifications were



FIGURE 2 Model blower snow fence (11 cm high).

- Scale: 1/30;
- Fence height: approximately 11 cm (equivalent to 3.3-m-high fence);
- Support interval: approximately 11.5 cm (equivalent to 3.5-m span);
- Fin shape: 2-cm-wide smooth plate (equivalent to 650-mm-wide fin);
- Fin angle: approximately 30°; and
- Bottom gap: approximately 3.3 cm (equivalent to 1 m for the real fence).

Measurement Method

Figure 3 shows a cross section of the test model. Markings were made on the floor at intervals of $0.5 H$ (H denotes the fence height, which is 11 cm) from the center of the fence toward the downwind direction. The wind velocity was measured 10 mm above each marked point. The measurement procedure was as follows:

1. Install the test model.
2. Start operating the wind tunnel (wind velocity becomes constant after about 20 s).
3. Adjust the wind angle of incidence (rotational angle adjusted by turntable).
4. Measure the average wind velocity for 15 s at the measurement points at $0.5 H$ to $3.0 H$ (Figure 3).

H (Figure 3).

5. Change the wind's angle of incidence in increments of 5° (0° to 25°) and repeat Steps 3 and 4.

Results

The wind velocity with fence is divided by the wind velocity without fence (the reference wind velocity), to calculate the wind velocity ratio (Equation 1). The area where the wind velocity ratio is 1.0 or greater is the wind-accelerated area. The blowing performance of the blower snow fence is considered to be satisfactory there.

The distance from the fence to the point where the wind velocity ratio no longer exceeds 1.0 is defined as the blowing distance.

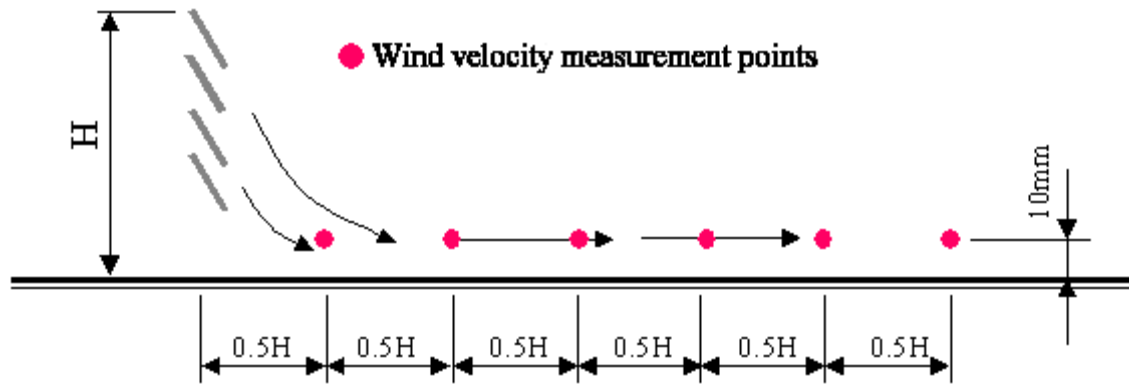

FIGURE 3 Blower snow fence and wind velocity measurement points.

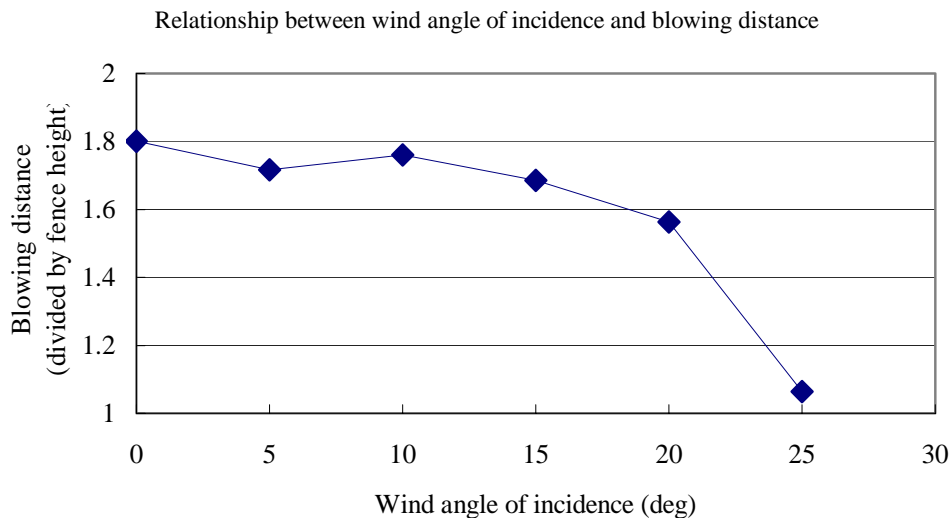

FIGURE 4 Wind angle of incidence and blowing distance.

$$\text{Wind velocity ratio} = \text{measured wind velocity} / \text{average reference wind velocity.} \quad (1)$$

Figure 4 shows the distance from the fence (blowing distance) where the wind velocity ratio exceeds 1.0. The effect of the conventional blower snow fence gradually decreases as the angle of incidence increases from 0° to 20° . After the angle exceeds 20° , the effect sharply decreases.

Analysis

Wind turbulence near the fins is responsible for the blower snow fence's ineffectiveness against oblique winds. This turbulence prevents the fence from sufficiently controlling wind passing through the bottom gap. We devised partitions on fins (wind-straightening vanes) to reduce turbulence and smooth the wind passing through the fence (Figure 5).

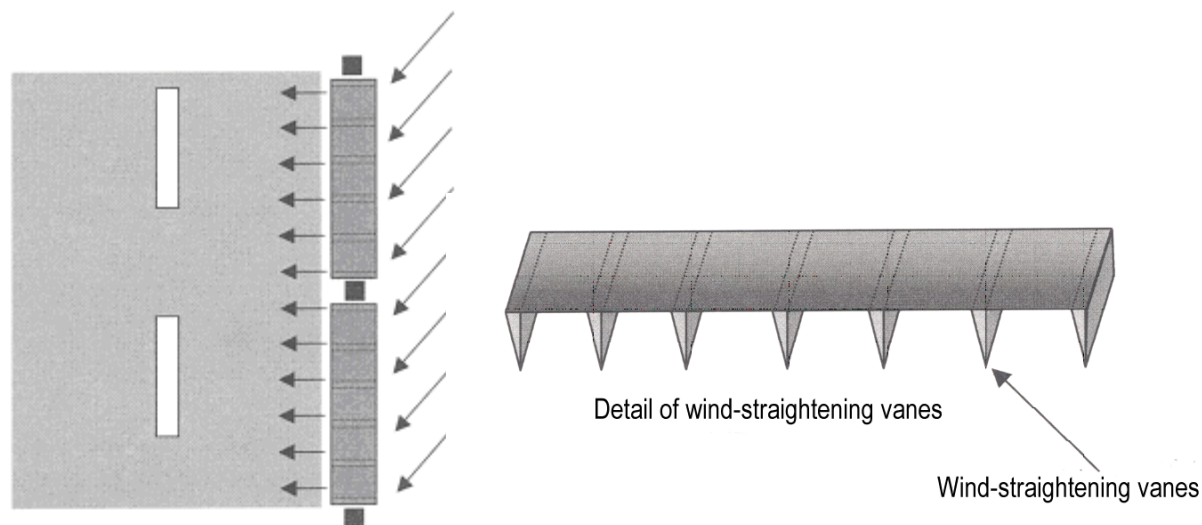

FIGURE 5 Proposed snowbreak fence with wind-straightening vanes.

Development Objectives

Before a new blower snow fence is developed, objectives should be set for its effect. The experiments thus far have demonstrated that the effect of the conventional blower snow fence dramatically decreases after the wind angle of incidence exceeds 20° . Wind direction surveys in winter suggest that if a fence can efficiently redirect oblique wind that is $\pm 25^\circ$ oblique to the prevailing wind incident angle, the snowbreak effect is expected to improve greatly. The objective was to develop a new blower snow fence that loses no more than 10% of its snowblowing effect in winds more acute than 25° .

WIND TUNNEL EXPERIMENT ON IMPROVED MODEL SNOWBREAK FENCE

Objectives

One way to maximize the effectiveness of the blower snow fence in oblique winds is to add wind-straightening vanes on the underside of the fins. Although a full-scale test fence needs to be made to conduct field tests, a wind tunnel experiment was conducted in advance to determine the basic shape of the new blower snow fence.

Test

Test Outline

The wind velocity inside the wind tunnel was measured on the downwind side of the model

snowbreak fence. From these measurements, the blowing distance was calculated for a comparison of snow-blowing effect.

Wind-straightening vanes were attached to the underside of the fins at an orientation perpendicular to the fence. The interval, height, and design (with or without holes) of the vanes were adjusted to measure changes in the blowing distance in order to find the optimum design (Figure 6). Table 1 shows the test series for model fences including that without wind-straightening vanes.

The wind-straightening vanes described above were mounted on the model snowbreak fence for wind tunnel tests. The model fence specifications are these:

- Scale: 1/10;
- Height: 33 cm;
- Support interval: approximately 150 cm;
- Fins: four 2-cm-wide plates at 60° from vertical; and
- Bottom gap: 4 cm.

Measurement Method

Markings were made at intervals of 0.5 H (H denotes fence height, which is 33 cm) from the center of the fence toward the downwind direction. Wind velocity was measured at points 30 mm above the markings (Figure 7). The measurement procedure was as follows:

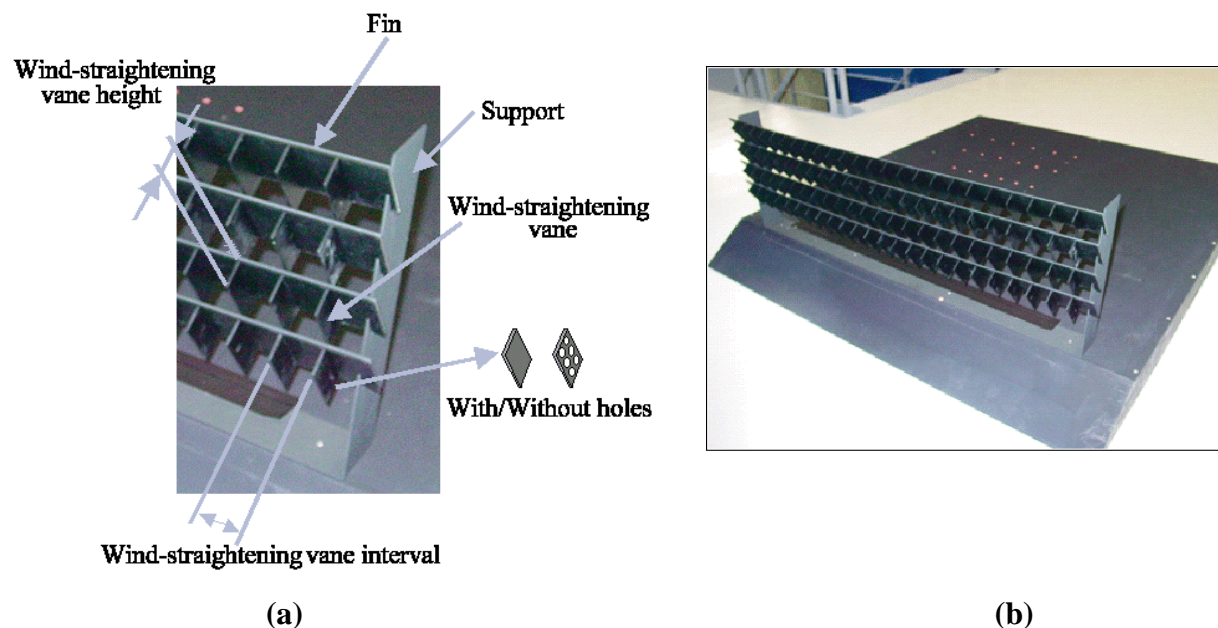
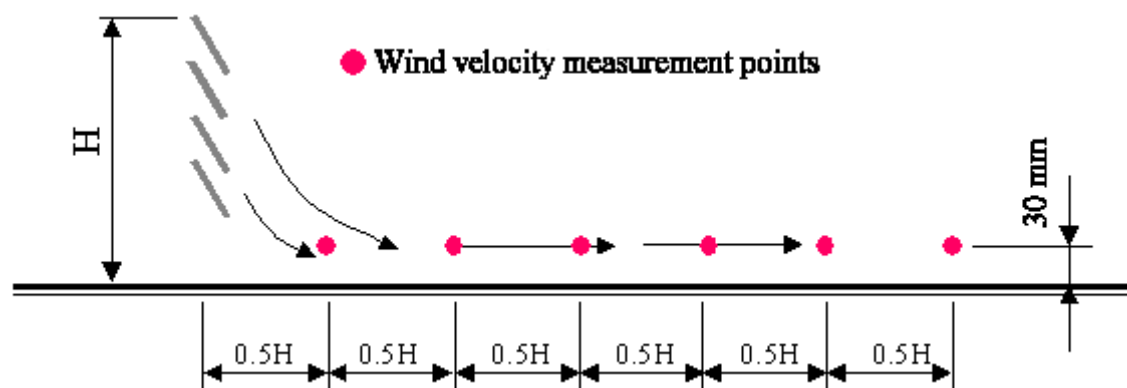

FIGURE 6 Components of the model snowbreak fence with (a) wind-straightening vanes and (b) fence model of Type 4.

TABLE 1 Wind Tunnel Test Series

Type	Interval of Wind-Straightening Vanes	Wind-Straightening Vane Height	Wind-Straightening Vane Design
0	N/A	N/A	Without holes
1	80 mm	12 mm	Without holes
2	80 mm	25 mm	Without holes
3	40 mm	12 mm	Without holes
4	40 mm	25 mm	Without holes
5	80 mm	12 mm	With holes
6	80 mm	25 mm	With holes
7	40 mm	12 mm	With holes
8	40 mm	25 mm	With holes

**FIGURE 7 Snowbreak fence and wind velocity measurement points.**

1. Install the test model.
2. Start operation of the wind tunnel (wind velocity becomes constant after about 20 s).
3. Adjust the wind angle of incidence (rotational angle adjusted at the turntable)
4. Measure the average wind velocity for 15 s at the measurement points ($0.5 H$ to $3.0 H$) (Figure 7).
5. Change the wind angle of incidence in increments of 10° (0° to 20°) and 5° (20° to 30°), and repeat Steps 3 and 4.
6. Repeat Steps 1 to 5 for each model.

Test Results

Figure 8 shows the blowing distance for Types 1, 2, 3, and 4. It reveals that the greater the height

of the vane, the greater the blowing distance, and the narrower the interval of vanes, the greater the blowing distance.

Figure 9 shows the blowing distance for Types 2, 4, 6, and 8. It reveals that the wind-straightening vane without holes affords a greater blowing distance.

Figure 10 shows the blowing distance for each type of snowbreak fence. The results of Type 4 are relatively good. Compared with the traditional fence (Type 0), the blowing distance for the new fence is 10% greater and the blowing effect is sustained until the angle of incidence exceeds 25°. The interval of wind-straightening vanes of Type 4 is small (40 mm), and the vane is tall (25 mm) and does not have holes.

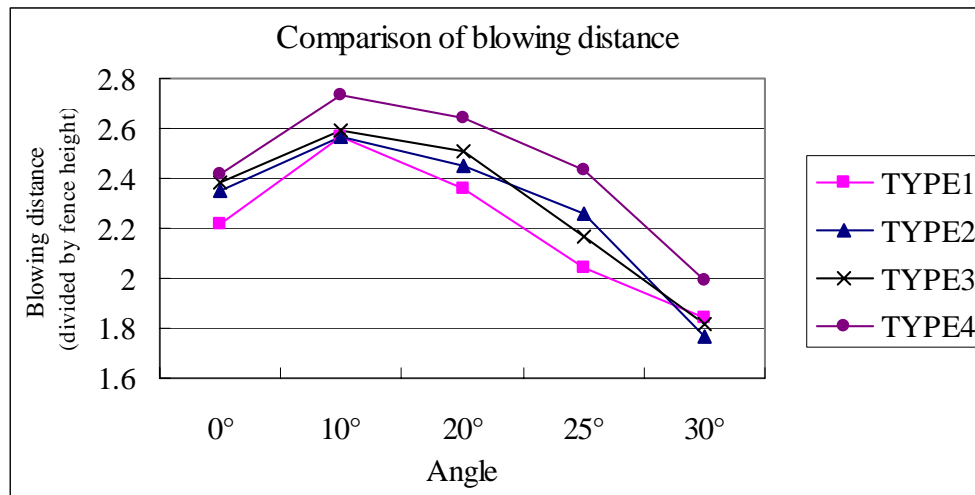

FIGURE 8 Comparison of blowing distance by interval and height of wind-straightening vane.

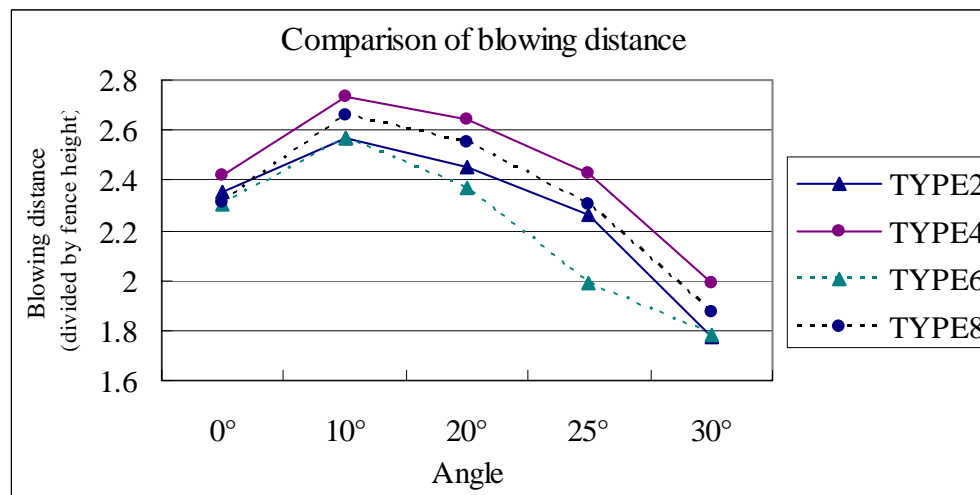

FIGURE 9 Comparison of blowing distance by wind-straightening vane design.

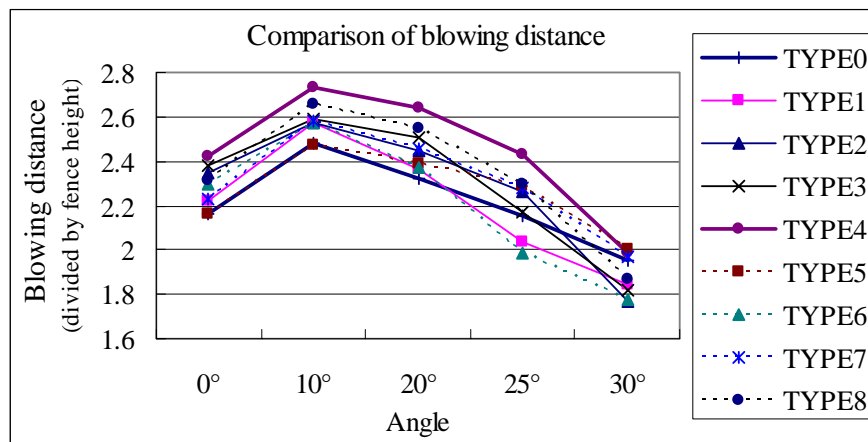

FIGURE 10 Comparison of blowing distance by model snowbreak fence type.

CONCLUSIONS

The wind tunnel test has yielded the following results:

1. The blowing distance tends to be the greatest when the wind angle of incidence is around 10°.
2. The blowing distance decreases with increases in wind angle of incidence beyond 10°.
3. The greater the height of the wind-straightening vane, the greater the blowing distance.
4. The narrower the interval of wind-straightening vanes, the greater the blowing distance.
5. The wind-straightening vane without holes affords a greater blowing distance.
6. Wind-straightening vanes of Type 4 achieve the greatest effect. Their blowing distance is 10% greater than for conventional blower fence.
7. Type 4 is effective for wind with incidence angle of 0° to 25°.

FUTURE DIRECTIONS

We conducted a wind tunnel experiment to examine improvement of the blower snow fence, which is known to be ineffective against oblique wind, by adding wind-straightening vanes. The experiment has confirmed that the addition of the vanes achieves a blowing distance greater than that of conventional snow fence. In the winter of 2003–2004, a full-scale blower snow fence will be installed for field experiments that compare it with the conventional fence. To develop a practicable blower snow fence, we will study how to reduce the costs incurred in adding wind-straightening vanes.

ACKNOWLEDGMENT

The staff of Hokkaido Northern Regional Building Research Institute provided us with great support in the wind tunnel experiments. We are truly grateful for their generous cooperation.

LARGE-VOLUME SNOW CONTROL

**Avalanche Hazard Reduction on
US-89/191 With Snow Sails****RAND DECKER***Northern Arizona University***ROBERT RICE***University of California–Merced***LEROY (TED) WELLS****JAMIE YOUNT***Wyoming Department of Transportation*

Snow sails are a form of passive avalanche-starting zone defense. A deployment of snow sails will disrupt the snowpack in an avalanche-starting zone and inhibit the formation of coherent, continuous avalanche wind-slabs. Snow sails were first constructed from on-hand materials and deployed in the European Alps in the late 1940s through the 1950s. They were known in German as *kolktafeln*, which translates literally as (airflow) eddy (generating) tables. Snow sails are only applicable to certain specific avalanche environments, including sites where the dominant avalanche mechanism is through the formation of wind slabs. The objective of the Milepost 151 avalanche project was to assess, test, and install an operational deployment of approximately 50 snow sails in the avalanche-starting zone as a means of cost-effectively reducing the avalanche hazard, due primarily to wind-slab avalanching, for motorists and Wyoming Department of Transportation maintainers on US-89/191. The 151 avalanche is located adjacent to a populated residential area of Jackson, Wyoming, and is also a critical, managed big game winter habitat. After 4 years of pilot-phase trials and technology demonstrations, a complement of 60 snow sails was fabricated, transported, and installed during the autumn of 2002. The final sail design was similar to the initial trial design. Helicopter-supported logistics were used to transport 50 of the preassembled snow sails, earth pin anchors, and cabling from the Jackson valley floor to the 151 avalanche site. Unlike other forms of constructed, passive avalanche-starting zone defense facilities, snow sails may be removed annually in the spring and reinstalled in the autumn. This minimizes their year-round visual impact. The 151 avalanche snow-sail deployment has undergone a requisite U.S. Department of Agriculture Forest Service/National Environmental Policy Act Environmental Assessment. The finding was one of no significant impact.

INTRODUCTION

Snow sails are a form of passive avalanche-starting zone defense, designed to use the inherent energy of the wind to disrupt and modify snow deposition patterns and result in a reduced occurrence of wind-slab avalanching. A deployment of snow sails will disrupt the snowpack in an avalanche-starting zone and inhibit the formation of coherent, continuous avalanche wind slabs.

To be effective in scouring and disrupting the snow depositional pattern, a given snow sail is deployed so that the wind must flow perpendicular, against, and under the broad face of the sail. A single snow sail is installed on a 14-ft mast. It has a broad trapezoidal fabric sail panel, 10-ft tall, mounted on two booms—10 ft at the top, 8 ft at the bottom—with a 4-ft gap between the ground surface and the lower edge of the sail. A given unit has an appearance similar to the sail of a Viking ship, hence the name: snow sails. The resulting complex, highly turbulent airflow erodes and disturbs the snow depositional pattern on the ground. The zone of disrupted snowpack is typically an ellipse 30 to 40 ft in diameter, with the shallowest snowpack being near or immediately under the snow sail itself.

Background

Snow sails were first constructed from on-hand materials and deployed in the European Alps in the late 1940s through the 1950s, when military garrisons (and hence, labor) were plentiful in the international passes. They were known in German as *kolktafeln*, which translates literally as (airflow) eddy (generating) tables. Figure 1 shows suggested configurations for these original *kolktafeln* (1).

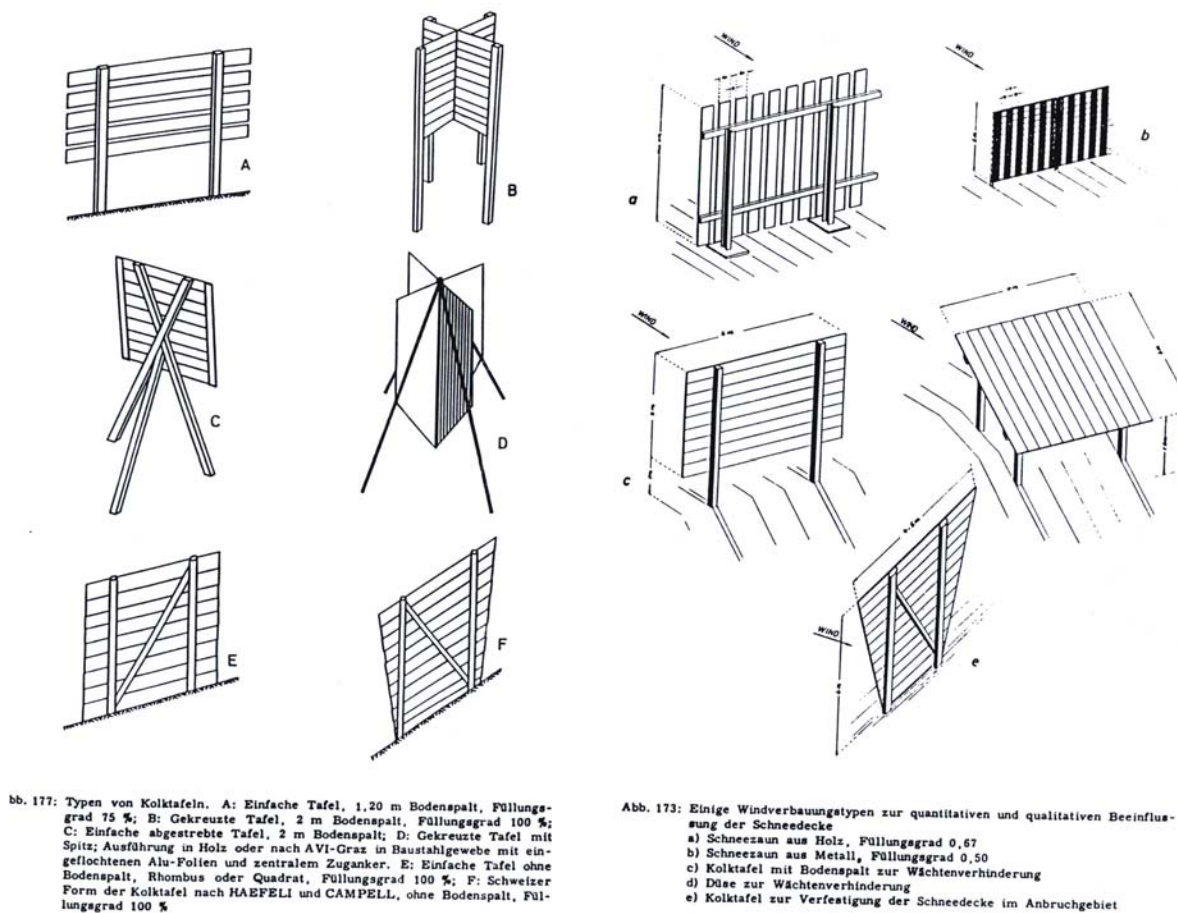

FIGURE 1 A schematic depiction of European *kolktafeln* circa 1960 (1).

Based on European guidelines, for snow sails to be effective in reducing wind-slab avalanches, the sails must be deployed so that the distance between any two adjacent sails is 1.0 to 1.5 times the sail top width (10 ft). Snow sails are only applicable to certain specific avalanche environments, including sites where the dominant avalanche mechanism is through the formation of wind slabs and the total snowpack depth does not become large (> 6 ft). For these reasons, snow sail use in Europe was superseded by the use of more effective (and more costly) snow-supporting structures in the avalanche-starting zone and avalanche sheds (tunnels) at the roadway.

However, for reasons of cost-effectiveness, European avalanche hazard specialist are once again experimenting with *kolktafeln*. Figure 2 shows a modern trial deployment of omni-(wind) directional *kolktafeln* in the Austrian Alps.

151 Snow-Sail Project Objectives

The objective the milepost 151 avalanche project was to assess, test, and install an operational deployment of ~50 snow sails in the avalanche-starting zone as a means of cost-effectively reducing the avalanche hazard, due primarily to wind-slab avalanching, for motorists and Wyoming Department of Transportation (WYDOT) maintainers on US-89/191. This site is about 3 mi south of the community of Jackson, Wyoming. US-89/191 is the primary route in and out of this valley from the south. The location of this site is shown in Figure 3.

The 151 avalanche is predominantly a wind-slab avalanche. During periods of heavy snow, coupled with strong southwesterly winds, snow is transported into the 151 avalanche-starting zone. When the resulting wind slabs become unstable, they may avalanche onto the US-89/191 roadway, which is located at the valley floor, approximately 1,000 vertical ft below.



FIGURE 2 Modern European technology trails with omni (wind) directional *kolktafeln* in the Austrian Alps.

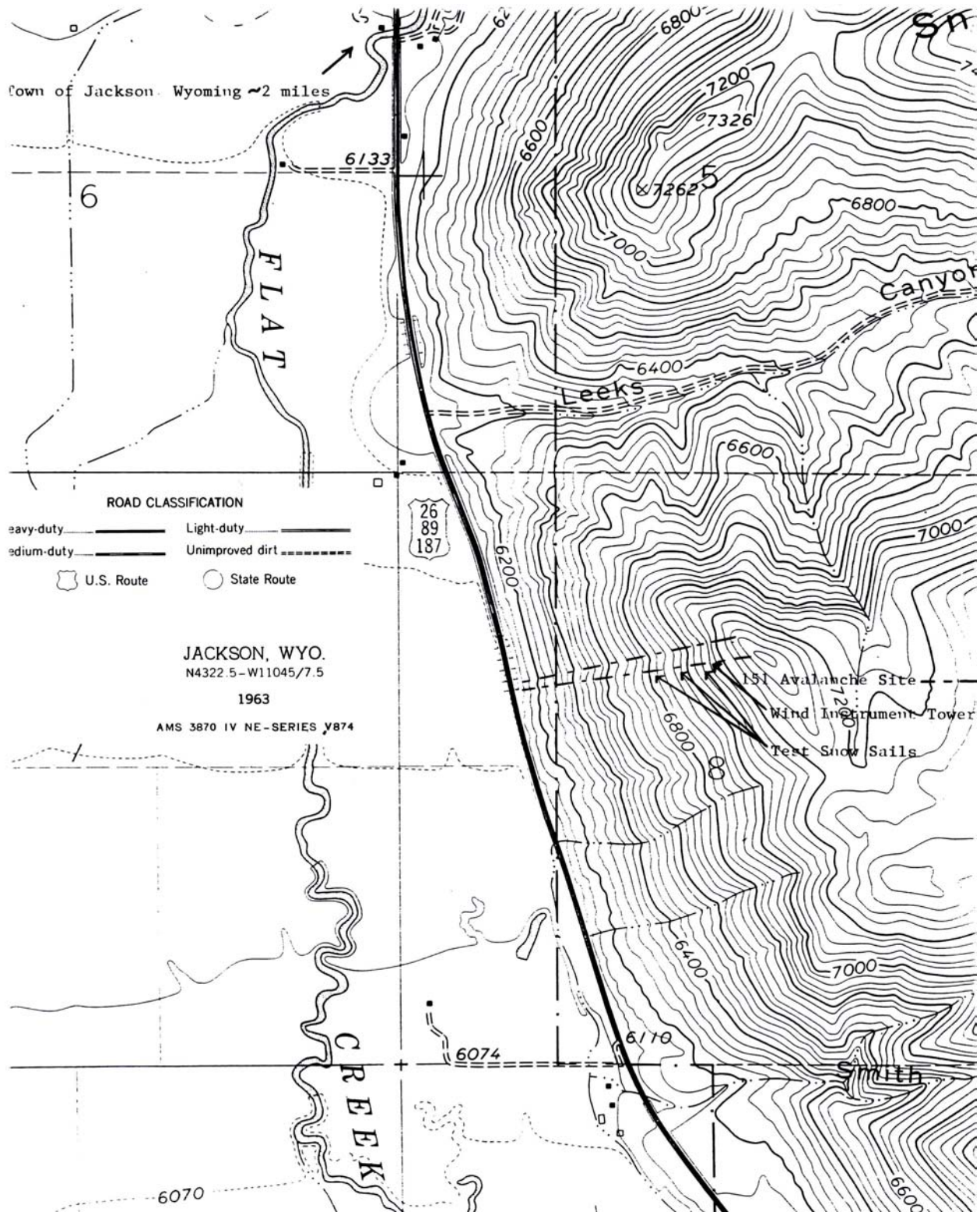

FIGURE 3 Location of the 151 avalanche with respect to the community of Jackson, Wyoming.

Potential alternative techniques for avalanche hazard reduction at the 151 avalanche site include the use of avalanche hazard forecasting and explosive control or other forms of constructed, passive defense measures, such as snow-supporting structures in the starting zone or a snow shed at the road. The 151 avalanche is located adjacent to a populated residential area and is also a critical, managed big game winter habitat. This precludes the regular use of explosives for avalanche control. Additionally, cost estimates for snow-supporting structures in the 151 avalanche-starting zone indicates that this form of passive avalanche defense at this site would cost ~\$1.4 million, installed. A snow shed at the roadway has been previously estimated at ~\$12.7 million for this site for a two-lane roadway. US-89/191 is now an upgraded four-lane highway.

151 SNOW-SAIL DEPLOYMENT SPECIFICATIONS

The net cost to fabricate, transport, and install the operational deployment of 50 snow sails on the 151 avalanche and leave 10 preassembled sails in reserve at the WYDOT maintenance facility in Jackson was about \$90,000. This cost was originally estimated at \$96,600. In addition, there were one-time prototype development and testing costs of \$82,000 during the pilot-phase testing during the winter seasons before 2002–2003. The final snow-sail design is fabricated from aircraft-grade aluminum and uses a vinyl commercial truck tarpaulin material for the sail. It is cable stayed with earth-anchoring pins, each driven about 3 ft deep. The static design wind load is 1,200 lbf lateral, which would be produced by a design wind of 90 mph. There is an ongoing, automated wind study being conducted on site.

During the summer and autumn of 2002 a complement of 60 snow sails was fabricated and transported from Salt Lake City, Utah, to the Jackson, Wyoming, area. The final sail design was similar to the initial trial design with little or no modification and the simplest (stitched) connection for the cloth sail panel to the aluminum frame. The original prototype of this sail is still in service on the 151 site. It has now been in continuous service since the summer of 1999. Helicopter-supported logistics were used to transport the preassembled snow sails, earth pin anchors, and cabling from the Jackson valley floor to the 151 avalanche site.

NATIONAL ENVIRONMENTAL POLICY ACT REQUIREMENTS

The 151 avalanche-starting zone is managed by the U.S. Department of Agriculture (USDA) Forest Service as a “critical big game” habitat. It also has high-quality visual attributes. Hence, during the autumn and winter of 1999–2000, Carter & Burgess, a Denver-based contractor, and WYDOT headquarters personnel pursued and developed the requisite National Environmental Policy Act of 1969 (NEPA) environmental assessment (EA) for the 151 snow-sail project.

The findings of the draft EA supported continued progress toward the full, operational deployment of about 50 snow sails on 151 as a preferred method of avalanche hazard reduction at this site. The visual impact of the approximately 50 sails remained the most pressing public and USDA Forest Service concern. The primary mitigation technique for visual impact includes the provision to remove the sails annually in the spring and reinstall them in the autumn. In addition, the winter 1999–2000 pilot project addressed the issue of sailcloth color and the visual impact of the sails when they were installed in the 151 avalanche-starting zone. The prairie brown color blended well visually. The white sails blended well with the snow and sky but stood out starkly when seen against the mountainside.

The 151 avalanche snow-sail deployment NEPA EA resulted in a finding of no significant impact (2). This was due in large part to the fact that, unlike other forms of constructed, passive avalanche-starting zone defense, snow sails may be removed annually in the spring and reinstalled in the autumn. This minimizes their year-round visual impact. Annual removal and redeployment and maintenance costs for the 151 avalanche snow-sail system has been estimated at \$21,000. [Figure 4](#) shows personnel reinstalling one of the final complement of 50 snow sails in the full deployment at the beginning of the 2003–2004 winter season.

An additional element of the EA included a recommendation that forest species planting (or replanting) be assessed and, if found feasible, conducted on the 151 avalanche-starting zone. The premise is that mature conifer stands on the 151 avalanche-starting zone, if in sufficient numbers and size, could serve the same purpose as the snow sails in disrupting snow depositional patterns and, hence, reducing avalanche hazard. There is some evidence (a few large, old downed timber trunks) in the upper reaches of the 151 avalanche-starting zone to suggest that there was once a stand of timber on this site during prehistory. Perhaps it was burned. Subsequently, it is possible that the barren nature of the site, with its attendant high winds, avalanching, and snow creep and glide, would not allow the site to reseed naturally.



FIGURE 4 Personnel reinstalling one of the 50 sails in the 151 avalanche full snow-sail deployment.

151 SNOW-SAIL PILOT STUDY AND FOLLOW-ON FULL DEPLOYMENT

The 151 avalanche snow-sail project was limited to the five initial pilot phase tasks as a technology path-finding and demonstration exercise prior to installing the full deployment of ~50 sails at the 151 avalanche site. These five pilot phase tasks included the following:

- Task 1
 - Preliminary unit design of a snow sail that is reliable, is cost-effective, and may be set up and removed seasonally. These snow sails are constructed of modern, lightweight materials (aluminum and vinylized nylon fabric).
 - Task 1 completed: June 1999.
 - Task 1 deliverables: preliminary design and unit cost for snow sails.
- Task 2
 - Deploy wind speed and direction instrumentation in the snow-sail deployment area of the 151 avalanche-starting zone.
 - Review available wind climate data from other local sites, including anemometers at the top of Snow King Mountain (about 2 mi to the northeast). Review wind regional wind climate data from National Weather Service, National Oceanic Atmospheric Administration, and other agencies.
 - Task 2 (wind instrumentation): May 1999.
 - Task 2 completion: May 2000.
 - Task 2 deliverables: wind climate assessment at the 151 snow-sail deployment site.
- Task 3
 - Install, as per the preliminary design efforts of Task 1, four full-size test snow sails in the 151 avalanche-starting zone.
 - Task 3 completion date: September 1999.
 - Task 3 deliverables: a field installed snow-sail test deployment at the 151 avalanche site.
- Task 4
 - Evaluate the reliability of the preliminary snow-sail design based on the performance of the test snow sails deployed at the 151 avalanche site.
 - Evaluate the effectiveness of the test snow sails in disrupting the snow depositional patterns in the 151 avalanche-starting zone and hence their potential, if deployed in sufficient numbers, to reduce or mitigate the formations of avalanche wind-slabs in the 151 avalanche-starting zone.
 - Task 4 completion date: May 2000.
 - Task 4 deliverables: an evaluation of snow-sail performance at the 151 avalanche site.
- Task 5
 - Based on the results of Tasks 2 and 4, develop a final design for snow sails at the 151 avalanche-starting zone.
 - Determine the number and location of snow sails required for effective avalanche hazard reduction at the 151 avalanche site.
 - Task 5 completion date: May 2000.

- Task 5 deliverables: evaluation of test snow-sail performance and wind climate assessment of the potential for a full deployment of snow sails to reduce avalanche occurrence at the 151 avalanche; final design for a full deployment of snow sails at the 151 avalanche.

The subsequent two tasks associated with the full deployment of 50 snow sails included

- Task 6
 - Based on the results of Tasks 1 through 5, deploy about 50 snow sails at the 151 avalanche-starting zone.
 - Task 6 completion date: October 2002.
 - Task 6 deliverables: a full deployment of snow sails at the 151 avalanche site.
- Task 7
 - Evaluate, based on the modification to the snowpack, among other parameters, the effectiveness of the full 50-sail deployment at inhibiting the formation of wind-slab avalanche conditions at the 151 avalanche site.
 - Task 7 completion date for interim results: May 2003; final, May 2005.
 - Task 7 deliverable: assessment and evaluation of the full deployment of snow sails at the 151 avalanche site.

151 Avalanche-Starting Zone Wind Climate

The 151 avalanche-starting zone wind climate was assessed using wind speed and direction instrumentation (anemometer) that had been operational since June 1999. It remains in operation. Peak hourly sustained winds exceeding ~25 mph, predominantly from the south or southwest, occur on about 5 separate occasions in any given winter. The maximum peak hourly sustained winds of approximately 30 mph from the west–southwest occurred September 24, 1999. Peak 3 second gusts exceeding 45 mph occur about 8 in any given winter. Their direction was more varied and came from the east–southeast through the west–northwest. The maximum 3-s gust was slightly over 60mph, occurring on December 14, 1999. The snow-sail structural design wind speed is 90 mph.

151 Snow Sail: Snowpack Disruption and Redistribution Assessment

A key element of the pilot-phase portion of the snow-sail investigation was to determine if an individual snow sail in the 151 avalanche-starting zone would disrupt the snow depositional pattern sufficiently such that, if deployed in large enough numbers (about 50), snow sails could effectively reduce the hazard due to wind-slab avalanche conditions at this site.

During the winter of 1999–2000 three methods were used to assess if the pilot project’s trial snow sails were successful in disrupting the snow depositional patterns in the 151 avalanche-starting zone: observations from the valley floor; an on-site, detailed snowpack distribution study on January 21, 2000; and an aerial survey on February 18, 2000. Access for the on-site snowpack distribution study was authorized by the USDA Forest Service, following an assessment of big game use on the 151 site on that specific day.

Four valley floor observation data sheets were prepared during the winter of 1999–2000. The results of these observations indicated that over the course of the winter the trial snow sails were effectively redistributing the snow immediately under and downwind (leeward, to the north) of the sails. It was observed that this snowpack redistribution was occurring during periods of snow and wind, as well as during windy periods without significant snowfall.

During the on-site snowpack redistribution study, personnel climbed to the 151 avalanche-starting zone and measured snowpack depths and densities at various stations around the trial snow sails. Specifically, snowpack depth was measured along three traverses downwind (leeward) and parallel to the line of trial sails. These three traverses were performed at 5, 17, and 40 ft downwind of the line of sails. The sails had successfully redistributed a snowpack with a nominal depth of about 10 in. to a high disrupted snowpack, with depth variations between 0 and 20 in. The last traverse, at 40 ft leeward of the sail line, was the downwind extent of the sail's snowpack disruption zone. As anticipated, there was a large area of snowpack scour immediately under each sail.

In addition, the presence of the snow sails led to elongated regions of increased snowpack density. The nominal snowpack density was 20% (note, the ratio of ice to air—a common, non-dimensional metric of snow density—solid ice is 100%). The densified regions were at 25% density.

The snowpack depositional pattern from this overflight aerial survey of the site on February 18, 2000, is shown in [Figure 5](#). The elongated regions correlate with the areas of increased snowpack density.



FIGURE 5 Aerial view of the pilot-phase technology-trial snow sails.

CONCLUSIONS

It was postulated that the extent of snowpack disruption and redistribution caused by the trial snow sails during the pilot phase of this project was sufficiently significant to extrapolate the following: if about 50 snow sails were to be deployed in the 151 avalanche-starting zone, the region of snowpack disruption and redistribution would be sufficient to reduce and inhibit the development of wind-slabs and the potential for wind-slab avalanching from this site.

This postulate remains the focus of ongoing full-deployment assessment and evaluation activities associated with the 151 avalanche snow-sail project. The full deployment of 50 sails on the 151 avalanche can be seen in [Figure 6](#). [Figure 7](#) show the full deployment from a closer angle.



FIGURE 6 A view from the valley floor of the full 50-sail deployment of snow sails on the 151 avalanche.

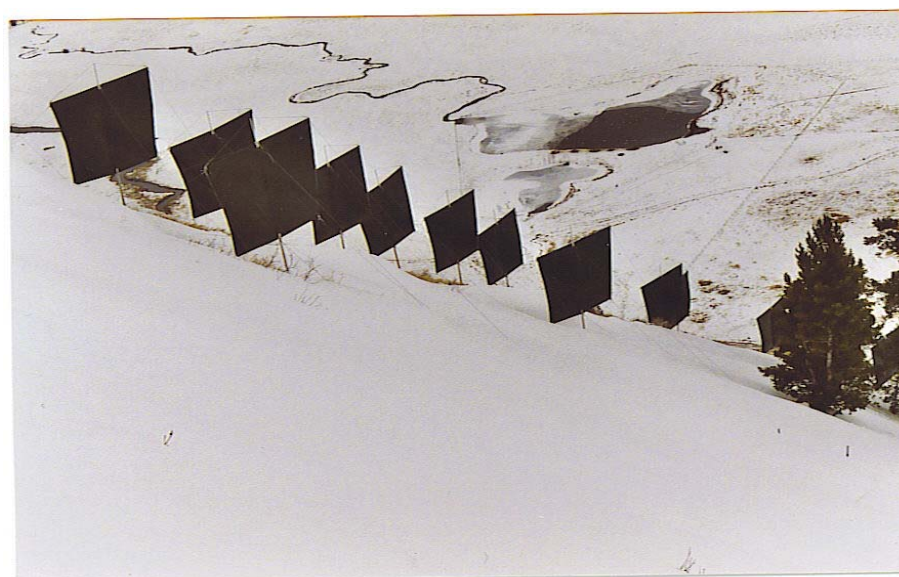

FIGURE 7 A view of a portion of the full snow-sail deployment of the 151 avalanche.

ACKNOWLEDGMENTS

The 151 avalanche snow-sail project has been supported by the Wyoming Department of Transportation, through ongoing reviews and funding by the WYDOT Research Advisory Committee.

REFERENCES

1. *Okologische Untersuchungen in der subalpine Stufe zum Zwecke der Hochlagenaufforstung; Windbeeinflussende Bauten in der Lawinen-verbauung and -vorbeaugung* (Austrian mountain engineering handbook, section on wind influences in avalanche formation and defense). Der Forstlichen Bundes—Versuchsanstalt (Forest Ministry), 1963.
2. *Snow Sail (Draft) Environmental Assessment—Jackson South Avalanche Mitigation*. Carter & Burgess for FHWA, Wyoming Department of Transportation, and the USDA Forest Service, April 2000.

APPENDIX

Author Contact List

E. E. Adams
Montana State University–Bozeman
Bozeman, Montana 59717
406-994-6122; fax: 406-994-6105
eda@ce.montana.edu

Teresa Adams
1204 Engineering Hall
1415 Engineering Drive
University of Wisconsin–Madison
Madison, Wisconsin 53706
608-262-9854; fax: 608-262-5199

Jose J. Alamo
Iowa State University
Ames, Iowa

Duane E. Amsler, Sr.
AFM Engineering Services
80 Blessing Road
Slingerlands, New York 12159
518-489-6055; fax: 518-453-6481
damsler3@nycap.rr.com

Motoki Asano
Civil Engineering Research Institute of
Hokkaido I.A.I. Japan
1-34, Hiragishi 1-3, Toyohira-Ku
Sapporo, Hokkaido 062-8602, Japan
+81-11-841-1738; fax: +81-11-841-9747
m-asano@ceri.go.jp

Lisa Ballard
Western Transportation Institute
P.O. Box 174250
Montana State University–Bozeman
Bozeman, Montana 59717-4250
406-994-6529
lballard@coe.montana.edu

Enrico V. Baroga
Washington State Department of
Transportation
P.O. Box 47358
Olympia, Washington 98504-7358
360-705-7864; fax: 360-705-6823
barogar@wsdot.wa.gov

Karin M. Bauer
Midwest Research Institute
425 Volker Boulevard
Kansas City, Missouri 64110-2299
816-753-7600, ext. 1468;
fax: 816-561-6557
kbauer@mriresearch.org

Dennis Belter
Indiana Department of Transportation

Ben C. Bernstein
National Center for Atmospheric Research
3450 Mitchell Lane
Boulder, Colorado 80301
303-497-8424; fax: 303-497-8401
bernstei@rap.ucar.edu

Robert R. Blackburn
16540 East El Lago Boulevard
Unit #9
Fountain Hills, Arizona 85268
480-837-4445; fax: 480-837-4445
rrblackburn@uswest.net

Carola Blazquez
1204 Engineering Hall
1415 Engineering Drive
University of Wisconsin–Madison
Madison, Wisconsin 53706
608-262-9854; fax: 608-262-5199

Göran Blomqvist
 Swedish National Road and Transport
 Research Institute
 SE-581 95 Linköping, Sweden
 +46-13-20-43-26; fax: +46-13-14-14-36
 goran.blomqvist@vti.se

S. Edward Boselly
 Washington State Department of
 Transportation
 360-705-7863; fax: 360-705-6823
 BosellE@wsdot.wa.gov

Alan Burkett
 Transit New Zealand
 P.O. Box 973 Hamilton
 New Zealand
 alan.burkett@transit.govt.nz

Dennis Burkheimer
 Iowa Department of Transportation
 800 Lincoln Way
 Ames, Iowa 50010
 Dennis.Burkheimer@DOT.STATE.Iowa.US

Marilyn Burtwell
 Transportation Research Laboratory Limited
 Crowthorne House
 Workingham
 Berkshire RG40 3GA, England
 +44(0) 1344-770214;
 fax: +40(0)1344-770356
 mburtwell@trl.co.uk

Eli Cuelho
 Western Transportation Institute
 Montana State University–Bozeman
 P.O. Box 174250
 Bozeman, Montana 59717
 406-994-7886; fax: 406-994-1697
 elic@coe.montana.edu

A. R. Curran
 ThermoAnalytics, Inc.
 Calumet, Michigan 49913
 906-482-9650
 arc@thermoanalytics.com

Richard S. Davis
 Beveridge & Diamond, P.C.
 1350 I Street, NW
 Suite 700
 Washington, D.C. 20005
 202-789-6025; fax: 202-789-6190
 rdavis@bdlaw.com

Rand Decker
 Northern Arizona University
 P.O. Box 15600
 Flagstaff, Arizona 86011-5600
 928-523-6083
 rand.decker@nau.edu or
 randdecker@aol.com

Dan Eriksson
 Swedish National Road
 Administration SE-781 87
 Borlänge, Sweden
 +46-24-37-59-55; fax: +46-24-37-52-30
 dan.eriksson@vv.se

Shinya Fujiwara
 Sekisui Jushi Corp.
 731-1 Kagami Ryuoh-cho Gamou-Gun
 Shiga 520-2596, Japan
 +81-748-58-1394; fax: +81+748-58-3092
 fujiwaras@sekisuijushi.co.jp

P. Gauer
 Norwegian Geotechnical Institute
 Oslo, Norway
 Formerly with Western Transportation
 Institute
 Montana State University–Bozeman
 Bozeman, Montana 59717
 Peter.Gauer@ngi.no

Tina M. Greenfield
Iowa State University
Ames, Iowa

Nick Gurr
Opus International Consultants
P.O. Box 43
Taupo, New Zealand
nick.gurr@opus.co.nz

Mats Gustafsson
Swedish National Road and Transport
Research Institute
SE-581 95 Linköping, Sweden
+46-13-20-43-26; fax: +46-13-14-14-36
mats.gustafsson@vti.se

Robert B. Haehnel
U.S. Army Corps of Engineers
Cold Regions Research and
Engineering Laboratory
72 Lyme Road
Hanover, New Hampshire 03755-1290

Fumihiko Hara
Hokkaido Development
Engineering Center, Inc.
South 1 East 2
Chuo-ku, Sapporo, Japan
+81-11-271-3028; fax: +81-11-271-5115
hara@decnet.or.jp

Christopher L. Hunt
Ohio Research Institute for Transportation
and the Environment
Russ College of Engineering and
Technology
Ohio University
Athens, Ohio 45701-2979
740-593-1470; fax: 740-593-1465
chunt@bobcat.ent.ohiou.edu

Tuomo Iivanainen
Intrinsic Ltd.
P.O. Box 57
FIN-33201
Tampere, Finland
+358-3-2720-550; fax: +358-3-214-8180
tuomo.iivanainen@intrin.fi or www.intrin.fi

Yasuhiko Ito
Civil Engineering Research
Institute of Hokkaido
1-3 Hiragishi Toyohira-ku
Sapporo 062-8602, Japan
+81-11-841-1746; fax: +81+11-841-9747
yasu-ito@ceri.go.jp

David Kack
Western Transportation Institute
Montana State University–Bozeman
P.O. Box 174250
Bozeman, Montana 59717
406-994-7526; fax: 406-994-1697
dkack@coe.montana.edu

Steve Kahl
Structural Research Unit
Michigan Department of Transportation

Yasuhiko Kajiya
Civil Engineering Research
Institute of Hokkaido
Hiragishi 1-3-1-34, Toyohira-ku
Sapporo 062-8602, Japan
+81-11-841-5553; fax: +81-11-841-9747
ykajiya@ceri.go.jp

Jouko Kantonen
Finnish Road Administration P.B. 33
FIN-00521
Helsinki, Finland
+35-82-04-22-2599;
fax: +35-82-04-22-2512
jouko.kantonen@tiehallinto.fi.

Akira Kawamura
 Kitami Institute of Technology
 165 Koen-cho
 Kitami 090-8507, Japan

Kunihiro Kishi
 Hokkaido University
 North 8 West 5, Kita-ku
 Sapporo, Japan
 +81-11-706-6864 ; fax: +81-11-706-6216
 kishi@eng.hokudai.ac.jp

Freddy Knudsen
 Danish Road Directorate

Kazuharu Kobayashi
 Niigata Experimental Laboratory
 Incorporated Administrative Agency
 Public Works Research Institute
 2-6-8, Nishiki-cho, Arai
 Niigata 944-0051, Japan
 +81-255-72-4131; fax: +81-255-72-9629
 k-kobaya@pwri.go.jp

George Kochumman
 IIHR Hydroscience and Engineering
 University of Iowa
 Iowa City, Iowa 52242-1585
 319-335-5166; fax: 319-335-5660

Tom Konieczny
 Indiana Department of Transportation

Dennis A. Kroeger
 Center for Transportation
 Research and Education
 Iowa State University
 2901 S. Loop Drive, Suite 3100
 Ames, Iowa 50010-8632
 515-294-8103; fax: 515-294-0467
 kroeger@iastate.edu

Jukka Lähesmaa
 SysOpen Plc
 Hiomotie 17, 00380
 Helsinki, Finland
 +358-424-2020-335;
 fax: +358-424-2020-700
 jukka.lahesmaa@sysopen.fi

Timothy Leggett
 Forensic Dynamics Inc.
 230 – 1210 Summit Drive
 Kamloops, British Columbia, V2C 6M1
 Canada
 250-374-6742; fax: 250-828-2743
 tim@forensicdynamics.com

Seth Linden
 National Center for Atmospheric Research
 3450 Mitchell Lane
 Boulder, Colorado 80301
 303-497-8433; fax: 303-497-8401
 linden@ucar.edu

Glen Liston
 InterWorks Consulting
 15048 NCR 25E
 Loveland, Colorado 80538

Craig Luker
 Forensic Dynamics Inc.
 230–1210 Summit Drive
 Kamloops, British Columbia V2C 6M1
 Canada
 250-374-6742; fax: 250-828-2743
 craig@forensicdynamics.com

Tikakuni Maeda
 Kitami Institute of Technology
 165 Koen-cho
 Kitami 090-8507, Japan

William P. Mahoney III
National Center for Atmospheric Research
3450 Mitchell Lane
Boulder, Colorado 80301
mahoney@ucar.edu

Justin Maloney
1204 Engineering Hall
1415 Engineering Drive
University of Wisconsin–Madison
Madison, Wisconsin 53706
608-262-9854; fax: 608-262-5199

Thomas Martinelli
Wisconsin Department of Transportation
Room 501
Hillfarms State Office Building
Sheboygan Avenue
Madison, Wisconsin 53708
thomas.martinelli@dot.state.wi.us

Teruhiko Maruyama
Nagaoka University of Technology
1603-1 Kamitomioka, Nagaoka-shi
Niigata Prefecture 940-2188, Japan
+81-258-47-9613; fax: +81-258-47-9600
terum@nagaokaut.ac.jp

Masaru Matsuzawa
Civil Engineering Research
Institute of Hokkaido
1-3 Hiragishi Toyohira-ku
Sapporo 062-8602, Japan
+81-11-841-1746; fax: +81-11-841-9747
masaru@ceri.go.jp

Diane McCauley
Iowa Department of Transportation
Ames, Iowa

Tony McClellan
Indiana Department of Transportation

Bob McCullouch
Purdue University
550 Stadium Mall Drive
West Lafayette, Indiana 47907
765-494-0643
bgm@ecn.purdue.edu

L. R. McKittrick
Montana State University–Bozeman
Bozeman, Montana 59717
406-994-1648; fax: 406-994-6105
ladeanm@ce.montana.edu

Seishi Meiarashi
Incorporated Administrative Agency
Public Works Research Institute
1-6, Minamihara, Tsukuba
Ibaraki 305-8516, Japan
+81-29-879-6763; fax: +81-29-879-6733
mei@pwri.go.jp

J. Mewes
Meridian Environmental Technology, Inc.
Grand Forks, North Dakota 58208
701-777-6520
jmewes@meridian-enviro.com

Gayle F. Mitchell
Ohio Research Institute for
Transportation and the Environment
Russ College of Engineering and
Technology
Ohio University
Athens, Ohio 45701-2979
740-593-1470; fax: 740-593-1465
gmitchel@bobcat.ent.ohiou.edu

Syuji Miyamoto
Independent Administrative Institute
Civil Engineering Research
Institute of Hokkaido
3-1-14 Hiragishi-1-Jyo
Toyohira-Ku, Sapporo-Shi
Hokkaido 062-8602, Japan
+81-11-841-1738; fax: +81-11-841-9747
s-miyamoto@ceri.go.jp

Staffan Möller
 Swedish National Road and
 Transport Research Institute
 SE- 581 95
 Linköping, Sweden
 +46-13-20-41-61; fax: +46-13-14-14-36
 staffan.moller@vti.se

Masayuki Murakami
 Sanei Kogyo Co. LTD
 1-65 17-jo 4-chome Hassamu Nishi-ku
 Sapporo 063-0837, Japan
 +81-11-662-6112; fax: +81-11-662-8615
 masayuki@3e-sanei.co.jp

William L. Myers
 National Center for Atmospheric Research
 Research Applications Program
 3450 Mitchell Lane
 Boulder, Colorado 80301
 myers@ucar.edu

Takashi Nakatsuji
 Hokkaido University
 Kita 13, Nishi 8, Kita-ku
 Sapporo 060-8628, Japan

Wilfrid A. Nixon
 IIHR Hydroscience and Engineering
 University of Iowa
 Iowa City, Iowa 52242-1585
 319-335-5166; fax: 319-335-5660
 Wilfrid-nixon@uiowa.edu

Steve Otto
 Maintenance, Specifications and
 Traffic Engineering Section
 Alberta Transportation
 4999 – 98 Avenue
 Edmonton, Alberta, T6B 2X3 Canada
 780-422-9972; fax: 780-422-2846
 steve.otto@gov.ab.ca

Matti Pettersson
 Intrinsic Ltd.
 P.O. Box 57
 FIN-33201
 Tampere, Finland
 +358-3-2720 550; fax +358-3-214 8180
 matti.pettersson@intrin.fi or www.intrin.fi

Yrjö Pilli-Sihvola
 Finnish Road Administration
 Kauppamiehenkatu 4
 45100 Kouvola, Finland
 +358-204-22-6260; fax +358-204-22-6219
 yrjo.pilli.sihvola@finra.fi

Paul A. Pisano
 Federal Highway Administration
 Road Weather Management Program
 HOTO-1 Room 3408
 400 7th Street, SW
 Washington, D.C. 20590
 paul.pisano@fhwa.dot.gov

Ju Qiu
 IIHR Hydroscience and Engineering
 University of Iowa
 Iowa City, Iowa 52242-1585
 319-335-5166; fax: 319-335-5660

Lin Qiu
 IIHR Hydroscience and Engineering
 University of Iowa
 Iowa City, Iowa 52242-1585
 319-335-5166; fax: 319-335-5660

Robert Rice
 University of California–Merced
 Merced, California 95344
 209-777-1793
 rrice@ucmerced.edu

Wallace Richardson
Ohio Research Institute for
Transportation and the Environment
Russ College of Engineering
and Technology
Ohio University
Athens, Ohio 45701-2979
740-593-1470; fax: 740-593-1465
wmrichardson@copper.net

Barry Rokosh
Forensic Dynamics Inc.
230-1210 Summit Drive
Kamloops, British Columbia V2C 6M1
Canada
250-374-6742; fax: 250-828-2743
barry@forensicsdynamics.com

Noriyuki Sato
Indiana University
701 E. Kirkwood Avenue
Bloomington, Indiana 47405
812-855-6303; fax: 812-855-1661
nosato@indiana.edu

Keiichi Sato
Hokkaido University
North 8 West 5
Kita-ku, Sapporo, Japan
+81-11-706-6864; fax: +81-11-706-6216
kkaku@eng.hokudai.ac.jp

Reggie Sinhaa
Center for Transportation Research
and Education
Iowa State University
2901 S. Loop Drive
Suite 3100
Ames, Iowa 50010-8632
515-294-8103; fax: 515-294-0467
sinhaa@iastate.edu

Leland D. Smithson
Iowa Department of Transportation
800 Lincoln Way
Ames, Iowa 50010
515-239-1519
leland.smithson@dot.state.ia.us

Andrew D. Stern
Mitretek Systems, Inc.
3150 Fairview Park Drive South
Falls Church, Virginia 22042
astern@mitretek.org

Akira Sugimura
Nagaoka National Highway Office
Hokuriku Regional Development Bureau
Ministry of Land, Infrastructure
and Transport
430-1, 4-chome Nakazawa, Nagaoka-shi
Niigata Prefecture, 940-8512, Japan
+81-258-36-4551; fax: +81-258-33-7566
sugimura-a842w@hrr.mlit.go.jp

Takehiko Suzuki
Civil Engineering Research
Institute of Hokkaido
Hiragishi 1-3-1-34
Toyohira-ku, Sapporo 062-8602, Japan
+81-11-841-5553; fax: +81-11-841-9747

Ronald D. Tabler
Tabler & Associates
P.O. Box 483
Niwot, Colorado 80544
303-652-3921; fax: 303-652-3973
tabler@sprynet.com

Naoto Takahashi
Civil Engineering Research
Institute of Hokkaido
3-1-14 Hiragishi-1-Jyo
Toyohira-Ku, Sapporo-Shi
Hokkaido 062-8602, Japan
+81-11-841-1738; fax: +81-11-841-9747
takahashi-n24k@ceri.go.jp

Toshiya Takeshi
Niigata Experimental Laboratory
Incorporated Administrative Agency
Public Works Research Institute
2-6-8, Nishiki-cho, Arai
Niigata, 944-0051, Japan
+81-255-72-4131; fax: +81-255-72-9629
takeshi@pwri.go.jp

Eugene S. Takle
Iowa State University
Ames, Iowa

Brian J. Tentinger
Iowa State University
Ames, Iowa

Gregory E. Thompson
ThomTech Design, Inc.
3830 Rustic Place
St. Paul, Minnesota 55126
651-482-9680; fax: 651-482-9469
greg@thomtechdesign.com

J. E. Thornes
University of Birmingham
Edgbaston, Birmingham B15 2TT
United Kingdom
+44 121-414-5556; fax: +44 121-414-5556
j.e.thornes@bham.ac.uk

Kimmo Toivonen
Finnish Road Administration
Kauppamiehenkatu 4, FIN-45100
Kouvola, Finland
+35-82-04-22-6262;
fax: +35-82-04-22-6256
kimmo.toivonen@tiehallinto.fi.

Roberto A. Tokunaga
Civil Engineering Research
Institute of Hokkaido
1-34, Hiragishi 1-3
Toyohira-Ku,
Sapporo, Hokkaido 062-8602, Japan
+81-11-841-1738; fax: +81-11-841-9747
roberto@ceri.go.jp

Christopher Y. Tuan
University of Nebraska–Lincoln
Room 203F
Peter Kiewit Institute
1110 S. 67th Street
Omaha, Nebraska 68182-0178
402-554-3867; fax: 402-554-3288
ctuan@mail.unomaha.edu

Tatsuya Uemura
Civil Engineering Research
Institute of Hokkaido
Hiragishi 1-3-1-34
Toyohira-ku
Sapporo 062-8602, Japan
+81-11-841-5553; fax: +81-11-841-9747

Torgeir Vaa
SINTEF Roads and Transport
Klaebuveien 153
N-7465 Trondheim, Norway
+47 73-59-4673; fax: +47-73-59-4623
torgeir.vaa@sintef.no

Alan Vonderohe
1204 Engineering Hall
1415 Engineering Drive
University of Wisconsin–Madison
Madison, Wisconsin 53706
608-262-9854; fax: 608-262-5199
vonderoh@engr.wisc.edu

Jerry R. Waldman
Surface Systems, Inc.–
Quixote Transportation Safety, Inc.
11612 Lilburn Park Road
St. Louis, Missouri 63146
314-569-1002; fax: 314-569-3567
jrw@surface.com

Carl-Gustaf Wallman
Swedish National Road and
Transport Research Institute
SE-581 95
Linköping, Sweden
+46-13-20-4027; fax: +46-13-20-4145
carl-gustaf.wallman@vti.se

Leroy (Ted) Wells
Wyoming Department of Transportation
P.O. Box 1260
Rock Springs, Wyoming 82902-1260
307-353-3032
Leroy.Wells@dot.state.wy.us

Jamie K. Wolff
National Center for Atmospheric Research
3450 Mitchell Lane
Boulder, Colorado 80301
303-497-2812; fax: 303-497-8401
jwolff@ucar.edu

Jing Xiong
IIHR Hydroscience and Engineering
University of Iowa
Iowa City, Iowa 52242-1585
319-335-5166; fax: 319-335-5660

Takashi Yamada
Hokuriku Construction Association
3-4 2-chome Kameda-Kogyodanchi
Kameda-machi, Niigata 950-0197, Japan
+81-25-381-1054; fax: +81-25-383-1205
takashi_yamada@hokurikutei.or.jp

Yuji Yamagiwa
Civil Engineering Research
Institute of Hokkaido
Hiragishi 1-3-1-34
Toyohira-ku
Sapporo 062-8602, Japan
+81-11-841-1746; fax: +81-11-841-9747

Chigako Yamamoto
Hokkaido University
North 8 West 5, Kita-ku
Sapporo, Japan
+81-11-706-6864; fax: +81-11-706-6216
chigako@gradus.net

Sherif A. Yehia
Western Michigan University
Parkview – G 246
1903 W. Michigan Avenue
Kalamazoo, Michigan 49008-5316
269-276-3218; fax: 269-276-3211
sherif.yehia@wmich.edu

Jamie Yount
Wyoming Department of Transportation
P.O. Box 14700
Jackson, Wyoming 83002
406-570-3688
pooderbum@hotmail.com

THE NATIONAL ACADEMIES

Advisers to the Nation on Science, Engineering, and Medicine

The **National Academy of Sciences** is a private, nonprofit, self-perpetuating society of distinguished scholars engaged in scientific and engineering research, dedicated to the furtherance of science and technology and to their use for the general welfare. On the authority of the charter granted to it by the Congress in 1863, the Academy has a mandate that requires it to advise the federal government on scientific and technical matters. Dr. Bruce M. Alberts is president of the National Academy of Sciences.

The **National Academy of Engineering** was established in 1964, under the charter of the National Academy of Sciences, as a parallel organization of outstanding engineers. It is autonomous in its administration and in the selection of its members, sharing with the National Academy of Sciences the responsibility for advising the federal government. The National Academy of Engineering also sponsors engineering programs aimed at meeting national needs, encourages education and research, and recognizes the superior achievements of engineers. Dr. William A. Wulf is president of the National Academy of Engineering.

The **Institute of Medicine** was established in 1970 by the National Academy of Sciences to secure the services of eminent members of appropriate professions in the examination of policy matters pertaining to the health of the public. The Institute acts under the responsibility given to the National Academy of Sciences by its congressional charter to be an adviser to the federal government and, on its own initiative, to identify issues of medical care, research, and education. Dr. Harvey V. Fineberg is president of the Institute of Medicine.

The **National Research Council** was organized by the National Academy of Sciences in 1916 to associate the broad community of science and technology with the Academy's purposes of furthering knowledge and advising the federal government. Functioning in accordance with general policies determined by the Academy, the Council has become the principal operating agency of both the National Academy of Sciences and the National Academy of Engineering in providing services to the government, the public, and the scientific and engineering communities. The Council is administered jointly by both the Academies and the Institute of Medicine. Dr. Bruce M. Alberts and Dr. William A. Wulf are chair and vice chair, respectively, of the National Research Council.

The **Transportation Research Board** is a division of the National Research Council, which serves the National Academy of Sciences and the National Academy of Engineering. The Board's mission is to promote innovation and progress in transportation through research. In an objective and interdisciplinary setting, the Board facilitates the sharing of information on transportation practice and policy by researchers and practitioners; stimulates research and offers research management services that promote technical excellence; provides expert advice on transportation policy and programs; and disseminates research results broadly and encourages their implementation. The Board's varied activities annually engage more than 4,000 engineers, scientists, and other transportation researchers and practitioners from the public and private sectors and academia, all of whom contribute their expertise in the public interest. The program is supported by state transportation departments, federal agencies including the component administrations of the U.S. Department of Transportation, and other organizations and individuals interested in the development of transportation.

www.TRB.org

www.national-academies.org

TRANSPORTATION RESEARCH BOARD

500 Fifth Street, NW
Washington, DC 20001

ADDRESS SERVICE REQUESTED

THE NATIONAL ACADEMIES™

Advisers to the Nation on Science, Engineering, and Medicine

The nation turns to the National Academies—National Academy of Sciences, National Academy of Engineering, Institute of Medicine, and National Research Council—for independent, objective advice on issues that affect people's lives worldwide.

www.national-academies.org