



## **Interim Design Assessment for the Blue Grass Chemical Agent Destruction Pilot Plant**

Committee to Assess Designs for Pueblo and Blue Grass Chemical Agent Destruction Pilot Plants, National Research Council

ISBN: 0-309-65586-2, 94 pages, 8 1/2 x 11, (2005)

**This free PDF was downloaded from:**

**<http://www.nap.edu/catalog/11473.html>**

Visit the [National Academies Press](http://www.nap.edu) online, the authoritative source for all books from the [National Academy of Sciences](http://www.nap.edu), the [National Academy of Engineering](http://www.nap.edu), the [Institute of Medicine](http://www.nap.edu), and the [National Research Council](http://www.nap.edu):

- Download hundreds of free books in PDF
- Read thousands of books online, free
- Sign up to be notified when new books are published
- Purchase printed books
- Purchase PDFs
- Explore with our innovative research tools

Thank you for downloading this free PDF. If you have comments, questions or just want more information about the books published by the National Academies Press, you may contact our customer service department toll-free at 888-624-8373, [visit us online](http://www.nap.edu), or send an email to [comments@nap.edu](mailto:comments@nap.edu).

This free book plus thousands more books are available at <http://www.nap.edu>.

Copyright © National Academy of Sciences. Permission is granted for this material to be shared for noncommercial, educational purposes, provided that this notice appears on the reproduced materials, the Web address of the online, full authoritative version is retained, and copies are not altered. To disseminate otherwise or to republish requires written permission from the National Academies Press.

# INTERIM DESIGN ASSESSMENT FOR THE Blue Grass Chemical Agent Destruction Pilot Plant

Committee to Assess Designs for Pueblo and Blue Grass  
Chemical Agent Destruction Pilot Plants

Board on Army Science and Technology

Division on Engineering and Physical Sciences

NATIONAL RESEARCH COUNCIL  
*OF THE NATIONAL ACADEMIES*

THE NATIONAL ACADEMIES PRESS  
Washington, D.C.  
**[www.nap.edu](http://www.nap.edu)**

**THE NATIONAL ACADEMIES PRESS      500 Fifth Street, N.W.      Washington, DC 20001**

NOTICE: The project that is the subject of this report was approved by the Governing Board of the National Research Council, whose members are drawn from the councils of the National Academy of Sciences, the National Academy of Engineering, and the Institute of Medicine. The members of the committee responsible for the report were chosen for their special competences and with regard for appropriate balance.

This study was supported by Contract No. W911NF-05-C-0036 between the National Academy of Sciences and the Department of Defense. Any opinions, findings, conclusions, or recommendations expressed in this publication are those of the author(s) and do not necessarily reflect the views of the organizations or agencies that provided support for the project.

International Standard Book Number 0-309-09698-7

*Limited copies of this report are available from:*

Board on Army Science and Technology  
National Research Council  
500 Fifth Street, N.W., Room 940  
Washington, DC 20001  
(202) 334-3118

*Additional copies are available from:*

The National Academies Press  
500 Fifth Street, N.W.  
Lockbox 285  
Washington, DC 20055  
(800) 624-6242 or (202) 334-3313  
(in the Washington metropolitan area)  
Internet, <http://www.nap.edu>

Copyright 2005 by the National Academy of Sciences. All rights reserved.

Printed in the United States of America

# THE NATIONAL ACADEMIES

## *Advisers to the Nation on Science, Engineering, and Medicine*

The **National Academy of Sciences** is a private, nonprofit, self-perpetuating society of distinguished scholars engaged in scientific and engineering research, dedicated to the furtherance of science and technology and to their use for the general welfare. Upon the authority of the charter granted to it by the Congress in 1863, the Academy has a mandate that requires it to advise the federal government on scientific and technical matters. Dr. Ralph J. Cicerone is president of the National Academy of Sciences.

The **National Academy of Engineering** was established in 1964, under the charter of the National Academy of Sciences, as a parallel organization of outstanding engineers. It is autonomous in its administration and in the selection of its members, sharing with the National Academy of Sciences the responsibility for advising the federal government. The National Academy of Engineering also sponsors engineering programs aimed at meeting national needs, encourages education and research, and recognizes the superior achievements of engineers. Dr. Wm. A. Wulf is president of the National Academy of Engineering.

The **Institute of Medicine** was established in 1970 by the National Academy of Sciences to secure the services of eminent members of appropriate professions in the examination of policy matters pertaining to the health of the public. The Institute acts under the responsibility given to the National Academy of Sciences by its congressional charter to be an adviser to the federal government and, upon its own initiative, to identify issues of medical care, research, and education. Dr. Harvey V. Fineberg is president of the Institute of Medicine.

The **National Research Council** was organized by the National Academy of Sciences in 1916 to associate the broad community of science and technology with the Academy's purposes of furthering knowledge and advising the federal government. Functioning in accordance with general policies determined by the Academy, the Council has become the principal operating agency of both the National Academy of Sciences and the National Academy of Engineering in providing services to the government, the public, and the scientific and engineering communities. The Council is administered jointly by both Academies and the Institute of Medicine. Dr. Ralph J. Cicerone and Dr. Wm. A. Wulf are chair and vice chair, respectively, of the National Research Council.

**[www.national-academies.org](http://www.national-academies.org)**



## **COMMITTEE TO ASSESS DESIGNS FOR PUEBLO AND BLUE GRASS CHEMICAL AGENT DESTRUCTION PILOT PLANTS**

ROBERT A. BEAUDET, *Chair*, University of Southern California, Los Angeles  
CHARLES BARTON, Iowa Department of Public Health, Des Moines  
JOAN B. BERKOWITZ, Farkas Berkowitz and Company, Washington, D.C.  
RUTH M. DOHERTY, Naval Surface Warfare Center, Indian Head, Maryland  
LAWRENCE E. EISELSTEIN, Exponent Failure Analysis Associates, Menlo Park, California  
HAROLD K. FORSEN, Bechtel Corporation (retired), Kirkland, Washington  
WILLARD C. GEKLER, PLG (retired), Los Alamitos, California  
CLAIR F. GILL, Smithsonian Institution, Washington, D.C.  
CHANDRA M. ROY, Exponent Failure Analysis Associates, Irvine, California  
KENNETH A. SMITH, Massachusetts Institute of Technology, Cambridge  
MICHAEL K. STENSTROM, University of California, Los Angeles  
THOMAS WEBLER, Antioch New England Graduate School, Keene, New Hampshire (member until  
March 22, 2005)

### **Staff**

DONALD L. SIEBENALER, Study Director  
HARRISON T. PANNELLA, Senior Program Officer  
DETRA BODRICK-SHORTER, Senior Program Assistant  
JAMES C. MYSKA, Research Associate

## **BOARD ON ARMY SCIENCE AND TECHNOLOGY**

JOHN E. MILLER, *Chair*, L3 Communications Corporation, Reston, Virginia  
HENRY J. HATCH, *Vice Chair*, Army Chief of Engineers (retired), Oakton, Virginia  
SETH BONDER, The Bonder Group, Ann Arbor, Michigan  
JOSEPH V. BRADDOCK, The Potomac Foundation, McLean, Virginia  
NORVAL L. BROOME, MITRE Corporation (retired), Suffolk, Virginia  
ROBERT L. CATTOI, Rockwell International (retired), Dallas, Texas  
DARRELL W. COLLIER, U.S. Army Space and Missile Defense Command (retired), Leander, Texas  
ALAN H. EPSTEIN, Massachusetts Institute of Technology, Cambridge  
ROBERT R. EVERETT, MITRE Corporation (retired), New Seabury, Massachusetts  
PATRICK F. FLYNN, Cummins Engine Company, Inc. (retired), Columbus, Indiana  
WILLIAM R. GRAHAM, National Security Research, Inc., Arlington, Virginia  
PETER F. GREEN, University of Michigan, Ann Arbor  
EDWARD J. HAUG, University of Iowa, Iowa City  
M. FREDERICK HAWTHORNE, University of California, Los Angeles  
CLARENCE W. KITCHENS, Science Applications International Corporation, Vienna, Virginia  
ROGER A. KRONE, Boeing Integrated Defense Systems, Philadelphia, Pennsylvania  
JOHN W. LYONS, U.S. Army Research Laboratory (retired), Ellicott City, Maryland  
MALCOLM R. O'NEILL, Lockheed Martin Corporation, Bethesda, Maryland  
EDWARD K. REEDY, Georgia Tech Research Institute (retired), Atlanta, Georgia  
DENNIS J. REIMER, DFI International, Washington, D.C.  
WALTER D. SINCOSKIE, Telcordia Technologies, Inc., Morristown, New Jersey  
JUDITH L. SWAIN, University of California, San Diego  
WILLIAM R. SWARTOUT, Institute for Creative Technologies, Marina del Rey, California  
EDWIN L. THOMAS, Massachusetts Institute of Technology, Cambridge  
BARRY M. TROST, Stanford University, Stanford, California

### **Staff**

BRUCE A. BRAUN, Director  
WILLIAM E. CAMPBELL, Manager, Program Operations  
CHRIS JONES, Financial Associate  
ROBERT J. LOVE, Senior Program Officer  
MARGARET NOVACK, Senior Program Officer  
HARRISON T. PANELLA, Senior Program Officer  
DONALD L. SIEBENALER, Senior Program Officer  
DEANNA P. SPARGER, Program Administrative Coordinator

## Preface

For the last two decades, the U.S. Army has been engaged in destroying its aging stockpile of chemical agents and munitions, which are located at eight sites in the continental United States.<sup>1</sup> Approximately 35 percent of the original stockpile of more than 30,000 tons of nerve and blister (mustard) agents has been destroyed to date.

As a signatory to the international treaty known as the Chemical Weapons Convention, which was ratified by the international community on April 29, 1997, the United States had 10 years to destroy its stockpile, with an allowable extension of 5 additional years. The United States has acknowledged that it will require the 5 additional years or more to complete destruction operations.

At four stockpile sites (Tooele, Utah; Umatilla, Oregon; Anniston, Alabama; and Pine Bluff, Arkansas), the destruction process is based on incineration. Two other sites have never had any assembled chemical weapons (i.e., munitions containing both energetic materials and chemical agent) but have chemical agents stored in bulk ton containers. The mustard agent at Aberdeen, Maryland, has now been completely destroyed by neutralization with hot water, though all the ton containers that contained the agent have not yet been decontaminated. Secondary treatment of the hydrolysate from Aberdeen was carried out at the DuPont Secure Environmental Treatment facility for industrial waste in Deepwater, New Jersey. The VX nerve agent

at Newport, Indiana, will also be destroyed by neutralization, but with hot caustic. Destruction operations began there in May 2005. The Army is hoping to send the VX hydrolysate from Indiana to Deepwater as well, but some citizens and government agencies in states along the transportation route are opposing the transport of the hydrolysate.

In 2003, at the request of the Program Manager for the U.S. Army's Assembled Chemical Weapons Alternatives (formerly, Assembled Chemical Weapons Assessment) program, the National Research Council (NRC) formed its Committee to Assess Designs for Pueblo and Blue Grass Chemical Agent Destruction Pilot Plants (ACWA Design Committee), tasking it to review and evaluate the initial and intermediate facility designs for the prospective pilot plants at Pueblo, Colorado, and Blue Grass, Kentucky. The committee's first report, *Interim Design Assessment for the Pueblo Chemical Agent Destruction Pilot Plant*, was published in January 2005.

Specifically, for the Blue Grass Army Depot, the Department of Defense chose hydrolysis (neutralization) followed by secondary treatment with supercritical water oxidation to destroy the chemical agents and energetic materials in the chemical munitions. The contract for the Blue Grass Chemical Agent Destruction Pilot Plant (BGCAPP) design was awarded to the Bechtel Parsons Blue Grass Team, which includes a group of subcontractors well experienced in chemical demilitarization matters.

This interim report highlights the assessment that the ACWA Design Committee has made based on its

---

<sup>1</sup>The Army completed destruction of munitions stored at a ninth site, on Johnston Island in the Pacific Ocean, in November 2000.



review of data and information on the initial BGCAPP design and on some data on the intermediate design that were made available to it during drafting of the report. The committee received regular presentations on the design, members made site visits to locations where the testing and construction of equipment was under way, and selected members attended periodic design reviews given by the Bechtel Parsons Blue Grass Team. Funding constraints delayed the further design of the secondary treatment process, supercritical water oxidation, until August 2005.

Delivery of sufficiently detailed written information concerning the initial design for the Blue Grass facility was complicated and delayed by the security concerns that arose after September 11, 2001. The new security requirements were not entirely compatible with existing NRC policies. The sponsor and the NRC continue to work to resolve security concerns and to establish effective procedures for the timely acquisition of data and information.

The committee is indebted to both the Program Manager for Assembled Chemical Weapons Alternatives and the Bechtel Parsons Blue Grass Team for their candor and cooperation during the committee's data-gathering sessions and resultant discussions. Appreciation is extended to Joseph Novad and Yu-Chu Yang from the Army Program Office and to Chris Haynes, Chris Midgett, and John Ursillo from the Bechtel Parsons Blue Grass Team, who were the committee's primary points of contact during this study.

Fortunately for the members of this committee, all of whom are volunteers, the NRC provided extensive logistics support. The committee is indebted to the NRC staff for their assistance, particularly to the study director for this report, Donald L. Siebenaler, to Harrison T. Pannella, who helped to organize and edit the report, and to James Myska and Detra Bodrick-Shorter, who provided much technical and administrative assistance throughout the study.

Robert A. Beaudet, *Chair*  
Committee to Assess Designs for Pueblo  
and Blue Grass Chemical Agent  
Destruction Pilot Plants

## Acknowledgments

This report has been reviewed in draft form by individuals chosen for their diverse perspectives and technical expertise, in accordance with procedures approved by the NRC's Report Review Committee. The purpose of this independent review is to provide candid and critical comments that will assist the institution in making its published report as sound as possible and to ensure that the report meets institutional standards for objectivity, evidence, and responsiveness to the study charge. The review comments and draft manuscript remain confidential to protect the integrity of the deliberative process. We wish to thank the following individuals for their review of this report:

Judith A. Bradbury, Battelle, Pacific Northwest National Laboratory,  
Lawrence B. Evans, Aspen Technology, Inc.,  
L. Louis Hegedus, Arkema Inc.,  
Frederick J. Krambeck, ReacTech Inc.,  
Ronald M. Latanision, Exponent, Inc.,  
Dan Luss, University of Houston,  
Richard S. Magee, Carmagen Engineering, Inc.,

James F. Mathis, Exxon Corporation (retired),  
Raymond R. McGuire, Consultant,  
Douglas Medville, MITRE (retired),  
George W. Parshall, E.I. du Pont de Nemours & Company (retired),  
Carl R. Peterson, Massachusetts Institute of Technology (retired), and  
John A. Sanchez, Los Alamos National Laboratory.

Although the reviewers listed above have provided many constructive comments and suggestions, they were not asked to endorse the conclusions or recommendations, nor did they see the final draft of the report before its release. The review of this report was overseen by Hyla S. Napadensky, Napadensky Energetics, Inc. (retired). Appointed by the National Research Council, she was responsible for making certain that an independent examination of this report was carried out in accordance with institutional procedures and that all review comments were carefully considered. Responsibility for the final content of this report rests entirely with the authoring committee and the institution.



# Contents

EXECUTIVE SUMMARY	1
1 INTRODUCTION	7
Background, 7	
Assembled Chemical Weapons Alternatives Program, 7	
Involvement of the National Research Council in the Assembled Chemical Weapons Alternatives Program, 8	
Statement of Task, 8	
Description of the Blue Grass Chemical Munitions Stockpile, 8	
Design Strategy for BGCAPP, 10	
Scope of the Report, 12	
Brief Description of the BGCAPP Process, 12	
Unpack Area, 13	
M55 Rocket Processing, 13	
Projectile Processing, 13	
Agent Neutralization, 13	
Energetics Treatment, 13	
Offgas Treatment Systems, 13	
Integrated Operation and Throughput Management, 14	
Permitting Considerations and Public Acceptability, 16	
Regulatory Permitting Activities, 16	
Public Participation Outside the Formal Permitting Processes, 17	
Organization of the Report, 18	
2 TECHNICAL RISK ASSESSMENT ISSUES	19
3 DELIVERY AND DISASSEMBLY OPERATIONS	26
On-site Munition Transportation, 26	
Transport from Igloos to Unpack Area, 26	
Unpacking Projectiles Without Bursters, 28	
Accessing of Agent and Energetics in GB and VX M55 Rockets, 29	
Accessing of Energetics in Projectiles, 32	
Accessing of Agent in Projectiles by Munitions Washout System, 33	

4	CORE PROCESSES FOR AGENT AND ENERGETICS DESTRUCTION	34
	Agent Hydrolysis, 34	
	Agent Hydrolysis Chemistry, 34	
	Agent Collection System, 35	
	Agent Neutralization System, 35	
	Analysis Issues Concerning Agent Destruction Removal Efficiency, 37	
	Potential Contamination of Mustard Agent with Mercury, 38	
	Energetics Hydrolysis, 38	
	Energetics Hydrolysis Chemistry, 38	
	EBH Input Streams, 41	
	Energetics Process Flow, 41	
	Energetics Offgas Treatment System, 45	
5	TREATMENT OF HYDROLYSATES AND RESIDUAL WASTES	48
	Supercritical Water Oxidation, 48	
	Basic Principles, 48	
	SCWO Reactor Design for BGCAPP, 50	
	SCWO Reactor Testing, 52	
	Dunnage Particulate Emission Control System, 54	
	Metal Parts Treater, 54	
	MPT Offgas Treatment System, 54	
	Heated Discharge Conveyor, 56	
	Secondary Wastes, 56	
6	GENERAL FINDINGS AND RECOMMENDATIONS	58
	REFERENCES	60
	APPENDIXES	
A	Summary Responsibilities of Bechtel Parsons Blue Grass Team Members	65
B	Diagrams of Chemical Munitions at Blue Grass Army Depot	66
C	Information on Current Composition of Levenstein Mustard Agent at Blue Grass Army Depot	68
D	Biographical Sketches of Committee Members	74
E	Committee Meetings and Site Visits	77

## Tables and Figures

### TABLES

- 1-1 Physical Properties of the Pure Forms of Chemical Agents at BGAD, 9
- 1-2 Description of the Chemical Weapons in the BGAD Stockpile, 10
- 1-3 BGCAPP Process Wastes, 11
- 1-4 BGCAPP Secondary Wastes, 11
- 1-5 Overall BGCAPP Train Availability, Including Facility Shutdown, 15
- 1-6 Average Processing Rates, Including Train Availability, 15
  
- 2-1 Probability, Consequence, and Risk Weighting Factors for BGCAPP Design-Build Plan Technical Risk Assessment, 20
- 2-2 Summary of Technical Risk Reduction Projects for BGCAPP as of February 15, 2005, 21
  
- 4-1 Agent Neutralization Parameters, 37
- 4-2 Energetic Materials in BGAD Chemical Munitions, 40
- 4-3 EBH Processing Cycle Sequence for M55 Rocket Parts, 43
  
- 5-1 Treatment Methods for Different Waste Stream Materials During Normal Disposal Campaigns and Closure, 49
- 5-2 Rates of Feed to SCWO Reactor During Test Runs, 52
- 5-3 General Types of BGCAPP Secondary Wastes to Be Managed, 57
  
- C-1 Composition of Liquid H (Levenstein Mustard), 16-42 wt% (Average = 31 wt%) of Agent Fill in the 10 155-mm H Projectiles Tested During Munitions Washout System Testing, 69
- C-2 Composition of H Heels, 58-84 wt% (Average = 69 wt%) of Agent Fill in the 10 155-mm Projectiles Tested During Munitions Washout System Testing, 70
- C-3 Liquid Chromatography–Electrospray Ionization–Mass Spectrometry Analysis of 14 Solid H Samples, 72
- C-4 Liquid Chromatography–Electrospray Ionization–Mass Spectrometry Analysis of Solids (Filtered from Liquid H Samples), 73
- C-5 Estimated Total Iron Contents in Liquid and Solid Phases of H Mustard Agent Fill in 155-mm Projectiles, 73

## **FIGURES**

ES-1 Block flow diagram for BGCAPP, 3

1-1 Block flow diagram for BGCAPP, 13

3-1 Rocket and projectile disassembly flow diagram, 27

3-2 Cut points for RSM cutting of M55 rockets, 30

3-3 Detail drawing showing planned BGCAPP RSM Cut 4 of M55 rockets, 30

4-1 Flow diagram for the agent neutralization system, 36

4-2 Drawing of EBH design for BGCAPP, 39

4-3 Peak VX EBH processing cycle, 42

4-4 Flow diagram for OTE system, 46

5-1 Flow diagram for OTM system, 55

A-1 Responsibilities of the members of the Bechtel Parsons Blue Grass Team, 65

B-1 Schematic drawing and specifications for M55 rocket, 66

B-2 Schematic drawing and specifications for 155-mm projectile, 67

B-3 Schematic drawing and specifications for 8-inch projectile, 67

## Acronyms

ACS	agent collection system	ECV	explosion containment vestibule
ACWA	Assembled Chemical Weapons Alternatives <sup>2</sup>	EIS	environmental impact statement
AEL	airborne exposure limit	ENR	energetics neutralization reactor
AFS	aluminum filtration system	EONC	enhanced on-site container
ANR	agent neutralization reactor	GB	nerve agent (Sarin)
ANS	agent neutralization system	H	Levenstein mustard agent
ASME	American Society of Mechanical Engineers	HD	distilled mustard agent
BGAD	Blue Grass Army Depot	HDC	heated discharge conveyor
BGCAPP	Blue Grass Chemical Agent Destruction Pilot Plant	HT	mustard agent containing mustard-T
BGCSOO	Blue Grass Chemical Stockpile Outreach Office	HVAC	heating, ventilation, and air conditioning
CAC	Citizens' Advisory Commission	IPT	integrated product team
CAM	cavity access machine	KDEP	Kentucky Department of Environmental Protection
CDCAB	Chemical Destruction Community Advisory Board	LPMD	linear projectile/mortar disassembly (machine)
CF	caustic fill	LSS	life support system
CHB	container handling building	MCE	maximum credible event
DBP	design-build plan	MDB	munitions demilitarization building
DPE	demilitarization protective ensemble	MPT	metal parts treater
DSH	dunnage shredding and handling	MWS	munitions washout system
EBH	energetics batch hydrolyzer		
ECR	explosion containment room		

---

<sup>2</sup>Formerly the Assembled Chemical Weapons Assessment program.



NCR	nose cone removal (machine)	RSM	rocket shear machine
NOI	notice of intent		
NRC	National Research Council	SCWO	supercritical water oxidation
		SSMP	System Safety Analysis Management Program
OTE	energetics offgas treatment		
OTM	MPT offgas treatment		
		T	bis[2-(2-chloroethylthio)ethyl] ether
PCAPP	Pueblo Chemical Agent Destruction Pilot Plant	TMA	toxic maintenance area
		TRA	technical risk assessment
PCD	Pueblo Chemical Depot	TRRP	technical risk reduction project
PMACWA	Program Manager, Assembled Chemical Weapons Alternatives		
		UL	unload liquids
		UPA	unpack area
		US	unload solids
RD&D	research, development, and demonstration		
		VX	nerve agent
RFP	request for proposal		
RM	rocket motors	WH	warhead
ROD	Record of Decision	WRS	water recovery system

## Executive Summary

The Program Manager for the Assembled Chemical Weapons Alternatives (PMACWA) program of the Department of Defense (DOD) requested the National Research Council (NRC) to review and evaluate the designs for pilot plant facilities to destroy the chemical weapons stored at the Pueblo Chemical Depot in Colorado and the Blue Grass Army Depot (BGAD) in Kentucky. To accomplish this task, the NRC established the Committee to Assess Designs for Pueblo and Blue Grass Chemical Agent Destruction Pilot Plants (ACWA Design Committee). This interim report presents the committee's assessment of the design for the Blue Grass Chemical Agent Destruction Pilot Plant (BGCAPP). It is based primarily on the initial design documentation and test plans, but also on various test reports and trade studies that became available to the committee and on communications with PMACWA and BGCAPP contractor personnel.

This interim report has been prepared so that PMACWA and the BGCAPP contractor can benefit from the committee's assessment and address identified concerns before the BGCAPP design becomes finalized. It focuses on significant issues that have so far come to the attention of the committee.

### BACKGROUND ON THE ACWA PROGRAM

DOD established the Assembled Chemical Weapons Assessment (ACWA) Program in response to Public Laws 104-201 and 104-208, enacted in 1996, mandating that DOD assess and demonstrate alternative

technologies to incineration for the destruction of chemical weapons at Pueblo Chemical Depot and Blue Grass Army Depot. Public Law 104-201 required DOD to coordinate with the NRC.

In August 2003, the Army requested the NRC to form a committee to assist in evaluating the designs for the pilot plant facilities at Pueblo and Blue Grass. The ACWA Design Committee was established in October 2003. The statement of task for the committee is as follows:

The Program Manager for Assembled Chemical Weapons Alternatives (PMACWA) has awarded contracts for the design, construction, systemization, pilot testing, operation and closure activities aimed at destroying the assembled chemical weapons stockpiles at the Pueblo Chemical Depot and Blue Grass Army Depot. Chemical neutralization-based technologies form the basis for destroying the agent and energetics associated with both stockpiles, along with new or adapted processes for preparing weapons for disposal and treating secondary waste streams generated during the primary neutralization processing step. These facilities differ from previously constructed baseline incineration facilities and from those constructed for bulk chemical agent disposal. To assist the PMACWA, the NRC will initially examine planning documentation and designs for the Pueblo and Blue Grass facilities and provide comments and recommendations. Separate reports will address the specific issues for each facility.

The NRC will:

- Assess planning documentation for design and construction of the Pueblo and Blue Grass facilities.
- Assess process and facility designs of the Pueblo and Blue Grass Chemical Agent Destruction Pilot Plants.
- Consider design issues raised by permitting considerations and public acceptability (e.g., design aspects of facility closure).
- Produce reports within three months following the date the initial and intermediate designs are provided to the NRC for Pueblo and Blue Grass.

This report is the committee's assessment of the initial design for BGCAPP.<sup>1</sup> The BGAD stockpile consists of M55 rockets that contain GB or VX, reconfigured 155-mm projectiles that contain VX, 155-mm projectiles containing LeVine mustard agent (H) and bursters, and reconfigured 8-inch projectiles containing GB.

## BRIEF DESCRIPTION AND ASSESSMENT OF THE BGCAPP INITIAL DESIGN

PMACWA awarded the contract for a chemical weapons destruction facility to the Bechtel Parsons Blue Grass Team, which is expected to design, construct, operate, and eventually close the pilot plant facility upon completion of its mission.<sup>2</sup> The committee believes that the contractor's initial technical risk assessment has identified the main technical risks and developed appropriate plans to address them.

The major steps in the destruction processes that will be used at BGCAPP are illustrated in Figure ES-1. Initially, the munitions on their storage pallets are transported from the storage igloos to the BGCAPP, where they are unpacked and the packaging material (dunnage) is separated from the munitions. Rockets are then conveyed to one of two rocket shear machines (RSMs) in separate explosion containment rooms (ECRs). The RSM punches holes in the top and bottom of the agent cavity to drain out the agent. A high-pressure water wash removes any remaining solidified heels or residuals. The agent is transferred to storage tanks to await processing. Rockets, contained within their fiberglass shipping/firing tube, are then cut into nine segments by a modified baseline RSM that uses a rotary disc cutter at cut points 4 and 8 and a guillotine-like blade at all other cut points. The locations of the cuts and the method of cutting were selected to minimize the amount of aluminum that will be sent to the energetics batch hydrolyzers (EBHs).

The committee is concerned that one of the cuts (cut number 4) is to be done very close to the igniter of the

rocket motor and must be very precisely placed, even though the rocket has as much as a half-inch of play within its shipping/firing tube. The Bechtel Parsons Blue Grass Team is reviewing this process and is expected to modify it to reduce the hazard. The use of a rolling disc pipe cutter instead of hydraulic shear is being considered as one means to achieve a more precise cut.

The energetics from the rockets, which include warhead segments containing burster charge segments and fuzes and rocket motor segments containing propellant, are placed in bins and transferred using multiaccess robotic arms to 16 EBHs for treatment. The rocket motor segments are placed in bins separate from those containing the warhead and tailfin pieces and are delivered to the EBHs in a specified sequence.

The EBHs are large rotating vessels similar to those found on concrete trucks. The flights within the EBHs mix munition pieces with caustic solution. The propellant is processed separately from the other energetics. First, water and caustic solution are added to an EBH. Then, the rocket motor segments are added and processed for 2 hours. The warhead and tailfin segments are then added and processed for 4 hours. At the end of this time, undissolved materials, consisting of firing tube pieces, burster wells, and metal parts from the rockets, are removed by reversing the direction of rotation of the EBH. When all the solids have been removed, the rotation speed of the EBH is increased to remove the hydrolysate, which is sent to one of the three energetics neutralization reactors (ENRs) dedicated to each of two lines of eight EBHs (six ENRs in all). Given the residence times in the EBHs, the committee believes energetics will have been completely destroyed before being sent to the ENRs. Employment of three ENRs per EBH line may therefore be overly conservative. The hydrolysate in the ENRs is sampled and tested by differential scanning calorimetry to verify that agent and energetic materials have been destroyed to acceptably low levels. The criterion for agent destruction is 99.9999 percent. The specific criterion for energetics is still to be determined but will be well below the level at which the hydrolysate would pose an explosion hazard. When these criteria are met, the hydrolysate is transferred to storage tanks awaiting treatment in the supercritical water oxidation (SCWO) reactors. Normally, one EBH in each line is a spare. The committee believes that a review of the sizing of the post-EBH components of the energetics hydrolysis system and of the number of EBHs may be warranted,

<sup>1</sup>The committee produced a similar report on the initial design for the Pueblo Chemical Agent Pilot Plant (PCAPP), which was published in January 2005.

<sup>2</sup>Unless otherwise indicated, information is drawn from Bechtel Parsons (2004a) and from the BGCAPP munitions demilitarization building (MDB) intermediate design briefing by the Bechtel Parsons Blue Grass Team to the BGCAPP MDB design review, Aberdeen Proving Ground, Md., February 15, 2005.

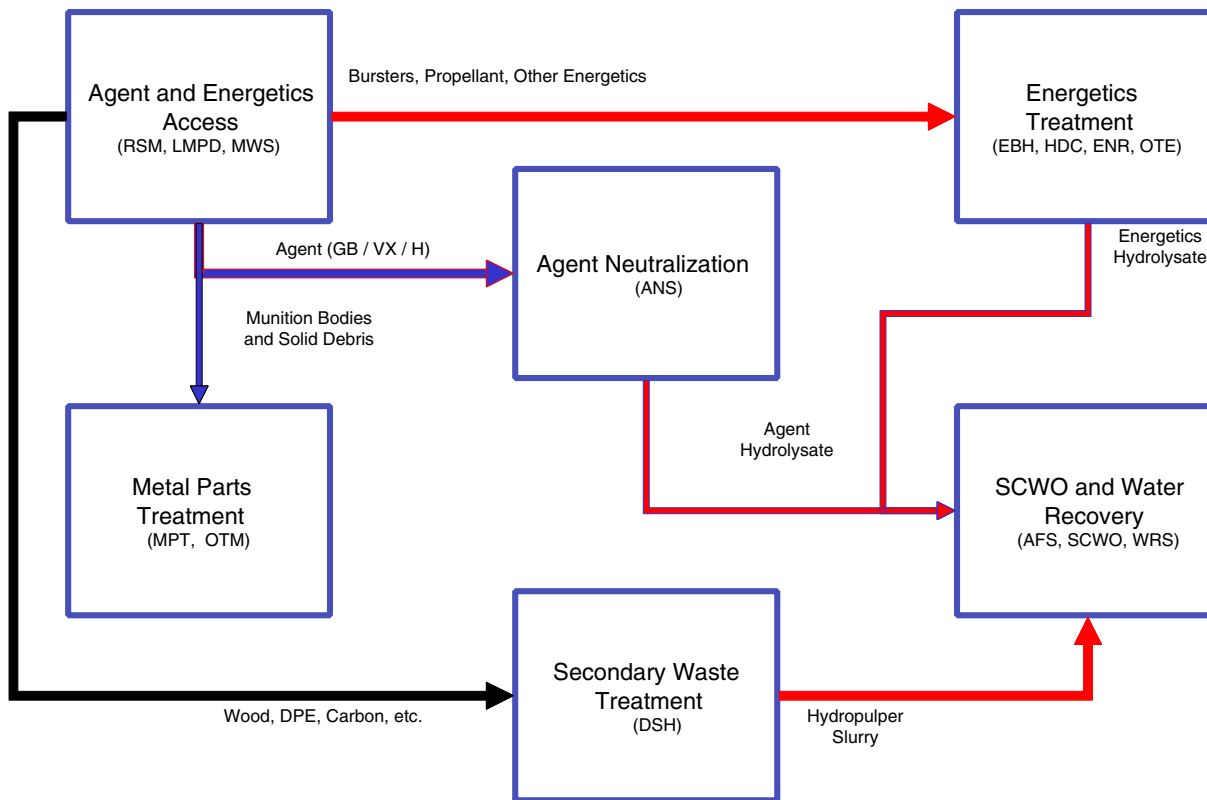

FIGURE ES-1 Block flow diagram for BGCAPP: ANS, agent neutralization system; DSH, dunnage shredding and handling; AFS, aluminum filtration system; WRS, water recovery system. SOURCE: Adapted from John Ursillo, BGCAPP Process Design/TRRP Manager, "Process design overview," briefing to the committee on September 22, 2004.

especially in light of the new analytical methods for verifying agent and energetics destruction. Metal parts from the EBHs are sent to the heated discharge conveyor (HDC), which is similar to the HDC used in the baseline systems. The HDC heats the metal parts to 1000°F for at least 15 minutes, after which they are cooled and sent to storage, where they await disposal.

Projectiles containing GB will be treated after all the rockets containing GB have been destroyed. Similarly, projectiles containing VX will be processed after the rockets containing VX. From the unpack area, the projectiles are sent to a linear projectile/mortar disassembly (LPMD) machine located in one of the ECRs. The Bechtel Parsons Blue Grass Team has selected a commercial off-the-shelf robotic machine to replace the circular projectile/mortar disassembly machines at chemical disposal facilities using baseline incineration technology. In the LPMD, the lifting lugs, fuze cups, and burster charge are removed. Prior testing of the new LPMD machines for PCAPP has shown that they

will be an effective, reliable, and maintainable means of removing the energetics from the projectiles stored at BGAD. Projectiles without burstors are processed in a nose closure removal (NCR) station. The NCR station is derived from the projectile/mortar disassembly machine used in baseline facilities.

From the LPMD and NCR, the projectile bodies, still containing agent sealed in the body by the burster well, proceed to the munitions washout system (MWS). Robots handle the projectiles in the MWS, where each projectile is first weighed and then placed in one of the cavity access machines (CAMs) of the MWS. A hydraulic ram shoves and crimps the burster well into the projectile body. The agent is drained and a high-pressure water spray nozzle on the hydraulic ram washes out any remaining residue while the projectile body is rotated. The emptied projectile body is weighed again to verify the mass of agent removed for Chemical Weapons Convention (CWC) treaty compliance. The agent is stored until ready for processing. Offgas

from the EBHs, HDC, and ENRs is collected and treated in an energetics offgas treatment (OTE) system. The design of this system, though discussed in this report, had not been fully resolved. Energetics processing requires this system to have a high availability.

The metal parts from the projectile body are conveyed to one of two metal parts treaters (MPTs) for decontamination by heating to 1000°F for more than 15 minutes. The MPT consists of an entry airlock, process chamber, and exit air lock. Metal parts are transported in carts on tracks through the MPTs. The inner wall surface of each MPT is maintained at 1200°F by induction heaters. Superheated steam at 1200°F is introduced into the process chamber of the MPT as a carrier gas to move vaporized agent and other gases produced by the decontamination process into the MPT offgas treatment (OTM) system. The design of this system, like that of the OTE, is briefly discussed in this report but has not been completed. It remains of concern to the committee because agent neutralization and metal parts processing require it, too, to have a high availability.

Agent concentrate from the cavity accessing and washout process is stored in agent storage tanks until ready for hydrolysis. Then, the agent is sent to one of two agent neutralization reactors (ANRs). VX and GB will be hydrolyzed with caustic. Mustard agent (H) will be hydrolyzed with hot water and then the pH will be raised to 10.5 with caustic solution. After reaction, the hydrolysate is sent to an agent hydrolysate tank, where it is stored until being blended with the energetics hydrolysate for further processing in the SCWO reactors.

SCWO is used to process the agent and energetics hydrolysates and slurry produced from contaminated dunnage. Supercritical conditions are typically 1112°F (600°C) and 3,626 psi (250 bar.) Air is miscible with supercritical water, as are most organics. The resulting oxidation typically converts the elements to their most stable oxidized state. Thus, carbon is oxidized to carbon dioxide, hydrogen to water, sulfur to sulfates, and so on. However, salts such as sodium sulfate will not dissolve in supercritical water and can block outlet orifices and coat the walls if not properly managed. Supercritical water containing oxygen is very corrosive. Thus, a liner is inserted into the reactor to protect the outer container walls. The Bechtel Parsons Blue Grass Team has selected titanium for the liner. During runs with VX and GB, liners must be replaced almost weekly, which necessitates opening the reactor.

Though it focused on design issues, the committee briefly reviewed the approach used for permitting and

for assuring public acceptability. The permitting process has been approved by the Kentucky Department of Environmental Protection (KDEP). Permits have been obtained on a timely basis, and KDEP, with the Army and its contractors, has established a well-defined sequence for interactively managing the modifications of permits for BGCAPP through the completion of its design, operation, and closure. In addition, the Army and its contractors have worked closely with the Kentucky Citizens' Advisory Commission (CAC) and a public focus group established by the CAC, the Chemical Destruction Community Advisory Board (CDCAB). The CDCAB meets frequently with the Army and its contractors to review design progress and to advise the public on policy issues of interest. The committee encourages the Army and its contractors to continue to pursue public involvement.

## GENERAL FINDINGS AND RECOMMENDATIONS

**General Finding 1.** The committee was able to review only initial design documentation for BGCAPP, results of completed technical risk reduction program studies and tests, and presentations pertaining to the developing intermediate design. Nevertheless, it believes that, given an appropriate response to the findings and recommendations in this report and the favorable resolution of any problems uncovered by the studies and tests still in progress, a BGCAPP that is able to safely and effectively destroy the chemical agent and energetic materials in the chemical munitions at Blue Grass Army Depot can be anticipated. The basis for this optimistic assessment can be summarized as follows:

- The chemical neutralization (hydrolysis) of GB, VX, and H has been extensively studied. The Bechtel Parsons Blue Grass Team, in its technical risk reduction project (TRRP) 2a, is verifying the operating temperature and concentration of caustic for actual degraded GB. Both liquid and solid residues removed from M55 GB rockets processed at Anniston Chemical Agent Disposal Facility are being used. In TRRP 2b, the team is performing a similar study for H. The operating conditions for VX were verified at Newport Chemical Agent Disposal Facility.
- The newly designed systems for disassembling the projectiles and the rockets and for accessing the chemical agent in these munitions are up-

to-date approaches that appear to be effective. The projectile line uses commercially available robots to handle the munitions. The rocket shear machine is a modification of the machine used in the baseline process. (The committee does note a concern: Cut number 4, which in rockets is made near the igniter, could result in inadvertent ignition of the propellant.) The high-pressure water washout removes all the solids and liquid agent from the projectile bodies, reducing the chemical agent load on the MPT.

- The MPT had already undergone some developmental testing by the time this report was being prepared. However, additional testing was needed to establish operating conditions for all feed streams. After completion of this testing, the MPT design is intended to be capable of decontaminating metal parts to a condition making them suitable for unrestricted release.
- Limited testing to date of the SCWO system indicates that it can be adequate for the treatment of agent and energetics hydrolysates at BGCAPP. However, there has been no testing of the BGCAPP SCWO system for the treatment of dunnage.

**General Recommendation 1.** PMACWA should continue with the existing design of BGCAPP and continue testing to address issues noted in the findings of this report.

**General Finding 2.** The safety of BGCAPP workers and the public is an integral part of the design and the planned operation of the BGCAPP.

**General Recommendation 2.** As the BGCAPP design evolves, the Army and the contractors making up the Bechtel Parsons Blue Grass Team should continue to make the safety of workers and the public a foremost consideration.

**General Finding 3.** The unit operations in the BGCAPP design have never been deployed together as a single integrated process. As a consequence, and notwithstanding positive throughput analysis results to date, a prolonged period of systematization will be necessary to resolve integration issues as they arise, even for apparently straightforward unit operations. The committee believes the high availability demanded for process equipment that is either new or significantly

different from existing equipment (e.g., the RSM) may be an unrealistic requirement.

**General Recommendation 3.** The Army and its contractors should review the availability assumptions, especially for new or prototypical equipment, giving particular attention to the probability of prolonged outages from major failures—for example, an explosion in the RSM from accidental ignition of the propellant.

**General Finding 4.** Much of the dunnage and secondary waste is not contaminated.

**General Recommendation 4.** All uncontaminated dunnage and secondary waste should be sent offsite for disposal. Adequate documentation should be maintained to certify the status of waste with respect to its exposure to agent.

**General Finding 5.** Use of SCWO for treatment of contaminated dunnage is still under evaluation, and only limited testing has been done to date. (The committee understands that uncontaminated secondary wastes will not be treated by the SCWO system.) In any case, before varied wastes can be sent in a slurry to the SCWO system, they must be shredded and micronized. The committee believes such treatment is problematic, especially given that the wastes could be sent whole to the MPT for treatment, which would probably be simpler and more reliable.

**General Recommendation 5.** Alternative approaches for treating contaminated dunnage and wastes should be considered by the Army, with involvement by the public. One alternative to SCWO for treatment of contaminated dunnage is to treat it in the MPT to levels suitable for release to appropriate waste disposal sites.

**General Finding 6.** The offgas treatment systems for agent/metal parts treatment and for energetics treatment still require development and testing to establish that all potential gas feeds can be treated. Furthermore, because the input streams have not been fully characterized, the composition of each of the effluent streams to be treated cannot be predicted.

**General Recommendation 6.** The offgas flowing to the bulk oxidizer units should be fully characterized to determine the presence of compounds that may result in unacceptable reaction products—for example, poly-

chlorinated dioxins or furans in the effluent from the treatment of energetics offgas.

**General Finding 7.** The steps that have been taken at the Blue Grass Army Depot to date to involve the public have been significant. The public has played a role through its comments on the various licensing and permitting activities and can directly contact the Blue Grass Chemical Demilitarization Outreach Office to have concerns and questions addressed. Furthermore,

it is represented by the Citizens' Advisory Commission, especially its Chemical Destruction Community Advisory Board.

**General Recommendation 7.** The Army should continue to pursue and support public involvement. Furthermore, the involvement and collaboration of stakeholders (especially the public) should remain a cornerstone of the chemical weapons destruction program.

# 1

## Introduction

### BACKGROUND

At the request of Congress and the public, the Army is designing full-scale chemical agent destruction pilot plants that will use neutralization (hydrolysis) with water or caustic (NaOH solution) to destroy the stockpiled chemical munitions at Pueblo Chemical Depot (PCD), Colorado, and at Blue Grass Army Depot (BGAD) in Kentucky. This program, formerly called the Assembled Chemical Weapons Assessment program, is now the Assembled Chemical Weapons Alternatives (ACWA) program. In 2003, the Army issued a request for proposal (RFP) to design, build, operate, and close a full-scale pilot plant facility at Blue Grass Army Depot. A system contract was awarded to the Bechtel Parsons Blue Grass Team, a joint venture formed by Bechtel National, Inc., and Parsons Engineering. The teaming subcontractors are Battelle, General Physics, General Atomics, and the Washington Demilitarization Company. See Appendix A for a summary of the responsibilities of these participants.

In August 2003, as mentioned above, at the Army's request, the NRC formed this committee to assist in the evaluation of the designs for full-scale chemical agent destruction pilot plants at PCD and BGAD.

This report contains the ACWA Design Committee's current assessment of the initial design for the Blue Grass Chemical Agent Destruction Pilot Plant (BGCAPP) supplemented by some information on the intermediate design. This chapter describes the ACWA program, the NRC's role in the program, the characteristics of the chemical weapons stockpile and chemical

agents stored at BGAD, and the design-build strategy required by the Program Manager for Assembled Chemical Weapons Alternatives (PMACWA) and being used by the contractor and presents a brief description of the design.

### Assembled Chemical Weapons Alternatives Program

In 1996, in response to local opposition to the use of incineration, the U.S. Congress passed Public Laws 104-201 and 104-208 that (1) froze funds for construction of chemical agent destruction pilot plants at PCD in Colorado and at BGAD in Kentucky, (2) required the Army to demonstrate at least two alternatives to incineration to destroy assembled chemical weapons, (3) directed the Department of Defense (DOD) to establish a program with a program manager who was not previously associated with the Army's chemical demilitarization program, and (4) required the Army to coordinate these activities with the NRC. This resulted in the creation of the ACWA program. In 1999, Congress passed Public Laws 106-79 and 106-52 requiring the Army to consider all feasible technology alternatives for destroying the chemical weapons at BGAD in Kentucky, where munitions containing both mustard and nerve agents are stored. The Defense Acquisition Board issued an Acquisition Decision Memorandum on February 3, 2003, that approved neutralization followed by supercritical water oxidation (SCWO) for full-scale pilot plant testing at BGAD. An RFP to design, build, operate, and close a chemical agent destruction pilot plant at Blue Grass was issued on February 7,



2003, and the Record of Decision (ROD), which documented the DOD's selection of technologies for BGCAPP, was signed on February 27, 2003.<sup>1</sup> The RFP and ROD specified that hydrolysis followed by SCWO was to be used and that all hazardous materials should be destroyed on site. The selection of all other unit operations was left to the RFP respondents. As mentioned above, the Army awarded the contract to the Bechtel Parsons Blue Grass Team, which submitted the initial design to the Army on July 29, 2004. However, this initial design was not made available to the ACWA Design Committee until early 2005 after it had passed operational security and International Traffic in Arms Regulations review.

### **Involvement of the National Research Council in the Assembled Chemical Weapons Alternatives Program**

In response to the congressional guidance in 1997, the NRC formed the Committee on Review and Evaluation of Alternative Technologies for Demilitarization of Assembled Chemical Weapons (known as the ACW I Committee) to evaluate alternative technologies to incineration for the disposal of chemical stockpiles at PCD and BGAD (NRC, 1999, 2000). The Army subsequently requested that the NRC further evaluate ongoing ACWA program developments until technology selections for these sites were made. A second NRC committee, the Committee on Review and Evaluation of Alternative Technologies for Demilitarization of Assembled Chemical Weapons: Phase II (known as the ACW II Committee) was formed, largely from the membership of the ACW I Committee. This committee completed its work when technologies for the two sites were selected (NRC 2001a, 2001b, 2002a, 2002b, 2002c).

In August 2003, as mentioned above, at the Army's request, the NRC formed this committee to assist in the evaluation of the designs for full-scale chemical agent destruction pilot plants at PCD and BGAD.

### **STATEMENT OF TASK**

The Army requested that the NRC ACWA Design Committee review and evaluate the Pueblo Chemical

<sup>1</sup>Jim Richmond, Blue Grass Lead, Program Manager for Assembled Chemical Weapons Alternatives, briefing to the committee on September 22, 2004. Personal communication between Kathy DeWeese, PMACWA, and James Myska, NRC staff, June 8, 2005.

Agent Destruction Pilot Plant (PCAPP) and BGCAPP design plans. The committee published its first report, *Interim Design Assessment for the Pueblo Chemical Agent Destruction Pilot Plant*, in January 2005 (NRC, 2005). The current report presents an interim evaluation of the BGCAPP design based largely on the initial design and presentations made to the committee by the ACWA program staff and the Bechtel Parsons Blue Grass Team. The statement of task is as follows:

The Program Manager for Assembled Chemical Weapons Alternatives (PMACWA) has awarded contracts for the design, construction, systemization, pilot testing, operation and closure activities aimed at destroying the assembled chemical weapons stockpiles at the Pueblo Chemical Depot and Blue Grass Army Depot. Chemical neutralization-based technologies form the basis for destroying the agent and energetic materials associated with both stockpiles, along with new or adapted processes for preparing weapons for disposal and treating secondary waste streams generated during the primary neutralization processing step. These facilities differ from previously constructed baseline incineration facilities and from those constructed for bulk chemical agent disposal. To assist the PMACWA, the NRC will initially examine planning documentation and designs for the Pueblo and Blue Grass facilities and provide comments and recommendations. Separate reports will address the specific issues for each facility.

The NRC will:

- Assess planning documentation for design and construction of the Pueblo and Blue Grass facilities.
- Assess process and facility designs of the Pueblo and Blue Grass Chemical Agent Destruction Pilot Plants.
- Consider design issues raised by permitting considerations and public acceptability (e.g., design aspects of facility closure).
- Produce reports within three months following the date the initial and intermediate designs are provided to the NRC for Pueblo and Blue Grass.

### **DESCRIPTION OF THE BLUE GRASS CHEMICAL MUNITIONS STOCKPILE**

The munitions stored at the BGAD contain either GB, VX, or Levinstein mustard agent (H). Table 1-1 lists some of the physical properties of the pure chemical agents GB, VX, and pure distilled mustard, called HD. Table 1-2 lists the types and quantities of munitions stored at BGAD for each type of agent. Additional details and schematic drawings of the weapons stored at BGAD are provided in Appendix B.

Nerve agent VX is a low-volatility liquid that has a high boiling point and can adhere to surfaces for days or weeks. Nerve agent GB is a liquid with volatility similar to that of water and therefore evaporates relatively rapidly. These two nerve agents are highly toxic and lethal in both liquid and vapor forms. They are absorbed by respiration or skin contact and can kill in a

TABLE 1-1 Physical Properties of the Pure Forms of Chemical Agents at BGAD

Agent Characteristic	Nerve GB	Nerve VX	Blister HD <sup>a</sup>
Chemical formula	C <sub>4</sub> H <sub>10</sub> FO <sub>2</sub> P	C <sub>11</sub> H <sub>26</sub> NO <sub>2</sub> PS	C <sub>4</sub> H <sub>8</sub> Cl <sub>2</sub> S
Molecular weight	140.10	267.38	159.08
Boiling point (°C)	150 (extrapolated)	292 (extrapolated)	218 (extrapolated)
Freezing point (°C)	-56	≤ 51	14.5
Vapor pressure (mm Hg)	2.48 at 25°C	0.000878 at 25°C	0.106 at 25°C
Volatility (mg/m <sup>3</sup> )	18,700 at 25°C	12.6 at 25°C	75 at 0°C (solid) 906 at 25°C (liquid)
Surface tension (dynes/cm)	26.5 at 20°C	32.0 at 20°C	43.2 at 20°C
Kinematic viscosity (cSt)	1.28 at 25°C	12.26 at 20°C	3.52 at 20°C
Liquid density at 25°C (g/cm <sup>3</sup> )	1.0887	1.0083	1.27
Solubility (g/100 g of distilled water)	100; soluble in organic solvents	5 at 25°C; best solvents are dilute mineral acids	0.092 at 22°C; soluble in acetone, CCl <sub>4</sub> , CHCl <sub>3</sub> , tetrachloroethane, ethyl benzoate, ether
Heat of vaporization (cal/g)	82.9	71.8	94
Heat of combustion (cal/g)	5,600	8,300	4,500

<sup>a</sup>The blister agents are labeled H, HD, and HT. Mustard, the active ingredient in all these blister agents, is bis (2-chloroethyl) sulfide, or (ClCH<sub>2</sub>CH<sub>2</sub>)<sub>2</sub>S. HD, called the distilled mustard, is nominally pure mustard agent. H, often called Leinsteinst mustard, was approximately 70 percent pure mustard agent and 30 percent impurities at the time of manufacture. However, the stored H mustard agent has deteriorated over time and its physical properties are highly variable. H is the only form of mustard agent stored at Blue Grass Army Depot.

SOURCE: Based on data provided to the ACWA Design Committee by the Army and drawn from Abercrombie, 2003.

matter of minutes by interfering with respiratory and nervous system functions.

Because GB is volatile, it presents the greatest respiratory risk to workers and the public, so munitions containing GB are usually destroyed first. At other storage sites, some munitions containing GB have been found to contain either a gel or crystals formed from the stabilizer added to the chemical agent. Thus, the munitions containing GB at BGAD could also contain crystals or gel.

Mustard blister agents are skin vesicants that evaporate very slowly.<sup>2</sup> Mustard agent is hazardous on contact or as a vapor. Mustard agent is only slightly soluble in water and is very persistent in the environment. The active ingredient is bis(2-chloroethyl) sulfide,

(ClCH<sub>2</sub>CH<sub>2</sub>)<sub>2</sub>S, called HD. H is approximately 70 percent HD and 30 percent impurities formed during the synthesis process. These impurities are polysulfides such as (ClCH<sub>2</sub>CH<sub>2</sub>)<sub>2</sub>S<sub>n</sub>, where n = 2, 3, and other compounds containing sulfur. The mustard agent munitions at BGAD contain only the H form. Sampling of 155-mm H projectiles at other sites indicates that they contain agent material that is approximately 30 percent liquid and 70 percent solids.<sup>3</sup> Current information on the constituents in these liquid and solid phases of the stored H can be found in Appendix C.

M55 rockets pose the greatest storage risk because each contains approximately 20 pounds of M28 propellant, a double-base propellant composed of nitroglycerine, nitrocellulose, plasticizers, a burn-rate modifier (lead stearate), and a stabilizer. The original

<sup>2</sup>Names such as mustard gas, sulfur mustard, and yperite have also been applied to this agent. The term mustard "gas" is often used, but the chemical is a liquid at ambient temperature.

<sup>3</sup>Yu-Chu Yang, PMACWA, teleconference with committee, March 31, 2005.

TABLE 1-2 Description of the Chemical Weapons in the BGAD Stockpile

Item	Fill	Quantity	Agent per Munition (lb)	Total Agent (tons, rounded)	Energetics <sup>a</sup>	Energetics Weight per Munition (lb)	Total Energetics Weight (tons, rounded)
155-mm projectile, M110	H	15,492	11.7	91	Tetrytol	0.41	3
8-inch projectile, M426	GB	3,977	14.4	29	None		
115-mm rocket, M55	GB	51,716	10.7	277	Composition B, M28 propellant	3.2 19.1	74 449
115-mm rocket warhead, M56	GB	24	10.7	0.13	Composition B	3.2	0.035
155-mm projectile, M121/A1	VX	12,816	6	38	None		
115-mm rocket, M55	VX	17,733	10.1	89	Composition B, M28 propellant	3.2 19.1	26 154
115-mm rocket warhead, M56	VX	6	10.1	0.03	Composition B	3.2	0.0086

<sup>a</sup>See Table 4-2 for a complete listing of the energetics compositions.

SOURCE: Adapted from data provided to PMACWA on the Munition Items Disposition Action System (MIDAS) by the MIDAS team in July 1997.

composition of the propellant is discussed in Chapter 4. In storage, the propellant slowly decomposes exothermically, forming nitrogen dioxide, which in turn can catalyze further decomposition. The stabilizer reacts with the nitrogen dioxide and prevents the autocatalytic action. However, these munitions have been stored since the 1950s and 1960s and their stabilizer concentration continues to slowly decrease, increasing the risk of a catastrophic event as time goes by. The rocket body is partially fabricated of aluminum, which is susceptible to corrosion by GB, creating a situation that has resulted in agent leakage, also increasing the risk of autoignition (U.S. Army, 2002). Although M55 rockets present the greatest storage risk at BGAD, the risk of autoignition remains relatively low in comparison with other possible (and still low probability) accidental ignition events (U.S. Army, 2002).<sup>4</sup> Historically, it has been observed that rockets containing VX are less likely to develop leaks than those containing GB. When routine inspections of the stockpile storage igloos reveal the presence of leaking rockets (or other munitions), the munitions are overpacked, stored, and handled separately. The leaking munitions for each

agent will be destroyed at the end of the respective campaign for each munition type. Because the changeover from one agent to another is expensive and lengthy, delaying leaker destruction until all nonleakers have been destroyed would require three additional agent changeovers and would not be reasonable.

A small number of M56 rocket warheads, the agent-containing portion of the M55 rockets, will be processed in the same way as M55 rockets. Since the M56 warheads have no propellant (or rocket motor), the only energetic materials in the M56 rocket warhead sections are those in the bursters and in the fuzes (see Table 4-2).

The only projectiles stored at BGAD that have any energetic materials are the 155-mm H-filled projectiles, which have a tetrytol burster but no propellant. Neither the 8-inch projectiles containing GB nor the 155-mm projectiles containing VX have any energetic materials. Besides munitions, a large amount of secondary waste, including dunnage and wastes generated by process operations, maintenance activities, and facility closure must also be processed at BGCAPP. Tables 1-3 and 1-4 itemize the total amounts of process wastes and secondary wastes, respectively, that must be processed.

<sup>4</sup>In a March 2002 report, the probability per year of an overpacked M55 rocket autoignition at Blue Grass was given as  $1 \times 10^{-5}$  and the probability per year of a nonoverpacked M55 autoignition as  $5 \times 10^{-7}$ . The probability per year of an M55 ignition initiation from lightning was given as  $2 \times 10^{-3}$  and from an earthquake as  $2 \times 10^{-4}$  (U.S. Army, 2002).

## DESIGN STRATEGY FOR BGCAPP

The Army procurement contract for BGCAPP is similar to the one issued for PCAPP. It called for bidders to propose an integrated approach to the full scope

TABLE 1-3 BGCAPP Process Wastes (pounds)

Waste Type	First Year	Second Year	Third Year	Total
	GB Campaign	VX and H Campaigns		
MPT residues	688,816	2,414,271	0	3,103,087
EBH/HDC residues	1,300,142	479,370	0	1,779,511
AFS precipitate	2,652,428	2,332,158	157,242	5,141,828
Water recovery salts	6,268,389	7,880,712	1,606,904	15,756,005
Total solid wastes	10,909,775	13,106,510	1,764,146	25,780,431

NOTE: These numbers do not include secondary waste that will be processed through the MPT and closure wastes.

SOURCE: Bechtel Parsons, 2004b.

TABLE 1-4 BGCAPP Secondary Wastes (pounds)

Waste Designation	Closure Waste	Secondary Process Waste	Total
Inert bulk solid metal	3,267,794	138,427	3,408,221
Inert bulk solid concrete	240,000	—	240,000
Aluminum waste	13,679	522	14,203
Foam core panels	102,298	—	102,298
Special coatings	17,387	—	17,387
Combustible bulk solid waste			
Nonhalogenated plastics	92,967	21,408	114,375
Toxicological agent protective gear	—	10,210	10,210
High-efficiency particulate air filters and prefilters	23,000	4,476	27,476
Absorbents, cottons, rags, etc.	—	10,036	10,036
Paper, wood, fiberglass, rubber	12,500	29,364	41,864
Other combustible wastes			
Halogenated plastics	727,869	146,640	874,509
Sludge	—	4,476	4,476
RCRA toxic-metal-bearing paint chips	—	272	272
RCRA toxic-metal-bearing leather gloves	—	501	501
Other RCRA toxic-metal-bearing wastes	—	2,000	2,000
Waste oil and hydraulic fluids	320	1,300	1,620
Agent-contaminated charcoal	—	360,168	360,168
Leaker campaign overpack waste	—	73,376	73,376

NOTE: RCRA, Resource Conservation and Recovery Act of 1976.

SOURCE: Bechtel Parsons Blue Grass Team response on March 3, 2005, to committee questions of February 12, 2005.

of necessary activities from design through construction, operations, and eventual decommissioning or closure of the facility. Taking the closure requirements into consideration in the design is expected to simplify and reduce the cost of the closure process.

The BGCAPP project is divided into three phases. For each phase, there is a contract and permit decision point. Phase I includes the design, construction, sys-

temization, pilot testing, and demilitarization of GB contained in rockets and projectiles. Phase II includes the demilitarization of VX and H munitions, but some form of demonstration may be required before full-rate processing is permitted. In Phase III, the site is closed, which includes decontamination and decommissioning of all process equipment, systems, and structures.

As required by the contract, the activities of the

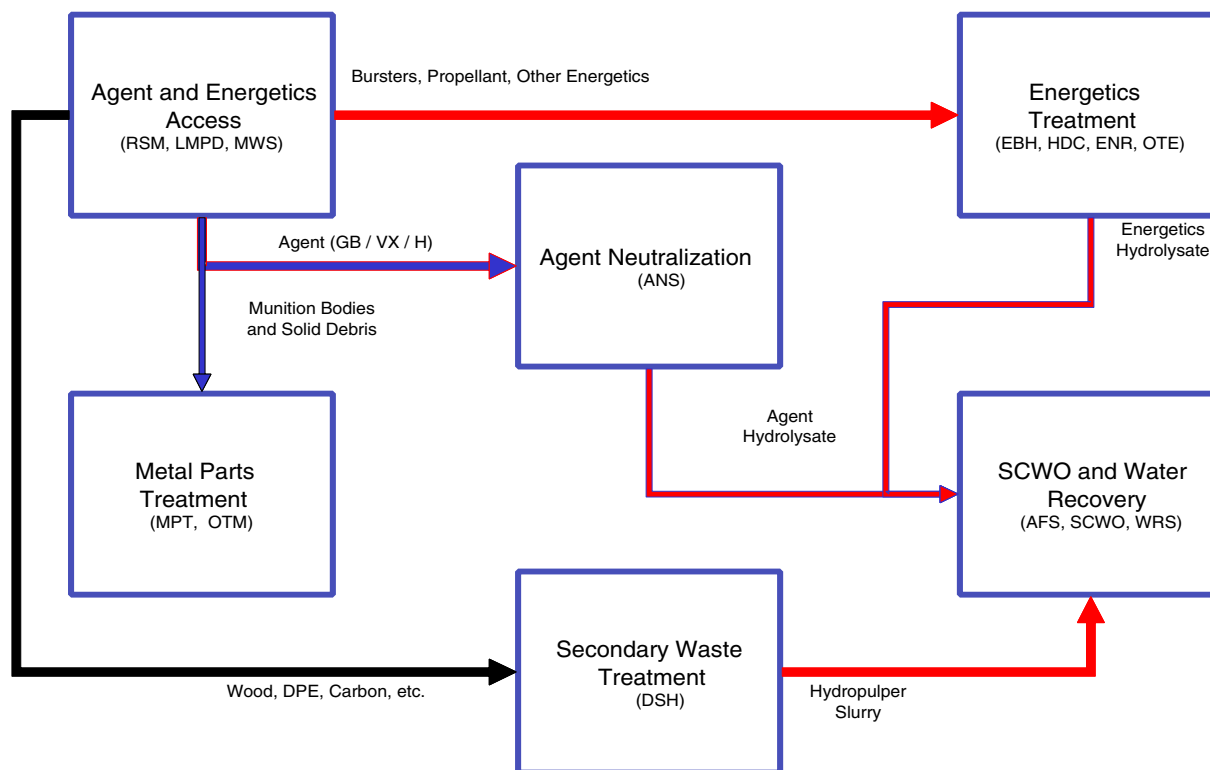

FIGURE 1-1 Block flow diagram for BGCAPP: ANS, agent neutralization system; DSH, dunnage shredding and handling; AFS, aluminum filtration system; WRS, water recovery system. SOURCE: Adapted from John Ursillo, BGCAPP Process Design/TRRP Manager, "Process design overview," briefing to the committee on September 22, 2004.

Bechtel Parsons Blue Grass Team include all design, procurement, facilities construction, process components fabrication and testing, installation, systemization, operations, and eventual closure. Included are safety analysis, licensing and environmental permitting, technical risk assessment, using lessons learned from operations at other chemical agent disposal facilities, and interfacing with the local community concerning all of these activities.

## SCOPE OF THE REPORT

This report primarily assesses the initial design (~30 percent complete design) for the BGCAPP. It is based on an initial design review held at Parsons in Pasadena, California, on August 2 and 3, 2004, and on presentations to the committee at its September 22-24 and November 17-19, 2004, meetings. The November meeting included a site visit to General Atomics in San

Diego to observe an energetics batch hydrolyzer (EBH) and SCWO unit. Several members of the committee also attended two reviews of the intermediate design presented at Parsons on February 7-10, 2005, and at Aberdeen Proving Ground on February 15, 2005.

The available design information on the BGCAPP design was preliminary in nature. The omission of a discussion on particular aspects of this design should not be taken to suggest approval or disapproval by the committee.

## BRIEF DESCRIPTION OF THE BGCAPP PROCESS

According to the initial design, and as depicted in Figure 1-1, the pilot plant entails six major processing steps to disassemble projectiles and rockets and to destroy the chemical agents and energetic materials: (1) chemical agent and energetic materials are accessed

by disassembling the munitions; (2) energetic materials are removed and destroyed by hydrolysis with caustic; (3) chemical agent is destroyed by hydrolysis with caustic or water; (4) the products of the hydrolysis of the chemical agent and energetic materials, called hydrolysates, are then treated further by SCWO; (5) metals and other solids are decontaminated by heating; and (6) other potentially hazardous wastes are shredded, converted to a slurry, and treated by SCWO.

### Unpack Area

The munitions are transported from their storage igloos in enhanced onsite containers to the container handling building, where they are stored awaiting processing. Then they are moved to the unpack area, where they are removed from their pallets for processing on one of two lines: a rocket input line or a projectile input line. The munitions are separated into three feed streams: (1) liquid chemical agent and agent-contaminated wash water, (2) contaminated metal parts, and (3) energetic materials. The dunnage is processed separately.

### M55 Rocket Processing

From the unpack area, each rocket, still in its firing tube, is individually conveyed to the punch and drain station in an explosion containment room. The machine punches holes in the top and bottom of the agent cavity to drain the agent from the warhead. The agent is sent to a storage tank in the agent neutralization area. A water jet flushes the remaining agent and any solids from the rocket. This wash water is also sent to the agent neutralization area. The drained and washed rocket, still containing energetics, is moved to the rocket shear machine (RSM) where it is cut into segments. These segments are then sent to the EBHs.

### Projectile Processing

The projectiles with bursters are placed on trays in the unpack area and conveyed to the linear projectile/mortar disassembly (LPMD),<sup>5</sup> machine where each lifting lug is removed. This is followed by removal of the burster charge, which is then sent to energetics hydrolysis. The projectiles next proceed to the muni-

tions washout system (MWS), where a hydraulically controlled ram forces and crimps the burster well into the projectile body, allowing the liquid agent to drain out. A high-pressure water jet on the ramming tool cleans out any remaining agent as well as any gel and crystals. The agent and contaminated water are sent to storage tanks in the agent neutralization area. The munitions bodies are returned to their tray and then conveyed to the metal parts treater (MPT), where they are heated to at least 1000°F for more than 15 minutes to destroy any remaining agent prior to release as decontaminated process waste. Projectiles without bursters are placed on trays in the unpack area and moved to a nose closure removal station and, subsequently, to the MWS for agent removal and to the MPT for decontamination.

### Agent Neutralization

The agent and wash water are sent from their respective storage tanks to the agent neutralization stirred reactors (ANRs), where the combined streams are treated with caustic or hot water until the agent has been destroyed to the level required. The resulting solution, called hydrolysate, is sent to intermediate storage and then to the SCWO reactors for further treatment.

### Energetics Treatment

Parts from rockets and projectiles containing energetic materials are conveyed from the RSM and LPMD to the EBHs, where the energetic material is hydrolyzed with hot caustic solution. The energetic hydrolysate is sent to the energetics neutralization system to complete the hydrolysis. Aluminum dissolved in the hydrolysate is removed by precipitation and filtration. The hydrolysate is then sent to intermediate storage, blended with agent hydrolysate, and finally then to the SCWO reactors for further treatment. Solids, including metal parts, not dissolved in the EBHs are carried to a heated discharge conveyor (HDC), where they are heated to over 1000°F for more than 15 minutes. Then, via a cooling conveyor, they are moved to a collection bin for head space sampling to verify that they are safe for discharge to an appropriate waste disposal site.

### Offgas Treatment Systems

All process offgas streams flow through an offgas treatment system prior to release to the munitions de-

<sup>5</sup>There are no mortar rounds containing chemical agent stored at BGAD as there are at PCD.

militarization building (MDB) heating, ventilation, and air conditioning (HVAC) system. There are three process offgas treatment systems in the BGCAPP: the MPT offgas treatment system (OTM) processes offgases from the MPTs and ANRs; the energetics offgas treatment (OTE) system treats offgases from the EBHs, energetic neutralization reactors (ENRs), and HDCs; and the dunnage emission control system. Available details of the operation of each process offgas treatment system are reviewed in the respective chapters on the processes. The treated offgas and all other vapors and particulates generated in the MDB flow with the cascaded ventilation air to the MDB HVAC system activated charcoal filters. The filtered air is discharged to the atmosphere via the MDB ventilation stack.

**Finding 1-1.** Although preliminary designs have been completed for most BGCAPP systems, the committee could only partially evaluate the treatment systems for metal parts offgas and energetics offgas because the designs had not been fully resolved. Elements needing resolution include the type of bulk oxidizer and related equipment, redundancy in the systems, the handling of other related offgas streams (from ENRs and ANRs and hydrolysate storage tanks), and the location of the offgas system equipment.

**Recommendation 1-1.** The OTM and OTE designs should be resolved as quickly as possible since they are key elements in determining the layout of the MDB and its overall throughput performance.

### Integrated Operation and Throughput Management

The various steps and associated hardware have been modeled in both a three-dimensional computer-assisted drawing and design mode and by an iGrafx Process 2003 modeling and simulation package for throughput analysis (Bechtel Parsons, 2004c). The three-dimensional design modeling is an ongoing activity to ensure constructability, operability, and ease of maintenance. It is used to support assumptions regarding operations and maintenance performance in the iGrafx throughput analysis. The throughput analysis is done early on to assist in establishing the number and availability of unit operations required to maintain the design throughput. The throughput analysis is especially important because BGCAPP combines batch processes and continuous processes.

Buffer storage has been added between nearly all

the unit operations or process steps to optimize the throughput of the overall plant. For example, the initial design provides for over 2,000,000 gallons of hydrolysate storage capacity prior to treatment in the SCWO reactors. This peak storage need occurs when processing rockets at maximum throughput rates in Phase II. Considerably less capacity is required at other times. This buffer storage results from a consideration of the maximum processing rates for weapons and the time required to analyze the hydrolysate. These buffer storage requirements, including tanks and processing units, are elements of the overall design and are reflected in the three-dimensional computer-assisted drawing and design model.

To optimize throughput, several spare processing units have been included for critical units. For example, the MWS will have spare cavity access machines (CAMs), and only one of the two MPTs and brine recovery systems will operate at any one time. The five SCWO reactors operate continuously, but individual units must be taken out of service for periodic maintenance. Only four of the five units are used for hydrolysate processing. The fifth unit, for dunnage processing, can be used, if necessary, as a spare hydrolysate unit. Other redundancies are included wherever there are critical components.

The iGrafx Process 2003 is a modeling and simulation package that permits discrete-event evaluation of the duration of a process step, the capacity of the step, and the resources or activities of the step. It permits the analysis of timing, quantities, and maintenance data for each step of a process. While the iGrafx package was used to develop process rates and buffer requirements for each step of the process, availability analyses done for various process steps and the plant itself leave many questions unanswered.<sup>6</sup> Train mechanical availability is the product of the assumed or measured mechanical availability of the various directly coupled subsystems affecting the train. For example, the train availability of the H projectiles is the product of the availabilities of coupling the LPMD to the EBH with the MWS, or  $0.9 \times 0.9 \times 0.9 = 0.72$ , or 72 percent. As suggested by the example, the anticipated equipment availabilities are all essentially taken as 90 percent and are based on

<sup>6</sup>Availability is defined in the report *Throughput and Availability Analysis* (Bechtel Parsons, 2004c) as “the percentage of the total operating time that equipment (or facility) is operating.” The availability reflects equipment downtime but not facility and operating time limitations.

TABLE 1-5 Overall BGCAPP Train Availability, Including Facility Shutdown

Period	Campaign	Train Mechanical Availability (% , rounded)		Facility Availability (%)	Overall Availability <sup>a</sup> (%)	
		Rocket	Projectile		Rocket	Projectile
Shakedown and ramp-up	GB	69	81	90	62	73
Performance test		69	81	90	62	73
Post-pilot		69	81	75 <sup>b</sup>	52	61
Shakedown and ramp-up	VX	69	81	90	62	73
Performance test		69	81	90	62	73
Post-pilot		69	81	75 <sup>b</sup>	52	61
Shakedown and ramp-up	H	—	73	90	—	66
Performance test		—	73	90	—	66
Post-pilot		—	73	75 <sup>b</sup>	—	55

<sup>a</sup>Includes planned facility shutdown.

SOURCE: Adapted from Bechtel Parsons, 2004c.

TABLE 1-6 Average Processing Rates, Including Train Availability

Period	Campaign	Peak Rate (rounds/hr)		Train Mechanical Availability (% , rounded)		Facility Availability (%)	Average Processing Rates (rounds/hr, rounded) <sup>a</sup>	
		Rocket	Projectile	Rocket	Projectile		Rocket	Projectile
Shakedown and ramp-up	GB	20	15	69	81	90	12	11
Performance test		20	15	69	81	90	12	11
Post-pilot		20	15	69	81	75 <sup>b</sup>	10	9
Shakedown and ramp-up	VX	24	26	69	81	90	15	19
Performance test		24	26	69	81	90	15	19
Post-pilot		24	26	69	81	75 <sup>b</sup>	12	16
Shakedown and ramp-up	H	—	26	—	73	90	—	17
Performance test		—	26	—	73	90	—	17
Post-pilot		—	26	—	73	75 <sup>b</sup>	—	14

<sup>a</sup>This rate is the expected plant average processing rate for each rocket or projectile line and considers the train mechanical availability and the facility availability.

<sup>b</sup>Includes planned facility shutdown.

SOURCE: Adapted from Bechtel Parsons, 2004c.

projected availabilities of the various steps, some based on operational data from the Johnston Atoll Chemical Agent Disposal System and Tooele Chemical Agent Disposal Facility and some based on subsystem complexity and test data of the various pieces of hardware. In the latter case, most are engineering estimates from first-of-a-kind hardware that are marginally prototypical and certainly not demonstrated or proven in a con-

tinuous, integrated operational mode. Tables 1-5 and 1-6 indicate, respectively, overall train availability, including facility shutdown, and average processing rates, including train availability.

With regard to facility availability during normal operations, the throughput and availability analysis takes account of various external causes of downtime amounting to some 98 days per year (including holidays, sched-



uled and unscheduled maintenance, and externally caused shutdowns), or 75 percent maximum facility availability. However, because maintenance and adjustment requirements cause facility processing time to be curtailed to 40 percent during shakedown and ramp-up periods, additional facility-wide shutdowns are not expected later on, and the total facility availability is assumed to be 90 percent during these periods.

Finally, overall availability is the product of the two percentages, train and facility availability, for rockets and projectiles. When these availabilities are then applied to the peak processing rates given in Table 1-6, the average processing rates for rockets and projectiles are calculated as indicated. The weeks needed to process the inventory are derived from these numbers—allowing for various testing periods, ramp-ups, and changeovers.

**Finding 1-2.** The committee believes that the proposed schedule for operations at BGCAPP as an integrated, first-of-a-kind plant is probably unrealistically optimistic given the vagaries of small spills, process upsets, start-up integrations, shutdowns, difficult maintenance and repair procedures, and unplanned interventions.

**Recommendation 1-2.** The Army and its contracting team should be prepared to modify the operations schedule as design and construction proceed.

## PERMITTING CONSIDERATIONS AND PUBLIC ACCEPTABILITY

### Regulatory Permitting Activities

The National Environmental Policy Act (42 U.S.C. §§ 4321-4347) requires the preparation of an environmental impact statement (EIS) for federal actions that may affect the environment. The U.S. EPA has given the Kentucky Department of Environmental Protection (KDEP) authority to implement the National Environmental Policy Act process. The important steps include (1) issuing a Notice of Intent (NOI) to prepare an EIS, (2) preparing a draft EIS, (3) having a public comment period for the draft EIS, (4) preparing a final EIS, (5) issuing a Record of Decision (ROD), and (6) applying for a research, development, and demonstration (RD&D) permit.

An NOI to prepare an EIS for the design, construction, operation, and closure of a facility for the destruction of chemical agents and munitions at BGAD was

posted in the Federal Register on December 4, 2000 (Federal Register, 2000). The EIS would examine potential environmental impacts of the following destruction facility alternatives: a baseline incineration facility, a full-scale facility to pilot test an alternative technology successfully demonstrated by the ACWA program, and no action (an alternative that would continue the storage of the chemical agent munitions at the BGAD). If any reasonable alternatives were identified during the environmental analysis process, they would be considered. The NOI indicated that incineration (also referred to as baseline incineration) has already been tested safely and successfully in full-scale facilities. Alternatives to baseline incineration for assembled chemical weapons destruction have been tested at the demonstration level, but not in pilot-scale or full-scale facilities. Furthermore, any alternative technology must be in accordance with Sec. 142 of Public Law 105-261, which requires three findings: (1) the alternative technology would have to be determined to be as safe as and as cost effective as baseline incineration, (2) it must also be capable of completing destruction of the stockpile by either the Chemical Weapons Convention destruction date or the date the BGAD stockpile would be destroyed if baseline incineration were used, whichever comes later, and (3) it must comply with federal and state health and safety laws.

In May 2002, KDEP released for public comment its draft EIS for the destruction of chemical agents and munitions stored at BGAD. The EIS considered the environmental impacts of no action, incineration, two neutralization technologies, and electrochemical oxidation. The final EIS, submitted in December 2002, incorporated all comments received on the draft. It considered four alternatives for the destruction of the BGAD stockpile: (1) baseline incineration, (2) chemical neutralization followed by supercritical water oxidation, (3) chemical neutralization followed by supercritical water oxidation and gas-phase chemical reduction, and (4) electrochemical oxidation. Based on the analyses in the EIS, KDEP could not say which of the four alternatives would be environmentally preferable. The EIS considered the overall impacts from chemical demilitarization activities to be minor.

The ROD, issued on February 27, 2003, by the deputy assistant secretary of the Army, documented DOD's decision to approve neutralization (hydrolysis) followed by SCWO as the technology for full-scale pilot testing at BGAD. The ROD states: "A variety of

factors were considered in making this decision, including, but not limited to, mission needs, cost, schedule, environmental considerations, public and local community concerns, and compliance with the CWC.” The ROD accepts the statement in the EIS that “none of the four alternatives can be identified as environmentally preferable.” The reason given is that the impacts on land use, water use, process waste generation, air, and endangered species were judged to be similar and minor. The ROD does not provide any detail on the other factors the Army considered in making its decision (ROD, 2003).

The purpose of the full-scale pilot testing is to demonstrate that neutralization followed by SCWO, when operated at full scale, is capable of safely and effectively destroying the chemical agents and munitions bodies stored at BGAD. In making its decision, DOD considered all comments received during the scoping meetings, public meetings, and the public comment period associated with the preparation of the EIS. The ROD also noted that due to increased security concerns and a desire to increase the probability of meeting the extended Chemical Weapons Convention treaty destruction deadline, the Defense Acquisition Executive directed the ACWA program to investigate ways to accelerate the destruction of the chemical stockpile at BGAD.

Prior to submission of the RD&D permit application, the Bechtel Parsons Blue Grass Team held a public meeting on the contents of the application at Eastern Kentucky University on January 22, 2004. More than 120 people attended.

The RD&D activity described in the current permit application will be conducted iteratively with the development of the facility. Data will be directly fed back to the design team so that the information can be used to improve and validate the process.

In parallel with the RD&D activity and in accordance with the Clean Air Act, an air permit application for enclosed air at BGCAPP was submitted to the KDEP in September 2004. A separate stand-alone construction and Clean Air Act Title V operating permit for BGCAPP was requested to allow more effective management of the monitoring, record keeping, and reporting of air emission sources during construction and operations. A separate Title V Permit for BGAD would then be issued based on total air emissions from the existing BGAD operations, to include proposed BGCAPP operations. When BGCAPP operations are completed and the pilot plant’s Title V Permit and in-

door air permit are rescinded, the permit for BGAD would not be affected—that is, the original permit would remain in effect.

### **Public Participation Outside the Formal Permitting Processes**

There are several other mechanisms through which the public can be represented and its concerns addressed. They include the Blue Grass Chemical Stockpile Outreach Office (BGCSOO), the Kentucky Chemical Demilitarization Citizens’ Advisory Commission (CAC), and the Chemical Destruction Community Advisory Board (CDCAB).

The BGCSOO, located in Richmond, Kentucky, and supported by DOD, is dedicated to increasing public involvement. BGCSOO assists the community in obtaining information on all aspects of the chemical weapons stockpile. It offers a variety of resources to the public and provides a forum for the public to provide input.

The CAC is made up of nine members appointed by the governor of Kentucky. Seven are local citizens and two are representatives of state agencies that work closely with the chemical weapons disposal program. The CAC provides a link between the public and the Army. The members provide a local perspective to the Army so that the public is as actively involved as possible in the disposal program. The CAC has a statutory duty to advise the Army on chemical demilitarization at BGAD. Since doing so may be beyond the capabilities of the nine CAC members, the CDCAB was formed to provide assistance and advice on major policy issues. CDCAB is a diverse group that represents the views and concerns of the public regarding the disposal program. Its primary objectives are to keep the public informed and to guide it in decision making. CDCAB meetings are independently facilitated by the Keystone Center. By providing input from the community, CDCAB plays an important role in the ultimate decisions.

Voting members of the CDCAB include the members of the CAC and representatives of local government entities, boards of education, chambers of commerce, Eastern Kentucky University, Berea College, the Madison County Ministerial Association, banks, hospitals, the NAACP, environmental organizations, civic groups, and elected state officials.

Included as nonvoting members are representatives from BGAD, KDEP, the Kentucky Department of

Emergency Management, PMACWA, Bechtel Parsons Blue Grass, and representatives of federal elected officials.

## **ORGANIZATION OF THE REPORT**

This chapter provides a concise background, describes the stockpile at BGAD, introduces the committee's task and the contractor's design-build approach, gives a brief overview of the process and a

throughput analysis, reviews the permitting process, and describes the venues available for public involvement. Prior reports and documents are cited for the reader who may wish to have more detailed information. Chapter 2 discusses the technical risk assessment and technical risk reduction program; Chapter 3, the delivery and disassembly operations; Chapter 4, core processes for agent and energetics destruction; Chapter 5, treatment of hydrolysates and residual wastes; and Chapter 6, general design considerations for BGCAPP.

## 2

# Technical Risk Assessment Issues

The Bechtel Parsons Blue Grass Team recognized the technological challenges involved in designing and integrating a new process. To address them, an integrated product team (IPT) was organized to define the set of unit operations that would best meet requirements for the Blue Grass Chemical Agent Destruction Pilot Plant (BGCAPP). This proposed design is described in the Design-Build Plan (DBP) for BGCAPP (Bechtel Parsons, 2003). Although the selection process was subjective, it drew on lessons learned from the chemical agent disposal facilities at Johnston Island; Tooele, Utah; Aberdeen, Maryland; and Newport, Indiana, and on expertise from the earlier Assembled Chemical Weapons Assessment program.

As the proposed BGCAPP design was being refined, the IPT recognized that there were technical risks and thus performed a technical risk assessment (TRA) of the proposed design concept. The stated purpose of the TRA was “to mitigate the technical risks associated with operations that have not yet been demonstrated at full scale” (Bechtel Parsons, 2003, p. 8-9). Also, it was noted in the DBP, Section 8.2, that “although these risks are intimately connected with safety, they are primarily schedule and cost oriented” (Bechtel Parsons, 2003, p. 8-8).

In accordance with AR-385-61 and DA PAM 385-61, the Bechtel Parsons Blue Grass Team prepared and implemented a system safety management program (SSMP) at the start of design. Detailed safety analyses of all areas of the process are being conducted as the initial designs are developed, and the findings of these analyses are fed back to the design-

ers and tracked to a resolution that satisfies worker and public safety. This program will continue to exist throughout the entire design, construction, operation, and closure of BGCAPP. The SSMP is separate from the technical risk assessment, which is focused on obtaining the best possible design using the selected technologies. Members of the safety analysis team responsible for the SSMP take part in the technical risk assessment to assure that safety issues are being addressed as solutions to risk issues are considered.

The IPT TRA team consisted of permanent core members and ad hoc members selected for their expertise on specific subject matter. The membership was drawn from Bechtel and Parsons personnel having expertise in all aspects of the operation of chemical plants and, particularly, chemical agent destruction facilities. Additionally, Assembled Chemical Weapons Alternatives (ACWA) program staff and supporting contractors participated. However, the Bechtel Parsons team chose not to invite the public to participate in the IPT because it believed that the IPT was an internal contractor activity and the public did not have the technical expertise to understand the issues.

The TRA process is intended to be continued and refined throughout the life of the BGCAPP project, at each stage of the project life cycle. To prioritize the risks, the IPT adopted a semiquantitative approach, assigning individual weighting factors to “probability of occurrence” and “technical, schedule, and cost consequence of occurrence.” The probability and consequence weighting factors are summarized in Table 2-1. As shown in the table, the weight for each technical

TABLE 2-1 Probability, Consequence, and Risk Weighting Factors for BGCAPP Design-Build Plan Technical Risk Assessment

Probability of Occurrence		Consequence of Occurrence			Aggregated Weight of Consequence
Probability Description	Weight of Probability	Technical	Schedule	Cost Impact (%)	
Remote	1	Minimal or no impact	Minimal or no impact	Minimal or no impact	0.2
Unlikely	2	Acceptable with some reduction in margin	Additional resources required to be able to meet need dates	<5	0.4
Likely	3	Acceptable with significant reduction in margin	Minor slip in key milestones, not able to meet need dates	5-7	0.6
Highly likely	4	Acceptable with no margin	Major slip in key milestones or critical path impacted	7-10	0.8
Nearly certain	5	Unacceptable	Cannot achieve key team or major program milestone	>10	1.0

NOTE: Risk ranking or weight = weight of probability × aggregated weight of consequence.  
 SOURCE: Adapted from Bechtel Parsons, 2003.

risk was calculated by multiplying the two weighting factors. For example, a probability weighting of 3 (the occurrence is likely) times an aggregated consequence weighting of 0.4 (technical, schedule, and cost consequences as described in Table 2-1) gives an overall risk weight of 1.2. Each of the risk weights was then assigned to one of three overall risk weight categories: low (overall weight less than 1.0), medium (overall weight between 1.0 and 3.0), and high (overall risk weight above 3.0). The committee believes that the basic approach has merit as a screening tool based on expert judgment (Bechtel Parsons, 2003).

The IPT identified 89 technical risks relating to major unit operations. All risks were ranked on the basis of the risk weight expected after implementing proposed mitigation activities, because the IPT believed that this approach “would allow assessment of compound risks as well as monitoring of implementation of the proposed risk mitigation measures” (Bechtel Parsons, 2003, p. 8-7).

No risks were identified with an overall weight of 3.0 or greater. Twenty-nine risks were identified with an overall risk weight between 1.0 and 3.0. The 89 identified risks are listed in Appendix P, Table P-1, of the BGCAPP DBP ((Bechtel Parsons, 2003) and in Appendix F of the BGCAPP TRA IPT Quarterly Reports).

On the basis of the preliminary TRA, the design for construction, operation, and closure was modified, as appropriate. Also, several trade studies and prototype test programs were selected to be carried out during the design phase to reduce overall technical risk. These studies and test programs were designated as technical risk reduction projects (TRRPs) and have become the focus of major risk mitigation activities for BGCAPP.<sup>1</sup> Subsequently, periodic reviews by the IPT TRA team during design had identified 24 additional items by July 2004.<sup>2</sup> Some of these risks were designated to be addressed by TRRPs. The status of ongoing and completed TRRPs as of February 15, 2005, is shown in Table 2-2.<sup>3</sup>

<sup>1</sup>The acronym TRRP has been used in various contexts to refer to either the overall technical risk reduction program that resulted from the technical risk assessment results, or (with a designation number, e.g., TRRP 7) to individual projects for mitigating specific identified risks. This report refers to the latter.

<sup>2</sup>Technical Risk Assessment Integrated Product Team Quarterly Report, July 2004, prepared for the PMACWA.

<sup>3</sup>February 15, 2005, represents the last time documented information on the design status was briefed to the committee by the PMACWA staff and the Bechtel Parsons Blue Grass Team. It therefore serves as a nominal cut-off date for information gathering on the status of TRRP projects for this report.

TABLE 2-2 Summary of Technical Risk Reduction Projects for BGCAPP as of February 15, 2005

TRRP No.	Short Title	Scope	Status/Results
1	LPMD Machine (trade study)	Redesign PMD machine to remove nose closure and burster in a linear series of stations (the baseline PMD used a series of stations set in a circle). Projectiles are to be disassembled in a vertical rather than horizontal position. Reduce congestion in ECR and possibly permit installation of redesigned PMD machine into the ECR after completion of VX campaign. Build on results of the PCAPP study.	This TRRP activity has been completed and the results are being implemented.
2a	GB Neutralization Analytical Methods (bench-scale test)	Verify process design assumptions and validate the method detection limit (MDL).  Evaluate hydrolysis of GB with caustic with a focus on verifying reaction stability at planned operating temperature of 194°F with caustic solution (11.34 wt%).	Analytical methods are being developed for measuring agent in the hydrolysate. The methods must be both reliable and fast enough to support throughput rate targets. This has not been demonstrated to date. If analysis turnaround times are too slow, additional storage capacity must be provided.  The Test Protocol, Rev. 1, was reviewed by the TRRP IPT, and the test plan was being finalized.
2b	H vs. HD Neutralization Analytical Methods (bench-scale test)	Verify process design assumptions and validate analytical method for H. Compare with HD analytical method for PCAPP.	This TRRP has been successfully completed.
3	Air Monitoring (bench-scale test)	Conduct testing to demonstrate efficacy of air monitoring systems. Reduce potential for interferences, particularly with GB and VX hydrolysates. Build on experience from the Newport Chemical Agent Disposal Facility. Evaluate multiagent monitoring systems.	This TRRP activity was in progress.
4	Energetic Hydrolysis Analytical Methods (bench-scale test)	Confirm reaction conditions for energetics hydrolysis (heat, kinetics, duration of hydrolysis, product characterization, etc.) by lab/pilot tests. Provide data to support, design, and develop an analytical method to measure agent in hydrolysates during operations.	The test program has been initiated. The test runs will commence when Battelle receives the necessary aluminum material and propellant material. Methods development was still in progress.

(continued on next page)

TABLE 2-2 Continued

TRRP No.	Short Title	Scope	Status/Results
5a	Prototype MWS Testing (prototype test)	Design and fabricate full-scale MWS line for GB/VX/H projectiles. Conduct a testing project to demonstrate the efficacy of the cavity access machine for 155-mm H and VX projectiles and 8-inch GB projectiles, all of which have operational requirements different from those of the projectiles that will be processed at PCAPP.	<p>During validation testing, a total of five trays (40 projectiles/tray) were processed at a throughput rate of 29 rounds/hr. Later off-line component tests conducted with the VX 155-mm projectiles showed that the burster wells of the test hardware used for the test were manufactured with seams. During the punch operation, the burster wells were observed to split along the seams, which could cause complications with the MWS punch/washout operation. PMACWA has determined that the stockpile at Blue Grass Army Depot may have both seamed and unseamed burster wells, so the BGCAPP MWS needs to be designed to handle both types of burster wells. The Bechtel Parsons Blue Grass Team is currently evaluating some equipment modifications that may correct the problems observed. Systemization tests for the VX 155-mm projectiles have been completed.</p> <p>Testing for heavier 8-inch projectiles was in progress.</p>
5b-1	Prototype EBH/HDC Testing (prototype test)	Perform tests of the prototype HDC to define final design parameters.	HDC testing was in progress, and design changes were being investigated.
5b-1a	Aluminum Filtration Tests (prototype test)	Using hydrolysate from prior Tooele Army Depot tests of the ERH/EBH, perform tests to confirm the method for filtering aluminum hydroxide precipitate from the hydrolysate feed to SCWO units. General Atomics performed aluminum filtration tests with a belt filter press at a vendor's facility using hydrolysate produced during the TRRP 5b-1.	Early hydrolysis tests conducted for the prototype EBH with hydrolysate at pH values of 5.5 and 7.3 resulted in aluminum concentrations in the filtrate greater than 400 ppm (the maximum acceptable value to avoid SCWO reactor plugging as observed during previous PMACWA SCWO tests). Four additional aluminum filtration tests were performed at pH values of 7 or 8 and with different acids and additives to see if lower aluminum concentrations in the filtrate can be achieved. General Atomics was waiting for lab analyses of samples taken from these most recent filtration tests.
5b-2a	EBH Full-Scale Testing (prototype test)	Simulate full-scale EBH operation. Verify key mechanical features and interfaces of the EBH drum, including liquid fill, solids feed and discharge, spray bars for rinsing, chute design and jam-free operation, and liquid discharge at rates consistent with peak RSM operating rates. Also, demonstrate interface of EBH with feed hopper and discharge conveyor.	Full-scale mock-up tests of the material handling and mechanical characteristics of the EBH have been completed. The tests employed simulated warhead and rocket segments and burster tubes and small parts such as those found in the fuze. The tests were conducted at ambient temperature with water rather than at operating temperature with caustic.
5b-2b	EBH Material Handling Testing (prototype testing)	Test material handling associated with handling solids remaining after treatment in the EBH operation. Includes solids conveyor and solids metering to the HDC.	Mock-up tests were in progress.

TABLE 2-2 Continued

TRRP No.	Short Title	Scope	Status/Results
5c	Prototype MPT Testing (prototype test)	Evaluate the design of the full-scale MPT for PCAPP and complete testing. The PCAPP MPTs are 6 ft and 10 ft in diameter. Only the 6 ft diameter unit is being tested. Same sizes to be used at BGCAPP.	Testing to verify the design parameters for projectiles has been performed, but problems were encountered and resolutions were not available at the time this report was prepared. Additional MPT testing by outside contractor on characterizing the thermal treatment and offgases from secondary and closure wastes has been scheduled.
5d	Prototype RSM Washout Testing (prototype test)	Evaluate various washout parameters using a transparent warhead filled with a gelled agent simulant. Demonstrate the punch, drain, and washout of the simulated gelled agent using a modified baseline system RSM punch-and-drain station.	Tests have provided information to improve the design of the punch-and-drain probes and to minimize the occurrence of aluminum in propellant batches to the EBH. No determination of the amount of aluminum in the washout water was performed. Using 400-psi hot water introduced through two punch nozzles, the modified RSM successfully washed out the simulated crystallized agent material. This TRRP activity has been completed.
6	Reactor Material and Corrosion Study	Select materials to be used for neutralization reactors.	Hastelloy C-276 has been selected as the material for neutralization reactors even though H hydrolysis in water could result in 2 wt% HCl formation and corrosion rates >50 mils per year. Since the H campaign has the shortest processing schedule (3 months), the Bechtel Parsons Blue Grass Team considers such high corrosion rates tolerable, and vessels can be fabricated with appropriate corrosion allowance. Teflon-lined stainless steel vessels were considered and were the most cost effective but were dismissed as they would generate fluorinated hydrocarbons when heated in the MPT during closure. This TRRP activity suggests additional testing be done to determine the actual corrosion rates expected during neutralization.
7	SCWO Maintenance (trade study)	Perform SCWO system predictive/preventive maintenance study to guide development of preventive maintenance schedule and improve plant availability.	This TRRP activity has been completed and the results are being implemented.
8	Blended SCWO Feeds (prototype test)	Blend agent hydrolysates with energetics hydrolysate for feed to SCWO. Reduces phosphate content of GB hydrolysates, mitigates corrosion problems, reduces liner replacements, and improves availability.	This TRRP activity has been completed and the results are being implemented.
9	SCWO Pilot Test	Conduct SCWO pilot testing. Validate scale-up factors and fill data gaps.	This TRRP activity has been completed and the results are being implemented.
10	EBH Containment Room Design (trade study)	Establish a conceptual design for the EBH rooms based on the expected explosive and propellant contents of the room under peak operating conditions and assumptions about the maximum credible event.	Results from this TRRP trade study have been incorporated into the EBH room design.

(continued on next page)



TABLE 2-2 Continued

TRRP			
No.	Short Title	Scope	Status/Results
11	VX Hydrolysis Analytical Methods Test (bench-scale test)	Develop and perform tests to establish VX hydrolysis process parameters, and establish an analytical methodology.	This TRRP activity was initiated after the analytical methods developed for use at the Newport facility were no longer applicable for BGCAPP due to reductions in the initial VX feed concentrations (to 8 wt%) for VX hydrolysis at Newport. Although the feed concentration now in use at the Newport site, 16 wt%, is similar to that planned for BGCAPP, the Newport site must attain a 20 ppb level of VX in the hydrolysate, whereas BGCAPP, which will have secondary treatment of the hydrolysate, must attain a 160 ppb level for which the analytical method used has fewer steps and needs to be completed as quickly as possible to minimize hydrolysate storage requirements. At the time this report was prepared, the test protocol for an analytical method suitable for BGCAPP had been prepared for TRRP IPT review.
12	RSM Cutting Accuracy Testing (prototype test)	Perform testing to provide recommendations to the design team regarding an improved rocket positioning system. The ability of the baseline RSM to accurately index a rocket within its shipping and firing tube has been estimated to be accurate within $\pm 0.25$ inch, provided the equipment has been properly systemized and maintained. Over time and use, this accuracy will drift and will require adjustments.	Telescoping and shifting of the rocket during shearing does occur and has been noted in videos of shearing operations. In addition to shifting during shearing at the shear station, shifting of the rocket within its shipping firing tube has been observed during TRRP 5d testing of punch-and-drain operations. While at the RSM punch-and-drain station, the warhead within its shipping firing tube is clamped by both the front and back clamps of the station. Despite this clamping, the warhead has been consistently observed to shift 0.5 inch in either direction within the shipping firing tube if the drain punches are alternately cycled. To prevent this shifting during the punch-and-drain operation, the drain punches are extended to simultaneously create drain holes and to peg the warhead in place until after the vent punches have been extended. Test Plan, Rev. B, was being prepared, and a magnetic detector for finding the interface between the steel rocket motor case and the aluminum warhead was being developed as part of this TRRP activity.

NOTE: EBH, energetics batch hydrolyzer; ECR, explosion containment room; ERH, energetics rotary hydrolyzer; HDC, heated discharge conveyor; LPMD, linear projectile/mortar disassembly (machine); MDL, method destruction limit; MPT, metal parts treater; MWS, munitions washout system; PCAPP, Pueblo Chemical Agent Destruction Pilot Plant; PMACWA, Program Manager, Assembled Chemical Weapons Alternatives; PMD, projectile/mortar disassembly; RSM, rocket shear machine; and SCWO, supercritical water oxidation.

**Finding 2-1a.** The implementation of the risk assessment methodology in the preliminary TRA for BGCAPP depends strongly on engineering judgment, even with the weighting system described in Table 2-1.

**Finding 2-1b.** The IPT membership included only government personnel and persons selected by the BGCAPP contractor from among experts in chemical demilitarization. Members were selected to ensure that process efficacy, safety, and environmental concerns would be addressed. There was no participation by representatives of the general public in the vicinity of the Blue Grass site.

**Recommendation 2-1.** The Bechtel Parsons Blue Grass Team should consider asking the Kentucky Citizens' Advisory Commission if members of the general public would be interested in participating or observing any future evaluations, not necessarily to identify the risks but to provide independent perspectives on the assessment of risk after mitigation and to demonstrate the transparency of the BGCAPP design process to the public.

The lay public often perceives risks differently than technical analysts. For example, the activist public preferred neutralization because they perceived that

baseline incineration technology was riskier. The public perceives as important mainly those risks that relate to worker and public safety, whereas the Bechtel Parsons Blue Grass Team may see those risks as manageable and less of a challenge than other technical risks with greater probability of large cost and schedule impacts.

**Finding 2-2.** Despite the qualitative nature of the TRA process, the committee believes that of the issues identified to date, the Bechtel Parsons Blue Grass Team has appropriately determined the main technical roadblocks requiring further study as technical risk reduction projects (TRRPs). TRRPs are under way to acquire design data for unit operations identified as having insufficient prior testing or operating experience, and studies have been undertaken to evaluate promising alternatives or to resolve design decisions for areas not requiring testing. The committee believes that other issues requiring study as TRRPs will probably be identified before the design is completed.

**Recommendation 2-2.** The Bechtel Parsons Blue Grass team should continue the technical risk assessment process as a mechanism to uncover issues that require further testing or studies.

# 3

## Delivery and Disassembly Operations

### ON-SITE MUNITION TRANSPORTATION

The Blue Grass Chemical Agent Destruction Pilot Plant (BGCAPP) design and operations for the delivery and disassembly of chemical munitions are similar to those used in baseline incineration system facilities but include evolutionary modifications that take advantage of lessons learned from operating baseline facilities. Other modifications include new machines and technology to accommodate the use of caustic hydrolysis for neutralization of agent and energetics. Similarities with baseline equipment and procedures include the use of enhanced onsite containers (EONCs) to transport munitions from storage to a container handling building (CHB) and the use of the baseline rocket shear machine (RSM) technologies, albeit with adaptations. Evolutionary modifications based on lessons learned include the linear projectile/mortar disassembly (LPMD) machine, originally developed as part of the design for the Pueblo Chemical Agent Destruction Pilot Plant (PCAPP). The linear (versus circular) configuration of the LPMD machine permits it to be installed after construction of the munitions demilitarization building (MDB) and also simplifies its disassembly for closure.<sup>1</sup> The RSM adaptations are required to ensure maximum segregation of aluminum-containing segments from those containing propellant before they are sent to the energetics neutral-

<sup>1</sup>The size of the circular PMD machine used at baseline system facilities requires that it be installed prior to construction. Otherwise, the size of the opening in the MDB required for it to pass through for installation would have necessitated major design changes and cost increases for the associated ECR.

ization process. These adaptations include changing the shear positions and use of rotary cutting wheels at two cutting positions.

Figure 3-1 illustrates the disassembly steps in the BGCAPP design for processing rockets and projectiles.

### Transport from Igloos to Unpack Area

During processing operations at BGCAPP, munitions will be removed from igloos on their storage pallets using a forklift and placed in an EONC mounted on a trailer that moves the EONC to the CHB. Leakers found in the storage igloos will be overpacked and placed on a separate leaker pallet, to be transported and processed after all nonleaking munitions of the same type and agent fill have been processed. Once in the CHB, the EONC is unloaded from the trailer and then moved on roller conveyors through an airlock into the unpack area (UPA) in the MDB. All of the preceding actions are identical to those used in the baseline facilities with the exception that movement into the MDB does not require an elevator since the BGCAPP CHB and MDB are on the same level. The EONCs are moved in the UPA using an overhead crane.

The BGCAPP UPA is designed to withstand the explosive force of an assumed maximum credible event (MCE) for the quantity of rockets or projectiles allowed by approved procedures to be located therein.<sup>2</sup> The

<sup>2</sup>In hazards evaluation, the MCE from a hypothesized accidental explosion, fire, or agent release is the worst single event that is likely to occur from a given quantity and disposition of ammuni-

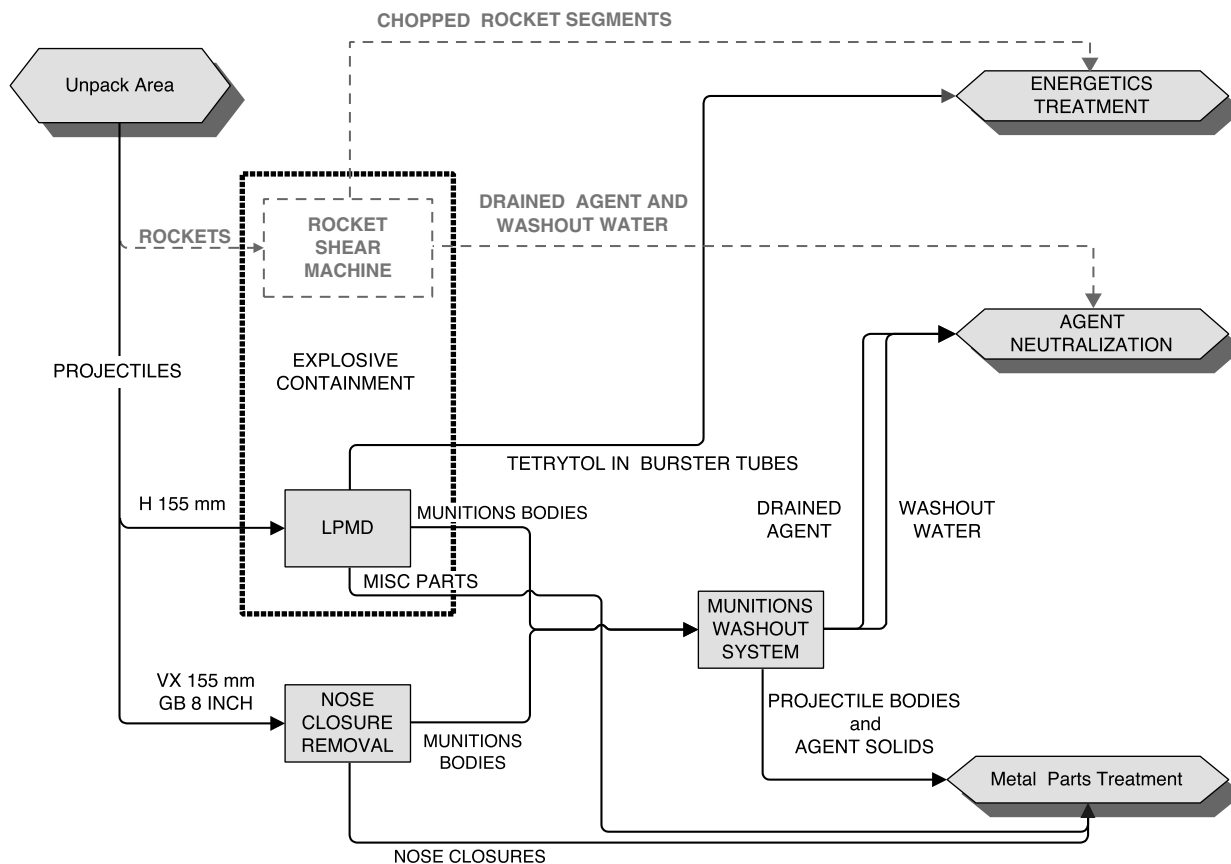

FIGURE 3-1 Rocket and projectile disassembly flow diagram. There are two RSMs, each in a separate ECR. Each RSM consists of a punch-and-drain section followed by a cutting station. The agent and washout water from the punch-and-drain station flow to agent neutralization, while energetics (propellant, bursters, and fuzes) are sent to energetics treatment as segments cut from the drained rocket. Miscellaneous projectile parts are carried in baskets or other containers placed in the projectile body trays and concurrently moved to the MPT with the projectile bodies as they are processed through the MWS. SOURCE: Briefing by the Bechtel Parsons Blue Grass team to the BGCAPP MDB Design Review, February 15, 2005.

MCE was accepted by the Department of Defense Explosive Safety Board. The design team has chosen to install bollards along the walls of the UPA to keep loads containing explosives from being placed or moved near the walls. This allows a somewhat lower blast loading for the UPA wall design. The dimensions of the UPA are sized to yield the area required for EONCs containing munitions with energetic materials in them.

Once in the UPA, the EONC atmosphere is sampled and monitored for agent. If agent is detected, the EONC

is moved past the explosion containment vestibules (ECVs) to an airlock connected to the EONC leaker unpack station adjacent to the toxic maintenance area (TMA). The EONC is then moved through the airlock into the leaker unpack station, where operations personnel clad in appropriate personal protective equipment open the EONC and unload the munitions pallet. The leaking munition(s) are located and placed in over-packs for later processing. The remaining munitions are then placed in trays that are transferred on roller conveyors through an airlock to the adjacent ECV, where the munitions are then transferred into the associated explosion containment room (ECR) for disassembly. The ECV provides for pressure gradient control of contamination between the UPA (higher pressure) and ECR (lower pressure). The EONC is then

tion and explosives. The event must be realistic and have a reasonable probability of occurrence considering the explosive propagation, burning rate characteristics, and physical protection given to the items involved. The MCE estimated in this way may then be used as a basis for effects calculations and casualty predictions.

decontaminated to the appropriate airborne exposure limit (AEL), and moved back out of the TMA through the EONC airlock.<sup>3</sup> The decontaminated EONC is then returned to service.

If there is no detectable agent in the EONC atmosphere, the EONC is moved in the UPA near the ECV assigned for the munitions in the EONC. Both ECVs can be used for processing rockets, while only one of the ECVs is used to process projectiles containing bursters before bringing them into the ECR containing the LPMD.

In the ECV, the EONC is opened and the munitions pallet is unloaded by forklift and placed at the appropriate location for feeding individual munitions into the disassembly process through the ECV airlock. Individual munitions are removed from the pallet and transferred to a feed conveyor using an appropriate lifting device.

Strapping and other packing material are removed and collected for transfer to the secondary waste treatment area along with the pallets. Currently, it is not planned to process dunnage that has never been in a storage igloo with a record of agent leakage because such dunnage is presumed to be agent-free. There have been relatively few leakers at BGAD, as noted below, so most of the dunnage is not contaminated. This agent-free material will be moved to an area designated for materials to be disposed of off-site without further decontamination.

### *Miscellaneous Items*

Bulk agents stored at Blue Grass Army Depot (BGAD) (i.e., one ton container of GB, one DOT bottle of VX, and two DOT bottles of H) will be processed at the end of the destruction campaign for each agent. These items will be moved from the CHB through the UPA airlock to the TMA airlock and then into the TMA, where they will be processed manually using appropriate personal protective equipment. Manual

<sup>3</sup>In June 2004, the Department of the Army issued *Implementation Guidance Policy for Revised Airborne Exposures Limits for GB, GA, GD, GF, VX, H, HD, and HT* (U.S. Army, 2004). Supplementary guidance was issued in a December 2004 memorandum. The AELs for the named agents were recently revised by the Centers for Disease Control to update previous standards dating back to 1988 (Federal Register, 2003, 2004). At the time this report was being prepared, implementation of the revised AELs for specific situations was undergoing development.

processing will be based on experience gained at other chemical agent destruction facilities processing similar containers and agents.

### *Processing of Leaking Munitions*

As of May 2005, there were 55 H and 76 GB projectiles reported as leakers at BGAD.<sup>4</sup> No VX leakers have been reported.

Overpacked leaking projectiles with and without bursters will be transferred into an ECR and opened on the reject table. If bursters are present, they will then be removed and sent to the energetics batch hydrolyzer (EBH). All leakers will be processed through the LPMD machine to verify the absence of a burster and then placed in a tray for transfer to the munitions washout system (MWS) room for agent removal.

The population of overpacked leaking rockets as of May 2005 was reported to comprise 91 GB rockets; there were no overpacked VX rockets.<sup>5</sup> Overpacked rockets containing a particular agent will be processed at the end of the campaign for nonleaking rockets containing the same agent. The same equipment will be used for draining and washout of agent and for shearing the rockets.

### **Unpacking Projectiles Without Bursters**

Pallets containing 155-mm VX projectiles or 8-inch GB projectiles without bursters are delivered in front of the airlock door between the UPA and the nose closure removal (NCR) room, where they are unpacked and placed in trays using a jib crane. The trays are then moved through the airlock and into the NCR room using roller conveyors. In the NCR room, the projectiles are placed horizontally in an NCR machine by a Fanuc-2000 multiaxis robotic arm. The NCR machine is the same as that used in the baseline design. In the NCR machine, the nose closure is removed and placed in a container along with other nose closures. The projectile burster well is tested to verify the absence of a burster, and the projectile is lifted by the robotic arm, rotated, and placed vertically in a tray for conveying to the MWS room. The container with nose closures is also placed in the tray being moved to the MWS room.

<sup>4</sup>Teleconference between PMACWA and the committee, May 9, 2005.

<sup>5</sup>Teleconference between PMACWA and the committee, May 9, 2005.

The container of nose closures is not processed by the MWS but simply proceeds on the same tray along with the projectile bodies on their way to the metal parts treater (MPT).

## ACCESSING OF AGENT AND ENERGETICS IN GB AND VX M55 ROCKETS

The rocket handling sequence to be used at BGCAPP is the same as that used in baseline system facilities (see Figure 3-1). Rockets on pallets are removed from an EONC and moved to the rocket metering system, where the individual rockets in their firing tubes are removed from the pallets, checked for orientation (nose first), and placed on roller conveyors for movement through an airlock into an ECV for feeding into the associated ECR through a blast-resistant door. The ECV conveyor is segmented and has a swing section in the middle to permit maintenance personnel in demilitarization protective ensemble (DPE) suits to pass through.

In the ECR, the rocket in its firing tube is placed in the first position in the RSM, where the warhead cavity that contains agent is punched and drained of liquid agent and then washed out. The RSM is basically the same design as that used in the baseline processes, with minor modifications for punching and draining the agent and for cutting the rockets.

The RSM uses top and bottom punches to access the agent cavity in the warhead and to drain and wash out liquid and solid agent and other degradation products. The baseline RSM is not washed out after draining. There are two top punches with spray heads for supplying washout liquid and three bottom punches for draining agent and washout liquid. Both top and bottom punches penetrate the firing tube and warhead cavity off center to avoid hitting the burster. The firing tube is gripped tightly and crushed to prevent the rocket from rotating inside the tube. The bottom punches are designed to punch the aluminum warhead at an angle that bends but does not break off aluminum from the punch area of the warhead in order to minimize aluminum fragments in the drained agent or washout liquid. Any aluminum fragments released by the punch-and-drain operations will be caught on a drain system filter, which will be periodically checked and cleared by operations personnel in suitable personal protective equipment. A similar approach is used for baseline RSM operations. After draining, warm (77°F) pressurized water (>400 psig) is sprayed into the warhead agent cavity through

the top holes to dissolve and wash out gelled and crystallized material formed during prolonged agent storage. The advantage of the power water wash over the gravity drain used in the baseline process is that all gelled agent and other solids such as the GB crystals are removed from the warhead. The drained agent and the wash water are sent to the agent storage tank in the toxic agent storage room.

The preceding drain-and-washout method was verified for the modified punch-and-drain equipment in TRRP 5d testing. This testing has been completed and demonstrates the washout capability and throughput rates for each agent. Test reports indicate success in all aspects of the washout operation.<sup>6</sup> The tests have provided information to improve the design of the punch-and-drain probes.

After draining and washout, the rocket grippers are released and the rocket is rotated 90 degrees to minimize drips outside the drain station. The rocket in its firing tube is then moved forward to the rocket shearing station, where a hydraulically operated shear cuts the rocket into nine segments (eight cuts required), beginning with the nose section. The cut points are shown in Figure 3-2. The baseline RSM produces eight segments (seven cuts required). The additional segment produced by the RSMs at BGCAPP is a consequence of the cuts (particularly Cut 4) being placed to minimize the amount of aluminum that is delivered to the EBH during hydrolysis of M28 propellant (see Chapter 4 for a further discussion of EBH operations). Figure 3-3 shows details of Cut 4.

As of February 2005, the Bechtel Parsons Blue Grass Team was planning to further modify the RSM design by incorporating a special cutting tool for the cutting positions at the interface of the rocket warhead and rocket propellant sections (Cut 4) and at the interface of the rocket tailfin and rocket propellant sections (Cut 8). This special cutting tool would be based on the standard disc-type pipe cutter. It cuts by rotating three cutting wheels around the body while the wheels are gradually moved inward toward the longitudinal axis of the rocket. This modification was proposed to address the difficulty of shearing at Cut 4 and Cut 8. Cut 4 is very close to the propellant igniter, and there is a risk of initiating the igniter if the cutter happens to strike it. The longitudinal location of the rocket inside

<sup>6</sup>Briefing by Bechtel Parsons Blue Grass Team, Intermediate Design Review Meeting, February 7-10, 2005.

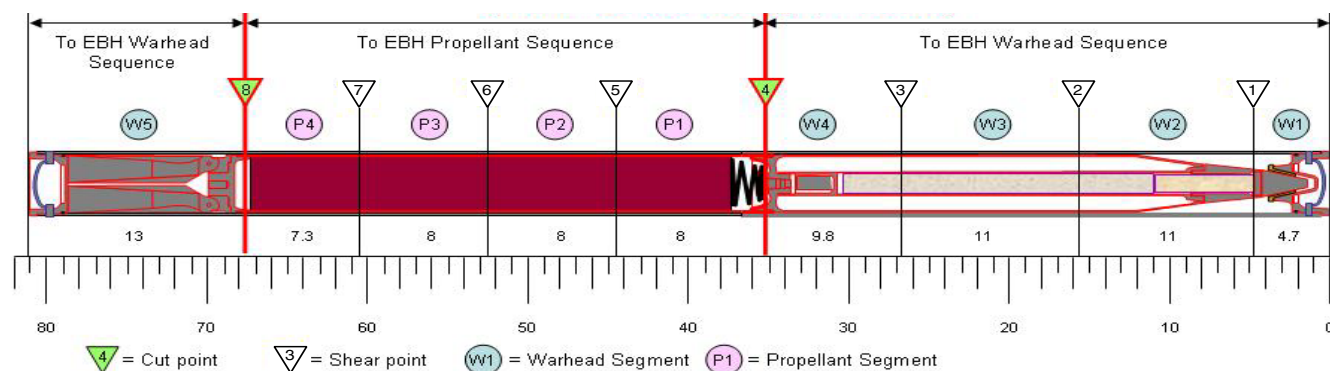

FIGURE 3-2 Cut points for RSM cutting of M55 rockets. SOURCE: Bechtel Parsons Blue Grass Team responses on May 2, 2005, to committee questions of April 25, 2005.

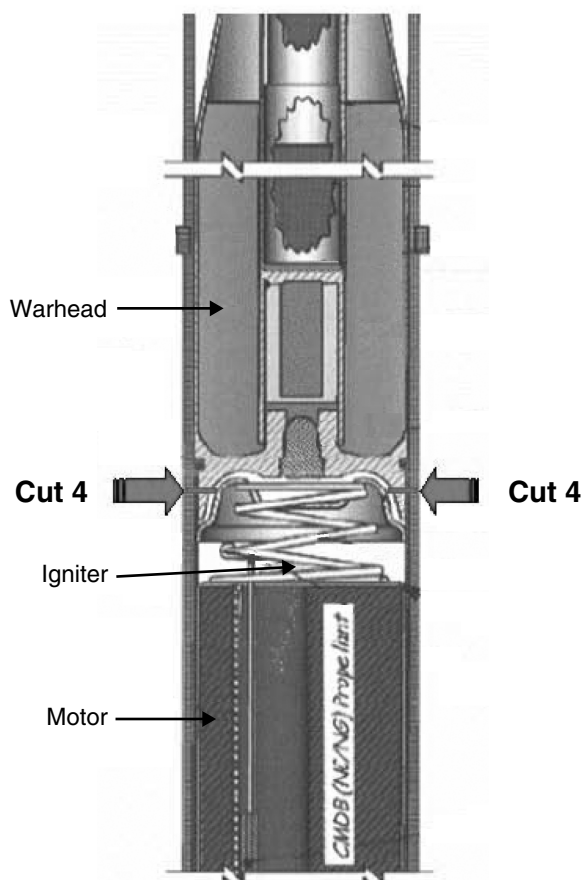

FIGURE 3-3 Detail drawing showing planned BGCAPP RSM Cut 4 of M55 rockets. SOURCE: U.S. Army and Bechtel Parsons Blue Grass Team responses on May 2, 2005, to committee questions of April 25, 2005.

the firing tube may vary by as much as  $\pm 0.5$  inch, and the rocket shear positioning system will have a longitudinal positioning variance. The disc-type cutter is not any more precise than the shearing blade in locating a longitudinal cut, but it will not cut deep enough into the rocket to interfere with the igniter. Cut 8, shown in Figure 3-2, involves cutting through a part of the steel rocket nozzle just above the tail fins. Shear tests at this point have shown incomplete cuts.

Tests are planned as a part of TRRP 12 to demonstrate the efficacy of both the shears and cutting disks. This TRRP also will involve using a magnetic detector to precisely locate the magnetic/nonmagnetic seam between the rocket motor casing and the rocket warhead through the shipping and firing tube. The tolerance desired for this demarcation alone is 0.125 inch. The idea is to cut forward of the spring and the section called the "fore closure," an end cap that holds the spring in place and screws into the front end of the rocket motor casing.

Each rocket segment with its associated fiberglass firing tube segment is collected in a bucket. Two collection buckets are used for each rocket. One bucket receives the washed-out warhead sections, including burster segments, the fuze, and the segment containing the aluminum tail-fin section from the preceding rocket. The other bucket receives the propellant-containing segments, including the propellant igniter and the smallest possible amount of aluminum from the adjacent warhead section. This segregation is necessary because the rocket propellant has been found to

ignite and burn briefly when aluminum is present during hydrolysis using a caustic solution. This phenomenon is discussed in detail in Chapter 4.

The buckets containing warhead and tail-fin segments or propellant segments are then moved on a conveyor to a position near the blast-resistant door leading to the EBH room. A deluge system is provided on the RSM to extinguish fires in the buckets in the unlikely event they should occur as a consequence of propellant ignition (owing, perhaps, to some mechanical stimulus involving sufficient impact or friction).

The buckets are then picked up by a multi-axis robotic arm and moved through a blast-resistant door, where they are placed in the airlock between the ECR and the EBH room. Subsequently, a Fanuc-2000 multi-axis robotic arm in the EBH room picks up the bucket from the airlock using an end effector designed for carrying the buckets. The robot raises the bucket to a platform at approximately the height of the EBHs, from which it is moved by another robotic arm to one of the EBHs. As noted above, two buckets are needed for each rocket processed. The peak target rate, 48 rockets per hour, occurs during VX rocket processing. Thus,  $24 \times 2$ , or 48, buckets transfer through the airlock from each RSM ECR to the respective EBH ECR. This requires one bucket transfer every 75 seconds for each airlock. For GB rocket processing, the peak target rate is 40 rockets per hour, or 20 rockets per RSM per hour. Bucket transfers occur at a peak target rate of 90 seconds from each RSM ECR. According to the system design description, maintenance and other downtime are expected to cut average processing rates to about 30 rockets per hour (15 per RSM) for VX and 25 rockets per hour (12.5 per RSM) for GB.

There are also 24 M56 rocket warheads filled with GB stored at BGAD. These warheads, which are stored in overpacks, will be processed in the RSMs at the end of the GB rocket campaign. Spacers as long as the rocket section that the warhead would normally be attached to in an assembled rocket will be used to facilitate indexing of the warhead in the RSM. It is currently anticipated that the overpacked warheads will be unloaded from the EONC in the TMA and then moved on conveyors into the ECV, where they will be unpacked by personnel in DPE suits and fed onto the rocket input conveyor along with a simulated rocket motor section. The warheads will be processed through the same punch, drain, and washout station of the RSM used for the M55 rockets prior to being sheared and fed to the EBH system. During the preoperational systemization

period for BGCAPP, the handling of these warheads will be tested using simulated warheads that have been modified with ogive sections for a closer approximation of the actual warhead's configuration.<sup>7</sup>

**Finding 3-1.** The cutting of rockets in a way that avoids or minimizes mixing aluminum with propellant will be difficult and could involve high risk of propellant ignition, depending on where Cut 4, which is near the rocket igniter, is made. To minimize the chance of accidental ignition during cutting, it is important to know the dimensional variations that might occur in the position of the rockets inside their firing tubes and in the positioning of the firing tubes themselves. The current plan is to use magnetic detectors to locate the transition between the aluminum warhead and the steel tube holding the rocket propellant and, thereby, to achieve adequate separation of aluminum and propellant in batches transferred to the EBHs.

**Recommendation 3-1.** The use of magnetic detectors to locate the transition between M55 rocket aluminum warheads and the steel tubes holding the rocket propellant may be appropriate to ensure safe and proper cutting, but the technique should be thoroughly demonstrated to guarantee reliability. Also, the safe management of any reactions occurring during hydrolysis of small amounts of propellant and the propellant igniter with aluminum warhead segments in the EBH requires suitable evaluation. Precluding vigorous reactions could eliminate the need for accurate location of the warhead-motor transition point at Cut 4 and the potential ignition hazard associated with cutting near the propellant igniter.

**Finding 3-2.** The committee believes that separating cut rocket segments into buckets containing propellant and buckets containing aluminum warhead segments will require reliable software for managing the robotic feeding of the segments to the EBH system.

**Recommendation 3-2.** Procedures, as well as software protections, should be developed to prevent mistakes such as incorrect mixing of rocket segments when manual overrides are activated during handling system failures or upsets. This can help prevent restarts out of proper sequence.

<sup>7</sup>Bechtel Parsons Blue Grass Team response on March 7, 2005, to the committee's request for information on February 2, 2005.



**Finding 3-3.** The Bechtel Parsons Blue Grass Team plans to demonstrate the processing of M56 warheads during systemization using simulated warheads. Delaying this demonstration until systemization greatly increases the risk that the start of operations could be delayed by the need for design changes.

**Recommendation 3-3.** The efficacy of planned M56 warhead processing should be evaluated in conjunction with the scheduled testing of the modified rocket shear machine prior to systemization.

### ACCESSING OF ENERGETICS IN PROJECTILES

Pallets with 155-mm projectiles containing H and bursters are unpacked by placing the pallets in front of the airlock for the ECV that feeds the ECR containing the LPMD machine. The projectiles are removed from their pallets in the UPA and moved by conveyor into the ECV, where they are placed in trays using a jib crane. The trays loaded with projectiles are then transferred into the ECR through a blast door to the unloading position, where a multiaxis pedestal-mounted robotic arm picks each projectile from the tray and moves it progressively in a nose-up orientation through three disassembly stations in the LPMD machine to remove (1) the nose closure, (2) miscellaneous small parts such as spacers and springs, and (3) the burster. As noted earlier, the LPMD machine was evaluated before selecting a projectile/mortar disassembly (PMD) machine for PCAPP. This evaluation concluded that the baseline PMD machine, a horizontal rotary arrangement of disassembly stations, could be replaced by installing the stations in a row or line, oriented for operation on projectiles that are in a vertical position. The projectiles are moved between these stations using a commercially available multiaxis robotic arm used in assembly lines requiring precise positioning. For BGCAPP, another trade study, TRRP 1, was conducted to confirm the advantage of the LPMD machine over the baseline design (see Table 2-2). This trade study confirmed the efficacy of the LPMD machine for use in BGCAPP (Bechtel Parsons, 2004d).

The projectile body, still containing agent in the cavity between the burster well and projectile body, is transferred by the robotic arm and placed horizontally on a conveyor. It then is conveyed from the ECR through a blast door to a position in the TMA where

another robotic arm lifts and places the projectile body nose up in a tray. When filled, the tray is transferred on roller conveyors into the airlock feeding the MWS room (see Figure 3-1).

Only one of the two ECRs is equipped with an LPMD machine, which will be installed during construction but not used until the H campaign. Before the ECR containing the LPMD machine is used for the H campaign, it will be used to process GB- and VX-containing rockets in the RSM that is also installed in it. During the rocket processing campaigns, the LPMD machine will be covered with a suitable plastic to protect against corrosive process fluids. The installation of both the LPMD machine and the RSM in the ECR during construction will facilitate quick mechanical changeover to H processing at the conclusion of the rocket campaigns.

As many as three projectiles may be in some stage of disassembly at the same time. The metal parts, fuze cups, and burster removed in the LPMD machine stations are moved by conveyor to a bucket similar to that used for rocket segments. The bucket follows the same path that buckets containing rocket segments follow into the EBH room and the EBHs; however, for projectiles there is no requirement for segregation of projectile parts as there is for processing rocket segments, since the projectiles contain no propellant or aluminum.

Reject projectiles in which some part of the disassembly process cannot be accomplished by the LPMD machine are moved to a reject stand by the robotic arm for future manual processing. The current reject stand design allows for up to three rejects to be stored before calling in specialists or explosive ordnance disposal personnel in DPE suits to manually complete disassembly.

**Finding 3-4.** The LPMD machine design for BGCAPP appears to be capable of reliably performing the disassembly of projectiles at the desired rate. It uses established baseline disassembly tools and a commercial robotic handling system with high positioning accuracy.

**Recommendation 3-4.** While the LPMD machine is considered a good candidate for projectile disassembly, it is recommended that it be shop tested and systematized prior to installation to confirm its effectiveness.

## ACCESSING OF AGENT IN PROJECTILES BY MUNITIONS WASHOUT SYSTEM

Agent is removed from projectiles by the cavity access machines (CAMs) of the MWS. The same MWS will be used for GB-, VX-, and H-containing projectiles, with H being the last campaign. Projectiles containing GB or VX are delivered to the MWS room in trays from the NCR room. As previously stated, the nose closures associated with these projectiles were placed in a special container on the projectile trays for subsequent treatment along with the washed-out projectile bodies in one of the MPTs. Also as noted earlier, H projectiles with energetics and nose closures removed will also be transferred by being placed in trays in the TMA and moved on the NCR conveyor feeding the MWS room.

In the MWS room, a Fanuc-2000 multiaxis pedestal-mounted robotic arm enshrouded in a flexible protective cover is used to accomplish the following:

- Lift each agent-containing projectile from a feed tray.
- Place the projectile in a weighing station to ascertain weight and to verify the absence of a burster. (For H projectiles, the LPMD will include a burster probe to verify burster removal. Thus, H projectiles will be tested twice for the absence of a burster.)
- Move and invert the projectile and place it in a CAM for punching the burster well into the

agent cavity, draining of the agent, and high-pressure washing out of the agent cavity.

- Slightly lift and tip the projectile on the CAM drain to remove the final drops of liquid, remove the washed-out projectile from the CAM, rotate it nose up, and place it in the weighing station for a tare weight.

After weighing and determining that the weight reduction is within target values (that is, that less than 2 percent of agent remains), the washed-out projectile is placed by the robotic arm in the discharge tray. If the weight reduction is less than specified, the projectile will be returned to the CAM for additional washout.

The CAM is identical in design and operation to the CAM planned for the Pueblo Chemical Agent Destruction Pilot Plant (PCAPP). It uses a ram to force and bend the burster well up into the agent cavity, allowing liquid agent to drain by gravity to an agent collection tank. The CAM is housed in a booth to reduce decontamination requirements during closure.

After draining liquid agent, 10,000 psig wash water at 110°F is sprayed into the cavity through a nozzle in the burster well ram head to wash out gelled and solid materials. The design is the same as for PCAPP except for a larger size being used for 8-inch projectile bodies. TRRP 5a provides for testing of the MWS system for both 155-mm and 8-inch projectiles. As of February 15, 2005, 155-mm testing had been successfully completed and 8-inch projectile testing was under way.

## 4

# Core Processes for Agent and Energetics Destruction

## AGENT HYDROLYSIS

### Agent Hydrolysis Chemistry

The neutralization of the pure nerve agents GB and VX with caustic (aqueous NaOH) and of mustard agent with water has been extensively studied by the U.S. Army and its support contractors (Yang et al., 1988, 1992; Yang, 1999). The Army and its contractor, Bechtel, had already optimized the hydrolysis process to efficiently destroy the bulk mustard stored at Aberdeen Proving Ground in Maryland. Chemical neutralization with caustic is also being used to destroy the bulk VX stored at Newport, Indiana. Also, earlier National Research Council (NRC) committees involved with the Army's Assembled Chemical Weapons Assessment program reviewed the chemistry and the efficacy of neutralization of these agents with caustic (NRC, 1999, 2000, 2001a, 2001b, 2002a, 2002b, 2002c).

However, because the neutralization of GB by hydrolysis has not been used at any other sites, a technical risk reduction project (TRRP) on GB neutralization for BGCAPP has been initiated. TRRP 2a, GB Neutralization Analytical Methods, is expected to verify process design assumptions, including the efficacy of the batch process, to obtain background kinetics data, and to validate the analytical method detection limits in hydrolysate for degraded GB found in actual stored munitions. Liquid GB and solid GB residues removed from M55 GB rockets that were processed at the Anniston, Ala-

bama, baseline system facility early in 2004 are being used in the tests.<sup>1</sup>

TRRP 2b, H vs. HD Neutralization Analytical Methods, has exactly the same objectives as TRRP 2a but is used for the Levinstein form of mustard agent in the munitions at BGAD. Previous studies had been performed on distilled mustard agent (HD) and HT.<sup>2</sup> In the TRRP 2b tests, samples of liquid H and solid H obtained from 155-mm projectiles stored at Deseret Chemical Depot in Utah are being used. These are the same samples used during ACWA testing of the munitions washout system (MWS) design in June 2003.<sup>3</sup> TRRP 2b has been completed, but the report has not been made available to the committee.

Studies of the neutralization of VX were not needed because they had already been performed in support of the Newport Chemical Agent Disposal Facility design. However, a new TRRP 11 activity, A Hardened Method for Detection of VX in Hydrolysates, was initiated recently to determine an acceptable procedure

<sup>1</sup>E-mail from Yu-Chu Yang, PMACWA, to R.A. Beaudet, committee chair, October 19, 2004.

<sup>2</sup>HD, the pure form of mustard agent, is bis(2-chloroethyl) sulfide. HT is the same but contains 20 to 40 wt% T, bis[2-(2-chloroethylthio)ethyl] ether. HT is prepared by a chemical process that synthesizes the HT directly in such a way that it contains both the HD and T constituents without further formulation. HT freezes at a lower temperature than HD.

<sup>3</sup>E-mail from Yu-Chu Yang, PMACWA, to R.A. Beaudet, committee chair, October 19, 2004.

for measuring the presence of VX in the hydrolysate.<sup>4</sup> Samples of hydrolysate made from VX collected in early 2004 from ton containers at the Newport site are to be used.<sup>5</sup> These samples are presumed to be similar in composition to those in the munitions at Blue Grass Army Depot (BGAD).

Another TRRP activity, TRRP 6, ANS Reactor Material and Corrosion Study, is a trade study that has been completed, but the final report had not been released when this report was prepared.<sup>6</sup> The committee understands that the study confirmed the appropriateness of the original selection of commonly available reactor materials to be used in constructing the agent neutralization system (ANS).

### Agent Collection System

The process for removing agent from projectiles and M55 rockets was described in Chapter 3. The agent drained from the rockets in the rocket shear machine (RSM) and from the projectiles at the MWS is collected in the agent collection system (ACS). The purpose of the ACS is to (1) collect agent drained from the munitions, (2) provide storage for excess agent spill or overflow if needed, and (3) collect the agent wash water from the MWS and RSM. The ACS includes a holding tank for agent and a surge tank. The surge tank is normally empty. Vent gases are directed to the metal parts treater (MPT) offgas treatment system. The agent is collected and remains in the tank until it is sent to the ANS.

The agent wash water from the high-pressure washes performed during MWS and RSM operations is collected in a spent decontamination fluid/agent washout water holding tank. The washout water solution, which consists of water along with some washed-out agent, is added to the agent hydrolyzers as part of the recipe for destruction of the agent that has been drained and washed out of the munition. (Bechtel Parsons, 2004e, 2004f).

The Bechtel Parsons Blue Grass Team has not decided yet how to handle the solids that are present and collected along with the liquid chemical agent in the process. The GB munitions contain crystals of diiso-

propylurea, which is formed by the reaction of the stabilizer, diisopropyl carbodiimide (commonly denoted DICDI), with acid in impure GB. Approximately 5,000 rockets and 3,000 projectiles are expected to have water-insoluble crystals. The crystals are not soluble in the regular process fluids and can plug the lines. In a recent solubility study, the crystals were found to be soluble in alcohols, including isopropyl alcohol, methanol, and isobutyl alcohol.<sup>7</sup>

The Bechtel Parsons Blue Grass Team has initiated laboratory tests under TRRP 2a, Phase 2, to study the effect of dissolving the crystals in isopropyl alcohol on the reaction parameters and the downstream processing equipment. Alternative methods of treating the crystals will be studied. As this report was being prepared, the plan was to separate the crystals and send them directly to the MPT for destruction.

Earlier studies reported finding a gel in some GB munitions. However, no gel remains in the munitions after washout. Thus, if gel were to be present in a munition, it would be washed out by the hot water.

GB taken from rockets at the Anniston, Alabama, site also contains some debris made up of fiberglass fibers, polymers, and white and grey dust (Rosso et al., 2005). The mustard projectiles also contain particles of iron, sulfur, and several minor solid contaminants that must be separated from the agent liquid. Strainers are proposed to remove the particles from the liquid streams from the RSMs and the cavity access machines of the MWS. The strainers that catch the particles will be periodically changed out by personnel in DPE and placed in a container for transfer to the MPT for decontamination or destruction.

### Agent Neutralization System

The purpose of the agent neutralization system is to (1) neutralize the chemical agents, (2) process agent-contaminated spent decontamination solution and MPT condensate, (3) sample and analyze the hydrolysate to ensure a destruction level of 99.9999 percent, and finally, (4) transfer agent-cleared hydrolysate to the hydrolysate storage tanks to await further treatment in the supercritical water oxidation (SCWO) system.

The process flow diagram is given in Figure 4-1. Two complete ANS lines are required to handle peak throughput rates for agent. Design parameters and

<sup>4</sup>John Ursillo, Bechtel, presentation to the Intermediate Design Review, on February 7-10, 2005.

<sup>5</sup>E-mail from Yu-Chu Yang, PMACWA, to R.A. Beaudet, committee chair, October 19, 2004; John Ursillo, Bechtel, presentation to the Intermediate Design Review, February 7-10, 2005.

<sup>6</sup>John Ursillo, Bechtel, presentation to the Intermediate Design Review, February 7-10, 2005.

<sup>7</sup>John Ursillo, Bechtel, presentation to the Intermediate Design Review, February 7-10, 2005.

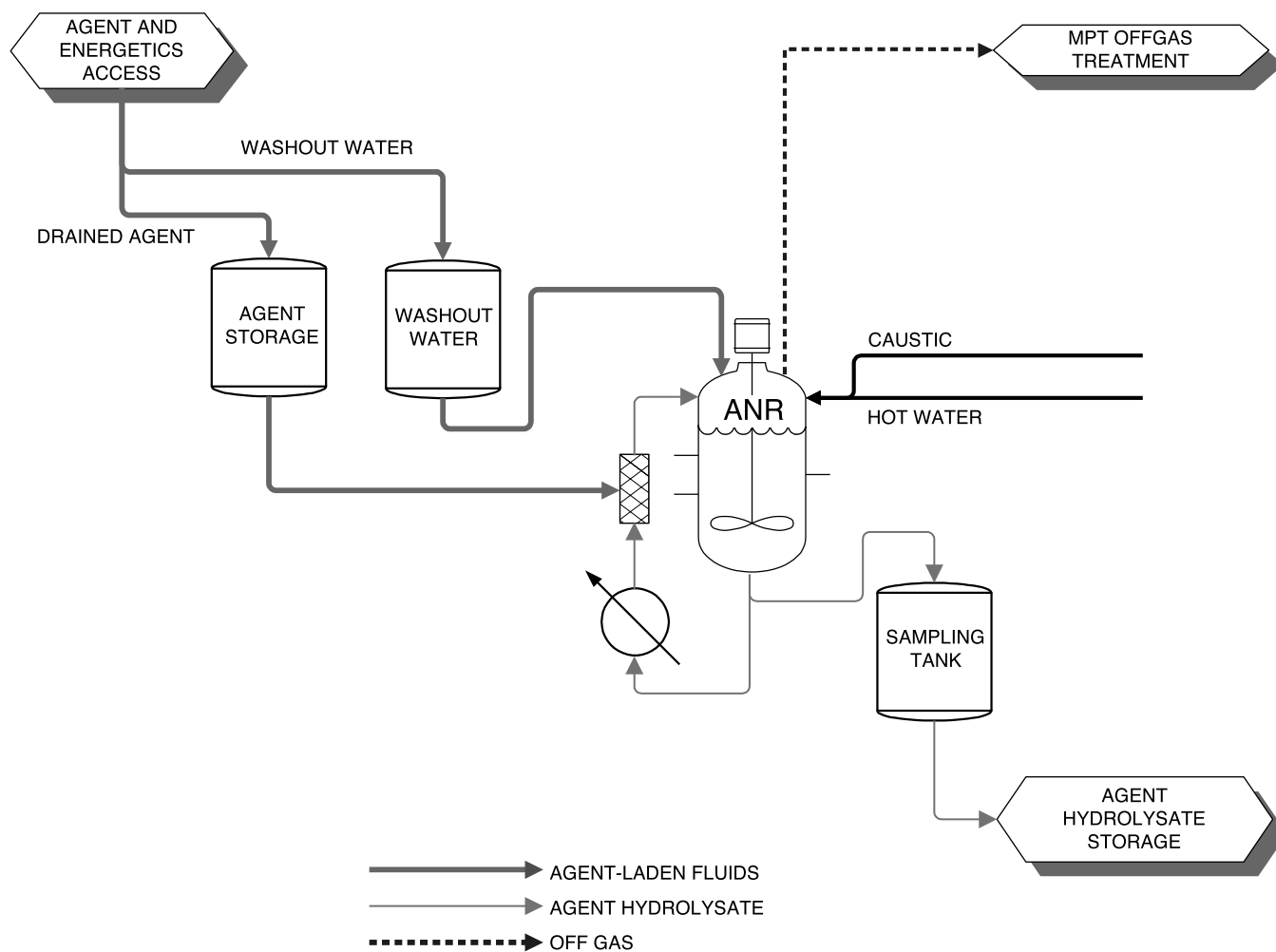

FIGURE 4-1 Flow diagram for the agent neutralization system. SOURCE: Chris Haynes, “BGCAPP MDB Intermediate Design,” briefing to the BGCAPP MDB Design Review, on February 15, 2005.

specifications for the hydrolysis of each type of agent are given in Table 4-1.

At the start of an agent processing cycle, an agent neutralization reactor (ANR) is charged first with demineralized water. The prescribed amount of caustic solution is then added if GB or VX is being treated. Any contaminated wash waters are added next. Finally, over the next 20 minutes, agent from the agent concentrate holding tank is added. The contents of the ANR are both stirred and recirculated to maintain good mixing. The target concentrations for the three agents and the prescribed conditions and processing time for each agent are shown in Table 4-1.

When mustard agent is being processed, only water is used as the neutralization medium and HCl is gener-

ated by hydrolysis. Caustic is added after 45 minutes to react with the HCl and bring the pH to 10.5. During the next 30 minutes, small amounts of caustic are added to maintain the pH at 10.5 while the hydrolysis of reaction intermediates and byproducts, mainly linear sulfonium ions, continues.<sup>8</sup>

If mustard agent or GB is being treated, the hydrolysate is transferred to a 2,000-gallon sampling tank when the reaction is completed. The agitated sampling tank holds two batches of hydrolysate. The holding tanks with the recirculating sampling loop are continuously

<sup>8</sup>E-mail from Yu-Chu Yang, PMACWA, to R.A. Beaudet, committee chair, April 7, 2005.

TABLE 4-1 Agent Neutralization Parameters

	Agent		
	GB	VX	H
Agent process feed concentrations			
Agent (wt%)	7.5	16.6	8.6
Caustic (wt%) (from 50% NaOH)	11.34	17.44	Added after to adjust pH to 10-12
Water (wt%)	81.16	65.96	91.4
System parameters and performance specifications			
Operating temperature (°F)	140	194	194
Peak rate baseline (units per hour)	40 GB rockets 15 GB projectiles	48 VX rockets 26 H projectiles	26 H projectiles
Peak rate (lb agent/day) <sup>a</sup>	15,540	15,379	7,301
Total time per batch (min)	168	516	243
Batches per reactor per day	6	2.5	2.5
Total weight of agent to be destroyed (tons)	305.7	127.2	90.63
Maximum agent concentration to achieve 99.9999% destruction efficiency (ppb)	75	160	85

<sup>a</sup>The peak rate is the maximum expected rate during a campaign. Normal operating rates will be lower. Peak rate agent volumes have been multiplied by a safety factor of 1.25 for the purpose of sizing the tanks and other critical materials handling equipment. The total number of batches per day is less than what can be processed in 24 hours, again providing a design safety margin.

SOURCE: Bechtel Parsons, 2004e.

stirred to prevent the solution from separating into two phases and to allow a representative sample to be obtained. The contents are analyzed to verify that the agent concentration is destroyed to 99.9999 percent of the original amount. The maximum agent concentrations allowed in the hydrolysates to satisfy this destruction and removal efficiency are given in Table 4-1.

Upon verification that the agent concentration is below the limit to achieve 99.9999 percent destruction, the hydrolysate is transferred to one of the tanks in the hydrolysate storage area. In contrast to the sampling protocol for H and GB, wherein samples are taken from a sampling loop attached to the ANR, the VX hydrolysate is sampled directly in the ANR. If the VX concentration in the hydrolysate indicates 99.9999 percent destruction, the hydrolysate is transferred directly to a storage tank that is continually stirred and recirculated to prevent the aqueous and organic layers from sepa-

rating.<sup>9</sup> The hydrolysates are stored until they are treated in the SCWO units.

### Analysis Issues Concerning Agent Destruction Removal Efficiency

Determining the concentration of GB in the hydrolysate has been problematic. Battelle used a method that involved neutralization of the hydrolysate, extraction of the organic components into an organic solvent (chloroform, methylene chloride, or hexane), and determination of the GB content by a gas chromatograph/mass selective detector. TRRP 2a, GB Neutralization Analytical Methods, was initiated when GB was de-

<sup>9</sup>John Ursillo, Bechtel, "Process design overview (Blue Grass)," briefing to the committee on September 22, 2004.

ected in the hydrolysate of a sample that should have had no detectable GB based on the kinetics of decomposition of GB in caustic at elevated temperature.<sup>10</sup>

Preliminary studies undertaken for TRRP 2a indicate that reformation of GB does not take place when the pH of the aqueous phase (hydrolysate) is high or even near neutral. Tests indicated that GB reformation in organic extracts began above 190°C. It was found that reformation was occurring in the gas chromatograph/mass selective detector injector, where a high temperature is used to flash-vaporize the analyte. A modified procedure was developed using a Hewlett-Packard cool-on column capillary injector that does not heat the analyte and avoids GB reformation. The analyte is heated directly by the column at well below 190°C. The new procedure was confirmed with GB recovery studies, and reliable measurements were obtained, showing that no GB reformation occurs in hydrolysates at neutral or high pH.<sup>11</sup>

Similar analytical problems exist with the analysis of VX in the hydrolysate. Originally, the Bechtel Parsons Blue Grass Team hoped this problem would be resolved at Newport, but now has initiated TRRP 11, VX Hydrolysis Analytical Methods Test, to resolve this issue. The analysis of mustard agent in the hydrolysate does not pose any problem.

When nerve agent hydrolysates are transferred from the munitions demilitarization building (MDB) to the agent hydrolysate storage tanks, the pH will be above 10. VX and GB hydrolysates will be stored at a pH of between 11 and 13.<sup>12</sup> Thus, there is no possibility that the agent will be reformed. Caustic will be added to the mustard agent hydrolysate to neutralize the HCl generated by the hydrolysis and to promote the decomposition of intermediates formed in the hydrolysis of H. Then, more caustic will be added to adjust the pH to between 10 and 12.

**Finding 4-1.** Given the experience of the Army's chemical demilitarization program with mustard hydrolysis at Aberdeen, Maryland, VX hydrolysis at

Newport, Indiana, and prior laboratory testing with all agents, including GB, the hydrolysis (neutralization) of these agents at BGCAPP should pose no insurmountable difficulties.

### **Potential Contamination of Mustard Agent with Mercury**

Mercury has been found in HD at other locations, including at Deseret Chemical Depot, Utah. Several theories exist for its source, including contamination from mercury diffusion vacuum pumps used in the distillation, mercury from broken manometers that were allowed to contaminate the HD, and residual mercury in containers that were used for HD storage. Insufficient Levenstein mustard has been sampled at Deseret Chemical Depot to predict the mercury concentration in the mustard agent hydrolysate that will be produced at BGCAPP and how much would be volatilized into the offgas streams. An unexpectedly high concentration of mercury in the offgas streams or hydrolysates might impact the BGCAPP design or delay its start-up. Also, the form of the mercury in the Levenstein mustard is unknown and cannot be predicted, since the mercury may have undergone transformation during storage.

**Finding 4-2.** The form of the mercury and its concentration in the Levenstein mustard is unknown at this time.

**Recommendation 4-2.** A design analysis should be performed to determine the potential impact of mercury in the Levenstein mustard on the operation or permitting of BGCAPP. One scenario that should be evaluated is the impact of mercury if the Levenstein mustard stored at BGAD contains mercury in concentrations as high as those observed for HD and HT at other locations.

## **ENERGETICS HYDROLYSIS**

### **Energetics Hydrolysis Chemistry**

Caustic hydrolysis is the basic process used in the BGCAPP design for the destruction of the rocket propellant grains and the other energetics (igniters, fuzes, and bursters). This technology was previously demonstrated to be suitable for the destruction of the energetic materials in the stockpile at BGAD (NRC, 2002a). The particular means of implementing caustic hydrolysis at BGCAPP is the energetics batch hydrolyzer

<sup>10</sup>John Ursillo, Bechtel, "Process design overview (Blue Grass)," briefing to the committee on September 22, 2004.

<sup>11</sup>John Ursillo, Bechtel, presentation to the Intermediate Design Review, February 7-10, 2005.

<sup>12</sup>U.S. Army responses on November 15, 2004, to committee questions from the September 22-24, 2004, meeting.

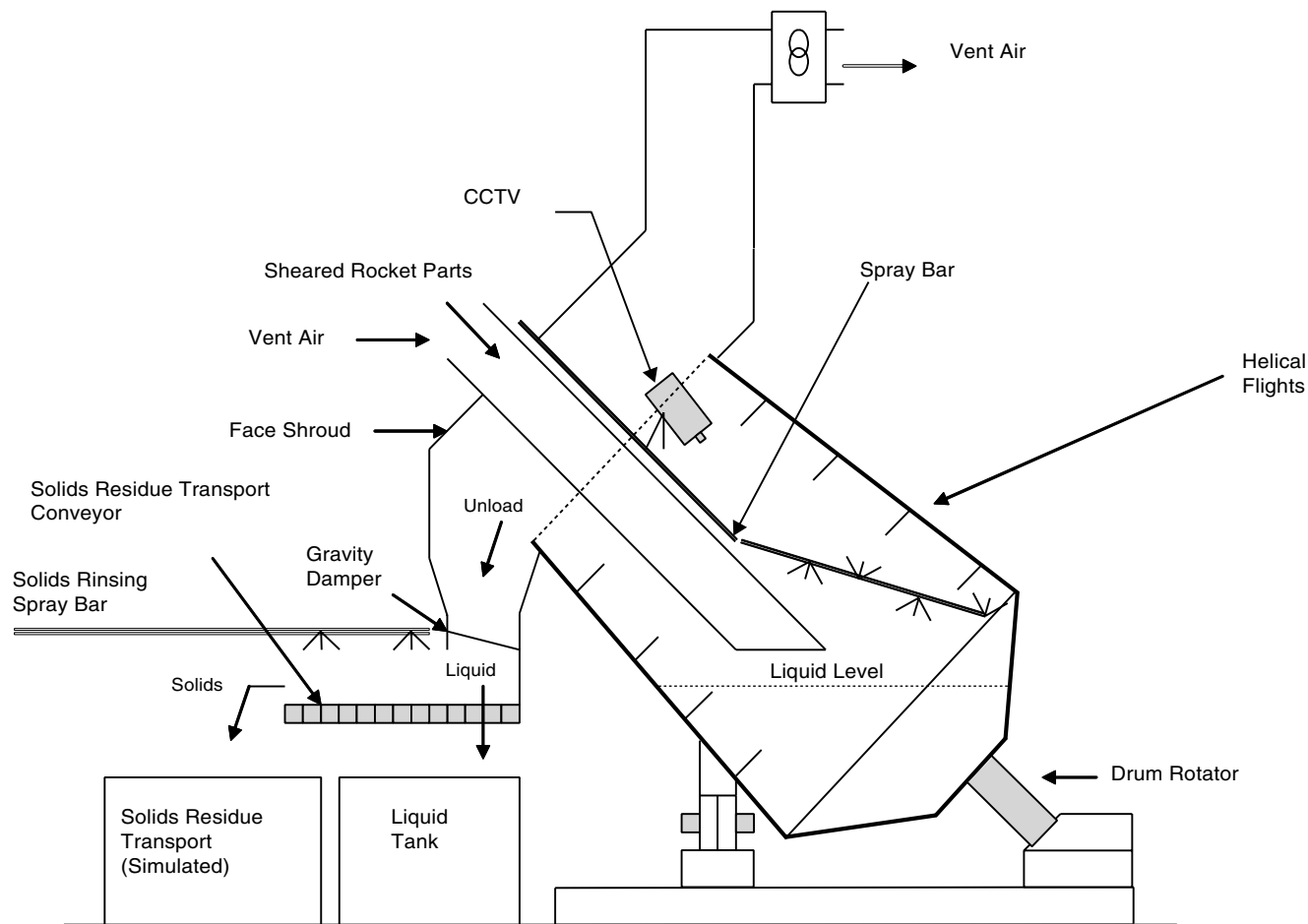

FIGURE 4-2 Drawing of EBH design for BGCAPP. SOURCE: John Ursillo, Bechtel, "Process design overview (Blue Grass)," briefing to the committee on September 22, 2004.

(EBH), which is described in detail below and shown schematically in Figure 4-2. The specific conditions to be used for the EBHs were selected based on the outcome of the EBH hydrolysis tests performed at Tooele Army Depot (Bechtel Parsons, 2004g) and on testing performed for the energetics rotary hydrolyzer designed to process energetics at the Pueblo Chemical Agent Destruction Pilot Plant.<sup>13</sup> The latter included testing of the hydrolysis reactions of the energetics rotary hydrolyzer in a single-flight reactor at the Tooele Army Depot for the Demo 1 phase of the Assembled Chemical Weapons Assessment program and later testing while the reactor was located at Dugway Proving Ground for the engineering design studies phase of the

program.<sup>14</sup> This testing is applicable to the EBH design proposed for BGCAPP.

At the start of each cycle, each EBH is charged with water and 50 percent NaOH to give a concentration of 39.5 percent caustic. The EBHs are operated at 122°C for the propellants and at 117°C for the burster materials. Testing at Tooele Army Depot confirmed that hydrolysis of rocket motor propellant is completed in less than 3 hours at these temperatures and that hydrolysis of the energetics from the warhead is complete in less than 45 minutes (Bechtel Parsons, 2004g).

The energetic materials to be treated at BGCAPP are listed in Table 4-2. The bulk of the energetics comes

<sup>13</sup>Deseret Chemical Depot was split off from Tooele Army Depot and remains a separate entity today.

<sup>14</sup>Bechtel Parsons Blue Grass Team responses on January 12, 2005, to committee questions of January 6, 2005.



TABLE 4-2 Energetic Materials in BGAD Chemical Munitions

Munition/Component	Energetic Material	Composition
M55 rockets/rocket motor	M28 propellant	60.0% nitrocellulose 23.8% nitroglycerin 9.9% triacetin 2.6% dimethyl phthalate 2.0% lead stearate 1.7% 2-nitrodiphenylamine
M55 rockets/igniter	M62 igniter pellets	49% magnesium 49% potassium perchlorate 2% cellulose nitrate-camphor (MIL-B-10854)
	M2 electric squib flash charge	32% lead thiocyanate 40% potassium chlorate 18% charcoal 10% Egyptian lacquer
M55 rockets/ M417 point detonating fuze	NOL primer mix (upper lead charge)	40% lead styphnate 20% lead azide 20% barium nitrate 15% antimony sulfide 5% tetracene
	Lead azide (intermediate charge)	100% lead azide
	M63 stab detonator (lower charge)	98% RDX 2% calcium resinate-graphite
	RDX (booster pellet and booster lead charge)	100% RDX
M55 rockets/burster	Composition B	60% RDX 39% TNT 1% wax
M110 projectiles/burster	Tetrytol	70% tetryl 30% TNT

SOURCE: Meyer et al., 2002; U.S. Army, 1962, 1965, 1966.

from the M55 rockets, each of which contains over 19 pounds of M28 propellant and over 3 pounds of Composition B. In contrast to this, the only projectiles that contain energetic materials are the mustard-loaded M110 projectiles, which have about 0.4 pounds of tetrytol in the steel-walled M6 burster.

The main gaseous products of the energetics hydrolysis are ammonia, nitrogen, carbon monoxide, and volatile hydrocarbons. Other main products of hydrolysis that have been identified are nitrate, nitrite, acetate and formate salts, and glycerol (when propellant is being processed). However, considerable quantities of unidentified carbonaceous compounds remain in the hydrolysate. The exact nature of these has not been established; in the case of explosives containing TNT or tetryl (Composition B and tetrytol), some of them are ill-defined aromatic compounds. The exact identity of these species is not in itself important, but it is impor-

tant that they not be energetic materials. The hydrolysis process is effective in counteracting the hazard associated with the energetic nature of the energetic materials being treated (NRC, 2002a).

To address the issue of any latent explosion hazard from the hydrolysate, a differential scanning calorimetry method is currently under development for the analysis of residual energetic materials in the hydrolysate. This method gives an indication of possible exothermic decomposition reactions in the hydrolysate, in recognition of the fact that even if there is no TNT or RDX or tetryl present, there might still be an explosion hazard from partially decomposed energetic materials. At the time this report was prepared, no final report was available to the committee on the differential scanning calorimetry method to be used to clear the energetics hydrolysate for transfer to the energetics hydrolysate storage tanks.

## EBH Input Streams

Following shearing of the M55 rockets in the RSM, the propellant segments are still encased in sections of the steel rocket motor body and surrounded by sections of the fiberglass shipping tube. All of these components are put into the EBHs. The steel body and the fiberglass sections are essentially unaffected by the hot caustic in the EBHs. The igniter assembly is encased in perforated polyethylene sheeting, which allows the caustic to contact the energetics in the igniter. The aluminum warhead assembly in the M55 rocket has a two-part burster system containing Composition B. The smaller M36 burster assembly is in a plastic casing, and the larger M34 burster is in a steel tube. The M417 point detonating fuze contains a variety of energetic materials in the fuze train (see Table 4-2), contained in an aluminum housing.<sup>15</sup> Testing under TRRP 5b-1 showed that some of the explosive charges of the M417 fuze remain intact during their residence time in the EBH. The explosive-containing steel rotor assembly is to be processed with the rest of the warhead solid materials through a heated discharge conveyor (HDC), which is designed to withstand the exothermic decomposition (“popping”) of the explosive charges. The resulting waste would then be suitable for disposal in accordance with the BGCAPP permits.<sup>16</sup>

In addition to the energetic portions of the warhead sections that are treated in the EBHs, the tail fins, fore and aft end caps, and warhead bodies are made of aluminum and will also react with the caustic to form aluminates and elemental hydrogen.

As long as the pH is high, the aluminum will stay in solution in the hydrolysate. However, corrosion considerations require that the pH be lowered. This is achieved by the addition of hydrochloric and sulfuric acids. At the lower pH, aluminum salts precipitate from the solution and are removed by filtration.

The composition of the feed to the EBHs during processing of M55 rocket segments as described above

<sup>15</sup>The fuze train contains a rotor assembly that is predominantly steel. Within the rotor assembly are two charges in series. The forward charge contains primary explosives (lead azide, lead styphnate, and RDX); the aft charge contains RDX. Both charges are encased in crimped copper tubes sealed with a waterproofing material that is also impervious to caustic.

<sup>16</sup>Bechtel Parsons Blue Grass Team responses on May 2, 2005, to committee questions of April 25, 2005.

gives rise to a propellant ignition issue. During one of the TRRP studies in which propellant was being hydrolyzed in the presence of aluminum, the propellant ignited on a few occasions.<sup>17</sup> These ignitions were nonpropagating and were never observed when aluminum was not present. The Bechtel Parsons Blue Grass team has postulated that the highly exothermic reaction of the aluminum in the caustic, which generates hydrogen gas and aluminum-containing salts, can produce enough heat locally to cause the propellant to begin burning briefly. The proposed solution to this problem is to (1) locate the cuts in the rocket motors so that little or no propellant is present in the segments that have aluminum parts and (2) hydrolyze the propellant completely before adding any aluminum parts to the EBHs. The process by which this is done is described below. The problem does not occur with projectiles because they do not contain propellant.

## Energetics Process Flow

As described in Chapter 3, when rockets and projectiles are disassembled, the energetic materials are segregated from the agent in the explosion containment rooms (ECRs) and the items containing energetic materials are placed in specially designed buckets, which are picked up by a robotic arm and moved into an airlock between the ECR and the EBH room. Other robots in the EBH room pick up the buckets from the airlock, raise them to a platform at the approximate level of the EBHs, and deposit them on the platform. One of two robotic arms, which are attached to separate monorails that run parallel to the row of EBHs, picks up the bucket and moves it to the inlet chute of one of the EBHs. The parts are dumped into the inlet chute and fall into the EBH, which has previously been charged with water and caustic and heated to give the desired concentration at the desired temperature.

The design for BGCAPP comprises two EBH rooms, each of which contains eight EBHs in a row. Each RSM is paired with an EBH line. The two EBH rooms are mirror images of each other and are separated by a blast containment wall.<sup>18</sup> As shown in Figure 4-2, each EBH

<sup>17</sup>John Ursillo, Bechtel, “Process design overview (Blue Grass),” briefing to the committee on September 22, 2004.

<sup>18</sup>As this report was being prepared, the PMACWA and the Bechtel Parsons Blue Grass Team were discussing the possibility of eliminating one EBH line and having the remaining one serve both RSMs.

is a rotating drum, 10 feet wide by 18.5 feet long, mounted at an angle (like a cement mixer), with a discontinuous helical flight to agitate the items containing energetics. The EBH is fitted with an inlet chute through which the energetics are introduced and an outlet chute through which hydrolysate and solid materials are discharged. The solids, consisting of metal and plastic parts from munitions and fiberglass shipping tube parts, are discharged onto a conveyor that carries them to a bucket elevator and metering screw feed system. The metering screw feed system discharges the solids onto the HDC. The hydrolysate is transferred through a Johnson screen to a 2,000-gallon hydrolysate collection tank (Bechtel Parsons, 2004h). The EBH drum rotates in one direction while the energetics are being processed; then the direction of rotation is reversed to discharge either the metal parts only if the rate of rotation is slow or the hydrolysate if the rate of rotation is fast.

The rockets contain both propellants and explosives, in contrast to the H projectiles, which contain explosives only in the bursters. When rockets are being processed, the rocket motor segments (containing propellant) produced by the RSM are placed in one bucket and the warhead segments (including energetics) are placed in another, together with the aluminum fins from the preceding rocket. This segregation of propellant and aluminum is necessary because, as noted in the preceding section, the Bechtel Parsons Blue Grass Team observed during testing that propellant could ignite in the hydrolysate if aluminum-containing parts were processed at the same time as the propellant. However, in TRRP 5b-1 tests, it was found that propellant hydrolysate that contained little or no residual propellant could be used to destroy the warhead energetics with no ignitions of energetic material in the EBH. The approach

for charging feed materials to the EBHs, which reflected this TRRP testing, is described below (Bechtel Parsons, 2004c).

A graphical representation of the timing of the delivery of energetics to the EBHs is given in Figure 4-3. Following the filling of two EBHs with caustic over a period of 30 minutes, one bucket filled with the parts from one rocket motor is delivered to EBH-1, and another bucket filled with the warhead parts and fins is delivered to EBH-2. Over a 2-hour period and at a planned peak operating rate of 24 VX rockets per hour, there will be 48 deliveries each to EBH-1 and EBH-2—that is, 48 bucketfuls of rocket motor parts to EBH-1 and 48 bucketfuls of warhead parts and fins to EBH-2. At the end of this 2-hour period, the next batches of rocket motor parts and warhead energetics/fins are delivered over the next 2-hour period to another pair of EBHs (EBH-3 and EBH-4). At the end of the second 2-hour period, the next pair of EBHs, EBH-5 and EBH-6, are loaded. After a total of 6 hours, the processing of the warhead energetics in EBH-2 is complete, the hydrolysate and residual solids have been removed, and the EBH has been refilled with caustic. Over the next 2 hours, 48 bucketfuls of rocket motor parts are delivered to EBH-2, while the corresponding deliveries of warhead energetics and fins go to EBH-7. Eight hours after the first rocket motor parts were delivered to EBH-1, EBH-4 is ready to receive rocket motor parts and EBH-1 is ready to receive warhead energetics and fins. Thus, over a 14-hour cycle, as summarized in Table 4-3, and at the planned peak operating rate of 24 VX rockets per hour, the propellant and warhead energetics from a total of 48 rockets will be destroyed in a given EBH.

When the RSMs are operating at the planned peak rate of 20 rockets per hour for GB and 24 rockets per

Process Sequence for Hydrolysis of Energetics from M55 Rockets at Peak Operating Rate																	
Hr EBH	1	2	3	4	5	6	7	8	9	10	11	12	13	14			
1	CF	Load RM	Process RM				US	Load WH	Process WH			US	UL				
2	CF*	Load WH	Process WH		US	UL	CF	Load RM	Process RM					US			
3			CF	Load RM	Process RM				US	Load WH	Process WH		US	UL			
4			CF*	Load WH	Process WH		US	UL	CF	Load RM	Process RM				US		
5					CF	Load RM	Process RM				US	Load WH	Process WH		US	UL	
6					CF*	Load WH	Process WH		US	UL	CF	Load RM	Process RM			US	
7							CF*	Load WH	Process WH		US	UL	CF	Load RM	Process RM		US

FIGURE 4-3 Peak VX EBH processing cycle. The caustic fill step marked by an asterisk is performed only when warhead segments are loaded first during the start of EBH processing, resulting in an initial cycle length of 14.5 hr: CF, caustic fill; US, unload solids; UL, unload liquid. SOURCE: Developed from “BGCAPP MDB Intermediate Design,” briefing to the BGCAPP MDB Design Review on February 15, 2005.

TABLE 4-3 EBH Processing Cycle Sequence for M55 Rocket Parts

Start Time	Duration (hr:min)	Operation
0:00	0:30	Fill EBH with caustic
0:30	2:00	Add rocket motors
2:30	5:30	Process rocket motors
8:00	0:30	Unload remaining solids from rocket motors
8:30	2:00	Load energetics from warheads
10:30	2:30	Process energetics from warheads
13:00	0:30	Unload remaining solids from warheads
13:30	0:30	Unload hydrolysate from EBH
14:00		End of cycle

SOURCE: Bechtel Parsons, 2004c.

hour for VX, seven of the eight EBHs in each line will be in use. The eighth is to be used as a spare, in case there are mechanical problems with one of the other seven. This will allow repairs to be deferred and performed with other routine maintenance of the EBHs, and will prevent the processing of energetics from being interrupted.

The average processing rates are expected to be 12.4 and 14.9 rounds per hour for GB and VX rockets, respectively. In the throughput and availability analysis (Bechtel Parsons, 2004c), it is assumed that the length of time needed to complete destruction of the M28 propellant is 3 hours after introduction of the propellant into the EBH, and of Composition B, 2 hours (Bechtel Parsons, 2004g). The residence time of the propellant in the EBH, as shown in Table 4-3, greatly exceeds the time required for destruction of its energetic components. In the case of Composition B, it is assumed that 2 hours will be required for complete destruction of the energetics, but 3 hours (2.5 hours processing time with an additional 0.5 hour during which the metal parts are unloaded) are allowed. In any case, the assumption of 2 hours is itself conservative, since testing at Tooele Army Depot showed that the energetics are consumed in less than 45 minutes at the planned operating temperature. Therefore, by the time the hydrolysate is removed from the EBH, all of the energetics should have been destroyed.

At the end of the propellant processing step, the solids (shipping tube segments and rocket motor segments plus miscellaneous metal parts) are removed from the

EBH by reversing the direction of the rotation and rotating the EBH slowly. The hydrolysate drains through the discontinuities (gaps) in the helical flight and remains in the EBH to be used for processing warhead energetics. The solids are pushed through the outlet chute onto a horizontal motion (slip) conveyor that is part of the EBH solid residue collection and transfer system. EBH operations were tested successfully in a full-scale mockup in TRRP 5b-2a, described in Table 2-2. Any liquid that is carried out with the metal parts drains off through Johnson screens in the outlet chute and is collected in a hydrolysate collection tank. At the end of the conveyor, the solids fall into a collection bin that is then raised by the solid residue transport system and tipped to deliver the solid residue into the HDC feed system. Here, an auger is used to meter the solids onto the HDC so that they are spread out on the conveyor. This particular transfer approach is being tested as part of TRRP 5b-2b. Test results were not available at the time this report was being prepared.

The metal parts and other solids are carried along the HDC, which is an electrically heated bucket conveyor, under a 600 pound per hour nitrogen gas purge stream, during which time they are subjected to 1000°F for 15 minutes to make them suitable for unrestricted release. At the end of the HDC, they are deposited on a cooling conveyor, from which they are transferred to a collection bin for removal and disposal. Operation of the HDC is being demonstrated as a part of TRRP 5b-1, as described in Table 2-2. Test results were not available at the time this report was being prepared.

After the residual solids from the rocket motors have been removed from the EBH, the hydrolysate remaining in the EBH is used for processing of warhead segments and the fin section. The main advantage of this cascading is that it produces a hydrolysate that has better flow characteristics than the hydrolysate that is produced from treatment of the propellants alone. At the end of the propellant processing step, there is a thick layer of cellulosic sludge floating on the surface of the hydrolysate. This sludge is broken down during the additional time required for the warhead energetics hydrolysis, and the resultant hydrolysate is all liquid.<sup>19</sup> This processing scheme is consistent with the need to destroy the propellant in the absence of aluminum and does not require separate EBHs dedicated to propellant

<sup>19</sup>Bechtel Parsons Blue Grass Team, "EBH system common drum for sequentially processing rocket motor propellant and warhead explosive," White Paper-015, Rev. 0, June 3, 2004.

processing or warhead energetics/aluminum parts processing.

At the end of the warhead energetics/aluminum parts processing step, the residual solids (burst tubes and steel parts from the fuze, at this point) are removed by reversing the direction of rotation of the drum and slowly rotating it to deliver the solids onto the EBH solid residue conveyor, as was done for the rocket motor parts. When the bulk of the solids has been removed, the rate of rotation is increased and the hydrolysate is pushed out of the EBH, where it drains through the screens in the outlet chute and is collected in a 2,000-gallon hydrolysate collection tank. The hydrolysate from several EBH cycles is accumulated in the collection tank and subsequently transferred to an energetics neutralization reactor (ENR). Each EBH line has one hydrolysate collection tank and three ENRs, each with a working capacity of 4,785 gallons.<sup>20</sup>

After the hydrolysate has been moved to one of the ENRs, it is analyzed for the presence of energetics and agent. If the analyses show that the hydrolysate has sufficiently low concentrations of energetics and agent (agent levels below those specified in Table 4-1; energetics below a level still to be determined), it is pumped to one of the hydrolysate storage tanks for later treatment in the SCWO reactors. If the analysis indicates the presence of energetic material or agent in excess of an acceptable level, the hydrolysate is treated in the ENR for 1 hour, then reanalyzed.<sup>21</sup> This process is repeated until the hydrolysate meets the standard for release to the hydrolysate storage area. The residence time of the energetic materials in the EBHs is long enough that they should all be consumed there, so it is unlikely that additional processing of the hydrolysate in the ENRs will be necessary. However, the ENRs have been designed as actual stirred reactors rather than simple holding tanks. Therefore if a sample of hydrolysate, containing some energetic does get through the EBH, it would not be necessary to pump the hydrolysate back to an EBH; instead, it could be further processed in the ENR.

The processing of energetics from projectiles is analogous to the processing of the energetics from the

rockets, but there is no propellant to be treated. The caustic concentration, processing temperature, and processing time are the same for projectile bursters as they are for the warhead segments of the rockets. Whereas two EBH lines will be run during the processing of M55 rockets, only one will be in operation during the processing of M110 projectiles, since only one ECR will be reconfigured for projectile handling (Bechtel Parsons, 2004h). The peak rate is projected to be 26 rounds per hour. At this rate, only two EBHs will be needed to handle the energetic materials. Energetics will be loaded into one of the two EBHs over a 20-hour period, which is followed by a 3-hour processing period, a 30-minute discharge period, a 30-minute period for recharging the EBH with caustic, and a 16-hour standby period.

**Finding 4-3.** There is the opportunity at several points in the hydrolysis operations of the BGCAPP process for single point failures to interrupt the process flow. For example, the use of a single robot to transfer buckets through the blast door to the EBH ECR or from the blast door to the EBH bucket transfer platform and of a single discharge conveyor, screw feeder, and HDC to service each line of eight EBHs could lead to the shutting of an entire line if there is a problem in any of those systems.

**Recommendation 4-3.** The selection of equipment and the configuration of the EBHs and HDCs and related systems should be reviewed to ensure the soundness of the estimates of throughput and availability.

**Finding 4-4.** The destruction of energetics in the EBHs is likely to be complete, making the ENRs as stirred reactors superfluous. However, if the ENRs are dispensed with, some storage capacity would still be needed to hold the hydrolysate until it has been cleared for release to the hydrolysate storage area.

**Recommendation 4-4.** The Army should consider retaining a single ENR per EBH line and two or more storage tanks in the energetics neutralization system instead of the six ENRs now in the BGCAPP design.

**Finding 4-5.** There is great variability in the sizes of the solid parts discharged from the EBHs, ranging from the large fiberglass shipping tube and rocket motor case segments to the small wires, springs, and screws. Limited testing has been done on the interface between the

<sup>20</sup>Bechtel Parsons Blue Grass Team, "Munitions demilitarization building energetics neutralization process flow diagram," drawing No. 24915-070M5-ENS-00001.

<sup>21</sup>Bechtel Parsons Blue Grass Team response on January 12, 2005, to committee questions of January 6, 2005.

EBHs and the HDCs to ensure that the small parts do not cause reliability problems in the transfer system.

**Recommendation 4-5.** The transfer system (TRRP 5b-2b) between the EBH discharge conveyor and the HDC should be tested with a representative mix of parts to verify that it can handle the range of solids expected from the EBHs.

The Bechtel Parsons Blue Grass Team has not included redundancy for some of the commercial robotic arms that will be used in the process or for some other elements such as the HDC. These units then become serial units whose failure stops the entire process in which they operate. For BGCAPP, this vulnerability is offset somewhat by the use of parallel process trains, so that failure of a robotic arm in one train shuts down only that train. The Bechtel Parsons designers have assigned very high availability and rapid cycle times to these units. Tests are ongoing to demonstrate the cycle time capability, but these tests are not being conducted in the environment that will exist in BGCAPP, where the robotic arms will be in rooms that undergo occasional decontamination wash downs so that they can be accessed for maintenance. The robotic arm manufacturer intends to house the arms in plastic suits to prevent the decontamination chemicals from contacting critical equipment in the arm operating system.

**Finding 4-6.** The committee is concerned that the high availability predicted for the robotic arms may be overly optimistic in light of the operating environment and ease of maintenance allowed by the BGCAPP design. This optimism could lead to the expectation of unrealistically high throughput rates.

**Recommendation 4-6.** Robotic arm operation should be evaluated in similar environments to confirm the high availability assumed in the throughput analysis and to identify any added design measures that need to be taken to achieve the desired availability.

In BGCAPP, energetics hydrolysis is performed in two separate ECRs, each housing eight EBHs, an inertial conveyor, an elevating and metering mechanism for feeding solid parts of the rockets and projectile bursters to a heated discharge conveyor, an HDC, and a cooling conveyor. All of these units are housed inside the ECR and are serial. There is one spare EBH in each

line at maximum throughput, but aside from this, a breakdown in any unit in either line will stop the entire hydrolysis operation on that line or severely limit its throughput rate. Much of this equipment has been subjected only to proof-of-principle operational tests in mock-ups for TRRP 5b-2a (Bechtel Parsons, 2004i) and those planned for TRRP 5b-2b (Bechtel Parsons 2004j). Long-term availability performance will not have been demonstrated by the time operations start up. Moreover, the many pieces of mechanical equipment in the ECR may require frequent downtimes for maintenance.

**Finding 4-7.** Maintenance requirements have been addressed in the three-dimensional modeling and layout of the ECRs to ensure that personnel will be able to access parts to repair or replace them, but it seems doubtful that these measures could prevent serious shortfalls in availability should extended downtimes or frequent outages for maintenance occur.

### Energetics Offgas Treatment System

The flow diagram for the energetics offgas treatment (OTE) system as it was configured when this report was being prepared is illustrated in Figure 4-4. Offgases are generated from energetics and aluminum hydrolysis in the EBHs, from the ENRs, from energetics hydrolysate storage tanks, and from the evaporation of water and organic materials from various metal parts and shipping/firing tube fiberglass segments passing through the HDC. The HDC offgas stream is fed to a flameless bulk oxidizer unit. The design of the bulk oxidizer and any supporting equipment had not been specified at the time this report was being written. The offgas streams from EBHs are combined with the discharge stream from the bulk oxidizer. Treatment of the ENR and energetics hydrolysate storage stream offgases had also not been specified at the time this report was being prepared.

The bulk oxidizer operates at 2200°F with a gas residence time of 2 seconds to ensure the oxidation of all organic compounds in addition to the complete destruction of any polychlorinated biphenyls present in the offgas stream. The bulk oxidizer unit is designed for staged injection of raw natural gas to increase the heating value of the gas stream if required. Natural gas injection is not required for the GB and VX campaigns, in which rocket pieces are treated in the HDC. However, it is required for the H campaign when burster

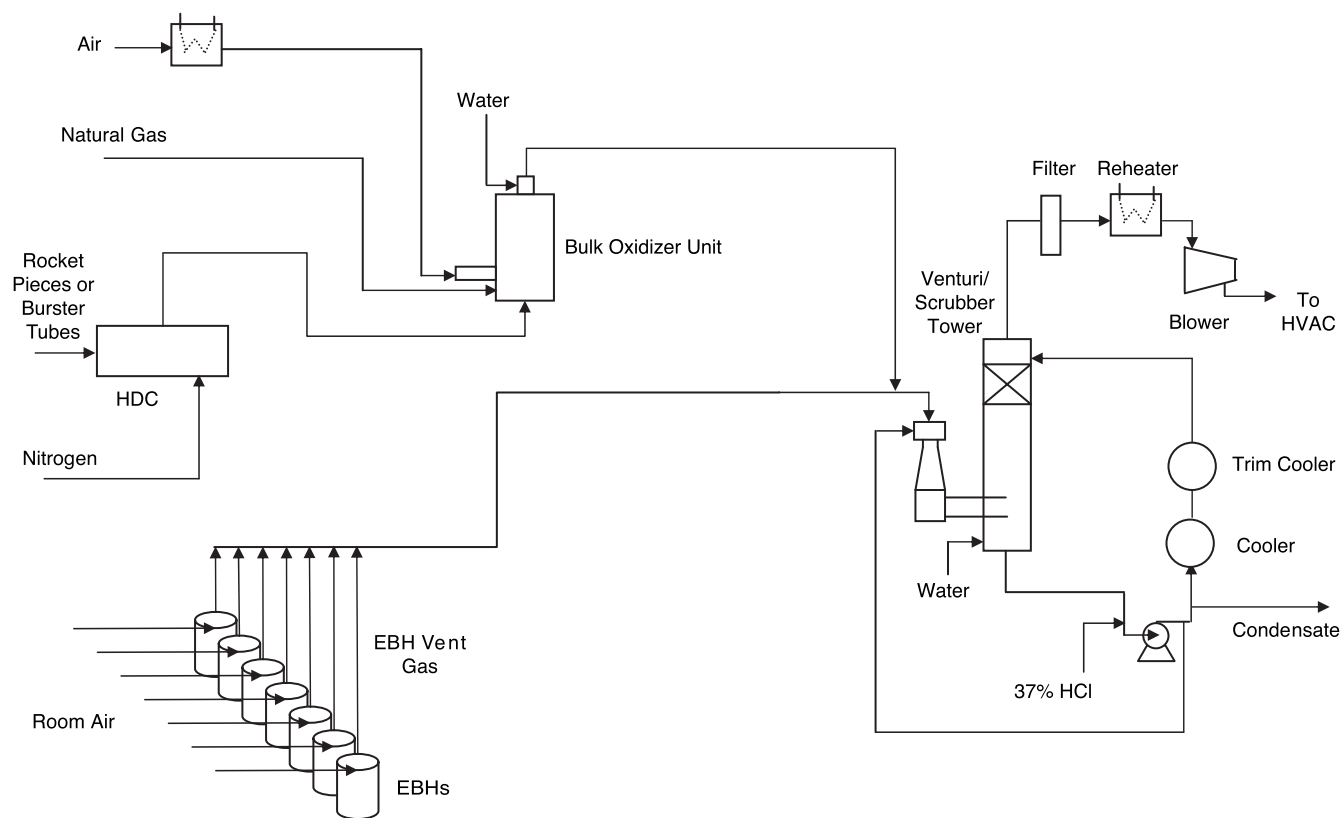

FIGURE 4-4 Flow diagram for OTE system. SOURCE: Adapted from Bechtel Parsons Blue Grass Team responses on May 2, 2005, to committee questions of April 25, 2005.

tubes are being processed in the HDC, since the latter do not produce a sufficient amount of hydrocarbons to sustain the required destruction temperature. The discharge stream from the bulk oxidizer will be cooled to 1200°F by injecting atomized process water into the top of the oxidizer unit.

The cooled discharge from the bulk oxidizer is then combined with vent gases from the EBH units and fed into the venturi/scrubber tower system, where it is scrubbed by a cool spray of scrubber solution. The EBH offgas contains hydrogen generated by caustic hydrolysis of aluminum parts of the rockets, but this offgas is diluted to below 25 percent of the lower flammable limit in individual EBHs and in the combined EBH offgas streams by adding air. When the hydrogen is combined with the bulk oxidizer offgas, its concentration is further reduced.

The venturi/scrubber tower system consists of a venturi, a scrubber tower with a surged bottom section, two 50 percent recirculation pumps and one spare, and

two cascading coolers. The venturi uses acidic scrubbing water to remove ammonia and provide quick quenching (0.3 seconds) and prevent formation of dioxins and furans. The scrubbing water pH is controlled by addition of 37 weight percent HCl. Additional cooling of the gases to no more than 100°F is accomplished in the scrubber tower. The scrubber water is cooled in two cascading coolers; the first cooler uses 100°F cooling water as the cooling medium, while the second cooler uses 70°F chilled water. Excess scrubber water, created by condensation of water from the offgas stream, is sent to storage and subsequent processing.

The scrubber gases are then sent to an offgas filter to remove any particulate matter over 0.5 microns in size. The size limit for the particulate is under review. Gas from the filter is then reheated to 120°F in an electric heater to ensure a gas relative humidity of less than 55 percent and to prevent condensation before sending these gases through the induced draft blowers and into an exhaust duct to the carbon filter system for the MDB heating, ventilation, and air conditioning system.

**Finding 4-8.** Because the type of flameless bulk oxidizer unit to be used for the OTE system was not identified, it was not possible for the committee to assess the appropriateness of the OTE system for this application.

**Recommendation 4-8.** The bulk oxidizer unit design should be finalized as quickly as possible to ensure that all necessary supporting equipment is identified and that the MDB footprint can accommodate the resulting OTE system.

**Finding 4-9.** Particulates and condensate in the HDC offgas stream flowing to the bulk oxidizer may cause plugging, depending on the design of the unit. If plugging occurs, the bulk oxidizer may cause excessive plant downtime when processing rockets.

**Recommendation 4-9.** The allowable size range of particulates and concentration of condensate in gas flowing to the bulk oxidizer unit when processing rockets should be fully characterized to ensure that this unit achieves the high availability needed for successful plant operation.

**Finding 4-10.** The storage and treatment of scrubber condensate to which HCl has been added have not been specified.

**Recommendation 4-10.** The design for the handling of scrubber condensate must be carefully reviewed, since it is unclear at this time where this condensate, which may be acidic, will be sent.

**Finding 4-11.** The EBH offgas contains hydrogen from the hydrolysis of aluminum. This gas is planned to flow directly to the venturi/scrubber system. The treatment of offgases from the ENRs and energetics hydrolysate storage tanks had not been specified at the time this report was being prepared.

**Recommendation 4-11.** Treatment requirements for EBH, ENR, and energetics storage tank offgas streams should be determined as soon as possible since they may affect the size of the MDB and the OTE venturi/scrubber system.



## 5

# Treatment of Hydrolysates and Residual Wastes

Processes selected by the Army for destruction of the chemical agents and associated energetics currently stored at Blue Grass Army Depot are hydrolysis as the core process, followed by supercritical water oxidation (SCWO) for secondary treatment of the hydrolysates. A destruction and removal efficiency of 99.9999 percent is required for agent hydrolysis. Both agent and energetics hydrolysates contain residual organics that require further treatment by SCWO.

The Army also specified that all other hazardous materials, which are listed in Table 5-1, should be destroyed on site. The destruction methods are planned to be as follows:

- Metal parts from drained and washed munitions are to be treated in a metal parts treater (MPT).
- Solid residue from the energetics batch hydrolyzers is to be treated by a heated discharge conveyor (HDC).
- Miscellaneous nonmetallic materials, designated as dunnage, are to be hydropulped and treated by SCWO, or to be treated in the MPT, or, if uncontaminated, shipped off-site for disposal. Other miscellaneous materials, designated secondary wastes, are to be treated in the MPT, hydropulped and treated by SCWO, or, if uncontaminated, shipped off-site for disposal.

This chapter discusses the use of SCWO for treatment of hydrolysates and dunnage; dunnage shredding and handling; the process train for treatment of metal

parts, including the treatment of MPT offgases; and the disposition of secondary wastes.

## SUPERCRITICAL WATER OXIDATION

### Basic Principles

Water at temperatures greater than 705°F (374°C) and pressures greater than 3,205 psi (221 bar) is in the supercritical state. In that state, it exists in a single phase that differs significantly in its physical properties from water in its normal liquid and vapor phases. Typical SCWO operating conditions are  $T \cong 1112^\circ\text{F}$  (600°C) and  $P \cong 3,626$  psi (250 bar). Under these conditions, the density of supercritical water is roughly 100 kg/m<sup>3</sup> (compared with 1,000 kg/m<sup>3</sup> for liquid water and approximately 10-30 kg/m<sup>3</sup> for steam used in commercial power plants). At supercritical density, the intermolecular distances are correspondingly greater than those that characterize normal liquid water. As a result, the hydrogen bonding tendency of water is greatly attenuated, and water in this state behaves much more like a typical nonpolar solvent. In particular, most organic species, including alkanes, are completely soluble in supercritical water. In addition, molecular oxygen is fully miscible in supercritical water. The greatly enhanced solubility and higher diffusivity of oxygen in the supercritical phase eliminates the usual interfacial resistance to oxygen transport in liquid water. In SCWO, the oxidation rate is typically controlled by chemical kinetics rather than by oxygen transport. At 1112°F (600°C), very high

TABLE 5-1 Treatment Methods for Different Waste Stream Materials During Normal Disposal Campaigns and Closure

Material Type	Material Category	Waste Stream	Components	Treatment Method	
				Normal Campaign	Closure
Liquid, combustible	Lubricant	Used oil-based lubricant fluids	Misc. fluids	DSH/SCWO	MPT
Liquid, noncombustible	Coolant	Ethylene glycol or propylene glycol	Misc. fluids	DSH/SCWO	MPT
Liquid, noncombustible	Hydraulic	Used water-based hydraulic fluid	Misc. fluids	DSH/SCWO	MPT
Solid, combustible	Carbon	Regular charcoal from MDB filters	Carbon	DSH/SCWO	MPT
Solid, combustible	Carbon	Metal impregnated charcoal from mask filters	Cu, Zn, Cr	DSH/SCWO	MPT
Solid, combustible	Cellulosic	Wood from maintenance cribbing	Cellulose-based materials	DSH/SCWO	MPT
Solid, combustible	Cellulosic	Wood munitions pallets and boxes	Cellulose-based materials	DSH/SCWO	MPT
Solid, combustible	Elastomer	Butyl boots	Butyl rubber	DSH/SCWO	MPT
Solid, combustible	Elastomer	Toxicological agent protective gear	Butyl rubber	DSH/SCWO	MPT
Solid, combustible	Halogenated	LSS <sup>a</sup> and equipment hoses	Neoprene	DSH/SCWO	MPT
Solid, combustible	Halogenated	Conveyer belt material	PVC	DSH/SCWO or MPT	MPT
Solid, combustible	Halogenated	DPE face shield	PVC	DSH/SCWO	MPT
Solid, combustible	Halogenated	DPE suits	PVC	DSH/SCWO	MPT
Solid, combustible	Halogenated	Face mask for Tyvek suit	PVC	DSH/SCWO	MPT
Solid, combustible	Halogenated	LSS and equipment hoses	PVC (reinforced)	DSH/SCWO	MPT
Solid, combustible	Halogenated	Gore-Tex fabric materials	Teflon	DSH/SCWO	MPT
Solid, combustible	Plastic	Tyvek suit	Polyaramid materials	DSH/SCWO	MPT
Solid, combustible	Plastic	Poly bags (5 mil)	Polyethylene	DSH/SCWO or MPT	MPT
Solid, combustible	Plastic	Poly bags (5 mil)	Polyethylene	DSH/SCWO or MPT	MPT
Solid, combustible	Plastic	Drum liners (20 mil)	PVC	DSH/SCWO	MPT

<sup>a</sup>LSS, life support system.

SOURCE: Adapted from Bechtel Parsons Blue Grass Team response on May 7, 2005, to the committee's request for information on February 2, 2005.

destruction efficiencies are attained with residence times of 1 minute or less.

The reaction mechanisms for the destruction of organic compounds by SCWO generally involve free-radical chain reactions with oxidative radicals (mostly

•OH and •OOH) (NRC, 1998). Thermal bond cleavage and polar or ionic reactions, including hydrolysis, also occur under these severe conditions. Aqueous organic wastes with sufficient fuel value can sustain the reaction temperatures, making supplemental fuel

unnecessary (NRC, 1998). Furthermore, the reaction products are benign. Carbon is converted to CO<sub>2</sub> and nitrogen is largely converted to N<sub>2</sub>, although a small amount of N<sub>2</sub>O is also formed. The effluent does not contain NO<sub>x</sub>, SO<sub>x</sub>, or polychlorinated dioxins or furans. Lastly, because supercritical water is denser than steam, the reactor volumes are modest and the SCWO process is compatible with a treatment philosophy of react, hold, test, and release. Reviews of the SCWO process can be found elsewhere (Tester et al., 1993; Gloyna and Li, 1998; Shaw et al., 1991; Shaw and Dahmen, 2000).

Despite its important advantages, SCWO has not yet become a commercial success. Only one commercial plant has operated for an extended period. The Huntsman Corporation's petrochemical plant, in Austin, Texas, was the first to run a commercial SCWO facility to destroy the organic waste and washdown water from its process stream. This facility was placed in operation in 1994 and apparently worked quite well for several years (NiDI, 1999; Shaw and Dahmen, 2000). Its feed stream was a dilute solution of alcohols and amines.

Because of the composition of the feed stream, the Huntsman plant was not prone to the problems of corrosion and plugging encountered at pilot plants designed for more complex feed streams that contain heteroatoms such as chlorine, fluorine, or phosphorus. Upon oxidation, these are converted to the corresponding mineral acids, which are extremely corrosive. To counter the corrosion, it is common practice to add caustic to the feed stream. This converts any acid to a salt. Unfortunately, for precisely the same reasons that supercritical water is a good solvent for most organic species, it is a very poor solvent for salts. The result is that the salts tend to precipitate, with associated fouling and plugging. Technologies used to deal with this precipitation have been discussed in some detail (Hodes et al., 2004; Marrone et al., 2004). The corrosion is typically an ionic process that proceeds best in a polar environment—the high subcritical regime. Thus, the heat-up and cool-down devices on either side of the supercritical water reactor (i.e., both the inlet and outlet regions) are particularly prone to rapid corrosion. The reactor itself is not spared from degradation due to corrosion, and frequent replacement of the reactor liner is planned for the SCWO units at the Blue Grass Chemical Agent Destruction Pilot Plant (BGCAPP).

## SCWO Reactor Design for BGCAPP

As discussed in more detail below, the feed stream composition will first be adjusted to achieve a desired ratio of chlorides to sulfates and to avoid high phosphate concentrations. The stream will then be pressurized and continuously pumped into a titanium-lined pressure vessel (Bechtel Parsons, 2004k).

High-pressure air is injected into the annulus between the titanium liner and the chromium-molybdenum (Cr-Mo) steel vessel wall. The air flow acts to keep the pressure-bearing, outer steel shell below its maximum operating temperature of approximately 900°F. The pressures in the annulus and in the reactor proper are essentially equal, so that the titanium liner will not have to support any pressure-induced stresses. The heat of reaction provides the energy necessary for maintaining the temperature within the reactor.

Start-up of the SCWO system occurs in three steps:

- Initial heating of the reactor with hot water,
- Continued heating via oxidation of a supplementary fuel, and
- Introduction of waste feed.

In Step 1, deionized feed water passes through an electric preheater and enters the reactor through the main feed nozzle. Control valves downstream of the reactor maintain the pressure at ~3,400 psig. As the reactor is heating, air flows into the system at a slow rate through the feed nozzle, and quench water is introduced at the bottom of the reactor. A low-flow, high-pressure air stream is also fed to the annular space between the removable liner and the reactor vessel. This purge stream prevents backflow of corrosive or combustible species into the annular space.

In Step 2, when the internal reactor temperature reaches ~750°F, 70 weight percent isopropyl alcohol and high-pressure air enter the reactor along with the supercritical feedwater through the feed nozzle. The isopropyl alcohol reacts exothermally with air, causing the reactor temperature to increase. The temperature is controlled to ~1200°F (650°C). The preheater is turned off. Fuel and air flows are increased to a combined flow rate of approximately 1,000 pounds per hour. Air flow is raised in conjunction with fuel flow to maintain a stoichiometric excess of oxygen in the reactor.

In Step 3, the flow of waste feed is started at a low flow rate and slowly increased, while water flow and fuel flow are decreased to maintain the reactor tem-

perature at ~1200°F (650°C). The waste feed is a blend of either energetics and agent hydrolysates or dunnage and energetics hydrolysates.

The heat produced by the oxidation must be removed by quenching with makeup water at the reactor exit. The quench fluid is usually water, but to help prevent plugging, dilute acid is sometimes used for feeds containing aluminum. The quenching serves two purposes. First, it drops the temperature; second, it redissolves salts that are not soluble in the supercritical phase. The salts, which are present as an immiscible flowable liquid phase under reactor conditions (1200°F; 650°C), could otherwise plug the reactor outlet port or pressure letdown valve. These mineral salts are separated later by evaporation. The cooled and diluted outlet stream is then passed through a cooldown heat exchanger and finally through gas/liquid separators for phase separation. The main system pressure control is performed on the gas effluent stream, which passes through a back-pressure regulator valve (Bechtel Parsons, 2004k).

Design of the full-scale SCWO reactor for BGCAPP was scheduled to begin in November 2004 and to be completed in December 2005. The design will respect the following principles:

- There will be no preheating of the feed. This avoids the high corrosion rates that might be expected in the high subcritical zone of a preheater. In lieu of preheating, the reactor will be significantly back-mixed and all heating will be derived from the heating value of the feed. Because hydrolysates have very low heating values, isopropyl alcohol will be added to the feed stream as needed.
- In lieu of a cooldown section, a rapid quench will be employed at the reactor exit. The high flow rate (2,100 lb/hr) of quench water is expected to minimize cooldown corrosion and plugging.
- The reactor will employ a Cr-Mo steel pressure vessel with a corrosion-resistant, replaceable, pressure-balanced titanium liner. In the past, the outer shells of test reactors were constructed of Inconel 617. However, because high-nickel-alloy reactor forgings are expensive, delivery times are long, and machining is difficult compared with normal Cr-Mo steel pressure vessels, General Atomics plans to construct the outer shell of the BGCAPP full-scale reactors out of 1 Cr–0.5 Mo–UNS K11564 (ASME SA182, Grade F 12) steel. That material is ASME code rated to 1200°F, although its strength falls off substantially above 1000°F. The liner that contacts the reactive fluid is fabricated of titanium. The outer surface of the liner is fitted with several layers of dimpled C-276 sheeting. Air will flow downward to the bottom of the reactor liner between the layers of dimpled C-276 sheeting located between the liner and the vessel wall and provide thermal insulation for the vessel wall. The design pressure in both the annulus between the liner assembly and the outer shell and the titanium reaction zone is 4,300 psig. General Atomics anticipates that the SA182 outer shell will reach a maximum temperature of 700°F.
- The hydrolysate is basic and contains a variety of anions. This feed stream will be neutralized with a mixture of sulfuric and hydrochloric acids. The mixture ratio will be chosen to produce a eutectic mixture of NaCl/Na<sub>2</sub>SO<sub>4</sub>. In calculating the mixture ratio, the role of species other than sodium, chloride, and sulfate ions is ignored. The eutectic temperature for a mixture of NaCl and Na<sub>2</sub>SO<sub>4</sub> is 1162°F (628°C), within the operating range of the reactor, 1157–1202°F (625–650°C). The design team therefore expects that the reactor walls will become coated with a eutectic melt and that plugging due to solids will be avoided.
- The titanium liner will be replaced at intervals that have yet to be determined. Factors that lead to corrosion and plugging are understood in concept, but not well enough to allow modeling the system quantitatively. Basically, higher temperatures promote salt melting and flowability. If phosphorus is present, higher temperatures also promote fluxing of the passivating layer of titania, leading to increased liner and thermowell corrosion. Blending of agent and energetics hydrolysates appears to reduce corrosion rates, largely due to dilution of the heteroatoms in the agent hydrolysates.
- Based on the advice of the National Research Council, the SCWO reactors planned for BGCAPP will have internal diameters of 7.5 inches and a length of 10 feet, an approximately threefold scale-up for the 4-inch-diameter reac-

tors used in the 500-hour engineering design studies, and a 1.5-fold scale-up for the 6-inch-diameter reactors used in the 500-hour engineering design studies and the 6-inch-diameter reactors used in more recent 100-hour tests of simulants (NRC, 2002a). General Atomics originally intended to construct an 18-inch-diameter reactor, 18 feet in length. The National Research Council noted that because this was “a substantial increase in size, the impact on the corrosion rate, plugging by precipitates and other solids, and other performance factors cannot be reliably assessed until the scaled-up SCWO unit is operated” (NRC, 2002a). Five of the smaller units are currently planned, four for blended agent and energetics hydrolysates and one for dunnage slurry blended with energetics hydrolysates.

### SCWO Reactor Testing

General Atomics recently conducted three runs, each of 100 hours duration, in a 6-inch-diameter reactor, which is sufficiently close to full scale that scale-up is unlikely to be a major problem. The runs were conducted with simulants formulated to contain representative concentrations of key species or key chemical bonds expected to be present in VX, GB, and H hydrolysates. Aluminum was included in the blended agent and energetics simulant feed to represent aluminum from rocket body parts dissolved during hydrolysis. Ratios of energetics hydrolysate to simulated agent hydrolysate in the tests conducted were 3.4:1 for GB, 2.5:1 for VX, and 1:1 for H. Table 5-2 shows the rates of feed to the reactor in the test runs. Destruction of organics was essentially complete within five diameters

of the inlet, i.e. within the top 30 inches of a 10-foot (120-inch) reactor. The corresponding residence time was approximately 15 seconds at a nominal throughput of 1,000 pound per hour of feed. No salt buildup was observed within the reactor, nor was scaling observed in the effluent heat exchanger.

Ultrasound measurements of liner thickness, made before and after the testing campaigns, were used to make maps of the amount of material removed due to erosion and corrosion.

A 100-hr SCWO test campaign was completed in September 2004 using blended energetic and agent simulant feeds.<sup>1</sup> The GB test used a simulated GB blended feed at 340 pounds per hour and 3,600 pounds per hour of quench water and showed that the titanium liner corroded at certain locations at rates up to 0.4 mils per hour (3,500 mil/year, or 3.5 inches of metal removal per year).<sup>2</sup> For most chemical process plants, a corrosion rate of 20 mils per year is considered the maximum economically acceptable rate. Even though the titanium corrosion rate in the SCWO reactor would not be acceptable for most commercial operations, the extreme corrosive conditions present in SCWO make it necessary to take the high corrosion rates into account in design and operation of the system. General Atomics plans to design the reactor to allow liner replacement at fairly frequent intervals (perhaps as often as 2 weeks, depending on the feed chemistry). The liner replacement mandated by the high corrosion rate becomes a routine maintenance cost item during the short life of the plant. In addition, the titanium liner was found to be hydrided in the GB simulant test, picking up about 2,800 ppm hydrogen, but it was not significantly embrittled as a result of this hydrogen pick-up.

The corrosion rate in the VX simulant campaign, 0.9 mils per hour (a corrosion rate of about 8 inches of metal removal per year), was even higher than that in the GB simulant campaign. The highest corrosion rate, however, was observed not on the liner but on the thermowell (1.3 mils per hour, or 11.4 inches per year). There was no observed hydrogen pick-up in the titanium for this campaign.

The corrosion rate for the H simulant campaign, 0.035 mils per hour (a corrosion rate of about 305 mils per year, or 0.3 inches per year) was significantly lower

TABLE 5-2 Rates of Feed to SCWO Reactor During Test Runs (lb/hr)

Feed Stream	GB simulant	VX simulant	H simulant
Blended feed flow	340	355	340
Isopropyl alcohol flow (70%)	61	51	61
Air oxidant flow	790	800	700

SOURCE: Kevin Downey, Project Engineer, Bechtel Parsons Blue Grass Team, “Supercritical water oxidizer (SCWO) system status,” briefing to the committee on November 17-19, 2004.

<sup>1</sup>Kevin Downey, Project Engineer, Bechtel Parsons Blue Grass Team, “SCWO system status,” briefing to the committee on November 17-19, 2004.

<sup>2</sup>A mil is 0.001 inch.

than that observed for GB and VX simulant campaigns. There was also very little observed hydrogen pick-up in the titanium for the H simulant campaign (70 ppm hydrogen).

Using these corrosion rates, General Atomics projects that liners will have to be replaced almost weekly for the GB and VX campaigns and not at all during the H campaign. There have been no tests with the actual hydrolysate from agent or energetics hydrolysis, much less any experience in changing related liners.

In the 100-hour mustard simulant test, salt was generated at a rate of 55 pounds per hour. After 100 hours of continuous operation, 37 pounds of salt remained in the reactor. In the VX simulant test, salt was generated at a rate of 69 pounds per hour. After 93 hours of continuous operation, 12 pounds of salt remained in the reactor. (The test was terminated after 93 hours because torrential rains led to a short circuit in the high-pressure air compressor electrical cabinet.) The composition of the salts had not been determined at the time this report was being prepared.

In the mustard simulant test, the high iron content in the feed resulted in the formation of iron oxide, which was found to be erosive to the stem and seat of the Badger gate valve used for liquid pressure letdown. The slurry letdown system was upgraded with a new valve manufactured by DFT Inc., which uses a rotating tungsten carbide ball instead of a traditional stem. Very little wear was observed with the DFT valve after 114 hours in service.

General Atomics indicated that if the phosphate content is reduced by half, the corrosion rate is reduced by a factor of 5 (Bechtel Parsons, 2004). This indicates a nonlinear relationship between phosphate concentration in the reactor and the liner corrosion rate. At any given phosphate concentration, however, the depth of corrosion increases linearly with time. Dilution of the phosphate in the agent hydrolysate with energetics hydrolysate seems to be largely responsible for reduced corrosion over time. There is nothing particularly unique about the composition of the energetics hydrolysate, which conveniently serves as diluent since it would have to be treated by SCWO anyway.

According to the initial design for BGCAPP, all dunnage that is potentially contaminated will be moved to the toxic maintenance area, where it will be segregated into shreddable and nonshreddable material. Dunnage includes wood pallets, demilitarization protective ensemble (DPE) suits, and spent carbon filters. Shreddable material will be reduced to less than 2 mil-

limeters and processed in a hydropulper with energetics hydrolysate to produce a slurry for feed to the SCWO unit. The planned dunnage shredding and handling system (DSH) will consist of three shredders and two hydropulpers. Separate shredders are planned for pallets, DPE suit material, and carbon.<sup>3</sup> The two hydropulpers will handle all shredded material, but the different types of shredded dunnage will be processed separately. No recent tests have been conducted with dunnage.

**Finding 5-1.** Operation of SCWO reactors will likely require reactor liners to be changed frequently. Corrosion rates observed in 100-hour tests with agent hydrolysate simulants blended with energetics hydrolysates suggest that liners may need to be changed almost weekly during runs with the hydrolysates from GB and VX hydrolysis and probably not at all during runs with the hydrolysate from H hydrolysis.

**Recommendation 5-1.** The frequency of liner changes should be determined more precisely for runs with actual agent hydrolysates rather than simulants.

**Finding 5-2a.** SCWO is intrinsically ill-suited to the treatment of wastes with high loadings of salts or salt-forming materials. Agent hydrolysates are therefore challenging materials for treatment by this technology. High corrosion rates, the threat of reactor plugging by precipitates, and scaling of heat transfer surfaces have been observed and are anticipated to be continuing operational issues.

**Finding 5-2b.** The currently proposed SCWO design addresses many of the previously discovered problems. In particular, the methods that have been tested to control the precipitation of solids and to mitigate the corrosion issues that arise as a result of material selection appear satisfactory for the blends tested. The design also appears to minimize the potential for severe corrosion problems in the heat-up and cooldown sections. The design requires that the extremely high corrosion rates within the reactor simply be accepted as part of the operating plan. During runs with VX and GB, shutdowns and start-ups will be required almost weekly for liner replacement and reactor maintenance.

<sup>3</sup>Granular activated carbon is mixed with spent decontamination fluid and then wet ground in a high-shear grinding mill.

**Recommendation 5-2.** SCWO testing to date has been limited in scope and restricted to simulated feeds. The data are encouraging, but additional testing is needed to provide confidence that the design will function as expected, particularly with actual munitions hydrolyzates representative of the Blue Grass stockpile.

**Finding 5-3.** The Bechtel Parsons Blue Grass Team plans to use a Cr-Mo steel for fabricating the outer shell of the SCWO reactors. However, the strength of this steel falls off significantly above 1000°F. Moreover, given that the outer shell is cooled by the flow of air in the annulus between the outer shell and the liner assembly, if that air flow is interrupted during operation owing to plugging or corrosion, the vessel wall could overheat and become damaged and the vessel could rupture. Overheating should be detected by thermocouples, but a hot spot might develop where there is no thermocouple.

**Recommendation 5-3.** The temperature monitoring system for the reactor pressure vessel should be designed to detect any possible hot spots resulting from poor cooling.

**Finding 5-4.** The SCWO unit currently being used for tests by General Atomics has not been tested with dunnage. This is partially because no decision has been reached about which dunnage components will be treated on-site and which will be shipped off-site.

**Recommendation 5-4.** Every effort should be made to keep uncontaminated dunnage separate from contaminated dunnage. For dunnage items that cannot be shipped off-site, consideration should be given to treating them in the MPT. For dunnage that must be treated by SCWO, it is imperative that the shredded and hydropulped materials be tested in the SCWO unit currently being used for BGCAPP SCWO testing.

## DUNNAGE PARTICULATE EMISSION CONTROL SYSTEM

As dunnage is shredded and reduced to a size suitable for production of a SCWO slurry feed, air from the shredding and size reduction processes and from the hydropulper is vented to the dunnage particulate emission control system. This system consists of a baghouse containing filters for capture of the particulates. The filtered dunnage air is exhausted through one of two induced-draft blowers into an exhaust duct and

flows to the carbon filter farm for the munitions demilitarization building (MDB) heating, ventilation, and air conditioning (HVAC) system.

**Finding 5-5.** The committee is concerned that moisture in the dust-laden air from the hydropulper will cause premature plugging of filters and greatly increase their maintenance.

**Recommendation 5-5.** The Bechtel Parsons Blue Grass Team should consider drying or heating the air drawn from the hydropulper to minimize the risk of premature plugging of filters in the baghouse.

## METAL PARTS TREATER

Projectile bodies, including their internal metal parts, are conveyed to one of two MPTs after removal of agent and energetics by the munitions wash system. Solid secondary wastes and waste from closure operations also will be sent to the MPTs. Treatment of secondary and closure wastes is discussed later in the chapter.

The MPT consists of an entry air lock, process chamber, and exit air lock. Metal parts are transported through the MPT in carts on tracks. The inner wall surface of each MPT is maintained at 1200°F by external induction heating coils. Superheated steam at 1200°F is introduced into the process chamber of the MPT as a carrier gas to move vaporized agent and other gases into the MPT offgas treatment system. The MPT is designed to heat parts to at least 1000°F for 15 minutes, allowing unrestricted release of the processed parts, perhaps for sale as scrap metal.

The committee is concerned by the temporary suspension of the Pueblo Chemical Agent Destruction Pilot Plant (PCAPP) design activity for the MPT at the Parsons Fabrication Facility in Pasco, Washington. Consequently, any problems that may have been encountered on the test unit at PCAPP and proposed resolutions were not available for review by the committee.

## MPT Offgas Treatment System

Each MPT is provided with an offgas treatment (OTM) system. A flow diagram of the OTM system as configured when this report was being prepared is given in Figure 5-1. Offgases are generated from the thermal treatment of projectile bodies and closure waste and secondary waste that are not processed in the dunnage slurry feed to the SCWO units.

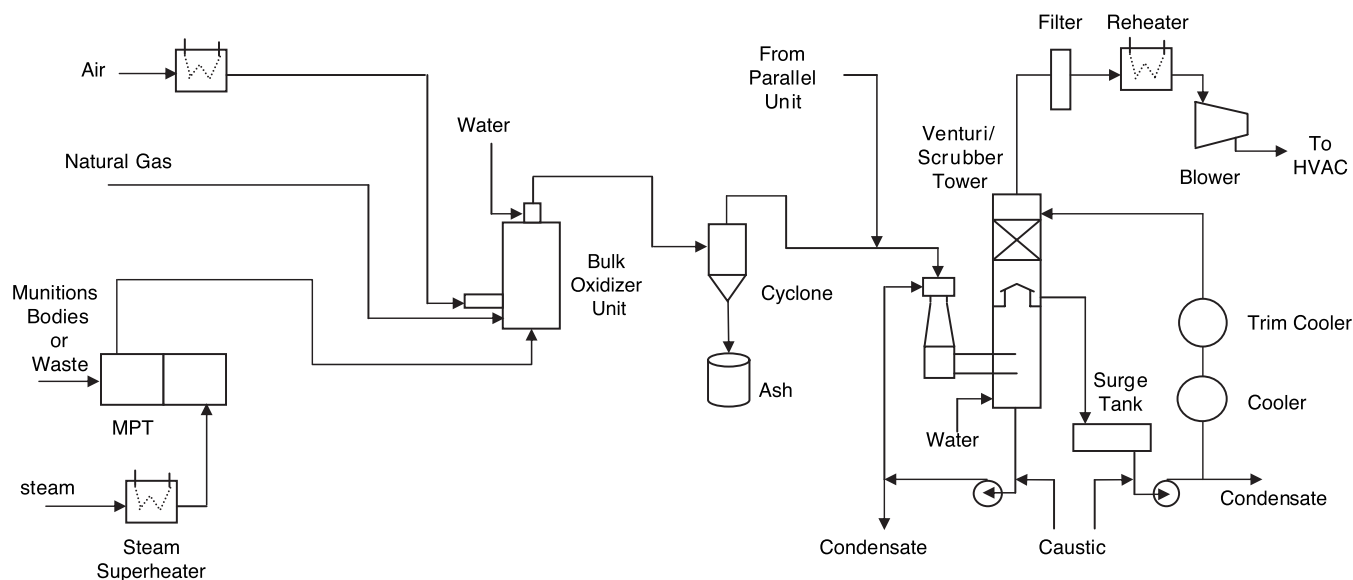

FIGURE 5-1 Flow diagram for OTM system. The offgas flow from the ANRs and the ANR hydrolysate storage tanks is not shown on this diagram. SOURCE: Adapted from the Bechtel Parsons Blue Grass Team responses on May 2, 2005, to committee questions of April 25, 2005.

Offgas leaving the MPTs flows to a flameless bulk oxidizer, where heated air and natural gas are mixed with the offgas to ensure oxidation of volatile and semivolatile organic compounds in the bulk oxidizer effluent.<sup>4</sup> The bulk oxidizer unit operates at 2000°F, with a gas residence time of 1 second to ensure the oxidation of all organics and hydrogen and to destroy any agent present. The bulk oxidizer uses staged injection of raw natural gas, as needed, into the unit to increase the heating value of the gas stream and to maintain the bulk oxidizer at 2000°F when organic content in the gas stream is not sufficient.

The bulk oxidizer discharge stream is cooled to 1200°F by injecting atomized process water into the outlet at the top of the bulk oxidizer. This cooling eliminates or minimizes the need for refractory in the discharge pipes. The cooled gas then flows through a cyclone separator to remove particulates. There is one cyclone for each MPT offgas treatment train. The design and efficiency of this cyclone had not been identified at the time this report was being prepared. The cyclone discharges collected particulates into a drum.

<sup>4</sup>The OTM systems and the OTE system (for energetics offgas treatment described in Chapter 4) both include a bulk oxidizer unit, but these respective units operate at different temperatures and residence times.

Since it cannot be guaranteed that the collected particulates, such as paint and rust particles from projectiles, have undergone decontamination to make them suitable for unrestricted release, they will be periodically fed back to the MPT.

Offgas leaving the cyclones is then combined with offgas from the agent neutralization reactors (ANRs) and agent hydrolysate storage tanks and fed to the venturi/scrubber tower system. This system consists of a venturi, a venturi recirculation pump, a scrubber tower, a scrubber recirculation pump, a surge drum, and two cascading coolers on the scrubber liquid recirculation line. The venturi/scrubber tower system provides quick quenching (0.3 seconds), caustic scrubbing of the acidic gases, and additional cooling of the gases to no more than 100°F. The two cascading coolers provide cooling for the venturi/scrubber tower liquids; the first cooler will cool the scrubber recirculation liquid to 100°F using cool water as the cooling medium, while the second cooler will cool the liquid to 70°F using chilled water as the cooling medium.

The scrubber overhead gases then pass through an offgas filter to remove any particulate matter over 0.5 microns in size. The particulate size is still under evaluation. The filtered gas is then heated in an electric heater to 120°F to ensure a gas relative humidity of less than 55 percent to keep it from condensing on its way through the blowers to the MDB HVAC system.



After start-up, additional scrubber liquid will be generated by condensation of the water in the incoming offgas stream. The liquid condensate generated in the scrubber tower is collected in the surge tank. It is monitored for pH and the presence of agent. Caustic solution is used to maintain the pH in the 7 to 10 range. If no agent is detected above the method detection limit, the "cleared" condensate is sent to an agent hydrolysate storage tank. If agent is detected above the method detection limit, the condensate is sent to the ANRs.

**Finding 5-6.** While operating conditions have been specified for the flameless bulk oxidizer unit for each MPT, details of the design were not provided. Thus, the committee could not judge whether the bulk oxidizer selected was adequate for heating the expected MPT offgas stream.

**Recommendation 5-6.** The bulk oxidizer unit design needs to be resolved as quickly as possible to assure that all necessary supporting equipment is identified and that the MDB footprint can accommodate the resulting OTM system.

**Finding 5-7.** The MPT offgas composition when treating secondary waste and closure waste streams has not been thoroughly characterized. Therefore, it is not possible to specify the level of particulate removal required to prevent excessive plugging of the bulk oxidizer and other downstream equipment.

**Recommendation 5-7.** Additional tests of the MPT should be performed, and representative ranges of MPT feed compositions based on all waste streams should be characterized and used to develop the data needed to specify particulate loading of the MPT offgas and bulk oxidizer performance, as well as the performance of other downstream equipment.

## HEATED DISCHARGE CONVEYOR

Solid residues from the energetic batch hydrolyzer units will be transported through an HDC. The residues will be heated to at least 1000°F for 15 minutes and then cooled and stored for eventual disposal. The HDC unit planned for BGCAPP is very similar to that for PCAPP. One important difference in terms of operations, however, is that the BGCAPP unit will have to handle a large

volume of fiberglass firing tubes when treating rockets. The Bechtel Parsons Blue Grass Team noted that pyrolysis (thermal decomposition) of these tubes in the HDC will produce large quantities of glass fibers in addition to tars and soot from the thermal destruction of epoxy resins (Bechtel Parsons, 2003).

**Finding 5-8.** The Bechtel Parsons Blue Grass team was planning to rely on tests of the HDC to be conducted for PCAPP at Pasco, but those tests were delayed and did not include processing of fiberglass firing tubes.

**Recommendation 5-8.** All of the testing for the HDC, including the processing of fiberglass firing tubes, should be performed as part of the program of technical risk reduction for BGCAPP.

## SECONDARY WASTES

The Bechtel Parsons BGCAPP team has developed a matrix of secondary wastes expected to be generated during the agent destruction campaign or during dismantlement for closure. The matrix contained 79 types of materials as of December 17, 2004. Bechtel Parsons is in the process of identifying treatment methods for each waste stream. The options being considered include off-site disposal, MPT processing, or dunnage shredding and handling (DSH) followed by SCWO. Table 5-3 lists the general types of wastes that will need to be managed.

The secondary waste matrix lists the MPT as the treatment method of choice for almost all of the contaminated or unknown wastes produced as part of the closure operations. DSH followed by SCWO is the treatment method listed for many of the same wastes as those produced as part of the normal chemical weapons destruction campaigns. Table 5-1 shows the wastes and treatment methods.

Bechtel Parsons has conducted thermal modeling on the suitability of the MPT for treatment of contaminated polyvinyl chloride extension cords with copper wire cores; butyl rubber and Teflon masks, sludge, and wood wastes. The models are based on the results of thermogravimetric analysis of polymeric materials to determine weight loss as a function of pyrolysis temperature, volatilization, and char/tar residue. Bench-scale tests are planned to verify the models. Ultimately, precommissioning tests will be needed to verify the approach.

TABLE 5-3 General Types of BGCAPP Secondary Wastes to Be Managed

Waste Type	Example
Aqueous liquids	Spent decontamination washdown fluids
Other noncombustible liquids	Ethylene and propylene glycols, water-based hydraulic fluids
Combustible liquids	Oil-based lubricants
Combustible solids	Filters, textiles, paper, rope, butyl boots, nitrile gloves, gaskets, tygon tubing
Metallic solids <sup>a</sup>	Canisters, lead solder, steel gratings, and ladders
Solids containing metals and organics <sup>a</sup>	Wire and cable, hoses
Miscellaneous noncombustible solids <sup>a</sup>	Rubble, wallboard, glass fiber insulation, kaolin, vermiculite
Unknown or mixed solids <sup>a</sup>	Heat tracing, filter cake, sludge

<sup>a</sup>These types of wastes, which are generated during operations and closure, will be treated in the MPT or sent to an appropriate treatment, storage, and disposal facility.

SOURCE: Adapted from Bechtel Parsons Blue Grass Team response on May 7, 2005, to the committee's request for information on February 2, 2005.

## 6

# General Findings and Recommendations

**General Finding 1.** The committee was able to review only initial design documentation for BGCAPP, results of completed technical risk reduction program studies and tests, and presentations pertaining to the developing intermediate design. Nevertheless, it believes that, given an appropriate response to the findings and recommendations in this report and the favorable resolution of any problems uncovered by the studies and tests still in progress, a BGCAPP that is able to safely and effectively destroy the chemical agent and energetic materials in the chemical munitions at Blue Grass Army Depot can be anticipated. The basis for this optimistic assessment can be summarized as follows:

- The chemical neutralization (hydrolysis) of GB, VX, and H has been extensively studied. The Bechtel Parsons Blue Grass team, in its technical risk reduction project (TRRP) 2a, is verifying the operating temperature and concentration of caustic for actual degraded GB. Both liquid and solid residues removed from M55 GB rockets processed at Anniston Chemical Agent Disposal Facility are being used. In TRRP 2b, the team is performing a similar study for H. The operating conditions for VX were verified at Newport Chemical Agent Disposal Facility.
- The newly designed systems for disassembling the projectiles and the rockets and for accessing the chemical agent in these munitions are up-to-date approaches that appear to be effective. The projectile line uses commercially available robots to handle the munitions. The rocket shear

machine is a modification of the machine used in the baseline process. (The committee does note a concern: Cut number 4, which in rockets is made near the igniter, could result in inadvertent ignition of the propellant.) The high-pressure water washout removes all the solids and liquid agent from the projectile bodies, reducing the chemical agent load on the metal parts treater (MPT).

- The MPT had already undergone some developmental testing by the time this report was being prepared. However, additional testing was needed to establish operating conditions for all feed streams. After completion of this testing, the MPT design is intended to be capable of decontaminating metal parts to a condition, making them suitable for unrestricted release.
- Limited testing to date of the SCWO system indicates that it can be adequate for the treatment of agent and energetics hydrolysates at BGCAPP. However, there has been no testing of the BGCAPP SCWO system for the treatment of dunnage.

**General Recommendation 1.** PMACWA should continue with the existing design of BGCAPP and continue testing to address issues noted in the findings of this report.

**General Finding 2.** The safety of BGCAPP workers and the public is an integral part of the design and the planned operation of BGCAPP.

**General Recommendation 2.** As the BGCAPP design evolves, the Army and the contractors making up the Bechtel Parsons Blue Grass Team should continue to make the safety of workers and the public a foremost consideration.

**General Finding 3.** The unit operations in the BGCAPP design have never been deployed together as a single integrated process. As a consequence, and notwithstanding positive throughput analysis results to date, a prolonged period of systematization will be necessary to resolve integration issues as they arise, even for apparently straightforward unit operations. The committee believes the high availability demanded for process equipment that is either new or significantly different from existing equipment (e.g., the RSM) may be an unrealistic requirement.

**General Recommendation 3.** The Army and its contractors should review the availability assumptions, especially for new or prototypical equipment, giving particular attention to the probability of prolonged outages from major failures—for example, an explosion in the RSM from accidental ignition of the propellant.

**General Finding 4.** Much of the dunnage and secondary waste is not contaminated.

**General Recommendation 4.** All uncontaminated dunnage and secondary waste should be sent offsite for disposal. Adequate documentation should be maintained to certify the status of waste with respect to its exposure to agent.

**General Finding 5.** Use of SCWO for treatment of contaminated dunnage is still under evaluation, and only limited testing has been done to date. (The committee understands that uncontaminated secondary wastes will not be treated by the SCWO system.) In any case, before varied wastes can be sent in a slurry to the SCWO system, they must be shredded and micronized. The committee believes such treatment is prob-

lematic, especially given that the wastes could be sent whole to the MPT for treatment, which would probably be simpler and more reliable.

**General Recommendation 5.** Alternative approaches for treating contaminated dunnage and wastes should be considered by the Army, with involvement by the public. One alternative to SCWO for treatment of contaminated dunnage is to treat it in the MPT to levels suitable for release to appropriate waste disposal sites.

**General Finding 6.** The offgas treatment systems for agent/metal parts treatment and for energetics treatment still require development and testing to establish that all potential gas feeds can be treated. Furthermore, because the input streams have not been fully characterized, the composition of each of the effluent streams to be treated cannot be predicted.

**General Recommendation 6.** The offgas flowing to the bulk oxidizer units should be fully characterized to determine the presence of compounds that may result in unacceptable reaction products—for example, polychlorinated dioxins or furans in the effluent from the treatment of energetics offgas.

**General Finding 7.** The steps that have been taken at the Blue Grass Army Depot to date to involve the public have been significant. The public has played a role through its comments on the various licensing and permitting activities and can directly contact the Blue Grass Chemical Demilitarization Outreach Office to have concerns and questions addressed. Furthermore, it is represented by the Citizens Advisory Commission, especially its Chemical Destruction Community Advisory Board.

**General Recommendation 7.** The Army should continue to pursue and support public involvement. Furthermore, the involvement and collaboration of stakeholders (especially the public) should remain a cornerstone of the chemical weapons destruction program.

## References

- Abercrombie, P.L. 2003. Physical Property Data Review of Selected Chemical Agents and Related Compounds, Updated Field Manual 3-9, ECBC-TR-294, September. Aberdeen Proving Ground, Md.: Chemical Materials Agency.
- Bechtel Parsons. 2003. Blue Grass Chemical Agent Destruction Pilot Plant (BGCAPP) Design Build Plan, Revision 2, September. Aberdeen Proving Ground, Md.: Program Manager for Assembled Chemical Weapons Alternatives.
- Bechtel Parsons. 2004a. Blue Grass Chemical Agent Destruction Pilot Plant (BGCAPP) Initial Design (redacted), Rev. 0, July. Aberdeen Proving Ground, Md.: Program Manager for Assembled Chemical Weapons Alternatives.
- Bechtel Parsons. 2004b. Blue Grass Chemical Agent-Destruction Pilot Plant Resource Conservation and Recovery Act Research, Development, and Demonstration Permit Application, March. Aberdeen Proving Ground, Md.: Program Manager for Assembled Chemical Weapons Alternatives.
- Bechtel Parsons. 2004c. Throughput and Availability Analysis: Blue Grass Chemical Agent Destruction Pilot Plant (BGCAPP) Project, July. Aberdeen Proving Ground, Md.: Program Manager for Assembled Chemical Weapons Alternatives.
- Bechtel Parsons. 2004d. BGCAPP TRRP Linear Projectile/Mortar Disassembly Study, Rev. 0, April. Aberdeen Proving Ground, Md.: Program Manager for Assembled Chemical Weapons Alternatives.
- Bechtel Parsons. 2004e. System Design Description (SDD) for Agent Collection and Neutralization, Blue Grass Chemical Agent Destruction Pilot Plant (BGCAPP) Project, Rev. A, July 26. Aberdeen Proving Ground, Md.: Program Manager for Assembled Chemical Weapons Alternatives.
- Bechtel Parsons. 2004f. System Design Description (SDD) for Munitions Washout System (MWS), Blue Grass Chemical Agent Destruction Pilot Plant (BGCAPP) Project, Rev. A, July 26. Aberdeen Proving Ground, Md.: Program Manager for Assembled Chemical Weapons Alternatives.
- Bechtel Parsons. 2004g. Energetics Batch Hydrolyzer (EBH) at Tooele Army Depot (TEAD) Interim Test Report, May 7. Aberdeen Proving Ground, Md.: Program Manager for Assembled Chemical Weapons Alternatives.
- Bechtel Parsons. 2004h. EBH HD (Energetics Batch Hydrolyzer Heated Discharge Conveyor) Mass and Energy Balance, July 9. Aberdeen Proving Ground, Md.: Program Manager for Assembled Chemical Weapons Alternatives.
- Bechtel Parsons. 2004i. TRRP Test Protocol for Study 5B-2A EBH Mockup Test, Rev. 0, June 15. Aberdeen Proving Ground, Md.: Program Manager for Assembled Chemical Weapons Alternatives.
- Bechtel Parsons. 2004j. TRRP Test Plan for Study 5b-2a Energetics Batch Hydrolyzer (EBH) Mockup Test, Rev. B, May 21. Aberdeen Proving Ground, Md.: Program Manager for Assembled Chemical Weapons Alternatives.
- Bechtel Parsons. 2004k. System Design Description (SDD) for the Supercritical Water Oxidation System, Blue Grass Chemical Agent Destruction Pilot Plant (BGCAPP) Project, Rev. B, June 25. Aberdeen Proving Ground, Md.: Program Manager for Assembled Chemical Weapons Alternatives.
- Federal Register. 2000. Blue Grass Chemical Depot, KY; Chemical Agents and Munitions Destruction Facility; Design, Construction, Operations, and Closure. Federal Register 65(233): 75677-75678.
- Federal Register. 2003. Final Recommendations for Protecting Human Health from Potential Adverse Effects of Exposure to Agents GA (Tabun), GB (Sarin), and VX. Federal Register 68(180): 54460-54462.
- Federal Register. 2004. Interim Recommendations for Airborne Exposure Limits for Chemical Warfare Agents H and HD (Sulfur Mustard). Federal Register 69(85): 24164-24168.
- Gloyna, E.F., and L. Li. 1998. Supercritical water oxidation for wastewater and sludge remediation. P. 4780 in Encyclopedia of Environmental Analysis and Remediation. R.A. Myers, ed. New York, N.Y.: Wiley.
- Hodes, M., P.A. Marrone, G.T. Hong, K.A. Smith, and J.W. Tester. 2004. Salt precipitation and scale control in supercritical water oxidation—Part A: fundamentals and research. Journal of Supercritical Fluids 29(3): 265-288.
- Marrone, P.A., M. Hodes, K.A. Smith, and J.W. Tester. 2004. Salt precipitation and scale control in supercritical water oxidation—Part B: commercial/full-scale applications, Journal of Supercritical Fluids 29(3): 289-312.
- Meyer, R., J. Köhler, and A. Homburg. 2002. Explosives, Fifth completely revised edition. Weinheim, Germany: Wiley-VCH.
- NiDI (Nickel Development Institute). 1999. Treating hazardous organic wastes. Available online at <http://www.nickelinstitute.org/nickel/0899/6-0899n.shtml>. Last accessed June 10, 2005.
- NRC (National Research Council). 1998. Using Supercritical Water Oxidation to Treat Hydrolysate from VX Neutralization. Washington, D.C.: National Academy Press.

- NRC. 1999. Review and Evaluation of Alternative Technologies for Demilitarization of Assembled Chemical Weapons. Washington, D.C.: National Academy Press.
- NRC. 2000. Evaluation of Demonstration Test Results of Alternative Technologies for Demilitarization of Assembled Chemical Weapons: A Supplemental Review. Washington, D.C.: National Academy Press.
- NRC. 2001a. Evaluation of Demonstration Test Results of Alternative Technologies for Demilitarization of Assembled Chemical Weapons: A Supplemental Review for Demonstration II. Washington, D.C.: National Academy Press.
- NRC. 2001b. Analysis of Engineering Design Studies for Demilitarization of Assembled Chemical Weapons at Pueblo Chemical Depot. Washington, D.C.: National Academy Press.
- NRC. 2002a. Analysis of Engineering Design Studies for Demilitarization of Assembled Chemical Weapons at Blue Grass Army Depot. Washington, D.C.: The National Academies Press.
- NRC. 2002b. Update on the Engineering Design Studies Evaluated in the NRC Report *Analysis of Engineering Design Studies for Demilitarization of Assembled Chemical Weapons at Blue Grass Army Depot*: Letter Report. Washington, D.C.: The National Academies Press.
- NRC. 2002c. Update on the Engineering Design Studies Evaluated in the NRC Report *Analysis of Engineering Design Studies for Demilitarization of Assembled Chemical Weapons at Pueblo Chemical Depot*: Letter Report. Washington, D.C.: The National Academies Press.
- NRC. 2005. Interim Design Assessment for the Pueblo Chemical Agent Destruction Pilot Plant. Washington, D.C.: The National Academies Press.
- Rosso, T.E., P.L. Abercrombie, A.B. Butrow, G. Hondrogiannis, J.M. Lochner, J.J. Loss, R.J. Malecki, J.M. Meuser, D.K. Rohrbaugh, Y.-C. Yang. 2005. Test Report: Characterization of Solid and Liquid GB Samples Collected from M55 Rockets Processed at Anniston Chemical Agent Disposal Facility (ANCDF), March 7. Aberdeen Proving Ground, Md.: Program Manager for Assembled Chemical Weapons Alternatives.
- Shaw, R.W., and N. Dahmen. 2000. Destruction of toxic organic materials using super-critical water oxidation: Current state of technology. Pp. 425-437 in *Supercritical Fluids—Fundamentals and Applications*. E. Kiran, P.G. Debenedetti, and C.J. Peters, eds. Dordrecht, The Netherlands: Kluwer Academic Publishers.
- Shaw, R.W., T.D. Brill, A.A. Clifford, C.A. Eckert, and E.U. Franck. 1991. Supercritical water: a medium for chemistry. *Chemical & Engineering News* 69(51): 26-39.
- Tester, J.W., H.R. Holgate, F.J. Armellini, P.A. Webley, W.R. Killilea, G.T. Hong, and H.E. Barner. 1993. Supercritical water oxidation technology: Process development and fundamental research. Pp. 35–76 in *Emerging Technologies for Hazardous Waste Management III*. ACS Symposium Series, Volume 518. W.D. Tedder and F.G. Pohland, eds. Washington, D.C.: American Chemical Society.
- U.S. Army. 1962. Military Specification MIL-B-46976, Bursters, Rocket, M34 and M36, October 11. Aberdeen Proving Ground, Md.: Program Manager for Chemical Demilitarization.
- U.S. Army. 1965. Military Specification MIL-R-46972A, Rocket, Chemical Agent, 115 millimeter, January 13. Aberdeen Proving Ground, Md.: Program Manager for Chemical Demilitarization.
- U.S. Army. 1966. Military Specification MIL-P-60071A(MU), Propellant Grain, M28, May 10. As amended by Amendment 1 of June 15, 1966. Aberdeen Proving Ground, Md.: Program Manager for Chemical Demilitarization.
- U.S. Army. 2002. Assessment of the Stability of M55 Rockets in Storage. Final, March. Aberdeen Proving Ground, Md.: Program Manager for Chemical Demilitarization.
- U.S. Army. 2004. Implementation Guidance Policy for Revised Airborne Exposures Limits for GB, GA, GD, GF, VX, H, HD, and HT, June 18. Washington, D.C.: Department of the Army, Office of the Assistant Secretary of the Army Installations and Environment.
- Yang, Y.-C. 1999. Chemical detoxification of nerve agent VX. *Accounts of Chemical Research* 32(2): 109-115.
- Yang, Y.-C., L.I. Szafraniec, W.T. Beaudry, and J.R. Ward. 1988. Kinetics and mechanism of the hydrolysis of 2-chloroethyl sulfides. *Journal of Organic Chemistry* 53(14): 3293-3297.
- Yang, Y.-C., J.A. Baker, and J.R. Ward. 1992. Decontamination of chemical warfare agents. *Chemical Reviews* 92(8): 1729-1743.



# Appendixes





# Appendix A

## Summary Responsibilities of Bechtel Parsons Blue Grass Team Members

The responsibilities of each of the members of the Bechtel Parsons Blue Grass Team are summarized in Figure A-1.

*Joint venture systems contractor*



- Project management
- Business services
- Safety and quality
- Procurement/subcontracting
- Construction
- Process and facility design
- Process equipment fabrication
- Support to systemization through closure
- Environmental compliance
- Public involvement

*Teaming subcontractors*



- Systemization
- Pilot testing
- Operations
- Closure
- Laboratory management
- Science and technology support
- On- and off-site training
- Training documentation
- Design support
- Technology support

FIGURE A-1 Responsibilities of the members of the Bechtel Parsons Blue Grass Team. SOURCE: Chris Midgett, Project Manager, Bechtel Parsons Blue Grass Team, "Blue Grass Chemical Agent Destruction Pilot Plant program overview," briefing to the committee on September 22, 2004.

## Appendix B

### Diagrams of Chemical Munitions at Blue Grass Army Depot

Figures B-1 through B-3 are drawings of the M55 rocket, 155-mm projectile, and 8-inch projectile stored at the Blue Grass Army Depot. There are also 30 M56 rocket warheads stored at BGAD. These are the same

as the upper part of the M55 rocket (they lack a lower shell section containing the rocket motor and propellant and tail fins) and are not depicted separately.

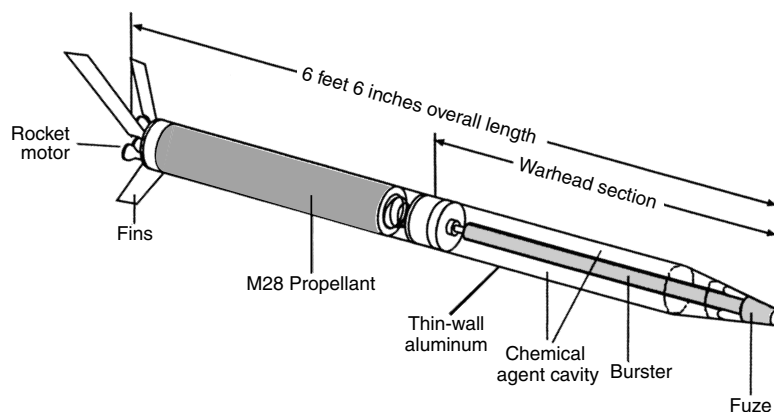

	<b>H521</b>	<b>H520</b>
Length	78 in.	78 in.
Diameter	115 mm	115 mm
Total weight	57 lb	57 lb
Agent	GB	VX
Agent weight	10.7 lb	10.7 lb
Fuze	M417	M417
Burster	M34, M36	M34, M36
Explosive	Comp B	Comp B
Explosive weight	3.2 lb	3.2 lb
Propellant	M28	M28
Propellant weight	19.3 lb	19.3 lb
Primer	M62	M62
Packaging	15 rounds/ wooden pallet	15 rounds/ wooden pallet

FIGURE B-1 Schematic drawing and specifications for M55 rocket. SOURCE: Beth Feinberg, Office of the Program Manager for Alternative Technologies and Approaches, briefing to the Committee on Review and Evaluation of the Army Chemical Stockpile Disposal Program on March 28, 2001.

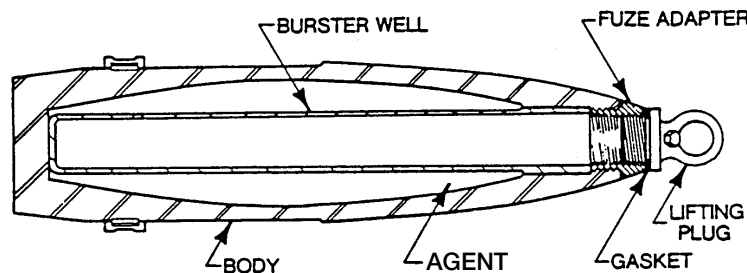

	M110	M121A1		M110	M121A1
Length	26.8 in.	26.7 in.	Explosive weight	N/A	N/A
Diameter	155 mm	155 mm	Propellant	None	None
Total weight	98.9 lb	98.9 lb	Propellant weight	N/A	N/A
Agent	H/HD	VX	Primer	None	None
Agent weight	11.7 lb	6.0 lb	Packaging	8 rounds/ wooden pallet	8 rounds/ wooden pallet
Fuze	None	None			
Burster	M6	M71	<b>Materials</b>		
Explosive weight	0.41 lb	2.45 lb	Shell	Steel	Steel
Suppl chg explosive	None	None	Burster well	Steel	Steel

FIGURE B-2 Schematic drawing and specifications for 155-mm projectile. NOTE: The projectiles stored at BGAD do not contain any energetic materials. SOURCE: U.S. Army, 1983.

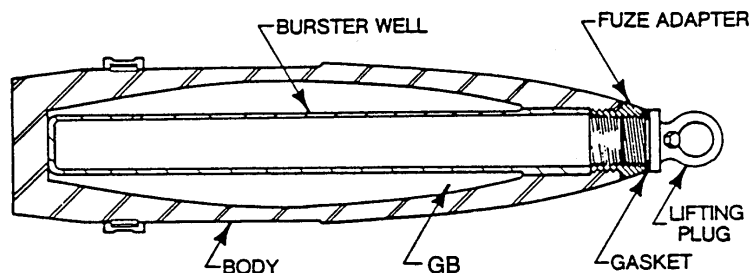

	M426		M426
Length	35.1	Explosive weight	0.3 lb
Diameter	8 in.	Propellant	None
Total weight	203 lb	Propellant weight	N/A
Agent	GB	Primer	None
Agent weight	14.5 lb	Packaging	6 rounds/ wooden pallet
Fuze	None		
Burster	M83	<b>Materials</b>	
Explosive Comp	B4	Shell	Steel
Explosive weight	7 lb	Burster well	Steel
Suppl chg explosive	TNT		

FIGURE B-3 Schematic drawing and specifications for 8-inch projectile. NOTE: The projectiles stored at BGAD do not contain any energetic materials. SOURCE: U.S. Army, 1983.

## REFERENCE

U.S. Army. 1983. Final Demilitarization Plan for Operation of the Chemical Agent Munitions Disposal System (CAMDS) at the Tooele Army Depot, Utah, June. Aberdeen Proving Ground, Md.: USATHAMA.

## Appendix C

### Information on Current Composition of Levenstein Mustard Agent at Blue Grass Army Depot



Tables C-1 through C-5 provide a summary overview of what is known about the current condition of the Levenstein mustard agent (H) in the U.S. chemical stockpile, including that in the projectiles stored at Deseret Chemical Depot.<sup>1</sup> This form of mustard agent

has degraded from what was originally about 70 percent pure mustard agent (liquid) and 30 percent (liquid) impurities into a mixture that is, on average, 70 percent solids and 30 percent liquid.

---

<sup>1</sup>E-mail communication from Yu-Chu Yang, ACWA, on April 12, 2005, to Robert A. Beaudet, committee chair.

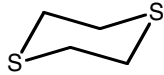
TABLE C-1 Composition of Liquid H (Levenstein Mustard), 16-42 wt% (Average = 31 wt%) of Agent Fill in the 10 155-mm H Projectiles Tested During Munitions Washout System Testing<sup>a,b</sup>

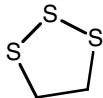
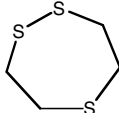
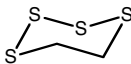
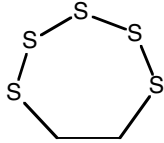
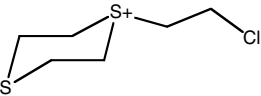
Compound Name	Structure	Gas Chromatograph/Mass Spectrometry—Chemical Ionization (GC/MS–CI) (area%)	Nuclear Magnetic Resonance (NMR) (wt%)
Volatile impurities		<i>Neat</i>	<i>CD<sub>3</sub>CN Solvent</i>
1-Butene		0.067 (0.040-0.12)	
2-Chlorobutane		0.034 (0.020-0.070)	
Diethyl ether		0.084 (0.030-0.20)	0.24 (0.070-0.40)
Chloroform		0.037 (0.010-0.12)	
HD and degradation compounds			
1,2-Dichloroethane	CICCCl	1.7 (1.1-2.6)	2.0 (1.4-2.9)
1,4-Dithiane		3.0 (2.0-3.6)	0.92 (0.45-1.2)
Ethylene sulfide (Thiirane)		0.036 (0.020-0.060)	
Bis(2-chloroethyl) sulfide (HD)	CICCCSCCCI	81 (78-84)	78 (74-81)
1,2-Bis(2-chloroethylthio)ethane (Q)	CICCCSCCSCCCI	7.9 (6.6-9.4)	10.2 (8.7-12)
C3/C4 HD analogs/impurities			2.0 (1.4-2.8)
Bis(3-chloropropyl) sulfide		0.24 (0.20-0.30)	
2-Chloroethyl-4-chlorobutyl sulfide		0.83 (0.70-1.0)	
2-Chloroethyl-2-chlorobutyl sulfide		0.059 (0.030-0.080)	
2-Chloropropyl-3-chloropropyl sulfide		0.41 (0.30-0.50)	
2-Chloroethyl-3-chloropropyl sulfide		0.27 (0.20-0.30)	
Linear polysulfides of HD			
Bis(2-chloroethyl) disulfide, HS <sub>2</sub>	CICC-S-S-CCCI	1.4 (0.80-2.4)	0.3 (0.14-0.41)
2-(Chloroethylthio) ethyl-2-chloroethyl disulfide	CICCCSCC-S-S-CCCI	0.18 (0.090-0.30)	
Bis(2-chloroethyl) trisulfide, HS <sub>3</sub>	CICC-S-S-S-CCCI	0.77 (0.20-1.5)	0.55 (0.27-0.95)
Bis(2-chloroethyl) tetrasulfide, HS <sub>4</sub>	CICCS <sub>4</sub> CCCI		0.89 (0.53-1.5)
Bis(2-chloroethyl) polysulfide, HS <sub>x</sub>	CICCS <sub>x</sub> CCCI		1.1 (0.45-2.0)
Cyclic polysulfides			
1,2,3-Trithiolane		0.63 (0.20-1.4)	
1,2,5-Trithiepane (7-membered ring)		0.77 (0.50-1.1)	
1,2,3,4-Tetrathiane		0.21 (0.050-0.40)	
1,2,3,4,5-Pentathiepane (7-membered ring)		0.16 (0.030-0.30)	
Cyclic sulfonium ion			
S-(2-chloroethyl)-1,4-dithianium ion			0.89 (0.31-1.6)
Total		99.78	97.09

<sup>a</sup>Results are the average and range for seven samples.

<sup>b</sup>Gas chromatography/thermal conductivity detector quantitative results for HD using an internal standard were 84.6 wt% (81.8-87.7).

TABLE C-2 Composition of H Heels, 58-84 wt% (Average = 69 wt%) of Agent Fill in the 10 155-mm Projectiles Tested During Munitions Washout System Testing<sup>a,b</sup>

Compound Name	Structure	GC/MS–CI Analysis of CH <sub>2</sub> Cl <sub>2</sub> Extract (area%)	NMR Analysis of Three Extracts (wt%)
<b>HD and degradation compounds</b>			
1,4-Dithiane		10 (7.4-15)	<i>CHCl<sub>3</sub> Extract</i> 1.3 (0.64-2.9)
1,4-Thioxane		0.23 (0.10-0.50)	
Bis(2-chloroethyl) sulfide (HD)	CICCSCCCCI	58 (52-64)	28 (10- 37)
1,2-Bis(2-chloroethylthio)ethane (Q)	CICCSCCSCCCI	17 (14-20)	4.1 (0.99-5.5)
Bis(2-chloroethyl) sulfoxide		0.46 (0.20-0.60)	
1,4-Dithiane-1-oxide		0.80 (0.30-1.6)	
2-Chloroethyl vinyl sulfide	CICC-S-CH=CH <sub>2</sub>	0.33 (0.020-0.60)	
Bis[(2-chloroethylthio)ethyl] sulfide	CICCSCC-S-CCSCCCI	2.6 (1.4-4.3)	
(2-chloroethylthio)ethyl vinyl sulfide	CICCSCCSCH=CH <sub>2</sub>	2.2 (1.5-2.9)	
<b>C3/C4 HD analogs/impurities</b>			
Bis(3-chloropropyl) sulfide		0.13 (0.050-0.20)	
2-Chloroethyl-4-chlorobutyl sulfide		0.71 (0.60-0.80)	
2-Chloroethyl-2-chlorobutyl sulfide		0.057 (0.040-0.080)	
2-Chloropropyl-3-chloropropyl sulfide		0.29 (0.12-0.40)	
2-Chloroethyl-3-chloropropyl sulfide		0.18 (0.11-0.30)	
<b>Linear polysulfides</b>			
Bis(2-chloroethyl) disulfide, HS <sub>2</sub>	CICC-S-S-CCCCI	0.29 (0.15-0.50)	
2-(Chloroethylthio) ethyl 2-chloroethyl disulfide	CICCSCC-S-S-CCCCI	0.41 (0.30-0.50)	
Bis(2-chloroethyl) trisulfide, HS <sub>3</sub>	CICC-S-S-S-CCCCI	0.86 (0.40-1.2)	
<b>Cyclic sulfides and polysulfides</b>			
2-Methyl-1,3-dithiolane		0.050 (one sample)	
1,2,3-Trithiolane		1.0 (0.40-2.2)	
1,2,5-Trithiepane (7-membered ring)		2.1 (1.1-4.4)	
1,4,7-Trithionane		0.12 (0.080-0.15)	
1,2,3,4-Tetrathiane		0.18 (0.080-0.40)	

TABLE C-2 Continued

Compound Name	Structure	GC/MS-Cl Analysis of CH <sub>2</sub> Cl <sub>2</sub> Extract (area%)	NMR Analysis of Three Extracts (wt%)
1,2,3,4,5-Pentathiepane (7-membered ring)		0.15 (0.080-0.30)	
2-Methyl-1,3-dithiolane		0.050 (one sample)	
1,4,7,10,13-pentathiacyclopentadecane		0.26 (0.070-0.90)	
1,4,7,10-tetrathiacyclododecane		0.49 (0.14-1.0)	
Elemental sulfur			
Sulfur S <sub>6</sub>		0.10 (0.040-0.15)	
Sulfur S <sub>8</sub>		6.0 (one sample)	
Unknown MW 118		0.18 (0.11-0.30)	
Cyclic thioethers			
1-oxa-4,7,10,13-tetrathiacyclopentadecane		0.080 (0.060-0.10)	
1-oxa-4,7,10-trithiacyclododecane		0.41 (0.30-0.50)	
1-oxa-4,7-dithionane		0.30 (0.070-0.70)	
			

(continued on next page)

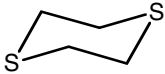
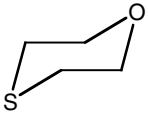
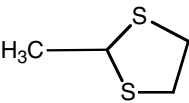
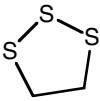
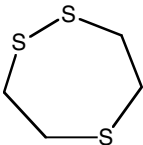
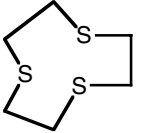
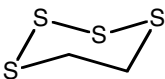
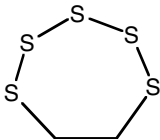
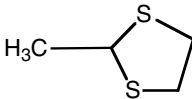
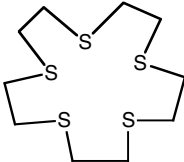
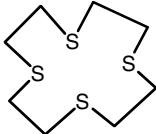
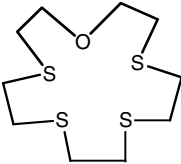
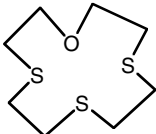
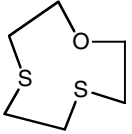
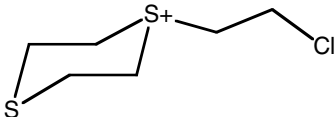

TABLE C-2 Continued

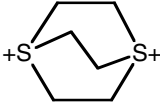

Compound Name	Structure	GC/MS–CI Analysis of CH <sub>2</sub> Cl <sub>2</sub> Extract (area%)	NMR Analysis of Three Extracts (wt%)
Cyclic sulfonium ion S-(2-chloroethyl)-1,4-dithianium ion		99.81	<i>CH<sub>3</sub>CN</i> Extract 36 (27-48)
Cyclic sulfonium dication 1,4-Dithioniabicyclo[2.2.2]octane dication			<i>H<sub>2</sub>O</i> Extract 1.4 (0.70-2.7)
Total			70.8 <sup>c</sup>

<sup>a</sup> Results are the average and range for seven samples.

<sup>b</sup> Using n-hexane extraction and an internal standard, gas chromatography/thermal conductivity detector quantitative measurements gave 13 wt% (5.47-18.4 wt%) HD.

<sup>c</sup> The main elements in the residual were iron and sulfur.

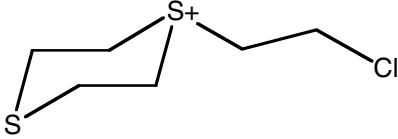
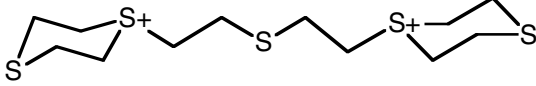
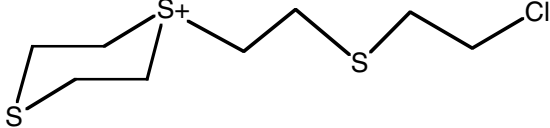
TABLE C-3 Liquid Chromatography–Electrospray Ionization–Mass Spectrometry Analysis of 14 Solid H Samples<sup>a</sup>

Name	Structure	Relative Intensity (%)	
		Range	Average
S-(2-chloroethyl)-1,4-dithianium ion [30843-67-5]		64.2-96.8	87.8
Bis[2-(1,4-dithianium)-S-ethyl] sulfide		0.7-25.8	6.9
S-(5-chloro-3-thiapentyl)-1,4-dithianium ion		2.0-7.7	4.1
1,2-Bis[1-(1,4-dithianium)]ethane		<0.1-3.3	1.2

<sup>a</sup> Samples were extracted into 50 vol% methanol-water solutions.

TABLE C-4 Liquid Chromatography–Electrospray Ionization–Mass Spectrometry Analysis of Solids (Filtered from Liquid H Samples)<sup>a</sup>

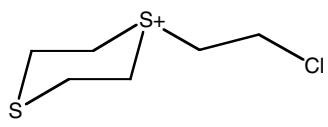
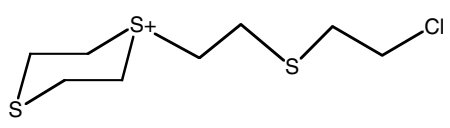
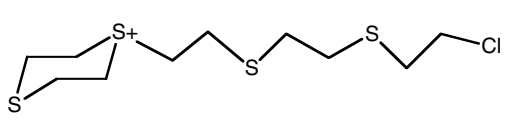
Compound Name	Structure	Relative Intensity (%)	
		Sample 003A	Sample 033A
S-(2-chloroethy)-1,4-dithianium ion		41.6	58.0
S-(5-chloro-3-thiapentyl)-1,4-dithianium ion		51.6	42.0
S-(8-chloro-3,6-dithiapentyl)-1,4-dithianium ion		6.8	Below detection limits

<sup>a</sup>An aliquot of 25  $\mu\text{L}$  of each liquid H sample was added to 250  $\mu\text{L}$   $\text{CH}_2\text{Cl}_2$ . Solutions were filtered using Gelman 0.45- $\mu\text{m}$  GHF acrodisc syringe filters and the filters rinsed with additional  $\text{CH}_2\text{Cl}_2$ . Methanol/water (50/50, 1 mL) was then passed through each filter to dissolve and elute  $\text{CH}_2\text{Cl}_2$ -insoluble residue. Methanol/water solution was analyzed by liquid chromatography-electrospray ionization-mass spectrometry on October 1, 2003.

TABLE C-5 Estimated Total Iron Contents in Liquid and Solid Phases of H Mustard Agent Fill in 155-mm Projectiles<sup>a,b</sup>

Phase	Solid in Munition (wt%)	Total Iron (wt%)
Liquid		1.0 (0.59-1.4)
Solid	69 (58-84)	6.6 (2.1-9.8)

<sup>a</sup>The total measured iron in the agent fill of the 155-mm projectiles is 4.92 weight percent.

<sup>b</sup>By inductively coupled plasma-mass spectrometry.

## Appendix D

### Biographical Sketches of Committee Members

**Robert A. Beaudet**, *Chair*, received his Ph.D. in physical chemistry from Harvard University in 1962. From 1961 to 1962, he was a U.S. Army Chemical Corps officer and served at the Jet Propulsion Laboratory as a research scientist. He joined the faculty of the University of Southern California in 1962 as an assistant professor and was chair of the Chemistry Department from 1974 to 1979. Dr. Beaudet has served on Department of Defense committees that have addressed both offensive and defensive considerations surrounding chemical warfare agents. He was chair of an Army Science Board committee that addressed chemical detection and trace gas analysis. He also was chair of an Air Force technical conference on chemical warfare decontamination and protection. He has participated in several National Research Council (NRC) studies on chemical and biological sensor technologies and energetic materials and technologies. Most of his career has been devoted to research in molecular structure and molecular spectroscopy. Dr. Beaudet is the author or coauthor of more than 100 technical reports and papers in these areas.

**Charles Barton** received his Ph.D. in toxicology from the University of Louisiana. Dr. Barton is currently the Iowa state toxicologist and director of the Center for Environmental and Regulatory Toxicology at the Iowa Department of Public Health. In addition to being a certified toxicologist, he is certified in conducting public health assessments, health education activities, and risk assessments; in emergency response to terrorism and emergency response incident command; and in hazardous waste operations and emergency response. In his

position as the state toxicologist, Dr. Barton serves as the statewide public health resource, providing health consultations and advice to other environment- and health-related agencies, as well as to health care providers and to business and industry representatives. He currently directs, or has directed, a host of Iowa Department of Public Health programs, including programs for PCBs, radon, water treatment system registration, hazardous substances emergency surveillance, the hazardous waste site health assessment, risk assessment for the Superfund program, the Iowa toxicology program, and many others.

**Joan B. Berkowitz**, who graduated from the University of Illinois with a Ph.D. in physical chemistry, is currently managing director of Farkas Berkowitz and Company. Dr. Berkowitz has extensive experience in the area of environmental and hazardous waste management, a knowledge of technologies available for the cleanup of contaminated soils and groundwater, and a background in physical and electrochemistry. She has contributed to several studies by the Environmental Protection Agency, been a consultant on remediation techniques, and assessed various destruction technologies. Dr. Berkowitz has written extensively on hazardous waste treatment and environmental subjects.

**Ruth M. Doherty** received a Ph.D. in physical chemistry from the University of Maryland. Dr. Doherty is currently the deputy director at the Indian Head Site for the Naval Energetics Enterprise, a collaboration between the Naval Air Systems Command and the Naval

Sea Systems Command to provide stewardship of the Navy's ordnance core equities. She has worked extensively on the research and development of energetics materials, mainly explosives, for over 20 years, beginning at the Naval Surface Warfare Center (NSWC) White Oak Detachment and later at the Indian Head Division of NSWC. Her main contributions in this area have been in the development of advanced underwater explosives and the characterization of new energetic materials. From 2001 to 2003, she was detailed to the Weapons Systems Division of the Office of the Deputy Under Secretary of Defense for Science and Technology to lead the development of a national program in science and technology for advanced energetic materials. In 2004, she was awarded the Naval Meritorious Civilian Service award for her contributions to the Navy. She is the U.S. principal member of Subgroup 1 (energetic materials) of the NATO Conference of National Armaments Directors Ammunition Safety Group and is a member of the editorial advisory board of the journal *Propellants, Explosives, and Pyrotechnics*.

**Lawrence E. Eiselstein** received Ph.D. and M.S. degrees in materials science from Stanford University and a B.S. in metallurgical engineering from the Virginia Polytechnic Institute and State University. Dr. Eiselstein currently manages the materials group in the Menlo Park, California, office of Exponent Failure Analysis Associates. He specializes in both the mechanical behavior of materials and corrosion science and testing. His research includes design analysis and testing for approval by the Food and Drug Administration (FDA) of implantable devices, support for 510k and premarket approval applications submissions to the FDA, failure modes and effect analysis for medical devices, failure analysis of implantable medical devices, fatigue in materials, hydrostatic extrusion wire design, design and fabrication of metal laminates for reactive armor and lightweight armor, and ballistics testing. Dr. Eiselstein has extensive experience dealing with solder joints, welds, and brazing; deformation and fracture of materials; the relationship between microstructure and properties; fractography; and failure analysis. He also has expertise in all aspects of corrosion, including corrosion fatigue, environmentally assisted cracking, hydrogen embrittlement, and corrosion of bridges, steam turbines, condensers, reactor vessels, pressure vessels, pipes and tubing, wire, tanks, chemical and power plant components, steam generators, oil and gas pipelines, and plumbing and piping.

**Harold K. Forsen**, a member of the National Academy of Engineering, received his B.S. and M.S. degrees in electrical engineering from the California Institute of Technology and his Ph.D. in electrical engineering from the University of California at Berkeley. Dr. Forsen is a retired senior vice president with Bechtel Corporation and a former foreign secretary of the National Academy of Engineering. His expertise and research interests cover a wide spectrum of engineering fields, including engineering and construction, energy, composites, electro-optical devices, power supplies and distribution, national energy policy, technology policy, nuclear and solar power, metals and alloys, industrial engineering, systems engineering, acoustics, applied nuclear physics, construction materials, and technical management. Dr. Forsen is specifically noted for outstanding technical and leadership contributions in the areas of fission, fusion, and energy technology in industry and academia.

**Willard C. Gekler** graduated from the Colorado School of Mines with a B.S. in petroleum refining engineering and pursued graduate study in nuclear engineering at the University of California at Los Angeles. Mr. Gekler is currently an independent consultant working for his previous employer, ABS Consulting, Inc. His extensive experience includes membership on the NRC ACW I and II committees and on the expert panel reviewing the quantitative risk assessments and safety analyses of hazardous materials handling, storage, and waste treatment systems for the Anniston, Umatilla, Pine Bluff, Aberdeen, and Newport chemical disposal facilities. He also served as project manager for the development of facility design criteria for the Johnston Atoll Chemical Agent Disposal System. His expertise is in hazard evaluation, quantitative risk analysis, reliability assessment, and database development for risk and reliability. Mr. Gekler is a certified reliability engineer and a member of the Society for Risk Analysis, the American Institute of Chemical Engineers, and the American Nuclear Society. He is the author or coauthor of numerous publications.

**Clair F. Gill** received a B.S. in engineering from the U.S. Military Academy and an M.S. in geotechnical engineering from the University of California at Berkeley. He currently serves as the chief of staff and resources/planning director for the Office of Facilities Engineering and Operations at the Smithsonian Institution. In this capacity, he oversees all facilities maintenance.

nance, operations, security, and capital construction and revitalization for the Smithsonian's museums and research facilities in Washington, D.C., and at several locations in the United States and abroad. Retired from the U.S. Army in 1999, General Gill has served as the Army's budget director. Throughout his military career, he was involved directly in various major construction projects, including military school facilities, a hotel complex, two flood control systems, and the reconstruction of a medical center. He was also involved in the operational concept for facilities worth nearly a quarter of a billion dollars to enable the Army to consolidate three branch schools at Fort Leonard Wood, Missouri, and worked on the environmental impact statement and the design and start of construction for that project.

**Chandra M. Roy** is a managing engineer at Exponent Failure Analysis Associates' mechanics and materials practice in Irvine, California. Dr. Roy specializes in the application of qualitative and quantitative risk assessment methodologies to engineered and business systems and processes. He also conducts consequence analysis for the release of hazardous chemicals. He has conducted source-term analysis, dispersion analysis, and fire and explosion analysis for accidental releases of airborne chemicals. Additionally, he is skilled in the analysis of failure and incident data for use in risk modeling. Dr. Roy has experience in the application of computational fluid dynamics methods to solve engineering problems. He is also familiar with a wide range of chemical processes and has experience in the operational management of the chemical process industry. He has authored or coauthored several technical publications and presented a number of papers and short courses. Dr. Roy received a Ph.D. in chemical engineering and an M.S. in nuclear engineering from the University of California at Santa Barbara; an M.S. in chemical engineering from Pennsylvania State University; and a B.E. in chemical engineering from the University of Roorkee, India.

**Kenneth A. Smith**, a member of the National Academy of Engineering, received Sc.D., S.B. and S.M. degrees in chemical engineering from the Massachusetts Institute of Technology (MIT), as well as a postdoctoral fellowship at the Cavendish Laboratory, University of Cambridge. He is currently Edwin R. Gilliland Professor of Chemical Engineering at MIT. In his election to the National Academy of Engineer-

ing, Dr. Smith was noted for diverse, creative, and fundamental research in fluid mechanics and rheology and heat and mass transfer and for professional and educational leadership. Dr. Smith's research interests are in the application of the principles of fluid mechanics, thermodynamics, heat transfer, and mass transfer to important engineering problems. Specific applications have included desalination, hemodialysis, atherogenesis, liquefied natural gas, aerosols in the atmosphere, and supercritical water oxidation.

**Michael K. Stenstrom** is a professor in the civil and environmental engineering department at the University of California at Los Angeles (UCLA). He has a Ph.D. in environmental systems engineering from Clemson University and is a registered professional engineer in California. He teaches undergraduate and graduate courses in water and wastewater treatment, mathematical modeling of environmental systems, and laboratory analysis. Prior to joining UCLA, Dr. Stenstrom was with Amoco Oil Company, where he performed research to improve petroleum refinery wastewater treatment facilities for five Amoco refineries. He is very familiar with the design and operation of municipal treatment systems and industrial treatment and pretreatment systems. He is the recipient of numerous awards, including the Harrison Prescott Eddy Prize for innovative research.

**Thomas Webler** received his Ph.D. in environment, technology, and society from Clark University, an M.S. in biomedical engineering from the Worcester Polytechnic Institute, and a B.S. in electrical engineering from the Virginia Polytechnic Institute and State University. He is currently on the faculty of the Department of Environmental Studies at Antioch New England Graduate School. Dr. Webler has taught courses in the political economy of environmental issues; the social dimensions of environmental management; and integrating science and politics in environmental decision making, survey design, and environmental and social impact assessment. He has been the principal investigator or coprincipal investigator on several funded research projects dealing directly with public involvement in various issues. Related publications are *Three Evaluative Tools to Empower Local Communities in the Environmental Cleanup of Sediment Contaminated Sites: A Comparative Analysis*; *Toward Better Theory of Public Participation*; and *Community Response to Risk Communication About Low Dose Radiation Exposures*.

# Appendix E

## Committee Meetings and Site Visits

### **MEETING 5, JULY 12-14, 2004<sup>1</sup>**

#### **Washington, D.C.**

*Objectives:* Discuss outline of the Blue Grass Chemical Agent Destruction Pilot Plant (BGCAPP) initial design report. Assign writing responsibilities for the BGCAPP initial design report.

#### *NRC Participants*

Committee members: Charles Barton, Robert Beaudet, Joan Berkowitz, Adrienne Cooper, Ruth Doherty, Lawrence Eiselstein, Harold Forsen, Willard Gekler, Clair Gill, John Merson, Chandra Roy, Kenneth Smith, Michael Stenstrom, and Thomas Webler. NRC staff: Bruce Braun, Nancy Schulte, Harrison Pannella, Carter Ford, and James Myska.

### **MEETING 6, SEPTEMBER 22-24, 2004**

#### **Woods Hole, Massachusetts**

*Objectives:* Receive comprehensive briefings and hold discussions on the Assembled Chemical Weapons Alternatives program, including schedule revisions and BGCAPP intermediate design, the technical risk reduction program, and chemical weapons information. Receive responses from the Army to committee queries.

---

<sup>1</sup>This committee also produced a report on the Pueblo Chemical Agent Destruction Pilot Plant (PCAPP) design. Meeting 5 was the last meeting for the PCAPP report and the first meeting to start work on this report.

#### *NRC Participants*

Committee members: Charles Barton, Robert Beaudet, Joan Berkowitz, Adrienne Cooper, Ruth Doherty, Lawrence Eiselstein, Harold Forsen, Willard Gekler, Clair Gill, Chandra Roy, Michael Stenstrom, and Thomas Webler. NRC staff: Bruce Braun, Donald Siebenaler, Harrison Pannella, William Campbell, Carter Ford, James Myska, and Nia Johnson.

### **SITE VISIT 5, OCTOBER 3, 2004**

#### **Blue Grass, Kentucky**

*Objective:* Attend the October Blue Grass Citizen's Advisory Commission meeting.

#### *NRC Participants*

Committee member: Thomas Webler.

### **SITE VISIT 6, OCTOBER 12-15, 2004**

#### **Tooele, Utah**

*Objective:* Become familiar with the Tooele Chemical Agent Destruction Facility.

#### *NRC Participants*

Committee member: Harold Forsen.

**MEETING 7, NOVEMBER 17-19, 2004**  
**San Diego, California**

*Objectives:* Tour the General Atomics facilities to review supercritical water oxidation and energetics batch hydrolyzer demonstration units. Hold discussions about the questions and answers received after the September 22-23 Woods Hole, Massachusetts, briefing, and review updates on the BGCAPP and PCAPP facility design and technical risk reduction projects since September 22, 2004. Hold committee deliberations and continue report writing.

*NRC Participants*

Committee members: Charles Barton, Robert Beaudet, Joan Berkowitz, Ruth Doherty, Lawrence Eiselstein, Harold Forsen, Willard Gekler, Clair Gill, Chandra Roy, Kenneth Smith, and Michael Stenstrom. NRC staff: Bruce Braun, Donald Siebenaler, Harrison Pannella, William Campbell, and Detra Bodrick-Shorter.

**MEETING 8, JANUARY 13-14, 2005**  
**Irvine, California**

*Objectives:* Hold discussions about the data and information received after November 17-19 meeting in San Diego and review updates on the BGCAPP and PCAPP facility designs provided on the Web site. Conduct committee deliberations and continue report writing.

*NRC Participants*

Committee members: Charles Barton, Robert Beaudet, Joan Berkowitz, Ruth Doherty, Lawrence Eiselstein, Harold Forsen, Willard Gekler, Clair Gill, Chandra Roy, and Michael Stenstrom. NRC staff: Bruce Braun, Donald Siebenaler, Harrison Pannella, William Campbell, and Detra Bodrick-Shorter.

**SITE VISIT 7, FEBRUARY 7-10, 2005**  
**Pasadena, California**

*Objective:* Attend BGCAPP intermediate design review.

*NRC Participants*

Committee members: Robert Beaudet and Willard Gekler.

**SITE VISIT 8, FEBRUARY 15, 2005**  
**Aberdeen Proving Ground, Maryland**

*Objective:* Attend BGCAPP intermediate design review executive overview.

*NRC Participants*

Committee member: Joan Berkowitz. NRC staff: Donald Siebenaler.

**MEETING 9, MARCH 31-APRIL 1, 2005**  
**Washington, D.C.**

*Objectives:* Hold discussions about the data and information received after the January 13-14 meeting in Irvine and review updates on the BGCAPP and PCAPP facility designs as provided on the Web site. Conduct committee deliberations and continue report writing.

*NRC Participants*

Committee members: Charles Barton, Robert Beaudet, Joan Berkowitz, Ruth Doherty, Lawrence Eiselstein, Willard Gekler, Clair Gill, Kenneth Smith, and Michael Stenstrom. NRC staff: Bruce Braun, Donald Siebenaler, Harrison Pannella, William Campbell, Detra Bodrick-Shorter, and James Myska.

**MEETING 10, MAY 9-10, 2005**  
**Washington, D.C.**

*Objectives:* Hold discussions about the Army's responses to the committee's requests for information since the March 31-April 1 meeting concerning the BGCAPP design. Receive reports from committee members on any significant new information about the BGCAPP design provided on the Bechtel Web site. Conduct teleconferencing with the sponsor for final informational inputs. Conduct final committee deliberations for each chapter, resolve remaining issues, and finalize substantive text content. Sign concurrence forms for BGCAPP interim design report.

*NRC Participants*

Committee members: Charles Barton, Robert Beaudet, Joan Berkowitz, Ruth Doherty, Lawrence Eiselstein, Harold Forsen, Willard Gekler, and Clair Gill. NRC staff: Bruce Braun, Donald Siebenaler, Harrison Pannella, William Campbell, and Detra Bodrick-Shorter.