

## Aesthetic Concrete Barrier Design

### DETAILS

---

77 pages | | PAPERBACK

ISBN 978-0-309-08849-7 | DOI 10.17226/13888

### AUTHORS

---

Nauman M Sheikh; Rebecca R Haug; D Lance Bullard; James R Schutt; Beverly J Storey; Roger P Bligh; Transportation Research Board

BUY THIS BOOK

FIND RELATED TITLES

### Visit the National Academies Press at [NAP.edu](http://NAP.edu) and login or register to get:

---

- Access to free PDF downloads of thousands of scientific reports
- 10% off the price of print titles
- Email or social media notifications of new titles related to your interests
- Special offers and discounts



Distribution, posting, or copying of this PDF is strictly prohibited without written permission of the National Academies Press. (Request Permission) Unless otherwise indicated, all materials in this PDF are copyrighted by the National Academy of Sciences.

NATIONAL COOPERATIVE HIGHWAY RESEARCH PROGRAM

---

---

**NCHRP REPORT 554**

---

---

**Aesthetic Concrete Barrier Design**

**D. LANCE BULLARD, JR.**

**NAUMAN M. SHEIKH**

**ROGER P. BLIGH**

**REBECCA R. HAUG**

**JAMES R. SCHUTT**

**BEVERLY J. STOREY**

Texas Transportation Institute

College Station, TX

**SUBJECT AREAS**

Highway and Facility Design

---

Research Sponsored by the American Association of State Highway and Transportation Officials  
in Cooperation with the Federal Highway Administration

---

**TRANSPORTATION RESEARCH BOARD**

WASHINGTON, D.C.

2006

[www.TRB.org](http://www.TRB.org)

## **NATIONAL COOPERATIVE HIGHWAY RESEARCH PROGRAM**

Systematic, well-designed research provides the most effective approach to the solution of many problems facing highway administrators and engineers. Often, highway problems are of local interest and can best be studied by highway departments individually or in cooperation with their state universities and others. However, the accelerating growth of highway transportation develops increasingly complex problems of wide interest to highway authorities. These problems are best studied through a coordinated program of cooperative research.

In recognition of these needs, the highway administrators of the American Association of State Highway and Transportation Officials initiated in 1962 an objective national highway research program employing modern scientific techniques. This program is supported on a continuing basis by funds from participating member states of the Association and it receives the full cooperation and support of the Federal Highway Administration, United States Department of Transportation.

The Transportation Research Board of the National Academies was requested by the Association to administer the research program because of the Board's recognized objectivity and understanding of modern research practices. The Board is uniquely suited for this purpose as it maintains an extensive committee structure from which authorities on any highway transportation subject may be drawn; it possesses avenues of communications and cooperation with federal, state and local governmental agencies, universities, and industry; its relationship to the National Research Council is an insurance of objectivity; it maintains a full-time research correlation staff of specialists in highway transportation matters to bring the findings of research directly to those who are in a position to use them.

The program is developed on the basis of research needs identified by chief administrators of the highway and transportation departments and by committees of AASHTO. Each year, specific areas of research needs to be included in the program are proposed to the National Research Council and the Board by the American Association of State Highway and Transportation Officials. Research projects to fulfill these needs are defined by the Board, and qualified research agencies are selected from those that have submitted proposals. Administration and surveillance of research contracts are the responsibilities of the National Research Council and the Transportation Research Board.

The needs for highway research are many, and the National Cooperative Highway Research Program can make significant contributions to the solution of highway transportation problems of mutual concern to many responsible groups. The program, however, is intended to complement rather than to substitute for or duplicate other highway research programs.

---

**Note:** The Transportation Research Board of the National Academies, the National Research Council, the Federal Highway Administration, the American Association of State Highway and Transportation Officials, and the individual states participating in the National Cooperative Highway Research Program do not endorse products or manufacturers. Trade or manufacturers' names appear herein solely because they are considered essential to the object of this report.

## **NCHRP REPORT 554**

Project 22-19

ISSN 0077-5614

ISBN 0-309-08849-6

Library of Congress Control Number 2005938042

© 2006 Transportation Research Board

**Price \$34.00**

## **NOTICE**

The project that is the subject of this report was a part of the National Cooperative Highway Research Program conducted by the Transportation Research Board with the approval of the Governing Board of the National Research Council. Such approval reflects the Governing Board's judgment that the program concerned is of national importance and appropriate with respect to both the purposes and resources of the National Research Council.

The members of the technical committee selected to monitor this project and to review this report were chosen for recognized scholarly competence and with due consideration for the balance of disciplines appropriate to the project. The opinions and conclusions expressed or implied are those of the research agency that performed the research, and, while they have been accepted as appropriate by the technical committee, they are not necessarily those of the Transportation Research Board, the National Research Council, the American Association of State Highway and Transportation Officials, or the Federal Highway Administration, U.S. Department of Transportation.

Each report is reviewed and accepted for publication by the technical committee according to procedures established and monitored by the Transportation Research Board Executive Committee and the Governing Board of the National Research Council.

Published reports of the

## **NATIONAL COOPERATIVE HIGHWAY RESEARCH PROGRAM**

are available from:

Transportation Research Board  
Business Office  
500 Fifth Street, NW  
Washington, DC 20001

and can be ordered through the Internet at:

<http://www.national-academies.org/trb/bookstore>

Printed in the United States of America

# THE NATIONAL ACADEMIES

## *Advisers to the Nation on Science, Engineering, and Medicine*

The **National Academy of Sciences** is a private, nonprofit, self-perpetuating society of distinguished scholars engaged in scientific and engineering research, dedicated to the furtherance of science and technology and to their use for the general welfare. On the authority of the charter granted to it by the Congress in 1863, the Academy has a mandate that requires it to advise the federal government on scientific and technical matters. Dr. Ralph J. Cicerone is president of the National Academy of Sciences.

The **National Academy of Engineering** was established in 1964, under the charter of the National Academy of Sciences, as a parallel organization of outstanding engineers. It is autonomous in its administration and in the selection of its members, sharing with the National Academy of Sciences the responsibility for advising the federal government. The National Academy of Engineering also sponsors engineering programs aimed at meeting national needs, encourages education and research, and recognizes the superior achievements of engineers. Dr. William A. Wulf is president of the National Academy of Engineering.

The **Institute of Medicine** was established in 1970 by the National Academy of Sciences to secure the services of eminent members of appropriate professions in the examination of policy matters pertaining to the health of the public. The Institute acts under the responsibility given to the National Academy of Sciences by its congressional charter to be an adviser to the federal government and, on its own initiative, to identify issues of medical care, research, and education. Dr. Harvey V. Fineberg is president of the Institute of Medicine.

The **National Research Council** was organized by the National Academy of Sciences in 1916 to associate the broad community of science and technology with the Academy's purposes of furthering knowledge and advising the federal government. Functioning in accordance with general policies determined by the Academy, the Council has become the principal operating agency of both the National Academy of Sciences and the National Academy of Engineering in providing services to the government, the public, and the scientific and engineering communities. The Council is administered jointly by both the Academies and the Institute of Medicine. Dr. Ralph J. Cicerone and Dr. William A. Wulf are chair and vice chair, respectively, of the National Research Council.

The **Transportation Research Board** is a division of the National Research Council, which serves the National Academy of Sciences and the National Academy of Engineering. The Board's mission is to promote innovation and progress in transportation through research. In an objective and interdisciplinary setting, the Board facilitates the sharing of information on transportation practice and policy by researchers and practitioners; stimulates research and offers research management services that promote technical excellence; provides expert advice on transportation policy and programs; and disseminates research results broadly and encourages their implementation. The Board's varied activities annually engage more than 5,000 engineers, scientists, and other transportation researchers and practitioners from the public and private sectors and academia, all of whom contribute their expertise in the public interest. The program is supported by state transportation departments, federal agencies including the component administrations of the U.S. Department of Transportation, and other organizations and individuals interested in the development of transportation. [www.TRB.org](http://www.TRB.org)

[www.national-academies.org](http://www.national-academies.org)



## **COOPERATIVE RESEARCH PROGRAMS STAFF FOR NCHRP REPORT 554**

ROBERT J. REILLY, *Director, Cooperative Research Programs*

CRAWFORD F. JENCKS, *Manager, NCHRP*

CHARLES W. NIESSNER, *Senior Program Officer*

EILEEN P. DELANEY, *Director of Publications*

NATALIE BARNES, *Editor*

BETH HATCH, *Editor*

### **NCHRP PROJECT 22-19**

#### **Field of Design—Area of Vehicle Barrier Systems**

MARK J. BLOSCHOCK, *Texas DOT (Chair)*

KEITH ROBINSON, *California DOT*

NORMAN W. GARRICK, *University of Connecticut*

DON J. GRIPNE, *Trinity Industries, Inc., Olympia, WA*

RICHARD D. LAND, *California DOT*

DOUGLAS E. MCCLURE, *South Carolina DOT*

RICHARD D. POWERS, *FHWA*

HOWARD R. RESSEL, *New York State DOT*

PRISCILLA TOBIAS, *Illinois DOT*

HARRY W. TAYLOR, JR., *FHWA Liaison*

STEPHEN F. MAHER, *TRB Liaison*

## FOREWORD

*By Charles W. Niessner  
Staff Officer  
Transportation Research  
Board*

This report contains guidelines for aesthetic treatment of concrete safety shape barriers. The report will be of particular interest to design and safety practitioners with responsibility for roadside safety improvements.

---

The increasing application of context-sensitive design solutions for highway projects has created a national need for aesthetic improvement of typical highway features. Requests for concrete barrier treatments and bridge rails that contribute to the overall aesthetic experience are increasing. Concrete barriers (e.g., New Jersey, F-shapes, single-slope, and vertical-face designs) are often the barriers of choice in urban and suburban environments. Many transportation agencies and communities have expressed a desire for aesthetic treatments for these standard shapes.

To date, there has been limited evaluation to determine which aesthetic treatments are safe and practical. Designers need guidance regarding the safety implications of aesthetic treatments for concrete barriers.

Under NCHRP Project 22-19, "Aesthetic Concrete Barrier and Bridge Rail Design," the Texas Transportation Institute developed design guidelines for aesthetic safety shape (New Jersey and F-shape profile) concrete barriers.

In Phase I, the research team identified the features and methods that contribute to the aesthetics of longitudinal traffic barriers and the aesthetic experience provided by the roadway. The research team conducted a literature review, surveyed U.S. and foreign sources for examples of aesthetic longitudinal traffic barriers, and reviewed existing test results and ongoing research to assess the crashworthiness of the aesthetic concrete barriers and see-through bridge rails.

At an interim meeting, the project panel and researchers agreed that the work to develop specific designs for see-through bridge rails should not continue. Also, after the initiation of this project, a California Department of Transportation (Caltrans) study developed guidelines for single-slope and vertical-face concrete barriers. Thus the focus of research under NCHRP Project 22-19 shifted to developing guidelines for aesthetic treatment of safety shape barriers only.

In Phase II, the research team conducted a finite element simulation pilot study, performed model validation, and developed a surrogate measure of occupant compartment deformation. Further finite element simulations were performed to develop preliminary design guidelines in terms of asperity depth, width, and angle of inclination. Based on these preliminary guidelines, a crash test plan was developed, in which the outcome of one test determined the configuration evaluated in a subsequent test. Results of the crash tests performed were used in conjunction with the preliminary guidelines developed through simulation to develop final design guidelines for aesthetic treatment of safety shape concrete barriers.

For the convenience of an aesthetic designer, guidelines developed for safety shape barriers in this research and the guidelines previously developed by the FHWA and Cal-

trans for stone masonry guardrails and for single-slope and vertical-face concrete barriers, respectively, were consolidated into a single set of design guidelines.

Designers now have sufficient guidelines to apply aesthetic treatments to various types of barriers.

# CONTENTS

<b>1</b>	<b>CHAPTER 1 Introduction</b>	Research Problem Statement, 1 Research Objective, 1
<b>2</b>	<b>CHAPTER 2 State of the Practice</b>	Review of the Literature, 2 Summary of Literature Review, 3 Survey of State DOTs, 4 Survey of U.S. and International Crash Test Laboratories, 5
<b>16</b>	<b>CHAPTER 3 Considerations for Developing an Aesthetic Barrier</b>	Developing a Definition for Aesthetics, 16 Changing the Aesthetics of a Longitudinal Concrete Traffic Barrier, 17 Design Techniques, 17 Factors Affecting Design, 17 Applications, 18 Viewer Preference Survey, 23 Assessment, 29 Aesthetic Design Discussion, 29
<b>30</b>	<b>CHAPTER 4 Aesthetic Concrete Barrier Design Guideline Development</b>	Objective, 30 Overall Summary of the Development Approach, 30
<b>32</b>	<b>CHAPTER 5 Simulation and Preliminary Aesthetic Design Guideline Development</b>	Introduction, 32 Pilot Study and Finite Element Model Validation, 33 Generalized Surface Asperity Definition, 47 Preliminary Aesthetic Design Guidelines, 48
<b>56</b>	<b>CHAPTER 6 Crash Testing and Further Evaluation of Preliminary Aesthetic Design Guidelines</b>	Crash Test Conditions and Evaluation Criteria, 56 Selection Considerations for Crash Test Configurations, 57 Crash Test 1 (474630-1), 59 Crash Test 2 (474630-2), 59 Crash Test 3 (474630-3), 60 Crash Test 4 (474630-4), 60 Crash Test 5 (474630-5), 62 Crash Test 6 (474630-6), 62 Crash Test 7 (474630-7), 64
<b>66</b>	<b>CHAPTER 7 Final Design Guidelines</b>	Guidelines for Aesthetic Surface Treatments of Safety Shape Concrete Barriers, 66 Comparison with Guidelines for Single-Slope and Vertical-Face Barriers and Stone Masonry Guardwalls, 66
<b>70</b>	<b>CHAPTER 8 Conclusions</b>	
<b>71</b>	<b>REFERENCES</b>	
<b>A-1</b>	<b>APPENDIX Guidelines for Aesthetic Barrier Design</b>	

## CHAPTER 1

# INTRODUCTION

### RESEARCH PROBLEM STATEMENT

In response to local expectations and the traveling public, there is a national need for aesthetic improvement of typical highway features. Requests for barrier treatments and bridge rails that contribute to the overall aesthetic experience are increasing. Research will assist owners in responding to design requests for aesthetic improvements to transportation systems.

Concrete barriers (e.g., New Jersey, F-shape, and single-slope, and vertical-face designs) are often the barriers of choice in urban and suburban environments. Many agencies and communities have expressed a desire for aesthetic treatments for these standard shapes. To date, there has been limited evaluation to determine which aesthetic treatments are safe and practical. Current standards do not provide guidelines to improve the appearance of concrete barriers.

Local communities and agencies are also demanding increasingly that state DOTs provide bridge rails with an enhanced “see-through” appearance. Existing designs do not fully meet the desire of the public for a see-through appearance. However, the use of innovative designs and materials may result in the development of aesthetic bridge rails with improved view spaces.

Designers need guidelines for aesthetic treatments of concrete barriers and additional options for see-through bridge rails.

### RESEARCH OBJECTIVE

The initial objectives of this research were to (1) assemble a collection of examples of longitudinal traffic barriers exhibiting aesthetic characteristics; (2) develop design guidelines for aesthetic concrete roadway barriers; and (3) develop specific designs for see-through bridge rails.

Following the submittal of the project interim report and the project panel members’ meeting with the researchers, the scope of the project and research objectives were modified to

only (1) assemble a collection of examples of longitudinal traffic barriers exhibiting aesthetic characteristics and (2) develop engineering design guidelines for aesthetic surface treatments of concrete safety shape barriers (e.g., New Jersey and F-shape profiles). Design guidelines for single-slope and vertical-face concrete barriers had been finalized after the initiation of this project in a California DOT study that is discussed in this report.

This report summarizes the entirety of the findings of the project, including work performed prior to the modification of the scope and objectives. Chapters 2 and 3 focus on the work performed by the researchers prior to the modification of the scope and objectives. Chapter 2 summarizes (1) the state of the practice pertaining to the features and methods that contribute to the aesthetics of longitudinal barriers and the aesthetic experience provided by the roadway; (2) the literature reviewed; and (3) the use of aesthetic longitudinal traffic barriers and treatments as identified through a survey of U.S. and foreign sources. Many aesthetic barrier examples were provided by transportation organizations from around the world and are presented in Chapter 2. Chapter 3 focuses primarily on barrier form and how it is perceived by the driver in its environment. The chapter defines aesthetics and discusses assessment, factors, and techniques for changing the aesthetic character of longitudinal concrete barriers. In addition, Chapter 3 discusses a viewer preference survey that was performed. Chapter 4 describes the development approach for the aesthetic concrete barrier design guideline. Chapter 5 describes the finite element simulation pilot study, model validation, and development of a surrogate measure of occupant compartment deformation. In addition, Chapter 5 presents preliminary design guidelines based on finite element simulation. Chapter 6 presents the selection considerations and results of the full-scale crash tests performed in support of the finite element simulations and the development of the final design guidelines. The final design guidelines for aesthetic safety shape concrete barrier design are presented in Chapter 7.

## CHAPTER 2

# STATE OF THE PRACTICE

### REVIEW OF THE LITERATURE

Aesthetics is a branch of philosophy dealing with the theory and perception of beauty and the psychological responses to it. How and why things are perceived as aesthetically pleasing is a subjective matter, yet many standards for beauty or aesthetics exist. In terms of highways and their components, Leonhardt<sup>(1)</sup> discusses the design of a structure as containing many variables that affect aesthetic visual quality. In agreement with many other designers and engineers, the basics of design are function, form, color, and texture. Yet other design characteristics, especially for linear structures such as a concrete barrier or bridge rail, include proportion, symmetry, rhythm, repetition, and contrast. Harmonious proportion is a valuable component of linear design. The manner in which various parts of the structure (height, width and depth, masses and voids, closed and open surfaces, light and dark created by sun and shadow) relate creates the character of the structure. Tang, in his “Philosophical Basis for Chinese Bridge Aesthetics” describes the concept of “yin and yang” in aesthetics. “The one form has no reality without the other, they are in opposition, comparison, harmony and succession.”<sup>(2)</sup> The structures express their unity by opposition as they reflect, complement, and transform one another.

Although the aesthetic component of design is the most visible to the user, few guidelines exist. Highway construction generally follows the safety and economy rule first. The Federal Highway Administration (FHWA) realizes that aesthetics and context-sensitive design are important factors in the design-making process and should be placed “. . . on an equal basis with mobility, safety and economics.”<sup>(3)</sup> Safety is the primary concern in highway design, yet safety and aesthetics are not mutually exclusive. “The successful inclusion of highway aesthetics can be achieved for any project by giving consideration to these five “C”s of design: context, comprehensiveness, cost, contractibility, and community.”<sup>(4)</sup>

The basic philosophical intent of creating highway aesthetics is to balance the safety and mobility needs of the transportation systems with the human need for a sense of community and aesthetic satisfaction. Both the FHWA and the American Association of State Highway and Transportation Officials (AASHTO) are working to develop the issues

of context-sensitive design and the incorporation of this mindset into the highway design process, from geometric design of the roadways to the aesthetic components within and extending beyond the roadway.<sup>(5)</sup>

With the exception of planting design, guidance on when and how to use specific aesthetic elements or treatments in the highway environment is virtually nonexistent. The question of when, where, and why to use color, pattern, textures, art, lighting, and so forth appears to be generally left to individual or group decision processes and is done in ad hoc manner. The type of criteria used in these decision processes (other than safety and cost issues) is not well established. Experience of the authors suggests that the most common criteria are probably consensus, embodied by the phrase: “Whatever everybody will agree to.” Evidently this is a common occurrence.<sup>(6)</sup>

Many highway design scenarios exist where selection of aesthetic elements and treatments may not pose any significant conflicts or issues. Obviously, however, since the roadway has a potentially hazardous element to its environment, a more clear set of criteria would be desirable to aid designers in their decision making. Two areas of study that offer a framework for roadway aesthetics design are environmental psychology and human factors. Each relates to the other in that both use research from both fields.

Environmental psychology seeks to understand and describe humanity’s relationship with the environment. Subsets of this field include environmental cognition and assessment and environmental design. These disciplines study visual perception and communication, as well as emotional responses, and how these things affect decision making in real-world environments.<sup>(7)</sup> This information also applies to deciding what is important in terms of cognition and the prediction of choices or preferences by an individual.<sup>(6)</sup> A large part of the study in this field attempts to describe this relationship in terms of scenic quality, our preferences for a certain aesthetic, the level of satisfaction we gain from a setting, or our comfort levels during certain activities. Much of the literature involves human responses to the natural environment and how positive experiences can be maximized, particularly in urban settings.

Of particular interest in terms of aesthetics is the work done in the areas of driver perception,<sup>(8)</sup> the visual quality of the driving environment,<sup>(9)</sup> the effectiveness of signed communication,<sup>(10,11)</sup> and driver performance related to visibility conditions.<sup>(12)</sup> These and other studies find that as the roadway

becomes more cluttered, the conspicuousness of traffic control devices worsened.<sup>(13)</sup> This condition is termed visual complexity and occurs when the background and the number of objects in the scene combine to the point of creating an information load that is excessive, confusing, or ambiguous.<sup>(14)</sup> The size of objects and their edge contrast are important determinants of conspicuity.<sup>(13)</sup> Contrast and luminance of the object with respect to the background and the surrounding area have a great impact on the perceptibility of objects.<sup>(11,15)</sup> Brighter colors are recommended as a tool to increase both conspicuity and contrast.<sup>(10,16,17)</sup>

The studies cited deal with making specific elements more visible (in particular, critical traffic control or driver performance information) but do not apply this approach to aesthetics. A basis is developed in a study from Japan.<sup>(8)</sup> This 3-year study looked at the issue of visual complexity in the view of the roadscape as a whole.

The study was specifically looking at the degree of visual image perception at the stage before cognition. In other words: “what you see” before “what you know.” It found that there is a hierarchical structure of articulation for elements versus backgrounds. The pavement is registered first, elements forming the skyline such as buildings or trees appear second, and roadside elements—including utility poles, pedestrian bridges, advertisement—are noticed last.

This hierarchy is established by virtue of the “conspicuousness” of the element that determines whether it is seen as an element of the scene or a background for other elements. In the study it was found that a roadscape in which buildings or other large structures are perceived early and are very conspicuous would receive a low aesthetic evaluation rating. Greenery such as trees rated high in the evaluation when they are the conspicuous part of the scene. A key to determining conspicuousness was which element formed the background against the skyline. The authors summarize: “Although conditions may differ by case, it is undesirable in terms of safety and amenity that such components, with no direct relevance to vehicle driving behavior, are perceived more strongly than the pavement, which is of major importance or greenery, which relates to the emotional dimension.”

This work stresses that the elements of the scene must be addressed before the meaning of the scene can be effectively conveyed. Also, the elements must first serve the needs of driving behavior. In terms of longitudinal barrier design, this finding suggests that the aesthetics of any structure must be considered in terms of the context in which it is viewed.

This issue of complexity as it relates to aesthetics was further explored and explained by Kaplan.<sup>(6)</sup> Using her own and the work of others in the field, Kaplan created a framework that offers insight into the design and management of the natural environment. Although heavily focused on the natural environment, the concepts employed embody many basic design rules that are applicable both for aesthetics and for perception and communication by and to a highway user. Kaplan used four informational factors to describe the way

in which humans perceive their environment and how they may combine to predict a particular response: complexity, coherency, legibility, and mystery.

*Complexity* is defined as how much is going on in a scene as determined by the diversity and number of elements.

*Coherency* (i.e., how easy the picture is to organize or comprehend) is based on the patterns of light and dark and how many major objects or areas these form. Readily identifiable objects result in greater coherence. Kaplan notes that humans can hold only so many major units of information or “chunks” at one time and that research indicates *five* such units is the norm.

Understood in these terms, it is easy to see the relationship between complexity and coherency. A scene can be complex (i.e., have a lot of things in it) but still be coherent (i.e., arranged in a few large chunks). This suggests that in visually complex scenes, ways might be sought to define logical areas as distinct units. This may be done by screening some elements, using textures or colors to separate important elements from the background, or removing some elements to create a simpler visual unit.

*Legibility* is making sense of three-dimensional space with the intention of functioning safely within it. A highly legible scene is described as one that is easy to oversee and cognitively map. Depth and well-defined space increase legibility. Landmarks, for example, increase legibility by providing easy understanding of one’s position relative to prominent elements.

*Mystery* involves the anticipation of something to come next based on the present scene. This concept relates to the concepts of novelty and surprise. In the highway environment, a degree of novelty may be appropriate in special cases (as in art pieces), but surprises in the driving environment are highly undesirable. Kaplan defines scenes that are high in mystery as being characterized by *continuity*, a connection between what is seen and what is anticipated, creating a promise of new information.

Kaplan’s model of visual perception and interpretation and their relationship to a response or an action offers a simple method to evaluate aesthetic design in the roadway. It can form the basis for identifying not only how a proposed enhancement may affect the scene but also how a scene may be improved based on the degree of conspicuity within a visually complex scene.

## SUMMARY OF LITERATURE REVIEW

Unfortunately, the application of much of this information to the realm of highway aesthetics is incomplete if not nonexistent. Studies showing the effect of a particular aesthetic treatment and its effect on driver performance cannot be found. The literature regarding aesthetics in highway design typically discusses the issue through the use of case studies and the presentation of imagery of noteworthy structures. These



are typically based on a subjective evaluation or on viewer-preference studies. Why any structure would be considered to be aesthetic in nature is rarely discussed. To be sure, the viewer preference aspect is and will always be an important consideration. But in the potentially dangerous highway roadway, it would be good to know the functional effects of design on driver perception.

There is little in the way of tested techniques for designers regarding the use of aesthetic treatments and how these affect the driver's performance. Except for areas of signage and signaling, how a driver perceives other elements in the roadside is poorly understood. Driver simulation studies with real-world verification would provide the needed science to enable designers to have a much better idea of how their designs might affect driver performance and safety.

Until such information is available, the single most critical guiding principle should be the delineation of the roadway edge. This implies that:

- Colors or shades should provide contrast at least between the base of the barrier and the pavement.
- Impact areas of the barrier should be in appropriate contrast to the background given a specific design speed and the view quality of the potential scene.

The following section discusses a viewer preference survey that was performed in this study. The study applies some of the concepts presented in the review of the literature.

## SURVEY OF STATE DOTs

The researchers conducted a telephone survey of state DOTs with the intention of gaining insight into the present practice of aesthetic barrier design. The research team prepared a set of interview questions and tested the questions with three interviews. Based on the results of those interviews, the questions were revised and the rest of the interviews were con-

ducted. All 50 states were contacted, but some interviews were unable to be completed. In total, 41 states were interviewed.

The questions asked were:

- Does your DOT have guidelines on aesthetic treatments for structures?
- What type of longitudinal concrete barrier (LCB) does the DOT typically use?
- Does your DOT incorporate any type of aesthetic treatments into LCBs or bridge rails?
- Do you use any aesthetic steel rail or barrier designs?
- Do you get requests from the public for aesthetic barriers and rails?
- Do you have and use see-through bridge rail designs?
- Do you incorporate any use of colors into your LCBs?
- Have you used any veneer products such as precast imitation stone or brick on LCBs?
- Have you used any sandblasted patterning on LCBs?
- Does your DOT conduct any testing of barriers or rails? What type? Results? Test levels (TL-1 thru TL-4)? Meet requirements of *NCHRP Report 350*?
- Is there some design you would like to see tested?

Of the states that were interviewed, only 22% have guidelines in place for the aesthetic treatment of roadside structures. The most common type of concrete barrier being used was the New Jersey or F-shape barrier (68%), with the Kansas Corral coming in a distant second (7%). Since the New Jersey and F-shape barriers are essentially identical in appearance, they are considered the same for aesthetic design purposes. Figure 1 shows the breakdown of concrete barriers currently in use.

Fifty-nine percent of the surveyed state DOTs do not incorporate any aesthetic treatments into their concrete barriers, while 39% do. The remaining 2% of respondents were unsure.

Thirty-two percent of states use a tube-type steel rail, and 44% stated that they do not use any type of steel rail or barrier design. Figure 2 shows the breakdown of steel rails used by the various states.

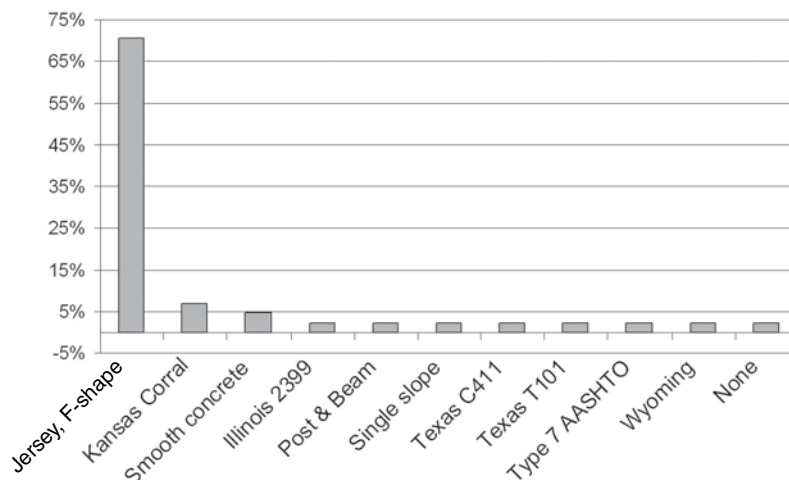

Figure 1. Concrete barriers in use in the United States.



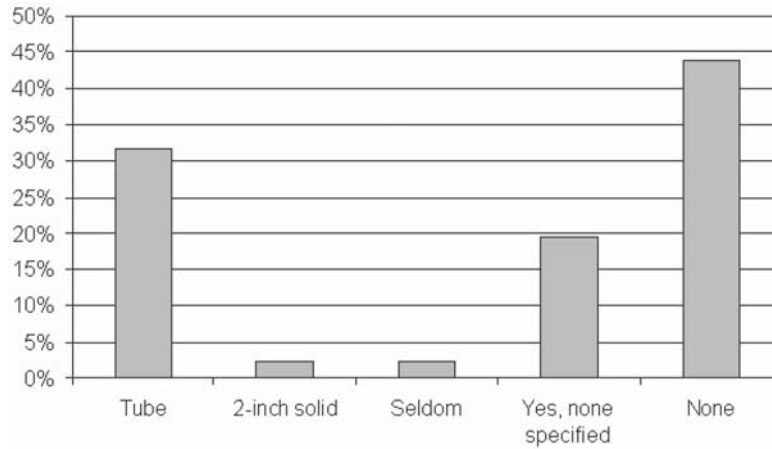

Figure 2. Typical steel rails used by state DOTs.

Public requests for aesthetic barriers and rails are very common in the states. Forty-six percent of states said that they get a lot of requests from the public for more aesthetically pleasing roadside structures. Figure 3 depicts the public requests.

Only 27% of states said that they use see-through bridge rail designs. Thirty-two percent incorporate colors into their concrete barriers, and 24% have used veneer products, such as precast imitation stone or brick, on their concrete barriers. Sandblasted patterning on concrete barriers is not a widely used practice, with only 7% of states using this aesthetic treatment.

Eighty-eight percent of states do not conduct any testing on their barriers or rails, and only 41% stated that they would like to see testing performed on specific designs.

Most state DOTs are getting increased requests for aesthetic roadway structures. Some are starting to develop their own guidelines for their designers, but most are relying on existing examples that have proven reliable in other states. There were some comments from respondents to the effect that the only good rail is a smooth rail and that aesthetics should in no way compromise it. This sentiment occurred in a very small number of responses, but may be common among designers in some states. This is reflected in the fact

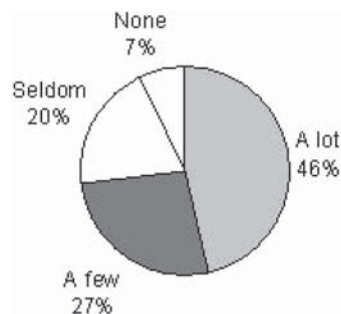

Figure 3. Public requests for aesthetic barriers and rails.

that the most commonly used barrier is the safety shape design.

A large number of photographs were received from around the country. An insight into concepts that are being experimented with can be gained from a review of these photographs. A few of these that demonstrate the range of ideas in current usage are shown in Figure 4.

### SURVEY OF U.S. AND INTERNATIONAL CRASH TEST LABORATORIES

#### U.S. Crash Test Laboratories

Out of 12 surveys sent via e-mail to U.S. crash test laboratories, 11 responses were received. Of these, 82% stated that they have not done any work in the area of aesthetic barrier design and/or testing and 18% provided information for use on this project.

California DOT (Caltrans) and Midwest Roadside Safety Facility (MwRSF) were the two U.S. labs that provided information as part of the survey. Caltrans provided crash test reports, 16-mm film, and videos for analysis of their research effort to develop design guidelines for single-slope and vertical-face concrete barriers. MwRSF provided crash test reports of aesthetic concrete barriers and steel rails.

#### International Crash Test Laboratories

Out of 18 surveys sent via e-mail to international crash test laboratories, 12 responses were received. Of these, 33% stated that they could not provide information due to confidentiality issues, 42% have not done any work in this area, and 25% provided information on aesthetic barriers. The labs that provided information were Autostrade, Italy; Transport Research Laboratory (TRL), United Kingdom; and Swedish National Road and Transportation Research Institute (VTI), Sweden.

Photographs provided by Autostrade are shown in Figures 5 and 6. Both installations are types of safety shape concrete barriers. The first, shown in Figure 5, is used in Rome near the Aurelian ancient walls of the city. In actual application, flowers and plants are planted in the upper part of the barrier. The second installation, shown in Figure 6, is a variation of a New Jersey border bridge, which allows motorists to view the landscape.

TRL also provided photographs of concrete barriers and see-through longitudinal bridge rails. Figure 7 depicts several types of concrete barriers currently used on the United Kingdom Highways Agency (HA) roads. All concrete safety barriers used on the HA network have a plain,

smooth concrete finish of natural color. The majority of all bridge rails take the form of vertical posts with horizontal rail members, deeming them see-through. Photographs of several see-through bridge rails are shown in Figure 8.

VTI is the only international test laboratory to submit results of *NCHRP Report 350* testing done at their facility. The GPLINK concrete road barrier, manufactured by Gunnar Prefab AB in Mora, Sweden, has FHWA approval for Test Level 3. The FHWA acceptance letter can be accessed at [http://safety.fhwa.dot.gov/roadway\\_dept/road\\_hardware/barriers/pdf/b-62.pdf](http://safety.fhwa.dot.gov/roadway_dept/road_hardware/barriers/pdf/b-62.pdf). Photographs of the GPLINK concrete barrier are shown in Figure 9.



Most of the unique designs were located in scenic areas where traffic speeds and traffic counts are quite low. This stone railing from Kentucky is a good example.



This culvert bridge is located near a golf course in Kentucky but is interesting for its craftsmanship and ingenuity. This is a steel-backed timber railing.



The trim hardware on this concrete bridge deck adds the convincing detail for this deception.

Figure 4. State DOT photographs.



**This Wyoming Rail from Virginia is a good example of the reason for a see-through rail. The rail is also suitably unassuming.**



**This steel tube rail is the metal equivalent of the concrete post & beam concept. The thinner profile allows more viewable area beyond and the surface may take color finishes easier.**

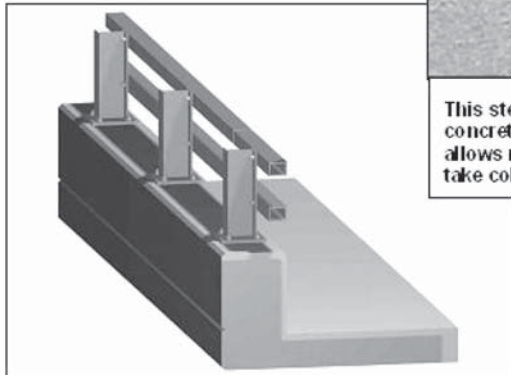

**This, and variations of this type of combination rail, is used in both low and high-speed applications over scenic areas.**

*Figure 4. (Continued).*



A concrete railing in Virginia is similar to the Texas T411 in section but the designers have added the posts at each end with a substantial wing wall. This view is an excellent example of an approach discussed later in which shorter bridges are dealt with as a unit rather than a repeating section.

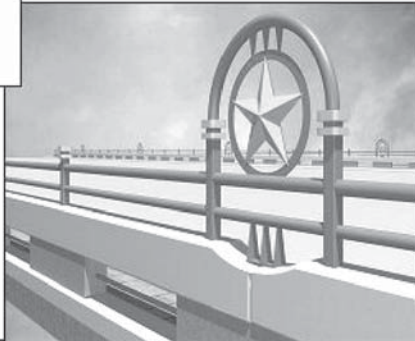

This proposed design in Texas provides a dramatic change for a typical post-and-beam rail.



CTDOT/AASHTO LRFD  
Open Bridge Rail with Bicycle Rail

This computer-generated model from Connecticut allows ample visual access to the scene beyond without competing with it. This example also shows the much better visual access afforded by horizontal openings. Contrast this with the example of the vertical slots in the railing from Virginia.

Figure 4. (Continued).





**This very recent photo from Iowa DOT represents the highest degree of creative application we have seen exercised on the inside of a concrete railing. This is a very effective use of line and contrast to create a unique railing. Note that it is topped with a steel pipe. The amount of relief in the face appears to be about 1/2" and since the lines are generally linear, may have a little to no effect on an impacting vehicle.**



**This project from El Paso, Texas was very popular with the community. The patterns were easily incorporated into existing forms at little additional cost.**

*Figure 4. (Continued).*



Special railing designs such as this one from Kentucky are typically associated with pedestrian access and always protected by a crashworthy wall.



Examples of steel rails were typically protected by a wall. In most cases, they were used in conjunction, located on a low traffic speed street.



This rail is another example of a popular method to create attractive rails in urban areas. This Virginia project is located in low-traffic-speed street.

Figure 4. (Continued).

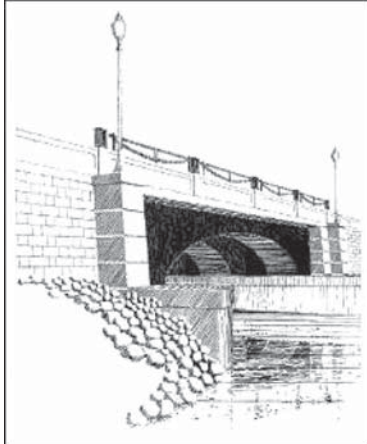

This is a sketch of a bridge rail design under construction in Iowa. The stone-cover creek crossing from Pennsylvania and cobblestone insets on the bridge in Michigan are good examples of the degree of attention the exterior portions of bridges are receiving. No interior rail images were provided.



Formliners have made it easy to install a wide range of patterns in almost any concrete structure. When finished with special coloring techniques, it is almost impossible to discern any difference from the real thing.

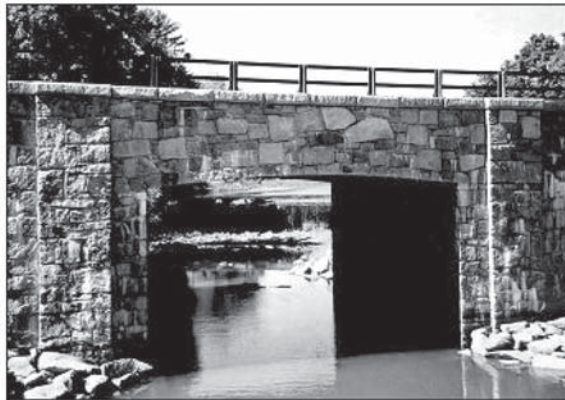

The stone on this bridge in Pennsylvania could be real or a veneer. The railing indicates that this is also a low-speed/low-traffic-volume bridge.

Figure 4. (Continued).

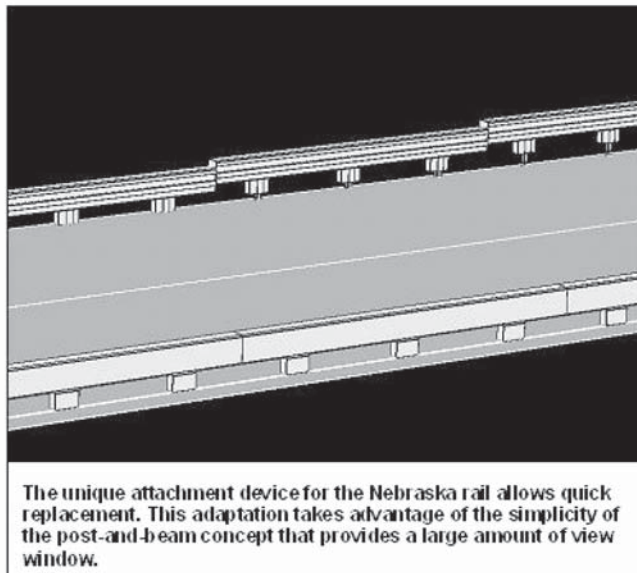
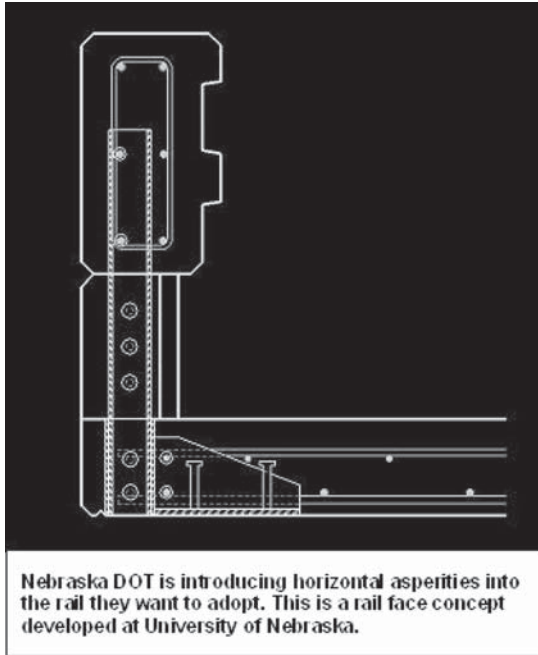

Figure 4. (Continued).





Figure 5. New Jersey barrier used in Rome.

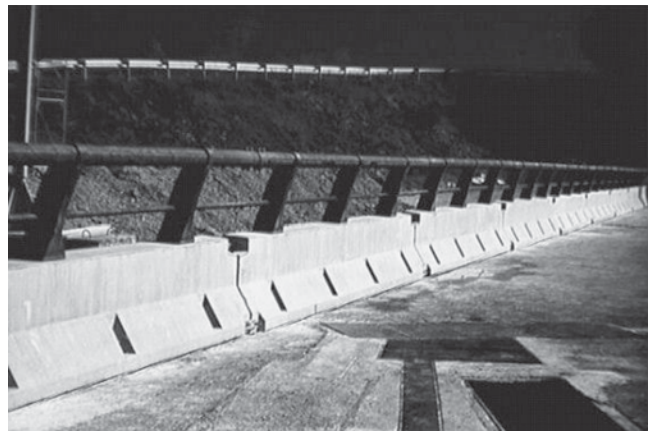
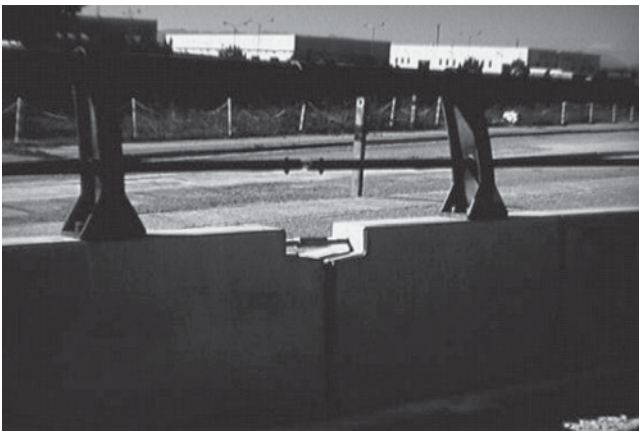

Figure 6. New Jersey border bridge used in Italy.



Figure 7. Concrete barriers used in the United Kingdom.



Figure 8. See-through bridge rails used in the United Kingdom.



Figure 9. GPLINK concrete barrier.

---



## CHAPTER 3

# CONSIDERATIONS FOR DEVELOPING AN AESTHETIC BARRIER

The evaluation plan for developing a guide for designers for aesthetic treatments of concrete barriers originally addressed both safety performance and the application of context-sensitive principles for selecting the appropriate barrier for the drivers and their environment. Research into the principles for selecting the appropriate barrier for drivers and their environment was performed early in the study. A review of the literature and an investigation into context-sensitive principles was performed. However, following the submittal of the project interim report and the project panel members' meeting with the researchers, the scope of the project and research objectives were modified to only (1) assemble a collection of examples of longitudinal traffic barriers exhibiting aesthetic characteristics and (2) develop engineering design guidelines for aesthetic surface treatments of concrete safety shape barriers (e.g., New Jersey and F-shape profiles). The focus of the design guidelines would be to determine the crashworthy geometric configuration of surface asperities that could be placed into the traffic face of New Jersey and F-shape concrete barriers. The investigation of geometric configurations of crashworthy surface asperities would be performed using finite element simulation and full-scale crash testing. Therefore, additional research relating to driver behavior and context-sensitive design principles was stopped. The information presented hereafter was gathered prior to the change of project scope and is presented as documentation of project work performed. This information may be considered incomplete and is only presented for the reader's edification.

Aesthetic barrier design has been poorly described as a technique dealing strictly with aesthetics. Previous studies dealing with barrier rail design have focused on structural performance and testing rather than the evaluation of aesthetic characteristics of a barrier and its effect on the driver, the roadway, and environment. The project work plan originally addressed developing guidelines for designers of aesthetic treatments of concrete barriers that addressed both safety performance and context-sensitive principles. The researchers approached this plan from both the viewer preference level and the behavioral level. The viewer preference level focused on applying characteristics that cause a rail or barrier to elicit a favorable response from a viewer, either consciously or subconsciously. The behavioral characteristics study identified for the engineer/designer those characteristics of rails that promote im-

proved visibility, principally as a combination of color, line, and contrast with other roadway elements or activities.

### DEVELOPING A DEFINITION FOR AESTHETICS

The issue of when something is considered "aesthetic" is important because many people consider aesthetics to be a heavily subjective assessment. For the sake of discussion regarding bridge rails and barriers, a more objective definition is needed. This is because, when a community asks for a more "aesthetically pleasing" design, designers must be able to know what that means.

The 2002 *AASHTO Roadside Design Guide*<sup>(18)</sup> describes an aesthetic barrier to be a barrier that harmonizes with the natural environment. This definition is clearly appropriate where the natural environment provides a strong visual presence, but the definition offers little when dealing with urban contexts. A general definition of aesthetic barrier that has emerged and has been suggested in the literature is "anything different from what is now used." This is a reaction of course to the common safety shape barrier or other smooth concrete barrier designs. This definition, however, offers no guidance on what makes a barrier "aesthetic." For that, more objective criteria are required. A starting place is with the characterization of the common traffic barrier.

The common concrete barrier is probably considered non-aesthetic based simply on its unadorned, utilitarian character. This is characterized by:

- **Uniformity of line.** Line typically infers linear directionality in the context of a barrier. Line is found in the edges of surfaces, shapes, or patterns, but most prominently as the edge of the structure that is silhouetted against the background. Unchanging lines over long distances can become static and boring.
- **Uniformity of profile.** Profile is the shape of the barrier. Typically this is a form constantly repeated throughout the length of the barrier. A consistent profile can also become boring, particularly if it is a very simple form.
- **Uniformity of surface.** A uniform surface can also become static and boring over long distance simply due to its plainness.
- **Lack of color.** White in the context of most highway structures is not a color but rather may be considered an absence of color. This includes the lighter shades of gray.

Typical concrete barriers are simple in shape, featureless, repetitive, and utilitarian in appearance. For most viewers, an aesthetically treated barrier will be different in some or all of these categories. The selection of one alternative aesthetic treatment over another will still be a subjective process. However, an objective set of aesthetic criteria can consist of line, profile, surface, and color.

### CHANGING THE AESTHETICS OF A LONGITUDINAL CONCRETE TRAFFIC BARRIER

Concrete traffic barriers are linear elements by design, and this linear character cannot be fundamentally altered. Improving the aesthetic character means that methodologies must be found to add interest to the structure without compromising the functionality of the structure. Interest may be achieved by modulating the linear character of the barrier. Modulation may be defined as a change in rhythmical measure. In terms of a linear structure we may take this to mean the change in the amplitude, frequency, or intensity of the line, color, pattern, or form.

The combination of these aspects will do one of two things:

- **Reinforce the linear character of the structure.** Introduce linear lines that parallel the edge of the structure or use a short, consistent sequence or repeating pattern.
- **Lessen the linear character of the structure.** Segment the rail by varying the height, introducing vertical lines, or using long, discontinuous patterns.

Because barriers are experienced while the viewer is in motion, the structure is experienced as a thing with a beginning and end, perceived over a period of time. This temporal aspect means that the structure is experienced as a pattern of both rhythm and sequence. The common concrete rail has an aesthetic character composed of a singular, boring rhythm and a lack of any sense of sequence. Therefore, creating an aesthetic barrier rail means creating a pleasing rhythm and sequence to the time in which a rail is experienced.

### DESIGN TECHNIQUES

Rhythm (i.e., the frequency of a repeated pattern) and sequence (i.e., the segmenting of distance and/or time) can be achieved through the following techniques:

- Create contrasting surface reflectivity by varying the amount of light reflected from a surface.
- Create a balanced discontinuity by introducing randomness into a line, rhythm, sequence, or pattern.
- Create an interesting pattern by using contrasting surface reliefs, textures, or colors to create vertical, horizontal, curvilinear, or angular shapes.

Modifying the surface of a barrier wall entails introducing a different surface coating or deforming the surface itself.

Surface coatings can be cementitious coatings or pigmented coatings (i.e., paints and stains).

Deforming a surface can be accomplished by sandblasting to change the color and reflectivity of a surface, or parts of a surface can be recessed or be made to protrude from the primary surface. Receding or protruding surfaces are perceived by the shadow contrast created by their edges. Surface reflectivity and shadow contrast are the ways in which patterns are perceived. It may be possible to communicate patterns through the contrast in reflectivity brought about by small changes in surface angles.

Adding aesthetic treatments to the interior of concrete barriers will entail the addition of vertical edges (i.e., lines perpendicular to the line of the barrier) into the face of the barrier. Research and experience clearly confirm that almost any edge that is part of a surface perpendicular to the direction of traffic can negatively influence vehicle impact. The size of the relative change in the surface determines whether or not it may snag some part of an impacting vehicle. The issue, then, is the degree to which surface reflectivity and patterns can be introduced into a rail surface without negatively affecting impact performance.

The key question is “how can vertical edges and other surface discontinuities be safely introduced into a rail surface design?”

### FACTORS AFFECTING DESIGN

Parameters have already been established that greatly influence the search for alternative barrier and rail designs. Three of the most critical parameters are (1) adequate rail height; (2) the need for a continuous solid surface (either rounded or flat) of adequate contact surface area at the point of impact; and (3) the absence or protection of any vertical edge that will snag a vehicle.

The dimensions may vary, but a representative example is shown in Figure 10. Of critical note is the 356-mm impact surface (and its 330-mm vertical location) and the 115-mm setback of the post. The post is set back from the face of the rail to prevent snagging of the vehicle tire/wheel. Snagging can lead to excessive occupant compartment deformation, high longitudinal deceleration, and/or vehicle instability.

This example reflects the minimum considerations for a new barrier design for either concrete or steel materials. Aesthetic elements such as pipes and decorative forms can be added to this form as long as these basic parameters are respected.

Vertical openings in a concrete rail present serious problems. The Texas T411 railing is frequently mentioned as having a very desirable aesthetic. A cross section of the T411 in plan view is shown in Figure 11. The T411 is rated for *NCHRP Report 350 TL-2* and is not crashworthy for high-speed applications. Using this as a model for performance enhancement, the width of the openings may be narrowed. However, at some point this approach results in a series of “slits” rather than “windows” and, in effect, becomes a more

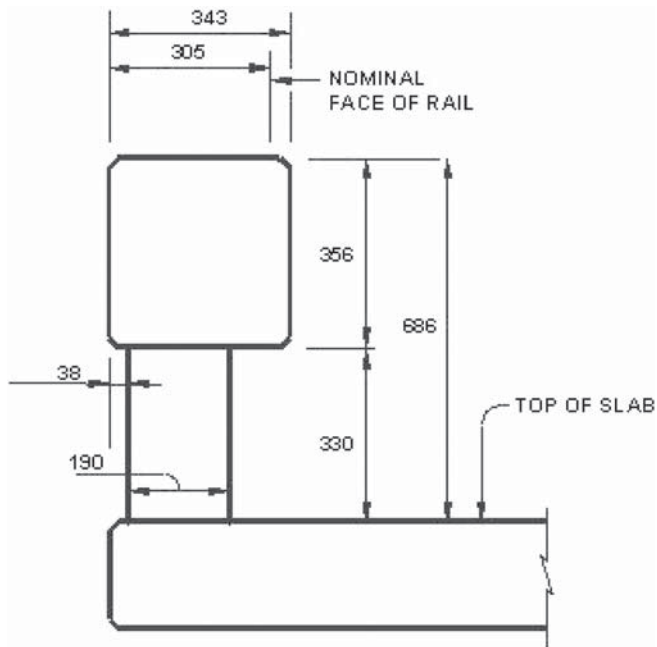

Figure 10. Dimensions of typical bridge railings (in millimeters).

uniform surface. The T411 was modified to perform in accordance with *NCHRP Report 350 TL-3* by providing a flat, smooth, vertical traffic face for a height of 457 mm along the lower portion of the barrier and forming the openings above that height.

In the case of steel see-through rails, the most limiting factors are (1) the allowable deformation of the horizontal element and (2) the exposure of the vertical supports to an impacting vehicle. The question becomes “how far back can the supports be placed and still achieve the requisite support for the horizontal elements?” The vertical opening distance or clear space between rail elements must be considered, as well as the size of the horizontal elements that define the contact area of the rail. An easy way to help ensure proper impact performance is to reduce the clear opening between the horizontal elements to a point that an impacting vehicle cannot reach the vertical support. At some point we approach an increasingly uniform surface, one for which concrete is a more suitable material.

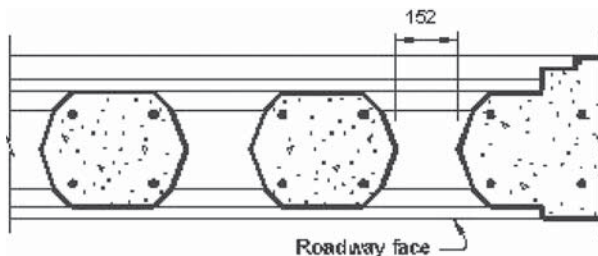

Figure 11. Plan view of Texas T411 bridge rail cross section (in millimeters).

The design of see-through rails reaches a point where a key question must be posed: “How much investment for aesthetic purposes is appropriate for a railing that should attract little attention?” (It is supposed that the scene beyond is the reason for seeing past the railing.) There will be a point of diminishing returns in fashioning a see-through rail, given the contextual issues of how they are seen. It may be possible to achieve acceptable visual access with small openings in the rail. Answering this question should be a major goal of the visual preference studies.

An aspect not demonstrated in the graphic studies but clearly apparent in existing examples of concrete barriers is the issue of the shape and location of the view window. Concrete barriers such as the Texas T411 have vertical openings between deep posts. A contrast to this is the concrete post-and-beam (P&B) type of rail (e.g., Kansas Corral), which has a horizontal opening. The depth of the T411 openings makes it impossible to see through the rail unless the viewer is nearly perpendicular to the rail. Until then, on approach to the rail, the surface appears as a solid, although textured, barrier. The rail offers little in the way of functional visual access. The horizontal opening of the P&B rail, however, affords a wide, continuous view window that is easily discernable on approach to the rail. Even though the concrete beam provides a significant visual screen, the viewers’ eyes can easily connect the upper and lower scenes into an understandable image.

## APPLICATIONS

A key question in aesthetic design is “how much visual impact will the barrier modification have and why?” The degree of visual impact will depend heavily on the visual prominence of the barrier relative to the background. How does this relationship affect the design of rails? To investigate this question, the researchers developed a series of barrier examples. These were used in a graphical study to explore the relationship between barrier and background.

Four images of each study alternative are presented in four settings. The first is the barrier alone, the second is with a rural background, the third is with an urban background, and the fourth is with both a rural and urban background. The background imagery is stylized to represent a visually complex urban backdrop and a simpler, flatter, rural scene. Since this study was to determine the effects of contrasting shapes, the graphics are prepared in shades of gray. The graphics show a true-to-scale (with the road) image of a 914-mm-tall, single-slope wall. The shoulder is 1.8 m wide and the travel lane is 3.7 m wide. The joints shown in the barrier are spaced 7.6 m.

### Alternative A—Untreated and Recessed Panels

*Alternative A1* is an untreated single-slope barrier (Figure 12).

*Alternative A2* has recessed panels of contrasting color (Figure 13).

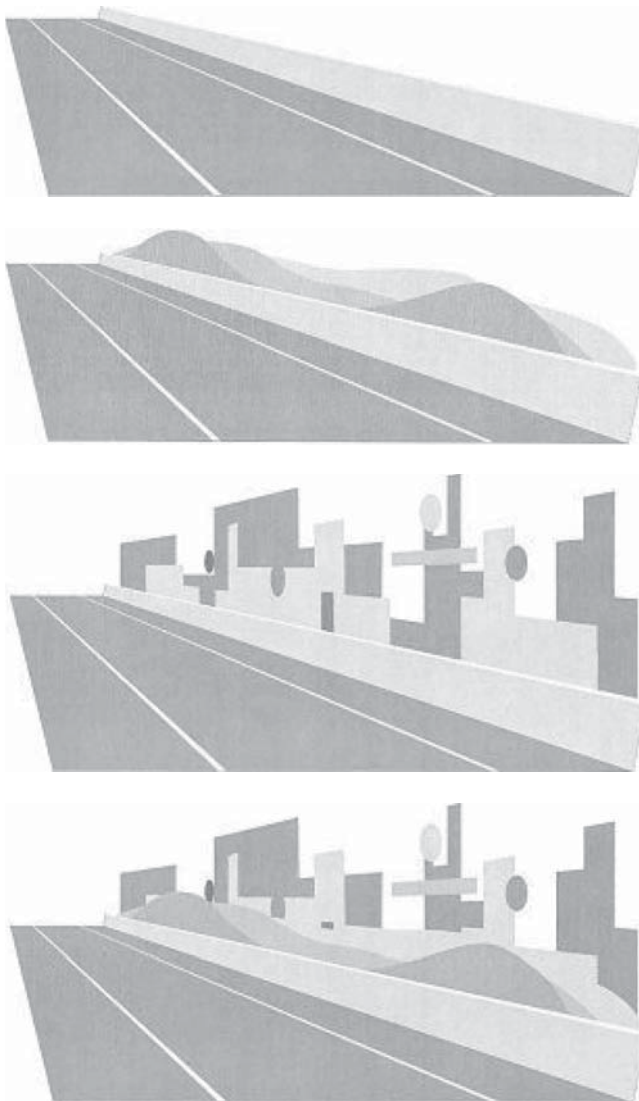

Figure 12. Alternative A1—single-slope barrier.

The contrast between these two rails without the background is significant. The untreated barrier reinforces the line of the roadway, while the segments of the panel design reduce this effect dramatically. In the rural set, A1 mimics the linearity of the background, while A2 appears more static by comparison. In the urban set, A1 stands in strong contrast to the numerous lines behind it, but A2 starts to blend with the background. In the combined rural/urban set, each rail appears more visually balanced with the background.

#### Alternative B—Recessed Line

Alternative B1 is a single, recessed line about 102 mm wide with a 13-mm-wide line above (Figure 14).

Alternative B2 is a recessed line alternately broken into 7.6-m and 15.2-m segments (Figure 15).

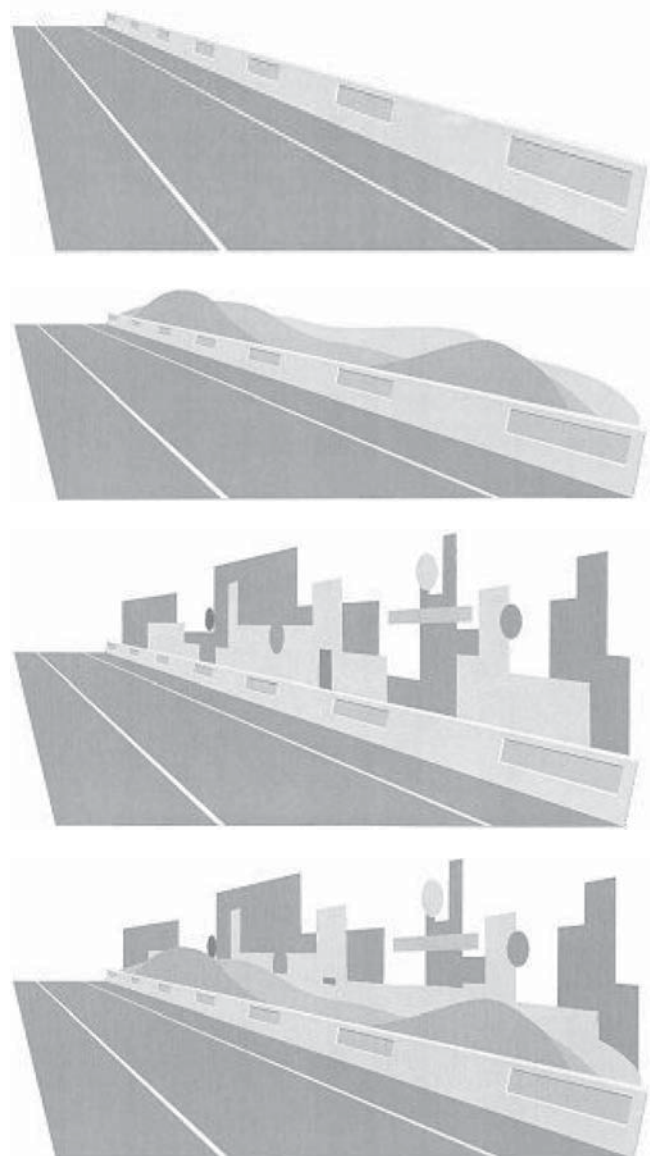

Figure 13. Alternative A2—recessed panels.

This study explores how much surface contrast is necessary to achieve the effects noted in Alternative A. A comparison of the two barriers without background clearly indicates the dashed line reduces the apparent length of the rail. The effects found in the two backgrounds in Alternative A are the same as well. This suggests that it may be possible to achieve a significant visual effect while limiting the segment-imparting elements to the top portion of the rail.

#### Alternative C—Arches

Alternative C1 is a 7.6-m arch pattern (Figure 16).

Alternative C2 is a 15.2-m arch pattern (Figure 17).



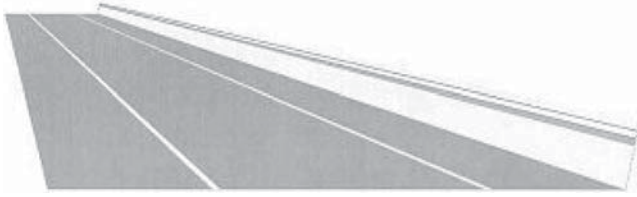

Figure 14. Alternative B1—recessed lines.

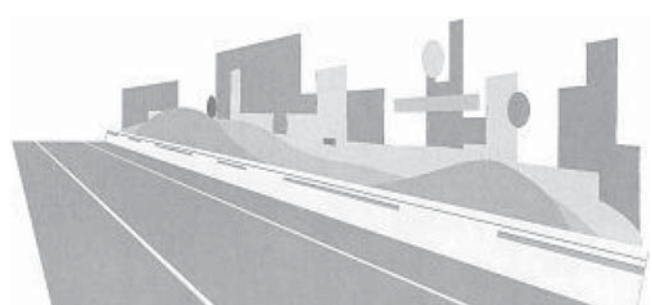
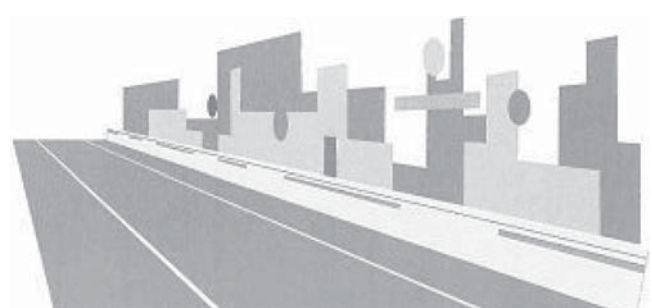
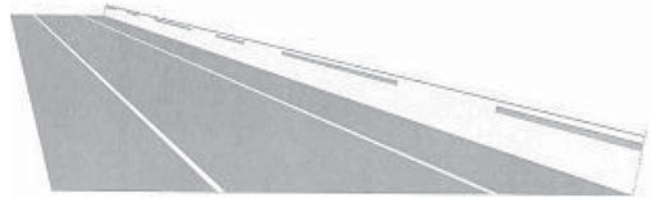

Figure 15. Alternative B2—segmented line.

This study was used to compare the effect of lengthening a continuous pattern, in this case an architectural pattern. The curves of the arches seem to be in character to the rounded forms of the rural background. The shorter version feels more “architectural” than does the long arch alternative. The longer pattern appears to be in higher contrast to the background than the shorter version due to the reduced numbers of lines on the surface. However, each may tend to blend too much with the urban background.

#### Alternative D—Copings

Alternative B incorporated a design that added a contrasting detail near the top of the barrier. This created a more

prominent edge and caused the rail to be more distinct against all backgrounds. Copings, shown in Figure 18, may provide an economical technique to improving the look of a barrier without affecting impact properties of the structure. Alternative D provides some coping options. Two (D1 and D2) are very simple; three (D3, D4, and D5) are more complex, with more edges.

*Alternative D1* is a coping without any additional surface treatment (Figure 19).

*Alternative D2* is a coping with an added protruding surface spaced at 15.2 m and with the same surface color as the barrier (see Figure 20).

*Alternative D3* is a contrasting color added to the protruding surface (Figure 21).



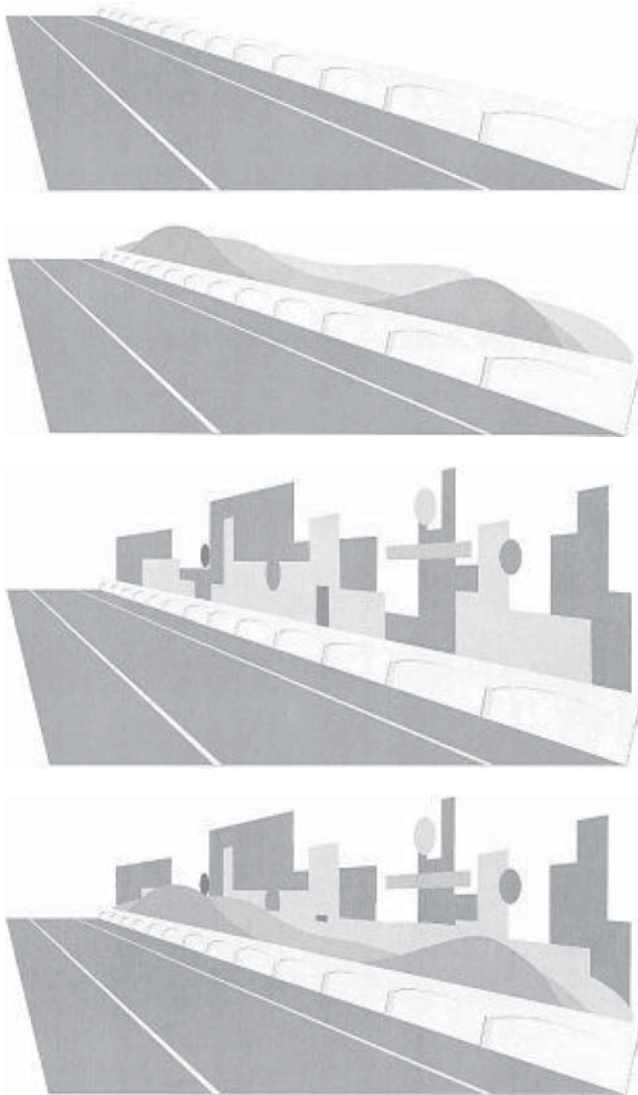

Figure 16. Alternative C1—7.6-m arch.

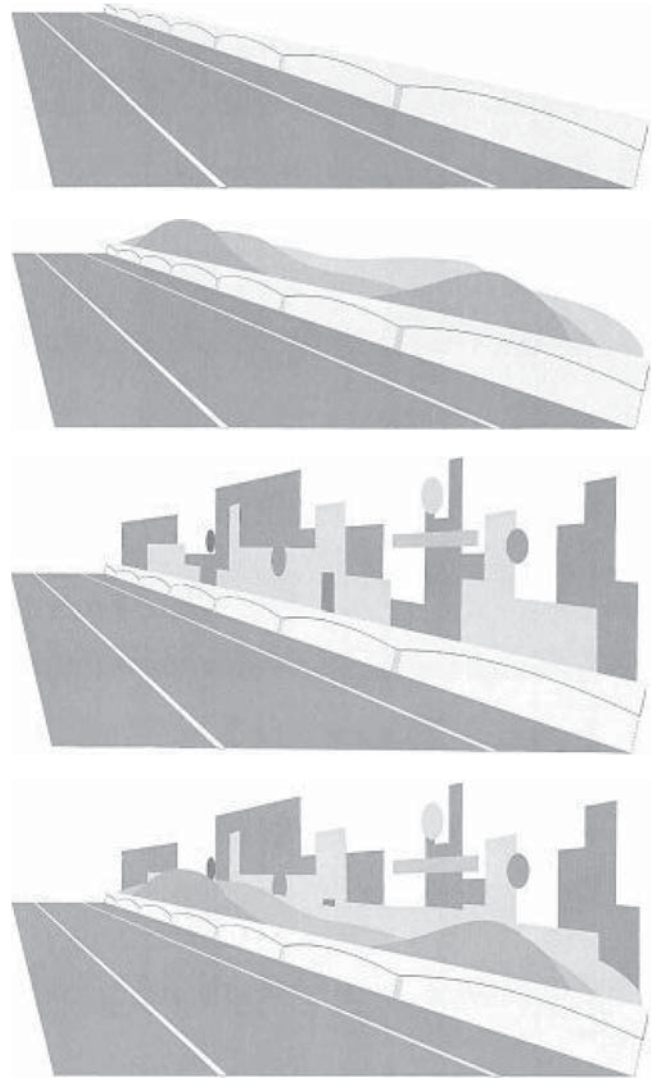

Figure 17. Alternative C2—15.2-m arch.

Alternative D4 is a protruding surface lengthened and matching the barrier color (Figure 22).

Alternative D5 is a contrasting color added to the protruding surface (Figure 23).

The effect of adding a spaced, protruding surface is the same as was found in alternatives A, B, and C.

**Alternative E—Open Metal Rail**

The rail shown in Figure 24 relies on collapsible steel panels that on impact would form a smooth, steel barrier. The see-through character of this design tends to blend the barrier with the background in both rural and urban settings. The effect is

more pronounced in the urban example. Barriers that allow a lot of the background to be seen may run the risk of losing a necessary degree of visual prominence. The visual prominence of these types of barriers may be increased through the use of strong colors.



Figure 18. Alternative D—copings.

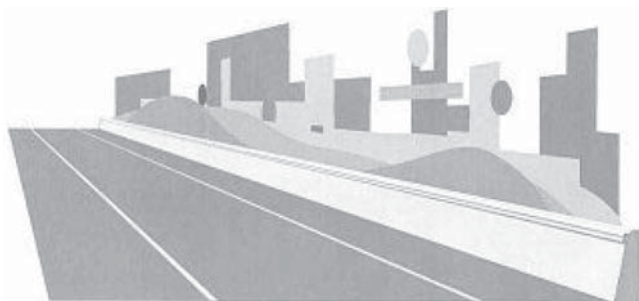
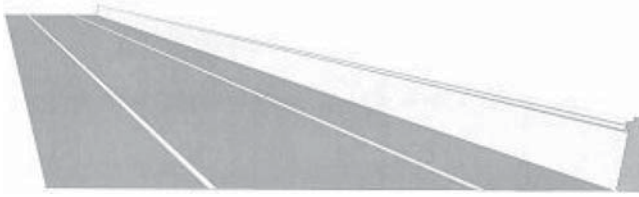

Figure 19. Alternative D1—coping only.

### Alternative F—Open Tube Rail

This rail, shown in Figure 25, exhibits the same characteristics as Alternative E. It is similar in concept to the widely used Wyoming Rail that features square tubing. The issue with railings that allow a lot of visibility through their structure is the question of “what is being seen?” The goal of any see-through barrier is to give visual prominence to the background scene. This suggests that the aesthetic character of these rail types is of less importance than that of solid barriers since we are intentionally making it less visible. If this is the case, the form of the rail may be less important than its finish.

### Alternative G—Concrete Post and Beam

This alternative is a modified version of a typical concrete post-and-beam design. In this alternative, shown in Figure 26,

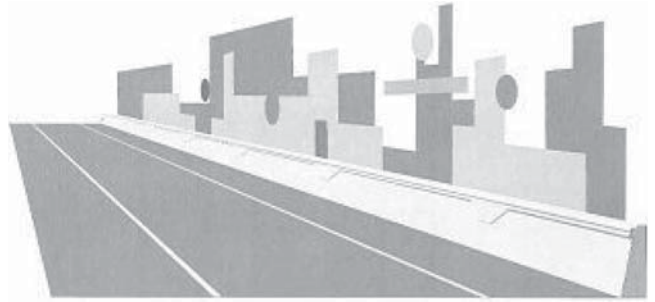
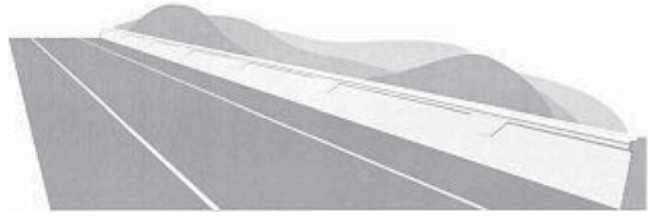
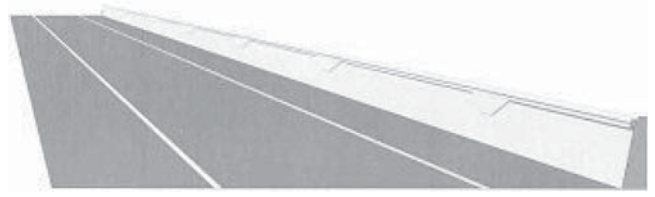

Figure 20. Alternative D2—coping with protruding surface.

the face has been converted to a curved recess. The effect will add depth to the face by imparting subtle shading to the barrier face and may have some “directive” capabilities regarding impacting vehicles. This is a visually prominent barrier, but the small amount of open space beneath the beam makes it appear less massive. Even though there is little view shed available through the openings, it is enough to complete the lower portion of the view above the rail. Despite their small size, the openings also reduce some of the linear emphasis of the rail.

### Discontinuous Element Concepts

Introducing discontinuous elements into the face of a barrier treats the barrier as a static unit over distance and time. A feature of some designs is that simple aesthetic elements

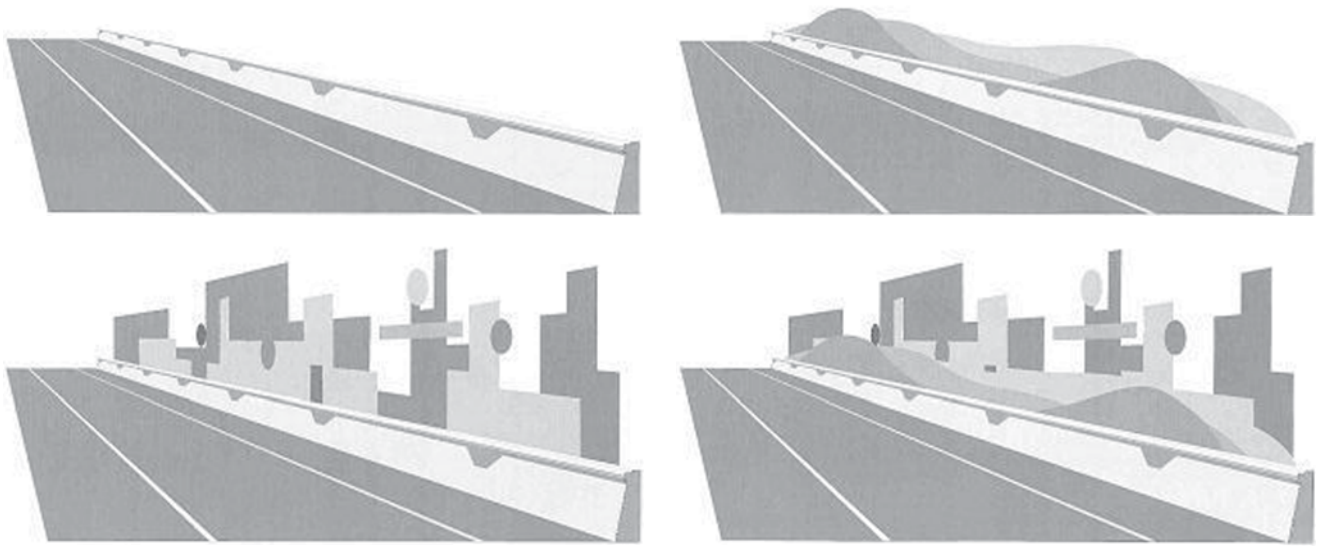

Figure 21. Alternative D3—coping with protruding surface in contrasting color.

are placed in only some or a few of the concrete barrier sections through the length of the entire installation. Fewer aesthetic sections permit costs to be lower. An example of this approach is to use key aesthetic elements to highlight the beginning and end of a bridge only and use a standard barrier shape between the aesthetic elements.

An underlying premise about this approach is that barriers do not have to be a repeatable cross section. This opens other options for creating balance, uniqueness, and innovation into the design. This application may be most appropriate for shorter spans where the driver sees the entire length at once, such as spans found in urban areas.

**VIEWER PREFERENCE SURVEY**

The viewer preference survey was performed in preparation for establishing the design guidelines for aesthetic concrete barriers and see-through bridge rails. The barriers selected for the study met fundamental aesthetic principles of attractive form, line, balance, and proportion and were studied in different background settings (i.e., rural and urban).

It was noted in the study that most people respond favorably to a rail aesthetic if it is different than what they are used to seeing. Of course, this does not provide suitable guidance to designers in how to design an aesthetically pleasing rail. The

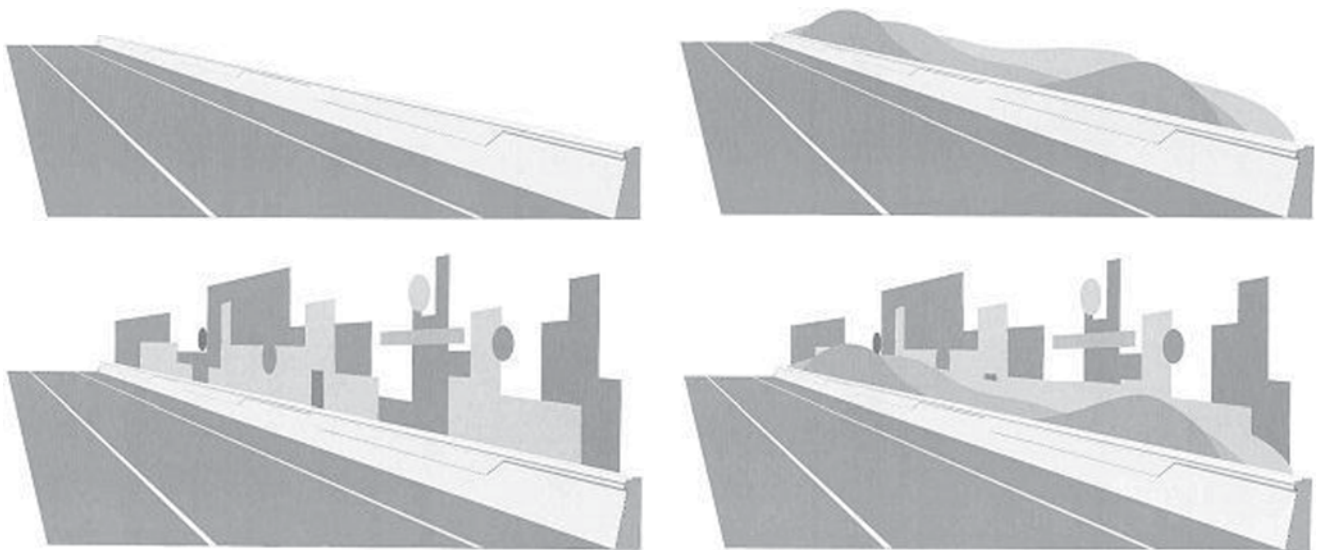

Figure 22. Alternative D4—coping with lengthened protruding surface.



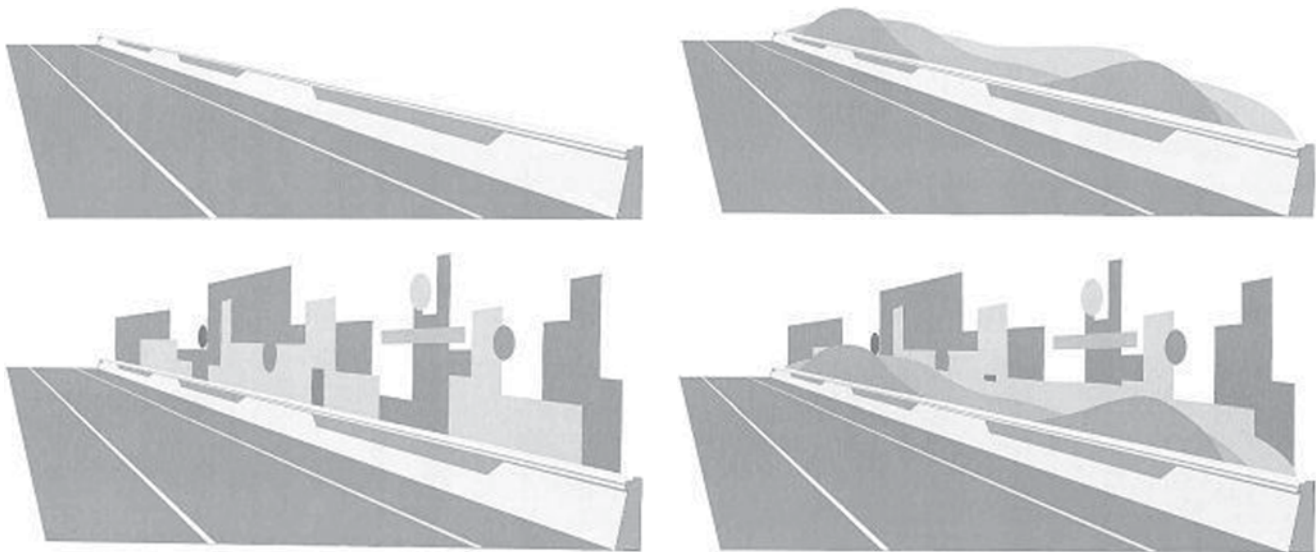

Figure 23. Alternative D5—coping with lengthened protruding surface in contrasting color.

experience gained by the researchers indicates that most aesthetic rail designs will meet with the favor of the general public. If it can be assumed that people will like a particular design, the questions, then, are “will people even notice the rail?” and “is there a preference for a particular rail or barrier design?” The researchers performed a viewer preference survey using a controlled photographic evaluation process to aid in answering these questions. The goals of the survey were to assess the following:

- Will people notice changes to a scene due to barrier design?

- To what degree does barrier design determine how a viewer feels about a scene?
- Is barrier design likely to change the way a viewer feels about a scene?
- Is there a preference for a particular barrier design?

Barrier rails are perceived in a distance/time/setting framework. Modeling all these conditions to achieve a real-time test condition is economically prohibitive. The researchers believed that sufficient insight into viewer preferences could be gained through a static image survey. The survey attempts to identify the gross characteristics of rail design that are noticed and/or

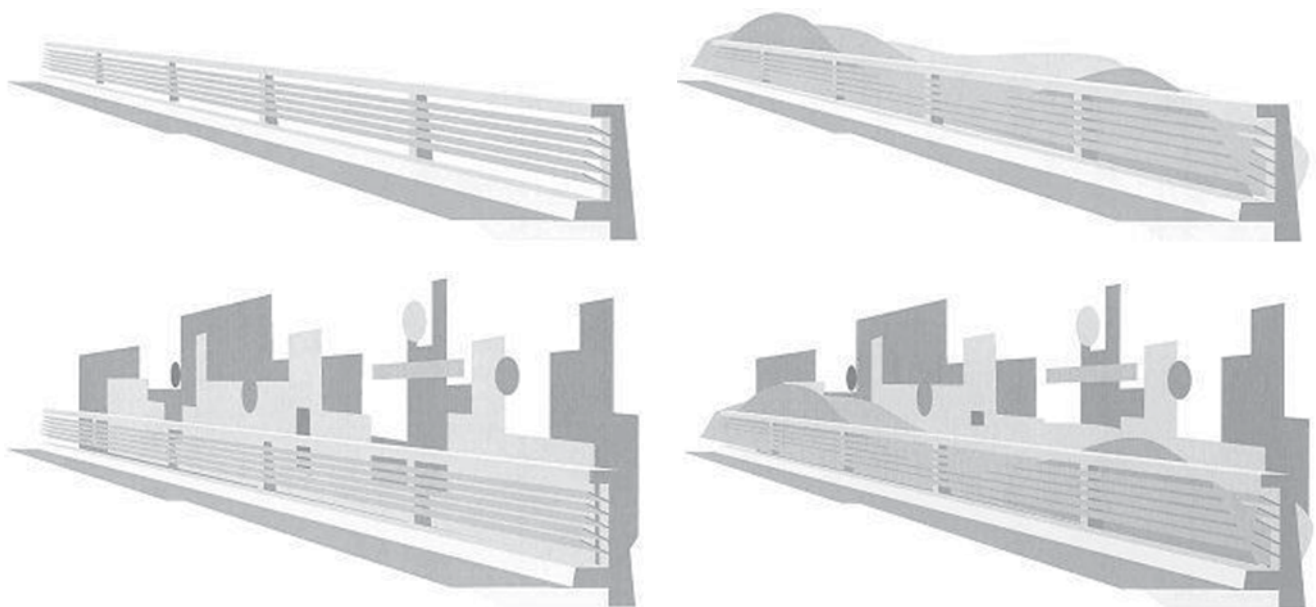

Figure 24. Alternative E—open metal rail.

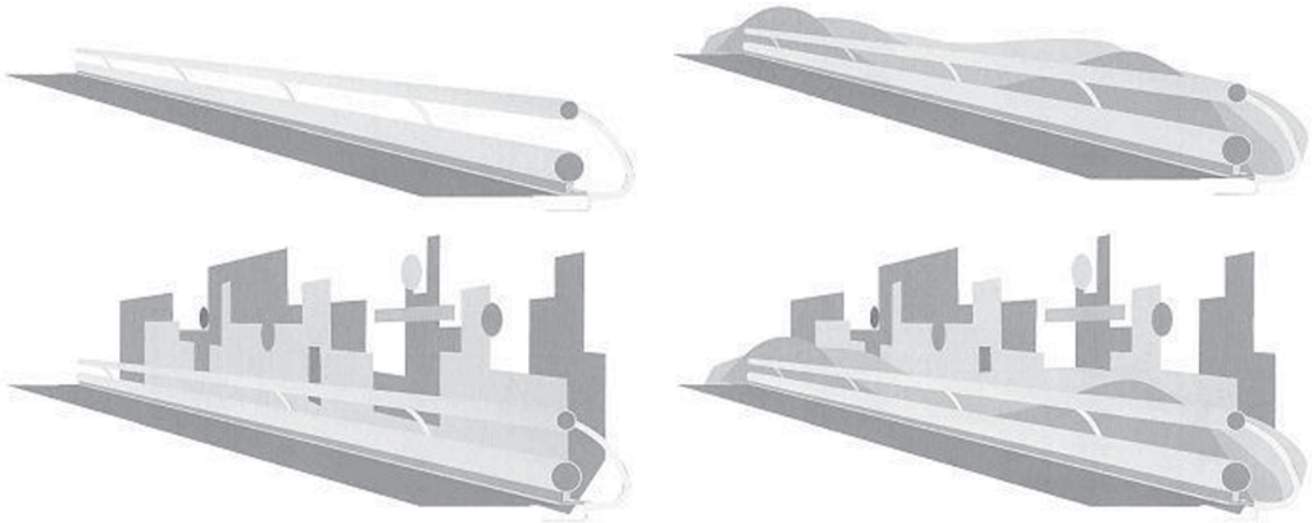

Figure 25. Alternative F—open tube rail.

preferred. The gross characteristics incorporated are the previously discussed design techniques that modify rhythm and sequence impressions. The viewer preference photographic survey was structured as follows:

- Five barrier/rail designs, shown in Figure 27, were used. Three of these were concrete, and two were steel see-through bridge rails. A plain, single-slope concrete barrier and W-beam guardrail were used as a control. Computer models of the rails were created and then inserted into photographs of rural and urban background scenes. This resulted in 30 scenes.
- Two hundred and fifty randomly selected individuals were shown a series of three scenes in rapid succes-

sion (2 to 3 seconds per scene) and then asked to rank the scenes in terms of their visual quality, from memory. A descriptor term was provided to aid the respondent in describing the feeling or emotion sensed when the photograph of the barrier/rail and scene were viewed together. Sets of three different descriptors were used depending on the scene. The descriptor sets were:

- Photograph Set 1—Rural 1 (Figure 28)
  - Architectural feeling
  - Rural feeling
  - Interesting feeling
- Photograph Set 2—Urban bridge (Figure 29)
  - Upscale feeling

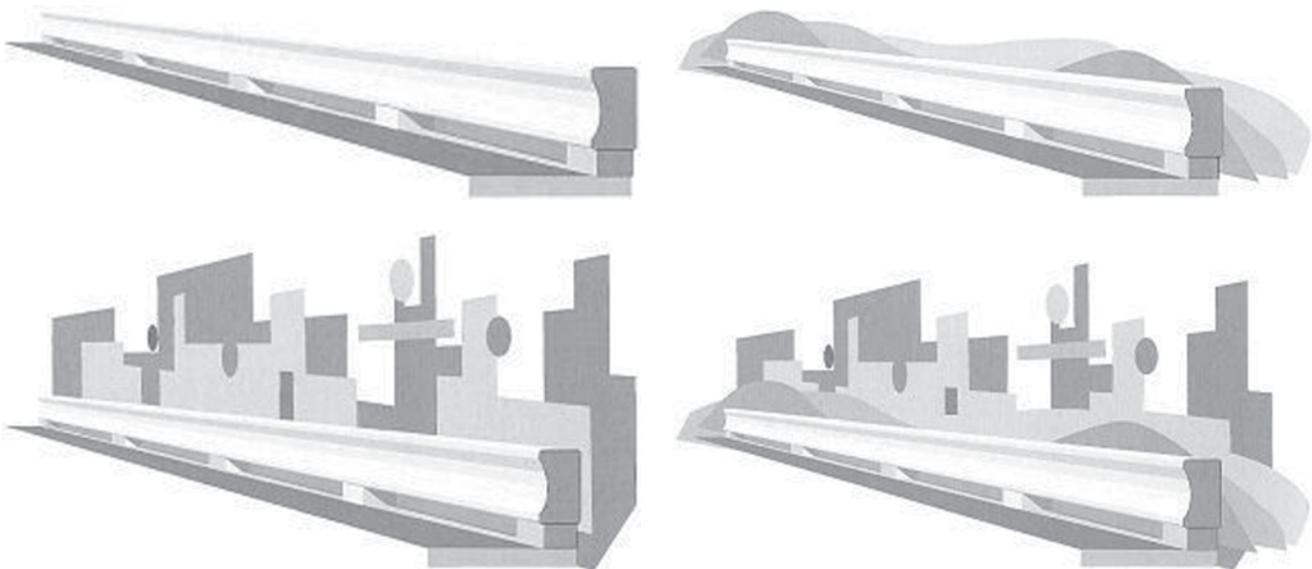

Figure 26. Alternative G—concrete post and beam.



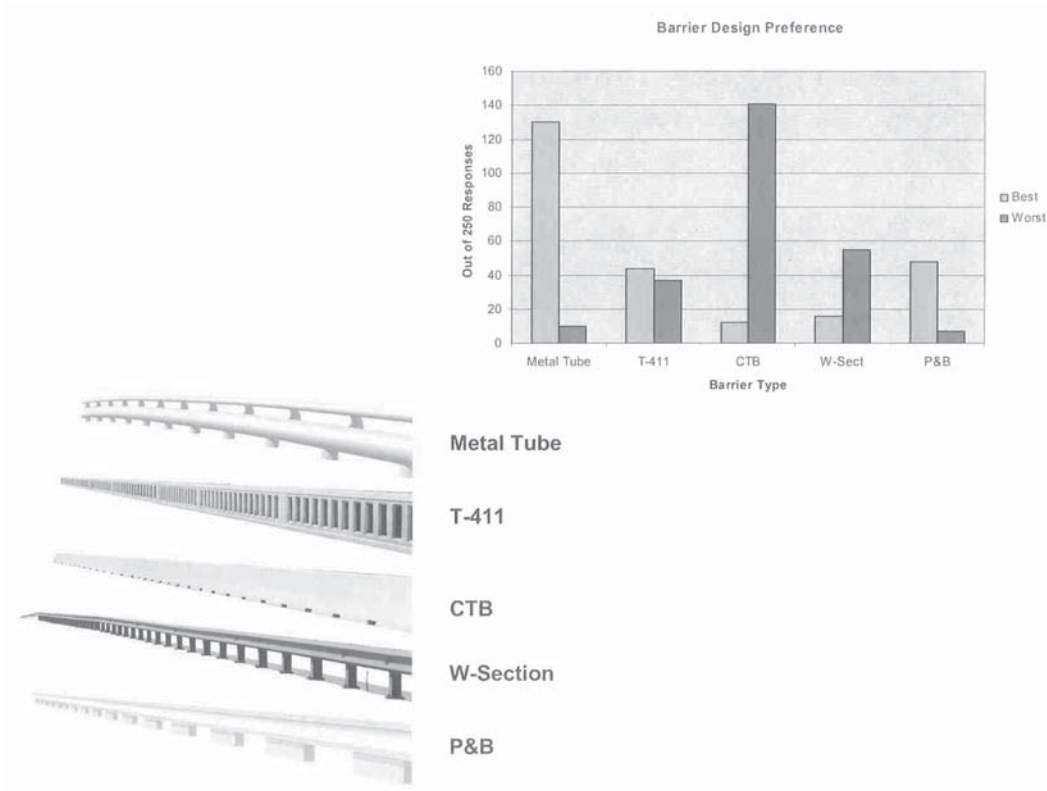

Figure 27. Barrier/rail designs used in viewer preference survey.

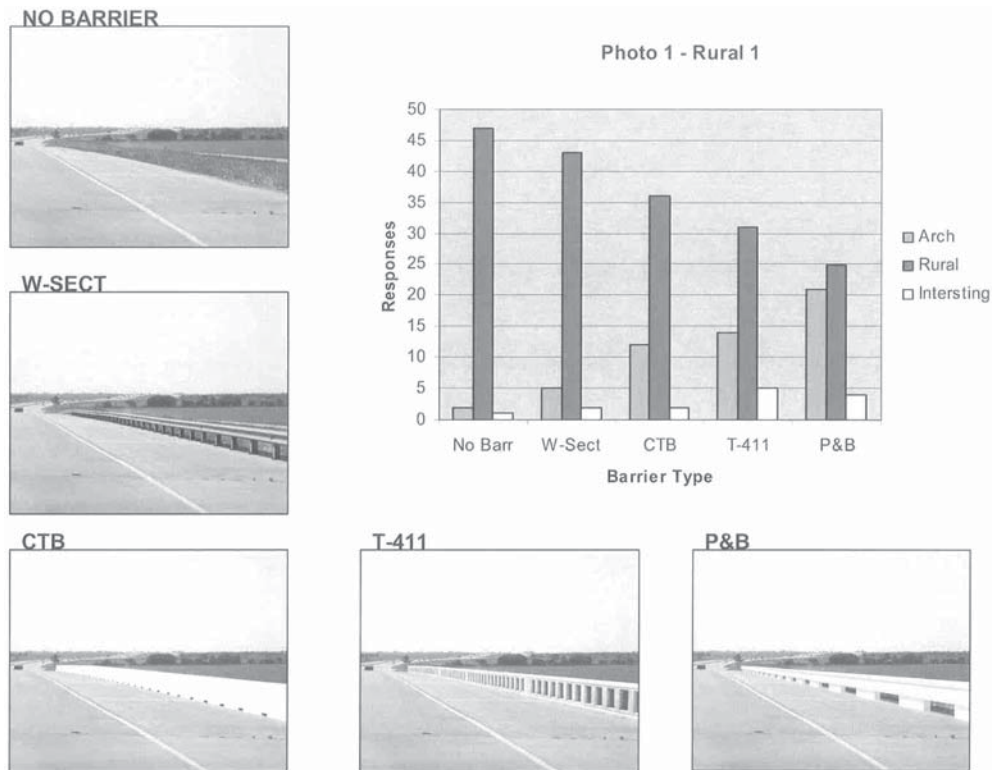

Figure 28. Photo Set 1—rural 1.

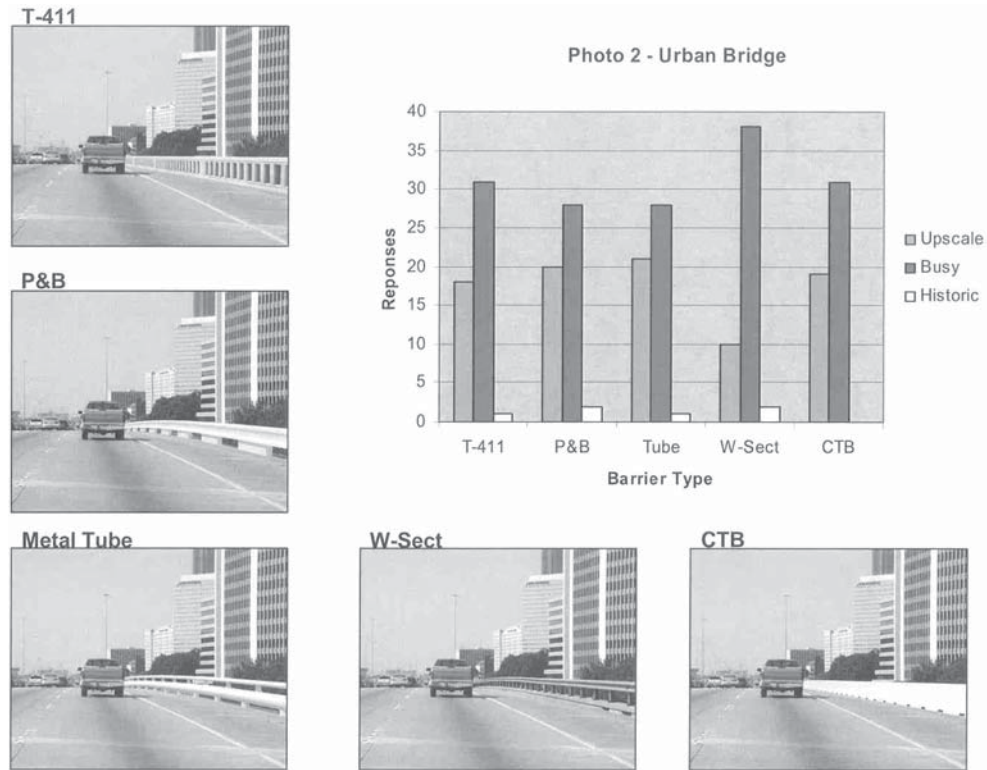

Figure 29. Photo Set 2—urban bridge.

- Busy feeling
- Historic feeling
- Photograph Sets 3 and 6—Rural and urban control sets, respectively (Figure 30)
  - Scenic feeling
  - High-speed feeling
  - Boring feeling
  - Congested feeling
  - Typical feeling
  - Stressful feeling
- Photograph Set 4—Urban at grade (Figure 31)
  - Historic feeling
  - Common feeling
  - Cluttered feeling
- Photograph Set 5—Rural 2 (Figure 32)
  - Country feeling
  - City feeling
  - Anywhere feeling

The three scenes each contained different barrier/rail designs in different settings. The process of presenting photographic scenes to the respondent was repeated five times. Each time a different design and setting combination was presented to the respondent. Each design was tracked for its ranking in different settings and against different rail choices. Additionally, the participants were asked to rank the barriers and rails as to “best” and “worst” designs.

### Results of the Viewer Preference Survey

The researchers found a preference among the respondents for the alternative designs over the common rail or barrier in all settings, but perhaps less so in complex urban backgrounds. Additionally, the researchers found smaller differences in preferences between the new alternatives themselves. It is hypothesized that much of the difference is due to the character of background influence. Regardless of the barrier or rail used, the urban setting consistently elicited a busy or cluttered response. In urban environments, with enormous amounts of background clutter, the barrier or rail had very little effect on the respondents, which suggests that providing an aesthetic application to the barrier is unwarranted. Responses were more positive to changing the aesthetics of the barrier in the rural settings, where the barriers were more prominent in the scene and did not compete for the viewer’s attention with other background images. With the exception of the W-beam guardrail, all the barrier designs had nearly the same effect on the rating of the scene. The aesthetic preference produced two components: the quality of the beauty and the quality of the experience.

A significant bias regarding a particular alternative design may reflect a subjective bias on the part of the viewer or may be simply due to the barrier’s visual prominence (i.e., contrast) in a given setting. Designing for individual subjectivity will most probably be inconsistent in most cases. Of more value to the engineer or designer will be the question of how much

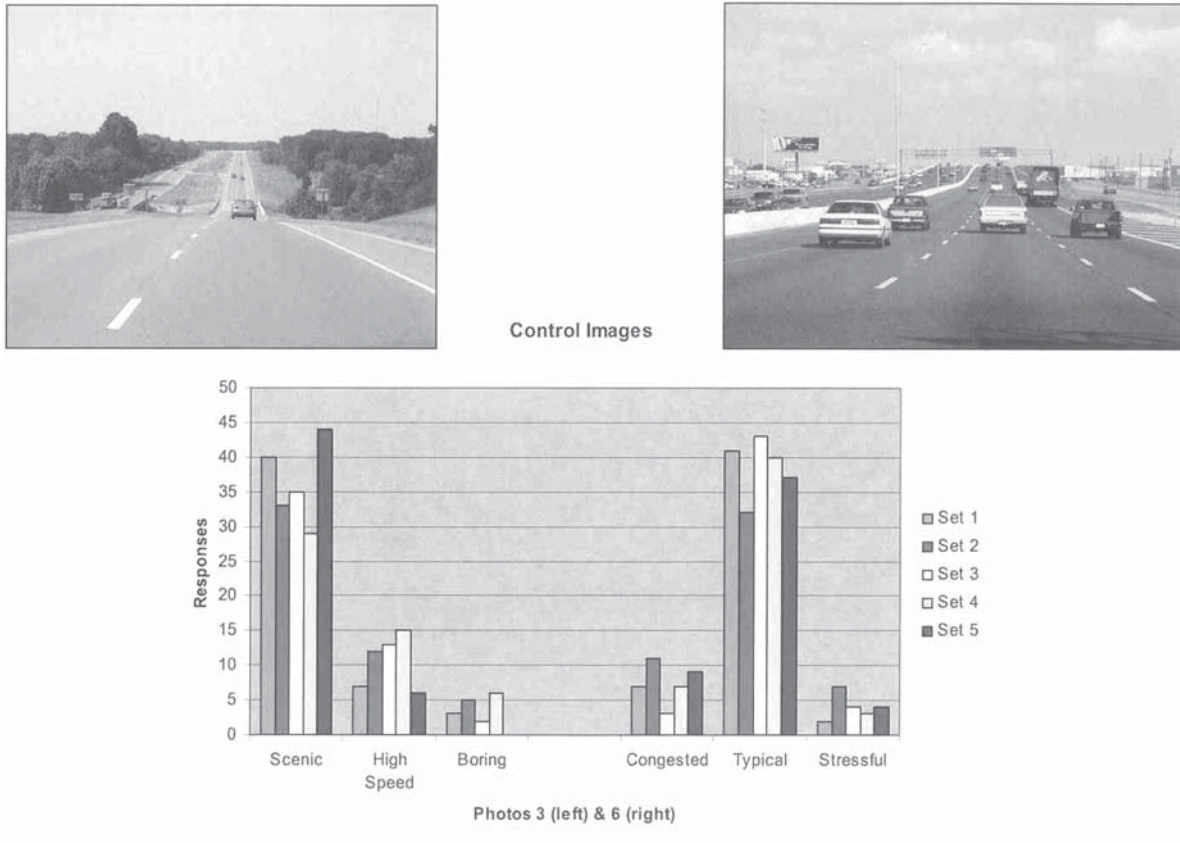

Figure 30. Photo Sets 3 and 6—rural and urban control images.

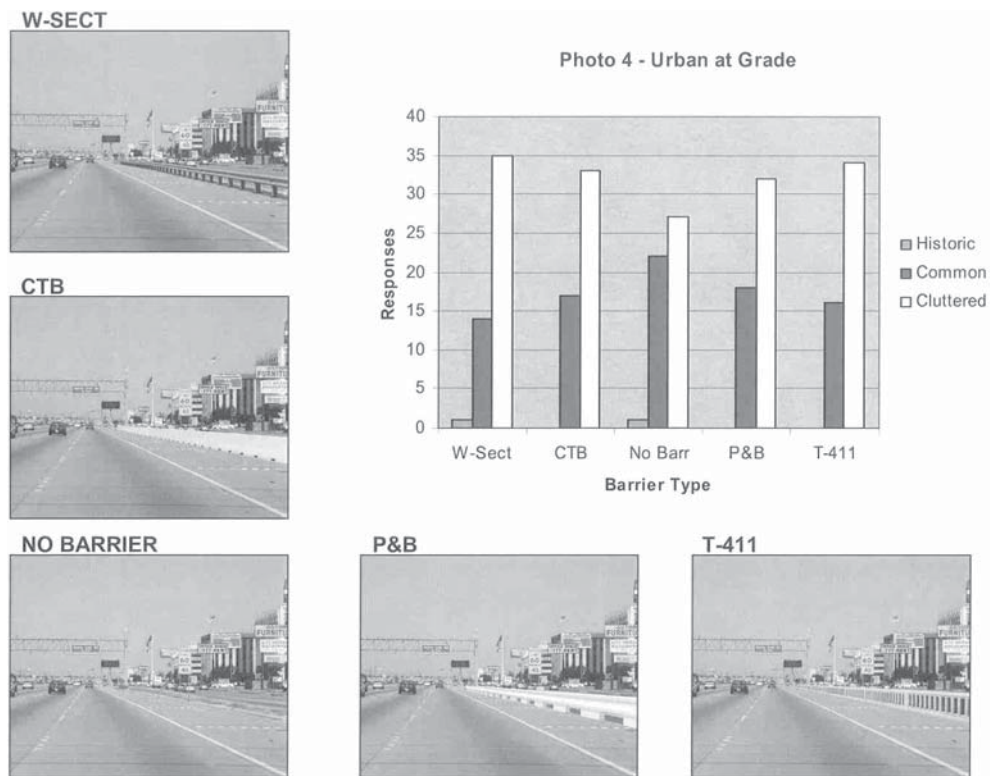

Figure 31. Photo Set 4—urban at grade.

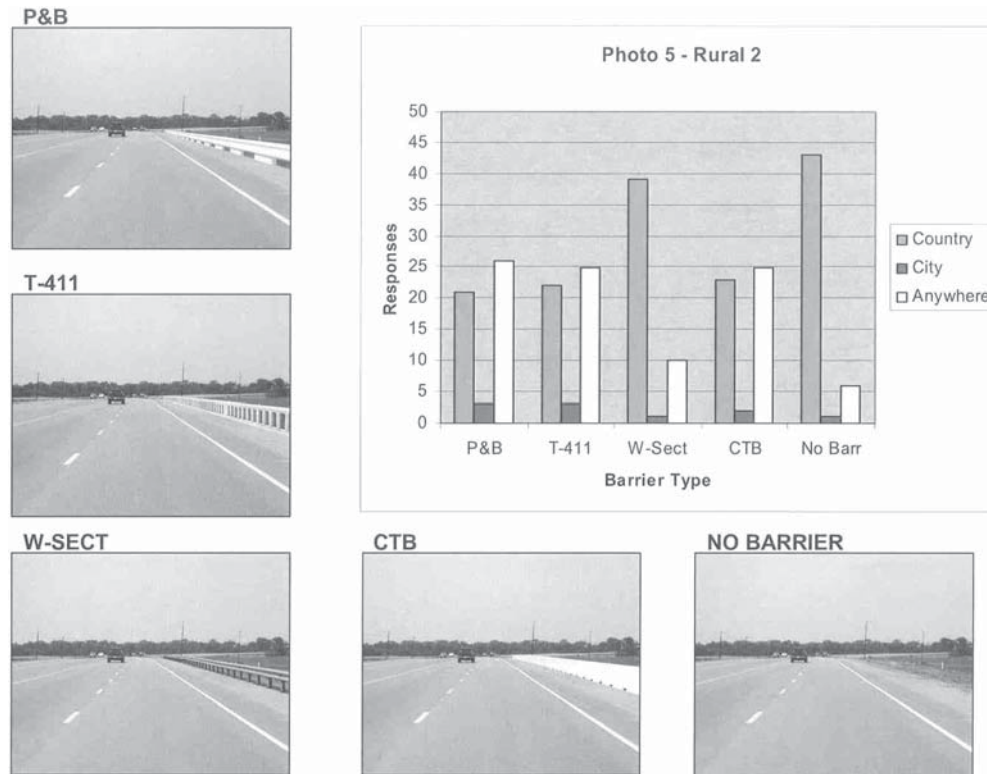

Figure 32. Photo Set 5—rural 2.

visual prominence is necessary to achieve a noticeable change in the way a barrier or rail is perceived by the viewer.

## ASSESSMENT

The study designs suggest that:

- Background plays a significant and critical role in how the barrier is perceived.
- The linear character of barrier rails can be significantly modified through the use of line and contrasting forms.
- Relatively small elements or openings near the top or near the bottom of the barriers can significantly change the character of the barrier.
- The aesthetic character of see-through rails should be secondary to the background scene.

The degree that these findings can be applied is determined by established, critical parameters.

## AESTHETIC DESIGN DISCUSSION

There can be a very large number of design variations for barriers and rails. The most important question to be answered in this and all other designs is “how significant of a surface

change (either recessed or protruding) can be accomplished without affecting the behavior of impacting vehicles?” In all the graphic studies, the features that most affect impacting vehicles appear to be:

- Depth and frequency of shadow forming by vertical elements in the barrier face.
- Thickness of protruding elements that form patterns in the barrier face.
- The angle of the edges of shadow-producing elements.

Determining these features will allow the development of detail-specific guidelines that, when coupled with context-sensitive design rules, can be applied to any alternative design in any situation.

The previous sections of this report have provided information on the state of the practice regarding defining aesthetics for barriers and assessing and using aesthetic treatments on concrete barriers. This information was obtained by reviewing the literature and surveying state DOTs, roadside safety researchers, and crash-testing laboratories in the United States and internationally. The remainder of this report presents the methodology used for developing design guidelines for aesthetic concrete safety shape barriers based on finite element simulation and full-scale crash testing of specific asperities cast into the face of concrete safety shape barriers.



## CHAPTER 4

# AESTHETIC CONCRETE BARRIER DESIGN GUIDELINE DEVELOPMENT

### OBJECTIVE

Demands from local communities and agencies for aesthetically pleasing concrete barrier alternatives have increased. Guidance regarding the application of aesthetic surface treatments to vertical and single-slope barriers is provided in the FHWA acceptance letter B-110. This guidance is based on a series of crash tests conducted by Caltrans.<sup>(19)</sup> However, existing design procedures and guidelines do not provide sufficient information to understand the effect of aesthetic surface treatments on the impact performance of concrete safety shape median and roadside barriers.

The objective of this research was to develop design guidelines for aesthetic surface treatments of concrete barriers for New Jersey or F-shape profiles. These design guidelines were developed through extensive use of finite element simulation, in conjunction with full-scale vehicle crash testing. An overall summary of the development approach is presented below. Detailed information regarding the guideline development process is presented in subsequent chapters of this report.

### OVERALL SUMMARY OF THE DEVELOPMENT APPROACH

To develop design guidelines for the application of aesthetic surface treatments on concrete safety shape barriers, a set of preliminary guidelines were initially developed. A parametric study was performed using finite element simulations to establish these preliminary guidelines. A full-scale crash-testing phase was then conducted. The test results were subsequently used to adjust and refine the guidelines into their final form.

Previous crash-testing data show that the most common failure mechanisms associated with longitudinal barrier impacts are excessive occupant compartment deformation (OCD) and vehicular instability (i.e., overturn). When surface asperities are introduced onto the face of a barrier, the primary concern relates to excessive OCD resulting from snagging of vehicle components (e.g., wheel) on the asperities.

*NCHRP Report 350* uses two basic design test vehicles: a 2,000-kg pickup truck (denoted 2000P) and an 820-kg passenger car (denoted 820C). The 2000P is generally considered to be the more critical of the two design vehicles in regard to assessment of OCD. For this reason, it was the primary design

vehicle used in the simulation effort conducted to establish the preliminary guidelines. Simulations with the 820C were to be used as a check to determine if the preliminary relationships required modification based on vehicular instability or other concerns with the small passenger car.

The pickup truck finite element model was validated by comparing simulation results to available crash test data for the New Jersey safety shape and single-slope concrete barriers. Similar comparative analyses were conducted to evaluate validation of the finite element model of the small car design vehicle.

Finite element vehicle models used in roadside safety design generally show good correlation with test data in regard to overall vehicle kinematics. However, little work has been done to validate the ability of these models to accurately capture OCD resulting from an angled impact into a longitudinal barrier.

Two primary types of OCD are of interest with respect to longitudinal barrier impacts: (1) deformation resulting from direct contact of the wheel assembly or other vehicle components with the floor board, toe pan, or fire wall and (2) deformation induced by impact loads applied to the frame or structure of the vehicle. The direct deformation typically results from some form of wheel snagging or an increase in effective friction between the wheel and barrier that fails components of the steering system and suspension and shoves the wheel assembly rearward. This type of deformation is particularly relevant to the investigation of surface asperities. Induced deformation is caused by lateral impact loads applied to the frame rails or other structural components of the vehicle and may manifest itself in buckling of the floor board or racking of the vehicle body.

The mechanism by which direct OCD is generated in the finite element vehicle model may differ from the mechanism of an actual crash test vehicle due to lack of suspension failure in the finite element vehicle model. For this reason, a direct measure of the vehicle's OCD from simulation results cannot be considered deterministic for comparing with the crash test data. Thus, to evaluate vehicle OCD from simulation results, a surrogate measure for quantifying OCD was developed.

Several available crash tests of concrete barriers were identified and simulated using the finite element vehicle model. Each simulation was set up to collect several potential surrogate

measures of OCD. The details of these measures will be presented in the next chapter. It was determined that the internal energy of the pickup truck floorboard in simulation results showed the best correlation with OCD reported in full-scale crash tests. Internal energy provides a measure of the overall deformation directly or indirectly generated in the floorboard. Truck floorboard internal energy was therefore selected as the surrogate OCD measure. By comparing the internal floorboard energies from 2,000-kg pickup truck simulations and the reported OCD values for several crash tests, thresholds for acceptable and unacceptable internal energy levels were established. Given a simulated barrier with a selected asperity configuration, these threshold values were used to determine the likelihood of failure due to excessive OCD. Further details are presented in Chapter 5.

The New Jersey safety shape barrier was used for the development of the preliminary and the final design guidelines. Vehicular impacts with the F-shape safety barriers are known to result in lower vehicle instabilities when compared with the New Jersey safety shape barriers. The guidelines developed are, therefore, considered to be applicable to both New Jersey safety shape and F-shape concrete barriers.

Generalized types of surface asperities were defined in terms of various parameters, such as the width, depth, and angle of

inclination. Parametric finite element simulations were performed for asperity angles of 30, 45, and 90 degrees, and each simulation was assigned an outcome of “acceptable,” “marginal/unknown,” or “unacceptable” based on comparison of the internal floorboard energy with the established threshold values. Preliminary guidelines were then developed in terms of asperity depth, width, and angle of inclination based on the combined set of simulation outcomes.

Based on these preliminary guidelines, a crash test plan was developed in which the outcome of one test determined the configuration evaluated in a subsequent test. In other words, the test matrix was adjusted as the crash tests were performed, and the results were analyzed in order to maximize the information available for adjusting and finalizing the relationships for asperity depth, width, and angle. The OCD measurements from the tests enabled the adjustment of the thresholds for acceptable and unacceptable floorboard internal energy upon which the final design guidelines are based.

Chapter 5 presents details of the simulation phase in the development of the preliminary guidelines, Chapter 6 presents details on the testing phase of the guideline development, and Chapter 7 and the appendix present the final design guidelines.

---

## CHAPTER 5

# SIMULATION AND PRELIMINARY AESTHETIC DESIGN GUIDELINE DEVELOPMENT

### INTRODUCTION

Opening geometry in see-through rails, if improperly designed, can have a devastating effect on the rail's crash performance when struck by a vehicle. Likewise, in monolithic concrete barrier surfaces that are not see-through, surface discontinuities, protrusions, or depressions in the face of the barrier can introduce vehicle instability and/or snagging. Surface discontinuities, protrusions, or depressions in the face of the rail or at rail openings may be acceptable, provided their depth and/or geometry do not produce excessive vehicular snagging and excessive decelerations. The effect of architectural surface treatments is little understood and could have significant safety-related effects.

Native area stones can be applied as a veneer to enhance the appearance of concrete barriers. To date, the FHWA's guidelines for vertical-faced, crash-tested stone masonry guardwall state that maximum projections should not extend beyond 38 mm of the neat line, deep raked joints should be 50 mm thick, and mortar beds should be 50–75 mm thick. Stone that creates protrusions greater than described is not considered crashworthy. Based on aesthetics and stone availability, a smoother stone face may be used, such as Class A or B masonry.

In addition to native stone, alternative methods of forming concrete walls and barriers provide designers with a wide range of possible architectural treatments in the form of patterns and textures. Caltrans tested several architectural surface treatments applied to the Type 60 single-slope (9.1-degree) concrete barrier and identified several textures and patterns that could be applied to the single-slope concrete barrier.

Crash testing of single-slope median barrier with aesthetic surface treatments by Caltrans resulted in the first set of guidelines for the aesthetic surface treatment of concrete barriers. As a result of the Caltrans study, recommendations for allowable surface asperity geometry on the face of single-slope and vertical-face barriers were developed. The guidelines, which were approved by the FHWA in acceptance letter B-110, permit the following types of surface treatments:

- Sandblasted textures with a maximum relief of 9.5 mm.
- Images or geometric patterns cut into the face of the barrier 25 mm or less and having 45-degree or flatter cham-

fered or beveled edges to minimize vehicular sheet metal or wheel snagging.

- Textures or patterns of any shape and length inset into the face of the barrier up to 13 mm deep and 25 mm wide. Geometric insets with an upstream edge with an angle of up to 90 degrees should be less than 13 mm deep.
- Any pattern or texture with gradual undulations that have a maximum relief of 20 mm over a distance of 300 mm.
- Gaps, slots, grooves, or joints of any depth with a maximum width of 20 mm and a maximum surface differential across these features of 5 mm.
- No patterns with a repeating upward sloping edge or ridge.
- Any pattern or texture with a maximum relief of 64 mm, if such pattern begins 610 mm or higher above the base of the barrier and all leading edges are rounded or sloped to minimize any vehicle snagging potential. No part of this pattern or texture should protrude below the plane of the lower, untextured portion of the barrier.

Prior to the Caltrans study, there was a lack of any guidance regarding acceptable surface treatment of concrete barriers at the national level, and little or no uniformity existed in aesthetic barrier design among the states. While the Caltrans study addressed single-slope and vertical-face concrete barriers, there was no design guidance for widely used safety shape concrete barriers. The primary objective of this research was to develop guidelines for the aesthetic surface treatment of New Jersey and F-shaped concrete barriers (herein generally referred to generically as safety shape barriers) based on barrier impact performance. The guidelines are intended to aid engineers and designers in choosing aesthetic surface treatments for concrete safety shape median and roadside barriers that will not adversely affect crashworthiness.

When considering the geometry of surface asperities, variables include the depth, width, and shape of the relief or recess. Due to the number and range of these variables, it was economically impractical to conduct a parametric investigation based solely on crash testing. However, the researchers believed that a parametric investigation could be performed using finite element computer simulations that can provide a detailed assessment of the three-dimensional impact response associated with the introduction of specific aesthetic treatments.

A pilot study was conducted to demonstrate the feasibility of using finite element simulation for this research. Simulation was used as a tool to develop a set of preliminary guidelines that defined relationships between different design parameters for aesthetic surface treatments on safety shape barriers. Once these preliminary guidelines were established, a full-scale crash-testing effort was conducted. The initial crash-tested configurations were picked based on simulation results. The results from these crash tests were analyzed in conjunction with the preliminary guidelines to determine the asperity geometries to be evaluated in subsequent crash tests. This procedure maximized the information available for adjusting the preliminary guidelines to yield the final design guidelines.

Simulations were performed using LS-DYNA. LS-DYNA is a general-purpose, explicit-implicit, nonlinear finite element program capable of simulating complex nonlinear dynamic impact problems. LS-DYNA has been used extensively in simulations involving vehicular impacts with roadside safety appurtenances, including safety shape barriers. The decision to choose this explicit finite element code for this research was based on several reasons, including:

- The availability of vehicle models that correspond to *NCHRP Report 350* design test vehicles (mainly the 820C and 2000P vehicles). These vehicle models have been used for roadside safety applications for the last 6 or more years, and their fidelity and limitations are reasonably understood.
- The ability to model the geometry of the safety shape barriers and the details of the aesthetic surface treatment (which affects the mechanics of the vehicle-barrier interaction) with a high degree of fidelity.
- The availability of a large contact algorithm library. These contact algorithms provide means to model vehicular collisions with roadside objects.

### PILOT STUDY AND FINITE ELEMENT MODEL VALIDATION

In all types of modeling, approximations must be made when trying to represent reality. If finite element analysis is to be used to assess the effects of surface treatments on concrete median barriers, the vehicle and barrier models must be capable of capturing the dynamic response associated with a concrete barrier impact. This capability was investigated by performing a pilot validation study. The pilot study had the following three objectives:

- Perform finite element simulation of previously available crash tests so as to identify potential modeling problems.
- Make necessary changes to improve the performance of the vehicle models and validate them for use in evaluating the performance of barriers with surface asperities.
- Identify surrogate measures for assessing OCD.

Accurately representing the geometry of a concrete barrier and added surface asperities is fairly straightforward. How-

ever, one of the limitations associated with using current finite element analysis codes to model concrete barriers relates to the material behavior. At the time of undertaking this research, there were no available robust concrete material models that could accurately and efficiently capture the failure/fracture of concrete. Even though the FHWA was at that time sponsoring the development of such a material model, it was not available in time for use in this project. However, since the concrete barrier profiles of interest in this project had been successfully crash tested and their structural adequacy was not at issue, this was not considered as a significant limitation. For this reason, modeling the concrete barriers as a rigid material without failure was considered a reasonable and practical assumption. Most of the effort devoted to the validation effort therefore focused on the vehicle models.

The validity of the improved 820-kg passenger car and 2,000-kg pickup truck vehicle models was established by comparing the results of simulations with the results of full-scale crash tests. It should be noted that an accurate comparison of a simulation with a successful test does not necessarily constitute validation. It is important that some of the tests selected for use in the validation study include relevant failure modes. The two most critical failure modes associated with the performance evaluation of longitudinal barriers are vehicular instability (i.e., rollover) and OCD. While the validation study focused on these two evaluation criteria, other vehicular acceleration-based criteria were also analyzed and compared.

### 820C Vehicle Model

The researchers identified historical crash tests that could be used to assist with vehicle model validation in the pilot study. The number of crash tests useful for this purpose was very limited. One of the first simulations that the researchers performed was that of Caltrans Test No. 582.<sup>(19)</sup> In this test, a 1990 Geo Metro impacted a single-slope concrete barrier with an inclined fluted surface at a speed of 100 km/h at an angle of 20 degrees. These testing conditions conform to the impact conditions for Test 3-10 in *NCHRP Report 350* (see Figure 33). The slope of the single-slope barrier was 9.1 degrees from vertical, and the overall height of the barrier



Figure 33. Caltrans single-slope barrier with fluted surface texture.



was 1.42 m. The surface of the barrier was modified to incorporate inclined flutes or ribs. The flutes were oriented at a 45-degree angle from the ground, rising in the direction of vehicle travel. The cross section of each flute was 19 mm high and 19 mm wide. The flutes were spaced 50.8 mm on the center along the length of the barrier. The vehicle was redirected but rolled over as it exited the barrier.

The vehicle model used in the initial simulation of this impact was the reduced Geo Metro model that was developed by the National Crash Analysis Center (NCAC) under FHWA sponsorship. This model contains approximately 16,100 elements. Initial simulation results did not show a good correlation with the test results. Several changes were made to the original model to improve its performance in interacting with the surface asperities. Changes focused primarily on the vehicle's front suspension and the tires. The suspension was modified to include deformable control arms and some of the other linkages for the suspension mechanism (see Figure 34). Simulation results with the modified 820C vehicle model showed better correlation with the Caltrans fluted-surface, single-slope concrete barrier test results.

In addition to the Caltrans fluted barrier, a smooth single-slope barrier was used as a baseline system to validate the modified Geo Metro model. A comparison of vehicle dynamics between crash tests and finite element simulations of the Caltrans fluted single-slope barrier and those of standard single-slope barrier follows.

#### *Caltrans Single-Slope Barrier with Angled Flutes*

Figure 35 shows sequential images comparing the actual crash test of the fluted single-slope barrier with the finite ele-

ment impact simulation of the barrier using the modified Geo Metro model. A comparison of roll, pitch, and yaw angles versus time is shown in Figures 36 through 38, respectively. A significant improvement in correlation of the roll angle was achieved, but with minor divergence in the pitch angle correlation.

#### *Single-Slope Barrier*

After the modified Geo Metro model demonstrated the ability to capture interaction with the inclined asperities on the fluted single-slope barrier, a baseline simulation using a smooth-faced single-slope barrier was performed. The purpose was to verify that the changes made to the Geo Metro model did not adversely affect other areas associated with concrete barrier impacts. Figures 39 through 41 compare the angular displacements of the vehicle obtained from the crash test<sup>(20)</sup> and simulation of the single-slope barrier. Improved correlation was observed with the modified model for both the roll and pitch behavior. Both models showed good correlation with the test data for the yaw angle.

#### *Summary of the 820C Vehicle Model Validation*

At the start of the simulation study, a significant effort was put into the improvement and validation of the 820-kg, small-car model for impacts into single-slope barriers with and without surface asperities. As described above, results from full-scale crash tests performed by Caltrans were used to help assess validity of the model for this purpose. The suspension on the original reduced Geo Metro model was extensively

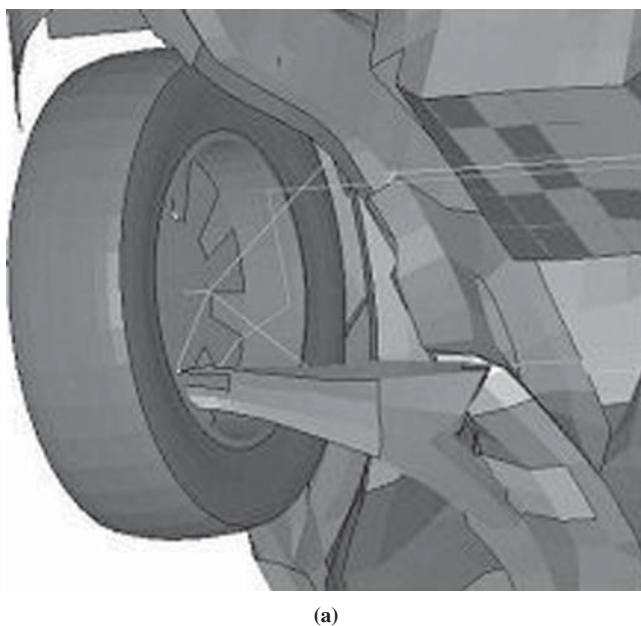

(a)

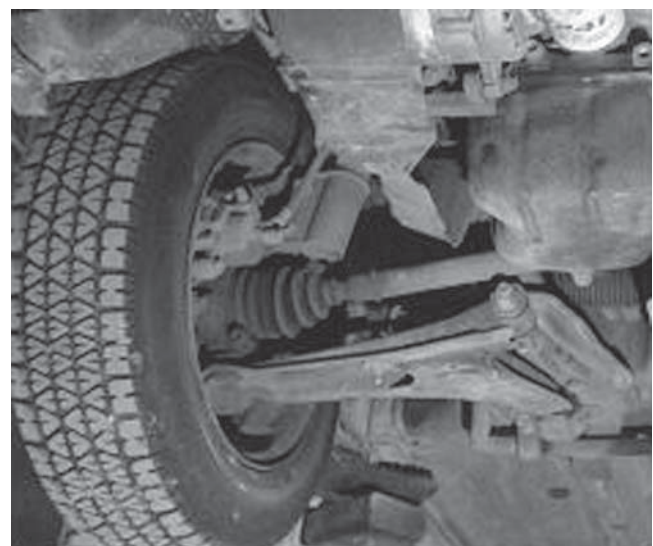

(b)

Figure 34. 820C front suspension: (a) modified model; (b) actual vehicle.

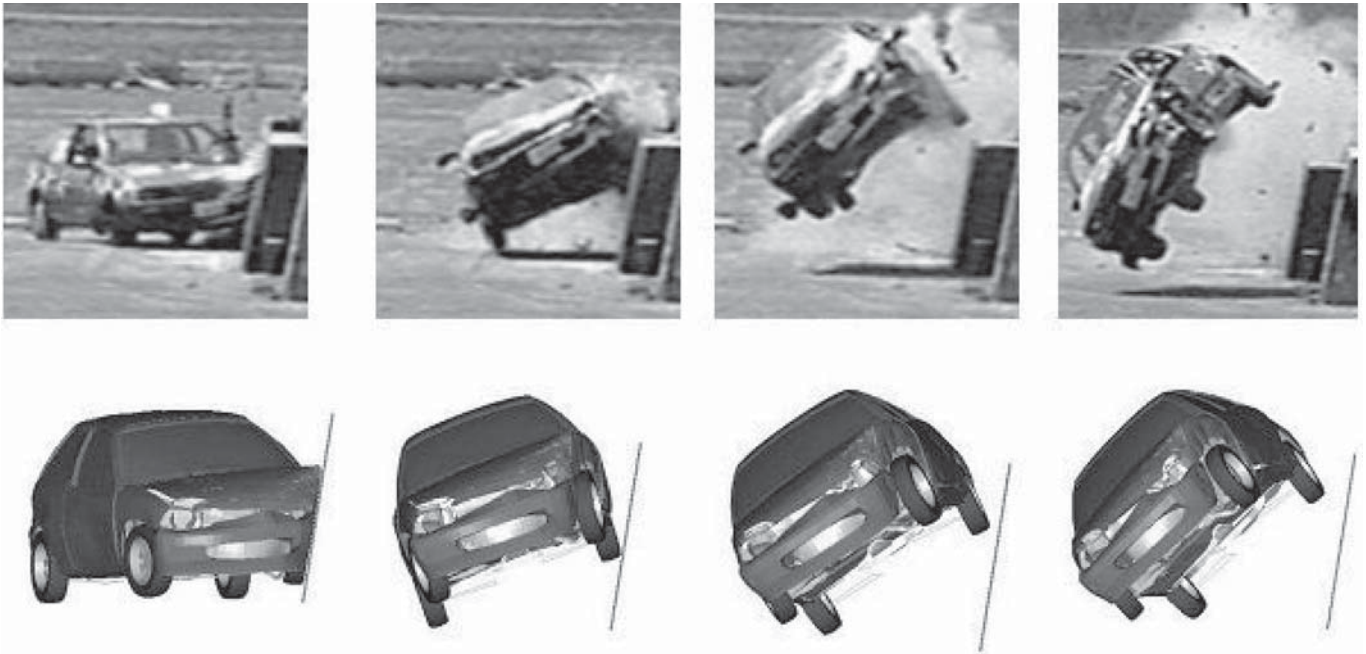

Figure 35. Sequential comparison of test and simulation of angle fluted barrier.

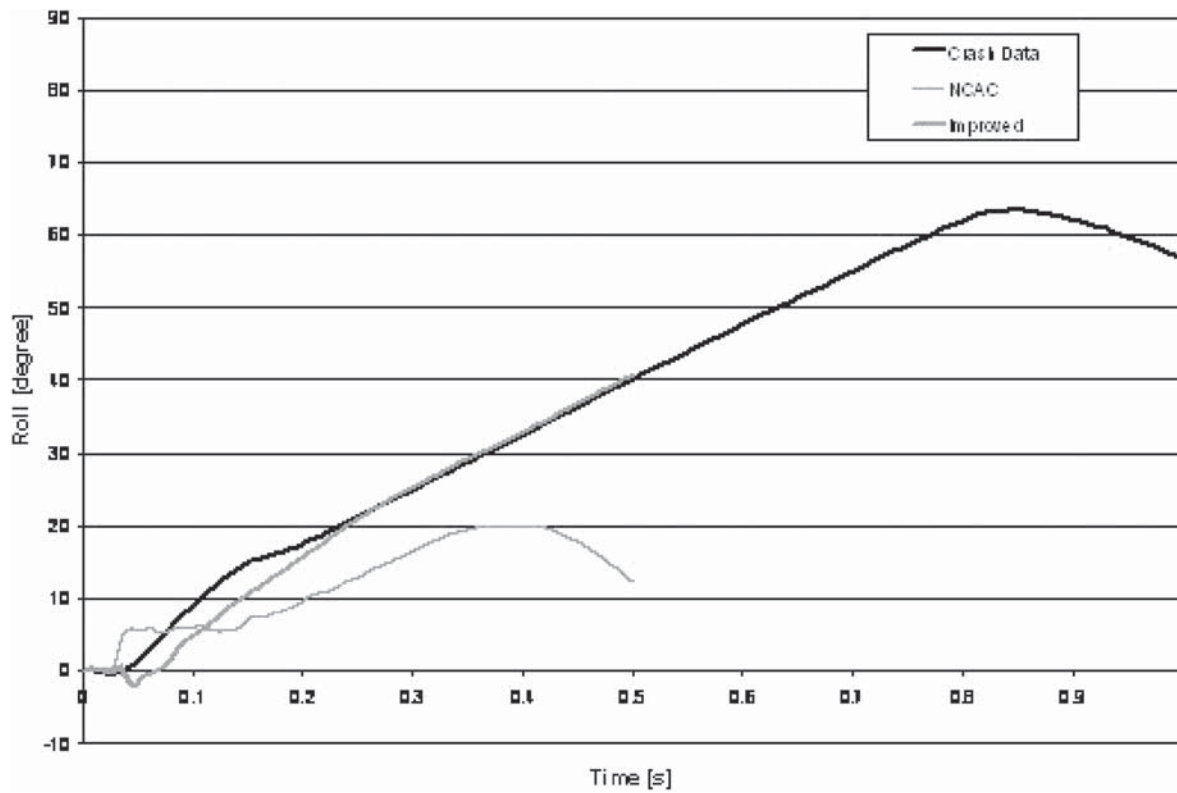

Figure 36. Comparison of roll angles from crash data with vehicle simulations for the angle fluted barrier.

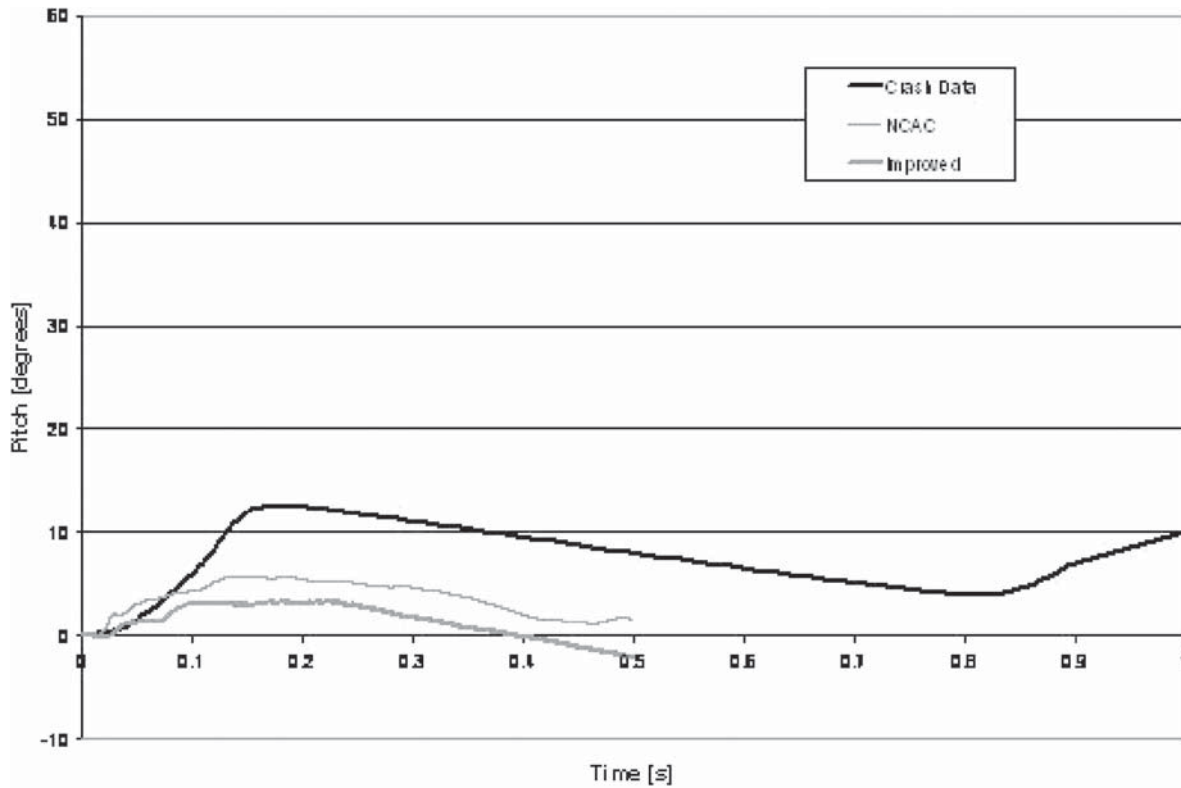

Figure 37. Comparison of pitch angles from crash data with vehicle simulations for the angle fluted barrier.

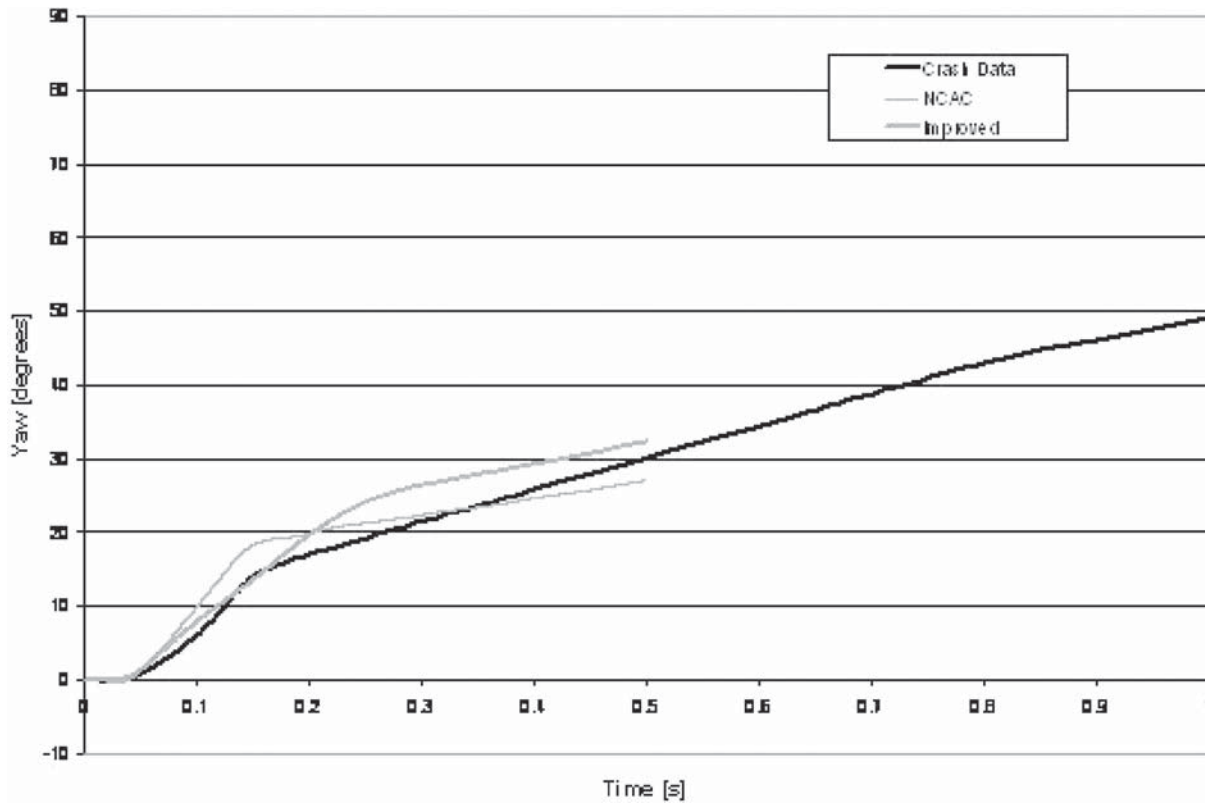

Figure 38. Comparison of yaw angles from crash data with vehicle simulations for the angle fluted barrier.

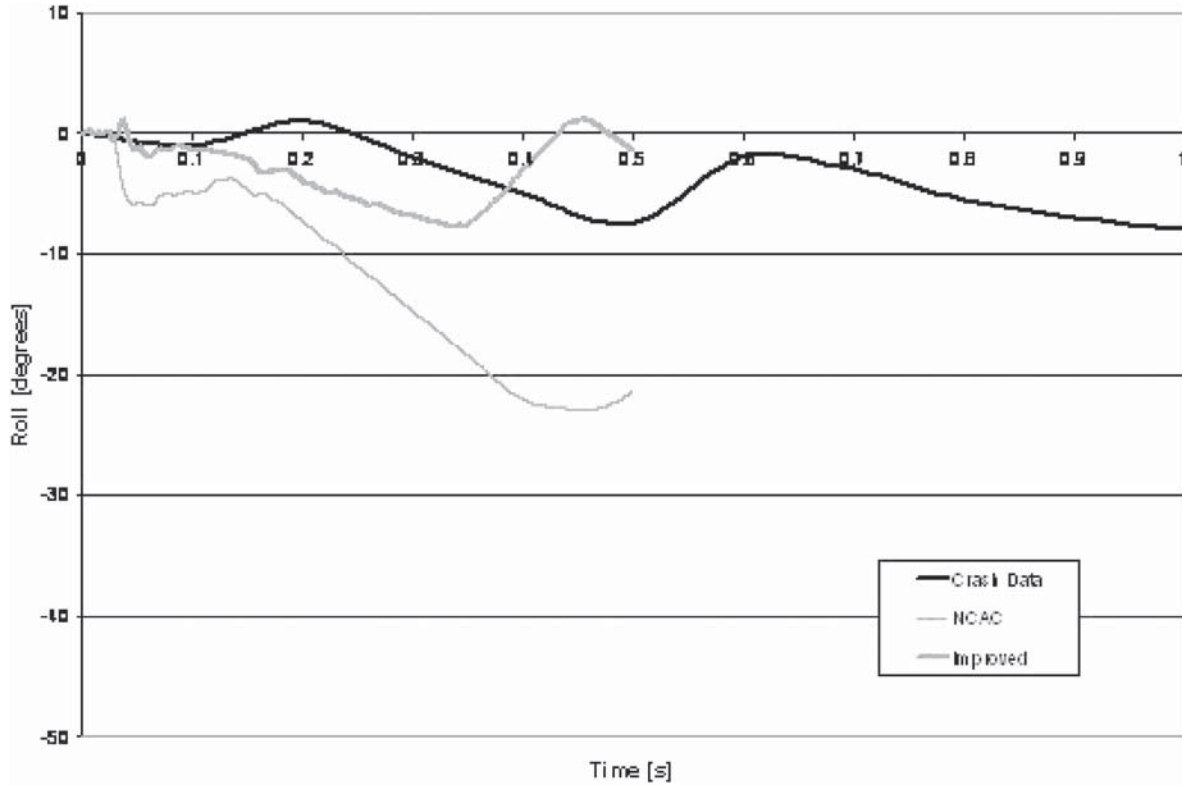

Figure 39. Comparison of roll angles from crash data with vehicle simulations for the single-slope barrier.

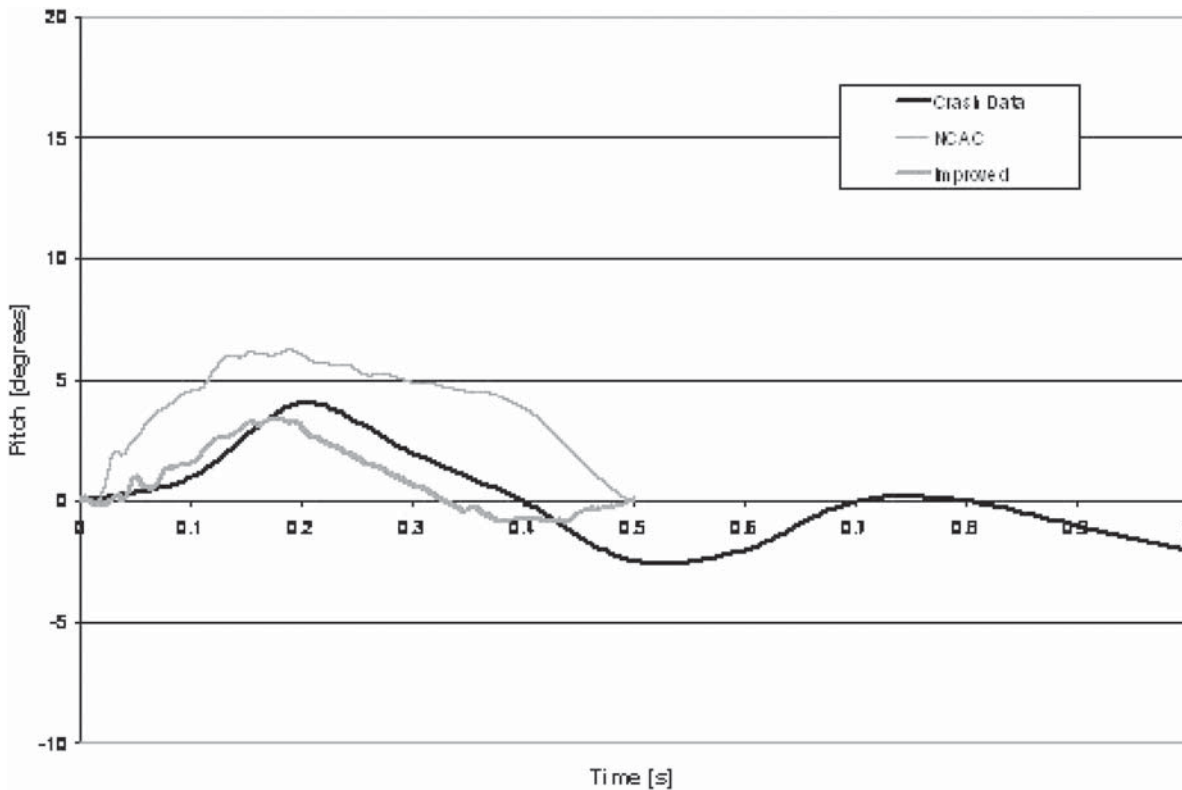

Figure 40. Comparison of pitch angles from crash data with vehicle simulations for the single-slope barrier.



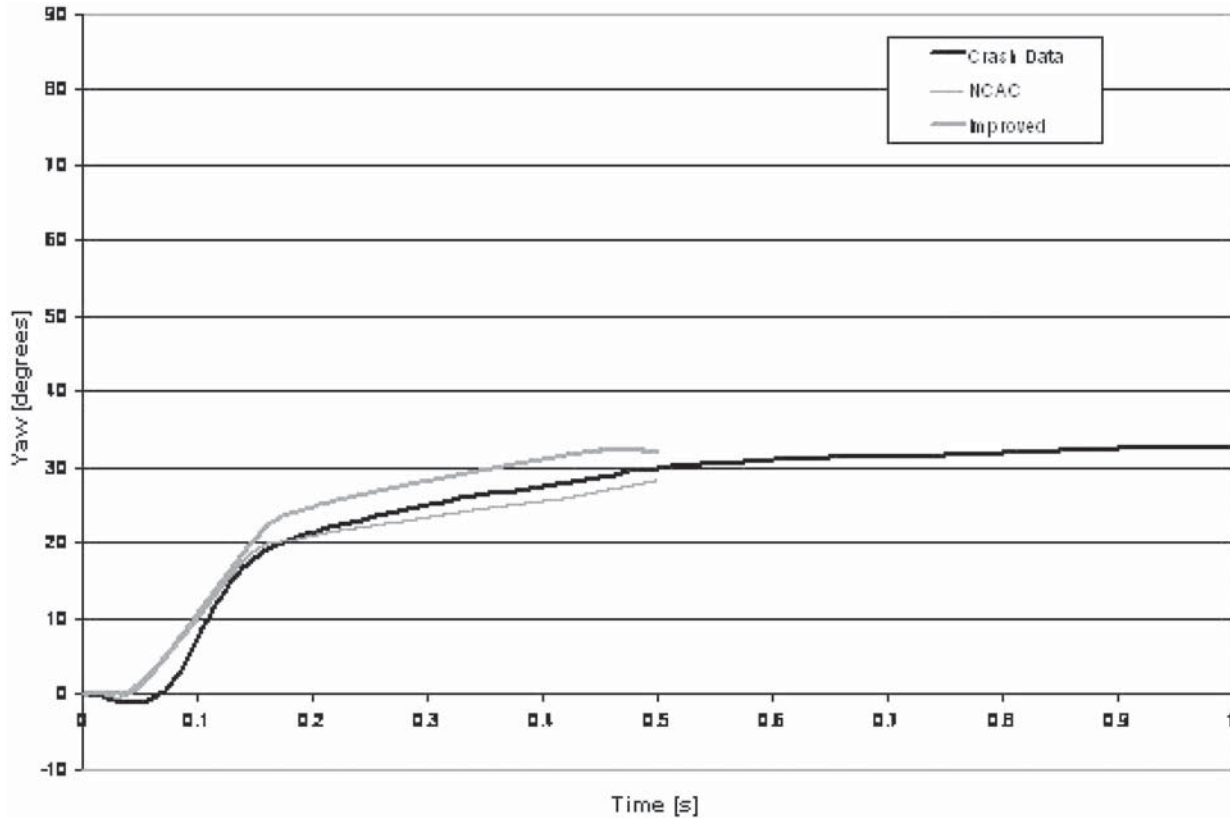

Figure 41. Comparison of yaw angles from crash data with vehicle simulations for the single-slope barrier.

modified, and this modified version of the Geo Metro was considered to be adequately validated against single-slope barrier tests with and without surface asperities (i.e., angled flutes) to proceed with its use in this project.

At the interim panel meeting, the focus of the research changed from single-slope barrier to New Jersey safety shape barriers. Consequently, the validation of the small-car finite element model had to be revisited. The number of crash tests into rigid concrete safety shape barriers with 820-kg cars was found to be very limited. Some New Jersey safety shape barrier tests that were identified were conducted on a modified-barrier profile in the early 1980s under *NCHRP Report 230*. The barrier modification consisted of a 75-mm pavement overlay in front of the barrier that covered the 75-mm reveal/lip at the bottom edge of the barrier. Further, the tests were conducted with a different vehicle (i.e., Honda Civic) at a 15-degree angle rather than the 20-degree angle currently specified in *NCHRP Report 350*. These factors limited the usefulness of these tests for validating the Geo Metro model for *NCHRP Report 350* impacts into a New Jersey safety shape barrier.

A reference to a 1981 test of an unmodified New Jersey safety shape barrier at a 20-degree impact angle was identified. The test was conducted by Dynamic Science, Inc., under FHWA contract DOT-FH-11-9115. Despite considerable efforts by the research team, including consultation with the

TTI librarian and the FHWA, the report and film for this test could not be located.

TTI researchers ultimately simulated impacts of the Geo Metro into an F-shape barrier and the New Jersey safety shape barrier with the 75-mm reveal/lip covered by a pavement overlay. It was discovered that for these safety shape barriers, neither the original NCAC model nor the TTI-modified model exhibited adequate correlation. Although correlation was achieved with the single-slope barrier, the safety shape barriers interact differently with the vehicle's tires, wheels, suspension, and so forth, and a model validated for one barrier shape will not necessarily work for another barrier shape. Further, the tests that were simulated were conducted with a Honda Civic rather than a Geo Metro. Therefore, it is not known how much of the observed differences between the tests and simulations were attributed to differences in vehicle-barrier interaction versus differences in vehicle type.

While the validation effort for the 820C vehicle was going on, TTI researchers were working in parallel on the 2000P vehicle model validation, details of which follow in subsequent sections in this chapter. As mentioned previously, the 2000P pickup truck design vehicle is believed to be more critical than the 820C in regard to evaluation of OCD and stability in impacts with concrete barriers. As an example, consider the Texas T411 aesthetic bridge rail shown in Figure 42. An impact into this barrier with an 820-kg passenger car at



Figure 42. Texas T411 aesthetic bridge rail.

97 km/h and 21.2 degrees was successful, while an impact into this barrier with a 2000-kg pickup truck at 101 km/h and 24.9 degrees failed due to excessive OCD (see Figure 43).

Since the small car was not considered to be the critical design vehicle from the standpoint of evaluating OCD or stability, the researchers planned to use the pickup truck as the primary vehicle for developing the preliminary guidelines. The role of the small-car model was to be limited to checking the preliminary guidelines established by the pickup truck. Therefore, rather than undertaking another extensive effort to improve the validity of the Geo Metro model for impacts into the New Jersey safety shape barrier while retaining sufficient fidelity to detect surface asperities, the research team shifted its focus to the development of preliminary guidelines based on parametric simulations with the pickup truck model.

Once the preliminary guidelines were established based on the parametric simulations conducted with the pickup truck, the research team sought input from the project panel regard-



Figure 43. Pickup truck after impact with Texas T411 bridge rail.

ing the panel's desire to revisit the validation of the small-car model for impacts with safety shape barriers. The research team believed that with additional time and resources, improved correlation of the Geo Metro for impacts into safety shape barriers could be achieved through further modification to the model. However, the benefits derived from such an effort needed to be weighed against the cost of the effort and the delay it would have imposed on the full-scale crash-testing program. Use of the small-car model was limited to providing a check of the preliminary guidelines established by the pickup truck. This objective could also be accomplished with a full-scale crash test.

This approach was approved by the project panel. Consequently, further validation of the small car for the New Jersey shape barrier was discontinued, and a crash test was performed to check the validity of the guidelines for the small car. Details of the crash-testing phase are presented in Chapter 6.

### 2000P Vehicle Model

Initial validation efforts for the 2000P vehicle were carried out with the reduced element pickup truck model that was developed by the NCAC. Simulations with the vehicle impacting a smooth-surface, single-slope barrier and a New Jersey shape barrier were performed and compared with available crash test data.<sup>(21,22)</sup> The correlation between test and simulation was not considered acceptable. Certain vehicle suspension parts in the reduced vehicle model (e.g., control arms) are modeled as rigid materials. The lack of deformability in the front suspension was believed to be the primary cause of the observed discrepancies between test and simulation.

TTI researchers then simulated these crash tests using the NCAC detailed pickup truck model. This model, which contains approximately 54,800 elements, incorporates a deformable front suspension. A comparison of the vehicle dynamics resulting from the simulation and crash test showed reasonable correlation for both barriers. Figures 44 through 46 compare the roll, pitch, and yaw displacements, respectively, for the single-slope barrier. Figures 47 through 49 provide a similar comparison of angular displacements for the New Jersey safety shape barrier. While reasonable correlation was obtained for both barriers, it can be seen from these figures that the single-slope barrier showed better correlation. This is likely due to the more prominent role of the vehicle suspension in impacts with the New Jersey shape barrier and limitations in the suspension model of the finite element pickup truck.

Having demonstrated reasonable correlation, the detailed NCAC pickup truck model was selected for use in the development of the preliminary design guidelines.

### Surrogate Measure of OCD

As mentioned previously, a common cause of barrier failure in a crash test is excessive OCD. As an example, OCD failure

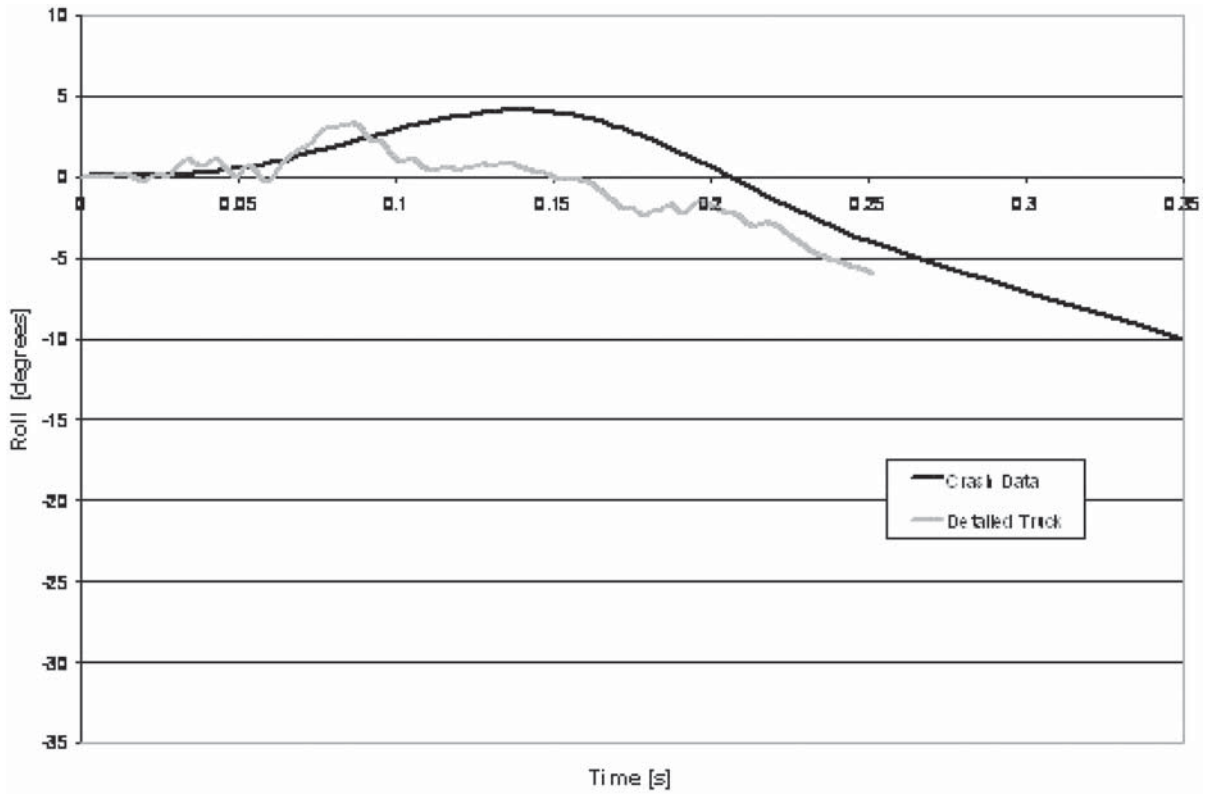

Figure 44. Comparison of roll angles of crash data with detailed pickup truck vehicle simulation on the single-slope barrier.

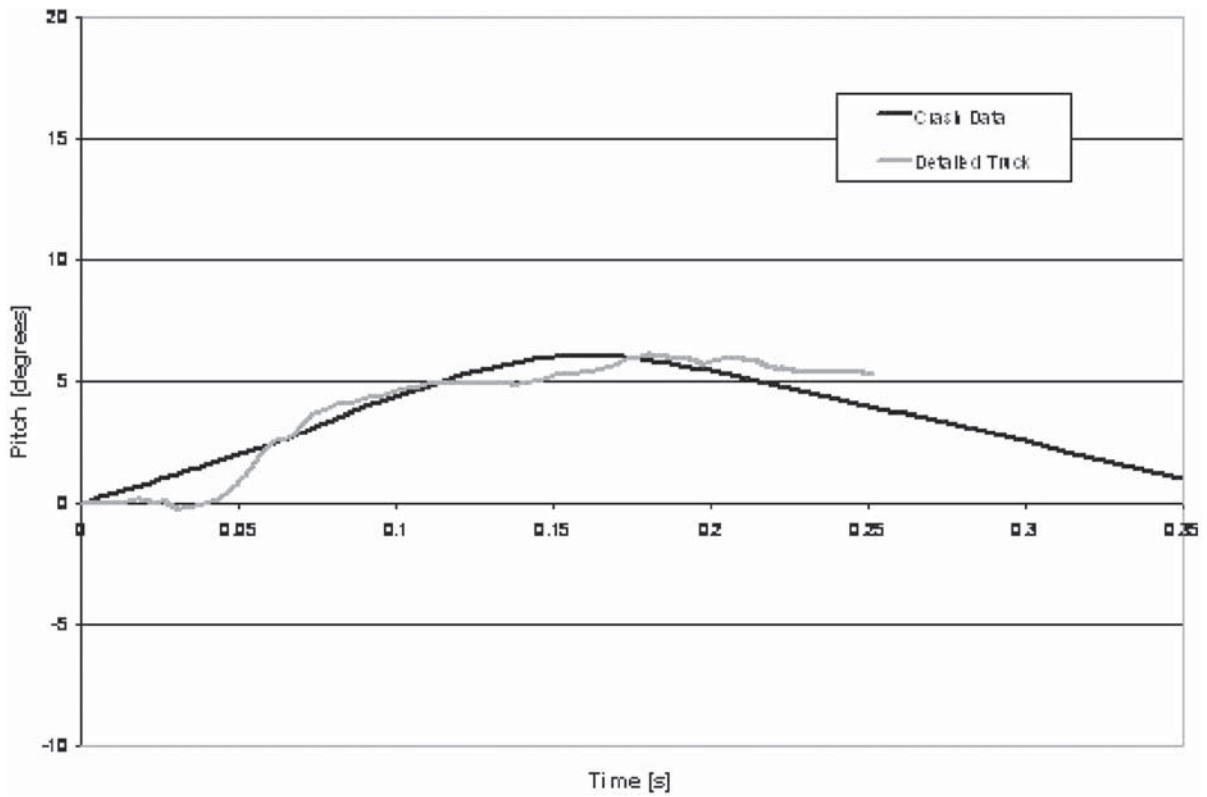

Figure 45. Comparison of pitch angles of crash data with detailed pickup truck vehicle simulation on the single-slope barrier.

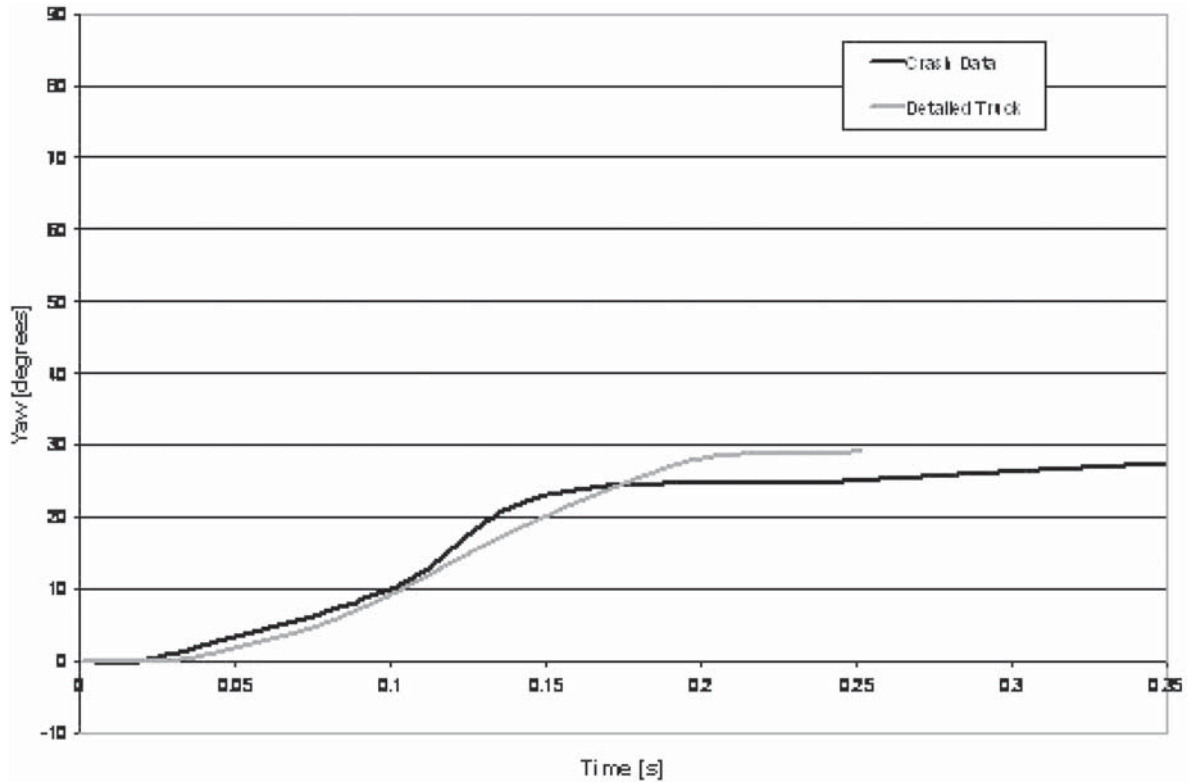

Figure 46. Comparison of yaw angles of crash data with detailed pickup truck vehicle simulation on the single-slope barrier.

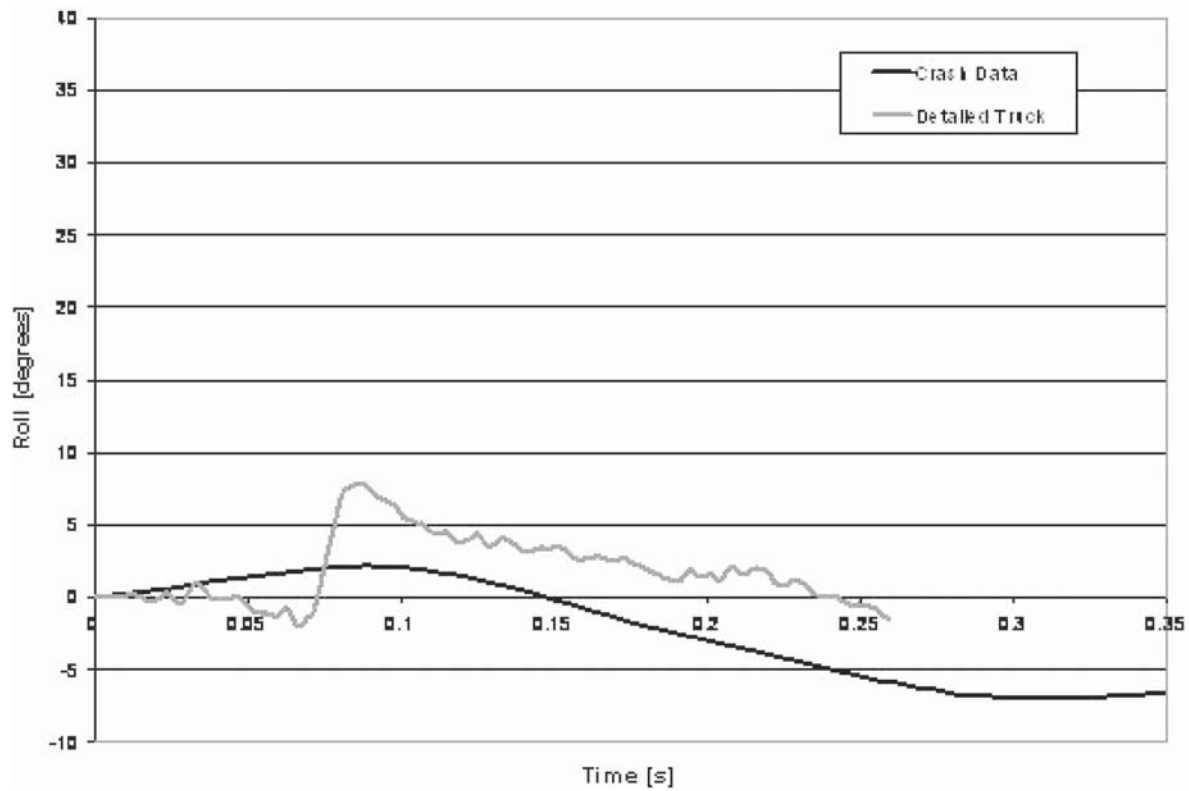

Figure 47. Comparison of roll angles of crash data with detailed pickup truck vehicle simulation on the New Jersey safety shape barrier.



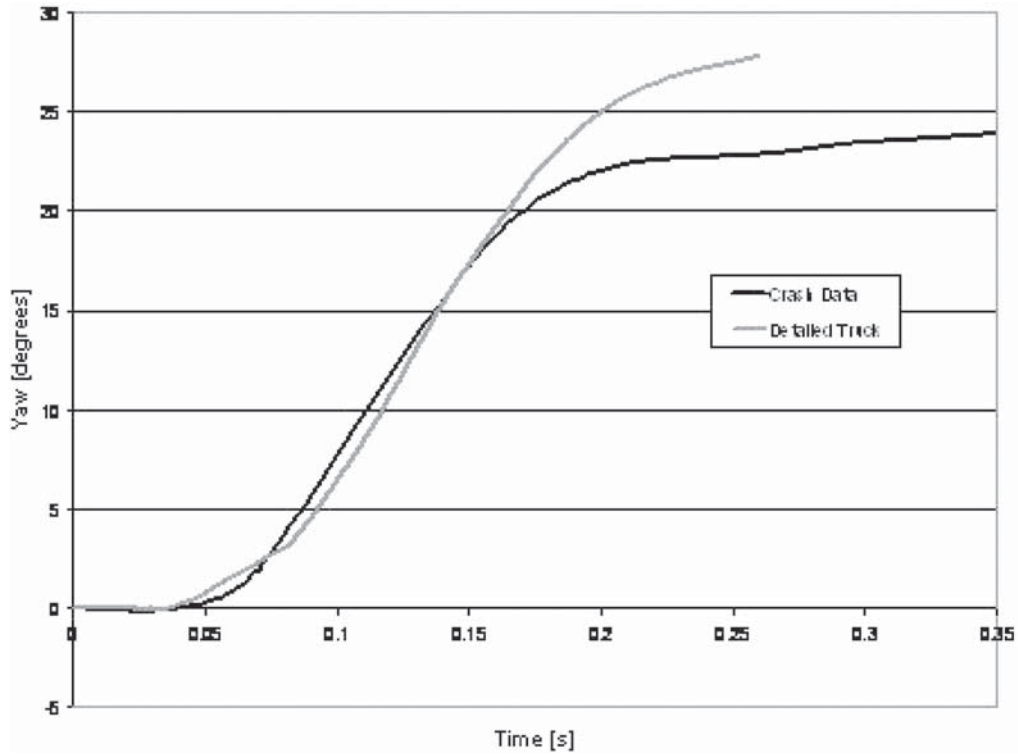

Figure 48. Comparison of yaw angles of crash data with detailed pickup truck vehicle simulation on the New Jersey safety shape barrier.

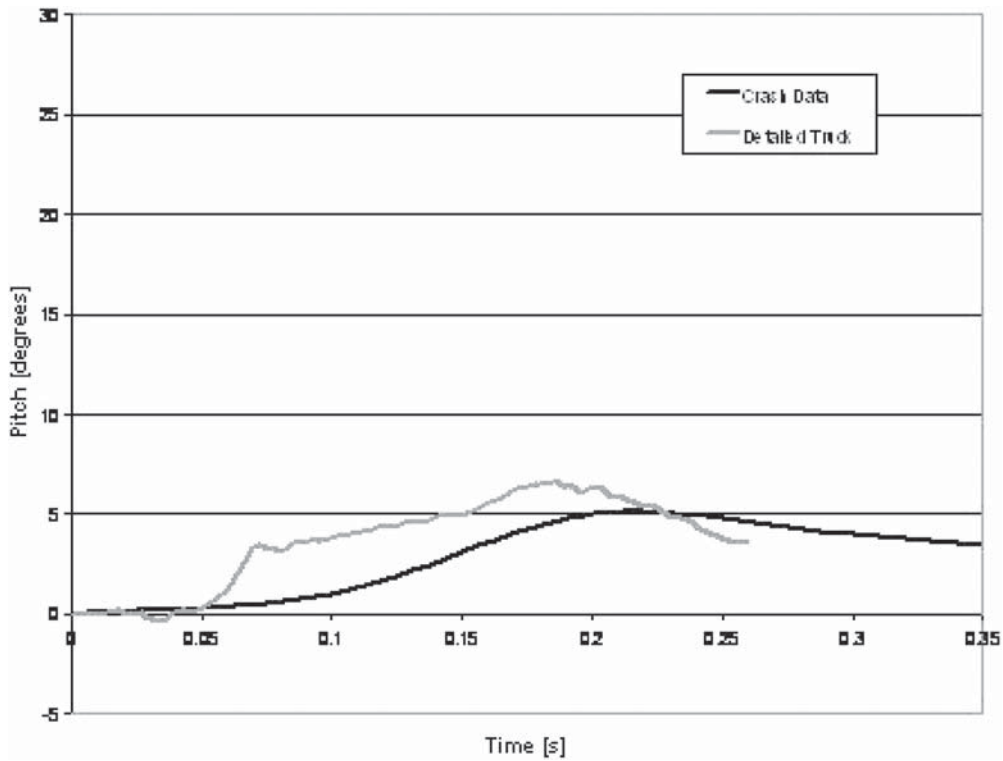

Figure 49. Comparison of pitch angles of crash data with detailed pickup truck vehicle simulation on the New Jersey safety shape barrier.

was the most predominant type of failure in the Caltrans study, “Crash Testing of Various Textured Barriers.”<sup>(19)</sup> There has been little research performed to assess or improve the ability of vehicle models to accurately capture and predict OCD resulting from a barrier impact. Part of the pilot study conducted under this project was devoted to assessing the ability of existing vehicle models to predict OCD, either through direct measurement of the maximum deformation inside the passenger compartment (similar to the procedure used in a crash test), or by means of a surrogate measure correlated against the OCD measurements obtained in full-scale crash tests.

Several crash tests of concrete barriers with the 820C passenger car and the 2000P pickup truck were identified. However, the number of useful crash tests was limited, especially for the small car. This was because OCD was not measured and reported prior to the publication and adoption of *NCHRP Report 350* and many of the small-car compliance tests with standard concrete median barrier shapes were conducted before *NCHRP Report 350*. All of the identified concrete barrier crash tests with measured OCD were modeled and simulated. Each simulation was set up to collect several potential measures of OCD. The objective was to determine a measure that would demonstrate the best correlation with the maximum OCD reported in the crash tests.

### Simulated Barrier Designs

*Oregon Bridge Railing.* The Oregon bridge rail is a concrete beam and post bridge rail similar to the Texas T411. When the impact performance of this barrier was evaluated with a pickup truck, the OCD was 475 mm, which significantly exceeded the 150-mm limit imposed by the FHWA.<sup>(23)</sup> Therefore, this test served as one of the failure points in the OCD pilot study. Figure 50 shows an image of the rail con-

structed for the crash test and the associated LS-DYNA model used in the simulation of the system.

*Deep Cobblestone Barrier.* The deep cobblestone barrier (shown in Figure 51) is a single-slope barrier with a random cobblestone surface treatment. This barrier was tested by Caltrans as part of its project to develop guidelines for aesthetic surface treatments for single-slope barriers. The barrier failed the test due to excessive OCD of the pickup truck caused by the interaction of the wheel with the cobblestones. The maximum amount of relief on the cobblestone surface was 64 mm.

For the simulation, the cobblestone surface was modeled using hemispherical and ellipsoidal shapes with the same depth as the actual surface treatment. Because this was one of the few pickup truck tests with a solid (i.e., without windows) concrete barrier that failed due to excessive OCD, it provided a useful data point for correlation of the surrogate OCD measures.

*Shallow Cobblestone Barrier.* After the failure of the deep cobblestone barrier, the depth of the cobblestone surface treatment was reduced to 19 mm and retested by Caltrans. Typical relief of the shallow cobblestone surface is shown in Figure 52. In the pickup truck crash test of this barrier, the drive shaft became dislodged from the transmission. Although the vehicle remained upright during the test, this type of damage was considered by Caltrans to represent a potential rollover risk. As a result, Caltrans decided that the barrier did not meet *NCHRP Report 350* evaluation criteria. However, since the shallow cobblestone reduced the maximum OCD of the vehicle to within acceptable limits, this test illustrated the effect of surface asperity depth on vehicle



(a)

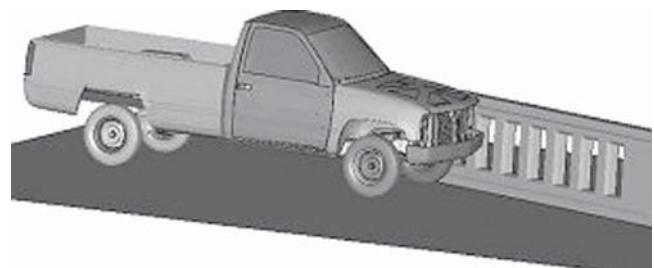

(b)

Figure 50. Oregon bridge railing: (a) actual; (b) simulation model.

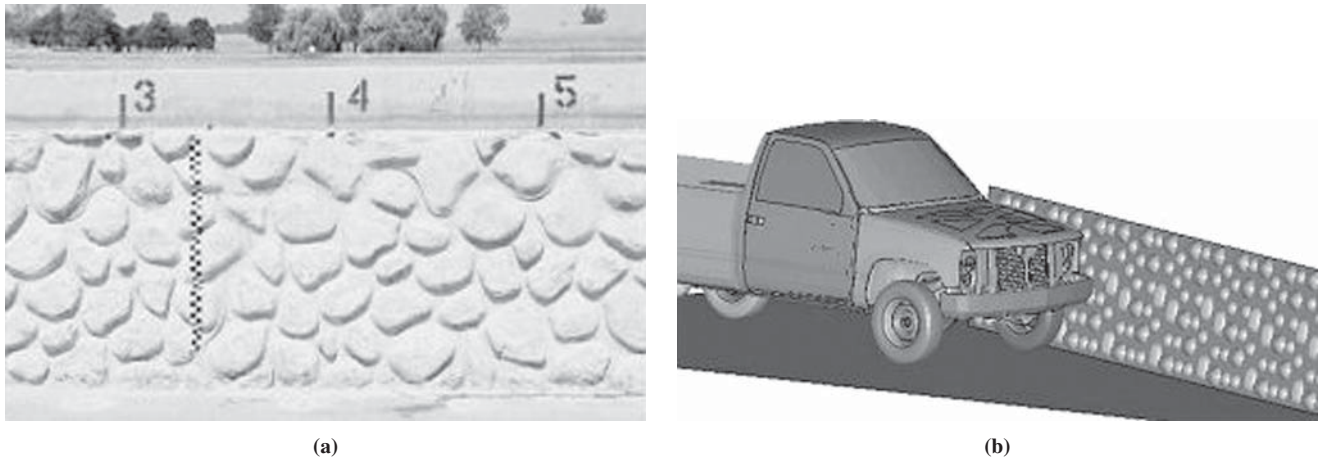

Figure 51. Cobblestone barrier: (a) actual; (b) simulation model.

response and represented another useful data point for developing a surrogate measure for OCD.

**Cobblestone Reveal Barrier.** An alternative treatment developed by Caltrans to address the OCD problems associated with the deep cobblestone barrier was to provide a smooth reveal at the bottom of the barrier. The 610-mm-tall reveal, which had a smooth, sandblasted finish (see Figure 53), was intended to reduce the snagging contact between the barrier and wheel assembly and, thereby, reduce the resulting OCD. This test successfully passed *NCHRP Report 350* criteria and provided another point for use in establishing the thresholds for a surrogate OCD measure. This barrier also possessed some similarity to the safety shape barriers that were to be addressed in this study, since the surface asperities were to be applied to the upper-wall portion of the safety shape barrier, while the toe of the barrier was to be left smooth.

*Single-Slope Barrier, New Jersey Safety Shape Barrier, and Modified Texas T203 Bridge Rail*

The standard single-slope barrier, New Jersey safety shape, and Texas T203 bridge rail were also modeled and evaluated. Each of these tests had acceptable OCD (i.e., < 150 mm) and met *NCHRP Report 350* guidelines. These “passing” crash tests provide confidence in establishing a “passing” threshold for the selected surrogate OCD criterion.

### Results

The first and most obvious measure of OCD was to take a direct measurement of the maximum deformation to the floorboard and toe pan of the vehicle in a manner similar to that used in crash test evaluation. An example of the OCD generated in the pickup truck model is shown in Figure 54. The deformation shown in Figure 54(b) is caused by induced buckling resulting from compression of the floorboard.

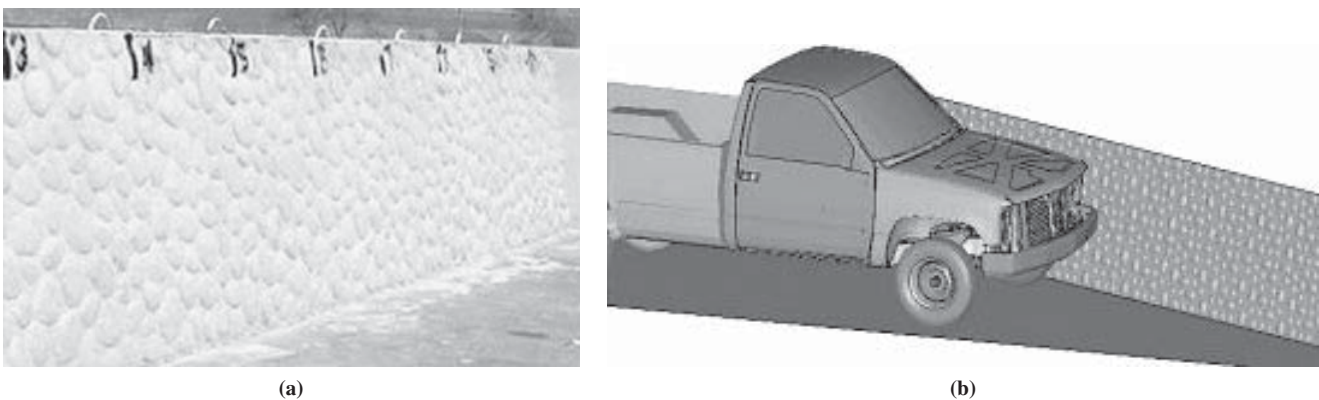

Figure 52. Shallow cobblestone barrier: (a) actual; (b) simulation model.

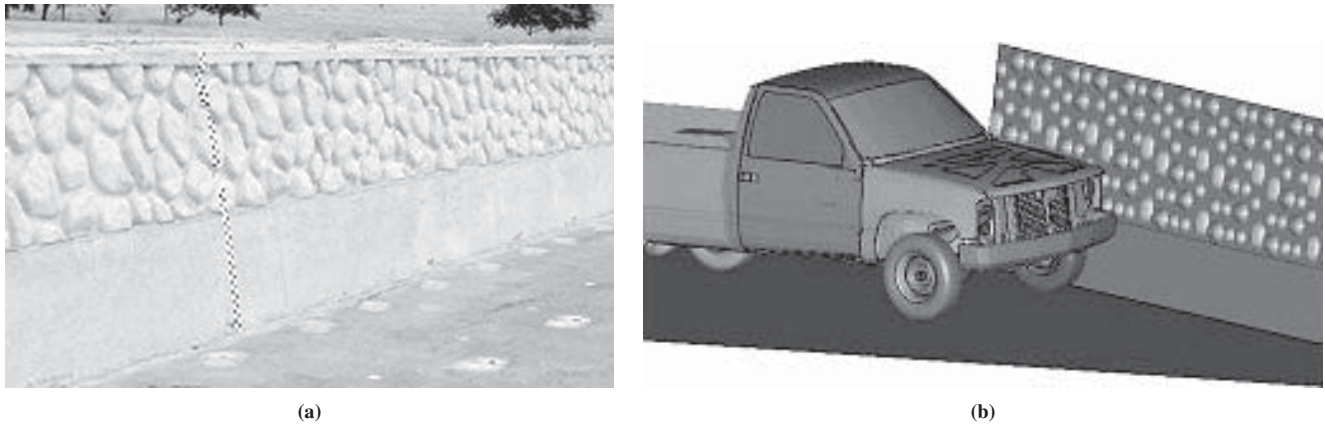

Figure 53. Cobblestone reveal barrier: (a) actual; (b) simulation model.

Direct measurements of OCD were obtained from the simulations and compared with measured full-scale crash test OCD values. As shown in Table 1, there is some correlation observed between the simulation and the test data. However, the reliability of predicting the outcome of a test, based on a single number from simulation, was not considered very high. In an actual crash test, the wheel, wheel well, fender, and other parts may contact the floorboard and cause additional OCD. The accurate representation of this mode of deformation requires failure in one or more components of the suspension that are not represented in current vehicle models. For this reason, direct measurement was not used as a measure for predicting OCD.

As mentioned above, much of the OCD in a barrier crash test results from the wheel and suspension assembly being deformed and shoved back into the toe pan area. An option was set into the model to collect the direct impact forces between the wheel and barrier. These forces were evaluated using several criteria. The XY and XYZ resultants of the peak force, peak 10-ms moving average force, impulse over the

time of initial impact, and total impulse were all computed and analyzed to investigate their correlation to OCD measurements. These measures of contact force between the wheel and the barrier have been tabulated in Table 2. The correlation between these measures and actual OCD measurements was found to be poor. The amount of variation that exists in these data between acceptable and failed crash tests was not adequate to confidently use these forces as a surrogate measure for OCD. This is possibly due to the unreliable values of force between parts undergoing such severe deformation.

Finally, the internal energies of the vehicle parts in the crushed region of the vehicle were obtained and checked for correlation to OCD measurement. The internal energy in a part is related to the overall deformation experienced by the part. Internal energies obtained from the floorboard and wheel well showed the best correlation to the actual crash test results among the measures evaluated (see Table 3). Between these, the truck floorboard was selected as the surrogate measure of OCD because it had slightly better correlation,

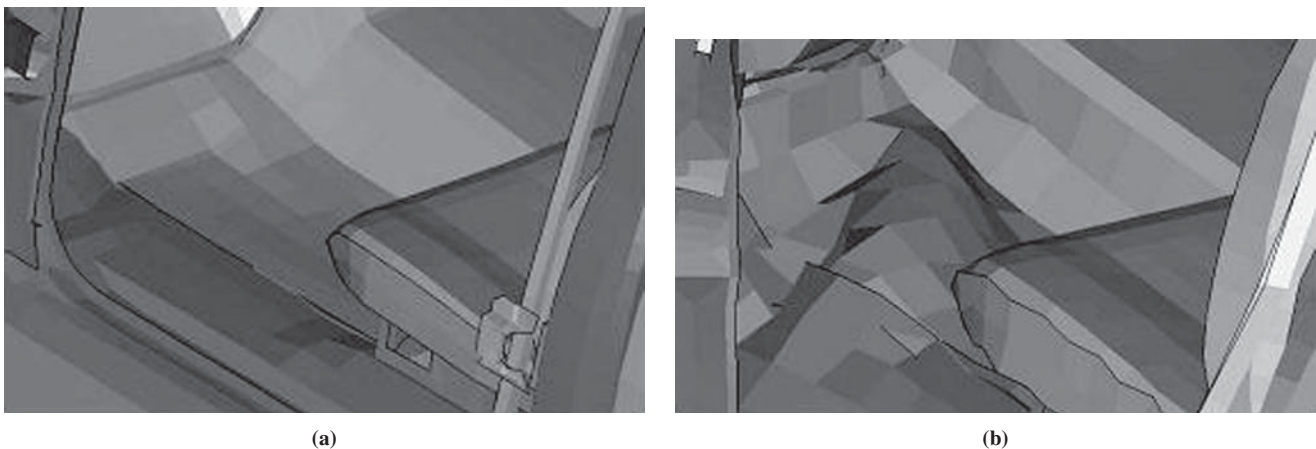

Figure 54. Buckling floorboard: (a) undeformed; (b) deformed.



**TABLE 1 Direct measurements for truck OCD study**

Name	Pass/Fail	Crash Test OCD [mm]	Direct Measurement [mm]
Oregon	Fail	475	170
Cobblestone	Fail	160	225
Cobblestone with Reveal	Pass	98	50
Single Slope	Pass	140	50
New Jersey	Pass	Not Reported	80
Modified T203	Pass	130	80
Shallow Cobblestone	Pass	133	105

**TABLE 2 Wheel to barrier contact forces and impulses for truck OCD study**

Name	Pass/Fail	Crash Test OCD [mm]	XYZ Resultant			
			Max Force [N]	Max 10 ms Moving Avg. [N]	Impulse [N-s]	Total Impulse [N-s]
Oregon	Fail	475	1,290,000	459,000	28,800	29,900
Cobblestone	Fail	160	1,340,000	450,000	34,500	40,100
Cobblestone with Reveal	Pass	98	278,000	195,000	14,500	14,800
Single Slope	Pass	140	510,000	164,000	10,700	15,200
New Jersey	Pass	Not Reported	229,000	197,000	12,100	12,800
Modified T203	Pass	130	290,000	231,000	12,800	21,100
Shallow Cobblestone	Pass	133	910,000	459,000	18,700	18,700
			XY Resultant			
Oregon	Fail	475	1,290,000	455,000	27,700	28,300
Cobblestone	Fail	160	1,176,000	438,000	31,900	35,900
Cobblestone with Reveal	Pass	98	276,000	195,000	14,300	14,600
Single Slope	Pass	140	498,000	164,000	10,600	15,100
New Jersey	Pass	Not Reported	228,000	196,000	12,000	12,700
Modified T203	Pass	130	263,000	123,000	11,900	19,800
Shallow Cobblestone	Pass	133	901,000	449,000	18,000	18,000

**TABLE 3 Internal energies for truck OCD study**

Name	Pass/Fail	Crash Test OCD [mm]	Floorboard Part [N-mm]	Wheel Well Part [N-mm]
Oregon	Fail	475	9,826,000	14,140,000
Cobblestone	Fail	160	10,783,000	11,040,000
Cobblestone with Reveal	Pass	98	782,400	3,980,000
Single Slope	Pass	140	721,300	2,469,000
New Jersey	Pass	Not Reported	1,130,000	2,870,000
Modified T203	Pass	130	1,172,000	3,300,000
Shallow Cobblestone	Pass	133	2,150,000	7,540,000

because its deformation is less influenced by contact with other parts of the vehicle, and because use of floorboard deformation is more intuitively appealing given the nature of OCD that occurs in a crash test.

#### *Conclusions for the 2000P Study*

As mentioned above, the internal energy of the floorboard of the pickup truck was selected as the most appropriate

surrogate measure for evaluating OCD. Using the internal energy from the simulations and the reported OCD values from the crash tests, thresholds for the surrogate measure were established. As shown in Figure 55, the passing limit was selected as 2,200 N-m and the failure limit was tentatively set at 10,700 N-m of internal energy in the floorboard of the pickup truck.

The failure point that occurs at an internal energy of 7,100 N-m is associated with the Oregon bridge rail. It is

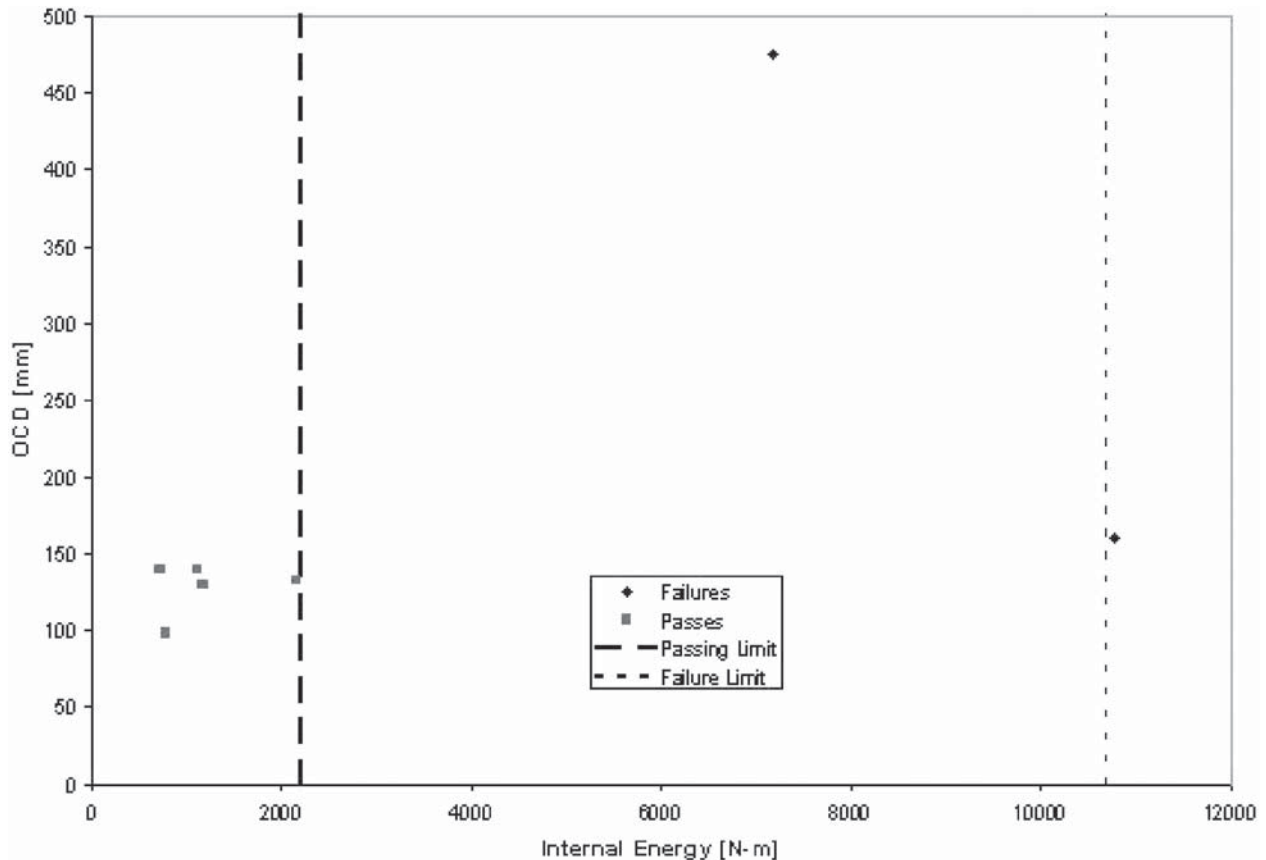

Figure 55. Passing and failing crash tests OCD versus internal energies of floorboard.

noted that the interaction of the vehicle with this rail is considered to be substantially different than what typically occurs in an impact with a “solid” barrier. In the test of the Oregon barrier, the frame rail of the pickup truck protruded inside one of the “windows” and snagged severely on the inside of one of the concrete balusters. As a result, instead of the load going to the floorboard as it does in most OCD failures, the load was directed to the frame. Therefore, the Oregon bridge rail crash test was not taken into consideration when selecting the failure limit.

The outcome of impacts with solid barriers in which the internal energy of the floorboard is between 2,200 N·m and 10,700 N·m is largely unknown due to lack of crash test data with a sufficient range of OCD values. As is described in Chapters 6 and 7, the full-scale crash tests were designed to adjust these energy thresholds and reduce the size of the region with unknown performance.

#### GENERALIZED SURFACE ASPERITY DEFINITION

In order to model asperities on the barrier surface for evaluation in the parametric simulation effort, it was necessary to adequately define their geometry. Almost all surface asperities can be placed within one of three categories: perpendicular, rounded, or angled surface interruptions. These generalized types of surface asperities are shown in Figure 56.

The angled or inclined asperity can be defined in terms of a depth  $d$  and angle  $\theta$ , either of which can be varied to achieve a different profile. The perpendicular asperity is a subset of the angled asperity with  $\theta = 90$  degrees. The rounded asperity can be approximated as an angled surface asperity by selecting an effective angle  $\theta$ . The illustration shown in Figure 56 uses a tangent to the rounded surface

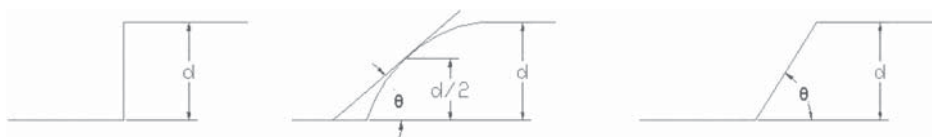

Figure 56. Generalized types of surface asperities.

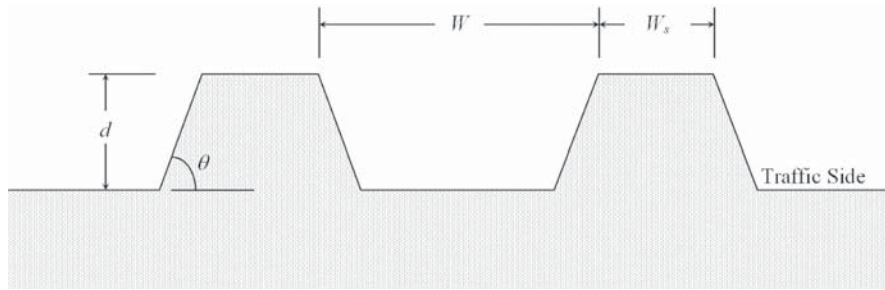

Figure 57. Surface asperity geometry variables.

at half the depth  $d$  to define an effective angle  $\theta$ . Because the angled asperity is the most general, it is the type of surface asperity used in the parametric study to develop guidelines for the aesthetic treatment of concrete safety shape barriers.

For the purpose of this research, asperities were defined as the portion of the barrier that was recessed into the barrier surface. In other words, an asperity is a depression in the surface of the barrier. Thus, another critical dimension to be included in the parametric study was the width of the asperity,  $W$ , which was defined as the distance between the outer edges of the asperity spacing, as shown in Figure 57. The distance between two adjacent asperities was defined as the asperity spacing ( $W_s$ ). For the parametric studies presented in this chapter, an asperity spacing of 25 mm was used.

The asperities were created by depressing the surface of the barrier profile at the desired asperity locations. The original barrier profile was, therefore, unchanged in the regions between asperities, defined in Figure 57 as the asperity spacing ( $W_s$ ). The asperities began at the top of the “toe” of the safety shape barrier and continued vertically to the top of the barrier. The toe of the barrier remained smooth, as shown in Figure 58.

### PRELIMINARY AESTHETIC DESIGN GUIDELINES

All simulations in the parametric study to establish the preliminary aesthetic design guidelines were performed with the 2000P pickup truck impacting a rigid New Jersey safety shape barrier following Test 3-11 of *NCHRP Report 350*. The impact conditions for Test 3-11 involve the 2000-kg pickup truck impacting the barrier at a speed and angle of 100 km/h and 25 degrees, respectively.

The parametric study was performed using 45-degree, 90-degree, and 30-degree asperity angles ( $\theta$ ). The asperity width ( $W$ ) and depth ( $d$ ) were systematically varied for each of these angles. The impact performance associated with each simulation run was assessed based on the established surrogate OCD thresholds. As previously mentioned, the passing and failing internal energy limits were selected as 2,200 J and 10,700 J, respectively. The results were used to establish preliminary relationships that identified asperity configurations having impact performance considered to be “acceptable,” “marginal/unknown,” and “unacceptable.” If for a simulated asperity configuration, the truck floorboard internal energy was more than 10,700 J, the configuration was marked as “unacceptable.” Floorboard internal energy value between

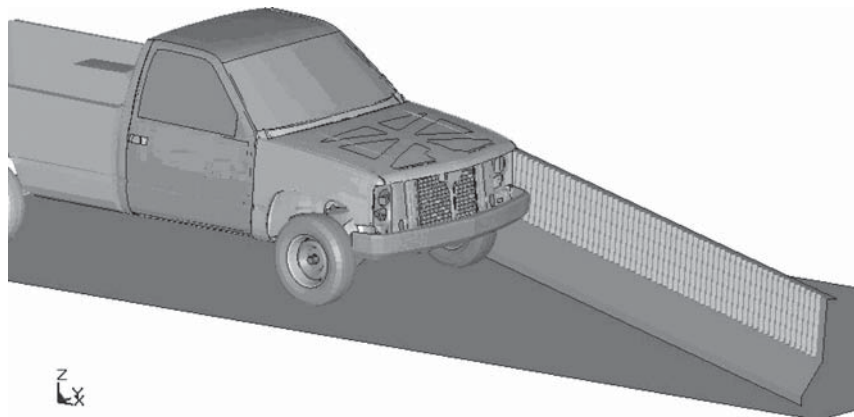

Figure 58. Truck with fluted New Jersey shape barrier.

2,200 J and 10,700 J implied that the asperity configuration was marked as “marginal/unknown.” If the floorboard internal energy was less than 2,200 J, the configuration was marked as “pass” or “acceptable.”

Other than the baseline simulation with the New Jersey barrier without asperities, none of the simulated configurations resulted in truck floorboard internal energy of less than 2,200 J. Consequently, “unacceptable” and “marginal/unknown” were the only two regions identified in the preliminary guidelines. The “pass” region was later identified with the use of full-scale crash testing, details of which follow in the next chapter. It is worth mentioning that asperity configurations (with very small depths and large widths) can be selected such that they would result in floorboard internal energies of less than 2,200 J. Such configurations can be used to establish a “pass” region in the preliminary guidelines. However, the asperity depth and width values for such configurations would have no practical significance for the aesthetic surface treatment of concrete barriers and hence were not simulated.

Simulation results for the truck floorboard internal energy for the 45-degree, 90-degree, and 30-degree asperity angles are presented in Tables 4 through 6, respectively. Simulations with no depth refer to a smooth-faced New Jersey safety shape barrier. The tables present floorboard internal energy for different asperity configurations. Using the results for the simulated values of  $W$  and  $d$ , a curve denoting the failure threshold was plotted for each asperity angle. The corresponding relationships for the 45-degree, 90-degree, and 30-degree asperity angles are shown in Figures 59 through 61, respectively. For convenience of use and comparison, the relationships for the

45-degree, 90-degree, and 30-degree asperity angles have been combined in Figure 62.

The curves shown in Figures 59 through 62 provide only a failure line, above which the asperity geometries were predicted to fail to meet impact performance criteria and below which the impact performance was unknown. As discussed previously, the existence of a region of unknown performance is due to a lack of crash tests of rigid barriers with measured OCD values corresponding to the regions below the failure line. This region of unknown performance was reduced through a judiciously selected full-scale crash-testing phase, the details of which are presented in the next chapter.

Examining the shape of the guideline curves, the effects of asperity width ( $W$ ) and depth ( $d$ ) on barrier performance appear logical. When the asperity width ( $W$ ) is small, the vehicle engages more asperities during its contact with the barrier. This in turn presents more resistance to vehicle sliding on the barrier and causes more snagging and damage to the vehicle. Consequently, we see a reduction in the allowable asperity depth ( $d$ ) for these smaller widths. As the width ( $W$ ) of an asperity increases, the allowable depth ( $d$ ) also increases up to a limiting or controlling value.

It can also be seen that as the angle becomes shallower, the failure line moves upward to higher asperity depths. Thus, the 30-degree asperity angle results in a larger “marginal/acceptable” region than the 45-degree asperity angle. Similarly, the “marginal/unknown” region significantly reduces with the increase in asperity angle from 45 degrees to 90 degrees. For the 90-degree asperity angle, it can be seen that for asperity widths less than 500 mm, the internal energy

**TABLE 4 Parametric study results for a 45-degree angle of asperity**

Run	Vehicle	Asperity Width ( $W$ ) [mm]	Asperity Depth ( $d$ ) [mm]	Truck Floorboard Internal Energy [J]	Pass/Fail
1	Truck	555	0	1,108	Pass
2	Truck	555	15	4,341	Marginal
3	Truck	555	27.5	6,986	Marginal
4	Truck	555	40	8,397	Marginal
5	Truck	555	52.5	12,835	Fail
6	Truck	555	65	15,939	Fail
7	Truck	555	90	18,318	Fail
8	Truck	280	0	1,108	Pass
9	Truck	280	15	8,965	Marginal
10	Truck	280	27.5	14,680	Fail
11	Truck	280	52.5	15,507	Fail
12	Truck	180	0	1,108	Pass
13	Truck	180	6.5	9,158	Marginal
14	Truck	180	15	11,844	Fail
15	Truck	80	0	1,108	Pass
16	Truck	80	6.5	8,900	Marginal
17	Truck	80	15	17,182	Fail
18	Truck	30	0	1,108	Pass
19	Truck	30	5	4,149	Marginal
Passing Limit = 2,200 J					
Failure Limit = 10,700 J					

**TABLE 5 Parametric study results for a 90-degree angle of asperity**

Run	Vehicle	Asperity Width ( <i>W</i> ) [mm]	Asperity Depth ( <i>d</i> ) [mm]	Truck Floorboard Internal Energy [J]	Pass/Fail
1	Truck	5	40	2,157	Pass
2	Truck	30	0	1,108	Pass
3	Truck	30	2.5	3,257	Marginal
4	Truck	30	15	6,077	Marginal
5	Truck	30	40	6,049	Marginal
6	Truck	55	0	1,108	Pass
7	Truck	55	2.5	17,497	Fail
8	Truck	55	40	25,000+	Fail
9	Truck	125	6.5	18,250	Fail
10	Truck	280	0	1,108	Pass
11	Truck	280	6.5	24,240	Fail
12	Truck	280	15	30,000+	Fail
13	Truck	400	0	1,108	Pass
14	Truck	400	6.5	12,000+	Fail
15	Truck	500	0	1,108	Pass
16	Truck	500	6.5	8,653	Marginal
17	Truck	500	12.5	21,000+	Fail
18	Truck	580	0	1,108	Pass
19	Truck	580	15	8,909	Marginal
19	Truck	580	27.5	14,000+	Pass
Passing Limit = 2,200 J Failure Limit = 10,700 J					

of the truck floorboard exceeds the failure limit for almost all practical asperity depths. In the simulations, the 90-degree asperity angle induces more severe snagging and resistance to sliding, which causes more damage to the vehicle. An analogy can be drawn between the 90-degree asperities and splices in tubular steel rail members that have demonstrated the potential for severe snagging and increased OCD in full-scale crash tests. One must bear in mind that all simulated asperities (45-degree, 90-degree, and 30-degree asperities) were modeled as rigid. In an actual impact, spalling or fracture of the concrete asperities may occur. This spalling can serve to reduce the snagging

forces below levels that would be induced by a rigid asperity. The degree of snagging reduction was difficult to quantify without additional test data.

For the 90-degree asperity angle, as the asperity width (*W*) increases beyond 500 mm, the allowable depth (*d*) increases up to a limiting or controlling value. Another interesting point to note is that as the width (*W*) decreases to a value of 30 mm or less, a significant increase in the asperity depth (*d*) can be achieved. This is because even though *d* is large, the small width of the asperity reduces the potential for vehicle parts to intrude into the asperity. Thus, the opportunity for vehicle

**TABLE 6 Parametric study results for a 30-degree angle of asperity**

Run	Vehicle	Asperity Width ( <i>W</i> ) [mm]	Asperity Depth ( <i>d</i> ) [mm]	Truck Floorboard Internal Energy [J]	Pass/Fail
1	Truck	100	0	1,108	Pass
2	Truck	100	25	4,476	Marginal
3	Truck	200	0	1,108	Pass
4	Truck	200	25	6,238	Marginal
5	Truck	200	50	7,652	Marginal
6	Truck	400	0	1,108	Pass
7	Truck	400	25	4,465	Marginal
8	Truck	400	50	7,538	Marginal
9	Truck	400	75	11,341	Fail
10	Truck	600	0	1,108	Pass
11	Truck	600	25	3,952	Marginal
12	Truck	600	50	4,701	Marginal
13	Truck	600	75	5,985	Marginal
14	Truck	600	100	6,724	Marginal
Passing Limit = 2,200 J Failure Limit = 10,700 J					



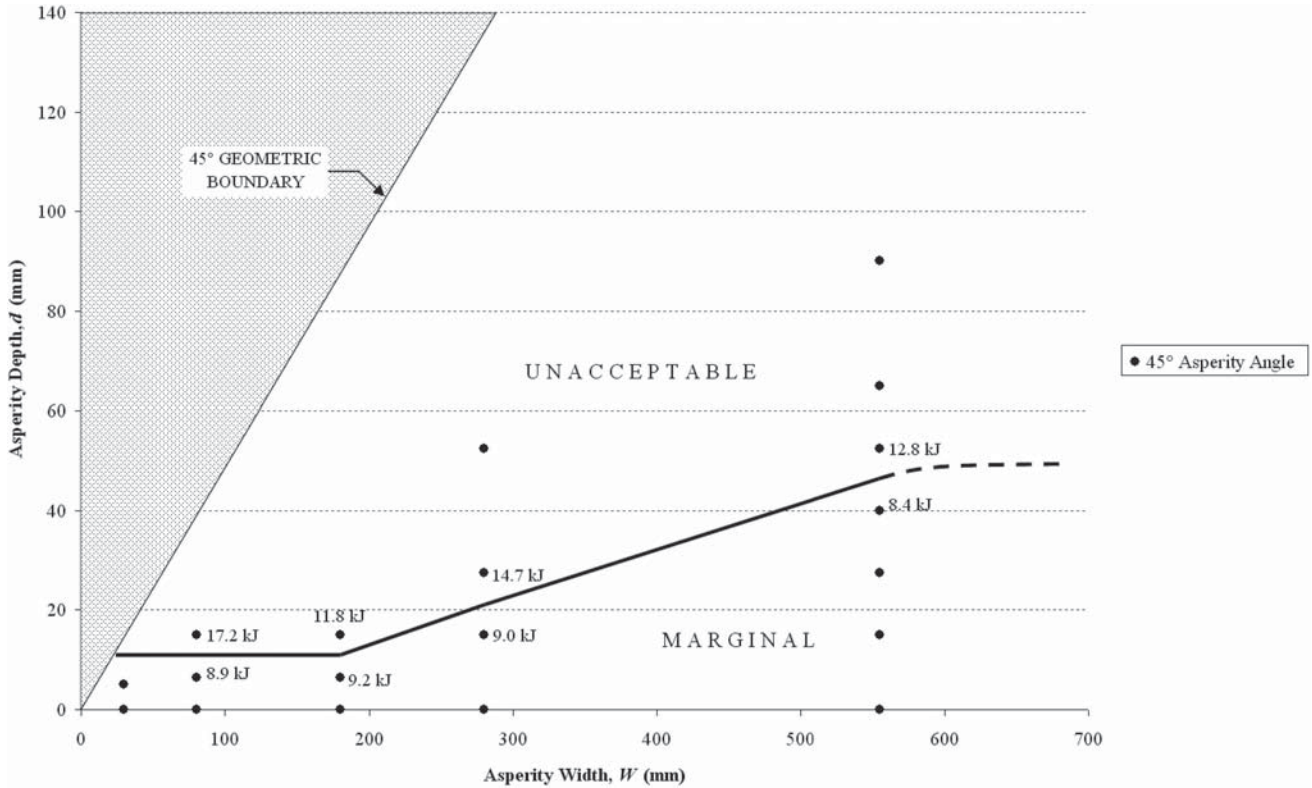

Figure 59. Depth versus width guideline for a 45-degree asperity angle.

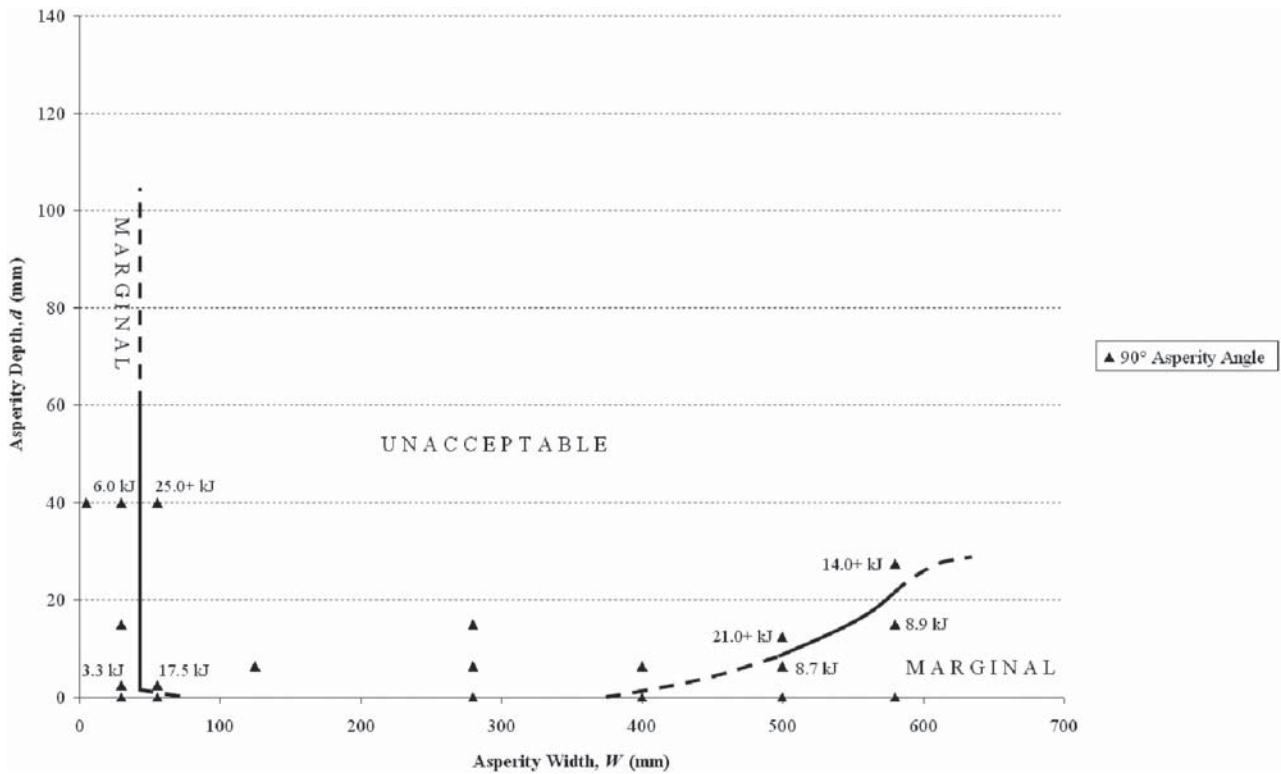

Figure 60. Depth versus width guideline for a 90-degree asperity angle.

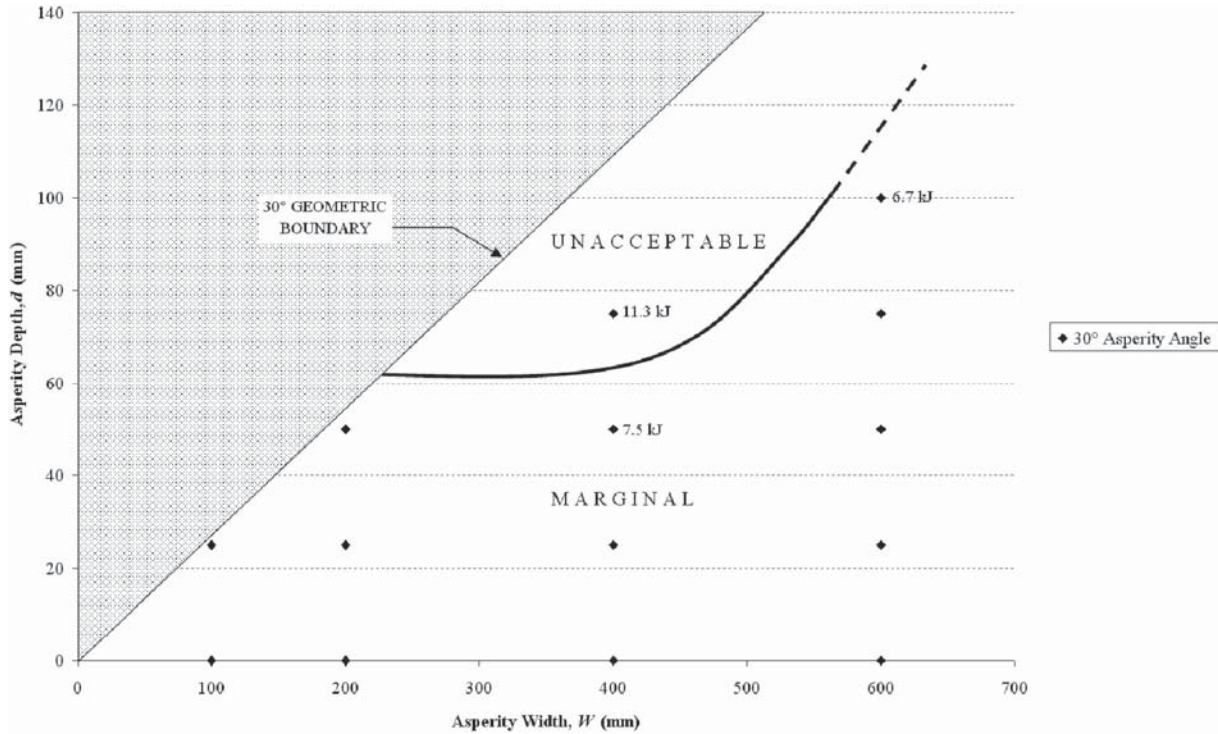

Figure 61. Depth versus width guideline for a 30-degree asperity angle.

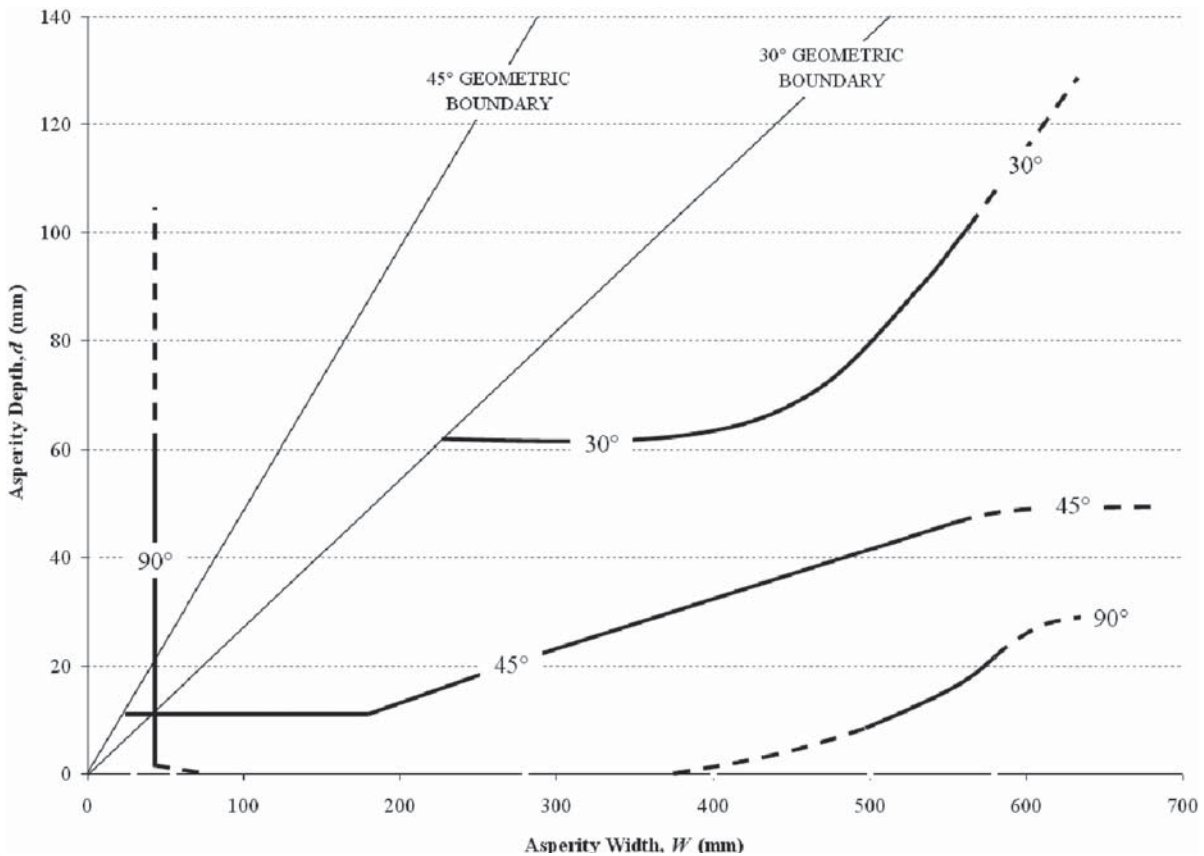

Figure 62. Overlaid depth versus width guideline curves.

snagging and cumulative vehicle damage is reduced. Even if some intrusion into the asperity occurs, the depth of the intrusion is again limited by the small width of the asperity. This effect is illustrated by the vertical failure line in Figure 60.

In summary, simulation results for the 90-degree asperity angle indicate that only a very limited set of asperity configurations with this angle can be used for aesthetic barrier design. Further investigation was performed with a full-scale crash test, details of which are presented in the next chapter.

It can be seen that for shallower asperity angles, much greater asperity depths can be achieved. Note that some of the simulated asperity depths for the 30-degree asperity angle may not be practical from a design standpoint. However, because not all desired aesthetic surface treatments can be anticipated, a wide range of asperity depths has been included in the analysis to more completely define the relationship between asperity depth and width for shallow-angle asperities.

It is noted that a standard concrete barrier design will have a functional limit on the maximum asperity depth that can be accommodated without exposing the reinforcing steel or leaving insufficient concrete cover. In order to maintain the desired clear cover (typically 37.5 mm to 50 mm) for reinforcement steel when significant asperity depths are incorporated into the

design, the barrier may need to be widened beyond the width required to satisfy strength requirements.

The exact nature of the curves beyond an asperity width of 600 mm (denoted with a dashed line) is not completely defined. However, the curves should reach a limiting asperity depth as the asperity width increases. As the asperity width continues to increase, a point will be reached where the vehicle is only engaging or interacting with a single asperity during redirection. At this point, there will be a critical asperity depth that will no longer be influenced by asperity width.

It is worth noting that the failure lines shown in Figures 59 through 62 are placed at the midpoint between simulated surface asperity depths at a given asperity width that resulted in marginal and unacceptable OCD (as defined by the internal floorboard energy). However, the increase in internal floorboard energy is not linearly related to asperity depth. This can be observed by comparing the internal energy values for different asperity widths and depths.

The truck floorboard internal energy data for the 45-degree, 90-degree, and 30-degree asperity angles is presented in three-dimensional graphs in Figures 63 through 65, respectively. For a given asperity width, the increase in internal energy with increase in the asperity depth can be

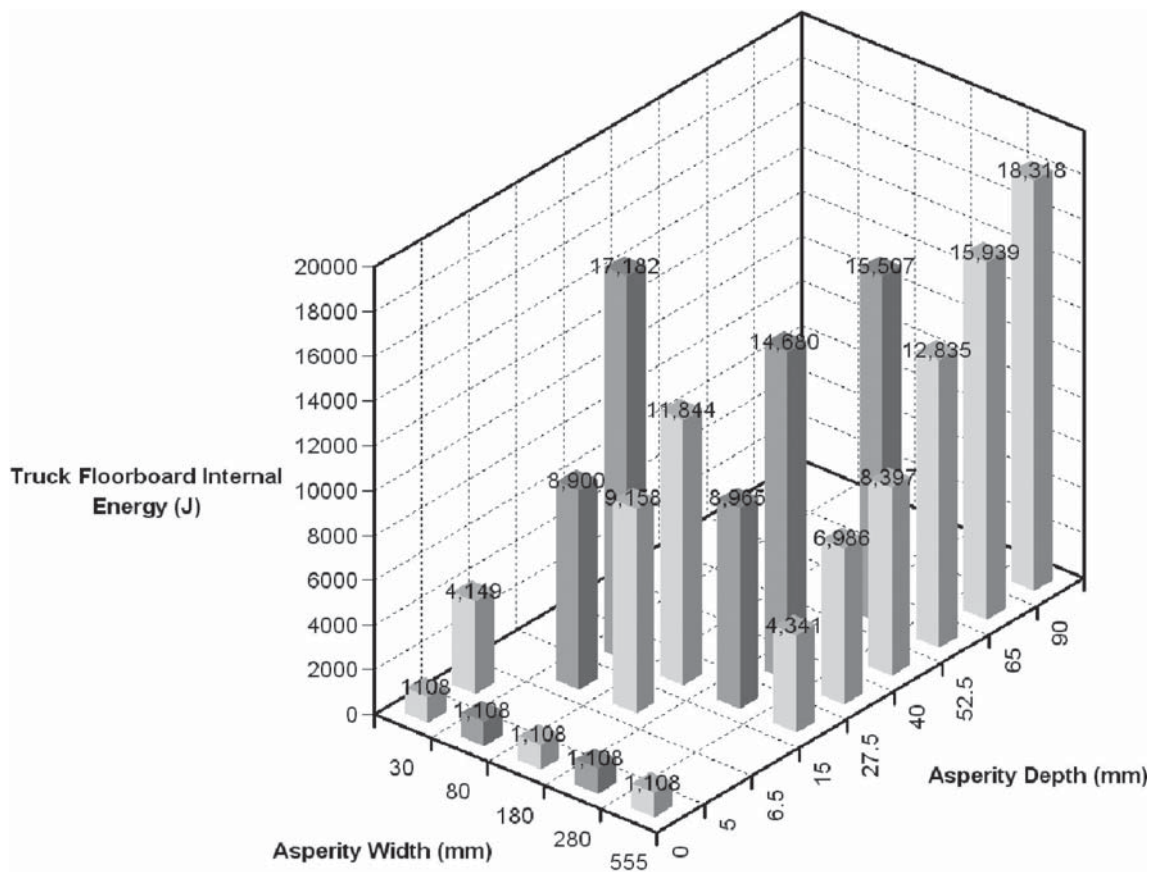

Figure 63. Truck floorboard internal energy values at different configurations for a 45-degree asperity angle.

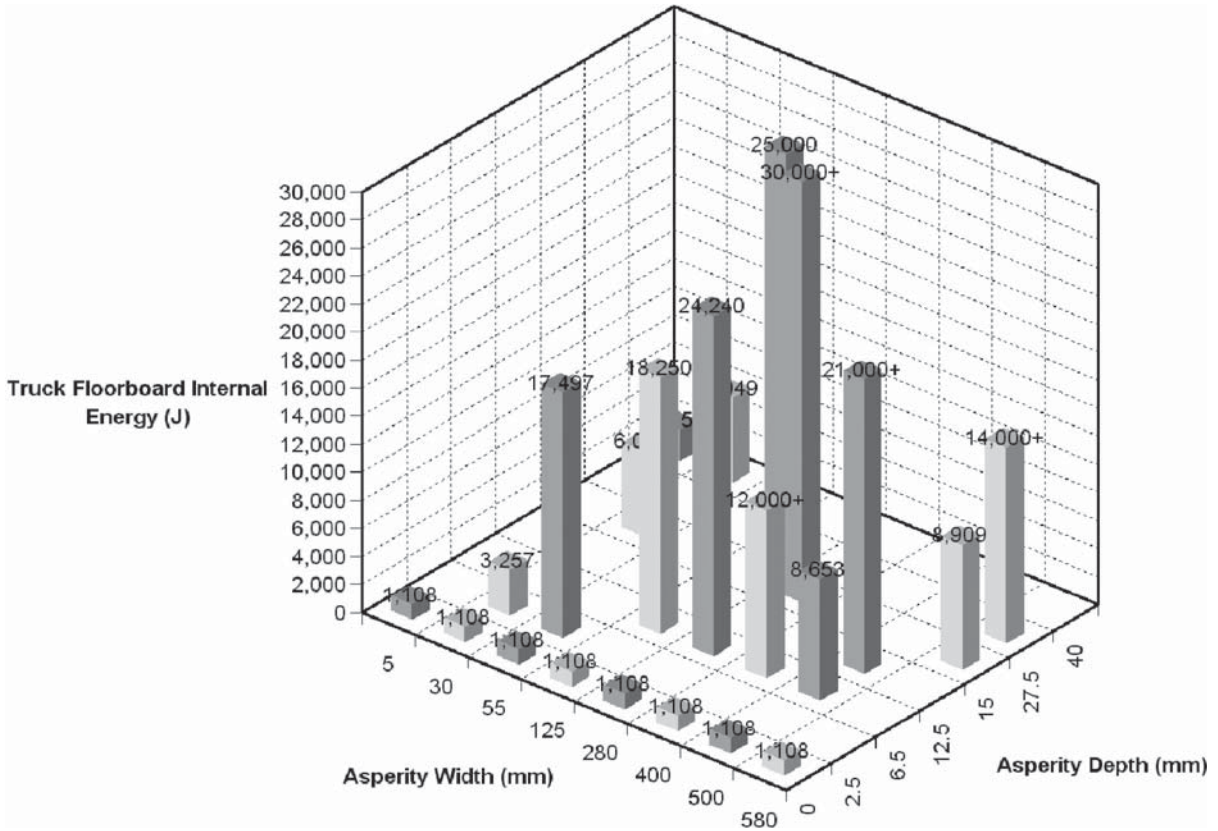

Figure 64. Truck floorboard internal energy values at different configurations for a 90-degree asperity angle.

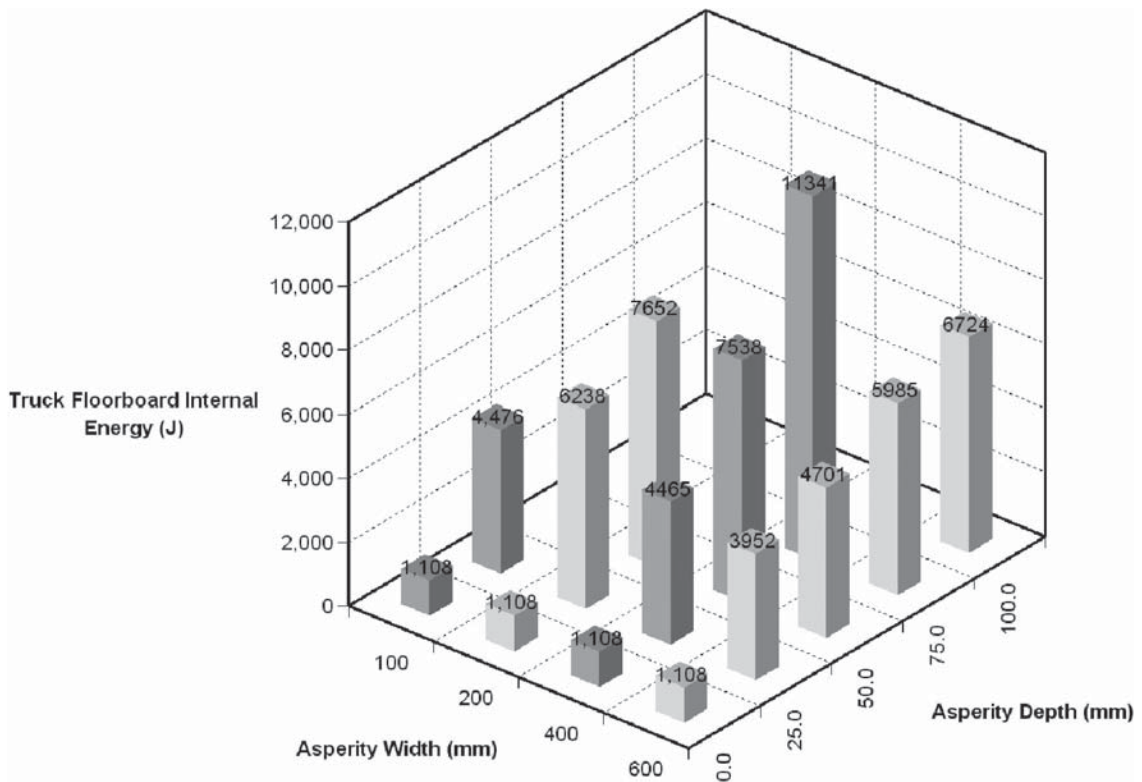

Figure 65. Truck floorboard internal energy values at different configurations for a 30-degree asperity angle.



visualized. It can be seen that as asperity width decreases, the relative difference in internal energy between two similar asperity depths increases. For example, with reference to Figure 63, it can be observed that for an asperity width of 555 mm, the internal energy increases 63% (from 4.3 kJ to 7.0 kJ) as the asperity depth increases from 15 mm to 27.5 mm, respectively. For an asperity width of 80 mm, the internal energy increases by 93% (from 8.9 kJ to 17.2 kJ) when the asperity depth increases from 6.5 mm to 15 mm. Similarly, for a specific asperity depth, the floorboard internal energy increases as the asperity width decreases. For example, with reference to Figure 63, for an asperity depth of

15 mm, the internal energy increases from 4.3 kJ to 17.2 kJ as the asperity width decreases from 555 mm to 80 mm.

Since the internal energy of the truck floorboard is believed to be related directly to the OCD, these graphs were helpful in understanding the relationships and trends associated with the asperity parameters. Such information was considered when developing the full-scale crash test plan.

Having gained a reasonable insight into the effect of different asperity parameters on OCD and having established the preliminary guidelines presented above, the researchers initiated the crash-testing phase of the project. Details of this phase of the project are presented in the next chapter.

---



CHAPTER 6

**CRASH TESTING AND FURTHER EVALUATION OF PRELIMINARY AESTHETIC DESIGN GUIDELINES**

Once the preliminary guidelines were developed using the finite element simulations, a full-scale crash-testing phase was conducted. The results of these crash tests were used to formulate the final design guidelines by assisting with refinement of the internal energy thresholds used to establish acceptable and unacceptable impact performance. A summary of details of the crash-testing phase are presented in this chapter.

**CRASH TEST CONDITIONS AND EVALUATION CRITERIA**

A brief description of *NCHRP Report 350* test conditions and evaluation criteria is provided in the following sections.

***NCHRP Report 350* Test Designations**

According to *NCHRP Report 350*, two crash tests are required for Test Level 3 (TL-3) evaluation of length-of-need longitudinal barriers:

- ***NCHRP Report 350* Test Designation 3-10:** 820C vehicle impacting the length-of-need section at a speed of 100 km/h with the vehicle bumper at an impact angle of 20 degrees.
- ***NCHRP Report 350* Test Designation 3-11:** 2000P vehicle impacting the length-of-need section at a speed of 100 km/h with the vehicle bumper at an impact angle of 25 degrees.

The small-car test is conducted for evaluating the overall performance characteristics of the length-of-need section of a longitudinal barrier in general and occupant risks in particular. The pickup truck test is performed for the purpose of evaluating the strength of the section in containing and redirecting the larger and heavier vehicle. Occupant risks are of foremost concern in the evaluation of both tests.

***NCHRP Report 350* and Other Evaluation Criteria**

Crash tests were evaluated in accordance with the criteria presented in *NCHRP Report 350*. As stated in *NCHRP Rep-*

*ort 350*, “Safety performance of a highway appurtenance cannot be measured directly but can be judged on the basis of three factors: structural adequacy, occupant risk, and vehicle trajectory after collision.” Accordingly, the following safety evaluation criteria from Table 5.1 of *NCHRP Report 350* were used to evaluate the crash tests reported herein:

• **Structural Adequacy**

- A. Test article should contain and redirect the vehicle; the vehicle should not penetrate, underride, or override the installation, although controlled lateral deflection of the test article is acceptable.

• **Occupant Risk**

- D. Detached elements, fragments, or other debris from the test article should not penetrate or show potential for penetrating the occupant compartment or present an undue hazard to other traffic, pedestrians, or personnel in a work zone. Deformation of, or intrusions into, the occupant compartment that could cause serious injuries should not be permitted.
- F. The vehicle should remain upright during and after collision, although moderate roll, pitching, and yawing are acceptable.
- H. Occupant impact velocities should satisfy the following:

Longitudinal and Lateral Occupant Impact Velocity—m/s

<u>Preferred</u>	<u>Maximum</u>
9	12

- I. Occupant ridedown accelerations should satisfy the following:

Longitudinal and Lateral Occupant Ridedown Accelerations—g

<u>Preferred</u>	<u>Maximum</u>
15	20

• **Vehicle Trajectory**

- K. After collision, it is preferable that the vehicle’s trajectory not intrude into adjacent traffic lanes.
- M. The exit angle from the test article preferably should be less than 60% of the test impact angle, measured at time of vehicle loss of contact with the test device.

In addition, the following supplemental evaluation factors and terminology, as presented in the July 25, 1997, FHWA memo entitled, “Action: Identifying Acceptable Highway Safety Features,” are also used for visual assessment of test results:

- **Passenger Compartment Intrusion**
  1. Windshield Intrusion
    - a. No windshield contact
    - b. Windshield contact, no damage
    - c. Windshield contact, no intrusion
    - d. Device embedded in windshield, no significant intrusion
    - e. Complete intrusion into passenger compartment
    - f. Partial intrusion into passenger compartment
  2. Body Panel Intrusion
    - a. Yes
    - b. No
- **Loss of Vehicle Control**
  1. Physical loss of control
  2. Loss of windshield visibility
  3. Perceived threat to other vehicles
  4. Debris on pavement
- **Physical Threat to Workers or Other Vehicles**
  1. Harmful debris that could injure workers or others in the area
  2. Harmful debris that could injure occupants in other vehicles
- **Vehicle and Device Condition**
  1. Vehicle Damage
    - a. None
    - b. Minor scrapes, scratches or dents
    - c. Significant cosmetic dents
    - d. Major dents to grill and body panels
    - e. Major structural damage
  2. Windshield Damage
    - a. None
    - b. Minor chip or crack
    - c. Broken, no interference with visibility
    - d. Broken and shattered, visibility restricted but remained intact
    - e. Shattered, remained intact but partially dislodged
    - f. Large portion removed
    - g. Completely removed
  3. Device Damage
    - a. None
    - b. Superficial
    - c. Substantial, but can be straightened
    - d. Substantial, replacement parts needed for repair
    - e. Cannot be repaired

One difficulty in evaluating OCD (e.g., floorpan/toe-pan damage) in tests is that the criteria are somewhat subjective and can be interpreted in different ways by different crash test agencies. In August 1999, at the summer meeting of TRB Commit-

tee A2A04 Roadside Safety Features, Mr. Richard Powers of the FHWA issued “Draft Guidelines for Analysis of Passenger Compartment Intrusion.” These guidelines provided recommended procedures for evaluating occupant compartment intrusion to promote uniformity among testing agencies and the development of uniform acceptance criteria. Three levels of evaluation were established: *acceptable* if intrusion does not exceed 100 mm; *marginal* if intrusion is more than 100 mm, but less than 150 mm; and *unacceptable* if intrusion is significantly greater than 150 mm and at a location where serious injuries are deemed likely to result.

### Test Article Construction

In November 2000, TTI performed a full-scale crash test on the Texas T501 longitudinal barrier (i.e., safety shape) with a soundwall.<sup>(24)</sup> The Texas T501 test installation remained intact at the time this project was initiated. It was modified and used as a structural support for the test installations presented herein. The fascia construction methodology used for this study was previously developed in a Caltrans research project.<sup>(19)</sup> The use of removable, relatively thin fascia panels attached to a support structure was used to minimize cost and construction time and to permit test installations to be re-erected if additional testing on a particular rail face configuration was found necessary at a later date in the research project. The fascia panels were constructed to emulate the geometric form of a standard concrete safety shape barrier (i.e., SBC05b & ROM01).<sup>(25)</sup>

### SELECTION CONSIDERATIONS FOR CRASH TEST CONFIGURATIONS

Preliminary guidelines developed through simulation included three different curves for asperity angles of 45, 90, and 30 degrees. In these preliminary guidelines, thresholds for surrogate measures of OCD were used to identify regions of “unacceptable” and “marginal/unknown” barrier performance for each of the asperity angles. The objective of the crash-testing phase was to reduce the region of “marginal/unknown” impact performance as much as possible. The asperity configurations subjected to crash testing were selected to bisect regions of unknown performance or to confirm points on the failure envelope. The results of the crash tests were used to adjust the previously defined passing and failing thresholds for the surrogate OCD measure. Using the new thresholds, the “acceptable” and “unacceptable” regions of the guidelines for the surface treatment of safety shape barriers were adjusted.

During the crash-testing phase, emphasis was placed on asperities with 45-degree angles of inclination. Of the seven crash tests performed, six were performed with 45-degree asperities and one was performed with 90-degree asperities. The 45-degree asperity is between the other angles investigated and was considered to be the most practical in terms of

construction. As was discussed in the previous chapter, shallower asperity angles allowed for greater asperity depths, whereas steeper angles significantly reduced the acceptable asperity depths. The 90-degree asperity angle yielded “unacceptable” results for almost all practical asperity depths.

The test matrix was designed to be flexible in the sense that the outcome of one test determined the asperity configuration evaluated in a subsequent test. In other words, the test matrix was adjusted as crash tests were performed and results were analyzed in order to maximize the information available for adjusting and finalizing the preliminary relationships.

The preliminary guidelines developed for the 45-degree asperities (see Figure 66) were used to select two initial asperity configurations for crash testing. The asperity geometry for these tests were:

Test 1:  $d = 25$  mm,  $W = 559$  mm,  $W_s = 25$  mm,  $\theta = 45$  degrees (pickup truck impact)

Test 2:  $d = 13$  mm,  $W = 178$  mm,  $W_s = 25$  mm,  $\theta = 45$  degrees (pickup truck impact)

where (with reference to Figure 66):  $d$  = asperity depth,  $W$  = asperity width, and  $W_s$  = the spacing between adjacent asperities.

The asperity depth for the Test 1 configuration was intended to bisect the “unknown/marginal” region on the preliminary guidelines (see Figure 66). It was also selected on the basis of having the maximum asperity width included in the preliminary design guideline. This first test was to serve two purposes: (1) establish a data midpoint in an area that had “unknown/marginal” performance and (2) either confirm or deny the ability to use a criterion similar to one approved for use on the single-slope barrier in the FHWA acceptance letter B-110. The internal energy thresholds used for pass/fail criteria were to be adjusted up or down as appropriate based on the outcome of this test, effectively reducing the “marginal/unknown” region of performance at that asperity width in half.

If this asperity configuration passed the test, all configurations of lesser depth and greater width would become part of the newly defined “acceptable” region, and the “pass” threshold for the surrogate OCD measure would be increased accordingly. If the asperity configuration failed to meet crash test requirements, any asperity of greater depth and lesser width would also fail. In this case, some of the previously defined “marginal/unknown” region becomes part of the “unacceptable” region, and the “failure” threshold for the surrogate OCD measure would be appropriately decreased.

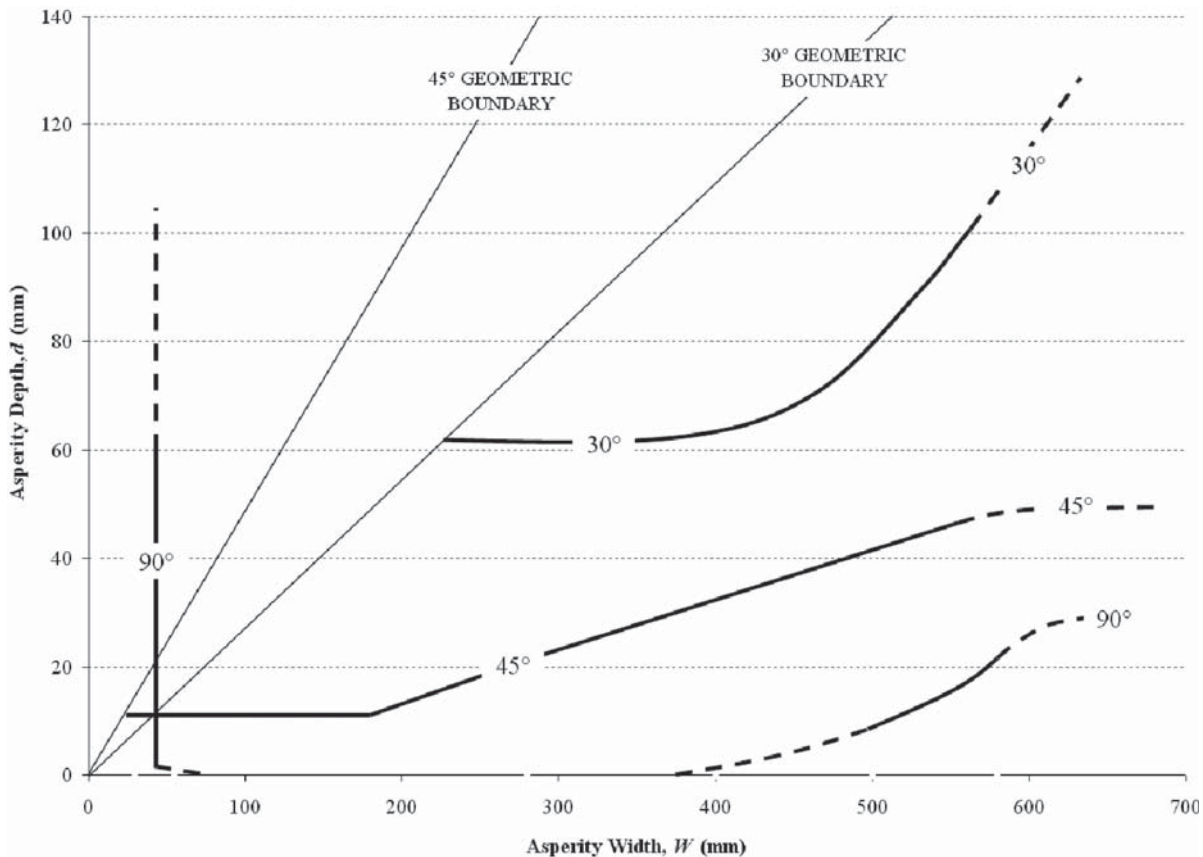

Figure 66. Depth versus width guideline for 90-, 45-, and 30-degree asperity angles (reproduced from Chapter 5).

For the Test 2 configuration, the selected width corresponded to the first inflection point on the preliminary failure curve established for the 45-degree asperity angle (see Figure 66). The depth for this test could have been selected to bisect the region of “marginal/unknown” performance. However, this would have involved testing asperities at a depth of approximately 6 mm, which was considered to be somewhat meaningless for a realistic aesthetic surface treatment and would not yield any significant information for adjusting the surrogate OCD thresholds. Hence, the depth for this test was selected to verify the failure line established by the preliminary guidelines.

#### CRASH TEST 1 (474630-1)

The New Jersey concrete safety shape barrier evaluated in the first test had asperities that were 559 mm wide and 25 mm deep. The asperity inclination angle was 45 degrees, and the asperity spacing was 25 mm. A photograph of the barrier before the test is shown in Figure 67.

The barrier was impacted by a 2,057-kg pickup truck at an angle of 26.5 degrees and an initial speed of 99.8 km/h. The barrier contained and redirected the pickup truck. The vehicle did not penetrate, underride, or override the installation. The vehicle remained upright during and after the collision period. The longitudinal occupant impact velocity and ride-down accelerations were within acceptable limits of the *NCHRP Report 350* requirements. Maximum OCD was 139 mm laterally across the cab from kick panel to kick panel. In the immediate area of impact, three of the “ribs” between asperities were sheared off and the face of the barrier was gouged (see Figure 68). The crash test met the evaluation criteria presented in *NCHRP Report 350*.

#### CRASH TEST 2 (474630-2)

The New Jersey concrete safety shape barrier evaluated in the second test had asperities that were 178 mm wide and



Figure 67. Setup for Crash Test 1.



Figure 68. Barrier damage for Crash Test 1.

13 mm deep. The asperity inclination angle was 45 degrees, and the asperity spacing was 25 mm. A photograph of the barrier before the test is shown in Figure 69.

The barrier was impacted by a 2,112-kg pickup truck at an angle of 24.9 degrees and an initial speed of 99.3 km/h. The barrier contained and redirected the pickup truck. The vehicle did not penetrate, underride, or override the installation. The vehicle remained upright during and after the collision period. The longitudinal occupant impact velocity and ridedown accelerations were within acceptable limits of the *NCHRP Report 350* requirements. Maximum OCD was 216 mm in the left firewall area, and the floor pan was separated at the seam between the firewall and the toe pan from the left side across the transmission tunnel.

Some of the ribs between asperities were partially sheared off from the surface of the concrete barrier, while others remained attached and received scrapes and gouges (see Figure 70). The crash test did not meet the evaluation criteria presented in *NCHRP Report 350* due to excessive OCD. The FHWA guidelines define failure to be a value significantly greater than 150 mm.



Figure 69. Setup for Crash Test 2.





Figure 70. Barrier damage for Crash Test 2.

Because Test 1 resulted in OCD within the limits defined in *NCHRP Report 350*, a pass point was established on the preliminary guidelines. Consequently, a passing line was established at asperity depth ( $d$ ) of 25 mm and asperity widths ( $W$ ) of 559 mm and higher. Test 2, on the other hand, failed due to excessive OCD, as expected. The failure line was verified for an asperity depth ( $d$ ) of 13 mm and higher with a width ( $W$ ) of 178 mm or less.

For the next two tests, the following two asperity configurations were selected:

Test 3:  $d = 38$  mm,  $W = 559$  mm,  $W_s = 25$  mm,  $\theta = 45$  degrees  
(pickup truck impact)

Test 4:  $d = 13$  mm,  $W = 279$  mm,  $W_s = 25$  mm,  $\theta = 45$  degrees  
(pickup truck impact)

The asperity configuration for Test 3 incorporated the same asperity width ( $W$ ) as Test 1. Given the successful impact performance of Test 1 with an asperity depth ( $d$ ) of 25 mm, the region of unknown performance was once again bisected using an asperity depth of 38 mm (see Figure 66). If Test 3 were to be successful, the passing line would move up to an asperity depth of 38 mm for asperity widths of 559 mm or higher. If Test 3 were to fail, the failure line would move down to asperity depth of 38 mm at asperity widths of 559 mm or less. The passing line in this failure scenario would remain at an asperity depth of 25 mm for asperity widths of 559 mm or higher, as established by Test 1.

Examining the asperity configuration selected for Test 4, it can be seen that the depth of the asperities was the same as Test 2 (i.e., 13 mm) while the asperity width was increased to 279 mm. The asperity depth for Test 4 could have been selected such that it bisected the remaining “marginal/unknown” performance area (i.e.,  $d = 7$  mm). However, the usefulness of establishing a pass/fail point at a depth of 7 mm was debatable from the standpoint of realistic aesthetic surface treatment. Hence, the asperity width was increased slightly in order to provide a greater reduction of the “mar-

ginal/unknown” performance region. Summaries of Test 3 and Test 4 are presented below.

### CRASH TEST 3 (474630-3)

The New Jersey concrete safety shape barrier evaluated in the third test had asperities that were 559 mm wide and 38 mm deep. The asperity inclination angle was 45 degrees, and the asperity spacing was 25 mm. A photograph of the barrier before the test is shown in Figure 71.

The barrier was impacted by a 2,112-kg pickup truck at an angle of 25.1 degrees and a speed of 96.1 km/h. The barrier contained and redirected the pickup truck. The vehicle did not penetrate, underride, or override the installation. The vehicle remained upright during and after the collision period. The longitudinal occupant impact velocity and ridedown accelerations were within acceptable limits of *NCHRP Report 350*. Maximum OCD was 91 mm in the left firewall area. The second through fourth “ribs” between asperities downstream of the impact point were mostly sheared off, and the first and fifth “ribs” after impact were gouged (see Figure 72). The crash test met the evaluation criteria presented in *NCHRP Report 350*.

### CRASH TEST 4 (474630-4)

The New Jersey concrete safety shape barrier evaluated in the fourth test had asperities that were 279 mm wide and 13 mm deep. The asperity inclination angle was 45 degrees, and the asperity spacing was 25 mm. A photograph of the barrier before the test is shown in Figure 73.

The barrier was impacted by a 2,088-kg pickup truck at an angle of 24.6 degrees and a speed of 102.3 km/h. The barrier contained and redirected the pickup truck. The vehicle did not penetrate, underride, or override the installation. The vehicle remained upright during and after the collision period. The longitudinal occupant impact velocity and ridedown



Figure 71. Setup for Crash Test 3.





Figure 72. Barrier damage for Crash Test 3.

accelerations were within acceptable limits of *NCHRP Report 350*. Maximum OCD was 120 mm in the left firewall area. The first through ninth “ribs” between asperities downstream of the impact point were mostly sheared off, as was part of the tenth (see Figure 74). The crash test met the evaluation criteria presented in *NCHRP Report 350*.

Given the success of Test 3 and Test 4, the passing line on the preliminary guidelines for the 45-degree asperity angle was further adjusted upward to coincide with the asperity configurations that were evaluated.

It was observed in Test 1 through Test 4 that several of the 25-mm-wide “ribs” between the concrete asperities were mostly sheared off in the immediate vicinity of the impact. What was not known was the force at which the concrete sheared and how close this force was to the maximum force that would be generated had the asperities been perfectly rigid. Some damage is expected to occur for any concrete protrusion subjected to an impact event of this severity. However, a question arose regarding the influence of the asperity spacing on the degree of concrete damage and level of snagging force that may be generated.



Figure 73. Setup for Crash Test 4.

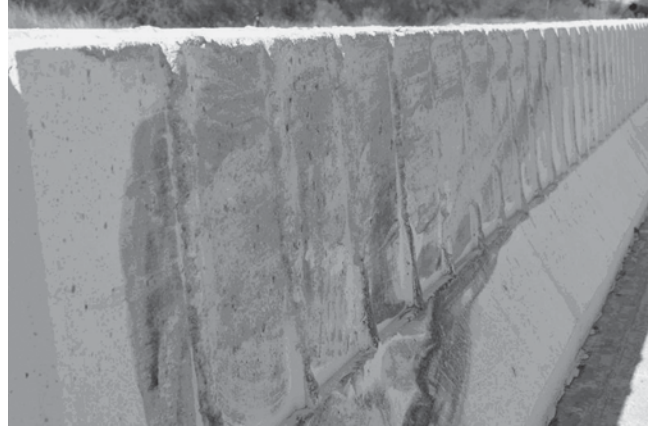

Figure 74. Barrier damage for Crash Test 4.

If the narrow “ribs” created by the 25-mm asperity spacing sheared off at a much lower force than would have been generated by a wider section of concrete that would be associated with a wider asperity spacing, then the severity of snagging would decrease. Consequently, the OCD would be reduced.

Conversely, if the “ribs” created by the 25-mm asperity spacing sheared off at a force close to the maximum possible force that can be generated by rigid asperities, then little change in snagging severity or OCD would be expected as the asperity spacing increases. Recall that because of a lack of a robust concrete material model with damage capabilities, the barriers and their asperities were modeled as rigid materials in the simulations. Therefore, it was important to further investigate the effect of asperity spacing failure on the outcome of the results to help confirm the validity of using the crash test data to adjust the guidelines for aesthetic surface treatment of safety shape barriers.

To help investigate the influence of asperity spacing on test outcome (primarily OCD), it was decided to conduct Test 5 using an asperity configuration with a wider asperity spacing. It was theorized that if the spacing of the asperities were increased, concrete failure would occur only at the outer edges of the asperities and the region between asperities would not be sheared off. This would enable an evaluation of the effect of concrete failure and would also help verify the preliminary guidelines developed through simulations with rigid barriers. The asperity configuration used for the fifth test was:

Test 5:  $d = 38$  mm,  $W = 559$  mm,  $W_s = 203$  mm,  $\theta = 90$  degrees (pickup truck impact)

The asperity spacing ( $W_s$ ) was increased from 25 mm (which was used in previous tests) to 203 mm. In order to maximize the information obtained from the crash test, the angle of asperity inclination selected for Test 5 was 90 degrees. The depth of the asperities was selected such that it bisected the “marginal/unknown” performance region at the asperity width ( $W$ ) of 559 mm (see Figure 66) for the 90-degree curve. This

asperity width is the same as that used in Test 1 and Test 3. A summary of Test 5 follows.

#### CRASH TEST 5 (474630-5)

The New Jersey concrete safety shape barrier evaluated in the fifth test had asperities that were 559 mm wide and 38 mm deep. The asperity inclination angle was 90 degrees, and the asperity spacing was 203 mm. A photograph of the barrier before the test is shown in Figure 75.

The barrier was impacted by a 2105-kg pickup truck at an angle of 24.5 degrees and a speed of 97.8 km/h. The barrier contained and redirected the pickup truck. The vehicle did not penetrate, underride, or override the installation. The vehicle remained upright during and after the collision period. The longitudinal occupant impact velocity and ridedown accelerations were within acceptable limits of *NCHRP Report 350*. Maximum OCD was 77 mm in the left firewall area. The first through fifth “ribs” between asperities downstream of the impact point showed some scraping close to the edges but were intact after the test (see Figure 76). The crash test met the evaluation criteria presented in *NCHRP Report 350*.

The asperity configuration in Test 5 was similar to that in Test 3, except that the asperity angle was changed from 45 degrees to 90 degrees and the asperity spacing was increased from 25 mm to 203 mm. The OCD values from both tests were very close (74 mm in Test 3 versus 77 mm in Test 5). Other occupant risk values were also similar between the two tests. Simulation results, which were based on rigid asperities with a 25-mm asperity spacing, indicated that the internal energy of the floorboard was 8.4 kJ and 8 kJ for the asperity configurations evaluated in Test 3 and Test 5, respectively. Comparison of the results from the two tests indicates that although shearing off of the concrete between asperities may reduce the severity of the impact, the overall effect on test outcome is not very significant.

Although the pickup truck is generally understood to be more critical than the small car in regard to evaluating sta-



Figure 75. Setup for Crash Test 5.



Figure 76. Barrier damage for Crash Test 5.

bility and OCD, the research team decided to verify applicability of the guidelines for small passenger cars. The most severe asperity configuration evaluated in the first five tests was selected to evaluate small-car response. Recall that the asperity configuration evaluated in Test 2 generated unacceptable OCD in the pickup. This same configuration was used in Test 6 with the 820C vehicle. Values for the pertinent asperity variables are given below.

Test 6:  $d = 13$  mm,  $W = 178$  mm,  $W_s = 25$  mm,  $\theta = 45$  degrees (small-car impact)

#### CRASH TEST 6 (474630-6)

The New Jersey concrete safety shape barrier evaluated in the sixth test had asperities that were 178 mm wide and 13 mm deep. The asperity inclination angle was 45 degrees, and the asperity spacing was 25 mm. A photograph of the barrier before the test is shown in Figure 77.

The barrier was impacted by an 854-kg Geo Metro at an angle of 19.4 degrees and a speed of 98.8 km/h. The barrier

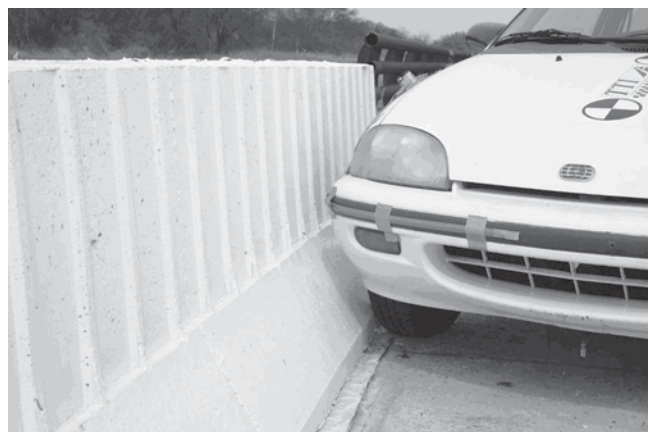

Figure 77. Setup for Crash Test 6.



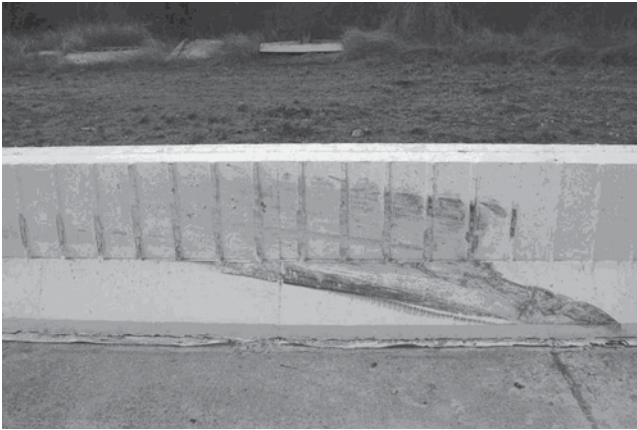

Figure 78. Barrier damage for Crash Test 6.

contained and redirected the small passenger car. The vehicle did not penetrate, underride, or override the installation. The vehicle remained upright during and after the collision period. The longitudinal occupant impact velocity and ride-down accelerations were within acceptable limits of *NCHRP Report 350*. There was no OCD, and the vehicle showed good stability. The third through tenth “ribs” between asperities downstream from the point of impact showed some scraping and gouging but were intact after the test (see Figure 78). The crash test met the evaluation criteria presented in *NCHRP Report 350*.

There were no concerns related to stability or OCD with the 820C small car for an asperity configuration that was unacceptable for the pickup truck. Therefore, this test verified that the pickup truck was a more critical vehicle than the small car in regard to establishing guidelines for aesthetic surface treatments for safety shape barriers.

### Simulation Study for Wider Asperity Spacing

To investigate the effect of asperity spacing on severity of snagging, the asperity spacing ( $W_s$ ) was increased in Test 5

from 25 mm to 203 mm. While this prevented the concrete between asperities from shearing off in the test, the effect of asperity spacing on the preliminary guidelines established using finite element simulations with rigid barriers was not completely known. To further investigate the effect of this variable on snagging severity and OCD, additional simulation runs were conducted to establish the relationship between asperity depth and asperity width for an asperity spacing ( $W_s$ ) of 203 mm and an asperity angle of 45 degrees. The simulated configurations and their corresponding results for the surrogate OCD measure are presented in Table 7. Using the previously established thresholds for the surrogate OCD, a failure line similar to the previous preliminary guidelines was established. Figure 79 shows this failure line (for  $W_s = 203$  mm) with the previously established failure line (for  $W_s = 25$  mm) for the 45-degree asperities.

During the course of this simulation study on asperity spacing, it was discovered that identical finite element models (both barrier and truck) produced different results for the truck floorboard internal energy when different binary files of LS-DYNA were used. Consequently all new simulations were performed using the exact same binary files (LS-DYNA Version 970 Release 3858) that were used in the initial simulation effort on which the preliminary guidelines were established. The reason for this variance could not be identified. However, using the same binaries that were originally used to establish the surrogate OCD thresholds eliminates variance when comparing the simulation results associated with the two different asperity spacings.

It can be seen from Figure 79 that increasing the asperity spacing results in an offset (i.e., upward shift) of the failure line. That is, for a given asperity width, the acceptable asperity depth increases as the asperity spacing increases. Note that as the asperity width ( $W$ ) decreases to a value of 200 mm or less, a significant increase in the asperity depth ( $d$ ) can be achieved. This is because even though  $d$  is large, the larger asperity spacing ( $W_s$ ) at an asperity width of 200 mm reduces the potential for vehicle parts to intrude into the asperity. Thus, the opportunity for vehicle snagging and cumulative vehicle

TABLE 7 Parametric study results for a 45-degree angle of asperity with 203-mm asperity spacing

Run	Vehicle	Asperity Width ( $W$ ) [mm]	Asperity Depth ( $d$ ) [mm]	Truck Floorboard Internal Energy [J]	Pass/Fail
1	Truck	559	0	1,108	Pass
2	Truck	559	51	10,300	Marginal
3	Truck	559	63.5	10,620	Marginal
4	Truck	280	0	1,108	Pass
5	Truck	280	38	9,600	Marginal
6	Truck	180	0	1,108	Pass
7	Truck	180	19	3,730	Marginal
8	Truck	180	51	3,250	Fail
9	Truck	180	76	3,050	Pass
Passing Limit = 2,200 J					
Failure Limit = 10,700 J					

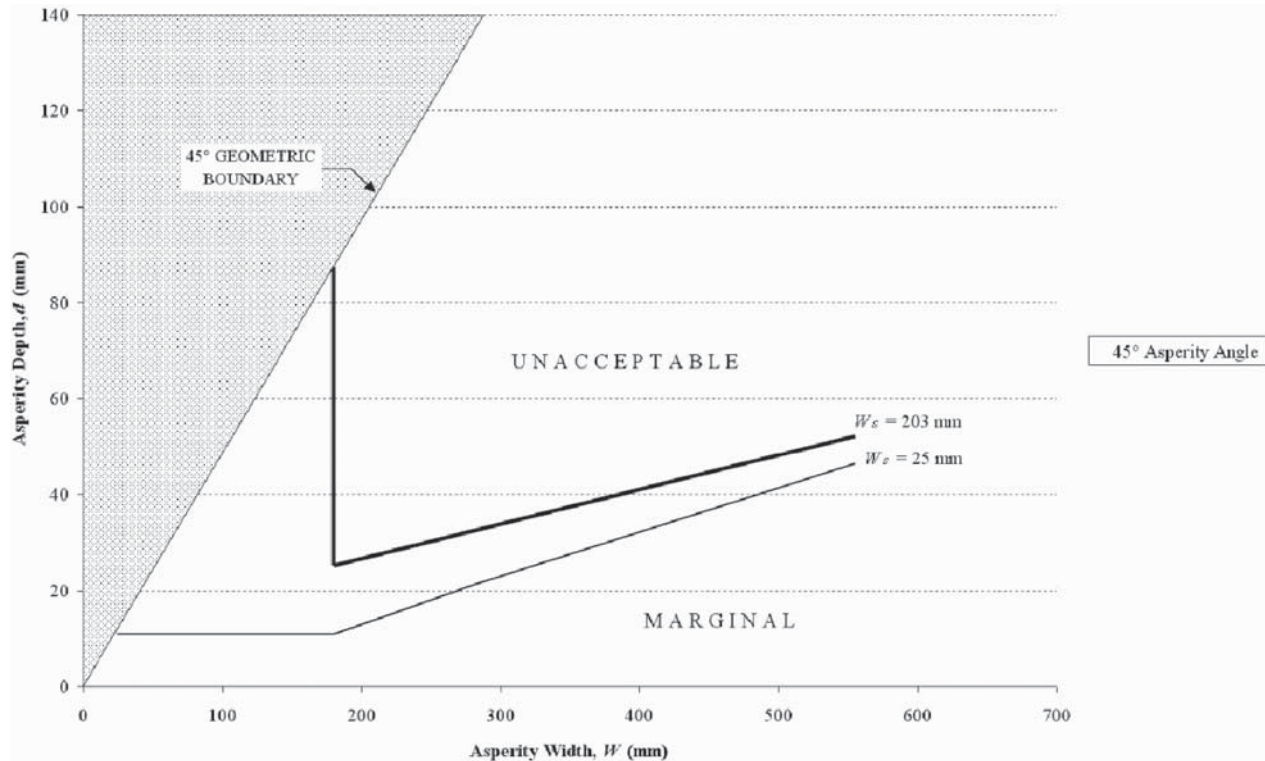

Figure 79. Simulation results with asperity spacing of 203 mm for a 45-degree asperity angle.

damage is reduced. This effect is illustrated by the vertical failure line in Figure 79 and is similar to the one observed for 90-degree asperities where greater asperity depths can be achieved for asperity widths of 30 mm and less (see Figure 66).

#### CRASH TEST 7 (474630-7)

Even though only six tests were budgeted for the project, the method of construction used to fabricate the barriers resulted in a cost savings. With the approval of the project panel, an additional crash test was conducted. This test was used to help verify the failure threshold of asperities with larger asperity spacing. The asperity configuration evaluated in Test 7 is given below.

Test 7:  $d = 51$  mm,  $W = 559$  mm,  $W_s = 203$  mm,  $\theta = 45$  degrees (pickup truck impact)

The New Jersey concrete safety shape barrier evaluated in the seventh test had asperities that were 559 mm wide and 51 mm deep. The asperity inclination angle was 45 degrees, and the asperity spacing was 203 mm. A photograph of the barrier before the test is shown in Figure 80.

The barrier was impacted by a 2,099-kg pickup truck at an angle of 25 degrees and a speed of 100.3 km/h. The barrier contained and redirected the pickup truck. The vehicle did not penetrate, underide, or override the installation. The

vehicle remained upright during and after the collision period. The longitudinal occupant impact velocity and ridedown accelerations were within acceptable limits of *NCHRP Report 350*.

Maximum OCD was 260 mm in the left firewall area. The first and second asperity spacings after impact point showed some scraping near edges but were intact after the test. The third through fifth asperity spacings were gouged but intact after the test (see Figure 81). The crash test did not meet the evaluation criteria presented in *NCHRP Report 350* due to excessive OCD.



Figure 80. Setup for Crash Test 7.



*Figure 81. Barrier damage for Crash Test 7.*

As can be seen from Figure 79, the asperity configuration tested in Test 7 was at the failure line established through simulation. The fact that the crash test failed due to excessive

OCD confirms that the originally developed energy thresholds are valid for wider asperity spacings ( $W_s$ ).

In conclusion, it was noted that snagging severity may be reduced below levels expected for rigid asperities when an asperity spacing of 25 mm is used. This is because the narrow concrete regions between asperities tend to shear off during impact. As the asperity spacing increases, the width of the concrete region between asperities increases. When this concrete region between asperities becomes sufficiently wide, the concrete is not completely sheared off. However, even though these concrete regions remain intact, the increased asperity spacing offsets (and in fact reduces) any increase in the overall snagging severity. In fact, the severity associated with the larger asperity spacing is actually reduced, even though the concrete spalling is significantly reduced.

As a last step in formulating the final design guidelines, all of the available crash test data were evaluated and used to make adjustments to the preliminary guidelines developed through simulation. The details of these adjustments are presented in the next chapter along with the final design guidelines.



## CHAPTER 7

# FINAL DESIGN GUIDELINES

### GUIDELINES FOR AESTHETIC SURFACE TREATMENTS OF SAFETY SHAPE CONCRETE BARRIERS

As described in the previous chapter, the internal energy of the floorboard of the pickup truck was used as a surrogate measure of OCD. Due to limited test data, the internal energy threshold associated with the maximum allowable OCD was not well defined. Consequently, the preliminary guidelines contained a large region of asperity configurations for which impact performance was unknown.

The crash test data were evaluated and used to make adjustments to the preliminary guidelines. Each asperity configuration that was crash tested has an associated level of truck floorboard internal energy that was derived from the simulation study. A summary of these data is presented in Table 8. The verification crash test with the 820-kg passenger car (Test 6) is excluded from the table because the small car is not critical in terms of the performance assessment of the asperities. Test 2 evaluated the same asperity configuration used in Test 6.

The tentative energy failure threshold upon which the preliminary guidelines were based was 10.7 kJ. Test 2 and Test 7 confirmed that this level of floorboard internal energy was indeed unacceptable. The highest level of energy associated with a successful test can conservatively be used as a pass/fail threshold. Based on this rationale, a floorboard internal energy of 8.5 kJ was selected as the pass/fail threshold. With reference to Table 8, the asperity configurations used in Test 3, Test 4, and Test 5, which were all successful tests, had internal floorboard energies ranging from 8.4 kJ to 8.9 kJ. Given that the highest OCD among these successful tests was 120 mm, using 8.5 kJ as the internal energy threshold provides good confidence in the validity of the “acceptable” or crashworthy region of the guidelines.

The failure curve associated with each asperity angle (i.e., 30, 45, and 90 degrees) was shifted to correspond to the revised energy threshold of 8.5 kJ. The final design guidelines for aesthetic surface treatment of safety shape concrete barriers based on the revised threshold are presented in Figure 82. For each asperity angle, the guidelines show regions of “acceptable” asperity configurations and regions of asperity configurations that are “not recommended” due to a high probability of failure during a design impact event resulting from excessive OCD.

It can be observed that for a given asperity width, the acceptable asperity depth varies with the asperity angle. For example, at an asperity width of 500 mm, the acceptable asperity depths are 6 mm, 35 mm, and 99 mm for 90 degree, 45 degree, and 30 degree asperity angles, respectively.

The guidelines do not include asperity spacing as an additional design parameter. In the opinion of the researchers, the degree of variation in the asperity configurations that are acceptable for the two asperity spacings investigated did not justify adding another level of complexity to the guidelines. Even though wider asperity spacing results in less spalling of the concrete between asperities, the net change was a reduction in overall snagging severity. Therefore, the final guidelines, which were based on an asperity width of 25 mm, are slightly conservative for wider asperity spacings.

### COMPARISON WITH GUIDELINES FOR SINGLE-SLOPE AND VERTICAL-FACE BARRIERS AND STONE MASONRY GUARDWALLS

Guidelines developed for the safety shape barriers under this research were compared, to the extent possible, with the previously developed guidelines for single-slope and vertical-face barriers and stone masonry guardwalls. In the case of guidelines for safety shape barriers, the use of finite element simulation studies in conjunction with crash testing enabled the researchers to define relationships over a range of asperity parameters. Previously existing guidelines for single-slope and vertical-face barriers and stone masonry guardwalls were developed using crash testing alone and therefore were not in the form of relationships defined over a range of asperity parameters. Moreover, a significant portion of the information contained in these guidelines cannot be displayed graphically.

Figure 83 shows an overlay of the guidelines developed for the safety shape barriers and some of the information from the guidelines for single-slope and vertical-face barriers that could be displayed graphically. This figure shows lines for 45- and 90-degree asperities that were suggested for single-slope and vertical-face barriers.

For the 90-degree asperities on single-slope and vertical-face barriers, the maximum depth and width allowed were 13 mm and 25 mm, respectively. At the same time, the guidelines allow gaps, slots, grooves, or joints of any depth with a maximum width of 20 mm. This amounts to the ver-

**TABLE 8 Floorboard internal energy associated with crash-tested asperity configurations**

Test No.*	Internal Energy (kJ)	Test Outcome
1	6.9	Pass
2	11.8	Fail
3	8.4	Pass
4	8.9	Pass
5	8.9	Pass
7	10.3	Fail

\* Test 6 with 820C excluded

tical line shown in Figure 84 for 90-degree asperities (see Figure 85 for English units). A similar vertical line has been suggested for the safety shape barriers, but with a slightly larger maximum asperity width (30 mm as opposed to 20 mm). In addition to an “acceptable” region for asperity widths of less than 30 mm, guidelines developed for the safety shape barriers show an “acceptable” region at higher asperity widths, which was identified through simulation and later verified by crash testing.

For the 45-degree asperities on safety shape barriers, the asperity depth versus width relationship allows for smaller depths when asperity widths are small. The acceptable maximum asperity depth increases with the increase in width for these guidelines. However, in the case of guidelines for single-

slope and vertical-face barriers, a single maximum asperity depth value of 25 mm was set, irrespective of the width of the asperities. The comparison thus shows that for smaller widths, guidelines for safety shape barriers allow for shallower asperities, whereas for larger widths, deeper asperity widths are acceptable when compared with the guidelines for the single-slope and vertical-face barriers.

The two guidelines are reasonably similar to each other. The differences highlighted above stem from the differences in the development approach. In the case of safety shape barriers, finite element simulations allowed for developing relationships as a function of asperity parameters. Moreover, a greater number of crash tests were conducted for the 45-degree asperities so as to allow verification and readjustment of these relationships. The single-slope and vertical-face barrier guidelines, however, were developed primarily through crash testing, and finite element simulations were not performed. This restricted the guidelines to single maximum asperity depth values for different asperity angles.

Initially, the comparison was done so as to generate a single graph of relationships between asperity depths and widths for all types of barriers. However, such a generalized graph can become very confusing for the designer. In addition, a significant portion of the information contained in the guidelines for single-slope and vertical-face barriers and stone masonry guardwalls can only be displayed textually.

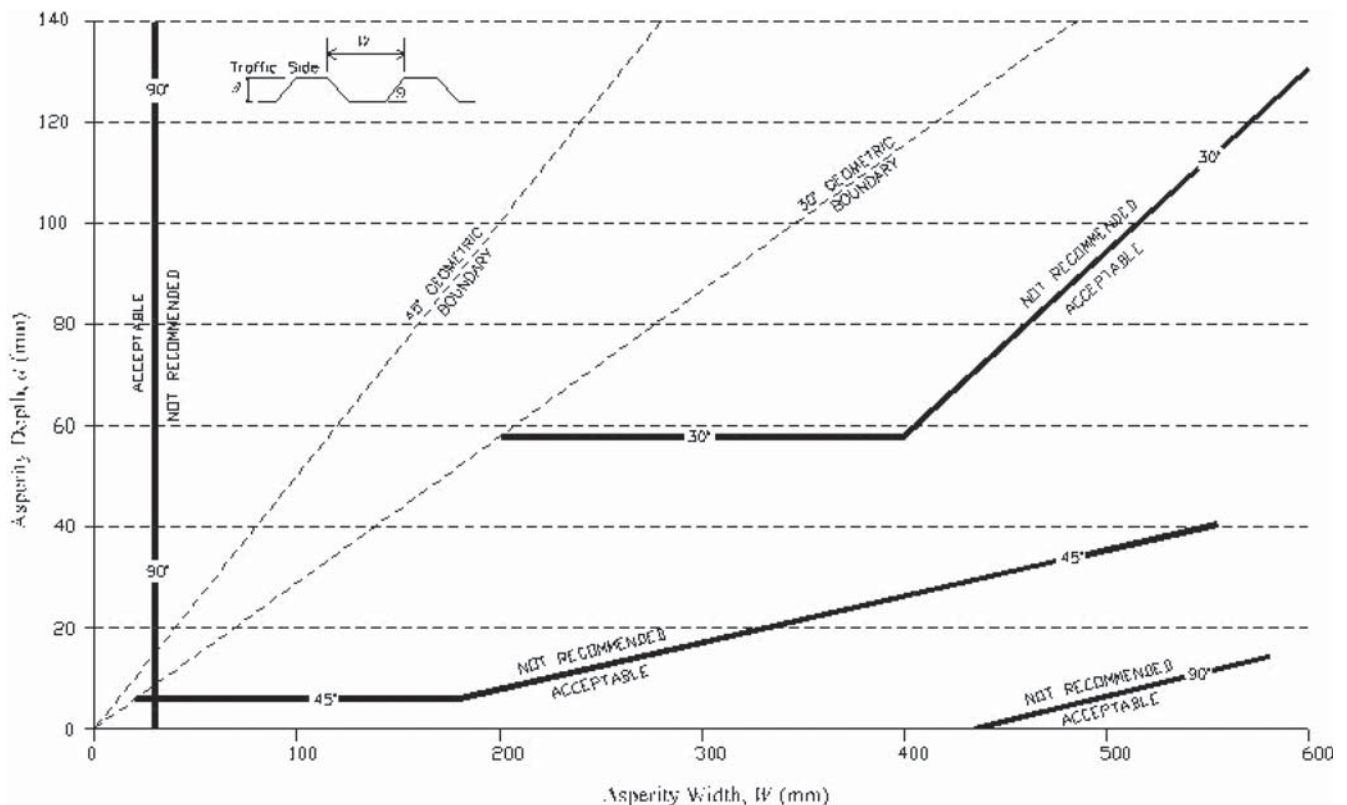

Figure 82. Final design guidelines for aesthetic surface treatment of safety shape concrete barriers.

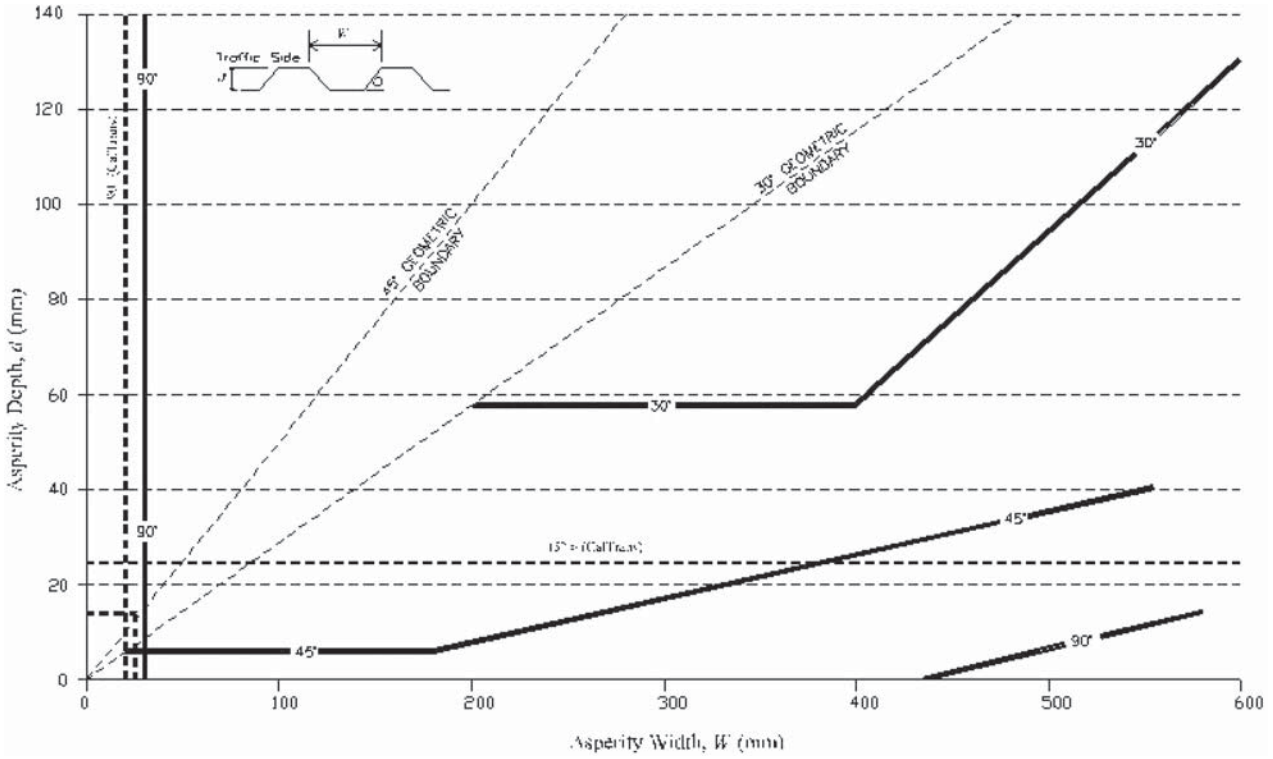

Figure 83. Comparison of guidelines for single-slope and vertical-face barriers and stone masonry guardwalls.

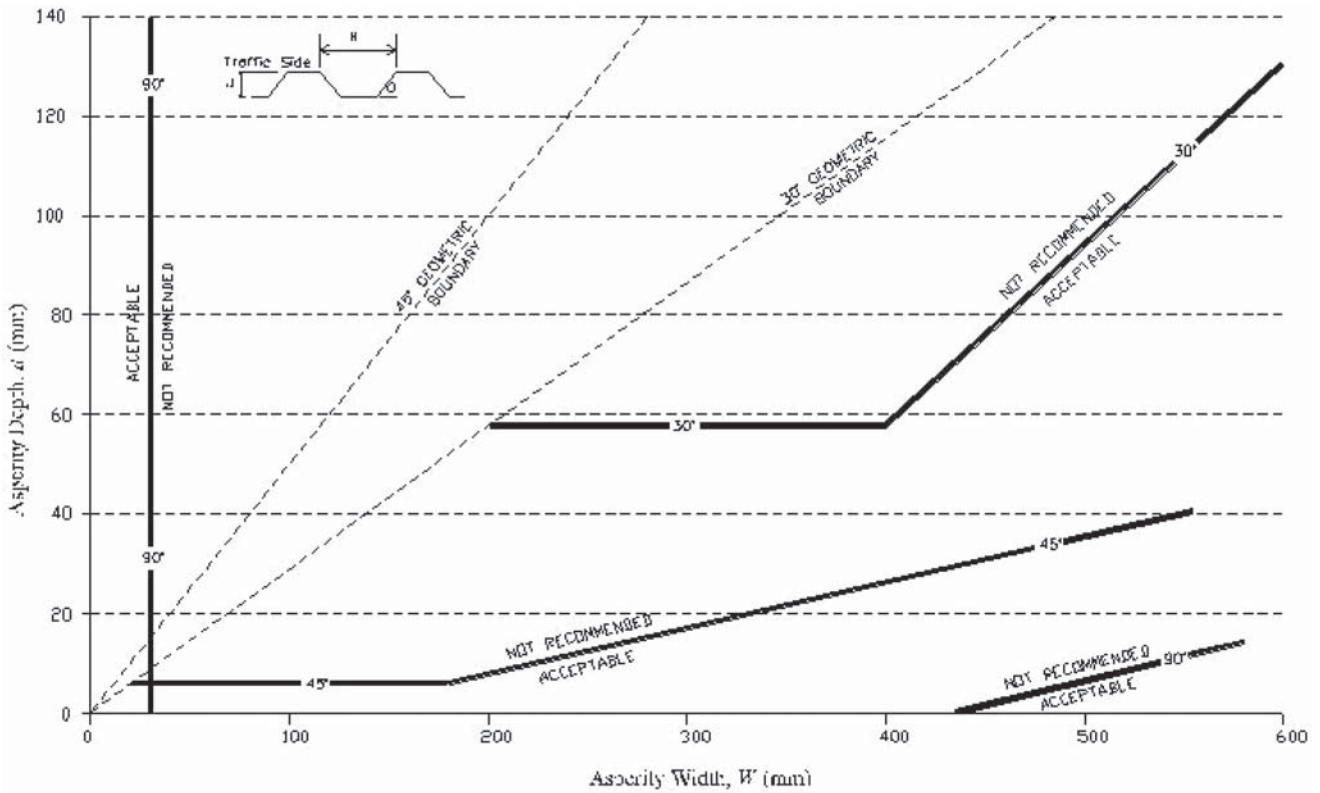

Figure 84. Final design guidelines for aesthetic surface treatment of safety shape concrete barrier (metric).

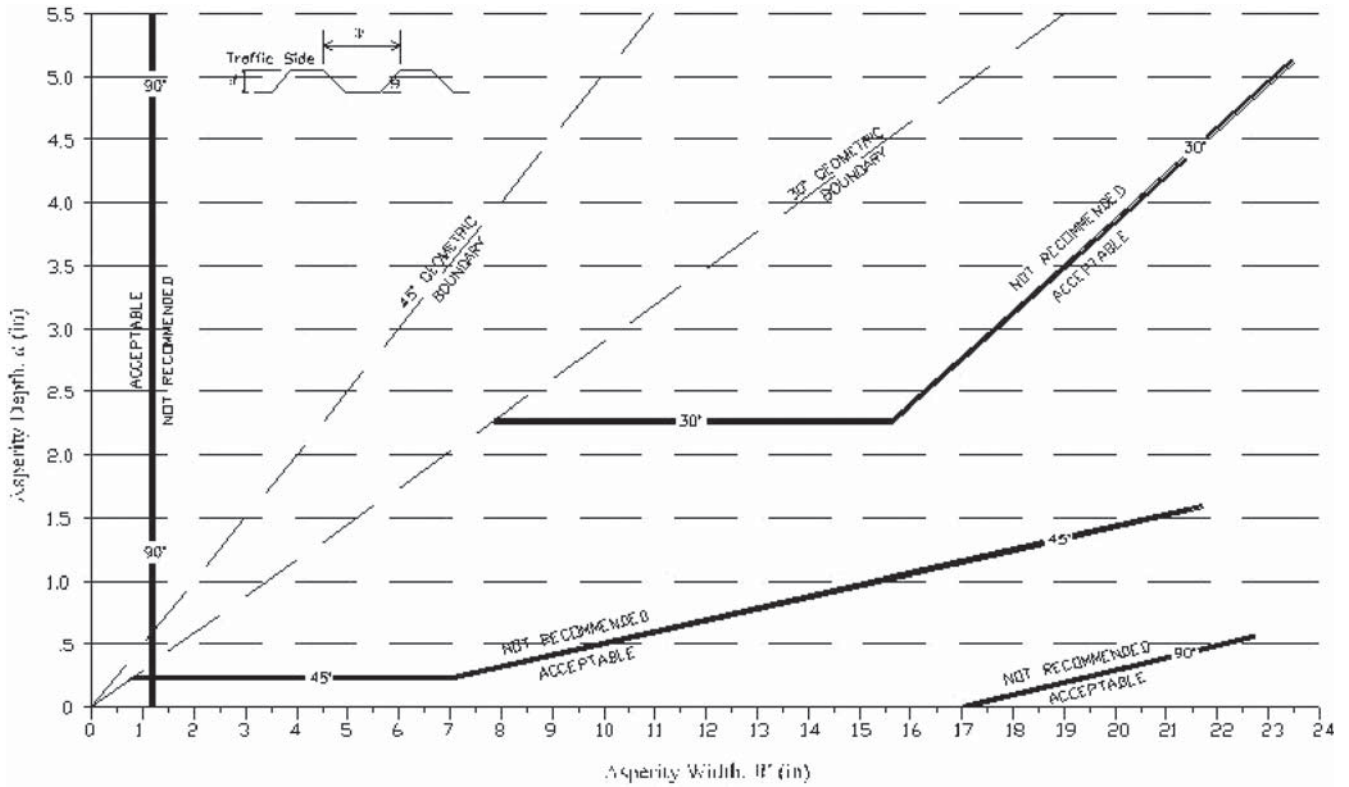

Figure 85. Final design guidelines for aesthetic surface treatment of safety shape concrete barrier (English).

For the convenience of an aesthetic barrier designer, all three guidelines have been consolidated into a single, standalone section, which appears in the appendix. The guidelines for safety shape barriers have been presented in graphic form,

whereas the guidelines for single-slope and vertical-face and stone masonry guardwalls have been presented in textual form. This appendix also includes examples of the use of the guidelines developed for safety shape barriers.



## CHAPTER 8

# CONCLUSIONS

The objective of this research was to develop engineering design guidelines for aesthetic surface treatments of concrete barriers for safety shape profiles, such as the New Jersey or F-shape barrier profile. The design guidelines were developed through extensive use of finite element simulation, in conjunction with full-scale vehicle crash testing.

The New Jersey barrier was used for the development of the preliminary and the final design guidelines. Vehicular impacts with the F-shape barriers are known to result in lower vehicle instabilities when compared with the New Jersey barriers. The guidelines developed are, therefore, considered to be applicable to both New Jersey and F-shape concrete barriers.

To develop design guidelines for the application of aesthetic surface treatments on concrete safety shape barriers, a set of preliminary guidelines were initially developed. A parametric study was performed using finite element simulations to establish these preliminary guidelines. Generalized types of surface asperities were defined in terms of various parameters such as the width, depth, and angle of inclination. Parametric finite element simulations were performed for asperity angles of 30, 45, and 90 degrees, and each simulation was assigned an outcome of “acceptable,” “marginal/unknown,” or “unacceptable” based on comparison of the internal floorboard energy with the established threshold values. Preliminary guidelines

were then developed in terms of asperity depth, width, and angle of inclination based on the combined set of simulation outcomes.

Based on these preliminary guidelines, a crash test plan was developed in which the outcome of one test determined the configuration evaluated in a subsequent test. In other words, the test matrix was adjusted as the crash tests were performed, and the results were analyzed in order to maximize the information available for adjusting and finalizing the relationships for asperity depth, width, and angle. A full-scale crash-testing phase was conducted. The OCD measurements from the tests enabled the adjustment of the thresholds for acceptable and unacceptable floorboard internal energy upon which the final design guidelines are based. For review, the guidelines for safety shape concrete barrier aesthetic surface treatments are presented again in Figure 84 (see Figure 85 for English units).

For the convenience of use, guidelines developed for safety shape barriers in this research and the guidelines previously developed by the FHWA and Caltrans for stone masonry guardwalls and for single-slope and vertical-face concrete barriers, respectively, have been consolidated into a single, standalone set of guidelines that appears in the appendix.

The appendix provides adequate guidelines to assist the designer with all current types of concrete barriers.

---

## REFERENCES

1. Leonhardt, F., "Developing Guidelines for Aesthetic Design." *Bridge Aesthetics Around the World*, Washington, DC, Transportation Research Board, National Research Council (1991).
  2. Tang, H. C., "Philosophical Basis for Chinese Bridge Aesthetics." *Bridge Aesthetics Around the World*, Washington, DC, Transportation Research Board, National Research Council (1991).
  3. Federal Highway Administration, U.S. Department of Transportation, "Context Sensitive Design and Thinking Beyond the Pavement." Washington, DC (2002).
  4. Grob, J., "Design Principles and Guidelines for Transportation Project; Getting Projects Built." American Society of Highway Engineers, *SCANNER Newsletter* (December 2001).
  5. Brewer, J., German, J., Krammes, R., Movassaghi, K., Okamoto, J., Otto, S., Ruff, W., Sillan, S., Stamatiadis, N., and Walters, R., "Geometric Design Practices for European Roads." Contract No. DTFH61-99-C-0005, Report No. FHWA-PL-01-026, American Trade Initiatives, Alexandria, VA (2001).
  6. Kaplan, R., "Environmental Description and Prediction: A Conceptual Analysis." *Environment, Cognition, and Action: An Integrated Approach*, New York, NY, Oxford University Press (1991).
  7. Garling, T., Lindberg, E., Torell, G., and Evans, G. W., "From Environmental to Ecological Cognition." *Environment, Cognition, and Action: An Integrated Approach*, New York, NY, Oxford University Press (1991).
  8. "Roadscape: The Analysis of Visual-Perceptual Mechanism." *International Association of Traffic & Safety Science* (1983).
  9. Hornbeck, P. L., and Okerlund, G. A., "Visual Quality for the Highway User: A Study of the Relation of Factors of Visual Quality to Route Design." *Highway Research Record 410*, Highway Research Board, National Research Council, Washington, DC (1972).
  10. Noble, M., and Sanders, A. F., "Searching for Traffic Signals While Engaged in Compensatory Tracking." *Human Factors*, Vol. 1, No. 22 (1980).
  11. Mace, D. J., and Pollack, L., "Visual Complexity and Sign Brightness in Detection and Recognition of Traffic Signs." *Transportation Research Record 904*, Transportation Research Board, National Research Council, Washington, DC (1983).
  12. Allen, R. W., and O'Hanlon, J. F., "Effects of Roadway Delineation and Visibility Conditions on Driver Steering Performance." *Transportation Research Record 739*, Transportation Research Board, National Research Council, Washington, DC (1979).
  13. Jenkins, S. E., and Cole, B. L., "Daytime Conspicuity of Road Traffic Control Devices." *Transportation Research Circular 297*, Transportation Research Board, National Research Council, Washington, DC (1985).
  14. Gallagher, V. P., and Lerner, N. D. "Measuring the Visual Complexity of Nighttime Roadways." *Transportation Research Circular 297*, Transportation Research Board, National Research Council, Washington, DC (1985).
  15. Adrian, W. K., "Visual Performance Under Night Driving Conditions." *Transportation Research Circular 297*, Transportation Research Board, National Research Council, Washington, DC (1985).
  16. Scallen, S., and Carmody, J., "Investigating the Effects of Roadway Design on Driver Behavior: Applications for Minnesota Highway Design." Minnesota Department of Transportation, Mn/DOT Report 1999-10, 1999. <http://www.research.dot.state.mn.us/detail.cfm?productID=500#>.
  17. Sekuler, R., and Blake, R., *Perception*. McGraw-Hill, New York, NY (1994).
  18. *AASHTO Roadside Design Guide*. American Association of State Highway and Transportation Officials, Washington, DC (2002).
  19. White, M., Jewell, J., and Peter, R., "Crash Testing of Various Textured Barriers." Contract No. F2001TL17, California Department of Transportation, Sacramento, CA (2002).
  20. Jewell, J., Rowhani, P., Stoughton, R., and Crozier, W., "Vehicular Crash Tests of a Slip-Formed, Single Slope, Concrete Median Barrier with Integral Concrete Glare Screen." California Department of Transportation, Sacramento, CA (1997).
  21. Mak, K. K., and Menges, W. L., "Testing of State Roadside Safety Systems, Volume VIII: Appendix G—Crash Test and Evaluation of the Single Sloped Bridge Rail." Texas Transportation Institute, Texas A&M University, College Station, TX (1996).
  22. Buth, C. E., Hirsch, T. J., and Menges, W. L., "Testing of New Bridge Rail and Transition Designs, Volume VI: Appendix E—32-in (813-mm) New Jersey Safety Shape." Texas Transportation Institute, Texas A&M University, College Station, TX (1997).
  23. Buth, C. E., Menges, W. L., and Butler, B. G., "Testing and Evaluation of NCHRP 350 Test Level Four Concrete Bridge Railing for Crooked River Gorge 18211." Texas Transportation Institute, Texas A&M University, College Station, TX (1997).
  24. Bullard, D. L., Buth, C. E., Williams, W. F., Menges, W. L., and Schoeneman, S. K. "NCHRP Report 350 Evaluation of the T501 Bridge Rail with Soundwall." Texas Transportation Institute, Texas A&M University, College Station, TX (2001).
  25. Federal Highway Administration, "Standard Specifications for Construction of Roads and Bridges on Federal Highway Projects: FP-96." Washington, DC (1996).
-

## APPENDIX

### GUIDELINES FOR AESTHETIC BARRIER DESIGN

The guidelines presented herein were developed for use by engineers and designers applying aesthetic surface treatments to safety shape, single-slope, and vertical-face concrete barriers. In addition, guidelines for stone masonry guardwalls are presented. The guidelines were developed for specific barrier shapes, and careful attention to applying the appropriate guidance to the correct barrier shape should be exercised.

The development of the guidelines for each barrier type was supported by performing full-scale crash tests and in some instances using computer simulation. These guidelines, when appropriately applied, satisfy the performance evaluation criteria for *NCHRP Report 350: Recommended Procedures for the Safety Performance Evaluation of Highway Features* Test Level 3 (i.e., 100 km/h [62 mph]).<sup>(1)</sup> These guidelines do not address the structural design of any type of barrier.

#### GUIDELINES FOR SAFETY SHAPE BARRIERS

Guidelines for safety shape concrete barriers presented herein were developed by Texas Transportation Institute under NCHRP Project 22-19. These guidelines apply to the New Jersey and the F-shape concrete barriers and were developed for Test Level 3 (TL-3) of *NCHRP Report 350*. The guidelines also apply to service levels higher and lower than TL-3. For service levels lower than TL-3, the presented guidelines may be conservative.

The guidelines for aesthetic surface treatment of the safety shape barriers are defined as a set of relationships between different surface asperity parameters. All generalized surface asperities (i.e., perpendicular, rounded, or angled surface interruptions) are defined in terms of the depth  $d$  and angle  $\theta$ , as shown in Figure A-1.

The perpendicular asperity is a subset of the angled asperity with  $\theta = 90$  degrees. The rounded asperity can be approximated as an angled surface asperity by selecting an effective angle  $\theta$ . Figure A-1 uses a tangent to the rounded surface at half the depth  $d$  to define an effective angle  $\theta$ .

Guidelines for the safety shape barriers were developed for 90-, 45-, and 30-degree asperity angles. Use of these guidelines is restricted to the specified angles, and interpolation between relationships for use with other asperity angles is not recommended.

These guidelines define the surface asperity as the portion of the barrier that is recessed into the barrier surface. In other words, an asperity is to be considered a depression in the surface of the barrier. Thus, the width of the asperity,  $W$ , has been defined as the distance between the outer edges of the asperity, as shown in Figure A-2. Additionally, the asperities

are only introduced into the very uppermost flat portion of the barrier face (above the barrier break point).

The developed guidelines are independent of the asperity spacing ( $W_s$ ), which is the distance between two adjacent asperities, as shown in Figure A-2.

The design guidelines are presented in Figure A-3 (in metric units) and Figure A-4 (in English units). Asperity depth,  $d$ , has been plotted as a function of asperity width,  $W$ , for asperity angles of 90, 45, and 30 degrees. For each of these curves, “acceptable” and “not recommended” regions have been indicated. All aesthetic surface treatments done to safety shape barriers should lie in the “acceptable” region. In Figure A-3, lines representing the “geometric boundary” for the 45- and 30-degree asperities are also shown. These lines simply imply that for the specified asperity angle, an asperity configuration to the left of the line is geometrically not possible.

In addition to meeting the requirements specified in Figure A-3, care must be taken to ensure that no patterns of surface asperity have repeating upward sloping edges. Such patterns are likely to cause vehicle instability and high roll angles on impact, possibly resulting in vehicle rollover.

#### Examples of Using the Aesthetic Design Guidelines for Safety Shape Barriers

Two sample design exercises are presented to demonstrate the use of the aesthetic design guidelines in applying aesthetic surface treatments to concrete safety shape barriers.

##### Example 1

An aesthetic surface treatment shown in Figure A-5 is evaluated and modified using the aesthetic design guidelines in this example. The initial design consists of repetitive asperities cast into the barrier top. The width of the asperities is 300 mm, and a gap of 100 mm exists between adjacent asperities. The asperities are 19 mm deep, and the edges of the asperities are cast at an angle of 45 degrees.

Using the design guidelines in Figure A-3, it can be seen that, for the 45-degree asperities, asperity width ( $W$ ) of 300 mm and asperity depth ( $d$ ) of 19 mm exists in the “not recommended” region. Therefore, modifications to the initial design are necessary.

Figure A-6(a) shows a modified design in which the asperity width was increased to 350 mm while the depth remained the same. This modified configuration now exists in the “acceptable” region of the aesthetic design guidelines. In Figure A-6(b), the width of the asperities was kept the same

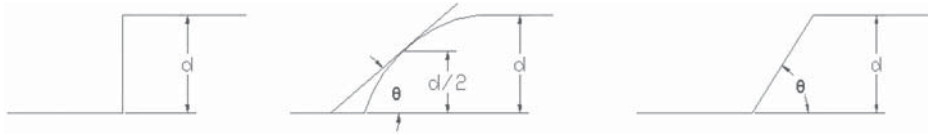

Figure A-1. Generalized types of surface asperities for safety shape barriers.

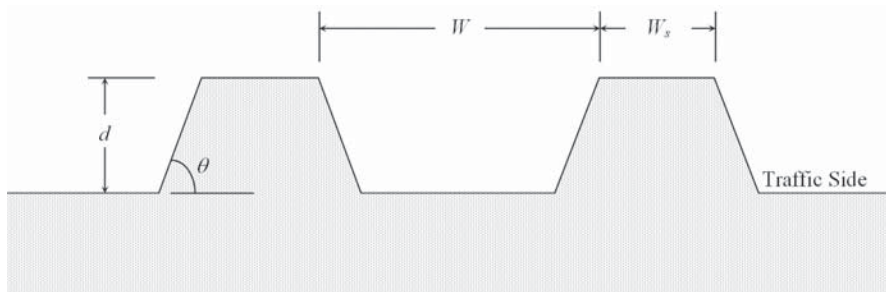

Figure A-2. Surface asperity geometry variables for safety shape barriers.

(i.e., 300 mm), but the depth of the asperities was reduced to 13 mm. This modification also results in a configuration that exists in the “acceptable” region of the design guidelines.

*Example 2*

In this example, the initial design shown in Figure A-7 consists of two types of asperity. The first type of asperity is 350 mm wide and 25 mm deep and has 45-degree asperity

edges. The second type of asperity is 100 mm wide and 25 mm deep and has 90-degree asperity edges. Gaps between adjacent asperities are 100 mm wide.

Using the design guidelines in Figure A-3, it can be seen that, for the 45-degree asperities, asperity width ( $W$ ) of 350 mm and asperity depth ( $d$ ) of 25 mm exists in the “not recommended” region. Similarly, the 90-degree asperities that are 100 mm wide and 25 mm deep also exist in the “not recommended” region of the design guidelines.

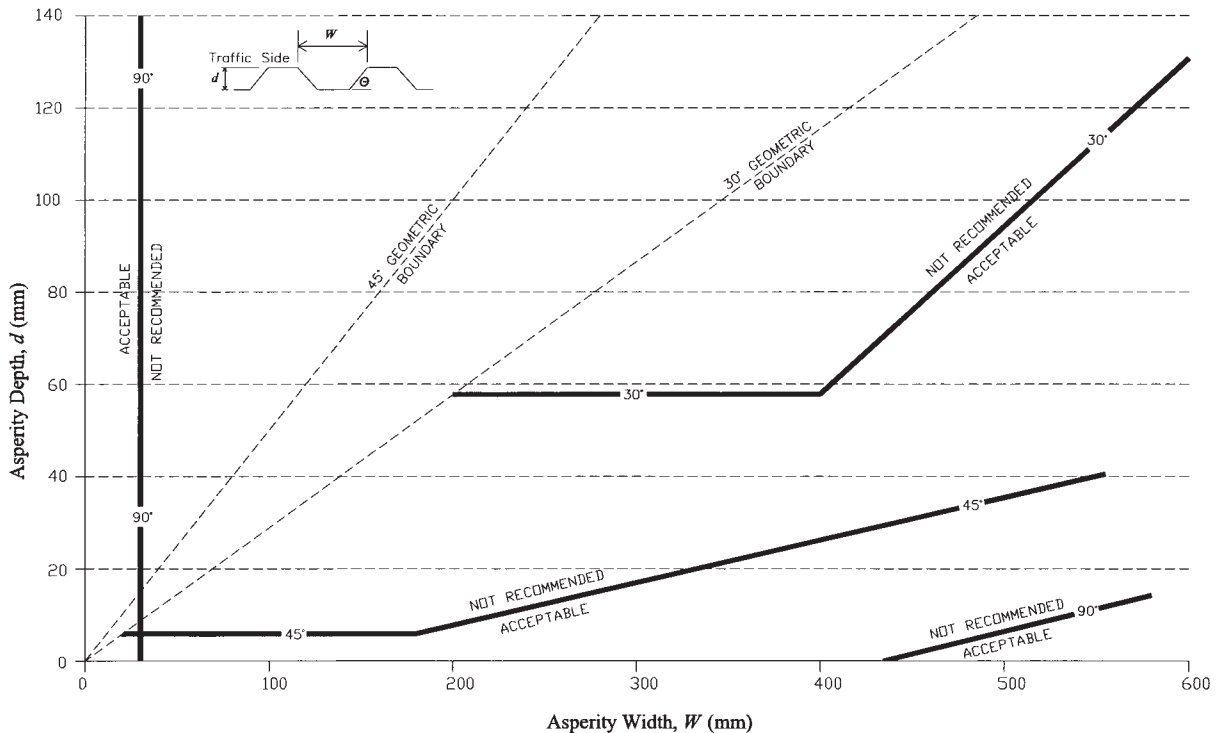

Figure A-3. Final design guidelines for aesthetic surface treatment of safety shape concrete barrier (metric).



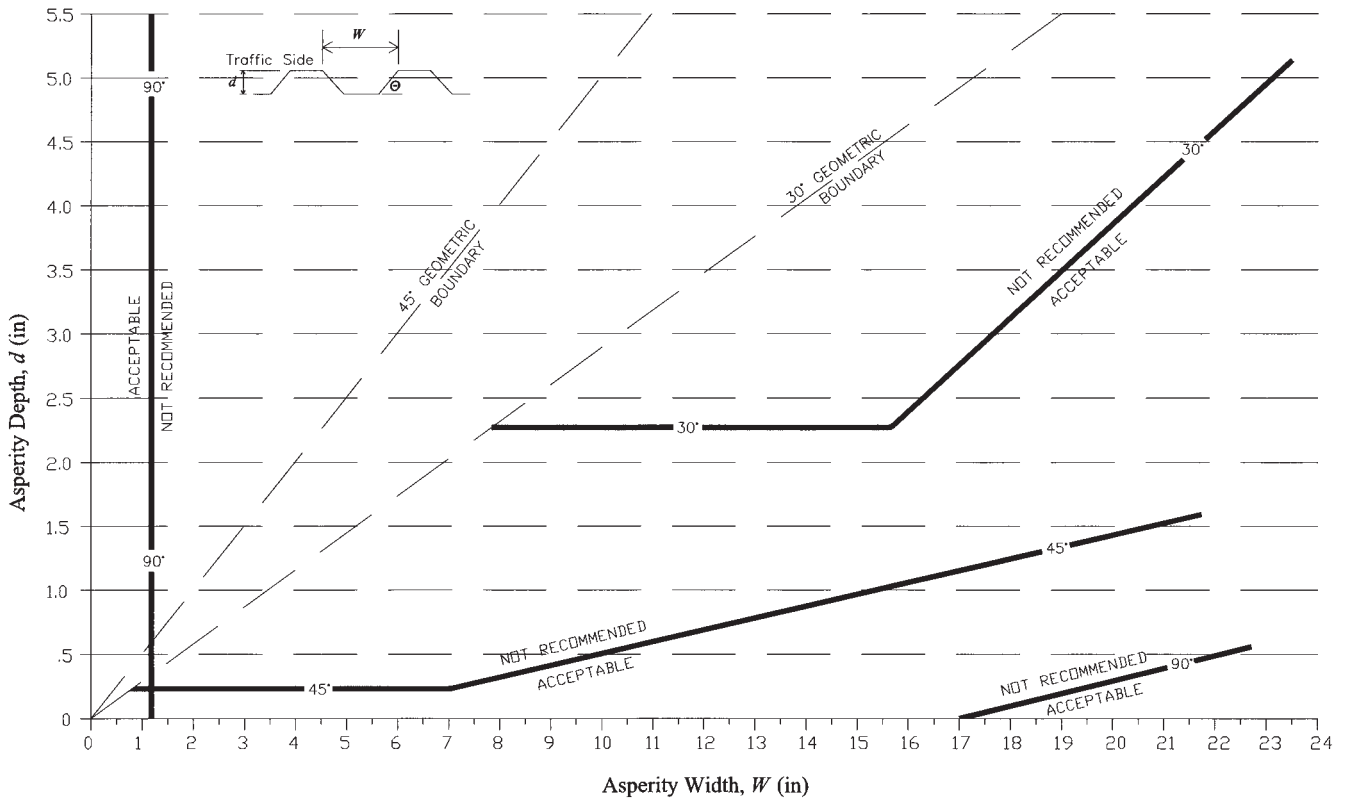

Figure A-4. Final design guidelines for aesthetic surface treatment of safety shape concrete barrier (English).

Figure A-8 shows a modification to the original design. The width of the 45-degree asperities was increased to 400 mm, while the depth was kept the same (25 mm). In addition, the width of the 90-degree asperities was reduced to 30 mm, while the depth was kept the same (25 mm). Making this modification shifts the asperity configurations for both angles to the “acceptable” regions in the final design guidelines.

If a width of 30 mm for the 90-degree asperities appears too small, the designer may consider changing the asperity angle to 45 degrees and increasing the asperity width. As an example, Figure A-9 shows one such modification in which

the original 90-degree asperities have been replaced by the 45-degree asperities that are 200 mm wide and 7 mm deep. This modification also shifts the asperity configuration to the “acceptable” region in the design guidelines.

**GUIDELINES FOR SINGLE-SLOPE AND VERTICAL-FACE BARRIERS**

Guidelines for single-slope and vertical-face barriers were developed by Caltrans<sup>(2)</sup> and approved by the FHWA in acceptance letter B-110. These guidelines permit the fol-

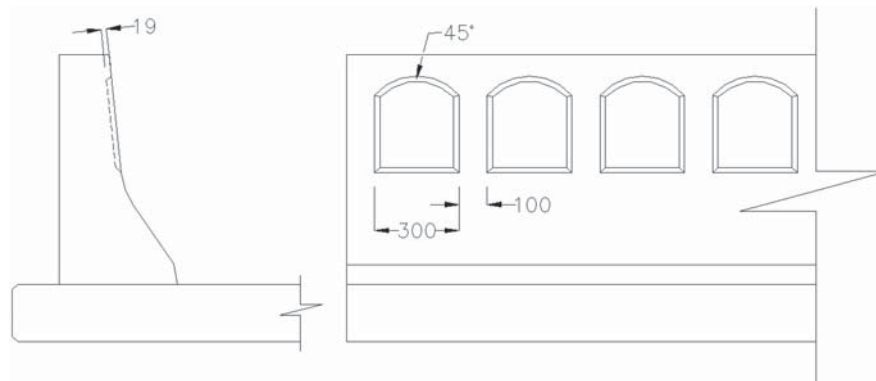

Figure A-5. Initial aesthetic barrier design.

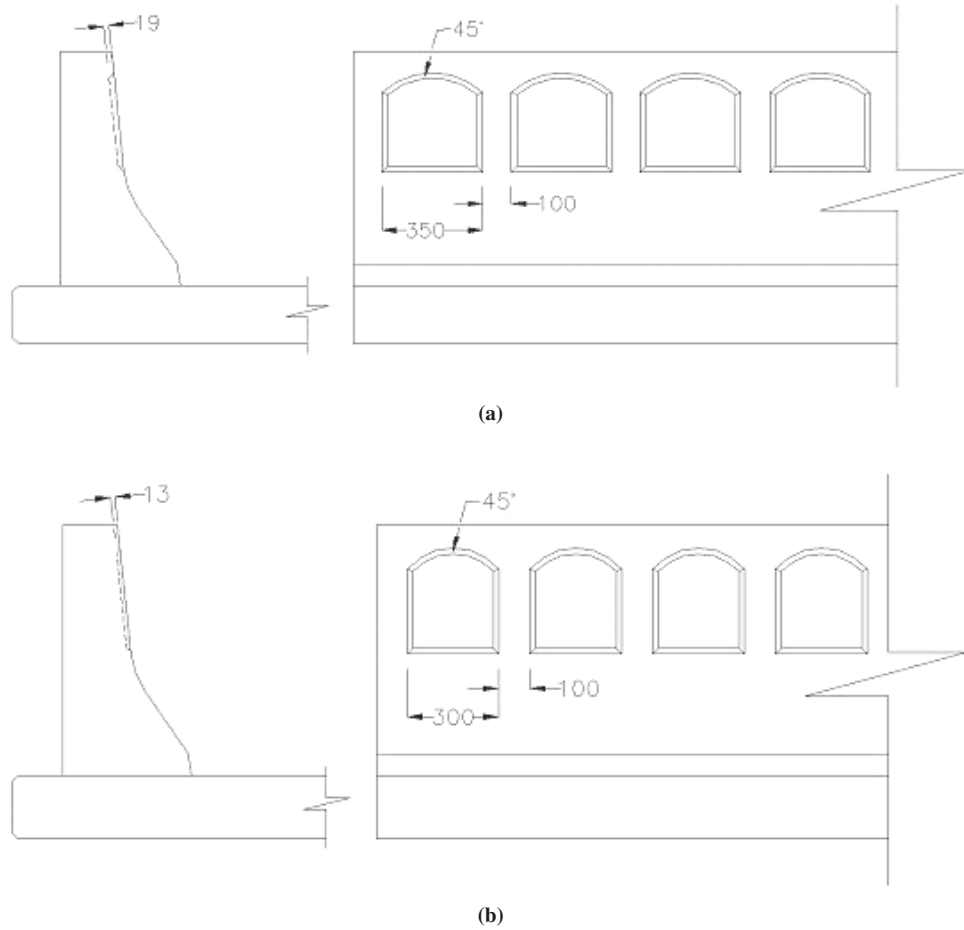

Figure A-6. Suggested modifications to the initial design using the aesthetic design guidelines.

lowing types of surface treatments to single-slope and vertical-face barriers:

- Sandblasted textures with a maximum relief of 9.5 mm.
- Images or geometric patterns cut into the face of the barrier 25 mm or less and having 45-degree or flatter chamfered or beveled edges to minimize vehicular sheet metal or wheel snagging.
- Textures or patterns of any shape and length inset into the face of the barrier up to 13 mm deep and 25 mm wide. (Geometric insets with an upstream edge and an angle of up to 90 degrees should be less than 13 mm.)
- Any pattern or texture with gradual undulations that have a maximum relief of 20 mm over a distance of 300 mm.

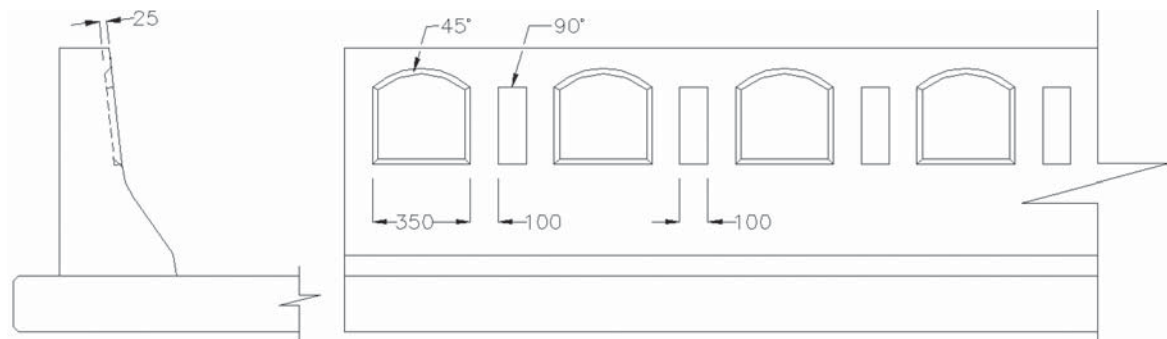

Figure A-7. Initial aesthetic barrier design.

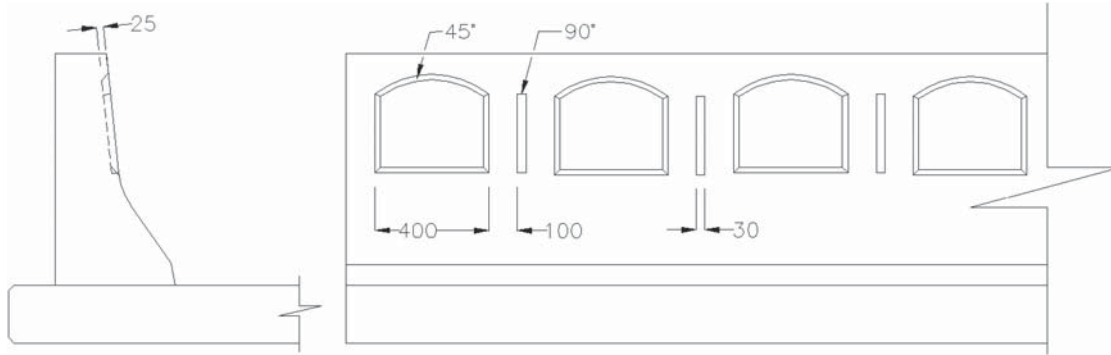

Figure A-8. Suggested modifications to the initial design using the aesthetic design guidelines.

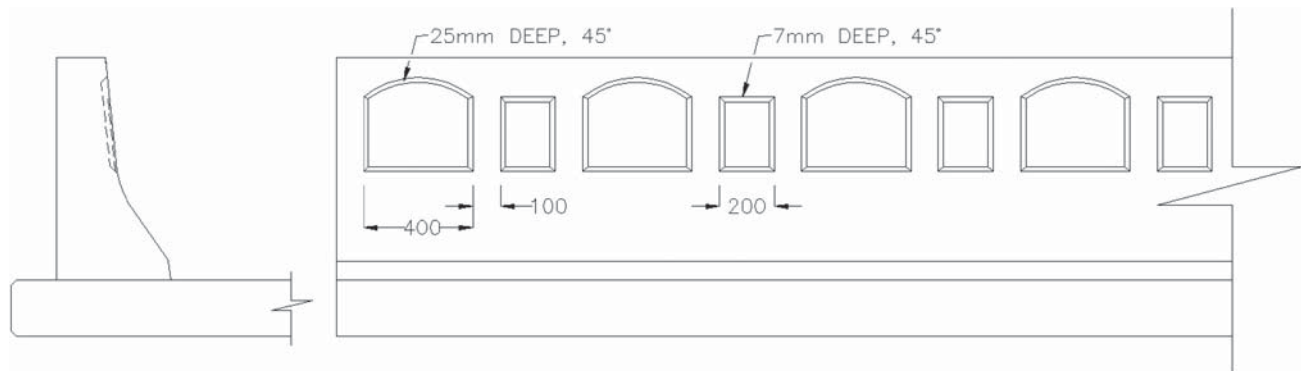

Figure A-9. Suggested modifications to the initial design using the aesthetic design guidelines.

- Gaps, slots, grooves, or joints of any depth with a maximum width of 20 mm and a maximum surface differential across these features of 5 mm.
- No patterns with a repeating upward sloping edge or ridge.
- Any pattern or texture with a maximum relief of 64 mm, if such a pattern begins 610 mm or more above the base of the barrier and if all leading edges are rounded or sloped to minimize any vehicle snagging potential. (No part of this pattern or texture should protrude below the plane of the lower, untextured portion of the barrier.)

- Make mortar beds and joints according to Table A-1.<sup>(3)</sup>
- Use a one-piece capstone for the full width of the guardwall for at least 25% of the total length. Use a two-piece capstone with the joint within 100 mm of the guardwall center for the remaining length.
- Place all stones, including the capstones, randomly to avoid a pattern.
- Lay stones to reflect the width of the expansion joints.
- Do not leave a gap or a mortar edge at the expansion joint.
- Use various sizes of stones to coin or key the corners of the guardwall.

### GUIDELINES FOR STONE MASONRY GUARDWALLS

Guidelines for stone masonry guardwalls were developed by the FHWA.<sup>(3)</sup> Native area stones are applied as a veneer to enhance the appearance of concrete barriers in this type of aesthetic treatment. Following are the guidelines for applying this treatment.

- Construct the guardwall true and uniform along its length, with no stone projecting more than 38 mm beyond the neat line.
- Rake the joints and beds to a depth of 50 mm on the front and top sides and to 38 mm on the back.

Stones that create protrusions greater than those described are not considered crashworthy. Based on aesthetics and stone

TABLE A-1 Masonry bed and joint thicknesses

Class	Beds (inches)	Joints (inches)
Rubble	0.50 - 2.50	0.50 - 2.50
Class B	0.50 - 2.00	0.50 - 2.00
Class A	0.50 - 2.00	0.50 - 1.50
Dimensioned	0.38 - 1.00	0.75 - 1.00

availability, a smoother stone face may be used, such as Class A or B masonry.

#### REFERENCES

1. Ross, H. E., Jr., Sicking, D. L., Zimmer, R. A., and Michie, J. D., *NCHRP Report 350: Recommended Procedures for the Safety Performance Evaluation of Highway Features*, Transportation Research Board, National Research Council, Washington, D.C., 1993.
  2. White, M., Jewell, J., and Peter, R. "Crash Testing of Various Textured Barriers." Contract No. F2001TL17, California Department of Transportation, Sacramento, CA (2002), 126 pp.
  3. "Standard Specifications for Construction of Roads and Bridges on Federal Highway Projects: FP-96." Federal Highway Administration, Washington, DC (1996).
-



## Abbreviations used without definitions in TRB publications:

AASHO	American Association of State Highway Officials
AASHTO	American Association of State Highway and Transportation Officials
ADA	Americans with Disabilities Act
APTA	American Public Transportation Association
ASCE	American Society of Civil Engineers
ASME	American Society of Mechanical Engineers
ASTM	American Society for Testing and Materials
ATA	American Trucking Associations
CTAA	Community Transportation Association of America
CTBSSP	Commercial Truck and Bus Safety Synthesis Program
DHS	Department of Homeland Security
DOE	Department of Energy
EPA	Environmental Protection Agency
FAA	Federal Aviation Administration
FHWA	Federal Highway Administration
FMCSA	Federal Motor Carrier Safety Administration
FRA	Federal Railroad Administration
FTA	Federal Transit Administration
IEEE	Institute of Electrical and Electronics Engineers
ISTEA	Intermodal Surface Transportation Efficiency Act of 1991
ITE	Institute of Transportation Engineers
NASA	National Aeronautics and Space Administration
NCHRP	National Cooperative Highway Research Program
NCTRP	National Cooperative Transit Research and Development Program
NHTSA	National Highway Traffic Safety Administration
NTSB	National Transportation Safety Board
SAE	Society of Automotive Engineers
SAFETEA-LU	Safe, Accountable, Flexible, Efficient Transportation Equity Act: A Legacy for Users (2005)
TCRP	Transit Cooperative Research Program
TEA-21	Transportation Equity Act for the 21st Century (1998)
TRB	Transportation Research Board
TSA	Transportation Security Administration
U.S.DOT	United States Department of Transportation