

Use of Geophysics for Transportation Projects

DETAILS

108 pages | | PAPERBACK

ISBN 978-0-309-09764-2 | DOI 10.17226/13941

AUTHORS

Phil C Sirles; Transportation Research Board

BUY THIS BOOK

FIND RELATED TITLES

Visit the National Academies Press at NAP.edu and login or register to get:

- Access to free PDF downloads of thousands of scientific reports
- 10% off the price of print titles
- Email or social media notifications of new titles related to your interests
- Special offers and discounts



Distribution, posting, or copying of this PDF is strictly prohibited without written permission of the National Academies Press. (Request Permission) Unless otherwise indicated, all materials in this PDF are copyrighted by the National Academy of Sciences.

NATIONAL COOPERATIVE HIGHWAY RESEARCH PROGRAM

NCHRP SYNTHESIS 357

**Use of Geophysics for
Transportation Projects**

A Synthesis of Highway Practice

CONSULTANT

PHIL C. SIRLES
Sirles Consulting, LLC
Lakewood, Colorado

SUBJECT AREAS

Soils, Geology, and Foundations

Research Sponsored by the American Association of State Highway and Transportation Officials
in Cooperation with the Federal Highway Administration

TRANSPORTATION RESEARCH BOARD

WASHINGTON, D.C.
2006
www.TRB.org

NATIONAL COOPERATIVE HIGHWAY RESEARCH PROGRAM

Systematic, well-designed research provides the most effective approach to the solution of many problems facing highway administrators and engineers. Often, highway problems are of local interest and can best be studied by highway departments individually or in cooperation with their state universities and others. However, the accelerating growth of highway transportation develops increasingly complex problems of wide interest to highway authorities. These problems are best studied through a coordinated program of cooperative research.

In recognition of these needs, the highway administrators of the American Association of State Highway and Transportation Officials initiated in 1962 an objective national highway research program employing modern scientific techniques. This program is supported on a continuing basis by funds from participating member states of the Association and it receives the full cooperation and support of the Federal Highway Administration, United States Department of Transportation.

The Transportation Research Board of the National Academies was requested by the Association to administer the research program because of the Board's recognized objectivity and understanding of modern research practices. The Board is uniquely suited for this purpose as it maintains an extensive committee structure from which authorities on any highway transportation subject may be drawn; it possesses avenues of communications and cooperation with federal, state, and local governmental agencies, universities, and industry; its relationship to the National Research Council is an insurance of objectivity; it maintains a full-time research correlation staff of specialists in highway transportation matters to bring the findings of research directly to those who are in a position to use them.

The program is developed on the basis of research needs identified by chief administrators of the highway and transportation departments and by committees of AASHTO. Each year, specific areas of research needs to be included in the program are proposed to the National Research Council and the Board by the American Association of State Highway and Transportation Officials. Research projects to fulfill these needs are defined by the Board, and qualified research agencies are selected from those that have submitted proposals. Administration and surveillance of research contracts are the responsibilities of the National Research Council and the Transportation Research Board.

The needs for highway research are many, and the National Cooperative Highway Research Program can make significant contributions to the solution of highway transportation problems of mutual concern to many responsible groups. The program, however, is intended to complement rather than to substitute for or duplicate other highway research programs.

NOTE: The Transportation Research Board of the National Academies, the National Research Council, the Federal Highway Administration, the American Association of State Highway and Transportation Officials, and the individual states participating in the National Cooperative Highway Research Program do not endorse products or manufacturers. Trade or manufacturers' names appear herein solely because they are considered essential to the object of this report.

NCHRP SYNTHESIS 357

Price \$36.00

Project 20-5 (Topic 36-08)

ISSN 0547-5570

ISBN 0-309-09764-9

Library of Congress Control No. 2006922158

© 2006 Transportation Research Board

COPYRIGHT PERMISSION

Authors herein are responsible for the authenticity of their materials and for obtaining written permissions from publishers or persons who own the copyright to any previously published or copyrighted material used herein.

Cooperative Research Programs (CRP) grants permission to reproduce material in this publication for classroom and not-for-profit purposes. Permission is given with the understanding that none of the material will be used to imply TRB, AASHTO, FAA, FHWA, FMCSA, FTA, or Transit Development Corporation endorsement of a particular product, method, or practice. It is expected that those reproducing the material in this document for educational and not-for-profit uses will give appropriate acknowledgment of the source of any reprinted or reproduced material. For other uses of the material, request permission from CRP.

NOTICE

The project that is the subject of this report was a part of the National Cooperative Highway Research Program conducted by the Transportation Research Board with the approval of the Governing Board of the National Research Council. Such approval reflects the Governing Board's judgment that the program concerned is of national importance and appropriate with respect to both the purposes and resources of the National Research Council.

The members of the technical committee selected to monitor this project and to review this report were chosen for recognized scholarly competence and with due consideration for the balance of disciplines appropriate to the project. The opinions and conclusions expressed or implied are those of the research agency that performed the research, and, while they have been accepted as appropriate by the technical committee, they are not necessarily those of the Transportation Research Board, the National Research Council, the American Association of State Highway and Transportation Officials, or the Federal Highway Administration, U.S. Department of Transportation.

Each report is reviewed and accepted for publication by the technical committee according to procedures established and monitored by the Transportation Research Board Executive Committee and the Governing Board of the National Research Council.

Published reports of the

NATIONAL COOPERATIVE HIGHWAY RESEARCH PROGRAM

are available from:

Transportation Research Board
Business Office
500 Fifth Street, NW
Washington, DC 20001

and can be ordered through the Internet at:
<http://www.national-academies.org/trb/bookstore>

Printed in the United States of America

THE NATIONAL ACADEMIES

Advisers to the Nation on Science, Engineering, and Medicine

The **National Academy of Sciences** is a private, nonprofit, self-perpetuating society of distinguished scholars engaged in scientific and engineering research, dedicated to the furtherance of science and technology and to their use for the general welfare. On the authority of the charter granted to it by the Congress in 1863, the Academy has a mandate that requires it to advise the federal government on scientific and technical matters. Dr. Ralph J. Cicerone is president of the National Academy of Sciences.

The **National Academy of Engineering** was established in 1964, under the charter of the National Academy of Sciences, as a parallel organization of outstanding engineers. It is autonomous in its administration and in the selection of its members, sharing with the National Academy of Sciences the responsibility for advising the federal government. The National Academy of Engineering also sponsors engineering programs aimed at meeting national needs, encourages education and research, and recognizes the superior achievements of engineers. Dr. William A. Wulf is president of the National Academy of Engineering.

The **Institute of Medicine** was established in 1970 by the National Academy of Sciences to secure the services of eminent members of appropriate professions in the examination of policy matters pertaining to the health of the public. The Institute acts under the responsibility given to the National Academy of Sciences by its congressional charter to be an adviser to the federal government and, on its own initiative, to identify issues of medical care, research, and education. Dr. Harvey V. Fineberg is president of the Institute of Medicine.

The **National Research Council** was organized by the National Academy of Sciences in 1916 to associate the broad community of science and technology with the Academy's purposes of furthering knowledge and advising the federal government. Functioning in accordance with general policies determined by the Academy, the Council has become the principal operating agency of both the National Academy of Sciences and the National Academy of Engineering in providing services to the government, the public, and the scientific and engineering communities. The Council is administered jointly by both the Academies and the Institute of Medicine. Dr. Ralph J. Cicerone and Dr. William A. Wulf are chair and vice chair, respectively, of the National Research Council.

The **Transportation Research Board** is a division of the National Research Council, which serves the National Academy of Sciences and the National Academy of Engineering. The Board's mission is to promote innovation and progress in transportation through research. In an objective and interdisciplinary setting, the Board facilitates the sharing of information on transportation practice and policy by researchers and practitioners; stimulates research and offers research management services that promote technical excellence; provides expert advice on transportation policy and programs; and disseminates research results broadly and encourages their implementation. The Board's varied activities annually engage more than 5,000 engineers, scientists, and other transportation researchers and practitioners from the public and private sectors and academia, all of whom contribute their expertise in the public interest. The program is supported by state transportation departments, federal agencies including the component administrations of the U.S. Department of Transportation, and other organizations and individuals interested in the development of transportation. www.TRB.org

www.national-academies.org

NCHRP COMMITTEE FOR PROJECT 20-5

CHAIR

GARY D. TAYLOR, *CTE Engineers*

MEMBERS

THOMAS R. BOHUSLAV, *Texas DOT*
DONN E. HANCHER, *University of Kentucky*
DWIGHT HORNE, *Federal Highway Administration*
YSELA LLORT, *Florida DOT*
WESLEY S.C. LUM, *California DOT*
JAMES W. MARCH, *Federal Highway Administration*
JOHN M. MASON, JR., *Pennsylvania State University*
CATHERINE NELSON, *Oregon DOT*
LARRY VELASQUEZ, *New Mexico DOT*
PAUL T. WELLS, *New York State DOT*

FHWA LIAISON

WILLIAM ZACCAGNINO

TRB LIAISON

STEPHEN F. MAHER

COOPERATIVE RESEARCH PROGRAM STAFF

ROBERT J. REILLY, *Director, Cooperative Research Programs*
CRAWFORD F. JENCKS, *Manager, NCHRP*
EILEEN DELANEY, *Director of Publications*

NCHRP SYNTHESIS STAFF

STEPHEN R. GODWIN, *Director for Studies and Information Services*
JON WILLIAMS, *Manager, Synthesis Studies*
DONNA L. VLASAK, *Senior Program Officer*
DON TIPPMAN, *Editor*
CHERYL KEITH, *Senior Secretary*

TOPIC PANEL

MURAD ABU-FARSAKH, *Louisiana State University*
MARC FISH, *New Hampshire Department of Transportation*
G.P. JAYAPRAKASH, *Transportation Research Board*
MOHAMMED A. MULLA, *North Carolina Department of Transportation*
BILL OWEN, *California Department of Transportation*
DAN REID, *Wisconsin Department of Transportation*
DICK SYLWESTER, *Golder Associates, Inc.*
KHAMIS Y. HARAMY, *Federal Highway Administration (Liaison)*
SAM MANSUKHANI, *Federal Highway Administration (Liaison)*

ACKNOWLEDGMENTS

I would like to express my sincere appreciation to the following who helped make this NCHRP Synthesis a quality product: the technical panel who were terrific to work with and thorough in their assis-

tance, Cecelia Slivick and Merrie Jones who were instrumental in each phase of the work, and Zonge Engineering & Research Organization, Inc., for their support in completing the Synthesis.

Cover photograph courtesy of Bay Geophysical, Inc., Traverse City, Michigan.

FOREWORD

*By Staff
Transportation
Research Board*

Highway administrators, engineers, and researchers often face problems for which information already exists, either in documented form or as undocumented experience and practice. This information may be fragmented, scattered, and unevaluated. As a consequence, full knowledge of what has been learned about a problem may not be brought to bear on its solution. Costly research findings may go unused, valuable experience may be overlooked, and due consideration may not be given to recommended practices for solving or alleviating the problem.

There is information on nearly every subject of concern to highway administrators and engineers. Much of it derives from research or from the work of practitioners faced with problems in their day-to-day work. To provide a systematic means for assembling and evaluating such useful information and to make it available to the entire highway community, the American Association of State Highway and Transportation Officials—through the mechanism of the National Cooperative Highway Research Program—authorized the Transportation Research Board to undertake a continuing study. This study, NCHRP Project 20-5, “Synthesis of Information Related to Highway Problems,” searches out and synthesizes useful knowledge from all available sources and prepares concise, documented reports on specific topics. Reports from this endeavor constitute an NCHRP report series, *Synthesis of Highway Practice*.

This synthesis series reports on current knowledge and practice, in a compact format, without the detailed directions usually found in handbooks or design manuals. Each report in the series provides a compendium of the best knowledge available on those measures found to be the most successful in resolving specific problems.

PREFACE

This synthesis presents the state of the practice regarding the use of geophysics for transportation projects. The report focuses on U.S. state and Canadian provincial departments of transportation (DOTs), and U.S. federal transportation agencies. The main points addressed include who is using geophysics and why, which methods and applications are the most commonly used, the use of in-house expertise compared with contracting private consultants, and how geophysical service contracts are procured and implemented. The scope was limited to how geophysics is being applied by geotechnical engineers during highway planning and construction activities.

The information included in this synthesis was obtained from a review of the published literature, a survey of all 50 state DOTs, the District of Columbia, Canadian provinces, and selected federal government agencies, and follow-up telephone interviews designed to clarify or expand on particular aspects of some survey responses.

Phil C. Sirles, Sirles Consulting, LLC, Lakewood, Colorado, collected and synthesized the information and wrote the report. The members of the topic panel are acknowledged on the preceding page. This synthesis is an immediately useful document that records the practices that were acceptable within the limitations of the knowledge available at the time of its preparation. As progress in research and practice continues, new knowledge will be added to that now at hand.

CONTENTS

1	SUMMARY
5	CHAPTER ONE INTRODUCTION Background, 5 Objective, 6 Scope, 6 Organization, 6
8	CHAPTER TWO GEOPHYSICAL METHODS Introduction, 8 Literature Search and Training Resources, 8 Methods, Techniques, Applications, and Standards, 9
13	CHAPTER THREE INFORMATION SOURCES AND GENERAL RESPONSES
16	CHAPTER FOUR AGENCY PRACTICE—METHODS AND APPLICATIONS Geophysical Methods and Techniques, 16 Applications for Geophysical Investigations, 16 Selection Criteria and Approval for Geophysical Investigations, 16
18	CHAPTER FIVE AGENCY PRACTICE—BUDGETING, COSTS, AND CONTRACTING Budgeting and Costs, 18 Contracting, 19
23	CHAPTER SIX AGENCY PROJECT EXPERIENCE Successes and Failures, 23 Case Histories, 24 Project Costs, 24
27	CHAPTER SEVEN CONCLUSIONS AND FUTURE RESEARCH NEEDS
29	GLOSSARY
32	REFERENCES
33	TOPICAL BIBLIOGRAPHY
43	APPENDIX A METHODS AND TECHNIQUES

61 APPENDIX B SURVEY QUESTIONNAIRE

79 APPENDIX C SURVEY RESULTS

100 APPENDIX D CASE HISTORIES

USE OF GEOPHYSICS FOR TRANSPORTATION PROJECTS

SUMMARY This synthesis presents the state of the industry regarding the use of geophysics on transportation projects. This use of geophysics on geotechnical projects is increasing among transportation agencies; however, the level of use varies significantly from agency to agency. In an attempt ascertain the current practice among U.S. state, federal, and Canadian transportation agencies, the synthesis was undertaken to:

- Review the state of knowledge;
- Assess the amount and type of geophysical investigations being undertaken—by whom and how;
- Discover what geophysical investigation methods and techniques are primarily used;
- Determine what engineering applications geophysics are used for the most;
- Assess annual budgets, in-house capabilities, and contracting practices;
- Identify the approach used for selecting geophysical methods and by whom within the agency;
- Ascertain the most common practices regarding Requests for Proposal solicitation and contract award;
- Evaluate the level of comfort with this technology among the end-users; and
- Establish if a need exists for educational and training opportunities.

The objective of the synthesis is to address and document these items as they are currently being implemented by U.S. and Canadian transportation agencies. For the purpose of this synthesis, geophysics is defined as the application of physical principles to define geology and study earth (geo-) materials. Engineering geophysics is used to evaluate natural and artificial foundation materials—soil and rock; however, this synthesis focuses on its application toward geotechnical problems.

Information for this synthesis was acquired from a variety of sources including a literature review, survey questionnaire, follow-up interviews, and requests for data solicited directly from respondent agencies. A survey of practice was conducted electronically. The questionnaire was sent to 70 agency representatives, primarily in geotechnical engineering branches and sections within each of the 50 state departments of transportations (DOTs), the District of Columbia, most Canadian transportation agencies, and 7 federal agencies involved with transportation projects. A total of 63 questionnaires were returned, for a response rate of 90%. Respondents included each of the 50 state DOTs, the District of Columbia, a port authority, and 8 Canadian and 3 federal agencies. Four more responses were received as additional responses from other departments at three states DOTs. Thus, 67 responses were analyzed. Only 9 of the 67 agencies reported that they do not use geophysics; therefore, the data presented in this synthesis are based on answers from 58 respondents to the questionnaire.

Approximately 50% of the respondents began implementing geophysics as part of their geotechnical investigations within the last 10 years; thus, for most agencies it is a relatively new investigation tool. Only a few agencies reported having in-house capabilities. Two agencies (of 58) indicated that funds are allocated annually for geophysics. The majority of agencies fund geophysical investigations through their design branches (departments) and

procure the work under contracts to architect and engineering firms as part of their larger geotechnical investigations or under lump-sum/fixed-price subcontracts. The primary mode of solicitation among the respondents is “limited solicitation” or “sole-source” contracting.

The typical number of geophysical investigations conducted each year ranges from one to five for more than half of the respondents. Contract values are predominantly less than \$10,000 per geophysical investigation; however, there are agencies that routinely use geophysics that will spend more than \$100,000 annually conducting geophysical investigations. These agencies tend to carry large on-call Indefinite Delivery/Indefinite Quantity-type contracts to easily access qualified service providers for projects. Such contracts ranged from \$300,000 per year to \$5 million for 3 years (with two service providers).

Between 50% and 60% of the agencies and individuals completing the survey provided an experience rating of “good” to “excellent” for their use of geophysics. However, several factors were identified as limitations to the implementation of geophysics, including difficult field instrumentation and software for data interpretation, poorly qualified service providers, and subjective and nonunique results. However, the majority of respondents indicated that inadequate understanding and knowledge of geophysics was the single greatest limitation.

The results of this synthesis suggest that the majority of in-house geoscientists and engineers have insufficient knowledge regarding the advantages of geophysics. As experiences (e.g., case histories) are shared and educational opportunities provided for transportation engineers and agencies, these advantages will be better understood, which could lead to more routine use of this technology on their projects. Because highway engineers acknowledge this, the survey respondents requested that additional training resources be made available, including the development of a National Highway Institute course. Although FHWA recently published and distributed the manual, *Application of Geophysical Methods to Highway Related Problems*, nearly 35% of the respondent agencies were not aware of it, more than half of the agencies did not have it or were not sure if they did, and approximately 45% have not used it. Since its publication in 2004 as a web-based document designed around problem solving and applications (not around geophysics), it is apparent that the effort to create the website and distribute the hard copy has not been fully realized.

The ten most important results derived from this synthesis are:

- Sixty-eight percent of respondents do not use geophysics very often (i.e., “occasionally”), and 45% of the agencies have used geophysics only in the past 10 years.
- Approximately 60% of the agencies mentioned that there is an increase in their level of effort to implement geophysics, with approximately 25% indicating an increase of between 50% and 100%.
- The three most commonly used geophysical methods are (1) seismic, (2) ground penetrating radar, and (3) vibration monitoring.
- The top three geotechnical engineering applications for geophysics are (1) bedrock mapping, (2) mapping (characterizing) soil deposits, and (3) roadway subsidence. An interesting note is that non-destructive testing ranked second on the list; however, it is not a qualified result because it is not part of this synthesis. This point emphasizes a general lack of understanding concerning the two technologies.
- The top three “greatest values” for using geophysics are (1) speed of data acquisition, (2) cost benefits, and (3) better characterization of the subsurface.
- The three greatest deterrents to using geophysics are (1) lack of understanding, (2) nonuniqueness of results, and (3) lack of confidence.
- Three items that can overcome the deterrents are (1) training, (2) experience (and sharing thereof), and (3) implementation of standards.
- Very few agencies allocate funds in their annual budgets specifically for geophysical investigations, and the majority of projects cost less than \$10,000.

- Limited or sole-source solicitations are the primary means of contracting geophysical providers; however, seven agencies are using large, on-call, multiyear contracts.
- A successful-to-unsuccessful project ratio of 7:1 was shown to exist for the set of entire responses, and similar ratios have been observed at other agencies.

Based on information gathered for this synthesis and previous discussions with hundreds of geotechnical engineers, it appears likely that as formal training occurs and successful project experiences among transportation agencies increase, using trained in-house professionals and qualified service providers, geophysics will become more widely accepted and implemented as another tool for the transportation industry. This synthesis determined that design and construction engineers are beginning to appreciate the benefits of geophysics through use and exposure over just the past 5 years. The majority of survey respondents believe that using geophysics has the potential to save governmental agency funds and time, and reduce the risk associated with unknown subsurface conditions.

INTRODUCTION

This chapter discusses the general nature of geophysics, its past and current use, particularly by transportation agencies. It also presents the objective, scope, and organization of the synthesis.

BACKGROUND

Geophysical methods have been used for nearly 70 years, although predominantly in the exploration for natural resources. Oil, gas, and mineral exploration demanded better technologies to locate and define highly needed natural resources before and during World War II (1). Since the 1950s, the use of geophysics in the natural resource exploration industry has increased to the point that it is used as the first level effort on every project. Drilling and other physical means of defining the geologic setting, composition, and depth of interest are used after imaging the subsurface beneath the property through successful application of geophysics.

The use of geophysics among U.S. state departments of transportation (DOTs) and Canadian transportation agencies varies widely depending on the knowledge of the individuals and the combined experiences of the transportation agency. Over the past decade there has been an increased effort on the part of the engineering geophysical community to provide technologies that aid the design and construction needs of transportation projects.

In the most generalized sense, geophysics is the application of physical principles to define geology and study geomaterials; for example, soil or rock (2). The following paragraph from the *Introduction to Geophysical Prospecting* (3) presents the best formal definition of geophysics:

We designate the study of the earth using physical measurements at the surface as *geophysics*. While it is not always easy to establish a meaningful border line between geology and geophysics, the difference lies primarily in the type of data with which one begins. Geology involves the study of the earth by direct observations on [soils and] rocks, either from surface exposure or boreholes, and the deduction of its structure, composition, or history by analysis of such observations. Geophysics, on the other hand, involves the study of those parts of the earth hidden from direct view by measuring their physical properties with appropriate instruments, usually on the surface. It also includes interpretation of the measurements to obtain useful information on the structure and composition of the concealed zones.

Geophysics affords the opportunity to cost-effectively sample large volumes of the subsurface using such principles as seismic- or electromagnetic (EM)-wave transmission, electrical current flow, and magnetic and gravity potential fields. The science is technical in its application, and is quantitative in its measurement, yet it provides only the qualitative information about geomaterial properties needed by engineers. For example, it does not directly measure density, moisture content, or stiffness, but provides a relationship between a measured value (e.g., seismic velocity) and the physical parameter that governs it (e.g., density). It is the complement of using a broad view of the subsurface imaged from a geophysical investigation and data directly obtained from drilling that creates the value and benefit of this technology.

Those responsible for design and construction on sites that pose significant risk to society require the most advanced technologies to better characterize the distribution of physical properties in the subsurface. The purpose of using geophysics, as defined for this synthesis, is to identify and characterize physical properties of subsurface geomaterials in a manner that benefits highway projects and transportation programs. These benefits can be associated with reduced project costs, better and broader subsurface characterization, increased speed of acquisition, and utilizing a noninvasive approach to evaluate subsurface conditions.

It can be construed that because it was not until 1992 that an international professional geophysical society was formed [the Environmental and Engineering Geophysical Society (EEGS)], the use and application of geophysics for shallow investigations (<30 m/100 ft) is relatively new. Over the past 10 years the increased need to reduce risk for the design and construction of engineered structures has dictated better instrumentation and data processing software, as well as added educational opportunities, to effectively make geophysical technologies available. EEGS and its members have worked to educate end-users on the correct application of geophysics.

The emergence of non-destructive testing (NDT) technology is even more recent. Although the science of NDT has undergone approximately 10 to 12 years of development, it has become standard practice in the transportation industry for only the last 6 to 7 years. For the purposes of this synthesis, it is important to distinguish between the terms “geophysics” and “NDT.” NDT uses many (if not all) of the physical principles used in geophysics; however, it is the application of the

technology that separates the two. NDT is used to image and evaluate engineered structures; that is, man-made features such as bridges, walls, and drilled shafts.

OBJECTIVE

In early 2005 (before the completion of this synthesis), Tandon and Nazarian reported that the use of geophysics on transportation projects varied significantly among DOTs (4). The objective of this synthesis is to determine the state of the practice and level of knowledge regarding the use of geophysics among transportation agencies. This synthesis focuses on U.S. state DOTs and U.S. federal and Canadian provincial transportation agencies. The main points addressed are who is and who is not using geophysics, and why; which geophysical methods and applications are most commonly used; trends related to in-house expertise versus contracting private consultants; how geophysical service contracts are procured and implemented; experiences gained and lessons learned through case histories; and identification of future needs.

SCOPE

Although this synthesis discusses a broad range of topics related to the actual day-to-day implementation of geophysical technologies, the main goal is to summarize the overall use of these technologies in the United States and Canada. The scope of this project was limited to how geophysics is being applied by geotechnical engineers during highway planning and construction activities. The emphasis is on the use of geophysics for geotechnical issues as they relate to natural and artificial foundations.

The majority of information included in this synthesis was obtained from published literature, the electronic survey and questionnaire (see Appendix B), and interviews. A comprehensive survey was developed and sent electronically to representatives in all 50 states and the District of Columbia, the Canadian provinces, and other federal government entities with experience in geophysical applications. Follow-up telephone interviews, to clarify or expand on particular aspects of some survey responses, were also conducted.

The e-mail survey method proved very effective. A total of 70 questionnaires were sent and 63 agencies replied, for a 90% response rate. Figure 1 shows that a total of 67 questionnaires were returned from 58 agencies: 56 from U.S. state DOTs (including the District of Columbia and the Port Authority of New York and New Jersey), 8 from Canadian agencies, and 3 from U.S. federal agencies. Three states returned multiple responses [Colorado (2), Michigan (2), and Oregon (3)]; therefore, a total of 56 state DOT agency responses were received. Their answers were tallied appropriately into the database, but the individual state DOT was considered as a single agency response. The questionnaire was sent to three other organizations: Kansas Geologic Society (a

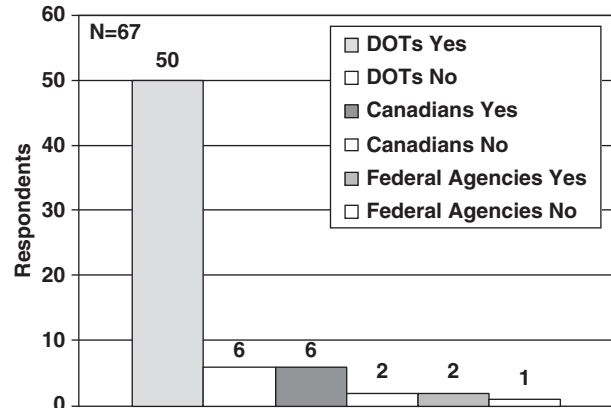

FIGURE 1 Breakdown of agency response to use of geophysics.

state agency), University of Missouri at Rolla (an educational institution), and Technos, Inc. (a private consulting firm), respectively. They were selected based on their qualifications and experiences with the transportation industry and queried to determine the validity of the survey. These three organizations replied promptly and agreed that they should *not* be included as respondents because their use of geophysics is not discretionary. Based on their responses and follow-up interviews, no additional questionnaires were sent to educational institutions or private consultants.

This specialized synthesis on the use of geophysics necessitated that agencies that do not use geophysics respond appropriately to Questions 14, 15, and 21L, so that they would not be included in the analysis. Figure 1 charts the responses to these questions and the distribution of U.S. state and federal and Canadian agencies that either use (responded “yes”) or do not use (responded “no”) geophysics. Only 9 agencies indicated that they do not use geophysics at all; therefore, 58 total responses (including the 4 extra from 3 state DOTs) is the base number in the analysis of the use of geophysics in transportation.

ORGANIZATION

Chapter two provides results from the literature search. It discusses the difference between educational materials and informational materials regarding application of geophysics to highway-related projects. The chapter will identify standards (e.g., ASTM) related to geophysical investigations. The approach to selection of geophysical methods and techniques is discussed and a matrix summarizing geophysical techniques versus geotechnical applications is presented.

Chapter three covers the method of data collection and analysis for the NCHRP survey. It discusses, in general, the demographics of the survey and the type of information requested, and then presents specific examples regarding the use of geophysics among the respondent transportation agencies.

At the end of the chapter, NDT will be discussed as it relates to this synthesis and briefly how it is used by the respondents.

Chapter four presents the geophysical methods, techniques, and applications. It presents the very broad and diverse use of geophysical methods as currently used on transportation projects. Because chapter three is directed toward the process of gathering the survey information, this chapter focuses directly on geophysical methods and geotechnical engineering applications.

Chapter five focuses predominantly on identifying the approach used by DOTs to procure geophysical service providers and discusses agency programs regarding budgets and contracting. The discussion is focused on allocation of funds, funding sources, and contracting methods and needs.

Chapter six discusses both successful applications and those that were deemed to be unsuccessful. A table shows the case histories that were provided for this synthesis that includes a brief description of the method used, application, status, and if the project was successful or unsuccessful. An important component of this chapter will be an evaluation of the benefits observed from both successful and unsuccessful projects. A brief discussion regarding the current level of comfort and what will increase the level of comfort among engineers and agencies to implement geophysics will be presented.

Chapter seven summarizes synthesis results. This chapter includes recommendations for future research regarding geophysical investigations, as defined by the respondents, and concluding remarks.

GEOPHYSICAL METHODS

INTRODUCTION

This chapter begins by defining geophysical methods and techniques, includes results from a literature search, and discusses the geophysical methods and techniques most commonly used for transportation projects.

As related by Telford et al. (1), applied geophysics can be divided into the following seven general methods of exploration:

- Magnetic,
- Electrical,
- Electromagnetic,
- Seismic,
- Gravitational,
- Radioactivity, and
- Well logging.

Each geophysical method can be used for many different applications (e.g., mining exploration, oil and gas exploration, engineering, and environmental). The division of each method is based on the physics that governs it; therefore, geophysical techniques (e.g., refraction) within each method (i.e., seismic) are designed primarily for applications of the method to a given problem (e.g., rippability). This synthesis will use the terminology of *methods* to refer to those seven major divisions and *techniques* to identify specific applications of the methods.

Material properties can be measured indirectly through the use of engineering geophysical methods such as seismic, electrical resistivity, EM and ground penetrating radar (GPR), to name only a few. The capability of conducting geophysical investigations in difficult or remote terrain and with greater sample density, demonstrates the potential geophysics has to significantly affect design efforts and construction activities. The most important factor geophysics can help address is to reduce the risk associated with unknown subsurface conditions and to avoid related costly claims and repairs. Before publication of this synthesis, it was well known that the success of any geophysical investigation requires that appropriate techniques be applied that address specific engineering objectives. For example, if karstic (e.g., pinnacles or sinks) limestone bedrock is expected to be encountered at shallow depths, applying a magnetic method would not be appropriate.

LITERATURE SEARCH AND TRAINING RESOURCES

A multitude of literature sources exist on geophysics. Existing works either deal purely with the theory and specifics of the physics regarding the variety of methods or they are segregated into the application of geophysics to specific fields. The standard of the geophysical industry for textbooks that contain all the geophysical methods are Telford et al. (1) and Dobrin (3), both published in 1976. Both books are still used in universities for geophysics coursework.

It was not until the mid-1980s that enough demand for engineering geophysics resulted in the publication of the *Handbook of Engineering Geophysics—Vol. 1: Seismic* (5), and *Vol. 2: Electrical Resistivity* (6). In the 1990s, a distinct need for specific, application-related books became apparent to present the state of the art for all the geophysical methods and techniques. Consequently, two “best-sellers” related to the use of engineering geophysics became available. The Society of Exploration Geophysicists produced one of the first books dedicated to shallow geophysics, *Geotechnical and Environmental Geophysics—Vols. I–III* (7). In 1995, the U.S. Army Corps of Engineers produced a comprehensive document, their engineering manual, *Engineering Design—Geophysical Exploration for Engineering and Environmental Investigations* (8). In these last two references, the practical application of geophysics was brought to the forefront through requests to authoritative contributors in specialized fields to develop chapters based on their expertise (Dr. Gregg Hempen, personal communication, 1995). Both books have remained key components of the early application of geophysics to shallow, engineering, and environmental studies. The Corps’ engineering manual is available for unlimited public distribution at <http://www.usace.army.mil/inet/usace-docs/eng-manuals/em1110-1-1802/toc.htm>.

With the publication of these two resources, available literature became much more specific as it dealt with particular geophysical methods or engineering applications. One such book, published by The Geological Society of London, *Modern Geophysics in Engineering Geology* (9), makes application of the geophysical techniques central to the theme of the book. More recently, FHWA published *Application of Geophysical Methods to Highway Related Problems* (10),

which is designed specifically for use by state DOT and federal highway engineering staff when particular applications necessitate the use of geophysics. The manual was not developed or designed to be a textbook, and although it was published as one, its primary function is the website, <http://www.cflhd.gov/geotechnical>, which uses a solution matrix that guides users to particular engineering problems (e.g., rippability) and what geophysical method may best suit the objectives of the investigation. However, an MS Word text version as well as a PDF version of the FHWA manual is also available for download.

The most recent textbook to be published on the subject comes from the Society of Exploration Geophysicists of Japan. This comprehensive book, *Application of Geophysical Methods to Engineering and Environmental Problems*, covers the most recent innovations for geophysical technology for 17 methods, and is available online from the website (11).

Numerous opportunities exist for instruction through attendance at geophysics conferences. Since 1988 the Symposium on the Application of Geophysics to Engineering and Environmental Problems (SAGEEP), the EEGS annual conference, consistently produces case-specific presentations on the use of geophysics. EEGS is dedicated to providing educational opportunities for nongeophysicists about the value and use of the technologies available. The EEGS website, <http://www.eegs.org/>, can be searched for case histories presented at SAGEEP by either geophysical technique or engineering application (e.g., geotechnical engineering). More than 600 case histories are available at <http://www.eegs.org/sageep/proceedings.cfm>, and that only covers SAGEEP conferences between 1988 and 2000. Searchable CD-ROMs of the annual proceedings are made available for purchase, with approximately 30 to 40 case histories presented related to engineering geophysics. Additionally, cutting-edge technologies are discussed and innovations in equipment and software made available by exhibitors and vendors.

In 2000, an introductory EEGS short course designed for geologists, engineers, and environmental scientists became available (2). The success of this particular introductory course created a high demand for the course notes and the CD-ROM, which were reproduced and distributed internationally. Simultaneously, FHWA became increasingly aware of the need for dialog and training; thus, it created a conference that deals specifically with the needs of the state DOTs; that is, a geophysical applications conference dedicated solely to transportation. Since 2000, three International Geophysical Conferences have been hosted by FHWA, with proceedings published on CD-ROM (12–14). The content of the training sessions as well as the experience presented through case histories has provided significant help to transportation engineers. The proceedings from 2000 are no longer available through a website; however, the 2002 and 2003 proceedings are still available (13,14). The

Topical Bibliography contains the papers, listed by topic, presented at each of the three FHWA conferences because they all contain useful information.

Literally hundreds of articles have been published pertaining directly to the topic of this synthesis in professional (peer-review) journals available from the major geotechnical, engineering, geology, and geophysical societies. The papers typically deal with one or two geophysical techniques and are dedicated toward solving a problem. Such articles can be accessed at TRB's Transportation Research Information Service (TRIS) on-line library (<http://trisonline.bts.gov/search.cfm>). It is the most comprehensive source for journal articles. The Topical Bibliography lists many of the articles germane to this synthesis from SAGEEP and the FHWA geophysics conferences, as well as journal articles obtained from the TRIS website. Engineering geophysics is a burgeoning field, and these articles represent the latest innovations and the most practical solutions to the problems facing today's engineers in the transportation industry. Therefore, the bibliography contains articles that are generally less than 5 years old at the time of this publication.

Only one NCHRP synthesis has been prepared that is concerned specifically with geophysics. Although it deals solely with the use of GPR for transportation projects (15), it is a well-prepared document explaining the technique, instrumentation, data, and applications for such projects.

METHODS, TECHNIQUES, APPLICATIONS, AND STANDARDS

As discussed in this chapter's introduction, there is a diverse set of geophysical methods capable of subsurface imaging at a scale appropriate for exploration and for engineering investigations. This section is intended to

- Present brief, introductory-level information regarding the most commonly used methods for transportation-related (engineering) studies;
- Identify the techniques associated with each geophysical method;
- Define general applications for the techniques as used for geotechnical investigations; and
- Present existing standard test methods and guides used for geophysical investigations.

Methods

Numerous publications were prepared for the three aforementioned FHWA International Conferences. As part of the keynote address at the first two of these conferences, matrices of method versus applications were published and presented (16,17). Another comprehensive matrix of methods, techniques, and applications is presented in *The Code of*

Practice for Site Investigation (18). Because this synthesis is not intended to be a training document, a simplified, combined version of a matrix for geotechnical practice is presented here. For more thorough tables and matrices depicting specific engineering applications and comprehensive methods/techniques see the referenced papers. Tandon and Nazarian (4) summarized the referenced FHWA conference papers and presented all of their matrices.

Techniques

Appendix A includes Technical Briefs for the following most common methods:

- Seismic Method: Refraction, reflection, Spectral Analysis of Surface Waves, Multi-Channel Analysis of Surface Waves, and crosshole techniques.
- Electrical Resistivity Method: Profiling and sounding techniques.
- EM: Time- and frequency-domain techniques.
- GPR method.
- Magnetic method.

The briefs are presented as specific techniques (e.g., frequency- and time-domain EM). They are reproduced from a draft FHWA geophysics workshop that is currently in development, and intended to be an educational workshop en-

TABLE 1
MATRIX OF SURFACE GEOPHYSICAL METHODS AND TECHNIQUES IN RELATION TO TYPICAL INVESTIGATION OBJECTIVES

Investigation Objectives	Methods												
	Seismic				Electro-Magnetic	Electrical	Other						
	Seismic Refraction	Seismic Reflection	Seismic Tomography	Shear Wave	Surface Wave (SASW, MASW, and passive)	Frequency-Domain EM (terrain conductivity)	Time-Domain EM (metal detector)	Time Domain EM Soundings	Electrical Resistivity	Induced Polarization	Gravity	Magnetics	Ground Penetrating Radar
Bedrock depth	P	P	P		P			S	S	S	S		
Rippability	P		P	P									
Lateral and vertical variation in rock or soil strength	P		P	P	P								
Location of faults and fracture zones	S	P	P	P	S	S		S	S	S	S	S	S
Karst features		S	P		P	S				P			P
Near-surface anomalous conditions					S	P		P	S				P
Soil characterization and lithology			S	S	S	P		S	P	P			
Locating landfill boundaries, waste pits, waste trenches, buried drums					S	P	P		P	P		P	P
Water table	S		S			P		P	P	P			
Water quality, fresh-saline water interfaces						P		P	P	S			

Notes: This matrix is intended to aid in the selection of an appropriate geophysical method and respective technique for typical geotechnical investigation objectives. The table *does not* account for geologic conditions, site cultural features, target size, and depth. Refer to Appendix A for additional information regarding methods and techniques. SASW = Spectral Analysis of Surface Waves; MASW = Multi-Channel Analysis of Surface Waves; P = primary technique; S = secondary technique; blank space = technique should not be used.

titled Workshop on Geophysical Methods for Transportation Applications.

Applications

Geophysical techniques present incredible diversity in how they may be applied. A particular number of applications tend to be used much more than others. Academic institutions and research organizations are constantly striving for better use of existing technology (i.e., techniques) to solve engineering applications. Table 1 identifies a basic or general approach that can be taken to select a primary (P) or a secondary (S) geophysical technique that could be applied on common transportation project objectives. It is not intended to be inclusive of geophysical methods or techniques, nor geotechnical-related investigation objectives. However, it covers the majority of needs for geotechnical engineers and for the state-of-the-practice geophysical methods. Often, multiple geophysical methods (e.g., seismic and electrical) are selected to satisfy project objectives. In many cases it is because the physical contrasts may be better imaged with one method versus the other; however, under specific site conditions, the two methods may complement one another to meet the objective. Table A1 (Appendix A) is another tool, developed for

the previously mentioned FHWA workshop, that can aid in the selection of appropriate geophysical techniques. It is beneficial to go through the form, step-by-step, and arrive at a method that best suits the geologic and cultural setting, the surface conditions, and most importantly the type and size of the target. This tool for selection of geophysical methods and/or techniques is not comprehensive; however, it will be useful to engineers and geoscientists to start a project with the same level of understanding regarding the site and objectives.

Standards

Mayne et al. (19) provides a good overview of geophysical procedures for acquiring quality data. This report is a National Highway Institute publication that discusses the approach for field work and data processing, yet leaves flexibility for the varying site conditions that inevitably occur with field studies. Since 1995, ASTM has produced 15 documents regarding the acquisition and processing of geophysical data for both surface and borehole methods (20). Table 2 presents the ASTM Guides and Standards that have been published for the particular geophysical techniques. Note that only two are Standard Test Methods (Crosshole—D4428 and Resistivity—G57), whereas the other 13 are identified as Standard Guides. The rationale for

TABLE 2
GUIDES AND STANDARDS FOR GEOPHYSICAL INVESTIGATIONS

Geophysical Methods and Techniques	ASTM Guide*
Standard Guide for Selecting Surface Geophysical Methods (included in this guideline are the following techniques)	D6429
• Seismic refraction	
• Seismic reflection	
• D.C. resistivity	
• Induced polarization (IP) or complex resistivity	
• Spontaneous potential (SP)	
• Frequency-domain electromagnetics (FDEM)	
• Time-domain electromagnetics (TDEM)	
• Very low frequency (VLF) electromagnetics	
• Metal detectors and pipe/cable locators	
• Ground penetrating radar (GPR)	
• Magnetics	
• Gravity	
Standard Guide for Conducting Borehole Geophysical Logging	D5753
Seismic Refraction	D5777
D.C. Resistivity	D6431
Frequency-Domain Electromagnetics (FDEM)	D6639
Time-Domain Electromagnetics (TDEM)	D6820
Metal Detectors	D7046
Ground Penetrating Radar (GPR)	D6432
Gravity	D6430
Seismic Reflection	In press
Mechanical Caliper-Borehole Logging	D6167
Gamma-Borehole Logging	D6274
Electromagnetic Induction	D6726
Neutron-Borehole Logging	D6727
Geophysical Methods and Techniques	ASTM Standard*
Crosshole Seismic Testing	D4428
Soil Resistivity Testing	G57

*Refer to Topical Bibliography for references.

guides versus standard testing procedures is simple; geophysical investigations require adaptation to the site conditions and the target to be identified. ASTM Standard Tests are rigid, whereas Standard Guides allow the operator some flexibility to acquire data that will meet the objectives of the investigation. Most people are not aware that ASTM Guides and Standards are available for geophysical testing. ASTM D6429 serves the industry as a guide for selection of appropriate geophysical methods based on objectives and setting. Several more are in

development and review through the ASTM committee process. ASTM Guides and Standards referenced in Table 2 are listed in the Topical Bibliography. AASHTO published a comprehensive manual in 1988 outlining the complex and diverse techniques for conducting subsurface investigations for transportation programs (21), and it includes the most common geophysical investigation techniques used in the late 1980s. Currently, there are no published AASHTO standards for acquiring or processing geophysical data.

INFORMATION SOURCES AND GENERAL RESPONSES

This chapter details the approach used for this synthesis in gathering specific information regarding the use of geophysics among state DOTs and selected federal and Canadian transportation agencies. General data regarding the demographics of who is involved with geophysical investigations, the way geophysics is implemented within these agencies, knowledge of available resources, and the amount of work performed annually will be discussed.

Data collection for this synthesis was undertaken in the following sequential process:

1. A 63-question electronic survey was developed using primarily a multiple-choice selection and was produced as an electronic questionnaire for e-mail distribution.
2. Fifty-one U.S. state DOTs (including the District of Columbia), 8 federal agencies, and 11 Canadian provinces (a total of 70 agencies) were requested to complete the questionnaire.
3. As responses were received, particular DOT or Canadian respondents were contacted for additional questions or a brief interview. Interviews were focused on either clarifying any discrepancies found in the questionnaire or to discuss the opportunity to obtain additional information (e.g., case histories).
4. Agencies that did not reply within several months were recontacted individually. During this process it was determined that the initial state representatives were no longer at their jobs (i.e., promotions, retirement, left the agency, etc.), e-mail addresses were incorrect as a result of changed names or extensions, or the questionnaire was sent to a person who was too busy or not interested in responding. In every case, another person was selected to complete the survey.
5. Data were entered into Microsoft Excel for information management and development of graphical illustration of the results.
6. Quality controls of the questions, responses, and charts and tables were established.
7. All the results from steps 5 and 6 are presented in Appendix C, but selected charts are presented in the text. Additionally, a few questions requested written comments, and these comments are included in tables in Appendix C.

Appendix B includes the entire electronic questionnaire as distributed. Appendix C provides graphical and tabular

summaries of all the survey responses. A total of 63 agency responses, 90% of the questionnaires sent to agency representatives, were returned.

The completed questionnaire received from the Port Authority of New York & New Jersey was not solicited, and Colorado, Michigan, Oregon, and Alberta each replied with at least two completed surveys. Almost 40% of the responses received were obtained by means of a personal communication requesting that someone within the agency other than the initial recipient of the questionnaire complete the survey. Replies were received from all 50 state DOTs, plus the Port Authority of New York & New Jersey and the District of Columbia (52 U.S. agencies). Seven of 11 Canadian provincial agencies plus the municipality of Edmonton also replied. In addition, three U.S. federal agency responses are represented in this synthesis. No effort was made to solicit responses from municipal, county, or other nonstate agencies (i.e., Edmonton's response was not solicited).

It was necessary to first identify who among the 63 respondent agencies is not currently using geophysics. Figure 1 (chapter one) identifies the total number of responses and denotes the agency distribution of nonusers. Approximately 12% of state DOTs, 25% of Canadian transportation agencies, and 33% of federal agencies indicated that they do *not* use geophysics in their programs. To maintain a relatively uniform analysis process, the agencies that do not use geophysics were not included in the remaining analysis. Figure 2 shows the distribution of agency response by the percentage of the remaining 58 respondents that do implement geophysics on their transportation projects. Ninety-five percent of the respondents discussed throughout this synthesis are either U.S. state or Canadian provincial DOTs.

During creation of the database it quickly became apparent very that (1) not all respondents answered all of the questions; (2) some respondents completed questions with multiple answers, when only one answer was requested; and (3) in a few cases both "Yes" and "No" answers were applied to the same question. Discretion was used and the interviews helped, but not in all cases. Therefore, for each chart presented there is an *N* value in the corner of the graph or in the caption that indicates the actual number of reliable answers used to assess the overall response to that particular question. For most of the questions the results are based on 58 respondents (i.e., completed questionnaires from agencies that *use* geophysics), but

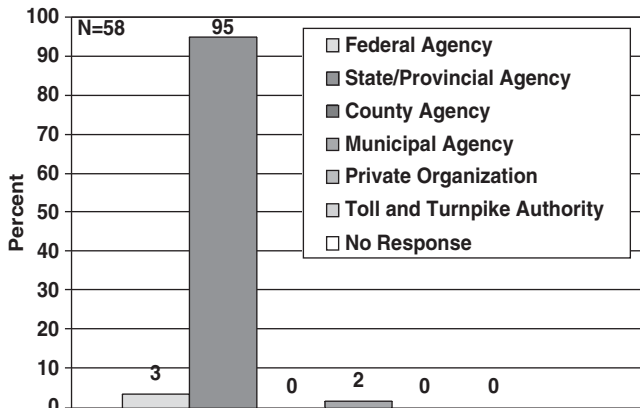

FIGURE 2 Type of transportation agency or organization that implements geophysics on transportation projects.

the *N* value is necessary to understand the result. This is particularly true for questions that recommended multiple responses (e.g., Questions 17, 22, and 24).

Figure 3 shows that 68% of respondents apply geophysical technologies on an “occasional” basis for their projects. This indicates that the number of transportation agencies using geophysics is high, but its frequency of use is quite low. Results from Part 1 of the survey are presented in graphical format in Appendix C, Part 1—General.

Part 1 of the questionnaire is summarized here:

- Forty-five percent of the agencies have used geophysics only in the past 10 years, 26% in the past 5 years, and just under 10% in just the past year (Question 1).
- Those primarily using geophysics are the geotechnical engineers and geologists (64%) (Question 2).
- Only 4% (three agencies) provide any training related to geophysics (Question 4).
- Fourteen agencies conduct between 75% and 100% of the geophysics with in-house capabilities, 24 agencies do 75% to 100% of their investigations using Request for Proposal (RFP) contract procedures, and 7 agencies con-

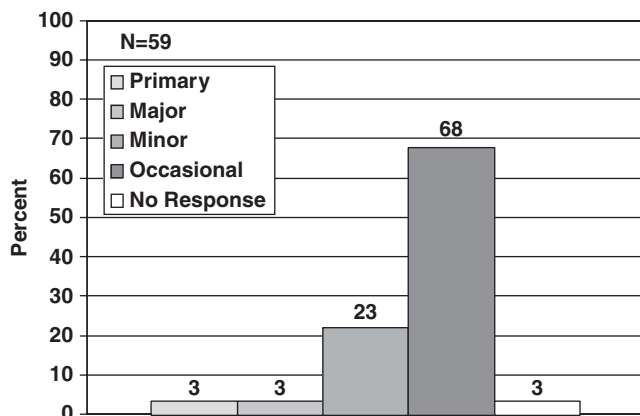

FIGURE 3 Involvement with geophysical investigations.

duct 75% to 100% of their geophysical investigations using Indefinite Quantity (IQ) contracts (Question 3).

Regarding the recently published (2003) FHWA *Geophysics Manual (10)* designed specifically to aid state, federal, and other highway engineers use and learn more about how to apply geophysics on their projects:

- 69% are aware of the manual,
- 46% own the manual,
- 14% have used the hardcopy version,
- 16% have the CD-ROM version,
- 5% use the CD-ROM,
- 50% know of the website, and
- 24% use the website for project work.

This demonstrates the need to better spread the word and educate transportation agencies about the manual and the value of this publication (in all of its formats). As more engineers are exposed to the website, more will understand its purpose and put it to use. Because 53% of the agencies conduct between one and five geophysical investigations per year (Figure 4), there is reason to believe that the FHWA manual may help increase this number.

As Figure 5 shows, nearly 60% of respondents indicated that the use of geophysics has been increasing in their agencies over

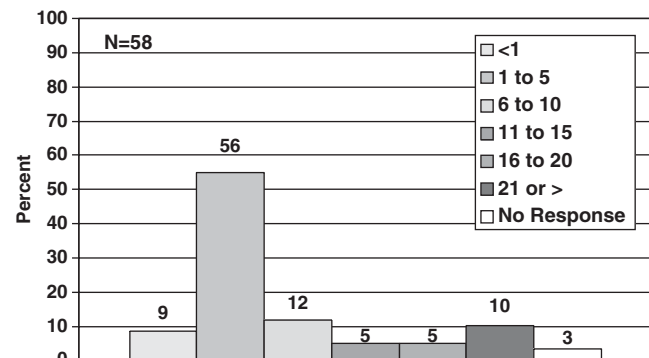

FIGURE 4 Typical number of geophysical investigations conducted by agencies each year.

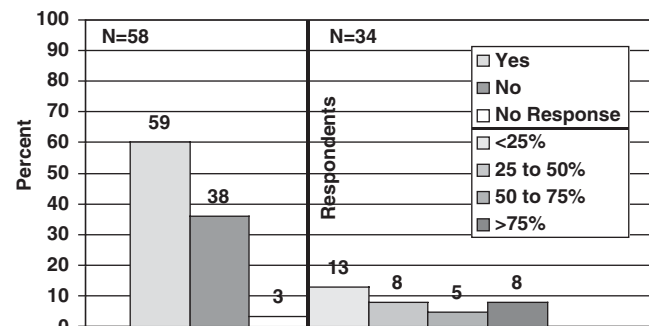

FIGURE 5 Percentage of increase in level of effort for geophysical projects over the past 5 years.

the past 5 years, and 13 agencies (of those answering “Yes”) showed an increase in use of greater than 50%. The FHWA manual and other educational efforts could continue this trend, because 66% of the respondents and 54% of the agency’s experiences are favorable toward the use of geophysics (i.e., “good” to “excellent” responses for Questions 14 and 15).

Questions 16 and 17 are two of the most important questions for this survey. If the agencies that do not use geophysics can understand the “greatest value” of implementing geophysical techniques currently used by their fellow DOTs, as shown in Figure 6 (Question 16), more are likely to implement the technology. The data in Figure 6 support the technical panel’s supposition that it is cost, acquisition speed, and better subsurface coverage that are the primary benefits to a field program when geophysics is included. Figure 7 shows that some (14) believe it is the expense aspect of a program that may restrict its use, but the results indicated that a large portion admit that the low usage is the result of a lack of understanding and/or confidence in the technology.

This synthesis is focused on the use of geophysics for geo-technical projects. However, because NDT technologies overlap with the methods and technologies discussed herein, it was crucial to distinguish the two and determine that the respondents knew the difference, as defined by the question-

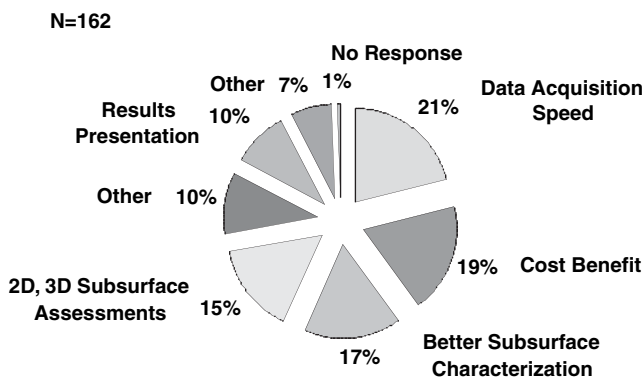

FIGURE 6 Greatest value geophysics lends to agency transportation projects.

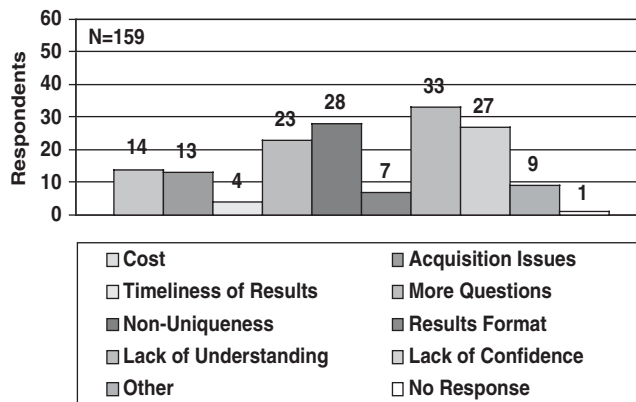

FIGURE 7 Greatest deterrent to using geophysics on transportation projects.

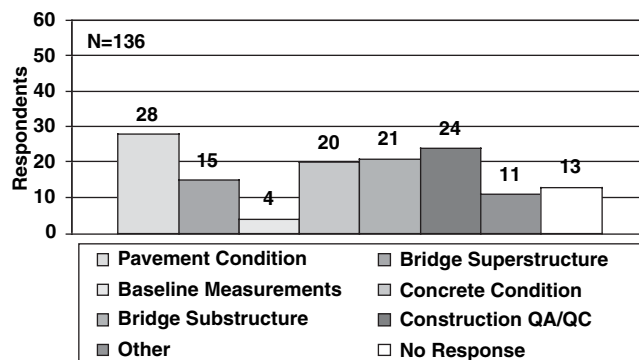

FIGURE 8 Types and percentages of applications used for NDT in the past 5 years.

naire and discussed in chapter one. With 91% reporting that they understood the difference (see Question 18), the remainder of the synthesis can reliably discuss issues regarding the application of geophysical technologies. It will be shown, however, in later chapters that there is overlap and that there is still confusion whether a field investigation is geophysics or NDT. The distinction and understanding of the difference will only come with training, time, and experience. NDT is being used quite frequently by respondents of this survey, as indicated by Figure 8. The broad range of applications used during the past 5 years indicates its value to the engineering community.

AGENCY PRACTICE—METHODS AND APPLICATIONS

This chapter focuses on the compiled results of Part 2 (Methods and Applications) of the questionnaire. Part 2 contains data gathered through the responses and interviews, and covers the main issues related to what geophysics is being used, how it is being applied, and who approves its use.

GEOPHYSICAL METHODS AND TECHNIQUES

Results from Questions 21 through 27 are presented graphically in Appendix C, Part 2—Methods and Applications. Figure 9 displays the geophysical methods most commonly used by the respondent agencies based on results from Question 22. It is apparent from this chart that the use of NDT is incorporated with geophysical methods, likely as a result of the overlap between the technologies (e.g., crosshole seismic for shear wave velocity versus crosshole sonic logging for drilled shaft integrity). The questionnaire allowed for significant flexibility in completing Question 22; therefore, responses varied considerably. The responses to “. . . the three most commonly used methods . . .” are categorized by the 10 surface geophysical methods defined in Question 21 (a through j). This simplified the answers and allowed for a graphical representation of the data shown in (Figure 9).

Seismic and GPR methods make up greater than 50% of the overall usage of geophysics among transportation agencies. Significant results are that (1) vibration monitoring represents a high percentage of use (22%), (2) electrical resistivity ranks fourth at approximately 10%, and (3) there is an obvious lack of EM methods used. A number of “other” methods were designated by respondents that do not fit the primary methods and they are listed along with all the responses in Table C1 in Appendix C.

Results from Questions 21a through 21i also indicated that seismic, GPR, and vibration monitoring are the most commonly used methods. Electrical, borehole logging, and a myriad of other methods are actively used. Magnetic methods have been used by 12 agencies and microgravity by 5. Refraction and borehole seismic techniques (crosshole and downhole) are the most common seismic techniques. Two-dimensional profiling is well ahead of any other electrical technique commonly used. Time-domain and frequency-domain electromagnetic techniques are applied about equally, although very infrequently. Marine and airborne geophysical investigations appear to be very rarely conducted. Vibration monitoring is equally

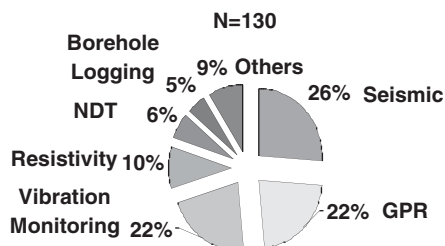

FIGURE 9 Most commonly used geophysical methods (51 agencies completed Question 22).

split by technique for construction monitoring (e.g., pile driving and dynamic compaction) and blast monitoring (e.g., rock mass excavation and quarry operations).

APPLICATIONS FOR GEOPHYSICAL INVESTIGATIONS

Results from Questions 23 and 24 deal specifically with the application of geophysics on projects. Figure 10 displays the most common applications for which geophysics is used by the respondent agencies. A footnote to this figure is required because almost 25% of the applications described in the responses to this set of questions fall into the NDT category. It was established that NDT was not a focus of this synthesis; however, this figure shows that the difference between the application of NDT or geophysics continues to be confusing. Similar to the results from Question 22 (Figure 9), Question 24 was worded in a way that allowed substantial freedom for the responses. As with Question 22, these responses were categorized based on the applications defined in Question 23. This allowed the variety of responses to Question 24 to be limited to the graphical presentation shown in Figure 10.

The responses were categorized on a general basis determined by the variety and different descriptions of applications. For example, “mapping depth to rock,” “mapping topography of rock,” or “mapping bedrock strength” were all placed in the bedrock mapping category. The categorization permitted a better illustration of the responses to this question. All the responses are listed in Table C2. Actual values for each particular application are shown in separate charts in Appendix C (Questions 23a through 23h). Questions 23 and 24 all indicate that one-third of the geotechnical applications involved the use

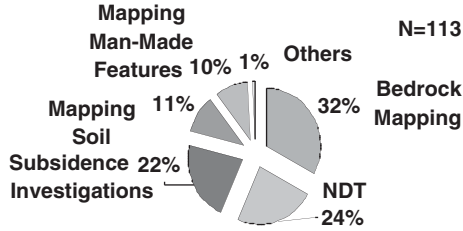

FIGURE 10 Most common applications of geophysics (50 agencies completed Question 24).

of geophysics to map bedrock characteristics such as depth, topography, or rippability. Numerous other applications, including a large representation of NDT applications, were provided by the respondents. As might be expected, roadway subsidence issues and soil mapping are dominant applications as well.

SELECTION CRITERIA AND APPROVAL FOR GEOPHYSICAL INVESTIGATIONS

Often the application of geophysics is warranted for a project; however, the particular method or technique may or may not be immediately obvious or a combination of methods might need to be determined to best meet the objective(s). Transportation agencies were queried about who helps select the appropriate method when geophysics is being proposed on a project. Figure 11 identifies the distribution for this responsibility selected. The data show that prior experience by the agency or the individual plays the key role in a selection process; however, it is quite evenly distributed between in-house geophysicists, engineers, and contractors. All the professional experience and other factors should assist in the method selection process. There appears to be a reasonable amount of “selection-by-committee” (i.e., no formal approach) as well.

The authorization process, and who is responsible for the authorization, is equally important for geophysical investigations. Figure 12 identifies who is typically responsible for approving the “appropriate” use of geophysics on a particular

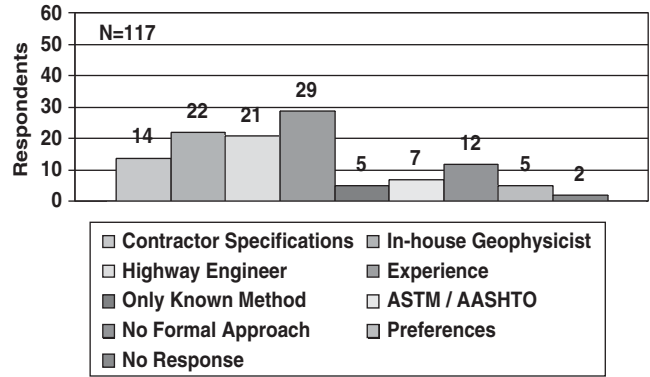

FIGURE 11 Individual who recommends the overall approach to the selection of the appropriate geophysical method.

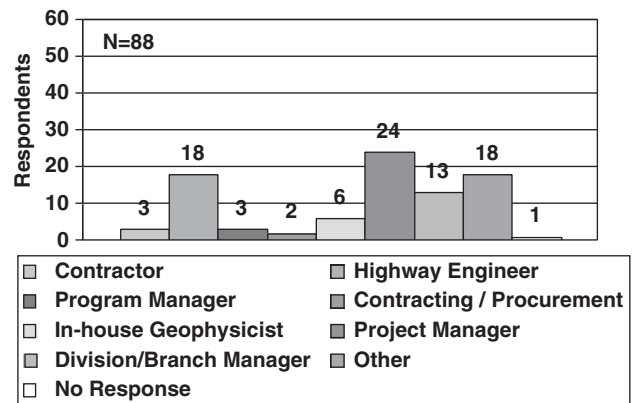

FIGURE 12 Individual who approves the appropriate geophysical method.

project. As expected, either the project or program manager or the highway engineer typically approves the selection. Based on these results, it is likely that an in-house or a contract geophysicist who selects the method(s) does not have the authority to approve its use.

Table C3 lists other comments regarding experiences with the methods used, the applications, and the selection of appropriate geophysics for projects that are not covered in this section.

AGENCY PRACTICE—BUDGETING, COSTS, AND CONTRACTING

This chapter discusses results and data gathered in Parts 3 (Budgets and Costs) and 4 (Contracting) of the questionnaire. It focuses predominantly on identifying if money is allocated for geophysics, who allocates it, how much money is allocated versus money spent, and different approaches agencies may have for contracting geophysical services. Graphical and tabular responses used for this chapter are included in Parts 3 and 4 of Appendix C.

BUDGETING AND COSTS

Fiscal budgets are critical to operations of state and federal agencies, particularly DOTs where unexpected events significantly affect annual budgets. A series of questions regarding allocation of funds and appropriation of funding were expected to reveal the approach taken by transportation agencies toward spending money on geophysical investigations. However, Figure 13a shows that geophysics is a low priority for funding. In general, geophysics simply does not get annual appropriation of funds at the agency level, primarily because the investigations are typically paid for through geotechnical investigation funds (TRB Technical Panel, personal communication, June 2005). Only 23% of the respondent agencies allocate any funds, and 67% of transportation agencies do not appropriate any funds for geophysics. Four respondents (California, New Mexico, Texas, and Washington State) appropriate a significant annual budget, in excess of \$100,000.

Figure 13b shows the level of money spent annually from “Other” sources, because the fiscal budgets of transportation agencies do not include geophysics. The amount of money that is required to complete geophysical investigations is less than \$50,000 annually at almost 50% of the agencies (Figure 13b). Results indicated that 63% of the respondent agencies use less than \$100,000 from other funding sources and 10% use funds in excess of \$100,000. Several respondents replied that although there are no independent funds allocated for geophysics, there are very large annual budgets for geotechnical investigations from which geophysics does get funded. Table C4 presents comments regarding budgets and funding at the respondent agencies. Figures 13a and b indicate that agency money spent on geophysical investigations is not allocated and not budgeted separately; therefore, it must eventually come from either the Design and Construction Branch budget or

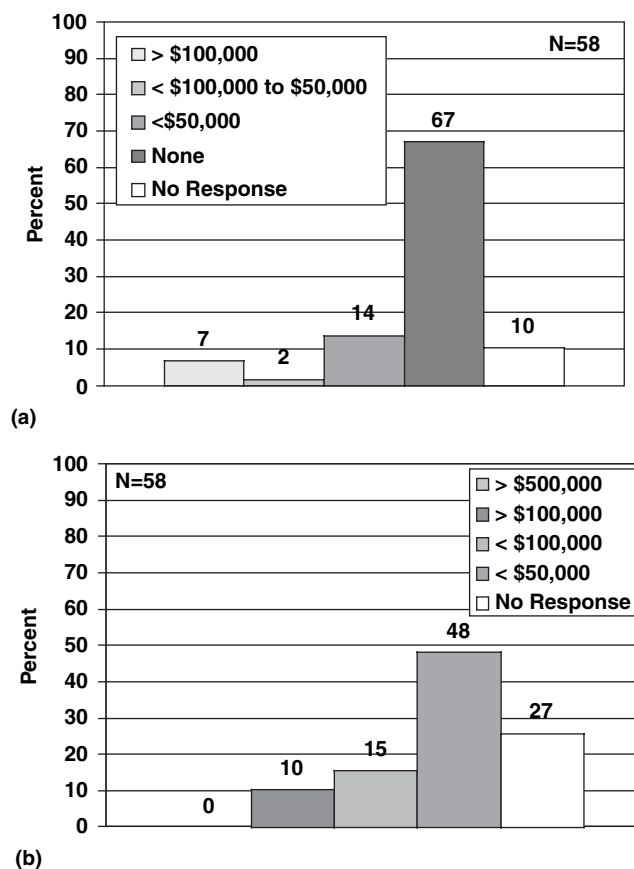

FIGURE 13 (a) Annual budget allocated to geophysical investigations; (b) annual funding from “other” funding sources for geophysics.

from emergency funds and “Other” sources. It is the Design Branches that carry the largest share of funding, although construction branches also fund the use of geophysics (refer to Question 34, Appendix C). When it comes to who makes decisions for budgets and approval of funds for geophysical investigations, it is primarily at the division or branch manager level, with only approximately 10% of the decisions being made at the agency level. However, approximately 30% of the time decisions regarding budgets (for projects) are made by a project manager or highway engineer (Figure 14).

This synthesis has demonstrated that among most agencies the use of geophysics has increased over the past 5

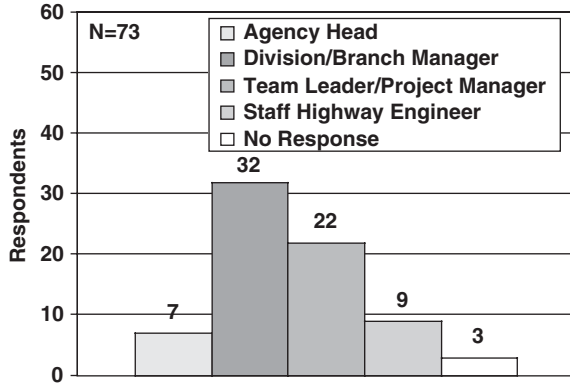

FIGURE 14 Decision maker for budget related to the use of geophysics.

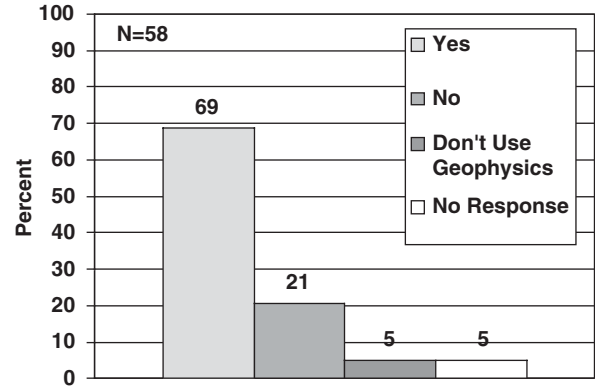

FIGURE 16 Use of standard, proven, state-of-the-practice geophysical methods.

years (see Figure 5). In addition, the results also indicated that cost-benefit (see Figure 6) is a major reason to perform such investigations. It appears likely that the approach taken to fund geophysics may change as its use becomes more routine, as it is for example in California and Saskatchewan. Significantly, when asked to predict how much will be spent during the current fiscal year (i.e., Question 33), the results indicated that more than half of the agencies (55%) have “no way to estimate” (Figure 15), and that 22% will spend less than \$50,000. Eleven agencies plan to spend more than \$100,000 in fiscal year 2005 on geophysical investigations.

Funding for research into geophysical applications is limited. Only 7% of transportation agencies allocate annual funds for geophysical research and this funding supports either educational or commercial institutions. A few final comments regarding spending and use may be drawn from Part 3 of the questionnaire:

- Nearly 70% of transportation agencies will *only* use “proven, state-of-the-practice geophysical methods” (Figure 16).

- Cost, skepticism, and lack of management buy-in are the primary reasons that transportation agencies limit the implementation of “leading edge or state-of-the-art geophysical methods” on their geotechnical projects (Figure 17).
- Twenty-six percent of the respondent agencies indicated that the cost of doing geophysics hinders agency staff from using it on their geotechnical projects (Figure 18).
- Figure 19 identifies the typical range of cost per investigation as well as the number of investigations performed at that spending level. Geophysical projects costing less than \$10,000 dominated the results.

CONTRACTING

Part 4 of the questionnaire dealt with contracting, in-house capabilities to perform geophysical investigations, contractor selection and award processes, and what would make DOTs more comfortable with geophysics. Results from this section are presented in Tables C5 and C6 and charts in Appendix C—Part 4. Table 3 identifies the position (i.e., title) of the in-

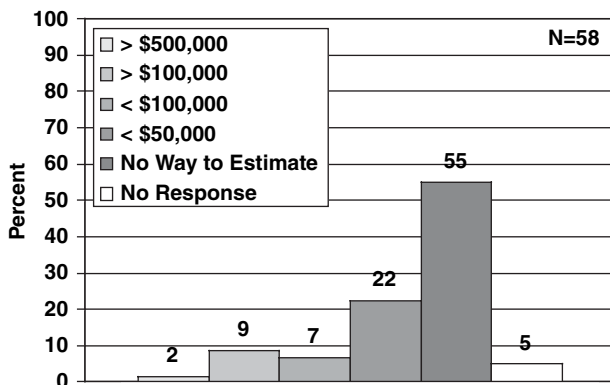

FIGURE 15 Prediction of money to be spent in fiscal year 2005 on geophysics.

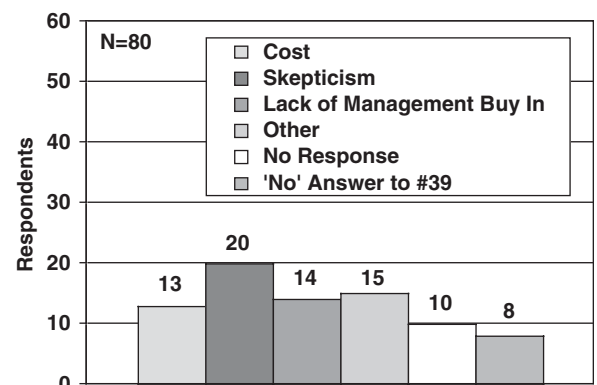

FIGURE 17 Rationale for not using leading-edge or state-of-the-practice geophysical methods.

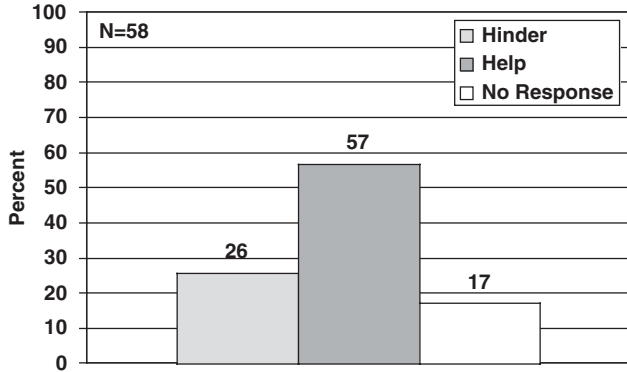

FIGURE 18 Costs related to geophysics hinder or help your highway engineering staff.

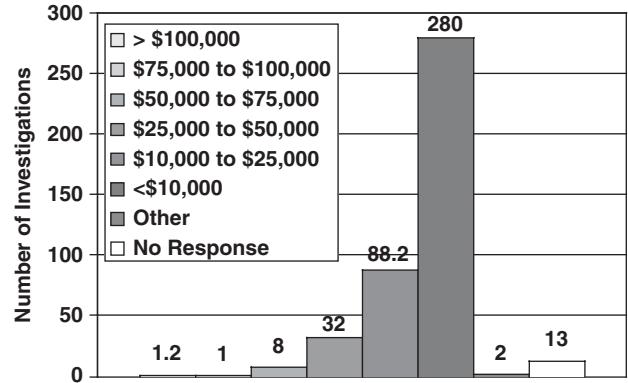

FIGURE 19 Typical cost range of investigations and the number per year at that cost level.

dividuals who are responsible for preparing RFPs and also shows how they are developed. The trend is for staff geologists or engineers to prepare the RFPs, with the exception of some supervisors or consultants enlisted to assist. In addition, although RFPs are prepared primarily by experienced staff or

consultants, they are most often done on a project-by-project or case-by-case basis.

State, federal, and Canadian transportation agencies all appear to contract out a major portion of the geophysics work to

TABLE 3
WHO PREPARES RFPs AND HOW THEY ARE PREPARED (Response to Question 43)

Agency	Who	How
AKDOT	Supervising geologists or engineers	N/R
AZDOT	Geotechnical design engineers	N/R
CALTRANS	Designated project lead	Internal consultation and review by geophysics branch
CFLHD	Geotechnical engineer	Personnel knowledge
CODOT	It varies—project design staff, geotechnical staff, or others	N/R
CODOT	Staff	Past projects and revised because of problems
CTDOT	It is usually someone at a project engineer level, from whatever group is interested in getting the information. It could be the geotech, structures, or pavement of design group that could develop the RFP	N/R
DCDOT	Design consultant	N/R
Edmonton	Project manager	Incorporated as addendums or special provisions to a standard contract
FLDOT	Geotechnical engineer	Either through project scope of service or through a district-wide contract (not efficient because prime consultant hires a sub-consultant to do work and charges an overhead/admin. fee)
GADOT	Geotechnical engineer/manager	Open-ended contracts (Infinite Delivery/Infinite Quantity)
HIDOT	Design Branch	N/R
IADOT	Design Office	Previous examples/usages
IDDOT	Project manager	N/R
ILDOT	Geotechnical engineer	Consulting with specialty subcontractor
INDOT	Designers	N/R
KSDOT	Chief geologist	In-house
KYDOT	Project engineer	Based on previous contracts
MADOT	Geotechnical engineer	In-house

TABLE 3 (continued)

Manitoba	Geotechnical engineer	Use the department's template
MDDOT	Chief, Engineering Geology Division	N/R
MEDOT	Geotechnical engineer	N/R
MIDOT	Project manager	Mostly boiler plate format tailored to specific project
Ontario	Regional supervisor	Standard RFP
MODOT	Geotechnical section	Working with university personnel or with consultant personnel for firms on contract list
MTDOT	N/R	In-house personnel perform work
NDDOT	Research section	N/R
New Brunswick	Me	N/R
NHDOT	Research geologist	Supplemental provisions
NJDOT	In-house/consultants	N/R
NMDOT	Geotechnical manager	On-call contracts
OHDOT	Our office or district managing engineer	Text document
ORDOT	Project geologist/engineer	N/R
ORDOT	Project geo-personnel	Case-by-case basis
Port Authority NY/NJ	Geotechnical engineer	Discussion with geophysical specialist or engineer
Quebec	Geotechnical engineer	N/R
Saskatchewan	Pavement engineer for GPR	Past experience
SCDOT	Consultant written, reviewed by geotechnical engineer	N/R
SDDOT	Unsure	N/R
TNDOT	Geotechnical section	As needed
TXDOT	University writes project statement	Through interagency contracts
UTDOT	Geotech division engineers and geologists	Define the scope of work and estimate, then utilize the existing pool contracts
VTDOT	Project manager, project engineer	Generally in cooperation with vendors
WFLHD	Project geotech	N/R
WSDOT	Chief engineering geologist	Provide to the consultant liaison

Notes: N/R = no response; RFP = Request for Proposal; GPR = ground penetrating radar.

private consultants. Figure 20 shows that there are just seven agencies that use qualified in-house staff to perform geophysical investigations (not necessarily geophysicists, but staff with experience conducting investigations), and that 23 use both in-house and contractors. Slightly less than 50% use only private contractors. Because there are a fair number of agencies that conduct their own geophysical investigations, Questions 46 and 47 asked if the equipment and software was owned or rented. The results indicated that 50% of the agencies do own the necessary equipment and software; however, they noted that it was equipment selected for particular methods and/or applications.

When using private contractors, the agencies noted that the most common form of solicitation is “limited solicitation,” as shown in Figure 21. Limited solicitation refers to sending RFPs to prequalified, preselected contractors, and contractors with whom the agency has had previous experience and therefore are confident in working with them.

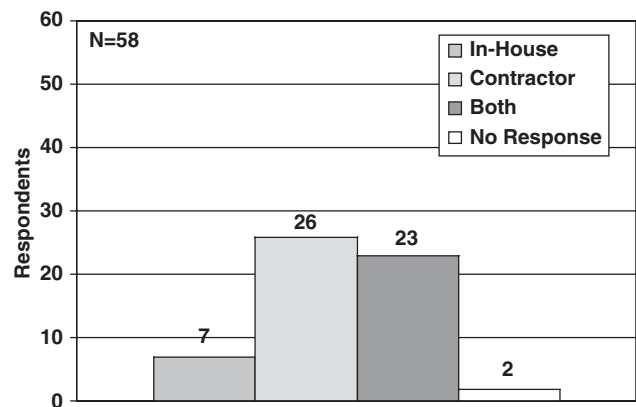

FIGURE 20 Use of in-house or contract geophysicists.

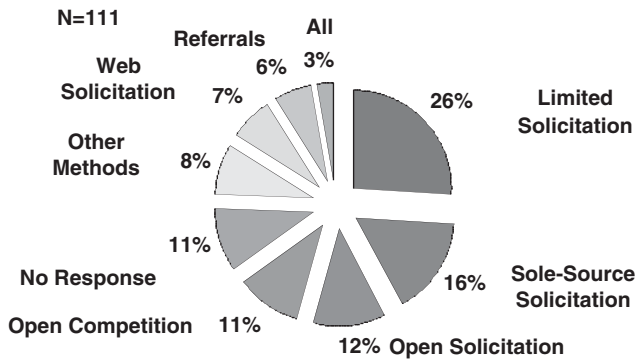

FIGURE 21 Type of RFP solicitation is used by your agency.

Figure 21 also shows that sole-source solicitation is the second most common approach to procuring service providers. Open competition and (open) web solicitations represent approximately 18% of the response. Answers to Question 49 revealed that 26% of the agencies use large Indefinite Delivery/Indefinite Quantity (ID/IQ) and “on-call” contract vehicles. These ID/IQ contracts allow for rapid access to the vendors who are technically qualified, and once the contract has been awarded by the agency it limits the task order (i.e., RFP) and the purchase order (i.e., procurement) process. The respondents indicated that the typical length of an ID/IQ and on-call contract is from 2 to 3 years, and ranges from \$100,000 to \$300,000 in contract value (no guarantee of use). However, some contracts as large as \$4 million over 5 years using multiple private contractors have been awarded (see results in Table C6, Appendix C—Question 49).

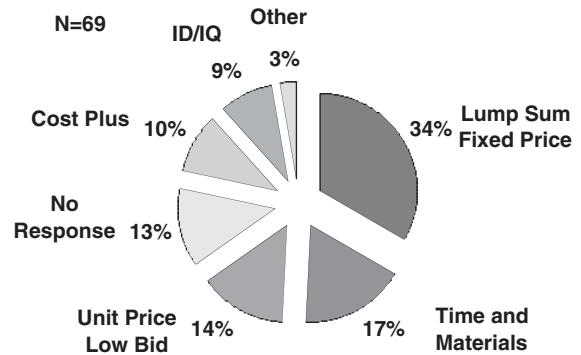

FIGURE 22 Typical type of contract for geophysical transportation projects.

In addition to the type of solicitation (see Figure 21) there is value in understanding what type of contracts transportation agencies award for geophysical services. Figure 22 shows the variety of contracts identified through answers to Question 50, and the distribution of award types. Lump-sum/fixed-price awards represent 34% of the responses, but unit price low-bid and time and materials are about even at approximately 15% each. Questions about using academic institutions to perform geophysical investigations indicated that 14% of the agencies do award “run-of-the-mill” geophysical projects to such institutions (Question 51); however, when it comes to “cutting edge” or “state-of-the-art” geophysical projects, approximately 22% use academic institutions and 29% use private/professional contractors for the projects that are more along the lines of research and development.

AGENCY PROJECT EXPERIENCE

This chapter discusses some broad issues regarding agency experience with geophysics. Areas such as the factors that affect comfort with the technology and their understanding of its application, what it will take to become more useful as a technology, and what will help geotechnical engineers become more comfortable using geophysics are reviewed. Finally, there is a brief discussion of the case histories that were supplied to this synthesis.

SUCCESSSES AND FAILURES

Part 5 of the questionnaire (Case Histories/Project Examples) solicited information regarding successful applications of geophysics, as well as the projects where geophysics did not meet the objective(s). It is important to note that projects were *not* defined as “successful” or “unsuccessful” by whether the investigation met the program budget or its deadlines; rather, success was solely based on if the geophysics met the objectives of the investigation. Figures 23 and 24 represent important results regarding agency experience. Figure 23 breaks down the total number of successful projects (714) completed over the last 5 years. This graphical presentation was necessary to cover the wide range of response values; that is, from six agencies with no successful projects to California’s more than 200 projects completed successfully over the past 5 years. Most of the agencies (49%) fall between 1 and 10 successful projects over this period. Nine agencies indicated implementing more than 20 successful geophysical projects over the 5-year period, with 2 of those agencies reporting more than 100 successful projects.

Geophysics has its limitations and a discussion was presented earlier (see chapter three) regarding appropriate use of the methods and techniques. Therefore, it is understandable that unsuccessful geophysical projects do occur. Figure 24 presents agency experience with geophysical investigations that did not meet the objectives (107 projects). Considering that there were about the same number of “no responses” as in Figure 23 for the past 5 years, the ratio of successful projects to unsuccessful projects is approximately 7:1. This indicates that geophysics is being used successfully significantly more often than not. The agency with the greatest impact on these results—the California DOT (Caltrans)—indicated approximately 40 successful and 5 unsuccessful projects per year (a ratio of 8:1), which correlates closely with the 7:1 ratio derived from all 58 agencies responding to these

questions. Therefore, based on the results of this synthesis, it appears that approximately 85% of geophysical investigations are able to meet project objectives. Table C7 lists additional comments regarding successful projects, unsuccessful projects, and the lessons learned by the application of geophysics (as generated from responses to Question 60). Two replies from this table are useful to demonstrate the value of documenting successes and failures: “Our failures have primarily occurred when a geophysicist was not consulted on the survey design or methodology, resulting in selection of an inappropriate method or the creation of a poorly defined scope of work” (Caltrans) and “Geotechnical engineers expect too much from geophysics (GPR, seismic refraction, resistivity) on every project they consider its use on (i.e., if it can’t give them the exact information they want, it is no good” (New Hampshire DOT).

Based on the information acquired for this synthesis, as well as discussions with a number of seasoned professional geophysicists, these data are representative of the overall number of successful versus unsuccessful projects. However, within the engineering community the perception of implementing geophysics would imply a higher rate of unsuccessful projects. In general, there is a wide range in the level of comfort for use of geophysics on geotechnical projects based on the responses from this questionnaire; that is, from agency to agency the level of comfort is quite different. When asked “What could be done that would increase your level of comfort to utilize more geophysics on projects?” (Question 55), the result was not surprising based on the data presented thus far, and that it had one of the lowest “no response” rates in the entire questionnaire (see Figure 25).

Figure 25 identifies six issues that could have an impact on geotechnical engineers promoting the use of geophysics on their projects. The two most-cited issues, training/knowledge and experience, are what will elevate the technology to a new level of use. That is, 81% (47 of the 58 respondents) reported these two issues as being of primary importance, and only 3% (i.e., 2) of the agencies did not. Recall that only three agencies indicated that they have formal training programs (chapter three). It is apparent that with time (i.e., experience) and additional training (i.e., conferences and short courses) other agencies will become more comfortable with the technology. Figure 25 also reveals that as the ASTM Guides and Standards (Table 2) are implemented and further developed (see “Standards”), the level of comfort among

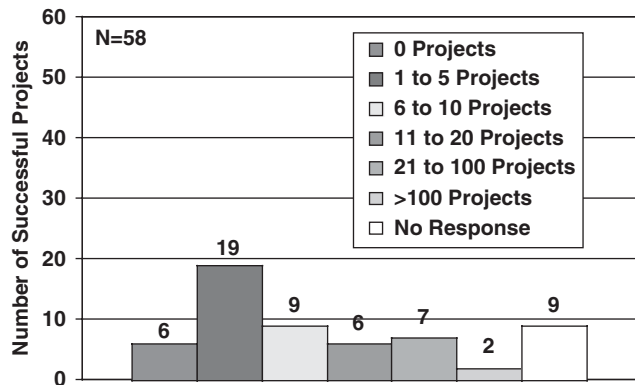

FIGURE 23 Number of successful geophysical projects within the past 5 years.

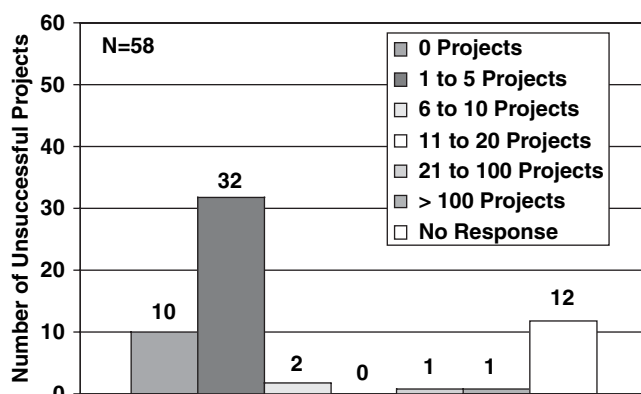

FIGURE 24 Number of unsuccessful geophysics projects within the past 5 years.

engineers will increase. Then the potential exists that more successful projects will follow owing to the correct implementation of geophysical techniques. It is interesting to note that between 50% and 60% of the agencies responded that equipment, software, and a database of “qualified service providers” would also help, although between 10% and 20% do not believe that this will be of assistance. Nevertheless, with additional training and experience these latter three is-

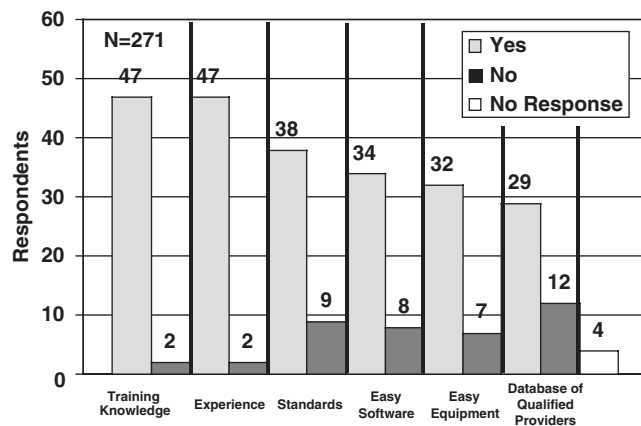

FIGURE 25 Increasing the level of comfort using geophysics.

sues will become less of a factor toward successful implementation of geophysics among transportation agencies.

CASE HISTORIES

The most acceptable approach to acquiring experience is to share successful and unsuccessful project examples. The survey asked for respondents to indicate if they would share case histories of either good or bad use of geophysics with others; 41% (or 22 agencies) replied “Yes” (Question 61). This represents a significant amount of knowledge to be shared with other like agencies. On request, 13 agencies supplied project examples for this synthesis, and 3 agencies supplied website links to more than one case history. It is clearly beyond the scope of this synthesis to present all the examples; however, they are listed in Table 4 (including the weblinks), so that interested parties may contact an agency to obtain the example(s) and learn from these other applications of geophysics to engineering problems. Based on the submitted documents, it was decided that four selected case histories would be included. Two successful (Saskatchewan and the Wisconsin DOT) and two unsuccessful (Kansas DOT and Caltrans) case histories are presented in Appendix D using a simple and patterned format to address objective, results, lessons learned, and conclusions. It is anticipated that the remaining case histories will be provided to FHWA for inclusion in their geophysics workshop for a more representative presentation regarding the use of geophysics as applied on engineering projects. Recall that an extensive literature search produced a Topical Bibliography for this synthesis that lists many more case histories for specific geophysical methods and techniques (e.g., through conference papers).

PROJECT COSTS

A portion of this synthesis topic intended to determine the cost of conducting geophysical investigations. Although a few charts were presented in chapter five relating to the range of costs, the actual expense to perform an investigation is not readily available. Both Owen (22) and Rutledge et al. (23) attempted to provide analysis of the commercial costs without the bias of being a commercial service provider. A concerted effort was recently made by Rutledge et al. (at Virginia Tech) to directly contact more than 30 well-established geophysical consulting companies within the United States with a survey/questionnaire regarding costs of performance; however, only 4 responses were received, a response rate of less than 15%. Based on discussions with Rutledge, it was determined that the conclusions were less than representative and therefore he “could not include absolute costing of geophysics in the primer, because of poor response.” Two reasons govern the inability to discuss costing: (1) contractors do not want to provide their labor rates nor their mark-up (i.e., multiplier) and (2) transportation agencies cannot compare the way they would “cost” a geophysical investigation in a fashion similar to private consultants (D. Reid, personal

TABLE 4
CASE HISTORIES SUPPLIED FOR THIS SYNTHESIS

Agency	Case History Provided by Agency	Method (Technique)	Application	Status
Caltrans	Faulting Structures for California Interstate Project Case History 1—Appendix D	Seismic (Reflection)	Detection of faulting	U
Central Federal Lands Highway Division	Lava Tubes	Seismic (Reflection) Resistivity (Ohm-Mapper) GPR Magnetics EM	Locate voids (lava tubes) beneath the ground surface and roadway	S
Colorado DOT	Idaho Springs Mineshaft, I-70	GPR	Sinkhole/ mineshaft	S
Kansas DOT	K-18 over the Kansas River Case History 3—Appendix D	Resistivity	Bedrock depth	U
		Seismic (Refraction)	Bedrock depth	U
Massachusetts DOT	Route 44 Carver, Massachusetts	Resistivity (Ohm-Mapper)	Detection of peat deposit	
Manitoba	Refraction Seismic Surveys near Falcon Lake, Manitoba	Seismic (Refraction)	Bedrock depth	S
		FDEM	Soil characterization	S
Maryland DOT	www.highwaygeologysymposium.org (multiple case histories available)			
Minnesota DOT	I35W Bridge 9613	Vibration monitoring	Establish safe vibration levels for pile driving	S
New Hampshire DOT	Report FHWA-NH-RD-12323U <i>Enhancing Geotechnical Information with Ground Penetrating Radar</i>	GPR	Bedrock depth and fractures	S
		GPR	Composition, sub-bottom profiling, and voids	U
	Rochester Bridge	Resistivity	Abutment imaging	S
		GPR	Bedrock profile	S
	NH Route 25 Warren–Benton 13209	Resistivity	Bedrock profile	S
		GPR	Subsurface characterization	S
	NH Route 102 Improvements Hudson 13743	Resistivity	Pipe	S
		GPR	Pipe	S
US Routes 4 and 202 and NH Route 9, Chichester 13922	Resistivity	Assess extent of organic soil	U	
Ohio DOT	Geotechnical Research Project Reports and Implementation Plans	www.dot.state.oh.us/research/Geotechnical.htm (multiple case histories available)		
	Construction Diary of the SR32 Mine Remediation Project Constructed 1998–1999	www.dot.state.oh.us/mines/FebMar99.htm (multiple case histories available)		
Port Authority of New York & New Jersey	Microtunneling at JFK International Airport	Seismic (Crosshole)	Microtunnel steel casings under an active runway	S
		SASW		S
Saskatchewan	Stony Rapids Airfield Case History 2—Appendix D	GPR	Runway subsidence	S
Wisconsin DOT	US Highway 53 Birch Street Interchange Site Case History 4—Appendix D	EM	Delineate landfill	S
		GPR	Delineate landfill	S

Notes: U = unsuccessful project case history; S = successful project case history; GPR = ground penetrating radar; EM = electromagnetic; FDEM = frequency-domain electromagnetic; SASW = Spectral Analysis of Surface Waves.

communication, Wisconsin DOT). Owen (22) showed hourly rates for contractors that ranged from 1.9 to 2.5 times that of the in-house rates (for GPR investigations); however, transportation agencies are not in the business of conducting geophysical investigations for profit.

Information gathered for this synthesis and results derived by Tandon and Nazarian (4) concluded that the rationale for the lack of response and the inability to present “costs per method” or “costs per project” is reasonably straightforward. Simply put, sharing the confidential information a company uses to bid projects does not serve that company’s best interests. Moreover, the cost to perform a geophysical investigation using an academic or research institution versus a private company is not directly comparable owing to the need of a private company to include profit (i.e., make money).

With that said, it is not that difficult to use assumed ranges of personnel rates and predict the number of crew members necessary for a particular technique (e.g., GPR generally needs only one person, whereas refraction can use a two- to four-

person crew depending on site conditions and schedule). Similarly, equipment daily rates can be obtained on-line from a number of manufacturers and vendors that rent geophysical instrumentation for profit. The combination of personnel rates and equipment rates can quickly yield a “crew day rate.” However, it must be made clear that the crew day rate is *less than half* of the equation in attempting to price a geophysical investigation for any of the techniques discussed in this synthesis. The most significant factor controlling project cost is the “production rate.” For example, it is the line miles per day of GPR, acres per day of EM, or number of seismic spreads per day that can be completed with quality standards that dictates the project cost. Because the site conditions (e.g., terrain and vegetation) and the objectives (e.g., depth of investigation, size of target, and aerial coverage) on nearly every project are different, so are the proposed costs to complete the survey, even with the same geophysical technique, explaining why Owen (22), Tandon and Nazarian (4), and most recently Rutledge et al. (23) and this NCHRP synthesis were unsuccessful in quantifying the actual cost to perform a geophysical investigation, specifically among commercial service providers.

CONCLUSIONS AND FUTURE RESEARCH NEEDS

The results of this synthesis are summarized in this chapter. The chapter also includes recommendations for future research regarding geophysical investigations, as defined by the respondent agencies.

The implementation of geophysical investigation techniques is increasing among transportation agencies, with project-specific applications continuing to diversify. However, there remains some skepticism among those engineers and geoscientists who are attempting to implement the technology on their projects and within their agencies. Through the use of the questionnaire, comments, interviews, and discussion of case histories, it appears that in some instances implementation of geophysics is being undertaken

- Without proper selection of the technique for the specific application(s),
- With an inadequately defined scope of work,
- With inadequate means to acquire and objectively interpret data, and
- By individuals with inadequate education or experience in the field.

These issues could be because transportation agency funding is insufficient for implementing geophysics as a reasonable alternative on field programs prior to conventional geotechnical investigation procedures (i.e., drill and sample). The synthesis indicates that typical geophysical field investigation expenditures are small (generally less than \$10,000) and at this level contracting out the service can be burdensome unless previously experienced or known contractors are available or larger Infinite Delivery/Infinite Quantity contracts can be used to award a task order with notice-to-proceed.

The synthesis identified the most common geophysical methods used by the 58 respondent agencies as (1) seismic, (2) ground penetrating radar, and (3) vibration monitoring. Generally, these geophysical methods are the most frequently used because they are best suited to resolve the majority of geotechnical engineering problems and applications for subsurface characterization. The most common geotechnical applications identified by this synthesis relate to (1) bedrock mapping, (2) roadway subsidence problems, and (3) mapping (characterizing) soil deposits.

It became clear through analysis of the literature that the distinction between nondestructive testing (NDT) and geo-

physical methods is not clear. Many times respondents included NDT technologies in their comments, responses, and examples although *geophysics* is the topic for this synthesis. Although significant overlap exists between the physics of the two technologies, it is the application that distinguishes between the two. As defined in this synthesis, geophysical techniques are applied to earth (geo-) materials, whereas NDT is applied to man-made structures.

Results indicated that the need for improved education and training is a primary concern, as well as the need for better equipment and software. Also, the development of standards could help engineers increase their level of comfort with geophysics. However, because geophysics is such a specialized field, and because engineering problems have risks associated with them, it appears that it might be some time before geophysics will be used as routinely as it is in the exploration for natural resources. That is, geophysics is the standard by which oil and gas and other natural resources (e.g., metals and coal) are located in the subsurface. It took nearly 50 years for the natural resources exploration geophysics industry to develop the tools and expertise necessary to make geophysics the primary tool that used ahead of or in lieu of conventional exploration methods.

Results from the survey questionnaire indicated that almost 50% of transportation agencies and the engineers (i.e., the end-users) have been applying geophysics technology for less than 10 years. Therefore, it should not be a surprise that obstacles such as understanding, cost, and skepticism continue to restrict its use. It is apparent, however, that the geoscientists and engineers associated with transportation programs believe that geophysics should be a user-friendly technology. Their request is for inexpensive approaches to acquire data and simple methods to objectively interpret the data. The paradox seems to be that geophysics is, by virtue, a technical and complex science. When applying theory to earth materials such as rocks and soils, which are inherently heterogeneous, the complexities compound. Engineers need to quantify material properties and site (subsurface) characteristics owing to the risk factors and safety needs associated with planning and constructing facilities used by the public. Utilizing the best available technology, or set of technologies, is appropriate when applied correctly, even if the results are qualitative and dependent on qualified individuals to produce subjective interpretations.

As shown by agencies responding to this synthesis, geophysics can aid in transportation planning and construction programs. Incorporating geophysics into geotechnical projects will simply take time, which will ultimately build a more solid base of experience. A few transportation agencies have already demonstrated the value of using this technology regularly and over extended periods of time, whereas most reported only “...occasional use.” The agencies that use it regularly understand the science and can promote the benefits within their agency. The values of geophysics as defined by this synthesis include:

- Cost-effectiveness,
- High density of measurements,
- Quick acquisition over large areas,
- The combination of two- and three-dimensional assessment, and
- Visualization of subsurface features.

As noted in the survey responses, comments, and discussions, these values and benefits will only come through education, training, and experience.

Finally, transportation agencies do not implement geophysics the same across the country and in Canada. Geologic settings, materials, and tests necessary to plan or construct transportation projects can vary greatly from state to state, from province to province, and from country to country. This is primarily the result of a lack of experience and education about the application of the technology, not the availability or cost. As costs for traditional geotechnical sampling and testing increase and the geophysical community continues to educate the end-users as well as advance its methods (hardware and software) there can be a much wider acceptance of the technology among transportation agencies. Geophysics can be used in a variety of settings, and when applied correctly can provide savings and permit quicker site assessment for geotechnical projects. Using multiple geophysical methods and integrating the data with standard geologic and geotechnical

site-specific data may ultimately lead to more consistent use of geophysics. Table C9 presents final comments from respondents concerning other items not covered by the questionnaire and general comments about the synthesis.

The final survey question (see Appendix B, Question 63) sought open comments on the future needs for geophysics technology. Comments were provided by 35% of the responding agencies and are presented in Table C8 (Appendix C). A brief review is provided here.

As anticipated, responses varied considerably for this topic; however, a definite call for standards and more educational opportunities were predominate. The Tennessee Department of Transportation respondent may have stated it best: “training, training, training, and ...training.” Development of a National Highway Institute course on the application of geophysics to geophysical problems was also a common theme. Simply put, it is through good, constructive, case-history education (i.e., experience-driven) that transportation agency engineers throughout the United States and Canada will be able to fully make use of existing state-of-the-practice technologies and appropriate applications of geophysical methods to help solve transportation-related problems. In addition, the development of “off-the-shelf” methods and applications appears to be a need, as well as easy-to-use (inexpensive) field instrumentation and software tools for interpretation. The most frequent comment regarding a particular geophysical technique involved more research into surface wave methodologies and applications (i.e., Spectral Analysis of Surface Waves, Multi-Channel Analysis of Surface Waves, and microtremor methods such as ReMi). Within the geophysical industry, these are among the most significant emerging technologies and their applications are just being realized. In addition, it was evident that an understanding of the difference between geophysics and NDT, the similarity of the physics applied, and the similar nature of applications needed by engineers will overlap until additional educational opportunities exist for the two technologies.

GLOSSARY

- Accelerometer**—device that converts the effects of mechanical motion into an electrical signal that is proportional to the acceleration value of the motion.
- Alluvium**—general term for unconsolidated material (e.g., clay, silt, sand, or gravel) deposited from running water. Often a sorted or semi-sorted sediment in the bed of a stream or on its flood plain or delta. Deposit may be in the form of an alluvial fan.
- Analytic signal**—automated function that enables one to determine analytic signal depth solutions from gravity and magnetic profiles.
- Anomaly**—deviation from uniformity in a physical property.
- Apparent resistivity/conductivity**—resistivity of a homogeneous isotropic ground that would give the same voltage/current or secondary/primary field ratios as observed in the field with resistivity or electromagnetic methods. The apparent conductivity is the reciprocal of the apparent resistivity.
- Aquifer**—rocks or unconsolidated sediments that are capable of yielding a significant amount of water to a well or a spring.
- Aquitard**—geologic formation(s) of low hydraulic conductivity, typically saturated, but yielding a limited amount of water to wells. Also referred to as a confining unit.
- Bedrock**—general term referring to rock that underlies unconsolidated material.
- Bulk modulus**—gives the change in volume of a solid substance as the pressure on it is changed. The bulk modulus for a solid substance is its resistance to change volume under pressure.
- Common Mid-Point (CMP) survey**—seismic reflection technique for detecting geologic boundaries.
- Complex resistivity (CR)**—geophysical effect, also the basis of the CR method, in which polarization within the medium results in the voltage and applied current being out of phase—that is, their ratio is complex. Also known as spectral induced polarization (IP). IP is one form of complex resistivity.
- Conductance**—product of conductivity and thickness (Siemens).
- Conductivity (electrical)**—ability of a material to conduct electrical current. In isotropic material it is the reciprocal of resistivity. Units are Siemens/m.
- Crosshole**—geophysical methods carried out between boreholes (see also tomography).
- Crosshole seismic**—seismic method between boreholes using a source in one borehole and a receiver in two or more boreholes to measure the P- and S-wave velocities of the strata within the borehole.
- Detector**—can be any kind of a sensor used to detect a form of energy, but usually refers to nuclear detectors, such as scintillation crystals.
- Dielectric constant**—measure of the ability of a material to store charge when an electric field is applied.
- Dipole**—pair of equal charges or poles of opposite signs.
- Elastic properties**—elastic properties specify the stress–strain properties of isotropic materials in which stress is proportional to strain. They include bulk and shear moduli.
- Electrode**—piece of metallic material that acts as an electric contact with a nonmetal. In chemistry, it refers to an instrument designed to measure an electrical response that is proportional to the condition being assessed (e.g., pH, resistivity).
- Electromagnetic (EM) method**—method that measures magnetic and/or electric fields associated with subsurface currents.
- Electromagnetic wave**—electric field associated with subsurface currents.
- Field**—space in which an effect, such as gravity or magnetism, is measurable.
- Frequency domain**—in geophysics, refers to measurements analyzed according to their constituent frequencies. The usual alternative is time–domain measurement.
- Gamma**—common unit of magnetic field intensity, equal to one nanoTesla (a Tesla is the SI unit). The Earth’s magnetic field strength is about 50,000 gammas (γ) in mid-latitudes.
- Geophones**—in seismic geophysical methods, receivers used to record the seismic energy arriving from a source.
- Gravity**—lateral density changes in the subsurface cause a change in the force of gravity at the surface. The intensity of the force of gravity owing to a buried mass difference (concentration or void) is superimposed on the larger force of gravity owing to the total mass of the earth. Thus, two components of gravity forces are measured at the Earth’s surface, total field, and second, a component of much smaller size that varies as a result of lateral density changes (the gravity anomaly).
- Ground penetrating radar (GPR)**—geophysical method in which bursts of electromagnetic energy are transmitted downwards from the surface, to be reflected and refracted by velocity contrasts within the subsurface. Also known as ground probing radar.
- Induced polarization (IP)**—geophysical effect whereby electrical charge is momentarily polarized within a material, usually a disseminated ore or a clay. This effect is the basis for the IP method, in which a decaying voltage owing to this polarization is measured following the turn-off of the activating current in time–domain surveying. See also complex resistivity.
- Induction (EM), induce**—process, described by Faraday’s Law, whereby a variable magnetic field generates an electric field (voltage) that, in the presence of a conductor, will produce electric currents.

- Karst**—topographic area that has been created by the dissolution of carbonate rock terrain. It is characterized by caverns, sinkholes, and the absence of surface streams.
- Magnetics**—the Earth possesses a magnetic field caused primarily by sources in the core. The form of the field is roughly the same as would be caused by a dipole or bar magnet located near the Earth's center and aligned subparallel to the geographic axis. Many rocks or minerals are weakly magnetic or are magnetized by induction in the Earth's field, and cause spatial perturbations or "anomalies" in the Earth's main field. Man-made objects containing iron or steel are often highly magnetized and locally can cause large anomalies. Magnetics is the geophysical method used to measure anomalies in the subsurface owing to a high ferrous composition.
- Magnetic permeability**—characteristic of a material, it is proportional to the magnetism induced in that material divided by the strength of the magnetic field used.
- Magnetic susceptibility**—measure of the extent to which a substance may be magnetized, it represents the ratio of magnetization to magnetic field strength.
- Magnetization**—magnetic moment per unit volume; a vector quantity.
- Mapping**—locating geological, chemical, or geophysical information in space (as opposed to time, which is *monitoring*). Results are usually summarized as maps.
- Mechanical caliper**—borehole tool used to measure the diameter of a borehole. The shape of the borehole is a result of the subsurface lithology and the drilling technique.
- Monitoring**—observing the change in a geophysical, hydrogeological, or geochemical measurement with time.
- Multi-Channel Analysis of Surface Waves (MASW)**—in situ method that analyzes dispersion of surface waves and inverts it in terms of mechanical properties of the soil.
- Nondestructive Testing (NDT)**—uses geophysical methods to test engineered structures for integrity.
- Permittivity**—property that enables a three-dimensional material to store electrical charge; that is, its capacitance.
- Poisson's Ratio**—ratio of lateral strain and axial strain. Ratio of transverse contraction strain to longitudinal extension strain in the direction of stretching force. Tensile deformation is considered positive and compression deformation is considered negative.
- Profiling**—in geophysics, an investigation method whereby an array of sensors is moved along the Earth's surface without change in its configuration to detect lateral changes in the properties of the subsurface (faults, buried channels, etc.). The alternative is usually a sounding.
- Pseudosection**—cross section showing the distribution of a geophysical property, such as seismic travel time, from which the distribution of the geological property of interest (e.g., depth to bedrock) can be interpreted.
- Radioactivity**—energy emitted as particles or rays during the decay of an unstable isotope to a stable isotope.
- Rayleigh Wave**—waves that travel along the free surface of a solid material. Particle motion is always in a vertical plane, elliptical and retrograde to the direction of propagation.
- Raypath**—direction a seismic generated source travels in the subsurface.
- Receiver**—part of an acquisition system that senses the information signal.
- Refractor**—portion of the raypath that travels along the interface of two solid materials that have two different velocities. Lower material has a higher velocity than the overlying material $V1 < V2$.
- Resistivity (electrical)**—electrical resistance to the passage of a current, expressed in ohm-meters; the reciprocal of conductivity.
- Rippability**—ease with which soil or rock can be mechanically excavated.
- Seismic**—see seismic reflection and seismic refraction.
- Seismic reflection**—surface geophysical method recording seismic waves reflected from geologic strata, giving an estimate of their depth and thickness.
- Seismic refraction**—surface geophysical method recording seismic waves refracted by geological strata.
- Seismic velocity**—if the ground is stressed by a hammer blow or explosion, three types of waves propagate into the subsurface; P-Primary waves, S-Secondary waves, and Surface waves. The rate at which these waves travel is the seismic velocity measured in meters per second or feet per second.
- Shear modulus**—stress-strain ratio for simple shear in isotropic materials that obey Hooke's law. Ratio of shear stress to engineering shear strain on the loading plane.
- Shear wave**—acoustic wave with direction of propagation at right angles to the direction of particle vibration (S-wave).
- Shear zone**—subsurface area in the lithology that causes an acoustic wave to propagate at right angles to the direction of particle vibration.
- Soil resistivity**—mineral grains composed of soil and rocks are essentially nonconductive. The resistivity of soils and rocks is governed by the amount of pore water, its resistivity, and the arrangement of pores.
- Sounding**—in geophysics, an investigation method whereby the geometry and/or frequency of an array of sensors are varied so as to measure the physical properties of the earth as a function of depth beneath the configuration. The alternative is usually profiling.
- Spectral Analysis of Surface Waves (SASW)**—in situ seismic method that analyzes dispersion of surface waves and inverts it in terms of mechanical properties of the soil.
- Spontaneous-potential log**—log of the difference in DC voltage between an electrode in a well and one at the surface. Most of the voltage results from electrochemical potentials that develop between dissimilar borehole and formation fluids.
- Statics**—time shift corrections to individual traces to compensate for the effects of variations in elevation, surface layer thickness or velocity, or datum references.
- Surface wave**—wave that travels along, or near to, the surface; its motion dropping off rapidly with distance from it. A distinct seismic mode from the body waves (P- and S-waves).

- S-wave—a body wave in which particles move perpendicular to the direction of propagation. Also known as secondary or shear wave.
- Terrain conductivity—geophysical method in which EM methods measure directly the average electrical conductivity of the ground. Operates at low induction number.
- Time domain—in geophysics it refers to measurements analyzed according to their behavior in time. The usual alternative is frequency domain measurements.
- Tomography—method for determining the distribution of physical properties within the earth by inverting the results of a large number of measurements made in three dimensions (e.g., seismic, radar, resistivity, and EM) between different source and receiver locations.
- Transducer—any device that converts an input signal to an output signal of a different form; it can be a transmitter or receiver in a logging probe.
- Unexploded ordnance (UXO)—any munition that has not functioned properly during its firing, where the munition is dangerous and potentially capable of exploding.
- Variable-density log (VDL)—a log of the acoustic wave train that is recorded photographically, so that variations in darkness are related to the relative amplitude of the waves. Also called a three-dimensional log.
- Vibroseis—mechanical device used as a seismic source instead of a hammer or explosives.
- Well logging—geophysical method used in boreholes to provide waveforms that are interpreted into geologic units. Televiewer logging provides actual pictures of the borehole or casing surface.
- Young's modulus—ratio of normal stress to strain in the loading plane. It is the ratio of equilibrium length over the change in length times the force applied over the area.

REFERENCES

1. Telford, W.M., L.P. Geldart, R.E. Sheriff, and D.A. Keys, *Applied Geophysics*, Cambridge University Press, Cambridge, England, 1976, 860 pp.
2. Greenhouse, J. and P. Pehme, *Applications of Geophysics in Geotechnical and Environmental Engineering*, EEGS, Denver, Colo., 2001.
3. Dobrin, M.B., *Introduction to Geophysical Prospecting*, McGraw-Hill, 3rd ed., 1976, 630 pp.
4. Tandon, V. and S. Nazarian, *Geophysical Applications in Highways*, Report No. DTFH61-02-X-00098, Center for Transportation Infrastructure Systems, El Paso, Tex., Jan. 2005, 94 pp.
5. Mooney, H.M., *Handbook of Engineering Geophysics, Vol. 1: Seismic*, Bison Instruments, Minneapolis, Minn., 1984.
6. Mooney, H.M., *Handbook of Engineering Geophysics, Vol. 2: Electrical Resistivity*, Bison Instruments, Minneapolis, Minn., 1984.
7. Ward, S.H., *Geotechnical and Environmental Geophysics, Vols. I-III*, Society of Exploration Geophysicists, Tulsa, Okla., 1990, 1,050 pp.
8. *Engineering and Design—Geophysical Exploration for Engineering and Environmental Investigations*, Publication No. EM 1110-1-1802, U.S. Army Corps of Engineers, Washington, D.C., Aug. 1995.
9. McCann, D.M., M. Eddleston, P.J. Fenning, and G.M. Reeves, *Modern Geophysics in Engineering Geology*, The Geological Society, London, England, 1997, 441 pp.
10. Wightman, W.E., F. Jalinoos, P. Sirles, and K. Hanna, *Application of Geophysical Methods to Highway Related Problems*, Report FHWA-IF-04-021, Federal Highway Administration, Washington, D.C., 2003.
11. *Application of Geophysical Methods to Engineering and Environmental Problems*, Society of Exploration Geophysicists of Japan (SEGJ), July 2004, 301 pp. [Online]. Available: http://www.segj.org/BOOKS/eibun_tebiki/index_eTebiki.html.
12. 1st International Conference on the Application of Geophysical and NDT Methodologies to Transportation Facilities and Infrastructure, *SAGEEP Proceedings*, St. Louis, Mo., Dec. 11–15, 2000 [Online]. Available: <http://www.dot.ca.gov/hq/esc/geotech/gg/links.htm>.
13. 2nd International Conference on the Application of Geophysical and NDT Methodologies to Transportation Facilities and Infrastructure, *SAGEEP Proceedings*, Pasadena, Calif., Apr. 15–19, 2002 [Online]. Available: <http://www.dot.state.fl.us/statematerialsoffice/geotechnical/conference/geophysics.htm>.
14. 3rd International Conference on Applied Geophysics—Geophysics 2003, Orlando, Fla., Dec. 8–12, 2003.
15. Morey, R.M., *Synthesis of Highway Practice 255: Ground Penetrating Radar for Evaluating Subsurface Conditions for Transportation Facilities*, Transportation Research Board, National Research Council, Washington, D.C., 1998, 37 pp.
16. Benson, R.C., “An Overview of Methods and Strategies Assessing Subsurface Geologic Conditions and Structural Testing of Roads and Bridges,” the First International Conference on the Application of Geophysical Methodologies and NDT to Transportation Facilities and Infrastructure, St. Louis, Mo., Dec. 11–15, 2000.
17. Anderson, N. and A. Ismail, “A Protocol for Selecting Appropriate Geophysical Surveying Tools Based on Engineering Objectives and Site Characteristics,” the 2nd Annual Conference on the Application of Geophysical and NDT Methodologies to Transportation Facilities and Infrastructure, Apr. 15–19, 2002.
18. *Code of Practice for Site Investigation* (revised), British Standards Institution, London, England, 1997.
19. Mayne, P.W., B.R. Christopher, and J. Dejong, “Manual on Subsurface Investigations,” National Highway Institute, FHWA Report NHI-01-031, Federal Highway Administration, Washington, D.C., 2001.
20. Hoover, R.A., “Evolving Geophysical Standards 2004,” Presented at the Environmental and Engineering Geophysical Society Symposium on the Application of Geophysics to Environmental and Engineering Problems (SAGEEP) in Atlanta, Ga., Apr. 3–7, 2005, 7 pp.
21. *Manual on Subsurface Investigations*, 1st ed., American Association of State Highway and Transportation Officials, Washington, D.C., 1988.
22. Owen, W.P., “Selling Geophysics: Some Observations on Creating and Marketing a Geophysics Program in State Government,” Paper 1-11, Presented at the First International Conference on the Application of Geophysical Methodologies and NDT to Transportation Facilities and Infrastructure, St. Louis, Mo., Dec. 11–15, 2000.
23. Rutledge, F.A., M. Mauldon, and C.J. Smith, “Geophysical Primer for Geotechnical Engineers,” Center for Geotechnical Practice and Research at Virginia Tech, Blacksburg, Va., 2005, 123 pp.

TOPICAL BIBLIOGRAPHY

BOREHOLE LOGGING

- Hughes, D., "An Overview of the Caltrans Borehole Geophysical Logging Program," Presented at the 2nd International Conference on the Application of Geophysical and NDT Methodologies to Transportation Facilities and Infrastructure, Los Angeles, Calif., May 15–19, 2002.
- Owen, W.P. and C.J. Roblee, "Borehole Velocity Logging for Caltrans' Earthquake Engineering Program: Comparison of Field Measurements," Paper 1-5, Presented at the First International Conference on the Application of Geophysical Methodologies and NDT to Transportation Facilities and Infrastructure, St. Louis, Mo., Dec. 11–15, 2000.
- Rucker, M., "Gamma Density Logging of Drilled Shafts—Observation and Interpretations," Presented at the 2nd International Conference on the Application of Geophysical and NDT Methodologies to Transportation Facilities and Infrastructure, Los Angeles, Calif., May 15–19, 2002.

ELECTRICAL RESISTIVITY

- Beard, L.P., J.R. Sheehan, and S.C. Brooks, "Time-Lapse Azimuthal Resistivity Survey in a Highly Industrialized Area: Problems, Diagnosis, and Solutions," Presented at the 18th Annual SAGEEP Meeting, Atlanta, Ga., Apr. 3–7, 2005.
- Cardimona, S., "Electrical Resistivity Techniques for Sub-surface Investigation," Presented at the 2nd International Conference on the Application of Geophysical and NDT Methodologies to Transportation Facilities and Infrastructure, Los Angeles, Calif., May 15–19, 2002.
- Garman, K.M. and S.F. Purcell, "Three-Dimensional Electrical Resistivity Surveys to Identify Buried Karst Features Affecting Road Projects," Presented at the 3rd International Conference on Applied Geophysics, Hotel Royal Plaza, Orlando, Fla., Dec. 8–12, 2003.
- Garman, M. and S. Purcell, "Geologic Evaluations Beneath Existing Structures Using Foundation Imager(tm) Three-Dimensional Resistivity Surveys," Presented at the SAGEEP Proceedings, Colorado Springs, Colo., Feb. 22–26, 2004.
- Hiltunen, D.R. and M.J.S. Roth, "Investigation of Bridge Foundation Sites in Karst Terrane via Multi-Electrode Electrical Resistivity," Presented at the 3rd International Conference on Applied Geophysics, Hotel Royal Plaza, Orlando, Fla., Dec. 8–12, 2003.
- Hutchinson, P.J., "Electrical Imaging of Deep Clay-Mine Voids," Presented at the 18th Annual SAGEEP Meeting, Atlanta, Ga., Apr. 3–7, 2005.
- Jung, Y., H. Ha, and Y. Lee, "Application of Electrical Resistivity Imaging Techniques to Civil and Environmental Problems," *ASCE Geotechnical Special Publication*, 2000, pp. 52–64.
- Kuras, O., R.D. Ogilvy, D. Beamish, P.I. Meldrum, and C.P. Nathanail, "Capacitive Resistivity Imaging with Towed Arrays," Presented at the SAGEEP Proceedings, San Antonio, Tex. Apr. 6–10, 2003.
- Leberfinger, J.L., "Three Dimensional Electrical Imaging," Paper 4-30, Presented at the First International Conference on the Application of Geophysical Methodologies and NDT to Transportation Facilities and Infrastructure, St. Louis, Mo., Dec. 11–15, 2000.
- Olayinka, A.I. and M.A. Oladunjoye, "2-D Resistivity Imaging and Determination of Hydraulic Parameters of the Vadose Zone in a Cultivated Land in Southwestern Nigeria," Presented at the 18th Annual SAGEEP Meeting, Atlanta, Ga., Apr. 3–7, 2005.
- Xu, Y. and J. Xia, "Application of Multi-Channel Electrical Method in the Investigation of Hydraulic Channels in Qiu Jia Wan Main Dike of the Yangtze River, China," Presented at the 18th Annual SAGEEP Meeting, Atlanta, Ga., Apr. 3–7, 2005.

ELECTROMAGNETIC AND MAGNETIC

- Brady, T., S. Cardimona, and N. Anderson, "Detection and Delineation of Underground Fuel Storage Tanks and Associated Utility Lines Using Electromagnetic Induction and Ground Penetrating Radar Methods," Paper 4-32, Presented at the First International Conference on the Application of Geophysical Methodologies and NDT to Transportation Facilities and Infrastructure, St. Louis, Mo., Dec. 11–15, 2000.
- Drnevich, V., "Time Domain Reflectometry Uses in Geotechnical Engineering," Presented at the 18th Annual SAGEEP Meeting, Atlanta, Ga., Apr. 3–7, 2005.
- Lin, C., C. Chung, and S. Tang, "Frequency Domain Analyses of TDR Waveforms for Soil Moisture Measurements," Presented at the 18th Annual SAGEEP Meeting, Atlanta, Ga., Apr. 3–7, 2005.
- Mallah, M. and W.P. Owen, "Preliminary Results of Cavity Mapping Using EM Induction to Aid Highway Design," Presented at the 2nd International Conference on the Application of Geophysical and NDT Methodologies to Transportation Facilities and Infrastructure, Los Angeles, Calif., May 15–19, 2002.
- Mickus, K., "Magnetic Method," Paper 1-9, Presented at the First International Conference on the Application of Geophysical Methodologies and NDT to Transportation Facilities and Infrastructure, St. Louis, Mo., Dec. 11–15, 2000.
- Tseng, H., K.H. Lee, and A. Becker, "A Wide-Band Electromagnetic Impedance Profiling System for Non-Invasive Subsurface Characterization," Presented at the 18th Annual SAGEEP Meeting, Atlanta, Ga., Apr. 3–7, 2005.

GROUND PENETRATING RADAR

- Behiry, M.E. and A. Helba, "Ground-Penetrating Radar to Map Subsurface Rock Conditions at the Dream Island, El-Montazah Bay, Alexandria, Egypt," Presented at the SAGEEP Proceedings, Colorado Springs, Colo., Feb. 22–26, 2004.
- Bergstrom, E.J., "Borehole Ground Penetrating Radar Surveys of Fractured Limestone," Presented at the 3rd International Conference on Applied Geophysics, Hotel Royal Plaza, Orlando, Fla., Dec. 8–12, 2003.
- Bergstrom, E.J., "The Use of Computer Assisted Radar Tomography for Damage Prevention of Underground Assets and Avoidance of Underground Hazards," Presented at the 3rd International Conference on Applied Geophysics, Hotel Royal Plaza, Orlando, Fla., Dec. 8–12, 2003.
- Billington, E.D., "GPR Surveys to Help Determine Condition of a Concrete Bridge Deck," Presented at the 3rd International Conference on Applied Geophysics, Hotel Royal Plaza, Orlando, Fla., Dec. 8–12, 2003.
- Birken, R., "Efficient Large-Scale Underground Utility Mapping Using a New Multi-Channel GPR System," Presented at the 2nd International Conference on the Application of Geophysical and NDT Methodologies to Transportation Facilities and Infrastructure, Los Angeles, Calif., May 15–19, 2002.
- Bullock, P.J. and A. Dillman, "Sinkhole Detection in Florida Using GPR and CPT," Presented at the 3rd International Conference on Applied Geophysics, Hotel Royal Plaza, Orlando, Fla., Dec. 8–12, 2003.
- Calabrese, M., L. Zanzi, and M. Lualdi, "Mapping an Industrial Landfill Area from Penetration of GPR Data," Presented at the SAGEEP Proceedings, Colorado Springs, Colo., Feb. 22–26, 2004.
- Cardimona, S., "Evaluation of GPR as a Tool for Determination of Granular Material Deposit Volumes," Presented at the 2nd International Conference on the Application of Geophysical and NDT Methodologies to Transportation Facilities and Infrastructure, Los Angeles, Calif., May 15–19, 2002.
- Cardimona, S., D.J. Webb, and T. Lippincott, "Ground Penetrating Radar," Paper 1-6, Presented at the First International Conference on the Application of Geophysical Methodologies and NDT to Transportation Facilities and Infrastructure, St. Louis, Mo., Dec. 11–15, 2000.
- Cardimona, S., "Subsurface Investigation Using Ground Penetrating Radar," Presented at the 2nd International Conference on the Application of Geophysical and NDT Methodologies to Transportation Facilities and Infrastructure, Los Angeles, Calif., May 15–19, 2002.
- Carnevale, M. and J. Hager, "GPR Survey to Characterize Lake Bottom Sediments, Cape Cod, Massachusetts," Presented at the SAGEEP Proceedings, San Antonio, Tex., Apr. 6–10, 2003.
- Choubane, B., S.C. Ross, J.G. Moxley, and B.T. Dietrick, "Application of Ground Penetrating Radar to Pavement Evaluation," Paper 4-20, Presented at the First International Conference on the Application of Geophysical Methodologies and NDT to Transportation Facilities and Infrastructure, St. Louis, Mo., Dec. 11–15, 2000.
- Eyuboglu, S., H. Mahdi, and H. Al-Shukri, "Detection of Water Leaks Using Ground Penetrating Radar," Presented at the 3rd International Conference on Applied Geophysics, Hotel Royal Plaza, Orlando, Fla., Dec. 8–12, 2003.
- Fish, M., "Enhancing Geotechnical Information with the GPR," Presented at the 2nd International Conference on the Application of Geophysical and NDT Methodologies to Transportation Facilities and Infrastructure, Los Angeles, Calif., May 15–19, 2002.
- Hickman, S., et al., "Ground Penetrating Radar Survey of Interstate 70 Across Missouri," Paper 4-22, Presented at the First International Conference on the Application of Geophysical Methodologies and NDT to Transportation Facilities and Infrastructure, St. Louis, Mo., Dec. 11–15, 2000.
- Jones, B., M. Carnevale, D. Delea, and J. Hager, "Method for High Volume, High Resolution GPR Concrete Investigation," Presented at the 18th Annual SAGEEP Meeting, Atlanta, Ga., Apr. 3–7, 2005.
- Lewis, S., "GPR as a Tool for Detecting Problems in Highway-Related Construction," Presented at the 2nd International Conference on the Application of Geophysical and NDT Methodologies to Transportation Facilities and Infrastructure, Los Angeles, Calif., May 15–19, 2002.
- Lualdi, M. and L. Zanzi, "A New System to Perform 3D GPR Surveys for Utility Mapping," Presented at the 3rd International Conference on Applied Geophysics, Hotel Royal Plaza, Orlando, Fla., Dec. 8–12, 2003.
- Maerz, N.H. and W. Kim, "Potential Use of Ground Penetrating Radar in Highway Rock Cut Stability," Paper 3-3, Presented at the First International Conference on the Application of Geophysical Methodologies and NDT to Transportation Facilities and Infrastructure, St. Louis, Mo., Dec. 11–15, 2000.
- Mellett, J. and S. Smith, "Use of Ground Penetrating Radar (GPR) as an Evaluation Tool in 19th Century Building Restoration," Presented at the 18th Annual SAGEEP Meeting, Atlanta, Ga., Apr. 3–7, 2005.
- Roark, M.S. and D.W. Lambert, "Application of Bistatic Multi-Low Frequency GPR for Mapping Karst Features and Bedrock Topography," Paper 4-25, Presented at the First International Conference on the Application of Geophysical Methodologies and NDT to Transportation Facilities and Infrastructure, St. Louis, Mo., Dec. 11–15, 2000.
- Sassen, D. and M. Everett, "Multi-Component Ground Penetrating Radar for Improved Imaging and Target Discrimination," Presented at the 18th Annual SAGEEP Meeting, Atlanta, Ga., Apr. 3–7, 2005.
- Wright, D., et al., "A Ground Penetrating Radar System for High Loss Environments," Presented at the 18th Annual SAGEEP Meeting, Atlanta, Ga., Apr. 3–7, 2005.

GRAVITY AND MICROGRAVITY

- Crawford, N.C., "Microgravity Investigations of Sinkhole Collapses Under Highways," Paper 4-33, Presented at the

First International Conference on the Application of Geophysical Methodologies and NDT to Transportation Facilities and Infrastructure, St. Louis, Mo., Dec. 11–15, 2000.

Mickus, K., “Gravity Method: Environmental and Engineering Applications,” Presented at the 3rd International Conference on Applied Geophysics, Hotel Royal Plaza, Orlando, Fla., Dec. 8–12, 2003.

INDUCED POLARIZATION

Slater, L., A. Binley, and A. Kemna, “Case Studies of Engineering and Environmental Applications of Induced Polarization Imaging,” Paper 4-31, Presented at the First International Conference on the Application of Geophysical Methodologies and NDT to Transportation Facilities and Infrastructure, St. Louis, Mo., Dec. 11–15, 2000.

Slater, L.D. and D. Lesmes, “The Induced Polarization Method,” Paper 1-8, Presented at the First International Conference on the Application of Geophysical Methodologies and NDT to Transportation Facilities and Infrastructure, St. Louis, Mo., Dec. 11–15, 2000.

INTEGRATED METHODS

Abdel, G.Z., A. Aal, A.M. Ismail, N.L. Anderson, and E.A. Atekwana, “Geophysical Investigation of Seepage from an Earth Fill Dam, Washington County, Missouri,” Presented at the 3rd International Conference on Applied Geophysics, Hotel Royal Plaza, Orlando, Fla., Dec. 8–12, 2003.

Agusetiawan, G., N. Anderson, and S. Cardimona, “Integrated Geophysical Investigation of Abandoned Landfill, Grandview Triangle Area, Kansas City, Missouri,” Presented at the 2nd International Conference on the Application of Geophysical and NDT Methodologies to Transportation Facilities and Infrastructure, Los Angeles, Calif., May 15–19, 2002.

Anderson, N. and S. Cardimona, “Evaluating the Utility of Geophysical Surveying Methods,” Paper 1-12, Presented at the First International Conference on the Application of Geophysical Methodologies and NDT to Transportation Facilities and Infrastructure, St. Louis, Mo., Dec. 11–15, 2000.

Anderson, N., “Non-Invasive Geophysical Methods Applied to Sanitary Landfills: Solid Waste Management Unit 059,” Presented at the 2nd International Conference on the Application of Geophysical and NDT Methodologies to Transportation Facilities and Infrastructure, Los Angeles, Calif., May 15–19, 2002.

Anderson, N., A. Ismail, and C. Davis, “Selection of Appropriate Geophysical Techniques: A Generalized Protocol Based on Engineering Objectives and Site Characteristics,” Presented at the 3rd International Conference on Applied Geophysics, Hotel Royal Plaza, Orlando, Fla., Dec. 8–12, 2003.

Anderson, N., S. Cardimona, and A. Hatheway, “A Protocol for Selecting Appropriate Geophysical Surveying Tools Based on Engineering Objectives and Site Characteristics,” Presented at the 2nd International Conference on the Application of Geophysical and NDT Methodologies to Transportation Facilities and Infrastructure, Los Angeles, Calif., May 15–19, 2002.

Anderson, N.L., et al., “Ground-Penetrating Radar and Shallow Reflection Seismic Surveys for Mitigation of Karstic Damage to I-44 Embankment, West Springfield Area, Missouri,” Paper 4-3, Presented at the First International Conference on the Application of Geophysical Methodologies and NDT to Transportation Facilities and Infrastructure, St. Louis, Mo., Dec. 11–15, 2000.

Anderson, N.L., et al., “Reflection Seismic and Ground-Penetrating Radar Surveys: Ralls County, Missouri,” Paper 4-2, Presented at the First International Conference on the Application of Geophysical Methodologies and NDT to Transportation Facilities and Infrastructure, St. Louis, Mo., Dec. 11–15, 2000.

Anderson, N. and S. Cardimona, “Forward Modeling of Reflection Seismic and Ground Penetrating Radar Signals to Aid in Field Survey Design and Data Interpretation,” Paper 1-2, Presented at the First International Conference on the Application of Geophysical Methodologies and NDT to Transportation Facilities and Infrastructure, St. Louis, Mo., Dec. 11–15, 2000.

Bannk, C. and students of GY250, “Student Research Involving Shallow Geophysics in and Around Colorado Springs,” Presented at the SAGEEP Proceedings, Colorado Springs, Colo., Feb. 22–26, 2004.

Benson, R.C., “An Overview of Geophysical and Non-Destructive Methods for Characterization of Roads and Bridges,” *ASCE Geotechnical Special Publication*, 2000, pp. 1–4.

Benson, R.C., “An Overview of Methods and Strategies Assessing Subsurface Geologic Conditions and Structural Testing of Roads and Bridges,” Paper 2-3, Presented at the First International Conference on the Application of Geophysical Methodologies and NDT to Transportation Facilities and Infrastructure, St. Louis, Mo., Dec. 11–15, 2000.

Benson, R.C., “Methods Used to Carry Out Six Roadway Investigations of Sinkholes,” Paper 4-34, Presented at the First International Conference on the Application of Geophysical Methodologies and NDT to Transportation Facilities and Infrastructure, St. Louis, Mo., Dec. 11–15, 2000.

Benson, R.C., L. Yuhr, and R.D. Kaufmann, “Some Considerations for Selection and Successful Application of Surface Geophysical Methods,” Presented at the 3rd International Conference on Applied Geophysics, Hotel Royal Plaza, Orlando, Fla., Dec. 8–12, 2003.

El-Hussain, I., G. Kraemer, and R. Myers, “Geophysical Characterization of a Proposed Street Extension in Cape Girardeau, Missouri,” Paper 4-29, Presented at the First International Conference on the Application of Geophysical Methodologies and NDT to Transportation Facilities and Infrastructure, St. Louis, Mo., Dec. 11–15, 2000.

Garman, M., “Identification and Delineation of Sinkhole Collapse Hazards in Florida Using GPR and Electrical Resistivity Imaging,” Presented at the 2nd International Conference on the Application of Geophysical and NDT

- Methodologies to Transportation Facilities and Infrastructure, Los Angeles, Calif., May 15–19, 2002.
- Hickman, S., T. Lippincott, S. Cardimona, N. Anderson, and T. Newton, “Geophysical Site Characterization in Support of Highway Expansion Project,” Paper 4-28, Presented at the First International Conference on the Application of Geophysical Methodologies and NDT to Transportation Facilities and Infrastructure, St. Louis, Mo., Dec. 11–15, 2000.
- Hollema, D. and L. Olson, “Application of a Combined Non-destructive Evaluation Approach to Detecting Subgrade Voids Below a Dam Spillway,” Presented at the SAGEEP Proceedings, Colorado Springs, Colo., Feb. 22–26, 2004.
- Hoover, R.A., “Geophysical Choices for Karst and Mine Investigations,” Presented at the 3rd International Conference on Applied Geophysics, Hotel Royal Plaza, Orlando, Fla., Dec. 8–12, 2003.
- Keiswetter, D., K. Davis, B. Carr, and C. Murray, “Case Studies in Geophysical Investigations of Landfills in Proposed Roadways,” Paper 4-35, Presented at the First International Conference on the Application of Geophysical Methodologies and NDT to Transportation Facilities and Infrastructure, St. Louis, Mo., Dec. 11–15, 2000.
- Leech, C., I. Hill, and T. Grossey, “Simultaneous Geophysical Surveys Using a Towed Multi-Sensor Platform and Its Application to Characterization of Brownfield Sites,” Presented at the 18th Annual SAGEEP Meeting, Atlanta, Ga., Apr. 3–7, 2005.
- Lefchek, T., “Geophysical Methods for Mapping Abandoned Mines,” Presented at the 2nd International Conference on the Application of Geophysical and NDT Methodologies to Transportation Facilities and Infrastructure, Los Angeles, Calif., May 15–19, 2002.
- Luna, R. and H. Jadi, “Determination of Dynamic Soil Properties Using Geophysical Methods,” Paper 3-1, Presented at the First International Conference on the Application of Geophysical Methodologies and NDT to Transportation Facilities and Infrastructure, St. Louis, Mo., Dec. 11–15, 2000.
- Meglich, T.M., M.C. Williams, S.M. Hodges, and M.J. DeMarco, “Subsurface Geophysical Imaging of Lava Tubes, Lava Beds National Monument, California,” Presented at the 3rd International Conference on Applied Geophysics, Hotel Royal Plaza, Orlando, Fla., Dec. 8–12, 2003.
- Mellor, C., P. Hubbard, T.J. Douglas, and B. Worley, “A Detailed Geophysical Survey to Characterize Subsurface Failures on Interstate 40, Pender County, North Carolina,” Presented at the 3rd International Conference on Applied Geophysics, Hotel Royal Plaza, Orlando, Fla., Dec. 8–12, 2003.
- Michaels, P., “Design of Geophysical Surveys in Transportation,” *ASCE Geotechnical Special Publication*, Vol. II, 2004, 8 pp.
- Mundell, J. and G. Byer, “Use of Geophysical Surveys for Fill Characterization and Quantity Estimation at Brownfield Sites—A Case History,” Presented at the SAGEEP Proceedings, Colorado Springs, Colo., Feb. 22–26, 2004.
- Nasseri-Moghaddam, A., G. Cascante, C. Phillips, and J. Hutchinson, “A New Quantitative Procedure to Determine the Location and Embedment Depth of a Void with Surface Waves,” Presented at the SAGEEP Proceedings, Colorado Springs, Colo., Feb. 22–26, 2004.
- Nazarian, S. and J. Diehl, “Use of Geophysical Methods in Construction,” *ASCE Geotechnical Special Publication*, 2000, 242 pp.
- Newton, T., “Geophysical Site Characterization: GPR and Reflection Seismic Study of Previously Mined Ground,” Presented at the 2nd International Conference on the Application of Geophysical and NDT Methodologies to Transportation Facilities and Infrastructure, Los Angeles, Calif., May 15–19, 2002.
- Olawumi, S., “Delineation of Subsurface Geometry by 2D and Joint Inversion of Resistivity and EM Sounding Data from a Dam Site at Owena River Area South Western, Nigeria,” Presented at the SAGEEP Proceedings, Colorado Springs, Colo., Feb. 22–26, 2004.
- Oristaglio, M., R. Birken, T. Hansen, R. Deming, S. MacIntosh, and Q. Zhu, “Efficient Large-Scale Utility Mapping with Radar and Induction Arrays,” Presented at the 18th Annual SAGEEP Meeting, Atlanta, Ga., Apr. 3–7, 2005.
- Petry, T.M., “Geotechnical Investigations for Transportation Facilities Founded in and Consisting of Expansive Clay Soils,” Paper 3-2, Presented at the First International Conference on the Application of Geophysical Methodologies and NDT to Transportation Facilities and Infrastructure, St. Louis, Mo., Dec. 11–15, 2000.
- Petry, T.M., “Geotechnical Investigations, for Non-Seismic Conditions, Conducted for Planning, Design, Construction and Maintenance of Transportation Facilities,” Paper 2-1, Presented at the First International Conference on the Application of Geophysical Methodologies and NDT to Transportation Facilities and Infrastructure, St. Louis, Mo., Dec. 11–15, 2000.
- Shoemaker, M.L., et al., “Reflection Seismic and Ground-Penetrating Radar Study of Previously Mined (Lead/Zinc) Ground, Joplin, Missouri,” Paper 4-1, Presented at the First International Conference on the Application of Geophysical Methodologies and NDT to Transportation Facilities and Infrastructure, St. Louis, Mo., Dec. 11–15, 2000.
- Smith, R., “GPR and EM Surveys to Detect and Map Peat and Permafrost,” Presented at the 2nd International Conference on the Application of Geophysical and NDT Methodologies to Transportation Facilities and Infrastructure, Los Angeles, Calif., May 15–19, 2002.
- Sylwester, R.E. and B. Dugan, “Evaluation of Geophysical Methods: Field Program,” *ASCE Geotechnical Special Publication*, Report FHWA-AK-RD-02-07, Alaska Department of Transportation and Public Facilities, Juneau, 2002, 43 pp.
- Szwilski, T.B., R. Begley, J. Ball, and P. Dailey, “Application of Geophysical Methods to Evaluate Rail Track Subsurface,” Presented at the SAGEEP Proceedings, San Antonio, Tex., Apr. 6–10, 2003.
- Szwilski, T., R. Begley, P. Dailey, and Z. Sheng, “Using Geophysical Techniques to Study Rail Track in an Area of

Ground Improvement,” *ASCE Geotechnical Special Publication*, Vol. II, 2004, 10 pp.

Yuhr, L., R.C. Benson, R.D. Kaufmann, D. Casto, and J. Jennings, “A Case History of a Large Karst Investigation,” Presented at the 3rd International Conference on Applied Geophysics, Hotel Royal Plaza, Orlando, Fla., Dec. 8–12, 2003.

Zoghi, M., B.H. Richard, P.J. Wolfe, E.C. Hauser, and J.D. Hicks, “Geophysical Survey Techniques for Identifying Potential Collapse Features Under Highways,” *ASCE Geotechnical Special Publication*, 2000, pp. 215–227.

MARINE

Campbell, K.J., “Marine Engineering Geophysics: Meeting the Deepwater Geohazards Challenge,” Presented at the SAGEEP Proceedings, San Antonio, Tex., Apr. 6–10, 2003.

Ismail, A., N. Anderson, J.D. Rogers, A.M. Abbas, and E. Atekwana, “Hydrogeophysical Investigation at Luxor, Southern Egypt,” Presented at the 3rd International Conference on Applied Geophysics, Hotel Royal Plaza, Orlando, Fla., Dec. 8–12, 2003.

Sylwester, R.E. and S. Lowell, “An Offshore Geophysical Survey in Support of a Highway Reconstruction Project, Washington,” Paper 4-4, Presented at the First International Conference on the Application of Geophysical Methodologies and NDT to Transportation Facilities and Infrastructure, St. Louis, Mo., Dec. 11–15, 2000.

NON-DESTRUCTIVE TESTING (NDT)

Aktan, H.M., I.O. Yaman, and J.F. Staton, “Bridge Deck Health Monitoring,” Paper 4-24, Presented at the First International Conference on the Application of Geophysical Methodologies and NDT to Transportation Facilities and Infrastructure, St. Louis, Mo., Dec. 11–15, 2000.

Anderson, N.L., A. Ismail, and T. Thitimakorn, “Monitoring Bridge Scour: An Application of Ground Penetrating Radar,” Presented at the 3rd International Conference on Applied Geophysics, Hotel Royal Plaza, Orlando, Fla., Dec. 8–12, 2003.

Arsenault, J.L. and M. Chouteau, “Application of the TISAR Technique to the Investigations of Transportation Facilities and Detection of Utilities,” Presented at the 2nd International Conference on the Application of Geophysical and NDT Methodologies to Transportation Facilities and Infrastructure, Los Angeles, Calif., May 15–19, 2002.

Bischoff, J., “PDA Monitoring of Piles End Bearing on Sloping Bedrock,” Presented at the 2nd International Conference on the Application of Geophysical and NDT Methodologies to Transportation Facilities and Infrastructure, Los Angeles, Calif., May 15–19, 2002.

Cardimona, S., “Cross Borehole Tomography,” Paper 1-4, Presented at the First International Conference on the Application of Geophysical Methodologies and NDT to

Transportation Facilities and Infrastructure, St. Louis, Mo., Dec. 11–15, 2000.

Choubane, B. and R.L. McNamara, “A Practical Approach to Predicting Subgrade Moduli Using Falling Weight Deflectometer (FWD) Data,” Paper 4-16, Presented at the First International Conference on the Application of Geophysical Methodologies and NDT to Transportation Facilities and Infrastructure, St. Louis, Mo., Dec. 11–15, 2000.

Chouteau, M., “An Investigation on Application of the Tomographic Resistivity Method to Concrete Structures,” Presented at the 2nd International Conference on the Application of Geophysical and NDT Methodologies to Transportation Facilities and Infrastructure, Los Angeles, Calif., May 15–19, 2002.

Fisk, P., “Sonic/Ultrasonic Measurements for Bridge Deck Evaluations,” Paper 4-14, Presented at the First International Conference on the Application of Geophysical Methodologies and NDT to Transportation Facilities and Infrastructure, St. Louis, Mo., Dec. 11–15, 2000.

Graybeal, B.A., R.A. Walther, and G.A. Washer, “Ultrasonic Inspection of Bridge Hanger Pins,” Paper 4-15, Presented at the First International Conference on the Application of Geophysical Methodologies and NDT to Transportation Facilities and Infrastructure, St. Louis, Mo., Dec. 11–15, 2000.

Gucinski, N., S. Zaghoul, R. Hadidi, A. Maher, and T. Chmiel, “Pavement Evaluation and Development of Seasonal and Temperature Adjustment Models Using Seismic Pavement Analyzer (SPA),” Presented at the 3rd International Conference on Applied Geophysics, Hotel Royal Plaza, Orlando, Fla., Dec. 8–12, 2003.

Hanna, K. and J.M. Descour, “Timely and Accurate Subsurface Characterization for Highway Applications Using Seismic Tomography,” Paper 4-9, Presented at the First International Conference on the Application of Geophysical Methodologies and NDT to Transportation Facilities and Infrastructure, St. Louis, Mo., Dec. 11–15, 2000.

Haramy, K. and N. Mekic-Stall, “Evaluation of Drilled Shafts at Piney Creek Bridge Using Crosshole Sonic Logging Data and Three-Dimensional Tomographic Imaging Method,” Paper 4-12, Presented at the First International Conference on the Application of Geophysical Methodologies and NDT to Transportation Facilities and Infrastructure, St. Louis, Mo., Dec. 11–15, 2000.

Jalinoos, F., N. Mekic and K. Hanna, “Tomographic Imaging of Concrete Structures Containing Planned Defects,” Presented at the 3rd International Conference on Applied Geophysics, Hotel Royal Plaza, Orlando, Fla., Dec. 8–12, 2003.

Janna, K., K.S. Haramy, A. Rock, and B. Hoekstra, “Three-Dimensional Tomographic Imaging for Deep Foundation Integrity Testing,” Paper 4-11, Presented at the First International Conference on the Application of Geophysical Methodologies and NDT to Transportation Facilities and Infrastructure, St. Louis, Mo., Dec. 11–15, 2000.

Jinxing, Z., “Estimate of CIDH Pile Concrete Compressive Strength from Cross-Hole Sonic Testing,” Presented at the

- 2nd International Conference on the Application of Geophysical and NDT Methodologies to Transportation Facilities and Infrastructure, Los Angeles, Calif., May 15–19, 2002.
- Jinxing, Z., “Revision of California Test Method—Nuclear Gage Calibration,” Presented at the 2nd International Conference on the Application of Geophysical and NDT Methodologies to Transportation Facilities and Infrastructure, Los Angeles, Calif., May 15–19, 2002.
- Jo, C.H.J., Y.H. Cha, and J.H. Choi, “A Borehole Magnetic Logging Tool for Estimating Unknown Foundation Depths,” Presented at the 3rd International Conference on Applied Geophysics, Hotel Royal Plaza, Orlando, Fla., Dec. 8–12, 2003.
- Kase, E.J. and T.A. Ross, “Quality Assurance for Deep Foundation Elements,” Presented at the 3rd International Conference on Applied Geophysics, Hotel Royal Plaza, Orlando, Fla., Dec. 8–12, 2003.
- Kase, E.J., T.A. Ross, and J.M. Descour, “Leveraging Existing Infrastructure: Using What’s Already in the Ground,” Presented at the 3rd International Conference on Applied Geophysics, Hotel Royal Plaza, Orlando, Fla., Dec. 8–12, 2003.
- Kemeny, J., “A Comparison of Digital Imaging and Laser Scanning Technologies for NDT Rock Mass Characterization,” Presented at the 2nd International Conference on the Application of Geophysical and NDT Methodologies to Transportation Facilities and Infrastructure, Los Angeles, Calif., May 15–19, 2002.
- Kim, D. and H. Kim, “Impact-Echo Response of Rock-Socketed Drilled Shaft,” Paper 4-19, Presented at the First International Conference on the Application of Geophysical Methodologies and NDT to Transportation Facilities and Infrastructure, St. Louis, Mo., Dec. 11–15, 2000.
- Kim, W., A. Ismail, N.L. Anderson, and E.A. Atekwana, “Mapping Variations in the Relative Spatial Locations of Embedded Dowel Bars Using GPR,” Presented at the 3rd International Conference on Applied Geophysics, Hotel Royal Plaza, Orlando, Fla., Dec. 8–12, 2003.
- Kim, W., A. Ismail, N.L. Anderson, E.A. Atekwana, and A. Buccellato, “Non-Destructive Testing (NDT) for Corrosion in Bridge Decks Using GPR,” Presented at the 3rd International Conference on Applied Geophysics, Hotel Royal Plaza, Orlando, Fla., Dec. 8–12, 2003.
- Liebich, B., “NDT of Cast and Drilled Hole Piles,” Presented at the 2nd International Conference on the Application of Geophysical and NDT Methodologies to Transportation Facilities and Infrastructure, Los Angeles, Calif., May 15–19, 2002.
- Liu, L. and T. Guo, “Seismic Non-Destructive Tests on Reinforced Concrete Column of the Longtan Highway Bridge, Guangxi, China,” Paper 4-17, Presented at the First International Conference on the Application of Geophysical Methodologies and NDT to Transportation Facilities and Infrastructure, St. Louis, Mo., Dec. 11–15, 2000.
- Maser, K., “Non-Destructive Measurement of Layer Thickness on Newly Constructed Pavement,” Presented at the 2nd International Conference on the Application of Geophysical and NDT Methodologies to Transportation Facilities and Infrastructure, Los Angeles, Calif., May 15–19, 2002.
- McNaughton, S., “Case Studies in Pile Dynamic Analysis (PDA),” Presented at the 2nd International Conference on the Application of Geophysical and NDT Methodologies to Transportation Facilities and Infrastructure, Los Angeles, Calif., May 15–19, 2002.
- Mekic-Stall, N., R.E. Grimm, and P. Tackenberg, “2D, 3D Crosshole Sonic Tomography (CST) Versus Crosshole Sonic Logging (CSL) for Drilled Shafts,” Presented at the 2nd International Conference on the Application of Geophysical and NDT Methodologies to Transportation Facilities and Infrastructure, Los Angeles, Calif., May 15–19, 2002.
- Mercado, E., “Two New Non-Destructive Methods to Measure Scour Depth and the Depth of Unknown Foundations,” Presented at the 2nd International Conference on the Application of Geophysical and NDT Methodologies to Transportation Facilities and Infrastructure, Los Angeles, Calif., May 15–19, 2002.
- Mercado, E.J. and M.W. O’Neill, “Methods to Measure Scour Depth and the Depth of Unknown Foundations,” Presented at the 3rd International Conference on Applied Geophysics, Hotel Royal Plaza, Orlando, Fla., Dec. 8–12, 2003.
- Nazarian, S., “Pavement Evaluation and Design with Seismic Methods,” Presented at the 18th Annual SAGEEP Meeting, Atlanta, Ga. Apr. 3–7, 2005.
- Norton, S.J., D. Keiswetter, and I.J. Won, “Ultrasonic Tomography for Imaging Reinforcement Steel in Concrete Bridge Girders,” Paper 4-13, Presented at the First International Conference on the Application of Geophysical Methodologies and NDT to Transportation Facilities and Infrastructure, St. Louis, Mo., Dec. 11–15, 2000.
- O’Connor, K.M. and C.H. Dowding, “Real Time Monitoring of Infrastructure Using TDR Technology: Principles,” Paper 1-7, Presented at the First International Conference on the Application of Geophysical Methodologies and NDT to Transportation Facilities and Infrastructure, St. Louis, Mo., Dec. 11–15, 2000.
- O’Connor, K.M. and C.H. Dowding, “Real Time Monitoring of Infrastructure Using TDR Technology: Case Histories,” Paper 4-27, Presented at the First International Conference on the Application of Geophysical Methodologies and NDT to Transportation Facilities and Infrastructure, St. Louis, Mo., Dec. 11–15, 2000.
- Price, K., “Crosshole Sonic Testing of Cast-in-Drill-Hole (CIDH) Piles,” Presented at the 2nd International Conference on the Application of Geophysical and NDT Methodologies to Transportation Facilities and Infrastructure, Los Angeles, Calif., May 15–19, 2002.
- Romero, F.A., D. Allen, R.L. Roberts, and J. Fleckenstein, “Ground-Penetrating Radar Investigation of an Interstate Concrete Pavement for Evidence of Segregation Caused by Poor Consolidation During Construction,” Paper 4-21, Presented at the First International Conference on the

- Application of Geophysical Methodologies and NDT to Transportation Facilities and Infrastructure, St. Louis, Mo., Dec. 11–15, 2000.
- Roubal, M., “Evaluating and Locating Engineering Structures Using Non-Destructive Testing Technology,” Paper 2-2, Presented at the First International Conference on the Application of Geophysical Methodologies and NDT to Transportation Facilities and Infrastructure, St. Louis, Mo., Dec. 11–15, 2000.
- Rucker, M.L., “Exploration for Transportation Facilities,” Paper 1-3, Presented at the First International Conference on the Application of Geophysical Methodologies and NDT to Transportation Facilities and Infrastructure, St. Louis, Mo., Dec. 11–15, 2000.
- Sjoblom, D., “SPT Energy Measurements with the PDA,” Presented at the 2nd International Conference on the Application of Geophysical and NDT Methodologies to Transportation Facilities and Infrastructure, Los Angeles, Calif., May 15–19, 2002.
- Webb, D.J., N.L. Anderson, T. Newton, and S. Cardimona, “Bridge Scour: Application of Ground Penetrating Radar,” Paper 4-26, Presented at the First International Conference on the Application of Geophysical Methodologies and NDT to Transportation Facilities and Infrastructure, St. Louis, Mo., Dec. 11–15, 2000.
- Webb, D.J., N.L. Anderson, T. Newton, and S. Cardimona, “Ground Penetrating Radar (GPR): A Tool for Monitoring Bridge Scour,” Presented at the 2nd International Conference on the Application of Geophysical and NDT Methodologies to Transportation Facilities and Infrastructure, Los Angeles, Calif., May 15–19, 2002.
- White, N.K., A.M. Sallam, A.K. Ashmawy and D.J. Horhota, “Evaluation of ASTM Time Domain Reflectometry Method for Soil Water Content and In-Place Density,” Presented at the 3rd International Conference on Applied Geophysics, Hotel Royal Plaza, Orlando, Fla., Dec. 8–12, 2003.
- Andrus, R., “Shear-Wave Velocity and Liquefaction Potential for Soils Under Dynamic Loadings,” Presented at the 18th Annual SAGEEP Meeting, Atlanta, Ga., Apr. 3–7, 2005.
- Carpenter, P.J., I.C. Higuera-Diaz, M.D. Thompson, S. Atre, and W. Mandell, “Accuracy of Seismic Refraction Tomography Codes at Karst Sites,” Presented at the SAGEEP Proceedings, San Antonio, Tex., Apr. 6–10, 2003.
- Carpenter, P., et al., “Seismic Tomographic Imaging of Buried Karst Features,” Presented at the SAGEEP Proceedings, Colorado Springs, Colo., Feb. 22–26, 2004.
- Cooksey, J.W., “High Resolution Seismic Reflection Applied to Rock and Soil Subsidence Problems,” Presented at the 2nd International Conference on the Application of Geophysical and NDT Methodologies to Transportation Facilities and Infrastructure, Los Angeles, Calif., May 15–19, 2002.
- Croxtan, N.M. and R.W. Henthorne, “High Resolution Seismic Reflection Investigation of Salt Dissolution Features in Kansas,” Presented at the 3rd International Conference on Applied Geophysics, Hotel Royal Plaza, Orlando, Fla., Dec. 8–12, 2003.
- Graizer, V., “Recent Strong-Motion Data Recorded by Downhole Arrays and Modeling Using Shake Program,” Presented at the 2nd International Conference on the Application of Geophysical and NDT Methodologies to Transportation Facilities and Infrastructure, Los Angeles, Calif., May 15–19, 2002.
- Gucinski, N. and P. Shokouhi, “Surface Wave Analysis Using Wavelet Transforms,” Presented at the 18th Annual SAGEEP Meeting, Atlanta, Ga., Apr. 3–7, 2005.
- Hanson, D.K., K. Haramy, and D.M. Neil, “Seismic Tomography Applied to Site Characterization,” *ASCE Geotechnical Special Publication*, 2000, pp. 65–79.
- Henwood, J., “Construction Vibrations,” Presented at the 2nd International Conference on the Application of Geophysical and NDT Methodologies to Transportation Facilities and Infrastructure, Los Angeles, Calif., May 15–19, 2002.
- Hipley, P., A. Shakal, V. Graizer, and M. Huang, “Status of the Bridge and Downhole Seismic Instrumentation Installed Through the Caltrans/CDMG Project,” Presented at the 2nd International Conference on the Application of Geophysical and NDT Methodologies to Transportation Facilities and Infrastructure, Los Angeles, Calif., May 15–19, 2002.
- Hunter, J.A., et al., “Measuring Sub-Seabottom Seismic Velocities—Some Unusual Experiments,” Presented at the 18th Annual SAGEEP Meeting, Atlanta, Ga., Apr. 3–7, 2005.
- Inazaki, T. and L. Xinglin, “High-Frequency Seismic Measurements Using a Piezoelectric Type Accelerometer Array,” Presented at the SAGEEP Proceedings, San Antonio, Tex., Apr. 6–10, 2003.
- Kase, E. and T. Ross, “Seismic Imaging to Accurately Characterize Subsurface Ground Conditions,” Presented at the

SEISMIC

- Anderson, N. and S. Cardimona, “Synthetic Reflection Seismic and Ground Penetrating Radar (GPR) Data: The Key to Understanding These Subsurface Imaging Techniques,” Presented at the 2nd International Conference on the Application of Geophysical and NDT Methodologies to Transportation Facilities and Infrastructure, Los Angeles, Calif., May 15–19, 2002.
- Anderson, N., “Overview of the Shallow Seismic Reflection Technique,” Paper 1-1, Presented at the First International Conference on the Application of Geophysical Methodologies and NDT to Transportation Facilities and Infrastructure, St. Louis, Mo., Dec. 11–15, 2000.
- Anderson, N., “Overview of the Shallow Seismic Reflection Technique,” Presented at the 2nd International Conference on the Application of Geophysical and NDT Methodologies to Transportation Facilities and Infrastructure, Los Angeles, Calif., May 15–19, 2002.

- SAGEEP Proceedings, Colorado Springs, Colo., Feb. 22–26, 2004.
- Khanna, V. and M.A. Mooney, “Comparison of Back-Calculated SASW Profiles with Results from Coring and DCP Testing,” Presented at the 2nd International Conference on the Application of Geophysical and NDT Methodologies to Transportation Facilities and Infrastructure, Los Angeles, Calif., May 15–19, 2002.
- King, K.W. and M.J. DeMarco, “Impacts of Construction Vibrations on Rock Pinnacles and Natural Bridges, General Hitchcock Highway, Tucson,” Presented at the 3rd International Conference on Applied Geophysics, Hotel Royal Plaza, Orlando, Fla., Dec. 8–12, 2003.
- Kociu, S., R. Luna, N. Anderson, W. Zheng, and D. Hoffman, “Non-Linear Soil Response to Strong Ground Motion: Determinations Based on SASW Velocity Profiles,” Presented at the 3rd International Conference on Applied Geophysics, Hotel Royal Plaza, Orlando, Fla., Dec. 8–12, 2003.
- Lambert, D.W. and M. Roark, “Combination Land and Underwater Seismic Refraction Survey Bedrock Characterization for Bridge Construction,” Paper 4-6, Presented at the First International Conference on the Application of Geophysical Methodologies and NDT to Transportation Facilities and Infrastructure, St. Louis, Mo., Dec. 11–15, 2000.
- Lambrecht, J., R. Miller, J. Ivanov, and S. Durrant, “High-Resolution Seismic Imaging of Catastrophic Salt Dissolution Sinkhole in Central Kansas,” Presented at the SAGEEP Proceedings, Colorado Springs, Colo., Feb. 22–26, 2004.
- Leeds, D., “Repeatability of Seismic Refraction Data,” Presented at the 2nd International Conference on the Application of Geophysical and NDT Methodologies to Transportation Facilities and Infrastructure, Los Angeles, Calif., May 15–19, 2002.
- Malovichko, A.A., D.A. Malovichko, D.Y. Shylakov, P.G. Butirin, and N.L. Anderson, “Estimation of Near-Surface Shear-Wave Velocities by SASW Method in Southeast Missouri,” Presented at the 3rd International Conference on Applied Geophysics, Hotel Royal Plaza, Orlando, Fla., Dec. 8–12, 2003.
- Miller, C.R., C.A. Link, and M.A. Speece, “Modified Land Streamer Configuration for Shallow Seismic Data Acquisition,” Presented at the SAGEEP Proceedings, San Antonio, Tex., Apr. 6–10, 2003.
- Miller, R., J. Ivanov, S. Hartung, and L. Block, “Seismic Investigation of a Sinkhole on Clearwater Dam,” Presented at the SAGEEP Proceedings, Colorado Springs, Colo., Feb. 22–26, 2004.
- Miller, R.D., J. Xia, C.B. Park, and J. Ivanov, “Shear Wave Velocity Field from Surface Waves to Detect Anomalies in the Subsurface,” Paper 4-8, Presented at the First International Conference on the Application of Geophysical Methodologies and NDT to Transportation Facilities and Infrastructure, St. Louis, Mo., Dec. 11–15, 2000.
- Narwold, C., “Seismic Refraction Analysis of Landslides,” Presented at the 2nd International Conference on the Application of Geophysical and NDT Methodologies to Transportation Facilities and Infrastructure, Los Angeles, Calif., May 15–19, 2002.
- O’Neill, A., “Shear Velocity Model Appraisal in Shallow Surface Wave Inversion,” Presented at the SAGEEP Proceedings, Colorado Springs, Colo., Feb. 22–26, 2004.
- Oh, Y., H. Jeong, Y. Lee, and H. Shon, “Safety Evaluation of Rock-Fill Dam by Seismic (MASW) and Resistivity Methods,” Presented at the SAGEEP Proceedings, San Antonio, Tex., Apr. 6–10, 2003.
- Park, C., “Shear-Wave Velocity Profiling by the Surface-Wave (MASW) Method,” Presented at the 18th Annual SAGEEP Meeting, Atlanta, Ga., Apr. 3–7, 2005.
- Park, C.B., R.D. Miller, J. Xia, and J. Ivanov, “Multichannel Seismic Surface-Wave Methods for Geotechnical Applications,” Paper 4-7, Presented at the First International Conference on the Application of Geophysical Methodologies and NDT to Transportation Facilities and Infrastructure, St. Louis, Mo., Dec. 11–15, 2000.
- Pugin, A.J.M., G. Overney, J.A. Hunter, and S.E. Pullan, “Walking Over Water: Seismic Reflection Data Acquisition Using a Hand Hammer,” Presented at the SAGEEP Proceedings, San Antonio, Tex., Apr. 6–10, 2003.
- Pullammanappallil, S., W. Honjas, and J.N. Louie, “Determination of 1-D Shear Wave Velocities Using the Refraction Microtremor Method,” Presented at the 3rd International Conference on Applied Geophysics, Hotel Royal Plaza, Orlando, Fla., Dec. 8–12, 2003.
- Ralston, M., “Near Surface Three Component Seismic Data Acquisition,” Presented at the 2nd International Conference on the Application of Geophysical and NDT Methodologies to Transportation Facilities and Infrastructure, Los Angeles, Calif., May 15–19, 2002.
- Roark, M.S. and T.P. Hart, “Seismic Vibration Monitoring at Ramp Construction Near the Martin Luther King Bridge, East Saint Louis, Illinois,” Paper 4-18, Presented at the First International Conference on the Application of Geophysical Methodologies and NDT to Transportation Facilities and Infrastructure, St. Louis, Mo., Dec. 11–15, 2000.
- Roble, C., “An Overview of ROSRINE Geophysical Testing,” Presented at the 2nd International Conference on the Application of Geophysical and NDT Methodologies to Transportation Facilities and Infrastructure, Los Angeles, Calif., May 15–19, 2002.
- Rucker, M.L., “Applying the Seismic Refraction Technique to Exploration for Transportation Facilities,” Paper 1-3, Presented at the First International Conference on the Application of Geophysical Methodologies to Transportation Facilities and Infrastructure, St. Louis, Mo., Dec. 11–15, 2000.
- Rucker, M.L., “Seismic Refraction Interpretation with Velocity Gradient and Depth of Investigation,” Presented at the 2nd International Conference on the Application of Geophysical and NDT Methodologies to Transportation

- Facilities and Infrastructure, Los Angeles, Calif., May 15–19, 2002.
- Rucker, M.L., “Applying the Refraction Microtremor (ReMi) Shear Wave Technique to Geotechnical Characterization,” Presented at the 3rd International Conference on the Applied Geophysics, Hotel Royal Plaza, Orlando, Fla., Dec. 8–12, 2003.
- Shokouhi, P. and N. Gucunski, “Application of Wavelet Transform in Detection of Shallow Cavities by Surface Waves,” Presented at the SAGEEP Proceedings, San Antonio, Tex., Apr. 6–10, 2003.
- Shokouhi, P., N. Gucunski, and A. Maher, “Detection of Shallow Cavities by Wavelet Transform Analysis of Surface Waves,” Presented at the 3rd International Conference on Applied Geophysics, Hotel Royal Plaza, Orlando, Fla., Dec. 8–12, 2003.
- Spikes, K., “Collecting Shallow CMP Seismic Data with Automatically Planted Geophones,” Presented at the 2nd International Conference on the Application of Geophysical and NDT Methodologies to Transportation Facilities and Infrastructure, Los Angeles, Calif., May 15–19, 2002.
- Tomio, I., “High-Resolution S-Wave Reflection Surveys for Delineating Near-Surface Geological Structures,” Paper 4-5, Presented at the First International Conference on the Application of Geophysical Methodologies and NDT to Transportation Facilities and Infrastructure, St. Louis, Mo., Dec. 11–15, 2000.
- Vandergrift, T.I., K.Y. Haramy, and P.R. Macklin, “Risk Management and Stabilization Planning for Excavated Slopes Using Tomographic Ground Imaging,” Paper 4-10, Presented at the First International Conference on the Application of Geophysical Methodologies and NDT to Transportation Facilities and Infrastructure, St. Louis, Mo., Dec. 11–15, 2000.
- Williams, R., V. Babeshko, and E. Kutsenko, “Reflection Seismology: Application to Identifying Fault Structure,” Presented at the 18th Annual SAGEEP Meeting, Atlanta, Ga., Apr. 3–7, 2005.
- Yoon, S. and G. Rix, “Combined Active-Passive Surface Wave Measurements for Near-Surface Site Characterization,” Presented at the SAGEEP Proceedings, Colorado Springs, Colo., Feb. 22–26, 2004.
- Zhang, J. and S.K. Hye, “3D Refraction Tomography for Near-Surface Geological Studies,” Presented at the SAGEEP Proceedings, San Antonio, Tex., Apr. 6–10, 2003.
- Zhang, J., Z. Sun, and C. Lippus, “On-Site Instant Automated Refraction Tomography,” Presented at the SAGEEP Proceedings, San Antonio, Tex., Apr. 6–10, 2003.
- ASTM International, “D6167 Standard Guide for Conducting Borehole Geophysical Logging: Mechanical Caliper,” West Conshohocken, Pa., 2004, 6 pp.
- ASTM International, “D6274 Standard Guide for Conducting Borehole Geophysical Logging—Gamma,” West Conshohocken, Pa., 2004, 11 pp.
- ASTM International, “D7046 Standard Guide for Use of the Metal Detection Method for Subsurface Investigation,” West Conshohocken, Pa., 2004, 6 pp.
- ASTM, “D5753 Standard Guide for Planning and Conducting Borehole Geophysical Logging,” West Conshohocken, Pa., 1995, 9 pp.
- ASTM, “D5777 Standard Guide for Using the Seismic Refraction Method for Subsurface Investigation,” West Conshohocken, Pa., 2000, 14 pp.
- ASTM, “D6429 Standard Guide for Selecting Surface Geophysical Methods,” West Conshohocken, Pa., 1999, 11 pp.
- ASTM, “D6430 Standard Guide for Using the Gravity Method for Subsurface Investigation,” West Conshohocken, Pa., 1999, 10 pp.
- ASTM, “D6431 Standard Guide for Using the Direct Current Resistivity Method for Subsurface Investigation,” West Conshohocken, Pa., 1999, 14 pp.
- ASTM, “D6432 Standard Guide for Using the Surface Ground Penetrating Radar Method for Subsurface Investigation,” West Conshohocken, Pa., 1999, 17 pp.
- ASTM, “D6639 Standard Guide for Using the Frequency Domain Electromagnetic Method for Subsurface Investigations,” West Conshohocken, Pa., 2001, 13 pp.
- ASTM, “D6726 Standard Guide for Conducting Borehole Geophysical Logging—Electromagnetic Induction,” West Conshohocken, Pa., 2001, 7 pp.
- ASTM, “D6727 Standard Guide for Conducting Borehole Geophysical Logging—Neutron,” West Conshohocken, Pa., 2001, 9 pp.
- ASTM, “D6820 Standard Guide for Using the Time Domain Electromagnetic Method for Subsurface Investigations,” West Conshohocken, Pa., 2002, 14 pp.
- ASTM, “G57 Standard Test Method for Field Measurement of Soil Resistivity Using the Wenner Four-Electrode Method,” West Conshohocken, Pa., 2001, 7 pp.
- Hoover, R. and W. Saunders, “Evolving Geophysical Standards,” Paper 1-14, Presented at the First International Conference on the Application of Geophysical Methodologies and NDT to Transportation Facilities and Infrastructure, St. Louis, Mo., Dec. 11–15, 2000.

STANDARDS AND GUIDES

- American Society for Testing and Materials (ASTM), “D4428 Standard Test Methods for Crosshole Seismic Testing,” West Conshohocken, Pa., 2000, 9 pp.

OTHER

- Cathcart, M. and R. Bock, “Soil Composition Determination Based on Soil Optical Properties in the Thermal Infrared,” Presented at the 18th Annual SAGEEP Meeting, Atlanta, Ga., Apr. 3–7, 2005.
- Cist, D., “A New Approach for Real Time Pipe Locating,” Presented at the 18th Annual SAGEEP Meeting, Atlanta, Ga., Apr. 3–7, 2005.

Hempmen, G.L. and D.L. Butler, "Contracting for Geophysical Services," Paper 1-13, Presented at the First International Conference on the Application of Geophysical Methodologies and NDT to Transportation Facilities and Infrastructure, St. Louis, Mo., Dec. 11-15, 2000.
SAGEEP Proceedings 1988-2000, CD-ROM, Denver, Colo.

Owen, W.P., "Selling Geophysics: Some Observations on Creating and Marketing a Geophysics Program in State Government," Paper 1-11, Presented at the First International Conference on the Application of Geophysical Methodologies and NDT to Transportation Facilities and Infrastructure, St. Louis, Mo., Dec. 11-15, 2000.

APPENDIX A

Methods and Techniques

Much of the following text and information presented in this appendix was provided for the synthesis project by FHWA. The documents were prepared as part of the Geophysics Workshop currently in preparation by FHWA.

Geophysical Method Selection Matrix			
FHWA/State DOT			
Name:		Phone:	
Title:		Cell:	
Agency:		Fax:	
Address:		E-mail:	
City/State/Zip:		Web:	
Geophysical Contractor			
Name:		Phone:	
Title:		Cell:	
Agency:		Fax:	
Address:		E-mail:	
City/State/Zip:		Web:	

Project Location: <input type="checkbox"/> State <input type="checkbox"/> County <input type="checkbox"/> City Street Address: _____	Estimated Budget: <input type="checkbox"/> +\$2,500 <input type="checkbox"/> \$2,500–\$10,000 <input type="checkbox"/> \$10,000–\$50,000 <input type="checkbox"/> \$50,000–\$100,000 <input type="checkbox"/> \$100,000–\$500,000 <input type="checkbox"/> >\$500,000 <input type="checkbox"/> Specify	Time Frame: <input type="checkbox"/> +2 weeks <input type="checkbox"/> 2 weeks–2 months <input type="checkbox"/> 2 months–6 months <input type="checkbox"/> >12 months <input type="checkbox"/> Specify Mobilization Date: _____ Demobilization Date: _____ Number of Mobilizations: _____
Specific Project Location:		
Project Objective: Bridge (chapter two) <input type="checkbox"/> Depth to foundation <input type="checkbox"/> Foundation socketing into bedrock <input type="checkbox"/> Integrity testing of foundation <input type="checkbox"/> Testing other substructure elements <input type="checkbox"/> Rebar quality <input type="checkbox"/> Foundation scour Decks (chapter three) <input type="checkbox"/> Stability analysis <input type="checkbox"/> QA/QC of new decks <input type="checkbox"/> Baseline condition assessment <input type="checkbox"/> Existing deck evaluation <input type="checkbox"/> Presence, pattern, density of rebar <input type="checkbox"/> Rebar condition/corrosion <input type="checkbox"/> Concrete condition/integrity <input type="checkbox"/> Incipient spalling	Pavement (chapter four) <input type="checkbox"/> QA/QC of new <input type="checkbox"/> Condition evaluation <input type="checkbox"/> Segregation in hot mix asphalt <input type="checkbox"/> Moisture variation <input type="checkbox"/> Rock pockets <input type="checkbox"/> Voids beneath <input type="checkbox"/> Cracking <input type="checkbox"/> Condition/integrity Roadway Subsidence (chapter five) <input type="checkbox"/> Clay content <input type="checkbox"/> Expansive clay <input type="checkbox"/> Voids, cavities <input type="checkbox"/> Sinkholes <input type="checkbox"/> Abandoned mines Subsurface Characterization (chapter six) <input type="checkbox"/> Depth of bedrock <input type="checkbox"/> Depth of structures <input type="checkbox"/> Depth of fractures	Subsurface Characterization (chapter six) <input type="checkbox"/> Identifying weak zones within bedrock <input type="checkbox"/> Mapping lithology <input type="checkbox"/> Locating shallow sands and gravels <input type="checkbox"/> Mapping groundwater surface and flow Imaging Buried Manmade Features (chapter six) <input type="checkbox"/> Utilities <input type="checkbox"/> Unexploded ordnance (UXO) <input type="checkbox"/> Pipeline <input type="checkbox"/> Underground storage tanks <input type="checkbox"/> Contaminant plumes Vibration (chapter seven) <input type="checkbox"/> Monitoring vibration <input type="checkbox"/> Specify: _____

<p>Road Type:</p> <input type="checkbox"/> Country lane <input type="checkbox"/> 2-lane road <input type="checkbox"/> 4-lane road <input type="checkbox"/> Freeway <input type="checkbox"/> Freeway interchange <input type="checkbox"/> Bridge <input type="checkbox"/> No shoulder <input type="checkbox"/> Not applicable <input type="checkbox"/> Specify: _____	<p>Surface Vegetation:</p> <input type="checkbox"/> Trees <input type="checkbox"/> Grass <input type="checkbox"/> Bare <input type="checkbox"/> Shrubs <input type="checkbox"/> Specify: _____ <p>Vegetation Density:</p> <input type="checkbox"/> Sparse <input type="checkbox"/> Light <input type="checkbox"/> Medium <input type="checkbox"/> Heavy	<p>Geology:</p> <input type="checkbox"/> Unknown <input type="checkbox"/> Limestone <input type="checkbox"/> Clay <input type="checkbox"/> Sand <input type="checkbox"/> Shale <input type="checkbox"/> Granite <input type="checkbox"/> Specify: _____
<p>Traffic Control:</p> <input type="checkbox"/> Road closed <input type="checkbox"/> Flagger(s) <input type="checkbox"/> provided by: _____ <input type="checkbox"/> Not applicable <input type="checkbox"/> Specify: _____	<p>Target Depth:</p> <input type="checkbox"/> 1–10 cm <input type="checkbox"/> 10–100 cm <input type="checkbox"/> 1 meter <input type="checkbox"/> 10 meters <input type="checkbox"/> 15 meters <input type="checkbox"/> 100 meters <input type="checkbox"/> 1 kilometer <input type="checkbox"/> >1 kilometer <input type="checkbox"/> Specify: _____	<p>Target Size:</p> <input type="checkbox"/> 1–10 cm <input type="checkbox"/> 10–100 cm <input type="checkbox"/> 1 meter <input type="checkbox"/> 10 meters <input type="checkbox"/> 15 meters <input type="checkbox"/> 100 meters <input type="checkbox"/> 1 kilometer <input type="checkbox"/> >1 kilometer <input type="checkbox"/> Specify: _____
<p>Supporting Information:</p> <input type="checkbox"/> Boring logs <input type="checkbox"/> Site history <input type="checkbox"/> Site photographs <input type="checkbox"/> Water table depth <input type="checkbox"/> Specify: _____ <p>Slopes:</p> <input type="checkbox"/> 0°–30° <input type="checkbox"/> 30°–45° <input type="checkbox"/> >45°	<p>Cultural Features</p>	
<p>OSHA 1910.120:</p> <input type="checkbox"/> None <input type="checkbox"/> Level D <input type="checkbox"/> Level C <input type="checkbox"/> Level B <input type="checkbox"/> Level A <input type="checkbox"/> Radioactive <input type="checkbox"/> Specify	<p>Recommended Geophysical Methods</p>	
<p>Notes/Action Items/Comments:</p> 	<p>Subsurface Characterization:</p> <input type="checkbox"/> Resistivity <input type="checkbox"/> Electromagnetics <input type="checkbox"/> Ground penetrating radar <input type="checkbox"/> Magnetics <input type="checkbox"/> Seismic refraction <input type="checkbox"/> Seismic reflection <input type="checkbox"/> Cross borehole tomography <input type="checkbox"/> MASW <input type="checkbox"/> SASW <input type="checkbox"/> Specify: _____	<p>Engineered Structures Evaluation:</p> <input type="checkbox"/> Crosshole sonic logging <input type="checkbox"/> Crosshole sonic logging tomography <input type="checkbox"/> Gamma–gamma density <input type="checkbox"/> Impact echo <input type="checkbox"/> Ground penetrating radar <input type="checkbox"/> SASW <input type="checkbox"/> Specify: _____

SEISMIC REFLECTION

Introduction

Seismic methods are the most commonly conducted geophysical surveys for engineering investigations. Seismic data provides engineers and geologists with the most basic information related to the elastic properties (strength) of rocks using well-understood geophysical procedures and common equipment.

Seismic waves are created using either an impulsive source (hammer, explosives) or a vibrating source called vibroseis. In either case these seismic waves travel into the ground and this energy is partitioned. When it reaches a rock layer that has a different impedance (related to velocity and density) some of the energy is reflected back to the ground surface, some is refracted along the interface, and some continues deeper into the ground. As the refracted wave travels along the interfaces, energy is continuously transmitted back to the ground surface. Geophones placed on the ground surface detect the reflected and refracted waves. Seismic waves can be divided into two main groups; body waves and surface waves that exist only near a boundary.

Body Waves

These have the highest velocity of all seismic waves and are called compressional or pressure or primary (P-wave). The particle motion of P-waves is extension (dilation) and compression along the propagating direction. P-waves travel through all media that support seismic waves, which includes solids, gases, and liquids. Compressional waves in fluids; e.g., water and air, are commonly referred to as acoustic waves.

The second wave type is the transverse or shear wave (S-wave). S-waves travel slower than P-waves in solids, usually at about 60% of the speed of P-waves. S-waves have particle motion perpendicular to the propagating direction. These transverse waves can only travel through materials that have shear strength. S-waves do not exist in liquids and gases, as these materials have no shear strength.

Surface Waves

Two types of waves, which exist only at “surfaces” or interfaces, are Love and Rayleigh waves. Traveling along a surface, these waves attenuate rapidly with distance from the surface. Surface waves travel slower than body waves. Love waves have particle motion similar to S-waves. Rayleigh waves travel in an ellipse similar to ocean waves. Surface waves are produced by surface impacts, explosions, and waveform changes at boundaries. Love and Rayleigh waves are also portions of the surface wave train in earthquakes. These surface waves carry greater energy content than body waves and travel more slowly, thus arriving after body waves. Because of

their greater energy content, surface waves may cause more damage than body waves during an earthquake.

Data Collection

A source, geophone, and seismograph are needed to collect data for a seismic survey. The source can be a hammer striking the ground, aluminum plate or weighted plank, weights of varying sizes that are allowed to drop onto the ground, rifle shot, harmonic oscillator, waterborne mechanisms, or explosives. The source is commonly referred to as a shot; however, this does not necessarily imply explosives. The source will vary depending on the objective of the survey, particularly the desired investigated depth and physical properties of the rocks at the sites.

The sensor receiving the seismic energy created by the source is called the geophone. The sensors are either accelerometers or velocity transducers, and convert ground movement into voltage. Geophones can be placed in a variety of geometric patterns referred to as a line, spread, or string of geophones depending on the objectives of the survey.

The seismograph records input geophone voltages in a timed sequence. Seismographs store the signals as digital data at a discrete time.

A portion of the seismic energy striking the interface between two differing materials will be reflected from the interface. The ratio of the reflected energy to the incident energy is called the reflection coefficient. The reflection coefficient is defined in terms of the densities and seismic velocities of the two materials:

$$R = \frac{\rho_{b2}V_2 - \rho_{b1}V_1}{\rho_{b2}V_2 + \rho_{b1}V_1}$$

where

- R = reflection coefficient;
- ρ_{b1}, ρ_{b2} = densities of the first and second layers, respectively; and
- V_1, V_2 = seismic velocities of the first and second layers, respectively.

Data Processing

Processing is typically done by geophysicists that specialize in seismic processing using special purpose computers. These techniques are expensive, but technically robust and excellent results can be achieved. A close association of the field geophysicist, processor, and the consumer is absolutely essential if the results are to be useful. Well logs, known depths, results from ancillary methods, and the expected results should be furnished to the processor. At least one iteration of the results should be used to ensure that the final outcome is successful.

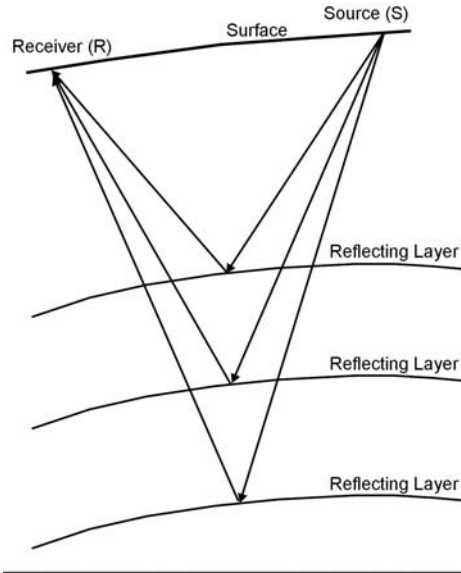

FIGURE A1 Schematic of seismic reflection method.

One important conclusion of the processing is the depth section. The production of depth sections requires conversion of the times of the reflections to depths by derivation of a velocity profile. Well logs and check shots are often necessary to confirm the accuracy of this conversion.

Figure A1 shows a schematic of the seismic reflection method illustrating the raypath through successive layers. The unique advantage of seismic reflection is that it permits the mapping of many horizons or layers with each shot. Figure A2 shows the raypaths of arrivals recorded on a multi-channel seismograph. Note that the subsurface depth is exactly one-half the distance between geophones on the surface. Figure A3 shows the arrivals on a seismic reflection record. The various arrivals are identified on Figure A3.

Advantages

The unique advantage of seismic reflection data is that it permits mapping many horizons or layers with each shot.

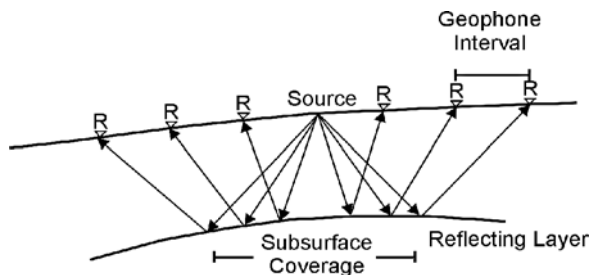

FIGURE A2 Multi-channel recordings for seismic reflection.

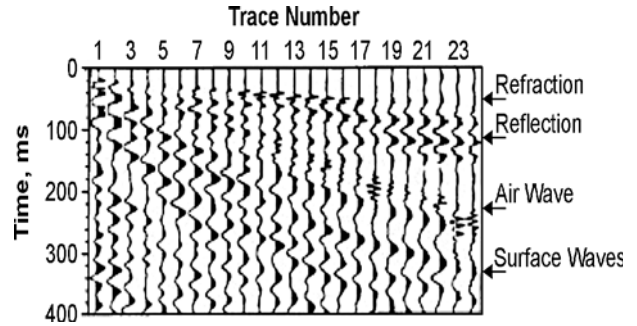

FIGURE A3 Simple seismic reflection record.

Limitations

Variations in field techniques are required depending on depth. Containment of the air-blast is essential in shallow reflection work. Success is greatly increased if shots and phones are near or in the saturated zone. Severe low-cut filters and arrays of a small number (1–5) of geophones are required. Generally, reflections should be visible on the field records after all recording parameters are optimized. Data processing should be guided by the appearance of the field records and extreme care should be used to stack refractions or other unwanted artifacts as reflections.

References 1–3, 5, 7, 8, and 10.

SEISMIC REFRACTION

Introduction

The refraction seismic method is used to measure the depths and velocities of subsurface layers. It is particularly useful for mapping the depth and topography of the bedrock surface. It can also be used to find the elastic properties of these layers, which are useful for engineering purposes. Using the velocity of the bedrock, the rippability of the bedrock can be determined along with an estimate of the size of machine required.

Basic Principles of the Refraction Seismic Method

When seismic waves are created on the ground surface they penetrate the subsurface until they encounter layers with different velocities and/or densities. In the case of refraction seismic, the subsurface layers must have successively increasing layer velocities with depth. At the layer boundaries, part of the incident wave is reflected back to the ground surface, part is transmitted deeper into the ground, and part is refracted along the surface of the layer boundary. Figure A4 shows the incident, reflected, transmitted, and refracted waves at a layer boundary with different velocities on either side. This drawing also shows the wave that travels along the ground surface, called the direct wave, and the air wave. As the refracted wave travels along the refractor surface, seismic energy is continuously refracted back to the ground surface.

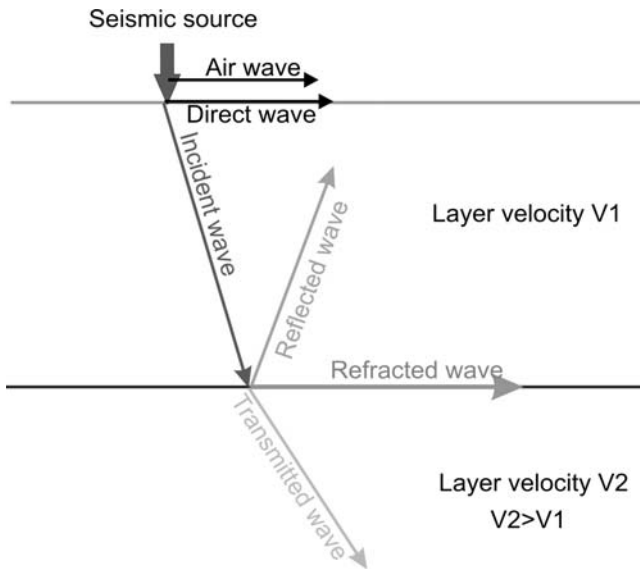

FIGURE A4 Main seismic waves and wave partitioning that occurs at a seismic interface.

Refraction seismic surveys can be conducted using two kinds of seismic energy, called compression and shear waves. Compression waves (P-waves) are the most common energy source and are created by impacts such as a hammer hitting a plate placed on the ground surface. In compression waves, the particle motion is parallel to the direction of travel of the wave, propagating as a series of contractions and dilations of the rock particles.

Shear waves (S-waves), in which the particles oscillate orthogonal to the direction of travel, are used along with P-waves to obtain the elastic properties of the rocks and to locate fracture zones. Creating shear waves is more difficult than creating compression waves. This requires hitting a plank of wood held firmly on the ground surface, or a specially made device, with a side impact. The velocity of S-waves is usually about three-fifths of the velocity of P-waves in consolidated rock.

In the seismic refraction method, the seismic waves that result from a ground impact are recorded, as illustrated in Figure A5. Normally, a minimum of five shots are used for each seismic spread. Only four shots are shown in Figure A5 for clarity. Normally, a shot in the center of the spread is also recorded. Additional shots may be recorded, mostly depending on the expected overburden velocity changes. If these changes are expected to be significant then more shots may be needed to better define the overburden velocity, thus improving the accuracy of the overall interpretation.

Data recording seismic wave detectors, called geophones, are planted in the ground along a straight line, usually with equal spacings. The number of geophones depends on the survey and the seismic recorder being used, but usually varies between 24 and 96. Sometimes the geophones near the ends

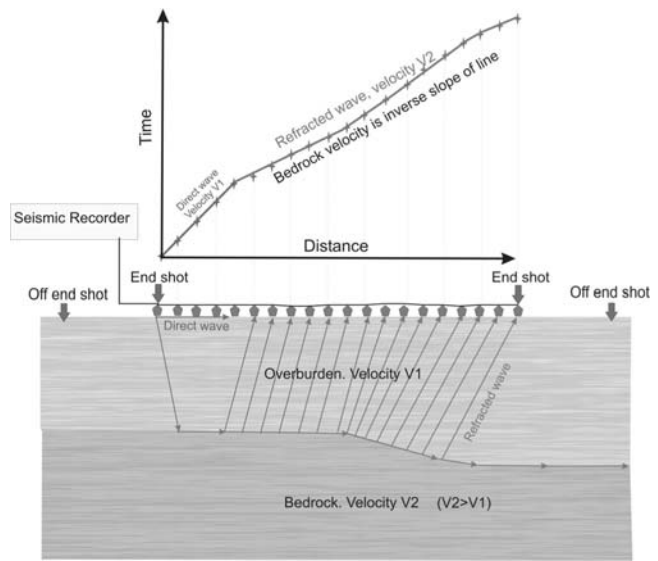

FIGURE A5 Schematic showing a seismic refraction time–distance curve and the refracted waves.

of the spread have smaller separations to obtain the velocity of thin overburden layers. Shots are positioned as described previously and the data are recorded on the seismograph. The source of the seismic energy can be a hammer hitting a metal plate placed on the ground surface, a small black powder charge placed in a hole about 2 ft deep, a weight drop system, or explosives.

Processing and Interpretation

The data are interpreted using one of several methods. Probably the most commonly used method is called the Generalized Reciprocal Method (GRM). This method provides depths and velocities under each geophone and usually produces reliable results providing the refractor dips at less than 20 degrees relative to the ground surface.

The first step is to pick the first arrival times of the seismic waves for each geophone and each shot. These arrival times are then plotted as a function of distance from the shot location (time–distance plot, Figure A5). The time–distance data are then input into the interpretation program and the data are then interpreted to give overburden and refractor depths and velocities. The method can be used to determine the depth and velocities of up to about four refractors under ideal conditions.

Method Limitations

The main sources of error in computing depth to bedrock from seismic refraction surveys are:

- Low signal-to-noise ratios owing to insufficient source energy, cultural noise, wind noise, rain, or other local sources of vibrations.

- Lateral variations in the overburden velocity.
- Potential “hidden layers” resulting from a low-velocity layer overlain by a higher-velocity layer (velocity reversals), layers too thin to support refracted wave energy, or thin layers with a low velocity contrast with the layers on either side.

References 1–3, 5, 7, 8, and 10.

CROSSHOLE SEISMIC TESTING

Introduction

Crosshole seismic testing is conducted to determine the properties of soils not rock using P- and S-waves in boreholes. The information obtained from these tests can be used to compute shear modulus, Young’s modulus, and Poisson’s ratio for static/dynamic analysis.

Basic Principles of Crosshole Seismic Testing

The crosshole seismic testing method is similar to seismic methods; however, it provides information on soil properties rather than rock properties. Two or more boreholes are used in this method. One borehole is instrumented with an energy source and the additional boreholes are instrumented with receivers (geophones or hydrophones). Figure A6 illustrates the field setup for a crosshole seismic test.

Field Data Recording

Crosshole seismic testing surveys are conducted using two or more (three are recommended for optimum results) boreholes. These boreholes are drilled to approximately 15 m and are spaced in a straight line approximately 3.0 m apart. The

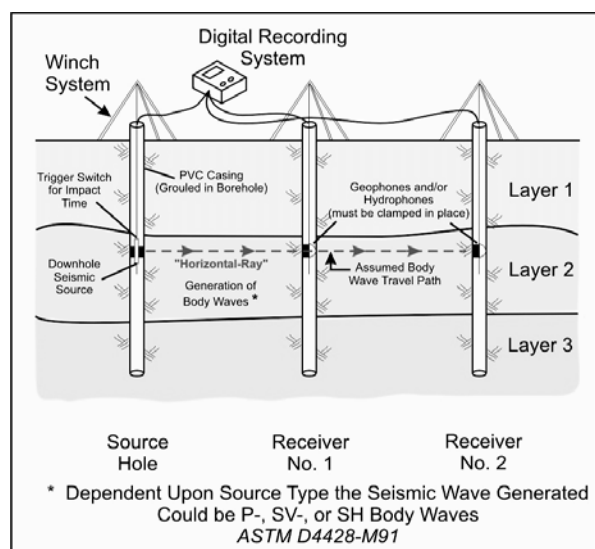

FIGURE A6 Field setup for crosshole seismic testing.

spacing can be increased to 4.5 m if the S-wave velocities will exceed 450 m/s, a common occurrence in alluvial materials. It is recommended that the boreholes be cased with PVC and grouted. This provides a smooth uniform surface that minimizes sidewall disturbance during testing. A borehole deviation survey must be conducted to ensure that the true vertical depth and horizontal position of any point in the borehole can be calculated.

A calibration test for the P- and S-wave must be performed in the hole. It is best to perform separate tests for the P- and S-waves for optimum results. The energy source is lowered into the borehole approximately 1.5 m, the same distance as the receivers in the remaining boreholes, and the source is activated. The signal amplitude and duration of the wave is adjusted so that they are both displayed in their entirety. Once the signal amplitude and duration have been adjusted, repeat the test at subsequent 1.5-m intervals for the source and receivers until the bottom of the borehole is reached (Table A1).

Interpretation determines the true vertical depth and horizontal position of any point in the borehole using the information from the deviation survey. Identify the arrival of the P-wave train followed by the S-wave train. The data are tabulated with three separate travel times, source to the first receiver, source to the second receiver, and the time difference between the first and second receiver. A computer program for crosshole seismic data interpretation is used to facilitate the number of calculations required for these data. These computer programs should be capable of solving the corrected distances, true velocities using Snell’s law, and the interface depth.

Limitations

- Poor borehole construction affects the data quality.
- Refraction events from high-velocity layers (either above or below a low-velocity layer) may be misinterpreted.
- Shear velocity is azimuthally anisotropic (velocity changes in direction).

TABLE A1
RANGE OF P-WAVE VELOCITIES
FOR COMMON ROCK TYPES

Rock/Fluid Type	Velocity Range (ft/s)
Freshwater	4,600
Sand (saturated)	4,900–6,600
Clay	3,280–8,200
Sandstone	6,500–18,000
Shale	3,100–16,700
Limestone	9,800–18,000
Dolomite	8,200–21,300
Granite	18,000–20,300
Gabbro	21,000–23,000
Glacial till	5,000–8,500

- ASTM requirement for three boreholes is costly.
- Good shear wave energy can be difficult to generate and record.

References 7, 8, 10, 11, and ASTM D4428.

GROUND PENETRATING RADAR

Introduction

Ground penetrating radar (GPR) surveys are commonly used for relatively shallow investigations, usually less than 10 m, although deeper targets can be detected under ideal conditions. The method has many applications, including locating underground storage tanks (UST), utilities, bedrock topography, and cavities in the bedrock. It is also used to evaluate roadbed integrity and to locate structural features in buildings such as post-tension cables.

The method relies on obtaining reflections of electromagnetic (EM) energy from objects beneath the ground or other surface, much like the seismic reflection method. Reflections occur when the object provides a contrast in its relative permittivity (also called dielectric constant) compared with that of the host material. The relative permittivity for most geologic materials is dominated by that of water, which has a relative permittivity of 80. The velocity (V) of an EM wave in a medium with a relative permittivity of ϵ is given by:

$$V = \frac{c}{\sqrt{\epsilon}}$$

where c is the velocity of light (3×10^8 m/s).

The wavelength of an EM wave in a medium can be found using the equation

$$\lambda = \frac{V}{f}$$

where f is the frequency of the wave.

Table A2 provides values of the relative permittivity, velocity, and electrical conductivity of EM waves for some common materials. These properties often vary with frequency; the table is for frequencies of approximately 100 MHz.

The success of a GPR survey depends mostly on three factors: the dielectric properties of the target and host, the electrical conductivity and clay content of the ground, and the size of the target. As mentioned earlier, the target has to provide a contrast in dielectric properties with the host to be observed. The electrical conductivity is important because EM waves become increasingly attenuated with increasing conductivity, which will limit the depth of penetration. In general, a target whose dimensions are smaller than approximately one-third of the wavelength of the GPR signal will probably not be imaged.

Figure A7 illustrates two modes for taking GPR data; reflection and common mid-point. The most commonly used mode is reflection. On some GPR systems the transmitter and receiver are housed in one unit and therefore may be restricted to recording data using the reflection mode.

Several companies manufacture GPR equipment. Usually a wide range of antennae are available from each manufacturer, providing frequencies ranging from less than 25 MHz to more than 1 GHz. Some of these instruments house both

TABLE A2
RELATIVE PERMITTIVITY, VELOCITY, AND CONDUCTIVITY OF
SOME COMMON MATERIALS

Material	Relative Permittivity (ϵ)	Velocity (m/ns)	Conductivity (mS/m)
Ice	3–4	0.16	0.01
Freshwater	80	0.033	0.5
Seawater	80	0.01	3,000
Sand saturated with freshwater	20–30	0.06	0.1–1.0
Dry sand	3–5	0.15	0.01
Limestone	4–8	0.12	0.5–2
Granite	4–6	0.13	0.01
Silt	5–30	0.07	1–100
Clay	5–40	0.06	2–1,000
Shale	5–15	0.09	1–100

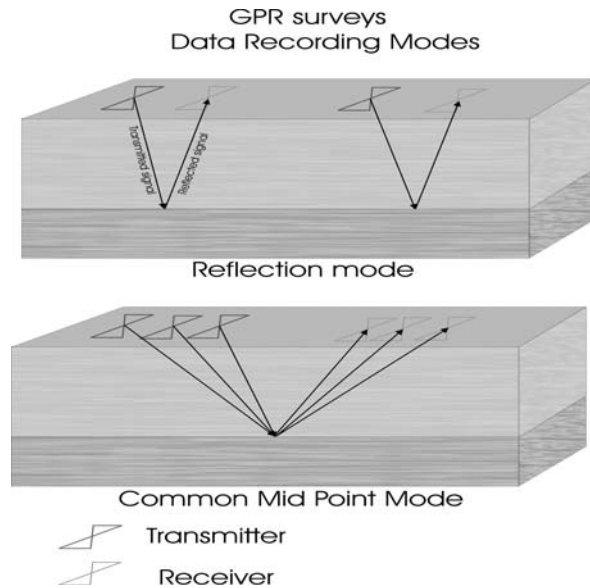

FIGURE A7 Two modes used to record GPR data.

the transmitter and receiver in one box, whereas others provide separate transmitter and receiver assemblies. High frequencies provide better resolution than lower frequencies but have less depth penetration. Conversely, lower frequencies provide better depth penetration but provide lower resolution.

Survey Procedures

Two general types of antenna are available. With the first type the antenna is designed to be in direct contact with the ground or surface containing the target. With the second type, called a horn antenna, the antenna is placed 2 or 3 ft above the ground. Data recorded with the horn antenna are also sampled at a much higher frequency than with the ground coupled antenna and can therefore be mounted behind a vehicle, allowing surveys to be conducted at up to 30 mph. Surveys conducted with the horn antenna are generally designed for investigations to depths less than approximately 6 in., such as roadbed surface analysis.

When using a unit that houses both the transmitter and receiver, the system is pulled along the ground at a slow speed. The data can usually be viewed on a monitor at the time of the survey, thereby allowing the operator to check that the target is being identified.

If it is desired to calculate the depth to an imaged target for a GPR survey, it is advisable to locate a suitable target at a known depth to calibrate the system and conduct a traverse across the feature. Such targets may include culverts and other features that should provide a clear response. If no calibration target is available, then the relative permittivity of the ground will need to be estimated. Velocity information can also be found from CMP surveys, where they can be obtained from

the variation in reflection time with offset. If such a survey is not feasible, then an estimate of the relative permittivity will need to be made using geologic knowledge and the information presented in Table A2.

Method Limitations

The main limitation of the GPR method is usually insufficient depth of penetration. This is often owing to conductive soils or overburden, usually because of high salt or clay content. Using lower-frequency antennae can sometimes minimize this limitation. Because of the dependence of depth penetration on the local ground conditions, such as electrical conductivity and clay content, the success of GPR surveys is site-specific, which sometimes cannot be accurately predicted ahead of the survey.

GPR data can be subject to interference from a number of sources. Local radio transmitters can saturate the electronics. Metal objects can interfere with the reflections. Above ground features, such as utility lines, can produce reflections that might interfere with the reflections from the target.

References 8–11 and 15.

DC RESISTIVITY MEASUREMENTS

Introduction

Resistivity measurements can be used to find the vertical and lateral variations in the resistivity of the subsurface. These measurements have many uses, including measuring the depth to the top of the water table, determining the depths and resistivities of geologic layers, mapping voids, fractures, and other geologic features. The method is most appropriate for depths generally less than approximately 200 ft, although deeper investigations can be performed.

Resistivity measurements can be divided into two main groups, soundings and traverses (profiling). Soundings are used to find the depths and resistivities of the geologic layers under the sounding site. Traverses are used to map the lateral variations in resistivity. It is also possible to efficiently conduct surveys combining both soundings and traverses, although the instruments generally used to perform these measurements employ transmitters with limited power and therefore provide limited depth penetration. Figure A8 shows the resistivity ranges of some common rock types.

Resistivity measurements can be recorded using several instruments. The most commonly used instruments are the Sting/Swift (from Advanced Geosciences Inc.), Iris (from Iris Instruments, France), and a Swedish company called ABEM. These companies produce instruments that can be used to measure the resistivity of the ground using a simple four electrode array or they can be used as an automated system where

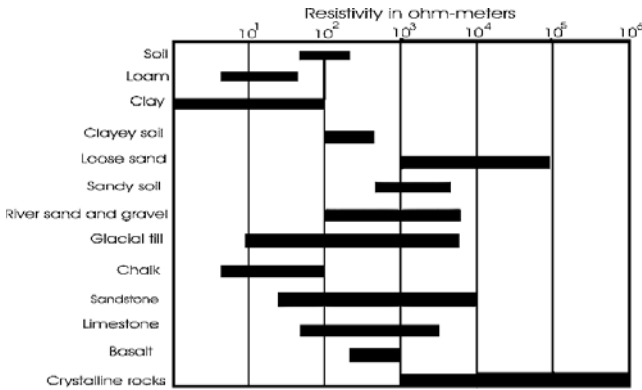

FIGURE A8 Resistivity ranges of some common rock types.

an array of electrodes are positioned before recording the data. Once this is done, and the electrodes connected to the recording instrument, the data are recorded with the instrument automatically switching between the required electrodes so as to acquire the data along the whole line.

Basic Principles of Resistivity Measurements

There are numerous electrode arrays that can be used to measure resistivity. These include Dipole–Dipole (used either in line or equatorially), Schlumberger, Wenner, Pole–Pole, Pole–Dipole, and the Square array. Each has particular advantages and disadvantages. Each array has four electrodes, two for injecting electrical current into the ground (current electrodes) and two different electrodes for measuring the resulting voltage (potential electrodes). The most commonly used electrode arrays are illustrated in Figure A9.

Unless the ground is homogeneous, the measured resistivity does not represent that of any particular layer until the data have been interpreted. Therefore, the measured resistivity is called Apparent Resistivity, can be thought of as a composite resistivity that includes contributions from all of the layers under the sounding site to the depth of investigation of the measurement.

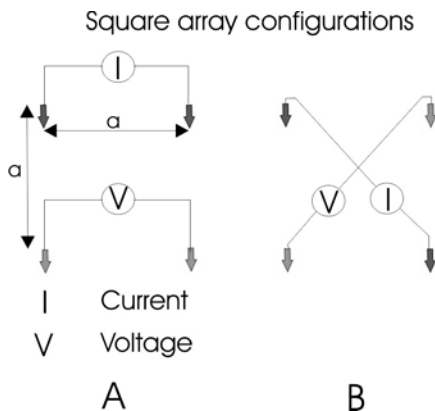

FIGURE A9 Common electrode arrays.

The equations for converting the measured resistance (V/I) into Apparent Resistivity are given below for the different arrays.

Dipole–Dipole array

$$\rho = \pi n(n+1)(n+2)a \frac{V}{I}$$

Pole–Dipole array

$$\rho = 2\pi n(n+1)a \frac{V}{I}$$

Wenner array and Pole–Pole array

$$\rho = 2\pi a V/I$$

Schlumberger array

$$\rho = \frac{\pi L^2}{2l} \frac{V}{I}$$

The Square array is shown in Figure A10. Square array; configuration A

$$\rho = \frac{2\pi a}{2-\sqrt{2}} \frac{V}{I}$$

In configuration B, no voltage is measured if the ground is electrically homogeneous.

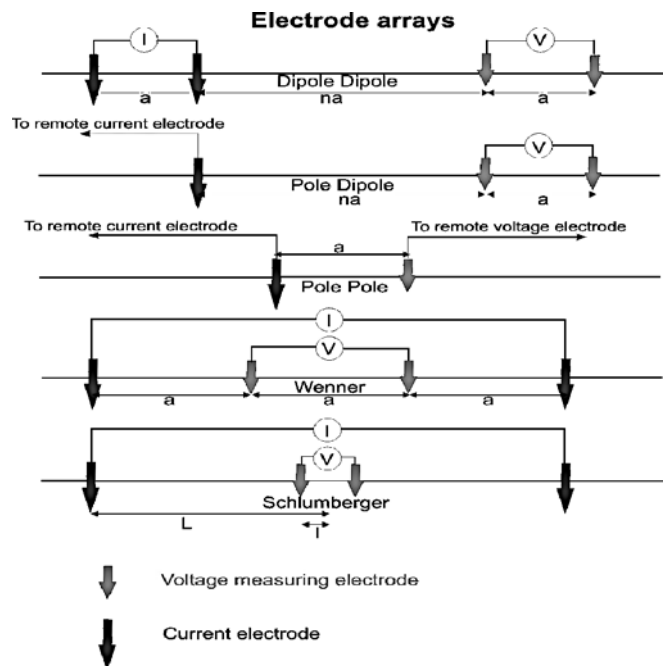

FIGURE A10 Square electrode array.

Resistivity Soundings

Resistivity soundings are conducted by measuring the Apparent Resistivity starting with a small electrode spacing and continuing to take measurements while increasing the electrode spacing until the required investigation depth has been reached. As the electrode spacings are increased the depth of investigation also increases. This is sometimes called a geometric sounding.

Generally the Schlumberger electrode array is best for soundings. This is because the voltage measuring (potential) electrodes are only moved when necessary to increase the measured voltage, thus minimizing offsets in the apparent resistivity sounding curve caused by local features near the potential electrodes; that is, boulders, shallow bedrock changes, soil resistivity changes, or other features that might cause significant lateral changes in the measured voltage.

A sounding curve can be plotted showing the Apparent Resistivity versus electrode spacing as illustrated in the upper drawing in Figure A11. Computer software is used to interpret the sounding curve producing a model showing the depths to the top, thickness, and resistivities of the layers under the sounding site. For this interpretation it is assumed

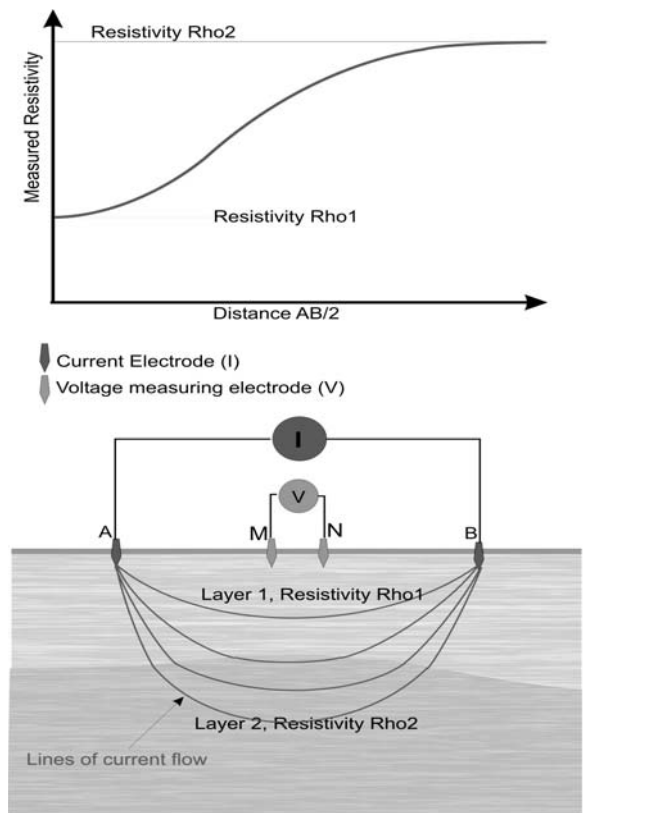

$$\text{Resistance} = V/I$$

$$\text{Resistivity} = \text{geometric factor for electrode array} * \text{Resistance}$$

FIGURE A11 Plot of measured resistivity (Apparent Resistivity) against AB/2 (electrode spacing) and a diagram showing the Schlumberger electrode array and lines of current flow in the ground.

that the layers under the sounding site are horizontal with no lateral changes in resistivity.

Resistivity Traverses/Soundings

Resistivity traverses are used to locate lateral variations in the resistivity of the subsurface. With automated resistivity systems, where the instrument automatically switches to the relevant electrodes, many different electrode spacings and locations can easily be recorded, thus producing an Apparent Resistivity section covering the line of electrodes. These data now combine both vertical (sounding) and lateral (traverse) resistivity information. Such sections are often called Pseudo Sections, because they show Apparent Resistivity plotted against electrode spacing along a traverse. These sections are interpreted using software that produces a section showing the modeled resistivity against depth.

Azimuthal Resistivity Measurements

Resistivity surveys can also be used to locate the occurrence of fractures and their orientation, using a technique called Azimuthal Resistivity. With this method, resistivity readings are taken while the array is rotated about its center. If the fracture zone is saturated with water and/or contains clay or soil then it may have a lower resistivity than that of the host rock and this may be observed as lower resistivities when the line of electrodes is parallel to the fracture.

With the square array, using diagonal electrodes for the voltage and current (see Figure A10) can be used to assess the occurrence of fractures. If no lateral resistivity changes are present within the area of influence of the array then the measured voltage will be zero. This method assumes that horizontal layering is present at the sounding site.

Capacitively Coupled Instruments

One of the more time consuming aspects of resistivity surveys is the time needed to insert electrodes into the ground. To overcome this problem, capacitively coupled electrode systems are available. In these systems, an array of capacitively coupled electrodes is connected by a cable and can be dragged along the ground by an operator walking at a slow speed. Data are then recorded as the system moves. However, these systems inject only very small currents into the ground and are usually limited to resistive ground conditions and depths of 10 to 20 ms. In addition, the surface conditions must be smooth and flat with little or no vegetation.

Method Limitations

The conventional resistivity method requires that electrodes be inserted into the ground, making it quite labor intensive. If the ground is hard then this may be difficult. In addition,

in dry ground conditions, the electrodes may need to have saline water poured on them to lower the electrical resistance between the electrode and ground. The interpretation of resistivity soundings necessarily assumes that the subsurface is horizontally layered with no lateral variations in resistivity.

References 1–3, 6, 7, and 10.

TIME DOMAIN ELECTROMAGNETIC SOUNDINGS

Introduction

Time Domain Electromagnetic (TDEM) soundings are done to obtain the vertical resistivity distribution of the subsurface. By performing several soundings along a line both the lateral and vertical variations in the resistivity of the subsurface can also be observed.

Some of the uses of resistivity measurements include finding the depth to the top of the water table, mapping geologic structure, and providing resistivity maps to aid in aquifer discovery and evaluation.

Several instruments are available for conducting TDEM soundings, with the most commonly used being the EM37, EM47 Protem, and EM57 systems manufactured by Geonics of Toronto, Canada.

The depth of investigation varies depending on the instrument used and the geologic conditions, but varies from about 20 ft to more than 1,000 ft. Figure A12 shows the resistivity ranges of some common rock types.

Basic Principles of TDEM Soundings

The TDEM method uses EM waves to image the subsurface. A square loop of wire is laid on the ground through which is passed electrical current having a positive on time followed by an off time. This is then followed by a negative on time and then another off time. This process is repeated while the data are being recorded. This current produces an EM field that penetrates the ground. When the current turns off, a rapidly

changing EM field is created that generates secondary currents in the ground. The magnitude of the secondary currents depends on the conductivity of the ground. The secondary currents, which are also time varying, produce their own time varying EM fields, which are detected by a receiver coil placed on the surface of the ground. The receiver coil records the signal after the transmitter current has turned off. Because the transmitter produces a square wave current, as described above, repeated at a predefined frequency, the received signal is stacked so as to improve the signal-to-noise ratio. The depth of investigation is related to the length of time after the transmitter loop current has turned off.

Figure A13 illustrates the layout of the system and the received signal when the transmitter current turns off. The instrument then converts this signal to Apparent Resistivity values for a series of times (time gates) after the current has turned off. These values are shown plotted as a measured resistivity (Apparent Resistivity) versus time plot, also illustrated in Figure A13, called a sounding curve. In this case, the sounding curve is that which would be observed over a low resistivity layer lying between more resistive layers.

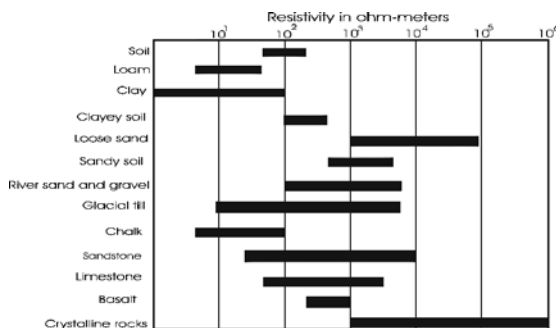
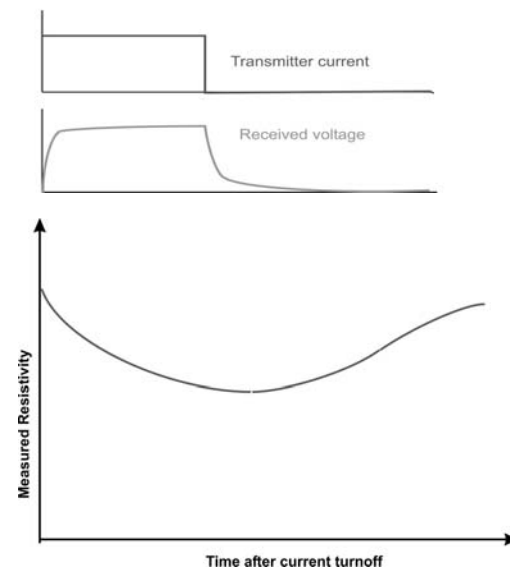
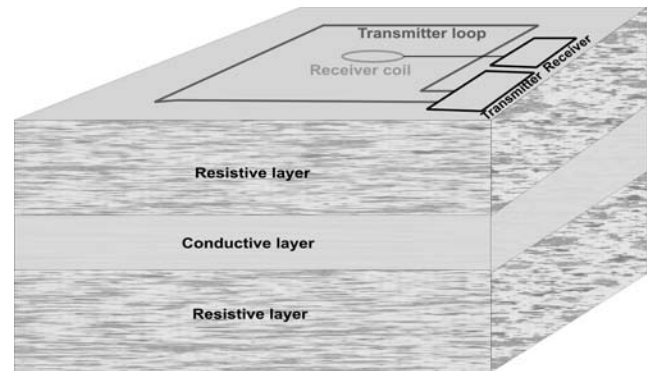

FIGURE A12 Resistivity ranges of some common rock types.

FIGURE A13 Schematic showing the field layout of the TDEM equipment, the transmitter current and received signal, and the resulting sounding curve.

Unless the ground is homogeneous the measured resistivity does not represent that of any particular layer until the data have been interpreted. Therefore, the measured resistivity is called Apparent Resistivity, which can be thought of as a composite resistivity that includes contributions from all of the layers under the sounding site, to the depth of investigation of the measurements.

The sounding curve is interpreted using software that iteratively modifies a proposed resistivity model (layer thickness, depths, and resistivities) until the calculated sounding curve matches the field curve.

Survey Procedures

TDEM soundings require a transmitter loop to be laid out along with the receiver coil, transmitter, generator, and receiver. For small depths of investigation where small transmitter loops are used, it is sometimes advantageous to place the receiver coil external to the transmitter loop.

The depth of investigation is related to the transmitter loop size, and can range from about one and one half to three times the side length of the transmitter loop. If both near surface and deeper interpretations are required, then two soundings may be performed with different transmitter loop sizes.

References 3 and 7–10.

Method Limitations

Because this is an EM method with a transmitter loop generating EM fields, surface and subsurface metal will influence the data and should be avoided. Moreover, this metal does not necessarily have to be grounded, as in the case with resistivity methods that use grounded electrodes. Metallic items such as metal fences, buildings with steel reinforcement, concrete with reinforcing bar, buried pipelines, and other metal features can influence the data. Power lines can also influence the data because they create electrical noise.

TDEM soundings are ideal for locating conductive layers, but are less effective at locating resistive layers. The method responds to the conductivity-thickness product (conductance) of the layer and for thin layers it may be difficult to determine either the conductivity or the thickness of the layer accurately.

CONDUCTIVITY MEASUREMENTS USING FREQUENCY DOMAIN ELECTROMAGNETIC (FDEM) INSTRUMENTS

Introduction

Measuring the electrical conductivity of the subsurface can be done relatively quickly. Several instruments are commonly used providing investigation depths from less than a

meter to approximately 60 m. These measurements are used for many purposes, including mapping soil/rock thickness, mapping the topography of subsurface layers, and locating fracture zones, clay beds, contaminant plumes, and prior excavations such as burial pits and buried metallic objects. They are also used in agriculture to estimate the salinity of the soil. This note provides a brief description of the method along with some examples of how the method can be used. The conductivity of common materials varies over a wide range, as shown in Table A3.

The most commonly used FDEM instruments are manufactured by Geonics Ltd. of Canada and are the EM31, EM31-MK2, EM31-3, EM34-3, EM34-XL, and EM38. The EM31-MK2 is similar to the EM31 but includes a data logger incorporated into the central console. With the standard EM31, the data logger is separate. Another EM31, called the EM31-3, is also available that has three receiver coils at distances of 1, 2, and 3.66 m from the transmitter coil, providing three investigation depths recorded simultaneously. A high-powered EM34-3 is also available, called the EM34-XL. This improves the signal-to-noise ratio by a factor of 10 at the 40-m coil separation and 4 at the 10- and 20-m coil separations. The system is useful in areas where increased cultural and/or atmospheric noise is expected.

All of the Geonics instruments listed previously convert the measured instrument response into “Apparent” conductivity before logging the data. The terms Apparent conductivity or “Terrain” conductivity are commonly used to describe the units of measurement recorded when using these instruments. This is because the measurement will only provide the true conductivity of the subsurface if it is homogeneous. In other cases where the ground is comprised of layers or other features having different conductivities, each measurement is the composite of all the contributions from each of these layers, or

TABLE A3
CONDUCTIVITY RANGES OF
COMMON MATERIALS

Material	Conductivity (mS/m)
Air	0
Distilled water	0.01
Freshwater	0.5
Seawater	3,000
Dry sand	0.01
Wet sand	0.1–1
Limestone	0.5–2
Shales	1–100
Silts	1–100
Clays	2–1,000
Granite	0.01–1
Dry salt	0.01–1
Ice	0.01
Metals	infinite

volumes, with different conductivities within the depth of investigation of the instrument.

Basic Principles of Conductivity Measurements

Figure A14 illustrates the concept behind measuring the electrical conductivity of the ground using EM induction techniques. For simplicity, a buried metal tank is presented in the drawing. The transmitter consists of a coil through which oscillating electrical current is passed. This current generates an oscillating EM field that penetrates the ground, illustrated by the red lines, called the primary EM field. This oscillating EM field then induces secondary oscillating currents in conductive material in the ground. The greater the conductivity of the ground the stronger will be the secondary currents.

These oscillating secondary currents also generate secondary oscillating EM fields that are detected by the receiver coil of the instrument. The instrument then compares the secondary signals with the signal from the transmitter and produces two components, one called the in-phase signal and the other called the out-of-phase (quadrature) signal. The out-of-phase signal is used to calculate the apparent conductivity of the ground and the in-phase signal is used when searching for highly conductive objects, such as buried metal tanks and pipes.

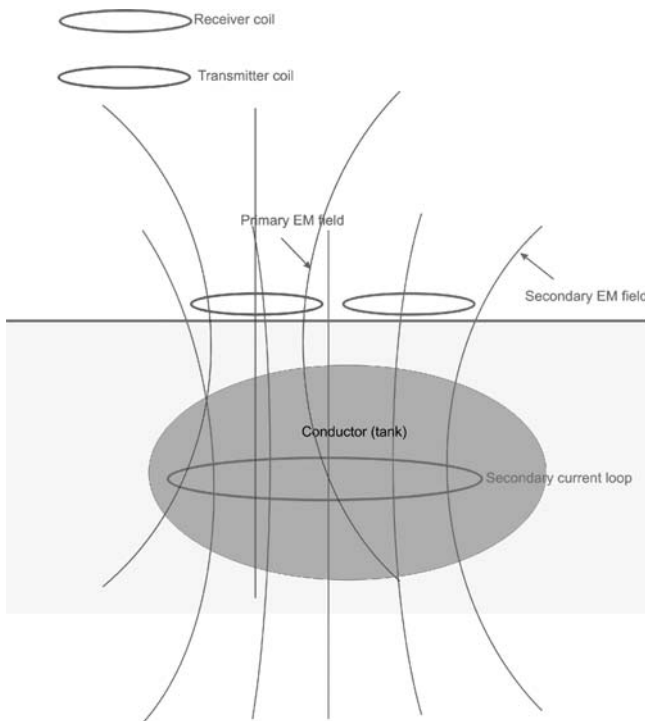

FIGURE A14 Schematic showing mechanics of EM induction method for measuring electrical conductivity of the ground.

Survey Procedures

The EM31 and EM38 require only one operator. The EM34-3 and EM34-XL require two people. The EM31-3 is cumbersome and heavy, requiring a trailer and tow vehicle.

Each of these instruments can be used in two different modes, one called the vertical dipole mode and the other called the horizontal dipole mode. When planning a survey it is important to understand the differences between the two modes. Figure A15 illustrates the relative contributions of a thin layer at depth (z = depth/coil separation) to the apparent conductivity indicated by the instrument. The horizontal dipole data are shown as $\Phi_H(z)$ and that of the vertical dipole as $\Phi_V(z)$.

In the vertical dipole mode (where the plane of the coils is parallel to the ground surface), the depth of penetration is maximized and the influence of changes in the near surface conductivity are minimized. In the horizontal dipole mode, the measurements are more sensitive to changes in the near surface conductivity, although depth of penetration is less. There are other important differences between the two modes, in particular the shape of the anomaly that is observed over a vertical conductive feature, such as may be found in a fracture zone. This is illustrated under the heading Terrain Conductivity Surveys.

The approximate depths of investigation for the more commonly used instruments, in each of the two modes, is presented Table A4.

With the EM31, EM34, and EM38 instruments, the data are usually plotted at the mid-point between the transmitter and receiver coils.

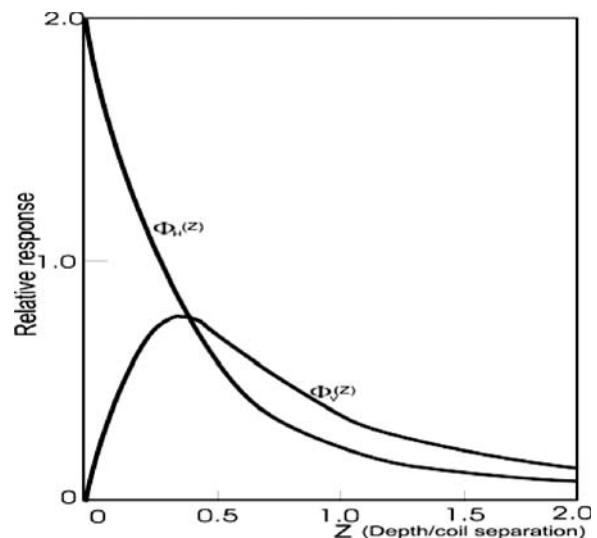

FIGURE A15 Relative responses from vertical and horizontal dipole modes when measuring electrical conductivity of the ground.

TABLE A4
DEPTH OF INVESTIGATION

Instrument	Coil Separation (meters)	Horizontal Dipole (meters)	Vertical Dipole (meters)
EM31	3.66	3	6
EM34	10	7.5	15
EM34	20	15	30
EM34	40	30	60
EM38	1	0.75	1.5

EM31 Surveys

The EM31 measures the electrical conductivity (Apparent Conductivity or Terrain Conductivity) of the upper 3 or 6 m of the ground, depending on the mode of use, as shown in the table presented above. Readings can be obtained either discretely, by pressing a button, or using a timed mode, taking readings up to twice per second with the EM31 or up to 10 readings per second with the EM31-MK2. Readings will normally be taken along lines crossing the area of interest. The beginning and end of these lines will need to be marked or surveyed prior to data recording, unless a GPS system is carried during the survey. The spatial coordinates of the data points can be obtained by interpolation, if necessary, using software, providing the spatial coordinates of the beginning and end marks have been surveyed.

EM34 Surveys

Two people are needed to operate the EM34; one for the transmitter coil and the other for the receiver coil. When used in the vertical dipole mode, ideally the two coils should be coplanar when a reading is taken. Usually, a flag is placed in the center of the cable joining the two coils. The flag is used to align the position at which a reading is taken. A data logger is used to record the data. Readings are taken along lines crossing the area of interest. The spacing between the readings and the lines depends on the target size and depth. Conventional surveying or GPS can determine the location of the data stations. If only the ends of the lines are surveyed, software can be used to provide interpolated spatial positioning between the beginning and end of each line.

EM38 Surveys

The EM38 is designed for shallow surveys down to depths of about 1.5 m. As such, it is used to measure the conductivity of the upper soil layers, which is then used to predict the degree of salinity (mostly for agricultural purposes). The system is also used in archeology, where the in-phase component can be used to provide information about soil magnetic susceptibility. Susceptibility is a measure of the amount of magnetic minerals in the soil. Readings can be taken in a timed mode or at discrete stations. As with the other EM systems, lines will need to be laid out before data recording, and spatial coordinates

will need to be obtained, either by using differential global positional systems (DGPSs) as the survey is being recorded or by surveying the ends of the lines and interpolating to obtain the spatial coordinates of the data along each line.

Terrain Conductivity Surveys

To explain the value of the reconnaissance level terrain conductivity surveys, two examples are shown. The first example (Figure A16) typifies what results can be expected if the layered earth has relatively homogeneous lateral extending materials and the conductive bedrock (e.g., shale or claystone) has a paleo-channel or dip in its surface. This bedrock feature will manifest itself in the conductivity readings as shown in the upper graph because of the thicker resistive overburden. The second example (Figure A17) shows conductivity readings taken in the vertical dipole mode over a vertical electrically conductive feature, such as a fracture zone.

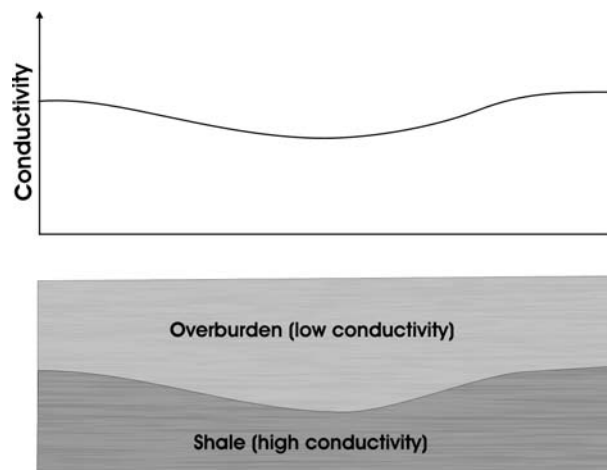

FIGURE A16 Conductivity readings taken over a conductive shale layer.

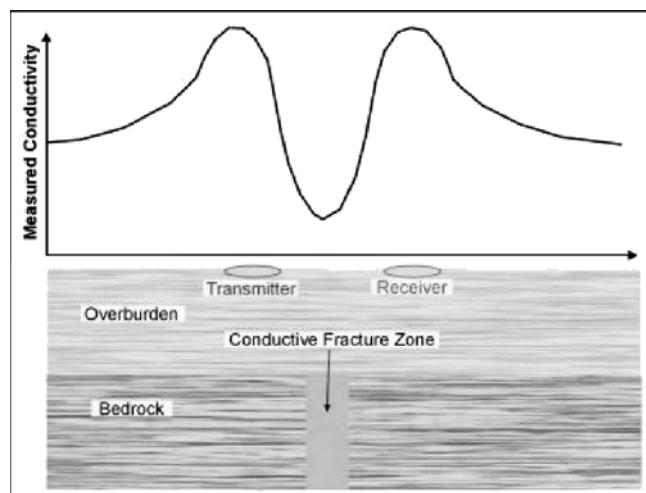

FIGURE A17 Example of the measured conductivity over a vertical conductive feature when taking readings in the vertical dipole mode.

In this mode, the anomaly shape over a vertical or subvertical, an electrically conductive feature such as a fracture zone is very distinctive and can be used to locate such zones. The characteristic shape of the anomaly expected over such a feature is shown in Figure A17. Conductivity measurements taken over this feature in the horizontal dipole mode would not show these diagnostic features.

When using this method to locate vertical conductive features, it is important to provide sufficient spatial data density such that the anomaly shape is well defined, otherwise the anomaly may be difficult to recognize.

Method Limitations

If the ground has a low electrical conductivity, then the transmitter can induce only very small electrical currents into the ground. This means that only small secondary electromagnetic fields will be generated, resulting in small voltages being measured by the receiver coil. Thus, the inductive method of measuring conductivity is not particularly suited to low conductivity (resistive) areas. Different investigation depths can be achieved by using different modes and coil separations. However, these investigation depths are only approximate. Although soundings can be conducted by taking readings at different orientations and with several instruments, layer depth and conductivity (or resistivity) interpretations are only approximate. Other methods, such as resistivity soundings, need to be conducted if layer resistivities and their depths are needed.

References 3 and 7–10.

MAGNETIC SURVEYS

Introduction

Magnetic surveys are conducted to evaluate geology, locate lava tubes in igneous rocks, find buried metal objects such as underground storage tanks (USTs) and pipelines, and locate unexploded ordnance (UXO).

The depth of investigation varies widely, depending on the target. Geologic structure can be determined to depths of many thousands of feet. USTs, pipelines, and UXO targets are usually shallow. The method will probably only locate shallow lava tubes.

Basic Principles of the Magnetic Method

The Earth's magnetic field is a vector quantity and has therefore a direction and a magnitude. The shape of this field is that which would be produced if a large magnet were placed inside the Earth. Superimposed on this field are time varying fluctuations resulting from electrical activity in the ionosphere, usually caused by solar flares.

The Earth's magnetic field induces a secondary magnetic field in ferromagnetic objects or geological structures that contains magnetite or other minerals that are magnetizable. This secondary magnetic field then "disturbs" the magnetic field of the earth creating an anomaly that can be detected with a magnetometer. Most magnetometers measure the magnitude of the magnetic field and can do so several times per second.

Figure A18 presents a schematic illustrating the magnetic field from a cylindrical ferromagnetic object. In this figure the Earth's field magnitude has been removed leaving only the magnitude of the field owing to the ferromagnetic cylinder, often called the magnitude of the anomalous field.

Because the magnitude of Earth's magnetic field changes with time, generally with daily cycles called Diurnal changes, these changes have to be removed from the field data. To do this, a base station is usually set up at a site near the survey area where magnetic anomalies are minimal. This instrument then records the magnitude of the magnetic field at regular intervals, say every minute. This allows the oscillations in the magnetic field to be removed from the survey data during processing.

In addition to induced magnetization, remnant magnetization can also produce anomalies. Remnant magnetization occurs in geologic materials, usually volcanic and igneous rocks, which originate as hot fluid lava and then cool before eventually solidifying. When the lava, or igneous material, cools below a temperature called the Curie point, the magnetic domains in the rock (usually magnetite) are oriented in the direction of the existing magnetic field at that time. Because the direction of the Earth's magnetic field changes over

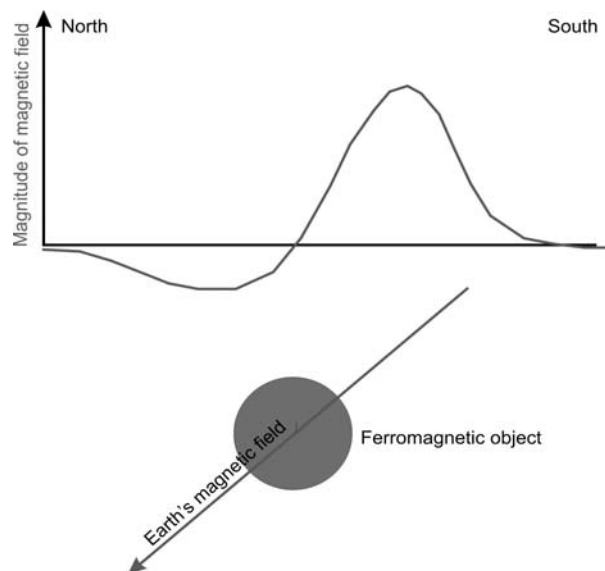

FIGURE A18 Magnitude of anomalous magnetic field created by a ferromagnetic cylinder in presence of the Earth's field.

geologic time, the remnant magnetic field can have a direction that is different from that produced by induction with the present Earth's magnetic field.

Field Data Recording

Magnetic surveys are conducted by first setting up a base station, as described previously. The survey is then conducted by walking across the area of interest while the magnetometer records data, usually at several times per second. The data are stored in solid state memory in the instrument. To position the data some magnetometers can be assembled with DGPSs, allowing the spatial coordinates to be acquired simultaneously with the magnetic data. Conventional or GPS surveying of the ends of the lines may be required if DGPS data are not acquired with the magnetometer data. Linear interpolation methods can then be used to assign spatial coordinates to the data.

Interpretation

Magnetic data can be interpreted using computer software to model the anomalies. Generally, an initial model is developed for the source of the anomaly and the program then calculates the anomaly resulting from this source. The program then modifies the depth and geometry of the source and recalculates the anomaly. It does this until a reasonable fit is obtained between the field and model data. This process is called inversion.

Another interpretation method is to calculate a function called the Analytic Signal from the field data. Figure A19 illustrates this function for a cylindrical source along with the magnitude of the field (Anomaly Magnitude). Because the

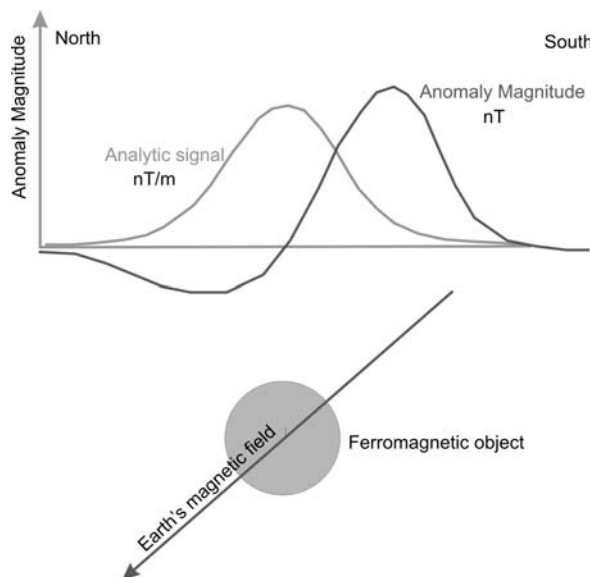

FIGURE A19 Anomaly magnitude and analytic signal over a ferromagnetic object.

Analytic Signal peaks over the top of the source, the location of the source is easier to position than it is from the anomaly magnitude data. In addition, the amplitude of the Analytic Signal is related to the susceptibility of the source and the width is related to the depth to the top of the source.

Method Limitations

The magnetic method only detects objects composed of ferromagnetic materials, and not metals such as copper, stainless steel, or aluminum. In interpreting magnetic data for geologic targets, there are generally several different solutions that can provide a theoretical fit of the field and model data, therefore each interpreted source is not necessarily unique. Such an interpretation is often called a “permissive” interpretation. This means that it is a valid theoretical interpretation but may be one of several possibilities. Nonunique interpretations are much less of a problem when searching for buried ferromagnetic objects.

During severe magnetic storms, when the time varying magnetic field changes are significant, it may not be feasible to record field data.

References 1–3, 8, and 10.

SPECTRAL ANALYSIS OF SURFACE WAVES (SASW)

Introduction

The SASW method provides bulk estimates of shear wave velocities of the subsurface. By taking measurements with an expanding geophone array a vertical profile can be developed showing the variation in shear wave velocity with depth.

Basic Principles of the SASW Method

The basis of the SASW method is the phenomenon that Rayleigh waves have phase velocities that depend on their wavelength, called dispersion, when traveling through a layered medium. Rayleigh wave velocity depends on the material properties of the subsurface to a depth of approximately 1 wavelength. These properties are primarily the shear wave velocity, but also the compression wave velocity and the material density. Figure A20 shows the variation of particle motion with depth and illustrates that longer wavelengths penetrate to greater depths.

Survey Procedures

SASW testing consists of measuring the surface wave dispersion curve and interpreting it to obtain the corresponding shear wave one dimensional vertical velocity profile. The dispersion curve is the variation of phase velocity of the fundamental mode Rayleigh wave with frequency. There are

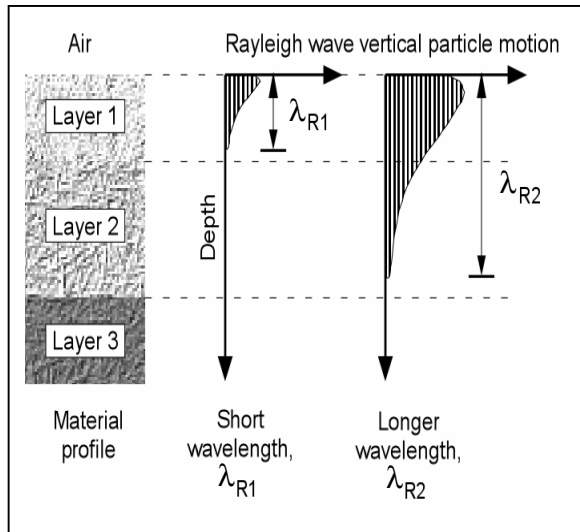

FIGURE A20 Schematic showing the variation of Rayleigh wave particle motion with depth.

two main methods used in surface wave exploration. The most common is called SASW testing, which uses two geophones. The other method, which uses a linear array of geophones, is generally called array methods, or Multichannel Analysis of Surface Waves (MASW). The field setup for the SASW method is shown in Figure A21.

A dynamic source is used to generate surface waves of different wavelengths (frequencies). This can be done using small sources such as a hammer or large sources such as a dozer. These waves are monitored using two or more receivers, as illustrated in Figure A21.

An expanding receiver array is used to avoid near-field effects associated with Rayleigh waves and source–receiver geometry is optimized to minimize body wave signal.

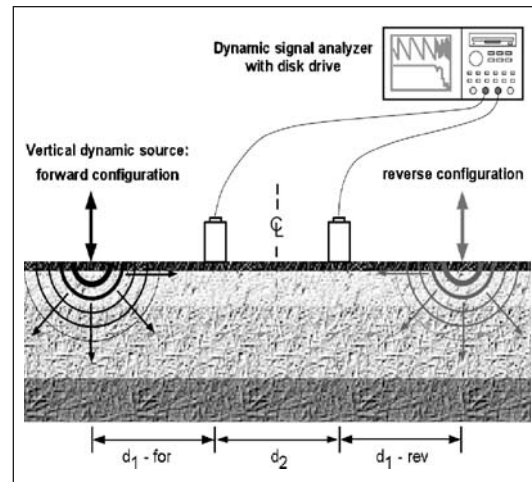

FIGURE A21 Field setup for the SASW method.

Microtremor surface wave techniques are also becoming more widely used. Passive sources typically can see deeper than active sources. MASW used in addition to Microtremor can be used to obtain both shallow and deeper interpretations.

Method Limitations

The depth of penetration is determined by the longest wavelengths in the data. Generally, heavier sources generate longer wavelengths. Also, the depth of penetration and resolution are heavily site dependent. Cultural noise at a site may limit the signal/noise ratio at low frequencies. The field setup requires a distance between the source and most distant receiver of two to three times the maximum penetration depth.

References 7, 8, 10, and 11.

APPENDIX B
Survey Questionnaire

NCHRP SYNTHESIS 36-08

USE OF GEOPHYSICS FOR TRANSPORTATION PROJECTS

PLEASE RETURN COMPLETED SURVEY BY FRIDAY, MARCH 18, 2005

PURPOSE OF THIS SYNTHESIS

State departments of transportation (DOTs) are, in general, increasing the utilization of geophysics as an effective technology to complement geotechnical engineering design and construction needs on transportation projects. It is generally accepted that state-of-the-practice geophysical surveys are well suited to assist state and federal highway agencies with their programs. However, a preliminary inventory regarding application of geophysics within these agencies indicates that many still do not use the available technology at all, whereas others utilize geophysics on a routine basis.

The focus of the synthesis will be on use of existing/proven geophysical technologies and the beneficial experience gained from the application of geophysics to highway projects. Information will be obtained from the state DOTs, as well as from federal transportation agencies.

We estimate it will take about 30 to 45 minutes to complete this questionnaire. The purpose of the questionnaire is to collect *specific information* on the use of geophysical survey practice from primarily state DOTs, but also federal and other agencies that support transportation programs (e.g., FHWA, FAA, FRA, Corps of Engineers, toll and turnpike agencies, etc.). **Additionally, any respondent who believes that they have a geophysical project that would make a good case study to illustrate a particularly successful—or unsuccessful—geophysical survey is invited to indicate their willingness to contribute detailed information about the project.** Interested individuals/agencies will be contacted directly by the researcher to obtain the specific case study information.

The results of this synthesis will be shared and distributed through AASHTO, FHWA, TRB, and others, with the goal of assisting in the development and implementation of training materials, assistance programs, and cooperative efforts between agencies for the successful use of geophysics.

I want to thank you in advance for your support on this project. It is not often that the geophysical industry gets the opportunity to do substantive research with the practitioners, you the highway engineer, as to the institutional use of a technology. We believe it is increasingly important to identify the usefulness and limitations of the current state of the practice for the application of geophysics in transportation

investigations. Clearly, the results of this synthesis will furnish a means to disseminate benefits, limitations, and general experiences in a meaningful fashion.

NOTES FOR COMPLETING THE SURVEY

PLEASE COMPLETE AND RETURN THIS QUESTIONNAIRE BY **MARCH 18**.

RETURN TO:

Phil C. Sirles

Phone: 720-934-2901

Sirles Consulting, LLC
10183 W. Maryland Drive
Denver, CO 80232

Fax: 720-962-4444

E-mail: psirles@comcast.net

We request a copy of this survey be given to to all departments within your agency that have experience with geophysical surveys for geotechnical applications. *Multiple responses from a single agency are welcomed and encouraged.* It would be advantageous to provide a copy to the individual(s) within the agency who has the most experience and familiarity with the application of geophysics to projects. In responding to all of the questions, if you do not have exact information or if it would be very difficult to obtain, please feel free to estimate the approximate answer and indicate that it is an estimate. It is better to have a qualified estimate than no information at all.

BACKGROUND INFORMATION AND DEFINITIONS

The use of geophysics in relation to highway projects involves the use of nondestructive physical methods to study earth materials. It has been shown that geophysics, when applied properly to transportation projects, has the potential to save money and time. Some of these benefits are realized in better site characterization, quick data acquisition and processing, and less harm to the environment. However, success of this technology hinges on correct application.

Geophysics, in the broadest sense, encompasses the assessment of both earth and man-made materials with noninvasive techniques. The purpose of using geophysics, as defined for this synthesis, is to identify and characterize physical properties of subsurface earth materials in a manner that benefits highway programs. Often its use is driven by project budget, site accessibility, environmental sensitivity, or experience and confidence in the technology. With this broad capacity for the use of geophysics, it is clearly important that this synthesis focus on the obvious applications, the most practical approaches, and the most effective technologies that benefit the engineer.

It is necessary that Synthesis Topic 36-08 be confined in scope to determine how geophysics has been used by civil and geotechnical engineers in design and construction activities, **with the emphasis focused on geotechnical issues as they relate to natural and artificial foundations.** That is, the material upon which a structure is built. For the purpose of this Synthesis, testing of structures and structure foundations (i.e., piles and footings) are excluded. However, three questions relating to *nondestructive testing*

(NDT) are included at the end of Part 1 to assess the current scope of its use. It is clear that transportation agencies are implementing innovative NDT technologies for evaluation of structures. It is anticipated that another synthesis, with a similar objective and relevance to this topic, may be needed to address the use of NDT for applications that traditional geophysics do not include (e.g., CSL for drilled shaft foundation testing or GPR for bridge deck assessment, etc.).

RESPONDENT INFORMATION

Agency/organization name:

State:

Country:

USA

Other country—Please specify:

Complete mailing address:

Point of contact name:

Point of contact phone:

Point of contact fax:

Point of contact e-mail address:

Type of transportation agency/organization:

Federal agency

State/provincial agency

County agency

Municipal agency

Private organization

Toll and turnpike authority

If private, what type?

A/E engineering firm

Geophysical consulting service company

Professional or trade organization

Other private organization—Please specify:

Involvement with geophysical surveys:

Primary business activity or program

Major portion of routine annual activity or program

Minor portion of routine annual activity or program

Occasional geophysical projects

Do you have a case study that you would be willing to share specific detailed project information that would illustrate an important “Application” or “Lesson Learned” by your organization?

Yes

No

If the answer to the above question is “Yes”:

What was the name of the project?

Provide the name and phone number of the person to contact:

In a few words, describe the “Application” or “Lesson Learned.”

QUESTIONNAIRE

Please answer the questions in the following 5 sections (Parts 1 through 5) to the best of your knowledge. If providing an exact answer will require more time than you can allow, please furnish your best estimate. If you have questions on the proper interpretation of a question or the questionnaire as a whole, please e-mail the researcher at psirles@comcast.net. There is space at the end of this questionnaire for your comments and thoughts that might not have been included or covered within the 5 parts of the survey or by the specific questions themselves. If different personnel are more appropriate to answer questions from different parts of the survey, please facilitate the distribution and submission of the survey. **We greatly appreciate your time and support on this synthesis project.**

PART 1—GENERAL

1. How long have you been involved with the implementation of geophysical surveys for geotechnical applications? _____ years
2. Who, in our organization, implements the use geophysics? (Check all boxes that apply.)
 - Geotechnical engineers
 - Civil engineers
 - Structural engineers
 - Pavement engineers
 - Geologists
 - Hydrologists
 - Other—Please specify:
3. At this time, what percentage of your geophysical surveys are conducted with:
 - In-house capability? _____ %

RFP/open solicitation contracting? %

IQ-type, open-ended contracts? %

4. Do you have any specific training program for engineers to be introduced to and on the use of geophysics?

Yes No

5. If the answer to Question 4 is “Yes,” what is the type of training?

Venue? (e.g., in-house, conference, tech updates, etc.)

Who attends?

How often?

Paid through? (i.e., departmental, divisional, functional funds)

Rough cost?

6. Are you aware of the web-based FHWA Geophysical Manual, *Application of Geophysical Methods to Highway Related Problems* (Report FHWA-IF-04-021, URL: <http://www.cflhd.gov/agm/>)?

Yes No

7. Does your office or agency have the 716-page hardcopy version of the FHWA publication (Report FHWA-IF-04-021)?

Yes No Don't know

8. Does your office or agency have the CD-searchable PDF version of the FHWA publication (Report FHWA-IF-04-021)?

Yes No Don't know

9. Have you or any of your staff used either the web-based manual, hardcopy, or CD version of the publication referenced in Question 6?

Yes No Don't know

If “Yes,” which version: Web-based Hardcopy CD

10. Are you aware of the FHWA geophysical website <http://www.fhwa.dot.gov/bridge/geophys.htm> that provides information on international conferences on geophysics and other related geophysics topics?

Yes No

11. Have you or any of your staff used the FHWA informational website referenced in Question 10?

Yes No Don't know

12. What is the typical number of geophysical surveys conducted for/by your agency each year?

Approximately

13. Has your level-of-effort increased over the last 5 years for applying geophysics on your transportation projects?

Yes No

If “Yes,” by what percent?

<25% 25–50%
 50–75% >75% Other: %

[Note: For Questions 14 and 15, the definition of “successful” or “unsuccessful” project purely relates to having *met* or *not met* the objective of the geophysical survey as specified in the scope of work. That is, success or failure *does not* relate to budget issues, conflicts with the contractor(s), timeliness of report delivery, or format of interpreted results.]

14. How do you rate your *personal* experience with the application of geophysical methods? (Check only one box.)

- Excellent—I intend to utilize it as the opportunities present themselves.
 Good—I have had successful project completion—will use it again.
 Fair—I have had unsuccessful projects—will utilize when necessary.
 Poor—I have had serious problems completing successful projects—will utilize it in a skeptical or reluctant fashion.
 Unacceptable—I only use it as a last resort or alternative.
 Not applicable—I do not use geophysics (answer Question 14 and skip to end of survey).

15. How do you rate your *organization’s* experience with the application of geophysical methods? (Check only one box.)

- Excellent—we intend to utilize it as the opportunities present themselves.
 Good—we have had successful project completion—will use it again.
 Fair—we have had unsuccessful projects—will utilize when necessary.
 Poor—we have had serious problems completing successful projects—will utilize it in a skeptical or reluctant fashion.
 Unacceptable—we only use it as a last resort or alternative.
 Not applicable—we do not use geophysics (skip to end of survey).

16. What do you or what might your organization feel is the greatest *value* geophysics lends to transportation projects? (Check the boxes that apply.)

Cost–benefit

- Speed of data acquisition
- Timeliness of results
- Better characterization of the subsurface (than drilling and sampling)
- 2D and 3D assessments of subsurface
- Presentation of the results
- Other—Please specify:

17. Conversely, what do you or what might your organization feel is the greatest deterrent to utilizing geophysics on transportation projects? (Check the boxes that apply.)

- Costs
- Acquisition issues and access
- Timeliness of results
- More questions generated regarding the subsurface (than obtained through drilling and sampling)
- Non-uniqueness or low accuracy of results (by engineering standards)
- Format of the results (e.g., non-engineering standards)
- Lack of knowledge/understanding of the technology
- Lack of confidence in the technology
- Other—Please specify:

[Note: The following three (3) questions relate to the use of NDT methods—they are the *only* NDT questions. The responses to these three questions will serve to determine if there is a need for a similar synthesis regarding the use of NDT methods for transportation projects.]

18. Do you understand the difference, as defined for *this* synthesis (on page 2 of this appendix), between the use of geophysical surveys for geotechnical applications and NDT methods for evaluating structures?

- Yes No

19. What is the typical number of NDT surveys conducted for/by your agency each year?

- Approximately Don't know Too many to count

20. Please indicate where NDT applications were used (in the last 5 years):

- | | |
|--|--|
| <input type="checkbox"/> Pavement condition | <input type="checkbox"/> Concrete condition |
| <input type="checkbox"/> Bridge superstructure | <input type="checkbox"/> Bridge substructure |

- Baseline measurements Construction QA/QC
 Other applications—Please describe:

PART 2—METHODS AND APPLICATIONS

21. Check *all* of the following geophysical methods, as well as the specific techniques you have applied on your projects (within the last 5 years):

a. Seismic

- Refraction
 Reflection
 SASW/MASW
 Crosshole or downhole (including VSP)
 SeisOpt ReMi
 Not sure of seismic technique used
 Other—Please specify method:

b. Electrical

- 1D resistivity soundings (e.g., VES)
 2D resistivity profiling (e.g., Dipole/Dipole, Wenner, etc.)
 3D resistivity imaging (e.g., pole-Dipole, etc.)
 Electrical resistivity tomography (i.e., crosswell ERT)
 Induced polarization (i.e., IP)
 Self-potential (i.e., SP)
 Mise-a-la-mass
 Not sure of electrical technique used

c. Electromagnetic

- Time-domain EM
 metal detection (e.g., utilities, UST, UXO, etc.)
 1D soundings for soil/rock stratigraphy
 Frequency-domain EM (i.e., geologic profiling)
 Very low frequency (VLF)
 Seismoelectric
 Not sure of EM technique used

- d. Ground penetrating radar (GPR)
 - Bedrock mapping
 - Soil mapping
 - Bedrock fracture mapping
- e. Magnetic
 - Total-field
 - Gradiometer
 - Not sure of Mag technique used
- f. Gravity
 - MicroGravity
 - Standard gravity
 - Not sure of gravity technique used
- g. Borehole logging
 - Electrical (SP, Resistivity, E-Logs)
 - EM induction
 - Nuclear (i.e., gamma–gamma, neutron, etc.)
 - Optical (e.g., televiewer)
 - Acoustic (e.g., sonic, variable density, televiewer)
 - Seismic (i.e., P/S Logger)
 - Hydrophysical (e.g., fluid column or fluid replacement)
 - Borehole deviation
- h. Marine
 - Fathometer
 - Sonar
 - GPR
 - Sub-bottom profiling (i.e., seismic)
- i. Airborne
 - Magnetics
 - Gravity
 - Electromagnetics (EM)
- j. Vibration measurements
 - Blasting
 - Construction (e.g., pile driving)

k. Other geophysical method: Please specify technique:

1. None of the above—Go directly to end of survey (do not collect \$200!).

22. What are the three (3) most commonly used geophysical methods used by your agency?

1)

2)

3)

23. Check *all* of the following applications that you have applied geophysics on your projects (within the last 5 years):

Depth to bedrock

Topography of bedrock

Faulting in bedrock

Fractures in bedrock

Mapping bedrock strength (i.e., rippability)

Mapping weak zones in bedrock (e.g., shear zones or weathered areas)

Mapping lithology in overburden soils

Mapping lithology in bedrock

Mapping sand and/or gravel deposits (i.e., borrow investigations)

Mapping clay (i.e., excavation issues for expansive or swelling clays)

Estimating clay content

Mapping groundwater salinity

Mapping groundwater table

Mapping groundwater flow

Mapping landslides:

volume assessment

slip surface identification/definition

pre-slide measurements

post-slide measurements

Determining engineering properties (i.e., elastic constants) of:

overburden soils

rock formations

Mapping roadway subsidence due to:

- natural karst (limestone features)
- dissolution cavities (evaporite features)
- culvert/sewer failure
- fill degradation/compaction
- unknown sinkholes
- abandoned mines
- Mapping buried man-made features
 - utilities
 - old foundations
 - underground storage tanks (USTs)
 - mapping contamination (e.g., plumes)
 - unexploded ordnance (UXO)
- Scour around bridge piers or other foundations
- Others—Please describe:

24. What are the three (3) most common applications where geophysics is used by your agency?

- 1)
- 2)
- 3)

25. What is the overall approach to selection of the *appropriate* geophysical method?

- Contractor specifications or recommendations
- In-house geophysicist (or experienced geo-professional) recommendations
- Highway engineer specified (geotechnical or civil)
- Experience (simply put—what worked in the past)
- Only known method
- ASTM or AASHTO specifications/guidelines/standards
- No formal survey design approach
- Individual or organizational preferences. Please briefly describe the rationale or basis for preference:

26. Who *approves* the selection of the *appropriate* geophysical method? (Check all that apply.)

- Contractor

 In-house geophysicist
 Highway engineer

 Project manager
 Program manager

 Division/branch manager
 Contracting/procurement
 Other—Please specify:

27. Comments regarding other experience related to geophysical methods and/or its application:

PART 3—BUDGETS AND COSTS

28. Do you make decisions regarding the budget for a geophysical (annual) program?

- Yes No

29. Do you, or can you, make decisions regarding the budget for geophysics on a specific project basis?

- Yes No

30. Who makes the decisions regarding the budgets related to the use of geophysics?

- Agency head
 Division/branch manager
 Team leader/project manager
 Staff highway engineer

31. What is the size of the *annual* budget allocated to geophysical surveys for your agency?

- >\$100,000 <\$100,000 to \$50,000
 <\$50,000 None*

*If there are *no* funds budgeted or allocated for geophysics, how much money is spent annually from “other” funding sources on geophysics (e.g., reduced drilling and sampling budgets, design or construction funds)?

- >\$500,000 >\$100,000

<\$100,000 <\$50,000

32. How much money is spent annually from allocated funds on geophysics?

>\$500,000 >\$100,000

<\$100,000 <\$50,000 Different every year

33. Can you predict how much money will be spent this year on geophysical surveys?

>\$500,000 >\$100,000

<\$100,000 <\$50,000 No way to estimate

34. Who spends the (allocated) budget, and what percentage of it?

Design branch %

Construction branch %

Emergency response team %

Other—Please specify: %

35. Do you have research funds allocated or budgeted annually for geophysical investigations?

Yes No

If “Yes,” please estimate amount: \$

36. Do you utilize research institutions or professional contractors to carry out *research* on geophysical investigations?

University/college Contractors Other:

37. Do you annually allocate or budget emergency (repair) funds for geophysical investigations?

Yes No

If yes, please estimate amount: \$

38. Do the costs related to the use of geophysics hinder or help its use among your highway engineering staff?

Hinder Help

39. Do you *only* utilize standard, proven, or state-of-the-practice geophysical methods?

Yes No Don’t use geophysical methods

40. If the answer to Question 39 is “Yes,” what is the rationale for *not* utilizing leading-edge or state-of-the-art geophysical methods?

- Cost Skepticism Lack of management buy in
 Other—Please specify:

41. What is the typical range of cost for a geophysical project, and number per year at that cost level?

- >\$100,000 /yr
 \$75,000–\$100,000 /yr
 \$50,000–\$75,000 /yr
 \$25,000–\$50,000 /yr
 \$10,000–\$25,000 /yr
 <\$10,000 /yr
 Other: \$ /yr

42. Comments regarding other experiences on geophysical budgets and/or costs:

PART 4—CONTRACTING

43. Who writes the Scope of Work for the RFPs and how are they prepared?

Who:

How:

44. How does geophysics get “incorporated” into a geotechnical project; that is, how do you identify which projects should use geophysics?

45. Do you utilize in-house or contract geophysicists?

- In-house Contractor Both

46. If you self-perform geophysical surveys, do you own or rent the equipment?

- Rent Own* Both

*If in-house capability—what equipment do you own? (Please list all.)

47. If you self-perform in-house geophysical surveys, do you own or rent the software for data reduction/presentation?

- Rent Own* Both

*If in-house capability—what software do you own? (Please list all.)

48. When requesting to contract geophysics, please indicate what type of RFP solicitation is used at your agency, and then rank the methods (1 being highest–8 being the lowest): Rank

- Web solicitation (electronic)
- Open competition (non-electronic)
- Open solicitation (pre-qualified bidder list)
- Referrals (from other state or federal agencies)
- Limited solicitation (prior utilized contractors)
- Sole-sourced solicitation
- All of the above
- Other method—Please specify and rank:

49. Do you utilize larger, indefinite delivery/indefinite quantity (ID/IQ), or “On-Call” contract vehicles?

- Yes No

If “Yes,” please specify the typical size and length of contract(s) awarded;

\$ for years; also the number of contractors:

50. What is the typical type of contract?

- Unit price-low bid Lump sum/firm fixed price
- Cost plus Indefinite delivery/indefinite quantity
- Time and materials Other—Please specify:

51. Have you awarded academic institutions contracts to perform “run-of-the-mill” geophysical investigations for instructional purposes or in support of cooperative arrangements?

- Yes No

52. Have you awarded academic institutions contracts to perform “run-of-the-mill” geophysical investigations because they offered best value (price)?

- Yes No

53. Have you utilized academic institutions to perform cutting-edge technology (i.e., advanced applications or methods)?
 Yes No
54. Have you utilized professional contractors to perform cutting-edge technology (i.e., advanced applications or methods and research-type investigations)?
 Yes No
55. What could be done that would make you or your agency feel more comfortable contracting geophysical surveys?
- Training/knowledge? Yes No
- Experience? Yes No
- Easy-to-use equipment? Yes No
- User-friendly software? Yes No
- Familiarity with ASTM/AASHTO/FHWA standards or guidelines for geophysical practices?
 Yes No
- Database of “qualified” geophysical service providers? Yes No
56. Based on your answer(s) to Question 55, what would give you the confidence to use geophysics more frequently on your geotechnical projects?
57. Comments regarding other experiences on contracting geophysical service providers:

PART 5—CASE HISTORIES/PROJECT EXAMPLES

58. Without specifics, can you state the number of successful geophysical projects you have had in the past 5 years? [Note: A “successful” geophysical project is defined as one that *met the objectives* of the investigation.]
59. Without specifics, can you state the number of unsuccessful geophysical projects you have had in the past 5 years? [Note: An “unsuccessful” geophysical project is defined as one that *did not meet the objectives* of the investigation.]
60. Are there any general comments regarding the successes (Question 58) and the failures (Question 59) experienced by your agency? (For example: a particular method that just will not work in your geographic/geologic setting; a particular

approach to the projects that might predetermine success or failure; or, just plain unknown factors.) Your comments:

61. As requested in Part 1, the technical panel and researchers are very interested in obtaining case history documentation of successful—and unsuccessful—geophysical projects on highway-related problems. If you have project experience, would you be willing to share the specific information regarding the approach, the scope of work, the field methods, data reduction procedures, interpretations, and final outcome with respect to budget and costs?

Yes No

If “Yes,” would you identify the engineer whom the researcher could contact directly to obtain the necessary information to develop a relatively good cost/benefit assessment of that project? Please provide

Full name:

Phone number:

62. Similar to Question 61, we would like to obtain sample scope of works and sample approaches to successful geophysical projects (not necessarily the full case history). Would you be willing to share this type of specific information from previous projects with the researcher?

Yes No

If “Yes,” would you identify the engineer whom the researcher could contact directly to obtain the necessary information? Please provide

Full name:

Phone number:

63. One of the objectives of this synthesis is to identify future research needs as you the highway engineer sees a need for them (i.e., not the geophysicists). Would you comment below on the areas you see important to either continue developing existing technologies or to pursue “out-of-the-box” methodologies that will aid in transportation engineering?

CLOSING COMMENTS

If there is anything that you would like to add that was not covered in this questionnaire that you feel would benefit this synthesis study, please provide your comments below. Your comments will be greatly appreciated!

THANK YOU FOR SUPPORTING THIS IMPORTANT EFFORT

PLEASE RESPOND BY FRIDAY, MARCH 18, 2005

APPENDIX C
Survey Results

AGENCY RESPONSE TO THE USE OF GEOPHYSICS

WHAT IS THE TYPE OF TRANSPORTATION AGENCY/ORGANIZATION?

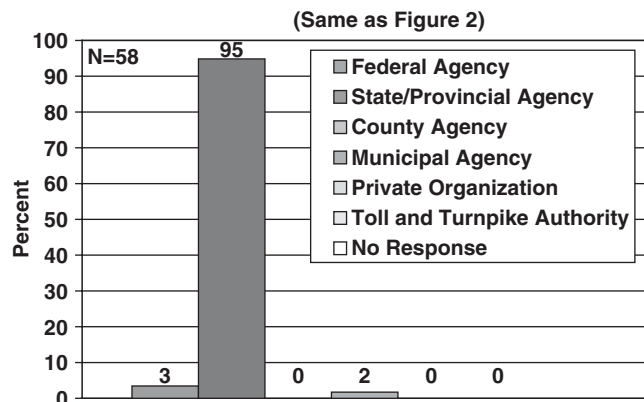

DO YOU HAVE A CASE STUDY TO SHARE?

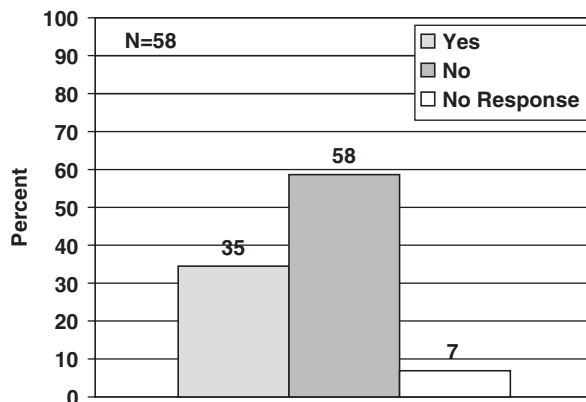

IF PRIVATE, WHAT TYPE?

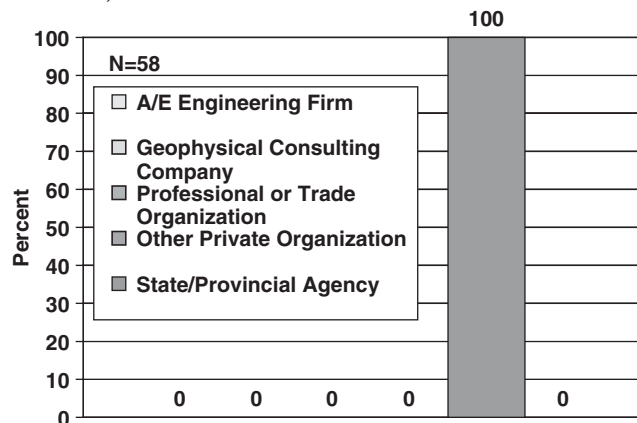

PART 1—GENERAL

#1 How Long Have You Been Involved with the Implementation of Geophysics for Geotechnical Applications?

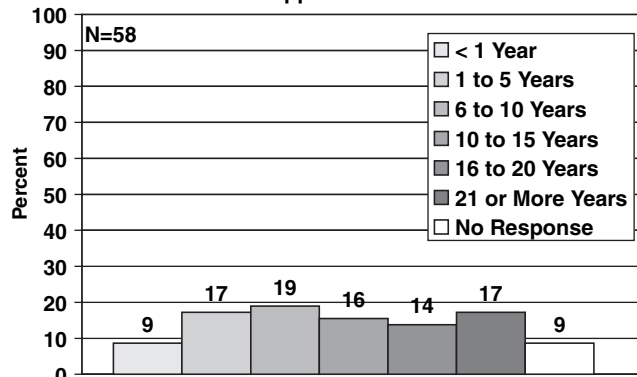

WHAT IS YOUR INVOLVEMENT WITH GEOPHYSICAL INVESTIGATIONS?

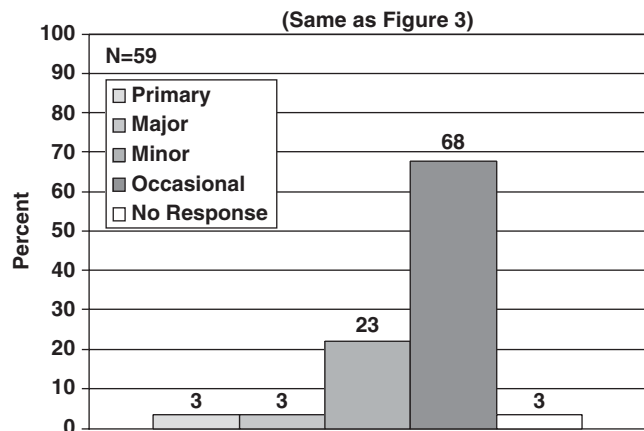

#2 Who in Your Organization Implements the Use of Geophysics?

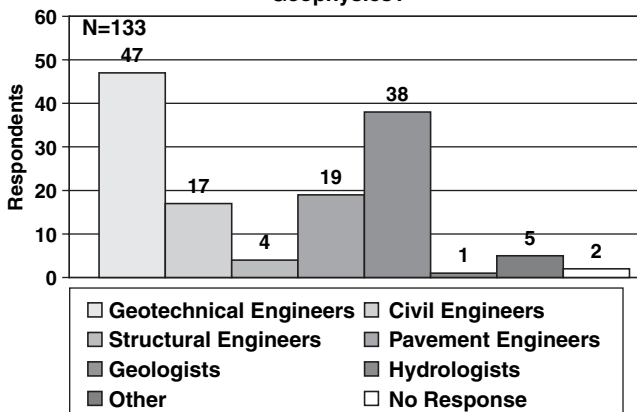

#3 What Percent of Geophysical Investigations are Conducted by In-House, RFP, and/or IQ Contracts?

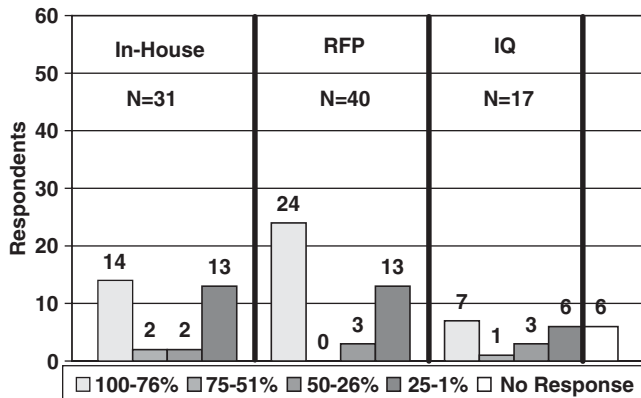

#6 Are You Aware of the FHWA (Web-based) Geophysical Manual?

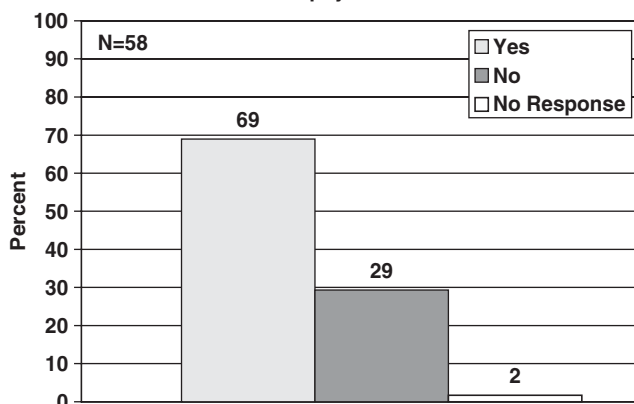

#4 Is Specific Training Offered to Staff on Geophysics?

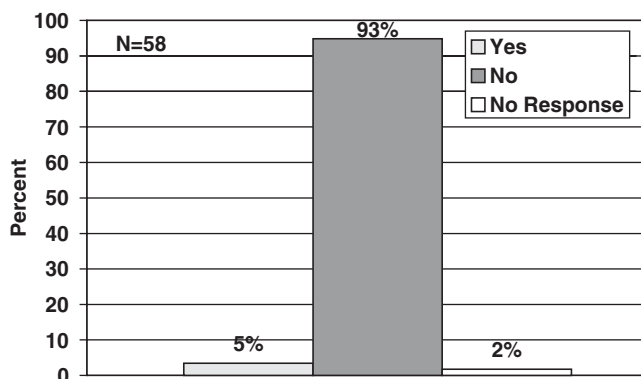

#7 Does Your Office or Agency Have a Hardcopy of the FHWA Geophysical Manual?

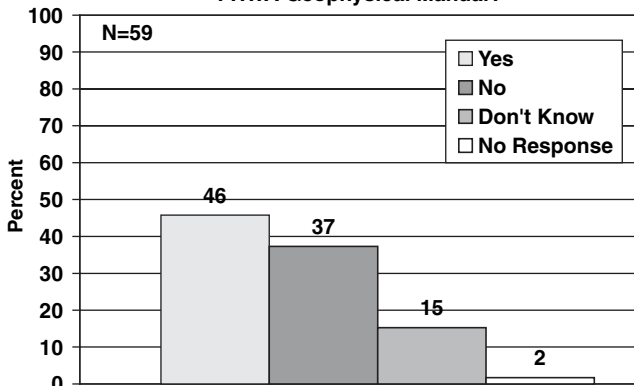

#5 If #4 is Yes, Provide Information about the Training?

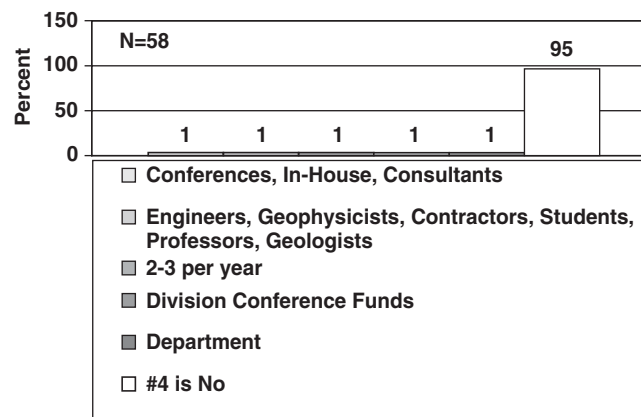

#8 Does Your Office or Agency Have the CD Searchable PDF-version of the FHWA Publication?

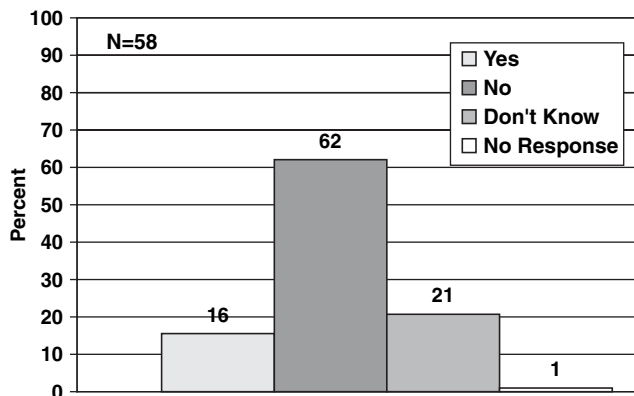

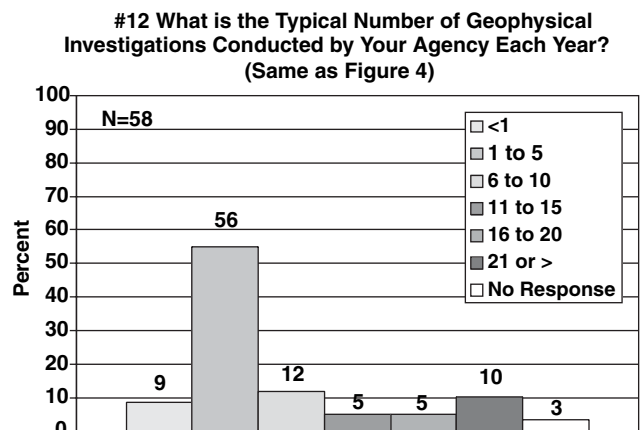
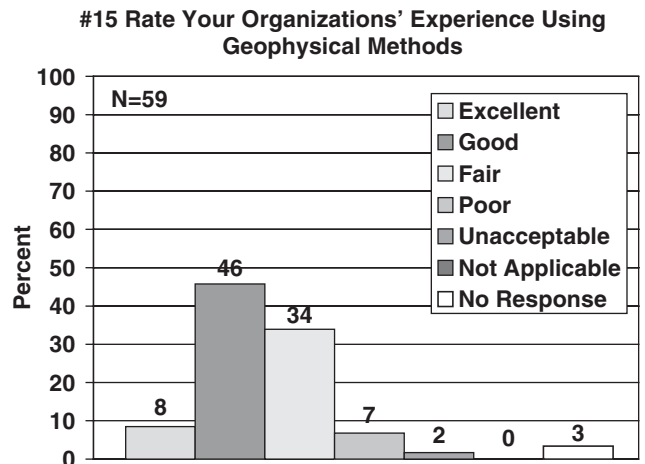
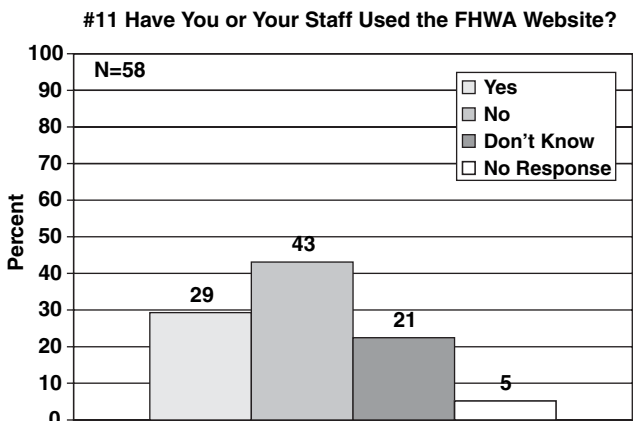
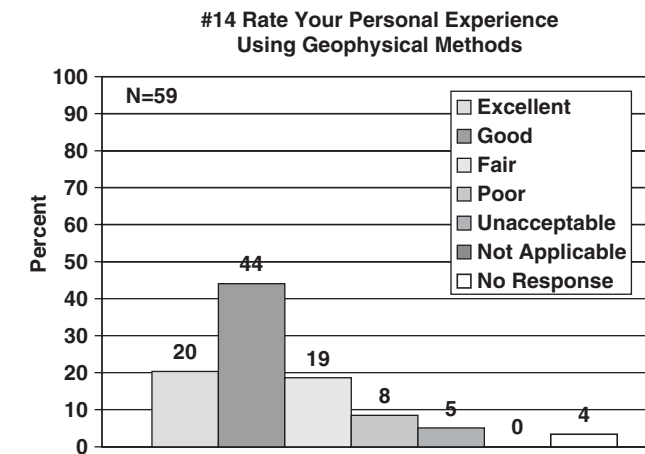
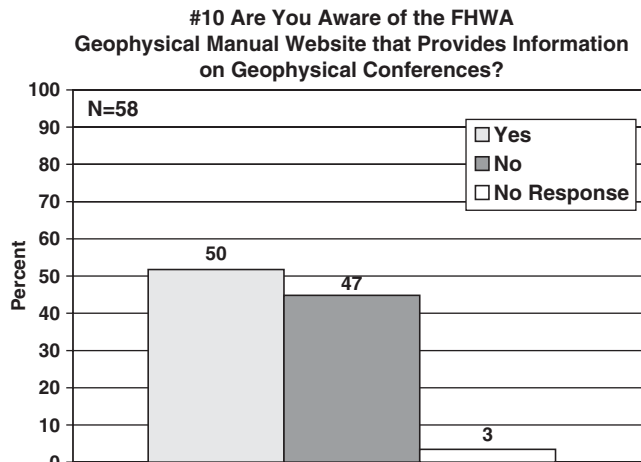
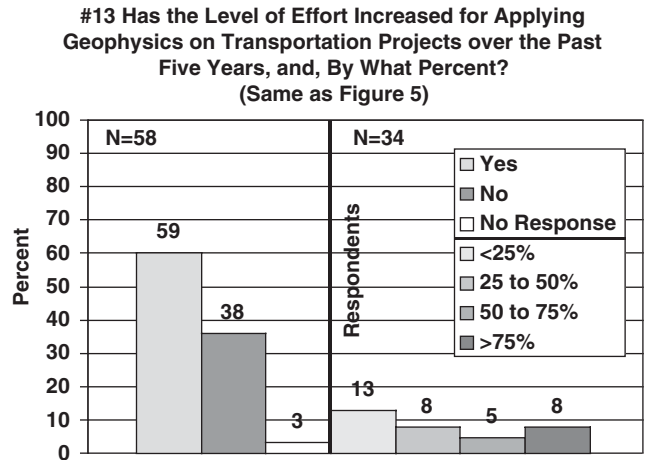
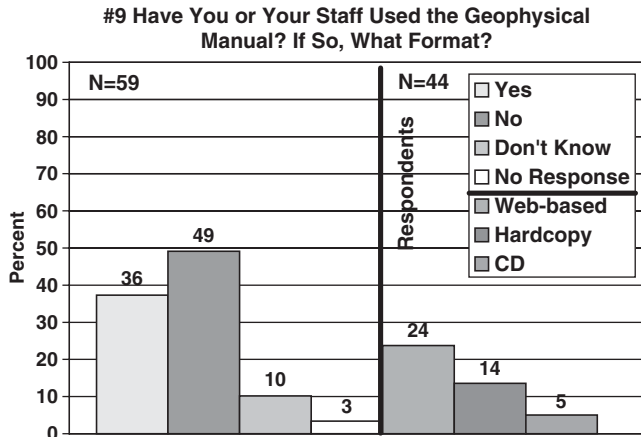

#16 Identify the Greatest Value Geophysics Leads to Your Transportation Projects

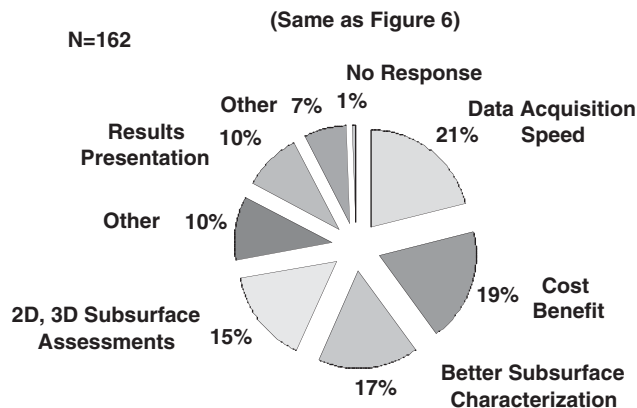

#19 What is the Number of NDT Investigations Conducted Per Year?

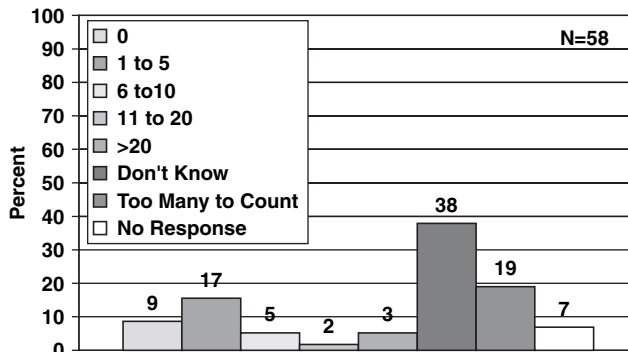

#17 What is the Greatest Deterrent to Using Geophysics on Transportation Project?

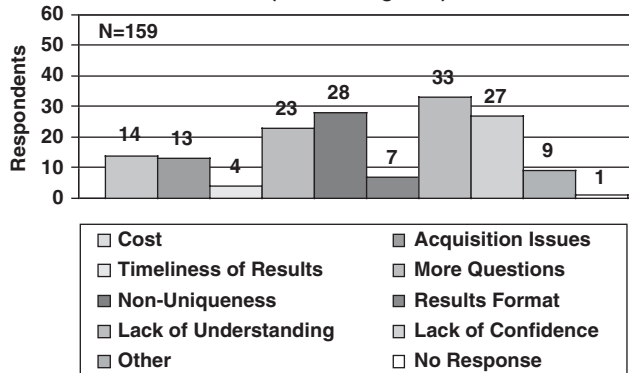

#20 Identify the Applications Used for NDT in the Past Five Years

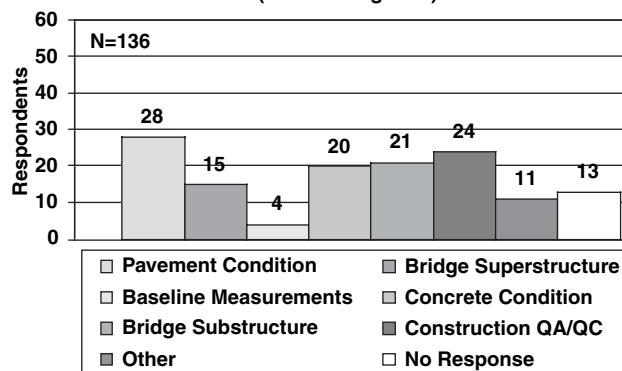

#18 Do You Understand the Differences between Geophysical Testing for Geotechnical Applications and NDT for Evaluating Structures?

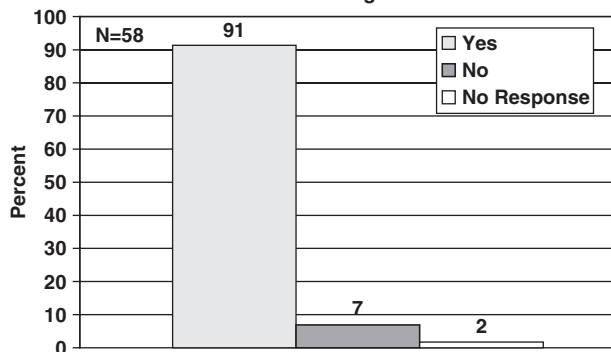

PART 2—METHODS AND APPLICATIONS

#21a Seismic Methods Used within Past Five Years

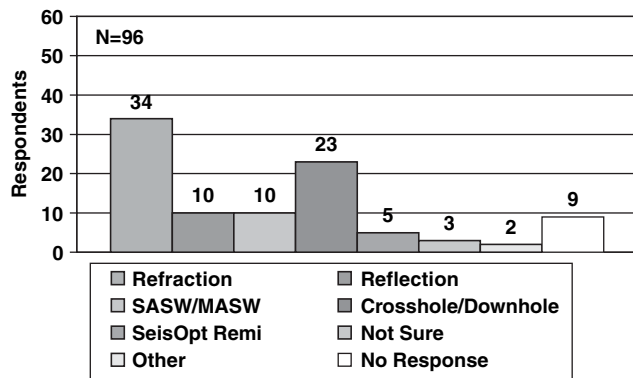

#21b Electrical Methods Used within the Past Five Years

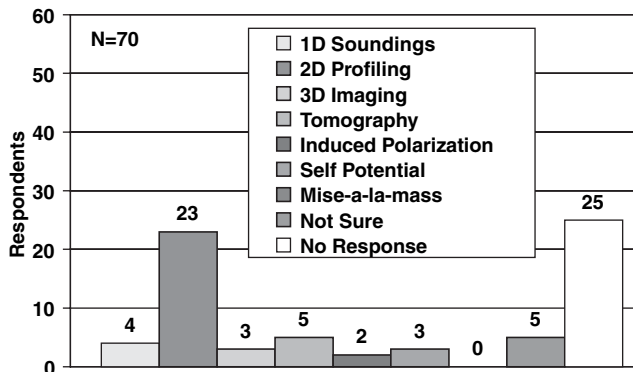

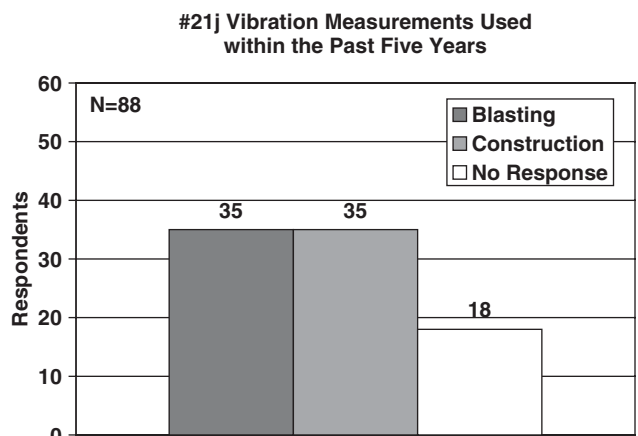
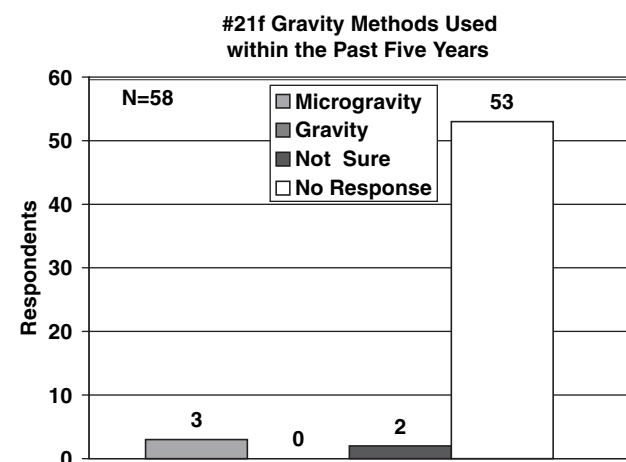
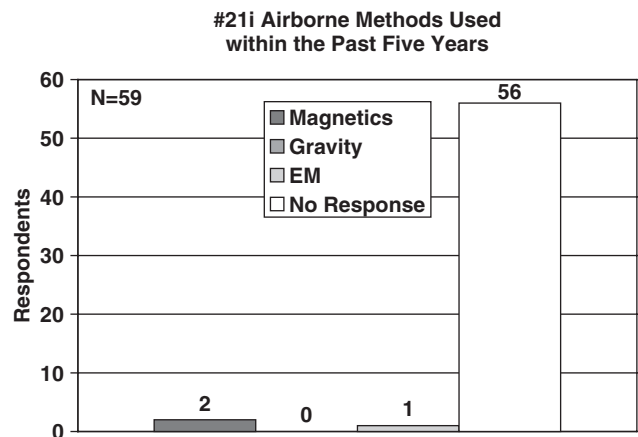
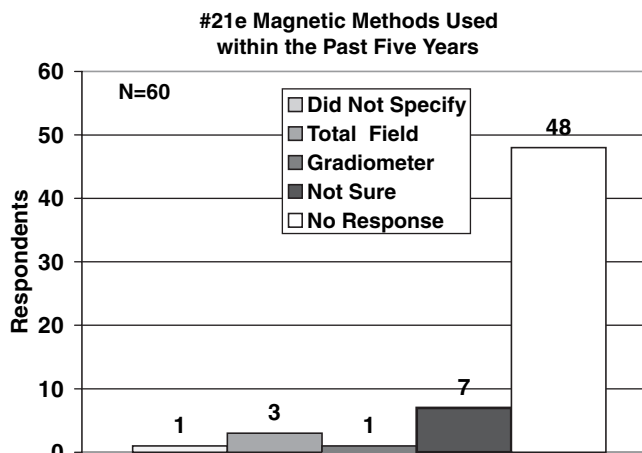
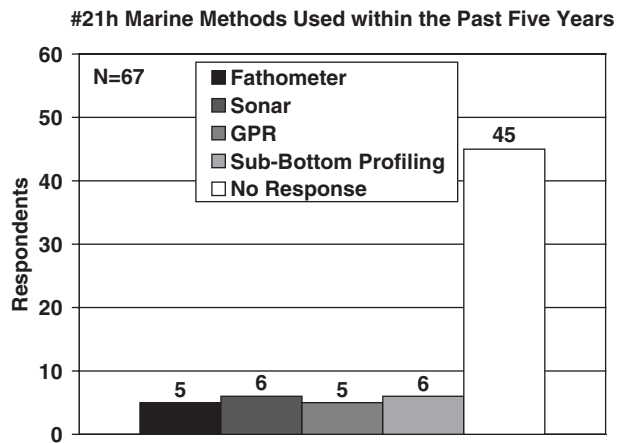
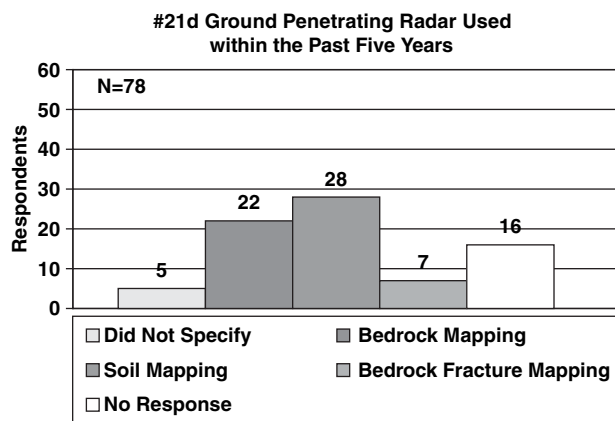
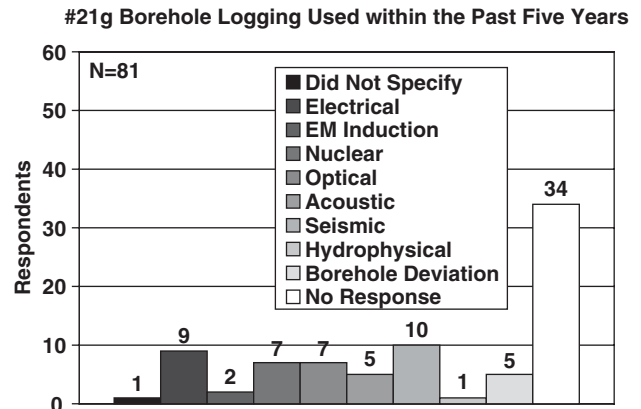
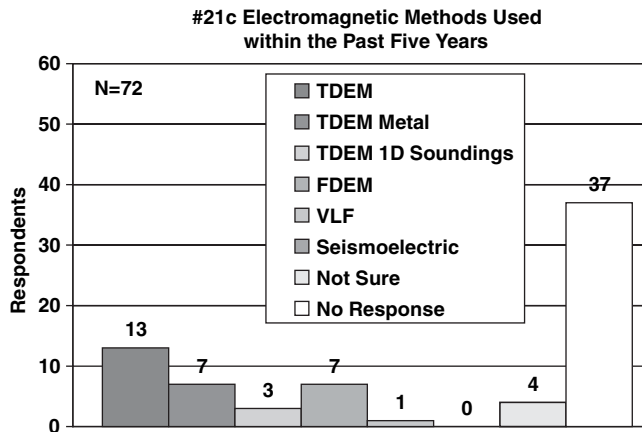

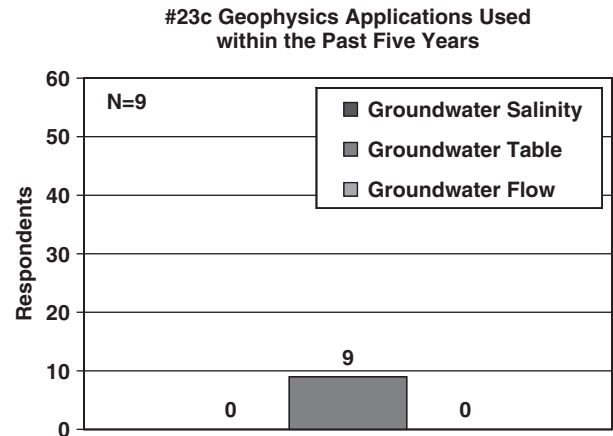
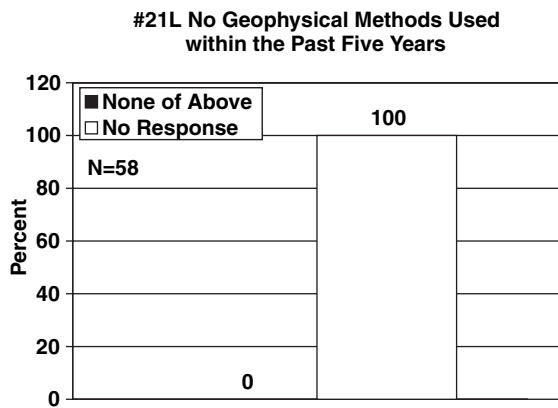
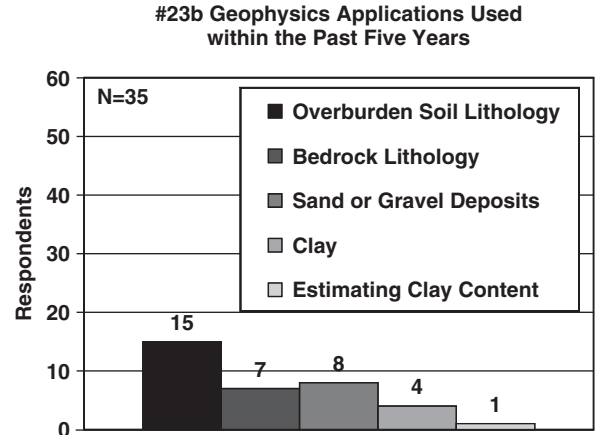
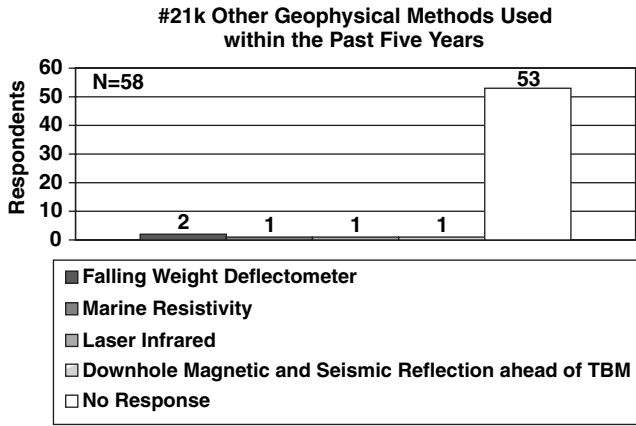

#22 Most Commonly Used Geophysical Methods

(Same as Figure 9, See Table C1 for Details)

N=130

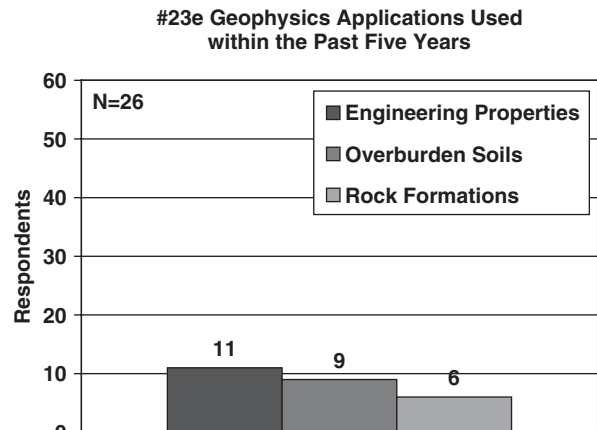
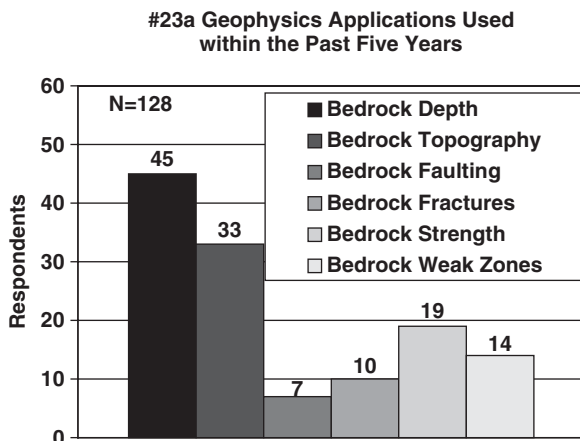
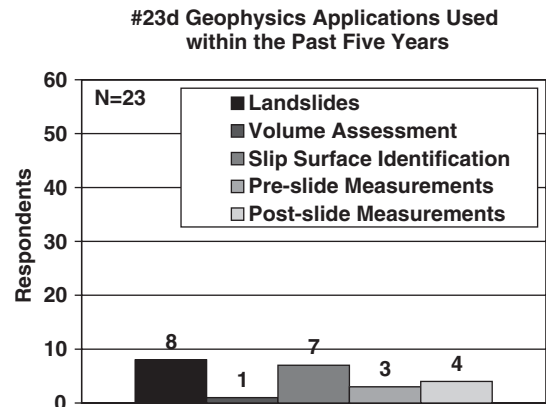
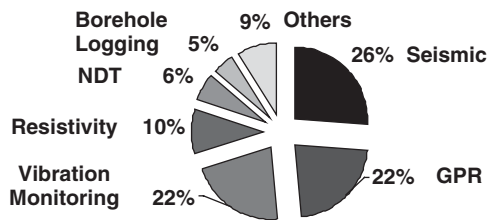

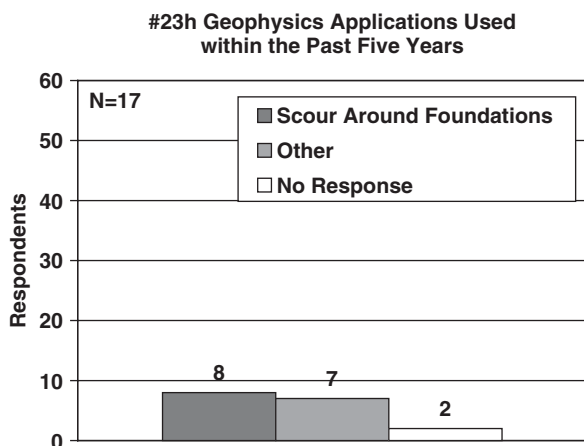
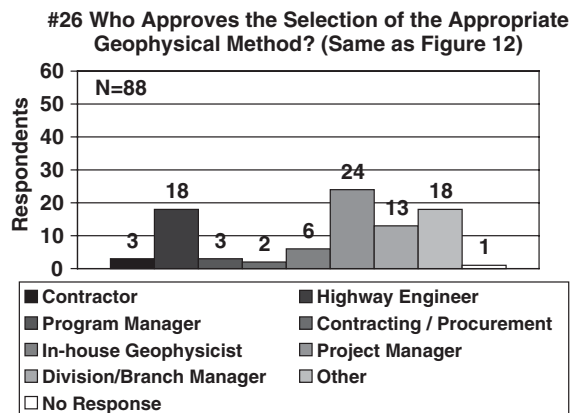
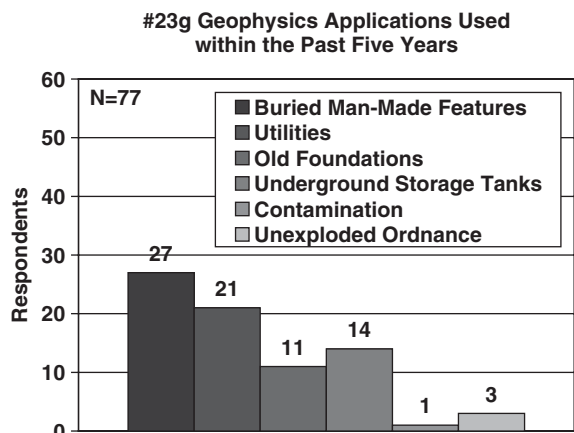
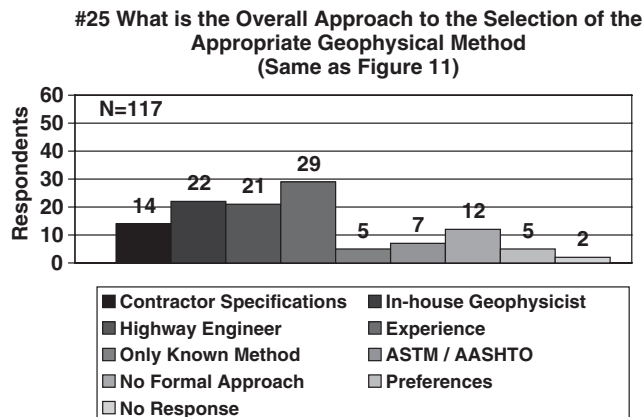
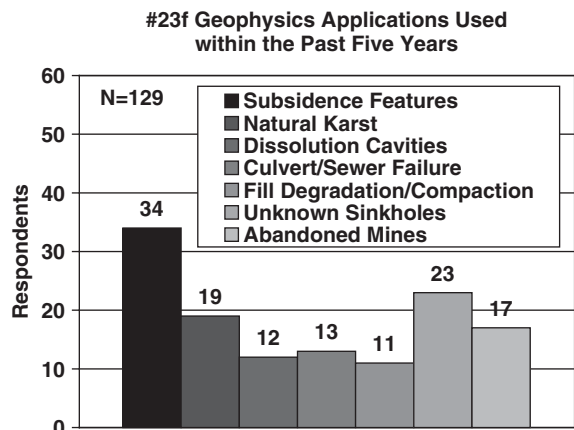

#27 Comments Regarding Other Experiences Related to Geophysical Methods and/or its Applications See Table C3

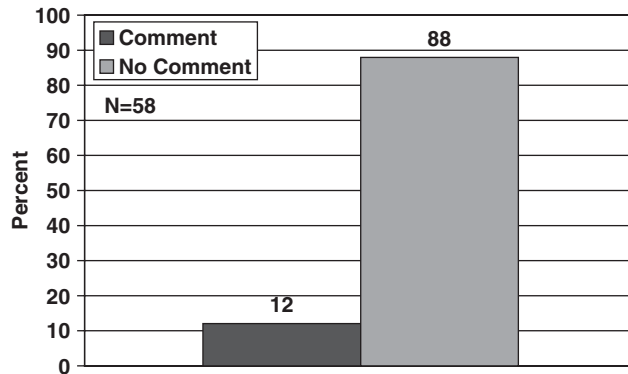

#24 Most Common Applications of Geophysics

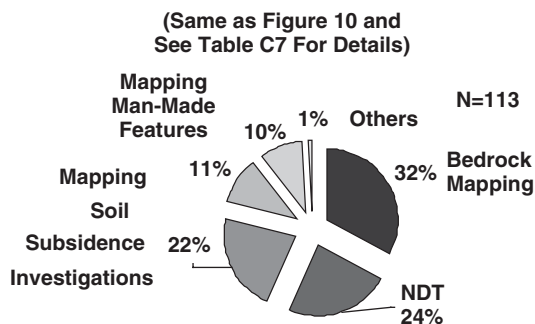

PART 3—BUDGETS AND COSTS

#28 Do You Make Budget Decisions for the Geophysical Program?

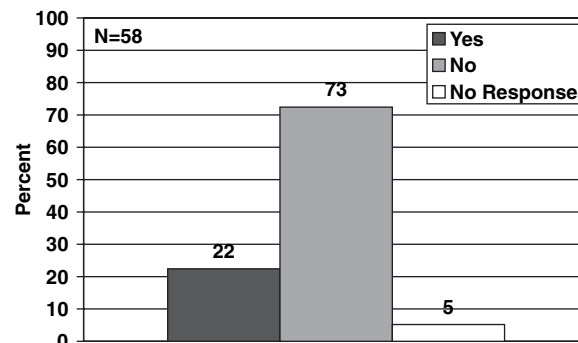

#29 Do You Make Budget Decisions for Specific Geophysical Projects?

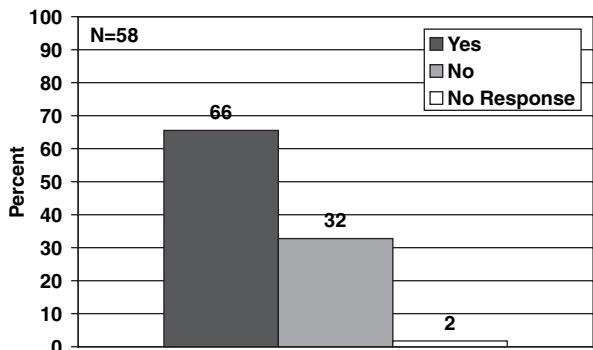

#32 How Much Money is Spent Annually from Allocated Funds on Geophysics?

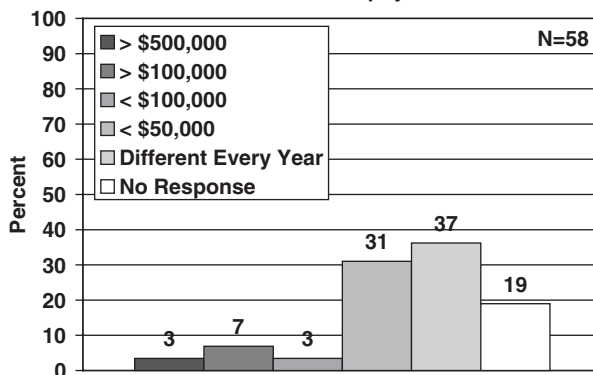

#30 Who Makes Budget Decisions Related to the Use of Geophysics (Same as Figure 14)

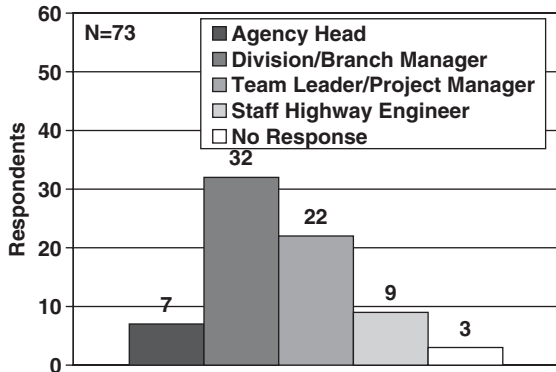

#33 Prediction of Money Spent this Year on Geophysics (Same as Figure 15)

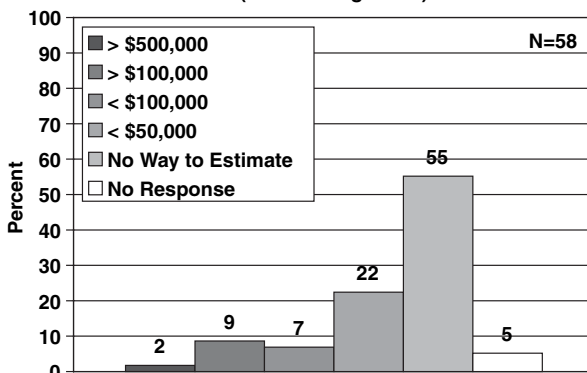

#31a Annual Budget Allocated to Geophysical Surveys (Same as Figure 13a)

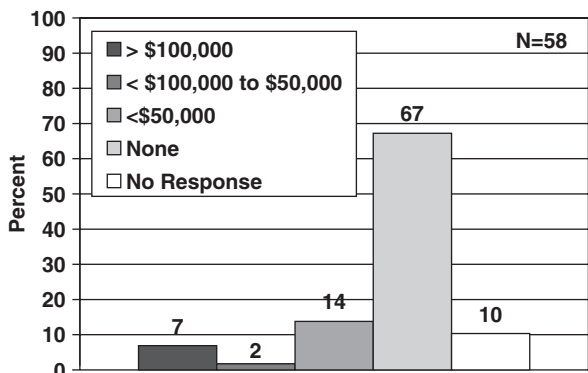

#34 Percentage of Allocated Budget Spent by:

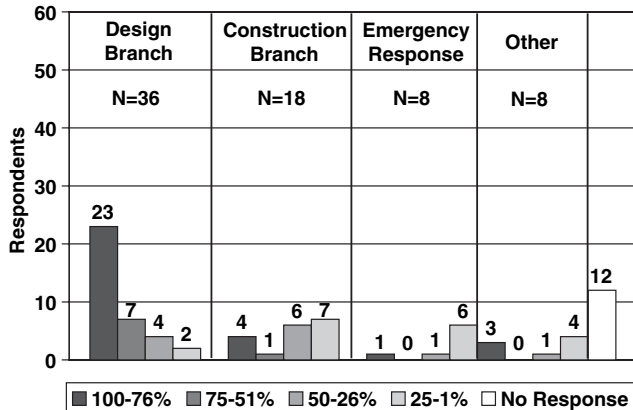

#31b Annual Funding from 'Other' Funding Sources for Geophysics (Same as Figure 13b)

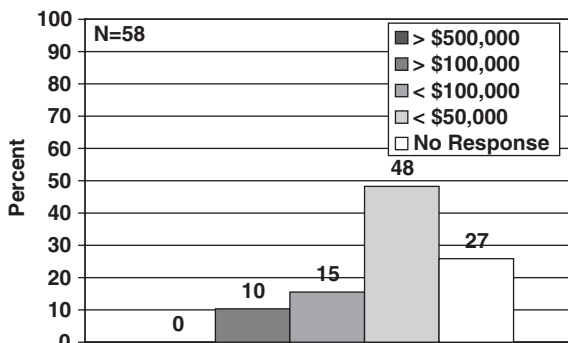

#35 Research Funds Allocated Annually to Geophysical Investigations

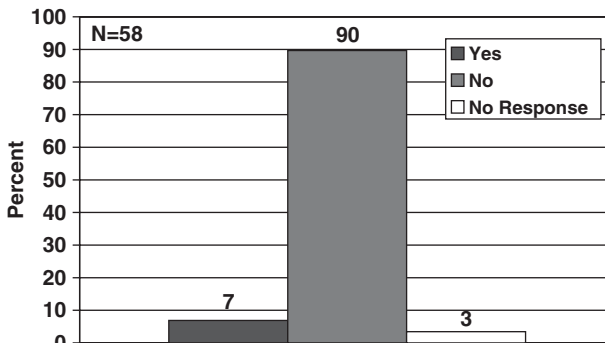

#36 Do You Use Research Institutions or Contractors to Perform Research on Geophysical Investigations?

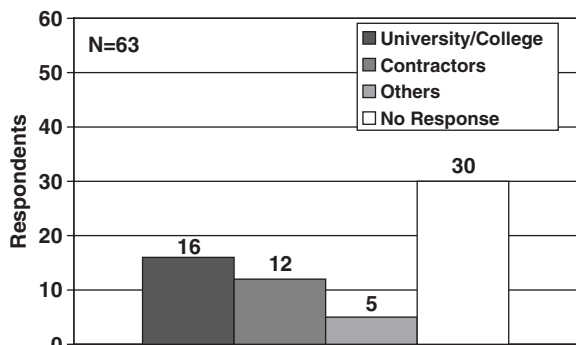

#40 What is the Rationale for Not Using Leading-Edge or State-of-the-Art Geophysical Methods (Same as Figure 17)

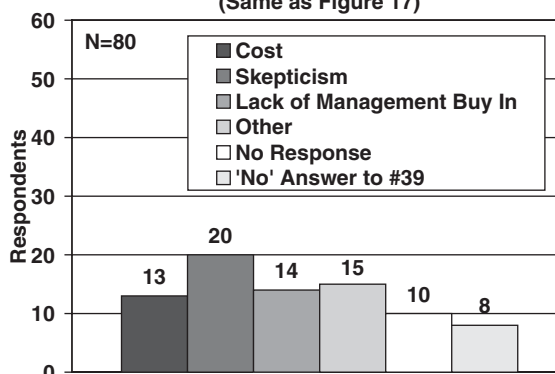

#37 Funds Allocated Annually for Emergency Repair for Geophysical Investigations

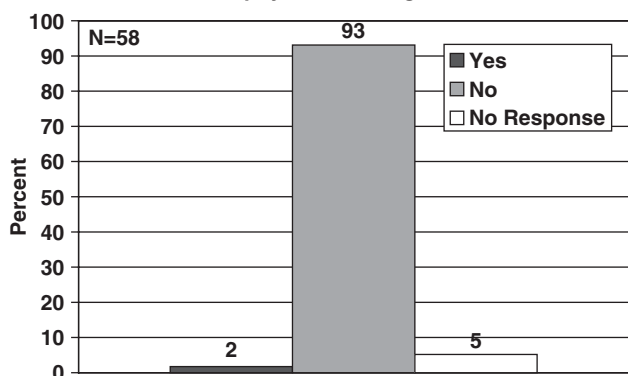

#41 Typical Cost Range of Investigations and the Number Per Year at that Cost Level (Same as Figure 19)

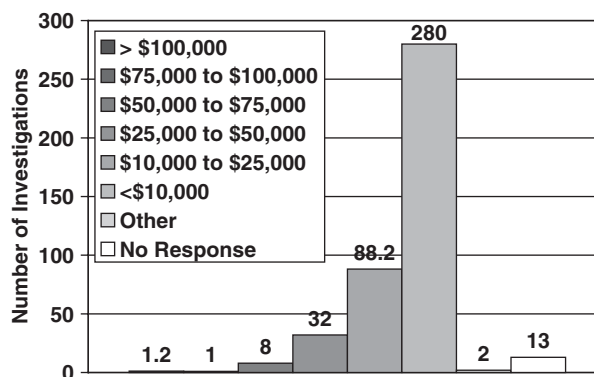

#38 Do Costs Related to Geophysics Hinder or Help Your Highway Engineering Staff? (Same as Figure 18)

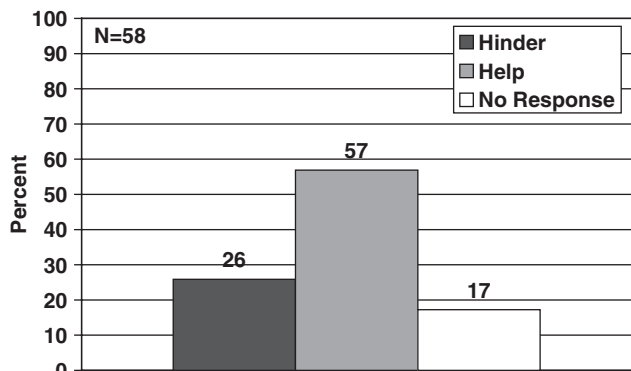

#42 Comments Regarding Other Experiences on Geophysical Budgets and/or Costs See Table C4

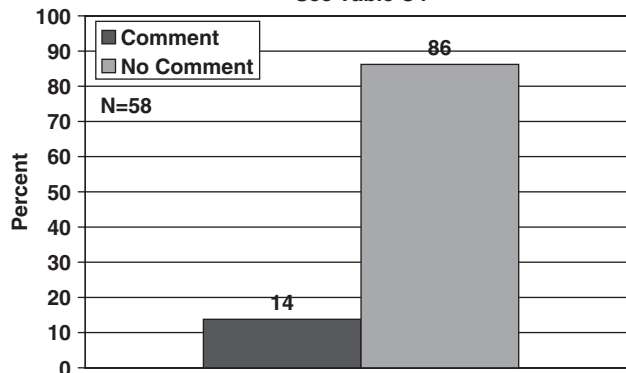

#39 Do You Use Only Standard, Proven, State-of-the-Practice Geophysical Methods?

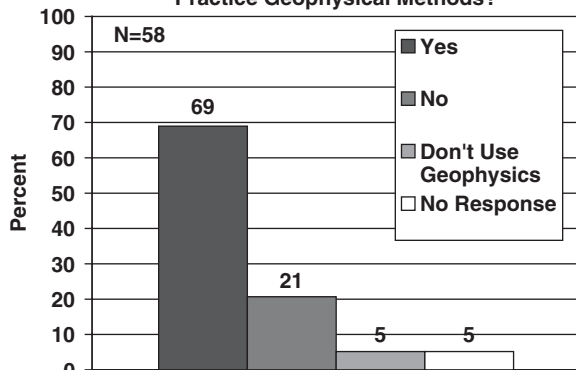

PART 4—CONTRACTING

#43 Who Writes the Scope of Work for RFPs and How are they Prepared? (See Table 3 for Details)

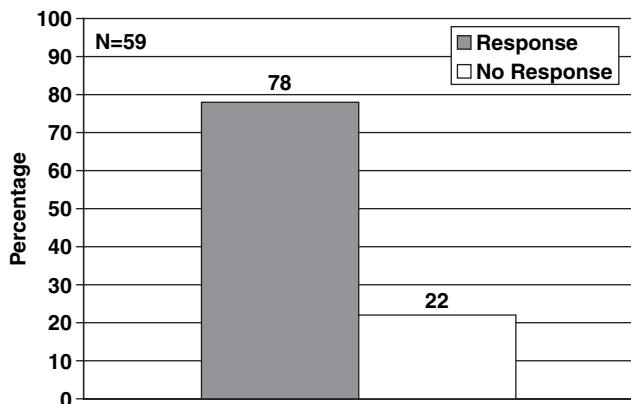

#44 How Does Geophysics Get Incorporated into a Geotechnical Project, and How Do You Determine Which Projects Should Use Geophysics? (See Table C5 for Details)

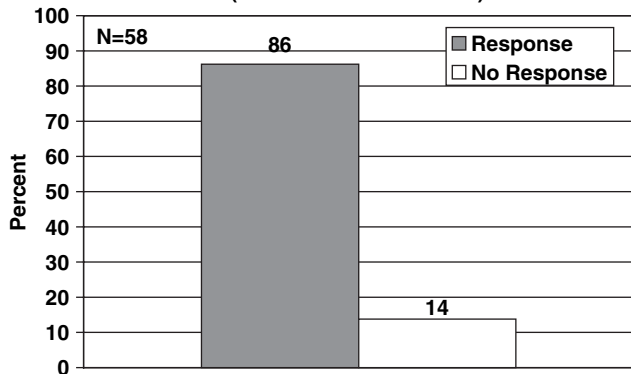

#45 Use of In-House or Contract Geophysicists

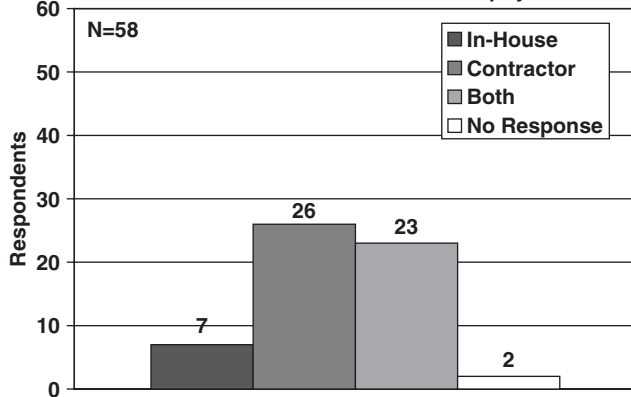

#46 If You Self Perform Geophysical Investigations is the Geophysics Equipment Rented or Owned?

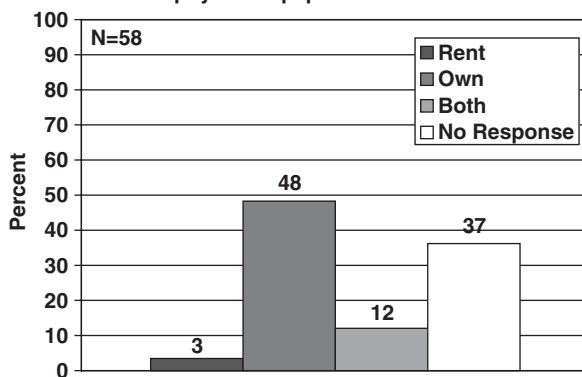

#47 If You Self Perform Geophysical Investigations is the Geophysics Software Rented or Owned?

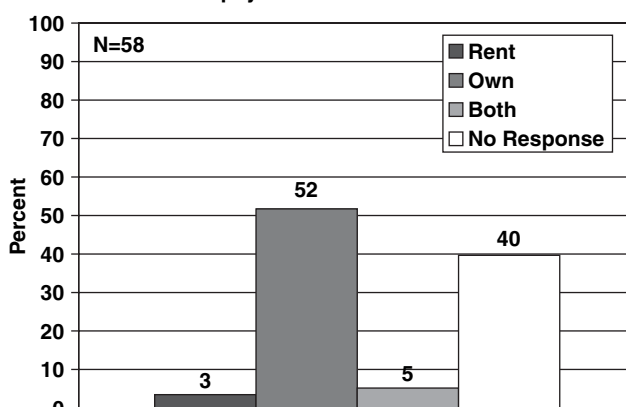

#48 What Type of RFP Solicitation is Used by Your Agency? (Same as Figure 21)

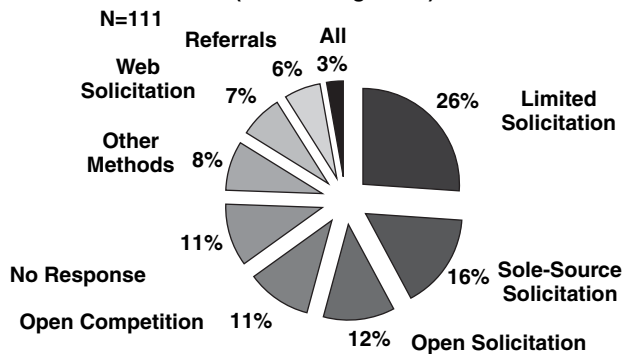

#49 Use of Larger Contract Vehicles (ID/IQ or On Call) (See Table C6 for Details)

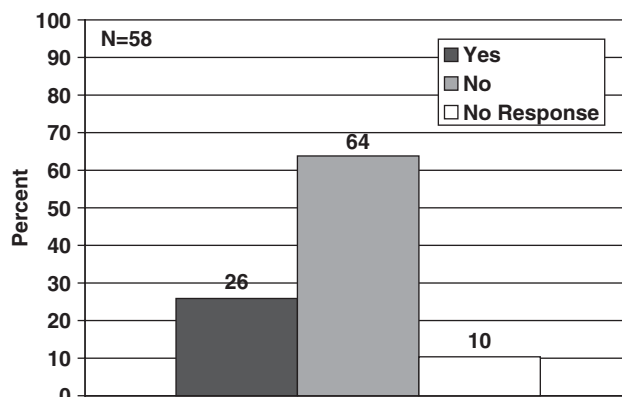

#50 Typical Type of Contract for Geophysical Transportation Projects (Same as Figure 22)

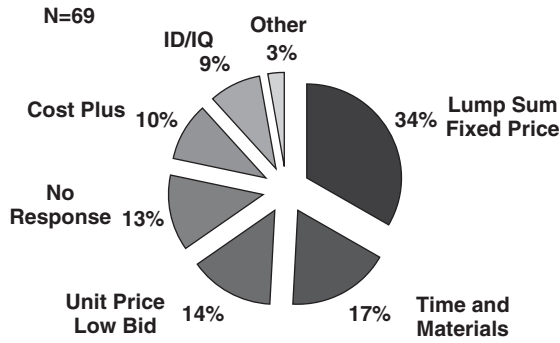

#54 Use of Professional Contractors to Perform Cutting-Edge Technology

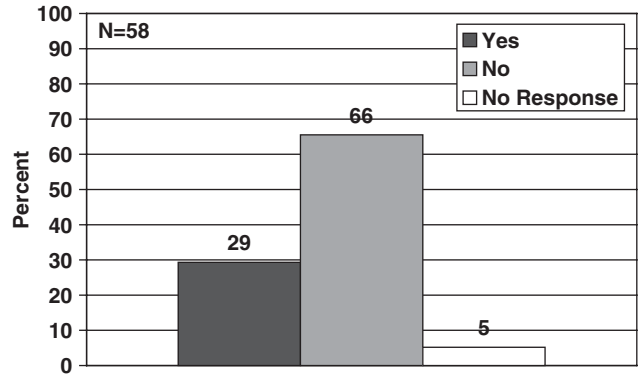

#51 Contract Award to Academic Institutions to Perform 'Run-of-the-mill' Geophysical Investigations because They Offered Best Value (Price)

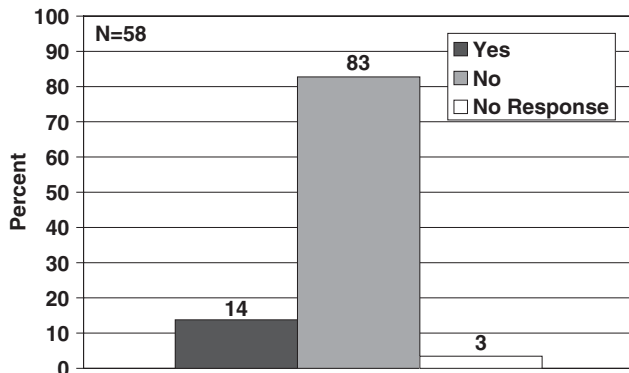

#55 What Would Increase the Level of Comfort Using Geophysics (Same as Figure 25)

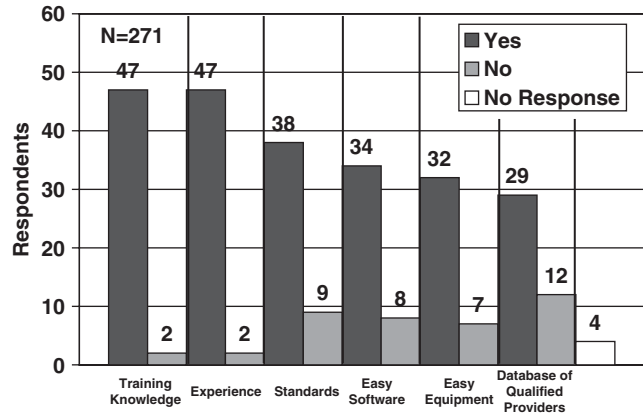

#52 Academic Contracts Awarded to Perform 'Run-of-the-Mill' Geophysical Investigations Based on Best Value (Price)

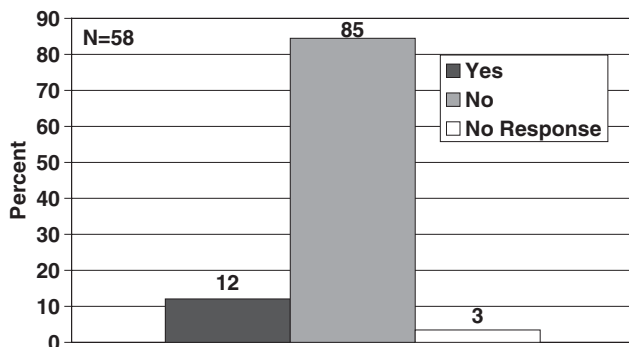

#56 Confidence Using Geophysics more Frequently on Geotechnical Projects (See Table C5 for Comments)

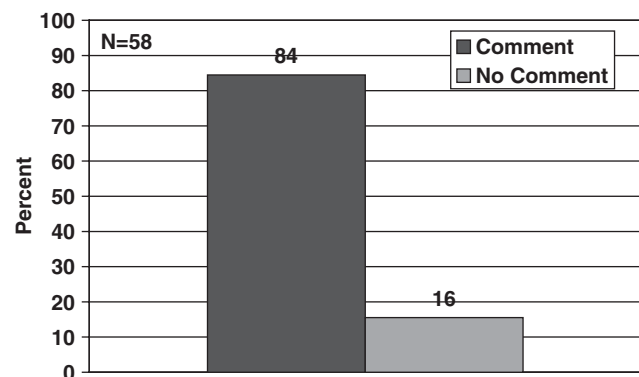

#53 Use of Academic Institutions to Perform Cutting-Edge Technology

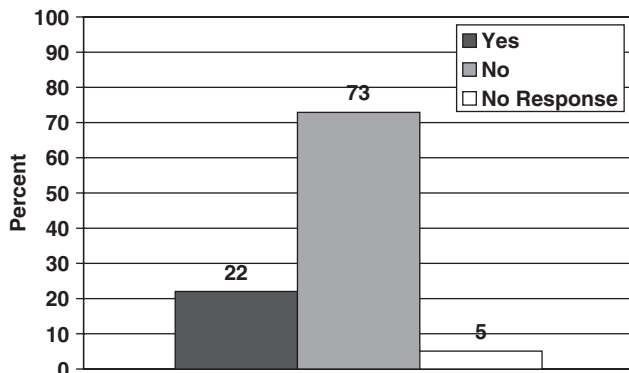

#57 Comments Regarding Other Experiences on Contracting Geophysical Service Providers

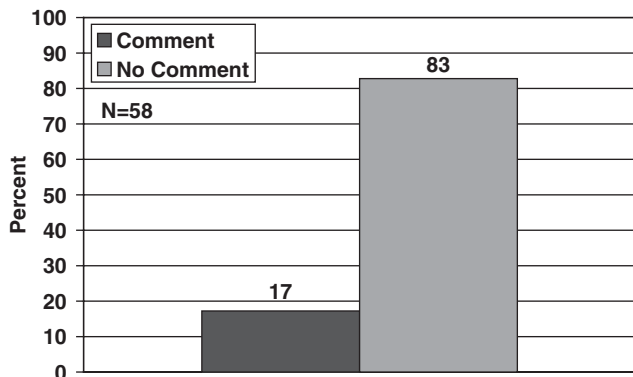

#61 Case Histories to Share for Successful and Unsuccessful Geophysical Projects on Highway Related Problems (See Table 4 for Details)

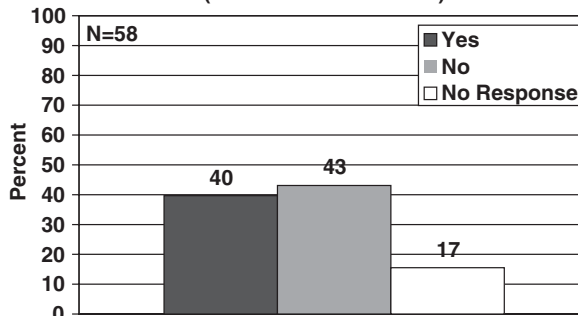

PART 5—CASE HISTORIES/PROJECT EXAMPLES

#58 Number of Successful Geophysical Projects within the Past Five Years (Same as Figure 23)

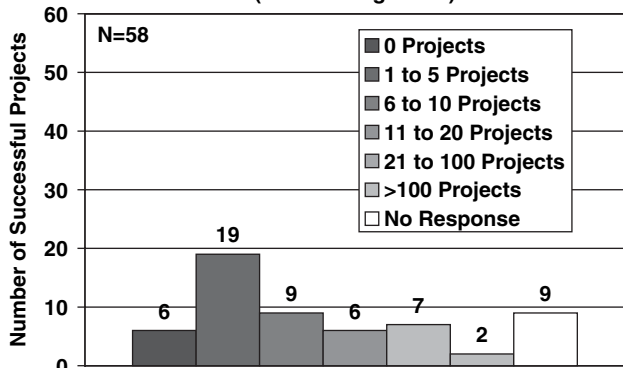

#62 Sample Scopes of Work to Successful Geophysical Project (Not the Full Case History)

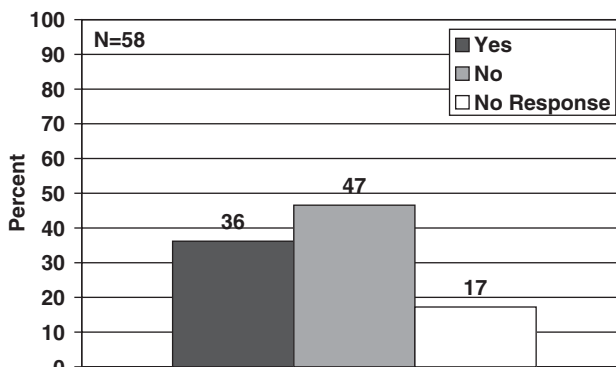

#59 Number of Unsuccessful Geophysics Projects within the Past Five Years (Same as Figure 24)

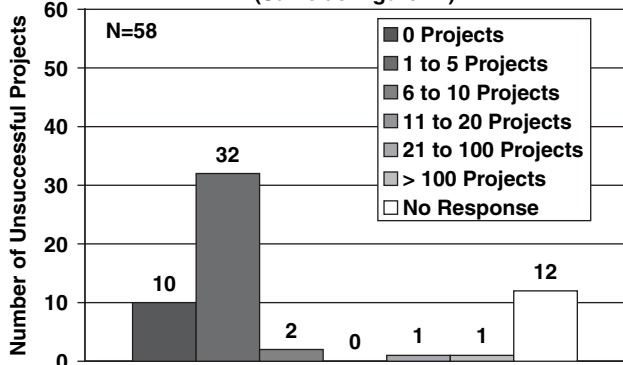

#63 Future Research Needs for Geophysics (See Table C8 for Details)

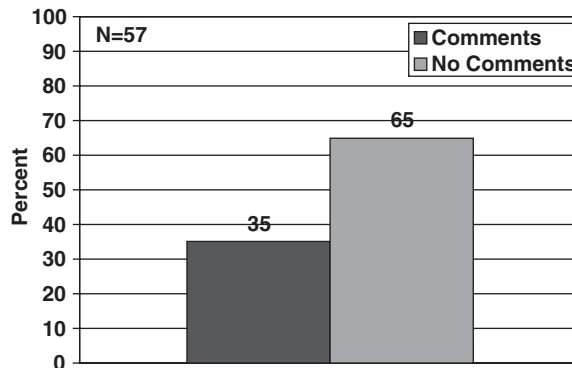

#60 Comments Regarding the Successes and Failures Experienced with Geophysics (See Table C7 for Details)

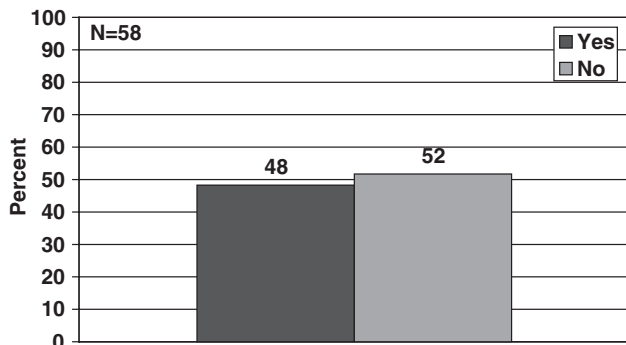

Part 5 Closing Comments (See Table C9 for Comments)

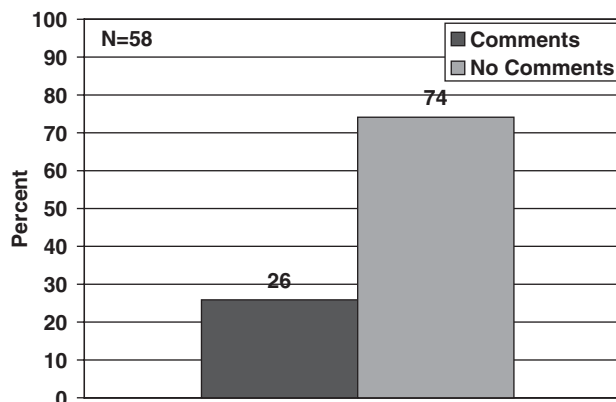

TABLE C1
THREE MOST COMMON GEOPHYSICAL METHODS

Agency	First	Second	Third
AKDOT	Downhole	—	—
AZDOT	Refraction	Blast monitoring	—
CALTRANS	Refraction	Borehole logging	GPR
CFLHD	Seismic	EM	Magnetic
CODOT	GPR	—	—
CODOT	GPR	Vibration monitoring of pile driving operations	ER
CTDOT	CSL	GPR	Vibration monitoring
DCDOT	Vibration monitoring	—	—
FLDOT	GPR	Refraction	—
GADOT	Vibration monitoring	Seismic resistivity	GPR
IADOT	Seismic	Resistivity	Vibration monitoring
IDDOT	Refraction	Blasting vibration measurement	Construction vibration measurements
ILDOT	None	—	—
KSDOT	Reflection	Resistivity	CSL
KYDOT	Resistivity	Microgravity	GPR
MADOT	Seismic	GPR	Vibration
MDDOT	GPR	Resistivity	Vibration
MEDOT	Refraction	Resistivity	—
MIDOT	Falling weight deflectometer	GPR	Vibration monitoring
MIDOT	CSL	GPR	—
MNDOT	Vibration monitoring	GPR	—
MODOT	Downhole seismic	Resistivity	GPR
MSDOT	Vibration monitoring	GPR	Refraction
MTDOT	Refraction	—	—
NDDOT	GPR	—	—
NHDOT	GPR	Refraction	Resistivity
NJDOT	GPR	Tomography	CSL
NMDOT	Refraction	Crosshole	FWD/GPR
NYSDOT	Refraction	Vibration monitoring	SeisOpt ReMi
OHDOT	Resistivity	GPR	Reflection
OKDOT	Refraction	—	—
ORDOT	Refraction	Vibration measurement	Magnetic
ORDOT	Vibration monitoring	Magnetic and EM	GPR
PADOT	Resistivity	Crosshole	Refraction
PANYNJ	Blasting vibrations	Marine applications	Crosshole surveys
RIDOT	GPR	—	—
SDDOT	Electric logs	Vibration monitoring	—
TNDOT	Resistivity	GPR	—
TXDOT	GPR	Falling weight deflectometer	Seismic
UTDOT	Vibration monitoring	Refraction	Crosshole logging
VADOT	Vibration monitoring	Refraction	Resistivity
VTDOT	CSL	GPR	Vibration measurement
WFLHD	Refraction	Vibration measurement	GPR/ER
WIDOT	Vibration measurement	—	—
WSDOT	Refraction	Resistivity	Optical televiewer
WYDOT	Seismic	Vibration monitoring	GPR
Edmonton	Vibration	GPR	—
Manitoba	Refraction	Terrain electrical conductivity (TEC) surveys	GPR
New Brunswick	IP	EM	Seismic
Ontario	GPR	Hammer seismic	—
Quebec	Refraction	MASW	GPR
Saskatchewan	Borehole logging	GPR	Electromagnetic

TABLE C2
THREE MOST COMMON GEOPHYSICAL APPLICATIONS

Agency	First	Second	Third
AKDOT	Depth to bedrock	Mapping material sites	Mapping roadway soils
AZDOT	Rippability	Depth to bedrock	Topography of bedrock
CALTRANS	Rippability	Bedrock depth/topography	Mapping man-made features
CFLHD	Mapping depth to bedrock	Mapping clay/uncompressed soils	Underground voids
CODOT	Depth to bedrock	Subsurface anomalies	—
CODOT	Embankment	—	—
CTDOT	Unknown foundation determinations—scour	Bedrock depths	Depths to unsuitable material (peat/highly organic soils)
FLDOT	Subsidence issues (real or imaginary sinkholes)	Assessing (protecting agency against) damage due to construction vibrations	Location of buried objects and utilities
GADOT	Blast/vibration monitoring	Depth to rock/PWR	Location of sinkholes, USTs, culverts, etc.
IADOT	Abandoned mines	Unknown sinkholes	Depth to bedrock
IDDOT	Depth to bedrock	Mapping bedrock strength	Determining engineering properties
INDOT	Crosshole	Shear wave (CPT)	TDR
KSDOT	Bridge foundations	Surface investigations	Underground mines or dissolution fronts
KYDOT	Depth to bedrock	Mapping karst features	Mapping abandoned coal mines
MADOT	Mapping buried features	Mapping roadway subsidence	Mapping lithology
MDDOT	Karst studies	UST studies	Vibration
MEDOT	Depth to bedrock mapping	Old foundations	Utilities and sinkhole mapping
MIDOT	Pavement design	Vibration monitoring	Void detection
MIDOT	Pavement cross section	Utility location	Locating steel in bridge decks/pavement
MNDOT	Vibration complaint analyses and compliance	Pavement/base/subgrade investigations	Modulus of base materials with FWD
MODOT	Determining engineering properties (shear wave velocity) of overburden (in-house SCPT and research MASW)	Abandoned mines, caves, karst	Rock profile, lithology
MSDOT	Subsurface mapping	—	—
MTDOT	Mapping depth to bedrock	Mapping topography of bedrock	Determining bedrock rippability
NDDOT	Thickness of pavements and bases	Detection of buried RCP	Test condition of bridge decks
NHDOT	Bedrock profile mapping	Mapping soils	Void detection
NJDOT	Abandoned mines	Karst/sinkholes	Unknown foundations
NMDOT	Bedrock depth/rippability	NDT drilled shaft foundations/piers	Pavement layers modulus
NYSDOT	Depth to bedrock for road cuts	Mapping water table elevation in overburden aquifers	Identifying possible voids or culverts
OHDOT	Abandoned underground mines	—	—
OKDOT	Depth to rock	Rippability	Water table
ORDOT	Location of underground structures, tanks, drums	Vibration monitoring	Depth of overburden
ORDOT	Locating utilities	Locating USTs	—
PADOT	Karst	Mine voids	Mapping bedrock surface
PANYNJ	Impact of microtunneling and directional drilling on surface pavements	Minipile evaluations (continuity of grouted socket)	Liquefaction assessments
RIDOT	Depth to bedrock/rippability	Monitoring construction-induced vibrations	Mapping UST locations
SDDOT	CSL drilled shafts	—	—
TNDOT	Construction in karst areas	—	—

TABLE C2 (continued)
THREE MOST COMMON GEOPHYSICAL APPLICATIONS

Agency	First	Second	Third
TXDOT	Pavement layer stiffness	Void, moisture, layer thickness, and damages under pavement	Sinkholes, utility lines
UTDOT	Controlling construction and blasting vibrations	Identifying bedrock and bedrock strengths	Quality control for dilled shaft construction
VADOT	Vibration	Karst	Depth to bedrock
VTDOT	Foundation integrity	Traffic and blast vibration monitoring	Bedrock mapping
WFLHD	Mapping bedrock	—	—
WIDOT	Construction QA/QC	Vibration of differential settlement monitoring	—
WSDOT	Refraction	2D electrical resistivity	Optical televiewer
WYDOT	Seismic	GPR	Blasting vibration
Edmonton	Mapping roadway subsidence	Soil characterization	—
Manitoba	Bedrock sounding	Detecting voids under pavement, unsuccessful	Detecting frozen soils or permafrost, inconclusive results
Ontario	Rockline	Depth and consistency of aggregate deposits	—
Quebec	Bedrock profile	Determination of cavity formation in embankments due to culvert failure	Vibration measures caused by traffic, blasting, or piling
Saskatchewan	Borehole logging	Pavement thickness determination	Locating buried aggregate deposits

TABLE C3
COMMENTS REGARDING EXPERIENCE RELATED WITH METHODS AND APPLICATIONS

Agency	Comment
CODOT	3D methods need more accuracy.
Manitoba	Should learn more about different geophysical methods and try to use to enhance the field investigation (i.e., drilling and sampling).
MTDOT	We are just implementing the use of geophysical methods on our projects; thus, our experience is limited.
NHDOT	It is not always possible to deliver “the desired” answer to the geotechnical engineer. They often want precise depth information and yes or no answers.
NMDOT	Remi used on karst geology with some success as verified by test pits.
OHDOT	Geophysical services are not readily available, so they are often not included in the project development effort owing to a lacking of time in schedule.
VTDOT	Very limited experience.

TABLE C4
COMMENTS REGARDING OTHER EXPERIENCES ON GEOPHYSICAL BUDGETS AND/OR COSTS

Agency	Comment
CODOT	Geophysics would normally be included in the cost of a geotechnical investigation. There is no allocated funding (that is to say, money set aside specifically for geophysical testing). Therefore, any costs associated with it are buried deep within the overall budget for a project.
FLDOT	Difficult to assess in Florida because such a high use of in-house resources. We do not tap into geophysics consultants enough. Looking into developing a statewide geophysics contract for districts to tap into and control the quality of the consultants.
MDDOT	Geophysical costs and budget are incidental to the general geotechnical explorations budget.
MODOT	We have one engineer who runs GPR for a small portion of his time. There are no allocated funds for it. In-house drilling/cpt can be mobilized quickly and the funding is already included in the Geotechnical Section annual budget (no direct cost to Project Managers/District budgets). Geophysical contracting typically takes 1–2 weeks to set up and this must wait until special funding can be arranged from outside of Geotechnical Section annual budget. Most Project Managers/Districts are hesitant or have difficulty finding funds for geophysical investigations.
MTDOT	Limited number of projects that have utilized geophysical methods; therefore, budget type information is limited at this time (the above-cited information is a very general estimate).
NHDOT	Mostly use in-house equipment and staff. Equipment purchases have been out of research funds based on specific research projects.
NMDOT	Based on in-house equivalent costs if consultant cost utilized.

TABLE C5
COMMENTS REGARDING INCORPORATING GEOPHYSICS INTO GEOTECHNICAL
PROJECTS

Question 44: How does geophysics get incorporated into a geotechnical project; that is, how do you identify which projects should use geophysics?	
Agency	Comment
AKDOT	Knowledgeable staff recommends it or consultant designers ask for it.
AZDOT	When traditional geotech sampling methods fail, we turn to geophysics.
CALTRANS	No formal process. Usually through project lead's experience and/or discussion with geophysics branch.
CFLHD	If the geotechnical engineer feels it is cost-effective to incorporate geophysical methods in the planning stages or if the use of geophysical methods reduces risk, such as in the case of UXO, or if there is no other way to obtain their data, such as in the case of vibration monitoring.
CODOT	Via the recommendation of the geotechnical engineer.
CODOT	Complexity.
CTDOT	It is incorporated into a project if it is determined that it is the best technique to get the required information.
DCDOT	When recommended by consultant.
Edmonton	Incorporated on the basis of experience or the requirement for specialized information that cannot be derived by more conventional means.
FLDOT	Through geotechnical engineer input.
GADOT	Determined by issues with access, speed of results, desire to limit damage to areas caused by drill rigs.
HIDOT	When it is deemed cost-beneficial to supplement borings with geophysics.
IADOT	Project-specific requirement and geologic review.
IDDOT	Site conditions access for drilling, supplemental to drilling.
INDOT	Base FHWA guidelines .
KSDOT	Regional geologist decision.
KYDOT	Geophysics is based on information obtained from drilling, available mapping, property owner information, and site location.
MADOT	Identification is based on magnitude of project, difficult subsurface conditions, and getting preliminary advice from consultants.
Manitoba	Recommended by the project engineers or geotechnical engineer.
MDDOT	Case by case.
MEDOT	Per recommendation of geotechnical engineer.
MIDOT	Need for pavement data, vibration monitoring, void detection, or consultant proposal for inclusion in subsurface investigation plan.
MIDOT	Requests from our regional offices.
Ontario	Normally when problem occurs.
MNDOT	By need.
MODOT	As needs are identified by personnel from the Geotechnical Section. We may consult with university faculty for their advice and suggestions as to the most appropriate methods and configurations/details of the geophysical investigation.
MTDOT	Generally identified on projects where supplemental information is required in addition to that obtained from conventional drilling and sampling, or on those projects/areas where conventional drilling methods cannot be utilized.
New Brunswick	When it will work, access, time, cost.
NHDOT	All geotechnical projects are considered when seismic refraction, GPR, or resistivity can help to determine the subsurface conditions.
NJDOT	Designer recommendations; prior knowledge of existing site condition.
NMDOT	Geologic application/suitability.
NYSDOT	It has been traditional to use seismic refraction to reduce the number of boreholes to identify depth to bedrock for cut areas. NYSDOT has been doing this since 1955.
OHDOT	Staff discussions between District Managing Engineer and a geotechnical engineer in our central office in the design resource section.
OKDOT	Materials Division, Geotechnical Branch specifies use.
ORDOT	Identify where lower-quality results can supplement data between borings, reducing the number of borings, or used to find suspected obstructions, cavities, etc.
ORDOT	Case-by-case defined need.
PADOT	Geotechnical engineer or design consultant request.
PANYNJ	Experience on past projects.
Quebec	When drilling methods are very expensive or the bedrock profile is very variable.
RIDOT	Based on past experience, project location/scope, project budget; will a particular geophysical method provide data that are timely and cost-effective.
Saskatchewan	All projects use these methods.
SCDOT	Proposed by consultant or selected by geotechnical engineer.
TNDOT	Suggested by geotechnical consultant or specifically requested by Geotechnical Section.

TABLE C5 (continued)
COMMENTS REGARDING INCORPORATING GEOPHYSICS INTO GEOTECHNICAL PROJECTS

Question 44: How does geophysics get incorporated into a geotechnical project; that is, how do you identify which projects should use geophysics?	
Agency	Comment
TXDOT	Site condition survey.
UTDOT	No set policy, engineer, geologist decides.
VADOT	Depends on size and area geology.
VTDOT	The size and scope of the project is evaluated along with the need for subsurface information, the in-house resources available, and the budget.
WFLHD	Project Geotech.
WIDOT	QA/QC requirements; vibrations/settlement involving deep foundations.
WYDOT	Project geologist decides.

TABLE C6
VALUE, LENGTH, AND CONTRACTORS FOR ID/IQ OR ON CALL " CONTRACTS

Agency	Value	Length	Number of Contractors
CALTRANS	>\$100,000	3 years	3 contractors
CFLHD	varies	—	—
GADOT	\$150,000	4 years	2 contractors
KSDOT	varies	—	—
MADOT	\$200,000	2 years	1 contractor
MDDOT	\$500,000	3 years	1 contractor
MEDOT	\$4 million	4 years	1 contractor
MODOT	—	2 years	6 to 8 geotechnical consultants; 2 with established geophysics capabilities
NCDOT	\$500,000	2 years	3 contractors
NJDOT	\$300,000	2 years	1 contractor
NMDOT	\$250,000	3 years	4 contractors
PANYNJ	\$100,000	3 years	2 contractors
SCDOT	varies	3 years	5 to 8 contractors
WFLHD	\$1 million	3 years	2 contractors
WSDOT	\$300,000	3 years	2 contractors

TABLE C7
COMMENTS REGARDING SUCCESSES AND FAILURES OF GEOPHYSICAL INVESTIGATIONS

Question 60: Comments regarding the successes (Question 58) and the failures (Question 59) experienced by your agency.	
Agency	Comment
AKDOT	Our successes have come in straightforward circumstances where we have used multiple methods. Our failures have come when we used geophysical methods in marginal situations and without a clear idea of what we were likely to get for results.
CALTRANS	Our failures have primarily occurred when a geophysicist was not consulted on the survey design or methodology, resulting in selection of an inappropriate method or the creation of a poorly defined scope of work. Secondary failure has occurred when we apply a method to a problem or areas where the applicability or site conditions are sub-optimal, but other means of obtaining the desired information are extremely limited.
CFLHD	The unsuccessful projects were actually research-oriented where new non-proven technologies were tried.
DEDOT	Unreliable data.
GADOT	Only unsuccessful application was the use of a method that did not apply to the site conditions.
KSDOT	KGS Seismic Group is top notice.
KYDOT	We have had problems with using ground penetrating radar owing to clayey soils. We have had success with both electrical resistivity and microgravity in identifying caves and sinkholes in karst regions.
MADOT	Sometimes depth of investigation is not reached or level of accuracy is not obtained.

TABLE C7 (continued)
 COMMENTS REGARDING SUCCESSES AND FAILURES OF GEOPHYSICAL INVESTIGATIONS

Question 60: Comments regarding the successes (Question 58) and the failures (Question 59) experienced by your agency.	
Agency	Comment
Manitoba	We used Refraction Seismic Surveys for bedrock sounding and the results were satisfactory. We also used GPR for mapping roadway subsidence to determine voids/sinkholes within a rock embankment, and the results were inconclusive or unsuccessful.
MEDOT	Seismic refraction has been most successful when there is enough boring data for calibration. It is great for go/no go decisions on entirely new highway alignments.
MIDOT	Used seismic to determine depth to bedrock on bridge project. Consultant got it wrong and it proved to be waste of money.
MIDOT	In some cases we were trying to utilize GPR in new ways and inadequate education/experience with the equipment probably led to the objectives not being realized.
MNDOT	We generally have success with the vibration monitoring equipment.
MTDOT	We have just begun the implementation of geophysics on projects; previous use of geophysics was very limited.
NCDOT	Hard to quantify; hard to generalize.
NHDOT	Geotechnical engineers expecting too much from geophysics (GPR, seismic refraction, resistivity) on every project they consider its use on (i.e., if it can't give them the exact information they want, it is no good).
NMDOT	GPR in finding.
NYSDOT	We have been using seismic refraction in a great variety of settings, for numerous uses, for many years. We generally give answers to depth to bedrock within a 10% error range. Because we are in a glaciated region, where the weathered bedrock has been eroded, there is a good velocity contrast between the rock and the overburden glacial soils. It almost always works, except for one situation a few years back when we had a velocity inversion caused by gaseous silts in lake waters. We conduct vibration monitoring surveys routinely, for construction, blasting, and traffic vibrations.
OHDOT	GPR is very limited regionally owing to combination of typical site characteristics of clay soils and high (near surface) groundwater table.
Ontario	Failure to accurately plot rock line.
PANYNJ	Detection of buried drums; induced current conductivity.
Quebec	We have good results with our seismograph, which represents at least 75% of our geophysical survey. We have less success with seismic refraction survey done by private office.
TNDOT	Methods have been proposed that do not really deliver what was promised or were generally unsuitable for the desired outcomes.
TXDOT	We are very happy with NDT.
UTDOT	Struggled to identify the shear plane in a landslide.
VADOT	Problems with seismic refraction in Piedmont saprolites and variably consolidated coastal plain sediments. Usually insufficient available space to lay out spreads for adequate depth penetration by our available practice.
WISDOT	WISDOT does not contract out very often for geophysical services because of cost. I am sometimes required to use one of the geophysical methods that are not appropriate for a particular project, simply because we own the equipment. I hear from project managers/engineers "let's do it anyway." These are cases where an unsuccessful outcome is virtually guaranteed.
WSDOT	Highly skilled geophysical consultants that try different method on the site to obtain the best result.

TABLE C8
FUTURE RESEARCH NEEDS IDENTIFIED BY RESPONDENT AGENCIES

Agency	Comment
CALTRANS	For transportation engineering, ways to quantitatively determine in situ soil and rock properties are a worthy avenue for future geophysical R&D. The biggest area for R&D, in my opinion, lies in NDT for roadway and structure maintenance, unknown foundation assessment, and construction QA/QC.
CFLHD	3D crosshole tomography and ReMi.
FLDOT	Any assistance to provide guidelines to the geotechnical engineer to use geophysical testing to plan out the subsequent boring/sounding program to identify nonselect soils, isolated rock formation, map out top of rock, etc., would be enormously helpful. Case studies, lessons learned, cost savings, contracting mechanisms, etc., would help the engineer implement this testing on a routine basis. The need to relate geophysical test results to engineering properties is needed. New geophysical techniques are needed to be developed in conjunction with existing/boring sounding test methods so they can be performed at the same time. FLDOT has an existing pool fund study request to look into these two items.
GADOT	Additional use and experience along with training (through NHI or others) would be needed.
IDDOT	Pursue out-of-the-box methodologies.
ILDOT	Continue developing existing techniques.
INDOT	Soil characterization (stiffness, density, and moisture).
KSDOT	Speed and ease of data filtering to allow us to present the information to all levels of transportation people.
KYDOT	Develop a NHI class for the states to reinforce the use of the technology.
MIDOT	Need to develop technology for continuous monitoring for compaction equipment to improve quality control of compacted soils.
MTDOT	Continue developing reliability and confidence in the output from geophysical surveys.
NHDOT	"Out of the box" technologies that are easy to use by in-house staff. Training to address geotechnical engineers expecting too much from geophysics (GPR, seismic refraction, resistivity) on every project they consider its use on (i.e., if it can't give them the exact information they want, it is no good).
NJDOT	One of the major obstacles to the utilization of geophysical methods is the susceptibility to interpretation and potential inaccuracy of obtained results. Any developments that will serve to reduce this situation will result in an increased level of confidence in both existing and new geophysical technologies.
NYSDOT	I'm a geologist, not an engineer, but I think the SeisOpt ReMi software holds great promise. Our experiences with it so far have been very favorable, not only for delineating shear wave velocities, but also for detecting voids above failing culverts. It is extremely easy to use in the field; using ambient noise for the energy source.
OHDOT	One area would be to complete the proposed pooled funding effort to determine how falling weight deflectometer data can actually be used as a form of seismic (?) data to determine areas underlain by subsurface voids. If this information could be developed, there would be a major victory in terms of cost-effective R&D. This cost-effective win would be because every DOT has FWDs, but right now most of them do not know that they can be used for more than pavement testing. Some of the states currently interested in this possible use of FWDs to detect subsurface voids include Ohio, Arizona, Kansas, Michigan, and Missouri.
PADOT	Ease of use, good interpretation tools, reduction in equipment and software costs, need to mainstream.
PANYNJ	Developing geophysical applications to assist with tunnel design; potential alignment may be investigated using directional drilling (install two pipes horizontally and perform crosshole measurements between pipes to interpret soil and rock strata).
TNDOT	Training, training, training, and training
TXDOT	GPR.
Manitoba	Geophysics is a specialized field. If geophysicists could provide marketing information/education, general geophysics applications for transportation, structure, and geotechnical engineers through universities, various conferences, trade shows, etc., this will be one of the keys to promote this technology.
Quebec	We are developing the Sherbrooke University and investigation method using MASW to find cavity formation in embankments owing to failure culvert.

TABLE C9
COMMENTS REGARDING ITEMS NOT COVERED IN THE SURVEY

Agency	Comment
ILDOT	This survey is the longest survey I've seen! Too many questions to keep focused!
INDOT	We like training, knowledge, and information sharing.
KYDOT	We are in the process of completing a research project of different geophysical techniques. This research study involves evaluating and implementing several geophysical methods and different contractors for further use in the state of Kentucky. If you would like a copy of this report, contact us when it is completed. Until recently, Kentucky has lacked a budget. Also, owing to tight time constraints during the design phase geophysical techniques have not been incorporated.
MADOT	We responded to a similar survey about 2 to 3 years ago to FHWA.
MIDOT	Answers to this survey pertain to the use of GPR by our Pavement Structures Group only. Our Geotechnical Services Unit passed it on to us to fill out with regards to GPR only. It is important to note that the greater portion (>80%) of our work with GPR has been in the pavement structure (i.e., above the original subgrade) or in bridges. So, the type of work this survey is trying to document has been very minor in the 4 years we have owned the equipment.
MNDOT	There are two areas of interest in MNDOT concerning the use of geophysics. There is the pavement side that routinely uses GPR and FWD. The other area is the structures side that has used geophysics on occasion to attempt to enhance and fill in the blanks of a standard site investigation involving SPT and CPT. Potential failure emphasis will include preliminary investigation with geophysics to help determine a course for a more detailed site investigation and testing program.
MODOT	Question 6 references the geophysics manual. The only problem is that it is so voluminous as to discourage its use somewhat. There is need for an expert system to aid engineering professionals in the selection of the appropriate geophysical methods. Question 13 asks about increase/decrease in use of geophysics. Our increase is generally related to in-house SCPT utilization for shear wave determination using downhole seismic techniques and not other in-house or contracted geophysical investigation.
MSDOT	I'm all for a program designed to expand the knowledge of geophysical methods among state DOTs. We would utilize the varying technologies if we had the training needed to understand what is available and how it can be used to enhance our designs.
MTDOT	Our previous experience with geophysics is limited and we have just implemented its use within the past year. Thus, our experience and ability to provide case histories and budget type information is limited at this time. I anticipate increased use of geophysical methods in the future.
OHDOT	Please send me a copy of this synthesis whenever it is completed. Thanks!
PANYNJ	Regarding specific projects referenced in responses, it should be noted that all data were lost on 9/11.
RIDOT	We are presently coordinating an effort to develop a database of prior borehole information throughout the state. An interest exists in reducing a number of point borings and geophysical methods, in accordance with prior data, which may be quite beneficial in this pursuit.
Saskatchewan	Saskatchewan Highways and Transportation has been utilizing geophysical methods in geotechnical practice since 1966. It is part of the everyday toolbox that is used in this organization and the time and money saved over the past 40 years would be very large. New technologies such as EM surveys and GPR surveys have made sub-surface aggregate location studies and Pavement Engineering more efficient as well.
SDDOT	The state of South Dakota does not do much geophysics for projects. The amount that is done is through CSL of drilled shafts with potential irregularities. There has been some discussion on GPR, but very little progress.
WIDOT	Good job in putting the questionnaire together—you have covered all of the bases. I believe this will benefit WISDOT and many other state DOTs. Thank you for your efforts.
Yellowknife	Our agency used GPR with limited success; on two occasions about 12 to 15 years ago to detect near surface cavities under roadways, which were caused by permafrost degradation in one case and by dissolution of gypsum bedrock in the other case.

APPENDIX D

Case Histories

Successful and unsuccessful case histories presented in this appendix were prepared by the respective transportation agencies; the synthesis consultant has made only minor modifications or comments. These four case histories were selected for this report because they cover a multitude of geophysical methods and techniques, as well as geotechnical applications. The authors have submitted them in a similar format to make for easy comparisons.

For the purpose of this synthesis, successful or unsuccessful case histories (as presented in Table 4) are based solely on meeting technical objectives, not whether the project met budget or timeline constraints.

It should be noted that an unsuccessful case history is not a criticism of geophysics—the methods or the techniques. As the authors indicate, poor application, instrumentation, or data interpretation software may often be the reason a geophysical investigation does not meet the objectives.

CASE HISTORY 1

How not to do it—A summary of a reflection seismic project to delineate potential faulting across structures proposed for a major Interstate project in southern California

An Unsuccessful Geophysics Project

William Owen, Chief, Geophysics and Geology Branch, California Department of Transportation

Objective and Purpose

In the summer of 2002, a staff geophysicist was consulted to propose investigations for Interstate improvements in the San Bernardino Valley in southern California. A number of bridges and overroads were proposed for this project, which is located in an area of significant seismic hazards. The purpose of the studies would be to evaluate possible fault traces beneath the proposed structures. Factors influencing the selection and sequencing of the geophysical surveys were: (1) the project area is in a deep alluvial basin, with estimated sediment deposition in places on the order of 2 km; (2) the area is heavily urbanized; (3) vibration noise is significant; (4) the client had deadline pressures (less than 90 days) and wanted a quick turnaround; and (5) there was no identified stable funding source to pay for the work.

Options Considered and Method Selected

When discussing the client's needs with the staff geologists, the consulting geophysicist outlined some options. Both sides agreed that reflection seismic was the primary method reasonably expected to provide the client's desired resolution. However, staff geologists wanted imaging of the basin to bedrock (up to 2 km). The geophysicist described the pros and cons of compressional (P) wave and shear wave reflection: P-wave could give them the desired depth, with reduced resolution; shear-wave could yield the desired resolution, with the potential for shallower investigation depth and a guarantee of increased cost. For either method, the noisy environment remained a problem.

Because the state department of transportation (DOT) had no in-house capability for this highly specialized work, the job required an outside contract. The opinion of the geophysicist was that high-resolution, shear-wave reflection seismic, using a vibratory source, was the best option; arguing that even if a deep P-wave survey was performed, the shear-wave survey would still be needed for accurate delineation of shallow offsets posing the greatest risk of surface rupture. Owing to cost issues, the staff geologists opted for a deep P-wave survey, using impact sources, with a subsequent shear-wave survey, once stable funding was secured.

The geophysicist, in consultation with a qualified consultant, developed scopes of work and initial cost estimates. Initial estimates were under budget, but the consultant's commitment to another project raised questions about the deadline. That uncertainty, despite assurance from the contractor, led the staff geologists to pursue a different consultant. The consulting geophysicist was eventually removed from the project as a result of disagreements with the staff geologists over consultant selection and project scope and cost. Ultimately, none of the original consultants was selected. Six months after the original deadline, staff geologists began work under agreement with a federal research agency, at a cost \$30,000 more than the geophysicist's original scope of work.

Four months after work had begun the consulting geophysicist was again contacted regarding the project. The geophysicist was invited to rejoin the technical team and was informed that the original geology team was no longer working on the project. At that point, fieldwork was nearly complete. The geophysicist requested a status briefing from the federal research agency's lead investigator. A response was not received.

Results

More than one year after that request, a draft report was submitted. The consulting geophysicist concluded in review that, as feared, the P-wave reflection data did not successfully image shallow targets of greatest interest to the project. Also of concern were the deeper portions of the data (Figure D1). In the opinion of the consulting geophysicist, the interpretation of the deep seismic sections included geologic structures that were not plausible given available knowledge of faulting and geology in the area. The rebuttal from the investigators essentially agreed that the data could not meet the primary objective required by the state DOT, but disagreed with the assessment of the interpretations. However, in their

final draft the investigators presented a significantly different reinterpretation of the same data (Figure D2).

Reasons for Failure and Lessons Learned

Both practitioners and users of geophysics must be cognizant of project limitations that may affect the geophysical investigation. In this case, a number of factors contributed to the failure.

Project deadlines placed extreme limits on what could be done. It was apparent from the outset that this type of investigation, from initialization to final report, could not be com-

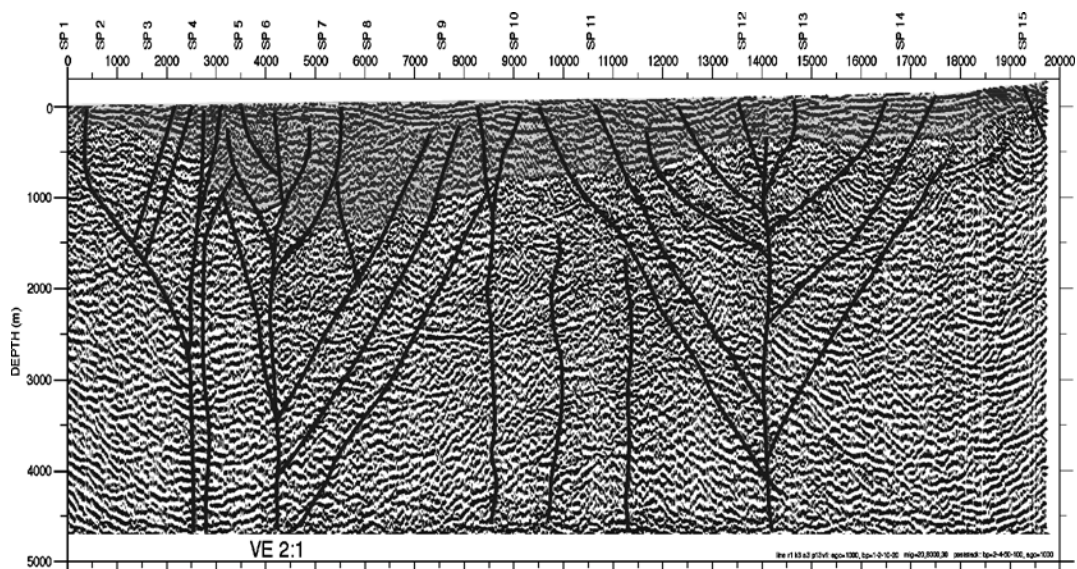

FIGURE D1 Initial interpretation of reflection seismic section. Grayed zone is interpreted extent of sedimentary basin. Many interpreted faults on the section appear inconsistent with the available data or are incompatible with existing knowledge of faulting in the basin.

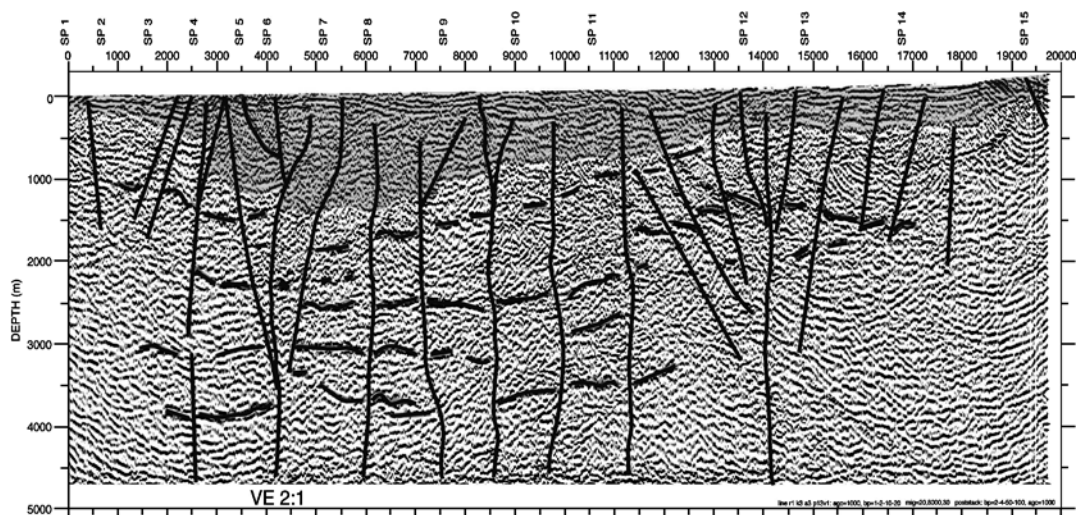

FIGURE D2 Revised interpretation of Figure D1. New interpretation may be more plausible, but spaciuousness is likely the result of poor data quality. Resolution, particularly in the upper 500 m, is insufficient to reliably discern fault proximity relative to structure locations.

pleted by the desired deadline. As it happened, the ultimate path chosen by the geology team resulted in project duration much longer than the consulting geophysicist's original plan. In the end, deadlines were extended to accommodate the investigation.

Lack of a stable funding source made it difficult to develop the scope of work and to obtain contractor commitments. Quite simply, although funding issues were the result of legislative actions beyond control of the state DOT, the DOT could not appear serious in its desire to pursue the investigation at an accelerated tempo when the consultants could not be assured that funding existed to carry it out.

The noisy environment significantly affected the data obtained using the impact sources. That and other factors limited usable bandwidth to lower frequencies, resulting in a low-resolution data set of questionable interpretation that could not satisfy the state DOT's need for detailed and accurate resolution of shallow features.

Conclusions

The main point of this case history is that a geophysicist is invaluable in planning, coordinating, and conducting geophysical surveys. Although California law allows geologists to incorporate geophysics into their practice, reflection seismic is particularly complex and was clearly beyond the experience and practice of the staff geologists, who against advice developed a scope of work without input from the consulting geophysicist. In the end, the client spent \$215,000 for work that could not fulfill the desired objective. The follow-up shear-wave survey was not carried out and, in this case, the client's negative experience makes that follow-up unlikely.

CASE HISTORY 2

Application of Ground Penetrating Radar at the Stony Rapids Airfield in a remote area of northern Saskatchewan

A Successful Geophysics Project

Saskatchewan Department of Highways and Transportation (SDHT) and Pavement Scientific International

P. Jorge Antunes, Principal Geotechnical Engineer
Curtis Berthelot, President,
Allan Widger, Executive Director Engineering
Gordon King, Regional Executive Director

Objective and Purpose

The objective of this trial project was to use ground penetrating radar (GPR) to measure the extent of moisture accumulation within the Stony Rapids Airfield substructure.

The Saskatchewan Department of Highways and Transportation (SDHT) is responsible for maintaining and operating 18 provincial airfields, including the Stony Rapids Airfield in Northern Saskatchewan. During regular airfield inspections, SDHT staff and pilots noticed the formation of two large depressions in the airstrip that were beginning to affect aircraft take-off and landing operations.

Owing to its remote northern location with limited equipment available, a make-shift site investigation was completed by drilling a few large diameter boreholes on the graded portion adjacent to the runway. The boreholes were drilled in the vicinity of the depressed areas with a large diameter auger on loan from the local electrical company. The boreholes identified large volumes of water contained in the substructure near the ground surface. SDHT needed to quantify the extent of the moisture accumulation beneath the runway to determine whether a subsurface drainage system would be required. If this system was required, design parameters would be necessary to determine the type and size of the subsurface drainage system needed for the Stony Rapids Airfield.

Options Considered and Method Selected

The first option considered to measure the extent of moisture accumulated in the Stony Rapids Airfield substructure was to use conventional coring, sampling, and laboratory analysis along a grid pattern on the runway. It was decided that the conventional methods were too expensive and not practical.

The other method considered was the use of GPR to use nonintrusive geophysical methods to map the groundwater beneath the runway surface. It was believed that this technology could be cost-effective for this project. As a result, SDHT contracted with Pavement Scientific International to perform a GPR assessment of the Stony Rapids Airfield.

The logistics of transporting the portable GPR equipment were handled by using a chartered aircraft to airlift the equipment and crew from Saskatoon, Saskatchewan, to the remote location. Once there, the equipment was attached to a standard pick-up truck for use in the geophysical survey, as shown in Figure D3.

Results

The GPR surveys were conducted on the runway during the intervals of aircraft inactivity. The truck-mounted GPR unit was shuttled on and off the runway throughout the day without having to restrict regular aircraft operations.

GPR profiles were collected starting from the northeast end of the airstrip and ending 1.6 km at the southwest end. There were five radar scans for each of the seven passes.



FIGURE D3 Truck-mounted GPR at Stony Rapids Airfield.

Figure D4 is as an example of a GPR scan. This scan shows a significant increase in dielectric permittivity (an indication of increased relative moisture content) in the subbase at the depressed areas, as well as the surrounding area. This indicated further expansion of the depressed areas. The

moisture accumulation contours measured within the granular base layer were the same as found in the subbase. This could be the result of moisture diffusion from the subgrade or moisture infiltration from the pavement cracks. The source of the moisture could not be determined because surface

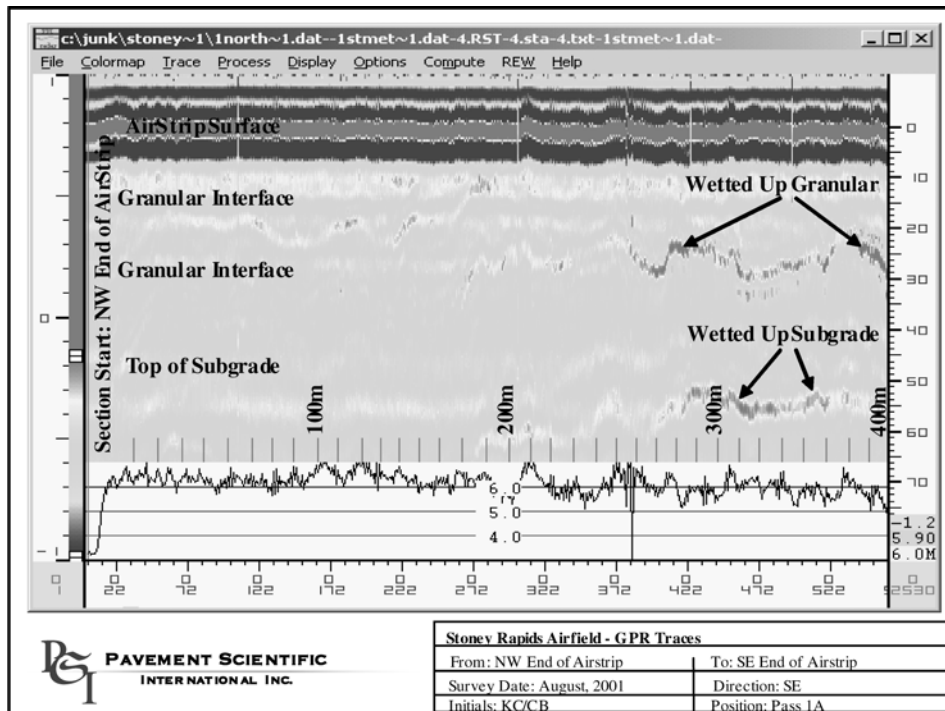

FIGURE D4 Ground penetrating radar scan pass 1A.

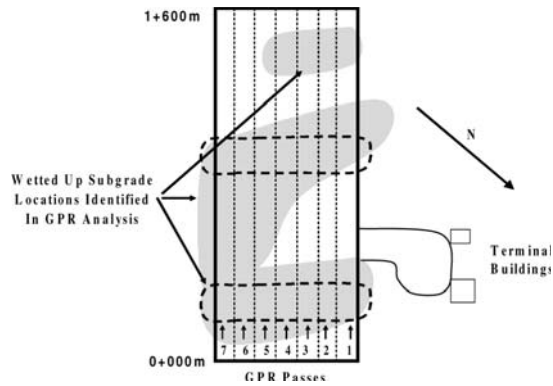

FIGURE D5 Stony Rapids Airfield wetted up subgrade contours.

cracking information was not available at the time of the GPR survey owing to a recent application of a bituminous surface course on the entire runway.

Figure D5 illustrates the moisture accumulation contours measured both at the top of the subbase and within the granular base layer within the Stony Rapids Airfield. These contours verified the theory that the runway depressions were caused by moisture within the runway substructure. The contours also showed that there were other areas that were prone to settlement along the runway. This confirmed the need for a subsurface drainage system beneath the airfield runway.

The entire survey was completed within 14 h, which included 6 h of flying time. In addition, one day was required to complete the data analysis and generate the results used for this study.

Reasons for Success

The GPR survey was an innovative solution to the problems faced at the Stony Rapids Airfield. The results of the survey proved that the extensive groundwater was already extending past the existing depressions in the runway and that remedial measures needed to be taken to install the subsurface drainage system. The information from this GPR survey was used in the design process as well as in a request made to a Canadian federal government agency to fund this airport work under a federal monetary grant structure.

The experience and knowledge of both the project engineers as well as the consultant involved made the project successful. SDHT has numerous senior engineers willing to share their knowledge and experience. Innovations and new technology are also encouraged within SDHT. This mindset within SDHT makes innovative technologies open to consideration by front-line staff and executive managers.

Conclusions

This case history illustrates SDHT's positive experience with GPR technology and ultimately the use of this type of geophysics. The ability to carry out a nonintrusive geophysical survey, in a single day, at a remote northern airport, while maintaining full airfield aircraft operations makes this project a success from a logistics point of view. In addition, the results allowed decision makers to confirm design parameters, as well as obtain federal government funding for the project. For these reasons, this project has helped to promote the further use of GPR and geophysics within SDHT.

CASE HISTORY 3

Geophysics and Site Characterization: K-18 bridge over the Kansas River

An Unsuccessful Geophysics Project

Neil M. Croxton, P.G., CPG, Regional Geologist, Kansas Department of Transportation

Objective and Purpose

In 2001, the Kansas DOT (KDOT) decided to begin incorporating geophysics in preliminary investigations to supplement drilling and sampling programs. Geologists at KDOT began looking for a place to experiment with different geophysical methods. We wanted to find a characteristic bridge project, preferably one with good as-built elevations, so that we could easily compare the geophysical results with site-specific data.

The project selected for the tests was a proposed bridge over the Kansas River on K-18 between Manhattan and Junction City (Figure D6). The bridge is to be built alongside the existing structure, which was constructed recently enough so that detailed geology information is available. The riverbed itself is nearly 800 ft wide, sits 10 ft below the bank, and is braided with sand bars. Fluctuations in water flow are common. To design the foundations for Piers 2, 3, and 4 we needed top-of-bedrock elevations across the riverbed, along with some idea about the degree of weathering at the soil/rock interface.

Options Considered and Method Selected

Drilling at the proposed pier locations in the riverbed would have only been possible by obtaining specialized drilling equipment or by conducting extensive earthwork. Neither option was economically possible, nor were they seriously considered. The site appeared to be a good choice however as a test of modern engineering geophysics. Bedrock in the area consists of alternating layers of Permian age limestone and shales. Kansas River alluvium typically consists of quartz sand with lenses of clay and silt; the alluvium is less



FIGURE D6 K-18 bridge site located on the Kansas River between Manhattan and Junction City.

than 30 ft thick at this location. We believed that the contrast of material properties at the alluvium/bedrock contact—sand overlying limestone and hard shale—might lend itself to good quantitative geophysics data that would provide the needed information.

Seismic refraction and 2D resistivity profiling were the two geophysical techniques that we believed could provide the necessary information. Geophysicists at the Kansas Geological Survey were consulted; the consensus was that both resistivity and refraction had their advantages and limitations in this geologic setting. We finally decided to try both the seismic and electrical methods and learn for ourselves.

KDOT has a standing contract for drilling services with a consulting firm that also performs geophysical investigations. A proposal from this company was submitted and accepted. KDOT would pay \$33,000 for resistivity and seismic refraction field surveys, data interpretations, and their report.

Results

Field work took place over 4 days in early December 2004. Later that month, the consulting firm submitted its report. In it, our consultant expressed little confidence with the refraction results. Background noise was blamed for the poor data—wind, road noise from the nearby bridge, and vehicle activity at the nearby Fort Riley military base. The resistivity data were much better, and the geophysicists were optimistic about the results. The report contained interpreted top-of-bedrock elevations for both surveys.

It is our experience that the alluvium/bedrock contact beneath even the largest rivers in eastern Kansas is generally planar (Figure D7). Occasional scour holes are found, but the rock is usually too resistant to give dramatic weathering differences across a site. At the K-18 crossing, drill holes on opposite banks (separated by about 800 ft) showed that the contact varied by less than 3 ft. We expected that at least one of the geophysics methods would clearly show this contact between such different materials as sand and hard Permian bedrock.

We were disappointed. Resultant interpretations for the bedrock contact from both refraction and resistivity data showed irregular soil/bedrock interfaces with unrealistic high and low points. In the riverbed itself, the refraction data yielded differences of up to 16 ft; the resistivity results varied by up to 20 ft. The two methods diverged by as much as 25 ft toward the north end of the channel area. The resistivity profile showed large areas of very high resistivity in locations where drill holes found only sand (Figure D8). Very low resistivity was shown in places that we know is hard bedrock. And finally, both methods seemed to reflect the topography, as the interpreted bedrock contact followed the surface elevation up both banks and over sand bars between river channels. In short, the results were useless for our design and planning work.

Reasons for Failure

We consulted with geophysicists at the Kansas Geological Survey to help us figure out what might have gone wrong. Seismic and electrical specialists decided that the computer

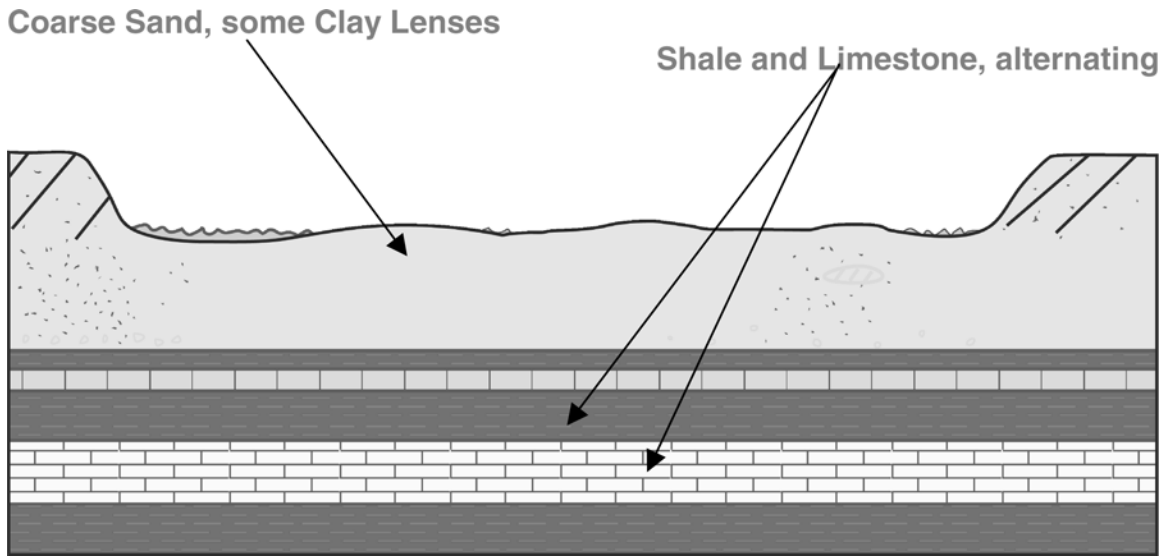

FIGURE D7 Conception geologic model of K-18 site.

programs used to interpret the data are most likely responsible for the poor results. There are a handful of different programs available to help geophysicists handle refraction and resistivity surveys, and each has its own biases. Scientists who use these programs must be very careful in choosing which to apply to a certain situation.

By this time, the bridge foundation geology report was due. There was no time to have the geophysical data reinter-

preted or evaluated any further. The piers in the channel were designed using geology information from the existing bridge.

Lessons Learned

Companies specializing in seismic refraction and resistivity on this scale are not common in the central plains. KDOT Geology assumed that, given the planer geology and existing

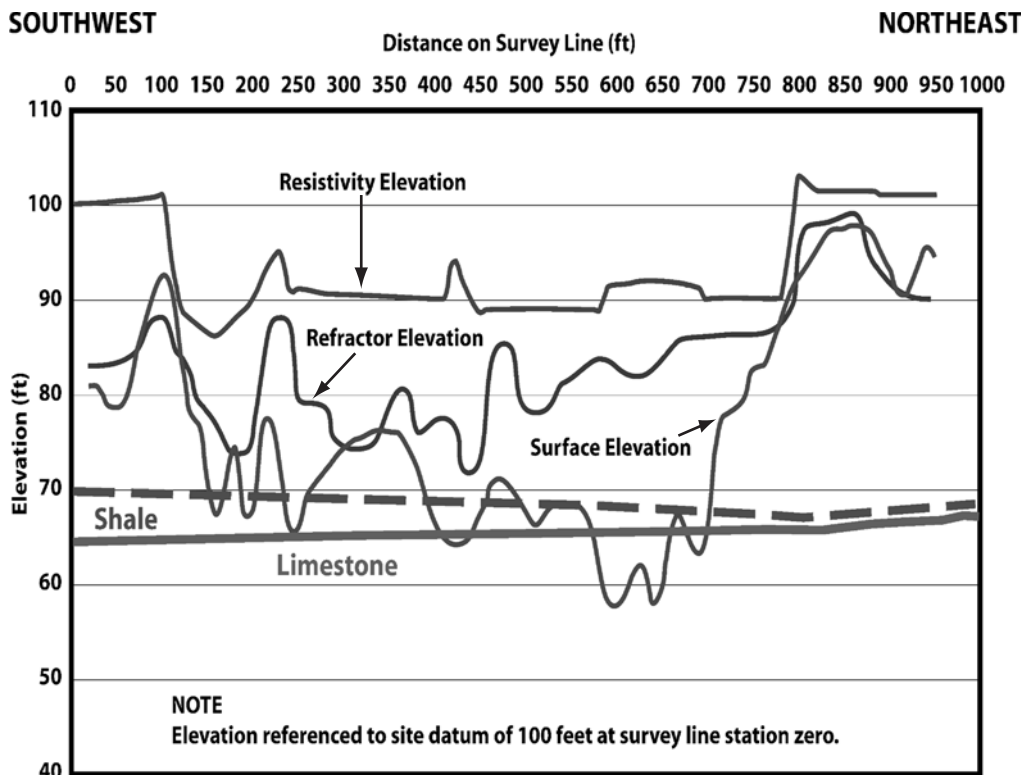

FIGURE D8 Geophysical results and geological (drilling) elevations for top-of-rock.

borehole data, local geotechnical firms could provide the same level of service as the well-known geophysics companies. In the future, KDOT will require proof of similar work with references and, through competitive bids, utilize firms that specialize in geophysical investigations.

Conclusions

The failure of seismic refraction and 2D electrical resistivity profiling to provide reliable information at the K-18 bridge has not affected KDOT's determination to use engineering geophysics during its preliminary site investigations. A different stream crossing will be chosen, and we will try again.

Synthesis Author's Comment

The construction phase may reveal details about the soil/bedrock interface and its surface relief and degree of weathering. It is recommended that these physical measurements, made during construction and/or additional site investigation work, be integrated into the geophysical data, the interpretation constrained by these parameters, and the same software used to produce new sections. Typically, applying constraints to the algorithms will help the geophysical model more closely reflect the geologic model; and, it is the opinion of the synthesis author that "ground truth" evidence is needed for this project in the areas interpreted to be anomalous from the conceptual model. This ground truth comment applies for all geophysical investigations.

CASE HISTORY 4

Geophysical Investigation of the USH 53 Birch Street Interchange Site, Eau Claire, Wisconsin

A Successful Geophysics Project

Dan Reid, Geologist, Bureau of Technical Services, Geotechnical Section, Wisconsin Department of Transportation

Objective and Purpose

As part of the realignment of U.S. Highway (USH) 53 in Eau Claire, Wisconsin, the Wisconsin DOT (WISDOT) will be constructing an interchange for the Birch Street connection to this highway on a parcel of property owned by the city of Eau Claire. An old city landfill, with little to no historical data on the nature and extent of filling, occupies a preexisting ravine on the property that extends beneath the limits of construction of the proposed Birch Street intersection. A geophysical investigation was conducted at the property in December 2002 to estimate the horizontal extent of landfilling within the proposed limits of construction and to focus future geotechnical and environmental work at the site.

Options Considered and Method Selected

During the design phase of the project, discussions between geotechnical engineering and project design staff indicated that a phased investigation approach was warranted at this site, and that a geophysical study would be appropriate as the second investigation phase (after a preliminary environmental investigation). Several geophysical options were considered for this study including seismic refraction, GPR, electrical resistivity, and electromagnetics (EM). Project design staff indicated that they had limited funds for this work and that they needed a quick turnaround on the results. Based on this information, and that soil borings from the project area indicated that native soils consisted predominantly of alluvial sand and gravel (which should be characteristically less conductive than the waste material placed in the ravine), the EM and GPR methods were selected. An EM31 terrain conductivity instrument manufactured by Geonics, Ltd., and a RAMAC GPR instrument with a 200 MHz antenna manufactured by Mala Geoscience were used for this investigation. Interpretations of the EM31 data were developed using SURFER^(t) (Golden Software, Inc.) to contour the data sets in 2- and 3-dimensional simulations of the study site, whereas GPR data were plotted and interpreted using the Mala, GroundVision^(t) software package.

The field investigation began by establishing a surveyed grid with 50-ft centers, approximately 750 ft long (north to south) and 600 ft wide (west to east) that covered the limits of proposed construction over the landfill. The terrain conductivity and GPR profiles were completed by running the instruments across the survey grid from west to east, beginning at the northern end of the site and proceeding to the south. Three additional profiles with each instrument were also completed from south to north after the first set of data had been obtained.

Results

The EM31 data indicate that there are two distinct anomalies; a conductivity high located in the northwest section of the grid and a conductivity low located in the west-central section of the grid. Both of these features are likely associated with landfilling at the site. In general, waste with higher apparent conductivity is located in the northwest portion of the landfill grid (later identified as industrial waste), whereas the southern portion of the grid contains waste with lower overall apparent conductivity (later identified as construction and demolition waste). Figure D9 presents 2D and 3D image maps of conductivity data on the landfill grid.

GPR profile data clearly illustrate the extent of filling along the margins of the landfill. For this study, interpretations made on GPR data sets were focused on the profile margins, primarily because some areas of the landfill, specifically the thicker fill sequences in the center of the preexisting ravine, were highly conductive to GPR signals and resolution of subsurface conditions in these areas of the profiles was

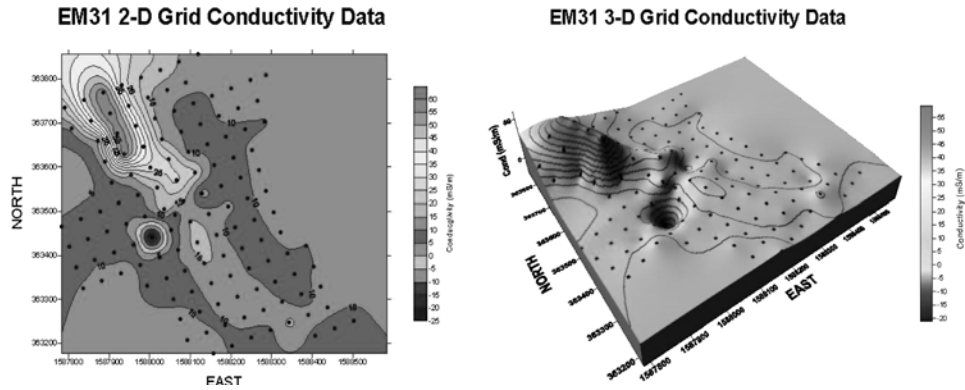

FIGURE D9 2D (left) and 3D (right) image maps of conductivity data on landfill grid.

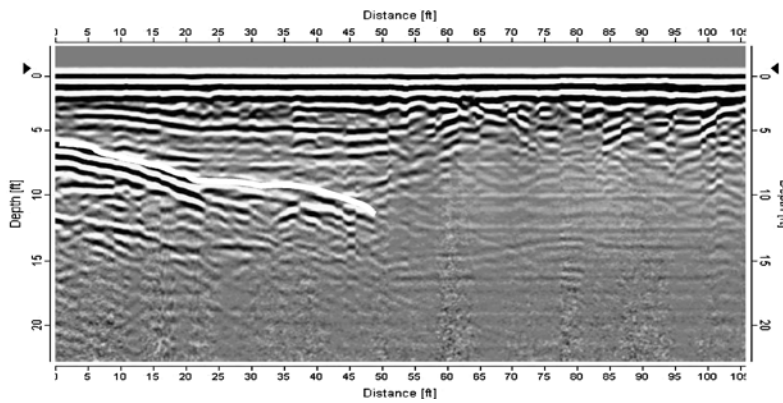

FIGURE D10 Partial GPR profile along west edge of site.

poor. In addition, the profile margins covered the limits of the preexisting ravine where the preexisting ground surface would be closer to the surface. The buried, preexisting ground surface was the primary target of GPR profiling to help characterize the limits of landfilling at the site. Figure D10 presents a partial GPR profile collected along the west edge of the site, near the conductivity high noted on Figure D9, and clearly shows the downward trending preexisting ground surface near the edge of the grid. Interpretations of the extent of landfilling at the site were developed using both the EM31 image maps and GPR profile data.

Reasons for Success and Lessons Learned

Overall, these two geophysical methods worked well to identify both the horizontal extent of filling and the location of

high conductive fill material within the preexisting ravine. A subsequent geotechnical investigation phase confirmed the geophysical interpretations and provided data on the character of the fill material. The geophysical methods achieved the objectives and purpose of this investigation primarily because they were appropriate for the subsurface conditions encountered.

Conclusions

The geophysical investigation used on this project proved to be a cost-effective, accurate, and timely method of evaluating the extent of landfilling on the site. The success of this investigation will help ensure that geophysical methods are considered as practical investigative tools on other WISDOT projects in the future.

Abbreviations used without definitions in TRB publications:

AASHO	American Association of State Highway Officials
AASHTO	American Association of State Highway and Transportation Officials
ADA	Americans with Disabilities Act
APTA	American Public Transportation Association
ASCE	American Society of Civil Engineers
ASME	American Society of Mechanical Engineers
ASTM	American Society for Testing and Materials
ATA	American Trucking Associations
CTAA	Community Transportation Association of America
CTBSSP	Commercial Truck and Bus Safety Synthesis Program
DHS	Department of Homeland Security
DOE	Department of Energy
EPA	Environmental Protection Agency
FAA	Federal Aviation Administration
FHWA	Federal Highway Administration
FMCSA	Federal Motor Carrier Safety Administration
FRA	Federal Railroad Administration
FTA	Federal Transit Administration
IEEE	Institute of Electrical and Electronics Engineers
ISTEA	Intermodal Surface Transportation Efficiency Act of 1991
ITE	Institute of Transportation Engineers
NASA	National Aeronautics and Space Administration
NCHRP	National Cooperative Highway Research Program
NCTRP	National Cooperative Transit Research and Development Program
NHTSA	National Highway Traffic Safety Administration
NTSB	National Transportation Safety Board
SAE	Society of Automotive Engineers
SAFETEA-LU	Safe, Accountable, Flexible, Efficient Transportation Equity Act: A Legacy for Users (2005)
TCRP	Transit Cooperative Research Program
TEA-21	Transportation Equity Act for the 21st Century (1998)
TRB	Transportation Research Board
TSA	Transportation Security Administration
U.S.DOT	United States Department of Transportation