



Joint International Light Rail Conference: A World of Applications and Opportunities

DETAILS

0 pages | | PAPERBACK

ISBN 978-0-309-43081-4 | DOI 10.17226/17610

BUY THIS BOOK

AUTHORS

Transportation Research Board

FIND RELATED TITLES

Visit the National Academies Press at NAP.edu and login or register to get:

- Access to free PDF downloads of thousands of scientific reports
- 10% off the price of print titles
- Email or social media notifications of new titles related to your interests
- Special offers and discounts



Distribution, posting, or copying of this PDF is strictly prohibited without written permission of the National Academies Press. (Request Permission) Unless otherwise indicated, all materials in this PDF are copyrighted by the National Academy of Sciences.

TRANSPORTATION RESEARCH
CIRCULAR

Number E-C112

January 2007

**Joint International
Light Rail Conference**

*A World of Applications
and Opportunities*

April 9–11, 2006
St. Louis, Missouri

Sponsored by
Transportation Research Board
American Public Transportation Association
International Union of Public Transport

TRANSPORTATION RESEARCH BOARD
OF THE NATIONAL ACADEMIES

TRANSPORTATION RESEARCH BOARD 2006 EXECUTIVE COMMITTEE OFFICERS

Chair: Michael D. Meyer, Professor, School of Civil and Environmental Engineering, Georgia Institute of Technology, Atlanta

Vice Chair: Linda S. Watson, Executive Director, LYNX–Central Florida Regional Transportation Authority, Orlando

Division Chair for NRC Oversight: C. Michael Walton, Ernest H. Cockrell Centennial Chair in Engineering, University of Texas, Austin

Executive Director: Robert E. Skinner, Jr., Transportation Research Board

TRANSPORTATION RESEARCH BOARD 2006 TECHNICAL ACTIVITIES COUNCIL

Chair: Neil J. Pedersen, State Highway Administrator, Maryland State Highway Administration, Baltimore

Technical Activities Director: Mark R. Norman, Transportation Research Board

Christopher P. L. Barkan, Associate Professor and Director, Railroad Engineering, University of Illinois at Urbana–Champaign, *Rail Group Chair*

Shelly R. Brown, Principal, Shelly Brown Associates, Seattle, Washington, *Legal Resources Group Chair*

Christina S. Casgar, Office of the Secretary of Transportation, Office of Intermodalism, Washington, D.C., *Freight Systems Group Chair*

James M. Crites, Executive Vice President, Operations, Dallas–Fort Worth International Airport, Texas, *Aviation Group Chair*

Arlene L. Dietz, C&A Dietz, LLC, Salem, Oregon, *Marine Group Chair*

Robert C. Johns, Director, Center for Transportation Studies, University of Minnesota, Minneapolis, *Policy and Organization Group Chair*

Patricia V. McLaughlin, Principal, Moore Iacofano Golstman, Inc., Pasadena, California, *Public Transportation Group Chair*

Marcy S. Schwartz, Senior Vice President, CH2M HILL, Portland, Oregon, *Planning and Environment Group Chair*

Leland D. Smithson, AASHTO SICOP Coordinator, Iowa Department of Transportation, Ames, *Operations and Maintenance Group Chair*

L. David Suits, Executive Director, North American Geosynthetics Society, Albany, New York, *Design and Construction Group Chair*

Barry M. Sweedler, Partner, Safety & Policy Analysis International, Lafayette, California, *System Users Group Chair*

TRANSPORTATION RESEARCH CIRCULAR E-C112

Joint International Light Rail Conference
A World of Applications and Opportunities

April 9–11, 2006
St. Louis, Missouri

Sponsored by
Transportation Research Board
American Public Transportation Association
International Union of Public Transport

January 2007

Transportation Research Board
500 Fifth Street, NW
Washington, DC 20001
www.TRB.org

TRANSPORTATION RESEARCH CIRCULAR E-C112

ISSN 0097-8515

The **Transportation Research Board** is a division of the National Research Council, which serves as an independent adviser to the federal government on scientific and technical questions of national importance. The National Research Council, jointly administered by the National Academy of Sciences, the National Academy of Engineering, and the Institute of Medicine, brings the resources of the entire scientific and technical communities to bear on national problems through its volunteer advisory committees.

The **Transportation Research Board** is distributing this Circular to make the information contained herein available for use by individual practitioners in state and local transportation agencies, researchers in academic institutions, and other members of the transportation research community. The information in this Circular was taken directly from the submission of the authors. This document is not a report of the National Research Council or of the National Academy of Sciences.

Public Transportation Group

Patricia V. McLaughlin, *Chair*

2006 Joint International Light Rail Conference Planning Committee

Paul O'Brien, *Chair*

Chair, APTA Light Rail Transit Technical Forum
Utah Transit Authority, Salt Lake City

John D. Wilkins, *Vice Chair*

Chair, TRB Light Rail Transit Committee
New Jersey Transit Corporation, Newark

Raymond Hue, *Vice Chair*

Chair, UITP Light Rail Assembly
Transport en Commun de l'Agglomération rouennaise, Rouen, France

John Aurelius, *Consultant*

Harvey L. Berliner, *Parsons Brinckerhoff*

Jack W. Boorse, *Parsons Brinckerhoff*

Thomas Carmichael, *Los Angeles County Metropolitan
Transportation Authority*

Richard F. Clarke, *Regional Transportation District (Denver)*

Leo Haring, *Haagse Tramwegmaatschappij (HTM), The Hague*

Frank Loetterle, *Metropolitan Council (Minneapolis)*

Jeffrey LaMora, *Utah Transit Authority*

Klaus-Dieter Lohrmann, *Stuttgarter Strassenbahn AG, (SSB)
(Stuttgart)*

Lynn Ritter Otte, *TranSystems, Inc.*

John W. Schumann, *LTK Engineering Services*

Winston M. Simmonds, *Port Authority of Allegheny County*

Gradimir Stefanovic, *Independent Consultant (London)*

Gregory L. Thompson, *Florida State University*

Johan van Ieperen, *International Association of Public Transport*

Vukan R. Vuchic, *University of Pennsylvania*

Peter L. Shaw, Transportation Research Board Representative

Brian Canepa, Editor, LRT Conference Proceedings

Martin P. Schroeder, American Public Transportation Association Representative

Laurent Dauby, International Association of Public Transport Representatives

Transportation Research Board

500 Fifth Street, NW

Washington, DC 20001

www.TRB.org

Jennifer M. Thompson, Mary McLaughlin, and Jennifer Correro, Proofreaders;
Jennifer Weeks and Jennifer Correro, Layout

Foreword

Light Rail Transit: A World of Applications and Opportunities is the first Joint International Light Rail Conference and the 10th in the Transportation Research Board (TRB) series starting in Philadelphia in June 1975. The American Public Transportation Association became a cosponsor in 1995 and the International Union of Public Transport joined TRB and APTA this year, thus the first Joint International Light Rail Conference.

In Philadelphia, the technical sessions focused on introducing—or reintroducing—the concept of light rail transit (LRT) in North America. At that time there were eight systems in operation. Now, 31 years later, there are 30 systems in North America, three “new starts” and seven projects in planning or design.

The focus and related topics of the previous nine national conferences have paralleled the development and reintroduction of LRT in North America:

- Introduction to LRT—1st National Conference, Philadelphia, Pennsylvania, 1975;
 - Light Rail Transit: Planning and Technology—2nd National Conference, Boston, Massachusetts, 1978;
 - Light Rail Transit: Planning, Design, and Implementation—3rd National Conference, San Diego, California, 1982;
 - Light Rail Transit: System Design for Cost-Effectiveness—4th National Conference, Pittsburgh, Pennsylvania, 1985;
 - Light Rail Transit: New System Successes at Affordable Prices—5th National Conference, San Jose, California, 1988;
 - Light Rail Transit: Planning, Design, and Operating Experience—6th National Conference, Calgary, Canada, 1992;
 - Building on Success, Learning from Experience—7th National Conference, Baltimore, Maryland, 1995;
 - Light Rail: Investment for the Future—8th National Conference, Dallas, Texas, 2000;
- and
- Light Rail: Experience, Economics, and Evolution: From Starter Lines to Growing Systems—9th National Conference, Portland, Oregon, 2003.

The technical information contained in the proceedings of these conferences (1–9) provides planners, designers, decision makers, and operators with a valuable collection of experiences and ingredients necessary for a successful transit development project.

The Joint International Light Rail Conference focuses on planning and urban integration, vehicle design and innovation, infrastructure use, security and fare enforcement, new infrastructure design, the case for contracting, LRT and bus rapid transit, regulations and standards, accessibility, streetcars, financing and controlling capital costs, operations, supervision, and service quality. A wealth of technical material is offered at the conference. There are 16 sessions; several technical tours of St. Louis-area transit construction, operations, and related development; and 26 papers presented at the conference and published in this compendium. The papers were peer reviewed by members of the TRB Light Rail Transit Committee and APTA Light Rail Transit Technical Forum in an anonymous online process.

The conference cosponsors—TRB, APTA, and UITP—wish to acknowledge special support from the Federal Transit Administration and the St. Louis Metro for providing invaluable assistance as the host organization.

The objective of each of these conferences is to add to the growing body of knowledge and real-world experiences with modern LRT applications in order to improve continually new systems being planned, as well as those already in operation.

Success can be fleeting, and we need to learn from past and current experience in order to do the best possible job of providing cost-effective public transportation services. The information, data, and research contained in this proceeding are meant to serve this need.

—Paul O'Brien, *Chair*
Chair, APTA Light Rail Transit Technical Forum
Rail Service General Manager, Utah Transit Authority,
Salt Lake City, Utah

—John D. Wilkins, *Vice Chair*
Chair, TRB Light Rail Transit Committee
Director, Capital Planning, New Jersey Transit Corporation
Newark, New Jersey

—Raymond Hue, *Vice Chair*
Chair, UITP Light Rail Assembly
President & Chief Executive Officer,
Transport en Commun de l'Agglomération rouennaise (TCAR)
Rouen, France

REFERENCES

1. *Special Report 161: Light Rail Transport*. TRB, National Research Council, Washington, D.C., 1975.
2. *Special Report 182: Light-Rail Transit: Planning and Technology*. TRB, National Research Council, Washington, D.C., 1978.
3. *Special Report 195: Light Rail Transit: Planning, Design, and Implementation*. TRB, National Research Council, Washington, D.C., 1982.
4. *State-of-the-Art Report 2: Light Rail Transit: System Design for Cost-Effectiveness*. TRB, National Research Council, Washington, D.C., 1985.
5. *Special Report 221: Light Rail Transit: New System Successes at Affordable Prices*. TRB, National Research Council, Washington, D.C., 1989.
6. *Transportation Research Record 1361: Light Rail Transit: Planning, Design, and Operating Experience*. TRB, National Research Council, Washington, D.C., 1992.
7. *Conference Proceedings 8: Seventh National Conference on Light Rail Transit*, Vols. 1 and 2, TRB, National Research Council, Washington, D.C., 1995.
8. *Light Rail: Investment for the Future: Eighth National Conference on Light Rail Transit* (CD-ROM). TRB, National Research Council, Washington, D.C., 2000.
9. *Transportation Research Circular E-C058: 9th National Light Rail Transit Conference*. TRB, National Research Council, Washington, D.C., 2003. (http://trb.org/news/blurb_detail.asp?id=2283)

Contents

OPENING GENERAL SESSION

Status of North American Light Rail Transit Systems: Year 2006 Update*	3
<i>John W. Schumann</i>	

LIGHT RAIL VEHICLE DESIGN AND INNOVATION

Development of the European LRV Market	21
<i>Nils Jänig and Steffen Plogstert</i>	
North American LRV and Streetcar Procurements Since We Last Met	38
<i>Thomas B. Furmaniak</i>	
Center Truck Performance on Low-Floor Light Rail Vehicles*	59
<i>Trevor Griffin</i>	
Incident-Friendly and Secure Light Rail Vehicle Design*	71
<i>John D. Swanson</i>	

PLANNING AND URBAN INTEGRATION

Innovative Traffic Control Practices for Light Rail Transit: A European Perspective*	87
<i>José Ignacio Farrán</i>	
LRT Integration in Traffic Patterns and City Fabric	107
<i>Georg Drechsler</i>	
A Report on the Status of Planning for MetroLink Expansion in the St. Louis Region* ...	130
<i>Donna L. Day</i>	

GENERAL SESSION

The State of Transit Advocacy	143
<i>Thomas R. Shrout</i>	

INNOVATION IN INFRASTRUCTURE USE

Track Sharing in the Kassel Region	153
<i>Ranier Meyfahrt</i>	
Feasibility of Combined Rail–Road Transport System in the Netherlands*	164
<i>Francis Cheung</i>	

Shortline Railroads and Rail Transit: Joint Development Planning Issues*176
Lewis T. Ames and Joseph R. Walsh

Provision of Expedited Rail Transit Service*194
Alfred E. Fazio

SECURITY AND FARE ENFORCEMENT

Cybersecurity: Not Just IT’s Business217
Susan Howard

Fare Evasion in Light Rail Systems230
Laurent Dauby and Zoltan Kovacs

Hiawatha Light Rail: Minneapolis, Minnesota*248
Jack Nelson

**Self-Service, Barrier-Free Fare Collection:
A Quarter Century of North American Experience**266
Thomas F. Larwin

DESIGN OF NEW INFRASTRUCTURE

**Using Climate Response in Designing Fixed Guideway Stations and
Bus Passenger Shelters: An Application in Phoenix, Arizona***279
Jeffrey Q. Jarvis

Regional Transportation District Light Rail Central Corridor Capacity Analysis*295
Eric Carl Miller

A Review of Track Design in Germany311
Wolfgang Predl

Construction of the Newark City Subway Broad Street Extension*330
Harvey L. Berliner, Anthony M. Fleres, and Kurt E. Kauffman

OPEN AND CLOSED MARKET: THE CASE FOR CONTRACTING

Contracting and Tendering Practice: The Case of Stockholm.....345
Gunnar Schön

Open and Closed Markets: NJT Light Rail Contracts.....357
Joseph North

Contract and Tendering Practice: The Case of Nottingham368
François-Xavier Perin

REGULATIONS AND STANDARDS

Regulations and Standards: A Double-Edged Sword	379
<i>Paul K. Stangas</i>	
Crashworthiness Standards for the U.S. Light Rail Environment*	403
<i>Steven Kirkpatrick and Martin P. Schroeder</i>	
The German Regulatory System	419
<i>Adolf Müller-Hellmann</i>	
UNIFE: European Technical Standards	434
<i>Bernard von Wüllerstorff</i>	

LIGHT RAIL TRANSIT AND BUS RAPID TRANSIT

A Comparative Discussion of the Light Rail Transit Mode and the Bus Rapid Transit Initiative*	447
<i>Jack W. Boorse</i>	
Comparative Performance of Public Transport in U.S. New Start Rail Cities Versus Bus-Only Cities*	457
<i>Lyndon Henry</i>	
Bus Rapid Transit: An Option Worth Considering—Lessons from TransMilenio	479
<i>Arturo Ardila</i>	
TEOR: The Rouen Case	490
<i>Werner Kutil</i>	
BRT System in Seoul	498
<i>Sun Gu Jeong</i>	

ACCESSIBILITY

The LibeRTiN Recommendations	513
<i>Johan Van Ieperen</i>	
Fare, Ticketing, and Information Systems in Singapore	524
<i>Boon Leng Goh</i>	
Creating Accessibility Without Low-Floor Technology*	533
<i>Jeff LaMora</i>	
Trends in Light Rail Accessibility	543
<i>Thomas G. Matoff</i>	

STREETCARS

Applying the Versatility of Streetcar Technology to North American Urban Transit*	561
<i>Lyndon Henry</i>	
Evaluation of Multiple-Unit Streetcar Operation in Toronto, Canada*	579
<i>Amer Shalaby, Kenny Ling, and Jim Sinikas</i>	
Streetcar Modernization in CEEC	595
<i>Michal Pospisil</i>	
Fitting the Streetcar into a Built Urban Environment	608
<i>James H. Graebner</i>	

MEET-THE-AUTHORS POSTER SESSION

How Much Do We Really Know? Evaluation of Past and Current Research Regarding the Costs and Benefits of the Hiawatha Light Rail Line*	619
<i>Gavin Poindexter and John O’Connell</i>	
Safety of Noncompliant Passenger Rail Equipment*	635
<i>Alan J. Bing, Thomas Tsai, David Nelson, and Ronald A. Mayville</i>	
Surface Rail Service and Surface Transit Ridership: A Statistical Inquiry	650
<i>Carl L. Natvig</i>	
Implementing a Winning Approach to Good Facility Design*	659
<i>Jon Claude Holler and Richard G. Shiffer</i>	
Analysis of St. Louis MetroLink Performance	670
<i>Edson L. Tennyson</i>	
MetroLink Light Rail System	686
<i>Chris Rimsky and Mike Pierce</i>	

FINANCING AND CONTROLLING CAPITAL COSTS

Getting to Ground Breaking: Top 10 Challenges in Federally Funded Transit Projects	691
<i>Gretchen J. Von Grossmann and Wendy Riggs-Smith</i>	
How to Raise Your Investment Money	699
<i>James Quinlan</i>	
Funding Engineering	717
<i>Ramon Escales</i>	
Calgary’s CTrain: Effective Capital Utilization*	724
<i>Neil McKendrick, Dave Colquhoun, Bob Charles, and John Hubbell</i>	

OPERATIONS, SUPERVISION, AND SERVICE QUALITY

Service Planning on Hudson–Bergen Light Rail: The Systems Engineering Basis*	741
<i>Alfred E. Fazio</i>	
A Wide Array of Operation Models: From On-Sight to Full Driverless	756
<i>G�rard Gabriel</i>	
Light Rail Transit in Calgary: The First 25 Years*	771
<i>John Hubbell and Dave Colquhoun</i>	

APPENDIXES

A. Transportation Research Board 2007 Executive Committee	789
B. American Public Transportation Association Board of Directors	791
C. International Union of Public Transport Executive Board	793
D. Final Program	794
E. Transportation Research Information Service	795
F. Research in Progress	828
Research Links	837
G. Future Meetings	838
H. Program Cover	839

* Paper peer-reviewed by TRB.

Opening General Session

OPENING GENERAL SESSION

Status of North American Light Rail Transit Systems
Year 2006 Update

JOHN W. SCHUMANN
LTK Engineering Services

This paper reports on changes and additions to light rail transit (LRT) and streetcar systems in the United States and Canada that have occurred since the last National Light Rail Conference was held in 2003. There were two completely new LRT start-ups during this period, Houston, Texas, and Minneapolis, Minnesota, as well as a new streetcar line in Little Rock, Arkansas, all in 2004. In addition, several cities extended existing lines: Jersey City, New Jersey; Denver, Colorado; Salt Lake City, Utah; Los Angeles; San José, and Sacramento, California; Portland, Oregon; and Calgary and Edmonton, Canada. These developments are discussed in the text and reflected in the accompanying data tables. The paper also provides an overview of ongoing work to further extend several of the existing LRT systems in North America, and progress on still more new starts. In the latter category, Phoenix, Arizona; Seattle, Oregon; and Charlotte, North Carolina, are under construction, the LRT projects in Norfolk, Virginia, are advancing through design, and the Oceanside–Escondido light diesel multiple unit (DMU) line is under construction in California. In summary, interest in and implementation of LRT, streetcar, and light DMU projects continue.

INTRODUCTION

After World War II, there was a divergence of opinion among the world's cities regarding the future of streetcars. In some, policy and economics combined to support their preservation and, in most cases, gradual upgrading and modernization to what we now call light rail standards. In others, notably Britain, France, and the United States, streetcar abandonment that had begun earlier accelerated as most places chose "bustitution" over modernization.

In 1917, nearly 45,000 mi (72,400 km) of streetcar and interurban lines were laced across the United States. By 1977, when the first edition of this paper was prepared, that figure had declined to eight cities operating little more than 300 mi (480 km) of lines, of which perhaps 125 mi (200 km) could be called light rail transit (LRT). Since then, there has been a rebirth of interest and activity, with 570 mi (924 km) of such services operating now in 22 U.S. cities plus three each in Canada and Mexico. More are under construction, being designed, or planned. This paper reports on the progress of North American LRT projects since the last Transportation Research Board (TRB)–APTA Conference on Light Rail Transit was held in 2003.

NEW STARTS AND EXTENSIONS SINCE 2003

There were two completely new LRT start-ups during this period, Houston and Minneapolis, as well as the new streetcar line in Little Rock, all in 2004. In addition, several cities completed or were constructing extensions to existing systems. Since this conference is in St. Louis, the listing of cities with operating LRT systems will begin in mid-America, work out to the Pacific Coast, then east across Canada, back to the eastern United States, and end with the several streetcar systems in the Deep South. Descriptive data for the LRT systems are provided in [Tables 1](#) through [6](#).

TABLE 1 Line Lengths, Car Fleets, and Productivity Indicators

City/System		One-Way Line		Fleet	Cars per		Weekday	Service Productivity, Psgrs per		
		km	miles	Cars	km	mi	Rides	Line km	Line Mile	Car
							(000s)			
Baltimore, Central Corridor	d	47.0	29.0	53	1.1	1.8	24.7	525	852	466
Boston, Green Line & Mattapan	b	41.5	25.6	222	5.3	8.7	237.4	5719	9273	1069
Buffalo, MetroRail	a	10.4	6.4	27	2.6	4.2	22.6	2178	3531	837
Cleveland, Blue/Green	b	25.0	15.4	48	1.9	3.1	15.1	605	981	315
Dallas, DART LRT	d	73.0	45.0	95	1.3	2.1	59.1	810	1313	622
Denver, RTD LRT	d	25.3	15.6	49	1.9	3.1	40.0	1581	2564	816
Houston, MTA	d	12.2	7.5	18	1.5	2.4	32.8	2697	4373	1822
Jersey City & Newark, NJ Transit	e	24.0	14.8	73	3.0	4.9	41.9	1746	2831	574
Los Angeles, Blue/Green/Gold	d	90.3	55.7	121	1.3	2.2	113.3	1255	2034	936
Minneapolis, Metro Transit	d	19.5	12.0	24	1.2	2.0	30.0	1542	2500	1250
New Orleans, Streetcars	b	14.1	8.7	66	4.7	7.6	14.1	1000	1621	214
Philadelphia, City & Suburban	b	68.9	42.5	159	2.3	3.7	100.0	1451	2353	629
Pittsburgh, South Hills	b	38.6	23.8	83	2.2	3.5	26.0	674	1092	313
Portland, MAX	a	71.3	44.0	105	1.5	2.4	97.0	1360	2205	924
Portland, Streetcar	d	4.9	3.0	7	1.4	2.3	7.8	1604	2600	1114
Sacramento, RT LRT	a	60.2	37.1	76	1.3	2.0	60.0	997	1617	789
St. Louis, MetroLink	d	60.8	37.5	83	1.4	2.2	46.0	757	1227	554
Salt Lake City, UTA LRT	d	30.8	19.0	40	1.3	2.1	52.0	1688	2737	1300
San Diego Trolley	a	85.1	52.5	134	1.6	2.6	100.0	1175	1905	746
San Francisco, Muni	c	49.8	30.7	175	3.5	5.7	164.2	3299	5349	938
San Jose, VTA LRT	a	68.4	42.2	100	1.5	2.4	23.0	336	545	230
Seattle/Tacoma	d	2.6	1.6	3	1.2	1.9	3.0	1156	1875	1000
Total U.S.		923.5	569.6	1761	1.9	3.1	1310.0	1418	2300	744
Calgary, C-Train	a	44.6	27.5	115	2.6	4.2	220.0	4934	8000	1913
Edmonton, LRT	a	13.1	8.1	37	2.8	4.6	42.0	3198	5185	1135
Toronto, Streetcars	b	79.3	48.9	248	3.1	5.1	307.1	3873	6280	1238
Total Canada		137.0	84.5	400	2.9	4.7	569.1	4154	6735	1423
a - New start since 1977. b - Major reconstruction/rehabilitation since 1977. c - Upgraded from streetcar to LRT standards since 1977. d - New start since 1990. e - Jersey City-d, Newark-b.										

TABLE 2 Key Descriptive Statistics

City/System	Reserved	Av Stop Spacing		Double Track	Through Service	Number of Cars		Approx. System Average Speed	
	R/W	km	mi	%	Routes	4-Axle	6-Axle	km/h	mph
Baltimore, Central Corridor	100%	1.6	1.0	61%	2	0	53	35	22
Boston, Green Line & Mattapan	97%	0.5	0.3	100%	5	11	211	22	14
Buffalo, MetroRail	100%	0.8	0.5	100%	1	27	0	20	12
Cleveland, Blue/Green	100%	0.8	0.5	100%	2	0	48	30	19
Dallas, DART LRT-a	100%	2.1	1.3	100%	2	0	95	34	21
Denver, RTD LRT	100%	1.3	0.8	98%	2	0	31	23	14
Houston, MTA	100%	0.8	0.5	100%	1	0	18	23	14
Jersey City & Newark, NJ Transit	100%	1.0	0.6	100%	3	0	45	28	17
Los Angeles, Blue/Green/Gold	100%	1.8	1.1	100%	3	0	121	34	21
Minneapolis, Metro Transit	100%	1.3	0.8	100%	1	0	24	32	20
New Orleans, Streetcars	91%	0.3	0.2	100%	2	41	0	15	9
Philadelphia, City & Suburban	33%	0.3	0.2	91%	7	141	0	18/26	11/16
Pittsburgh, South Hills	63%	0.5	0.3	91%	4	0	55	26	16
Portland, MAX	100%	1.1	0.7	99%	2	0	78	30	19
Portland, Streetcar	0%	0.3	0.2	100%	1	7	0	16	10
Sacramento, RT LRT	92%	1.1	0.7	77%	2	0	56	34	21
St. Louis, MetroLink	100%	1.4	0.9	97%	1	0	65	43	27
Salt Lake City, UTA LRT	100%	1.4	0.9	99%	2	0	33	40	25
San Diego Trolley	100%	1.4	0.9	99%	2	0	123	30	19
San Francisco, Muni	59%	0.2	0.1	100%	6	39	136	18	11
San Jose, VTA LRT	100%	1.1	0.7	96%	3	0	50	32	20
Seattle/Tacoma	100%	0.6	0.4	~50%	1	3	0	20	12
Total U.S.	--				55	269	1242		
Calgary, C-Train	100%	1.0	0.6	100%	2	0	99	29	18
Edmonton, LRT	100%	1.3	0.8	100%	1	0	37	30	19
Toronto, Streetcars	11%	0.2	0.1	100%	10	196	52	15	9
Total Canada	--				13	196	188		
Total U.S. & Canada					68	465	1430		
a-one LRV expanded in 2003 to 8-axle double articulated w/low floor middle car.									

TABLE 3 Right-of-Way Locations

City/System	km of line by category*				miles of line by category*				% A or B
	A	B	C	Total	A	B	C	Total	
Baltimore, Central Corridor	0.5	46.2	--	46.7	0.3	28.7	--	29.0	100%
Boston, Green Line & Mattapan	28.6	11.4	1.1	41.1	17.8	7.1	0.7	25.6	97%
Buffalo, MetroRail	8.4	1.9	--	10.3	5.2	1.2	--	6.4	100%
Cleveland, Blue/Green	11.3	13.5	--	24.8	7.0	8.4	--	15.4	100%
Dallas, DART LRT	8.5	63.9	--	72.4	5.3	39.7	--	45.0	100%
Denver, RTD LRT	14.0	11.1	--	25.1	8.7	6.9	--	15.6	100%
Houston, MTA	--	12.1	--	12.1	--	7.5	--	7.5	100%
Jersey City & Newark, NJ Transit	6.9	16.9	--	23.8	4.3	10.5	--	14.8	100%
Los Angeles, Blue/Green/Gold	36.7	52.9	--	89.6	22.8	32.9	--	55.7	100%
Minneapolis, Metro Transit	5.6	13.6	--	19.2	3.5	8.5	--	12.0	100%
New Orleans, Streetcars	--	12.7	1.3	14.0	--	7.9	0.8	8.7	91%
Philadelphia, City & Suburban	4.0	18.5	45.8	68.3	2.5	11.5	28.5	42.5	33%
Pittsburgh, South Hills	3.4	20.9	14.0	38.3	2.1	13.0	8.7	23.8	63%
Portland, MAX	24.5	46.2	0.1	70.8	15.2	28.7	0.1	44.0	100%
Portland, Streetcar	--	--	4.8	4.8	--	--	3.0	3.0	0%
Sacramento, RT LRT	9.5	45.3	4.8	59.6	5.9	28.2	3.0	37.1	92%
St. Louis, MetroLink	15.6	44.8	--	60.4	9.7	27.8	--	37.5	100%
Salt Lake City, UTA LRT	--	30.5	--	30.5	--	19.0	--	19.0	100%
San Diego Trolley	17.2	67.2	--	84.4	10.7	41.8	--	52.5	100%
San Francisco, Muni	10.8	18.1	20.4	49.3	6.7	11.3	12.7	30.7	59%
San Jose, VTA LRT	15.8	52.1	--	67.9	9.8	32.4	--	42.2	100%
Seattle/Tacoma	--	2.6	--	2.6	--	1.6	--	1.6	100%
Total U.S.	221.3	602.4	92.3	916.0	137.5	374.6	57.5	569.6	90%
Calgary, C-Train	3.2	41.1	--	44.3	2.0	25.5	--	27.5	100%
Edmonton, LRT	5.2	7.9	--	13.1	3.2	4.9	--	8.1	100%
Toronto, Streetcars	1.3	7.2	70.2	78.7	0.8	4.5	43.6	48.9	11%
Total Canada	9.7	56.2	70.2	136.1	6.0	34.9	43.6	84.5	48%
Total U.S. & Canada	231.0	658.6	162.5	1052.1	143.5	409.5	101.1	654.1	85%
R/W categories: A: fully controlled; B: at grade with crossings, but separated from parallel traffic; C: mixed traffic.									
(Source: Vuchic)									

TABLE 4 Stations, Double Tracking, Electrification, and Signaling

City/System	Passenger Stations & Car Stops	Double Track		Traction Power (vDC)	Substations		Type of Overhead	Signals	
		km	mi		No.	Rating (mW)		Block	Traffic
Baltimore, Central Corridor	28	28.6	17.8	750	14+	1.0	Catenary	91%	9%
Boston, Green Line & Mattapan	~83	44.4	27.6	600	12	3-6	Trolley	62%	38%
Buffalo, MetroRail	14	10.3	6.4	650	5	2.0	Catenary	81%	19%
Cleveland, Blue/Green	33	21.1	13.1	600	6+	?	Catenary	84%	46%
Dallas, DART LRT	34	32.2	20.0	750	?	?	Catenary	~80%	~20%
Denver, RTD LRT	17	22.0	13.7	750	7	1.0	Both	60%	40%
Houston, MTA	16	12.2	7.5	750	?	?	Both	[b]	100%
Jersey City & Newark, NJ Transit	29	23.8	14.8	750	4+	?	Both	?	?
Los Angeles, Blue/Green/Gold	36	66.3	41.2	750	21	1.5-3.0	Both	86%	14%
Minneapolis, Metro Transit	17	19.5	12.0	750	15	1.5 [a]	Both	?	?
New Orleans, Streetcars	55	14.0	8.7	600	?	?	Trolley	0%	100%
Philadelphia, City & Suburban	217	49.6	30.8	600/635	4+	?	Trolley	25%	75%
Pittsburgh, South Hills	59	27.4	17.0	640	6	6.0	Both	90%	10%
Portland, MAX	46	52.5	32.6	750	34	0.8	Both	52%	48%
Portland, Streetcar	24	8.1	5.0	750	5	0.3	Trolley	0%	100%
Sacramento, RT LRT	30	25.4	15.8	750	15	1.0	Both	77%	23%
St. Louis, MetroLink	18	26.5	16.5	750	12	1.5	Catenary	100%	0%
Salt Lake City, UTA LRT	16	24.4	15.2	750	20	1.5	Both	77%	13%
San Diego Trolley	48	72.0	44.7	600	33	1.0	Both	92%	8%
San Francisco, Muni	~215	35.6	22.1	600	12	2-8	Trolley	19%	81%
San Jose, VTA LRT	41	43.1	26.8	750	15+	1.5	Both	58%	42%
Seattle/Tacoma	5	0.8	0.5	750	2	?	Catenary	?	100%
Total U.S.	1053	659.7	409.8	--	--	--	--	--	--
Calgary, C-Train	31	29.3	18.2	600	17	2.0	Both	92%	8%
Edmonton, LRT	10	12.3	7.6	600	8	2.0	Catenary	100%	0%
Toronto, Streetcars	~625	75.5	46.9	600	?	?	Trolley	0%	100%
Total Canada	666	117.1	72.8	--	--	--	--	--	--
Totals - U.S. & Canada	1719	776.8	482.6	--	--	--	--	--	--

[a] 1 @ 2.5 mW at O&M facility. [b] Terminal interlockings and one midline where limited vision only.

TABLE 5 Revenue Service Vehicles

City/System	Car Types ¹	Builders	Fleet No.	Characteristics of Most Common Vehicle											
				Accel		Vmax		Length		Weight		Train # cars	Capacity	ATS	
				m/s/s	mph/s	km/h	mph	m	ft	tonnes	tons				
Baltimore, Central Corridor	LRV-6-ADac	ABB/Adtranz	53	1.3	3.0	88	55	29	95	50	55	3	84/174	No	
Boston, Green Line & Mattapan	LRV-6-ADac	Boeing, Kinki, Breda ²	222	1.3	3.0	80	50	22	72	38	42	3	50/130	No	
Buffalo, MetroRail	LRV-4-RDac	Tokyu	27	1.3	3.0	80	50	20	67	17	19	3	51/121	Yes	
Cleveland, Blue/Green	LRV-6-ADac	Breda	48	1.3	3.0	88	55	24	80	40	45	2	80/144	Part	
Dallas, DART LRT	LRV-6-ADac	Kinki Sharyo	95	1.3	3.0	105	65	28	93	50	55	3	76/160	?	
Denver, RTD LRT	LRV-6-ADac	Siemens	49	1.3	3.0	88	55	24	80	37	41	3	64/144	No	
Houston, MTA	LRV-6-ADac	Siemens	18	1.3	3.0	106	66	29	96	44	48	18	72/170	?	
Jersey City & Newark, NJ Transit	LRV-6-ADac	Kinki Sharyo	73	1.3	3.0	80	50	27	90	45	49	2	68/160	?	
Los Angeles, Blue/Green/Gold	LRV-6-ADac	Siemens, Nippon Sharyo	121	1.3	3.0	88	55	27	89	43	47	3	76/160	Yes	
Minneapolis, Metro Transit	LRV-6-ADac	Bombardier	24	1.3	3.0	88	55	29	94	48	52	3	66/186	No	
New Orleans, Streetcars	VTL-4-RD	Perley Thos, NORTA	66	0.8	1.7	43	27	14	48	19	21	1	52/68	No	
Philadelphia, City & Suburban	LRV-4-RS/Dac	Kawasaki ⁴	159	1.3	3.0	80	50	15/16	50/53	27	30	1	50/95	No	
Pittsburgh, South Hills	LRV-6-ADac	Siemens & CAF	83	1.3	3.0	80	50	26	84	36	40	2	62/150	Yes	
Portland, MAX	LRV-6-ADac	Siemens & Bombardier	105	1.3	3.0	88	55	27/28	89/92	42/50	46/55	2	64-76/170	Yes	
Portland, Streetcar	LRV-4-ADac	Inekon-Skoda	7	1.5	3.4	70	43	20	66	29	32	1	30/90	No	
Sacramento, RT LRT	LRV-6-ADac	Siemens + CAF ³	76	1.1	2.5	80	50	24	80	36	40	4	60/144	No	
St. Louis, MetroLink	LRV-6-ADac	Siemens	83	1.3	3.0	88	55	26	86	41	45	2	72/155	Yes-Cab	
Salt Lake City, UTA LRT	LRV-6-ADac	Siemens ³	40	1.3	3.0	88	55	24	80	37	41	4	64/144	No	
San Diego Trolley	LRV-6-ADac	Siemens	134	1.3	3.0	88	55	24	80	37	41	4	64/144	No	
San Francisco, Muni	LRV-6-ADac	Breda	175	1.3	3.0	84	52	23	75	30	33	3	60/130	Part-Cab	
San Jose, VTA LRT	LRV-6-ADac	Kinki Sharyo ³	100	1.3	3.0	88	55	27/28	89/92	45	49	2	75/160	No	
Seattle/Tacoma	LRV-4-ADac	Inekon-Skoda	3	1.5	3.4	70	43	20	66	29	32	1	30/90	?	
Total U.S.			1761												
Calgary, C-Train	LRV-6-AD	Siemens	115	1.0	2.2	80	50	24	80	32	35	3	64/162	Yes	
Edmonton, LRT	LRV-6-AD	Siemens	37	1.0	2.2	80	50	24	80	40	45	5	64/162	Yes	
Toronto, Streetcars	LRV-4/6-R/AS	UTDC	248	1.3	3.0	85	53	16/23	53/75	23/37	26/40	1	46/95	No	
Total Canada			400												
Totals - U.S. & Canada			2161												
1-LRV=light rail vehicle, VTL=vintag trolley, #=no. of axles, A/R=articulated or rigid, D/S=double or single ended & sided, ac=air conditioned. 2-Boston total includes 11 PCC															
3-50 UTDC LRV-6-ADac sold by San Jose, VTA to Sacramento, RT (21) and Salt Lake City, UTA (29), but are not yet in regular service.															
4-Philadelphia total includes 18 remanufactured PCC cars.															

TABLE 6 Changes in North American LRT and Streetcar Systems, 2001–2003

City/System	Code*	Changes
UNITED STATES:		
Baltimore, Central Corridor	R	Double tracking in progress - 9.4 mi
Boston, Green Line & Mattapan	RV	Introducing Type 8 LFLRVs
Buffalo, MetroRail	--	--
Cleveland, Blue/Green	--	--
Dallas, DART LRT	XV	Designing 40+ mi NW, West & SE extensions; adding 20 LRVs and plans to "stretch" existing fleet with low floor middle section
Denver, RTD LRT	XV	Opening 19 mi TREX (southeast) in 2006 & adding 34 LRVs; planning/designing FasTracks extensions in several corridors
Houston, MTA	N	Opened 7.5 mi Central LRT line in Jan 2004
Jersey City & Newark, NJ Transit	X	Opened Hoboken extension 2002; under construction: 6.1 Mi Tonelle Av extension (HBLRT) & 1.1 mi NERL (Newark)
Los Angeles, Blue/Green/Gold	XV	Opened 13.7 mi Pasadena Gold Line mid-2003 w/26 Siemens LRVs; building 6 mi East LA Gold Line; adding 50 LRVs; designing Expo Line.
Minneapolis, Metro Transit	N	Opened 12.0 mi Hiawatha line in two stages, Jun and Dec 2004
New Orleans, Streetcars	XV	Opened 4.1 mi Canal line in 2003; added 24 replica streetcars built in house
Philadelphia, City & Suburban	R	Opened restored 8.2 mi Girard Ave line in 2005 w/15 remanufactured PCC cars
Pittsburgh, South Hills	RV	Completed 5.5 mi Stage 2 reconstruction in 2004; purchasing 28 New CAF LRVs; building North Shore Connector for 2007 opening
Portland, MAX	XV	Opened 5.8 mi Interstate MAX in 2004; purchasing 27 Siemens LFLRVs & building 8.3 mi I-205/Portland Mall MAX for 2009 opening
Portland, Streetcar	NX	Opened 0.6 mi Waterfront extension 2005; opening 0.6 mi South Waterfront extension 2006; buying 3 more streetcars
Sacramento, RT LRT	XV	Opened 6.3 mi South line fall 2003; 10.9 mi Folsom extension in stages in 2004-05-06; purchased 40 new CAF LRVs, 21 used VTA LRVs
St Louis, MetroLink	XV	Opened 20.5 mi East extension in two phases 2001 and 2003; added 9 Siemens LRVs; building 8 mi Cross County line
Salt Lake City, UTA LRT	XV	Opened University line in 2001 (2.5 mi) and 2005 (1.5 mi); added 3 new Siemens LRVs + 29 used UTDC LRVs from VTA
San Diego Trolley	XV	Opened 5.8 mi Mission Valley East extension in 2005; purchased 11 Siemens LFLRVs; planning/designing Mid-Coast Corridor extension
San Francisco, Muni	XV	Building 5.4 mi Bayshore Line (3rd St) for 2006 opening
San Jose, VTA LRT	XV	Opened 6.4 mi Tasman East/Capitol & 5.3 mi Vasona extensions; purchased 70 Kinki Sharyo LFLRVs (replace 50 UTDC cars & expand fleet)
Seattle/Tacoma	N	Building 14 mi Seattle Central Link LRT for 2009 opening
CANADA:		
Calgary, C-Train	XV	Extending all lines: NW 1.9 mi (2003), South 1.9 mi (2004), 1.3 mi NE (2005-6); purchasing 26 Siemens LRVs
Edmonton, LRT	X	5 mi South extension to Heritage Mall in design for 2005 opening; purchasing 26 Siemens LRVs
Toronto, Streetcars	--	--
NEW STARTS UNDER CONSTRUCTION: Houston (Jan 2004); Minneapolis (spring 2004)		
* N = New Start; R = Renovation/Reconstruction; V = Vehicle Procurement; X = Extension.		

St. Louis

Since opening its original line from East St. Louis to Lambert International Airport (1993, 17 miles), the system has more than doubled in length with the phased opening of the line out into the Illinois suburbs (2001–2003, 20.5 mi). Presently, a third branch—the 8-mi Cross-County extension—is nearing completion and is expected to open during 2006. It includes a 1.3-mi tunnel. Most of this remarkable system effectively reuses surplus railroad lines, even including the historic Eads Bridge over the Mississippi River and the tunnel under downtown St. Louis, perfectly located to serve today's central business district (CBD). With no trackage in streets, even in reserved lanes, LRT in St. Louis really could stand for Light Rapid Transit; it is a very high-quality alignment.

Minneapolis: New Start

The 12-mi Hiawatha line is the newest of U.S. new-start LRT systems. Opened in two segments in 2004, it connects downtown Minneapolis with the Minneapolis–St. Paul International Airport and the Mall of America in Bloomington. With only 24 cars, the line is carrying 25,000–30,000 rides per day, depending on the scheduling of sporting events, and already has exceeded the daily ridership forecast for 2020 by about 25%. Several extensions are in various stages of planning. Most advanced is the Central Line, which would connect the Minneapolis and St. Paul downtowns by way of the University of Minnesota and the busy University Avenue corridor.

Houston: New Start

Despite sustained efforts by anti-rail political forces, the MTA of Harris County managed to locally fund and build the 7.5-mi Main Street LRT line, which opened at the start of 2004. This urban corridor links downtown Houston with the Texas Medical Center and various other intermediate educational and cultural institutions, terminating at the Astroworld complex. Its 18 LRVs carry in excess of 32,000 weekday passenger trips, a very strong showing for a relatively short line. LRT is planned for five other corridors; but on four, financial and political pressures appear likely to require introduction of enhanced transit in the form of BRT lines that can be converted to LRT later.

Dallas

LRT in the Dallas portion of the Metroplex is thriving. The 20-mi Y-shaped system opened in 1996 was more than doubled in length—to 44 mi—and became a two-route elongated “X” in 2002. Now, design is well advanced for a third line that will connect southeastern Dallas through downtown to the Medical Center and northwest suburbs out to Carrollton. DART is buying 20 additional LRVs for this service. To improve accessibility and increase fleet carrying capacity system-wide, a program has begun to stretch all the cars into double-articulated vehicles with a low-floor middle section.

Denver

Planning for Denver area rail transit began in the 1970s; but it was not until 1994 that the Regional Transit District's first 5.5-mi LRT line was opened. An immediate success with riders, it set technology and helped build community consensus for its extension 8.5 mi southwest to Littleton. This longer line's effectiveness and the popularity of the short 1.6-mi Central Platte Valley branch in 2002 led to inclusion of 19 more LRT miles as part of the T-REX project to rebuild I-25 and I-225 in the southeast. This latest mileage will open for service in 2006. As T-REX construction was progressing, the region's voters approved a referendum in November 2004 that will provide local funds for another 100+ mi of rail transit, a combination of LRT and commuter rail in several more of the Denver area's radial corridors, as well as along circumferential I-225. These additional lines are to be complete within a decade, making Denver's program one of the country's most aggressive timetables for completing a multiline regional network.

Salt Lake City

This region's first 15-mi LRT line opened in 1999 to link Salt Lake City and its southern suburb of Sandy. Almost immediately, the Utah Transit Authority (UTA) secured funds and agreements to build a 4-mi branch from downtown Salt Lake City east to and through the University of Utah campus. This well-placed line now carries 25% of the university's student-faculty-administrative staff every day, relieving parking demand on campus. Plans are advancing for a Mid-Jordan extension to southwestern suburbs. To accommodate this new line as well as growing demand on the present system, UTA purchased 29 surplus LRVs from Santa Clara County to increase its total fleet to 62.

San Diego

The new age of LRT in the United States began in 1981, when San Diego opened its 15.9-mi South Line to the Mexican border at San Ysidro. Like the later initial line in Salt Lake City, the San Diego Trolley coupled about 2 mi of reserved track in downtown streets with a high-quality railroad alignment for the remainder of the line. San Diego's second line to El Cajon (1989) and the third line north to Old Town also followed railroad rights-of-way (ROWs). This and other shorter extensions grew the system to 40.5 mi by 1996. East of Old Town, the 6.1-mi Mission Valley West line (1997) required acquisition of new ROW, but brought service to the Qualcomm Stadium and a number of transit-friendly communities such as the Hazard Center. In 2004, the Mission Valley East extension opened, adding another 5.9 mi parallel to a freeway, and including a 4,000-ft tunnel, the system's first, to reach the campus of San Diego State University. Planning and design are in progress for phased development of the 10.7-mi Mid-Coast Corridor line north from Old Town to the University of California at San Diego and University City. Finally, under construction is the 22-mi *Sprinter* light diesel multiple unit (DMU) project that will link Oceanside and Escondido in northern San Diego County starting in late 2007.

Los Angeles

The City of Angels now has the largest one-way line mileage of LRT in any U.S. or Canadian city (Table 1) and more weekday riders than all except Toronto, Boston, Calgary, and San Francisco. The three operating lines are Blue to Long Beach (1990, 22 mi), Green from Norwalk to El Segundo (1995, 20 mi), and Gold to Pasadena (2003, 13.7 mi). Construction is in progress for a 6-mi East Los Angeles extension of the latter, to open in 2009. At the same time, design is progressing for the Expo Line, a 9.5-mi corridor to the west that is intended to eventually reach Santa Monica, and for an eastward extension of the Gold Line from Pasadena to Pomona. In addition, cities such as Glendale and Burbank are starting to evaluate the feasibility of streetcar lines as complements to the region's growing LRT, commuter rail, and heavy rail system. In Long Beach and San Pedro, the replicated Red Car Line is an attractive addition to waterfront leisure-time facilities.

San Francisco

The San Francisco Municipal Railway operates the only first generation survivor streetcar system in the western United States, the Muni Metro. Its five routes in western residential neighborhoods merge to reach the Financial District in the upper level of the Market Street Tunnel, built in the 1970s as part of Bay Area Rapid Transit (BART). Since then, there has been an extension of the outer J Line to Balboa (1991, 2.3 mi), and from the city end of the tunnel up to grade and around to the Caltrain Depot at 4th and King (1998, 1.7 mi). In 2000, the 1.5-mi streetcar line to Fishermen's Wharf was opened and linked with surface tracks on Market Street to form the popular F Line, operated with presidential passenger cars (PCCs) and older vintage trolleys. Muni's next LRT addition will open in fall 2006: the 5.4-mi line from 4th and King along Third Street through the southeast section of the city to Bayshore.

San José

Valley Transportation Authority opened a portion of its Guadalupe Corridor LRT in 1987, and completed the 20.8-mi line in 1991. Attention then turned to the Tasman West Line, opened in 1999 to extend service 7.6 mi to Mountainview. Thereafter, work continued on the 8.5-mi Tasman East and Capitol Lines, which opened in stages between 2001 and 2004. Also under design and construction was the Vasona Line, a 5.3-mi extension west to Campbell opened in 2005. Planning for additional LRT lines continues, but their phasing and funding must be coordinated with the proposed extension of BART to Santa Clara County.

Sacramento

When Regional Transit opened its first segment in March 1987, it became the second new-age LRT property in California, after San Diego, most of whose design criteria were adopted to achieve an effective yet low-cost project. Coordinated with the region's buses, the addition of the 18.3-mi LRT "starter line" spearheaded a doubling of total transit ridership in the region during the 1990s. By 1998, the line had been extended 2.3 mi. Then, in 2003, a 6.3-mi South Line was added. Most recently, the eastern end of the starter line was extended in stages in 2004 (2.8 mi) and 2005 (7.4 mi) to reach the City of Folsom. LRT ridership now surpasses 60,000 a day. A

further 0.5-mi branch to the Amtrak station in downtown Sacramento will open late in 2006. Extension of this line to the north—eventually 12 mi to the airport—is being planned.

Portland

Oregon's single major metro area is the scene of one of transit's best success stories in the United States. After 17 years of improving and expanding the region's bus system, TriMet opened its first LRT line 15.1 mi to Gresham in 1986. Trains were busy from the start, and crowded in a.m. and p.m. peaks. Nonetheless, working through the federal process and building a line that includes a 3.5-mi tunnel consumed fully 12 years before the Westside Line was completed to Hillsboro (1998, 17.5 mi). Thereafter, the pace quickened, with the locally and privately funded Airport Line (5.6 mi) opening in 2001 and federally supported Interstate MAX (5.8 mi) completed in 2004. During these same years, the City of Portland built its initial 2.4-mi streetcar line (2001) and extended it to River Place (2004, 0.6 mi). Another 0.6-mi extension opening in 2006 will take streetcars to the new South Waterfront neighborhood of offices and high-density residential developments. On MAX, final design is under way for the 6.5-mi I-205 Gateway–Clackamas extension, to open in 2009. Addition of LRT on an updated and rejuvenated Portland Mall through downtown is also part of this project.

Tacoma and Seattle

The Central Puget Sound Region's first new LRT line opened in 2003, 1.6 mi to connect downtown Tacoma with edge-of-downtown parking, the Tacoma Dome Arena and a hub for commuter trains and buses. The line uses three cars added to the Portland streetcar order; but facilities are built to LRT standards for eventual use by larger LRVs operating on a regional line to Seattle. In the latter city, a 14.5-mi line is under construction, with a planned 2009 opening between downtown Seattle and the SeaTac International Airport. Planning and design also are in progress to extend this line north to the University of Washington and beyond to Northgate. Concept plans envision this line eventually extending north to Everett, creating an LRT truck over 60 mi long between Everett and Tacoma, with Seattle at about its midpoint. Studies of alternatives also are being conducted for enhanced transit—LRT or BRT—to communities east of Lake Washington. Meanwhile, Seattle's Waterfront Streetcar Line is closed temporarily while a new car barn is being designed and built; and an assessment district has been formed to help finance construction of the new 1.3-mi South Lake Union streetcar line, due to open in 2007.

Edmonton

Similar to St. Louis, but 15 years earlier, Edmonton coupled an existing railroad ROW with a downtown tunnel, new in their case, to create the very first new-age LRT line in North America, and one for which light rapid transit fairly defines the LRT acronym. Though providing a high-quality alignment, tunneling also was costly. Thus, extension of the system has been rather slow, but as of 2005, the line surpassed the 8-mi mark with the latest 0.5-mi extension at the University of Alberta. This work also brought the line back up to grade, setting the stage for a substantial 4.7-mi further South Extension to Century Park, to open in 2009. Another 26 LRVs have been ordered to serve this extension. Well integrated with connecting buses, and gradually

expanding, Edmonton's pioneering LRT line has been a beacon to which others have looked as they developed and implemented their own LRT plans.

Calgary

With the opening of Calgary's South Line in 1981, Alberta could claim the first two new-age LRT lines in North America. Using virtually the same design criteria as Edmonton, Calgary made one significantly different decision: to live with surface operation through downtown until a regional system was built, and then perhaps build a central subway. As a result, Calgary has been able to sustain an ongoing series of extensions outside downtown, bringing the system now to three lines (South, Northeast, and Northwest), all of which have been or are being extended. When the latest Northeast Extension is finished in 2006, the system will have 27.5 mi, served by 116 LRVs (with 26 more on order), and accommodating 220,000 rides each weekday, a figure exceeded by LRT systems only in the much larger cities of Toronto and Boston. As in Edmonton, LRT and buses are fully coordinated in a multimodal, multidestinalional timed-transfer transit system. This system also has been followed by most of the more successful new-age LRT operators in the United States.

Toronto

The nine routes operated by the Toronto Transit Commission represent the only surviving first-generation streetcar system in Canada. Its 49 mi of lines are served by a fleet of 196 four-axle cars and 52 six-axle articulated LRVs. They carry substantially more weekday passengers—more than 300,000—than any other LRT or streetcar system in North America, working with TTC subways and buses as part of the city's coordinated public transit network. Perhaps surprisingly, only 11% of the streetcar system's trackage is not in mixed-traffic street lanes shared with automobiles, the median at the west end of the Queensway and on Spadina Avenue and the Waterfront, and the short subway at Union Station. Creation of additional median reservations is being discussed, but no firm decision has been made as this is written (late November 2005).

Boston

The MBTA's Green Line, really a network of a central trunk and four branches, continues to be the most heavily patronized of U.S. LRT systems. A major physical improvement recently completed was relocation of the line in the vicinity of North Station, from the old elevated structure to a new subway and ramp up to the Science Park viaduct. At the Lechmere end of the system, plans are moving forward on two extensions, to West Medford and to Somerville's Union Square. Both are part of a package of transit improvements to offset impacts of the Big Dig highway project. However, it now appears the mixed-traffic portion of line from the Arborway to Heath Street will not be restored, and the latter point will be the permanent terminus of that branch. Efforts continue to resolve issues with the Type 8 low-floor LRVs (LFLRVs); it is anticipated a report on this topic will be on the LRT conference agenda. Finally, the Ashmont–Mattapan line will be out of service for several months while Ashmont station is under reconstruction, during which time the overhead contact system and cars will be converted from trolley pole to pantograph operation.

New Jersey Transit

Jersey City

Since 2003, the Hudson–Bergen LRT line has grown from 9.6 mi as the full 20.1-mi project originally envisioned, and as of 2006 extends from Bayonne 34th Street to Tonnelle Avenue. The last northwestward extension includes the Bergenline Avenue station in tunnel, and Tonnelle Avenue on the Meadows side of the Palisades. This is one of the few North American LRT systems presently operating both express and local services. There is some consideration being given to an electric LRT extension to the Meadowlands Sports Complex; and a DMU feeder from Tonnelle Avenue 9 mi north to Tenafly is proposed.

Newark

The City Subway was rebuilt, reequipped with new LRVs and extended 1 mi to Bloomfield in year 2000. Since then, work was begun and is nearing completion on a 1-mi link from Penn Station, on the Amtrak Northeast Corridor, north through downtown Newark at grade to Broad Street Station serving NJ Transit's Morris and Essex commuter rail lines. This segment connects the two Newark commuter rail stations served by NJ Transit with each other and with destinations in downtown Newark. In Union County, a separate Cranford–Elizabeth LRT line is in the early planning stage.

River Line

Though not LRT as defined by TRB, because it is not electrically powered, the Camden–Trenton light DMU River Line has several LRT-like characteristics, including frequent service with one- and two-car trains operated by one person, POP fare collection, and some street running in Camden. Widely disparaged prior to completion, it has performed reliably, and is developing patronage, now more than 7,000 a day, quite satisfactory given the relatively low population in its service area. It feeds passengers to radial rail transit lines at both ends: NJ Transit–Amtrak at Trenton and PATCO Lindenwold Line in Camden, where it also serves several leisure venues along the Delaware River waterfront.

Philadelphia

In September 2005, Philadelphia enjoyed what must be a rare event, the return of streetcars to a line mothballed for many years. The 8.2-mi Route 15–Girard Avenue, run with buses for more than a decade, was restored as a trolley line, using 18 rebuilt PCCs equipped with new propulsion systems, wheelchair lifts, and air conditioning. At its west end, this line shares the Overbrook loop with Route 10, and this is joined physically to the five subway–surface lines. In Delaware County, the Media–Sharon Hill lines continue with no significant changes since 2003.

Pittsburgh

Port Authority Transit completed Stage 2 of its South Hills Car Lines rebuilding program in 2004. Now, all Library and some South Hills Village trains operate over this shorter line, while some South Hills Village trains continue to operate via Beechview and Mount Lebanon. In 2006, work is starting on the 1.2-mi North Shore Connector, a short but complex project to extend LRT from downtown Pittsburgh under the Allegheny River to the developing North Shore, and setting the stage for potential future extensions to northern suburbs.

Buffalo

The 6.4-mi Metro continues to link downtown and the State University of New York's Buffalo campus. Midlife overhauls are being done on Buffalo's 27 LRVs, the only nonarticulated four-axle cars built for a North American new-age LRT project. A new special events station has been added near the waterfront end of the line to serve the HSBC Arena.

Cleveland

The Blue and Green LRT lines, including the Waterfront Extension of 1996, continue to serve the cities of Cleveland and Shaker Heights. Overhauls of the early 1980s Breda LRVs are in progress.

Baltimore

Double-tracking of 9.4 mi of the Central LRT line should be completed in 2006, bringing a full restoration of service to the entire line. The work areas were four segments north of downtown Baltimore, and three sections south of downtown, one of the latter including the junction and a short section of the branch to Baltimore–Washington International airport.

New Orleans

One of the great delights of this report was to have been the 2004 reconversion of Canal Street from bus to streetcar operation on new tracks in the neutral ground (median) of this broad boulevard. The project was completed, and included 24 new replica streetcars built by the New Orleans RTA in its own shop. It functioned well, but with much of the rest of the city was inundated in the flooding that occurred in the wake of Hurricane Katrina in 2005. All of the Canal cars and most of the Riverfront fleet were damaged and must undergo extensive propulsion system repairs or replacement, as is also the case for substations. Tracks and the overhead contact systems (OCSs) on these two routes came through well. On the historic St. Charles line, the cars remained dry; but the OCS is reported to need rebuilding, a project that already was planned. In late 2005, some St. Charles cars were running on the Riverfront line and a truncated Canal service was being offered within the CBD.

Memphis

Opened as a Main Street Shuttle in 1993 using vintage cars, this system was extended along the Mississippi River waterfront a few years later. The fleet now includes both vintage and replica streetcars. In 2004, a 2-mi extension on Madison Avenue was opened to reach the Medical Center. It is intended that this serve as the first segment of an eventual 9-mi route to the Memphis airport.

Little Rock

The Arkansas capital city became the newest operator of streetcars in 2004, when it opened the 1.5-mi River Rail using three replica double-truck Birney cars from Gomaco. By late 2006, a 0.9-mi extension to the new Clinton Presidential Library should be in service, with two more replica Birney cars added to the fleet.

Tampa

The TECO Trolley Line continues to link downtown Tampa with Ybor City and other leisure venues along the 2.3-mi route.

FUTURE NEW STARTS

In addition to Seattle, previously noted, two more completely new-start LRT lines are under construction, as is a streetcar line in Washington, D.C.:

- **Charlotte:** The South Corridor LRT line will extend 9.6 mi south from Uptown Charlotte to suburban Pineville, with revenue service anticipated to start in 2007. Located mostly on a former railroad ROW, the line will have 15 stations served by 16 articulated 70% LFLRVs. The Charlotte Area Transit System also is planning a central area streetcar system; and additional LRT lines may emerge from a regional planning process. A short replica trolley line in the city was suspended in late 2005 so that its line could be rebuilt as part of the LRT project.
- **Phoenix:** Valley Metro Rail's 20.5-mi Central–East Valley LRT line will link Phoenix, Tempe, and Mesa, opening in December 2009. Except for a short segment through the Arizona State University campus in Tempe, the entire line will be located in median and curb lane reservations within existing street ROWs. There will be 27 stations and a fleet of 36 articulated 70% LFLRVs. Already, planning is in progress for extensions that could develop into a 57-mi LRT system.
- **Washington, D.C.:** A system of several lines throughout the District has been proposed to complement the Metro and bus systems. Of these, a portion of the first line is under construction in Anacostia to link that community and its Metro transit center with nearby military bases. Three modern streetcars are being built for this project.

Two other projects under construction will use “light” DMUs to provide service similar in character to LRT: the Oceanside–Escondido route in northern San Diego County, and Capital Metro's line from Austin to Leander, Texas.

Other cities with LRT planning or design in various stages include:

- Norfolk—a 7.5-mi LRT line has completed preliminary engineering (PE) and is ready for final design;
- Vancouver, British Columbia—the 6.8-mi Evergreen LRT line is undergoing “project definition” (similar to PE), for the corridor linking TransLink’s Coquitlam and Lougheed centers;
- Atlanta—a 22-mi circumferential loop line and an 11-mi north-south streetcar line are in the works;
- Columbus—environmental work for a planned LRT line north from downtown is being completed;
- Miami—a 3- to 6-mi streetcar line will link downtown Miami, the Arts District, Midtown Miami (a new town on an old rail -yard site), and the Design District;
- Spokane—concept plans for light rail or a streetcar line are in development; and
- Tucson—a short extension is being built for a volunteer-operated heritage streetcar line that could serve as the core for a larger public system.

In other locations, LRT is included as an alternative in multimodal planning studies from which a project may or may not emerge.

CONCLUSION

From eight cities with survivor trolley systems in the mid-1970s, new LRT and streetcar projects have spread across North America so that today about 30 cities in the United States and Canada are served by LRT or streetcars or both. Extensions and more new starts under construction, and additional cities in various stages of project development, indicate that LRT has proven to be an attractive addition to local transit systems, and that the appetite for such projects is not yet saturated. LRT continues to offer cities the possibility of meaningful and affordable transit improvement.

Light Rail Vehicle Design and Innovation

LIGHT RAIL VEHICLE DESIGN AND INNOVATION

Development of the European LRV Market

NILS JÄNIG
STEFFEN PLOGSTERT
TTK



APTA/UITP Joint Light Rail Conference



Development of the European LRV Market

TTK, Nils Jänig and Steffen Plogstert

Slide 1

Development of the European LRV market

Table of Contents

- ▷ Who is TTK?
- ▷ Light Rail Systems in Europe
- ▷ LRT Market Potential in Europe
- ▷ Manufacturer Concentration Process
- ▷ Vehicle Sales — System Vehicles
- ▷ New Technological Developments
- ▷ Conclusion and Outlook



TTK

Slide 2

Development of the European LRV market

Who is TTK?

- ▷ Subsidiary to PTV (Visum, Vissim) and AVG (Karlsruhe tramtrain operator)
- ▷ International light rail consultancy with 25 members of staff
- ▷ Existing since 1996
- ▷ Coordinator of LibeRTiN (EC-light rail thematic network)



TTK
www.ttk.de

TTK

Slide 3

Development of the European LRV market



Light Rail Systems in Europe



Country	Systems (#)	Lines (#)	Track (km)
Austria	6	47	313
Belgium	5	33	332
Czech Republic	7	71	333
Estonia	1	4	39
Finland	1	11	76
France	11	20	202
Germany	56	231	2768
Greece	1	1	48
Hungary	4	34	188
Ireland	4	2	22
Italy	1	1	1
Netherlands	5	34	280
Poland	14	204	1445
Portugal	2	6	65
Slovakia	3	28	68
Spain	4	5	206
Sweden	3	14	186
UK	7	10	156
Total for European 25	137	787	7033

Source:
 Light Rail and Metro Systems in Europe;
 Current market, perspectives
 and research implications,
 The European Rail Research
 Advisory Council, ERRAC,
 April 2004

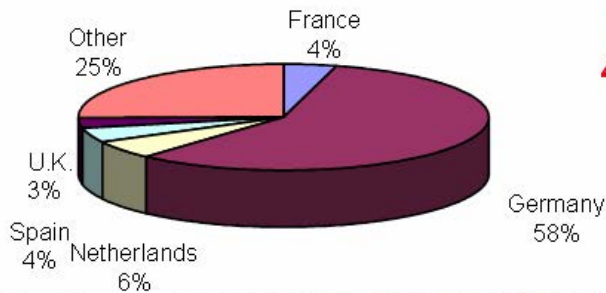
Slide 4

Development of the European LRV market



Market Potential — Light Rail Systems in Europe 2020 Horizon

Vehicle Replacement Market European 25



Total:
4,640

Source:
ERRAC and TTK



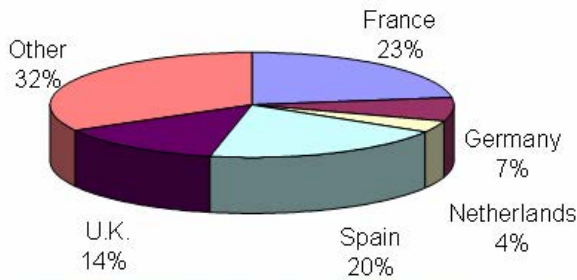
Slide 5

Development of the European LRV market



Market Potential — Light Rail Systems in Europe
2020 Horizon

Vehicle Expansion Market
European 25



Total:
3,272

Source:
ERRAC and TTK



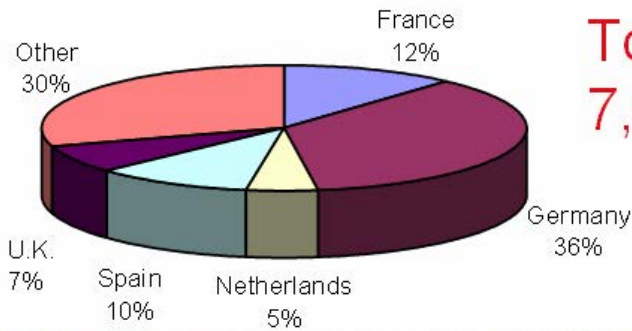
Slide 6

Development of the European LRV market



Market Potential — Light Rail Systems in Europe
2020 Horizon

Total Expected Vehicle Purchase
EU 25



Total:
7,912

Source:
ERRAC and TTK



Slide 7

Development of the European LRV market



Consolidation Process in the Market — An Example

- ▷ The Karlsruhe tram vehicles always left the same factory
 - ▷ The electrical parts came from Mannheim
 - ▷ The mechanical parts from Krefeld
- ▷ These companies manufactured the trams:

Electrical Part:



Mechanical Part:



Slide 8

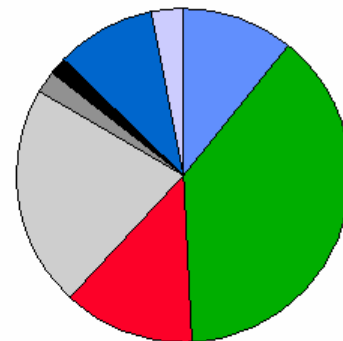
Development of the European LRV market



System Vehicles — Tram

- ▷ The "big players"
 - ▷ Bombardier Flexity Outlook Sold: 211!
 - ▷ Bombardier Flexity Classic Sold: 190!
 - ▷ Alstom Citadis Sold: 760!
 - ▷ Siemens Combino Sold: 489!
- ▷ The "underdogs"
 - ▷ Stadler Variotram Sold: 39!
 - ▷ LfB Leoliner Sold: 35!
 - ▷ AnsaldoBreda Sirio Sold: 248!
 - ▷ Skoda / Inekon Astra/14T etc. Sold: 62!

- Outlook
- Citadis
- Sirio
- Combino
- Variotram
- Leoliner
- Classic
- Skoda/Inekon



Slide 9

Development of the European LRV market



Flexity Outlook — Bombardier



BOMBARDIER

Slide 10

Development of the European LRV market



Flexity Classic — Bombardier



BOMBARDIER

Slide 11

Development of the European LRV market

TTK

Citadis — Alstom



ALSTOM



Slide 12

Development of the European LRV market

TTK

Combino — Siemens



SIEMENS



Slide 13

Development of the European LRV market

TTK

Variotram — Stadler



STADLER
We Track Clever Solutions

Slide 14

Development of the European LRV market

TTK

Sirio — AnsaldoBreda / Leoliner — LfB




ANSALDOBREDA

 **LEOLINER Fahrzeug-Bau Leipzig GmbH**



Slide 15

Development of the European LRV market



Astra / 14T — Skoda / Inekon



Slide 16

Development of the European LRV market



System Vehicles — Light Rail

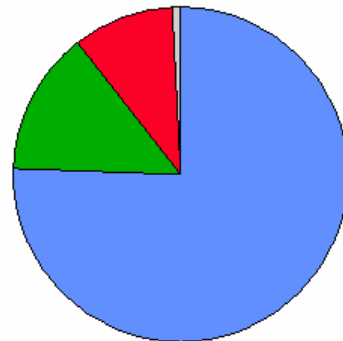
▷ The "big players"

- ▷ Bombardier Flexity Swift Sold: 473!
- ▷ Alstom RegioCitadis Sold: 87!
- ▷ Siemens Avanto / S70 Sold: 60!

▷ The "underdogs"

- ▷ Stadler Tango Sold: 6!

- Swift
- RegioCitadis
- Avanto / S70
- Tango



Slide 17

Development of the European LRV market

TTK

Flexity Swift — Bombardier



Slide 18

Development of the European LRV market

TTK

RegioCitadis — Alstom



ALSTOM

Slide 19

Development of the European LRV market

TTK

Avanto S70 — Siemens



SIEMENS



Slide 20

Development of the European LRV market

TTK

Tango — Stadler



STADLER
We Track Clever Solutions

Slide 21

Development of the European LRV market

TTK

Technologies — quo vadis??
The following main innovations play a significant role in Europe's LRV domain:

- ▷ 100% – 70% low floor?
- ▷ "Real Bogies" or independently rotating wheels?
- ▷ Modular vs. differential construction?
- ▷ Energy recuperation and operation without overhead line (e.g., Bordeaux)?
- ▷ Real-time passenger information and interfaces with other communication modes (web/cellular phones)?
- ▷ "Diesel-trams"? Kassel and Nordhausen



Slide 22

Development of the European LRV market

TTK

100% or 70% LF? — "Real Bogies" or IRWs?

- ▷ Question really should be
 - ▷ What speeds will we be operating?
 - ▷ Do we need large wheel diameters?
 - ▷ Do we need multiple articulations?
- ▷ Tendency in Germany goes toward "more conventional" systems, generally with axles on the power bogies and often also with axles on the trailers.
- ▷ Examples are BT Flexity Outlook, BT Flexity Swift, Alstom "Magdeburg," and Siemens Avanto/S70 (though this has no axles on the trailer).
- ▷ In France, the tendency remains toward 100% low floor with multiple articulations (better gauging envelope, but increased wear).




Slide 23

Development of the European LRV market

TTK

Construction Methods?

- ▷ Three basic types are seen:
 - ▷ **Type 1:** Fully welded [including exterior panels (e.g., Sirio, "new" Combino, Alstom Magdeburg)].
 - ▷ **Type 2:** Welded chassis or car body and bonded roof, exterior panels etc. (e.g., Variotram, BT Classic, Avanto/S70, "old" Combino).
 - ▷ **Type 3:** Fully modular, with body and all other parts being of different materials and bonded (e.g., BT Outlook, BT Swift, Alstom Citadis).
- ▷ In the past 10 years:
 - ▷ **Type 1:** 1,310 times (32%),
 - ▷ **Type 2:** 1,425 times (35%), and
 - ▷ **Type 3:** 1,323 times (33%).  **No clear tendency is visible!**



Slide 24

Development of the European LRV market

TTK

Construction Methods?

- ▷ **Type 1 (steel):**
 - ▷ **Advantages:**
 - ▷ Easy welding repairs and
 - ▷ Known behavior over time.
 - ▷ **Disadvantages:**
 - ▷ Long production time and
 - ▷ Difficult to change design.
- ▷ **Types 2 and 3 (modular):**
 - ▷ **Advantages:**
 - ▷ Reduced production time (and cost) and
 - ▷ Vehicle modules can be replaced.
 - ▷ **Disadvantages:**
 - ▷ Greater difficulties in engineering and
 - ▷ Unknown long-time behavior.



Slide 25

Development of the European LRV market



Energy Recuperation?

- ▷ Development is ongoing both on the vehicle and on the infrastructure (OLE) side.
- ▷ Developments on the infrastructure side are more likely on existing systems, e.g., in Germany:
 - ▷ Equipment of substations with four quadrant choppers will allow the feeding back of energy all the way to the power stations;
 - ▷ Some operators also test flywheels in the substation to store peak energy and feed it back into the system; and
 - ▷ Advantage: No additional weight and complexity on the vehicle.



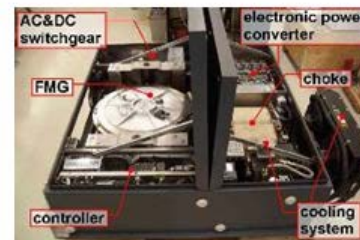
Slide 26

Development of the European LRV market



Energy Recuperation?

- ▷ On the vehicle side, systems are usually introduced under special requirements (e.g., heritage sites) and in new systems:
 - ▷ The ULEV-TAP2 project (funded by the EC) was just finalized, in which a dual-mode LRV was developed using diesel engine plus flywheel technology. Operation without OLE and with reduced energy requirement is possible (www.ulev-tap.org).
 - ▷ Manufacturers are also developing electric-only vehicles with energy storage devices (e.g., flywheel, ultracaps).
- ▷ Alstom introduced a third rail solution in Bordeaux (combination of infra and on-board measures)



Slide 27

Development of the European LRV market



Passenger Information and Links to Modern Communication Modes

- ▷ On-time passenger information is employed by more and more light rail and tram operators.
- ▷ Provision of information to passengers on less used stations by short message service on cellular phones is being introduced in some systems.
- ▷ Good information within the vehicle is important; trials to provide location-related information via GPS have been carried out.
- ▷ Electronic ticketing is difficult in an open system. Standards for “be-in be-out” systems are being discussed.

Tram to Station Street



Slide 28

Development of the European LRV market



Diesel Trams?

- ▷ Hybrid diesel and electric "Combino Duo" operates successfully in Nordhausen as a tramtrain on a narrow gauge secondary railroad (Harzer Schmalspurbahnen, HSB).
- ▷ One 180-kW diesel engine-generator pack inside the vehicle is employed.



Slide 29

Development of the European LRV market



Diesel Trams?

- ▷ Hybrid diesel and electric "Regiocitadis" operates on Kassel tramway (750V DC) and on non-electrified railroads.
- ▷ Two 375 kW roof-mounted diesel engine-generator packs are employed.



Slide 30

Development of the European LRV market



Conclusion and Outlook (1)

- ▷ The number of suppliers and the demand for vehicles make this a challenging market with the structure of an oligopoly.
- ▷ For the time being, it appears that Siemens will remain active in the field of light rail (its future product is the GT type low-floor tram).
- ▷ Alstom and Bombardier are currently the most successful rolling stock suppliers.
- ▷ In these market conditions, innovation will hardly be driven by the suppliers alone.
- ▷ Compared to the aviation or automobile industries, this remains a market where the final product is supplied in prototype-like numbers.



Slide 31

Development of the European LRV market



Conclusion and Outlook (2)

- ▷ France and Germany have been a driver of innovation (e.g., low-floor technology in France, tramtrain in Germany).
- ▷ The further development of some of these technologies remains to be seen.
- ▷ A revitalization of old values can be seen, at least in the biggest section of the market.

▷ **Take Bremen as an example:**

- ▷ Now ordered 46 "BT Classic" type cars with conventional traction bogies and low-floor trailer bogies (with IRWs) on the center section only (Figure 1);
- ▷ Originally operated with old Duewag/Wegmann cars (Figure 2); and
- ▷ Introduction of 100% low-floor vehicles with stub axles (IRWs) in the early 1990s (Figure 3).



Figure 1



Figure 2

Slide 32



Figure 3

LIGHT RAIL VEHICLE DESIGN AND INNOVATION

**North American LRV and Streetcar
Procurements Since We Last Met**

THOMAS B. FURMANIAK
LTK Engineering Services

**North American
LRV / Streetcar Procurements
...*Since We Last Met***

Thomas B. Furmaniak, P.E.
Vice President, Southeast Region
LTK Engineering Services

A World of Applications & Opportunities



Joint International Light Rail Conference

Light Rail Vehicles

LTK *A World of Applications & Opportunities* **NRB** **UITP** **APTA** AMERICAN PUBLIC TRANSPORTATION ASSOCIATION

Joint International Light Rail Conference

Boston

- MBTA
- AnsaldoBreda
- 74 ft (22.6 m)
- 70% Low Floor
- 44 Seats
- 85/215 Cars
- \$2M/car
- 1999–2007



Richard Panse
Executive Director

LTK *A World of Applications & Opportunities* **NRB** **UITP** **APTA** AMERICAN PUBLIC TRANSPORTATION ASSOCIATION

Joint International Light Rail Conference

Calgary

- CTS
- Siemens
- 81 ft (24.8 m)
- High Floor
- 64 Seats
- 33/149 Cars
- \$2.6/car
- 2006–2007



LTK A World of Applications & Opportunities

TRB **UITP** **APTA** AMERICAN PUBLIC TRANSPORTATION ASSOCIATION

Joint International Light Rail Conference

Charlotte

- CATS
- Siemens
- 94 ft (28.5 m)
- 70% Low Floor
- 72 Seats
- 16 Cars
- \$2.6M/car
- 2007



LTK A World of Applications & Opportunities

TRB **UITP** **APTA** AMERICAN PUBLIC TRANSPORTATION ASSOCIATION

Joint International Light Rail Conference

Charlotte

- CATS
- Siemens
- 94 ft (28.5 m)
- 70% Low Floor
- 72 Seats
- 16 Cars
- \$2.6M/car
- 2007



A photograph of a white and black Siemens light rail vehicle (LRV) inside a large industrial facility, likely a factory or assembly plant. The vehicle is positioned on a yellow safety platform with railings. The background shows the interior of the factory with various structures and equipment.



A World of Applications & Opportunities


 AMERICAN PUBLIC TRANSPORTATION ASSOCIATION

Joint International Light Rail Conference



Dallas

- DART
- Kinki Sharyo
- 93 ft (28.2 m)
- High Floor
- 76 Seats
- 20/15 Cars
- \$2.8M/car
- 2006



A photograph of a white and yellow Kinki Sharyo light rail vehicle (LRV) stopped at a station platform. The vehicle has "WESTMORELAND" and the number "132" on its front. The platform has a modern, curved roof structure. In the background, a city skyline is visible under a clear blue sky.

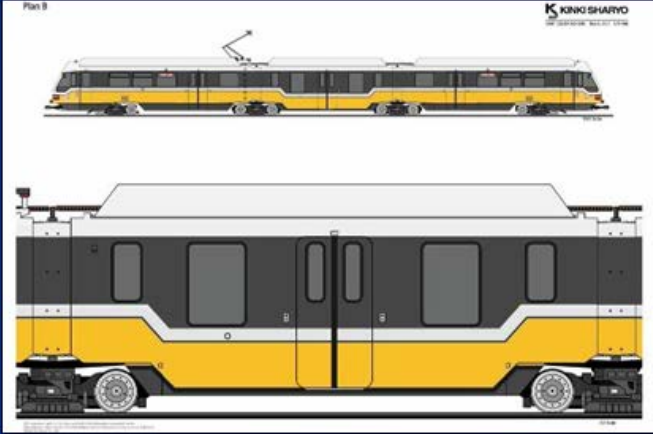

A World of Applications & Opportunities


 AMERICAN PUBLIC TRANSPORTATION ASSOCIATION

Joint International Light Rail Conference

Dallas

- DART
- Kinki Sharyo
- 124 ft (37.7 m)
- Low-Floor Center
- 104 Seats
- 115 "C" Cars
- \$ TBD
- 2008–2010



Plan B

KINKI SHARYO
OF JAPAN

LTK *A World of Applications & Opportunities* TRB UTP APTA AMERICAN PUBLIC TRANSPORTATION ASSOCIATION

Joint International Light Rail Conference

Dallas

- DART
- Kinki Sharyo
- 124 ft (37.7 m)
- 23% Low Floor
- 104 Seats
- 115 Super LRVs
- \$ TBD
- 2008–2010



LTK *A World of Applications & Opportunities* TRB UTP APTA AMERICAN PUBLIC TRANSPORTATION ASSOCIATION

Joint International Light Rail Conference

Denver

- RTD
- Siemens
- 81 ft (24.8 m)
- High Floor
- 64 Seats
- 34/83 Cars
- \$2.4/Car
- 2003




A World of Applications & Opportunities


 AMERICAN PUBLIC TRANSPORTATION ASSOCIATION

Joint International Light Rail Conference

Edmonton

- ETS
- Siemens
- 81 ft (24.8 m)
- High Floor
- 64 Seats
- 26/63 Cars
- \$3.2/Car
- 2008




A World of Applications & Opportunities


 AMERICAN PUBLIC TRANSPORTATION ASSOCIATION

Joint International Light Rail Conference

Houston

- Metro
- Siemens
- 96 ft (29.4 m)
- 70% Low Floor
- 72 Seats
- 18 Cars
- \$2.5/Car
- 2004



LTK A World of Applications & Opportunities

TRB **UTP** **APTA** AMERICAN PUBLIC TRANSPORTATION ASSOCIATION

Joint International Light Rail Conference

Los Angeles

- LACMTA
- AnsaldoBreda
- 89 ft (27.1 m)
- High Floor
- 76 Seats
- 50/171 Cars
- \$2.8/Car
- 2006–2007



LTK A World of Applications & Opportunities

TRB **UTP** **APTA** AMERICAN PUBLIC TRANSPORTATION ASSOCIATION

Joint International Light Rail Conference

Minneapolis

- Metro Council
- Bombardier
- 94 ft (28.7 m)
- 70% Low Floor
- 66 Seats
- 24+3 Cars
- \$2.3–\$2.8/Car
- 2004; 2006–2007




A World of Applications & Opportunities



 AMERICAN PUBLIC TRANSPORTATION ASSOCIATION

Joint International Light Rail Conference

Newark/Jersey City

- NJ Transit
- Kinki Sharyo
- 90 ft (27.4 m)
- 70% Low Floor
- 72 Seats
- 34/63 Cars
- \$3.0/Car
- 2006




A World of Applications & Opportunities


 AMERICAN PUBLIC TRANSPORTATION ASSOCIATION

Joint International Light Rail Conference

Norfolk

- HRT
- Kinki Sharyo
- 92 ft (28.0 m)
- 70% Low Floor
- 66 Seats
- 9 Cars
- \$~2.9m/Car
- 2008–2009



LTK *A World of Applications & Opportunities* TRB UTP APTA AMERICAN PUBLIC TRANSPORTATION ASSOCIATION

Joint International Light Rail Conference

Pittsburgh

- PAT
- CAF
- 85 ft (25.8 m)
- High Floor
- 62 Seats
- 28/83 Cars
- \$2.3/Car
- 2004



LTK *A World of Applications & Opportunities* TRB UTP APTA AMERICAN PUBLIC TRANSPORTATION ASSOCIATION

Joint International Light Rail Conference

Phoenix

- Valley Transit
- Kinki Sharyo
- 92 ft (28.0 m)
- 70% Low Floor
- 66 Seats
- 36 Cars
- \$2.9/Car
- 2008




A World of Applications & Opportunities


 AMERICAN PUBLIC TRANSPORTATION ASSOCIATION

Joint International Light Rail Conference

Portland

- TriMet
- Siemens
- 92 ft (28.0 m)
- 70% Low Floor
- 64 Seats
- 27/105 Cars
- \$2.6m/Car
- 2003





A World of Applications & Opportunities


 AMERICAN PUBLIC TRANSPORTATION ASSOCIATION

Joint International Light Rail Conference

Portland

- TriMet
- TBD
- ~95 ft (29 m)
- 70% Low Floor
- 75 Seats
- 24/129 Cars
- \$/Car TBD
- 2009



LTK A World of Applications & Opportunities **TRB** **UITP** **APTA** AMERICAN PUBLIC TRANSPORTATION ASSOCIATION

Joint International Light Rail Conference

Sacramento

- RT
- CAF
- 84 ft (25.5 m)
- High Floor
- 64 Seats
- 40/90* Cars
- \$2.1m/Car
- 2005




LTK A World of Applications & Opportunities **TRB** **UITP** **APTA** AMERICAN PUBLIC TRANSPORTATION ASSOCIATION

Joint International Light Rail Conference

St. Louis

- Metro
- Siemens
- 89 ft (27.3 m)
- High Floor
- 72 Seats
- 22/87 Cars
- \$2.4m/Car
- 2006




LTK *A World of Applications & Opportunities* **TRB** **UTP** **APTA** AMERICAN PUBLIC TRANSPORTATION ASSOCIATION

Joint International Light Rail Conference

Salt Lake City

- UTA
- Siemens
- 81 ft (24.8 m)
- High Floor
- 64 Seats
- 33* Cars



LTK *A World of Applications & Opportunities* **TRB** **UTP** **APTA** AMERICAN PUBLIC TRANSPORTATION ASSOCIATION

Joint International Light Rail Conference

San Diego

- MTS/SANDAG
- Siemens
- 91 ft (27.7 m)
- 70% Low Floor
- 68 Seats
- 11/134 Cars
- \$2.5m/Car
- 2005



LTK A World of Applications & Opportunities

TRB UTP APTA AMERICAN PUBLIC TRANSPORTATION ASSOCIATION

Joint International Light Rail Conference

San José

- VTA
- Kinki Sharyo
- 88 ft (26.9 m)
- 70% Low Floor
- 68 Seats
- 100* Cars
- \$2.7m/Car
- 2002–2003



LTK A World of Applications & Opportunities

TRB UTP APTA AMERICAN PUBLIC TRANSPORTATION ASSOCIATION

Joint International Light Rail Conference

Seattle

- Sound Transit
- Kinki Sharyo
- 92 ft (28.0 m)
- 70% Low Floor
- 72 Seats
- 31 Cars
- \$3.5m/Car
- 2009



LTK *A World of Applications & Opportunities* **TRB** **UITP** **APTA** AMERICAN PUBLIC TRANSPORTATION ASSOCIATION

Joint International Light Rail Conference


Modern Streetcars

LTK *A World of Applications & Opportunities* **TRB** **UITP** **APTA** AMERICAN PUBLIC TRANSPORTATION ASSOCIATION

Joint International Light Rail Conference

Portland

- City of Portland
- Inekon
- 66 ft (20.1 m)
- 50% Low Floor
- 29 Seats
- 3/10 Cars
- \$2.6m/Car
- 2006



LTK A World of Applications & Opportunities **TRB** **UTP** **APTA** AMERICAN PUBLIC TRANSPORTATION ASSOCIATION

Joint International Light Rail Conference

Seattle

- City of Seattle
- Inekon
- 66 ft (20.1 m)
- 50% Low Floor
- 29 Seats
- 3 Cars
- \$2.7m/Car
- 2007




LTK A World of Applications & Opportunities **TRB** **UTP** **APTA** AMERICAN PUBLIC TRANSPORTATION ASSOCIATION

Joint International Light Rail Conference

Washington, DC

- D.C. DOT
- Inekon
- 66 ft (20.1 m)
- 50% Low Floor
- 30 Seats
- 3 Cars
- \$2.7m/Car
- 2006–2007



LTK *A World of Applications & Opportunities* **TRB** **UTP** **APTA** AMERICAN PUBLIC TRANSPORTATION ASSOCIATION

Joint International Light Rail Conference

Vintage Trolleys

LTK *A World of Applications & Opportunities* **TRB** **UTP** **APTA** AMERICAN PUBLIC TRANSPORTATION ASSOCIATION

Joint International Light Rail Conference

Charlotte

- CATS
- Gomaco
- 45 ft (15.2 m)
- High Floor
- 40 Seats
- 3 Cars
- \$0.7m/Car
- 2004



LTK *A World of Applications & Opportunities* **TRB** **UTP** **APTA** AMERICAN PUBLIC TRANSPORTATION ASSOCIATION

Joint International Light Rail Conference

Tampa

- HART
- Gomaco
- 46 ft (14.0 m)
- High Floor
- 48 Seats
- 1/9 Cars
- \$0.6m/Car
- 2005



LTK *A World of Applications & Opportunities* **TRB** **UTP** **APTA** AMERICAN PUBLIC TRANSPORTATION ASSOCIATION

Joint International Light Rail Conference

Tampa

- HART
- Gomaco
- 44 ft (13.3 m)
- High Floor
- 78 Seats
- 1/10 Cars
- \$0.2m/Car
- 2005



Eric Sitiko

LTK *A World of Applications & Opportunities* **TRB** **UTP** **APTA** AMERICAN PUBLIC TRANSPORTATION ASSOCIATION

Joint International Light Rail Conference

Little Rock

- CAT
- Gomaco
- 45 ft (13.6 m)
- High Floor
- 40 Seats
- 3+2 Cars
- \$0.8–0.9m/Car
- 2004; 2006




LTK *A World of Applications & Opportunities* **TRB** **UTP** **APTA** AMERICAN PUBLIC TRANSPORTATION ASSOCIATION

Joint International Light Rail Conference

Memphis

- MATA
- Gomaco
- 48 ft (14.6 m)
- High Floor
- 40 Seats
- 1/20 Cars
- \$0.6m/Car
- 2004



LTK *A World of Applications & Opportunities* **TRB** **UTP** **APTA** AMERICAN PUBLIC TRANSPORTATION ASSOCIATION

Joint International Light Rail Conference

New Orleans

- NORTA
- NORTA/Brookville
- 48 ft (14.5 m)
- High Floor
- 40 Seats
- 24/66 Cars
- \$~1.2m/Car
- 2004




Peter Ehrlich





LTK *A World of Applications & Opportunities* **TRB** **UTP** **APTA** AMERICAN PUBLIC TRANSPORTATION ASSOCIATION

Joint International Light Rail Conference

Philadelphia

- SEPTA
- Brookville
- 47 ft (14.2 m)
- High Floor
- 46 Seats
- 18/159 Cars
- \$1.2m/Car
- 2005




A World of Applications & Opportunities


 AMERICAN PUBLIC TRANSPORTATION ASSOCIATION

Joint International Light Rail Conference

'Til We Meet Again?

- New starts
- Fleet expansion for capacity improvements, line extensions
- Fleet replacement programs (e.g., Toronto)
- Streetcars, streetcars, streetcars


A World of Applications & Opportunities


 AMERICAN PUBLIC TRANSPORTATION ASSOCIATION

LIGHT RAIL VEHICLE DESIGN AND INNOVATION

Center Truck Performance on Low-Floor Light Rail Vehicles**TREVOR GRIFFIN***Interfleet Technology Inc.*

This paper describes work that has been undertaken to date on TCRP Research Project C-16, the purpose of which was to assist the introduction of low-floor light rail vehicles (LFLRVs) into North America. Most vehicles so far introduced are 70% low floor with a three-section articulated vehicle body with the center section mounted on a truck with nonpowered, independently rotating wheels. Where these have been in use for a while they have experienced various performance problems such as derailments, excessive wheel and rail wear, noise, and reduced ride quality. The transit systems appear to have been successful in applying solutions to these problems but the objective of the research has been to develop generic guidance that can avoid them, especially for totally new systems. The research involved a team of both U.S. and European experts who undertook a broad study of the issues and also undertook some simulation modeling to improve understanding of some of the key contributory factors that were identified. The conclusions were that it should be possible to use this type of vehicle without serious problems if fundamental guidance was followed but that it would also be worthwhile to investigate the possibility of introducing other types of LFLRVs that were now in common use elsewhere in the world.

INTRODUCTION

This paper describes work that has been undertaken to date on TCRP Research Project C-16.

The purpose of this research was to assist the introduction of low-floor light rail vehicles (LFLRVs) into North America. LFLRVs offer significant advantages especially in terms of easier accessibility and the ability to use less intrusive low platforms at stops. They are especially attractive for new start-up systems and have become the standard design solution offered by all the major suppliers.

Most LFLRVs used in the United States make use of the independent rotating wheels principle (Figure 1). Instead of the rotating solid axle normally associated with high-floor vehicles (the first diagram), the wheels rotate independently on the ends of a bent beam or cranked axle, which then acts like an axle, except that it does not rotate (the second diagram).

The low floor height precludes the use of conventional wheel sets with solid axle connections between right and left wheels of the center truck. This wheel arrangement is used on the nonpowered truck, which supports the short central section of the three-section articulated vehicle body (Figure 2). The leading and trailing sections of the vehicle are each supported by a motored truck at one end and by the common nonpowered center truck, via the articulation, at the other. Figure 3 illustrates this configuration.



FIGURE 1 Independent rotating wheels on a nonrotating cranked axle.



FIGURE 2 Kinki-Sharyo LFLRV in Santa Clara.

Unlike a conventional wheel set, the independently rotating wheels of such a center truck do not have the inherent ability to steer the wheel set through the curve. This leads to increased flange wear, gauge face wear, flange squeal, and potential for derailment at curves and on lateral discontinuities in alignment. External factors related to the configuration of the overall vehicle design have a stronger influence on the dynamics of the truck than with conventional running gear. The interval between needing to reprofile the wheels on the low-floor center truck has been half that of the conventional motored trucks at the outer ends of the vehicle, in some cases.

The research was commissioned in order to better understand the performance of these center trucks, to compile lessons learned to date, and to provide guidance to transit agencies and LFLRV manufacturers for the mitigation of problems associated with this type of vehicle.

This paper describes the research undertaken on Project C-16, which at the time of writing has not been concluded. It gives preliminary results including findings on the experience of operating these vehicles in the United States, the nature of the guidance being produced by the project, and the emerging main conclusions. More information will be provided when the final report is published.

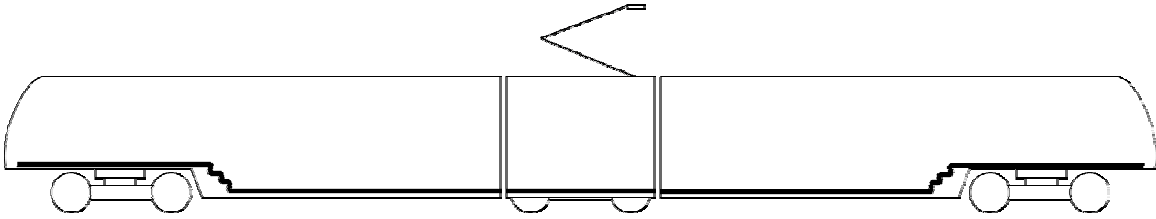


FIGURE 3 Configuration of the U.S. LFLRVs studied.

THE RESEARCH UNDERTAKEN

Work commenced on October 19, 2004; the completion date was March 17, 2006.

The first main task was to undertake a literature review; this showed that the amount of literature that was directly relevant and of high value to this research was fairly limited. This included work carried out on TCRP Project D-7 (1) that included the flange climbing derailment criteria for light rail vehicles (LRVs) with independent rotating wheels. Other earlier TCRP reports on LFLRVs (2), noise (3), and the design of special trackwork (4) proved to be of value along with about 30 other references.

The first phase of the research identified the basic contributing factors and obtained information from the supply industry and also from transit systems by way of a questionnaire.

The initial assessment suggested that Phase 1 could give best value by concentrating on modeling the features that had been identified as being critical for LFLRV performance in combinations that are appropriate to U.S. applications.

ADAMS/Rail vehicle and track models were created to cover the main combinations of design features. A traditional high-floor articulated vehicle, a low-floor vehicle that is reportedly experiencing some problems, and a low-floor vehicle that is reportedly successful were modeled. The detail designs of the three cars are known to differ substantially from one another. The key parameters of the models were varied in order to gauge the effects of introducing different design features. The models were run on five different types of track model representing the range of situations that exists on U.S. light transit systems. One was the set of parameters that were identified in TCRP Research Project D-7, in the work on the investigation of wheel flange climb criteria for transit vehicles as a virtual test track.

Track standards, requirements, and maintenance practices were examined. As part of this work a detailed comparison of typical U.S. practices with the equivalent German standard was also carried out.

All the results were consolidated and assessed; this included visits to discuss the key issues and to obtain information from four of the transit systems and a focused workshop of the European experts involved, who could draw on much wider experience.

WORLDWIDE LOW-FLOOR LIGHT RAIL DEVELOPMENT

To date LFLRVs have been introduced on eight U.S. transit systems. [Table 1](#) is a comparison between these figures for North America and other parts of the world:

TABLE 1 Examples of the Worldwide Application of LFLRVs

Region	Systems That Could Use LFLRVs	Systems That Are Using LFLRVs	Percentage of Systems Using LFLRVs	Note
United States and Canada	26	8	31%	Some old and many new light rail transit (LRT) systems
United Kingdom and Ireland	7	5	71%	Mostly new systems
France	12	12	100%	Some old and many new LRT systems
Germany	59	42	71%	Large number of old systems, very few new ones
Benelux	9	8	89%	Mostly old systems
Australia	3	3	100%	Mostly old systems

This table suggests that the United States is progressing more cautiously in applying this technical solution than other countries.

As Figure 4 shows, low-floor vehicles are taking over from conventional high-floor ones and there has been a rapid adoption of 100% low-floor vehicles, which have not appeared in North America as yet.

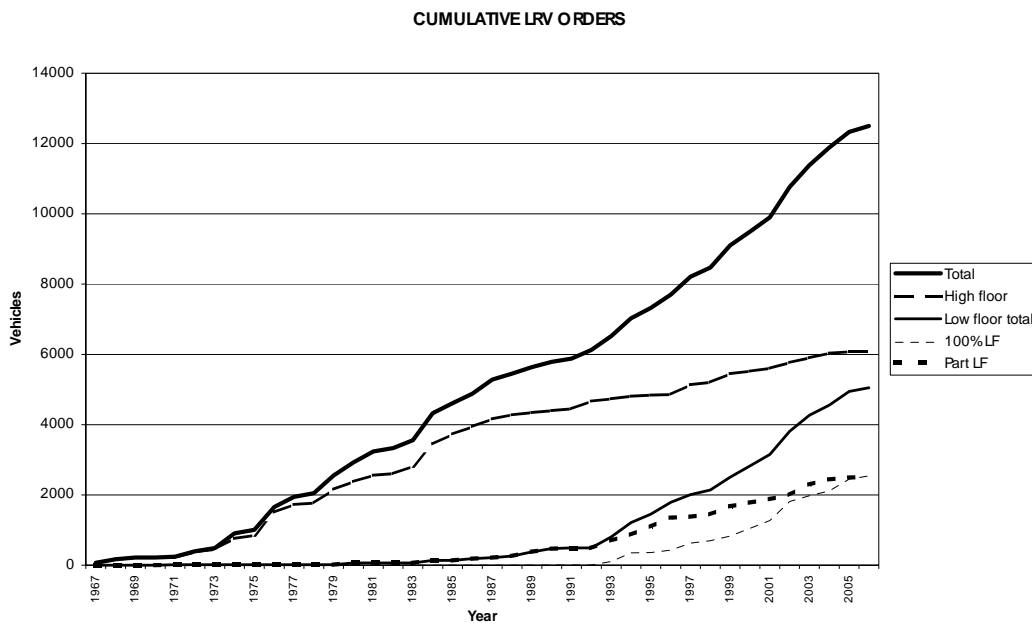


FIGURE 4 Cumulative worldwide pattern of LRV vehicle orders since 1967.

LOW-FLOOR LIGHT RAIL VEHICLES IN THE UNITED STATES

Application

Table 2 summarizes the deliveries of LFLRVs in the United States. As explained in the previous section, all of these cars are of the partial low-floor type shown in **Figure 3** with center trucks having independently rotating wheels. It can be seen that there are six basic types of car, originating from three separate supplier groups. When this is overlaid over the eight transit systems with differing characteristics, it provides substantial scope for varied but perhaps not exhaustive experience. Table 2 does not include the Skoda streetcars introduced in Portland, Oregon, and Tacoma, Washington, which are three-section articulated cars in which the center low-floor section is suspended from the end sections and does not have any wheels. More than 80 additional 70% low-floor cars are currently on order for three new starts, i.e., Charlotte, Phoenix, and Seattle.

Types of Vehicle

Siemens

The Portland SD-600A and SD-660A are virtually identical and can be considered as one type; they are similar to other low-floor vehicles of the same basic configuration that Siemens has supplied to a number of European systems.

The center truck frames are rigid and have independent resilient wheels on a cranked drop axle. The primary suspension is provided by conical rubber chevron springs, the secondary by coil springs controlled by lateral and vertical dampers. Resilient traction links control yaw.

More recently Siemens has introduced the Avanto type having a short center section with independent wheels. These were introduced into the United States prior to their use elsewhere although some are ordered for Paris. The design uses cranked axles, rubber chevron springs, and coil secondary springs.

TABLE 2 LFLRVs, North America

City/System	LFLRVs	Fleet	Years Supplied
Portland MAX	Siemens/Duewag SD-600A and SD660A	79	1996–2004
Boston MBTA	Breda Type 8	100 ordered	1999–2003
NJ Transit Hudson–Bergen and Newark Subway	Kinki-Sharyo	45	2000–2004
San José, Santa Clara VTA	Kinki-Sharyo	100	2001–2004
Minneapolis Metro Transit	Bombardier Flexity Swift	24	2003–2004
Houston METRO	Siemens Avanto S70	18	2003–2004
San Diego SDT	Siemens Avanto S70	11 ordered	2004

Breda

Breda has built LFLRVs of the type used in the United States for Boston and in Birmingham, United Kingdom, but the center trucks are not the same design. In Boston they are known as “Type 8” and operate on the Green Line.

The unique center truck design has a flexible truck frame based on spherical elements. The wheels are located on low-level cranked axles. Stiff rubber primary and air spring secondary suspensions are provided. The movement of the center section relative to the end sections is controlled by an anti-pitching system fitted to the truck and by transverse rods to prevent roll, which are roof mounted.

These cars are relatively short compared with the other LFLRVs in use in the United States, the Green Line infrastructure being that of a long established streetcar system.

Kinki–Sharyo

Kinki–Sharyo is the manufacturing arm of the Kintetsu Group of companies. It has worked with ALSTOM and has only supplied LFLRVs within North America. The center trucks were developed by FIAT/SIG with assistance from PROSE AG. The truck design is conventional, employing cranked axles, chevron rubber primary suspension, and air bag secondary suspension. Resilient traction links control yaw. The center truck is linked to the end sections by bearings under the articulation and the relative movement is controlled by a pair of “Z-links” and two dampers above one of the joints. These Z-links and dampers are roof mounted.

The cars used by New Jersey Transit (NJT) on the Newark Subway ([Figure 5](#)) and the Hudson–Bergen Line are the same except for the wheel profile and wheel back-to-back dimensions. This is because the former also uses streetcar track standards including a 60-ft radius turn back loop at the Penn Station terminus, while the latter is a modern light rail system. The Santa Clara cars are also of the same type but have a different wheel profile that has been adapted to meet track conditions ([Figure 6](#)).

Bombardier

The Flexity Swift LFLRV cars that run in Minneapolis are part of a reasonably large range of similar products. Bombardier developed the standard Flexity Swift range with the first examples appearing in Cologne in 1995. Very similar vehicles have also been built for Istanbul, Croydon, Rotterdam, and Stockholm. This product is a classic three-section partial low-floor vehicle with an independent wheel truck under the short center section. It is intended for light rail systems with a mix of street track and segregated running. The trucks have radial arm suspension with the arms linked by a horizontal rod. The primary springs are rubber and the secondary suspension is provided by coil springs.

Minneapolis’ Hiawatha Line is a new system that opened in 2004.

Infrastructure

When comparing experience between systems that have used this type of car in the United States and systems in other parts of the world, it is important to recognize the different types of infrastructure that are used and the effects that this will have. Systems can be categorized



FIGURE 5 Center truck, Kinki-Sharyo LFLRV, Newark Subway.



FIGURE 6 Roof-mounted dampers and Z-links, Santa Clara VTA cars.

by age as traditional streetcar or modern light rail, the latter being systems that have come into existence since the 1950s. Usually systems in the traditional streetcar category will have modernized but are likely to still be restrained by their history. This is important because it causes significant variation in the standards used on these systems including rail types and profiles, switch types, operating speeds, and track curvature, all of which impact on the performance of low-floor vehicles.

Experience of Performance Problems

Some performance problems with these types of cars have been discussed at previous Transportation Research Board National Rail Transit Conferences (5, 6).

Derailment

Fourteen derailments that have occurred in the United States since this type of LFLRV was introduced and that were noted in the research may have been caused by technical issues associated with this vehicle type. Half of these occurred on switches and the other half all on one system, where the issues that may have caused them are now being managed.

Excessive Wheel and Rail Wear

Excessive wheel and rail wear is a major problem for a large number of light rail systems, and many new systems worldwide seem to have experienced this, regardless of the type of vehicles used.

Three of the systems studied reported rapid wheel wear, sometimes as much as a factor of 10 higher than what was expected. The newer system had not accumulated enough service experience to observe this. Rapid rail wear tended to happen on sharp curves but was not necessarily seen as resulting from this vehicle type.

Rapid rail wear means that on one system the rail on the sharpest curves (60- and 80-ft radius) has to be replaced every 10 years.

Noise

The U.S. transit systems using LFLRVs have not generally experienced any significant noise problems that can be directly related to the use of this type of car.

Two systems have experienced a noisy environment within the vehicles but have either found solutions or consider it to be within acceptable limits. Another system noted problems with wheel squeal but also considered that the noise does not exceed limits.

In general systems may have problems, perhaps only at certain locations, but they have been able to manage them effectively.

Ride Quality

Questionnaire responses were obtained from six transit systems using LFLRVs. All of these said that the ride quality of LFLRVs had not caused any serious issues. Where some rough riding has been experienced it has usually not reached the point at which passengers have complained.

Solutions Applied to Date

Where problems have arisen the transit systems, sometimes with the involvement of the vehicle suppliers, have taken remedial action. In many cases this has been a global action in order to mitigate a number of performance issues simultaneously.

A number of systems have changed the wheel profile, following the introduction of LFLRVs and the emergence of problems. The original profile either being that supplied or one specified because it matched previous practice on that transit system. An example of a modification is shown in [Figure 7](#); in this case the objectives were to improve the steering capability of the wheels and also to increase the flange angle to reduce derailment risk. If the profile is changed and the LFLRVs are only part of a fleet, then the issue arises of the value of having common wheel profiles on a system.

Some transit systems have also modified the rail profile by grinding.

Modifications have been made to the center trucks of some cars to insert different systems for the control of movement in the suspension. Other modifications have included providing more noise insulation and experiments with vehicle-mounted friction modifiers.

Wayside friction-modifying lubrication has been introduced on some systems and flange lubrication is usually provided on exceptionally sharp curves (typically 100-ft radius or less).

Derailment on special track work has been dealt with on one system by applying raised guide rails, known as house tops, which act on the back of the wheel flanges, on fully guarded switches ([Figure 8](#)). This is, however, a relatively expensive solution in some circumstances.

Systems have modified their maintenance procedures and tolerances and introduced speed limits as other means of avoiding some of the problems.

GUIDANCE

Guidance on how transit systems and others can overcome some of the main performance problems was a deliverable of the research.

The guidance is split into sections so that it can be applied by different people at different stages and to different types of system rather than being just a single set of recommendations and parameters. It covers infrastructure as well as the vehicles themselves. It can be seen as state-of-the-art guidance subject to the limitations of this and earlier research programs.

The main causes of derailment that are covered are flange climbing derailment and derailment on switches and crossings. For wear the main causes are high guiding forces due to poor steering capability, constant flange contact on straight track, incompatible wheel and rail profiles, and badly aligned track.

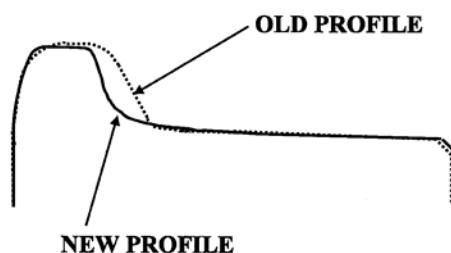


FIGURE 7 Example of a modification to the wheel profile of LFLRVs.



FIGURE 8 Fully guarded switch with added house top protection.

These problems can affect any LRV, but LFLRVs using independent wheels are intrinsically more prone to these problems due to their poorer dynamic performance and sensitivity to external factors.

There are various types or sources of noise and some of these can be aggravated by the use of center trucks with independent wheels. In addition there is less space on this configuration of vehicle to install damping material and the low-floor car body design tends to amplify noise as the floor is nearer to the noise source.

Noise problems can be managed within acceptable limits by a combination of measures, some of which may also relieve the other problems already noted and by solutions that might only be applied locally, such as wayside lubricators on sharp curves or vehicle-borne friction conditioners.

Vehicle ride can be poor because the vehicle configuration may cause the end sections to pitch. This can be eliminated by design of the articulation and linkages between the sections. There are also limitations on the space available on this design of center truck in order to accommodate the suspension elements.

The research identified which design features have the most effect on performance and suggested suitable parameters and tolerances for application in different circumstances. The guidance was based on some suggested fundamental principles that focused on the need for vehicle-track interface compatibility, which is the most crucial requirement for avoiding performance problems.

KEY CONCLUSIONS

To fully understand all the issues associated with the dynamics and performance of center trucks on this type of LFLRV would be a considerable task. Therefore the conclusions of this research project were seen more as observations that have arisen during the course of this work rather than fully evaluated findings:

- Performance issues have arisen during the introduction of LFLRVs into the United States but in all cases they are now being managed reasonably effectively as a result of corrective action. The solutions adopted may not be the optimum ones and certainly not optimum for application in all cases. The problems that have arisen do not appear to be significantly worse than those that have arisen in other parts of the world during the introduction of this type of vehicle.
- There is a distinct difference in the issues associated with introducing these cars onto older systems where the track conditions may not be ideal and new ones where the infrastructure can be built to accommodate them.
- In terms of the vehicle, the performance problems are mainly influenced by the use of independent rotating wheels, rather than the configuration and attachment of the center truck.
- Track standards, including maintenance standards, must be appropriate for this type of vehicle.
- The introduction of LFLRVs into North America has not had the impact that it has in other parts of the world where this concept now dominates. Only one vehicle concept has been generally applied whereas there are other concepts now proving successful elsewhere that might give better overall performance than this one.
- There does not seem to be any significant difference in the standards used in the United States with those used in Germany that is affecting LFLRV performance.
- Lack of standardization in U.S. light rail transit systems makes it more difficult to introduce LFLRV technology, for which the wheel–rail interface parameters are critical. Virtually every system is using a different type or combination of wheel and rail profile.
- The general advice to make sure that the wheel–rail interface is both compatible and managed properly is even more important for this type of vehicle.
- New systems that intend using LFLRVs of the type studied should avoid the extreme track geometry that characterized older streetcar lines.

ACKNOWLEDGMENTS

This paper reports some of the results of the research that was carried out as project C-16 of the TCRP and acknowledgement is due both to the program officer, Christopher Jenks, and to all panel members. Thanks are due to MBTA, MTA Houston, NJT, San Diego Transit, SEPTA, Tri-Met, TTC, and VTA Santa Clara for providing assistance and information for the research.

Thanks are also due to members of Interfleet's team who carried out the research, including John Simpson and Paul Heath, Robin Hazy and Peter Klauser of Raul V Bravo + Associates, Don Holfeld of Zeta-Tech Associates, Bernhard Huber, Martin Schmidt and Roman Häfeli of PROSE AG (Switzerland), Nils Jänig, Steffen Plogstert and Peter Forcher of TTK

(Germany), and Heribert Lehna of the Railway Technical Institute of Berlin University (Germany).

REFERENCES

1. Wu, H., X. Shu, and N. Wilson. Flange Climb Derailment Criteria and Wheel/Rail Profile Management and Maintenance Guidelines for Transit Operations. *Transit Cooperative Research Program Report 71*, Vol. 5. Transportation Research Board of the National Academies, Washington, D.C., 2005.
2. Booz, Allen, and Hamilton, Inc. Applicability of Low-Floor Light Rail Vehicles in North America. *Transit Cooperative Research Program Report 2*, TRB, National Research Council, Washington, D.C., 1995.
3. Nelson, J. T. Wheel/Rail Noise Control Manual. *Transit Cooperative Research Program Report 23*, TRB, National Research Council, Washington, D.C., 1997.
4. Zaremski, A. (unpublished data). Derailment of Transit Vehicles in Special Trackwork, Transit Cooperative Research Program Final Draft Report, TRB, National Research Council, Washington, D.C., July 1996.
5. Marianeschi, M., A. Bandinelli, and A. Aprile. Integrating Low-Floor Technology into a Pre-Existing Infrastructure: Partial Low-Floor Light Rail Vehicle in a Mixed Environment: Lessons Learned from the Manufacture of Boston's Partial Low-Floor Light Rail Vehicle. *Transportation Research Circular E-C058: 8th National Rail Transit Conference*, TRB, National Research Council, Washington, D.C., 2003.
6. Fraser, G. R., R. J. Leary, and M. Marianeschi. Integrating New Light Rail Vehicle Technology into Mature Infrastructure. *Transportation Research Circular E-C058: 9th National Rail Transit Conference*, TRB, National Research Council, Washington, D.C., 2003.

LIGHT RAIL VEHICLE DESIGN AND INNOVATION

Incident-Friendly and Secure Light Rail Vehicle Design

JOHN D. SWANSON
Parsons Brinckerhof

More and more new light rail systems in the United States are operating for substantial distances on city streets where more contact with pedestrians and rubber-tired motor vehicles is inevitable, giving increase to the likelihood of serious accidents. Despite other system changes designed to make the overall system safer such as better barriers, crossing gates, signals, and signage, changes to the basic light rail vehicle designs have been notably absent, even though this is both desirable and technically possible at a reasonable cost provided these requirements are established at the design stage. In addition, ensuring the safety of passengers and operators in and around the vehicle in today's higher-security environment also requires consideration and further modifications to the basic vehicle design. With careful design work, great improvements can be made in light rail vehicle design.

THE DESIGN APPROACH

The Goal: To specify, design, and build an optimal, cost-effective light rail vehicle (LRV) suitable for today's operating environment, with a special emphasis on improved passenger, operator, pedestrian, and motorist safety and security.

The Operating Environment: In creating any light rail vehicle specification, the specific operating environment must always be carefully considered. Worldwide there are three basic types of light rail infrastructure:

1. Isolated rail system with few or no grade crossings. Such systems are usually descended from heavy rail systems utilizing traditional railroad rights-of-way, but are also sometimes created using elevated structures or tunnels or combinations thereof. The light rail systems in San Diego, Salt Lake City, and St. Louis are typical U.S. examples.
2. Integrated rail system running in city streets with many possible points of contact with road traffic. These may range from total integration into street traffic, as may be found in traditional streetcar type operations to totally segregated systems operating in city streets but still exposed to contact with road traffic at intersections. Examples include Toronto, Philadelphia, and Houston.
3. Hybrid system consisting of both types. Typically such systems often run in city streets in the downtown areas but use totally segregated rights-of-way outside the urban core. The light rail systems in Santa Clara, Portland, and Hudson–Bergen are typical U.S. examples.

Another critical factor to consider is whether the system is to use high-floor or low-floor vehicles. Although many existing U.S. light rail systems were built using high-floor vehicles (the only option at that time), there has in recent years been a steady move toward 70% low-floor

vehicles (a development started in Europe some 20 years ago), and no new systems have been designed and built using high-floor cars for some years. The use of low-floor vehicles automatically brings with it low-level platforms that are cheaper to build, less obtrusive in the environment, and safer for passengers from a falls perspective, but which also provide more opportunities for passengers to come into contact with moving LRVs as passengers may freely circulate between the platforms.

It is imperative to note that choice of the basic system infrastructure type and the type of cars, when taken together, creates unique basic overall system characteristics that in turn dictate system-specific levels and types of contact with passengers and road vehicles.

In the case of the Central Phoenix–East Valley light rail transit (LRT) system now under construction, the use of 70% low-floor vehicles combined with the extremely high percentage of segregated but in-street running (98%) meant that there was an increased likelihood of occasional contact between vehicles and passengers at the low-level platforms and with road vehicles at street intersections. This dictated a careful consideration of how the vehicle could be more incident friendly to both pedestrians and motorists, as well as be quick to return to revenue service whenever such incidents might occur.

In addition, the events of September 11, 2001, led to security issues also becoming a major consideration, and last, but certainly not least, the unusual extreme climatic conditions found in the Phoenix area were an important factor.

Once the overall system-specific operating environment was clearly defined, the next step was to investigate current vehicle design approaches with an open mind as to how they might be improved.

Evaluation of Existing Design Approaches

Using the system-specific environmental requirements as a guide, all U.S. 70% low-floor vehicle designs were evaluated in detail to see how well they responded to the system requirements (Figure 1a-d).

At the same time, the latest in European 70% and 100% low-floor vehicle designs were also studied to see what types of design features and safety- or security-related improvements they contained and whether any of these might be transferable to U.S. vehicles (Figure 2a-d).

Accident research was central to making an informed decision as to what approach to take as regards the vehicle structural design. Key findings from the initial phase of this research utilized accident data obtained from the Statistisches Bundesamt Deutschland in Germany where extensive streetcar and S-Bahn systems are in operation. This extensive collection of data showed that vehicles running in city streets had the vast majority of their serious accidents with motor vehicles crossing in front of them or making a left turn into their path. Very occasionally, these vehicles suffered rear-end collisions with other stopped LRVs. All other potential collision scenarios were relatively rare. It was notable that even though these vehicles have only 25% to 30% of the buff strength of typical U.S. LRVs, there were no operator fatalities over the studied period of 8 years and over 5 billion tram journeys, despite the cab area being the prime area of collision impact, and few serious injuries.

Perhaps not surprisingly, vehicles that operated on totally reserved right-of-way had the majority of their serious accidents with other rail vehicles, rear ending of stopped vehicles being the most prevalent. Such incidents were not common, but did occur occasionally.

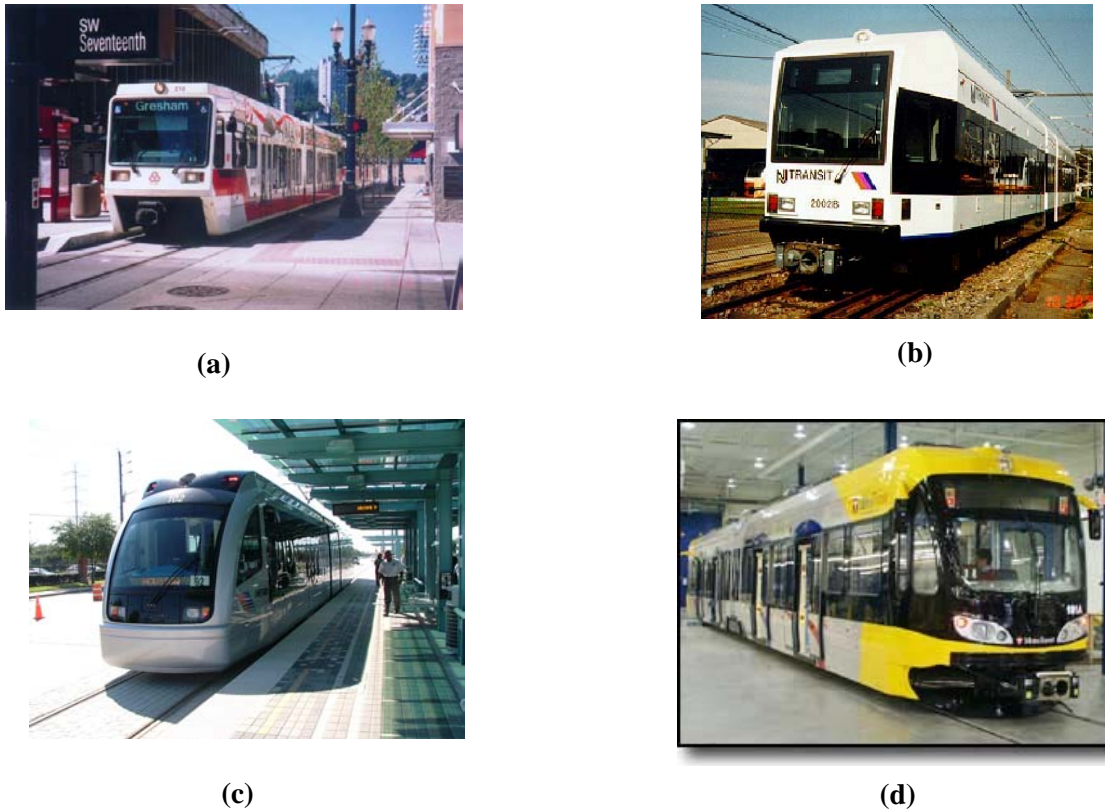


FIGURE 1 U.S. low-floor vehicle designs: (a) traditional design 70% low-floor, Portland; (b) first crashworthiness design, Hudson–Bergen; (c) newer design, Houston; and (d) newer design, Hiawatha.

It was also clear from this research that virtually all the passenger deaths that occurred on such vehicles in collisions were the result of secondary impacts of riding passengers with structures within the passenger area due to the sudden stop, particularly older passengers. More than half the passenger fatalities recorded did not involve another vehicle!

Since this initial study, accidents in the United States involving LRVs have been studied using data from the National Transportation Database and the informal monitoring of various LRT systems, most especially Houston where significant street running occurs. The U.S. data gathered to date strongly correspond to the German experience.

Research as regards light rail vehicle impacts with pedestrians is ongoing as sufficiently detailed information is not readily obtainable, but clearly the more serious situations occur when a pedestrian steps out in front of a vehicle. Not as common, but still a concern (especially with high-floor vehicles), is the area between coupled cars where a passenger might fall when vehicles are stopped at a station.

LRV design, construction, and operational experience, combined with accident research over many years in both Europe and the United States, allowed the identification of areas where design improvements would be desirable. These were then considered both separately and as an organic whole in order to specify the optimal design within a reasonable budget and without unduly affecting operations and maintenance.



(a)



(b)



(c)



(d)

FIGURE 2 European low-floor designs: (a) Strasbourg 100% low floor; (b) Chemnitz 100% low floor; (c) Cologne 70% low floor; and (d) Grenoble 70% low floor.

Desirable Design Improvements

For the Phoenix LRT system LRVs, the following desirable design improvements were identified, many of which would also be desirable for other LRT systems:

1. Improved safety for passengers and pedestrians in case of contact with LRV. Existing cab-end designs are too angular with protruding anticlimber ribs and autocoupler. There are no fairings or other guards lower than anticlimber level to prevent pedestrians from going under the LRV. Generally, the cab front is not designed to deflect passengers from the LRV's path or to minimize injury to pedestrians.

2. Improved safety for motor vehicles in case of contact with LRV. Existing LRV designs have a protruding autocoupler that acts as a battering ram and concentrates impact forces on motor vehicles due to the relatively small contact area, even though these couplers are shock absorbing. Again no significant fairings or bumpers, etc., are provided to prevent motor vehicles from going under the LRV, possibly also derailing it. Again, the cab front is not designed to minimize damage to motor vehicles or injury to motor vehicle occupants (addressed to some degree by new designs for Houston and Minneapolis).

3. Improved safety in the interior of LRVs in case of sudden stops. Interiors are not designed to cope with secondary impacts of passengers into interior fittings following sudden stops. Interior furniture is too angular and stainless steel grab-handrails have no resilience. Often seats are of stainless steel construction for durability and vandal resistance but unyielding in collisions. Operators usually are injured by being thrown from the seat in a collision.

4. Improved visibility of platforms by LRV operators. Traditional rear-view mirrors are inadequate to properly monitor all doors on a multi-unit train that may be nearly 300 ft long. Direct replacement of mirrors by cameras on some vehicle designs is an improvement, but these still suffer the same coverage problem as mirror designs.

5. Improved visibility of platforms by passengers. Passenger doors usually are solid in the bottom half and not always full width in the top half, restricting passenger view of the platform as the vehicle comes to a halt.

6. Improved security for passengers traveling in the coupled vehicles of a train. Existing designs have basic passenger to operator intercoms, but the operator has no visibility of what is going on anywhere except directly behind his cab. Cab partition windows usually are minimal, further restricting both operator view rearward and passenger view forward.

7. Improved security monitoring of vehicle exterior and interior. There is no facility for recording or monitoring activities either inside or outside the vehicle, making accident investigations and prosecution of vandalism or other criminal acts more difficult.

Implementation of Design Improvements

Implementation of design solutions to incorporate the desired improvements proved to be an iterative process as is common with new developments. It is important to recognize that such solutions always contain a certain level of compromise as it is never possible for all conflicting requirements to be resolved. Ease of use, reliability, simplicity, and maintainability, as well as the overall cost of such changes, were all significant considerations. Similarly, the solutions sought were based to some degree on what was thought to be desirable, but this is not always provable as inadequate research data exist to establish such needs unequivocally.

In a number of instances, design approaches already in use in Europe were used, but were significantly modified to meet the specific operational requirements of U.S. light rail systems. In some cases, safety design approaches used by the automotive industry were applied. In other cases, entirely new systems had to be developed using state-of-the-art technology.

Improvements in safety for pedestrians and road vehicles potentially in the path of LRVs have been approached as an organic whole. Utilizing developments undertaken by the ASME RT-1 standards committee, combined with experience with U.S. and European rail and automotive crashworthiness solutions, has led to the specification of an improved multistep collision energy management system design for Phoenix with the following features:

- Stage 1: This consists of a smooth, rounded resilient bumper cover to absorb low-level impacts with pedestrians and deflect them out of the path of the vehicle. This is combined with a totally enclosed cab front with no protruding sharp objects or couplers to prevent them from going under the vehicle and reduce injuries due to impact. The autocoupler is folded and stowed out of sight. Anticlimbers are covered with a rounded sacrificial shrouding. The usual truck-mounted obstacle deflector remains as a final defense should the cab front somehow fail to deflect the pedestrian ([Figure 3](#)).

- Stage 2: This consists of a full-width shock-absorbing bumper across the full front of the vehicle (for the first time in the United States) to absorb impact forces arising from LRV to motor vehicle collisions ([Figure 4](#)). Bumper height matches those of motor vehicles. Use of a bumper also necessitates use of a folding autocoupler that is stowed and secured behind the bumper. To minimize operational impact when coupling LRVs, the bumper assembly is raised

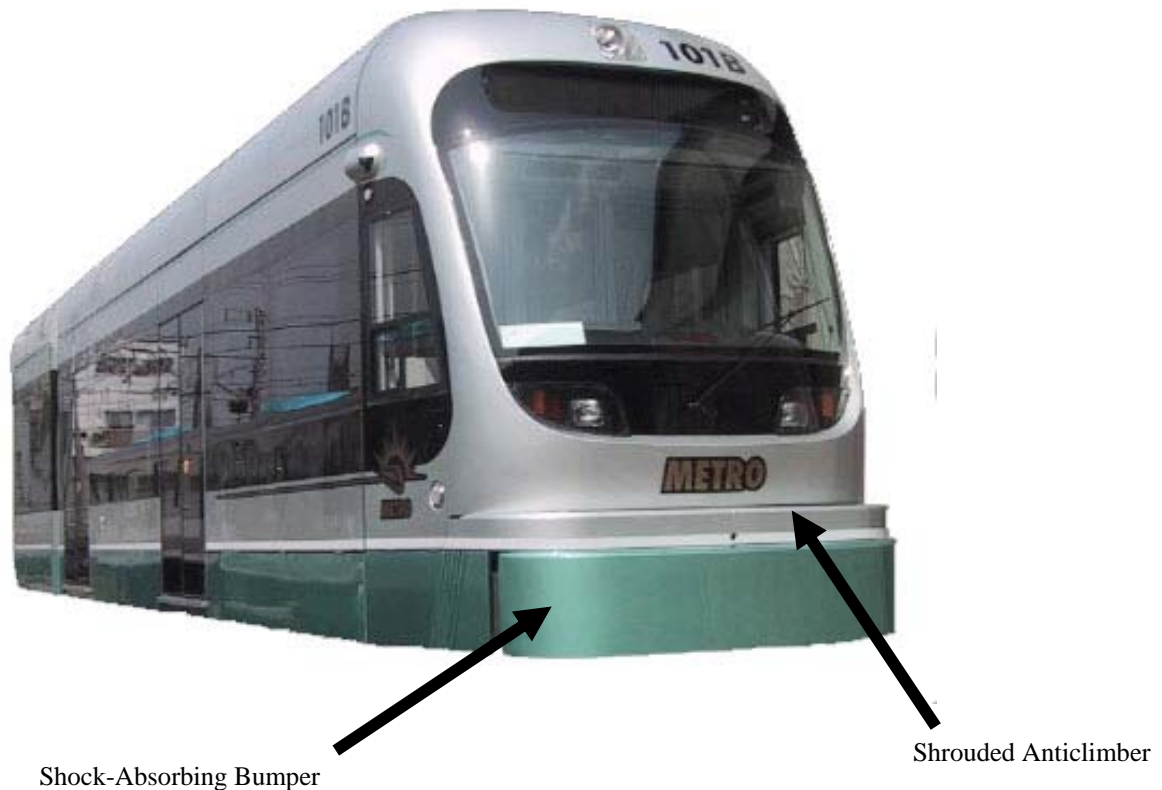


FIGURE 3 Parts of an improved multistep collision energy management system.

using a power assist (due to the weight of the bumper) while the coupler is simply unfolded manually. In most cases, following a collision, the bumper unit will automatically restore itself to operating condition, but in case of very severe impacts, the complete bumper assembly can be quickly replaced and the vehicle returned to revenue service.

- Stage 3: This provides a controlled collapse energy-absorbing cab structure with a guaranteed operator survival space (Figure 5). Included in this design is a reduction in the overall vehicle structural strength over anticlimbers from the traditional “2g” [which varies according to vehicle weight and can be up to 200,000 lb (890 kN)] to 90,000 lb (400 kN), as was first implemented in the United States on the LRVs for Hudson–Bergen and Newark City Subway. This allows the cab to deform under severe collisions before any significant loads are imposed on the passenger areas that retain the traditional 2g strength. (Note that such cab designs require impact forces to reach over 2g before collapse is initiated.)

As a bonus, these safety improvements also led to a design that is aesthetically pleasing. Note that these changes were deliberately limited to the cab area only and do not significantly impact the design of the majority of the structural components making up the basic car shell, thus helping minimize the cost of implementation.

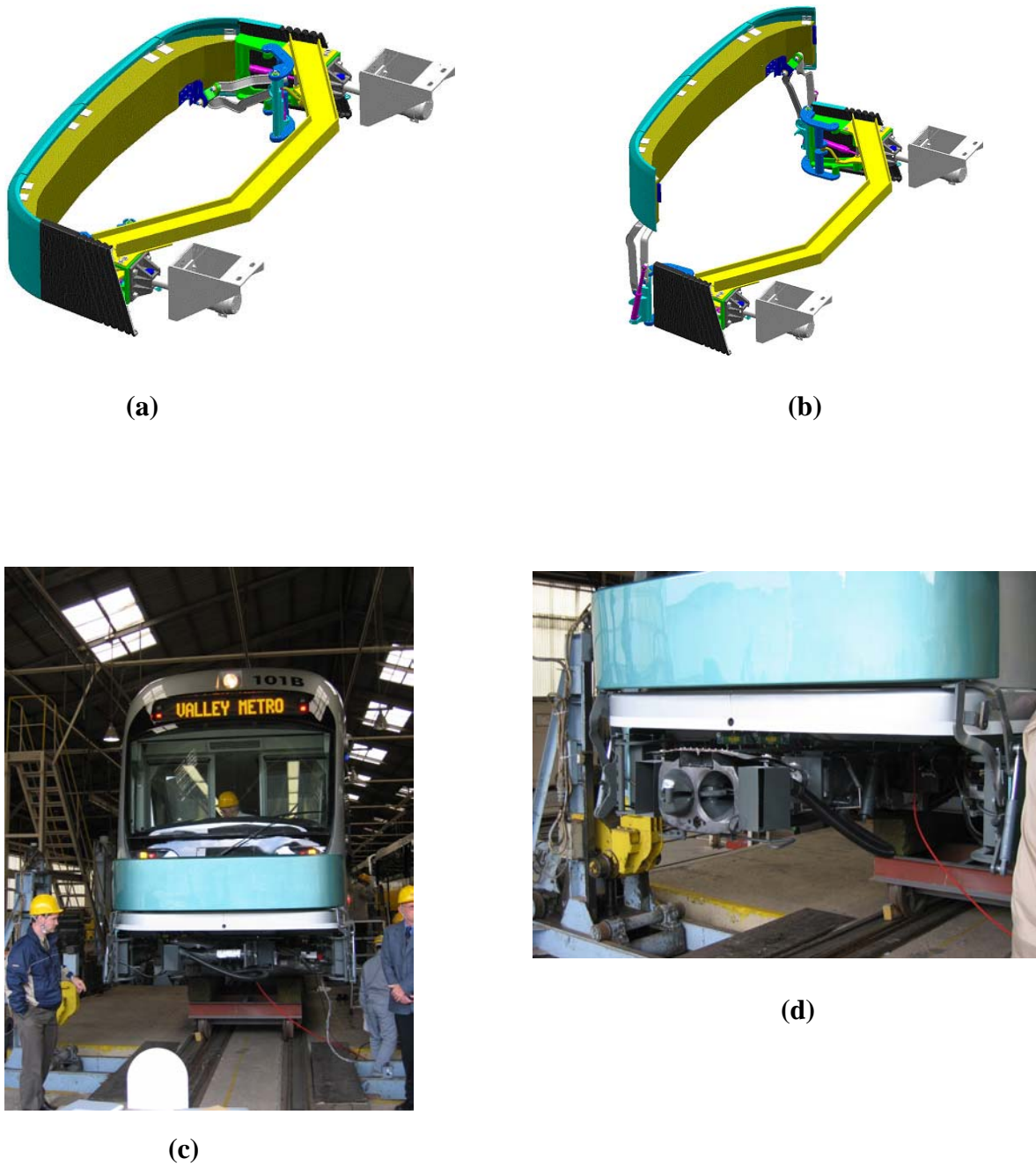


FIGURE 4 Full-width shock-absorbing bumper: (a) shock-absorbing bumper closed; (b) shock-absorbing bumper raised; (c) bumper raised, bumper still folded; and (d) bumper raised, coupler extended.



FIGURE 5 Controlled collapse cab structure prior to crash test.

Interior safety in collisions was a thornier issue. The many conflicting requirements made this a difficult area to significantly improve given today's level of technology. A suite of changes was implemented that is expected to improve interior safety, but it is acknowledged that more improvement is still possible. These include the following measures:

- Elimination of sharp edges inside the vehicle to minimize secondary injuries arising from sudden stops.
- Cantilevered seats attached to car shell sides, which remove aisle support legs that in turn remove possible impact points while making items underneath seats more visible and the vehicle easier to keep clean (Figure 6a–b).
- Addition of grab rails on seat backs and other handholds throughout the vehicle interior to better support standees (Figure 7).
- Addition of resilient grab handles on seat backs to cushion impact in case of sudden stops.
- Illuminated edges on steps to high floor area to minimize trip hazard on steps (Figure 8).
- Use of fiberglass seats built to 2g rear impact standards with slightly cushioned inserts that are more forgiving in impact scenarios than stainless steel seats.
- Fitting of a seat belt to the operator's seat to keep the operator in his seat during collisions.



(a)



(b)

FIGURE 6 New seating: (a) comfortable cantilevered seats and (b) seats attached to car shell sides.

Improved operator viewing of platforms borrowed the European approach of providing video cameras at each cab end of a vehicle, giving the operator a clearer view of passenger activities at doorways, especially at the other end of the vehicle. While readily implemented on single vehicles, the standard U.S. operational practice is to create trains of between one and four vehicles. To provide a similar functionality thus requires the ability to train-line video signals through the train autocouplers. To provide this ability required the new development of inductively coupled “Etherpins” that allow twin 100-base T Ethernet lines to pass through the autocoupler (Figure 9). This has opened many video and digital audio capabilities throughout the whole train that are only starting to be exploited. For the Phoenix vehicle these video security enhancements include:

- Rear-facing exterior cab cameras at both ends of the train that provide the operator with a view of the platform from both ends of the train, greatly improving his view of boarding and alighting passengers at platforms.



FIGURE 7 Multiple grab handles.



FIGURE 8 Transition from low- to high-floor area.

- Forward-facing exterior cab cameras that continuously record all activities to the front of the lead cab to assist in accident investigation and operator safety training.
- Passenger-area interior cameras located in passenger information displays and in the cab back partitions that continuously record all activity inside the vehicles for a period of 48 h to assist in incident investigations such as vandalism and accidents (Figure 10). These images are not available to the train operator so as to not distract from normal duties and to prevent possible abuse of the system.
- Activation of the passenger-to-operator intercom (POIC), which for the first time allows the operator to view and record as well as hear activities in the area surrounding the passenger activating the POIC in any vehicle in the train by using the two local interior cameras



FIGURE 9 Etherpin installation on test.

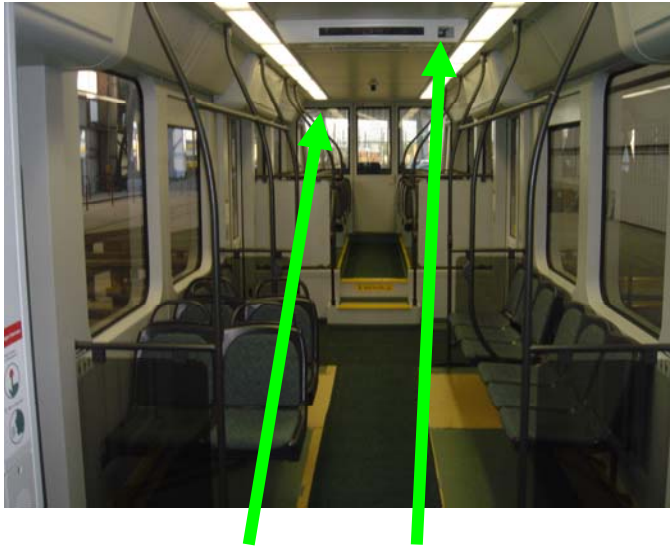


FIGURE 10 Interior video cameras.

which best cover the active POIC. These video images are not displayed until the operator specifically allows this using a separate button. As in existing systems, a two-way audio link is established immediately.

- A coupler camera for when the operator's field of view of the autocoupler is obstructed by the raised shock-absorbing bumper assembly when coupling cars. The coupler camera is provided (and recorded) to assist in this operation.

Although not yet implemented, consideration is being given to future real-time streaming of video images from any vehicle in distress to the operations control center (OCC) and security personnel.

Visibility of platforms by passengers (and visibility of them from the vehicle exterior) is another important safety and security issue that may not be so obvious. Passengers need to see where they are (in addition to the on-board passenger information displays) so they can position themselves near the door and see the platform before the doors open to mentally prepare themselves to step out while avoiding others coming into the vehicle. Similarly, waiting passengers (and security personnel) outside the vehicle need to see passengers inside the vehicle. The Phoenix vehicle incorporates the following enhanced visibility features:

- Fully glazed passenger doors to provide maximum visibility for passengers, light and airy illumination of the vehicle interior, and easy identification of door locations to those on the platform (Figure 11).
- Larger bodyside windows to provide better views, with medium tinting and solar reflective coatings to improve thermal performance while not obscuring visibility in or out of the vehicle.
- Large interior windows in the cab back partition to improve passenger view forward (Figure 12).



FIGURE 11 Fully glazed doors.

Other safety and security improvements provided for the Phoenix vehicle include:

- A covert alarm system that automatically alerts OCC staff, continuously records all active cab conversations, and activates a shielded, blue, roof-mounted strobe to allow police helicopters readily to identify the vehicle where the incident is taking place. This alarm can only be reset by the OCC.
- An improved ergonomic layout of operator controls and monitors to make operation of vehicles more intuitive, less distracting, and more operator friendly (Figure 13).



FIGURE 12 Glazed cab back partition with wide windows.

- A seat-mounted joystick master controller configured to brake in the forward position. (Momentum in a sudden stop scenario tends to throw the operator forward.)

The exact cost of all these changes is difficult to quantify as the contract price for LRVs in the United States tends to be more market driven than bottom-up cost driven. The current cost of the Phoenix LRVs stands at \$2.94 million per car, which compares well with recent LRV procurements of a more traditional design for Seattle and Charlotte, which were both more expensive.

RESEARCH CONCLUSIONS

It is believed that the technology exists to provide an LRV design that is both more incident friendly and more secure at a reasonable cost provided these requirements are identified early and incorporated from the beginning into the vehicle design. In the case of the vehicle for Phoenix, we believe that significant advances have been made in the safety and security design of these vehicles while maintaining a reliable and maintainable vehicle at a competitive cost, but it is equally recognized that further improvements are possible. It is also evident from this work that further scientifically based research, particularly in the area of crash energy management for LRVs, is long overdue and lack of this information is hampering widespread adoption of mutually agreed standards that would lead to safer vehicles, just as a 2006 model automobile is a much safer car than a 1955 model.



FIGURE 13 Ergonomic cab with video monitoring.

SOURCES OF INFORMATION

Accident data from Statistisches Bundesamt Deutschland, 1991–1998.

Accident data from National Transportation Database.

Author-collected information regarding LRV accidents from public sources, newspapers, websites, magazines, etc.

Design review and systems development of the new 70% low-floor LRV currently in build by Kinki-Sharyo LLC for Valley Metro Rail in Phoenix.

Numerous white papers, presentations, and studies undertaken by the author over the last 7 years on behalf of the ASME RT-1 Standards Committee, Central Phoenix–East Valley LRT (Valley Metro Rail), Orange County CenterLine LRT, and Seattle–South Lake Union Streetcar and presented at APTA, ASME, IEEE, and other conferences. Related published papers include:

- *Light Rail Vehicles and Running Safety*. ASME/IEEE 2002 Joint Rail Conferences Proceedings.
- *Running Safety and Light Rail Vehicles 2*. APTA 2002 Rail Transit Conference Proceedings.
- *Advanced Light Rail Vehicle Communication System Design*. ASME/IEEE 2003 Joint Rail Conference Proceedings.

Planning and Urban Integration

PLANNING AND URBAN INTEGRATION

Innovative Traffic Control Practices for Light Rail Transit *A European Perspective*

JOSÉ IGNACIO FARRÁN
Wilbur Smith Associates

Descendants of the streetcar, light rail vehicles (LRVs) have their own distinct characteristics, including a broad range of operating environments (both on-street and in semi-exclusive or exclusive rights-of-way) and a wide extent of typical operating speeds (from 15 to 60 mph). This flexibility, coupled with passenger attraction and capacity of the vehicles, has made light rail an increasingly viable public transportation option.

Accommodating light rail transit (LRT) in these multiple environments while maintaining or improving safety has led transportation planners and engineers to utilize a variety of innovative traffic control practices. These practices are used to manage conflicting movements with LRVs and to provide motorists, as well as pedestrians and bicyclists, with better information upon which to base their decisions. Over the years, traffic engineers and transportation planners in the United States have implemented a number of practices to minimize potential conflicts with LRVs, but because increased LRT safety is a worldwide need, other countries, particularly in Europe, have also implemented their own traffic control practices, which may have current or future value to LRT agencies in the United States.

This paper examines and describes the observations resulting from visits to four LRT systems in Southwest Europe, where the author had the opportunity to observe firsthand traffic engineering practices related to solving LRT conflicts with motor vehicles, pedestrians, and bicyclists. Those practices that could have the greatest potential for implementation in the United States are identified.

INTRODUCTION

A key strength of light rail transit (LRT) is its ability to integrate well into an urban environment sharing the public right-of-way (ROW) with motorists, bicyclists, and pedestrians. It is this characteristic that makes LRT successful in those urban corridors where a high-capacity mode of transportation is required to operate well in both an exclusive and a shared right-of-way. Although LRT is an inherently safe mode of transportation, accidents sometimes do occur, negatively affecting not only the parties involved in the accident, but also the entire operation of the LRT system and the reputation of the transit property.

According to past research conducted by the author (*1*), accidents between pedestrians and light rail vehicles (LRVs) are the least prevalent type of LRT-related accidents, representing approximately 10% of the total, but are the most severe and account for at least 50% of all fatalities resulting from LRT accidents. The interactions between pedestrians and LRVs are substantially different from those between motorists and LRVs. In general, motorists tend to be more aware of their environment, while pedestrians, traveling in the relatively safe venue of

protected sidewalk areas, do not routinely share the same continuous attentive edge. Moreover, unlike motor vehicles, LRVs cannot swerve or stop quickly enough to compensate for pedestrians who are errant or disobedient of traffic control devices.

The same research indicated that the single most frequent LRV–motor vehicle accident type involved motorists turning in front of overtaking LRVs (i.e., LRVs traveling in the same direction as the motor vehicle), where vehicles turning in front of LRVs accounted for 57% of all collisions (including those involving pedestrians) and almost two thirds of all motor vehicle–LRV accidents.

Possible strategies to minimize LRV–pedestrian and LRV–motor vehicle conflicts are summarized in [Table 1](#). These solutions address the types of situations identified above and underscore the need for establishing a set of principles and guidelines to achieve greater uniformity and consistency in implementing a safer LRT system.

The following sections of this paper provide a summary of pedestrian and traffic control designs and practices that have been applied to recently opened light rail systems in France and Spain to address the types of conflicting motor vehicle and pedestrian movements with LRVs described above.

TABLE 1 Possible Solutions to Observed Conflicts

Situation	Possible Solution
Pedestrian Conflicts	
<ul style="list-style-type: none"> • Low level of pedestrian awareness 	<ul style="list-style-type: none"> • Install LRV-activated signs and signals • Install LRV-specific passive signage
<ul style="list-style-type: none"> • Poor definition of pedestrian pathways 	<ul style="list-style-type: none"> • Delineate dynamic envelope by contrasting pavement color and/or texture or paint
<ul style="list-style-type: none"> • Cross-street access 	<ul style="list-style-type: none"> • Provide adequate storage/queuing/refuge space • Install positive pedestrian control devices (automatic gates, swing gates, bedstead barriers, or Z-crossings)
Motor Vehicle Conflicts	
<ul style="list-style-type: none"> • Illegal turns across tracks 	<ul style="list-style-type: none"> • Provide left/right-turn phase after through-LRV phase • Limit multiple LRV preemptions within same cycle • Install active “LRV APPROACHING” signs • Increase passive signage and striping • Provide photo enforcement
<ul style="list-style-type: none"> • Right-angle conflicts 	<ul style="list-style-type: none"> • Increase clearance intervals for cross-street traffic • Modify or limit LRV preemption to maintain cross-street progression • Install LRV-activated signs or signals • Provide photo enforcement
<ul style="list-style-type: none"> • Motor vehicle blocking of LRT crossing 	<ul style="list-style-type: none"> • Delineate dynamic envelope by contrasting pavement color and/or texture or paint • Increase enforcement
<ul style="list-style-type: none"> • Confusing LRT signal indications 	<ul style="list-style-type: none"> • Provide distinctive LRT signal aspects that are placed at separate locations from motor vehicle signal heads

CASE STUDIES OF LRT SYSTEMS

Over the past few years, several cities in Southwestern Europe have opened new LRT systems in order to relieve congestion, help in the redevelopment of emerging areas, provide alternative transportation infrastructure to the automobile, and improve air quality. The four cities described in this paper as case studies (Bordeaux in France, and Barcelona, Bilbao, and Valencia in Spain) represent four examples of reintroduction of LRT after the abandonment of the traditional streetcar system during the second half of the 20th century. In all four cities, both motor vehicles and LRVs operate on the right-hand side of the road, like in the United States.

Bordeaux, France

The original electrical streetcar network within the city of Bordeaux opened in 1900 and provided service until 1958. Construction for a completely new LRT system in Bordeaux started in February 2000 and operation commenced 46 months later. The current Bordeaux LRT system consists of three major phases ([Figure 1](#)) (2). Phase 1 includes three lines, 47 stops, and 22.5 km of track. Line A operates from Mériadeck to Cenon and Lormont, Line B operates from Quincoces Square to the University campus, and Line C operates from Quincoces Square to the St. Jean railroad station.

Line A was opened for service in December 2003. Line C was opened for service in April 2004 and Line B opened in July 2004. Phase 1a, a 2.5-km extension of Line A to the Bordeaux's regional medical center near St. Augustin with six additional stops, opened for service in September 2005. Phase 2 is currently planned for opening in mid-2007 and includes extensions of all three lines, adding 31 stops and 19 km of track.

Entire system: 44 km total length with 84 stops:

- Three lines in operation:
 - Line A—Cenon–Lormont to St. Augustin (13 km),
 - Line B—Quincoces to Pessac (8.5 km), and
 - Line C—Quincoces to Gare St. Jean (3.5 km);
- Service: 5- to 10-min headways;
- Rolling stock: 44 low-floor Alstom Citadis LRVs; and
- First opened for service: December 2003.

Most of Bordeaux LRT alignment is double tracked and operates in the median, segregated from adjacent traffic except at intersections (semi-exclusive alignment). LRVs operate in a pedestrian mall environment in the old town quarter. The surrounding environment changes from intense urban to suburban as the lines move away from the downtown to the nearby suburbs of Bordeaux.

Barcelona, Spain

Barcelona, the capital of the Catalunya region of Spain, opened a completely new light rail system in April 2004 to expand and support its extensive subway, bus, and commuter rail system. Known locally as the *Trambaix* and *Trambesòs*, these two light rail lines represent the introduction of modern light rail service in Barcelona after the abandonment of conventional streetcar service more than 30 years prior. The alignments of the Trambaix and the Trambesòs lines are shown in [Figure 2](#) (3). Both lines operate mostly in double-track semi-exclusive, median running, and urban environment.

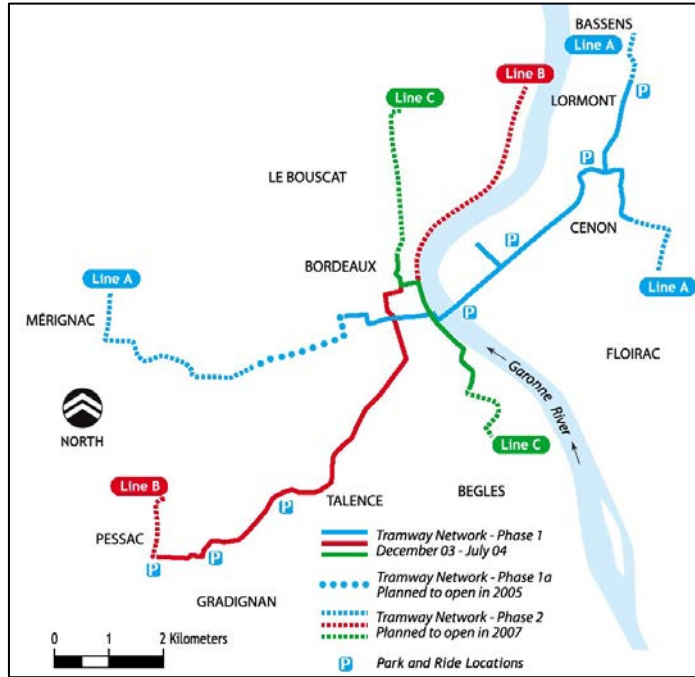


FIGURE 1 Bordeaux LRT system, France.



FIGURE 2 Trambaix and Trambesòs LRT systems, Barcelona, Spain.

Trambaix: 16 km total length with 28 stops:

- Three branches:
 - T1—Cornellà (11 km),
 - T2—St. Joan Despí (12 km),
 - T3—St. Just Desvern (11 km);
- Service: 5- to 10-min headways;
- Rolling stock: 20 low-floor Alstom Citadis LRVs; and
- First opened for service: April 2004.

Trambesòs: 14 km total length with 14 stops:

- One branch currently in operation:
 - T4—Ciutadella/Vila Olímpica to St. Adrià (7 km);
- Service: 5- to 10-min headways;
- Rolling stock: 8 low-floor Alstom Citadis LRVs; and
- First opened for service: May 2004.

Bilbao, Spain

Bilbao, the capital of the Basque Country, opened a new starter LRT line in December 2002, bringing back a streetcar system that had been abandoned since 1964. Known locally as *EuskoTran*, the starter segment between Atxuri and Uribitarte includes 2 km of mostly single track (due to the narrow streets in the old part of town) with passing sidings and six stops. In April 2003, the line was extended one stop, from Uribitarte to the Guggenheim Museum, and in July 2003 it was extended four stops further south from Guggenheim to San Mamés. In July 2004, the final segment (San Mamés–Basurto) was opened for service. The segment between Uribitarte and Basurto includes 3 km of double track and six stops. Line A, as the LRT line is officially designated (Figure 3), connects downtown Bilbao and the waterfront with the Guggenheim Museum, the University campus, and a large medical complex in Basurto.

Line A: 5 km total length with 12 stops:

- One branch:
 - Single track with sidings—Atxurri–Pío Baroja (1.5 km), and
 - Double track—Pío Baroja–Basurto (3.5 km);
- Service: 10-min headways;
- Rolling stock: 8 low-floor CAF LRVs; and
- First opened for service: December 2002.

Valencia, Spain

In 1994, *Ferrocarrils de la Generalitat Valenciana* reintroduced light rail service in Spain in the city of Valencia, from where it had disappeared in 1970. Officially designated as Line 4 (Figure 4), the first segment between Dr. Lluch and Ademuz (now Empalme) opened in May 1994. This segment is 10 km in length, double tracked, and includes 21 stations. The line connects the Mediterranean coast at El Grao with the University campuses and the downtown.

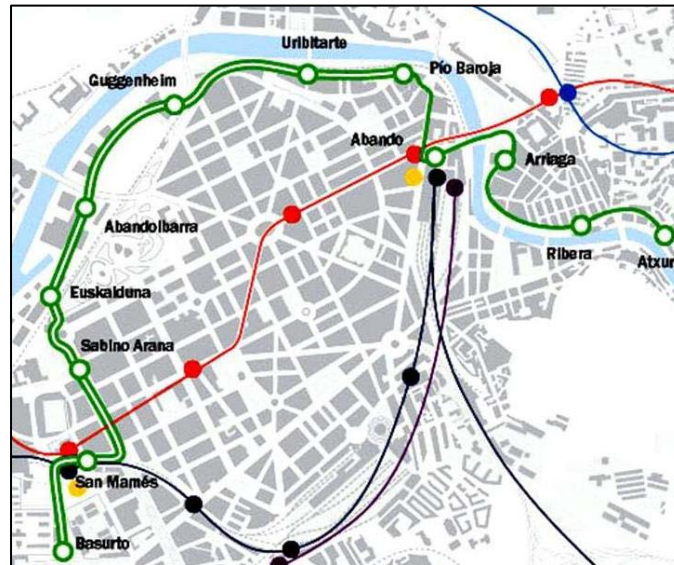


FIGURE 3 EuskoTran LRT system, Bilbao, Spain.

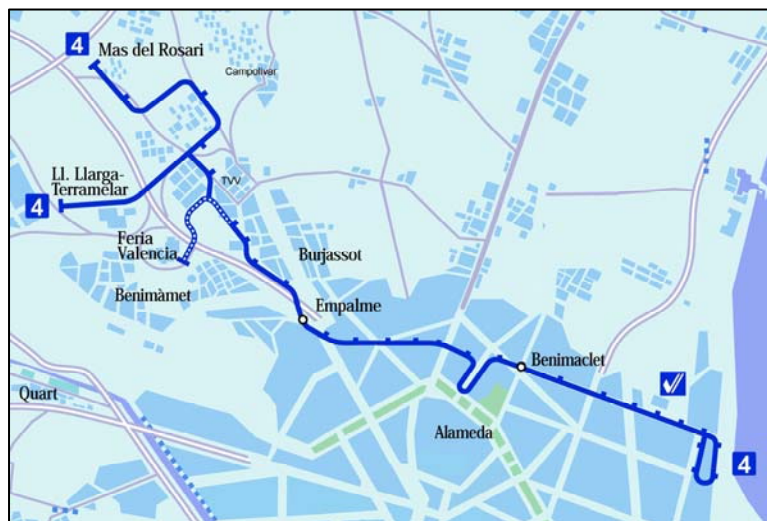


FIGURE 4 Valencia LRT system, Spain.

In March 1999, the line was extended to the Valencia TV (TVV) area. The new 2.5-km double-track segment has five stops and services medical facilities, as well as a university campus and several large employment centers. In September 1999, a new 0.8-km double-track branch went into operation connecting to the city's convention center (Feria Valencia). In the summer of 2003, work started on a new extension from the TVV station toward the northwest corner of the city, to service the neighborhoods of Mas del Rosari and Loma Llarga–Terramelar. The 3-km five-stop double-track segment to Mas del Rosari opened in September 2005.

Line 4: 17 km total length with 33 stops:

- Three branches:
 - Mainline—Dr. Lluch—Mas del Rosari (15.5 km),
 - Feria Valencia (0.5 km), and
 - Ll. Llarga—Terramelar (1 km);
- Service: 7- to 10-min headways;
- Rolling stock: 24 unidirectional low-floor Alstom-CAF LRVs; and
- First opened for service: May 1994.

OVERVIEW OF SOLUTIONS

The four LRT properties described in the previous section are examples of LRT renaissance in cities where the historic streetcar systems had been abandoned for more than 30 years. Thus, the transit planners and traffic engineers responsible for implementing the new LRT systems in these cities had to consider how to present a clear and uniform message about the presence of a new mode of transportation sharing the public ROW with which neither motorists nor pedestrians were familiar.

The following paragraphs describe the observations resulting from visits to these LRT systems, where the author had the opportunity to observe firsthand many traffic control and traffic engineering practices related to solving LRT conflicts with motor vehicles, pedestrians, and bicyclists in a manner consistent with the solutions presented in [Table 1](#).

Pedestrian Conflicts

Devices to control pedestrian travel across LRT tracks and warn about the presence or approach of an LRV can be grouped under three major categories (4): regulatory and warning devices (both passive and active), delineation markings, and positive control devices.

Pedestrian Crossing Regulatory and Warning Devices

Pedestrian crossing regulatory and warning devices include signs, pedestrian signals, flashing light signals, and audio devices. Signs used at LRT crossings are typically fixed standard signs, such as the railroad cross buck or the LRV symbol, or LRV-activated internally illuminated signs depicting words or graphic symbols. LRV-activated internally illuminated signs warn pedestrians of the increased risk associated with violating the crossing in the presence of an LRV. [Figure 5](#) shows an example of an LRV-activated internally illuminated warning sign in Valencia depicting the international LRT crossing warning sign. The sign is installed where substantial pedestrian presence is expected.

Supplemental warning plaques are also used extensively in the European cities evaluated in this paper. [Figure 6](#) shows an example of an LRV warning sign used in the Barcelona LRT system, in combination with pedestrian traffic signal heads, while [Figure 7](#) shows a similar sign installation in Bordeaux at a pedestrian-only crossing. The intent of the signs is to clearly alert pedestrians about the possibility of LRVs approaching the crossings from both sides, and they are normally installed at all pedestrian crossings.

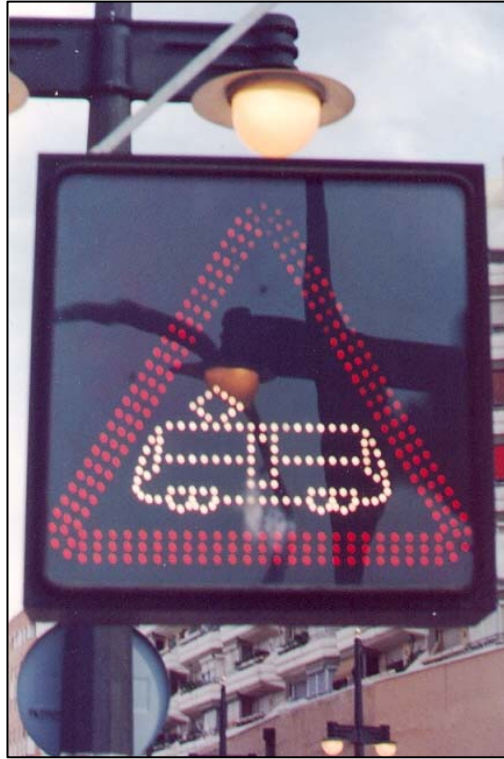


FIGURE 5 LRV-activated internally illuminated warning sign, Valencia, Spain (urban environment, median operation).



FIGURE 6 Two-way LRV warning sign with LRV symbol, Barcelona, Spain (urban environment, median operation).



FIGURE 7 Two-way LRV warning sign with LRV symbol, Bordeaux, France (urban environment, median operation).

Pedestrian crosswalk signals in all of these cities are similar to those installed at non-LRV crosswalks, with internally illuminated heads depicting the pedestrian “WALK” and “DON’T WALK” symbols. The city of Bordeaux, however, has installed LRV-specific regulatory signals at key locations with heavy pedestrian usage, such as the pedestrian mall in the old town area (Figure 8), to emphasize the impending arrival of a train and raise the pedestrian awareness about the prohibition to cross the street. The signal is normally blanked out and becomes activated by the approaching LRV.

Pedestrian Crossing Delineation Markings

Delineation markings direct pedestrians to cross LRT tracks at a designated location. Pedestrian path delineation can be accomplished with line striping, differential pavement color or texture, contrasting surface materials, or landscaping. Delineation is also used to mark the edge of the dynamic envelope of the LRV, that is, the clearance on either side of an LRV required for the overhang resulting from any combination of loading, lateral motion, or suspension failure. Figures 9 and 10 show a combination of line striping, contrasting color, and differential pavement texture used in Barcelona and Bilbao to delineate the LRV dynamic envelope, typically installed at all crossings.

In addition to the dynamic envelope delineations shown in Figures 9 and 10, arrow striping indicating the direction that LRVs typically traverse the crossing is also used extensively in Barcelona at all pedestrian crossings to warn pedestrians and help them look in the most appropriate direction (the opposite from where the arrow is pointing) before they walk onto the track area. The arrow in combination with the LRV symbol is striped between the two rails for a



FIGURE 8 LRV-activated pedestrian signal (regulatory), Bordeaux, France (urban environment, pedestrian mall operation).



FIGURE 9 LRV dynamic envelope delineation, Barcelona, Spain (urban environment, median operation).



FIGURE 10 LRV dynamic envelope delineation, Bilbao, Spain (urban environment, median operation).

given LRV direction immediately downstream of the pedestrian pathway. A single arrow is used where LRVs typically operate in a single direction (Figure 11), while two arrows are used when LRVs typically operate two-way in a single track (Figure 12).

Pedestrian Crossing Positive Control Devices

Positive control devices provide a physical barrier between the outer edge of the LRV dynamic envelope and the area where it is safe for pedestrians to congregate. These devices can be fixed or moveable. Figure 13 shows a bedstead barrier crossing in Bordeaux. The barriers are placed in an offset, maze-like manner that requires pedestrians moving across the LRT tracks to turn toward the direction of approaching LRVs before they cross each track. The bedstead barriers shown in Figure 13 are used in combination with pedestrian signals and supplemental warning plaques.

Motor-Vehicle Conflicts

Motor-vehicle conflicts with LRVs include illegal left- or right-turns across the tracks, right-angle conflicts, motor vehicles blocking the LRT crossing, and confusing LRT signal indications to motorists. This section describes several traffic control devices implemented in the European LRT systems to address these conflicts.



FIGURE 11 LRV directional striping (warning) on a one-way track, Barcelona, Spain (urban environment, median operation).



FIGURE 12 LRV directional striping (warning) on a two-way track, Barcelona, Spain (urban environment, median operation).



FIGURE 13 Bedstead barrier midblock crossing (regulatory), Bordeaux, France (urban environment, median operation).

Illegal Turns Across Tracks

Prevention of illegal motor vehicle turns across the LRT tracks is a very important element for the safe operation of an LRT system. Moreover, this type of collision is the most severe, because the door of the motor vehicle is the only protection between the driver or the passenger and the LRV. Therefore, turns across the LRT tracks should be carefully considered during the planning and design phases of a new LRT system or the extension of an existing system.

The LRT properties discussed in this paper have devised different types of signs to warn motorists about the presence of the LRT tracks and the increased risk associated with violating the traffic signal or signs. Valencia, for example, has installed internally illuminated signs with the “LRV APPROACHING” symbol shown in [Figure 5](#) at key crossings, which are then activated by an approaching LRV.

Barcelona has devised a combination of signs, striping, and supplementary devices intended to minimize illegal left turns, which is shown in [Figure 14](#); these are installed at most crossings. As indicated in the figure, two consecutive “NO LEFT TURN” signs are placed on the left-hand side of the road, in combination with an LRV symbol warning sign and a supplementary plaque. The furthest “NO LEFT TURN” sign is mounted at the top of a white bollard at a height of approximately 3 ft, well within the motor vehicle driver cone of vision. Both the sign and the bollard are made of flexible plastic material glued to the pavement. In addition, the width of the intersection has been narrowed as much as possible by installing additional green flexible plastic bollards that are glued to the pavement so that the driver recognizes more clearly the left-turn prohibition. All the bollards are fitted with retroreflective stripes for improved nighttime visibility. Finally a straight arrow striping is located on the travel lane to further emphasize the turn prohibition. A similar intersection design had also been implemented in Bilbao.

Alternately, other LRT properties have installed a combination of regulatory and guide signs that emphasize the turn prohibition while directing motorists to the most appropriate location to make the turn. An example of such application is shown in [Figure 15](#) for Valencia.

Although the traffic control devices shown in [Figures 14](#) and [15](#) have proven very effective at most locations, a handful of intersections experienced a high number of collisions between motor vehicles and LRVs, shortly after start of operation of the LRT system (5). These collisions took place at locations where left turns were prohibited as a result of the implementation of the LRT. The configuration of these crossings, sometimes at roundabouts, made it difficult to apply some of the standard solutions already developed to address left-turn violations, such as installation of plastic bollards. As a result, Barcelona has added additional more visible signage and implemented an automatic video enforcement system at these locations ([Figure 16](#)).

As shown in [Figure 16](#), the traffic control devices at these intersections include duplicative standard regulatory and warning signs, as well as supplementary plaques. In addition, video cameras have also been installed that automatically record the events at the intersection when the LRV is traveling across the roundabout. The automatic video enforcing is prominently advertised, acting as a further deterrent for illegal turns. According to Tramvia Metropolità, incidents at these locations have been substantially reduced since implementation of these improvements and the video system (6).



FIGURE 14 Left-turn prohibition (regulatory and warning) devices, Barcelona, Spain (urban environment, median operation).



FIGURE 15 Regulatory and guide sign combination, Valencia, Spain (urban environment, median operation).



FIGURE 16 Video enforcement of left-turn prohibitions (regulatory and warning sign combination), Barcelona, Spain (urban environment, median operation).

Right-Angle Conflicts

Motorists traveling perpendicular to the LRT alignment sometimes violate traffic signals trying to beat LRVs to the crossing. In order to raise motorist awareness about the presence of the LRV, some of the properties have implemented automatic video enforcement systems, similar to those shown in Figure 16 (Barcelona), at locations where crossing violations became an issue, while others have installed internally illuminated signs with the “LRV APPROACHING” symbol (Valencia, Figure 17) or a post-mounted flashing red light signal assembly (Bordeaux, Figure 18), both used in combination with standard traffic signals, which are then activated by an approaching LRV.

Motor-Vehicle Blocking of LRT Crossing

Most of the LRT properties evaluated in this paper have experienced conflicts with motorists queuing back from a nearby intersection typically due to downstream congestion blocking the LRT tracks. In order to minimize the potential for accidents, the three LRT properties in Spain have installed cross-hatched markings at most crossings. As shown in Figures 19 (Barcelona) and 20 (Valencia), the yellow striping, a standard vehicle code regulation, clearly delineates the LRV envelope, marking the “DO NOT STOP” area to both motorists and LRV operators.

LRT Signal Indications

All of the four LRT properties discussed in this paper adhere to the European LRT signal standard,



FIGURE 17 LRV-activated, internally illuminated warning sign at midblock motor-vehicle crossing, Valencia, Spain (suburban environment, separate ROW operation).



FIGURE 18 Post-mounted flashing red light signal assembly (regulatory), Bordeaux, France (urban environment, pedestrian mall operation).

in which the “PROCEED” indication is a vertical white bar and the “STOP” indication is a horizontal white bar. In all four systems the “STOP” indication is placed above the “PROCEED” indication, similar to the configuration of a conventional traffic signal. The LRT signals are placed separate from motor vehicle traffic signals and positioned in such a way that are viewed exclusively by the LRV operator and not by motorists. The distinctive LRT aspect configuration and the location of the signal head are key to minimizing motorist confusion at the crossing.



FIGURE 19 LRV envelope delineation (regulatory), Barcelona, Spain (urban environment, median operation).



FIGURE 20 LRV envelope delineation (regulatory), Valencia, Spain (urban environment, median operation).

On the other hand, slight variations among LRT systems do occur. The LRT signals in Bordeaux, for example, include a flashing white dot indication between the horizontal and vertical bars (Figure 21), used to indicate “PREPARE TO STOP.” Although the LRT systems in Spain generally use a two-head (“STOP/PROCEED”) LRT signal configuration, Barcelona has added, at some locations, a third white triangle indication above the horizontal bar (Figure 22). The triangle is used in either a flashing or a steady mode to inform the LRV operator that his train has been detected, a traffic signal preemption sequence has been initiated, and he will be shown a “PROCEED” indication at the upcoming intersection.

POTENTIAL FOR IMPLEMENTATION IN LRT SYSTEMS IN THE UNITED STATES

Figures 23 and 24 show the typical configurations of a pedestrian crossing and a motor-vehicle crossing in Europe, indicating the traffic engineering principles used in the designs of the crossings. Many of these principles could be easily applied to the United States, such as the multiple striping,



FIGURE 21 LRT signal indication (Stop/Prepare to Stop/Proceed), Bordeaux, France.



FIGURE 22 LRT signal indication (LRV Detected/Stop/Proceed), Barcelona, Spain.

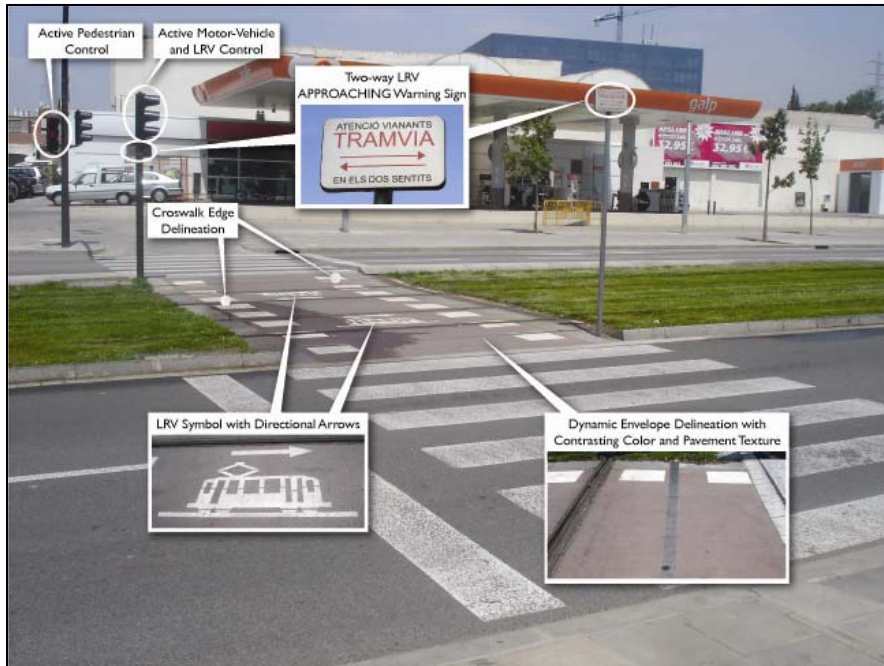


FIGURE 23 Traffic engineering principles in the design of a pedestrian crossing (urban environment, median operation).

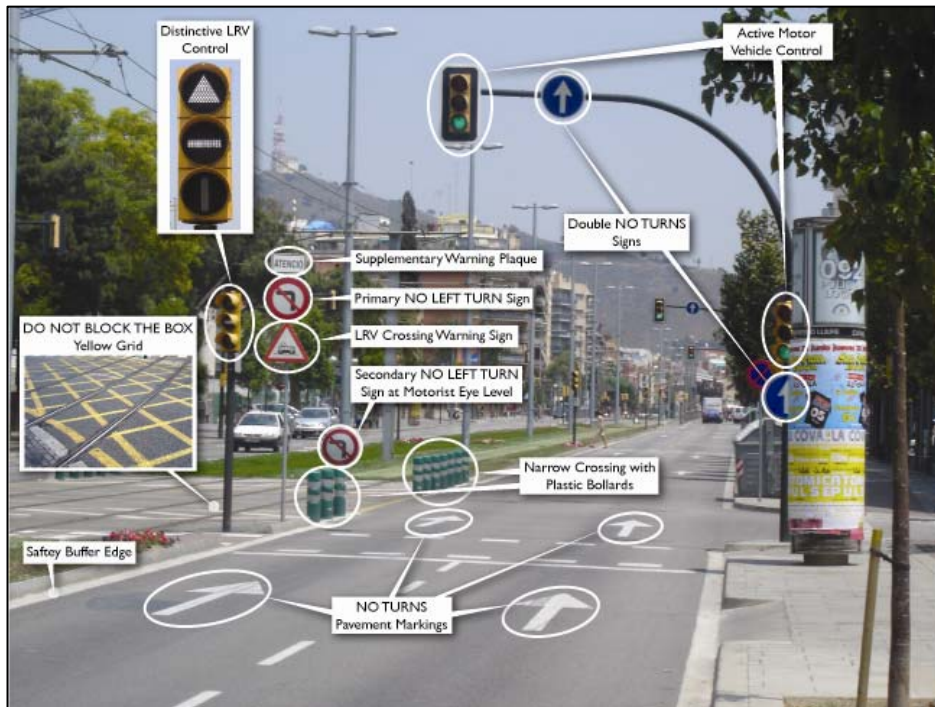


FIGURE 24 Traffic engineering principles in the design of a motor-vehicle crossing (urban environment, median operation).

redundant signage, and dynamic envelope delineation. Specifically, the two traffic control devices with the highest potential for implementation in LRT systems in the United States are the LRT warning signs used to alert pedestrians about the potential for LRVs approaching the crossings from both sides, shown in more detail in [Figure 6](#), as well as the arrow striping indicating the direction that LRVs typically traverse the crossing, shown in [Figures 11 and 12](#), which helps pedestrians look in the most appropriate direction before they walk onto the track area. Although pedestrians may look in the wrong direction during LRV reverse-running situations, these are performed at lower speeds and typically are used only during maintenance or emergency situations.

In addition, another traffic control device with potential for implementation in the United States is the combination of regulatory and guide signs shown in [Figure 15](#) (adapted to the specific characteristics of the LRT crossing location) used to emphasize the turn prohibition while directing motorists to the most appropriate location to make the turn.

ACKNOWLEDGMENTS

The author would like to thank Salvador Álvarez Cortizo, systems engineer with Tramvia Metropolità S.A., and Jean Pierre Bonneuil, project manager with Systra Consulting, for their assistance and information provided. The author would also like to acknowledge Joan Olmos Llorens, Lisa Young, and Tim Erney for their contributions to this paper.

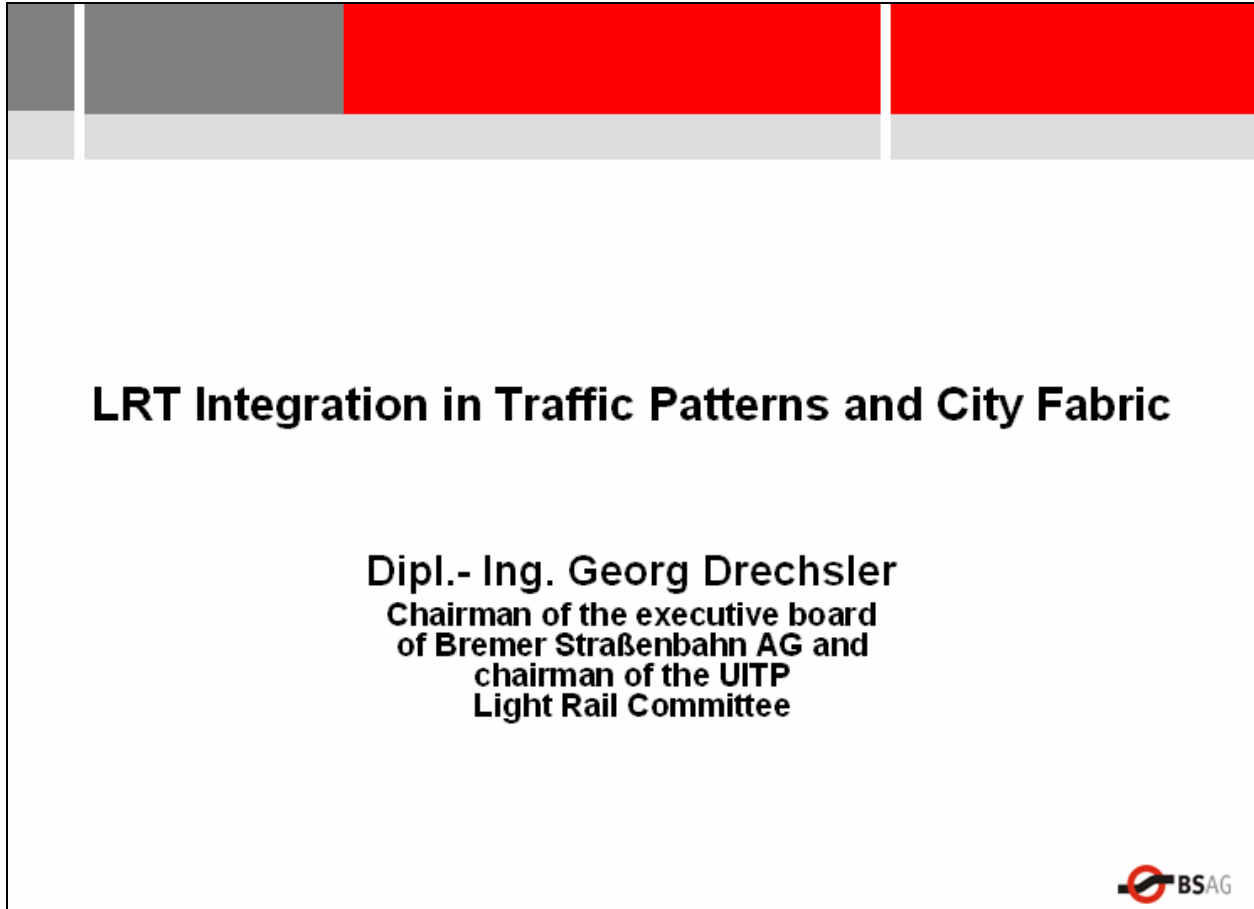
REFERENCES

1. Korve Engineering, Inc., et al. *Integration of Light Rail Transit into City Streets*. TCRP Report 17, TRB, National Research Council, Washington, D.C., 1996.
2. La Cub, Inauguration du Tramway de la Communauté Urbaine de Bordeaux. *Dossier de Presse*, Bordeaux, 2003.
3. Álvarez Cortizo, Salvador; Tramvia Metropolità S.A., November 2005.
4. Korve Engineering, Inc., et al. *Light Rail Service: Pedestrian and Vehicular Safety*. TCRP Report 69, TRB, National Research Council, Washington, D.C., 2001.
5. *La Vanguardia*, Barcelona, July 1, 2004.
6. Álvarez Cortizo, Salvador; Tramvia Metropolità S.A., November 2005.

PLANNING AND URBAN INTEGRATION

LRT Integration in Traffic Patterns and City Fabric

GEORG DRECHSLER
Bremer Straßenbahn AG





Significance of the short-range public transportation for the city and the region

City centers suffer from traffic (noise and pollution).

A city needs a traffic system that works well.

Using the short-range public transportation offers more advantages than using one's own car.

In the city, pedestrians, cyclists, and users of the short-range public transportation are more mobile than drivers.

The short-range public transportation must be made attractive for citizens in order to reduce traffic congestion.

=

When people are convinced of public transport they focus more on short-range public transportation than on their own cars.

=>



Significance of the short-range public transportation for the city and the region

Important insights:

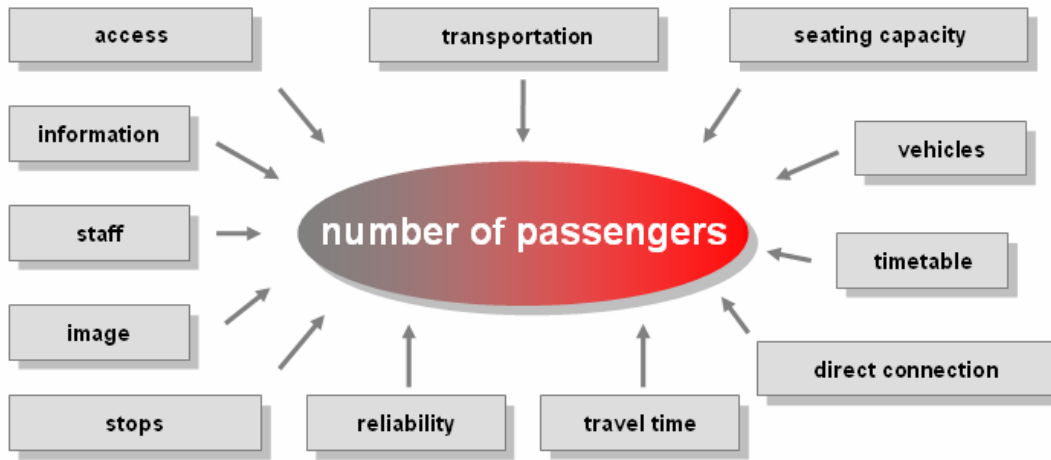
- **Relief of traffic congestion in the city center when people from the city and local areas have a good choice/variety of public transport.**
- **The traffic system finds acceptance when it offers fast and direct links (minimal travel time is important).**
- **The complete traffic system must be coordinated (timetable, rate) — also cross-company.**
- **A system is needed that removes**
 - a) **barriers of technical differences and**
 - b) **barriers of political responsibilities.**

The flow of traffic is all that matters.





Determining factors to the ridership



Ridership development

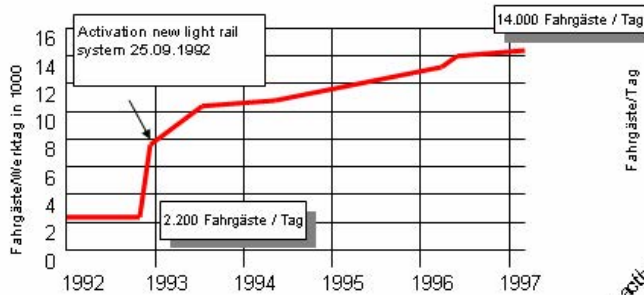


Karlsruhe



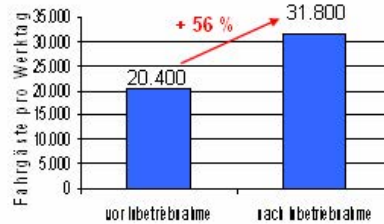
Saarbrücken

Karlsruhe – Bretten

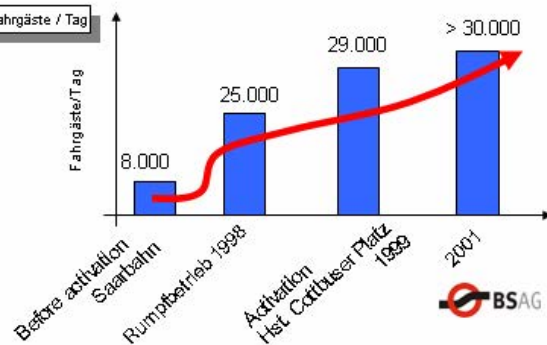


Quelle: AVG

Bremen (line 6 university)



Saarbrücken

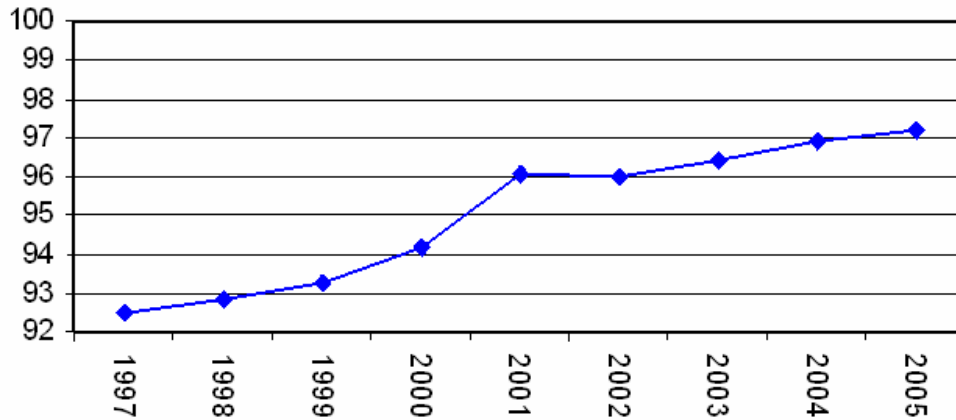




Ridership development in Bremen 1997 – 2005

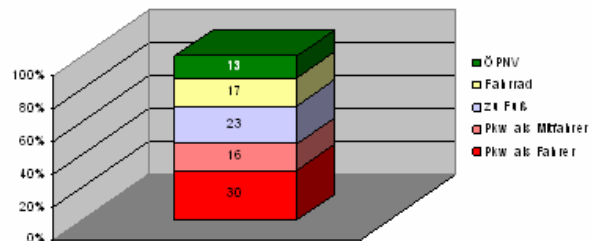
passengers

Mio. passengers

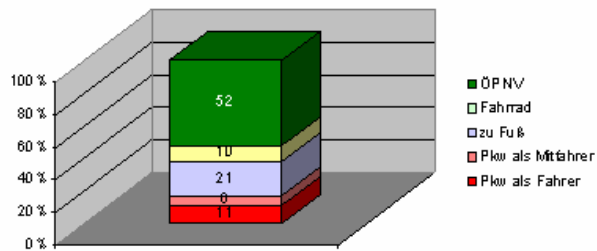


Modal Split in Bremen

Total



Destination city center



Quelle: Socialdata München





LRT Integration

- LRT integration in city fabric maximizes the number of passengers and focuses attention on short-range public transportation.
- The actual increase of passengers exceeds all expectations.
- The light rail system has to take the passenger directly to his or her destination, for example, close to home or to the city center.



LRT integration

- The LRT can easily be integrated into the city fabric.
- The LRT is environmentally friendly (no pollution, not much noise).
- The LRT requires little space.
- The LRT is suitable for pedestrian zones and also for narrow streets.
- The LRT fits in with the architecture of historical areas.
- The LRT can go through parks (Rasengleis) and rural areas.





LRT Integration into City Fabric—Pedestrian Zone in Bremen



LRT Integration into City Fabric—Pedestrian Zone in Halle





LRT Integration into City Fabric—Pedestrian Zone in Karlsruhe



LRT Integration into City Fabric—Pedestrian Zone in Kassel





LRT Integration into City Fabric in Dresden (City Center)



LRT Integration into City Fabric in Würzburg (City Center)





LRT Integration into City Fabric in Heilbronn (City Center)



LRT Integration into City Fabric in Bremen (City Center)



LRT Integration into City Fabric in Erfurt (City Center)



LRT Integration into City Fabric in Dresden (City Center)





LRT Integration into City Fabric in Eskisehir (Turkey)



LRT Integration into City Fabric in Bremen on the Street



LRT Integration into City Fabric in Mannheim on the Street



(c) Bernd Kittendorf, 2004



LRT Integration into City Fabric in Stuttgart on the Street





Stops in Bremen



Stop in Hannover





Tram Stop in Frankfurt



Stop in Düsseldorf





Stop in Hannover



Bremen Station Forecourt





Schottergleis



Besonderer Bahnkörper

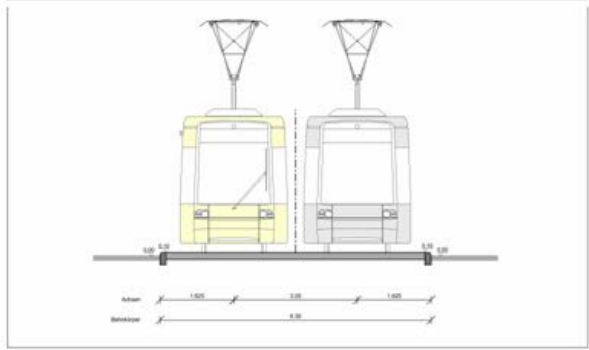
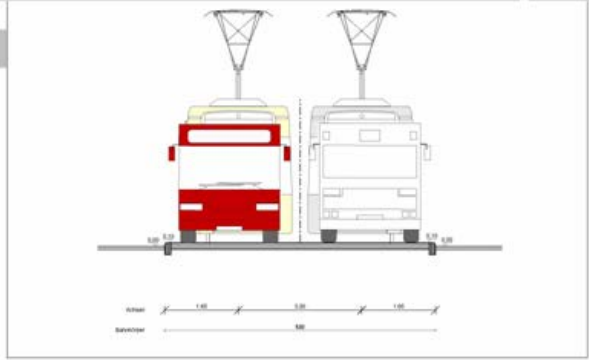




LRT Integration into City Fabric in Bremen on the Street



Profile Tram/Bus





LRT Integration into City Fabric—Rasengleis in Bremen



LRT Integration into City Fabric—Rasengleis in Freiburg





LRT Integration into City Fabric—Rasengleis in Vienna



LSA





Light Rail Vehicle in Dresden



Light Rail Vehicle in Bremen





Light Rail Vehicle in Düsseldorf

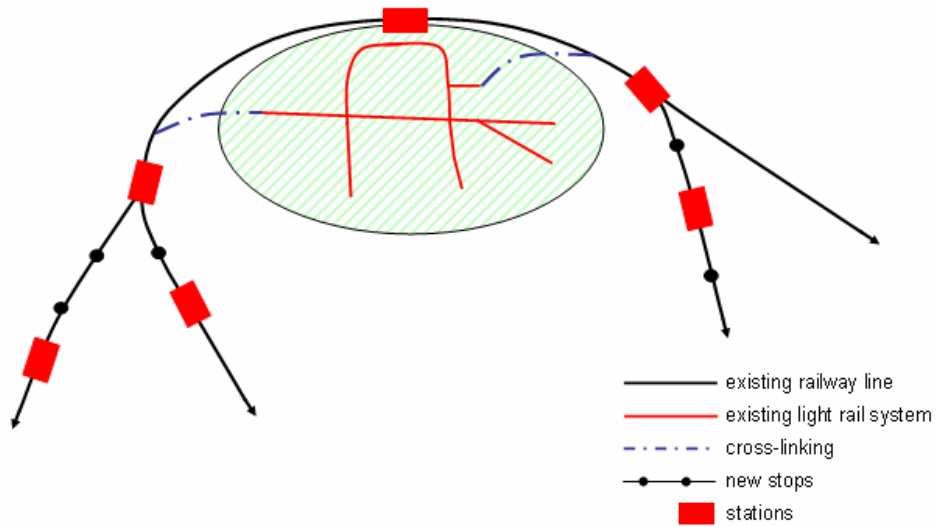


Cross-Linking Tramway and Railway





Basic Idea of LRT



Light Rail Vehicle in the Surrounding Region of Bremen





Light Rail Vehicle in the Central Station of Karlsruhe



PLANNING AND URBAN INTEGRATION

A Report on the Status of Planning for MetroLink Expansion in the St. Louis Region

DONNA L. DAY

Transportation Corridor Improvement Group, East–West Gateway Council of Governments

The main purpose of this paper is to review the history of MetroLink planning in the St. Louis region and the status of current studies and to assess the prospects for future expansion of the system. This is meant to resolve any confusion about the possibilities for long-term MetroLink expansion and whether there is an overall system plan. The paper will also highlight some lessons that the region has learned during this process. This paper includes a review of the history of MetroLink planning in the region with reference to the 1991 St. Louis Systems Analysis for Major Transit Capital Investments (Systems Analysis). The status of planning and implementation in each of the nine corridors that emerged from the Systems Analysis is described. The paper also discusses current MetroLink planning studies and analyzes the prospects for future expansion of the MetroLink system in the region. Finally, the paper will summarize some lessons that the region has learned about developing a regional light rail system. The paper finds that the planning and implementation of MetroLink in the St. Louis region has been systematically advanced in the years since 1991 based upon the adopted systems plan. It also finds that the prospects for MetroLink expansion beyond 2006 remain uncertain. Lack of expanded local revenue prevents the St. Louis region from competing for federal capital funds and also places a growing strain on the ability of the regional transit agency (Metro) to operate the existing multimodal transit system.

PURPOSE

There has been some confusion about the long-term prospects for expanding the MetroLink light rail system in the St. Louis region and whether there is, in fact, an overall systems plan. The purpose of this paper is to clarify this issue by providing an overview of our plan for MetroLink expansion and to review the status of planning and implementation of the system. This will include a look at current studies and an assessment of the prospects for future expansion. The paper will also include a brief review of some lessons that the region has learned from the experience of developing a light rail system in the region.

ST. LOUIS REGION

The St. Louis region includes four counties and the City of St. Louis in Missouri, plus three counties across the Mississippi River in Illinois. The regional population is approximately 2.5 million of which approximately 1 million reside in St. Louis County.

The East–West Gateway Council of Governments is the metropolitan planning organization (MPO) for the region. East–West Gateway is responsible for carrying out major planning studies for transportation improvement projects in the region, including light rail planning. Since 1996, the planning studies have been conducted in collaboration with the implementing agencies through the Transportation Corridor Improvement Group. The role of this group was discussed in a paper for the Joint Ninth Annual Light Rail Transit Conference (1). All decisions are made by the Council’s Board of Directors. Projects that emerge from the planning studies are then transitioned to the implementing agencies for design and construction. The transit authority is Metro, also known as the Bi-State Development Agency.

HISTORY OF METROLINK PLANNING

Early Planning

Early consideration of a rapid transit system for the St. Louis region began in the early 1970s with a feasibility study of a 100-mi heavy rail system. This concept was rejected as being too ambitious for the region and a combined light rail and express bus system was examined instead. In 1982, out of four conceptual light rail corridors that were studied, the highest-priority corridor was identified as the one from East St. Louis to Clayton. An Alternatives Analysis and Draft Environmental Impact Study (AA/DEIS) for Major Transit Capital Improvements began the next year focused on the East St. Louis–Clayton–Hazelwood corridor. In 1984, the East–West Gateway Board of Directors asked the council staff to proceed with preliminary engineering on the selected priority MetroLink corridor from East St. Louis to Lambert International Airport and to explore the potential for future expansion to create a regional light rail system, beginning with the consideration of a line into Illinois.

Regional System Plan

As a result of the 1984 board action, council staff initiated and carried out a system planning study for the St. Louis Systems Analysis for Major Transit Capital Investments (2). This planning document, commonly referred to as the Systems Analysis, was first approved by the board in 1989 and revised in 1991. It was considered to be the first step in the five-step project development process for major transit projects under federal rules. Subsequent steps in the process are corridor-level alternatives analysis, preliminary engineering, final design, and construction.

As presented in [Figure 1](#), the Systems Analysis divided the region into nine broad corridors with potential for major transit improvements based on travel patterns in the region. Possible transit alternatives (light rail, busway, transportation system management) were considered in each of these nine corridors and analyzed with respect to their potential for major transit improvements. The evaluation considered transit opportunities in terms of level of need (i.e., level of congestion on roadways, potential transit ridership), costs (capital and operating and maintenance), degree of local support (civic and financial), and ease of implementation [i.e., availability of right-of-way (ROW)].

As a result of the evaluation, the 1991 document grouped the corridors into four priority tiers. Three corridors were identified as being in the top tier for advancement in the planning

process: Cross County, St. Clair, and St. Charles. A second tier included Northside, Southside, and West County. The final tiers included Southwest, Northeast, and Madison.

The document explicitly recognized that moving forward with these transit projects would require an expanded commitment of local and state governments to the financing and operation of mass transit in the region.

This systems analysis has served as the master plan or blueprint for transit planning in the St. Louis region for the past 15 years.

The First MetroLink Line

Construction on the initial line in the region's MetroLink system began in 1990 and it opened for service in 1993. The line was completed to Lambert International Airport in 1994. This 19-mi line traverses three counties and two states and links Illinois with downtown St. Louis, major destinations in the City of St. Louis and St. Louis County, and Lambert International Airport.

The total capital cost was \$464 million. It was funded with 80% federal New Starts funding and a local match consisting of ROW and existing infrastructure. The line reutilized former freight rail facilities including the rail deck of the 1974 Eads Bridge over the Mississippi River, the railroad tunnels under downtown, and the former Wabash rail ROW.

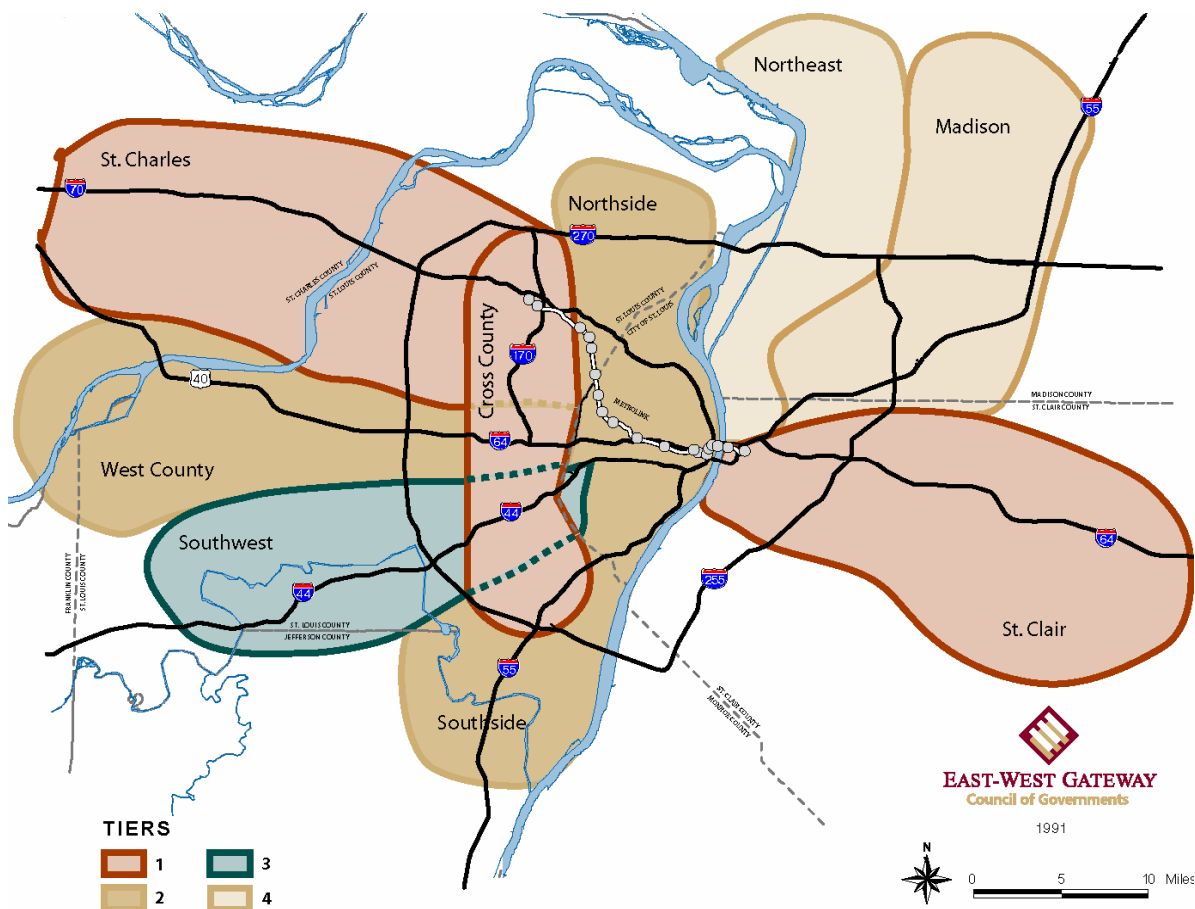


FIGURE 1 Systems Analysis transportation corridors, 1991.

This first MetroLink line was immediately successful. Early ridership exceeded the planning forecasts. This helped lead the voters in the City of St. Louis and St. Louis County in Missouri and in St. Clair County in Illinois to pass referendums for local sales taxes in 1994. The tax proposed and passed in Missouri was for ¼ cent, even though the region had state approval to ask for ½ cent. The tax in Illinois was for ½ cent.

St. Clair County

The Systems Analysis identified the St. Clair corridor as a Tier I priority (Figure 2). The council completed an AA/DEIS on this line through St. Clair County in 1995. The project was then transitioned to Metro (known at that time as the Bi-State Development Agency) for preliminary engineering, design, and construction.

A full funding grant agreement for the 18-mi extension as far east as Southwestern Illinois College was signed in 1996 with 72% federal New Starts funds and the local match funded by the St. Clair County Transit District based on revenue from the ½-cent local sales tax. This line from East St. Louis to Southwestern Illinois College opened for service in May of 2001.

Three more miles of track were added in 2003, funded by the State of Illinois and the transit district. The line now extends to Scott Air Force Base. A further 5-mi extension to Mid-America Airport is planned but remains unfunded.

The total capital cost of the existing St. Clair line from East St. Louis to Scott Air Force Base was \$414 million.

St. Charles County

The St. Charles corridor was also a Tier I priority in the Systems Analysis. The council completed an AA/DEIS on transit improvements through St. Charles County in 1996. The alternatives extended from the existing MetroLink line at or near Lambert International Airport to the City of St. Peters in St. Charles County. A final preferred alternative was not selected. No project advanced out of this study because two local sales tax referendums for ½ cent in St. Charles County were defeated in 1996.

Cross County

The other Tier I priority was the Cross County Corridor, mainly located in St. Louis County. In the mid-1990s, initial planning for multimodal improvements in the Cross County Corridor began with a major investment study (locally known as a Major Transportation Investment Analysis or MTIA). This study resulted in a range of transit and highway improvements being selected by the board in 1997 for more detailed planning and design. After two more years of additional planning, in June 1999, the conceptual design for the Cross County MetroLink extension to Shrewsbury was approved by the board and transferred to Metro for implementation. This 8-mi line will run from the existing line at Forest Park in the City of St. Louis west to Clayton and then south to I-44 and Shrewsbury in St. Louis County near the City of St. Louis. This Cross County extension is currently under construction and due to open for revenue service in the fall of 2006.

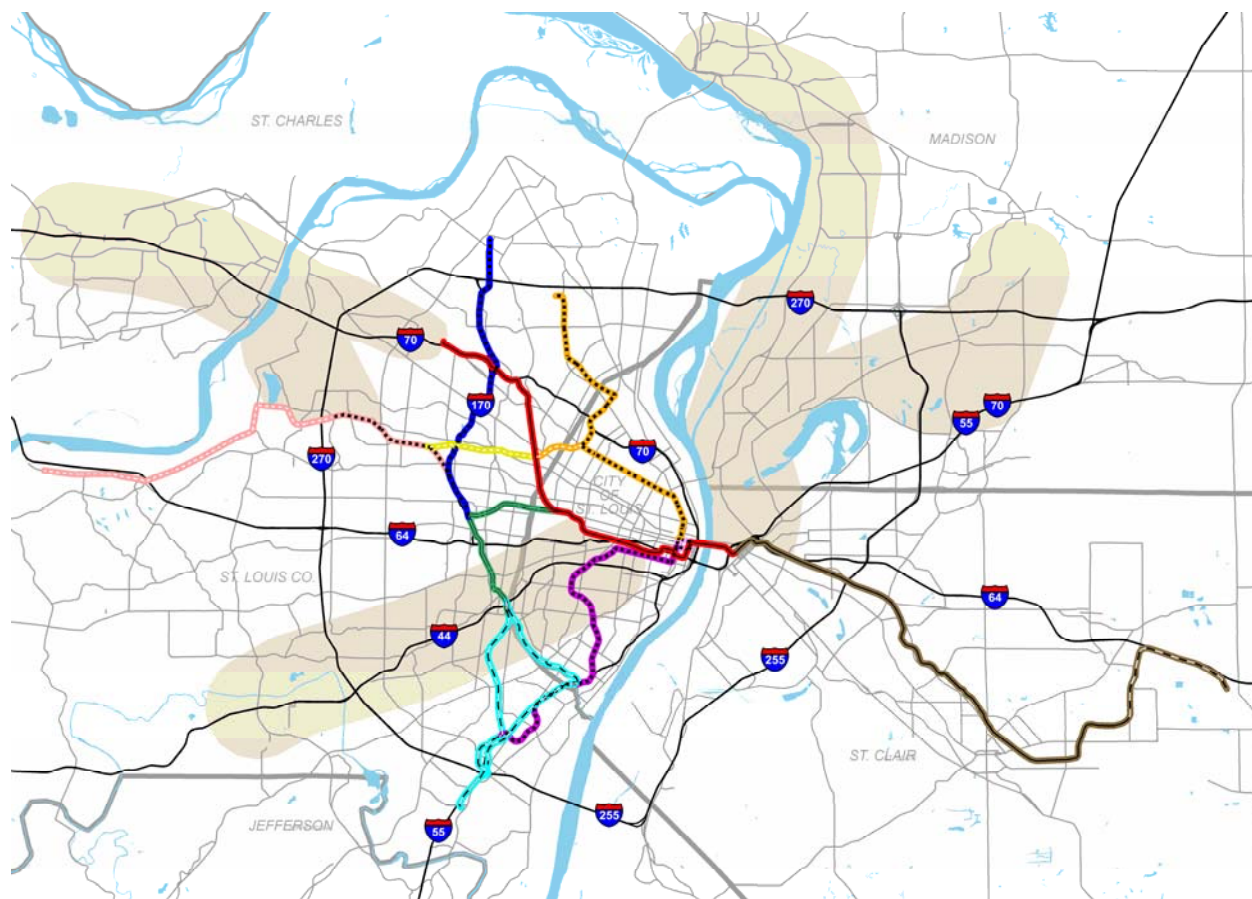


FIGURE 2 MetroLink Corridors, 2005. Existing, planned, and potential alignments.

NOTES:

Existing: **Red** – Initial Line **Brown** – St. Clair **Green** – Cross County

Planned: **Turquoise** – Metro South **Blue** – Metro North

Orange – Northside **Purple** – Southside **Pink** – Daniel Boone

Potential: **Yellow** – Northwest Connector

Shaded Areas – St. Charles, Madison and Southwest

The project is being funded entirely with local revenue, based on bonds backed by the ¼-cent local sales tax passed in the city and county in 1994. The total capital costs are expected to be in the range of \$680 million based on year of expenditure.

In addition to this 8-mi extension, the mid-1990s major investment study identified MetroLink light rail lines extending from Shrewsbury all the way south to South St. Louis County near I-270 and I-55 and from Clayton north to Florissant in North St. Louis County. The portions of this proposed alignment that are beyond the Cross County MetroLink extension currently under construction are now known as Metro North and Metro South.

The Metro South corridor has been the subject of further, more detailed planning that will be described below. No further planning has taken place on the Metro North corridor.

Northside, Southside, and Daniel Boone

The three Tier II corridors from the Systems Analysis were studied concurrently, starting in 1998. The initial planning studies for Northside, Southside, and West County (later renamed Daniel Boone) were completed and the results approved by the board in 2000. These were MTIAs. The selected alternative in each of the three corridors included a MetroLink alignment or other high-speed transit line. The Northside MetroLink line was planned to run from downtown St. Louis to Florissant Valley Community College at I-270 while the Southside line would extend from downtown to South County. Both of these lines would share a surface loop through downtown St. Louis. The Daniel Boone MetroLink alternative was planned to extend from Cross County in Clayton west to the Westport area at I-270 and Page Avenue.

Further analysis identified a potential connection between the Northside and Daniel Boone corridors, which could provide service from downtown to West County via North St. Louis City.

The capital costs for the selected alternatives in the MTIAs were approximately \$620 million for Northside, \$720 million for Southside, and \$530 million for Daniel Boone in year 2007 dollars. These costs do not include the Northwest Connector.

Madison County

Two corridors to Madison County in Illinois were identified in the Systems Analysis Tier III/IV, the Northeast Corridor to Alton and the Madison corridor to Edwardsville. A feasibility study to consider the costs and benefits of a possible MetroLink line to Madison County was recently completed. Madison County funded this study that was not intended to identify actual alignments. However, the study did examine general conceptual build options along with costs and financial feasibility. All of the options would connect to the existing MetroLink line in East St. Louis.

The costs of the alternatives ranged from \$150 million to \$650 million in year 2005 dollars.

Southwest

No further light rail transit planning studies have been carried out on the Southwest corridor since the Systems Analysis. However, Metro did conduct a conceptual planning study of commuter rail in this corridor in the early 1990s. At the time, a similar commuter rail study was also carried out on the I-55 corridor to the south from St. Louis. No projects advanced out of these studies.

CURRENT PLANNING STUDIES

Metro South

The council is now completing the final details of an AA/DEIS for the Metro South area. This study builds on the results of the Cross County MTIA in the mid-1990s by examining alternative

alignments to extend the MetroLink system into South County from the terminus of the Cross County line in Shrewsbury.

There are three MetroLink build alternatives that meet the purpose and need but perform differently. One of these final build alternatives follows alongside the Burlington Northern Santa Fe Railroad ROW through South St. Louis County to I-55 and Butler Hill Road, while the other two follow River des Peres Boulevard and Germania Avenue through the City of St. Louis and I-55 through St. Louis County to either Butler Hill Road or Reavis Barracks Road.

The capital costs range from approximately \$300 to \$700 million in 2010 dollars.

In October 2004, the board approved a staff recommendation delaying the selection of a preferred alternative for this Metro South corridor.

The DEIS has recently been completed and circulated for public comment. The public hearing was held in December 2005 and the official comment period ended on January 6, 2006. No project will advance out of this study until a preferred alternative is selected.

Northside–Southside

The council has recently begun work on a conceptual design and environmental analysis study for minimum operating portions of the Northside and Southside major transit alternatives that fall within distressed communities, as defined by the State of Missouri. This study will reevaluate and refine the locally preferred alternatives identified by the 2000 MTIAs and complete the conceptual engineering and environmental to a higher level of detail.

If the council is able to secure additional funding, this study will be expanded to include the full Northside, Southside, and Daniel Boone alignments selected as the locally preferred alternatives in the 2000 MTIAs, as well as the connector from Northside to Daniel Boone.

The Northside MetroLink line being examined in this current study will run from downtown in the City of St. Louis north along North Florissant Avenue and Natural Bridge Road to I-70 near Riverview. The Southside line will run south from downtown along Chouteau Avenue and then alongside the Union Pacific Railroad ROW to I-55 near Loughborough Avenue. In the downtown area, the two lines will conceptually follow a shared one-way loop through the downtown streets.

These are considered to be minimum operating segments for the full build alternatives that were identified in the previous studies.

This study will be completed in 2007. Unless additional funding is identified, the study will not include preparation of the actual DEIS document.

REGIONAL LONG-RANGE TRANSPORTATION PLAN

Based on the planning activities carried out to date, the Metro South, Metro North, Northside, Southside, and Daniel Boone MetroLink extensions are included in the “illustrative” project list in the region’s long-range transportation plan, *Legacy 2030* (3).

There is no funding available for the design and construction of any of these lines. However, some funding was included (but not committed) for these MetroLink lines in the recent Safe, Accountable, Flexible, Efficient Transportation Equity Act: A Legacy for Users authorizations. Metro South was authorized for \$135 million and Northside–Daniel Boone for \$275 million (Table 1).

TABLE 1 Status of MetroLink Corridor Planning

Corridor	Segment	Systems Analysis	Feasibility Study	MTIA 1.0/1.5*	Concept'l Design	AA/DEIS	PE/ Design	Const.
Orig. Line	E. St.Louis to N. Hanley	1982				1984	1990	1993
	To Lambert Airport	1982				1984	1990	1994
St. Clair	To College	1991				1995	1998	2001
	To Scott AFB	1991				1995	1998	2003
	To Mid-America	1991				1999		
St. Charles	To St. Peters	1991				1996		
Cross County	Clayton-I-44	1991		1997	1999		2003	2006
Metro South	To Mehlville	1991		1997		2006		
Metro North	To Florissant	1991		1997				
Northside	To I-70/Riverview	1991		2000*	2007			
	To Flo Valley	1991		2000*				
Southside	To I-55/Loughborough	1991		2000*	2007			
	To Butler Hill	1991		2000*				
Daniel Boone	To Westport/Chesterfield	1991		2000*				
NW Connector	North City to Westport		2000					
Madison	To Alton/Edwardsville	1991	2005					
Southwest	To Fenton/Valley Park	1991						

NOTES: MTIA is the local term for a major investment study (MIS) under Intermodal Surface Transportation Efficiency Act of 1991.

Option 1.0 refers to a MIS not carried out under the National Environmental Policy Act of 1969 (NEPA) process.

*Option 1.5 refers to a MIS carried out under the NEPA process, but without completing a DEIS.

Bold indicates most recent action completion date or estimated completion for current studies.

PROSPECTS FOR FUTURE EXPANSION

The prospects for further expansion of the MetroLink system are uncertain at this time.

As discussed in the long-range plan (3), Metro is projected to have a \$1 billion shortfall over the next 25 years based on current revenue streams. Therefore, unless additional revenues are obtained, the future of the regional system is problematic. Two major revenue enhancements are possible. The first would entail voter approval of an additional local sales tax. The other option would be a statewide funding package for transit in Missouri.

The following scenario for funding MetroLink expansion is outlined in the long-range plan. If MetroLink is to be expanded in the Missouri portion of the region, the transit agency will require an influx of \$100 million a year in new state or local revenue. A combination of an additional ¼-cent sales tax and a sizable statewide transit program would provide the needed revenue. With an additional \$100 million a year, plus a 50% federal share for construction costs, the region could build and operate as many as three MetroLink extensions in St. Louis City and St. Louis County over the next 25 years.

LESSONS LEARNED

The experience of the St. Louis region over the past 20 years in developing a regional light rail system can be examined to draw out some lessons learned.

First, the region's success in creating the initial MetroLink line established a valuable model. This line was built very cost-effectively using existing transportation corridors and a fairly simple design that kept costs down. This model was followed as closely as possible in planning the St. Clair extension. However, the regional leadership abandoned this path in the planning and design of the Cross County extension. The Cross County route runs through the heart of the built-up, heavily populated urban area where no railroad ROW exists and there are more conflicts with adjacent land uses and roadway traffic. The regional leadership yielded to community pressure to add design features to this extension that increased the cost and complexity of the project.

Regarding popular support for a light rail transit system, prior to the successful opening of the initial line, many people were openly skeptical that anyone would use a high-speed transit system in St. Louis. However, early ridership success convinced the public and the decision makers that MetroLink was an important asset to the region. This led to voters passing local sales taxes in St. Louis County and the City of St. Louis in Missouri and separately in St. Clair County in Illinois in 1994.

However, since that time there have been a number of local sales tax failures at the ballot box. These included referenda in St. Charles County in 1996 and in St. Louis County and Madison County, Illinois, in 1997.

One mistake the regional leadership made was in not taking full advantage of the early MetroLink success by asking for the full ½-cent tax authorized in Missouri in 1994, rather than just the ¼ cent that was proposed and passed. The later tax referendum in 1997 for the remaining ¼ cent passed in the City of St. Louis but was defeated in St. Louis County and has therefore not been implemented. At that time, the Cross County extension was a matter of great public controversy. Also, the initial 1994 campaign had over promised on the extent of the work that could be covered by a ¼-cent tax, and the goodwill generated by the early success was largely dissipated. All of these factors helped lead to the failure of the additional ¼-cent tax in 1997 in St. Louis County.

In general, experience has now shown that the public is more supportive of new local taxes if the related plans are clear and if they know exactly how the funds would be used. Uncertainty generally results in failed initiatives. For example, the plans for the St. Clair extension were fairly well in place (AA/DEIS completed) when the ½-cent tax successfully passed in that county in 1994. However, the plans and priorities for additional routes after Cross County had not yet been developed when the second ¼-cent referendum failed in St. Louis County in 1997.

In St. Charles County, two referenda for new taxes failed in 1996. At that time, plans for MetroLink in St. Charles were fairly well developed (AA/DEIS completed). However, there was still uncertainty about whether a MetroLink line could actually be built in St. Charles County because the line would have to first pass through part of St. Louis County whose leaders did not consider it a priority. There was also significant doubt about whether the financial plan for building the line was realistic and achievable.

A referendum for a local tax also failed in Madison County, Illinois, in 1997 for similar reasons. In this case, there was no plan for a line prepared in advance and the financial plan was

questionable. Also, the controversy from Cross County that year negatively affected that election, as it did in St. Louis County.

One final note on sales tax referenda: it has been shown that it is best to avoid low turnout election cycles (such as the second ¼-cent referendum in St. Louis County in 1997) because opponents to a specific project can more easily affect the overall results.

The last lesson relates to the planning process. As discussed in a previous paper (1), the St. Louis region is unique in the way that the planning, transit, and highway agencies work as partners to carry out transportation planning studies. It is very clear that the transit agency and the MPO must work closely together in order to develop successful light rail projects that balance technical, community, and political factors. Formal interagency mechanisms and shared resources can best assist in advancing a project smoothly from initial planning through design and construction. The most critical step is to ensure a good transition between the agencies as the project moves forward.

CONCLUSIONS

East–West Gateway adopted a comprehensive plan for the MetroLink light rail system in 1991. The council has systematically advanced planning and design of MetroLink expansions in the years since the adoption of that plan. However, despite the ongoing success of MetroLink, the prospects for expansion beyond 2006 remain cloudy at best. The lack of an expanded local revenue source prevents the region from competing for federal capital funds and will put a growing strain on Metro’s ability to operate a multimodal public transit system.

REFERENCES

1. Day, D. L., and S. A. Stauder. Joint Agency Planning for MetroLink Expansion in St. Louis, Missouri. *Transportation Research Circular E-C058: 9th National Light Rail Transit Conference*, TRB, National Research Council, Washington, D.C., 2003, pp. 37–43.
2. East–West Gateway Coordinating Council. St. Louis Systems Analysis for Major Transit Capital Investments. EWGCC, St. Louis, Missouri, March 1989, Amended June 1991.
3. East–West Gateway Council of Governments. *Legacy 2030: The Transportation Plan for the Gateway Region*. EWGCOG, St. Louis, Missouri, 2005.

General Session

GENERAL SESSION

The State of Transit Advocacy

THOMAS R. SHROUT

Citizens for Modern Transit

Thank you for the opportunity to talk about Citizens for Modern Transit. I remember when I took this job in 1988, I had just turned 40 years old and my mother was sure that I had made, shall I say, an “unwise career choice.” She was worried I would be looking for another job within months if not weeks. She had never heard of light rail, much less knew you could get paid to advocate for it.

I found her feelings are shared by many. A conversation with someone whom I meet for the first time often goes like this:

I will meet someone and they will ask me, “What do you do?”

I answer, “I am the executive director of Citizens for Modern Transit.” And invariably the reply is, “Yes, but what is your job?”

In preparing for today’s talk, it occurred to me that perhaps some of our international attendees might have a similar reaction and find it curious that the conference devote a luncheon session to transit advocacy—because aren’t the benefits of rail transit obvious to everyone?

Well, in the United States unfortunately that is not always the case, although the progress we and others across the country have made in recent years is striking. When I took this job in 1988, there were new light rail systems in only a few cities such as Portland, San Diego, Pittsburg, and San José. Since that time we have added Denver, Los Angeles, St. Louis, Minneapolis, Salt Lake, Dallas, Houston, Baltimore, and New Jersey. Plus Charlotte, Phoenix, and Seattle are under construction. And I may have missed a city or two. A true national movement has developed. Once cities get light rail, they want more and city after city is adding extensions or planning for more lines.

I have been asked to discuss the role Citizens for Modern Transit (CMT) played in developing the light rail system here in St. Louis. CMT was incorporated in 1985. We are fairly unique around the country although Denver and Phoenix have very strong citizen groups with staff who work to mobilize public support for light rail.

The story in St. Louis begins in the early 1980s when a small group of St. Louisans had a vision for a better city that would include adding a rail component as a way to revitalize the transit system that was losing riders in droves—dropping from about 80 million annual rides in 1980 to about 37 million the year prior to the opening of MetroLink. There was also a vision that rail would help focus redevelopment in the core of the region.

As background, St. Louis city limits were locked by the Missouri constitution in the 1880s. Population in the City of St. Louis peaked in 1950 at about 850,000 and after that dropped precipitously as highway development spawned sprawl and at the same time did in a once-thriving streetcar system. As an example, in 1939 the streetcar fleet in operation in St. Louis City and St. Louis County was 1,100 streetcars; by 1966 there were none.

By 1990, the population in the City of St. Louis had declined to 375,000 residents. Meanwhile the urbanized part of the region had engulfed 250% more space than 1950 while the regional population had increased by only 20% during that time.

The challenge every mayor of the City of St. Louis has faced is how to repopulate the city and how to do it with the political support of suburban elected officials and citizens.

This informal band of citizens and the mayor of St. Louis in the late 1980s—Vince Schoemehl—shared a belief that light rail could serve to reinforce downtown as the center of the region while serving to anchor and encourage redevelopment in the city. All of this would be attractive—we hoped—to suburban elected officials and citizens because of light rail’s ability to provide them a quick commute to downtown.

The challenges in St. Louis and the reason for light rail are far different than most light rail cities such as Portland, Los Angeles, Phoenix, or Charlotte—in those cities light rail is a way of dealing with growth. Here light rail is a tool for redevelopment.

In the early 1980s plans for a light rail line began to take shape and were shared with the public for the first time. The first concept was to run MetroLink through University City and Clayton, well-to-do St. Louis suburbs that soon will be served by the Cross County extension. Well, over 20 years ago that first public hearing, shall we say, didn’t go all that well.

All the familiar negative arguments were heard here for the first time:

- No one will ride it.
- Only those people will ride.
- My housing values will go down.
- Crime will increase.

The head of the metropolitan planning organization (MPO), Les Sterman, famously said, “I’m not going to another public meeting without some supporters.”

Thus the small band of supporters decided to formalize their efforts and CMT was founded with a handful of members and importantly, a pledge from a business organization—Civic Progress—to support the organization financially for 4 years, which was crucial and something that set CMT apart from many transit advocacy organizations: We had staff from day one.

Soon CMT members were writing letters to the editor, and testifying at public meetings about their experiences with light rail and how it improved the quality of life for so many people. We formed a speakers bureau and at our peak were doing about two speeches a week. Many of those were done by a loyal group of volunteers.

CMT members also were able to poke holes in the specious arguments put forward by the critics. No, light rail riders were not going to break into your house, steal your TV, and then wait on the platform for the next train to arrive.

Slowly, support for light rail in St. Louis grew. We took community leaders to Portland, Pittsburgh, San José, and San Diego to ride systems that were up and running by the late 1980s.

On those trips it was evident to skeptics that light rail attracted all kinds of riders, riders like you and me. Riders were enthusiastic, told how they had once opposed light rail at a public meeting or at the ballot box and how now, light rail had changed their lives, lowered their transportation costs, and took them to places they had not been to before.

Businessmen told similar stories. One of our members and big supporters, Dean Wolfe, a former vice president at the May Company, liked to tell how he led the business opposition to MAX in Portland when he was the store manager at the Myron Frank Department Store on Pioneer Square in downtown Portland. Dean would tell whomever would listen how wrong he was and how St. Louis needed light rail.

Later Dean Wolfe played a key role in getting the Cross County line through Clayton when he served on the Clayton Board of Aldermen.

Today Clayton and U-City are thrilled to get stations on the Cross County alignment when 20 years earlier their citizens successfully forced alterations to the original alignment to bypass those two suburban municipalities.

Our funding through the years has been important to making all of this happen. As I said, the business organization Civic Progress support continued for 13 years—and many of its member companies continue their membership in CMT to this day. Early on, business provided about 70% of the income of the organization and other memberships provided about 30%.

Today CMT has diversified its funding base, a step that was crucial to the solvency of the organization. Business provides about 30% of our income. Memberships provide about 30% and the rest is made up with grants and contracts.

We have about 1,000 dues-paying members, a 26-member board of directors, and a staff of two. As Kim Cella, my long-time associate likes to say about CMT, “Tom does the public speaking and the media interviews and I do the work.”

Our primary mission has been the establishment and now the expansion of MetroLink.

We played a central role in our successful 1994 ¼-cent sales tax referendum that is going to build the Cross County MetroLink extension. We formed a separate organization to run the campaign. We weren’t quite so lucky in 1997 when we passed a second referendum in St. Louis City, but lost in St. Louis County.

Our members have attended countless public meetings expressing their support for MetroLink expansion in the face of a small but vocal opposition.

We also have worked for public support and funding of a new multimodal terminal now under construction in downtown St. Louis that will include Amtrak and Greyhound and is located adjacent to a MetroLink station and MetroBus transfer facility. We also have been the key organization in sustaining state funding for Amtrak service in Missouri, employing a contract lobbyist in the state capital of Jefferson City to assist us with that program. Last year CMT was successful in securing legislative approval for raising the sales tax cap from a half cent to a full cent that would be available for MetroLink expansion and operation. This was something that citizens asked for, not the transit agency, and I think it made a big difference in the minds of legislators.

Most of the time CMT and Metro are on the same page. We talk daily about issues of the day and strategies to solve them. Years ago we discussed folding CMT into the public relations operation. But the CMT board wisely rejected that idea and is adamant that we maintain our independence and the ability to talk with Metro board members and elected officials when there are different points of view.

Having said that, we work daily with Metro, and we have programs in partnership with Metro to boost ridership on the transit system. One such program is the Guaranteed Ride Home program, which we started several years ago under contract to Metro. Metro applied and received Congestion Mitigation and Air Quality (CMAQ) funding and put out a request for proposal (RFP) for a vendor. Metro selected us.

We have continued to operate the program after grant funds ran out. This popular program has enabled us to register some 7,000 transit riders with more than 200 employers.

Five years ago with the help of CMAQ funding, CMT launched an Environmental Protection Agency program, Best Work Places for Commuters. This initiative recognizes employers who help their employees through a variety of means with the work commute. Five

years ago virtually no St. Louis employers were subsidizing transit passes. Today several thousand employees are riding Metro to work each day with either a partially or wholly subsidized transit pass.

Recently Washington University struck a deal with Metro to offer passes to all of its students and employees. Some 25,000 students, faculty, and staff will receive free transit passes. Both the main and satellite campuses of Washington University sit on the new Cross County MetroLink extension. Plus the medical school sits on the airport line at the Central West End Station. This breakthrough program will be a boon to ridership on the new line and serve as an example to other large employers.

Another important function CMT serves is the work of our Riders Advocate Committee and MetroLink station monitors. We survey riders quarterly about the Metro System and our monitors grade station cleanliness, repair, and security each month. This is entirely independent of Metro. The data are compiled and shared with Metro management. And most of the time, our conclusions are received with the mutual CMT–Metro goal of providing customers with a quality experience.

One of the first things Larry Salci did when he arrived in St. Louis was to go on a tour of MetroLink with me. I had the station monitor reports in hand that were repeatedly citing the same areas of concern: dirty stations, burned-out lights, and outdated signage. It was all documented and Larry fixed it.

Recently CMT has been working on a historic streetcar project and last year completed the renovation of two Peter Witt streetcars that some day will operate from Forest Park to a portion of the city we call the Loop, which is a vibrant mixed-use area in University City. If you have time while touring St. Louis, you can see the cars at either the Missouri Historical Society, which is a short walk from the Forest Park MetroLink station, or at Commerce Bank on Delmar, which is a short walk from the Delmar MetroLink station.

CMT has been blessed to have an active board and a solid group of volunteers to guide the organization over the 21 years. The organization has much to be proud of.

The vision of the founders of CMT is beginning to take place. Downtown is beginning to thrive with 5,000 new residents moving into lofts in the last 5 years, with another 5,000 expected in the next year or two. Retail is beginning a comeback. Developments are in the works at several stations including the Meridian at the Brentwood and I-64 Station on the Cross County line. Within a year of the opening of the Cross County line, BJC hospital will be locating 800 employees in a new office building at this station. Every one of the employees will be eligible for a transit subsidy.

Developers are beginning to buy up property along the entire alignment. Belleville, Illinois, will see a mixed-use development soon. The new Boulevard Development in Richmond Heights is perhaps the best new mixed-use development along MetroLink.

Recently, CMT brought together 50 St. Louis leaders in real estate, municipal government, and developers to talk about the kinds of developments that take the best advantage of the benefits offered by light rail. We brought Jack Wierzenski in from Dallas Area Rapid Transit to educate the St. Louis community about the kinds of developments that can take place around light rail.

Local government is so fragmented in St. Louis that sometimes there is not a regional perspective about what should go in or the false lure of the sales tax revenue generated by a big box development—a disaster in my opinion for proximity to light rail.

Well, that is a glimpse of the history and programs of CMT. In the 18 years I have been organizing light rail advocacy efforts, I have seen some important changes that I would like to share with you and also some of the challenges that face light rail advocates, whether you are on the consulting side, transit agency side, manufacturer, or what. I am talking to all of you as light rail advocates.

First, CMT's membership is aging—along with its executive director I might add. I go to meetings and the people in the room are in their 50s and 60s and older. The generation that rode our streetcar system is dwindling. This important source of knowledge and understanding about the symbiotic connection between a healthy urban environment and rail transit is dying.

Some of CMT's strongest advocates and best writers of letters to the editor and op-ed pieces are not being replaced by the younger generation. As author Robert Putnam pointed out in his book *Bowling Alone*, Americans sign fewer petitions, belong to fewer organizations that meet, know our neighbors less, meet with friends less frequently, and even socialize with our families less often. We're even bowling alone. More Americans are bowling than ever before, but they are not bowling in leagues.

One of the reasons for this Putnam found in his research. There is a direct correlation between the level of civic involvement and the time spent in a car. The more time spent in a car commuting, the less time spent being involved in church groups, civic organizations, political groups, or CMT, Friends of Transit, or the Transit Alliance.

We have to do better in recruiting and retaining young people to our cause. The Internet appears to be part of the solution. CMT sends out a weekly electronic newsletter and maintains an extensive website and attempts to monitor and respond to some of the bloggers on the other side.

My friend Lyndon Henry of Austin does a great job with the *Light Rail Now* website. Lyndon's work to spread news and watch the likes of Wendell Cox, Tom Rubin, and Randall O'Toole is a great service to us all. But the future may well include podcasting and text messaging, in addition to the more traditional methods of advocacy.

While technology and the Internet offer much to advocacy and building a younger constituency, the Internet is not a good substitute for showing up in person at a public meeting or meeting face-to-face with an elected official.

Second, we need to do a better job of making common cause with the transit-dependent on transit issues. All too often the expansion of rail is seen as a threat to the existing bus system. With buildouts of rail painstakingly slow, it is hard to sell a vision of rail transit that might take 30 years or more to become a reality, especially when a minimum wage worker's main concern is whether there will be a bus to get him or her to work or the doctor tomorrow.

In St. Louis, MetroLink has broadened the constituency for transit and I believe saved Metro from a precipitous decline in ridership that was halted with the opening of light rail. What's more, skeptical suburban voters have supported rail transit. Now affluent suburbanites and poor intercity residents have a common interest in a better transit system—but neither group knows it. We need to do better of seeing what we have in common and moving forward with a better bus and rail system.

One of the things we are doing is keeping up our communication with registered transit riders even though they are not dues-paying members of CMT. As much as we need the money, I recognize for many transit riders spending \$50 on a membership in CMT just isn't in the cards.

Third, from a national perspective we are making progress as light rail advocates. Several years ago, I spoke at an APTA Legislative Conference about the work of CMT. Conference

attendees were lamenting the difficulty of getting advocates to come to Washington to visit with their elected representatives. I pointed out that the \$1,500 or so it cost me to come to the conference was a big chunk out of the CMT budget and an even steeper figure for most transit advocacy organizations who for the most part do not enjoy the financial stability of CMT.

To its credit APTA founded the Center for Transportation Excellence and has been awarding a number of small grants to transit advocacy organizations across the country the past several years. I congratulate APTA on this outreach effort and for its PT2 program. It helps our cause here in St. Louis when people hear and see advertisements about the benefits of public transit in national magazines, cable television, and National Public Radio.

I also challenge APTA business members while funding PT2 not to forget those all-important memberships paid directly to local organizations. They are the lifeblood of organizations like CMT. A \$500 or \$1,000 membership is a huge—huge—to our budget.

In addition to support from industry, the Transit Alliance in Denver has been a leader in mobilizing municipalities to support the Transit Alliance not only in name, but also through financial support. At CMT we are just now beginning to have some success in that arena. Even after 20 years, there are still things to be learned.

I also believe more can be done nationally to improve and unite local advocacy while strengthening our presence in Washington. APTA and several local advocacy organizations should jointly commission a study on whether local transit advocacy organizations should merge into a national organization—certainly one with considerable local autonomy.

Such a national organization—I believe—should operate under a single name with local chapters perhaps along the lines of the Women’s Transportation Seminar or the AARP. Right now there is a hodgepodge of names: Friends of Transit, Light Rail Now, Modern Transit Partnership, Transit Alliance, CMT. We all are doing basically the same thing.

I believe if we could find a way to merge and operate under the same name, that over time local advocacy organizations would benefit from greater name recognition, support from a national structure, and the opportunity to learn and network with one another. Much is to be said about strength in numbers and a formal national organization might help achieve that goal.

A second point I would like to make about the national scene is that we are at risk of losing the public policy wars to some of the think tanks that for years have questioned the value of rail transit. We cannot afford to cede ground to the likes of the Heritage Foundation, the Reason Foundation, or the Cato Institute who still love to trot out the canard of “we could buy everyone a Lexus for less money.”

We got a dose of this nonsense in 2004 when an economist at the St. Louis Federal Reserve Bank published a variation on this theme suggesting we buy poor people a Toyota Prius rather than expand MetroLink. I found the interest on the part of the bank a bit curious until I looked at the biography of the president of the St. Louis Federal Reserve. William Poole, president, is an adjunct scholar at the Cato Institute.

When we learned of the article, CMT organized rebuttals from Lydon Henry, John Roach, Haynes Goddard, and Todd Littman, debunking the article for a variety of reasons including the most basic that the author failed to account for the cost of people who could not drive, the cost of parking, and the cost of additional road capacity.

Often in these issues the first line of defense has been the Surface Transportation Policy Partnership (STPP). Everyone should be concerned about the financial health of the STPP. Unfortunately for STPP some of its long-term foundation supporters have grown weary of funding the same thing year after year, believing STPP has won the war of greater funding for

nonhighway modes, greater citizen input into planning, and more flexibility in spending federal transportation money.

As an industry we need to participate with STPP in finding a solution to its funding issue. Everyone in this room should be concerned about the future of STPP. After all, it was STPP that led the way with the late Senator Patrick Moynihan to initiate the original Intermodal Surface Transportation Equity Act of 1991 (ISTEA), which overhauled how local, state, and federal governments choose and fund transportation projects. ISTEA was of enormous benefit to the transit industry. STPP is an important ally.

Our continued desire for further transportation reform—the hallmark of STPP—should be continued. Along with its many studies about the important role transit should play in our society, STPP partnered with many groups across the country in gaining strong media coverage for its work. Those linkages are falling apart. We must get busy or risk losing the public policy gains we've made to the well-funded libertarian think tanks. APTA, I know, is addressing the funding issues of STPP—and I thank APTA for that. But we can't leave it just to APTA.

On a brighter note, the Rail~Volution conference continues to draw well. Now in its 12th year as a national meeting, the conference has done a superb job of attracting a broad array of people interested in rail transit and building livable communities.

While not an advocacy organization, Rail~Volution often appears to be one big coalition. In addition to transit agency employees, mayors, aldermen, community planners, representatives of the media, and advocates meet annually to discuss the latest things happening with transit-oriented development from across the United States as well as several foreign countries.

If you are not involved, you should be. It is another venue to getting the message out, especially light rail's ability to spur development.

The lessons that you might take from CMT back to your community are that successful light rail advocacy costs money, but it is affordable, especially if you are creative. Business can chip in, local government should help, the transit agency can help by contracting out some activities as Metro did with the Guaranteed Ride Home program with CMT. The engineering community and car manufacturers should be big players, and we have been able to do a lot with our CMAQ grants. Also important is building a base of small contributors. They are your foot soldiers. We have a great group as I said, but we need more and we need some young folks.

I can't emphasize enough the need for staffing an organization. I have been invited to cities across the country talking to citizens about our success and their starting an advocacy organization. And the difference I see is staff—Tampa started an advocacy organization but couldn't sustain the staff and the light rail effort fizzled. The same thing happened in Orlando. Denver has sustained a staff organization and has a huge light rail expansion plan in place, likewise in Phoenix and the Twin Cities.

Fledgling all-volunteer organizations in Louisville, Kansas City, Rochester, Harrisburg, and Albuquerque have had a tougher time getting rail in place.

We all need to do better attracting younger members and being innovative with the Internet.

Finally, I urge that we continue this national—if not international—conversation about formalizing a structure that perhaps helps local groups morph into a national transit advocacy organization all operating under the same name. It would strengthen us all, for there is more work to be done.

Innovation in Infrastructure Use

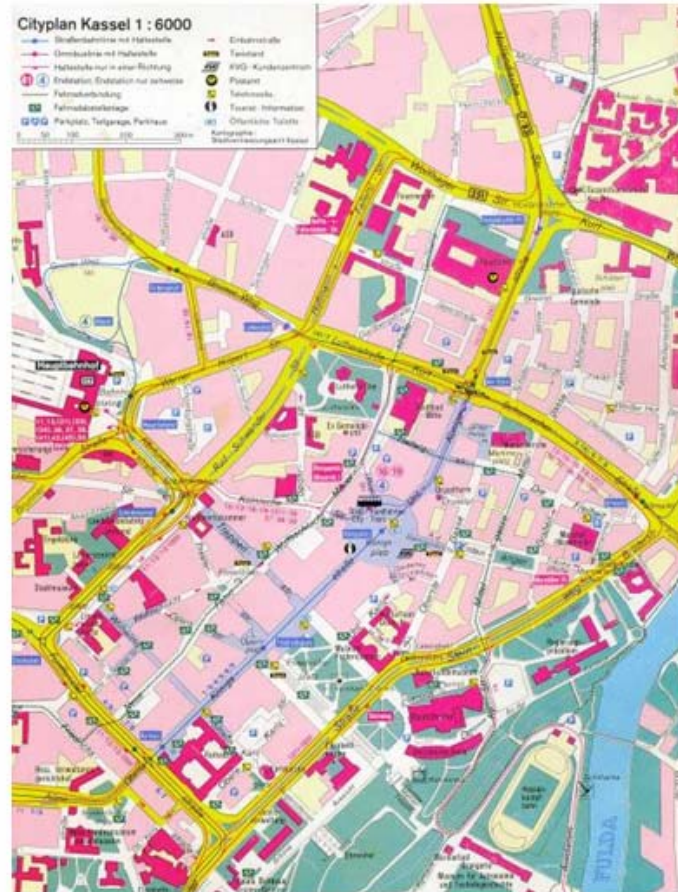
INNOVATION IN INFRASTRUCTURE USE

Track Sharing in the Kassel Region

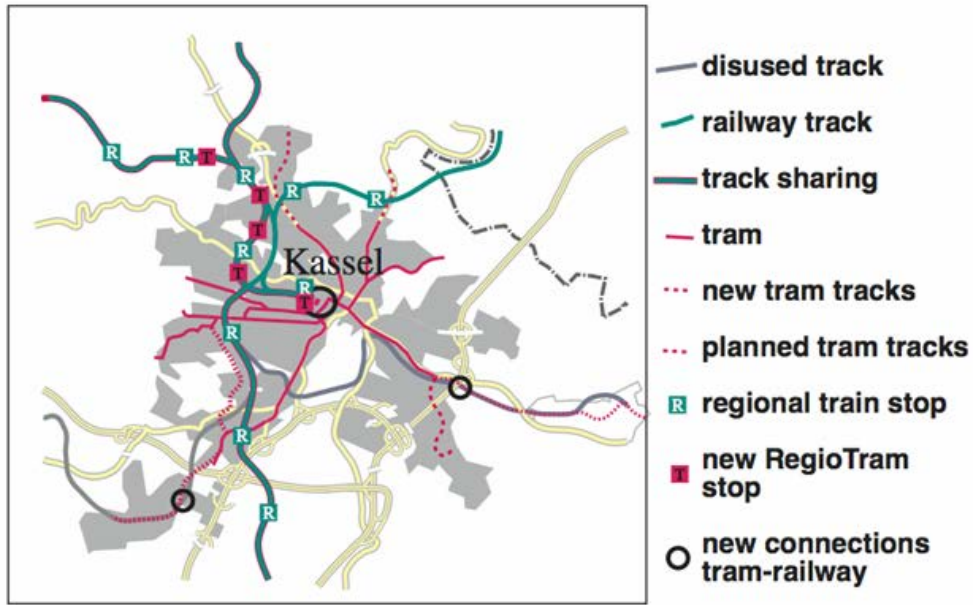
RANIER MEYFAHRT

KasselerVerkehrsgesellschaft AG

Track-Sharing in the Kassel Region



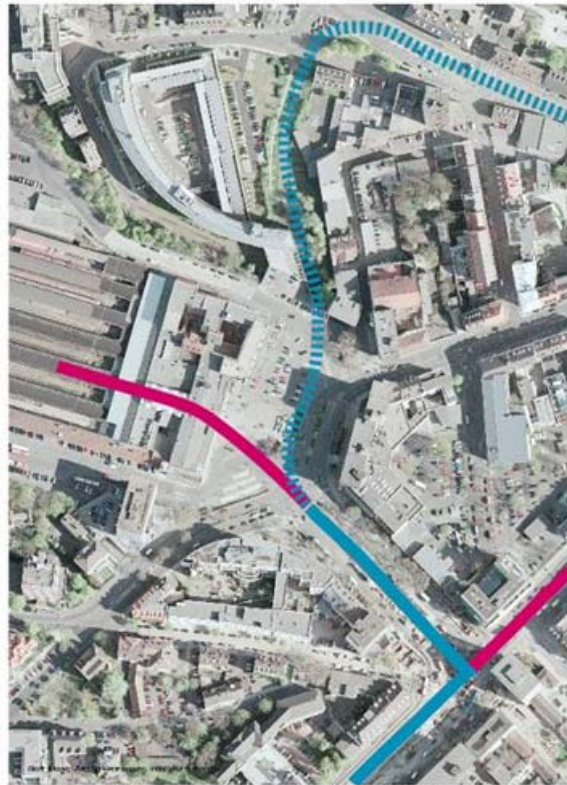
Kassel City Map



RegioTram: Network

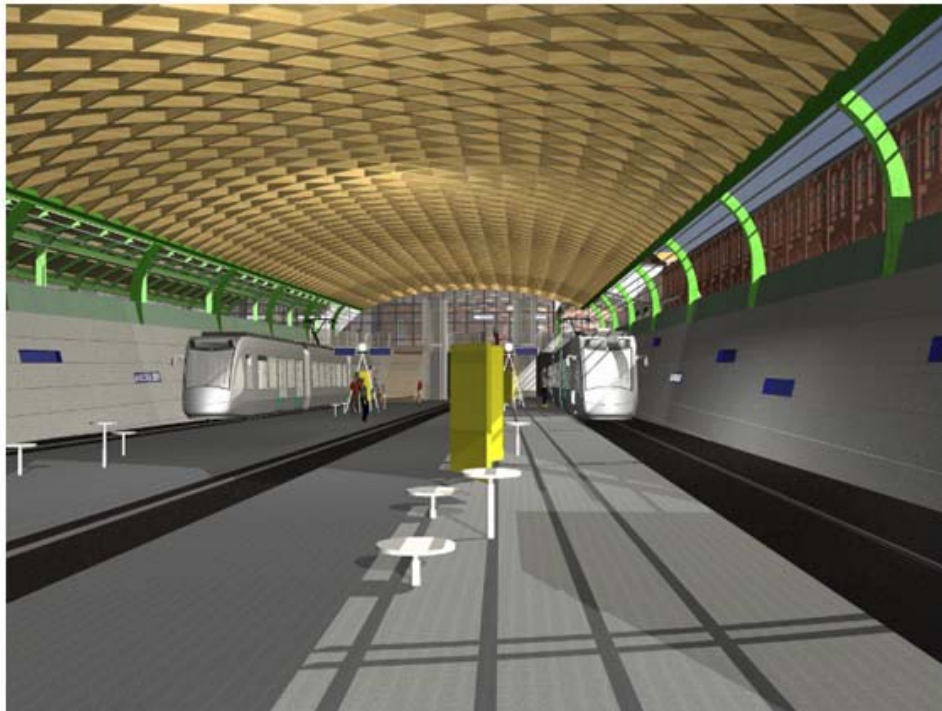
2

Kassel Main Station:
Connection Between
Light and Heavy Rail



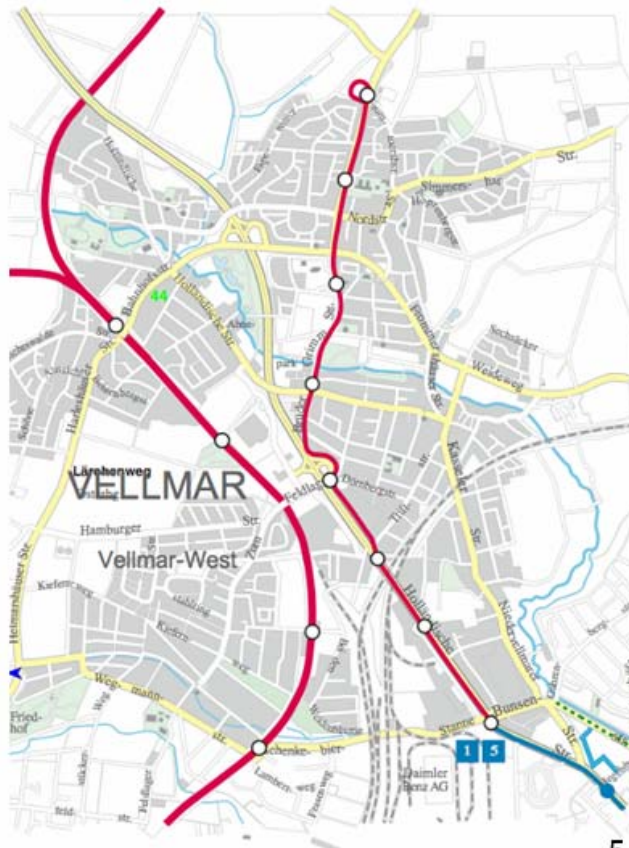
3

New RegioTram stop in existing old main station.



4

New RegioTram stations on existing railway.



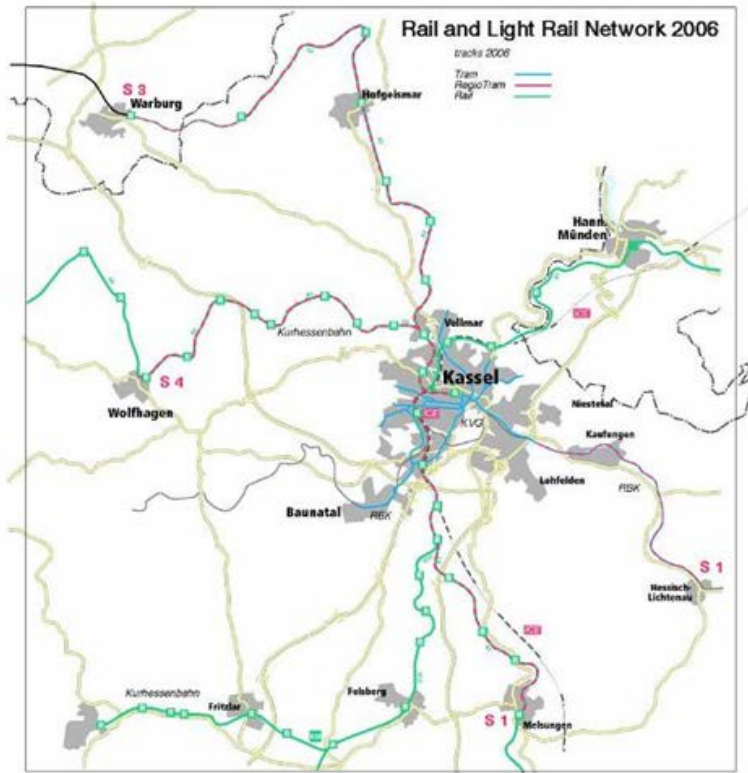
5



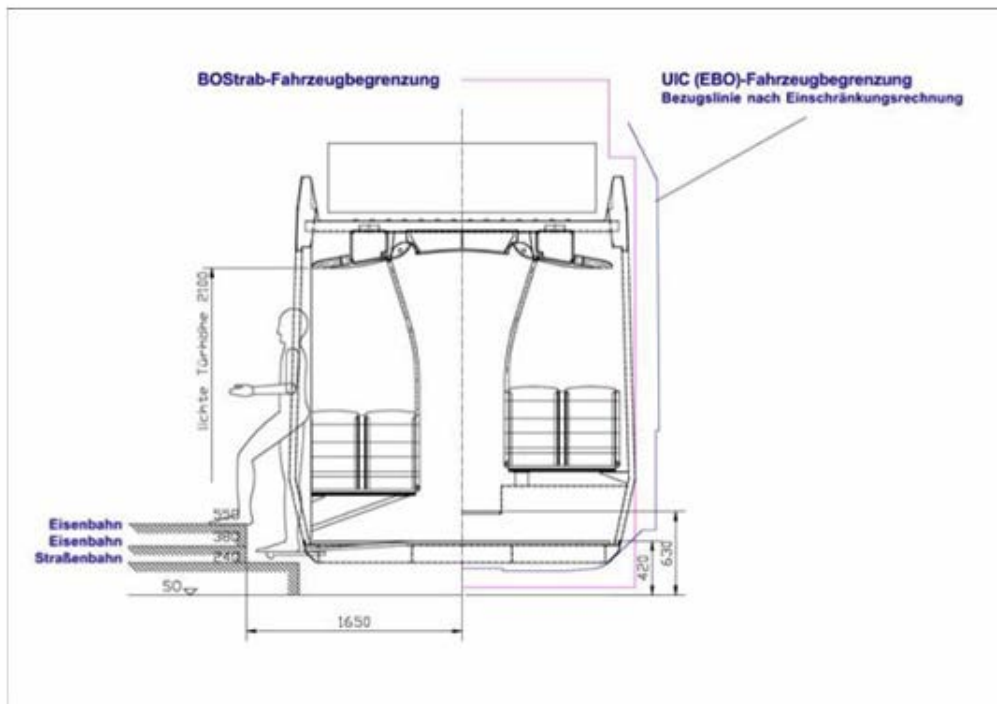
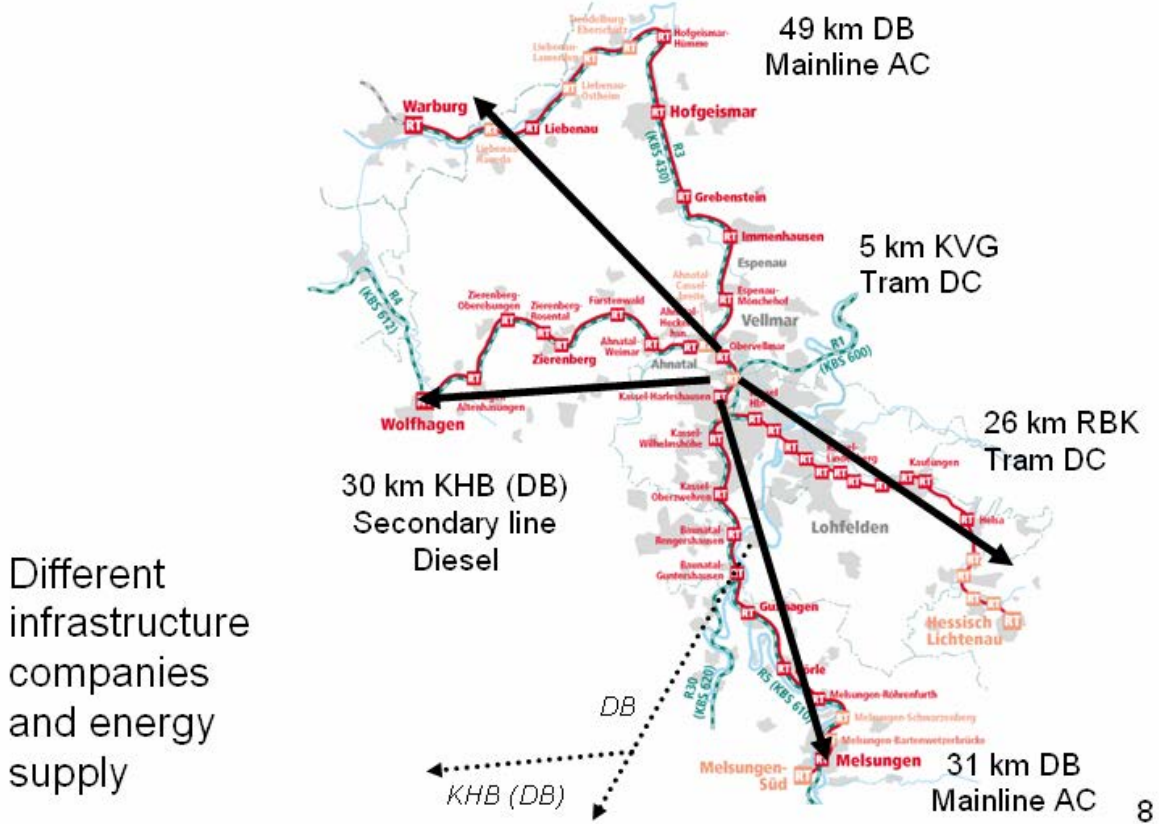
New station on existing tracks.

6

Network Overview



7



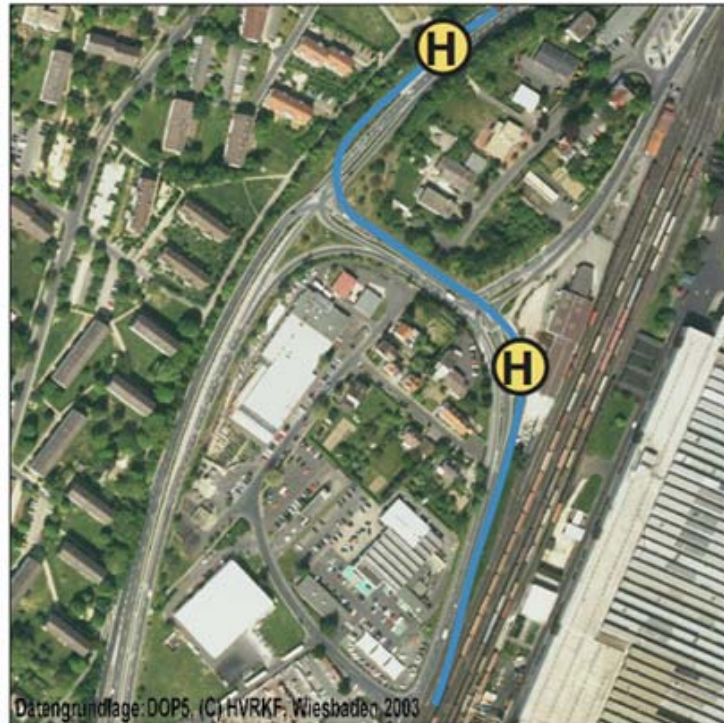
Different heights of platforms: 0, 24, 38, and 55 cm.



Track sharing: different width of vehicles: 2,40; 2,65; 3,00 m. 10

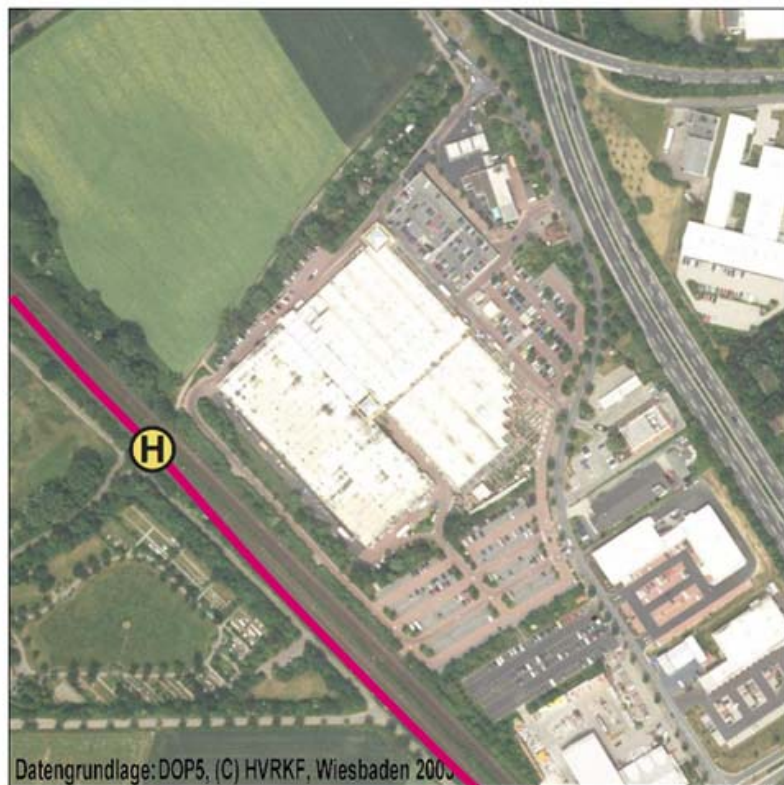


Traction flexibility



Track sharing at VW factory Baunatal.

12



New station on existing tracks near shopping area Herkules.

13

Disused tracks near shopping area DEZ.



14

New tracks and stations in Hessisch Lichtenau.

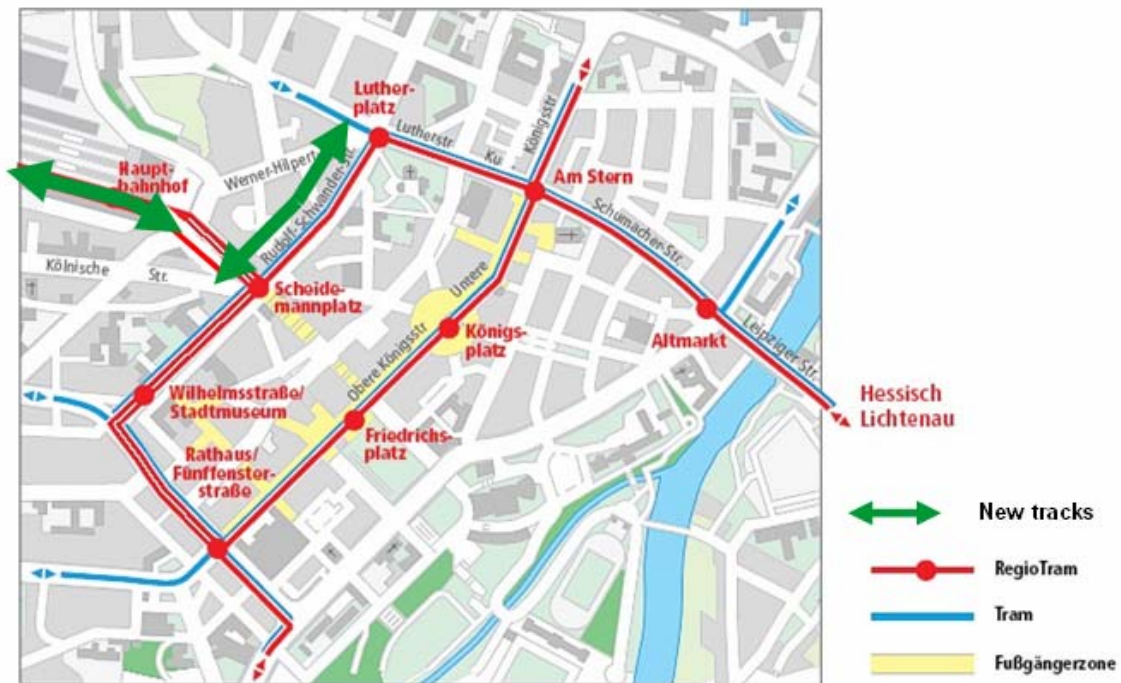


15



RegioTram in small street of Hessisch Lichtenau.

16



RegioTram system in the city of Kassel.

17



Tram and RegioTram in the pedestrian area of Kassel.

18



Pedestrians and passengers: face to face.

19



ICE and RT on mainline rail.

INNOVATION IN INFRASTRUCTURE USE

Feasibility of Combined Rail–Road Transport System in the Netherlands

FRANCIS CHEUNG

AVV Transport Research Centre

Increase in automobile use in the Netherlands leads to discussions about how best to enhance accessibility to major socioeconomic centers by public transport. In addition to the construction of new infrastructure, the Transport Ministry wishes to improve the utilization of existing transport infrastructures. A project was undertaken to determine the feasibility of a combined rail–road transport system so that the vehicle could use both the existing rail and road infrastructures. The research had to demonstrate that such an innovative concept would be technically feasible and financially viable under the existing legal framework and that the technology could be implemented within 5 years. On the basis of an extensive literature survey, expert panel reviews, and dialogues with transport industries, the research team reported that specific examples on trial had been found in several countries, but none in commercial operation. Judicial experts concluded that no legal constraints stand in the way even though existing legislation would limit the maximum capacity to 100 passengers per vehicle. To gain insights into the relative performance of the bimodal system compared with conventional light rail transit (LRT), bus rapid transit, and light train systems, a case study was undertaken. The transport–land use model used in the Rijn–Gouwe Line study was applied to forecast patronage and to evaluate economic viability. Analytical results indicated that the bimodal system would have no advantage over and above those for the proposed LRT. In the absence of commercial experience, it was not possible to give realistic estimates of the development and operating costs.

INTRODUCTION

In September 2004, the Netherlands Ministry of Transport published the transport policy document “*Nota Mobility: Towards reliable and predictable accessibility*” (1), which outlines the transport planning strategy in the period 2004–2020. The transport policy goals are to achieve a strong economy, to ensure sustainable development, to improve quality of life, and to enhance the living environment. The operational objectives are to improve accessibility to the major socioeconomic centers, to enhance road safety, and to mitigate the environmental damages. Total travel demands are expected to increase exponentially and the use of the private car also shows a growing trend. Public transport is expected to play an important role to increase its share in the modal split and to provide reliable and predictable door-to-door accessibility. Network integration and technological innovations are perceived as important planning instruments to enhance the efficient use of the existing transport infrastructure. New infrastructures will be provided only when there is a clear case that alternative means of transport are inadequate or inappropriate to ensure economic growth and social development in the Netherlands. An efficient and properly functioning transport system is seen to be essential to the strengthening of the regional economy and to promote the competitive position of the country as the “Gateway to Europe.”

In recognition of the key position of public transport to meet rising travel demands, research and planning efforts have to concentrate on exploring the potential benefits offered by technological advancement and to identify opportunities provided by innovative use of the existing infrastructures. AVV Transport Research Centre in Rotterdam, which is the research department within the Dutch Ministry of Transport, is constantly in search of possible “windows of opportunities.” A measure to increase the social–economic benefits of using existing rail infrastructure is by sharing the tracks with other passenger transport modes and not only sharing with rail freight. If successful, such a measure will generate additional net benefits for the whole rail system. And if the application could be used in redundant or disused transport infrastructures, the benefits will even be greater.

This paper describes the results and findings of an exploratory study commissioned by the Directorate-General of Passenger Transport, the policy department in the Ministry of Transport. Even though the project was undertaken and completed in 1999, the outcomes are still interesting for wider dissemination and for discussion among planners and practitioners. The primary objectives are that lessons learned can be shared and that views, opinions, and judgments of transport experts can be assembled for future reference. The original aim of the research was to determine the feasibility of a combined rail–road (bimodal) system that could fit into the existing infrastructures and use the spare rail capacity that would be available. The goals were to investigate the practical value of such a concept and to achieve a better understanding of how it could support policy planning.

The structure of the paper is as follows. As the project was organized in three phases, the objectives of the research and issues under discussion in each phase will be given, followed by a description of the methodology used, and the approach adopted to determine feasibility. Results and findings in each phase of evaluating the bimodal system will then be described including the outcomes of a case study. The transport–land use model that had been used previously in the Rijn–Gouwe Line study (2) was used to forecast the ridership and to determine the relative performances of the bimodal system compared to alternatives such as light rail transit (LRT), bus rapid transit (BRT), and light trains. The paper will conclude with a description of the insights gained, lessons learned, and an assessment of the opportunity to actualize the bimodal concept within the next 5 years.

STUDY AIMS AND ISSUES IN HAND

The conventional wisdom of building more roads and constructing new rail infrastructure to cater to rising travel demand has to be reexamined critically in the pursuit of sustainable transport. In line with the thinking expressed by the European Parliament, the Dutch Transport Ministry decided to investigate the practical application of the bimodal concept. The aim was to establish its feasibility so that appropriate vehicles could be designed, constructed, and put in use to serve the public within 5 years in the Netherlands. It was considered to be a fruitful topic for investigation because of a shortage of land to absorb additional new infrastructure and a rising need to curtail public expenditures in the transport sector. The emerging sense of financial prudence had raised an awareness to make better use of existing infrastructures. Proponents of the bimodal system stated that the concept had been put into use in restricted circumstances and that, under favorable conditions, innovative applications in passenger transport could provide better accessibility, minimize interchange, shorten travel time, and increase ease of travel and convenience. As a consequence, it would be plausible that successful applications could encourage ridership and provide an attractive alternative to the private car.

Hitherto, the bimodal concept was relatively unknown, except in the limited cases of small vehicles that had been constructed for operators to inspect rail tracks and for routine

maintenance. Such a concept had been investigated in the past and prototypes constructed to demonstrate that the idea was not totally illusive. In freight transport, there were commercial examples that had been shown to work well even though the market was quite small and insignificant relative to the total market size.

The Directorate-General of Passenger Transport, the policy department in The Hague, asked AVV Transport Research Centre to look into the idea and to investigate the feasibility of applying the bimodal concept. The basic requirements were laid down:

- Shared use of rail tracks would lead to improved utilization of rail infrastructures.
- Practical application could be actualized within a short time (say, 5 years).

To meet these requirements, the project had to provide insights on the technical feasibility, judicial barriers, legal constraints, financial viability, and operating performances relative to alternative proven techniques that were already in existence. To meet this unusual challenge, AVV Transport Research Centre was given the task to design a suitable research strategy, prepare a study program, organize a multidisciplinary team, and supervise the project's progress. On the basis of invited tendering by suitable research institutes, consultants, and engineering bureaus, the consortium formed by the transport-planning consultant AGV (Adviesgroep voor verkeer en Vervoer) in Nieuwegein and Holland Railconsult in Utrecht was assigned to undertake the study. A steering group compiled of officials and researchers from different departments within the Transport Ministry was given the task to oversee the progress and to report back to the Directorate-General. In December 1999, the consultants presented their final report (3) together with a separate technical report with several appendices to provide detailed results of the part studies.

RESEARCH PROGRAM, METHODOLOGY, AND APPROACH USED

Intensive consultations with the experts in the research team and preliminary assessment of the knowledge available came to a decision that the study should proceed in three phases. If early results indicated that the concept for passenger transport was barren or unlikely to generate usable products, the project could be terminated.

Phase 1: Identification of system types. Prepare an inventory of all the different ways and means to enhance the shared use of existing rail infrastructures and undertake preliminary appraisal of the proposals with respect to technical feasibility and judicial constraints. At this stage, the vehicles under consideration would include metal or rubber wheels as well as air-filled balloon.

Phase 2: Rail-road (bimodal) systems. Prepare a realistic list of the opportunities, constraints, and barriers that were likely to affect the practical application of the proposals in real-life situations so that a shortlist of candidates could be drawn up for more in-depth study.

Phase 3: Case study and evaluation. Perform a detailed evaluation of the chosen candidate(s) on the basis of more robust and vigorous testing methods, e.g., using traffic forecasting study in specified real-life situation(s) and to appraise the financial viability of such a package.

In short, the appraisal would concentrate on four aspects: technical, legal, operating performance, and financial results. Technical feasibility and legal feasibility were considered to be the basic requirements and would be critical to determine whether the project should proceed. Therefore, these two aspects were given prior attention in the evaluation process. In view of the

pioneering nature of this project, it was recognized at the outset that the study would be exploratory in character and the results indicative to provide first impressions. Should the first results be promising, decision makers would then have to decide on a “go–no go” basis together with the stakeholders. Major questions would include these issues: what would be the risk factor, where would be the potential areas for practical applications, what additional research to perform, and the kind of refinements necessary to deepen our understanding. The ultimate aims would be to determine the potential contributions that future development of the bimodal concept could bring and the likely payoff.

RESULTS AND FINDINGS FROM PAST STUDIES

Phase 1: Identification of System Types

On the basis of extensive desk research and comprehensive review of the literature available, the research team drew up an inventory list of relevant aspects that should be examined. Attempts were also made to uncover practical examples and to identify the locations where experiment with bimodal vehicles or shared utilization of the rail infrastructure had previously taken place. This exercise was supplemented with focus group discussions with specialists and experts in order to determine what techniques would be worthwhile for the in-depth inquiry and what were the chances for short-term implementation. In total, 16 rail–road systems were identified and they were classified into four categories:

- Vehicles that would be self-standing (with their own traction) and could run on existing rail tracks and on the road, e.g., rail–bus, road–train, work vehicles for laying tracks and for regular maintenance of rail infrastructure.
- Road vehicles that could wholly or partly tranship by rail vehicles, including those techniques where the load (rather than the vehicles) could tranship to rail vehicles, e.g., roll-on, roll-off techniques and the Straben–Schienen Omnibus in Germany.
- Vehicles that could be on the road and, with the construction of new infrastructure such as rights-of-way or automatic guidance system, could ride on rails, e.g., RUF system in Australia and Denmark; guided buses in Runcorn, Nancy, and Essen; guided automobiles or guided freight vehicles.
- Other vehicles such as people movers, trolleybus, guided paratransit, rail vehicles that can operate on light and heavy rail, rail vehicles riding on air-balloon wheels, e.g., Micheline, hybrid vehicles with electricity supply fed from pantograph and the wagon rides on railway wheels, and various experimental forms of vehicles and personal mass transit systems.

After an extensive consultation, two categories were reckoned to be promising. To meet the requirement that the system could be in operation within 5 years, only one category fit the description: combined rail–road vehicle. At this point, it was unanimously decided in the steering group that subsequent research would concentrate singularly on the bimodal system that would be self-standing with its own operating support system. The same vehicle would be capable to run on existing rail and on the road with potentials within 5 years.

Phase 2: Rail–Road (Bimodal) Systems

Extensive review of the published information available indicated that there was little or no empirical material on the application of the bimodal concept in passenger transport. It was even more difficult to obtain informed views on the market potential for such a technology.

Information regarding barriers and constraints that could inhibit technical development was also not in the public domain. It was decided then to undertake a questionnaire survey to be sent to relevant transport industries and to undertake face-to-face or telephone interviews with specialists directly responsible for system development. In total, 33 experts in the Netherlands and elsewhere were approached, including 13 persons from the vehicles manufacturers sector. This method produced some useful information and gave the research team some confidence regarding where and how to look for relevant information. Four specific applications were identified:

- In the 1930s, a railbus was in operation in the Netherlands between Rotterdam–Oostvoorne–Rockanje. Due to the failure to obtain an operating license from the responsible authority, the operation had to cease.
- In diverse European countries including the Netherlands, maintenance vehicles for the rail infrastructure are in regular use; they ride on rubber wheels and have small rail wheels on the side to guide their operation on the rails. The manufacturer *Zweiweg Schneider* in *Leichlingen* produces different types of bimodal vehicles. For the mounting of the overhead cables, vehicles using 14-ton heavy freight lorry that can run on the rail up to 50 km/h are available. For welding purposes, a 35-ton vehicle with a top speed of 80 km/h is used.
- In England in the early 1980s, a road vehicle was developed that could operate on heavy rail and had ridden in the U.K. (on the *West Somerset Railway*, at the *Tramway Museum* at *Crich* and at *Edinburgh*) and in Germany to demonstrate that the technique could work. However, further development had to terminate because the company that had pioneered this unique design, *Lucas Aerospace*, did not regard such adventure as its core business, the building of airplanes.
- In Canada, the *Brand Power Unit* has been developed. It is a freight lorry-wagon with rail wheels in addition to air-filled tires and it functions as a locomotive. The unit can be used for passenger and freight transport depending on the wagons that the locomotive has to pull.

In 1996 the business unit *Netherlands Railways Passenger* (network North–East) had undertaken a feasibility study to assess the bimodal vehicle in a concerted effort to determine its potentials. The corporate objectives were to expand the range of products in the passenger market to meet increasing discontent of passengers having to interchange between modes and to improve travel comfort and convenience. The study concluded that the costs of bimodal vehicles would be higher than the intercity luxury coach service called *Interliner*. However, the study did not examine market potentials or the likely incomes that it could generate.

Phase 3: Case Study and Evaluation

On the basis of findings from the literature study, the questionnaire survey and the testing of expert opinions in interviews under Phase 2, it became apparent that the bimodal concept was not completely baseless and that real-life opportunities might exist under favorable circumstances. Situation analysis was then undertaken with a brainstorming session among members of the research team. The exercise identified a short list of actual situations in the Netherlands where the bimodal system might be considered to be suitable. A comparative study of expected travel demands and likely traffic effects that could be attributed to alternative public transport systems was also performed. The aim was to determine the relative strength and weakness of the various options.

System Characteristics

Proponents of the bimodal system had claimed that the concept could reduce the number of interchanges or even negate completely the need to transfer between different public transport modes. Costs savings and quality improvement on specific pairs of origin and destination might result in not having to have expensive and lengthy construction works that could cause severe disruptions to daily operation. However, the disadvantages of bimodal would be the limited opportunity that would arise and the engineering demands that the system would impose on the road and the rail networks. The transposition or transshipment of the bimodal vehicles could take one of three possible constructions: road-railers with the vehicles transferring to rotating platforms and being pulled by a locomotive; vehicles with a built-in, whirling mechanism and having their own propulsion system; or self-sufficient vehicles able to operate without having to switch between wagons. Depending on the specific technical specifications such as radius of the arch and width of the vehicle, additional supporting infrastructures might be called for, e.g., construction of rotating tables, vehicle locks, or gates. Low-floor platforms at stations and stops may also be needed to make the system work efficiently. In the technical feasibility study, these features had to be specified in some details. Other important aspects that would require particular attention were the energy supply system, intended operating speed, and the kind of safety precaution mechanism needed to avoid derailment.

Judicial Requirements and Legal Considerations

A major concern at the outset was to ascertain the legal position and to specify the judicial requirements that the proposed system had to fulfill before an operating license could be considered and granted. By virtue of its bimodal nature, judicial requirements that have been laid down for the rail system as well as the road system have to be satisfied. That means, in effect, having to meet a double set of standards. The most restrictive requirement would be the maximum acceptable dimension for vehicles under the road traffic laws: 18 m long and 2.55 m wide. That is equivalent to a maximum capacity of 100 passengers per vehicle. On the rail side, the crucial factor is safety requirements. The vehicles are required to sustain damages incurred by collision on impact and to meet the safety standards set for passengers and rail personnel. On the basis of preliminary assessment by legal experts, it was concluded that there exists no a priori reason purely on legal or judicial ground that would inherently prohibit the bimodal system (assuming the system is financially and technical feasible) from revenue earning services if the basic technical prerequisites were met in full.

Technical Feasibility

The following technical requirements have to be met:

- It must be able to be detected adequately when in operation for a safe and efficient path assignment on the rail network. Under existing Dutch detection and safety system requirements, the minimal weight of bimodal vehicle has to exert the equivalent of 4.6-ton axle pressure to activate the system. In case of inadequate short-circuiting between the vehicle and the rail detective system, additional measures have to be taken or the detective mechanism in the rail infrastructure has to be modified, e.g., by having a second detection layer or extra axle counters.
- It must meet the same safety standards as demanded of heavy rail, e.g., installation of collision prevention systems, meeting the physical and mechanical construction specifications demanded, etc. In the event that the bimodal vehicle uses material with lesser strength for the carriages, additional measures have to be provided to enable train driver and passengers to

recover from collision impacts and deride the risk of injury. (Recently, light train vehicles have been permitted to operate on the Dutch rail system; technical progress has developed materials to meet safety requirements and satisfy the collision-strength standards. At the same time, the infrastructure manager, ProRail, has relaxed the entrance requirements for new light rail materials on routes that will be operated on the contract sector.)

- On the infrastructure side, the transposition mechanism or transshipment facility to lift the vehicle from road to rail (and vice versa) had to be sorted out to avoid the risk of derailment and to make a seamless transfer possible. Some kind of vehicle sluice or lock may provide an answer.
- The height of the station platform relative to that of the bimodal vehicle floor would need attention in the detail design stage (even though this problem also applies to LRT and BRT materials when rail tracks are shared). Existing stations operated by Netherlands Railway have a platform height of 84 cm above the rail track.

Outcomes of Situation Analysis

In the brainstorming session, the research team evaluated all the results and findings that had been obtained in the different stages of the project. In an open discussion, the experts together documented the strength, weakness, opportunities, and threats (the SWOT exercise) that could possibly be attributed to the bimodal concept. Ways and means to resolve conflicts and to overcome identified constraints and barriers were presented to the steering group in an effort to give an overview of the opportunities and to identify the areas that were considered to be promising. In appropriate cases, recommendations were made to consolidate the knowledge gained as a first step toward functional specification. When there was clear evidence that the required expertise was absent, the team would spell out in clear and unambiguous terms what were the gray areas and what actions would be required.

An important conclusion from the situation analysis was the need to maximize the advantages that such a radical solution would offer, e.g., to provide better door-to-door accessibility and to save expensive investment in areas where the rail infrastructures already exist but utilization was known to be less than optimal. It was also essential that the intended transformation would enhance total ridership using the new system, yet the expected increase would not exceed the permitted handling capacity. Professional judgment provided the following guidelines for detailed technical specifications:

- Maximum passenger limit: 100 per vehicle under existing safety requirements.
- Maximum length of bimodal vehicles: 18 m and width 2.65 m. (If expected new legislations would allow vehicle length to be extended to 26 m, capacity could increase to 150 passengers.)
 - Operating speed: within built-up area 20 km/h and outside 55 km/h.
 - Distance between stops: in the built-up area 800 to 1,000 m.
 - Maximum vehicle transshipment time from road to rail (and vice versa): 2 min.

To give further guidance, it was deemed necessary to embark on a specific case study and to identify a location that would provide quantitative data from travel demand forecasting techniques to give insights and to analyze comparative performance. The relative merits of bimodal, compared with alternative systems such as the LRT, BRT, and light train, should be investigated. Discussions with transport planners came to the conclusion that the Rijn–Gouwe Line (2) study would provide a suitable case for the comparative study. The regional transport and traffic model that had been designed for evaluation purposes by Provincial Government

Zuid–Holland could be made available for test runs to give quantitative data and to provide insights on the value of the bimodal system relative to alternative options.

Rijn–Gouwe Line Case Study

The Rijn–Gouwe Line has been planned to serve the major towns in the Province Zuid–Holland. The project is a joint undertaking by the Directie Zuid–Holland of the Directorate-General of Public Works, together with Provincial Government Zuid–Holland and the related local municipal authorities. It has been conceived as a major strategic transport investment to rejuvenate the regional economy and to improve accessibility for the traveling public. The study team wanted initially to examine all potential techniques including BRT. The modern concept operating specially designed buses on extensive lengths of right-of-way was under development in the Zuid–Tangent Project by regional operator Connexxion and in the Phileas Project in Eindhoven. However, the BRT option was considered to be inappropriate for this particular region. Therefore, the performance and expected patronage associated with bimodal was compared only with two other public transport systems:

- A light train-based system with fast-stop trains and many stations and
- A light rail-based system using LRT materials with many stops.

For each system, a separately designed and interrelated regional and local bus system had been prepared to cater as feeder services or for regional transport in the hinterland not served by the rail-based services. Together they provided a tightly knitted public transport network in an integrated transport and traffic plan for the study area.

For each of the three systems, individual traffic and ridership estimates were presented. The figures were all derived from the output of running the full Rijn–Gouwe traffic evaluation model twice. In the first run, it was assumed that the existing rail capacity would be sufficient and could without any problem meet traffic flows expected from running bimodal vehicles. However, results from the first model run indicated that the vehicle capacity in the section between a major residential area (Alphen Noord) and a key employment center (Gouda) was inadequate to meet the travel demands in the peak periods. To cater for the extra peak travel demands, additional capacity would be needed that would adversely affect the financial viability. Even though reductions in the need to interchange would raise the absolute amount of socioeconomic benefits, extra capital investment needed would lower the overall financial performance. It was also found that increasing the number of stops and making the distance from stations to the intended residential neighborhood shorter would not increase ridership. Therefore, it was decided for the second model run to take the opportunity to refine the networks proposed to capture extra values and to optimize the overall operational advantages, particularly in Leiden where urban buses could be strong competitors.

In the optimized second model run, it became evident that the higher operating speed of the LRT vehicles would be more attractive to both the existing and potential travelers and would outweigh the shorter walking distance between stop and home address that bimodal with deeper penetration could offer. And, in spite of having higher capacity scheduled for the bimodal system in the optimized model run, the high-volume flows in the peak between Alphen–Noord and Gouda would cause enormous strain and stress, making it necessary to have additional investments. It was estimated that to carry all the passengers comfortably with an assumed frequency of 4 vehicles per hour (vph), capacity had to be increased to 250 passengers per vehicle. This would be a technical obstacle. Raising the planned frequency would increase investment and the associated operating costs, making the whole scheme less attractive than alternative packages.

The case study provided an important indication that the bimodal system has an inherent weakness: the capacity would have to be between 200 (based on an assumption of 2 vph) and 600 passengers/hour (based on the frequency of 6 vph per direction). Any higher passenger flows would be better met by other techniques or it would be necessary to suppress the peak demands by measures to smooth the flow and spread out the peak to the shoulder periods. The steering group considered such steps as unattractive repressive actions and rejected them.

Table 1 presents the results of the second model run showing how many trips would be carried by the different components in each of the three transport packages. The figures giving the number of trips compared with the total number of journeys were particularly interesting because the answer provided an indication of the average number of interchange. The number of journeys by the bimodal system under the optimized variation would be higher than the equivalent figure for the light train package. Admittedly, the difference was less than 1% and, therefore, within the margin of inaccuracy. The difference in the number of journeys between bimodal and LRT was 3% whereas the total number of trips by bimodal is lower than both other variants, indicating that some passengers have to transfer from the bus to light train or light rail in order to complete the journey.

In the context of this appraisal, no allowance was given to the question of the image effect even though some people have argued that the exalted nature of new technology or the attributes of specific public transport modes would themselves have a positive impact on expected patronage. Literature studies indicated that such image effect could lead to an additional 0.5% to 24% ridership over and above the traditional estimation. In the present study, the image effect was explicitly not taken into account on the ground that the phenomenon had not been proved conclusively and there was a lack of empirical evidence.

Analysis of Financial Viability

Outputs from the two model runs also offered the necessary data for a series of analyses to determine the financial viability of the bimodal system. The aim was to determine the business and commercial case from the operating company’s point of reference. There were two stages: the likely development and production costs of the bimodal vehicles at the factory and the total costs for operating the bimodal vehicles for the operator relative to those incurred in exploiting alternative systems to meet the predicted travel demands.

On the question of production and development costs, there was not an answer received from the questionnaire sent to the different manufacturers. The team had to resort to ringing the

TABLE 1 Total Number of Passenger Trips per Public Transport System in Peak Period

	Light Train	LRT	Bimodal
Personal trips by Rijn–Gouwe Line	1,697	2,681	2,108
Personal trips by bus	2,406	1,563	1,145
Personal trips by train	887	745	1,619
Total	4,990	4,989	4,872
Number of public transport journeys	4,318	4,509	4,360
Interchange factor	1.16	1.11	1.12

product managers of the companies directly to obtain a response. The overwhelming reaction was either that the concept was not sufficiently interesting for their core business or that the specifications for the bimodal vehicles had not been worked out in sufficient detail to have a reasonable estimate of the range of likely costs. A few would be prepared to quote the price of their existing products and make projections. It was evident that manufacturers would be reluctant to spend time and resources unless there was confirmed commitment to proceed and the costs could be declared. The decision was then taken not to proceed and this cost item would form the subject of future investigation.

The attempt to estimate the operating costs for alternative systems was based on expert opinions and the standard costing model that had been devised by AGV based on its extensive experiences from past projects and extensive internal intelligence sources. The basic requirements as inputs were a comprehensive description of the operating features, e.g., financial data related to different levels of service provision, and the supply conditions necessary to meet the evening peak travel demands. With the assistance of expansion factors, the evening peak results were grossed up to average working day and yearly figures. In the calculations, the model runs had produced fine details regarding travel demand expected and service frequency needed by route and per direction. In the operating costs calculation, all the relevant components (with the exception of the costs for the management and maintenance of the infrastructures) were included.

Table 2 gives an overview of the fare-box cost recovery ratios in 2010. It can be seen that the ratio for all three systems was around 0.67 showing significant improvement compared with a national average of 50% in regional and rural transport at that moment. And because the bimodal system with improved neighborhood penetration would reduce the need to have an extensive and dense local bus network as feeders, there would be savings on material and personnel and in operating costs. If one included the management and maintenance costs, the expectation was that the cost-recovery ratio for bimodal would be higher than the other two packages because there would be fewer buses to maintain and fewer repairs.

To estimate the fare-box revenues received, it was assumed that the existing national fare structure and scale would apply. The characteristics of the fully integrated Dutch fare system are having standard fare zones 4.5 km in diameter, price undifferentiated between modes, and allowing free transfer between modes within given time limits. Therefore, the total revenue receipts among the three systems would not be significant different.

[To update the exercise to reflect present-day situations, new calculations will be needed. Legislation in 2000 (*Wetpersonenvervoer 2000*) has given the 19 public transport authorities freedom to introduce greater fares differentiation. In the near future, nationwide implementation of the smartcard technology will further facilitate structural changes making it even easier to

TABLE 2 Fare-Box Cost Recovery Ratio in 2010 per Package

	Rijn-Gouwe			Train	Bus Net Total	
	LT	LR	RW			
Light train (LT)	0.97			0.89		0.66
Light rail (LR)	0.76		0.84	0.56	0.67	
Bimodal (RW)	0.70		0.52	0.86		0.67

differentiate fares by mode and time of the day (4). There will be more room for local initiatives to refine the fare system and tailor the structure to improve the overall financial results of localized networks.]

In terms of the total costs for the complete system, there were few major differences; however, substantial variations existed between different modes that form the principal components within each package. In the light train option, the costs for regular train traffic were lower because the supply of normal train services would be lower while the costs for the related bus net would be high in order to provide adequate before and after transport. In the two other variants, both would have more direct access to the major socioeconomic centers in the region and hence the required bus net as feeder services could be smaller, particularly under the bimodal system. For the Rijn–Gouwe line itself, the costs for the bimodal variant would be higher than LRT because more bimodal vehicles would be needed to provide the same capacity, thus raising the kilometer cost and capacity cost. In contrast, the cost for the related bus net under bimodal would be lower owing to fewer buses in operation.

In conclusion, the financial viability calculations showed that there were considerable uncertainties regarding the likely development and production costs. It was also impossible to estimate total investment costs that would be needed for the bimodal system. Using conventional wisdom and the best expert opinions available, tentative attempts were made to identify the key cost and revenue components to enable the calculations to proceed. Results showed that the likely fare-box cost–recovery ratio would be similar in all three systems assuming the existing fare structure would prevail and administrative–maintenance costs for the systems are similar.

CONCLUSIONS

On the basis of the results and findings obtained from the different parts of the study carried out throughout the three phases, the research team had not been able to uncover materials that would totally contradict the assertion that practical application of the bimodal system with combined rail–road vehicles would be impossible or inadvertently become a total failure. In the contrary, the comprehensive literature survey and contacts with informed experts in diverse specialist fields had identified rare occasions when the concept was put to practical use albeit in very small scale and not in commercial environments. Owing to the need to guarantee passenger and staff safety and to give the technology a clean bill of health, the bimodal system has several barriers to overcome and stringent technical specifications to meet. It is, therefore, doubtful whether there would be sufficient interest to promote the concept and to speed up the development process so that the system could be in application in 5 years. Defining more precisely what functionalities to serve and drawing up detailed technical specifications are labor intensive and time consuming.

The technical feasibility and legal assessment have shown that under favorable circumstances, there might be potential. However, to actually bring the concept into fruition would require deep pockets, bold management actions, careful technical preparations, sympathetic hearings from the industries, and genuine interest from the public transport authorities. In addition, the operating companies have to formulate a detailed marketing strategy to tailor the product to suit the requirements of the consumers in the passenger market. At the time of preparing the report, it was rather doubtful whether such preconditions exist. In particular, there were several alternative proven technologies available from the shelf or on the planning table whereas a workable blueprint for the combined rail–road system was still in the making. It would not be unreasonable to conclude that the feasibility of combined rail–road system within a 5-year period would be unattainable. With regards to the longer-term future, much would depend on external technical progress, passenger attitudes to the need to

interchange, political desire to have direct door-to-door accessibility, and the community's willingness to pay for a new, innovative method of travel.

REFERENCES

1. Ministry of Transport. *Nota Mobiliteit: Towards Reliable and Predictable Accessibility*. The Hague, September 2004.
2. Ministry of Transport, Directorate-General of Public Works, Directie Zuid-Holland. *Verkenning Rijn Gouwe Oost, Rijn Gouwe Lijn*. Rotterdam 1999.
3. Ministry of Transport, AVV Transport Research Centre. *Verkenning naar de haalbaarheid van rail-wegvoertuigen in Nederland Eindrapport en Bijlagenrapport*. Rotterdam, December 1999.
4. Cheung, Y. H. F. *Cost-Benefit Analysis of Nationwide Smartcard for Public Transport in the Netherlands*. Presented at 85th Annual Meeting of the Transportation Research Board, Washington, D.C., 2006.

INNOVATION IN INFRASTRUCTURE USE

Shortline Railroads and Rail Transit *Joint Development Planning Issues*

LEWIS T. AMES

San Francisco Municipal Transportation Agency

JOSEPH R. WALSH

Tri-County Metropolitan Transportation District

This paper considers a scenario of increased rail transit new starts that share infrastructure and track with lightly used railroads. New start sponsors who see an opportunity to share infrastructure with a railroad that has capacity for rail transit traffic are likely to engage a local, shortline business. Regional transportation planning involvement of railroads in public-sector programs and goals is uncommon. This paper explores the perspective of local railroads in the context of potential rail transit planning and joint development. Surveys and interviews were conducted at 30 shortline and regional railroads, primarily serving cities without rail transit, but where the railroad operates on a potential rail transit route. A smaller, parallel survey engaged transportation planners at 13 metropolitan planning organizations and one regional port, where almost half of the surveyed railroads are located, in order to compare planning agency and shortline perspectives. The surveys sampled attitudes, interest, and conditions related to potential joint development that can be broadly summarized by four questions: To what extent are shortline railroads recognized and incorporated in regional plans and transportation programs? What public policies are important to the shortline railroads? What business issues are important to shortlines that may help transit developers achieve mutually agreeable joint development? What are operating and right-of-way conditions that might suffice for FRA approvals of shared track transit operations using noncompliant diesel-powered vehicles? The survey results point to new planning methodologies that meld rail transit and rail freight interests, project goals, and conceptual design standards in joint development programs.

STUDY BACKGROUND

If federal railroad safety standards were to follow European precedents to incrementally increase cooperation between rail freight and rail transit services on lightly used freight tracks, the first generation of shared-track systems in San Diego, Salt Lake City, and Southern New Jersey could quickly accommodate a small number of additional, late evening freight moves mixed with off-peak transit service. The planning issues would focus on procuring and verifying enhanced communications and controls. Entirely new starts of diesel multiple unit (DMU) vehicle or light rail service could also be considered where a shortline or lightly used freight corridor is attractive for rail transit. However, transferring the planning and institutional practices of established shared track systems to potential new starts is not well established. California, Utah, and New

Jersey shared-track freight services operate on public agency right-of-way (ROW). Many agency sponsors and population centers that could consider a new start with rail freight shared track as the locally preferred alternative may not be capable of an outright purchase of large-scale access to the ROW of the local railroad. Similarly, shortlines serving cities without rail transit would avoid sharing infrastructure with a passenger-based service that overrides their business and customer priorities. Concurrently, many shortlines are now spending millions in local, state, and federal funds to improve their railroad's ROW outside of the metropolitan planning organization (MPO) coordination and development processes that traditionally focus on public transit.

This paper considers planning approaches that could facilitate shortlines and transit agencies in a mutually agreeable new start–joint development process. The shortline perspective in this study is that of a growing business, with strategies that are achieving success after difficult effort, with 75 route miles of freight track under their control and several more miles through leases. The railroad has 20 or more skilled employees and is increasingly recognized as important to the local economy. The railroad considers its ROW a core asset. This perspective of a railroad business is generally not in many rail transit venues that consider shared-track opportunities.

TESTING SURVEY ISSUES

Table 1 summarizes an initial scan that was conducted of city regions with existing systems or recent studies of potential joint development to test issues and survey content. Regional planning, shortline, or transit agency staffs were contacted. California includes three existing shared track–corridor systems in San Diego, San Pedro, and San José, shared crossings (limited connections) in Sacramento and San Francisco, and a shared-track line under construction at Oceanside–Escondido. Recent studies have explored joint development in Tulare, Sonoma–Marin, Napa, and Santa Cruz counties.

Figure 1 shows existing shared rail infrastructure locations (in bold type) and the survey locations that were conducted across eight FRA regions. The initial review in **Table 1** reveals several common features to the existing systems and recent studies. Travel demand and markets match DMU vehicle capacity (of less than 400 peak passengers that are projected in the respective planning studies). The systems operate on suburban–linear routes between multiple, smaller cities. Oceanside–Escondido projected that 2010 daily ridership (12,000) will come from four primary population centers along 22 mi linking the Los Angeles–San Diego Surfliner rail corridor at its western end and Oceanside (128,398), Vista (133,559), San Marcos (54,977), and Escondido (89,857) residents and jobs. Tri-Met's Washington County–Beaverton project in final design has similar population centers distributed along the 15-mi line connecting to the primary light rail transit (LRT) system at its northern end. While the populations are relatively small, the lines penetrate multiple centers in a linear route at stations close to urban activity. The small scale of these systems allows short distances to access and distribute riders around the ("last mile" of the) station area and thereby can generate ridership from multiple origins and destinations.

For several of the systems in **Table 1** that own the corridor, transit service is the regional priority; freight service is a necessary accommodation. However, a trend appears evident that more extensive project development efforts have been required by the transit agencies to balance rail transit and rail freight design, goals, costs, and benefits. The challenges can be grouped into four planning issues for projects to progress: (1) economic benefits that are integrated and

mutually agreeable to the public stakeholders and the railroads; (2) new local, state, and federal funding of private railroad capital improvements and ongoing public transit operations; (3) integrated rail transit–rail freight conceptual planning and design criteria; and (4) integrated institutional arrangements to operate and maintain initial and expanded transit and freight service. The first two issues, integrated economic benefits and funding, merit further research—particularly the cutting-edge issue of blending a railroad improvement and new start transit funding application. The second two issues, integrated conceptual design criteria and institutional arrangements to achieve joint development, were the framework for the survey questions and are the focus of the conclusion.

The preview and feedback from preliminary interviews resulted in a four-page survey form of 22 questions with 71 distinct multiple-choice options. Questions to probe established industry data points were dropped, such as shortline industry growth in carloads and revenues over the previous 3 to 4 years that are well documented.

TABLE 1 Initial Scan of Existing Shared-Track Systems and Related Studies (Ranked by population)

	City-Region	Primarily City Radial or Suburban Linear Route	Right-of-Way Ownership	Population (rounded 000s)
I. FRA Region 7 Existing and Pending Systems—by population				
1.	San Pedro ^a Los Angeles neighborhood	Suburban–linear	Public agency	72,000
2.	Sonoma County ^b California	Suburban–linear	Public agency	470,000
3.	Salt Lake City ^c Utah	City radial	Public agency	1,405,000
4.	San Diego ^{a+b} California	Both city radial and suburban–linear	Public agency	2,932,000
II. FRA Region 7 Recent Studies of Joint Development—by population				
5.	Santa Cruz County ^a California	Suburban–linear	Public agency if established.	251,000
6.	Napa County ^a California	Suburban–linear	Private if established.	300,000
7.	Ventura County ^{a+b} California	Suburban–linear	Public agency	798,000
III. Other Existing and Pending Joint Development Locations—by population				
8.	Oceanside–Escondido ^c California	Suburban–linear	Public agency	407,000
9.	Washington County, pending Oregon ^{a+b}	Suburban–linear	Private with major public investment.	490,000
10.	Trenton–Camden, in service ^c New Jersey	Suburban–linear	Public–private	1,200,000
11.	Raleigh–Durham, pending ^c North Carolina	Suburban–linear	Public agency via significant purchase	1,328,951

NOTE:

^a Designates locations where shortline managers were surveyed to test the survey and identify potential joint development planning issues.

^b Designates locations where regional planning agencies were surveyed.

^c Designates locations where interviews were conducted of rail transit system or shortline staff or industry literature reviewed but a full survey form was not tested or reviewed directly during this outreach.

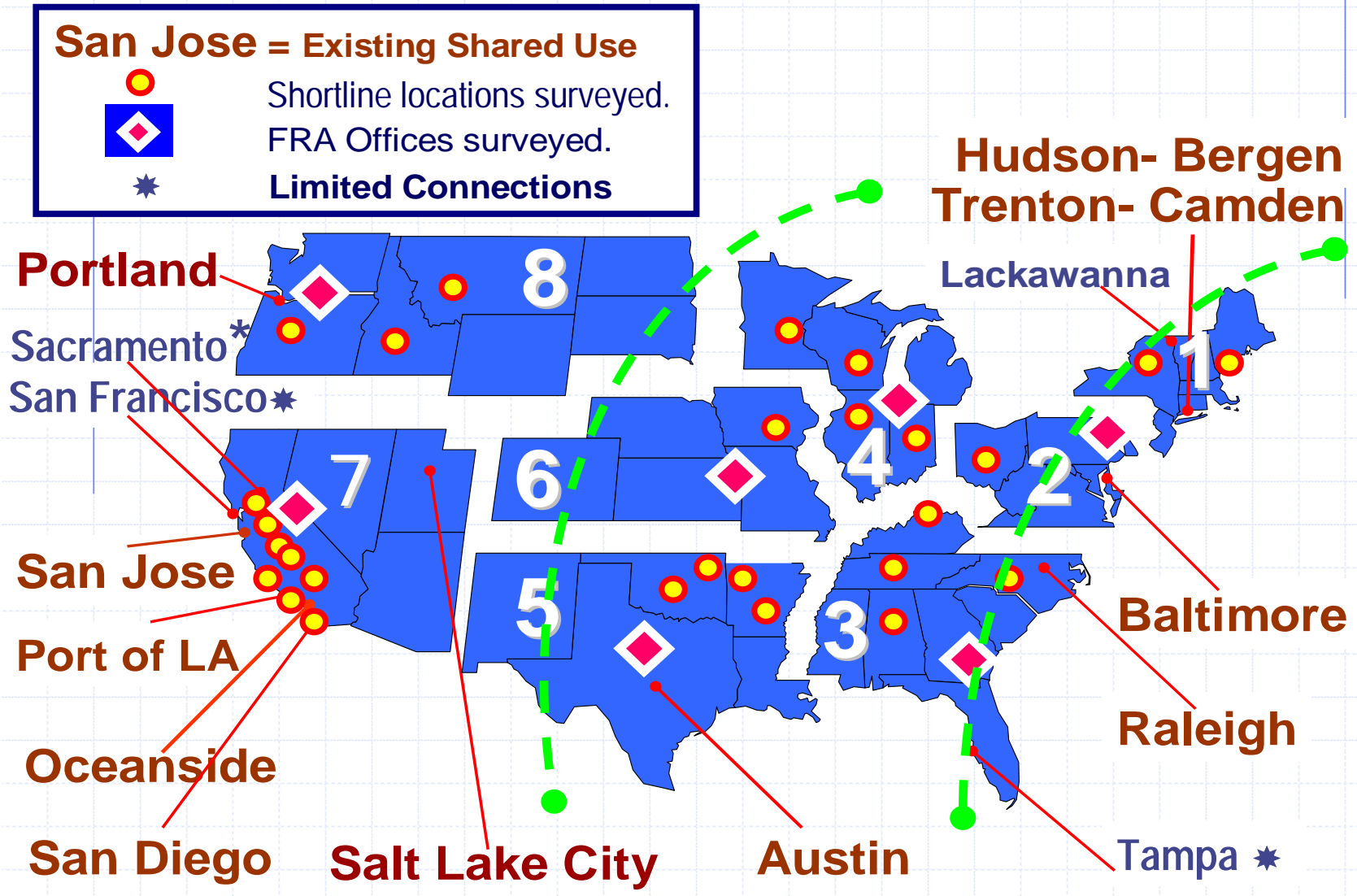


FIGURE 1 Existing joint development and survey locations within eight FRA regions.

SURVEY LOCATION CRITERIA

Table 2 presents shortline railroads by state and FRA region. The two states with the highest number of shortlines are in bold type. States with more shortlines (e.g., North Carolina in Region 3 or Oregon in Region 7) generally have larger state-sponsored shortline development programs as well as active shortline member associations. **Table 3** presents the criteria used to guide shortline railroad selection for the survey. For geographic distribution, (a) at least one railroad was surveyed in each FRA region; (b) for proportional distribution, one railroad in each FRA region was surveyed in the two states with the highest numbers of shortlines; and (c) one railroad was surveyed serving smaller populations and travel markets in each of the FRA regions to capture joint development issues in smaller populations, as found to be common in **Table 1**. Smaller population locations found to be engaged in potential shared track studies during the survey include Ventura, California, Bentonville, Arkansas, and Iowa City, Iowa.

The study approach was to sample representative shortlines regarding potential joint development without suggesting or leading to the question of actual feasibility. Applying the guidelines developed from Tables 2 and 3, **Table 4** lists 23 locations selected to study joint development planning issues by surveying the railroad and/or the MPO. The locations are ranked by metropolitan statistical area (MSA) and the city populations within each FRA region. Locations where shortline managers were surveyed are designated with an “a” footnote next to the name of the city; locations where planning agencies were concurrently surveyed are designated with a “b” footnote. The gray shading highlights city–regions with existing or approved rail transit (or commuter rail such as Nashville) that may have a potential for additional rail transit on a shortline or lightly used freight line route. These cities also provided a peer comparison with cities without rail transit.

Because most large cities without rail transit in the United States fall within a broad geographic arc between San Antonio, Texas, to the south, the largest city in the United States without rail transit and 1,200 mi away, Indianapolis (core city population 781,870, according to the 2000 Census) and Columbus (711,470), the two next largest cities without rail transit (shown in Figure 1), a majority of the cities selected for the survey came from this heartland universe. **Table 4** shows that a majority of these cities are among the largest in their respective states.

A number of cities with similar populations as those selected are not well served by shortline routes including San Antonio, El Paso, and Jacksonville, Florida. Several cities were not included to limit the scope of this research. Candidates for further study may be Omaha, Nebraska; Des Moines, Iowa; Detroit, Michigan; and Hartford, Connecticut.

JOINT DEVELOPMENT CONCEPTUAL PLANNING ISSUES

What are ROW and operating conditions for considering new start–joint development with a shortline business?

Operating characteristics that distinguish joint development potential for this research are train speeds and frequency of moves together with the shortline manager’s judgment if their ROW is sufficiently wide to be substantially double tracked. Conversely, poor opportunities for rail transit and rail freight mixed traffic would be combinations of existing train speeds greater than 40 mph and more than 10 trains a day, multiple time-sensitive departures and a ROW that is too narrow to double track.

TABLE 2 Regional and Shortline Railroads by State and FRA Region

	Region 1			Region 2			Region 3	
	NY - New Jersey			Central Atlantic			South and	
	New England	RRs		to Ohio	RRs		Eastern Gulf	RRs
1	Connecticut	4	1	Delaware	1	1	Alabama*	17
2	Maine	3	2	Maryland	5	2	Florida	12
3	Massachusetts	7	3	Ohio *	19	3	Georgia	14
4	New Hampshire	1	4	Pennsylvania	34	4	Kentucky	6
5	New Jersey	12	5	Virginia	8	5	Mississippi	14
6	New York*	17	6	West Virginia	5	6	North Carolina*	17
7	Rhode Island	1				7	South Carolina	9
8	Vermont	14				8	Tennessee*	14
	Total	59		Total	72		Total	103
	Region 4			Region 5			Region 6	
	Great Lakes	RRs		Central South	RRs		Mid West	RRs
1	Illinois*	14	1	Arkansas*	17	1	Colorado	9
2	Indiana*	27	2	Louisiana	11	2	Iowa*	10
3	Michigan	14	3	New Mexico	4	3	Kansas	6
4	Minnesota*	12	4	Oklahoma *	14	4	Missouri*	9
5	Wisconsin*	4	5	Texas*	37	5	Nebraska	6
	Total	71		Total	83		Total	40
	Region 7			Region 8			Railroads in All	
	California			Northwest			FRA Regions	Rank
	Western - Rockies	RRs		and Rockies	RRs			
1	Arizona	8	1	Idaho*	4	1	59	5
2	California *	19	2	Montana	4	2	72	3
3	Nevada	0	3	North Dakota	1	3	103	1
4	Utah*	2	4	Oregon*	10	4	71	4
			5	South Dakota	3	5	83	2
			6	Washington	9	6	40	6
			7	Wyoming	2	7	29	8
						8	33	7
	Total	29		Total	33	Total	490	

NOTE: Bold type designates the two states with the largest number of shortlines and regional railroads. RR is the abbreviation for railroads. The column shows the number of shortline railroads in each state.

SOURCE: American Shortline and Regional Railroad Association website.

* Shortline railroads from these states are included in the joint development survey.

TABLE 3 Criteria to Guide Shortline Railroad Selection for Joint Development Study

Shortline Railroad Study Candidates Selection Criteria and Examples	Criteria Application Issues	Estimated Candidates from 490 Railroads
<u>Type of Railroad</u>		
1. Exclude most switch and terminal railroads	Short, centered at ports, yards	-270
2. Exclude most regional railroads Example: Dakota and Minnesota—multistate route.	Class 2 mimic Class 1 railroad scale	-30
<u>Corridor Connectivity</u>		
3. Route penetrates population and employment centers Example: San Joaquin Valley Railroad serving Fresno	Avoid routes far from centers	10-15 +/-
4. Radial corridor serves MSA population > 400,000 Example: Indiana Railroad serving Indianapolis		10-15 +/-
5. Linear route comparable to Escondido-Oceanside Example: Cedar Rapids-Iowa City	Look for former interurban lines.	10-15 +/-
6. Route links to existing rail transit transfer station Example: Ventura County Railroad connecting to Surfliner	Criteria fit several suburban lines in Table 1	-
<u>Geographic Location of Corridor</u>		
7. At least one railroad survey from each of eight FRA regions		8-24
8. At least one railroad from each of two states with highest number of shortlines within each FRA region Example: North Carolina and Alabama in FRA Region 3	Exceptions: states with many small railroads serving small cities	16
<u>History of Corridor Investment Studies</u>		
9. Cities without long-established rail transit are the focus Example: Columbus, Ohio	If established, then look to new market corridors	10 +/-
10. Corridor is subject of recent or current studies. Example: Arkansas and Missouri Railroad, Bentonville, Arkansas	Also look for recent studies of streetcars	5
Shortline railroad joint development study candidates		+/- 20-35

TABLE 4 Joint Development Opportunities with Shortline Candidates by FRA Region

	City and FRA Region	2004 MSA Population (rounded)	2004 Core City Population Rank in U.S.	2004 City Population Rank in State	Radial or Linear Route
	REGION 2				
1.	Richmond, Virginia^b	1,057,000	105	1	—
2.	Columbus, Ohio^{a+b} Ohio Central Railroad	1,615,000	14	1	Radial and linear
3.	Cincinnati, Ohio^b Indiana and Ohio Railway	1,680,000	50	3	Radial and linear
	REGION 3				
4.	Louisville, Kentucky^a Indiana and Ohio Railroad	891,000	76	1	Radial
5.	Birmingham–Bessemer, Alabama^{a+b} Birmingham Southern Railroad	1,051,004	61	1	Radial
6.	Nashville–Davidson, Tennessee^{a+b} Nashville and Eastern–Western	1,289,000	27	1	Radial
7.	Charlotte, North Carolina^{a+b} Aberdeen Carolina and Western	1,651,894	23	1	Radial
	REGION 4				
8.	Peoria, Illinois^a Illinois and Midland Railroad	347,387	Less than 200 in rank	5	Radial
9.	Madison, Wisconsin^a Wisconsin and Southern	450,000	82	2	Radial
10.	Indianapolis, Indiana^a Indiana Railroad	1,675,000	12	1	Radial
11.	Minneapolis, Minnesota^a Twin Cities and Western	3,000,000	42	1	Radial
	REGION 5				
12.	Fayetteville–Bentonville, Arkansas^{a+} Arkansas–Missouri Railroad	354,000	Individual cities are less than 200 in rank	2	Linear
13.	Albuquerque–Santa Fe, NM^c Santa Fe Southern Railroad	525,000	33	1	Radial and linear
14.	Little Rock–North Little Rock, Arkansas^{a+b} Little Rock Western Railway	601,000	115	1	Radial
15.	Tulsa, Oklahoma^a Stillwater Central Railroad	824,000	40	2	Radial
16.	Oklahoma City, Oklahoma^a Stillwater Central Railroad South Kansas and Oklahoma Railroad	1,130,000	26	1	Radial
	REGION 6				
17.	Cedar Rapids–Iowa City, Iowa^a Cedar Rapids–Iowa City Railroad	369,000	Combined cities are less than 100 in rank	2	Linear
18.	Kansas City, Missouri^c Gateway Western	1,844,000	33	1	

(continued on next page)

TABLE 4 (continued) Joint Development Opportunities with Shortline Candidates by FRA Region

	City and FRA Region	2004 MSA Population (rounded)	2004 Core City Population Rank in U.S.	2004 City Population Rank in State	Radial or Linear Route
	REGION 7				
19.	Fresno, California ^{a+b} San Joaquin Valley Railroad	1,005,723	36	5	Radial and linear
20.	Woodland–Sacramento–Stockton, California ^{a+b} Central California Traction Sierra Northern, California Northern	1,832,338	37	4	Linear
	REGION 8				
21.	Missoula, Montana ^a Montana Rail Link	90,000	Less than 200 in rank	2	Radial and linear
22.	Boise, Idaho ^a Rio Grande Pacific	477,000	112	1	Radial
23.	Portland, Oregon ^{a+b} Portland and Western	1,918,009	28	1	Linear

NOTE: Source for MSA population ranking is based on Census 2000 Ranking Tables for Metropolitan Areas. Populations include contiguous city pairs such as Little Rock–North Little Rock. Locations where shortline managers were surveyed are designated with an “a” footnote. A “b” designates locations where regional planning agencies were concurrently surveyed; a “c” footnote indicates locations where responses from the shortline or MPO are pending.

Train Frequencies and Current Maximum Speeds

- Sixty percent of the railroads currently operate five or fewer trains per day with the next 20% operating 6 to 10 trains.
- Sixty percent currently operate at a maximum speed of 25 mph or less.
- Higher total route miles are where there are more trains per day. Only five systems, all greater than 200 mi in length, operated more than eight daily trains. It appears that these higher train volumes operate only on portions of segments that could also serve rail transit.

Conceptual Planning Issues

- A majority of the freight services surveyed appear to satisfy their customer base with average speeds of 20 to 30 mph—speeds in the range of LRT services. Railroads balance the maximum speed needed for efficiency versus the greater track maintenance demanded by higher speeds—where the highest speed may not be cost-effective.
- That 40% operate at 30 mph or higher testifies to a growing level of track improvements and maintenance, which should be a reliable indicator of business growth in the industry.

Train Miles, Train Lengths, and Time-Sensitive Schedules

- Fifty percent have typical daily train moves greater than 20 mi with the balance evenly split between 1–10 mi and 11–20 mi.
- Thirty-five percent operate trains with more than 30 cars. Again, this survey did not pinpoint the extent of overlap of the primary train moves with the potential rail transit segments but it appears evident that in larger systems only a portion of the total freight service is on track that would be most useful to rail transit service. Thirty-plus train lengths, nevertheless, appear to be a potential factor in joint development planning.
- Seventy-five percent currently operate with flexible schedules that are generally not time sensitive. Of those that are time sensitive, critical time departures are only for a portion of their customer base.

Conceptual Planning Issues

The existing higher speeds on many shortlines and future higher speeds possible (if not necessary) on double track and improved joint-use ROWs point to conceptual planning of track, signal, train control, and communication systems that would completely transform most shortlines today and go beyond nearly all common light rail design standards. The apparent schedule flexibility may be a key feature for a joint timetable that provides freight moves with multiple off-peak daytime windows to choose from.

Railroad ROW Lengths and Width

- Seventy-five percent of the respondents estimated that 70% of their ROW is wide enough for double tracking. A minority of this group estimated 90% of the ROW could be double tracked.
- Average system routes are greater than 100 mi, even without counting roads surveyed with more than 300 route miles such as Portland and Western, Indiana Railroad, Wisconsin Southern, and Ohio Central. The portions of the total systems surveyed that may provide opportunities for joint development appear to average 50 to 60 mi in length, comparable to commuter rail lines today.

Conceptual Planning Issues

- Many railroads noted historical choke points or physical constraints that may be costly to remove. Southern New Jersey and Portland illustrate double tracking major strategic segments to achieve initial sufficient capacity.

ROW Ownership

- Ninety percent of the main line trackage operated by the survey sample is privately owned. Small portions are leased from a Class 1 railroad.
- Responses to the question, how many miles of ROW not in use could be used for public transit, were not clear. Six out of the 30 respondents indicated an average segment of 20 mi but most of these segments do not appear to be desirable for rail transit.

Conceptual Planning Issues

The question of how many miles of ROW are owned by a public agency revealed nine railroads with segments less than 10 mi publicly owned and a smaller number with an average of 40 mi publicly owned. Here, the survey interviews pointed to railroads not surveyed but in the same states with large holdings of public ROWs leased to shortlines including Wisconsin, Tennessee, and North Carolina. Several other states not included in the survey (Pennsylvania, Georgia, and Vermont) also actively purchase railroad ROWs for economic development that involve multiple private and public stakeholders to attract industry and maintain the local employment base.

The Wisconsin Southern's 400-mile railroad operates entirely on a publicly owned ROW serving numerous smaller cities along with the largest cities, Milwaukee and Madison. The railroad is a significant public-private partnership for state economic development. In addition, the stakeholders have studied commuter and rail transit service for Madison (Wisconsin Southern charter trains have served the University of Wisconsin football stadium via a platform constructed by civil engineering students). Although this survey did not identify extensive publicly owned mainlines serving larger cities, the widespread state and local efforts to preserve and enhance shortline railroads for economic development stand out as a key finding in the conceptual planning issues summarized in the conclusion.

Potential Connectivity with Existing Passenger or Transit Services

Sixty percent of the railroads connect to or approach within 1,000 ft of an Amtrak line.

Conceptual Planning Issues

Connections by the shortline route to existing rail transit routes at the survey locations do not now exist. However, with the 60% that approach or connect to a track used by Amtrak, a transfer to intercity service would appear possible in many of the survey locations. At the same time, many respondents noted that connections with existing Amtrak stations would not serve their urban center, surrounding central business districts and other high-volume destinations. The need to penetrate beyond historical stations into large cities to achieve access for the "last mile" may point to using noncompliant rail transit vehicles that could travel beyond the shortline ROW into city street alignments.

SHORTLINE BUSINESS ISSUES

What policies, organizations, and opportunities are important for shortline railroad's to succeed?

Public and Private Business Success Factors

- Sixty-six percent selected their own railroad to be the first or second choice for the most important source of future business growth. That two-thirds rank their business over five strong options suggests that railroad managers have a sense of potential success if given the chance.

- Class 1 railroads were the second most important private-sector influence on shortline business success—when asked about current conditions and when asked about the next year. Eight out of 30 ranked the current trend of Class 1 business support “unfavorable.” Nine of the 14 planning agencies ranked Class 1 railroads the most important private-sector influence.

- State departments of transportation (DOTs) were ranked the most important public-sector source of influence on business success. The MPO and port rankings were the same as the railroads.

- Leveling “the playing field between trucking and rail freight” tax burdens was ranked as the most important state or federal policy for railroad business growth ahead of more favorable financial–insurance–tax laws or favorable railroad regulations.

- Seventy-seven percent choose “preservation of zoning and land use” to assure shippers can locate close to their tracks as their first choice of a desired local government policy. The alternative local government policy choice, promoting use of the local railroad’s services to regional businesses as a regional asset, was designed to force a difficult decision. Protective zoning appeared to be a fundamentally important public-sector policy issue and stands out in the conceptual planning key issues summarized in the conclusion.

Conceptual Planning Issues

No shortline manager expressed opposition to consider shared-track operations as a business prospect. Sharing the main line in terms of basic capacity or safety did not appear to be a significant concern assuming that the existing single-track railroad without signals or adequate sidings is substantially double tracked and signaled with new, sufficient sidings and leads added. The managers’ experience appeared to give them confidence to work with transit traffic. Capacity concerns that are important to the shortline businesses are strategic, including:

- Timely, special moves of equipment and quick response to customers increase the use of “just in time” materials planning.
- In addition to special moves, capacity is a function of seasonal peaks and urgent plan changes.
- The existing mainline track also serves as a yard for idle equipment or to make up trains.

As a result, compensation for access to their ROW could include many forms other than purchase or direct payment for access and trackage rights:

- Operation and maintenance of the rail transit that would cover a portion of overhead costs.
- New regional agreements of trackage rights and access from or to other railroad transfer points that the shortline is not able to achieve alone.
- New leads and spurs to existing or new customers that would be included in the rail transit track upgrades required. Likewise, new yards would provide an opportunity for train make up flexibility off the mainline.
- Agreements to assist in establishing new customers through economic development initiatives including encouragement to local shippers that could use rail to do so.

INSTITUTIONAL PLANNING ISSUES

Involvement in MPO Planning Processes

The established MPO role to coordinate regional transit development programs has little to no equivalent level of effort for local railroads:

- Eighty percent of the shortline managers do not know of a peer railroad representative participating on a public freight policy advisory committee or MPO committee in their region.
- Eighty percent have not seen a public planning document in the 2 years that identified their shortline railroad system as part of an approved or adopted regional plan or any approved, published regional transportation planning and policy document.
- Fifty-five percent have not seen a public planning document that discusses the region's freight railroad system—related to all classes of railroads serving the region—in the previous 2 years.
- Seventy-seven percent of the railroad managers know of a shortline railroad that has received a grant or loan \$200,000 or greater in the previous 2 years—but only one such loan was credited with having been approved via an MPO.

Institutional Planning Issues

The MPO responses to virtually the same questions mirrored the above results, e.g., 10 of the 14 planning agencies do not have a freight policy advisory committee. MPOs studies and programs that involve railroad infrastructure (San Diego and Columbus MPOs are leading examples) address freight under economic development initiatives. These efforts are intended to preserve and enhance regional, competitive assets such as access to ports or major rail distribution centers. The studies provide problem definition and consensus for carrying out long-term infrastructure improvements. The survey interviews also touched on MPOs generally found in smaller cities and the Midwest or South that are constrained from developing regional programs (rail transit or rail freight) due to local policies. These constraints include a history of suburb versus central city debates about regional funding and state policies that restrict use of highway-related taxes by public transit sponsors. Nevertheless, MPOs will inevitably be required to exercise oversight and approvals for local transit agencies and shortline railroads to progress a joint development program. In the process, new planning standards and practices will be used for projects to progress. Examples could include transit agencies collaborating with shortlines for ROW improvement capital costs (see Capital Projects and Financing Opportunities); in turn, a shortline could achieve zoning that protects the railroad's customer base.

Capital Projects and Financing Opportunities

Nearly all railroad participants revealed that their company takes part in ongoing meetings with members of Congress to discuss the railroad's business needs. "Railroad Day on the Hill" conducted every March and pioneered by the American Short Line and Regional Railroad Association (ASLRRA) now includes the American Association of Railroads and the National Railroad Contractors Association in a united industry lobby. The level of contact with members of Congress appears equivalent to many public transit agencies. The shortline industry appears to

be capable of conveying a strong message of their importance to local jobs and business development, particularly in smaller cities and states where the railroad provides a primary local competitive location advantage to prospective shippers that are often large employers.

On the state and federal level, 70% of the railroads surveyed have received a grant or loan between \$200,000 and \$1.5 million over the past 2 years and an additional 10% have received amounts greater than \$1.5 million. Typical of state funding of small railroads is the Wisconsin voter-approved 1992 constitutional amendment to allow state money to loan up to 100% of the costs for improvements on privately owned lines. Since 1992, \$58 million in loans has been awarded for Wisconsin projects that develop the economy, line rehabilitation, and transloading facilities. Continuous annual funding comes from repayments of prior loans. Other states include the November 2005 announcement of a \$12 million new grant program by Tennessee followed in December by New York (\$16 million) for shortline rehabilitation (1).

FRA's Railroad Rehabilitation and Improvement Financing (RRIF) Program is one of several sources of FRA funding for shortline railroads. Established by Transportation Equity Act for the 21st Century, the RRIF program was amended in 2005 by the Safe, Accountable, Flexible, Efficient Transportation Equity Act: A Legacy for Users to provide direct loans and loan guarantees up to \$35.0 billion with up to \$7.0 billion reserved for regional and shortline railroads to acquire, improve, or rehabilitate facilities, track, bridges, yards, buildings, and shops as well as refinance outstanding debt incurred for these purposes. Loans fund up to 100% with repayment periods of up to 25 years and interest rates equal to the cost of borrowing to the government. Examples of FRA low-interest loans include:

- \$2.3 million 2003 FRA grant to the Nashville–Western Railroad operating on a public ROW and part of the Nashville and Western Railroad that is now under reconstruction as part of a shared-track system for Nashville's new commuter rail.
- \$11 million FRA low-interest loan for ROW improvements on the Arkansas and Missouri Railroad in Bentonville, Arkansas, now the subject of an active local initiative to operate a rail transit service on the same route—see the status of the FRA RRIF program below (2).

Institutional Planning Issues

Eligible borrowers include state governments, local governments, and joint ventures. The potential for funding arrangements between shortlines and transit development initiatives was readily acknowledged as feasible by shortline railroad managers experienced in this federal funding program. Opportunities for joint development funding may depend on common efforts more than funding resources.

CONCLUSION

Rail transit and rail freight once shared an industry family tree of infrastructure design, construction, and service for more than 50 years. In the past 50 years, the common standards separated. Today, a number of DMU–LRT new starts are likely to face planning issues that have counterparts at the same locations for local railroads that are implementing expansions and enhancements. In many cases, these railroads that are poised to expand in order to better serve

local economies are in cities where the absence of rail transit is a constraint on the region's standard of living. Common approaches for shortlines and transit agencies to consider a mutually agreeable new start–joint development require new funding arrangements, planning practices, vocabularies, and visions of development. Funding, planning studies, and agreements are likely to be the subject of MPO oversight of regional investment studies. Drawing from the survey and interviews, [Table 5](#) summarizes joint development conceptual planning issues and [Table 6](#) summarizes joint institutional planning issues. As an example of the former, transit-oriented development at stations has a counterpart of train-oriented development at freight customers. The two urban forms need not be at the same place but must be on the same corridor with zoning enacted by local government. Synergies are illustrated by four quadrant gate installations at grade crossings that would assure fewer collisions for transit and assist freight trains to pass through the same locations without having to use locomotive horns and thus reduce impacts.

STUDY APPROACH

Three parallel surveys addressed conditions and attitudes where there appears to be some potential for shared track by rail transit and rail freight. Half of the 30 railroad surveys were conducted in person at four shortline conferences–workshops and half were initiated by letter with the survey enclosed. Of those contacted by letter, eight mailed or faxed back the completed surveys and seven chose to respond by phone at the time of a follow up call.

All participants reviewed the four-page questionnaire before the survey was conducted. Out of 31 requests to shortlines to participate, one did not respond because of hurricane damage. The second, smaller survey of 14 regional planning agencies addressed both the agency's and the planner respondent's involvement in rail freight studies and initiatives in general and shortlines in particular. As a further step to develop background, seven of the eight FRA regional administrators were surveyed using a survey packet that was identical to that used for the railroads and planning agencies. The questions were generally parallel to those of the shortlines and MPOs with other questions related to FTA new starts and FRA participation where joint development appears in the alternatives. Two of these surveys were in person and five were by phone. The FRA administrator surveys were designed to obtain perspective and test ideas and the results are not specifically reported in this paper.

Between May and October 2005, 40 draft survey packets were distributed to stakeholders to review and test the surveys. The results of the 11 initial test surveys that focused on California were compared with the final total balance of 19 other surveys from across the country to identify any marked differences by region. Reviewers included:

- Members of the APTA Shared Use Working Group.
- Staff at the Association of Metropolitan Planning Organizations (AMPO) in Washington, D.C. Several survey questions were developed from a survey conducted by the AMPO in 2003 to assess MPO regional freight planning practices. The survey's 136 responses show that while a majority (80%) declared that freight is discussed in the MPO's long-range plans, only 37% of the MPOs actually include freight in their transportation improvement plan and 16% have a priority list of freight projects (3).

TABLE 5 Rail Transit–Rail Freight Joint Development Conceptual Planning Issues

Planning Areas	Rail Transit Issues	Rail Freight Issues
Information technology–train location	<p>Achieve:</p> <ul style="list-style-type: none"> • Central control real-time train location and tracking • Customer information of real-time next train location 	<p>Achieve:</p> <ul style="list-style-type: none"> • Increasingly real-time car location that builds on current car tracing • Railcar locations, customer spotting on spurs and in storage areas
Station platform access	<p>Provide Americans with Disabilities Act:</p> <ul style="list-style-type: none"> • Compliant paths of travel to platform through stations to boarding platform edge • Compliant pedestrian approach paths through grade crossings adjacent to station areas 	<p>Provide:</p> <ul style="list-style-type: none"> • State public utilities oversight standards for platform clearance for freight cars • Customer access to mainline • Railcar spotting and storage areas convenient to customer needs
Corridor development	<p>Corridor zoning: Use zoning and development incentives to increase mixed-use density near stations to capture higher percent of travel via transit</p>	<p>Corridor zoning: Use zoning and development incentives to increase shipper density near freight stations to protect use of rail freight</p>
	<ul style="list-style-type: none"> • Mix land use to achieve multiple destination trips in close proximity • Design streetscape to encourage pedestrian and bicycle connections to the corridor 	<ul style="list-style-type: none"> • Mix land uses compatible with shippers and train movement • Transition and buffer residential from heavier industrial businesses near the corridor
	<p>Integrate amenities—sight lines, pocket parks, children’s play areas—to serve diverse populations</p>	<ul style="list-style-type: none"> • Isolate and buffer truck feeder routes to rail–truck exchange points • Mitigate noise and vibration
	<p>Market specific corridor segments and development to achieve highest and best use—to appreciate land value and attract development</p>	<p>Market other specific corridor segments and development to achieve stable zones that will not evolve to highest land value</p>
Transfer facilities	<p>Develop transfers and connections to enhance convenience and travel options</p>	<p>Develop transfer areas and connections to Class 1 railroads and major local customers to optimize shipping options</p>
Track and grade crossings	<ul style="list-style-type: none"> • Achieve low vibrations by subgrade dampening, rail to tie fasteners; railroad wheel profile • Use collision incidents at highway grade crossings with four quadrant gates 	<ul style="list-style-type: none"> • Achieve low track vibration same as transit but with sufficient drainage of track bed and subgrade strength for significantly heavier loads • Achieve low train horn noise and quiet zones at crossings with four quadrant gates

TABLE 6 Rail Transit–Rail Freight Regional and Institutional Planning Issues

Planning Areas	Rail Transit Issues	Rail Freight Issues
Regional transportation planning	<p><u>Established:</u> Intermodal Surface Transportation Efficiency Act of 1991-based protocols are established for long-range plans, regional and state transportation improvement plans.</p> <p><u>New:</u> Apply MPO programming to new starts projects involving concurrent public rail transit service and private rail freight service development.</p>	<p><u>New:</u> Regional planning protocols to address shortline railroads and goods movement are evolving. Programming regional goods movement investments that involve public and private funding of freight rail infrastructure is new for many MPOs.</p>
Project and Safety Oversight	<p><u>Established:</u> Capital project oversight practices by the FTA and MPOs are established.</p> <p>Rail transit safety oversight is increasingly exercised by state public utilities commissions.</p> <p><u>New:</u> Many railroad design standards are not familiar to transit-only engineers.</p>	<p><u>Established:</u> Capital projects oversight practices are established by the FRA for RIFF loans and by state DOTs for state grants and loans.</p> <p>Rail freight safety oversight by the FRA with support from the state public utilities commissions in some states is established.</p> <p><u>New:</u> Oversight of a joint development project would generate significant interest and require resources not normally part of new projects today.</p>
Funding sources	<p>100% public funding operating costs. Sufficient ongoing, local revenues for operating costs are the most challenging for regions to generate for new starts.</p> <p><u>New:</u> Joint development of rail transit–rail freight follows the precedent of real estate joint development at stations. Public funding sources of capital costs typically require local, state, and federal concurrent sources. Federal funding is constrained.</p>	<p>100% private funding of operating costs, though contracts and business with public agencies may provide important revenues. Private funding of capital costs range from 50% to 100%. State and federal funding trend is at year-to-year increasing levels. Local city funding is generally for grade crossings only.</p> <p><u>New:</u> Public transit agencies are eligible to be a stakeholder with FRA loan programs available to shortlines.</p>
Performance measures	<ul style="list-style-type: none"> • Travel time < bus service/no build. • On-time service > bus service/no build • Operating revenues > bus revenue. 	<ul style="list-style-type: none"> • Car load volume > no build. • Responsiveness to special orders. • Operating revenues > costs.
Return on investment	<p>FTA methodology assesses cost-effectiveness of new starts for new transit users.</p> <p>Time to measure success is 5–10 years.</p>	<p>FRA methodology calculates cost-effectiveness of ROW improvements to shipping business.</p> <p>Time to measure success: Months to 5 years.</p>
Environmental compliance	<p>FTA new starts project definition methodology integrates with National Environmental Policy Act (NEPA) to produce environmental impact statement and conceptual engineering.</p>	<p>Railroad improvements on existing railroad ROW are exempt from NEPA. Such exemption is not likely to apply to joint development impacts related to transit service added to the railroad.</p>
Secondary benefits	<p>Public policies now encourage transit use to achieve social good, e.g., fare discounts and transit preference traffic management.</p>	<p>The use of public policies to encourage use of freight rail is not yet well established or put into practice.</p>

- ASLRRA, the industry association for the nearly 500 smaller local and regional railroads operating in every state in the nation. The survey was reviewed with ASLRRA Washington, D.C., staff and shortline managers within the elected member leaders.
- California Shortline Railroad Association (CSRA), the state association of small railroads that is representative of active associations in several states. The survey was reviewed by members and elected leadership and conducted with a majority of the CSRA membership.
- Finally, as information copies, several updated drafts were forwarded to FRA and FTA safety and research staffs.

REFERENCES

1. Freight Railroad Infrastructure Improvement Program. Wisconsin Department of Transportation. <http://www.dot.wisconsin.gov/localgov/aid/friip.htm>. Accessed December 2, 2005.
2. Railroad Rehabilitation and Improvement Financing. Federal Railroad Administration. <http://www.fra.dot.gov/us/content/177>. Accessed November 30, 2005.
3. Association of Metropolitan Planning Organizations Survey: MPOs Need More Freight Resources. <http://www.ampo.org/survey/freight.html>. Accessed June 2005.

INNOVATION IN INFRASTRUCTURE USE

Provision of Expedited Rail Transit Service**ALFRED E. FAZIO***Southern New Jersey Rail Group*

The linear expansion (i.e., lengthening) of light rail transit (LRT) and rail rapid transit (RRT) lines causes a lengthening of trip times beyond what might be considered reasonable for these transit modes, and also impacts capacity along the line. Service patterns on most LRT and RRT double-track lines can generally be characterized as “plain vanilla,” i.e., all trains make all stops. The second edition of the *Transit Capacity and Quality of Service Manual* is one example of an emergent industry standard that makes no mention of express operations on LRT other than to note occasional use of “demand stops,” although several examples are available in current practice. More specifically, this document inadequately describes the benefits and methods of various types of express service, herein referred to as “expedited” service. In fact, various forms of expedited service have historically been provided on two-track systems, and a number of such significant operations exist today. This paper presents the methods, benefits, and system design (i.e., track, station, signaling) characteristics that are essential if expedited services are to be provided. It suggests that further research be conducted into documenting current expedited service practices and their benefits for incorporation into future editions of the manual. It particularly suggests that more attention be focused on the importance of the relationship between rail systems and railway operations in network design.

INTRODUCTION

Most light rail transit (LRT) and rail rapid transit (RRT) lines expand beyond the bounds of their initial operating segments. The linear expansion (i.e., lengthening) of rail lines causes a lengthening of trip times beyond what might be considered reasonable for these transit modes, and also impacts capacity along the line. Service patterns on most LRT and RRT double-track lines can generally be characterized as “plain vanilla,” i.e., all trains make all stops.

The second edition of the *Transit Capacity and Quality of Service Manual* (TCQSM) is one example of an industry standard that purports to address state-of-the-art practices, but is virtually silent on the topic of alternative operating methods. For LRT systems, there is no mention of current express operations other than to note occasional use of demand stops, as illustrated by the following statement:

Light rail operations may also skip stations when an on-demand operating policy is adopted. This is a particularly efficient way to increase line schedule speed and reduce operating costs. However, at higher capacity levels all trains will stop at all stations and so the practice has no effect on line capacity.

Of greater concern, the manual inadequately describes the benefits and methods of various types of express service, referred to herein as “expedited service.” In fact, various forms of expedited service have historically been provided on two track systems and a number of such significant operations exist today. In contrast, the second edition of the 1917 textbook *Electric Railway Transportation* devotes five full pages to operating and schedule strategies of “accelerating traffic movement along the line” for streetcars alone.

This paper presents the methods, benefits, and system design (i.e., track, station, and signaling) characteristics that are essential if expedited services are to be provided. It seeks to demonstrate the importance of the relationship between railway systems engineering and operations. It seeks to encourage rail transit operators to explore the provision of “expedited service” as a means of inducing additional ridership and accommodating the extensions of LRT and RRT lines. The paper addresses information contained in the TCQSM that essentially dismisses the concept of express service for LRT. The implications are serious as designers and operators of new start systems are expected to refer to this type of document as a basis for system development.

Currently, a number of transit systems are considering implementation of some form of expedited service. Each of these systems has a special need that can be addressed by some form of expedited service. They include

- Improving equipment utilization on Los Angeles–Long Beach Blue Line;
- Improving trip times on Sacramento’s future Folsom extension;
- Offering more attractive premier service to Denver International and Chicago’s O’Hare Airport; and
- Reducing trip time and offering of a commuter rail competitive service to Bergen County by the Hudson–Bergen Light Rail (HBLR).

Each of these systems is constrained by use of no more than two tracks. For each service, a particular form of expedited service could be an appropriate solution.

In order to clarify the uses and benefits of expedited service, and the appropriate application of various types of such service, this paper

- Presents a summary of types of expedited service which are possible on two-track lines;
- Provides a summary of current and of historically significant examples of such service;
- Discusses those engineering systems whose design characteristics are significant in the operation of the various types of expedited service; and
- Reviews operating issues and benefits, e.g., capacity implications, improved equipment utilization, crew utilization, fare policy, and operating safety associated with expedited service.

TYPES OF EXPEDITED SERVICES

A number of methods exist for providing expedited service on two-track transit lines. For purposes of this paper, lines with short sections of third track and lines with station passing

tracks (either on or “off” platform) are classified as two-track lines. A number of benefits accrue to the rider and to the transit company when such service is provided, the most obvious of which is reduced trip time to the rider. It is important to note that even a relatively short reduction in trip time may offer a significant perceived benefit to the customer as a consequence of such attributes as reduced door cycles and less perceived disruption due to intermediate boardings. Expedited service is relatively common on two-track (and single-track) commuter rail lines; however, the tighter headway, more intensive investment in infrastructure, and more rigid operating patterns generally associated with rail transit (LRT and RRT) require greater analysis of engineering systems and operating patterns when considering the implementation of expedited service.

The types of expedited service and a summary description of each are listed below;

Figure 1 provides an illustrative schematic of stopping patterns for these services.

- *Demand Stops.* Trains stop only upon request. The “request-based” stopping may apply to onboard passengers, wayside passengers, or both. Demand stopping offers a marginal level of expedited service, and while utilized on some light rail systems, is not practical on most RRT [Southeastern Pennsylvania Transportation Authority (SEPTA) Route 100 being a notable exception].
- *Skip-Stop.* Trains are differentiated, such as by “A” or “B” designations. Certain stations are served by “A” trains only; others are served by “B” trains only. Certain stations are made by all trains. In order to preserve headway at the line’s “critical” schedule point (e.g., at the end terminals) or central business district (CBD), the “A” and “B” stops are generally balanced; that is, they alternate and there are approximately the same number of “A” stops as “B” stops. Exceptions to the balanced pattern of skip-stops may exist for specific applications.

Demand Stops	CBD
	<p style="text-align: center;">‘D’ ‘D’ ‘D’ ‘D’</p> <p style="text-align: center;">●---●---○---○---●---○---●---○---●---●---●</p> <p style="text-align: center;">‘D’ indicated train stops at this station only upon request.</p>
Skip-Stop	<p style="text-align: center;">A/B B A B A B A/B A A/B A/B A/B</p> <p style="text-align: center;">●---○---○---○---○---○---●---○---●---●---●</p> <p style="text-align: right;">CBD</p>
	<p style="text-align: center;">A A A A A/B B B B A/B A/B A/B</p> <p style="text-align: center;">●---●---●---●---●---○---○---○---●---●---●</p> <p style="text-align: right;">CBD</p>
Zone Express	<p style="text-align: center;">A/B A A B B B A A A/B A/B A/B</p> <p style="text-align: center;">●---○---○---○---○---○---○---○---●---●---●</p> <p style="text-align: right;">CBD</p>
	<p style="text-align: center;">A/B A A B B B A A A/B A/B A/B</p> <p style="text-align: center;">●---○---○---○---○---○---○---○---●---●---●</p> <p style="text-align: right;">CBD</p>

CBD = Central Business District
 ● = Station at which all trains stop (i.e., no trains bypass)
 ○ = Station at which selected trains stop and other trains bypass

FIGURE 1 Stopping pattern, types of expedited service.

- *Zone Express.* Stations are designated by zone, with trains stopping only at stations in their designated zone. Typically three to five stations constitute a zone, although there are examples of much larger zones. Stations in a zone are sequential, and stops may be scheduled at common stations at zonal boundaries to enable passengers to transfer between trains serving different zones. Where minimal travel demand exists between intermediate stations or where such demand is served by other modes, common stations may not be provided.
- *Skip-Zone.* Trains operate according to a “zone” stopping pattern but make station stops in more than one zone. This pattern is appropriate to longer lines as it permits readjustment of headways. Common stations are generally utilized.
- *Spot-Overtakes.* A line is configured for overtake of a local by an express train at a specific location. The transit schedules for the entire line are developed based on the requirements associated with “spot overtakes.” An overtake may be scheduled to take place at a station or along the line.
- *Special Combinations.* Expedited service may be based on a combination of the above methods, e.g., operation of skip-stop or zone express with a spot-overtake. An example of such a case is Hudson–Bergen’s River Line, which is discussed later in this paper. The category of “special” also includes the provision of special expedited express service on four-track systems, an often overlooked concept.

EXAMPLES OF EXPEDITED SERVICE

It is important that the reader recognize that implementation of expedited service is neither an academic exercise nor a planning concept with little or no practical application. The general lack of awareness of current examples of such services in North America is somewhat troublesome. In order to enhance this awareness, a summary of important examples is provided.

Contemporary Examples

This section includes a brief survey of expedited services that are currently operated or have been operated within the past 10 years within North America.

Zone Express

- *SEPTA Routes 101 and 102 (Media–Sharon Hill LRT Lines)*—two suburban light rail lines that operate into Philadelphia’s western suburbs from 69th Street Terminal. These former Red Arrow Lines share a common track as far west as Drexel Hill Junction, approximately 3 mi. With Sharon Hill extending south from this point for 4 mi and Media extending west for 7 mi. This is a “low-technology” light rail system that utilizes selected “demand stops” in off-peak and operates some zone expresses, as well as “short turns” from or to 69th Street in peak periods. The shared portion of the line is double tracked; each branch is a combination of single and double track. Peak headways are on the order of 2 to 4 min, with zone expresses operating express to Drexel Hill Junction. A highly efficient loop terminal configuration at 69th Street feeding a two-track, four-position boarding platform helps expedite zone express operations.
- *SEPTA Route 100 (Norristown High Speed Line)*—a unique light RRT line on exclusive right-of-way (ROW) extending about 13.5 mi from 69th Street Terminal in Upper

Darby to Norristown, Pennsylvania, in suburban Philadelphia. The line is double tracked with the exception of a single-track viaduct entering Norristown. The line presently operates a five-tier combination of zone express services based upon identified passenger demand to minimize trip times and maximize equipment utilization. Middle “pocket tracks” are provided at Bryn-Mawr and Wynnewood Road to “short-turn” peak-period trains without interfering with through movements of other trains (the Wynnewood Road pocket is not currently used). Short turns at Hughes Park are accomplished on mainline tracks between opposing movements. The 69th Street Terminal is arranged as a highly efficient, three-track, four-platform stub station. Combined peak period headways are approximately 2 to 4 min.

- *NJ Transit HBLR (MOS-1)*—best described as light RRT, operating along the Hudson County, New Jersey, waterfront. Two lines operate south of Hoboken, sharing a common two-track line (River Line), 3 mi to Liberty State Park Station. From this location to the Bayonne Line consists of 4 mi of exclusive, high-speed double track to 22nd Street and the West Side Avenue Line operates to the west for approximately 1 mi. A zone express operates on the Bayonne Line (the “Bayonne Flyer”) at a 24-min headway; while locals operate on the West Side and Bayonne lines with a 12-min headway each. This makes an average headway of slightly less than 5 min on the River Line into Exchange Place. A new line to the north of Hoboken has been specifically designed for an express service that combines zones with “spot” overtake.

- *PATCO Speed Line*—a two-track, rapid transit line operating for 15 mi between Center City Philadelphia, Pennsylvania, and Lindenwold, New Jersey. A limited period of two-zone express service is provided during peak periods to provide reduced trip time for longer-distance passengers and balance train loadings. Alternate trains operate local between Philadelphia and Woodcrest Station or express between Center City Philadelphia and Woodcrest, then continue making local stops between Woodcrest and Lindenwold. Woodcrest Station is configured with two-island platforms and a middle track to accommodate turn-backs. A pocket track is also available at Ferry Avenue Station and was formerly used for a similar purpose, but Ferry Avenue locals are no longer compatible with present travel patterns.

- *Metropolitan Transit Authority (MTA) New York City Transit (NYCT) Staten Island Railway*—a 14-mi, two-track suburban rapid transit line that serves the Ferry Terminal at St. George. Trains are scheduled to meet ferries from and to Whitehall Terminal (South Ferry), Manhattan. During evening commission hours a zone express service is provided that consists of inner zone locals from St. George to Great Kills (approximately 6 mi), and outer-zone expresses, making first stop at Great Kills. Locals reverse direction on the mainline between revenue moves. Departure of evening locals and expresses from St. George are scheduled in conjunction with arrivals of ferries from Manhattan. In the morning peak a more complex skip-zone service is operated with two or three trains scheduled into St. George for each scheduled ferry departure.

Skip-Stop and Skip-Zone

- *Chicago Transit Authority (CTA) “L.”* The post-war extension of elevated lines coupled with the closer station spacing on the older, inner segments of these lines led CTA to implement a policy of systemwide skip-stop (as well as station closures) on its two-track lines. Virtually all lines in Chicago operated “A” and “B” service during peak hours. Most interesting is the operation of expedited service on the North–South line between the Loop and Evanston. This line is four tracks from Wilson Avenue to Chicago Avenue; at Chicago, two tracks continue south to the Loop Elevated, and two tracks enter the State Street subway. The four-track

segments are fed by the two-track Ravenswood Line (Purple Line), which joins the North–South Line at Belmont Station. North of Wilson, the line is a two-track line to Evanston and a separate two-track line to Skokie. The peak hour service offers super-express trains from Evanston, which operate to the Loop Elevated, and which make no intermediate stops between Wilson and the Loop. A variety of expedited service operates on this line including Evanston express, North–South local–express, and Ravenswood locals, which operated to the Loop into a skip-stop pattern on the local tracks.

- *SEPTA Market–Frankford Line.* A 14-mi, two-track “diametrical” line which operates through Center City, Philadelphia, and connects terminals at 69th Street and Frankford. This line operates a skip-stop pattern during peak hours, with “A” and “B” trains bypassing five and four stations, respectively. All trains stopping at all stations within the CBD, narrow platforms, and high peak loadings are potential capacity limiting factors. The train control system is capable of sustaining 2-min headways.

- *MTA NYCT Jamaica Line.* The two-track portion of this line extends 8 mi from Broadway Junction in Brooklyn to Jamaican Center and includes 15 stations. Skip-stop service comprised of “J” and “Z” trains operates during peak hours with “J” trains and “Z” trains bypassing five stations.

Spot Overtakes

- *Port Authority Trans–Hudson (PATH).* A morning peak non-stop express was recently operated between Newark, New Jersey, and the World Trade Center. An overtake of a Newark to World Trade local occurred at Journal Square Station utilizing a running track around the station. “Reverse engineering” led to the installation of a higher-speed, tangential geometry turnout at the tunnel portal, where the bypass track rejoined the mainline. However, the relatively low speed obtainable by the express through the station proper, coupled with the fact that single-station bypass is generally insufficient for an express to attain a complete “jump” (i.e., clear the signal control) of a local, caused delays to the local train. These delays occurred despite the “reverse engineering” of site-specific enhancements including higher speed and tangential geometry turnout at the merge point of the bypass track.

- *NJ Transit HBLR (MOS-2).* Based on the success of the MOS-1 Bayonne Flyer Zone Express, HBLR marketing policy and operations doctrine was revised to incorporate express operations in the extension of service north of Hoboken to Tonnel Avenue. Analysis of the aforementioned PATH overtakes led to systems design for a zone express with a predefined triple-track location configured for a spot overtake. The actual overtake does not occur on the triple-track segment, however. The triple-track section creates the overtake opportunity by permitting the overtaking train to close on its leader, and then switch to the opposing track when two-track territory resumes. The actual overtake occurs within two-track territory, with the express train passing the local train while “wrong-railing” between opposing train moves.

Combinations of Methods

- *MTA NYCT Eighth Avenue Line.* To the casual observer, this Independent System (IND) subway line appears as a conventional four-track subway offering express and local service. This line is, in fact, configured as two lines with express and locals providing essentially a zonal operation. Research conducted during the 1920s on New York’s original Interborough

Rapid Transit (IRT) four-track subways indicated that two major operations problems existed due to the excessive number of passengers transferring between expresses and locals. First, the addition of express tracks did very little to augment the IRT's line-haul capacity since large volumes of local train passengers would transfer to express trains the first opportunity at frequent common station stops. Second, the large volume of transferees was causing excessive dwells to express trains, thus reducing the line capacity of the express tracks. The IND engineers learned from the IRT experience and configured Eighth Avenue Subway service to minimize transfers between express and local trains as indicated by the stopping patterns and the station configurations. It effectively operates as two line-haul railways serving inner and outer zones, as shown in [Figure 2](#).

Historically Significant Services

A large number of historic "expedited services" were surveyed. Selected examples are presented in the following discussion based upon their relevance to current operating requirements or their treatment of specific design and operating issues.

- *Brooklyn–Manhattan Transit (BMT) 14th Street Express (Zone Express)*. The two-track 14th Street–Eastern Line of the BMT (today's MTA NYCT "L" Canarsie Line) operated a zone express service with the express bypassing six consecutive stations. Between Myrtle Avenue and Lorimer Street, locals turned in a pocket track south of Myrtle Avenue Station, which served as a common station. The significance of this service is that it was a zone operation on a high-density rapid transit line with headways averaging 2 to 4 min. The local's running time was scheduled at 2 min longer than the express.

- *BMT 36th Street (Selected Skip-Stop)*. The configuration at this four-track, two-island platform station was such that morning peak hour Sea Beach Express trains, which stopped at 36th Street Station, would delay express trains entering the Fourth Avenue Subway from the West End Line. Because West End Line trains operated to both the express and local tracks in the subway, a delay to West End Express could also cause delays on the following West End local. The crowding at 36th Street Station from local-to-express transfers caused excessive dwells. These dwells and the slow merging of the West End Line trains (due to alignment deficiencies) caused this junction and the 36th Street Station to be the capacity limiting point for the entire Fourth Avenue Subway. The solution was to schedule Sea Beach Express trains to run-through (i.e., bypass) the stations, thus allowing West End Express ample time to operate over the low-speed crossover, enter the station, and dwell. The string lines shown in [Figure 3](#) illustrate this operation.

- *Chicago, Aurora, and Elgin (CA&E) (Spot Overtakes)*. The CA&E was a high-performance interurban electric railway serving near and distant western suburbs of Chicago, Illinois. These trains traversed the Chicago "L" double-track Garfield Park Line to reach a stub-end terminal at the Loop (Chicago's CBD). Gunderson Station along the "L" route was constructed with side platforms and a short center track. Careful scheduling allowed interurbans to overtake and pass "L" trains while the latter were making a station stop. Unfortunately, in practice a one-station "jump" was inadequate to prevent some delay to local "L" trains.

- *Pacific Electric (PE) Western District (Spot Overtakes)*. PE's Western District, unlike the Southern and Northern Districts elsewhere in the Los Angeles, California, basin, did not

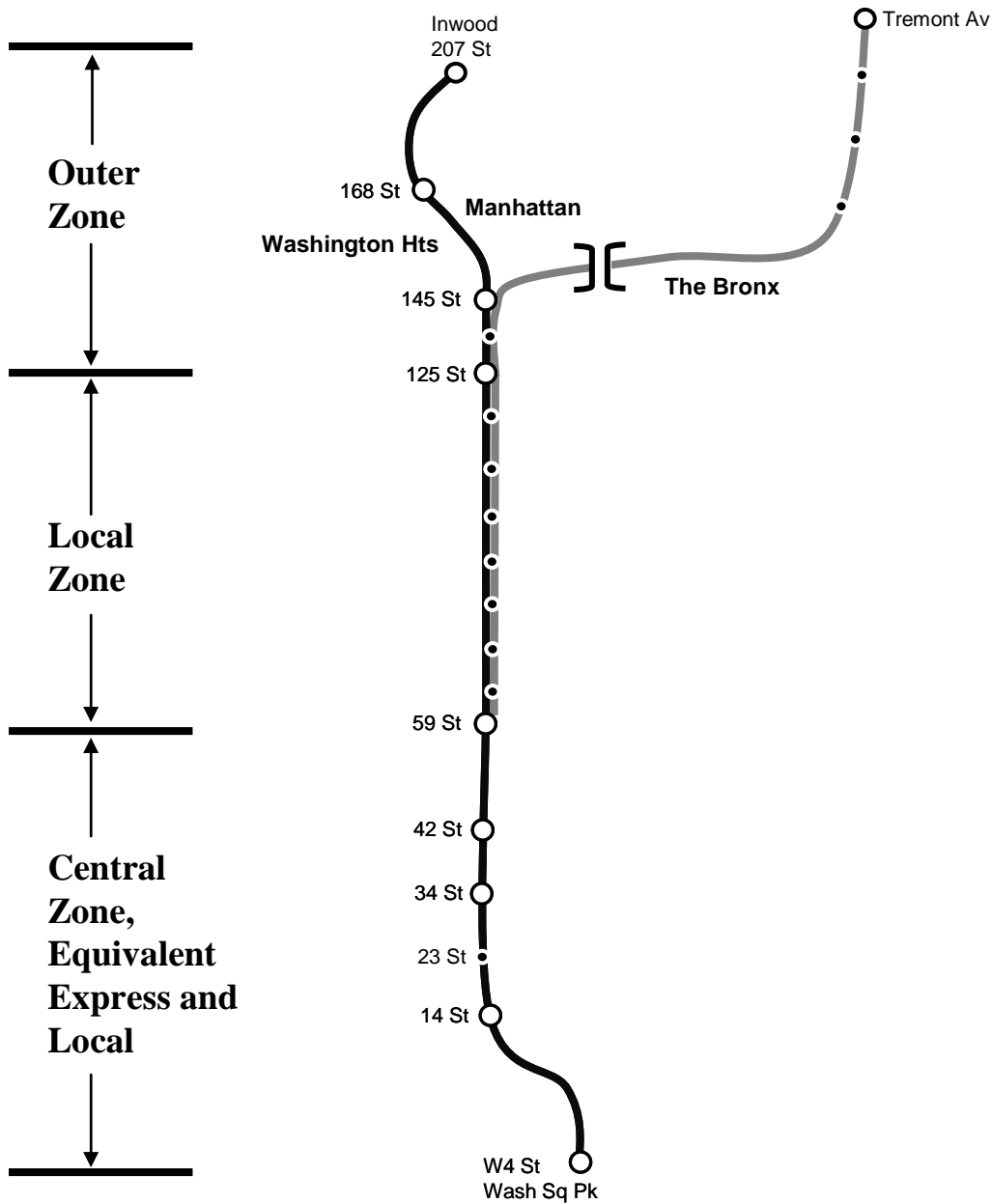


FIGURE 2 IND Eighth Avenue subway stopping pattern and key station configuration.

possess four-track sections of mainline to support independent express train operations. Instead, it utilized short sections of triple track to permit longer-distance, interurban expresses from Venice and other oceanfront communities to pass local cars. This was a simplistic, unsignaled operation in which operators of local cars entering the triple-track segments were advised to “look out” for overtaking trains and to allow such trains to pass when observed.

- *Shaker Rapid (Zone Express)*. Trains of the Shaker Rapid were comprised of President's Conference Committee streetcars configured for multiple-unit operation. They entered downtown Cleveland, Ohio, over tracks shared with the rapid transit trains of the Cleveland Transit System. During peak hours, Shaker service included the operation of zone expresses.

- *BMT Fulton Street Elevated (Skip Zone with Overtake)*. This line provided service from central Brooklyn and western Queens to downtown Brooklyn and Park Row Manhattan (via the Brooklyn Bridge). It was partially rebuilt with a center express track for approximately one-quarter of its length. The middle track existed from Fulton Street to Atlantic Avenue, covering only the middle third of the line. During the 1930s this was an extremely high usage line. In order to provide improved trip times and improve equipment utilization, an innovative three-tier service combining skip-zone and spot overtakes service was implemented as follows:

1. *Local*: All stops Sands Street, Brooklyn, to Atlantic Avenue.
2. *Local-Express*: All stops Park Row, Manhattan, to Franklin Avenue express to Atlantic Avenue, then continue express to Lefferts Avenue via the middle track.
3. *Express-Local*: Express Park Row to Franklin Avenue, then local to Lefferts Avenue.

Figure 4 illustrates this line and provides a typical stringline for the evening peak service.

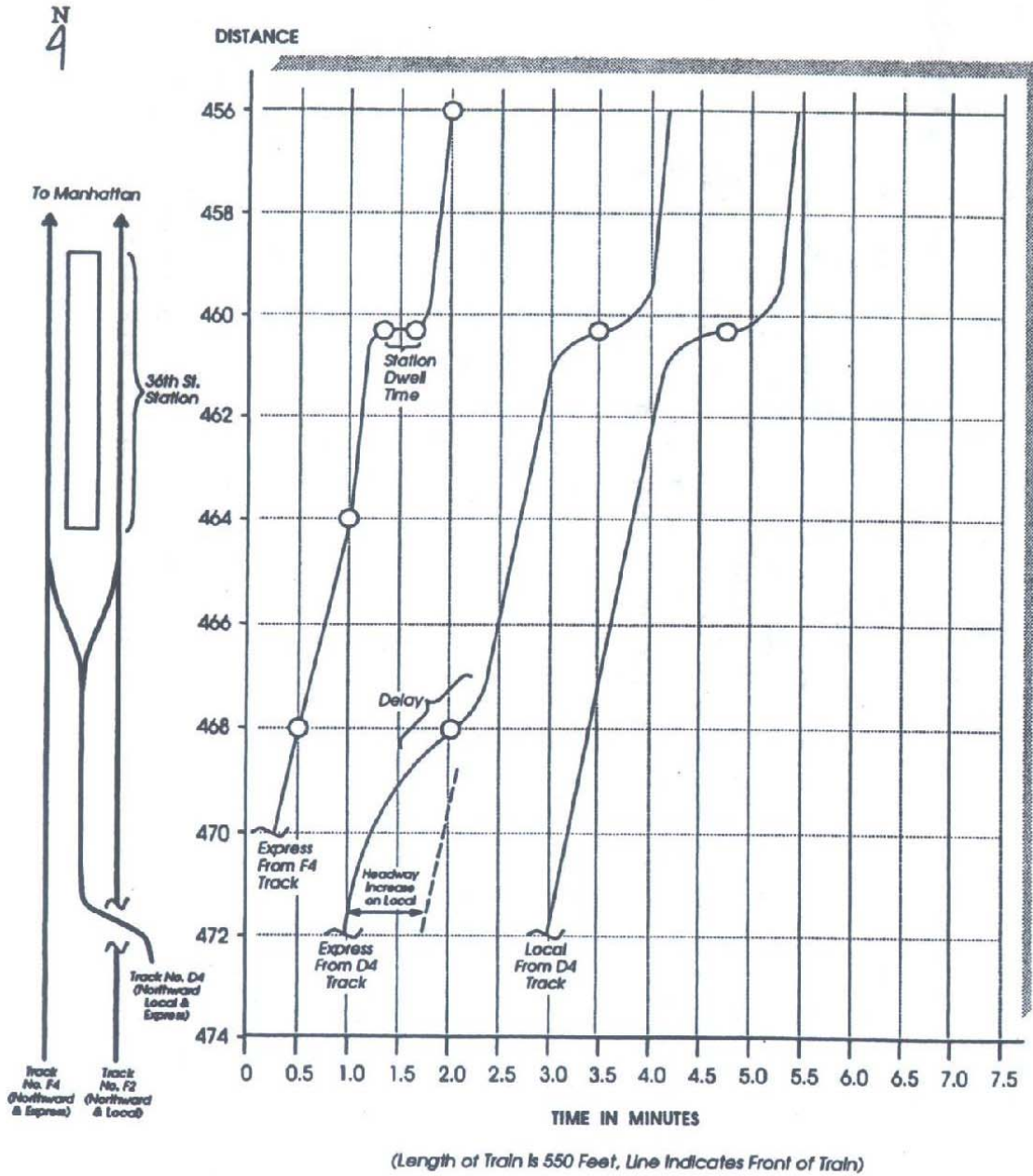
SYSTEMS DESIGN AND INTEGRATION REQUIREMENTS

Systems Critical to Expedited Services

A basis for description and categorization of the various engineering systems that comprise a passenger railway has been described elsewhere. The systems that are most critical to the delivery of expedited service are train control (signaling), track (alignment), supervisory control, and stations (including platform configuration, means of egress, and signage). During deployment of a new railway or extension, or in the rehabilitation or reconfiguration of existing railways, the operating entity must work closely with the systems engineering team in designing the type and specifics of the expedited service and must assure that the design of the railway systems supports the operating requirements.

Ideally, a formal operating requirement document (ORD) is established during system planning. The ORD should reflect the following:

- *Critical Service Requirements*. These include maximum speed, headways, and schedule speed, peak link load, boarding and alighting data, and stopping patterns as well as more routine items (e.g., hours of service).
- *Concept of Operations for Expedited Service*. If expedited service is anticipated, or if it is even a consideration, the type of service and operating concepts requires development



(a)

FIGURE 3 (a) BMT morning operation at 36th Street, Brooklyn (without skip-stop).

(continued on next page)

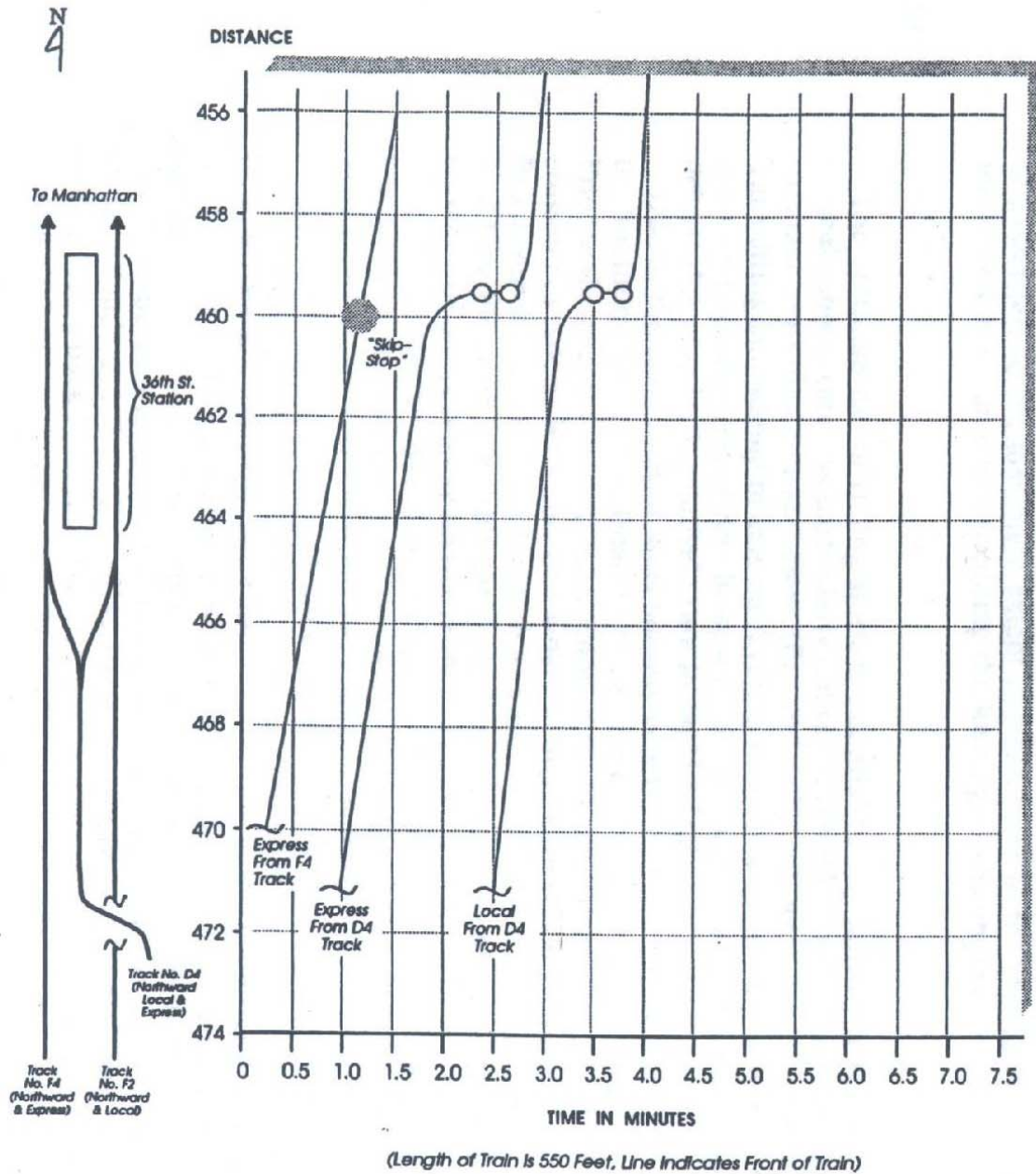


FIGURE 3 (continued) (b) BMT morning operation at 36th Street, Brooklyn (with skip-stop).

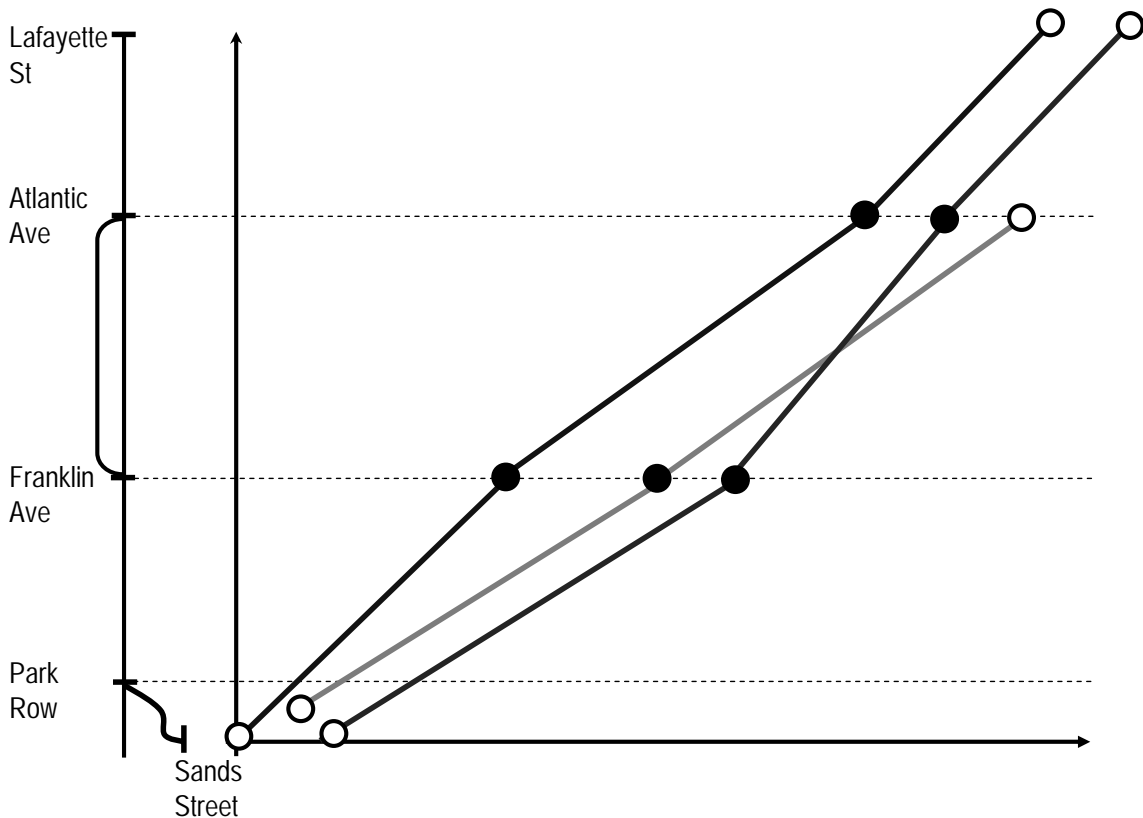


FIGURE 4 BMT Fulton Street elevated—evening service configuration stringlines.

during the preliminary systems engineering. While it is possible to “reverse engineer” expedited service on to an existing system (as was done with the Bayonne Flyer), it is always optional to design and build in accordance with an appropriate concept of operations.

- *Critical System Design Requirements.* This refers to those system design requirements that are exceptions to the systemwide design criteria. They include special requirements to be imposed, on a site-specific basis, on such elements as headway, turnout design, interlocking configuration, and station platforms. Some of these items are based directly in the performance requirements of the expedited service, while others are indirectly based or arise as a consequence of such service, e.g., due to system safety or passenger orientation.

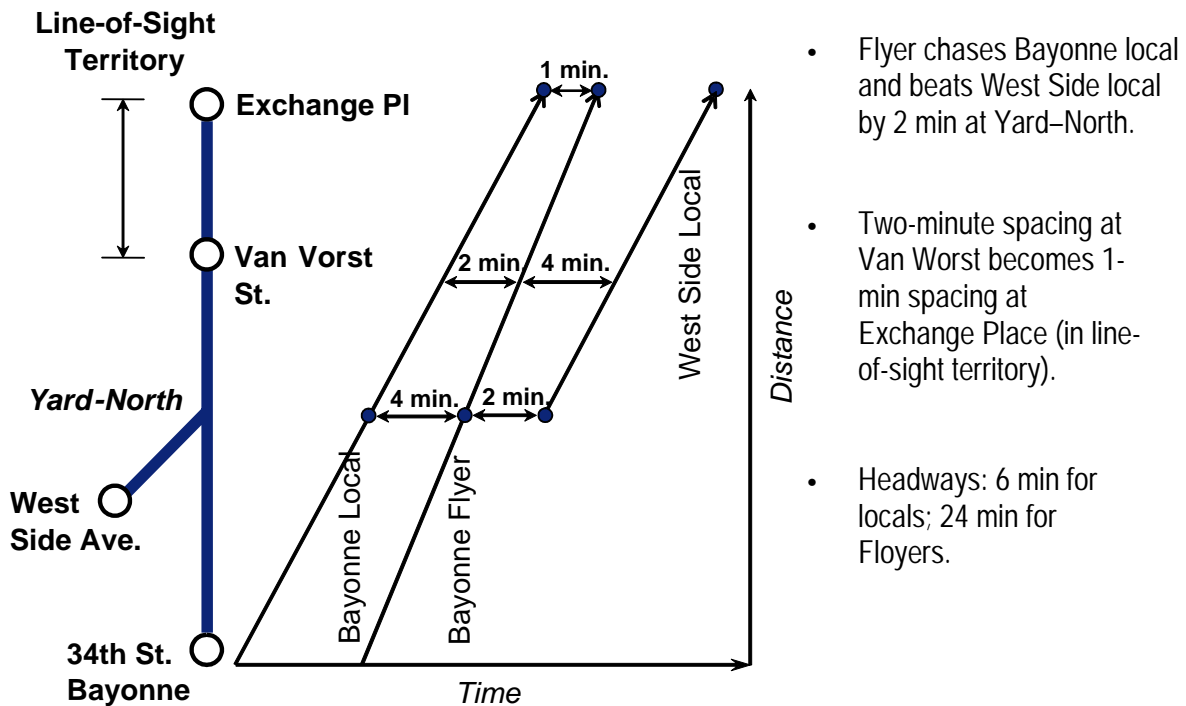
Systems Analysis for Zone Express

Zone express service is most appropriate where the great majority of the ridership has the origin–destination within a central core district. Where a significant ridership exists between intermediate stations outside of the central core, common stations are required in order to permit transfers between trains of different zones. The ideal configuration of common stations is to include a middle-turning track with two-island platforms for use by “locals.” Entry/exit to the

middle should be at the highest possible speed and at the most favorable signal aspect possible, since the scheduling of trains at the end point of a zone is at a tight headway.

The fundamental operational concept of a zone operation is that the express train overtakes “ghost” slots, as illustrated in Figure 5. This figure illustrates scheduled trains, locations of “clear” signal control, and ghost slots for the Bayonne Flyer. The headway design for a line planned for zone operation should be specifically tuned to the operation. Conversely, a line that operates at capacity along most of its length is not suited for implementation of zone express. However, a zone is most appropriate if additional capacity is required at only a few select stations.

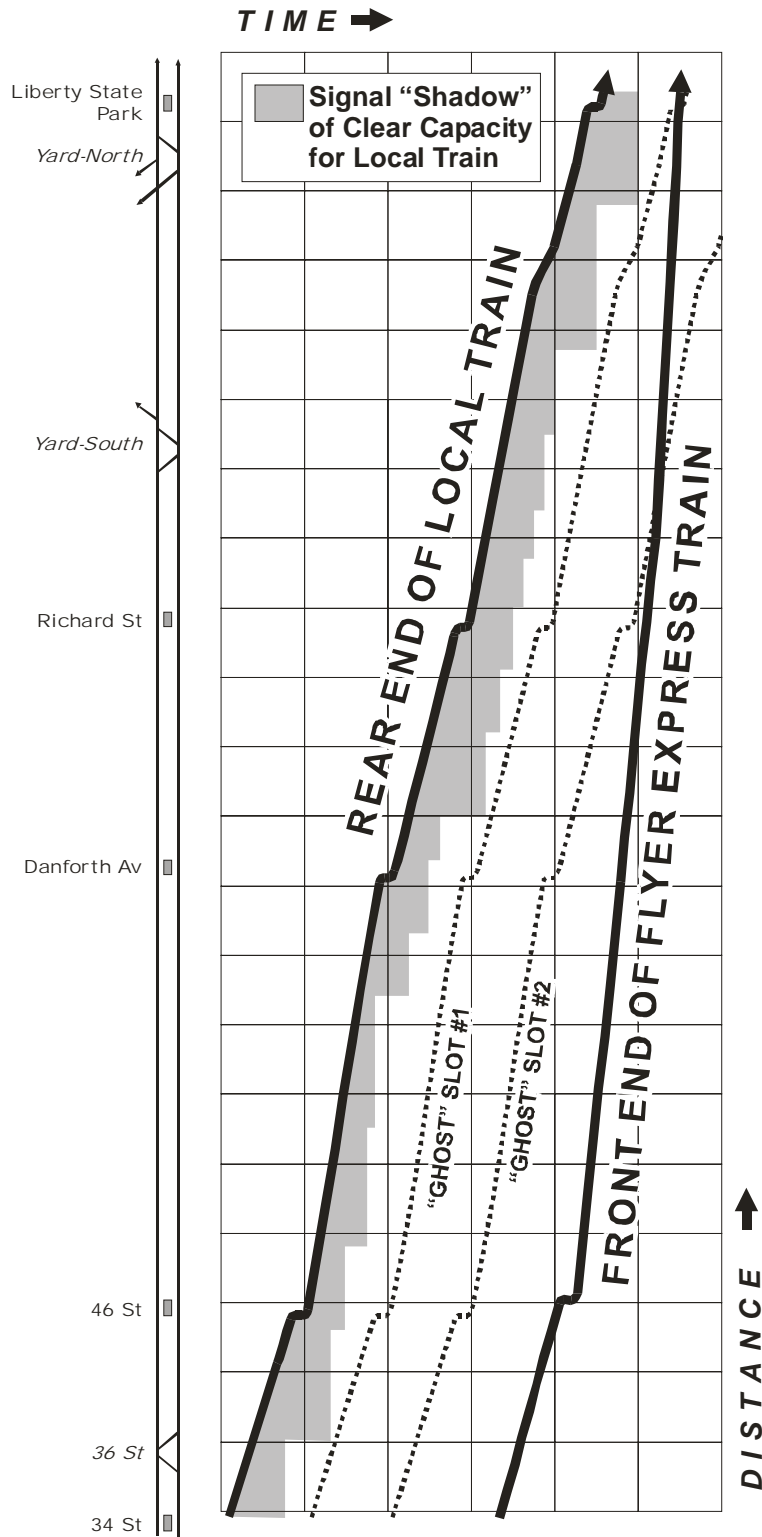
The Bayonne Flyer represents a modified zone service that operates in conjunction with two local services. One of the local services enters from a branch, while the other operates along the full length of the Bayonne Flyer service. The Flyer is scheduled as an “extra” train while locals provide base service over the entire line (this is a deviation from classic “zone” service). While the Flyer is marketed as a ridership “attractor,” it was actually implemented to accommodate the existing service demand at the Bayonne stations. A modified zone express was seen as a means of efficiently raising capacity to meet highly peaked, localized demand. The Flyers serve the peak demand at three Bayonne stations, and as conceived, were “short-turned” on the mainline in downtown Jersey City to reduce their cycle time. Flyers initially operated on a 48-min cycle as compared to a cycle that exceeded 65 min for locals operating the full route between Bayonne and Hoboken.



(a)

FIGURE 5 (a) Bayonne Flyer stringline (schedule intervals).

(continued)



(b)

FIGURE 5 (continued) (b) Bayonne Flyer stringline (signal control and “ghost slots”).

The critical locations for scheduling morning Flyers is “Y-North” interlocking and Liberty State Park Station. The minimum headway at the interlocking is 2 min and schedules are based on a Flyer proceeding through the interlocking 2 min ahead of a merging West Side local. In practice, morning Flyers arrive at Liberty State Park at or near capacity, and essentially no passengers (on the order of two to three passengers per train) detrain at this station. Passengers boarding a crowded train cause excessive dwells (20 to 25 s), which in turn delay the West Side local (which has excess capacity as the West Side ridership is light) sitting at the Y-North home signal. This congestion is exacerbated by the extreme length of Y-North interlock. The recommended solution was to improve the signal design by adding additional blocks, and to having morning Flyers bypass Liberty State Park. Such a scheduling practice, the bypass of one of the busiest stations on the line, appears paradoxical. In this case it is appropriate as local trains of the Bayonne and West Side Line serve the station at 6-min intervals, thereby providing more than sufficient capacity at that station. The historical precedent to this is the bypass of 36th Street Station by the morning (but not evening) BMT Sea Beach Express; this historical case is absolutely relevant to Liberty State Park.

The scheduling theory of the evening Flyer differs from the morning; what is most significant for the evening is the left-handed operation of the Bayonne Line. This operation was made necessary by a system safety review of the station platform configurations; it was made possible by train control design that provides for reverse operation at the same design headway (2 min) as provided for normal direction operation, by a full supervisory control system including full display of train status and location, and by the island platform station configuration. The evening Bayonne Flyer service is inhibited by low-speed interlocking (15 and 20 mph diverging speeds) that is totally out of character on a high-speed, reverse-signaled railway constructed on exclusive ROWs. The operation is further challenged by long signal blocks (albeit in conformance with the systemwide design criterion of a 2-min “clear” headway) on the southward approach to Liberty State Park Station. The evening schedule causes this to be the point of minimum required headway as it is the end of the inner zone. Finally, station signage is inadequate, as the fixed signs did not anticipate reverse running. [Table 1](#) presents a summary of railway system configuration issues associated with the evening Bayonne Flyer; this table provides a useful template for application to other railways considering expedited operations.

System Analysis for Skip-Stop and Skip-Zone

Skip-stop service raises “scheduled speed” and generally improves train crew and equipment utilization, although it generally does not affect the level of improvement in these measures of performance that can be achieved by “zone” operation. A significant advantage of skip-stop over zone is that the former does not consume signal capacity; at worst, a properly designed skip-stop service is neutral with respect to line capacity. [Figure 6](#) provides an illustrative example of a stringline for a balanced skip-stop service. As shown, proper scheduling and appropriate signal design will permit the “B” service trains to make a station stop in the shadow of the station stop made by the “A” train; this minimize the propagation of “ghost” slots. Thus if an entire line is operating at capacity, skip-stop provides a means of expediting service while zone does not.

TABLE 1 Systems Design for Bayonne Flyer

System	Subsystem	Functionality or Capability
Train control	Train separation/automatic train protection	<ul style="list-style-type: none"> • 90–120 s headway • Reverse operation at same headway capability as normal
Rolling stock	Light rail vehicle	<ul style="list-style-type: none"> • High acceleration and brake rates • High speed
Track	Standard track work	<ul style="list-style-type: none"> • Designed and built for 129 km/h (80 mph) operation
Integrated control system	Supervisory control	<ul style="list-style-type: none"> • Permits supervisory control of all interlocking and of railroad direction of traffic • Permits continuous surveillance of all trains from control center
Stations	Platforms and signage	<ul style="list-style-type: none"> • Accommodations made for run-through at moderate speed

In order to maintain headway at the minimum on high-density lines, skip-stops should be closely balanced between different services (“A” and “B”) and should regularly alternate. Some special exceptions to this practice are warranted when uneven headways are acceptable, such as in the case of original MTA NYCT “J” and “Z” service.

Passenger perception of skip-stop as an “express” or premium service is generally inferior to that of a zone and special attention is required to customer orientation. Although line capacity may actually be enhanced using skip-stop as a result of reduced station dwells, major all-stop-stations must be customized to improve throughout. Other limiting points, e.g., junctions and terminals, must then be considered. The SEPTA Market–Frankford Line terminal at 69th Street includes a double-track turnback loop feeding an island inbound platform (“A” trains and “B” trains on opposite sides), which is ideal.

Dwells at busy line stations may be the next highest limiting point after terminals. These can be mitigated by operational practice; in fact, the busiest station may not need to be an “all-stop” station if it is adequately served by one service or by system design, for example, installation of additional platforms to permit one-way passenger flow, and shorter signal blocks at all-stop stations.

CTA was most instrumental in advancing the art of skip-stop operations. Passenger orientation was assisted by consistency of service, by use of appropriate signage and maps, and in the case of certain lines with branches (e.g., Congress–Douglass–Milwaukee), by having “A” trains serving one branch and “B” trains serving the other. Chicago’s most innovative use of skip-stop was to expedite the local service on the North–South line. Although Chicago has recently reduced skip-stop service, planning efforts are being directed toward offering expedited service to O’Hare Airport along the Milwaukee Avenue leg of the Blue Line.

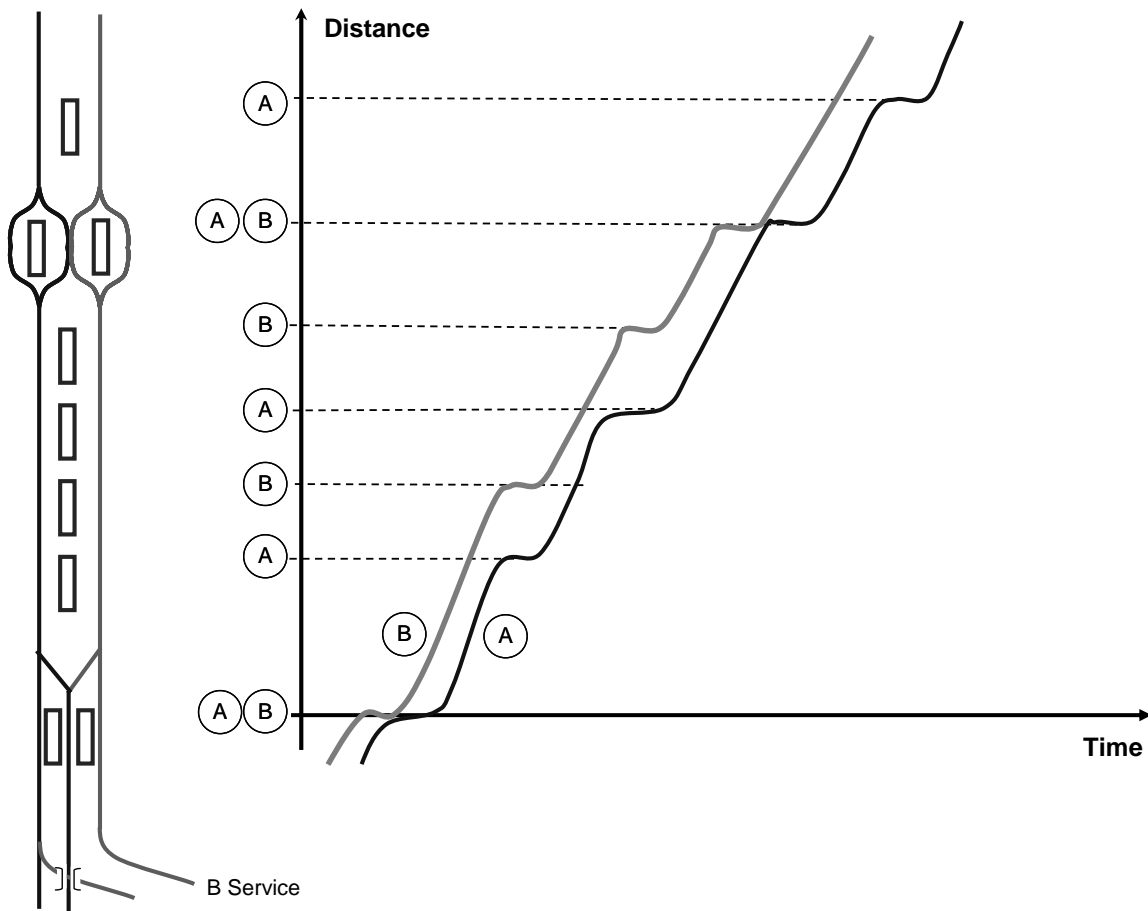


FIGURE 6 Typical stringline, balanced skip-stop operation.

Table 2 indicates some of the critical systems engineering considerations for a line that is to be designed for skip-stop capability.

Skip-zone represents a hybrid skip-stop and zone. While providing a superior perception of express service to the customer, it adversely impacts line capacity and has minimal, if any, advantage over skip-stop with respect to schedule speed. It does favor short-turning of some trains (refer to Figure 1) and can therefore improve equipment and crew utilization over skip-stop operations.

Systems Analysis for Special Expedited Service

As previously discussed, special types of expedited service include combinations of the more standard categories as well as special means of expediting express and local service on three- and four-tracked lines. MTA NYCT “J” and “Z” service prior to 2004 offers an interesting example of expediting service on a “less than optimally” designed transit system.

TABLE 2 Systems Design for Skip-Stop

System	Subsystem	Functionality or Capability
Train control	Headway	Block layout at stations is critical, particularly “entering” and “leaving” signals
Rolling stock	Passenger information	Signage and onboard announcements
Stations	Line platforms	At limiting points consider extra platform or middle track; as a minimum, consider staggering “A” and “B” stopping at all-stop stations
	Terminals	Design for rapid entry
Interlockings	Junction of lines	Incorporate planned stopping pattern if junction occurs in vicinity of station

Jamaica Center serves as a transit hub for the Borough of Queens, New York City, where multiple MTA NYCT subway and bus lines converge adjacent to the Long Island Rail Road and Airtrain Jamaica station. A high-performance express serves the Jamaica Center subway station; this service operates to Midtown Manhattan via the IND’s four-track subway in Queens Boulevard. The other service to Jamaica Center operates to Manhattan over the antiquated, two-track, former BMT Jamaica Elevated and the triple-tracked Broadway (Brooklyn) Elevated. In order to reduce crowding on the IND subway, a creative expedited service was developed to attract riders to the Elevated line.

This service, which is illustrated in [Figure 7](#), includes skip-stop on the Jamaica line in which “J” trains and “Z” trains each stop at five stations exclusively and each of which bypass five stations. On the Jamaica line there are four common stations, including Broadway Junction. On the triple-track section between Broadway Junction and Myrtle Avenue, the express track is not utilized and “J” trains and “Z” trains each stop at two of the four intermediate stations. Skip-stop was necessary over this segment of the elevated, since a former all-stop local service (Broadway–Brooklyn local) which operated here had been eliminated as a cost-reduction item. At Myrtle Avenue, “M” service local trains join the line and replace “Z” trains on the local track. Peak direction “Z” trains operate on the center express track from this point to Marcy Avenue, bypassing three local stations. Beyond Marcy Avenue the line is again comprised of two tracks only, and crosses the Williamsburg Bridge into Manhattan.

The Jamaica line service provides a particularly interesting example of the application of expedited service. The line, portions of which were constructed prior to 1904, required a highly customized application in which “M” trains operate as pure locals, and “Z” trains and “J” trains operate as expresses in a combined skip-stop and spot overtake mode. The merged “M” trains replace the gap created by the absence of the “Z” and “J” trains at the bypassed local stations.

CONCLUSIONS

As this review indicates, customer demand exists for expedited transit service and such services are offered on a relatively large number of two-track systems. A number of additional systems

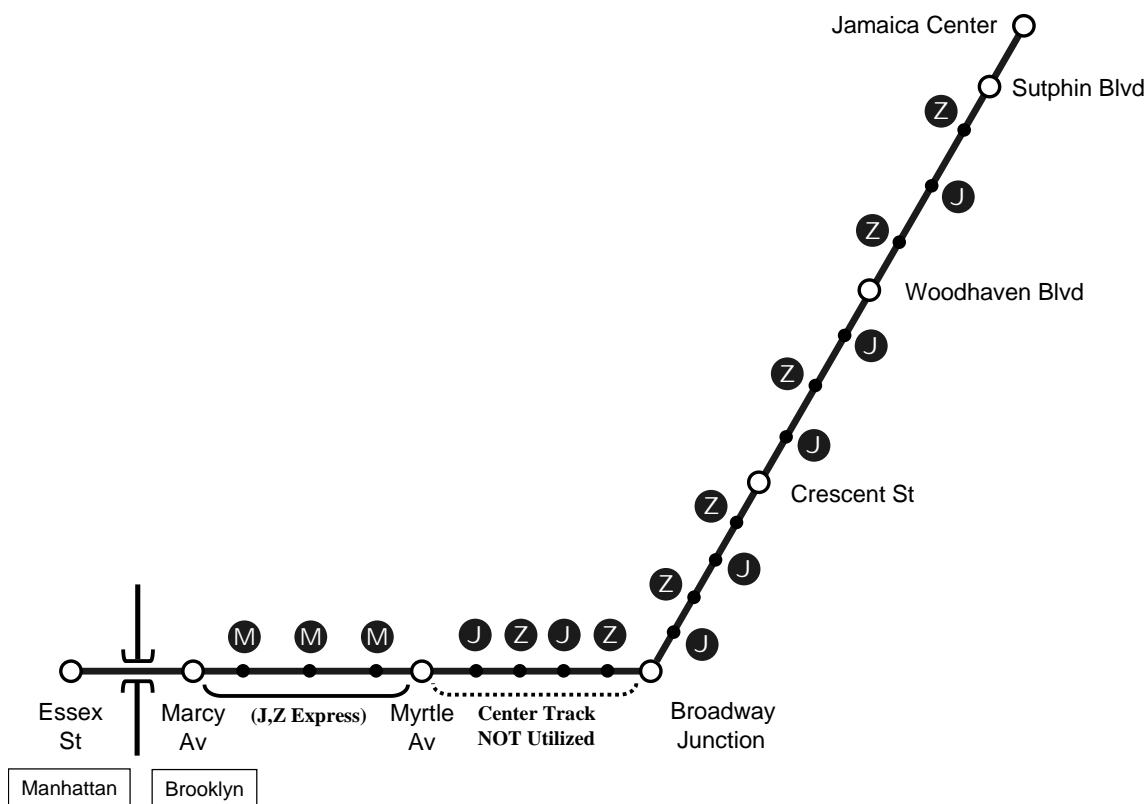


FIGURE 7 BMT Jamaica line, expedited service.

are planning such services. Review of literature, most notably the current edition of the TCQSM and TCRP research subjects, indicates the need for development and promulgation of an operating doctrine for expedited service. Such a doctrine would address types and design of service, systems engineering issues, system safety, marketing, and benefits.

The following specific conclusions are offered:

- Expedited services clearly have a role in building transit's customer base, in improving the efficiency of operations, and in creating a progressive image for rail transit that goes beyond "plain vanilla."
- A number of distinct varieties of expedited service can be designed, each with its appropriate application.
- With proper analysis, planning, and design, an efficient form of expedited service can be customized to the needs of a specific rail transit system.
- Ideally, planning for expedited service begins during system development; the requirements are expressed within the ORD and are incorporated into the design of critical systems. The most critical systems to consider in this process are stations, train control, track, and supervisory control.

- Less optimally, expedited service may be “reverse engineered” onto an existing system. This will generally require selected reverse engineering for some of the critical engineering systems.
- A revision to the selections of the TCQSM that address expedited service is in order, and would be of great benefit to transit system designers, operators, and customers as an initial step toward the formulation of an industrywide operational doctrine for expedited service.

ACKNOWLEDGMENTS

The author wishes to thank the following individuals for their thoughtful review of the research and concepts presented in this paper:

- T. R. Hickey, Gannett-Fleming, Inc.,
- Joseph North, NJ Transit,
- Nagel Shashidhara, Hudson–Bergen Interurban Railway, and
- Cameron Beach, Sacramento Regional Transit .

RESOURCES

- Blake, H. W., and W. Jackson. *Electric Railway Transportation, Second Edition*. McGraw-Hill Book Company, 1924.
- BMT Map and Guide*. Brooklyn–Manhattan Transit Co., 1939.
- Calnan, J. F. Resurrection of Multi-Tiered Service on SEPTA’s Norristown High-Speed Line. *Proc., APTA Rail Transit Conference*, Pittsburgh, Penn., June 2004.
- Chicago Rapid Transit, Volume II*. CERTA, Chicago, Ill.
- CTA Map and Guide*, 1993.
- Eisele, D. Operational Efficiency of Suburban Railroads. *Proc., Conference on Urban Transportation Efficiency*, ASCE, Washington, D.C., 1976.
- Fazio, A. E. Relationship Between Light Rail Systems Design and System Operations. *Journal of Transportation Engineering*, ASCE, May–June 2004.
- Fazio, A. E., and T. R. Hickey. Designing New Light Rail: Taking Engineering Beyond Vanilla. *Transportation Research Circular E-C058: 9th National Light Rail Transit Conference*. TRB, National Research Council, Washington, D.C., 2003.
- Lines of Pacific Electric, Southern and Western Districts. *Interurban Specials*, No. 60, 1975.
- Sachs, P. A Solution to the Transportation Problem in New York City. *The Municipal Engineer’s Journal*, March 1926.
- Raisnoni, A. I. Some Elements of Subway Design. *The Municipal Engineer’s Journal*, December 1925.
- Transit Capacity and Quality of Service Manual, Second Edition*. TCRP Report 100, Washington, D.C.

Security and Fare Enforcement

SECURITY AND FARE ENFORCEMENT

Cybersecurity
Not Just IT's Business

SUSAN HOWARD
LTK Engineering Services

**CYBERSECURITY
NOT JUST IT's
BUSINESS**

Susan Howard
LTK Engineering Services



A World of Applications & Opportunities



AMERICAN
PUBLIC
TRANSPORTATION
ASSOCIATION

CYBERSECURITY TOPICS TO BE ADDRESSED

- Cybersecurity Terms and Concepts
- Light Rail Communications System Components
- Vulnerabilities in Light Rail Systems
 - Central Control System
 - SCADA
 - Other Light Rail Systems
- Common Agency Pitfalls
- Recommendations

CYBERSECURITY TERMS AND CONCEPTS

- What is cybersecurity?
- Security and usability are inversely proportional.
- Use technology to shift the curve.

CYBERSECURITY TERMS AND CONCEPTS

- Attack Mechanisms
 - Denial of Service
 - Man in the Middle

- Firewalls

- Patches

- Virtual Private Networks (VPNs)

CYBERSECURITY TERMS AND CONCEPTS

- Denial of Service Attacks: “Flooding” the network with IP packets.

- Man in the Middle Attacks: Attacker inserts itself between sender and receiver and pretends to be one of the two parties.

CYBERSECURITY

TERMS AND CONCEPTS

FIREWALLS: We're Not Talking Sheetrock

- Software and hardware systems designed to prevent unauthorized access to computer networks.



- Firewalls are static; they are not meant to change.

CYBERSECURITY

TERMS AND CONCEPTS

PATCHES: WHAT ARE THEY?

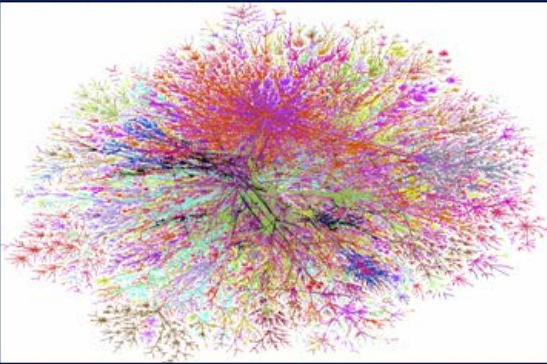
- Computer programs released by vendors to “patch” software that was released with security weaknesses.
- Hundreds of “patches” are released by software vendors each year.

CYBERSECURITY TERMS AND CONCEPTS

VPNs: WHAT ARE THEY?

- VPNs are simply networks connected to the Internet with a firewall

Current Map of the Internet



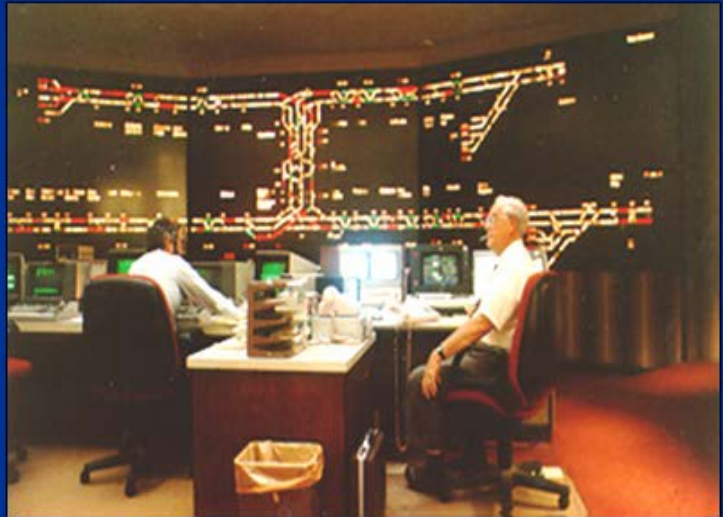
Can VPNs really be secure in this environment?

Typical Components of a Light Rail Communications System

- Central Control System (CCS)
- Supervisory Control and Data Acquisition (SCADA)
- Closed Circuit Television (CCTV)
- PBX and Voice Over IP (VoIP) Phone Systems
- Public Address/Variable Message Signs (PA/VMS)
- Computer-Aided Dispatch (CAD)
- Automatic Vehicle Locator (AVL)
- Fare Collection
- Radio Systems (increasingly digital)
- Gateways for Enterprise Network Reporting

Light Rail Central Control System Components

- Servers
- Workstations
- Database Systems



Central Control System Vulnerabilities

- Lack of patch management for Microsoft platforms after implementation.
- Lack of clearly documented areas of responsibility after implementation (i.e., IT versus light rail comm).

Central Control System Vulnerabilities

- Lack of funding for ongoing maintenance after implementation.
- Lack of proper staffing levels for ongoing maintenance after implementation.
- Tendency to design for physical layer ONLY— i.e., fiber, copper, wireless, but no inclusion of network services and associated risk mitigation during design phase.

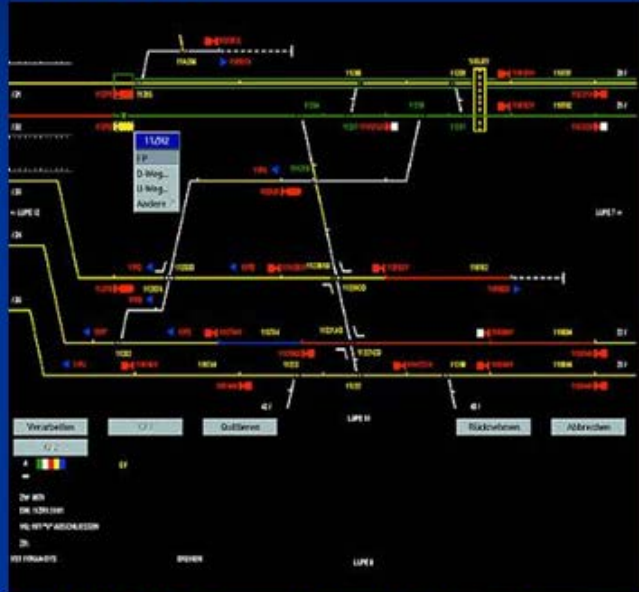
Central Control System Vulnerabilities

Network Services Often Overlooked Include:

- Name Service (DNS)
- Network Time (NTP)
- LDAP (Lightweight Directory Authentication Protocol)
- Remote Access (how can vendors securely support their products remotely?)
- Simple Network Management Protocol (SNMP)
- Internet Protocol (IP) (use of IPsec, etc.)
- Windows Domain Structure (how new servers will fit in)

Light Rail SCADA Systems Applications

- Signals
- Train to Wayside Communications
- Ticket Vending Machines (legacy)
- Voice and Data Communication Devices
- Traction Electrification



SCADA Displays at Central Control

SCADA VULNERABILITIES

- Although legacy protocols are often proprietary, there is no encryption/authentication built in.
- TCP/IP is being used increasingly by SCADA vendors, opening them up to all the intrinsic and often-exploited TCP/IP vulnerabilities.
- SCADA information is increasingly being used by management which is creating more points of ingress/egress for SCADA subsystems.



SCADA PLC Devices

SCADA SYSTEMS ATTACKED

- 2004: Sasser Worm took down light rail signaling SCADA in Sydney, stranding 300,000 travelers.
- 2006: Hacker attacked Brisbane sewage system SCADA, sending tons of raw sewage into streets.

SCADA SYSTEMS ATTACKED

- 2003: Blaster Worm infected computer systems at East Coast Railroad Company bringing down signaling systems and causing train delays for several days.

Other Light Rail Systems Targets

- Fare collection systems including smart card vulnerabilities.
- Wireless systems being used for CCTV, phones, and other applications.

COMMON AGENCY PITFALLS

- **Operating costs:** Most agencies don't have funding to maintain expensive support contracts after warranty (i.e., Cisco SmartNet). This means OS on Ciscos, HPs, Siemens, etc., is often outdated and not secure.
- **Staffing:** Most agencies don't have operations staff with the skill set to maintain Cisco, HP, etc., network equipment.

COMMON AGENCY PITFALLS

- No documented security policies at most agencies.
- Lack of regular “internal audits” using port-mapping software, sniffer traces, and other widely available tools.
- No formal incident response plan for when an attack occurs; common to think “it has never happened, therefore it won’t” or “not at our agency.”

COMMON AGENCY PITFALLS

- Common misconception that light rail networks are “stand alone” even though VPNs and “gateways” are installed.
- Territorial issues: IT staff versus light rail communication staff
- Lack of well-documented processes and procedures.

RECOMMENDATIONS

- Educate, educate, educate at ALL levels.
- Build cybersecurity INTO designs, not as an afterthought.
- Transit agencies must establish and enforce cybersecurity policies.
- Develop a formal incident response plan that includes internal processes for recovery.
- Perform frequent computer security internal audits.

STANDARDS BODIES AND REGULATORY AGENCIES

- CERT – www.cert.org
- SANS – www.sans.org
- Department of Homeland Security
 - National Cybersecurity Division
 - www.dhs.gov
- ISA SP99 – www.isa.org
- CISP FOR for VISA in Fare Collection – usa.visa.com

Reference URLs

■ Fare Collection URLs:

- www.smartcardalliance.org
- www.apta.com/about/committees/UTFS/

■ SCADA System Attacks:

- <http://www.securitypipeline.com/showArticle.jhtml?articleID=13800101>
- <http://feeds.computerworld.com/Computerworld/Hackers/and/Hacking/Feed?m=44>
- <http://www.sophos.com/virusinfo/articles/sassertrain.html>
- <http://www.washingtonpost.com/ac2/wp-dyn/A23020-2003Aug20>

CYBERSECURITY

NOT JUST IT'S BUSINESS

Susan Howard
LTK Engineering Services

101 SW Main St, Suite 810
Portland, Oregon 97204

503-944-1192
showard@ltk.com

SECURITY AND FARE ENFORCEMENT

Fare Evasion in Light Rail Systems

LAURENT DAUBY

International Union of Public Transport

ZOLTAN KOVACS

BKV, Budapest

With the increasing cost pressure in public transport systems, productivity gains must be accompanied by efficient measures to combat fare evasion. Indeed, besides the direct revenues losses, high rates of fare evasion trigger a feeling of inequity or insecurity among the paying customers.

International surveys have shown that the population's attitude toward fare evasion in public transport follows a Gauss curve (Figure 1). The majority is willing "to give it a try" if the perceived opportunity "of getting away with it" outreaches the perceived risks.

The most efficient strategy against fraud is to control access to the system. This principle can lead to specific measures depending on the chosen mode of transport:

- Metro systems can be closed or gated easily due to their specific station environment; this can be the case at the initial design stage, or can be implemented as a retrofit. The Metro Committee of the International Union of Public Transport (UITP) is preparing a specific report on the latter aspect.
- Buses can be operated with the "front boarding" philosophy with little adverse impact on operation and boarding time.
- Light rail systems offer far less favorable conditions; it operates mostly within an "open space" platform environment and the high patronage requires many doors. It means that the most efficient strategies to keep fare evasion as low as possible are only possible to a limited extend.

That was the reason for the Light Rail Committee to perform a specific study on fare evasion. The present report summarizes the results of a survey conducted in 18 cities—Amsterdam, Berlin, Brussels, Budapest, Cologne, Düsseldorf, Gothenburg, London (Croydon Tramlink), Manchester, Milan, Montpellier, Rouen, Porto, Saarbrücken, Salt Lake City, Stuttgart, The Hague, and Tunis. It also includes discussions held during meetings of a smaller group of operators exchanging views and experience, and during face-to-face interviews.

TYPOLGY OF ACCESS PHILOSOPHIES

The choice of the access philosophy is mainly determined by:

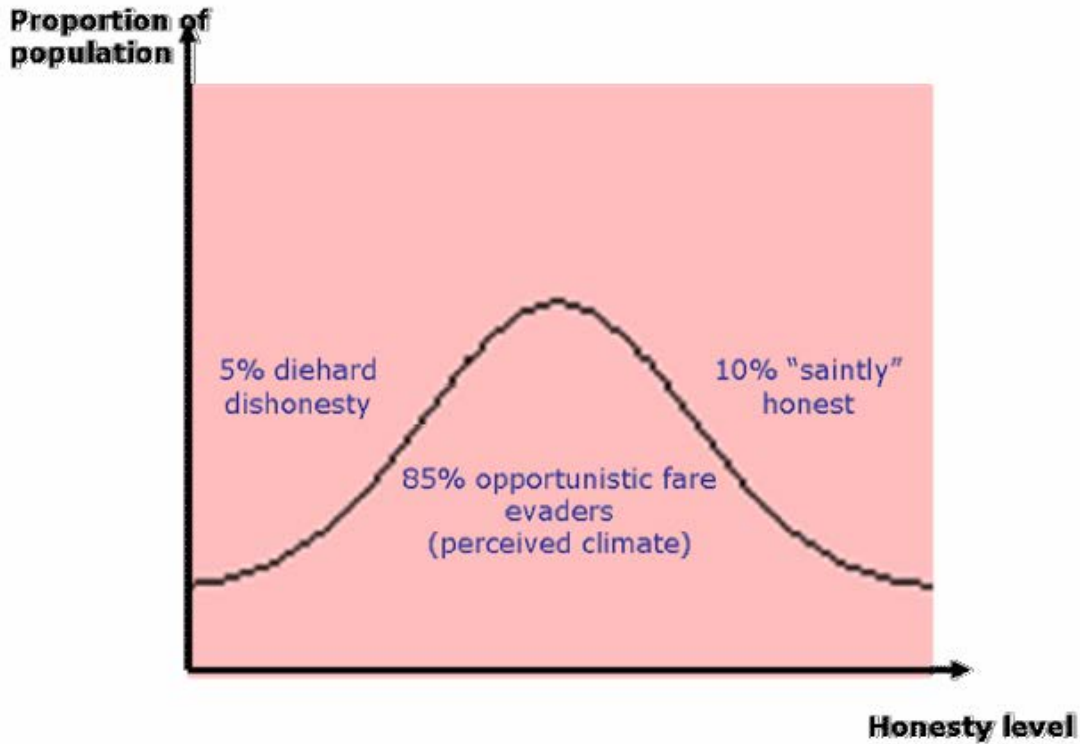


FIGURE 1 The Gauss curve of natural behavior.

- The intensity of passenger flows;
- The locally prevailing fare evasion and (in)security level, later called the “environment”; and
- The available space at and around stations, as well as the opinion of urban stakeholders [is light rail transit (LRT) a “closed transport zone,” or an “open public space”?].

LRT systems can be classified into four main types of access “families” (Table 1).

TABLE 1 Four Main Types of Access Families

	Features	Advantages	Disadvantages
“Honor” system	Open space, few controls	Urban integration, feeling of freedom, self-organized flows	Lack of human presence, feeling of insecurity, high fare evasion
Strong control	Open space, frequent roving controls	Urban integration, increased security, less fare evasion	
Systematic control	Open space, permanent controls (conductors)		Flows, throughput limitation at rush hours, conflicts with staff
“Metro”-like station	Closed space, station architecture	Minimal fare evasion	Available space, public street space, severance effect

In the first three options, the passenger is expected to have a valid ticket when boarding the vehicle. In the last case, a ticket is already needed to enter the station or boarding area. Controls can thus be performed differently.

Open (Honor) Systems

Most of the LRT systems surveyed are open (14 out of 18). The general principle is openness, freedom of use, and “honor” behavior. Random roving inspection is performed. This type of access is easier to adopt when the legal and judicial framework and resulting consequences actually become a clear “deterrent.”

As Figure 2 shows, this option can be applied to all kind of passenger flows because of its low costs and absence of physical constraints. Its limits, however, are easily reached when the pressure from fare evasion increases. The vicious circle is always a threat, and operators should keep a close eye on any negative development and quickly adopt corrective measures to avoid the fare evasion spiral. The survey sample suggests that virtually all LRT systems with an open philosophy actually introduce reinforced inspections. This can be explained by the natural inclination to evade fare if the risks perceived are too small, as stated in the introduction.

The horizontal axis represents the intensity of the passenger flows and the vertical axis the environment [the locally prevailing fare evasion and (in)security level]. The green surface represents the recommended area of application.

Strengthened Human Presence

This is the next step in the scale of the proposed typology. The general principle is to strengthen the honor system by more frequent roving human controls. Indeed, the link between an open system, fraud, and insecurity is obvious since an open system provides unlimited physical access to everyone, including illegal travelers or criminals. These controls should be highly visible in order to modify the risk perception and influence the passenger’s natural opportunistic behavior.

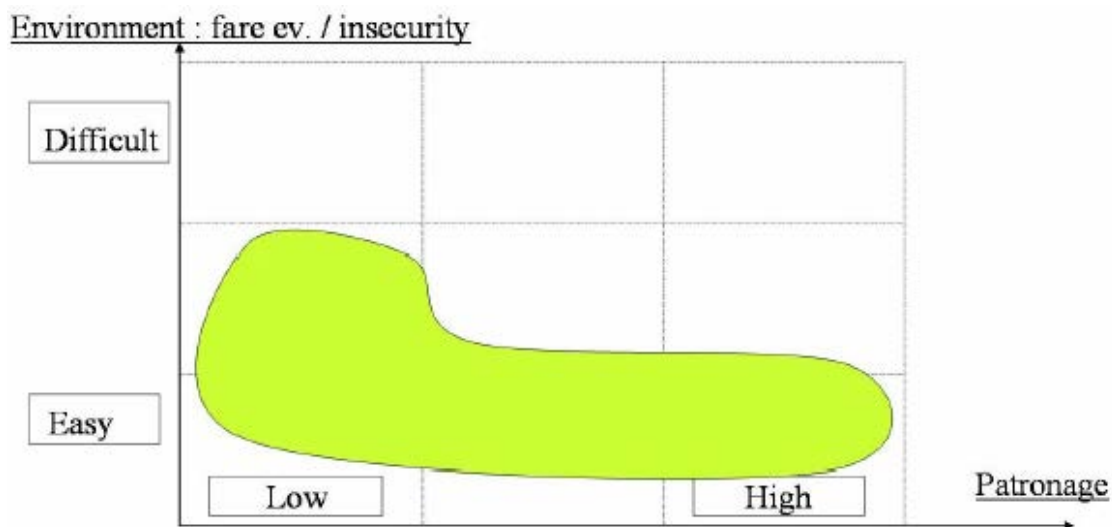


FIGURE 2 Typical situation for open or honor system.

All open systems surveyed (14 out of 18) are using this principle on lines where the environment is more difficult, i.e., where higher fare evasion or higher insecurity is reported (Figure 3). The big advantage of this solution is its high flexibility: depending on the “hotspot areas,” the operators can target precisely its zone of intervention nearly in “real time.” Considering labor costs, it is important to define clearly the return on investment in order not to “overcontrol” where it is not necessary, nor cost-effective. The limits of this philosophy are reached when passenger flows are increasing, i.e., during peak time.

Systematic Human Presence

This is the next step in the scale of our typology. The general principle is to have a systematic, face-to-face contact with each passenger. Several forms are possible: “front boarding,” limited to smaller sized trams (often associated with ticket sale by the driver), or the reintroduction of a conductor for ticket sale and inspection purposes. Fare evasion and insecurity are naturally expected to be kept low. But the presence of staff carrying cash was reported to introduce a new type of hazard factor inside the vehicles. For this reason, certain systems prefer to stick to a “cashless” option. This factor should be carefully considered (Figure 4).

Only one of the systems surveyed is using systematic human presence (Amsterdam, but it is also the case in some cities outside the sample, such as Nottingham or Rotterdam; to read more on it, please see separate article).

Generally, this “extreme” and costly measure is of a corrective nature and follows a serious disruption of the system, escalating fare evasion or security concerns (be it objective or subjective). Costs justify this option only in difficult environments with large passenger flows. However, this approach can also be deliberately chosen at the system design stage (e.g., Nottingham); this would typically be the case in contractual environments where the commercial risk lies exclusively with the operator. In this case, the promoter/operator saves the investment in sales [ticket vending machines TVM] and cancellation equipment [ticket canceling machines (TCM)]. Reliability and maintenance equipment is also not an issue.

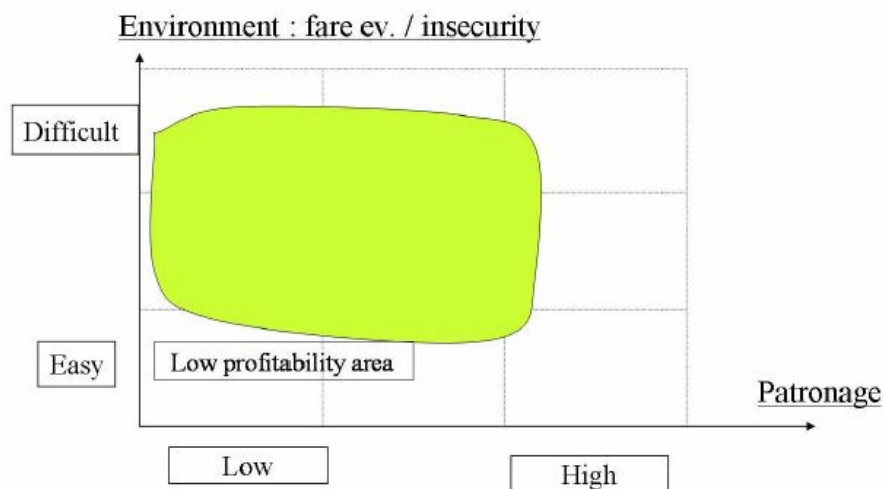


FIGURE 3 Typical situation for open systems with strong control.

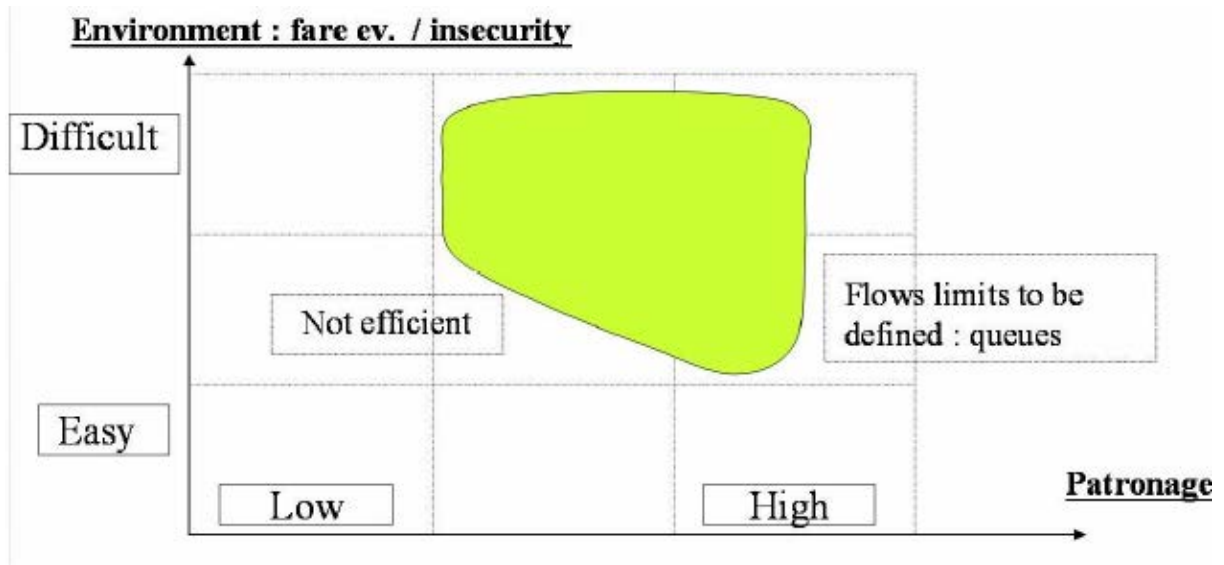


FIGURE 4 Typical situation for open systems and systematic control.

The limits of this philosophy are reached when passenger flows are increasing, i.e., during peak time, when queuing conditions becomes unacceptable for efficient operation, or when conductor movements inside the train become virtually impossible.

Closed Stations (Metro Type)

This is the ultimate step in the scale of our typology. The general principle is to physically “close” the station (Figure 5). This can be implemented with various severities: a symbolic border line defining a no-go zone if not a holder of a valid ticket, or the actual “gating” of the station, using doors or turnstiles.

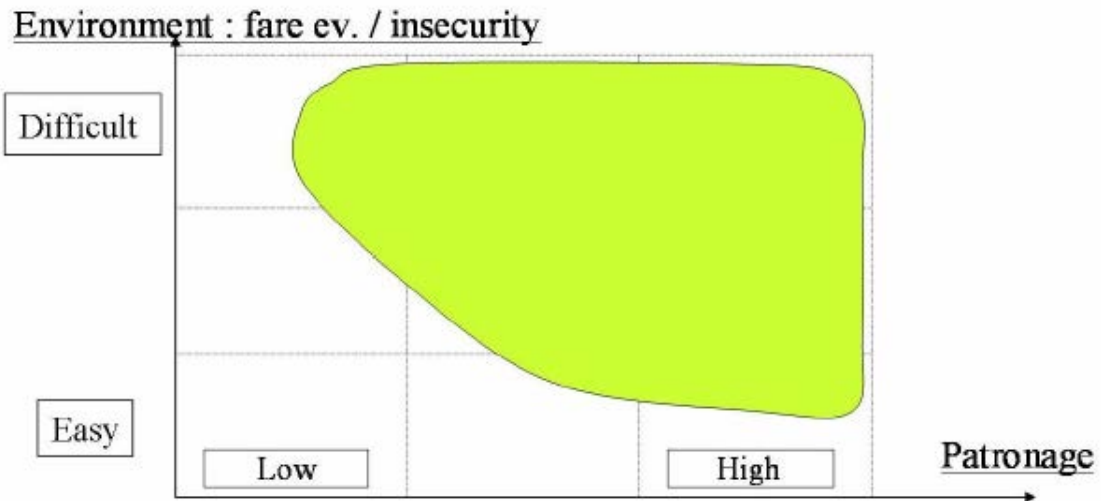


FIGURE 5 Typical situation for closed systems.

Few of the systems surveyed (4 out of 18) are using it on parts of their system. This type of configuration is mainly suitable for underground or elevated stations, but some high-platform systems are using it for at-grade stations all along their lines (Istanbul).

Given the stronger integration in the urban fabric, no cases of closed low-floor LRT systems are known to the working group. While being extremely effective against fare evasion and being compatible with larger passenger flows, the limits of this philosophy for LRT applications are numerous: lack of space at street level, costs, and reluctance against severance effect in public urban space. For these reasons, a strategy of full “closing” is neither cost-effective nor acceptable for LRT.

Experience, however, suggests that applying this principle to only a third of the light rail stations can be a viable option. With this approach, it makes sense to target the busiest stations, which are likely to be in the densest area of the central business district (CBD). This speaks, therefore, in favor of underground station design in the CBD.

Problematic Configurations

The four matrixes depicted in the pictures above cover most of the spectrum of patronage/environment situations adequately with some overlapping. Two situations, however, are problematic (see [Figure 6](#)):

Weak Flows in Difficult Environment

In this case, the problem lies with a poor design of the appropriate transport mode, and a bus line may have been more appropriate, with “boarding at the front” and thus systematic control at no extra costs.

Very High Patronage in Difficult Environment and Without Control Possibility

In case of systems running over capacity at peak time and at capacity at off peak (e.g., Tunis), the reason for this difficulty may also lie in a system design based on incorrect or underestimated traffic forecasts. In this case, the design should have proposed a metro or even suburban railway line, with higher investment costs but more appropriate conditions for controlled access.

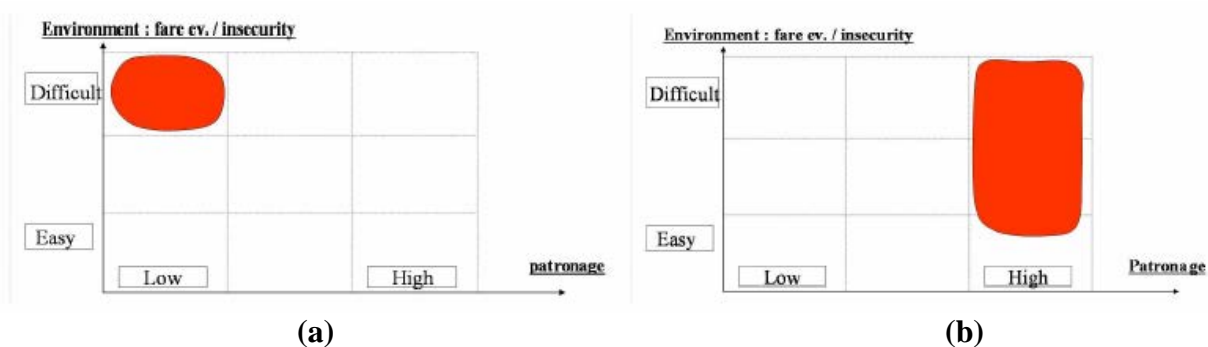


FIGURE 6 Two difficult situations in the matrix.

FARE AND TICKETING SYSTEMS

Fare Systems

There are 5 flat and 13 zone systems among the participant cities. The characteristics are as shown in Figure 7 below.

A direct ratio between this kind of categorization and the extent of fare evasion cannot be detected. However, as “misunderstanding of the system” is often cited as a common “trick” for fare evasion (intentional or not—see below), we can reasonably presume that zone systems are more prone to fare evasion. Generally speaking, zone systems allow more efficient and fair pricing, hereby motivating to pay. But if the zone system is difficult to understand and use, it may produce a contrary effect. Zonal fares or distance-based fares encourage the fraudulent practice of so called “overriding”—or riding too far. Statistics from Porto show that this represents a third of the detected evasion. Flat fares do not have this problem. Interviews reveal that a significant number of operators are confident that the introduction of smart cards will contribute to reduction of this practice (at least for unintentional fare evaders).

The price of the single fare lies between €0.6 and €2.75.

Ticket Types

The proportion of single tickets sold lies between 3% and 73%. Season tickets are popular among frequent daily users and commuters. This proportion depends highly on the available ticket assortments.

The most common tickets are still paper format, followed by magnetic strip card and smart cards (Figure 8).

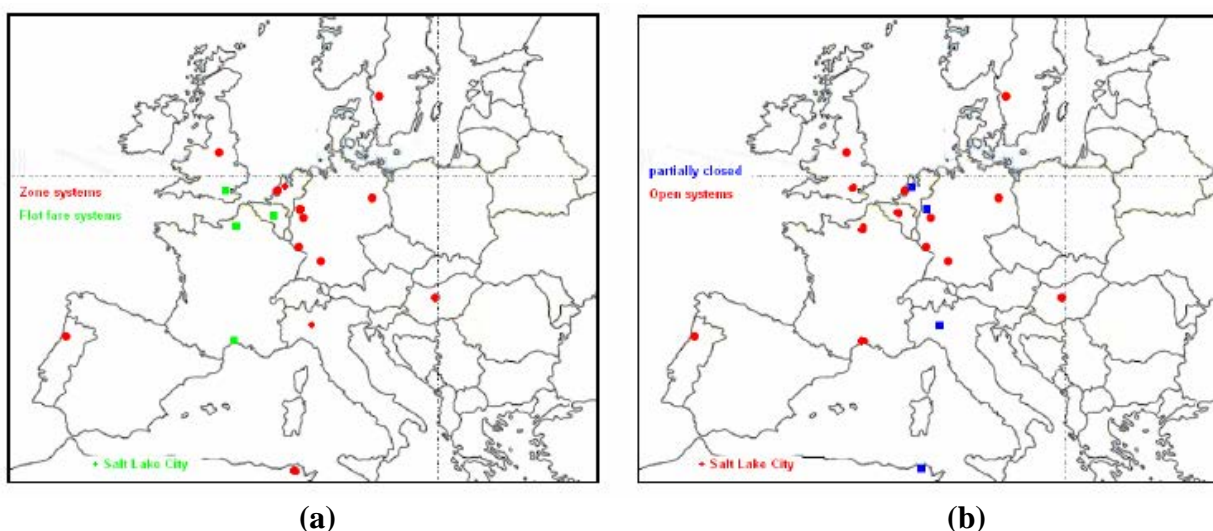


Figure 7 (a) Flat fare (green square) and zonal (red circle) ticketing systems, (b) (partially) closed (blue square) and open (red circle) systems.

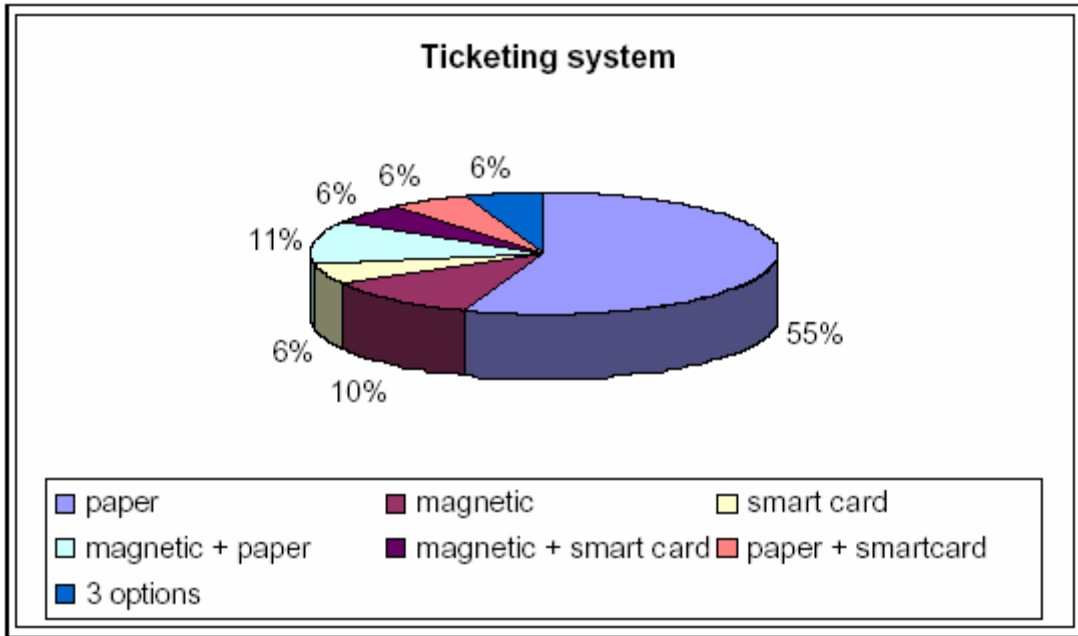


FIGURE 8 Types of tickets.

Ticket Vending Machines

TVMs are usually found on platforms and not in the vehicles, with the notable exception of German systems, which accounts for nearly half of LRT systems in Europe. In Tunis, ticket sales are only performed by staff in stations; there is no TVM available. This is also the case in Nottingham (outside the sample), where a conductor is selling tickets (see separate article).

A critical issue raised on several occasions in interviews is reliability of the machines. Machines that are out of order lead to subjective “legal” fare evasion.

Ticket Cancelling Machines

Most (16/18) systems have TCMs (or validators). These can be inside the vehicles (9/16), both on platforms and in vehicles (3/16) or on the platforms only (4/16). The latter option can contribute to more effective boarding process and time. It also hampers the common practice of late stamping when inspectors show up. However, this option may be prone to high vandalism and degradation rates. Two systems do without TCMs; the ticket is valid from the moment you buy it.

Again, smart card technology is believed to help considerably in decreasing fare evasion. However, this potential should not be exaggerated: smart cards remain only a medium, and only the most sophisticated configuration of software and hardware will permit a solution for “the right fare to be paid automatically.” They will, however, not prevent a passenger without a valid ticket to board in an open system.

But truly magnetic card TCM are maintenance intensive due to the sensitive mechanical parts, and therefore, the spread of contactless TCM and smartcards is likely to lead to a significant reliability increase, and then to decreasing the subjective “legal” fare evasion due to “machine out of order.”

FARE EVASION

As the Gauss curve of natural behaviors indicates, fare evasion is unfortunately inevitable (except in some rare and particular cultural environments). It is often heard that 5% is taken for granted. In our sample, it ranges from 1% to 25%, as [Table 2](#) shows. This high dispersion depends on the operating and legal environment, the measurement methodology applied, and the operator's attitude to it: leniency or zero-tolerance.

Each operator has its own targeted fraud rate in line with its specific environment. This target can be expressed in various terms:

- Targeted fare evasion rate (to reduce fare evasion to x%),
- Targeted fare evasion reduction (to cut fare evasion by x%), and
- General intention (to keep fare evasion as low as possible).

The most common “tricks” used by fare evaders are (not in order of importance):

- Standing close to a validator, and only validating the ticket in case of inspection. With modern technology, it is possible to switch off TCMs at the beginning of a roving or blockade inspection, either from the driver cab or centrally from the operation control center (Rouen, Barcelona, Tenerife in future).
 - Getting off when you see the inspection team. For this type of attitude, prefer the blockade inspection regime to roving.
 - Misunderstanding of the system and rules (need to validate, zone logic, or limits). Note that some customers may really experience difficulties using the system. With the market segment of occasional users, an attitude of zero-tolerance may be counterproductive and push them away from public transport. Understanding and leniency are recommended. Experts interviewed assured that very clever questions are enough to find out whether the fraud is really unintentional.
 - Blaming the (faulty) TVM. This demonstrates again how crucial reliability and proper maintenance of the sales machine are.
 - “I have forgotten to stamp my ticket.”

Very often, there is a discrepancy between the measured and the estimated fare evasion level, as [Figure 9](#) shows. Fraud shows high dispersion and includes high uncertainty. The differences between the measured and the estimated figures show the lack of a credible measurement methodology in all cities.

STRATEGIES AND MEASURES TO DECREASE FARE EVASION

Two complementary approaches are often found in strategies to combat fare evasion: direct and indirect:

Direct Effect

The so-called “direct effect” aims at implementing direct deterrent measures. Mainly two

TABLE 2 Fraud and Inspection Rates

	Fraud Rate (%)	Inspection Rate (%)		Fraud Rate (%)	Inspection Rate (%)
Amsterdam*	1–19	0.54	Budapest	10–12	2.5
Brussels	5–19	1	Milan	8–12	5
Croydon	2–6	5–10	Saarbrücken	2–10	2
Gothenburg	2–10	1.3	Berlin	4–5	1.6
Manchester	2–6	14	Montpellier	2–15	4.1
Porto	1–4	5.4	Cologne	4.2	0.8
Rouen	1.5–6	2.64	Düsseldorf	2	<2
Stuttgart	3–10	1.6	Tunis	11	3
The Hague	5–25	3–4	Salt Lake City	2.5	8

* The fare evasion rate varies a lot depending on the control philosophy: tram with conductor and front-boarding bus, 1%; tram without conductor, 9.8%; and underground, 19.3%.

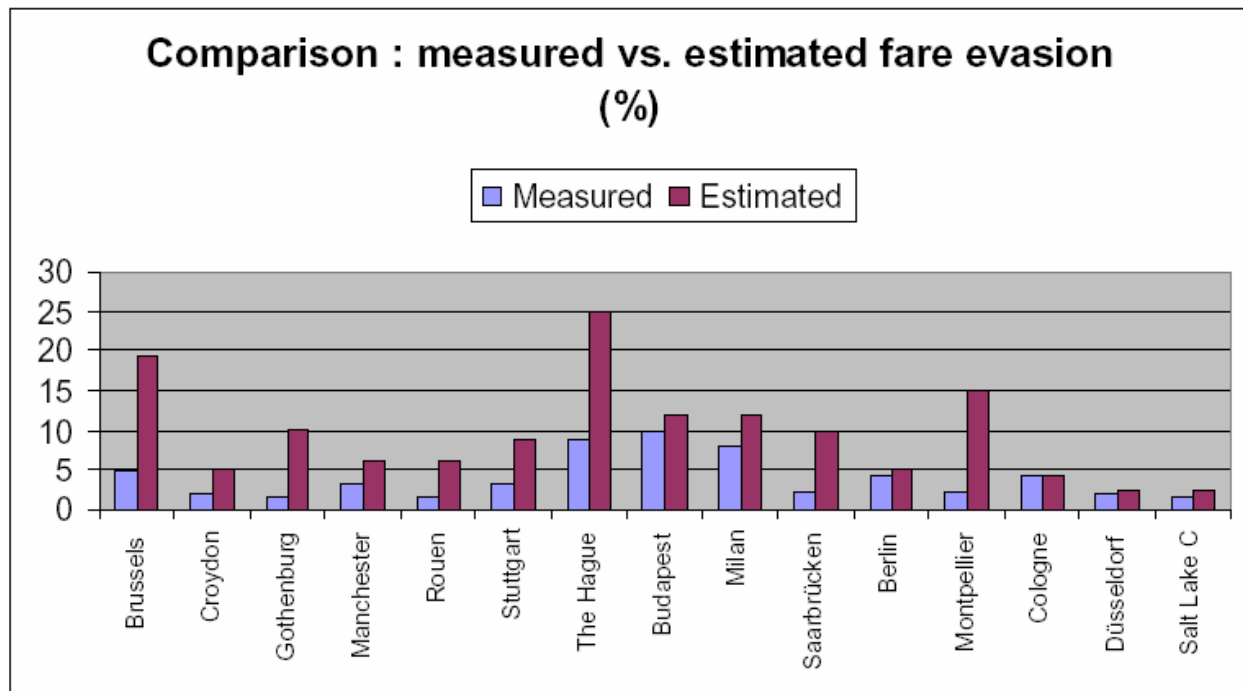


FIGURE 9 Discrepancy between the measured and the estimated fare evasion level.

parameters are available to LRT operators: the intensity of human presence and the severity of penalty. Station design is another effective levy, but is only applicable to a limited extent for LRT.

The control inspecting resources can vary a lot, and so does the percentage of passenger inspected, ranging from 1% to 18%, with an average at 4%. This depends largely on the characteristics of the public transport network.

Ticket inspections, whatever the strategy adopted (blockade or roving), are always working in teams of two to eight persons.

Companies need to devise ways of targeting interventions to hot spots by dynamic staff allocation. Again, new technologies can help. For instance, light rail vehicles of the newest generation can be equipped with infrared passenger counting devices at each door, and with continuous data communication to the OCC, and real-time computer comparisons of the number of boardings and the ticket validation data. When discrepancy reaches a certain threshold, an alarm can inform the operator, who can decide to send a ticket inspector team.

For efficiency reasons, some companies may decide to concentrate their efforts on the most heavily used routes, and neglect controls on secondary lines. However, they should be careful that such targeting strategy does not lead to zones of “non-right” or moments during the day when there are never any inspections. This can be prejudicial to equity and worsen the feeling of insecurity on such lines.

A limited number of companies operate with conductors. Most of them opted for this as a corrective measure of open systems. Sheffield and Birmingham switched from TVMs to conductors as a response to the severe problems with TVM reliability or to theft vulnerability of platform TVMs (cash box could be stolen in less than 20 s). In Rotterdam (see below) and Amsterdam, this reintroduction was meant to cut unacceptable fare evasion rates. Nottingham is a special case since conductor operation has been used since the opening of the line (see below).

Tram Conductors on Rotterdamse Elektrische Tram

In Rotterdam, the fare evasion rate could be decreased from 20% to 2.8% following the introduction of 450 conductors. Ticket income has increased by 10% and a survey shows a decrease of the insecurity feeling of 60%. It is estimated that the direct cost recovery ratio of this approach is 20%.

Tram Conductors on Nottingham Express Transit

Introduction

The tram in Nottingham is operated by a joint venture of Nottingham City Transport and the Transdev Group.

During the concept and design stage, Nottingham Express Transit (NET) fare collection was envisaged to be by way of platform TVMs with “revenue inspectors” responsible for checking 5% of the travelers on a random basis.

As the project progressed, however, several factors combined to provide a serious challenge to this approach, such as poor sale and canceling equipment reliability, and vulnerability to theft. Approximately 2 years before NET opened, therefore, the philosophy of fare collection changed.

Unlike other tramways, however, where conductors are the entry-level grade and relatively poorly paid when compared with tram drivers, it was decided that the conductors and drivers would be amalgamated to form a single grade of “tram crew” who would both drive and conduct.

Benefits of Conductors—Generic

- Passengers who wish to pay are more likely to have the opportunity to do so.
- Some minor fare evaders are deterred.
- Reduced maintenance costs (TVMs are expensive).
- The public likes having a member of staff on the tram. This benefit is very difficult to measure, but a high proportion of passengers say they like traveling by tram because of the friendly staff.
- Passengers are likely to feel safer—particularly when traveling at night.
- Drivers feel less isolated.
- Tram vandalism is reduced, particularly seat damage, graffiti, and window etching.
- Penalty fare regimes are extremely expensive to administer and are seldom self-financed.
- Random revenue inspections or penalty fare regimes are, by definition, more confrontational than conductors.

Benefits of the NTC Dual-Trained Approach

- Dual-training increases the variety of jobs.
- Drivers appreciate the needs of passengers.
- Drivers appreciate the needs of conductors (smoother ride style).
- There is a mutual assist in dealing with incidents, etc.
- Flexibility is increased—fewer dedicated “spare/standby” shifts are needed.

Downsides of Conductors

- Expectations of clients and customers can be unrealistic—conductors cannot guarantee against fare evasion.
- Conductors are always open to scrutiny and criticism; some degree of variability in performance both between different individuals and in the same individuals on different days is inevitable.
- Supervision and checking regimes for conductors need to be rigorous.
- Conductors cannot afford to concentrate on fare evaders—while they are dealing with the minority, they will not be collecting revenue from those who want to pay.
- Effectiveness of conductors is greatly reduced as trams get very busy. Studies have suggested that once a tram has 120+ passengers, two conductors are necessary, but that after about 150+, even this does not help.
- There is twice the number of staff.
- Dual training does not suit everyone—many staffers would prefer to drive only.
- Handheld ticket machines must issue tickets quickly—the speed of issue of tickets is

the single biggest factor affecting conductor performance.

- Few handheld ticket machines are available.
- Ticket types must be limited—a very complicated ticketing regime is harder to remember and will slow ticket machines and conductors down.
- There is always a payoff between focusing conductors on customer care or revenue protection—different parties may not agree on the priority.

Inspectors are associated with “repression,” although the visible presence of staff is the best prevention tool available. In eight out of 18 networks, ticket inspectors wear uniforms. Plain clothes inspectors have a purpose to “catch” fare evaders while uniformed inspectors contribute to “educate” customers to pay for their trips.

There is a rather clear correlation between fare evasion and the level of “contact” between ticket inspectors and customers, as [Figure 10](#) shows. To reach low level of fare evasion (approximately 5%), you need an inspection rate of approximately 8%.

In the sample, some companies are using outsourced inspection capabilities, in addition to in-house resources. In one case, the efficiency of own inspectors is reported to be significantly (40%) lower than of external inspectors. Possible reasons are bad motivation and the lack of incentives in personal monthly payment. To overcome this in Prague, ticket inspectors are paid a fixed-base salary complemented with a variable income depending on their efficiency.

The basic penalty varies greatly—between €5 and €100.

Such absolute figures are meaningless given the disparities of socioeconomic reality. Therefore, a better picture is given by calculating the ratio of basic penalty divided by the single fare price. The two extremes are Stuttgart (penalty is three times more than the single fare) and Milan (100 times). This reflects attitudes toward fare evasion ranging from leniency to zero tolerance.

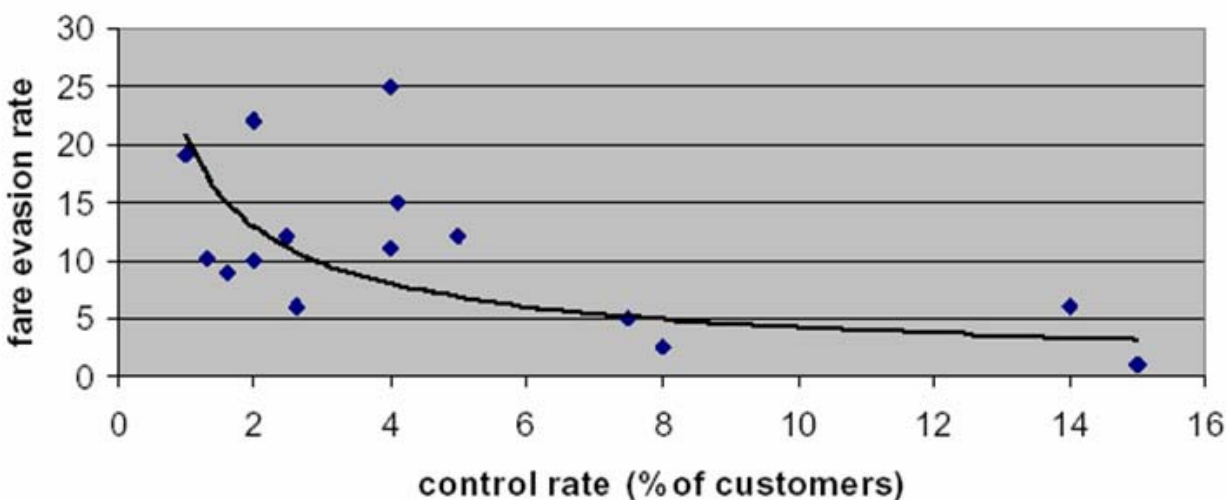


FIGURE 10 Fare evasion versus the level of “contact” between inspectors and customers.

- The penalty fare can sometimes be reduced if paid immediately (Croydon, Manchester, Budapest, Milan), this being justified by reduced administrative costs.
- Persistent fare evaders or “repeaters” are exposed to increased financial risks (sometimes dramatic, e.g., €55, €190, €380 in Brussels) but no other types of consequence take place, except in Rouen where French legislation provides a severe provision: 10 fines within 12 months can be punished with 6 months prison and a €7,500 fine. However, this is rarely applied (“professional” fare evaders seem to be aware of the limits and risks they are ready to face).
 - Court procedure: between €21 and €375 can be charged extra to cover court procedure costs.
 - One system in the sample is looking at possibilities to persuade the legislative partner to introduce provisions to withdraw the driving license of persistent fare evaders.

But the direct effect does not only include repressive measures. Targeted awareness-raising campaigns are also commonly used, in general, a few weeks before “crackdown” campaigns or the introduction of a new policy toward fare evasion. Such campaigns vary in length, depending on the nature of the campaign itself and its role in the overall policy.

Indirect Effect

Under “indirect effect,” we understand a series of long-term measures aimed at contributing to a climate and attitudes more favorable and respectful for public transport (thereby contributing to the re-creation of the “honor” system conditions). The return of such measures is reflected in terms of fare evasion, but also on security.

- Cooperation with police: All respondents’ organizations have more or less some form of cooperation with the police, but practice is varying. Police can help to check people’s identity, especially where ticket inspectors do not have this power.
- Cooperation with justice: Not considered as petty crime.
- Education: Visiting schools is a routine in seven networks. Campaigns can differ in period, target group, and message. Students and pupils are a special target group altogether in eight networks.
- Presence of staff in “critical dwelling areas.”

Multistakeholder Initiative in Rouen

Clearly, the success of any strategy to reduce fare evasion (and insecurity) is dependent on the good cooperation between different agencies covering various fields of competence. In Rouen a formal “local security contract” commits all stakeholders (Préfecture, justice, police, cities, associations, organizing authority, and operator) to contribute actively aiming to reduce the urban insecurity.

Police A specific squad (22 policemen) was created to secure public transport. They can be deployed on the whole network or even support ticket inspectors.

Justice A “fast track” procedure was created for public transport crime (fare evasion, vandalism, etc.) with a staff seconded from the operator to optimize the interface. Offenders are

preferably sentenced with so-called “general interest work” to repair their damages (pedagogic value). The better cooperation made it also possible to significantly increase the recovery of fines/penalties for fare evaders (50%, which is considered high in France). Also, the use of closed-circuit television is a precious help for justice to establish evidence formally.

Education Information sessions (so-called “citizenship awareness raising”) are organized in schools (and jails for first-time offenders). All partners are represented—police, justice, firemen, drivers, etc. Close contact is also maintained with various associations (sporting, youth, etc.).

Transport operator A dedicated team of 28 staff is in charge of ensuring staff presence on the network and enters into a relationship with the customers and noncustomers in and around the installations in order to perform preventive measures and avoid possible escalation (discussion, confidence building, etc.).

In particular, their missions consist of:

- Fulfilling an active presence next to the drivers and the clients;
- Preventing conflicts, favoring the dialogue;
- Reminding of the rules and regulations and getting them to be respected;
- Actively participating in the “fight against fraud” (encouraging ticket validation—the mediation agents are not on oath and cannot give fines);
- Providing a complimentary service to the clients (information, creating an atmosphere of security); and
- Giving feedback to the management from the field in terms of security and fraud.

Between 1997 (before strategy implementation) and 2001, vandalism decreased—seat damages by 30%, window scratching by 65%, and shelter damages by 29%. Mugging also decreased. An opinion survey indicates better satisfaction and confidence. Staff also appreciate the efforts and are less prone to stress.

Such efforts are well beyond the role of a mere transport operator; they aim at modifying in a sustainable way the image of public transport and strengthening its place in the heart of the citizen’s life. The operator profiles itself as an essential “urban stakeholder” aware of its social responsibilities. The whole exercise consists in sharing such values with the users and non-users.

Usually, a constant effort is strengthened by targeted campaigns.

FUNDING OF MEASURES

Except for two cities, the recovery rate or “return on investments” varies between 17% and 72%. Therefore, the extra revenues collected are rarely enough to cover the extra costs incurred. The issue of funding is thus acute.

Operators and organizing authorities share the costs of measures in half of the systems analyzed. It is justified because decreasing fraud should be of primary interest of the authority. In seven cities the costs of the measures are covered only by the operator (Budapest, Gothenburg, Milan, Montpellier, Porto, Rouen, and Saarbrücken).

To have the real picture it is necessary to consider the funding scheme of the PT system

as a whole, to know how the costs and risks are distributed. Typically, in the case of net-costs contracts, where the operator is bearing revenue costs, incentive for the operator to enforce efficient fraud-decreasing measures is high. In gross costs, where the operator is only responsible for the industrial/production costs, the authority would be more likely to be in charge of ticket revenue protection. Contract regime is therefore of paramount importance. But it is out of the scope of this survey.

SECURITY ASPECTS

Both aspects of fare evasion and insecurity are intimately linked even though characterizing and quantifying this relationship is extremely difficult and even dangerous (see separate article on the Rouen strategy). Some consider fare evasion as the first step toward more severe crime, but this reflects a more individual attitude (leniency/zero tolerance).

But one finding is unanimously shared: not all fare evaders will escalate on the scale of (petty) criminality, but all law offenders evade fare when using public transport. According to interviewed experts, any larger ticket inspection crackdown campaign is likely to reveal more serious law breaches (credit card falsification, weapon smuggling, pickpockets, etc.).

In order to contribute to customer service and security, ticket inspectors have an additional role: giving information or lending a helping hand. The legal power of ticket inspectors is mainly restricted to checking tickets, removing persons without ticket, imposing penalties, and collecting fines. In seven networks they have specific extra competence for security (Amsterdam, Brussels, Croydon, Stuttgart, Milan, Tunis, and Salt Lake City).

However, the trend seems to be that security tasks are separated (outsourced) and provided by specific staff. Because of the importance and complexity of security aspects it is not an additional task of the operator's staff any more but the primary task of the well-trained security staff.

Other categories of staff can contribute to keep order: service officers, security, and prevention personnel, special customer care officers, operation supervisors, some drivers, etc. Most of these categories do not reveal the exact rights and duties, and moreover, some "job names" and "job descriptions" are specific to a given network and not necessarily existing elsewhere.

In 11 systems the police are present, including Amsterdam, Croydon, Rouen, and Salt Lake City, where dedicated transport police forces work. Police are not present in six networks (Gothenburg, The Hague, Budapest, Saarbrücken, Berlin, and Cologne).

The presence of uniforms in installations or trains is reported to have positive impact on fare evasion and security. One company (outside the sample) has a policy of letting anybody wearing an uniform (soldier, fire brigade, police, etc.) use its system free of charge, and expressed its satisfaction with the cost-benefit ratio of this low-cost measure. Its effectiveness can, however, suffer when it pertains to populations that are (becoming increasingly) less affected by "authority."

CONCLUSIONS

System Design

The choice of the fare system and access philosophy is local in nature. However, stakeholders should be aware of the operative consequences as early as in the design stage.

The fare and ticket system should be easy to understand and use for passengers, and be as clear-cut as possible: any possibility for discussion and/or interpretation will be misused by fare evaders. The best system is a system of “black-and-white” scenarios. This implies a clear concept and stringent requirements on technical installations and especially vending machines and validators (reliability).

The preferred and most efficient option is to close the system, but in a majority of cases, it is not possible with LRT. So revenue protection has to take place through inspector checks and the challenge for each LRT system is to find its own optimum balance to maximize revenue protection and minimize costs.

The inaccuracy of the data calls for an improvement of the measurement methodology.

The introduction of smart cards has a potential for reducing (unintentional) fare evasion and can lead to significant machinery reliability increase, but it will not solve the issue alone.

Any measure aimed at increasing use of prepaid tickets or season tickets is instrumental in reducing fraud.

It is beneficial to target service excellence in order to increase the willingness to pay.

Inspections

- Target inspections and allocate staff dynamically to hot places and periods, but also avoid areas or periods without controls.
- Train your staff adequately, especially with conflict de-escalation and relational techniques.
- Prefer visible ticket inspectors because this acts as a deterrent for the majority of travelers who behave opportunistically.
- Recognize that having conductors are an expensive option, but can be justified temporarily or permanently.
- Allow free travel to all uniformed staff.

Legal Framework

- Improve prosecution (especially youngsters) to avoid a climate of perceived impunity.
- Increase repeater fines.

ACKNOWLEDGMENTS


This report was prepared by Zoltan Kovacs (BKV, Budapest) and Laurent Dauby (UITP), with the kind support and guidance of the companies listed in the survey sample, the extra contribution from Nottingham, and the enlightened comments of members of the Light Rail Committee.

The authors also acknowledge the essential support of Philippe Ventejol (RATP, Paris) and Geoff Inskipp (GMPTE, Manchester), who led the fare evasion working group for several years.

SECURITY AND FARE ENFORCEMENT

Hiawatha Light Rail
Minneapolis, Minnesota

JACK NELSON
Metro Transit



Hiawatha Light Rail
Minneapolis, MN

Safety and Security

Hiawatha LRT



Hiawatha LRT

- Downtown Minneapolis to Mall of America
- 12 mi
 - 6 bridges (2 new, 4 old)
 - 2 tunnels
- 17 stations
 - 2 elevated
 - 1 subterranean
- Downtown Transit Mall
- Two Stations at MSP Airport
- Crosses Fort Snelling Military Reservation



Ridership

- 11.4 million from opening through January 2006
- 65% above projections
- Served symbolic 10 millionth rider Nov. 25, 2005
- 23,800 weekday rides in 2005, impacts congestion

Hiawatha LRT

Metro Transit Police Department

Transit Police

- **Protecting the transportation needs of**
 - 72 million passengers per year
 - 1,400 drivers
 - 950 buses
 - 24 light rail vehicles
 - 10 facilities
 - 7 counties
 - 85 cities

How We Protect

- Transit Police
- Canine
- Fast Action Response Team
- Federal Protective Service
- Airport Police
- 55th Civilian Support Team (U.S. Army)
- Mall of America Security
- Joint Countywide Weapons of Mass Destruction Team

Transit Police Staff — 144

- 1 Chief
- 1 Deputy Chief
- 1 Captain
- 7 Patrol Lieutenants (1 Canine)
- 1 Administrative Lieutenant
- 23 Full-Time Officers
- 12 Light Rail Officers
- 88 Part-Time Officers
- 3 Investigators (2 Full-Time and 1 Part-Time)
- 5 Office Support Staff
- 2 Asset Protection Staff

Canines

- Captain Robert Elmers—Radar
- Lieutenant Gordon Greenwaldt—Holly
- Explosive Detection and Patrol



Fast Action Response Team



Old Fast Action Response Team Member



Fare Inspectors / Equipment



Paid Fare Zone Platform



Wrapped and Unwrapped LRV



Light Rail Enforcement

■ 06/28/04 to 12/31/05	
■ Passengers Checked for Fare Compliance	1,553,839
■ LRT Vehicles Inspected	51,962
■ Citations Issued	4,049
■ Warnings Issued	8,439
■ Arrests	734

Year 2005

■ Arrests	2,056
■ Citations	7,734
■ Parking, Traffic, and Criminal	
■ Detoxs	831

Typical Security Issues

- Safety of Passengers
 - On Train
 - On Platforms
- Safety at Grade Crossings

Physical Security

- **Stations**
 - Cameras
 - Emergency Telephone
 - Visibility
- **Trains**
 - Fare Inspectors

Major Security Areas

- Airport Tunnel
- Mall of America
- Metrodome Stadium

Hiawatha LRT

Airport Tunnel

Airport Tunnel

- **The tunnel:**
 - Twin bore
 - 8,000 ft long
 - 10 cross passages
 - Bored tunnel
 - Crosses under both parallel runways

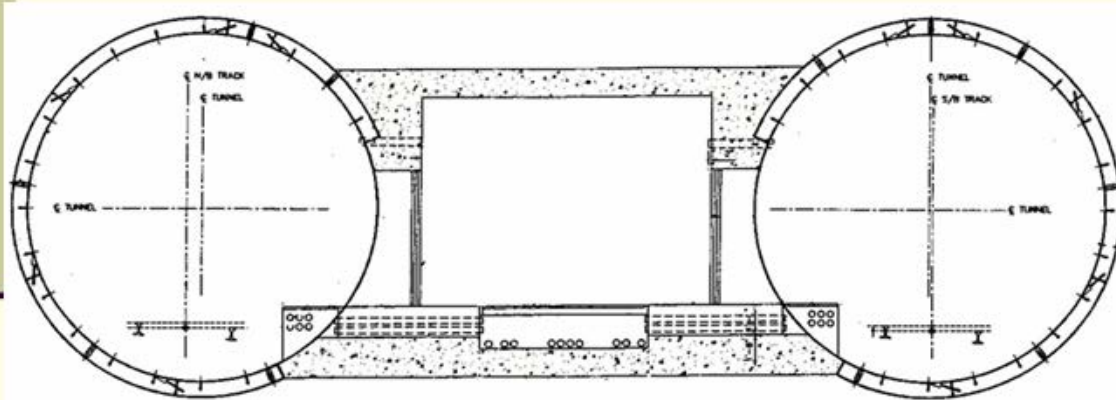


Airport Tunnel



Tunnel Cross Section

- Twin Bore with 10 Cross Passages



Airport Stations

- There are two stations at the airport:
 - Lindbergh Terminal
 - Humphrey Terminal



Lindbergh Terminal Station



Humphrey Station



Airport Tunnel

- Nature of Threat
- Security Procedures
 - Airport police
- Physical Security
 - Intrusion detectors at tunnel portals and at Lindberg Station
 - Cameras in portal areas
 - Physical isolation of portals

Hiawatha LRT

Mall of America

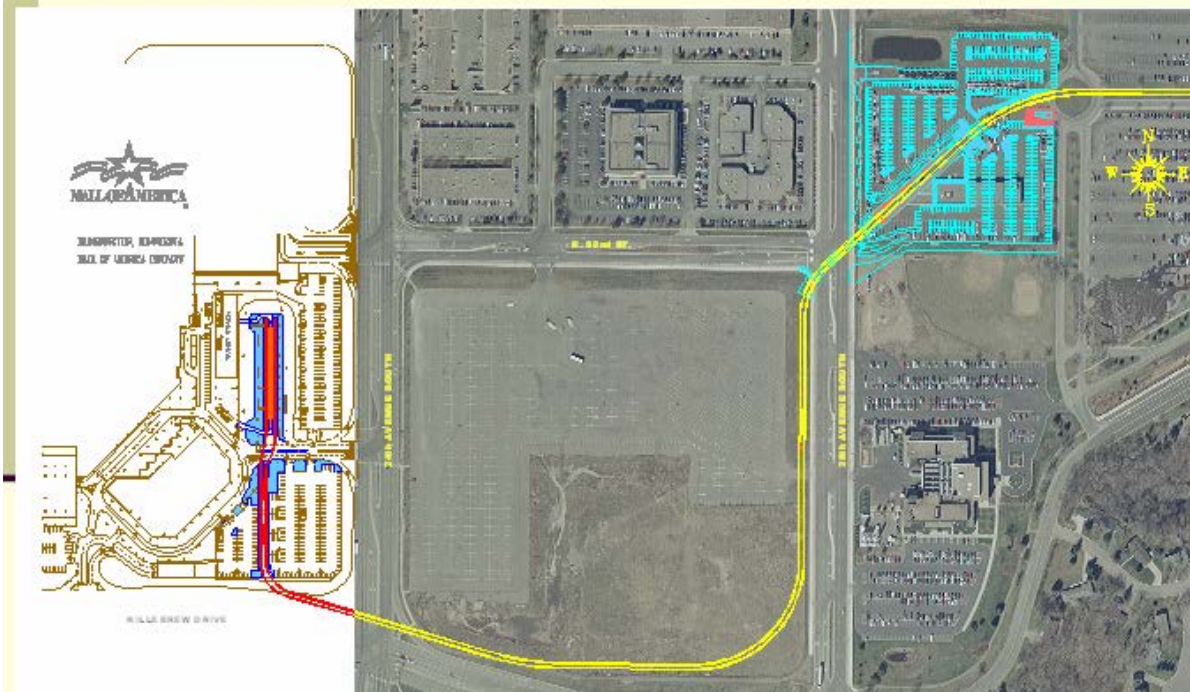
Mall of America Station Site



Mall of America

- Description
- Nature of threat
- Security procedures
- Physical security

MOA Alignment



Hiawatha LRT

Metrodome Stadium

Metrodome Stadium Platform



Metrodome Stadium

- Description
- Nature of threat
- Security procedures
- Crowd control
- Physical security

Mission Statement

The mission of the Metropolitan **Transit** Police is to provide a safe, secure environment for transit customers and employees and to protect Metropolitan Council assets and property. These responsibilities will be accomplished according to the highest standards of professional skill, ethics, and accountability with full respect for human dignity.

SECURITY AND FARE ENFORCEMENT

Self-Service, Barrier-Free Fare Collection
A Quarter Century of North American Experience

THOMAS F. LARWIN
Larwin Consulting

**Self-Service, Barrier-Free
Fare Collection:
A Quarter Century of North
American Experience**



Tom Larwin
San Diego, CA



Context Leading Up to 1981

- SSBF essential for low-cost, functional LRT
- Little North American experience to draw upon
- Minimal research on subject
- European experience offered some confidence (BoD tour in 1977)
- General skepticism (people in United States are not as honest as...)
- “Model T” TVMs

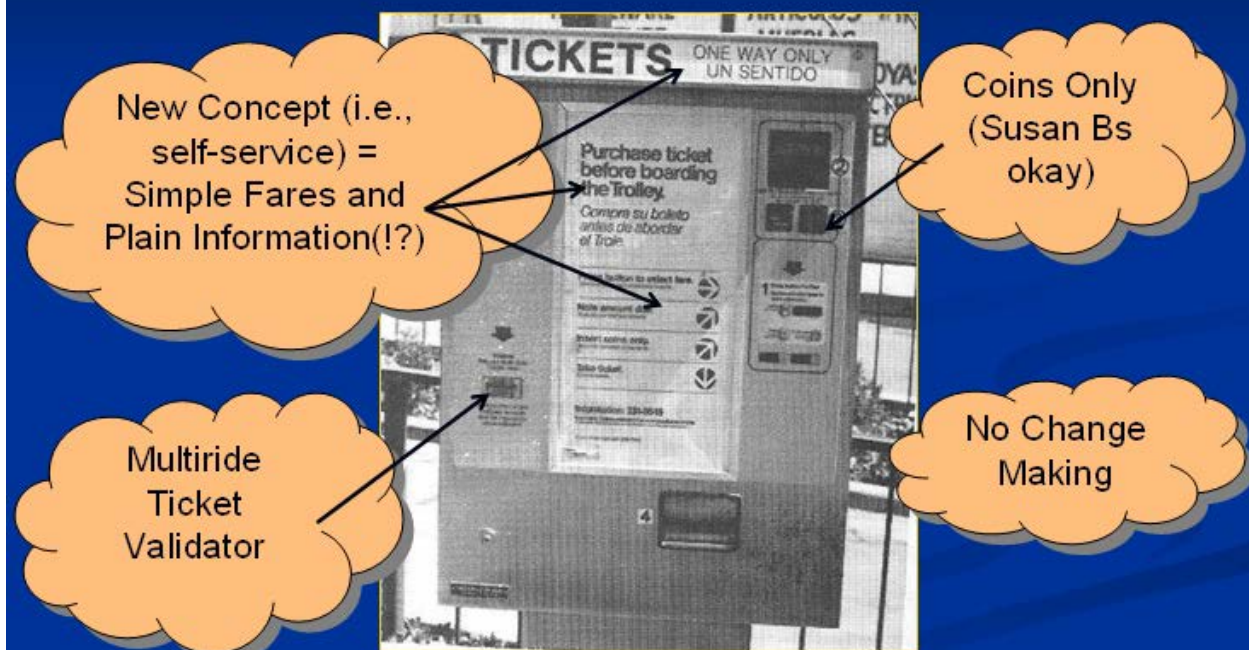
Examples of Skepticism

- “Based upon the amount of difficulty we presently experience and the hassles on buses currently caused by fare collection, we must express our skepticism about the SSFC system proposed in the MTDB plan.” (SDTC Board memo, 7/6/78)
- “Is the Honor Fare System on the Tijuana Trolley a Ticket for Trouble” (editorial, *LA Times*, 3/19/81)

Context Leading Up to 1981

- SSBF essential for low-cost, functional LRT
- Little North American experience to draw upon
- Minimal research on subject
- European experience offered some confidence (BoD tour in 1977)
- General skepticism (people in United States are not as honest as...)
- “Model T” TVMs

Early TVM (1981, San Diego)

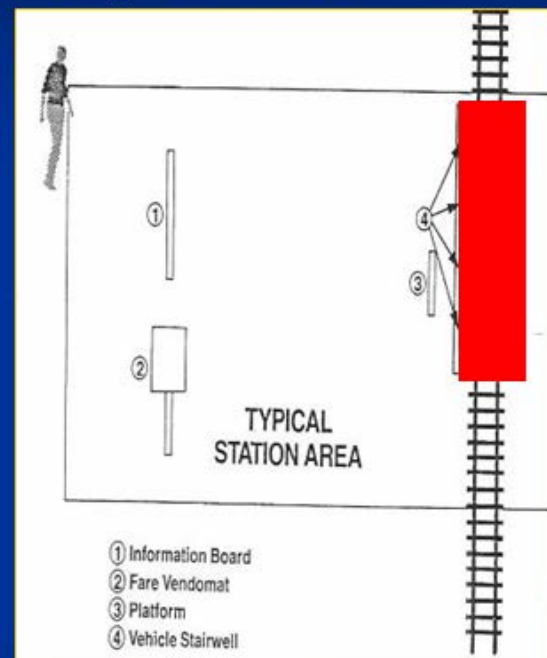


Early San Diego Experiences

- Direct relationship between fare inspection and evasion rates
- Enforcement attitude needed to be customer oriented
- People were generally honest ($\pm 1\%$ evasion)
- Prepayment (multiride tickets, passes) was beneficial

Early San Diego Experiences

- Communications Challenges (i.e., how to get information to customers on how to pay fares)
 - Use of multiple locations
 - Station information signs (1) (3)
 - TVMs (2)
 - LRV stairwells (4)
 - Loud speaker aboard trains
 - Complexities
 - Plain English
 - Multilingual
 - Legal requirements
 - ADA
 - Attractive graphics



25 Years Later: *What's the Pulse?*

- Contacted eight LRT properties (all in the United States)
- Reviewed *TCRP Report 80: A Toolkit for Self-Service, Barrier-Free Fare Collection*, 2002
- Talked with Tom Parkinson (Vancouver consultant to San Diego in 1979–1981)

Evasion

- Evasion Rates
 - 1% to 6%, average = 2.5% (TCRP Report 80)
 - 1% to 5%, average = 2% to 2.5% (Larwin, 2006)
 - Management–Policy Goal: < 3%

Inspection

- Inspection rates
 - 6% to 42% (TCRP Report 80)
 - 6% to 32% (Larwin, 2006)
- Inspection % ↑: Evasion % ↓
- Percentages are system dependent
- Strategies
 - “Blitzes” and “sweeps”
 - “Swarms”
 - Intercept on platforms



Common Issues

- Too many fare media
- New segments add complexities
- TVM replacement
 - More “bells and whistles”
 - Versus financial resources
- Inspection during crowded periods (e.g., peaks, special events)
- Security responsibilities

Emerging Enforcement Aids

- Expanded paid areas
- Creative enforcement options
- Canine patrols
- Administrative process for citations



Array of Fare Equipment



New Technologies

- CCTV
- Handheld PCs
- Electronic fare media (e.g., smart cards)



Smart Card System Components



Findings—Part 1 of 2

- **SSBF has worked successfully for 25+ years in North America!**
- “Generally” accepted by customers, courts, policy boards
- Increasing emphasis on security
- Fare collection technology becoming more expensive
- ...and more complex
- Good: high % prepaid fares
- Bad: too many fare media

Findings—Part 2 of 2

- “Initially shocked” (i.e., that it is working!)
- Benefits outweigh costs
- Open stations are easy for customers to use
- Creative enforcement strategies a routine dynamic
- Significant sharing of ideas and experiences among operators
- BRT is next

Self-Service, Barrier-Free Fare Collection in North America: Positive Experiences!

Tom Larwin
Larwin Consulting
San Diego, CA
LarConsult@yahoo.com

Design of New Infrastructure

DESIGN OF NEW INFRASTRUCTURE

Using Climate Response in Designing Fixed Guideway Stations and Bus Passenger Shelters *An Application in Phoenix, Arizona*

JEFFREY Q. JARVIS
TranSystems Corporation

For many transit customers, using buses and trains means waiting outdoors for their trips. While many systems invest considerable dollars in the installation of passenger shelters, transit centers, and rail station platforms, it seems as though proportionally less consideration is given to the design of these facilities to take advantage of local climate. Through the innovative use of building materials and design it is possible to offset the adverse effects of climate to make patrons feel physically comfortable. The author has successfully applied “climate response” design to shelters and rail stations in Phoenix, Arizona, and elsewhere. This paper describes climate response design, explains how this design approach can improve the apparent comfort of passenger waiting outdoors for service, and presents a demonstrated application of this technique to passenger facilities in Phoenix.

INTRODUCTION

The purpose of this paper is to explain and demonstrate the application of climate response design in the development of transit facilities for light rail and bus passenger facilities in Phoenix, Arizona. The author believes this technique can be applied in almost any climate in almost any community. In fact the author is applying this technique in Nashville, Tennessee, as part of a major downtown transit center project. Climate response design is the use of architectural and landscape elements to offset the adverse effects of climate. Thus, in the summer, climate response design can make a rider at a bus shelter feel physically cooler than he or she would otherwise feel. Conversely, in the winter, this same passenger at a rail station platform can physically feel warmer than he or she might otherwise feel.

BACKGROUND

The application of climate response was used by the author as part of the expansion of transit service in Phoenix starting in 2002. The initial application was with passenger shelters and eventually applied to the design of three rail stations as part of the Central Phoenix East Valley light rail service. The author, through his company TranSystems Corporation, was hired by Valley Metro to design passenger shelters and rail stations. In addition to the standard architectural design elements, the author also applied climate response design to a park-and-ride facility for the town of Gilbert, Arizona, and a new standard bus shelter for Phoenix.

METHODOLOGY OVERVIEW

Climate response design owes its theoretical basis in *biomechanics*. Biomechanics is the study of the mechanics of a living body. The biomechanics of living organisms urge people to maximize their thermal comfort as efficiently as possible. Climate has a significant impact on the thermal comfort of anyone waiting at an outdoor bus stop or rail station. All transit facilities interact with their climate and serve to either increase or decrease the thermal comfort of their users. To fully appreciate this relationship, consider how the human body interacts with climate.

In order to live and maintain health, the human body seeks to maintain a constant core temperature. This condition, called *homeostasis*, is achieved through a balance that includes metabolism, activity level, and the exchange of heat between the human body and its environment. The easier it is for a body to achieve homeostasis, the more comfortable it is. It takes very little effort for a human body to achieve homeostasis while dressed in business casual attire and seated in a mechanically conditioned room with an air temperature of 72°F and a relative humidity of 50% in still-air conditions. People in those conditions will generally describe themselves as comfortable. A person dressed in a business suit, standing in the full sun on an August afternoon in Phoenix when the temperature is 110°F, will have a hard time reaching homeostasis and will thus be very uncomfortable. The same is true of a person waiting at a bus stop in Chicago on a February morning exposed to a wind of 15 mph and an air temperature of 15°F.

To understand how the human body interacts with the environment, one needs first to understand that the human body cannot tell temperature. For example, recall a time when you were staying in a hotel with marble or ceramic tile bathroom floors and thick terrycloth towels. When you finished taking a shower and you stepped out of the shower stall onto that marble or ceramic tile floor, your foot would have felt cold. Your foot felt cold because it was wet and in direct contact with a dense thermal mass whose radiant temperature was significantly lower than your internal body temperature. The water on your foot helped to conduct heat out of your foot and into the tile increasing the rate of heat loss from your body making the tile feel even colder. Now imagine that at the same moment that your foot touched the tile floor, you had reached out with your hand and grabbed the terrycloth towel. Your hand would have felt warm. Your hand felt warm because the towel had dried the surface of the skin which slowed down the transfer of your body heat to the surrounding air. Your hand also felt warm because the towel is a poor thermal conductor and the towel insulated your hand from the cool bathroom air around it. So the tile felt cold to your foot while the towel felt warm to your hand. In truth, the tile and the towel were the same temperature. What the body measures is not the absolute value of the temperature of objects but the rate of heat flow from itself to its surroundings and from its surroundings into itself.

The flow of heat in and out of our bodies is what drives the biomechanics of human comfort. There are four ways that heat flows into and out of our bodies (*1*):

- *Convection*—heat gained or lost from contact with air that is warmer or cooler than the body;
- *Conduction*—heat gained or lost from direct contact with an object warmer or cooler than the body;
- *Radiation*—heat gained or lost from being exposed to surfaces that are warmer or cooler than the body; and

- *Evaporation*—heat lost through the evaporation of water from the respiratory tract or the skin.

Figure 1 illustrates these relationships.

Gains

1. Metabolic heat produced by:
 - a. Basal processes
 - b. Activity
 - c. Digestive, etc. processes
 - d. Muscle tensing & shivering in response to cold
2. Absorption of radiant energy:
 - a. From direct or reflected sunlight
 - b. From hotter surrounding surfaces
3. Heat conducted toward the body:
 - a. By contact with hotter objects
4. Heat convected toward the body:
 - a. From air above skin temperature

Losses

5. Outward radiant energy:
 - a. To "sky"
 - b. To colder surrounding surfaces
6. Heat conducted away from body:
 - a. By contact with colder objects
7. Heat convected away from the body:
 - a. To air below skin temperature (can be hastened by air movement)
8. Evaporation:
 - a. From respiratory tract
 - b. From skin

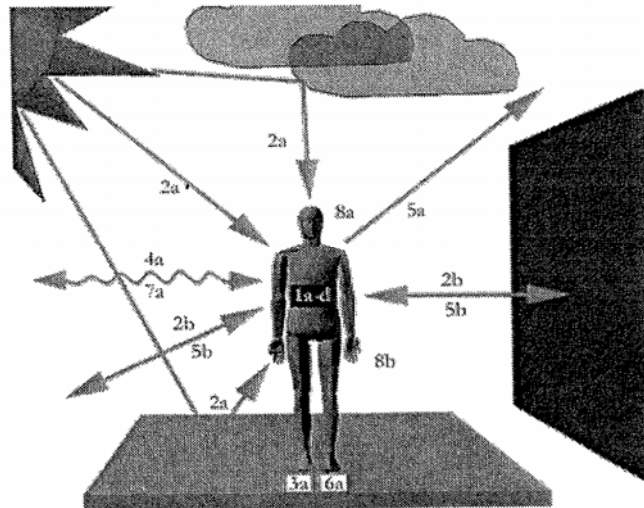


FIGURE 1 Relationship of climate and the human body.

Source: Cook, J., and H. Bryan. *Climate, Comfort and Health: Central Phoenix/East Valley Light Rail Transit Final Report*. Arizona State University, May 2001, p. 21.

With this level of understanding of the biomechanics of human comfort, the reader is ready to understand the body's interaction with climate. Climate response design recognizes this interaction and attempts to significantly increase the level of customer service while potentially increasing ridership often at no significant additional first cost or long-term cost. Providing transit shelters and waiting space that are responsive to climate is a simple process though climate is dynamic and requires a dynamic response.

APPLICATION OF CLIMATE RESPONSE TO PHOENIX TRANSIT FACILITIES

The key to applying climate response design is to first understand climate of a locale. [Figure 2](#) shows a climatology chart prepared in the 1960s by Victor Olgay of Princeton University (2).

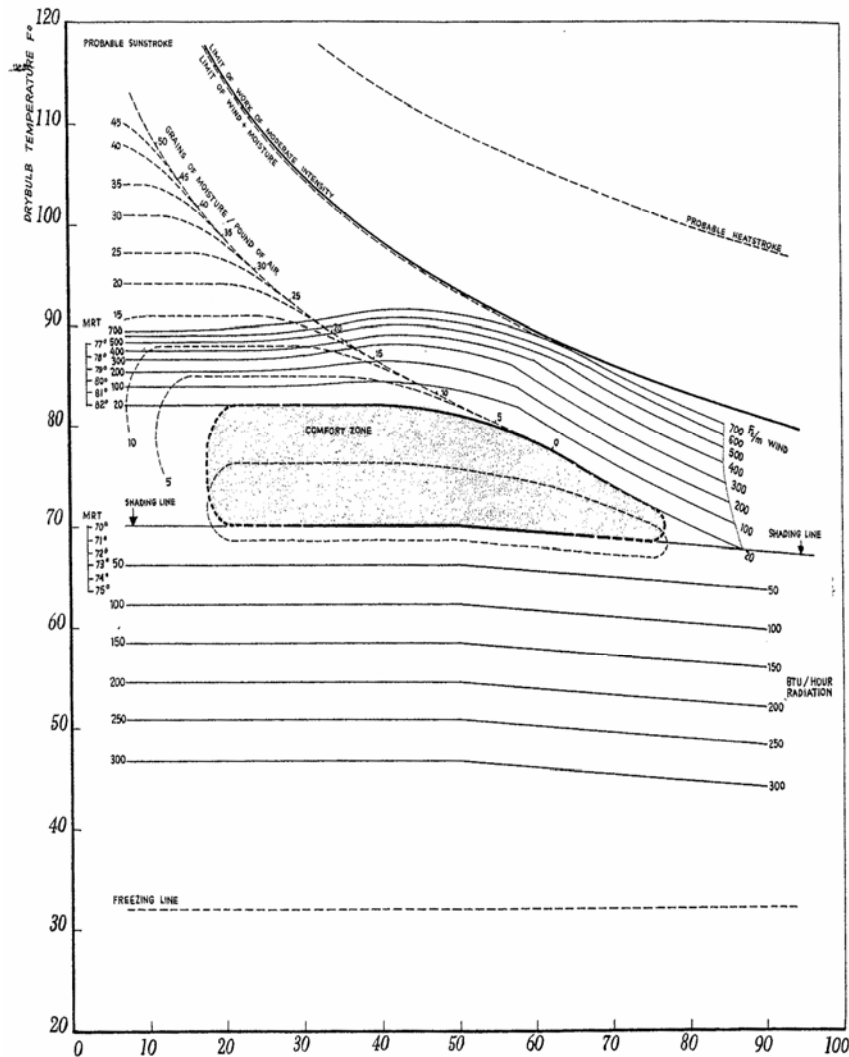


FIGURE 2 Olgay climatology chart.

Source: Olgay, V. *Design with Climate: Bioclimatic Approach to Architectural Regionalism*. Princeton University Press, Princeton, N.J., 1963, Figure 45.

The climatology chart in [Figure 2](#) represents what a healthy adult in long pants and a shirt seated at rest would need in order to feel comfortable. It describes the way one might dress and act seated at a bus stop waiting for the bus. The vertical scale on the chart is temperature. The horizontal scale is relative humidity. Any combination of temperature and humidity can be plotted on these scales and the chart will describe which climatology resources are required to create the sensation of human comfort. This gray area toward the middle of the chart is called the *comfort zone*. Anytime the intersection of temperature and humidity falls within this area, assuming you are not exposed to the sun, it is going to be very easy for a human body to achieve homeostasis or, in other words, be comfortable. The *shading line* is located at the 70-degree point. If a combination of temperature and humidity falls above the shading line, a person outdoors would want to be in the shade in order to feel comfortable. For points below the shading line, the body will be losing heat too quickly to be comfortable so the warmth of the sun if it is available will be required to create the sensation of human comfort. The lower the point, the more solar radiation would be needed. For points above the comfort zone, exposure to breeze or some added moisture in the air will be necessary in order to regain the comfort sensation. The mean radiant temperature (MRT) scales along the vertical axis describe how comfort can be achieved by changing the MRT of the surfaces surrounding a person. Figure 3 shows how this concept works in Phoenix.

Applying Olgay Chart to Phoenix

Point A in [Figure 3](#) is 72°F and 25% relative humidity, the average condition for just at sunset in April in Phoenix. Phoenix is famous for fabulous winter and spring climate. Anyone from Phoenix knows how wonderful April evenings are and can easily understand why that time of year would be classified as in the comfort zone. Point B on this chart is 55°F and 40% relative humidity, typical conditions in Phoenix in January at midmorning. Again, if you are from Phoenix, you know what a January morning feels like and it is too cold. The chart in Figure 3 tells us, however, that if on that January morning you can be in the sun and protected from the wind, you can feel just as comfortable as you did on the April evening. Conversely, point C is 92°F and 15% relative humidity, typical conditions in Phoenix on a May afternoon. Now you are too hot unless, that is, if you can be in the shade and exposed to the breeze. In that case you can be just as comfortable once again as on the April evening.

There are a couple items to notice about the information in Figure 3. First, the range in temperatures goes from the mid-40s to the mid-90s. The chart is telling us that within that temperature range, the proper manipulation of sun, shade, wind, and MRT (assuming these elements are available in sufficient quantities) can create circumstances that most people would consider comfortable. Please note this temperature range is many times greater than what we who are used to getting our comfort from a thermostat would usually associate with comfort. Another implication of this chart is that beyond the mid-40s to mid-90s temperature range, while we can't create an ideal condition, we can significantly reduce the discomfort associated with temperature extremes. That is, just because you won't be as comfortable as you could be in conditioned space, there is no reason why we shouldn't try to shave off the peaks and valleys of climate extremes. Plotting the climate data from any location on this chart, you can quickly understand how to manipulate the forces of nature to make people comfortable out of doors.

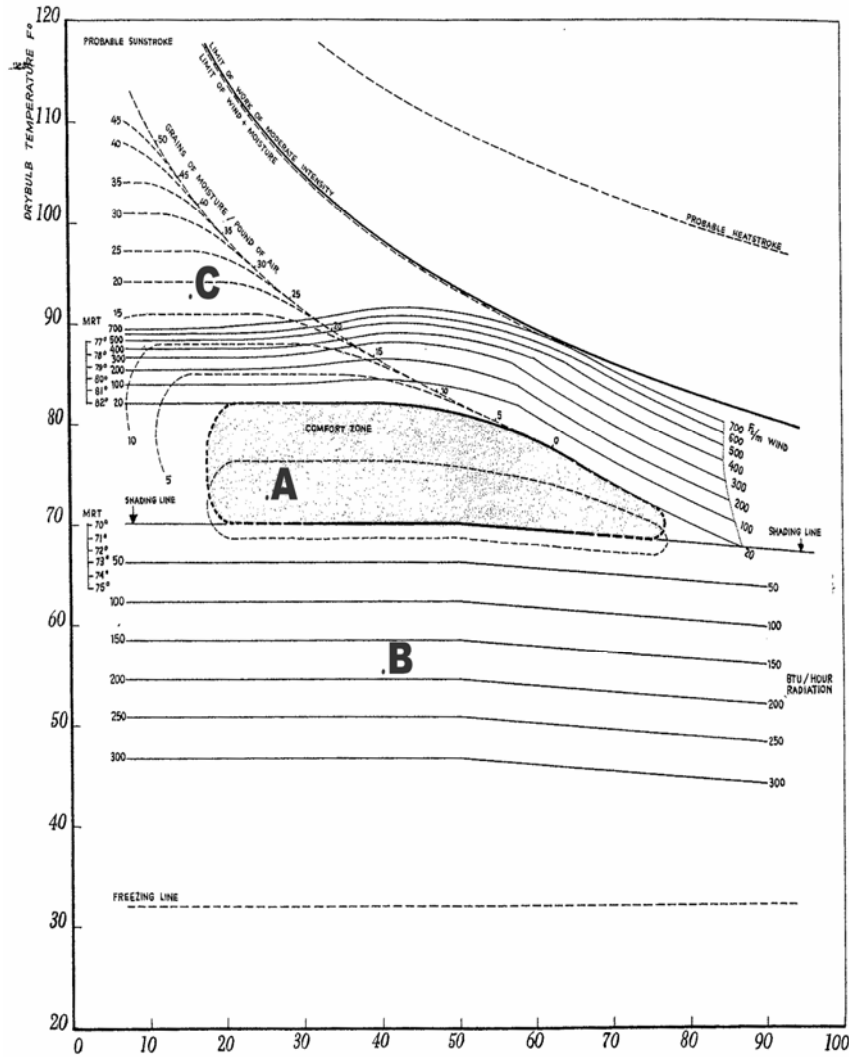


FIGURE 3 Application of Olgay climatology chart in Phoenix.

Source: TranSystems Corporation.

When the author was asked to design a rail or bus facility that has people waiting outside, he ordered a National Oceanic and Atmospheric Administration (NOAA) chart with a description of the climate. These charts can be ordered over the Internet at <http://www.ncdc.noaa.gov>. The chart for Phoenix is shown as [Figure 4](#).

Besides interesting background information about the locality and its climate patterns, the chart in [Figure 4](#) lists normals, means, and extremes for a lot of different metrics. Included in the list are monthly average high and low temperatures as well as relative humidity values for early morning and late afternoon. Because warm air can hold more water vapor than cool air, the warmest temperatures occur coincident with the lowest relative humidity and the coolest temperatures are paired with the highest relative humidity. We combine these paired values for every month of the year and plot them on Olgay's chart. The Olgay chart for Phoenix is shown in [Figure 5](#).

NORMALS, MEANS, AND EXTREMES
PHOENIX, AZ (PHX)

LATITUDE: 33° 26' 35" N LONGITUDE: 111° 59' 25" W ELEVATION (FT): GRND: 1103 BARO: 1106 TIME ZONE: MOUNTAIN (UTC + 7) WBAN: 23183

ELEMENT	FOR	JAN	FEB	MAR	APR	MAY	JUN	JUL	AUG	SEP	OCT	NOV	DEC	YEAR	
TEMPERATURE °F	NORMAL DAILY MAXIMUM	30	55.0	69.4	74.3	83.0	91.9	102.0	104.2	102.4	97.4	86.4	73.2	64.5	
	MEAN DAILY MAXIMUM	54	66.3	70.3	75.7	84.3	93.5	103.0	105.3	103.3	98.3	88.3	74.5	66.3	
	HIGHEST DAILY MAXIMUM	67	88	92	100	105	113	122	121	116	118	107	95	88	
	YEAR OF OCCURRENCE		1971	1986	1988	1992	1984	1990	1995	2003	1950	1980	2001	1950	JUN 1990
	MEAN OF EXTREME MAXS.	57	77.8	82.2	88.2	97.2	104.9	112.2	113.5	110.7	107.5	99.4	86.7	77.5	96.5
	NORMAL DAILY MINIMUM	30	43.4	47.0	51.3	57.5	66.3	75.2	81.4	80.4	74.5	62.9	50.0	43.5	61.1
	MEAN DAILY MINIMUM	54	42.2	45.3	49.8	56.3	64.9	73.5	81.1	79.9	73.4	61.6	49.1	42.6	60.0
	LOWEST DAILY MINIMUM	67	17	22	25	32	40	50	61	60	47	34	25	22	17
	YEAR OF OCCURRENCE		1950	1948	1966	1945	1967	1944	1944	1942	1965	1971	1938	1948	JAN 1950
	MEAN OF EXTREME MINS.	57	31.2	34.7	38.6	45.1	53.2	63.6	71.6	71.3	63.0	49.1	37.5	32.1	49.2
	NORMAL DRY BULB	30	54.2	58.2	62.7	70.2	79.1	88.6	92.8	91.4	86.0	74.6	61.6	54.3	72.8
	MEAN DRY BULB	57	53.9	57.6	62.6	70.0	79.2	88.3	93.0	91.5	86.1	74.5	61.9	54.0	72.7
	MEAN WET BULB	52	44.0	46.1	48.7	52.3	56.7	62.0	70.0	70.4	65.7	57.5	49.0	44.0	55.5
	MEAN DRW POINT	52	33.1	33.2	33.5	33.6	35.6	40.6	56.7	59.1	52.8	43.6	36.2	32.9	40.9
	NORMAL NO. DAYS WITH:														
	MAXIMUM ≥ 90°	30	0.0	0.1	2.2	10.5	23.1	29.2	30.8	30.7	28.0	15.3	0.7	0.0	170.6
	MAXIMUM ≥ 32°	30	0.0	*	0.0	0.0	0.0	0.0	0.0	0.0	0.0	0.0	0.0	0.0	0.0
	MINIMUM ≤ 32°	30	1.3	0.4	0.1	0.0	0.0	0.0	0.0	0.0	0.0	0.0	0.1	0.9	2.8
	MINIMUM ≤ 0°	30	0.0	0.0	0.0	0.0	0.0	0.0	0.0	0.0	0.0	0.0	0.0	0.0	0.0
	H/C	NORMAL HEATING DEG. DAYS	30	322	187	125	79	29	4	0	0	11	129	318	1125
		NORMAL COOLING DEG. DAYS	30	2	12	70	199	457	724	878	645	324	43	0	4189
	RH	NORMAL (PERCENT)	30	50	45	40	28	23	19	31	35	34	35	42	49
		HOUR 05 LST	30	64	59	55	42	34	29	43	48	47	48	56	64
HOUR 11 LST		30	44	39	34	23	19	16	28	32	30	31	36	44	
HOUR 17 LST		30	32	28	25	17	14	12	20	23	23	23	26	32	
HOUR 23 LST		30	53	47	41	28	23	19	32	36	36	39	46	54	
S	PERCENT POSSIBLE SUNSHINE	11	79	82	85	89	94	95	86	86	89	88	83	77	
W/O	MEAN NO. DAYS WITH:														
	HEAVY FOG (VISIBY≤1/4 MI) THUNDERSTORMS	67	0.5	0.2	0.1	0.0	0.0	0.0	0.0	0.0	0.0	0.0	0.2	0.5	
CLOUDINESS	MEAN:														
	SUNRISE-SUNSET (OKTAS)	1		2.4	2.0	2.4	1.2	1.2	1.6	0.8				1.6	
	MIDNIGHT-MIDNIGHT (OKTAS)	1		2.4	2.4	2.4	1.2	1.2	1.6	0.8				0.0	
	MEAN NO. DAYS WITH:														
	CLEAR	1	5.0	17.5	18.0	14.0	26.0	17.0	6.0	10.0	15.0	15.0		13.0	
PARTLY CLOUDY	1	1.0	5.0	5.0	4.0	1.5	4.0		1.0	2.0			5.0		
CLOUDY	1		6.0	4.0	1.0				1.0						
PR	MEAN STATION PRESSURE (IN)	31	28.89	28.87	28.78	28.72	28.66	28.64	28.68	28.69	28.69	28.76	28.84	28.89	
	MEAN SEA-LEVEL PRESS. (IN)	51	30.04	30.01	29.93	29.86	29.80	29.75	29.79	29.80	29.80	29.85	30.00	30.05	
WINDS	MEAN SPEED (MPH)	49	5.1	5.7	6.6	6.8	6.9	6.6	6.9	6.5	6.1	5.6	5.2	4.9	
	PREVAIL. DIR (TENS OF DEGS)	33	10	10	10	09	27	27	27	09	10	10	10	10	
	MAXIMUM 2-MINUTE:														
	SPEED (MPH)	10	36	35	43	51	32	33	47	45	39	37	31	39	
	DIR. (TENS OF DEGS)														
	YEAR OF OCCURRENCE		1995	2004	1998	2001	2001	2000	2003	2004	2002	2004	2003	2002	
	MAXIMUM 5-SECOND:														
	SPEED (MPH)	10	39	43	53	59	40	40	61	53	51	48	37	47	
YEAR OF OCCURRENCE		1995	2004	1998	2001	2001	2000	2002	2004	1999	1998	2003	2002		
PRECIPITATION	NORMAL (IN)	30	0.83	0.77	1.07	0.26	0.16	0.09	0.24	0.24	0.75	0.79	0.73	0.92	
	MAXIMUM MONTHLY (IN)	57	5.22	3.15	4.16	2.10	1.06	1.70	5.15	5.56	4.23	4.40	3.04	3.98	
	YEAR OF OCCURRENCE		1993	2003	1941	1941	1976	1972	1984	1951	1939	1972	1962	1967	
	MINIMUM MONTHLY (IN)	67	0.00	0.00	0.00	0.00	0.00	0.00	T	T	0.00	0.00	0.00	0.00	
	YEAR OF OCCURRENCE		1972	1967	1959	1962	1983	1983	1995	1975	1973	1973	1980	1981	
	MAXIMUM IN 24 HOURS (IN)	67	1.84	1.65	2.04	1.38	0.96	1.64	2.75	3.07	2.43	2.32	2.16	1.89	
	YEAR OF OCCURRENCE		1993	2003	1983	1941	1976	1972	1984	1943	1970	1988	1993	1967	
	NORMAL NO. DAYS WITH:														
	PRECIPITATION ≥ 0.01	30	4.2	4.3	4.6	1.7	1.1	0.7	4.2	4.5	3.1	2.9	2.7	3.7	
	PRECIPITATION ≥ 1.00	30	*	*	0.1	0.0	0.0	*	0.2	0.2	0.2	0.1	0.1	0.1	
	SNOWFALL	NORMAL (IN)	30	0.*	0.*	0.*	0.0	0.0	0.0	0.0	0.0	0.0	0.0	0.*	0.0
		MAXIMUM MONTHLY (IN)	62	T	0.6	T	T	T	T	0.0	0.0	0.0	T	0.0	0.4
YEAR OF OCCURRENCE			1993	1939	1991	1949	1992	T	0.0	0.0	0.0	T	0.0	1990	
MAXIMUM IN 24 HOURS (IN)		62	T	0.6	T	T	T	T	0.0	0.0	0.0	T	0.0	0.4	
YEAR OF OCCURRENCE			1993	1939	1991	1949	1992	T	0.0	0.0	0.0	T	0.0	1990	
MAXIMUM SNOW DEPTH (IN)		48	0	0	0	0	0	0	0	0	0	0	0	0	
NORMAL NO. DAYS WITH:															
SNOWFALL ≥ 1.0	30	0.0	0.0	0.0	0.0	0.0	0.0	0.0	0.0	0.0	0.0	0.0	0.0		

published by: NCDC Asheville, NC

FIGURE 4 NOAA climatology data for Phoenix.

Source: NOAA, Silver Spring, Maryland.

The data in Figure 5 show that a lot of the year in Phoenix falls within the comfort zone. It also shows that about 75% of the year, a person could be comfortable out of doors in Phoenix through the proper manipulation of sun and wind and MRT. Analyzing the data for each month, the author created a matrix as shown in Figure 6.

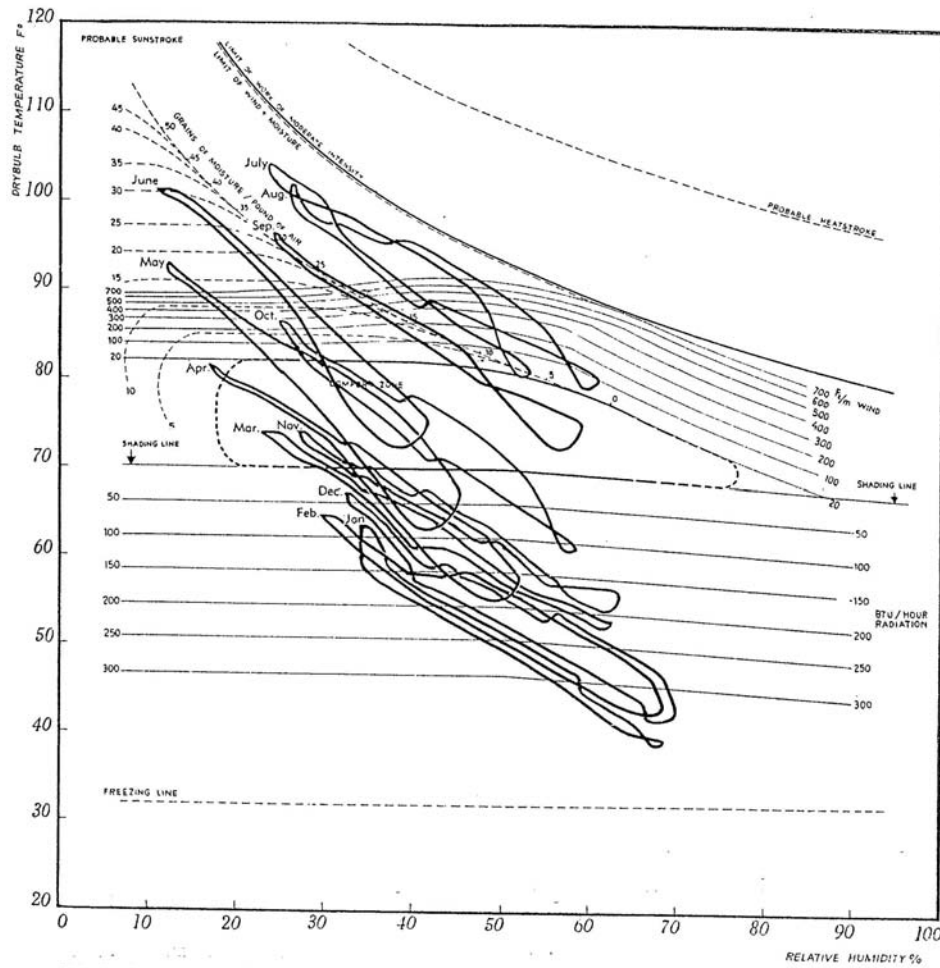


FIGURE 5 Olgay climatology chart for Phoenix.

Source: Olgay, V. *Design with Climate: Bioclimatic Approach to Architectural Regionalism*. Princeton University Press, Princeton, N.J., 1963, Figure 54.

As seen in Figure 6, the matrix shows for 7:00 a.m., noon, and 5:00 p.m. for each month whether the correct climate response is to admit or block the sun, admit or block the wind, and where the wind is coming from. The author used these three times of day to get an overall view of the climate response needs over the course of the day. The NOAA chart does include wind speed and direction information, but it is averaged over the entire day. This information is most useful when the wind comes from a fairly constant direction all day long. For Phoenix the author gathered wind information from the airport to chart the changing of wind direction throughout the day. The author used the matrix to test computer models of existing and proposed transit shelters to see if they are responsive to climate.

	7:00 a.m.				Noon				5:00 p.m.			
	Sun	Wind	Dir	Spd	Sun	Wind	Dir	Spd	Sun	Wind	Dir	Spd
Jan	A	B	E	5.2	A	B	E	7.0	A	B	W	6.6
Feb	A	B	E	5.6	A	B	E	7.1	B	B	W	6.9
Mar	A	B	E	6.1	B	A	ESE	6.9	B	A	W	8.5
Apr	A	B	E	6.7	B	A	S	6.8	B	A	W	9.0
May	B	A	E	7.2	B	A	S	6.7	B	A	W	9.3
Jun	B	A	E	6.5	B	A	S	6.1	B	A	W	8.9
Jul	B	A	E	6.0	B	A	ESE	6.6	B	A	W	8.9
Aug	B	A	E	6.1	B	A	SSE	6.3	B	A	W	7.9
Sep	B	A	E	6.3	B	A	SE	6.8	B	A	W	7.5
Oct	B	B	E	5.7	B	A	ESE	5.9	B	A	W	6.3
Nov	A	B	E	4.9	A	A	E	5.9	B	A	W	6.0
Dec	A	B	E	4.5	A	B	E	6.2	A	B	W	5.4

FIGURE 6 Phoenix climate response chart.

Source: TranSystems Corporation.

Using Climate Response Design

Figure 7 shows a computer model of the standard Phoenix bus stop shelter and the shade that it provides in its four primary orientations in September at 5:00 p.m. Based on our climate analysis, that is a time in Phoenix when you want to be in the breeze and out of the sun. This shelter is effective in the southbound and eastbound locations but it is not effective in creating shade in the westbound and northbound locations. The City of Phoenix requested that TranSystems Corporation, in conjunction with Arizona State University, study an alternative shelter design that would provide shade particularly during the overheated periods of the year. The task included providing shade for two seated persons and space of someone in a wheelchair. The first step was modeling the shade performance of the existing shelter at 7:00 a.m., noon, and 5:00 p.m. for each of the months of the year in all four cardinal directions. The tests demonstrated that 31% of the year when shade was required the existing shelters did not provide it. In addition to the problem of not enough shade, the Phoenix shelter has a very high radiant temperature. It is made of a metal frame with an uninsulated metal roof and perforated metal panels for walls. While the metal is painted a light color to reduce the radiant temperature, it is not uncommon for these metal surfaces to achieve temperatures in excess of 140°F in the summer time.

Figure 8 shows a Phoenix passenger shelter on August 15, 2005, at 2:00 p.m. with a radiant imaging camera. The roof temperature is above 130 degrees. As the sun drops in the sky toward the afternoon, the temperature of the roof will begin to drop while the temperature of the wall panels will increase until they too become an intense radiant source of heat-making conditions very uncomfortable for people sitting in the shelter.

The City of Phoenix had other objectives for their shelters beyond climate response. Some of these objectives included:

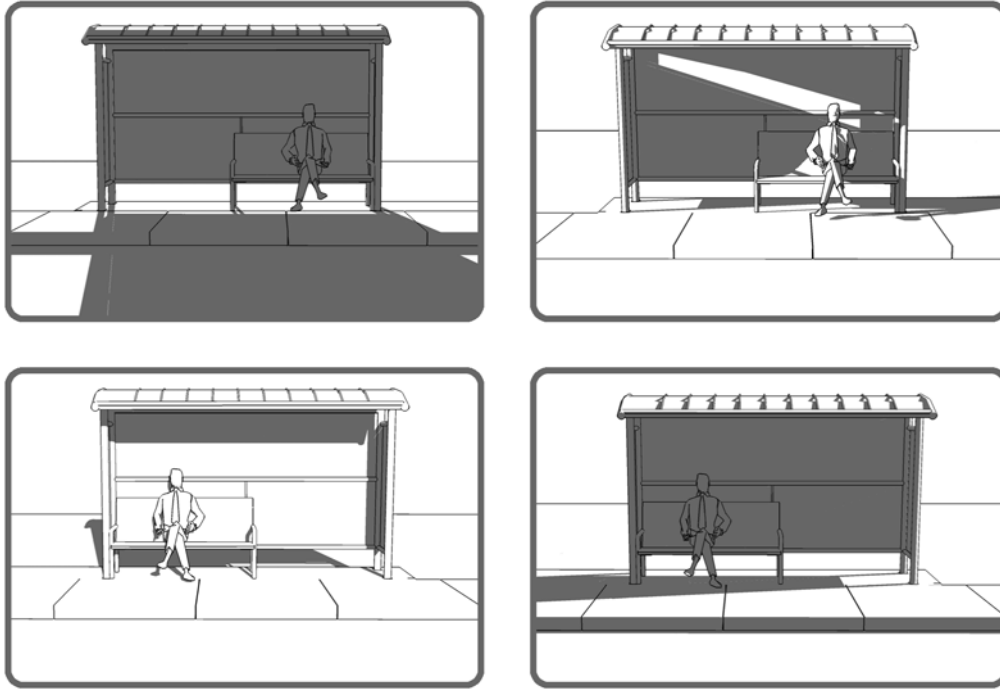


FIGURE 7 Passenger shelter without climate response design.

Source: Arizona State University, TranSystems Corporation.



FIGURE 8 Radiant image of passenger waiting shelter.

Source: H. Bryan, Arizona State University.

1. Visibility through the shelter for safety and security reasons as well as permitting the bus driver to see if someone is waiting at the stop;
2. Ease of maintenance;
3. Ease of constructability on the site;
4. Ease of transportability to the site;
5. Expandability for those locations that experience higher levels of passenger boarding;
6. How easy it is to repair if one portion of the shelter is damaged;
7. The integration of lighting and photovoltaic; and
8. Lowest possible cost.

In addition to the city's objectives, the design team was concerned about how the shelter would contribute to the urban design fabric of the city and how to make the shelter attractive.

Figure 9 is a picture of a new proposed standard bus shelter for Phoenix in the four cardinal orientations. This shelter uses approximately that same amount of material as the original shelter, but it completely satisfies the shade requirements for the seasons of the year when shade is required for comfort. It is composed of an L-shaped unit with an angled roof. The units are built in a left- and right-hand configuration and grouped in different ways to respond to the different solar orientations. It is a modular unit that can be replicated as many times as needed to provide for those stops that have a greater number of passenger boardings. The light fixture fits into a slot in the roof that corresponds to the valley line in the roof planes. The photovoltaic panels are mounted flat on the roof and the battery is hidden in the box that displays the bus sign.

The proposed shelter has a tube metal frame. The roof is made of an insulated metal panel. The wall panels are comprised of industrial fiberglass grating. The depth and spacing of the grating allows for greater visibility through the shelter for safety and security while providing for improved shading and a more pleasant lighting environment. The concrete surface under the shelter will be crumb rubber concrete. The net reduction in radiant temperature is expected to be as much as 25°F to 30°F. Total cost for the unit is anticipated to be slightly higher than the current design. The cost increase is likely to be more than offset by the increase in ridership encouraged by the more comfortable conditions at the bus shelters.

Other Examples of Climate Response Design

Figure 10 shows how climate response has been incorporated in the design of one of Phoenix's light rail stations. Figure 10 depicts a rendering of the Phoenix light rail station that will be built at 40th Street and Washington. This station is on an east–west arterial roadway. Shade will be provided by the horizontal louvers, the fabric shade canopies, trees, and a large shade structure filled with plant material located at the western end of the platform. Seats are provided in different orientations to allow transit users to migrate to different locations based on the season or time of day. Reduced MRT will be achieved on the platform through the use of trees, vines, fabric canopies, plastic seats, absorptive light-colored pavers, and light colors for the metal frames. The plant materials will have radiant temperatures cooler than human body temperature and be effective heat sinks.

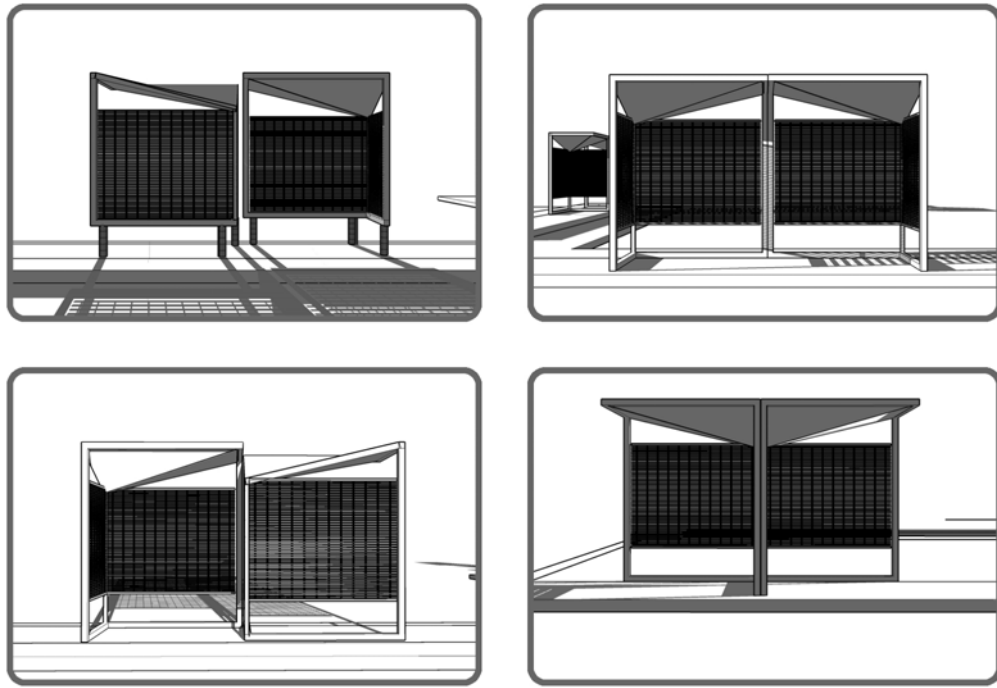


FIGURE 9 Passenger shelter using climate response design.
Source: Arizona State University, TranSystems Corporation.



FIGURE 10 Climate response designed light rail station, Phoenix.
Source: TranSystems Corporation.

Figure 11 is a picture of a bus shelter at a park-and-ride facility in Gilbert, Arizona. Gilbert has the same climate conditions as Phoenix. This shelter uses vine-covered screens, trees, an insulated roof, and thick concrete arches to provide shade. Radiant temperatures are reduced by using the vines, trees, roof insulation, the dense thermal mass of the concrete arches, light colors, and the double diamond configuration of the shelter. **Figure 12** is a floor plan of the shelter. The double diamond shape allows bus riders to sit in the shade of the shelter while exposing themselves to a large portion of the sky dome. In Phoenix in the summer, the part of the sky dome without the sun may have a radiant temperature 8°F to 10°F cooler than the human body and will thus act as a heat sink.

These three projects demonstrate a range of thermally effective design responses to the same climatic conditions.

The examples have been from a hot, dry climate in the southwest United States. The United States, as seen in **Figure 13**, has a range of climates that also include hot humid, cold, and temperate. It is possible to apply the above techniques to those climates as well. The author is applying this approach in Nashville, Tennessee, as part of a downtown transit center project for the Nashville Metropolitan Transit Authority.



FIGURE 11 Passenger shelter at Gilbert park-and-ride facility.
Source: TranSystems Corporation.

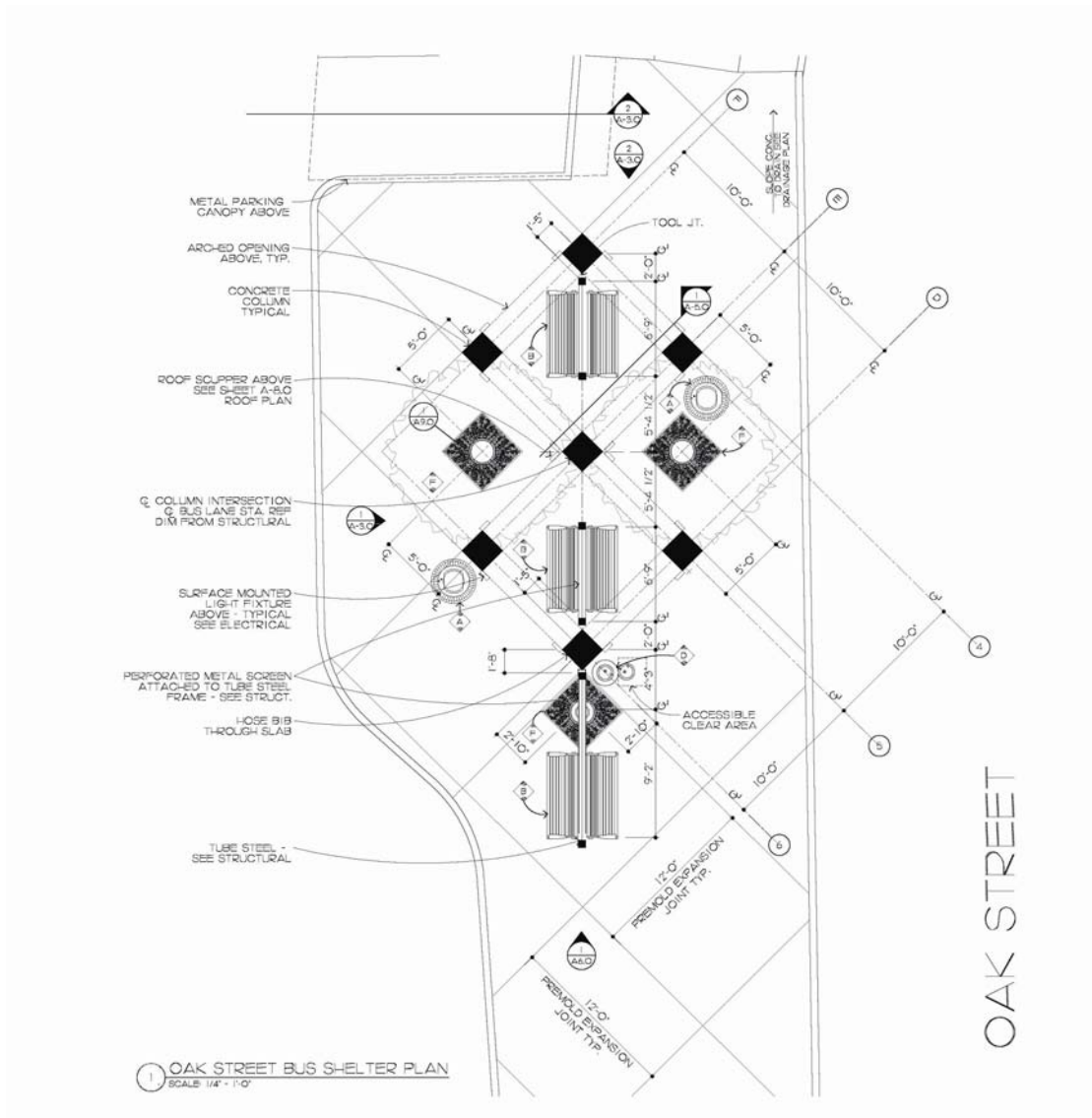


FIGURE 12 Floor plan of Gilbert park-and-ride passenger shelter.

Source: TranSystems Corporation.

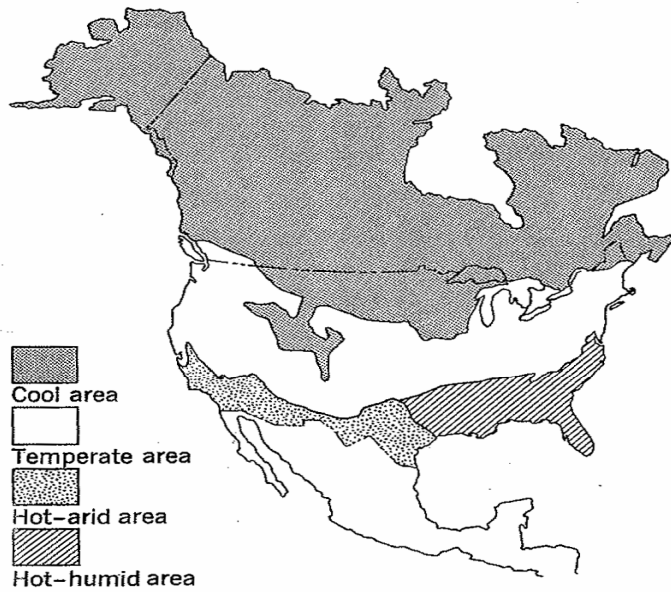


Fig. 2.1 Regional climate zones of the North American continent. From Victor Olgay, Design with Climate: Bioclimatic Approach to Architectural Regionalism, Copyright © 1963 by Princeton University Press. Reprinted by permission.

FIGURE 13 U.S. climate zones.

Source: Olgay, V. *Design with Climate: Bioclimatic Approach to Architectural Regionalism*. Princeton University Press, Princeton, N.J., 1963.

CONCLUSION AND NEED FOR FURTHER RESEARCH

All climates in the world can use the same basic principles that are described in Olgay's work. From designing bus shelters and transit stations in many different climates, it is possible to develop a few standard climate response principles:

- Climate is dynamic. Though the path of the sun is symmetrical around June and December, ambient air temperature is not. It is very difficult to design a single seat that is comfortable in all seasons at all times of the day. A migration strategy that has bus riders sit in different locations at different times of the year or hours of the day can be very effective.
 - The more extreme the temperatures are, either hot or cold, the more important it is to manipulate the radiant temperatures of the surfaces around the bus riders.
 - Wind is much more difficult to predict and manipulate than sun.
 - Good climate data are generally and easily available as are solar modeling techniques.
 - It is fairly easy in most circumstances to manipulate the forces of nature to increase the comfort of transit users.

Further Research

While the theoretical underpinnings of climate response design are compelling, empirical research in how passengers react to a waiting facility designed with climate response is not currently available. While ridership is affected by many factors, determining whether climate response improves customer perceptions of transit would be of value. Since the cost of designing for climate is not materially different than not designing for climate, one could argue that designing for climate should be thoroughly considered in most any transit passenger amenity.

REFERENCES

1. Cook, J., and H. Bryan. *Climate, Comfort, and Health: Central Phoenix/East Valley Light Rail Transit Final Report*. Arizona State University, May 2001, p. 21.
2. Olgyay, V. *Design with Climate: Bioclimatic Approach to Architectural Regionalism*. Princeton University Press, Princeton, N.J., 1963.

DESIGN OF NEW INFRASTRUCTURE

Regional Transportation District Light Rail Central Corridor Capacity Analysis

ERIC CARL MILLER
URS Corporation

As light rail transit systems continue to grow, train capacity issues are becoming a danger to transit quality and level of service. Denver's Light Rail Central Corridor, a 2.5-mi segment where several lines will share the same track, is identified in the FasTracks regional transit plan to have train capacity issues. The future ridership in this corridor after the completion of FasTracks is expected to exceed the current capacity. This capacity study analyzed the available train capacity of the Central Corridor and then analyzed the capacity requirements necessary for future growth in order to determine physical improvements for the system. A combination of improvements will be needed to increase the capacity in order to provide for the ridership expectations for the Central Corridor upon implementation of FasTracks. These should include grade separating at least one of the two light rail junctions, increasing the number of tracks from two to four, and improving capacity at stations and on light rail vehicles.

CENTRAL CORRIDOR INVENTORY

Objectives

This study will apply the *TCRP Report 100: Transit Capacity and Quality of Service Manual* to calculate the capacity to determine whether the Central Corridor can accommodate the necessary number of trains for the ridership projected in 2025 after the implementation of FasTracks. If the capacity cannot accommodate this ridership growth, then operational and physical improvements to the system will be identified. This includes

- Calculating existing available capacity,
- Calculating future required capacity,
- Identifying operational improvements, and
- Identifying physical improvements if operational improvements do not meet capacity requirements.

Therefore, this study will complete certain steps to attain these conclusions. These are

- Conducting an inventory of the operational and physical elements of the Central Corridor,
- Assigning variables that affect capacity,
- Calculating the available and required capacity, and

- Suggesting operational and physical improvements.

This will lead to a final conceptual plan that will detail the improvements, capital costs, and steps to implementation to increase the corridor capacity to accommodate future ridership growth.

Light Rail System Background

The Central Corridor is part of the original 5.3-mi light rail system, which was opened on October 7, 1994. For the purposes of this study, the Central Corridor is defined as the 2.5-mi segment between CPV Junction and Broadway Junction. The basic challenge of the Central Corridor is that it was built as a starter system and today must carry the bulk of light rail corridors entering the Downtown Denver area, which is heavily patronized by downtown employees during rush-hour commute times.

The FasTracks plan, shown in [Figure 1](#), contains a diversity of transit technology options, and most corridors are planned to terminate at Denver Union Station. This reduces potential congestion on the Central Corridor; although, the spur to Denver Union Station also creates potential capacity issues by introducing another junction on the light rail line.

Currently, two light rail routes from the Southwest Corridor operate over the Central Corridor:

- The D/Green Line from Mineral Station to 30th–Downing Station and
- The C/Orange Line from Mineral Station to Union Station.

The next light rail corridor to open will be the Southeast Corridor, in late 2006, which will bring three additional light rail routes onto the Central Corridor, which includes:

- Lincoln Avenue Station to Union Station,
- The H/Blue Line from the Parker Road Station,
- The E/Purple Line from 18th Street, and
- The F/Red Line from Lincoln Avenue station to 18th Street.

Methodology

In addition to the TCRP report, the capacity analysis methodology was developed from recent capacity studies from Bay Area Rapid Transit (BART) and Chicago Transit Authority (CTA) and long-range plans from Regional Transportation District (RTD). This methodology will basically analyze the available capacity and then analyze the capacity requirements for the forecasted 2025 peak-hour, peak-direction ridership to determine physical improvements needed for the system. 2025 ridership is used in this case because it is the only projected ridership forecast available from RTD.

The evaluation of capacity for the Central Corridor is the critical focus of the analysis, which uses information gained from existing conditions and presents information that will be crucial in forming a conceptual final plan for recommendation to RTD. The general methodology, illustrated in [Figure 2](#), is divided into the following three phases:



FIGURE 1 FasTracks map.

Operational Inventory

Currently, RTD operates 12 light rail trains per peak hour in each direction on the Central Corridor, with the shortest scheduled headway at 180 s. This service is planned to increase to 18 light rail trains per peak hour per direction once the Southeast Corridor is opened in 2006, but capacity is not expected to be an issue because the shortest existing headway will become the average headway, still at 180 s. The highest hourly ridership in this corridor is forecasted to be about 5,800 passengers in the p.m. peak southbound direction.

However, once the additional rapid transit corridors are opened as planned under FasTracks, ridership will increase to approximately 10,800 passengers per peak hour per direction (PPHPD) in 2025, which is anticipated to be more than the current Central Corridor can carry. This is due to passengers transferring from the other corridors, parking expansions at several stations, and corridor extensions on the Southeast and Southwest Corridors.

Adjacent issues were examined to ascertain information on the environment surrounding the Central Corridor. Specific issues that were looked at include:

- The three light rail stations in the Central Corridor,
- Freight and passenger rail maintenance yards, and
- At-grade railroad–street crossings.

The three light rail stations within the Central Corridor study area—10th and Osage, Alameda, and 1-25 and Broadway—are all surface-level stations with horizontal access and no stairs or elevators. Under FasTracks, the stations will be expanded to accommodate four-car trains. Starting in the fall of 2005, RTD will conduct a study of the existing Union Pacific Burnham Yard for reuse as a light rail maintenance facility for the West, Gold, and I-225 corridors. This could also open up right-of-way (ROW) for capacity expansion in the Central Corridor,

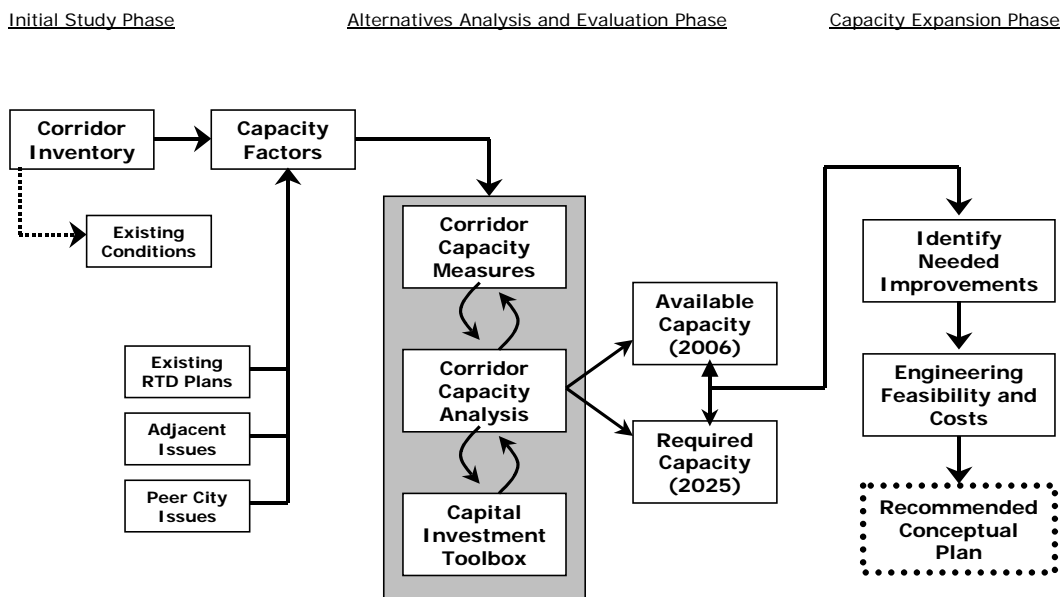


FIGURE 2 Methodology flow chart.

and negate the Burnham Yard north and south lead tracks, which parallel the Central Corridor.

Two at-grade crossings along the Central Corridor, at 13th Avenue and Bayaud Avenue, have not been known to produce significant traffic collisions; however, as the number of trains increases, the crossings might need to be grade-separated or closed.

Physical Inventory

An initial inventory of the physical environment of the Central Corridor was undertaken to determine existing conditions. Information gathered in this process includes:

- Type and location of tracks,
- Number and location of turnouts and junctions,
- Type of light rail vehicles (LRVs) used, and
- Physical nature of passenger platforms at existing stations.

Upon this inventory, it is determined that RTD light rail employs acceptable design features for the construction of light rail that can serve capacity into the future. The rail used in the Central Corridor is standard 115-lb rail (115 lb per yard) and tracks are graded evenly for operation of up to 55 mph, the top speed for the existing LRV fleet.

The existing stations and the plans to improve them also appear acceptable for meeting future capacity growth. The stations on the Central Corridor each have one platform per track and these platforms will be extended to provide access to four-car trains as part of the FasTracks plan. The platforms are wide enough to hold peak hour commuter loads and are free of obstructions, such as turnstiles, which inhibit easy access to LRVs.

However, the junctions, turnouts, and LRVs are the most restrictive to capacity growth. Recently installed turnouts north and south of I-25 and Broadway Station require trains to slow before entering the station, then speed up again before making the final approach to the station.

The two junctions at each end of the Central Corridor are not grade-separated, also known as “flat junctions,” and require trains to move slowly through them. In some cases, trains must wait on other trains before entering the junction. An efficient, although costly, way to solve this problem is by introducing “flying junctions,” which are completely grade-separated and involve constructing several overpasses.

The high-floor LRVs currently in use require more time to board for passengers due to the steps. These steps also take up space that could be otherwise occupied by passengers and the high-floor nature of the vehicles requires a high-block platform at each end of the station platform for passengers that cannot climb stairs. New LRVs for the Southeast Corridor will have more reliable sliding doors that will also be faster to open and close. However, in order to increase reliability and lower dwell times, it may be beneficial to introduce low-floor vehicles in the near term.

Most of the track in the Central Corridor is at ground level except for the Santa Fe–Kalamath Overpass, an approximately 2,700-ft long overpass that crosses over four city streets. This permits a safe grade separation of the busy Santa Fe Drive and Kalamath Street one-way couplet. [Figure 3](#) shows this overpass.



FIGURE 3 Light rail Santa Fe–Kalamath overpass.

Identification of Capacity Variables

To analyze the available and required capacity for the Central Corridor, capacity variables were determined for calculating the capacity. These were derived from background information gathered earlier in the study from looking at the current system, RTD plans, and recent studies and reports. The original list of variables is then evaluated for feasibility to carry forward, as shown in [Table 1](#).

Analysis of Capacity Variables

The capacity variables that are carried forward were associated with a common variable that can be assigned a measure, or metric, to it for specific calculation. These include

- Weakest link:
 - Replace flat junctions with one flying junction, and
 - Replace flat junctions with flying junctions;
- Dwell time: Low-floor LRVs (LFLRVs);
- Line capacity:
 - Run express/local trains in Central Corridor;
 - Improve signaling system, line capacity; and
 - Increase electrical power capacity, line capacity;
- Number of cars per train: Add more trains to peak-hour service;

TABLE 1 Capacity Variables Matrix

Capacity Factors	Carry Forward	Reason
Add 2 Extra Tracks	Yes	Right of Way is Available
Add More Trains to Peak Hour Service	Yes	Can Increase Quality of Service and Capacity With Ridership Demand
Construct Another Central Connection	No	Study Completed and Found Not Feasible
Longer Trains (Five or More Vehicles)	No	All Stations Would Need to Be Retrofitted in the System, Compromise Quality of Service
Do Not Build Light Rail Extensions	No	Against Regional and Local Plans
Do Not Expand Parking Spaces at Stations	No	Against Regional and Local Plans
Expand Station Platform Area	No	Station Platforms Have Suitable Capacity
Grade-Separate Railroad Crossings	Yes	Less Chance of Collisions Decreases Chance of Delays
Have Certain Routes Serve Certain Stations Only	No	Would Not Serve All Stations and Not Improve Running Time
Implement Moving Platforms	No	Not Feasible for Engineering and Constructability
Improve Fare Collection Procedure	No	Fare Collection Procedure Already Allows for Easy Circulation
Improve Signaling System	Yes	Can Add More Station Blocks and Phases
Improve/Increase Tail Tracks	Yes	Can Provide Layover and Storage for Trains
Increase Electrical Power Capacity	Yes	Increase Power With Increase of Tracks
Increase Line Speed in Central Corridor	No	Maximum Speed is Already Achieved
Increase Local and Regional Bus Service Instead of Increasing Light Rail Service	No	Does not Conform with Regional and Local Transportation Growth Plans
Increase Vertical Circulation With Pedestrian Bridges	Yes	Can Increase Station Capacity and Minimize Train Collisions
LFLRVs	Yes	Can Introduce With Current Equipment
Run Express/Local Trains in Central Corridor	Yes	Could Mitigate Passenger Confusion
Overhaul LRV Interiors	No	Would Not Meet Comfort Policy
Reduce Time Spacing from 75 s	No	Not Feasible for Light Rail Passenger Safety
Remove High Blocks	No	Against Federal ADA Regulations
Remove Some Stations in Central Corridor	No	Would Decrease Transit Accessibility in Central Corridor
Replace Flat Junctions With 1 Flying Jct.	Yes	Feasible Engineering and Constructability
Replace Flat Junctions With Flying Jcts.	Yes	Feasible Engineering and Constructability
Replace Low Quality Turnouts with Faster Turnouts	Yes	Can Improve Train Throughput While Staying Within Speed Limits
Replace With Automated Operating Vehicles	No	Would Require Replacing all Existing Light Rail Vehicles
Replace With Bilevel LRVs	No	Would Require Retrofitting Entire Catenary Wiring System
Wider/Faster Doors on LRVs	Yes	Better Doors Can Be Introduced on New Vehicles
Final Factors (12)		Assigned Factor for Metric (6)
Add 1 Extra Track		Operating Margin
Add 2 Extra Tracks		Operating Margin
Add More Trains to Peak Hour Service		Train Length
Grade-Separate Railroad Crossings		Operating Margin
Improve/Increase Tail Tracks		Operating Margin
Increase Electrical Power Capacity		Line Capacity
Increase Vertical Circulation With Pedestrian Bridges		Passenger Loading Level
LFLRVs		Dwell Time

- Operating margin:
 - Add two extra tracks;
 - Grade-separate railroad crossings;
 - Improve/increase tail tracks; and
 - Replace low-quality switches with faster switches; and
- Passenger loading level: Increase vertical circulation with pedestrian bridges.

ANALYSIS AND EVALUATION

Metrics for Analysis

Six specific variables identified in the analysis are then used directly in the calculation of capacity. In order to optimize the accuracy of capacity calculations, these variables must have precise metrics, or values, assigned to them that can be used in calculations.

The six variables with their metrics that will be used in calculations are

- Weakest link (flat junctions): 30-s delay to headway;
- Dwell time: 30 s;
- Line capacity, or trains per hour: 18 trains per hour;
- Number of cars per train: four cars per train;
- Operating margin: 45 s per headway; and
- Passenger loading levels: 125 passengers per LRV.

These variables will then lead to the corridor's person capacity, which will determine whether the corridor can accommodate the necessary number of trains for the ridership projected for 2025 upon the opening of the FasTracks corridors. These variables and their metrics are further explained below.

Weakest Link

The first step in calculating a light rail system's capacity is to determine its weakest link. In the case of the Central Corridor, the weakest link is the two flat junctions at either end. While the shortest signalized headway in this corridor is 130 s, or 2.17 min, the delay caused by trains running through the flat junctions actually increases the headway, similar to CTA trains entering the Loop.

Delay caused by flat junctions is basically calculated by determining the delay by acceleration and deceleration, time to throw and lock the switch, and factoring in the switch angle factor. The delays of the RTD flat junctions at the CPV Junction (north end) and Broadway Junction (south end) are estimated to be approximately 30 s each.

Dwell Time

Dwell time is a station-specific factor that relies more on the conditions at each individual station rather than the light rail system itself. The type of LRVs also has a large influence on dwell time.

The three main components of dwell time include door opening and closing timing and passenger flow through the doors.

The I-25 and Broadway Station presents the longest dwell time factor of the three stations in the Central Corridor. The 30-s dwell time is subject to additional delay by issues caused by dysfunctional folding doors, crush loads causing the doors to remain open longer than the usual time, and passengers needing to access the train by the high-block platforms. Implementing LFLRVs to reduce delays can be an improvement. Continuing the practice of the proof of payment (POP) system for purchasing and checking light rail fares is also the best way to collect fares and achieve high capacity at light rail stations.

Line Capacity

Line capacity is the maximum number of trains that can be operated over a section of track in a given period of time, which is usually 1 h. Generally the two most important variables controlling line capacity is the train signaling system being used and the station with the longest dwell time. Additionally, several other variables have been shown to control line capacity, including

- Signaling systems designed for the minimum planned train headway;
- Speed restrictions due to curves, grades, or track conditions; and
- Line crossings and merges such as flat junctions.

The factor providing the lowest capacity, which is considered the weakest link, will constrain the capacity of a given section of a line. In RTD Light Rail's case, the flat junctions at Broadway Junction and CPV Junction are the weakest link in the Central Corridor.

RTD Light Rail currently uses a signaling system that allows a 2.5-min headway between trains for the Central Platte Valley, Central Corridor, and Southeast Corridor segments. The Southwest Corridor, which currently uses a 3-min signaling system, has no current plans to be upgraded to a shorter headway system. The 2.17-min signaling system can accommodate a maximum number of 27 trains per peak hour in each direction and the Southwest Corridor schedule must now be arranged according to the needs of the rest of the system.

Additionally, there are speed restrictions caused by switches north and south of the I-25 and Broadway Station. In this case, trains slow down when entering the switch, then speed up again, and then slow down for the station.

Given the current RTD service plan after the opening of the Southeast Corridor, 18 trains per hour per direction are planned to operate through the Central Corridor. This requires an average headway of about 180 s (3 min), with a limited varied headway of 150 s, which is possible as evidenced under current operating conditions and also allows slack time for scheduling and delay.

Number of Cars per Train

Currently, RTD Light Rail uses a maximum of three cars per train with plans to upgrade the system to a maximum of four-car trains after the opening of the Southeast Corridor. However, the four trains per peak hour destined for 30th Avenue will still need to use three-car trains for the Welton Street segment. The four-car train study currently underway should accomplish

problems associated with four-car trains running through downtown for trains destined for 18th Street.

Operating Margin

The operating margin is the amount of time a train can run behind schedule without interfering with other trains. This is added to the dwell time and the minimum train separation to create the shortest headway.

With the critical dwell time on the Central Corridor of 30 s and a time separation time of 75 s (the standard for downtown running trains), using a 130-s (2.17-min) minimum headway, the minimum operating margin would be 25 s. With this operating margin, trains running under an average sustained 130-s headway cannot fall behind by more than 25 s, or the entire light rail system could fall behind schedule.

Improvements to the operating margin can only be done by increasing the frequency of trains; in future scenarios this may only be possible by expanding the physical infrastructure to allow for more trains per hour with a more frequent headway.

Passenger Loading Levels

Passenger loading levels are comprised of the number of cars per train and the maximum load standard. Together these determine the number of passengers each train can hold. The maximum load standard depends on the light rail station platform and the accessibility of moving through the station to board the train. RTD uses 125 passengers per car for a standard standing load.

Available Capacity Analysis

The existing or available capacity was calculated to determine the capacity of the Central Corridor as it exists in the present, which is determined by improvements incurred by the Southeast Corridor, scheduled to open on November 17, 2006. Ridership projections for 2010 are used for the available capacity analysis. This available capacity is used as a base capacity figure that explains the difference between existing capacity and the needed capacity for the future.

Available capacity is divided by both the scheduled capacity—the capacity that the system is scheduled to deliver and the actual capacity—the capacity that the system can actually carry.

Taking the six variables listed previously and their respective metrics into account, the available capacity is calculated by a line item of variables that influence capacity. This gives the Central Corridor's capacity by train and passenger in 2010, when the corridor is forecasted to have an hourly peak direction ridership of about 5,800 passengers.

The available system capacity for the Central Corridor in 2010 is 8,500 passengers per hour per direction, using the planned Southeast Corridor service plan's 18 trains per hour and a minimum average headway of 180 s. The variables include

- Maximum dwell time: 30 s;
- Time separation: 75 s; and
- Operating margin: 95 s.

Under maximum peak conditions, the Central Corridor's train capacity is 20 trains per hour, which is limited by the minimum sustained headway of 180 s. Under maximum peak conditions, the Central Corridor can carry up to 9,500 PPPHPD. The variables include

- Maximum dwell time: 30 s;
- Time separation: 75 s; and
- Operating margin: 75 s.

These calculations assume 125 peak hour passengers per LRV with four three-car trains running to 30th Avenue and the balance as four-car trains. If the entire system ran four-car trains during the peak period, an additional 500 passengers could be accommodated.

Required Capacity Analysis

Once again using the corridor capacity variables and measures identified above, the requirements for additional scheduled and actual capacity in the Central Corridor are estimated. These estimations take into consideration FasTracks changes for 2015, such as station improvements and available light rail vehicles. Ridership figures for the projected 2025 peak-hour, peak-direction of 10,800 are used for the required capacity analysis.

For the required capacity, the scheduled capacity is calculated by determining a schedule that will meet the needs of ridership levels. The actual capacity is calculated by determining the actual capacity resulting from improvements needed to meet or exceed the scheduled capacity.

The optimal minimum sustained headway to exceed the forecasted ridership demand of 2015 is 150 s with 24 trains per hour. This brings the peak-hour, peak-direction ridership up to 11,500 passengers, which is enough capacity to serve the projected demand and leave room for future ridership growth and scheduling slack time. The variables include

- Maximum dwell time: 30 s;
- Time separation: 75 s; and
- Operating margin: 45 s.

However, considering the minimum train separation of 75 s and the critical dwell time of 30 s, this headway only allows for a 45-s operating margin, which is the flexible time each train has for delays. If a train is delayed by more than 45 s, the entire light rail system running on the Central Corridor could be delayed. The existing system uses an operating margin of 95 s and a minimum operating margin of 60 s is recommended.

The actual system capacity is determined by assuming improvements to the Central Corridor to meet the scheduled capacity for 2025. In this case, the existing infrastructure would need to be expanded in order to increase the operating margin caused by only two tracks and decrease the delays caused by the flat junctions. If the Central Corridor infrastructure is doubled from the existing infrastructure, the actual capacity would basically double as well.

The actual capacity for 2015 is calculated at 40 trains per peak hour per direction and a ridership of 19,500 PPPHPD, assuming improvements to the existing infrastructure. This figure takes into account four three-car trains per peak hour and a balance of four-car trains. The line items include

- Maximum dwell time: 30 s;
- Time separation: 75 s; and
- Operating margin: 75 s.

Figure 4 shows the discrepancy between the 2010 and 2015 forecasted capacity by PPPHPD. The 2006 scheduled capacity would almost bring the Central Corridor to the actual line capacity. Alternatively, an expanded infrastructure has the potential to exceed the 2015 capacity needs for ridership and train throughput and leaves room for future ridership growth.

To reach the required scheduled capacity without sacrificing the operating margin, improvements must be made to the existing physical infrastructure to increase the operating margin and allow shorter headways. These improvements include:

- Upgrade CPV Junction and Broadway Junction to grade-separated junctions and
- Expand the number of tracks between the junctions from two to four.

With these physical improvements, approximately twice as many trains could be run through the Central Corridor as will be run in 2006 with the opening of the Southeast Corridor. This brings a maximum capacity of almost 20,000 PPPHPD, or 40 trains per hour per direction.

It is necessary to construct two additional tracks along the entire length of the Central Corridor; leaving any segments with only two tracks would cause the corridor to face the same capacity restraints it does today. With two tracks at any section of the Central Corridor, trains

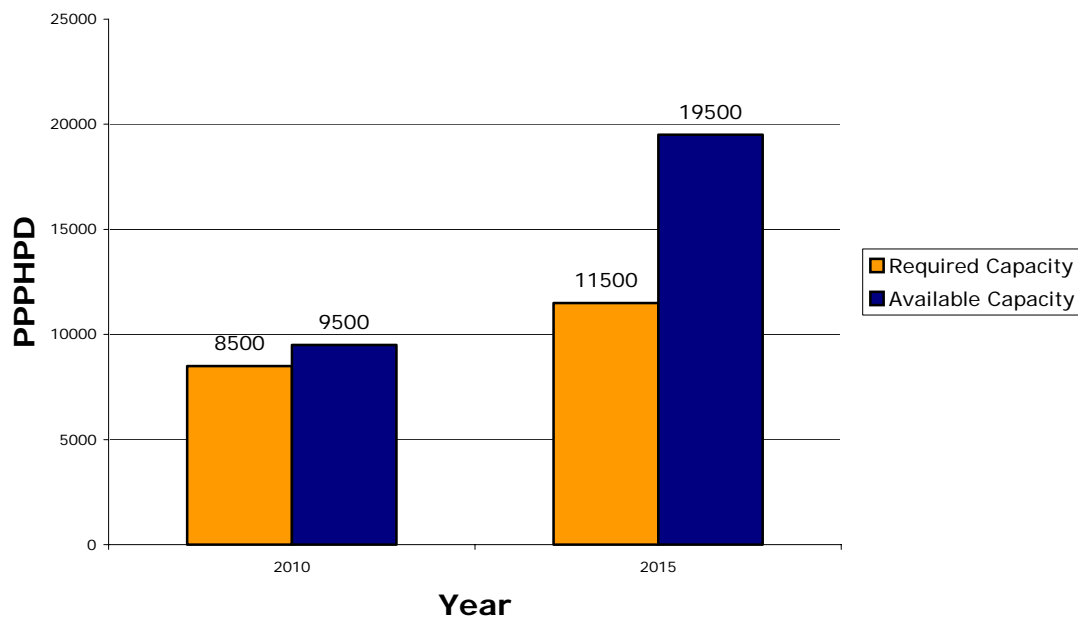


FIGURE 4 Capacity forecast—operational and physical improvements.

would still have a minimum sustained 180-s headway, which translates to delays to the entire light rail system.

The following optional improvements can be made to the system to increase capacity that may not have an impact on the overall physical capacity, but will help alleviate potential delay:

- Begin purchase of LFLRVs,
- Run express operations for the Southwest Corridor for the 10th and Osage Station and the Alameda Station, and
- Construct pedestrian bridges at stations to improve circulation and safety.

Construction Feasibility

Of the two recommended improvements to the light rail system, there are different possibilities for construction. With regard to improving the flat junctions, there exist three situations for implementation:

- Replace the two flat junctions with two flying junctions and
- Replace the two flat junctions with one flying junction at CPV Junction or Broadway Junction.

Of these possibilities, replacing the two flat junctions with a flying junction at CPV Junction is the most feasible. This is mostly due to the situation that Broadway Junction does not permit enough space for a flying junction because of the I-25 and Broadway Station and the I-25 overpass north of I-25 and Broadway Station. The Southeast Corridor enters I-25 and Broadway Station to the south and a light rail flyover was recently constructed that makes a tight turn just south of the I-25 and Broadway Station. At the CPV Junction location, there exists at least two blocks of space for elevated light rail activity.

Also essential to expanding the capacity of the Central Corridor is the use of ROW currently in use by Union Pacific for the Burnham Yard. By using the ROW from the north lead (13th Avenue to Colfax Avenue), the south lead (6th Avenue to Bayaud Avenue), and the yard itself, it would be possible to expand the number of tracks to the west side of the existing Central Corridor ROW. [Figure 5](#) shows the existing light rail corridor adjacent to the Union Pacific Burnham Yard.

The capital cost estimates appear to show that the required new construction is feasible for existing RTD policies. The most significant costs with the new construction are the grade-separated structures.

The total capital cost estimate for both the new double tracks and the new flying junction is \$100.07 million. This cost is within two independent budget numbers: the \$118.4 million estimate listed in FasTracks and the \$182.8 million estimate listed in the Central Corridor report.

These costs contain the ROW acquisition costs, the base cost for the infrastructure, the construction bid items, and contingencies for planning and engineering. The basis for the line items is the RTD Major Investment Study Guideline Manual, 2001. All costs have been inflated to 2005 values. Since the engineering and construction appear feasible, and are within budget estimates, these improvements are recommended to move forward to the conceptual plan.



FIGURE 5 Central Corridor and Burnham Yard.

Conceptual Plan

Components of the conceptual plan are taken from the engineering and construction evaluation and the alternatives developed to meet future capacity projections. These components include:

- New CPV Junction,
- Grade-separated 13th Avenue crossing,
- New double-track ROW, and
- Pedestrian bridges at light rail stations.

A flying junction for the new CPV Junction would make it possible for all trains running through the Central Corridor to be sorted to their appropriate destination so trains would not have to change tracks at or near I-25 and Broadway Station.

In order to mitigate passenger confusion at stations with four tracks, in addition to increasing the safety at the stations, the Southwest Corridor could be run as an express operation between the 10th and Osage Station and the Alameda Station. In the conceptual track configuration, the two tracks on the west, for the Southwest Corridor, would simply be blocked off from these two stations. The I-25 and Broadway Station would then serve as an express station for the Southwest Corridor and would continue its use as a major light rail transfer station.

Most of the existing tracks and turnouts can be reused for the new Broadway Junction design. Two existing tracks can be turned into space for short-term train storage, located east of the Southwest Corridor tracks and south of where the Southeast Corridor tracks turn east.

Constructing overhead pedestrian bridges at all three Central Corridor light rail stations would increase vertical capacity by providing another alternative to crossing light rail tracks to gain access to platforms. This can also increase safety by reducing the chance of pedestrian–light rail collisions. As noted earlier, constructing pedestrian bridges is also an opportunity for external improvement that will increase pedestrian accessibility to the stations by providing access on either side of the station.

CONCLUSION

Final Plan

The final plan includes fixing the flat junction problem by constructing a new CPV Junction (including 13th Avenue grade-separated crossing) and solving the headway issue by constructing a new double track ROW adjacent to the existing track. This will improve transit capacity in the Central Corridor for the long term, achieving the capacity necessary for FasTracks implementation, and leaving room for future ridership growth on RTD's busiest light rail segment. It should be noted that this recommendation is merely a suggestion by the author and does not represent the official position of RTD.

Next Steps for Implementation

Several steps will need to be conducted in order to lead to the implementation of Central Corridor capacity expansion improvements. These include:

- Conducting a Central Corridor Capacity Simulation Study to confirm the capacity analysis results of this study,
- Preparing a feasibility study and environmental assessment for the planning and engineering aspects associated with upgrading the Central Corridor, and
- Conducting a final design and engineering study for physical improvements on the Central Corridor prior to construction.

The first new rapid transit corridor in the FasTracks plan to open will be the West Corridor in 2014. Therefore, construction should begin on Central Corridor improvements by 2010 to allow 3 to 4 years for construction and testing. The remaining planning process steps, as identified above, are estimated to take about 1 year for each study; therefore, the next step should be implemented by 2007.

ACKNOWLEDGMENTS

As with any report that requires information from public agencies and the people who work in them, this paper could not have been produced without the assistance and contribution from a number of people. Specific thanks are extended to Robert Rynerson, Jeff Dunning, and Lee Cryer of RTD; Jeff Busby, Peter Fahrenwald, and Mark Patzloff of CTA; and Peter Albert of BART.

RESOURCES

- BART Silicon Valley Rapid Transit Project Impact Study. Bay Area Rapid Transit District, San Francisco, California, January 2003.
- CTA Brown Line Expansion Environmental Assessment. Chicago Transit Authority, 2002.
- CTA Loop Capacity Analysis. Chicago Transit Authority, January 13, 2003.
- RTD Central Connector Conceptual Feasibility Study. Regional Transportation District, December 30, 2002.
- RTD FasTracks Plan. Regional Transportation District, 2004.
- RTD Four-Car Train Simulation Study, 2005.
- RTD I-70, US 36, I-225 and North Metro Corridor Major Investment Studies Guidance Manual for Technical Analysis, Regional Transportation District, March 2001.
- RTD Southeast Corridor Service Plan 2006 Addendum, Regional Transportation District, December 2004.
- RTD Southeast Corridor Service Plan 2006, Regional Transportation District, April 2004.
- TCRP Report 100: Transit Capacity and Quality of Service Manual*, Second Edition, Transportation Research Board, National Research Council, Washington, D.C., 2003.

DESIGN OF NEW INFRASTRUCTURE

A Review of Track Design in Germany

WOLFGANG PREDL

Verkehrs-Consult Dresden-Berlin



International Association of Public Transport
Union Internationale des Transports Publics
Internationaler Verband für öffentliches Verkehrswesen
Unión Internacional de Transporte Público

Session 3a
"Design Of
New
Infrastructure"

Saint Louis, 10
April 2006

A Review of
Track Design in Germany

Verkehrs-Consult
Dresden-Berlin (VCDB)

Dr.-Ing. W. Predl



Better mobility for people worldwide

Table of Contents

- 1. Preliminary**
- 2. Definitions/general views**
- 3. Requirements/interactions**
- 4. Noise and vibrations**
- 5. Stray currents**
- 6. Grass track**
- 7. Several basic track types**
- 8. Conclusion**
- 9. Literature**

1. Preliminary



2. Definitions/general views

Track formation:

Combination of superstructure and substructure

Superstructure:

Permanent railway above ground level

Substructure:

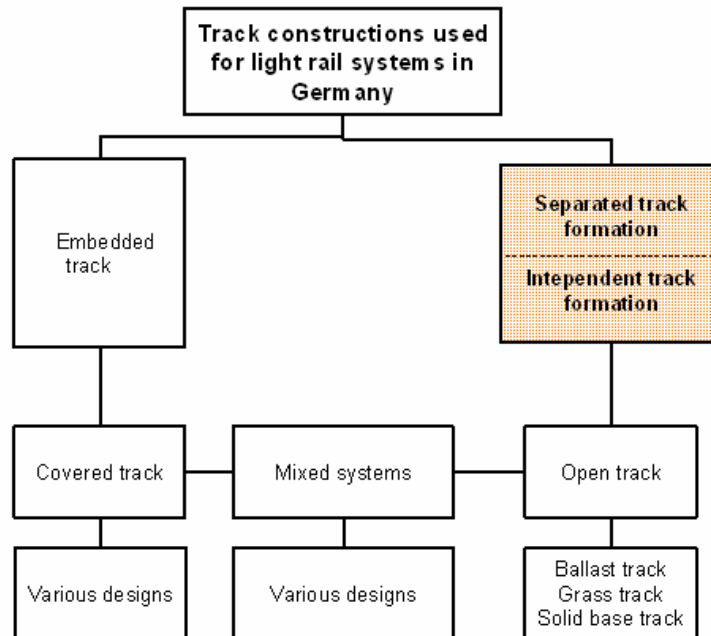
Artificial soil structure between underground and superstructure

Underground:

Soil/rocks situated directly underneath substructure

Generic Terms		Layers/Parts of Construction
Track formation	Superstructure	With/without covert Paver , Slabs, asphalt.../ballast Grass tracks (Green tracks)
		Railway Tracks and switches with elements: Rails, fastenings, gauge fixings, supports, drainage, abbr of Sleepers
		Supporting layers Bedding (ballast , concrete layer, asphalt layer) Anti-frost layer /ground protective layers (plastic foils, filter fleece, foam boards)
	Substructure	Compressed or optimized transition layers Compressed sustructural beddings Bridges , Retaining walls other artificial structures, draining
	Underground	Laying ground

2. Definitions/general views



In accordance with Article 16 of the Ordinance on the Construction and Operation of Tramways (BOStrab)

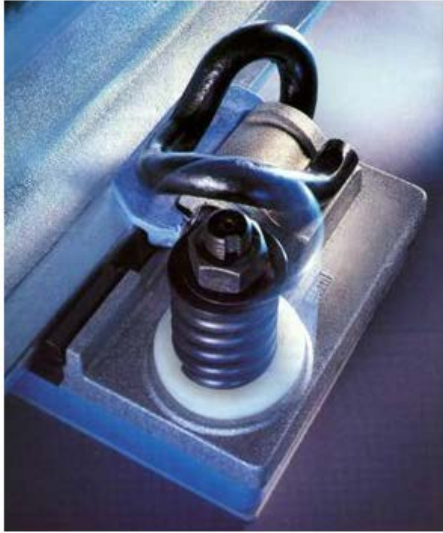
3. Requirements/interactions

- ⇒ **Operational safety**
- ⇒ **Safe track guidance, supporting strength**
- ⇒ **Electrical conductivity and insulating properties**
- ⇒ **Avoidance of stray currents**
- ⇒ **Ease of access for road vehicles, where applicable**
- ⇒ **Vibration and noise control**
- ⇒ **Integration into the urban environment**
- ⇒ **Service life and economic efficiency**

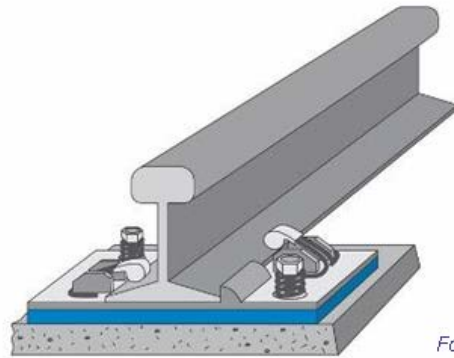
4. Noise and vibrations

- ⇒ **Grinding of rail surface**
- ⇒ **Grinding/turning of wheels**
- ⇒ **Lubricating of wheel flanges**

4. Noise and vibrations



Highly elastic rail fastener with a deflection under wheel load of more than 2 mm



Fotos: Getzner

4. Noise and vibrations

Under ballast mats

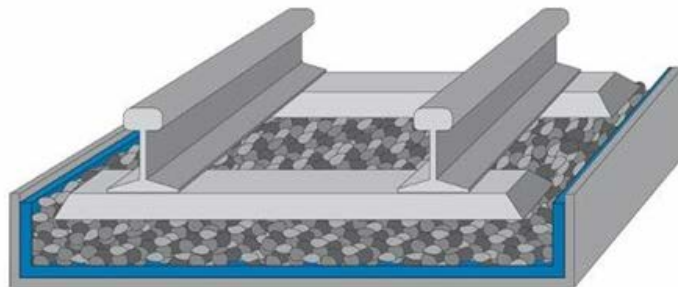


Foto: Getzner

4. Noise and vibrations

Elastically laid concrete sleepers



Foto: Getzner

4. Noise and vibrations

Mass-spring systems

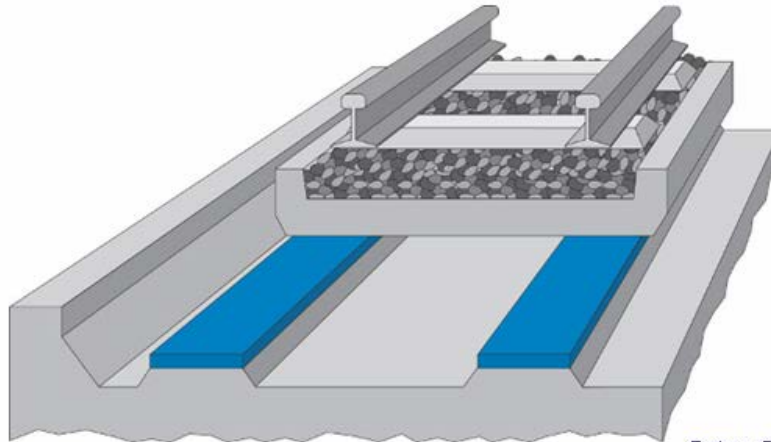


Foto: Getzner

4. Noise and vibrations

Increase in superstructure costs for damping superstructure types on tunnel sections

Superstructure Types	Cost Factor
Ballast or simple elastic rail fastener	1
Highly elastic rail fastener	1,2–1,6
Under ballast mats	1,4–1,8
Mass-spring systems	2,5–4,5

4. Noise and vibrations



4. Noise and vibrations



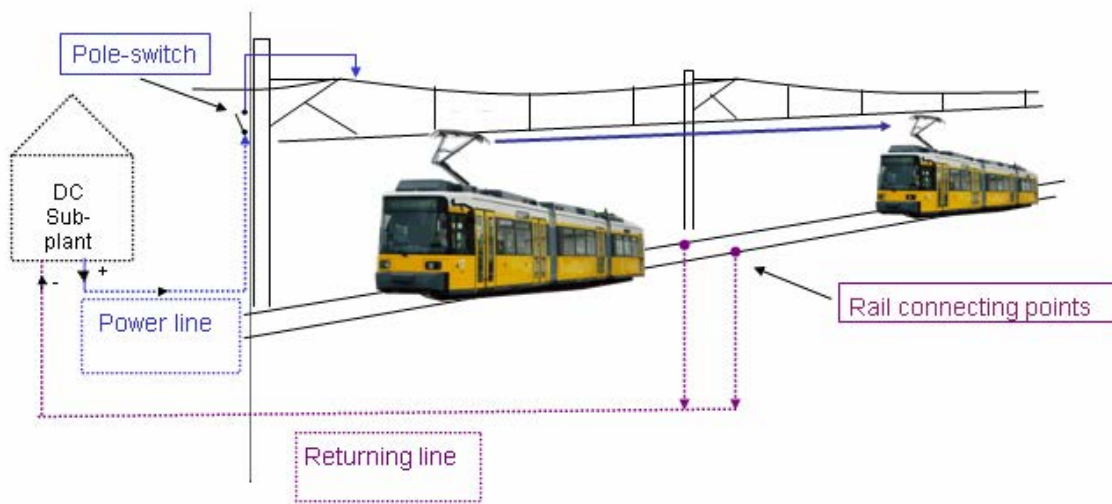
↑
**System
Flüsterschiene
(Whispering Rail)**



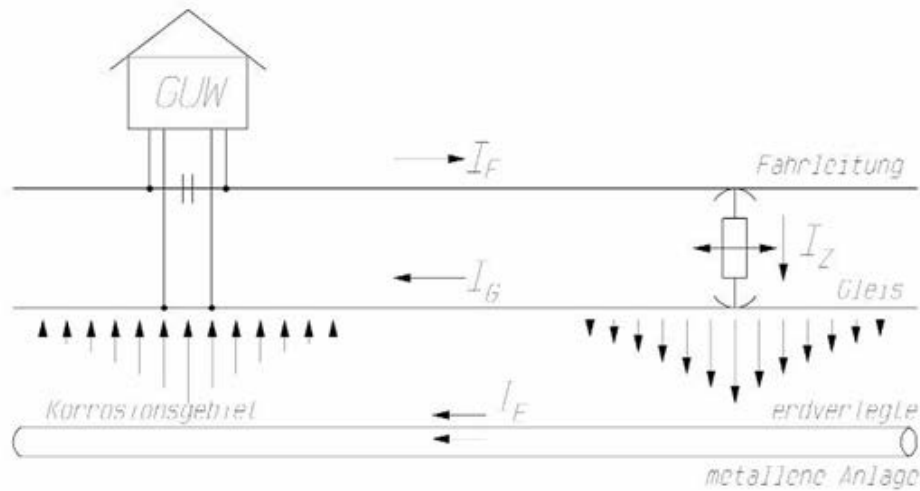
↑
**System Deltalager
(Delta Bearing)**



5. Stray currents



5. Stray currents



6. Grass track

- ⇒ **The broad, green area of the track and adjacent grass margins planted with flowers and trees contribute significantly to making the city visually pleasing.**
- ⇒ **Use of grass track reduces the spreading of dust, avoiding unpleasant conditions for passengers, pedestrians, and local residents, as well as obviating deterioration of the rolling stock.**
- ⇒ **The trams travel practically silently over grass track, even at higher speeds.**

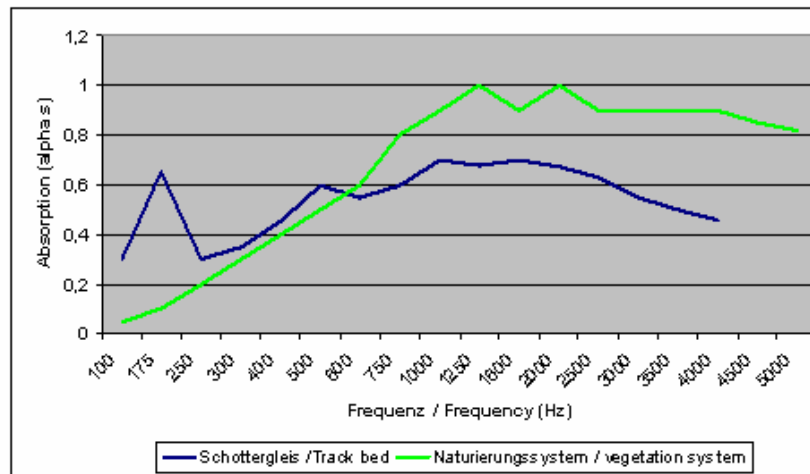
(Giese: 1917)

6. Grass track



6. Grass track

Frequency-related performance of a vegetation system based on a 45-mm substrate, with track formed of rails on concrete sleepers on a 50-cm layer of ballast.



7. Several basic track types

Paver cover on a concrete track bed



Pavers

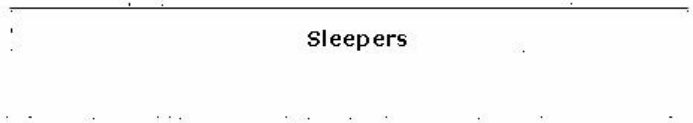
Concrete or bituminous track bed

Anti-frost layer/ground protective layer



7. Several basic track types

Track with sleepers and ballast



Sleepers

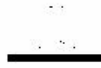
Ballast

Anti-frost layer/ground protective layer

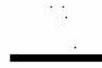


7. Several basic track types

Solid base tracks (ballastless track)



Concrete slab



Anti-frost layer/ground protective layer



7. Several basic track types

Embedded concrete sleeper



Concrete sleeper



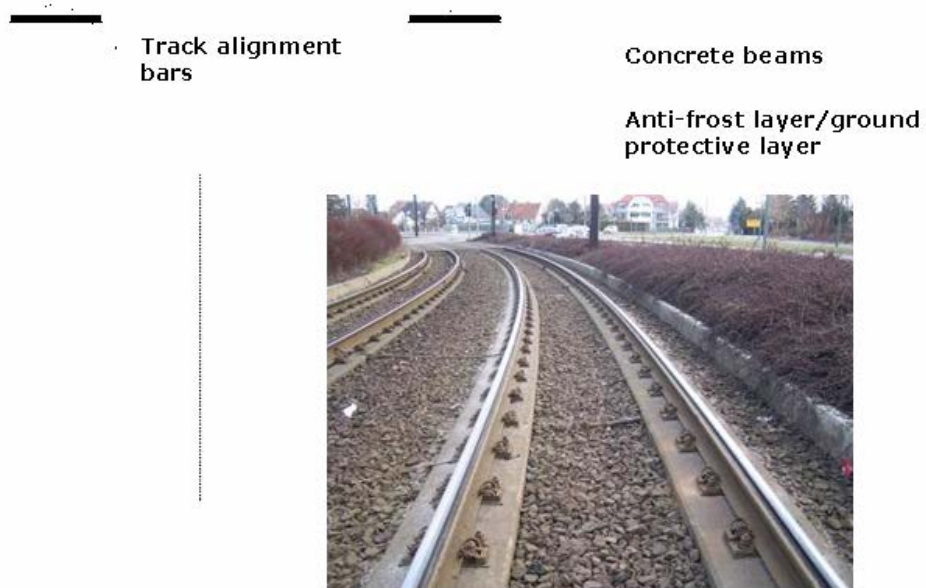
Concrete slab

Anti-frost layer/ground protective layer



7. Several basic track types

Concrete beams



7. Several basic track types

Paved cover

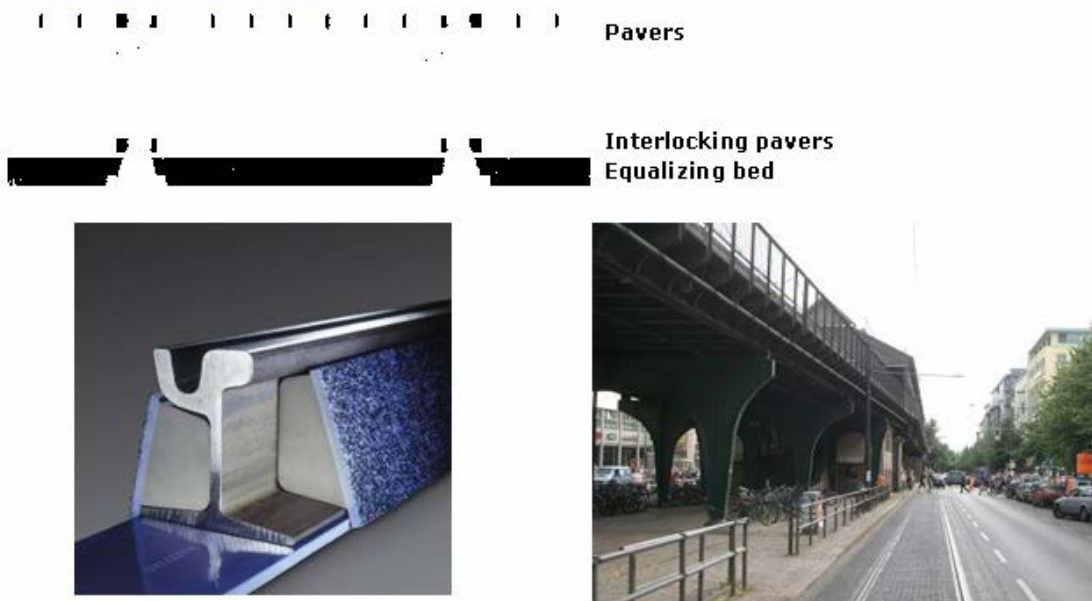


Foto: Getzner

7. Several basic track types

Slab cover



Concrete slabs



7. Several basic track types

Slab track bed

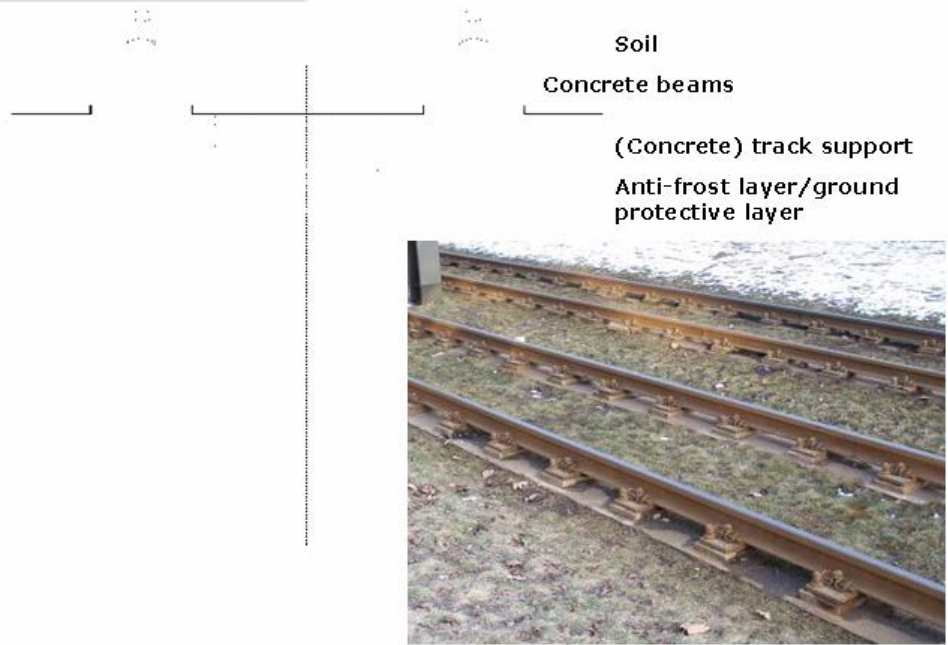


(Concrete) slab track bed



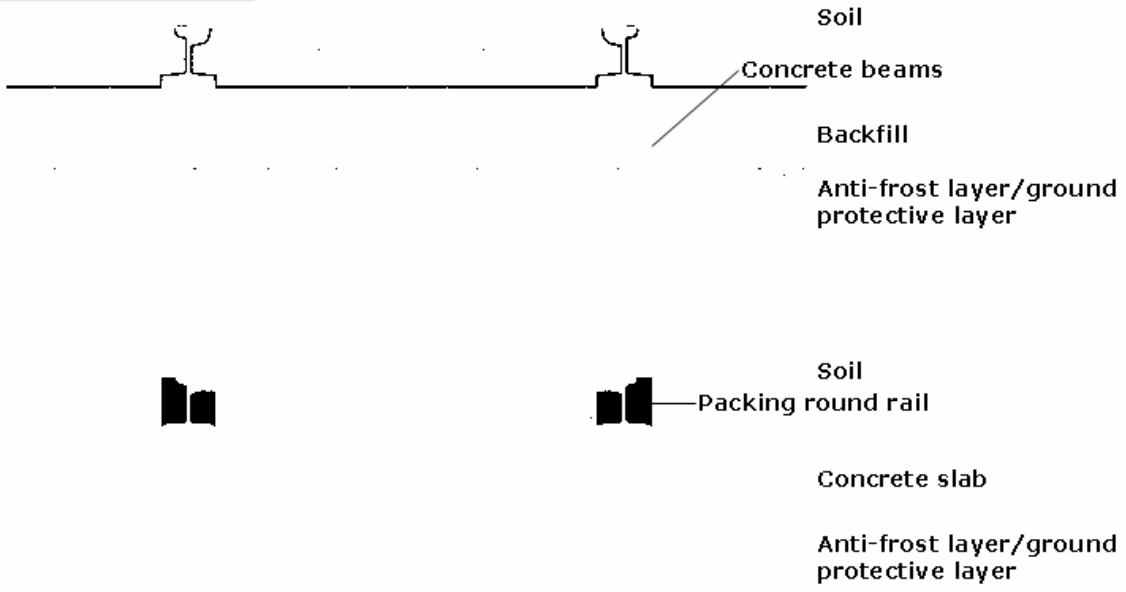
7. Several basic track types

Open grass track



7. Several basic track types

Closed grass track



7. Several basic track types

Closed grass track



*"NBS"
Rheda City Berlin ®
by Pfliederer*

7. Several basic track types

Stopping points



7. Several basic track types

Stopping points



8. Conclusion

Type of Track	Where Used	Tunnels	Ground Level	Bridge/Miaduct
Solid base (ballastless) track	Berlin Dortmund Hamburg Köln Mühlheim/Ruhr Nürnberg		Bonn Stuttgart	Bonn Köln Nürnberg Stuttgart

	Ground Level Only		
Grass track	Berlin Bochum Bremen Chemnitz Dortmund	Dresden Düsseldorf Freiburg Karlsruhe Kassel	Köln Mannheim München Stuttgart Würzburg

DESIGN OF NEW INFRASTRUCTURE

Construction of the Newark City Subway Broad Street Extension

HARVEY L. BERLINER

Parsons Brinckerhoff Quade & Douglas, Inc.

ANTHONY M. FLERES

URS Corporation

KURT E. KAUFFMAN

NJ Transit

The Newark City Subway Broad Street Extension is a 1.6-km (1-mi) extension of the existing Newark City Subway light rail transit system from New Jersey Transit's Newark Penn Station to the historic Broad Street Station. The alignment is underground and at-grade, adjacent to historic buildings, commercial developments, the New Jersey Performing Arts Center, and Riverfront Stadium, home of the independent Newark Bears baseball team. This paper will explore how the project team worked with the City of Newark, local utilities, adjacent property owners, and other stakeholders so that the construction could proceed with minimal interruptions and so that the project could be kept on schedule and within budget. It also will highlight the experience gained by the owner, engineer, construction manager, and the contractors working together to solve problems to allow construction to proceed.

HISTORY

The Newark City Subway (NCS) in Newark, New Jersey, is operated by New Jersey Transit Corporation (NJ Transit). Despite its name, the NCS is a subway–surface light rail line that runs underground downtown and aboveground in outlying areas. The Newark City Subway Broad Street Extension (NSCE) was originally the first phase of the Newark–Elizabeth Rail Link from downtown Newark to the Newark International Airport and the City of Elizabeth, more commonly known as NERL. Eventually NJ Transit abandoned the subsequent phases of NERL and the project was then renamed to NSCE.

The original line opened in 1935 along the old Morris canal right-of-way (ROW), from Broad Street, at the old Newark Public Service Terminal, north to Heller Parkway. In 1937, the subway was extended to a lower level of the new Newark Penn Station. Additionally, the Cedar Street Subway, which had been used to access the Newark Public Service Terminal from Washington Street, was pushed through to a junction with the subway between Broad Street and Penn Station. An extension to North 6th Street, now Franklin Avenue, opened in 1940.

The Public Service Corporation as its #7 line originally operated the subway. NJ Transit took over operations in 1980. For many years President's Conference Committee (PCC) cars bought from Twin City Rapid Transit in the 1950s were running on the route. In 2001, new light

rail cars built by Kinkisharyo in Japan replaced the PCCs. Some of the old PCCs were sold to the San Francisco Municipal Railway's Market Street Railway, which runs a system of historic streetcars. Others have ended up in museums.

In the mid-1980s, the City of Newark officials and business leaders requested the New Jersey Department of Transportation (NJDOT) and the New Jersey Transportation Coordinating Council to fund a consultant study to address improved transit access in downtown Newark and access to Newark Airport from both Newark and Elizabeth.

A part of this study it was recommended to build a new maintenance facility. In June 2002, the NCS was extended to the suburbs of Belleville and Bloomfield with the new vehicle storage yard and maintenance facility located at the end of the line in Bloomfield. This was necessary because the old facility to store and maintain the PCC cars was located under Newark Penn Station. This old facility could not accommodate the new vehicles. New stations were also opened at Silver Lake and Grove Street, and the Heller Parkway and Franklin Avenue stations were combined into a new Branch Brook Park Station. The loop at Franklin Avenue was removed because the new light rail cars can travel in either direction, unlike the old PCC cars.

The study also recommended that the NCS be extended a distance of 14.6 km, 13.0 km (8 mi) to the south to connect with the City of Elizabeth and Newark Airport and 1.6 km (1 mi) to the north to connect to Newark Board Street Commuter Rail Station. Due to funding constraints, it was determined to build the extensions in stages, with each new phase to be built in succession.

ALIGNMENT

The first phase or northernmost NERL segment was the connection of the NCS from Newark Penn Station to Newark Broad Street Commuter Rail Station (see [Figure 1](#)). As mentioned above, it was first known as NERL, but was renamed to NCSE when the subsequent NERL stages were abandoned. The segment actually begins at an underground connection with the NCS at the intersection of Raymond Boulevard and Mulberry Street. This connection uses the existing tunnel turnout ramps that had been constructed in 1935 to connect with the Public Service Terminal. The ramps had been closed when the terminal was demolished in the early 1960s to make room for a new Public Service Electric and Gas (PSE&G) headquarters complex.

Due to the horizontal and vertical alignments of the two existing turnout ramps, the NCSE alignment begins with two independent tunnels. Portions of the existing ramps were demolished in order that the two tunnels could be orientated under Mulberry Street. The line continued northward under Mulberry Street and then under the abandoned ROW of old Mulberry Street where it transitioned from tunnel to open cut and then to at-grade. The portal was located between the historic St. John's Church and the Episcopal House. The two tunnels became one structure at the same alignment at the portal. The at-grade alignment then crossed Center Street with the first station [Center Street–New Jersey Performing Arts Center (NJPAC) Station] located just north of roadway.

The alignment then proceeded northward along the old southbound lanes of McCarter Boulevard–NJ Route 21. Route 21 was relocated to the east by NJDOT before the construction of this segment of the alignment began. To the immediate west of the alignment at this location is the NJPAC, which was built in the mid-1990s. The alignment then parallels Route 21 from Center Street to Fulton Street, where it turns to cut diagonally across the block of bounded by

Fulton and Lombardy Streets. When it reaches Lombardy Street, the alignment divides into two one-way pairs.

The alignment proceeds northbound track in an exclusive lane along Atlantic Street, passes within exclusive ROW in front of Riverfront Stadium, Newark’s minor league baseball stadium, and then crosses Broad Street where it reconnects to the southbound track alignment. The Atlantic Street Station is located just north of Lombardy Street and a drop-off area is located in front of Riverfront Stadium. The southbound track curves to the west at the intersection of Lombardy and Atlantic Streets, running along the south side of Lombardy Street to Broad Street where it crosses the roadway and then travels in an exclusive lane along the west side of Broad Street. The alignment continues northward along the west side of Broad Street to Lackawanna Plaza where it connects back up with the northbound tracks. Along this segment is Washington Park Station.

At Lackawanna Plaza the alignment precedes westward with the Broad Street Station located directly in front of the Newark Broad Street Commuter Rail Station. A tail track is located immediate to the west of the station where the alignment ends. The total length of the alignment is 1.6 km (1 m). The tunnel segment is 250 m (800 ft) with the remainder being at-grade. The at-grade alignment has 12 roadway crossings.

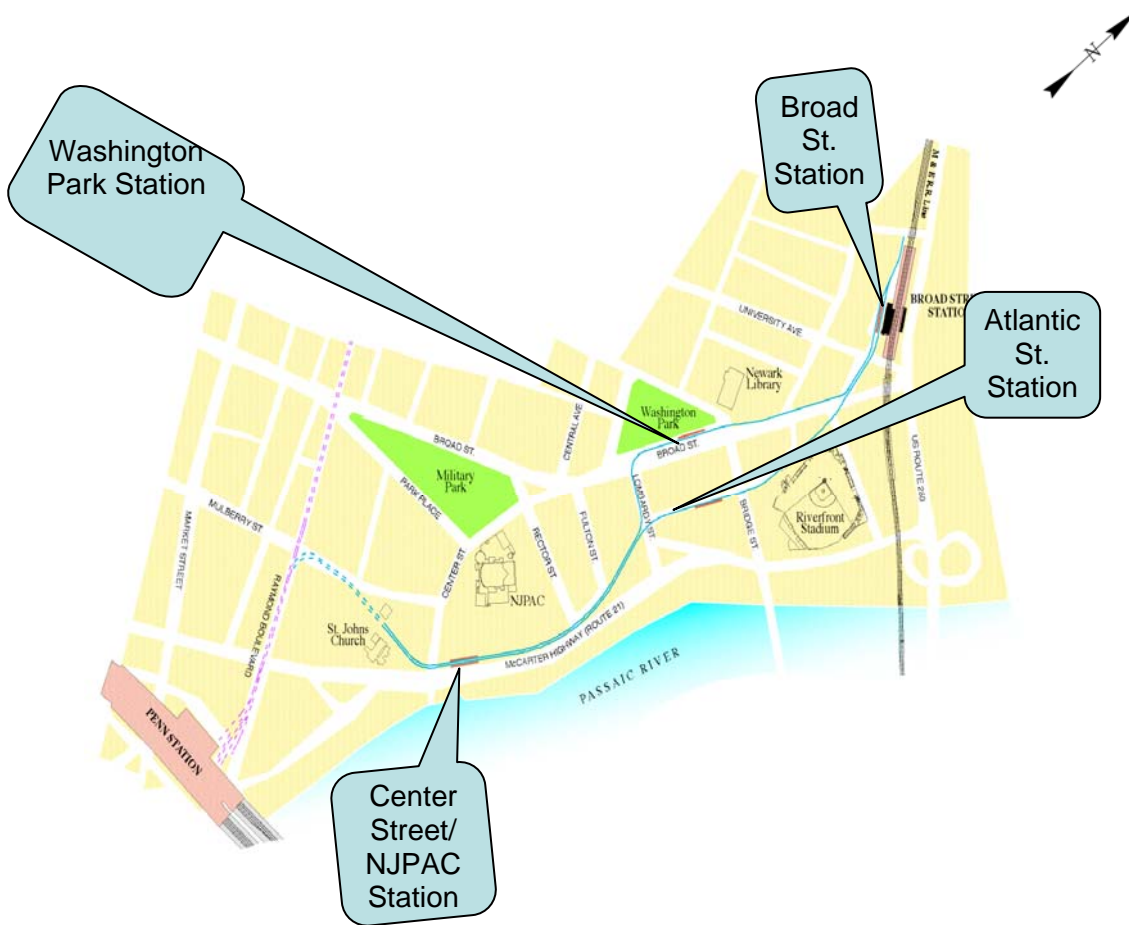


FIGURE 1 Newark City Subway Broad Street Extension.

Key factors in developing this alignment were:

1. The use of the old NCS turnout tunnels to avoid disruption to the existing NCS service, proximity to the NJPAC, realignment by NJDOT of Route 21;
2. Use of abandoned ROW where the alignment angles across from Route 21 to Lombardy and Atlantic Streets (development rights over the alignment were maintained by the property owner);
3. Development of Riverfront Stadium with the provision for the track alignment in the plans; and
4. Working with the City of Newark on traffic circulation, reconfiguration of Broad Street traffic, and urban-design plans for downtown Newark.

NJ Transit and the design team worked closely with the City of Newark and the stakeholders to coordinate all the above issues during the design period.

The original NCS tunnel ventilation consisted only of unpowered ventilators terminating in sidewalk grating that rely upon “natural ventilation” and piston action to ventilate the tunnels. As part of an upgrade of the entire existing NCS tunnels and stations, it has been proposed to upgrade the tunnels to be NFPA-130 compliant and at the same time to upgrade the electrical distribution system for the existing tunnels. The work of adding new power supplies and ventilation fans installed into the existing sidewalk ventilators to minimize effects on the historic subway was added to the NCSE project during the final design process.

FINAL DESIGN

The final design was done by BRW/PB JV, a joint venture of URS Corporation (originally BRW, Inc., which was purchased by URS during the final design period) and Parsons Brinckerhoff Quade & Douglas, Inc. (PB). The final design was started in 1999 and completed when the last contract was awarded in 2003. The final design began with the preliminary design documents and required close coordination with NJ Transit, City of Newark, NJDOT and all the stakeholders. The Construction Manager (CM), a joint venture of DMJM+Harris/STV, Inc., was on board during the final design period. They attended all joint meetings and reviewed and provided comments on each of the design submittals.

Weekly and then biweekly project managers (PM) meetings were held throughout the design period. These meetings included the NJ Transit Project Manager plus members of his staff, BRW/PB JV, the CM, and a representative of the project management oversight team hired by FTA. Project issues were discussed and an action item list was maintained and reviewed as to status each meeting. These meetings were successful in discussing project status, issues, and keeping the work moving forward.

One of the major issues was how to break up the construction segments. Originally six contracts were proposed for the NSCE alignment plus the NCS tunnel ventilation contract. When the design began the contracts were divided into these seven contracts. However, as design progressed and discussions were held between NJ Transit, BRW/PB JV, and the CM it was decided to combine as many contracts as possible to facilitate coordination between the various disciplines. In the end the construction was divided into the following three main construction contracts, two advanced utility relocations, and one early procurement contract:

- Contract 1: tunnel structure;
- Contract 1A: tunnel advanced utilities;
- Contract 2: at-grade alignment, stations, trackwork, signaling, communication, overhead catenary system, and traction power;
- Contract 2A: at-grade advanced utilities;
- Contract 7: NCS tunnel ventilation and NCSE jet fans; and
- Rail procurement: girder rail advance procurement.

Contracts 1 and 1A

It was decided to keep the tunnel structure as a separate contract because this was special work from the other construction and could be done in advance of the other construction and be ready in time when the Contract 2 contractor needed to tunnel to complete their work. It also had no interference from the Route 21 construction by NJDOT as will be discussed under Contract 2. Contract 1A provided for the advance relocation of the utilities that interfered with the tunnel construction. This helped expedite the actual construction of the tunnel.

NJ Transit negotiated with the City of Newark to close Mulberry Street between Raymond Boulevard and Park Avenue and with St. Johns Church, PSEG, and Episcopal House for temporary parking during construction. Therefore, the tunnel design provided for cut and cover construction using soldier piles and lagging. Access needed to be maintained to the few driveways within the project site. In areas close to existing buildings, the design provided a suggested method of underpinning the structures. Also where the new structure connected with the existing turnout tunnels close to the main NCS tunnel, a method was proposed to underpin and jet grout the existing tunnel structure.

As part of the new tunnel structures, an underground ancillary structure was also constructed. This structure contained a train control room, electrical substation, ventilation room, and pump room. Contract 1 was responsible for equipping and connecting up the electrical substation, ventilation room, and pump room. All remaining work within the tunnel was the responsibility of Contract 2.

While the tunnel could be constructed independent of the Route 21 construction, this was not true of the open-cut ramp area between the portal and Center Street. This work was included in Contract 2 because it depended on the Route 21 relocation.

Contracts 2 and 2A

The surface segment of the alignment posed several challenges for the design team. The proposed LRT will run on existing streets through downtown Newark. The need to create an environment where all elements can coexist is referred to as “urban fit.” These elements played a significant role in the design and were decisive in selecting embedded track for all the trackwork and standardize fluted poles for the entire system.

Since the design provided for the alignment in the existing southbound lanes of Route 21, coordination with NJDOT was a major issue during the design period. Many meetings were held between NJ Transit, NJDOT, and the two design firms. At one time NJDOT was going to prepare the trackway subgrade for the at-grade contractor. However, it was eventually determined and agreed that the NJDOT schedule would allow Contract 2 to enter the abandoned roadway in time to do all their work.

In the same area of Route 21 is the NJPAC. It was necessary to evaluate potential noise and vibration impacts to the existing NJPAC building, a possible future concert hall, churches, and a school. With the assistance of BRW/PB JV's noise and vibration consultant, Wilson Ihrig & Associates, Inc. (WIA), a floating slab was designed adjacent to the NJPAC building and future concert hall. WIA also provided recommendations for rail fasteners in the open-cut area adjacent to St. Johns Church.

The construction of Riverfront Stadium was occurring at the same time that the NCSE final design was proceeding. The design team worked together with the stadium architect to set aside an area in front of the ballpark for the light rail transit (LRT) alignment. This required that a revision in the preliminary engineering alignment and roadway configuration in the immediate area. The architect and design team also worked coordinated the civil and landscape architecture in the immediate area.

The LRT system needed to fit into the City of Newark's existing traffic system. BRW/PB JV modeled the existing traffic auto traffic flow by using the Synchro modeling program. This program allowed the engineers to model complex phasing of interconnected multiple signals, which could be adopted for LRVs and auto traffic. The major objective of the traffic analysis was to develop a street running system that maximized traffic signal preemption for the light rail system. In New Jersey, all LRT and traffic signals need to be authorized by the NJDOT traffic department. Due to the high traffic volumes and the need to maintain signal timing, the City of Newark would not permit preemption on the six intersections affecting Broad Street, but did allow it on the remaining six intersections. The process of holding meetings with affected stakeholders, receiving approval of the City of Newark traffic department and submitting the applications to NJDOT was done during the final design process. This resulted in authorizations to install all of the traffic signal systems.

The track structure within the tunnel is composed of 115 RE rail on vibration-dampening direct fixation fasteners. The surface portion is made up of Ri59 girder rail embedded in a reinforced concrete slab. Due to the long lead-time for procurement, NJ Transit purchased the Ri59 separately and provided it to the contractor during construction.

The four stations on the system were designed to have their own identity. The design team's architects, FXFowle and Barton Myers Associates, designed the stations in close coordination with the relative stakeholders and BRW/PB JV. Three artists (Kate Dodd, Willie Cole, and Ron Fisher) chosen by the Transit Arts Committee were part of the station design teams and integrated art into each of the station designs.

The northern end of the line terminates in front of the former DL&W RR historic Broad Street Station. As a result, New Jersey State Historic Preservation Office approval of the station design was required and obtained. The station at Center Street is immediately adjacent to the NJPAC and care was taken to ensure that its design blended in with the architecture and finishes of that building.

Trolley wire was used throughout the at-grade segment of the project due to aesthetic reasons. The trolley wire is fed by an underground traction power dual cable system. A traction power substation located near the new Broad Street Station feeds the traction power cables. Since the substation is located adjacent to the historic Broad Street Station, it was designed to blend into the surrounding area. In the underground portion of the project, a catenary with feeder and contact wire was designed. The catenary needs to work in conjunction with the new overhead contact trolley system recently installed in the existing NCS tunnel.

Line-of-sight operation will be used throughout the at-grade segment. One set of signals is located on the tunnel ramp and another set at the portal. Central instrument houses for the crossovers are placed between Fulton and Lombardy Streets and at Broad Street Station. Since the entire at-grade trackway is embedded, embedded switch machines were provided at each turnout. In the tunnel, topside signals controlled by the train control room are used. These signals have been integrated with the new signal system in the NCS tunnel.

As with most dense urban environments, downtown Newark was laced with a myriad of underground utilities. Many of these lines had to be relocated to clear the LRT ROW. In the area of the abandoned Route 21, the NJDOT's contractor preformed all utility relocations in advance of the LRT contract. Early in the design stage it was decided that BRW/PB JV would design for and the LRT contractors would construct all necessary publicly owned utility relocations, which were water, storm, and sanitary lines. The privately owned utility companies were responsible for relocating their own facilities.

As with Contract 1, an advanced utility contract, Contract 2A, was awarded prior to main at-grade construction. This contract relocated the city-owned storm and sanitary sewer lines as well as several high- and low-pressure water lines that interfered with the at-grade construction.

As final design neared completion it was determined that the privately owned utility relocations (electric, gas, telephone, cable TV, and fiber optics) could be better coordinated if work was performed under the supervision of a single contractor. Therefore the installation of new manholes and duct lines were added to Contract 2. In some cases the LRT contractor was required to use utility company-approved subcontractors to perform some of this work. Each utility company later installed its own cables and made final connections to its system.

Contract 7

In the mid-1990s, PB for NJ Transit under a separate contract substantially completed the design to upgrade the ventilation in the existing 2.1-km (1.3-mi) NCS tunnel. However, due to funding problems, the design was never completed nor constructed.

When the NCSE design was started, the ventilation for the new tunnel needed to work in conjunction with the new design proposed for the NCS tunnel. NJ Transit decided to add the NCS tunnel ventilation to the NCSE scope of work. The actual scope of work for the NCS tunnel also included an upgrade of the electrical system within the tunnel. A new electrical substation was designed for the NCS tunnel. This substation fed the new ventilators being installed and each of the existing underground NCS stations. Also, since a single PSE&G incoming service feed both the new NCS and NCSE substations, it was decided to interconnect the two substations to provide the system with dual redundant feeds. While Contract 1 provided the conduits within the new tunnel, Contract 7 provided all the conduits with the exiting tunnel and the interconnect cable between the two substations.

The ventilation of the new NCSE tunnels consisted of eight (four pairs of two each) jet fans. Two additional jet fans were designed to be installed in the loop at the existing Penn Station. For the NCS ventilation, small axial fans were designed within the existing ventilator structures. The total system required over 140 of these small (27 and 36 in. in diameter) fans. Using the existing ventilation plants avoided new construction in the congested Newark downtown areas. The jet and axial fans are designed to work together in case of emergency use.

CONSTRUCTION

BRW/PB JV provided construction assistance during construction. This included the review of shop drawings, response to the technical request for information (RFI), and the preparation of Change Notices when required. The design team was also consulted on the field technical matters when requested to do so by the CM. The biweekly PM meeting continued throughout the construction period. The design team also attended construction meetings with each contractor that were held on a regular basis. While the responsibility for each contract transferred from BRW/PB JV to the CM after NJ Transit awarded the contract, the design team continued to remain involved in the project throughout construction and was a critical part of the construction process.

Contract 1

This contract was bid in February 2002 and awarded to EE Cruz and Company. They were given notice to proceed in April 2003. Mulberry Street was closed to traffic in July 2003 and reopened to traffic in January 2005. The work has been substantially complete for some time; however, at the time of this writing the electrical substation still has not been energized so the contract has not been completely finished. The Contract 2 contractor has had access to the tunnel for some time and is processing with their work. The Contract 7 contractor has also installed the interconnect cable between the two substations and the jet fans in the new tunnel roof.

The contractor used the soldier pile and lagging excavation as shown on the plans. However, due to the noise restriction in the immediate area, rather than driving the sheeting during the evening, a special machine was brought in the push the sheeting into the ground. Noise readings were constantly measured and this equipment was able to stay within the guidelines specified in the specifications.

Where the alignment was close to the Episcopal House and One Newark Center parking garage, the design documents suggested underpinning these structures prior to installing the soldier pile and lagging. The contractor proposed a concrete wall using interconnected secant piles in lieu of both the underpinning and soldier piles/lagging. To create the secant pile wall, 18.3-m (60-ft) holes were drilled and 90 cm (36 in) diameter steel casings were installed, 1.2 m (4 ft) on center. As the casings were withdrawn, pulling out dirt from the cavity, concrete was poured in the hole. Steel I-beams were then installed vertically into the fresh concrete. The process was repeated with a second set of piles in concentric circles overlapping the first set. No I-beam was installed in the second set of piles. This method formed a continuous concrete wall. The contractor's engineer provided calculations for their proposed method. After review by the design engineer, the method was accepted. The buildings were monitored on a regular basis and showed very little to no movement. The method proposed by the contractor worked successfully.

A small portion of the alignment traveled under a PSE&G electrical transformer vault. The design drawings indicated that the vault should be underpinned prior to doing any excavation support work in the area. The contractor's engineer proposed an alternate method. Caissons were installed around the vaults. Then a steel frame was built above the vaults. The transformer equipment was then hung using threaded rods. This support stayed in place throughout the excavation and placement of the new tunnel structure. The vaults were permanently supported from underneath during the tunnel construction and the excavated portions filled in with lean concrete. After the tunnel work was complete, the framework was

removed and the caissons were cut off at-grade. This method was reviewed extensively with PSE&G's engineer and finally agreed to by them. This construction method was also successful.

Another method that was changed from the suggested method shown on the drawings was the connection to the existing southbound turnout tunnel structure. Because of the closeness to the existing NCS main tunnel it was recommended in the documents to place piling and jet grouting under the existing tunnel structure. The contractor's engineer recommended that the first section of the turnout tunnel be constructed by the use of a steel I-beam section similar to the design of the old tunnel replace it. This allowed the actual reinforced concrete connection location to move away from the existing tunnel and thus eliminated the need for the piling and jet grouting under the existing tunnel structure. NJ Transit required the design team to develop the revised contract documents. This was done first by sketches so the contractor could order and install the steel I-beams and then followed through with design drawings issued via a design change notice.

Construction of the tunnel proceeded from the portal to the existing tunnel. At the portal there was one combined structure, which then split into two separate tunnels to connect to the existing inbound and outbound turnout tunnels. The ancillary structure is 30 m (100 ft) long and is adjacent to inbound tunnel about 60 m (200 ft) from the portal. Due to the depth of the inbound tunnel to connect with the exiting tunnel, the contractor was required to install and maintain a deep well system to keep the excavation dry.

The contractor used the bottom up method to construct the entire tunnel. After the invert slab was poured and cured, the bottom temporary supports were removed. The contractor then proceeded to construct the side and center walls and then the roof. Contract 1 made provisions in the roof construction for the future installation of the jet fans by Contract 7. After installing the water proofing material on the roof, the area was backfilled and the surface restored to its original condition.

During construction, the contractor provided temporary parking for the Episcopal House and St. John's Church. Also St. John's Church has a feed-the-hungry program that needed to be maintained during the construction period. The entrances to the independent and PSE&G parking garages were maintained at all times. NJ Transit made provisions for the use of the vacant space at the northeast corner of Raymond Boulevard and Mulberry Street as a staging area during construction.

After construction of the tunnel structure, the dry standpipe system and lights were installed in the tunnel. Also, the electrical and mechanical equipment was brought in through the tunnel to equip the substation, ventilation room, and pump room.

Contract 2

Bids were opened for the surface contract in July 2003 with a Notice to Proceed coming that September. Contract completion is scheduled for June 2006. There were two major schedule restrictions in this contract. The first was that the contractor could not have access to the ROW along the abandoned section of Route 21 until the contractor no longer needed it for traffic detours in June 2004. The second was that the contractor would not be guaranteed access to the tunnel being constructed under Contract 1 until October 2004.

This initial task facing the contractor was the relocation of underground utilities to clear the ROW for track construction. This work required a number of field design changes since once construction began, it was discovered that, despite close coordination with the utility companies

and a significant subsurface exploration program during design, a number of lines were not in the anticipated locations or were significantly different than what was shown on utility record drawings.

Prior to beginning track construction along the west side of Broad Street, the contractor had to first relocate the curb on the east side in order to create an additional traffic lane to make up for the one lost to the light rail trackway. At several buildings, sidewalk transformer vaults were reconstructed.

Prior to the start of construction, a campaign to inform property owners, tenants, and other stakeholders of upcoming construction activities was established. Owners and tenants were consulted to ensure their building access requirements were met while the sidewalks in front of their buildings were reconstructed. This effort continued throughout construction.

The portion of the ROW in front of Riverfront Stadium is through an area where a number of buildings had been demolished years earlier. In this section a number of abandoned basements were encountered. A significant unanticipated item was the number of abandoned oil storage tanks discovered. The contents of each tank had to be tested and disposed of within NJ Department of Environmental Protection regulations.

As can be expected with construction in downtown Newark, a well-executed traffic control plan is essential. In this regard the NJDOT Traffic Department was extremely cooperative and helpful, both when developing the proposed detours and street closures and later providing the flexibility that is needed during construction.

Prior to the start of construction, Broad Street was a major six-lane wide access route into Newark with the two center lanes being reversible to provide four lanes in the direction of rush hour traffic. The sidewalk was reduced in width on the east side of the street and a parking lane eliminated so that six traffic lanes will remain during and after construction of the light rail line on the west side of the street. While the city has subsequently decided to eliminate the reversible lane operation, it has requested that the contractor maintain this operation during construction especially during the numerous long-term lane closures.

Contract 7

This contract was bid in March 2003 and awarded to Daidone Electric, Inc (DEI). DEI was given notice to proceed in July 2003 and the work is scheduled to be substantially complete in spring 2006. At the time of this writing, all the major electrical work has been completed, the new substation is energized, the axial fans have been installed, the jet fans have been installed, and testing of all the components should begin in March 2006.

The installation of the new electrical conduit and cable throughout the existing NCS tunnel required close coordination with NJ Transit Operations. The NCS operates from 5:00 a.m. to 1:00 a.m. For many months each evening, NJ Transit began a single-track operation around 9:00 p.m. to allow the contractor to first install the conduits, then pull the cable, and then install the axial fans. The contractor needed to be completely off the site so normal operations were able to begin in the morning. Single-track operations were also available on some weekends for extended work.

The jet fan installation in the new tunnel and the pulling of the cable to the substation located in the new tunnel required coordination with the Contract 2 contractor. The two contractors worked together for the successful completion of these tasks.

SUMMARY

The NCSE light rail project will offer a direct link between two of NJ Transit's major hubs in Newark, Penn Station, and Broad Street Station. Along the way, the new segment will also serve Newark attractions such as the NJPAC, Riverfront Stadium, the Newark Museum, and the Broad Street business district. The alignment was able to thread a needle through a dense urban environment while minimizing impact on the community and existing structures.

The project is on track to begin revenue service by June 30, 2006. Final systems testing is scheduled to begin in April and the NCS operator training with simulated service is scheduled to begin in May.

Along the way there have been a few unanticipated hurdles that could prove instructive for future projects.

There is no substitute for getting detailed existing utility information along the project site during design including doing exploration of underground utilities in areas of potential conflicts. It was found that utility record drawings could not produce the accuracy needed to properly identify all underground systems, either in plan or elevation.

The utility agencies need to be brought into the design process at an early stage and their efforts have to be monitored as closely as any other member of the design team. In a few cases, utility companies acting independently of each other proposed relocations that were in conflict with other companies.

The municipality and stakeholders need to be part of the design process from the very beginning. All agreements and review comments also need to be properly documented and kept in the project files. This is especially important as property owners and building users will change over time and agreement terms that were acceptable early in the project-planning phase may become unworkable during construction.

All property and easements acquisitions should be available to the contractor at the start of construction. If not available immediately, the contract documents should indicate when specific parcels or access to work by others would become available to the contractor.

The contractor, CM, designer and owner need to meet regularly to discuss project issues. Formal partnering sessions at least quarterly are also advisable.

Light rail in an urban environment is usually at-grade. The designer and municipality need to work together to resolve traffic issues during the design phase of the project.

REFERENCES

1. Berliner, H. L. Newark–Elizabeth Rail Link Minimum Operable Segment-1 Final Design and Implementation. Presented at APTA/TRB 9th Annual Light Rail Conference, November 2003.
2. Lutin, J. M. Newark–Elizabeth Rail Link's First Operable Segment Completion of Planning and Environmental Impact Statement. Presented at APTA/TRB 9th Annual Light Rail Conference, November 2003.
3. Newark Builds Light Rail Link Downtown. *New York Construction Magazine*, May 2005.

Open and Closed Market

The Case for Contracting

OPEN AND CLOSED MARKET: THE CASE FOR CONTRACTING

Contracting and Tendering Practice
The Case of Stockholm

GUNNAR SCHÖN
Veolia Transport

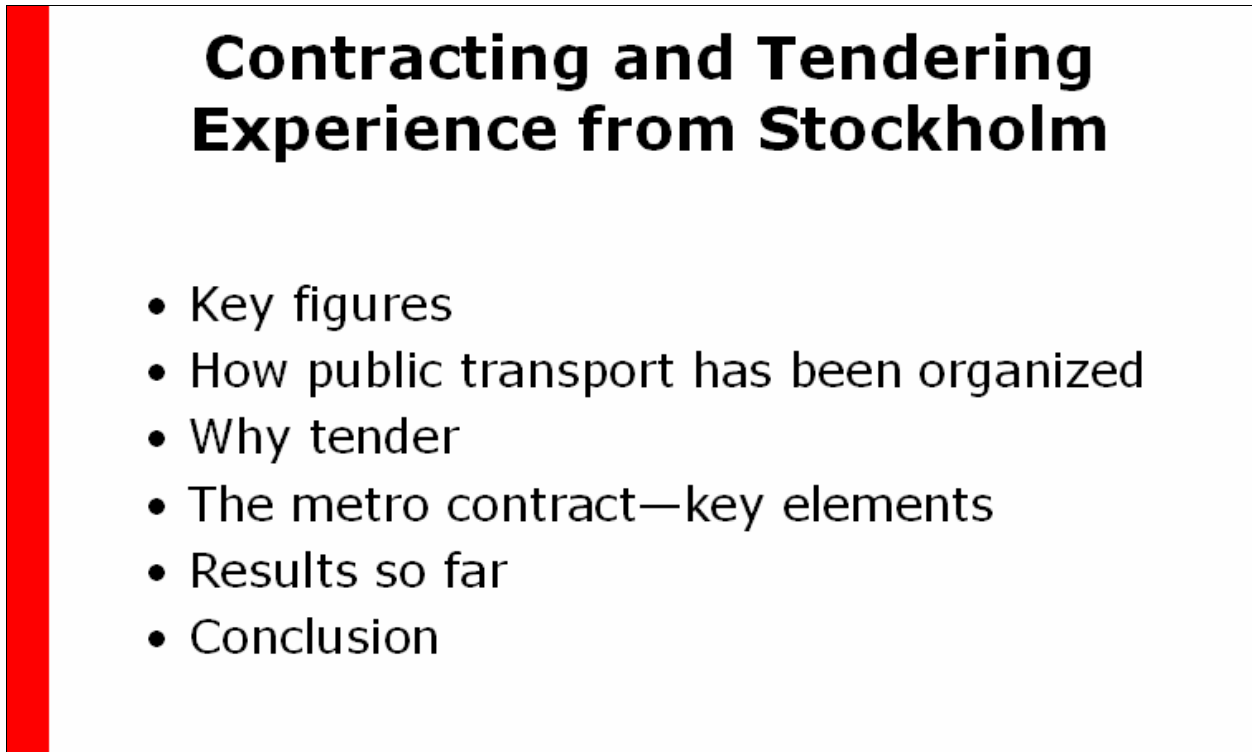
**Contracting and
Tendering Practice**
The Case of Stockholm

Presented by
Gunnar Schön
Development Director
Northern, Central Europe and the Pacific Area
Veolia Transport

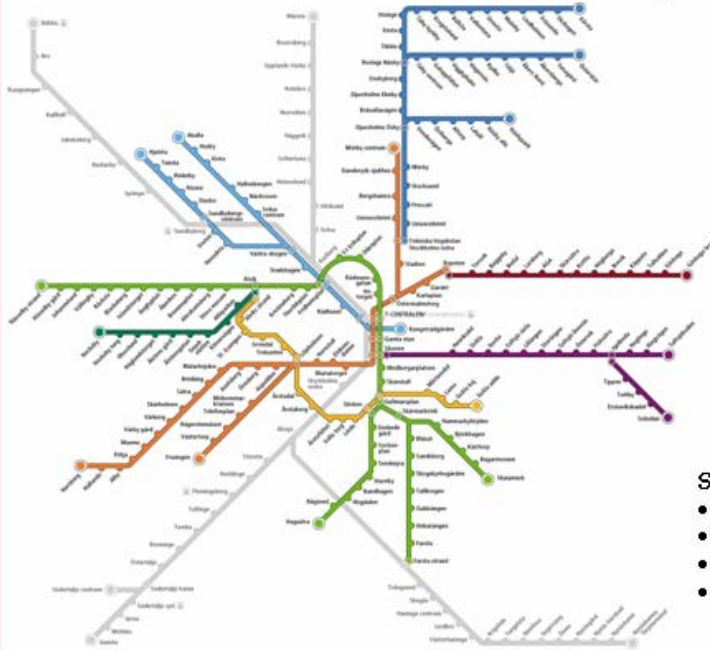
Gunnar Schön, Veolia Transport
UITP, Contracting & Tendering practice
April 2006

1 -





Stockholm County Rail Network



 	subway
 	light rail
	suburban train
	commuter train

Stockholm County:

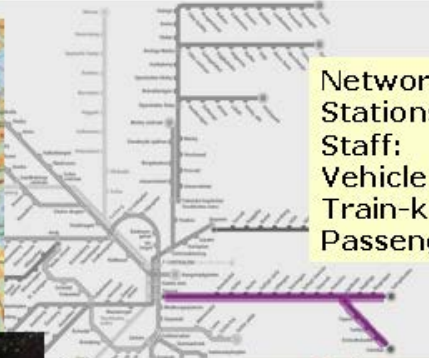
- Municipalities: 26
- Area: 6,500 km², 2% of Sweden
- Inhabitants: 1.85 million, 21% of Sweden
- PTA: SL, StorStockholms Lokaltrafik

The Metro

Network: 113 km
 Stations: 100
 Staff: 2,820
 Vehicles: 535
 Train-km: 12.2 million
 Passengers: 279 million



Saltsjöbanan – Local Train



Network:	18 km
Stations:	18
Staff:	100
Vehicles:	30
Train-km:	0.6 million
Passengers:	5.2 million



Lidingöbanan – Light Rail

Network:	9 km
Stations:	13
Staff:	80
Vehicles:	19
Train-km:	0.4 million
Passengers:	2.4 million

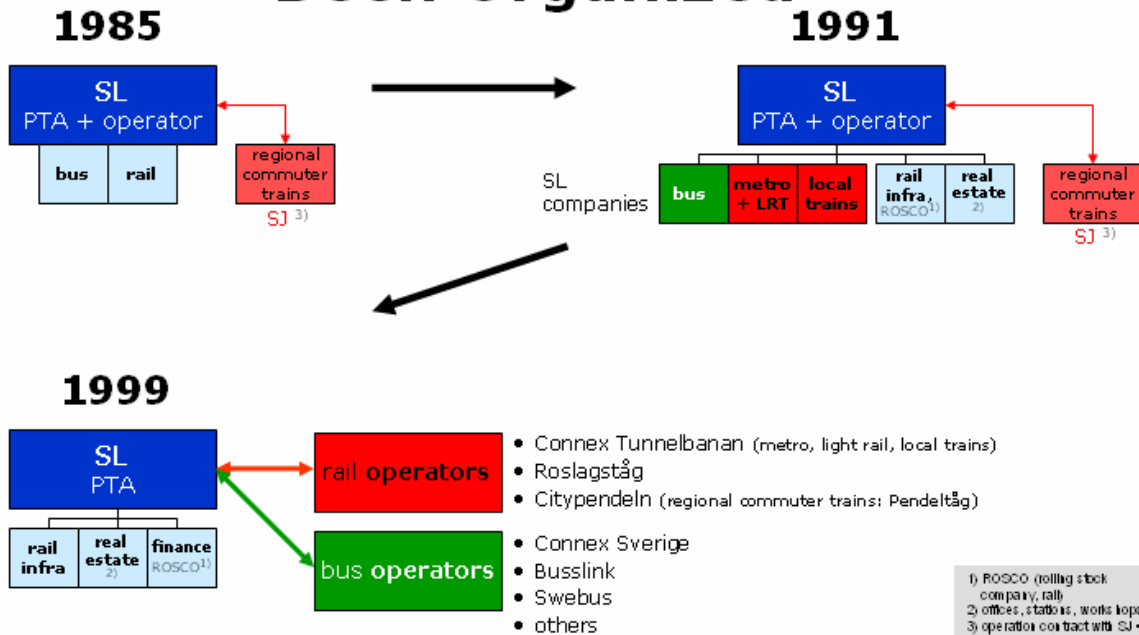


Tvärbanan – Light Rail



Network:	17.1 km
Stations:	27
Staff:	100
Vehicles:	28
Train-km:	1.3 million
Passengers:	10.7 million

How Public Transport Has Been Organized



Why Start a Tender Process?

- Decrease costs
- Increase service volume
- Increase service quality

Stakeholders

- The passengers
- Employees
- Unions
- Politicians

Tender Process, Key Issues

- How to create a market?
- Bus and rail separated
- 20% per year
- Risk sharing
- Incentives
- How to avoid private monopoly

Tender Process

- 1992: First tender launched, buses and light rail
- 1993–1995: The 3 metro lines in separate tenders
- 1997: Tender for Roslagsbanan
- 1998: Tender for commuter trains
- 2000: Recurrent process for tender
- 2000: Privatization process starts

Why Privatization?

- Credibility
- The market was created
- Quality improvement needed
- Two different roles

Privatization of Tunnelbanan AB

Phase 1, January to July 1999

- Prepare the target
- List of acceptable partners
- Strong track record as rail operator
- Focus on takeover plan

Privatization of Tunnelbanan AB

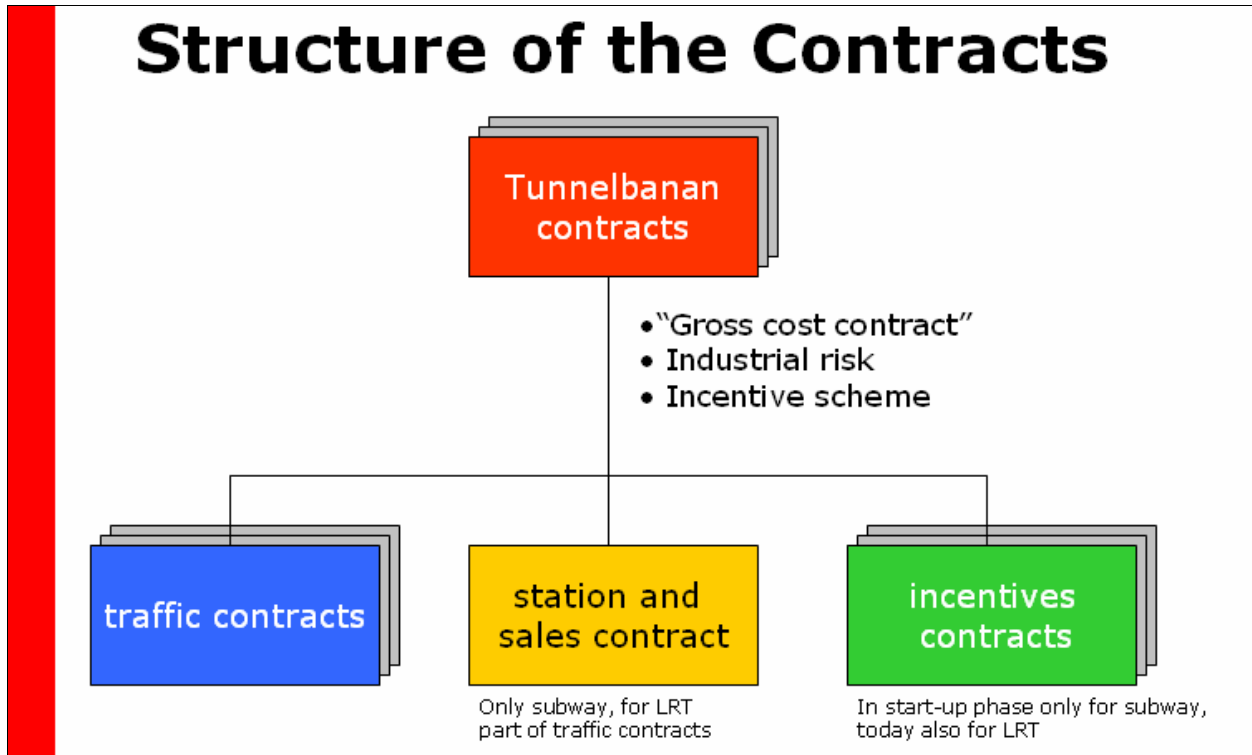
Phase 2, July 1999

- CGEA buys 60% of the shares
- Put and call option 2002 triggered by performance

Privatization of Tunnelbanan AB

Phase 3, Spring 2002

- Quality performance reviewed
- Option triggered
- Remaining shares sold
- Contracts prolonged



- ## Key Elements of the Agreements
- Volume of traffic, train hours
 - Frequency and service hours
 - Train length, capacity
 - Punctuality
 - Rolling stock rental
 - Real estate rental
 - Track access
 - Incentive scheme

Results So Far

- Cost per seat-km reduced by 25%
- Service volume increased by 10%
- Service quality stable

Results So Far

- Customer satisfaction index, 42% to 64%
- Reduced fraud, 27% or more in some areas
- Cleanliness, from 4 to 7.5 on a 10 grade scale
- Staff behavior, from 5 to 8 on a 10 grade scale

Conclusion

- Tendering is a very effective tool
- All stakeholders must be involved
- Make sure you have a market
- Give the operator a strong reason to care about the passengers

OPEN AND CLOSED MARKET: THE CASE FOR CONTRACTING

Open and Closed Markets
NJT Light Rail Contracts

JOSEPH NORTH
New Jersey Transit



Open and Closed
Markets

NJT Light Rail Contracts

APTA TRB UITP

St. Louis, MO
April 2006

Agenda

- Overview of NJT Light Rail Services
- Contracted Services Discussion
 - Hudson Bergen
 - River LINE
- Lessons Learned
- Comparison to European and Asian Outsourcing
- Conclusions

Overview

NJ Transit operates three light rail systems

- Newark City Subway
- Hudson Bergen Light Rail
- River LINE



Overview

Directly Operated—Newark City Subway



Overview

Outsourced Operations—Hudson Bergen

- 21 mi
- 23 stations
- 52 light rail vehicles (LRVs)



Overview

Outsourced Operations—River LINE

- 34 mi
- 20 stations
- 20 diesel LRVs
- Shared-freight right-of-way (ROW)



Contracted Services

When NJ Transit first considered implementation of its new light rail services, experiences in Europe and Asia provided various outsourcing examples:

- Design–Build
- Design–Build–Operate
- Design–Build–Operate–Maintain
- Build–Own–Operate–Transfer
- Design–Finance–Build–Operate–Transfer

Contracted Services

NJT selected Design–Build–Operate–Maintain (DBOM) as the approach best suited for the U.S. market.

- **Single contractor**
- **Parallel design and construction reduced schedule**
- **Operating and maintenance (O&M) responsibilities provided incentive for good design and material choices**
- **No design omission or defect claims**
- **Integration risk placed on DBOM contractor**

Contracted Services

DBOM balanced the risk appropriately from a business perspective for NJT.

- **No capital funds from contractors**
- **Fixed O&M payments**
- **No revenue risk for contractors**
- **Modest bonus/penalty provisions**
- **Relatively short O&M term**
- **NJT/State of NJ provided liability insurance**

Contracted Services

Hudson Bergen was the first U.S. experience with DBOM.

- 41 months from NTP to first phase operation
- Six additional extensions from November 2000 to February 2006
- Challenges
 - Civil work
 - Real estate
 - Relocating freight
 - 4600-ft tunnel
 - Environmental



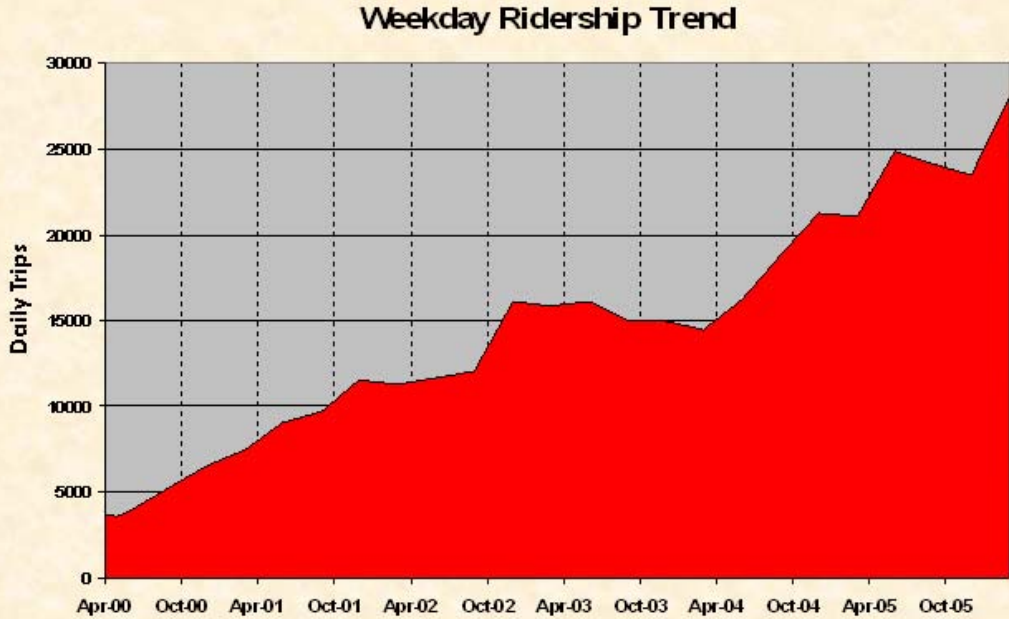
Contracted Services

The project was a contracting success and there has been a strong positive public reaction to the service.

- \$2 billion project with no litigation
- On-time performance sustained at 98% to 99% for 5 years
- Spurred economic development
- Ridership growing quickly with each operating phase

Contracted Services

Hudson Bergen has experienced continual ridership growth.



Contracted Services

NJT also chose a DBOM strategy for River LINE.



Contracted Services

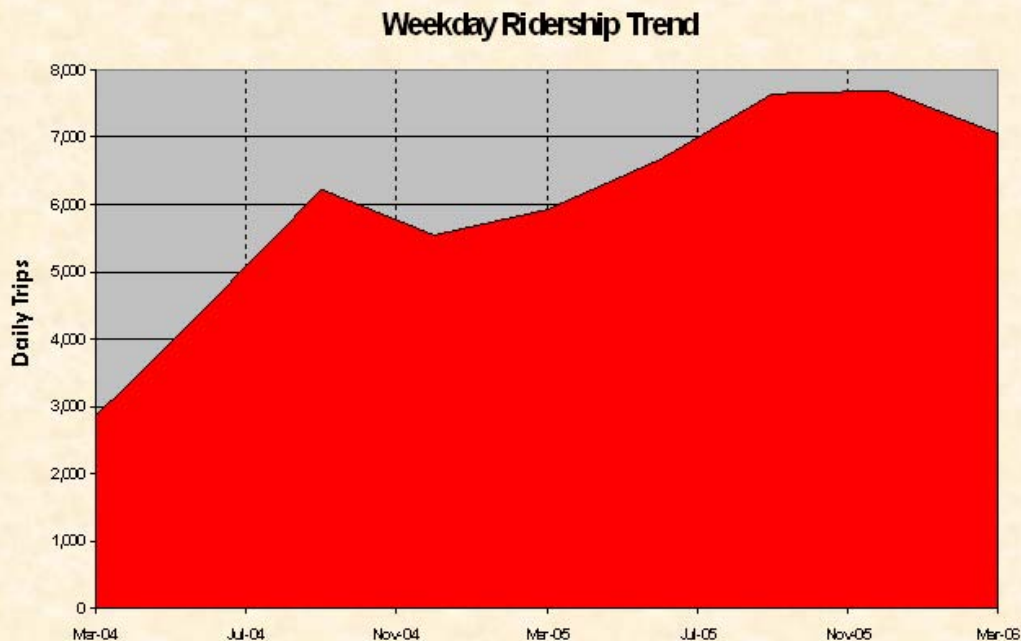
Early River LINE results are promising.

- Excellent service delivery
- Positive reaction to diesel LRV
- Positive impact on local redevelopment
- Exploring new concepts of shared-use operations



Contracted Services

River LINE ridership is exceeding expectations.



Contracted Services

But... River LINE has also had its challenges:

- Revenue-ready service scheduled for December 2002—service started March 2004
- Owner and contractor in litigation



Lessons Learned

These projects provide valuable lessons to future outsourced operations...

- U.S. market conditions in mass transit limit outsourcing options
- Owners and contractors are risk adverse:
 - High reliability specifications
 - Short O&M terms
 - Agency branding of service
 - Fixed payments
 - Imbalanced incentives and penalties
- Qualified O&M service providers are limited and turnover is high

Lessons Learned

... and point to contract terms that could be revised for improved benefit to the owner.

- Longer O&M terms needed
- Integrated DBOM teams are essential
- More structured price proposal requirements needed to reflect differing capital and operating funding constraints
- O&M contract management is different from CM on the design–build phase and contracts need to reflect that

Contrasts with Overseas Experience

Europe and Asia outsourcing terms are often more aggressive.

- Longer O&M terms—30+ years not unheard of
- Contractors accept revenue risk
- Contractors provide capital financing
- Owner relinquish more design and operating decisions
- Contractors brand their service offering (e.g., Virgin Express)

Conclusions

There is a role for outsourcing in the U.S. transit market.

- **Some outsourcing is good, especially for large owner-operated systems or small management-only agencies.**
- **Contractors can attract better candidates for technicians and have a training advantage.**
- **Renegotiation of business agreements is easier than labor agreements.**
- **Like any project, the actual results depend on the participants.**

OPEN AND CLOSED MARKET: THE CASE FOR CONTRACTING

Contract and Tendering Practice
The Case of Nottingham

FRANÇOIS-XAVIER PERIN
Transdev PLC



CONTRACT AND TENDERING PRACTICE
THE CASE OF NOTTINGHAM

Francois-Xavier Perin
Chief Executive Transdev Plc



 p. 1

TRANSDEV PRESENTATION—GENERAL

- Bus, coach, ferries, tram, and train network operator
- Turnover €1.3 billion
- Operating in seven countries via 80 subsidiaries and 25 mixed-equity companies
- Carrying over 3 million passengers per day
- 21,600 employees and 8,000 vehicles



TRANSDEV PRESENTATION—TRAMS



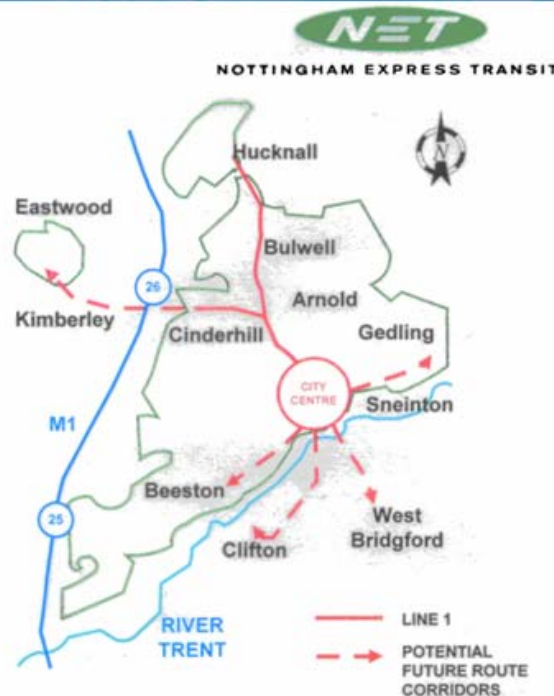
- Eight tram and light rail systems in operation worldwide—Grenoble, Melbourne, Montpellier, Nantes, Nottingham, Orleans, Porto, and Strasbourg.
- Seven tram systems/ extensions undergoing construction.
- Nottingham tram built as a PFI project; Edinburgh and Tenerife are early operator's involvement.

NOTTINGHAM EXPRESS TRANSIT A BRIEF (!) HISTORY

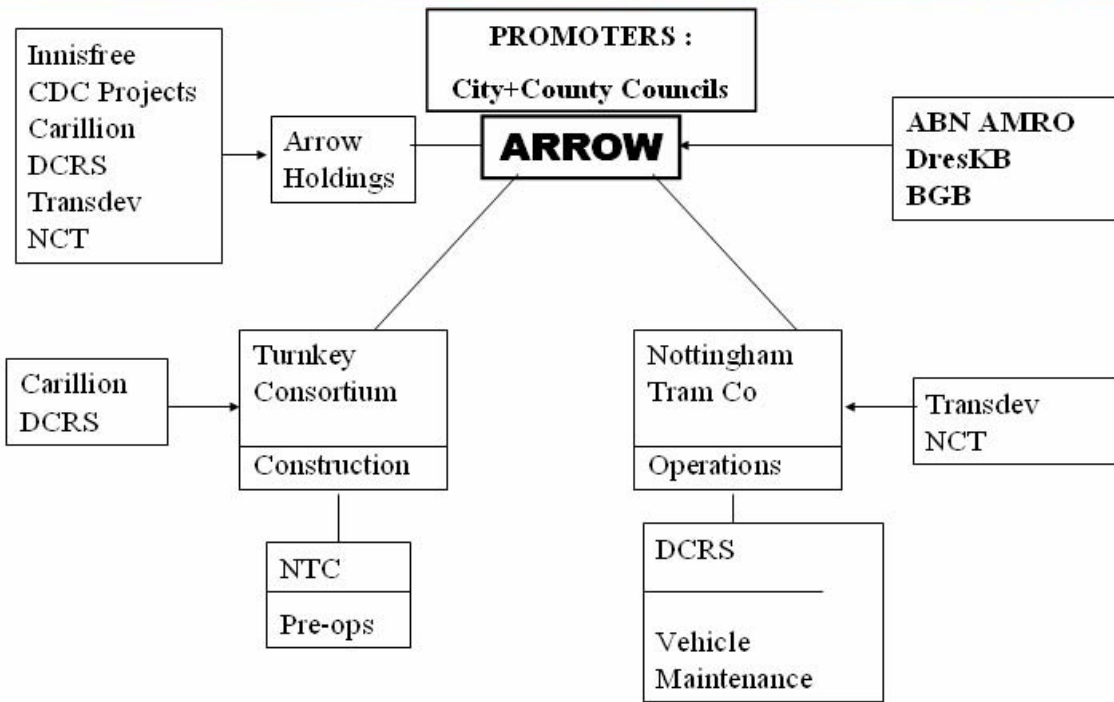
- 1989: Council decision
- 1994: Act of Parliament
- 1995: Invitation to tender
- 1997: Arrow declared preferred bidder
- 1998: Government's approval
- May 2000: Financial close
- March 2004: Start of commercial operations
- November 2030: End of concession

TECHNICAL

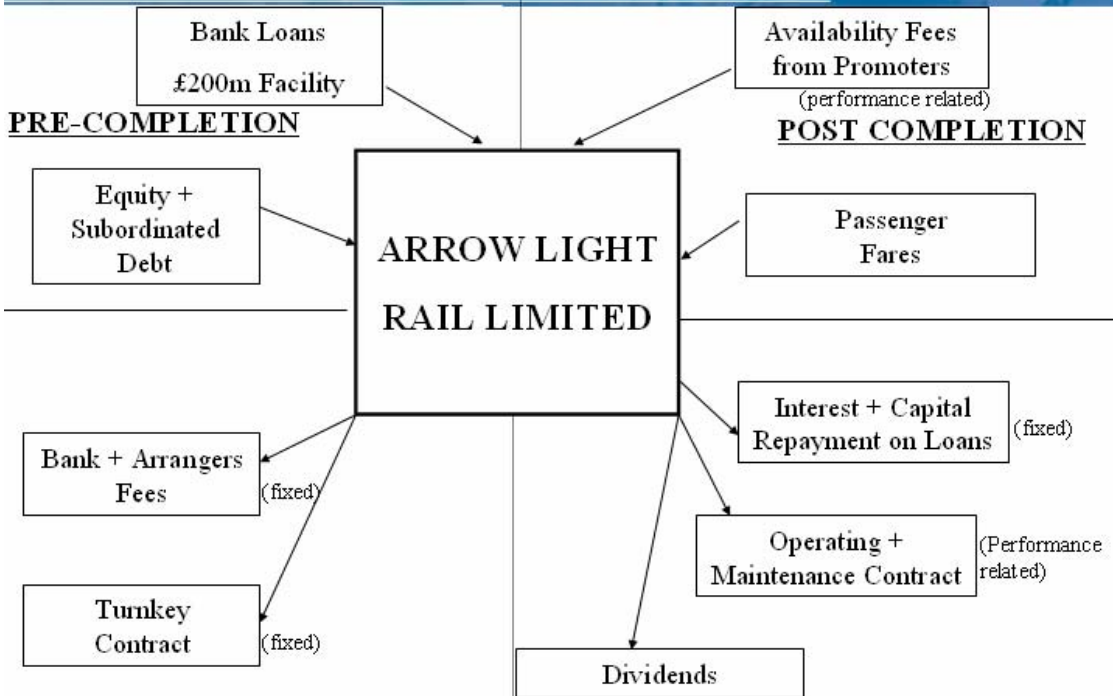
- 14-km system
- 8-km rail alignment
- 4-km on-street
- Three termini
- 23 stops
- Five park-and-ride sites (3,200 cars capacity)
- 11.6 m passengers/year
- 15 Incentro trams
- Roving conductors



LEGAL STRUCTURE



FINANCIALS





COMPARISONS WITH OTHER SYSTEMS

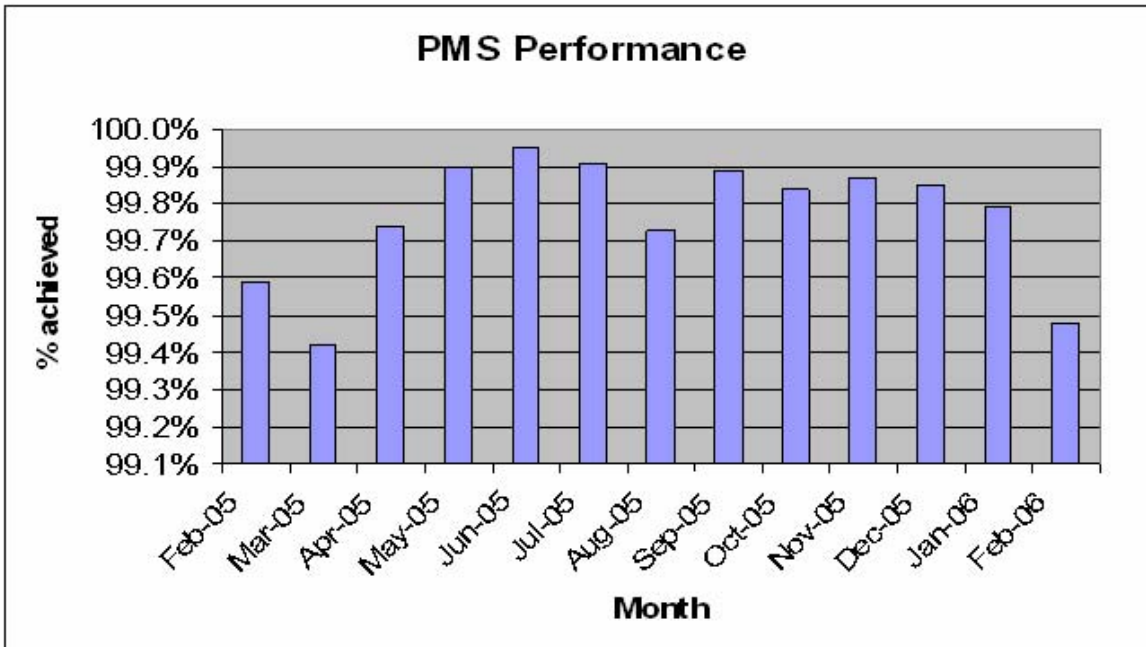
	NET	Manchester	Sheffield	Birmingham	Croydon
Route km	14	39.2	29	20.1	28.2
Stations	23	36	47	23	38
Fleet	15	32	25	25	24
Average fare	0.83	1.12*	0.66*	1.02*	0.80*
P&R	3200	700	1200	450	

* 2002 figures

CONTRACTED FOR PERFORMANCE

- Driven by 23 monthly KPI (of which 85% timetable related)
 - Trigger availability fee deductions
 - Maximum deduction of 20% of the operator's fee
 - Cascaded to the maintenance provider
- ↓
- Over 99% global almost from Day 1
 - Average monthly reliability at 99.7% for the last 12 months

AND PERFORMANCE IS DELIVERED!





CONTRACTED TO DELIVER ON TIME

- Risk transfer to operator at commissioning.
- Turnkey to satisfy three main tests:
 - Run time satisfaction,
 - Performance monitoring system satisfaction for 28 consecutive days, and
 - Reliability tests of eight major subsystems.
- Performance deductions shared 50/50 between turnkey and operator between tests 1 and 3.



CONTRACTED TO DELIVER ON TIME

- 4 months late despite an initial relaxed program of 42 months.
- Liquidated damages mechanism has put appropriate pressure on turnkey, but not early enough.
- Overall performance has reduced ghost running from 13 to 9 weeks without compromising on key issues.



CONTRACTED TO DELIVER QUALITY

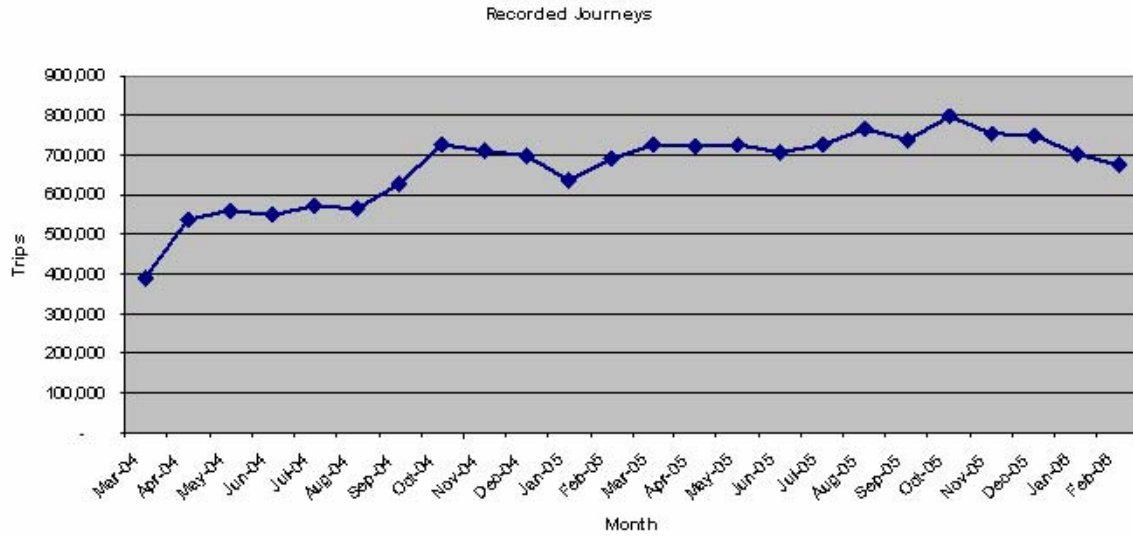
- Design control rests with contractor along with design risk—to an output specification.
- Completion tests now passed.
- Lenders had a much greater influence over completion tests than either the promoter or the operator.
- Operator strongly incentivized by performance-based payments.



LESSONS LEARNED

- Conflicting interest can be reduced by better coordination on the ground by good managers with the right powers.
- A number of issues relate to an imprecise input specification.
- Some of the operators' early comments have proved to be of value to constructors and not gold-plating.
- Operator removed some gold-plating in the initial stages put by constructors.

WITH THE RESPONSE OF THE MARKET



Regulations and Standards

REGULATIONS AND STANDARDS

Regulations and Standards *A Double-Edged Sword*

PAUL K. STANGAS
Booz Allen Hamilton

The purpose of this research was to examine evolution and development of regulations and standards that affect public rail transportation systems and agencies. Additionally it should enhance understanding of those effects, the costs and benefits and define the applicability of regulations and standards.

It explains the role of regulations and standards. It discusses the negative impacts and costs and how they help or hurt. The difference between regulations and standards is explained and as well as their influence on capital and operation and maintenance costs incurred by an agency.

Regulatory entities are listed, and the scope of their authority and the process (including all appropriate federal and state agencies) are described. Standards setting entities are identified and their role and process is discussed. The evolution of regulations and development of standards are reviewed.

Successful or beneficial experiences with standardization and regulation are mentioned. Current Railroad Safety Advisory Committee activities and progress on regulations are reviewed in addition to current and future APTA standards development activities. The safety benefits of regulation are highlighted.

The paper also identifies the “unintended” consequences of regulations and standardization, or complications and conflicts between regulations and standards if any. Constraints on the application of rail equipment and technology are reviewed. The “stakeholders” in regulatory and standardization process are summarized.

The reactive nature of regulations is explained, and the technical/economic incentives for standardization are noted. Positive and negative aspects of regulations and standards are highlighted. Some candidate issues for regulations are recommended. Process improvements in establishment of regulations and standards are suggested.

INTRODUCTION

This paper examines the evolution of regulations and standards to better understand their impact on public rail transportation. These increasingly complex requirements encompass all aspects of rail fixed guideway systems. These requirements extensively pervade both technology and management policy. A clear and enhanced appreciation of regulations and standards, their development and effect on operating agencies is necessary for managing, designing and operating a modern transportation system.

Key “stakeholders” in the regulatory and standardization process include (besides the regulators) the operating agency, vendors, consultants, employees, oversight entities, and of course passengers and the general public, all of whom have a legitimate interest.

Practically, regulations cover a wide range of equipment and operations with a “one size fits all” approach. Additionally regulations and standards can be “double edged” partially as a result of “unintended” consequences arising from their interpretation and application. Furthermore, in pursuit of safety, regulation tends to add complexity and cost to any project. Ultimately it can be difficult to quantify the safety benefit in relation to the added cost.

Over the past decade the FRA has revised and issued new regulations relating to passenger equipment safety, emergency preparedness, engineer certification, signaling and train control, and all other aspects of railroad operations. Recent FRA and FTA policy have had the effect of increasing the reach of regulations by more broadly defining FRA interests with respect to rail fixed guideway transportation systems. Similarly, APTA has increased its efforts and participation in the regulatory and standard setting processes. While the application of new regulations to all equipment lowers the unit cost, this creates upwards pressure on the cost of acquisition, operation, and maintenance

A significant impact of these developments falls on shared track or even shared corridor operations in service or under consideration, because current federal regulations require light rail vehicles (LRVs) and freight vehicles to meet rail safety standards of the FRA when they share the general railroad corridors in integrated operations.

A useful discussion should identify key regulatory entities; describe their scope of authority, and process of creation. Similarly, for organizations that establish standards, their role and process should be identified. To better understand these aspects of regulations and standards they are addressed in the following manner:

1. Objectives—this section summarizes the purpose of this review and provides some fundamental assumptions and definitions to aid in understanding the topic
2. Background—this provides a brief explanation of the history of regulations, leading up to the current regulatory climate.
3. Regulations and standards—this section looks at regulations (primarily Federal and some state) standards, the development process of regulations and standards, the “stakeholders” in the process.
4. Perspectives on regulations and standards—this provides comments, illustrative examples of the results of regulations and standards, and a discussion of trends and anomalies.
5. Conclusion—contains conclusions about their effects, and suggestions to improve the process and results.
6. Appendices—the appendices includes agency definitions, lists of FRA, FTA, Environmental Protection Agency (EPA), Occupational Safety and Health Administration (OSHA) regulations, and Americans with Disabilities Act (ADA) requirements.

OBJECTIVES

Purpose

1. To initiate and advance transportation projects, agencies, vendors, planners, and consultants benefit from established, consistent guidelines. These contribute to a reasonable

assurance of successful completion and budgetary control. Specificity and clarity with respect to governmental requirements that can minimize unanticipated costs or delays are advantageous to any project.

2. Nevertheless, project sponsors should recognize the cost and schedule impacts arising from compliance, especially the virtually “perpetual” operating and maintenance costs. Regulations create major hurdles to the development and commencement of rail transportation in a conventional railroad environment, but the effects are magnified in non-traditional environments, such as shared track or corridor with non-FRA compliant equipment. Standards can have a similar but lesser effect and therein lies “unintended consequence,” i.e., the other edge of the sword, in other words, the “downside.”

3. Surely the primary objective of regulations and standards is not to drive up costs, or create an “exclusive” club; there is a direct cause-effect on project expenses. This examination focuses on four primary objectives that help explain how and why this happens:

- Explain the purposes of regulations and standards and clarify the differences
- Recognize authorities responsible for regulations and standards; identify the stakeholders, and explain the process
- Acknowledge the positive and negative effects of regulations and standards
- Discuss achieving regulatory goals, and consider alternate or more focused approaches

4. Compliance with regulations and standards directly increases the “cost of entry” for those building or maintaining transportation systems. In fact, the desire for relief from regulation is often driven by the potential cost savings arising from non-compliant alternatives to regulatory conformity and the need for more flexibility in addressing local transportation needs with low cost solutions that use available resources.

Assumptions and Definitions

A common understanding of terminology and certain underlying assumptions are presumed in this context. Rail fixed guideway systems is a generic term used here to encompass commuter rail, heavy rail (rail rapid transit), and light rail modes. The term comprises systems, technology, components, operations and management in a comprehensive manner.

This discussion emphasizes public rail transportation because of recent higher FRA visibility, technical advances, growing interest in use of non-compliant equipment in a shared track/shared corridor arrangement, inherent structural incompatibility and risk of a collision between light rail and conventional rail equipment, and community focus generated by accidents, project plans, operational characteristics.

Regulations

Their purpose is safety; they are requirements applied to rail transportation systems by governmental authorities legally endowed with the right to enforce them using the force of law. The breadth of regulation tends to impact the interoperability of different equipment serving a single route or traversing a network of routes. Non-compliance is permitted only by explicit non-applicability or legal waiver granted by the issuing authority.

Standards

Their purposes are manifold and varied, and may include elements of safety, efficiency, cost control, technical improvement, labor cooperation, or reduction in risk. They are guidelines and recommended practices voluntarily developed and adopted by operating agencies and government authorities or can be mandated for vendors, consultants, and professional specialists. A rail transit agency can be selective and adopt only certain standards or parts of standards.

Standards typically state what must be done or not done, but may or may not stipulate how it must be done, since there is more latitude in their application to a system or operation. Standards are typically created to establish minimums and common principles of performance, technical compatibility and functionality, while avoiding specific requirements. Standards can be viewed as “best practices” since they are often derived from practical experience. Standards may or may not affect interoperability, since that is not its primary purpose.

Derivative Standards

These are standards that apply to many components and systems that may be universally used in many devices or systems and not limited exclusively to rail transit systems. These are performance, technology, or quality driven standards and are typically cited in most procurement or even vendor documents. They are supplemental or subordinate to the direct standards.

Standardization

This is mentioned to distinguish “standards” from “standardization.” The term encompasses technical features and characteristics voluntarily adopted, which often results in lower cost and facilitates interoperability and interchange. But standardization effectively requires standards so the terms are often use interchangeably. Examples are the track gauge, couplers, conventional block signal system, rules of interchange, technical interface etc. Standardization also provides ready reference designs and requirements for engineers suitable for rail fixed guideway systems. Standardization can contribute to improved safety or reflect standards, e.g., the American Association of Railroads (AAR) has long been active in developing standards, resulting in the “standardization” of railroad systems, technology, infrastructure and procedures. More recently, APTA and the American Railway Engineering and Maintenance-of-Way Association (AREMA) have begun developing standards applicable to heavy rail and light rail, as well as commuter rail systems.

BACKGROUND

Evolution of Regulations

1. The phrase “safety rules are written in blood” unfortunately has been all too true. Accidents and hazards involving employees and the public have driven the regulatory process over many decades. Major incidents including Amtrak–Conrail collisions on the Northeast Corridor (NEC) and accidents involving commuter rail trains at Silver Spring, Maryland, and Secaucus, New Jersey, affecting many passengers in the late 1990s raised the public

consciousness and were the motivation for many new regulations emphasizing their protection. Railway labor added its voice too, accelerating the urgency for more attention to safety. Railroad accidents tend to energize the regulatory process, in a direct and proportional reaction to the severity of the incident.

2. Accidents referred to earlier created urgency for an increased effort by the FRA to develop regulations that focus on passenger safety. In 1996, FRA established the Railroad Safety Advisory Committee (RSAC) to develop new regulatory standards, through a collaborative process, with all segments of the rail community working together to fashion mutually satisfactory solutions on safety regulatory issues. The cooperation and participation of APTA was enlisted in the development of Passenger Rail Equipment Safety Standards (PRESS) standards. APTA provided a forum and a conduit for proposing, discussing and reviewing new regulations and standards for rail equipment, and assessing their impacts on operating agencies.

3. Grade crossings are particularly vulnerable to accidents and incidents primarily due to public behavior and impatience when approaching a crossing. Grade crossing accidents involving trucks, school buses, and recently in an off-crossing train–SUV collision in California have increased the visibility of these events with the public, local officials, the FRA, and National Transportation Safety Board (NTSB). Consequently grade crossings are the subject of significant regulatory attention.

4. Prior to 1998 FRA regulations accommodated two ranges of equipment structural characteristics—under 600,000 lb buff strength and over. This approach suited commuter railroads that operated with compatible equipment on predominantly exclusive track using MU equipment. Now FRA defines equipment tiers by speed, Tier I (below 125 mph) and Tier II (above 125 and below 150 mph) and tailored regulations accordingly.

5. Previously, there were fewer requirements regarding passenger equipment safety or passenger train emergency preparations, so the FRA created two major additions to the regulations: Parts 238 and 239 enhance the passenger safety of vehicles and emergency preparedness. The FRA also revised regulations applying to locomotives, roadway worker safety, and many other aspects of railroad operations. These are codified in 49 CFR Parts 200 through 268, whose scope has expanded in the last decade as a result of severe accidents involving fatalities, serious injuries, and property damage that also complicated the efforts of first responders.

6. The increased level of regulatory interest was reflected in the issuance of the FRA/FTA Joint Policy in 1999, later expressed in Parts 209 and 211 asserting FRA jurisdiction over certain types of systems, specifying the extent of its interest and authority. This policy explains FRA priorities of regulations and reasons for relief. This policy also discusses the relationship and authority of the FRA and the FTA.

7. Ultimately the new policy and regulations broadened scope regulation of rail equipment and operations, and these efforts have taken on greater significance in recent years, particularly where shared track/shared corridor operations exist or are contemplated. This is because the FRA has asserted jurisdiction over certain types of traditional LRT operations already in service as shared track operations (San Diego and Baltimore). More recently shared track–shared corridor systems in Utah and New Jersey have become subject to FRA regulation. Even tourist railroads are subject to FRA regulation if certain conditions exist.

8. As described in FRA's public policy, the FRA maintains jurisdiction and oversees use of the corridors based on regulations, laws, and policies developed during a century of safety oversight of the railroad industry. These current federal regulations require LRV and freight

vehicles to meet rail safety standards of FRA when they share the general railroad corridors in integrated operations.

9. Rail transit systems beyond FRA purview have had only limited federal oversight (via FTA rules) but other approaches are evolving. California has had extensive regulations applicable to its public transit for decades. Additionally some states are considering some form of regulation or oversight as permitted and required by FTA rules, 49 CFR Part 659 (State Safety Oversight). APTA has also developed a PRESS-type process for rail transit outside the scope FRA authority known as Rail Transit Task Force to establish standards and practices applicable to rail transit systems that are not subject to FRA authority.

External Influences on Regulation

1. The threat of litigation can be a motivation for developing regulations and standards, although there may not be universal preference for more regulation rather than less. Railroad system owners/operators are risk averse, because of the open-ended liability potential. This “unknown” can be more of an obstacle to change than regulations. Additionally liability issues raise the question about holding rail transportation systems responsible for the irresponsible actions of others.

2. Public perception regarding transportation of hazardous materials (hazmats), grade crossing safety, local rail system speed limits, and recent accidents all contribute to the impetus for more regulation. Often these perceptions are based on inaccurate or insufficient information, misrepresentation of cause and effect, simple ignorance, and lack of comparative data regarding alternatives. A recent example involves shipments of hazmats; certain jurisdictions are actively trying to ban shipment through their municipalities.

3. Yet the alternative may result in more hazmat movement by truck, or longer, more complex rail routings. Furthermore, all this accomplishes is transferring the risk to another community (although perhaps less densely populated). One cannot authoritatively verify that risk is reduced as the result of a proposed alternative unless a risk analysis is prepared or potential hazards associated with each alternative are assessed and compared.

4. Railroads are regulated as a system, in a comprehensive manner that encompasses vehicles, operations, operator skills, signaling, communications, physical infrastructure, and employee training and behavior. And a risk analysis will consider these factors.

Regulatory Environment

1. Regulation now looms large in every aspect of modern life but that was not always the case. Nevertheless, rail transportation has been subject to increasing regulation for decades. Both regulations and standardization have contributed to improved safety of rail transportation in the United States. The development and application of rules have become progressively more important to both regulators and the regulated because

- The scope and breadth of recent FRA regulations has increased as a result of number of serious accidents and incidents involving passenger operations. The NTSB often initiates and supports these efforts and has become a strong advocate for increased regulation. It is worth noting the NTSB has again repeated “Implement Positive Train Control Systems” in its 2006 list of Most Wanted Transportation Safety Improvements.

- Higher costs of technical complexity, management and administrative burdens that result from regulatory compliance, resulting in extended project durations, and increased operations and maintenance costs over the life of a system.
 - The mixing of FRA-compliant and non-compliant equipment is perceived to be inherently more hazardous to passengers due to incompatible weight, structural, and performance characteristics, hence the effort to mandate certain features to mitigate the potential danger. Regulations pose an additional significant burden when applied to shared operations because of the disparities. The growth of existing and planned rail transportation projects based on shared operations that use a corridor or track also used by FRA compliant equipment with non-FRA-compliant equipment is attractive because rail freight corridors often provide the only transportation links left to connect suburban development in many urban communities. The latest policy change by FRA and FTA (jointly issued in 2000) provides a means of addressing many of these issues.
2. A thorough understanding of regulatory compliance can make significant contributions to timely and cost-effective project delivery. There is a financial incentive to minimize regulatory “reach” because regulations don’t always accommodate local constraints or unique features.

REGULATIONS AND STANDARDS

Federal Railroad Administration: Authority and Regulations

1. The FRA administrator stated recently that its mission is safety—not advocacy.
2. The resulting process fundamentally has been a reactive effort in that the apparent primary cause of an accident leads to a regulation to prevent a recurrence, but it does not always anticipate the next potential hazard. While this action improves one element of safety, it conceivably could impact safety elsewhere and does not fully recognize the burdens to current operators or future systems arising from compliance with regulations. Regardless of these concerns there is no debate that increased regulation has improved safety and reduced accidents and injuries over time.
3. The FRA is headquartered in Washington, D.C., and has eight regional offices strategically located in the United States. The regional offices serve an on-site inspection and reporting function with respect to FRA rules; accident investigations provide direct communication with railroad systems.
4. The FRA asserts jurisdiction over all railroads and corridors considered part of the general railroad network. Recent policy has defined this to include all operations that involve shared track, shared corridors, common grade or track crossings used by multiple systems, or connection between separate systems (e.g., a railroad and a separate rail transit system, not normally subject to FRA regulations). FRA authority encompasses five aspects of railroad systems, these cover rail operations, equipment, facilities, technology, maintenance, training, and record keeping:
 - Motive power and equipment,
 - Operations,
 - Signal and train control,
 - Track, structures, and maintenance of way, and

- Hazmat.

5. The regulations that affect these elements are expressed in the Code of Federal Regulations, Title 49 Parts 200 to 244. Regulation has a direct and comprehensive effect on technology and complexity, training, resources, staffing, management and administration. This discussion does not examine each regulation; the complete list of FRA regulations is in the appendices of this paper.

6. Although there are other Parts, these are the key sections that apply to railroads or rail transit systems subject to their jurisdiction. That jurisdiction is defined in Parts 209 and 211. In those sections there are provisions that define the waiver process. An operating agency can petition the FRA for relief from regulatory requirements, if there is justification. This provides a means of reducing the impact of regulation by eliminating certain requirements if such actions can be shown to be technically warranted.

7. The FRA possesses authority to issue “Emergency Orders” to immediately address a specific situation or particularly urgent hazard. This action bypasses the more traditional means of public notice of proposed rulemaking in the federal register. A list of recent Emergency Orders is in the appendix.

Other Federal Regulatory Authority

In the United States a number of federal agencies have authority for issuing regulations. Authority is divided among the agencies and departments listed below. These agencies are provided direct or indirect enforcement authority through fines or even imprisonment of those subject to the regulations. There also other federal rules that impact rail transportation systems.

1. These are the other primary federal agencies that have either broad or limited regulatory authority over elements of rail transportation systems:

- FTA—limited oversight of transit systems, planning, funding, and regulation limited to designation of state safety oversight departments, regular system audits, and prevention of alcohol and drug use. Cedes certain authority to the FRA for regulation of rail transit systems in accordance with joint policy.
- EPA—regulates certain technical aspects of rail and transit operations and technology, with respect to their environmental impact.
- Federal Communications Commission (FCC)—regulates communications devices and technology used on rail transit systems.
- OSHA—regulates workplace safety of certain employees and their job functions, although certain FRA rules may take precedent.

2. Other federal agencies that influence railroad and rail transit systems include:

- NTSB—investigates accidents and incident above a certain threshold, determines their causes, issues reports that express the need for corrective action, and recommends regulations
- Surface Transportation Board (STB)—an economic regulatory agency that Congress charged with the missions of resolving railroad rate and service disputes and reviewing proposed railroad mergers. It is the successor agency to the Interstate Commerce Commission (ICC). This agency will affect new systems or extensions that involve acquisition or transfer of freight track for public transportation.

3. Finally there are federal rules issued by the Congress and enforced by the federal government which affect rail transportation systems:

- ADA—this is the law that mandates the accessibility of rail transit vehicles, facilities, and offices.
- Federal Employers Liability Act (FELA)—this law provides compensation for railroad workers who are injured as a result of their employment and applies only to railroad employees, subject to FRA jurisdiction.

Regulatory Processes and Stakeholders

1. The promulgation of regulations or standards involves a variety of participants who influence the process for better or worse. All are stakeholders in the result. Leading the way are the regulators or those setting the standards. Other participants are operating agencies, manufacturers, trade groups, labor unions, and perhaps consultants. State and local governments sometimes play a role. Those directly regulated are the agencies and their employees, so there is some overlap between participants and the regulated. Vendors are impacted by technical requirements, and the general public is affected by the application and effectiveness of regulations and standards. Ultimately the cast of characters is diverse, each expressing differing viewpoints.

2. The regulatory approach in the United States has evolved over decades arising from accidents and failures, a desire for enhanced safety, technical advances, increasing complexity, and need for standardization, adaptability, and interoperability.

3. In 1996, FRA established the RSAC to develop new regulatory standards through a collaborative process, with all segments of the rail community working together to fashion mutually satisfactory solutions on safety regulatory issues. RSAC is organized into three working groups and within each working group there are a number of specialized task forces that focus on critical issues or concerns.

- Railroad Operating Rules Working Group,
- Passenger Safety Working Group, and
- Roadway Worker Working Group.

When it is considering issuing or changing a regulation, the FRA first publishes a Notice of Proposed Rulemaking or Advanced Notice of Proposed Rulemaking in the Federal Register, seeking comment. The FRA has improved the process over the years, using the RSAC as a forum to discuss the merits and impacts of proposed rules.

State Authority and Regulations

While the federal government dominates the regulatory environment, it lacks jurisdiction over isolated rail transit systems not considered part of the general railroad network. So some states are becoming more active too, particularly since more states and localities now operate rail fixed guideway systems. Systems outside FRA purview have had accidents and incidents that arouse regulatory interest. The Baltimore LRT has experienced terminal station overruns and Washington Metropolitan Area Transit Authority has also recently had severe accidents. NTSB has voiced its concerns and identified deficiencies in need of corrections—this often creates an impetus for regulation. There are three regulatory mechanisms available to states:

1. Assertion of direct regulatory authority by the state government over systems, contained within its own borders,
2. Designation by the FRA and FTA of responsibility for State Safety Oversight under existing regulations (FRA Part 212 and FTA part 659),
3. The FTA created “Implementation Guidelines for State Safety Oversight of Rail Fixed Guideway Systems,” and mandates annual submission of reports and triennial safety audits, using APTA guidelines, that can be used to monitor events.

An example of the first case is the state of California. The state has established extensive regulations cited in the General Orders of the California Public Utilities Commission (CPUC, available on the Internet) and portions of the CPUC General Orders apply to rail fixed guideway systems. These do not supersede Federal Regulations, apply only within California, and establish additional requirements for the operators or planners.

Other states and localities (e.g., New York State and New York City) have some regulation, but they are not nearly as extensive as California’s (e.g., New York City prohibits steam or diesel trains within the borough of Manhattan). A survey of regulations in all states is beyond the scope of this paper, but rail fixed guideway system operators are typically cognizant of state or local regulations that affect their operation.

Localities have enacted whistle bans to reduce local noise; the FRA has overruled these local rules but recently has provided alternatives and objective criteria to assess the problem. Municipalities attempt to restrict the movement of hazmats, or force rerouting or use of other modes. They have enacted speed limits across grade crossings and environmental restrictions at yards or other facilities. Some of these actions have had limited success.

Such issues complicate system operation by imposing strictures or forcing operational change, thus adding to costs and limiting management flexibility. They can also initiate a cascading “me too” phenomenon in adjacent communities.

Another more onerous recent example of state regulation involves a California legislator who now proposes prohibitions on push–pull operation as a result of a recent accident, with no concern or even acknowledgment of impacts or the added equipment, fleet, storage, and operating costs on agencies. This is clearly based on a reaction to one incident, rather than an analysis of the overall safety records of push–pull operations. Nevertheless, states have the right to regulate anything as long as it does not conflict with federal authority or impede interstate commerce.

In the third case, state systems that operate under FTA guidelines must comply with FTA requirements for prevention of alcohol use and prohibited drug use in transit operations and are subject to audits by APTA or the FTA as stated in 49 CFR Part 659.

State Regulatory Process

1. The federal government has encouraged the states to play an increased role as expressed in 49 CFR Part 212 (FRA) and 49 CFR part 659 (FTA) via the State Rail Safety Participation Program [State Safety Oversight (SSO)].
2. The Rail Safety Act of 1970 (Public Law 91-458) authorized the states to work with the FRA to enforce federal railroad safety regulations. By 1975, federal regulations had been issued enabling states to enforce track and freight car safety standards. In 1980, legislation

broadened state involvement to include the Safety Appliance, Locomotive Inspection, Signal Inspection, and Hours of Service Acts.

3. In 1992, the State Safety Participation regulations (49 CFR, Part 212) were revised to permit states to perform rail hazmat inspections, thereby allowing them to participate in all five of the safety disciplines (track, signal and train control, motive power and equipment, operating practices, and hazmat). Three years later, the Grade Crossing Signal System Safety regulations (49 CFR, Part 234) were again revised to authorize both federal and state signal inspectors to ensure that railroads were properly testing, inspecting, and maintaining automated warning devices at grade crossings. The devices include flashing lights, gates, bells, and related circuitry.

4. Today, the Rail State Safety Participation Program consists of 30 states employing 160 safety inspectors in the five rail safety inspection disciplines. State programs generally emphasize planned, routine compliance inspections; however, states may undertake additional investigative and surveillance activities consistent with overall program needs and individual state capabilities.

5. Before participation can begin, each state agency must enter into a multiyear agreement with FRA for the exercise of specified authority. This agreement may delegate investigative and surveillance authority regarding all or any part of federal railroad safety laws.

6. The training of state inspectors is one of FRA's major initiatives. FRA assists states with rail safety inspector technical training. The training program helps states to develop rail safety programs and enables qualified state inspectors to maintain technical proficiency. Approximately one-third of the FRA's Office of Safety training budget is allocated to state rail safety programs. Additionally, FRA routinely provides on-the-job training to state inspector candidates.

Standards

1. Any discussion of "standards" should distinguish between standards and standardization. For purposes of this paper, standard implies a uniform approach to performance or standard technology. Standards are not legally mandated, because there is no "enforcement" mechanism, so self-enforcement is the norm. But standards can be cited in design or product specifications to ensure their incorporation in a legally binding contract.

2. Standards are not necessarily restricted to technology and hardware, and often address practices, procedures, rules, and responsibility. There are two classes of standards: direct and derivative. Direct standards are created by individuals, professional groups, and organizations that have a direct role with rail fixed guideway systems. Such standards are also exclusively and directly applicable to rail fixed guideway systems. Examples are:

- AREMA Standards,
- AREMA C&S Standards,
- AAR Wheel and Axle Standards, and
- APTA PRESS and Rail Transit Standards.

3. Often the regulations assume or cite compliance with derivative standards. Individual systems and components are often covered by other regulations and standards (e.g., radios by FCC and vehicle software by IEEE, Mil. Spec.). ISO, ANSI, IEEE, NEC, National Electrical Safety Code, National Fire Protection Association, et al., are other examples of these requirements. Most rail system related procurement specifications cite these standards in a "boilerplate" section.

Standards Development Processes and Stakeholders

1. Standards development organizations issue standards and recommended practices. These groups are typically comprised of groups of professional or technical staff established to standardize technical requirements, ensure compatibility between systems or components, develop safety requirements, and disseminate information. In recent years their role in enhancing safety has increased and their published practices have become de facto regulations, adopted by most agencies or their staffs.

2. Development of standards is often a more collegial “bottoms up” activity rather than driven from the top as is typical of regulations. A peer group arrives at consensus, after an iterative process of meeting, producing, revising, and editing until the technical result is satisfactory to be issued by the group.

3. To be most effective, these groups must include vendors, consultants, government oversight agencies, and rail system employees to issue standards that are likely to be accepted by the industry. APTA’s group, the Rail Transit Task Force, has been active in establishing standards and practices applicable to rail transit systems.

4. Applicability of specific regulations or standards is dependent upon rail technology, operational characteristics, rail–highway grade crossings, joint use and interchange service, connections to the general railroad network, exclusive access controlled right of way (ROW), street running, etc.

PERSPECTIVES ON REGULATIONS AND STANDARDS

Regulatory Impacts and Complications

Effects on Rail Fixed Guideway Systems

While increased regulation has measurably improved rail system safety and reduced accidents, these efforts have had negative effects and produced unintended consequences, in addition to increasing the overhead costs of running a rail fixed guideway system.

Regulation is also complicated by the need to grandfather existing systems and equipment; otherwise fleets and systems are rendered obsolete or in violation. It is assumed that time and attrition will resolve the disparity between differing standards, but it does leave equipment in place that was built to different standards.

Regulations influence the system infrastructure, including ROW maintenance, alignment, physical plant facilities, train control technology, and employee safety. This all-encompassing approach can complicate the introduction of new public transportation service if it deviates from federal requirements. Regulations that are quite suitable for freight-oriented service may burden passenger services with inappropriate requirements.

Regulation can encourage standardization of equipment, components, and equipment. This keeps the playing field level and participants honest, since all must play by the same rules. Regulations establish a minimum level of safety, without considering the cost. The need for compliance can help an agency justify a request for funds since it is legally mandated. Conversely, regulation may mean higher costs, less design flexibility, and improvements limited

to regulated items because of budget restrictions. This can reduce the funds available for other desirable improvements.

Regulation may favor domestic suppliers and older technology; foreign vendors face a “burden of proof” to show compliance, and modern technology may not fit the regulatory parameters.

Regulations may also restrict the use of certain proprietary designs, since a rail system operator does not wish to be beholden to a single supplier. Standards need to be broad enough to permit multiple suppliers.

Regardless of regulations and standards, any rail transit service is less hazardous in a closed environment where all equipment is similar and vehicles, systems, and operations are tailored to unique local characteristics (e.g., isolated corridor, compatible equipment, fixed guideway systems), in short any situation that permits more control over the operating variables.

FRA and other federal regulations typically preempt and supersede state and local requirements if they conflict. Preemption can be an advantage since it may limit the inclination of municipalities to micromanage or impose restrictive or punitive requirements on a rail system. However, overruling state or local authority can backfire since it does not contribute to a neighborly relationship between the rail system and the jurisdictions it traverses or occupies. Some state regulation may be the result of local concerns advocated by legislators; such rules can be reactionary and disregard overall system or service objectives and add to costs that must be borne by the state.

Management and Administrative Effects

Administrative costs of compliance should not be underestimated, since there is considerable documentation, storage, and retrieval effort required. Such data assist the FRA in verifying the effectiveness of its rules and an agency’s compliance. This recordkeeping can be duplicative with other efforts and burden a system’s management with additional staff or layers of organization over and above simple collecting and reporting information. Different governmental agencies (federal and state) may require different reports or formats for the same information. Operators can anticipate a duplicative effort and try to develop some common report format acceptable to multiple agencies.

Railroad regulations also require a program for drug and alcohol testing, engineer certification, qualification of vehicle and track maintenance personnel, and a method for penalizing employee violations of FRA rules.

Railroad safety staff has previously functioned as “reporters” rather than being preventive; but this is changing as some agencies have introduced a hazard analysis activity as part of the engineering design program.

Emergency Preparedness

New FRA regulations have resulted in the addition of features (e.g., lighting, signage, window access, etc.) to equipment that makes it easier for passengers and responders in an emergency. Regulations also mandate more emergency drills, training, and preparations by the operator. Such measures increase costs and training requirements, and require the allocation of equipment and staff resources for drills.

While these are prudent and now require precautions, they should be tailored to system characteristics, e.g., if a system lacks tunnels or elevated guideways, preparations, or specific vehicle features, then the drill and exercise should reflect those elements. Alternatively, if overhead electrification or third rail is present, this should not be overlooked. Similarly different types of equipment should be treated appropriately (e.g., coaches, MU, LRV, etc.)

One newly apparent downside is that railcar safety signage and warnings have added a great deal of clutter near doors, access panels and other locations. Aside from conflicting with efforts to make rail vehicle interiors attractive, they become simply “visual noise”, somewhat indistinguishable from the background, and thus fail to serve their purpose. In most cases they appear to be added as afterthoughts on a piecemeal basis, somewhat paralleling the issuance of the regulations requiring them. This may not be such a problem with new vehicles that can lay out signage in a coordinated arrangement.

Vehicles and Maintenance

MU equipment provides a higher level of reliability for safety critical systems (e.g., brakes) so it is not entirely rational to hold them to the same requirements as standard locomotive hauled equipment. Regulations do not consider reliability–failure rates of different equipment. Nor do they properly accommodate the difference in acceleration–deceleration rates of MU or passenger equipment as compared to freight equipment. These aspects complicate the introduction of non-FRA-compliant equipment in a shared use–corridor environment.

Current regulations inhibit changes to maintenance regimes; all commuter railroads use FRA calendar-based maintenance instead of “service based” typical of the airline industry. While surely there are components that need to be checked according to the calendar regardless of use, there are other components where wear and tear is reflected by accumulated use in service; each type should be maintained appropriately. Regulations permit reliability based maintenance but cost of conversion and data collection, tracking, and reporting are prohibitive to most agencies.

New brake inspection requirements in 49 CFR Part 238.313 show that brake inspections are too difficult to do with low-slung cars and/or disc brakes without endangering personnel. Massachusetts Bay Transportation Authority (MBTA) has asked for a waiver; FRA is revising the rule but the issue remains. This is a reminder that the problem could or should have been anticipated, and careful thought regarding practical compliance is essential with regulations.

Operational Issues

To reduce accidents caused by operator and crew fatigue the FRA enforces “hours of service” law enacted by the Congress, to limit certain employees from working too much in short period with out rest.

This rule was originally geared to long-distance freight and passenger operations, and it may still be appropriate for freight operations. But the same rule may not be suited to commuter rail or shared-track passenger service, where the train operator often takes midday, or end-of-run breaks from duty. Currently passenger services have to carefully schedule crews and keep track of time to ensure that no crew member exceeds the daily limit, a significant recordkeeping effort. This can be difficult when delays or service interruptions complicate transfers of crew.

One unintended consequence of this rule resulted in a crew abandonment of a passenger train before it reached its terminal. This desertion was certainly not the desired result, and apart

from the inconvenience, it created more danger to the passengers. This is an area where latitude and good judgment must prevail in the broader interest of passenger safety. The rigidity of regulations created a more serious problem in this case. Ironically “hours of service” cannot be waived, because it is statute, although there is a bureaucratic means of modifying the requirement.

FRA regulations require contingency protection in the event of a failed grade crossing protection system. The train cannot pass unless this protection is provided, and normally one or more crew members can flag the crossing while the train moves across it.

This requirement is more onerous if this occurs in a shared track–corridor environment where non-FRA-compliant vehicles traverse the crossing. Such trains typically are operated by a single crew member. In these situations the operator cannot leave the vehicle to flag the crossing. Again the rules do not examine the practical differences between a freight train, a commuter rail train, and an LRV. Surely the shorter train length, higher acceleration and deceleration, and improved visibility merit consideration for a modified rule.

It remains to be determined how newer security objectives are influencing the scope of regulation, budgets, staffing, and enforcement.

Regulatory Trends

1. It is reasonable to expect technical changes and advances to be more rapid and complex, and new technology is more difficult to define/categorize and fit into a regulatory “box.” Given the increasing breadth of regulations, it is likely that the trend to regulate that new technology will continue in the future.

2. As new technologies are introduced, new regulations will also be developed, as exemplified by 49 CFR Part 236, Subpart H which was drafted in response to evolving PTC technology. Moreover, any new regulations may need to be more performance based rather than the traditional detailed model to accommodate technical progress.

3. In a novel approach, New York City Transit has specified that one of its new communications-based train control systems must comply with the requirements of 49 CFR Part 236 Subpart H Standards for Processor-Based Signal and Train Control Systems. The agency voluntarily applied FRA regulations to its nonregulated system. It is possible that other agencies would consider a similar approach, i.e., “regulatory trickle down.” It is also possible that the application of FRA rules would arouse federal interest where previously none existed.

4. There is extensive research in structural crashworthiness going on at Volpe National Transportation System Center; this is likely to lead to more regulations. There are other studies of shared operations sponsored by the TCRP (A-27) and the FRA/FTA/FHWA JPO (ITS Technology for Integrated Rail Corridors) that may influence the direction of regulation.

5. Railroads are unfairly blamed for most grade crossing accidents and must assume the burden of litigation. In the interest of reducing such accidents, the FRA has issued new requirements for use of the “horn” when approaching crossings, and a number of prototype methods including four-quadrant gates and sealed corridor techniques are being tested. Grade crossing warning systems often must fulfill both federal and state/local requirements.

Furthermore, nearly any railroad-related accident or incident results in a public or legislative call for more regulation, even before the cause is determined although this reaction may not contribute to improved safety.

CONCLUSIONS AND RECOMMENDATIONS

Some conclusions from this review are stated:

1. Regulations are not sufficiently focused to serve multiple needs; they are broadly applied to all users of a rail corridor in a “one size fits all fashion.”
2. Regulations can act as a constraint to technical progress. They are not readily adaptable to new technology, they are generally behind the curve, nor are they necessarily appropriate in all situations (e.g., freight, commuter rail, or non-FRA-compliant systems). New MU fleets are required to meet the same structural requirements as locomotives, and new LRV (electric or diesel multiple unit) equipment can’t comply with regulations. Only recently was a regulation issued to accommodate communications-based train control.
3. Regulations complicate planning, design, operation and maintenance of rail transportation systems.
4. Regulatory compliance tends to increase the overall cost of system construction, operation, and maintenance.
5. Regulatory compliance subjects an agency to increased governmental and bureaucratic scrutiny and requires associated documentation and administrative support from an agency.
6. In spite of national goals to reduce energy consumption and improve the environment, current structural regulations encourage adding weight to and size to the vehicle that decreases acceleration and deceleration performance, increases energy requirements, restricts adaptability to various kinds of service. These requirements effectively limit the use of LRV equipment in shared track–corridor operations without a waiver.
7. Engineers, operating system technical staff, and others in the design process should carefully consider the impacts of regulations and standards and evaluate their cost and technical implications for their management.

Nevertheless, the following should not be overlooked. The latest statistics issued by the U.S. Department of Transportation on overall train accidents and derailments decreased. This includes a reduction in grade crossing fatalities, human factor-caused accidents, and employee on-duty injuries. In spite of these trends train to train collisions increased. Detailed analysis of these statistics may offer some insights to improving or focusing the regulatory process.

Some recommendations also seem apparent from this review:

1. Detailed requirements that focus on the unique deficiency or cause of an accident are quicker and easier for regulators to understand and implement. Performance- or results-based requirements are more difficult and complex to codify, and may need research and analysis to properly draft a regulation, and such regulations will likely require a higher burden of proof. A performance-based standard breaks new ground for both the regulator and the regulated, hence a comfort level with detailed requirements.

It would be beneficial to quantify the cost/operational impact versus expected safety improvement. The cost of technical improvements versus the associated safety benefit would contribute to better regulatory choices.

2. Compliance with federal, state, and local regulations and standards does not appear to offer insulation from liability from the actions of external parties. Agencies that conscientiously

adopt and adhere to current requirements and best practices in order to reduce risk and eliminate hazards merit some protection from legal action from events beyond their control.

3. Operating system staff, government agencies representatives, consultants, and suppliers are encouraged to participate in APTA, RSAC, AREMA, and any other committees and forums that set standards or consider regulations. The opinions of those closest to the problems and most affected need to be heard.

4. Rail fixed-guideway systems should consider greater use of “risk analysis,” hazard identification techniques, and improving accident–incident databases to make appropriate technical choices that reduce hazards in a quantifiable way. It may be necessary to educate staff and regulators about the process, identify sources of valid data, interpret results, and evaluate alternate technology or features in a quantifiable and comparative manner.

5. Since European suppliers provide equipment and components for domestic rail fixed-guideway systems, there is a need to relate the two different criteria to understand if non-U.S. products comply with our regulations. If they don't, designers and engineer need to quantify the differences should there be a need to seek relief from the regulations or recognize the limits of their suitability for the application.

6. Regulations pose a great difficulty for initiation of shared track or shared corridor operations. The latest policy change by FRA and FTA (jointly issued in 2000) moves towards more flexibility but does not eliminate any requirements. Perhaps the establishment of a special subset of regulations based on shared use can be drafted. As an example, FRA regulations have Tier I and Tier II based on operating speeds, and this applies to track and structures, equipment design, and maintenance regimes. It may be appropriate to create a similar set of guidelines for shared track operations if risk can be reduced and the physical weights, dimensions, and configuration disparities can be accommodated by other technical means. Possibly freight speeds or train lengths can be limited by agreement. The focus should be on safety and minimization of hazards, rather than specific requirements.

7. The desire for improved safety drives the regulatory process. Safety data are collected and measured by mode and improvements are proposed accordingly. Each modal administration (FRA, FTA, FAA, FHWA) tends to look at safety with agency blinders. It may be opportune to rethink that approach and compare safety data across modes using some type of normalized metrics.

Comparisons between automobile and rail passenger safety or truck shipping versus rail freight could influence the regulatory process by identifying those regulations which, because of cost or complexity, discourage rail travel or shipment, and simply force those movements to a highway-based mode. If the goal is improved safety, regulations should not unduly burden one mode by requiring safety enhancement, while leaving other modes unaffected.

APPENDIXES**Appendix A: Acronyms**

AAR	Association of American Railroads
ADA	Americans with Disabilities Act
ANSI	American National Standards Institute
APTA	American Public Transportation Association
AREMA	American Railway Engineering and Maintenance Association
CPUC	California Public Utilities Commission
EPA	Environmental Protection Agency
FAA	Federal Aviation Administration
FCC	Federal Communications Commission
FELA	Federal Employers Liability Act
FHWA	Federal Highway Administration
FRA	Federal Railroad Administration
FTA	Federal Transit Administration
IEEE	Institute of Electrical and Electronics Engineers
NTSB	National Transportation Safety Board
SSO	State Safety Oversight
STB	Surface Transportation Board

Appendix B: FRA Regulations, Title 49*Part*

200	Informal rules of practice for passenger service
201	Formal rules of practice for passenger service
207	Railroad police officers
209	Railroad safety enforcement procedures
210	Railroad noise emission compliance regulations
211	Rules of practice
212	State safety participation regulations
213	Track safety standards
214	Railroad workplace safety
215	Railroad freight car safety standards
216	Special notice and emergency order procedures: Railroad track, locomotive and equipment
217	Railroad operating rules
218	Railroad operating practices
219	Control of alcohol and drug use
220	Railroad communications
221	Rear end marking device--passenger, commuter and freight trains
222	Use of locomotive horns at public highway-rail grade crossings

- 223 Safety glazing standards--locomotives, passenger cars and cabooses
- 224 Reflectorization of rail freight rolling stock
- 225 Railroad accidents/incidents: Reports classification, and investigations
- 228 Hours of service of railroad employees
- 229 Railroad locomotive safety standards
- 230 Steam locomotive inspection and maintenance standards
- 231 Railroad safety appliance standards
- 232 Brake system safety standards for freight and other non-passenger trains and equipment; end-of-train devices
- 233 Signal systems reporting requirements
- 234 Grade crossing signal system safety
- 235 Instructions governing applications for approval of a discontinuance or material modification of a signal system or relief from the requirements of part 236
- 236 Rules, standards, and instructions governing the installation, inspection, maintenance, and repair of signal and train control systems, devices, and appliances
- 238 Passenger equipment safety standards
- 239 Passenger train emergency preparedness
- 240 Qualification and certification of locomotive engineers
- 241 United States locational requirement for dispatching of United States rail operations
- 244 Regulations on safety integration plans governing railroad consolidations, mergers, and acquisitions of control
- 245 Railroad user fees
- 250 Guarantee of certificates of trustees of railroads in reorganization
- 256 Financial assistance for railroad passenger terminals
- 260 Regulations governing loans and loan guarantees under the railroad rehabilitation and improvement financing program
- 261 Credit assistance for surface transportation projects
- 265 Nondiscrimination in federally assisted railroad programs
- 266 Assistance to States for local rail service under section 5 of the Department of Transportation Act
- 268 Magnetic levitation transportation technology deployment program

Appendix C: FTA Regulations*Part*

601	Organization, functions, and procedures
604	Charter service
605	School bus operations
609	Transportation for elderly and handicapped persons
611	Major capital investment projects
613	Planning assistance and standards
614	Transportation infrastructure management
622	Environmental impact and related procedures
624	Clean fuels formula grant program
630	Uniform system of accounts and records and reporting system
633	Project management oversight
639	Capital leases
640	Credit assistance for surface transportation projects
655	Prevention of alcohol misuse and prohibited drug use in transit operations
659	Rail fixed guideway systems: state safety oversight
661	Buy America requirements—Surface Transportation Assistance Act of 1982, as amended
663	Pre-award and post-delivery audits of rolling stock purchases
665	Bus testing

Appendix D: OSHA Regulations—Title 29: Labor, Chapter XVII*Part*

1900–1901	[Reserved]
1902	State plans for the development and enforcement of State standards
1903	Inspections, citations and proposed penalties
1904	Recording and reporting occupational injuries and illnesses
1905	Rules of practice for variances, limitations, variations, tolerances, and exemptions under the Williams-Steiger Occupational Safety and Health Act of 1970
1906	Administration witnesses and documents in private litigation [Reserved]
1908	Consultation agreements
1910	Occupational Safety and Health Standards Subject Index for 29 CFR Part 1910—Occupational Safety and Health Standards

Appendix E: FRA Emergency Orders

Text of Emergency Order 24, Notice No. 2 This notice amends Emergency Order No. 24 (EO 24) in response to informal comments received from railroads and labor organizations. This amendment provides additional guidance, clarifying amendments and expanded relief from the EO.

Text of Emergency Order 24 Emergency Order Requiring Special Handling, Instruction and Testing of Railroad Operating Rules Pertaining to Hand-Operated Main Track Switches.

Questions and Answers Regarding Emergency Order No. 24

Text of Emergency Order 23, Notice No. 2 Clarifying Amendment to the Emergency Order To Prohibit the Continued Use of Certain Railroad Tank Cars Equipped With a Truck Bolster Bearing Either (1) Association of American Railroads (AAR) Identification Number B-2410 and National Castings of Mexico (NCM) Pattern Number 52122 or (2) AAR Identification Number B-2409 and NCM Pattern Number 52202.

Text of Emergency Order 23 Emergency Order to Prohibit the Continued Use of Certain Railroad Tank Cars Equipped With a Truck Bolster Bearing Either Association of American Railroads (AAR) Identification Number B-2410 and National Castings of Mexico (NCM) Pattern Number 52122 or AAR Identification Number B-2409 and NCM Pattern Number 52202.

Text of Emergency Order 22 Oregon Pacific Railroad; Emergency Order to Prevent Operation of Trains on the Railroad Bridge Crossing Johnson Creek in the City of Milwaukie, Oregon.

Text of Emergency Order 21 Emergency Order to Prevent Operation of Trains on Northwestern Pacific Railroad's trackage from Arcata, California, to Mile Post 63.4 between Schellville and Napa Junction, California.

Text of Emergency Order 20, Notice No. 2 Clarification of Emergency Order Requiring Enhanced Operating Rules and Plans for Ensuring the Safety of Passengers Occupying the Leading Car of a Train With Appropriate Amendments.

Text of Emergency Order 20 Emergency Order Requiring Enhanced Operating Rules and Plans for Ensuring the Safety of Passengers Occupying the Leading Car of a Train.

Regarding Emergency Order 20 Letter from FRA Administrator Jolene Molitoris and FTA Administrator Gordon Linton.

Text of Emergency Order 19 Emergency Order to Prevent Operation of Trains on Bridge 7708810.

Text of Emergency Order 18 Notice No. 1 Emergency Order Requiring Capability to Initiate Emergency Application of Air Brakes from the Head End and Rear of Trains.

Text of Emergency Order 18 Notice No. 2 Notice Rescinding FRA Emergency Order 18 Notice No. 1

Text of Emergency Order 17 Notice No. 3 Owners of Railroad Tank Cars; Modification of Emergency Order Requiring Inspection and Repair of Stub Sill Tank Cars.

Text of Emergency Order 15 Required Florida East Coast Railroad to sound warning device at grade crossings and to revoke operating rules/bulletins to the contrary. (State had enacted "whistle ban" statute, permitting local governments to prohibit train horns during night hours.)

Appendix F: RSAC History and Tasks

RSAC History

In 1996, FRA established the Railroad Safety Advisory Committee (RSAC) to develop new regulatory standards, through a collaborative process, with all segments of the rail community working together to fashion mutually satisfactory solutions on safety regulatory issues.

RSAC Purpose

The Committee shall seek agreement on the facts and data underlying any real or perceived safety problems; identify cost effective solutions based on the agreed-upon facts; and identify regulatory options where necessary to implement those solutions. In determining whether regulations are necessary, the Committee shall take into account section 1(a) of Executive Order 12866 (Regulatory Planning and Review).

RSAC Regulatory Philosophy

Federal agencies should promulgate only such regulations as are required by law, are necessary to interpret the law, or are made necessary by compelling public need, such as material failures of private markets to protect or improve the health and safety of the public, the environment, or the well-being of the American people. In deciding whether and how to regulate, agencies should assess all costs and benefits of available regulatory alternatives, including the alternative of not regulating. Costs and benefits shall be understood to include both quantifiable measures (to the fullest extent that these can be usefully estimated) and qualitative measures of costs and benefits that are difficult to quantify, but nevertheless essential to consider. Further, in choosing among alternative regulatory approaches, agencies should select those approaches that maximize net benefits (including potential economic, environmental, public health and safety, and other advantages; distributive impacts; and equity), unless a statute requires another regulatory approach.

The resultant rules must be reasonable, clear, effective, and enforceable; impose as small a burden as is practicable; and shall, to the extent feasible, specify performance objectives, rather than specifying the behavior or manner of compliance that regulated entities must adopt.

The RSAC will provide advice and recommendations to the Federal Railroad Administration (FRA) regarding the development of the railroad safety regulatory program, including issuance of new regulations, review and revision of existing regulations, and identification of non-regulatory alternatives for improvement of railroad safety. Of course, the

RSAC's own resource limitations will not permit FRA to refer every safety regulatory task to the RSAC. Moreover, on occasion, the need to address a safety issue in a very expedited way will preclude such a referral.

It is FRA's policy to utilize consensus recommendations of the RSAC as the basis of proposed and final agency action, whenever possible, consistent with applicable law, including guidance from the President. In considering whether to adopt RSAC recommendations, the Administrator weighs the interests of the public at large and the ability of the agency to administer, and, if necessary, to enforce, any requirements that would result from final agency action.

FRA will consult with the RSAC on a periodic basis regarding the development of its regulatory program, advising the RSAC of emerging issues, statutory requirements, and other identified needs. It is the intent of the FRA to consider the views of RSAC members in determining regulatory priorities.

The RSAC provides advice and recommendations on specific tasks assigned to it by FRA. Whenever possible, FRA will consult with the RSAC prior to assigning a task to the committee. As each task is assigned, the RSAC may elect to accept or reject the task, or to recommend that the task be restructured. When a task is assigned, FRA sets a target date for the presentation of the RSAC's recommendations to the Administrator. The target date is based on consultation with the RSAC and may be adjusted by FRA based on further consultation. FRA may withdraw a task from the RSAC at any time. FRA will provide the RSAC an explanation when it does so.

RSAC Tasks

<i>Task Statement</i>	<i>Task Number</i>
Reduce Human Factor-Caused Train Accident/Incidents	2005-02
Review of Roadway Worker Protection Issues	2005-01
Review of Passenger Safety Issues	03-01
Accident/Incident Reporting/Conformity	2001-1
Railroad Operating Practices—Blue Signal Protection of Workmen	2000-1
Definition of Reportable "Train Accident"	97-7
Standards for New Train Control Systems	97-6
Positive Train Control Systems-Implementation Issues	97-5
Positive Train Control Systems-Technologies, Definitions, and Capabilities	97-4
Revision of Event Recorder Requirements	97-3
Locomotive Cab Working Conditions	97-2
Locomotive Crashworthiness	97-1
Locomotive Crashworthiness and Working Conditions	96-8
Safety Standards for Track Motor Vehicles Self Propelled Roadway Equipment	96-7
Revision of Qualification and Certification of Locomotive Engineers Regulations	96-6
Revision of Steam-Powered Locomotive Inspection Standards	96-5
Tourist, Excursion, Scenic and Historic Service	96-4
Railroad Communications	96-3
Revision of the Track Safety Standards	96-2
Revision of Freight Power Brake Regulations	96-1

Appendix G: ADA Requirements, Part 36 and Part 49

Title 36: Parks, Forests and Public Property

Chapter XI—Architectural and Transportation Barriers Compliance Board

- 1120 Public availability of information
- 1121 Privacy Act implementation
- 1150 Practice and procedures for compliance hearings.
- 1151 Bylaws
- 1154 Enforcement of nondiscrimination on the basis of handicap in programs or activities conducted by the Architectural and Transportation Barriers Compliance Board
- 1191 Americans with Disabilities Act (ADA) accessibility guidelines for buildings and facilities; Architectural Barriers Act (ABA) accessibility guidelines
- 1192 Americans with Disabilities Act (ADA) accessibility guidelines for transportation vehicles
- 1193 Telecommunications Act accessibility guidelines
- 1194 Electronic and information technology accessibility standards

Title 49: Transportation

Subtitle A—Office of the Secretary of Transportation

Part

- 37 Transportation services for individuals with disabilities (ADA)
- 38 Americans with Disabilities Act (ADA) accessibility specifications for transportation vehicles

Appendix H: EPA Regulations

Title 40: Protection of Environment

(This index contains parts 87 to 99)

Part

- 87 Control of air pollution from aircraft and aircraft engines
- 88 Clean-fuel vehicles
- 89 Control of emissions from new and in-use nonroad compression-ignition engines
- 90 Control of emissions from nonroad spark-ignition engines at or below 19 kilowatts
- 91 Control of emissions from marine spark-ignition engines
- 92 Control of emissions from locomotives and locomotive engines
- 93 Determining conformity of Federal actions to State or Federal implementation plans
- 94 Control of air pollution from marine compression-ignition engines
- 95 Mandatory patent licenses
- 96 NOX Budget Trading Program for State Implementation Plans
- 97 Federal NOX Budget Trading Program
- 98-99 [Reserved]

REGULATIONS AND STANDARDS

Crashworthiness Standards for the U.S. Light Rail Environment

STEVEN W. KIRKPATRICK
Applied Research Associates, Inc

MARTIN P. SCHROEDER
American Public Transportation Association

Rail vehicle safety standards for the United States have historically placed emphasis on high structural strength requirements to ensure safety. The primary requirements to ensure crash safety were the 800,000-lb longitudinal buff strength requirement for heavy rail applications and the corresponding buff strength specification equal to twice the vehicle weight in many light rail vehicles. These requirements have resulted in rail vehicle designs that are heavier and often require significant modifications from those developed for international markets. Current efforts to develop a safety standard for light rail vehicles (LRVs) in the United States are attempting to reconcile the benefits and costs of these different design methodologies. In addition, any proposed LRV safety or crashworthiness standard should include the recent improvements in crashworthiness engineering that have been incorporated into many modern rail vehicle designs. This study addresses some of these concerns within the light rail community.

INTRODUCTION AND BACKGROUND

There are several current efforts related to development of crashworthiness standards for rail vehicles in the U.S. market. The standards for all modes of rail transportation, including commuter rail, heavy rail, and light rail, are under review. A motivating factor for this review is the rail industry's interest in incorporating modern crash safety technologies, commonly used in the automobile market, which has led to improved occupant survivability in collisions. It is a natural extension to apply the same approaches for safety improvements in rail vehicles. However, the complexities of vehicle design, differences in vehicle design philosophy, differences in operating environments, and performance of hazard analyses have all complicated the formulation of crashworthiness standards, particularly for light rail vehicles (LRVs).

The historical origins of current crash safety requirements for rail vehicles in the United States can be traced back to the 1940s. Several disastrous collisions of federal mail cars operating on mainline railroads showed that higher strength vehicles improved safety for train car occupants. As a result of studies during that period, a standard was developed for mainline cars that required an 800,000-lb static compressive longitudinal (buff) strength, which today is a federal law.

The requirements for LRVs in the United States are not defined by federal law. Instead, specifications for LRVs have been developed primarily by individual transit agencies, industry, and consultants. Common practice has been to adopt specifications from a previous LRV design

and modify them if any deficiencies were identified in the previous design or if additional requirements are necessary for the new operational environment. The specifications that evolved in this process have typically included a large static longitudinal compression load requirement. Most U.S. LRV procurement specifications have required that cars be designed with a compressive strength of twice the vehicle weight (2 g). Actual origins of this 2-g value have always been elusive, but its acceptance began to evolve in the early 1970s, and in 1978 became part of an order of the Public Utilities Commission of the State of California. Some departure from the 2-g specification has been seen in the United States, primarily with the advent of low-floor vehicles, providing cars with compressive strength closer to 1 g for some cities outside of California.

Looking outside the United States, European and Asian standards specified a buff load without reference to LRV weight as early as 1981. For example, a 37,000-kg European LRV with a 200-kN buff load requirement results in a 0.5 g design, or 25% of the U.S. 2-g specification. Furthermore, European standards have introduced different compression load specifications as a function of operating environment. Different strength values are prescribed for low-speed streetcars, LRVs operating at higher speeds, and LRVs operating on railroad right of ways with mixed vehicle strengths.

A new movement started within the international rail crash safety community in the early 1990s as modern crashworthiness design or crash energy management (CEM) design techniques were applied to rail vehicles. CEM is a methodology that addresses performance requirements of a vehicle in a crash. This has been made possible by widespread application of modern nonlinear dynamic finite element codes that can accurately simulate the crash behavior of vehicles, reducing the need for expensive crash tests to evaluate design alternatives. One of the first extensive applications of CEM methodologies in the rail environment was the design of new equipment for the French train à grande vitesse (TGV) by Alstom and Société Nationale des Chemins de Fer Français (1–3). Their design relied extensively on CEM design principles using nonlinear collision analyses validated with crash testing.

Following these initial implementations in France, several active rail crashworthiness research programs were pursued internationally including the United States and United Kingdom. Through studies and tests of heavy rail passenger vehicle designs, CEM has been shown to improve crashworthiness behavior and reduce passenger injuries. Using CEM principles, vehicle structural behavior can be specified so that vehicle crush is progressive, stable, and contained within desired crush zones. The CEM metrics for specifying collision behaviors are commonly energy absorption, crush distance, and crush force.

The application of CEM is gaining widespread acceptance in the design of modern-day rail vehicles. Currently, CEM technologies are being applied around the world for all rail vehicle types. CEM design is being applied in new equipment throughout Europe. The CEM technologies developed for the TGV were applied in the design of the ACELA high-speed train in the United States. The Indian Railways are currently redesigning their passenger coach cars to include CEM. Several recent LRV equipment procurements, such as Minneapolis, Minnesota, Charlotte, North Carolina, and Phoenix, Arizona, have all included some level of crashworthiness design.

Although CEM has entered into the specifications for most modern rail car procurements, the high static longitudinal strength or buff strength remains a part of most rail vehicle standards in the United States. This discrepancy in U.S. rail vehicle designs from lower buff strength cars in Europe is a potential problem for the international rail market. As a consequence, foreign rail

vehicle designs, with a proven safety record, typically require significant modification before they can be implemented in the U.S. market. This customization has led to heavier, more costly vehicles without a guarantee that such strength requirements translate into safer vehicles in a crash. Rigid application of such design specification is a potential barrier to design innovation.

DEVELOPMENT OF U.S. LIGHT RAIL VEHICLE SAFETY STANDARDS

The ongoing effort to develop safety standards for U.S. LRVs began in 1996 with a task force under sponsorship of the American Society of Mechanical Engineers (ASME). At that time, the primary concept for U.S. crash safety specifications was based on static structural strength requirements with a buff strength requirement to protect the operator and occupants in a collision between LRVs. However, it has become increasingly clear that application of crashworthiness design and CEM principles can lead to safety improvements for LRV operations.

The development of a U.S. LRV safety standard is very complex as a result of conflicting viewpoints. Some advocate the position of continuing the U.S. emphasis on high strength requirements, such as the 2-g buff load, with a proven service record in the United States. Others advocate the position of applying the new technologies in crashworthiness design and CEM for overall safety improvements. And yet others advocate the position of adopting standards consistent with international LRV standards to allow for potential reductions in vehicle weight and cost for U.S. markets. Furthermore, implementation of crash safety principles in a standard requires resolution of factors, such as:

- Balancing the benefits of potential weight reductions and future safety improvements with compatibility issues of older vehicles designed without CEM technology.
- Balancing the crush strength and energy absorption requirements to limit crash decelerations for lower-severity collisions, but protect operator and passenger volume for more severe collisions.
- Balancing the design specifications for optimum protection of both occupants of the LRV and road vehicles.

An additional difficulty of including CEM in the LRV safety standard is that the methodologies are sufficiently new that there is not universal agreement on the optimal approach for implementation. One approach used to introduce CEM into LRV specifications was to specify a particular crash scenario for which the vehicle should be designed. For example, the LRV must withstand a 32-km/h (20-mph) collision between two vehicles and provide protection for the operator and passengers in that collision. The problem with this approach, however, is that the design will be optimized for the particular crash scenario but may result in a reduced overall crash safety for the range of potential collisions scenarios. For example, the LRV would perform well in the 32-km/h (20-mph) LRV–LRV collision, dissipating the collision energy in crush of the forward cab structures. However, the design of the forward cab structures that are optimized for the LRV–LRV collision may be incompatible with the much more frequent collisions with automobiles.

A better approach for crashworthiness requirements is to specify a range of collision scenarios and acceptable outcomes for the vehicle. This approach was previously proposed for heavy rail vehicles (4). The resulting design will be more balanced and provide crash protection

for a range of collisions. The proposed train-to-train collision scenarios included a heavy shunt incident, a low-speed collision, and a more severe collision. Acceptable consequences ranged from energy dissipation in recoverable elements, to energy dissipation in replaceable elements, and finally to energy dissipation from controlled collapse of the rail vehicle end structures.

In the light rail environment, these scenarios would need to be adjusted for the operating environment and collision risk throughout the world. LRVs experience a wide range of operating conditions, from mixed urban traffic zones, to circulator routes, to dedicated right of way and shared-use lines linking downtown centers with outlying communities. During operation an LRV travels at speeds typically less than 35 mph in the city to 55 to 65 mph in suburban service, so the threats have many different forms. Unlike a commuter rail train, an LRV spends much of its operating time within a city, where most collisions are between the LRV and road vehicles.

Transit accident data collected in the United States over the last decade have provided the information necessary to perform an assessment of the LRV collision risk (5–9). The National Transportation Statistics for transit mode fatalities per 100 million passenger miles (in 1997–2001), from the U.S. Bureau of Transportation Statistics, are shown in [Figure 1](#) (9). These data illustrate that light rail operations have the potential for significant safety improvements compared to other transit modes and passenger car (automobile) operations. However, the comparisons of safety statistics for different modes of transit are collected using different methods and can be misleading. For light rail operations, the majority of reported fatalities are those of the occupants of automobiles or pedestrians that are struck by an LRV. Thus the transit system safety record does not reflect the safety of travel on an LRV. Similarly, the majority of LRV collisions are with road vehicles and typically the accident is not the fault of the LRV. However, these collisions are included in light rail transit (LRT) system safety records, even when the pedestrian or driver of the road vehicle is clearly at fault for the collision.

A closer investigation of the accident data allows us to separate out the injuries for the LRV passenger versus the pedestrians and automobiles (8). The corresponding distribution of injuries and fatalities is shown in [Figure 2](#). This shows that the majority of the fatalities in LRV collisions are the pedestrians and motorists that collide with the LRV. These collisions do, however, result in a significant number of injuries to LRV passengers. When we separate out the fatality rates for the occupants of the various transit modes, as shown in [Figure 2](#), the LRV operations compare much more favorably.

An example of collision data for a typical LRV system, the Denver Central Corridor, is available from Reference 10. From August 1994 through May 2004 there were 308 collision events recorded. Seventeen of the collisions were with pedestrians and four with bicyclists. The majority of the collisions (238 or 77%) were with cars. The rest are with a variety of other types of road vehicles (30 trucks, seven vans, five taxis, two police cars, two busses, a limo, a semi truck, and one unspecified vehicle). Seventy-six of the collisions involved the motor vehicle violating a stop sign or traffic signal. Forty-nine of the collisions are described as the vehicle hitting the train. These statistics indicate that potential safety gains can be achieved for LRT systems by improved education of the public on traffic safety and improved enforcement of traffic laws in the zone adjacent to the LRV operations. Crash avoidance is always a primary consideration for improvements in crash safety.

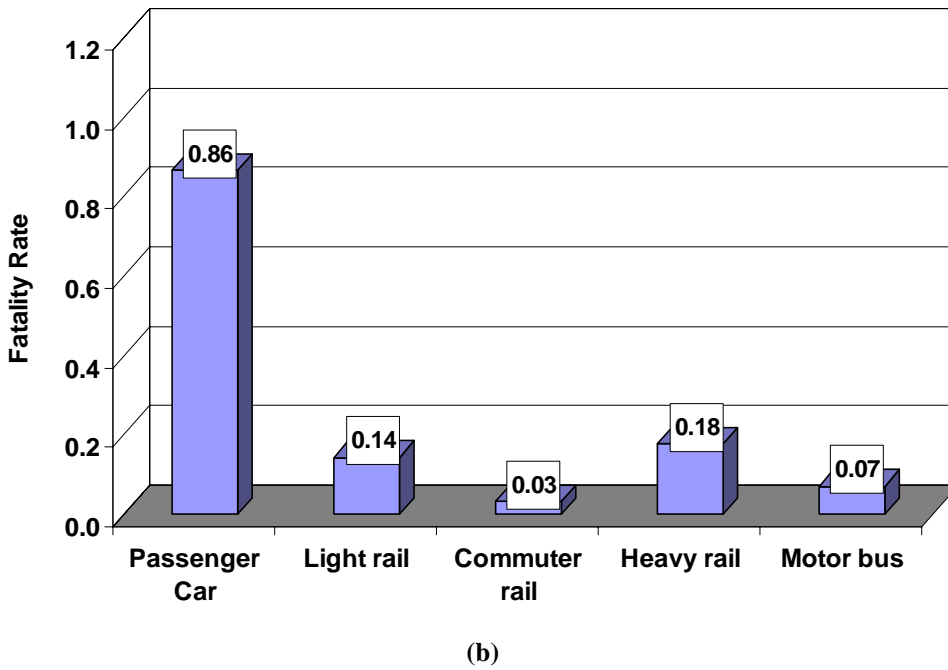
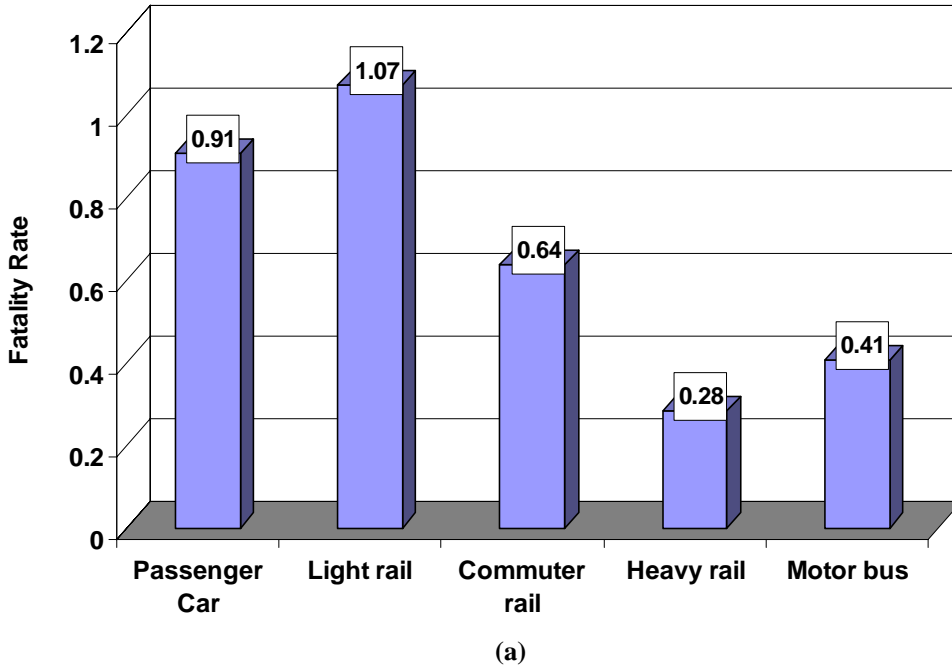
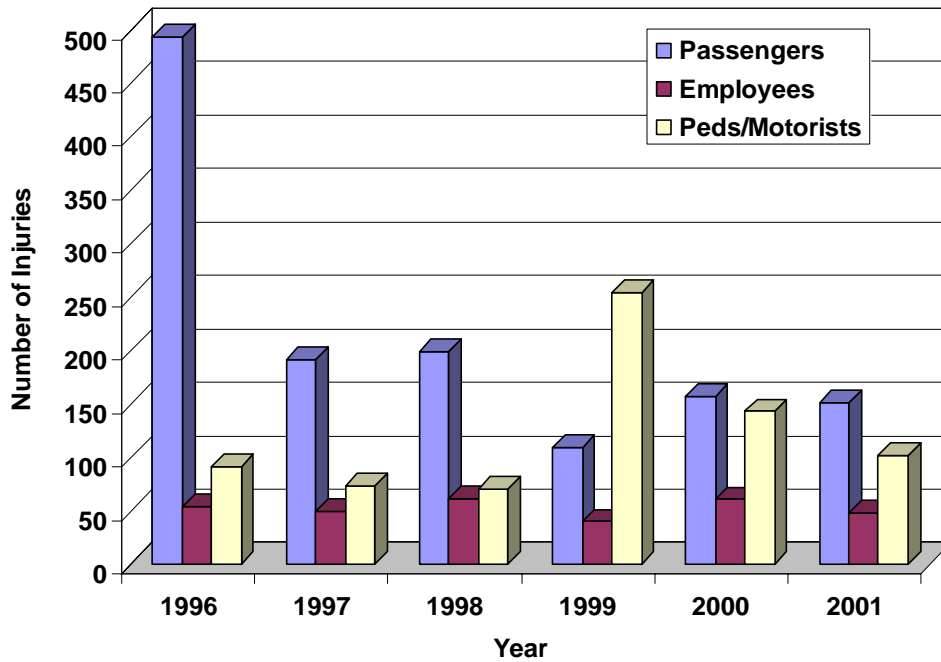
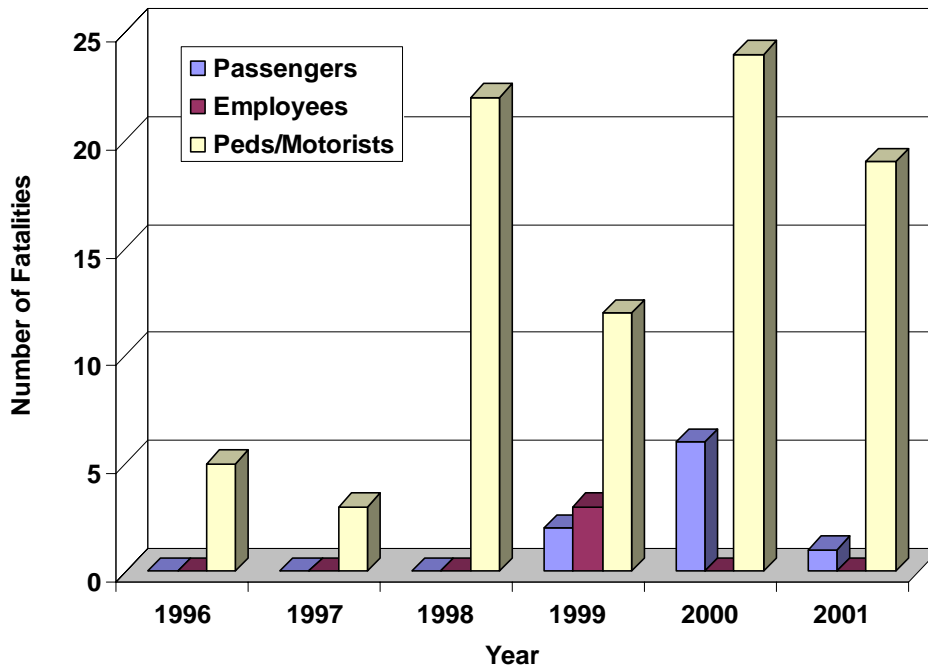


FIGURE 1 Transit mode fatality rates per 100 million passenger-miles (1997–2001):
 (a) Transit mode fatalities and (b) Transit occupant fatalities (7–9).



(a)



(b)

FIGURE 2 Distribution of injuries and fatalities for LRV accidents (7): (a) distribution of injuries and (b) distribution of fatalities.

Clearly, the collision between an LRV and an automobile needs to be considered as part of the overall collision safety. The majority of these collisions are the fault of the automobile drivers; however, the associated injuries and fatalities are counted against the safety record of the LRT system. Application of crashworthiness design technology should help reduce the severity of accidents involving road vehicles. For example, in collisions where the LRV strikes the side of an automobile, a compatible LRV cab-end can potentially result in significantly less structural intrusion into the street vehicle leading to a reduction in injury or fatality rates. This will contribute to a better overall safety record and a more positive view of LRV operations.

In general, considering LRV operations, a strategy that provides the greatest potential for safety would address five factors:

1. Provide for collisions between an LRV and a pedestrian or cyclist;
2. Provide for a collision between an LRV and automobile or truck;
3. Provide for the more severe LRV–LRV collisions;
4. Provide protection to the LRV operator and passengers from crushing or penetration effects of collisions (maintain the occupant survival space inside the LRV); and
5. Provide for the secondary impact of occupants with the LRV interior during a collision (LRV interior crashworthiness).

The difficulty in developing a safety standard for LRVs is to provide for the above five factors given economic and engineering constraints. For example, protecting bicyclists or pedestrians in a collision is very difficult due to the large discrepancy in mass and the LRV structural constraints. Adding energy absorbing devices for these collisions would be difficult and require force levels that are too low for protection against collisions with automobiles or other LRVs. As a result, the only practical provisions for collisions with pedestrians and bicyclists may be a smooth enclosed geometry of the front end to deflect them and reduce override potential in a collision.

Other requirements of significant importance, but beyond the scope of current LRV safety standard development efforts, include specifications for interior design characteristics that may have a significant effect on passenger injury potential. Interior crashworthiness requirements would include specification of attachment strengths for seats and other components, crash padding for seating, elimination of sharp corners or other objects that could injure an occupant in a collision (11, 12).

In the following sections, we address some of these safety factors in more detail and how they can be implemented into the safety standards.

Collisions Between LRVs and Road Vehicles

An initial modification that can be made to improve compatibility in collisions with automobiles is to eliminate features in the LRV front-end geometry that make it aggressive. One of these measures is to adopt retractable or fold-away couplers at the ends of the LRV. The second modification is enclosing the front end of the vehicle and having a sufficiently low nose to prevent override of cars. A collision where the LRV overrides an automobile is all too common, as seen in [Figure 3](#), and can lead to negative consequences. First, the override behavior results in significantly greater crush intrusions into the automobile. Second, the override collision has the potential to produce much more extensive damage to the LRV and greatly increase the repair costs and time before the vehicle is placed back in service. Finally, the override collision has a

much higher potential to derail the LRV or create higher crash accelerations that can result in higher injury potential to the LRV occupants.

The modification of simply improving the geometry of the LRV front end would have an improvement in collision with automobiles. Studies have found that the geometry of the striking vehicle has as large an effect on injury potential as the mass of the striking vehicle in car-to-car side impacts (15, 16). In particular, the height of the striking vehicle relative to the struck vehicle is important. The forces required to crush the side of the automobile are significantly higher if the impact engages the door sill at the level of the under frame of the car. As a result, engaging the door sill in the collision will dissipate the crash energy more efficiently with lower intrusion levels than if the collision occurs primarily above the level of the door sill. Unfortunately, many LRVs have a relatively high nose at the position of the end beam that is significantly higher than the door sill in most passenger cars. This is clearly seen in the LRV designs seen in [Figure 3](#).



FIGURE 3 Override collision behaviors between LRVs and automobiles (13, 14).

The concern over aggressivity of LRVs, trams, and streetcars colliding with road vehicles is not new (16). Many older streetcar designs included bumpers or other devices to protect pedestrians and automobiles in collisions (17). Similarly, bumpers and crash compatibility features are being incorporated in modern U.S. LRV designs. The Houston METRO vehicle has a retractable coupler and fully enclosed front end. The Phoenix LRV design is fully enclosed with an energy absorbing bumper with 100 to 150 mm of stroke before the anticlimber elements engage (14).

A large body of research on automotive crashworthiness is available to assist in preliminary analyses of collisions between LRVs and cars. These include analyses of the effects of vehicle strengths, geometry, and impact orientations on injury potential. These methodologies can be applied to evaluate the range of CEM features for protection in collisions between LRVs and road vehicles such as bumper height and energy absorption characteristics.

One approach is to make the LRV bumper geometry and force levels similar to those of an average road vehicle. A range of vehicle front-end profiles and frontal crush strengths are shown in Figures 4 and 5 (18). Using this type of data should result in LRV frontal CEM specifications that are compatible with the road vehicles. For example, from the vehicle geometries in Figure 4, the LRV bumper should extend over a vertical height range of approximately 10 to 30 in. above street level (top of rail). Similarly from the automotive frontal crush data in Figure 5, the LRV bumper force levels should be increasing over the initial 100- to 200-mm of stroke with a maximum level on the order of 400 kN.

Two factors in side impact collisions of automobiles that are closely tied to injuries of passengers are the change in velocity (ΔV) and the amount of intrusion of the car side into the occupant compartment (19). In a collision between an LRV and a car, the disparity in mass is so large that the car will typically be accelerated to nearly the speed of the colliding LRV. The longitudinal momentum balance for the collision can be used to calculate the lateral velocity of car struck by the LRV as

$$\Delta V = \frac{M_1}{(M_1 + M_2)} V_o$$

where V_o is the LRV impact velocity, M_1 is the mass of the LRV, and M_2 is the mass of the side struck vehicle. Using a 45,000-kg (100,000-lb) LRV and a relatively heavy sport utility vehicle (SUV) at 2,500 kg (5,500 lbs), the lateral ΔV for the SUV will be 95% of the impact speed of the LRV. For lighter automobiles the ΔV will be even closer to the LRV impact speed. This shows that, in general, the automobile will experience a ΔV that is nearly equal to the LRV impact speed for a direct collision into the side of an automobile.

The severity of collision that should be survivable can be estimated from research on side impact safety of automobiles. The potential for various severity injuries as a function of lateral ΔV and crush intrusions in side impacts is shown in Figure 6 (19). The injury probabilities are based on crash data from the National Automotive Sampling System database.

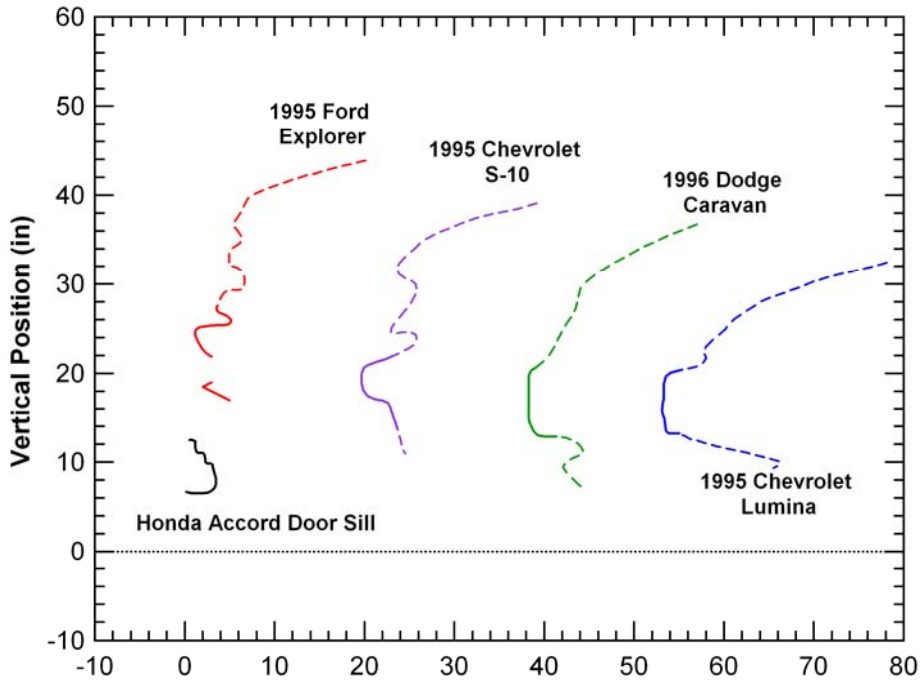


FIGURE 4 Front profile measurements for various road vehicles (18).

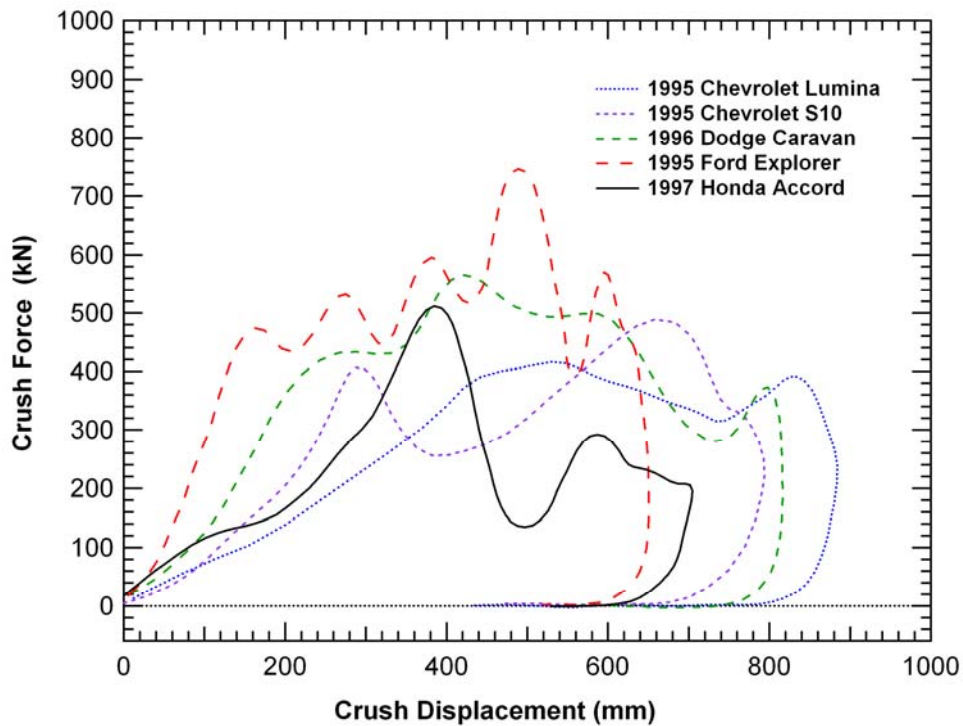
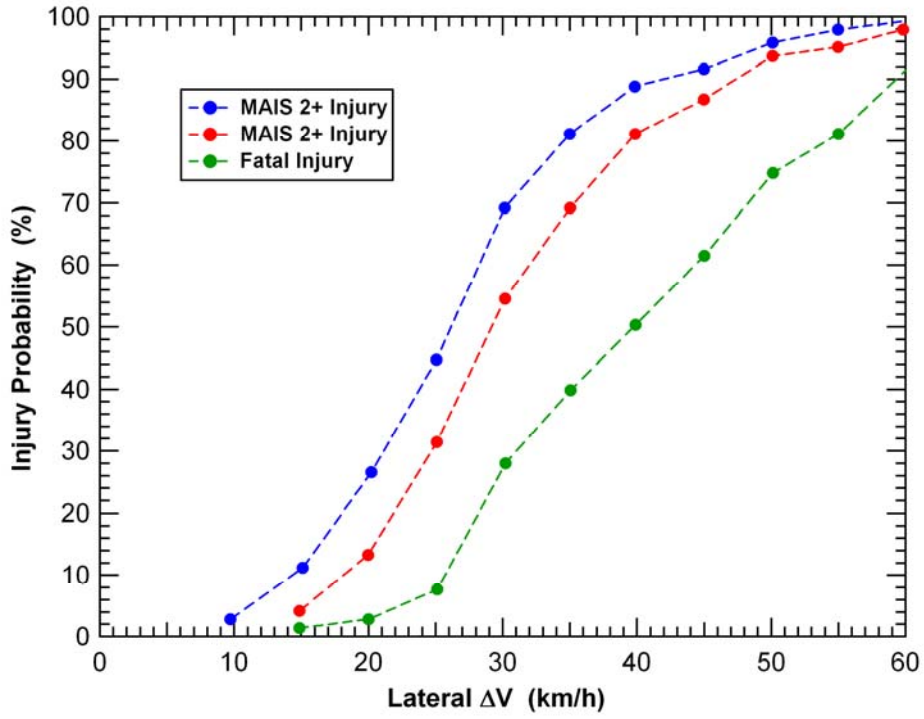
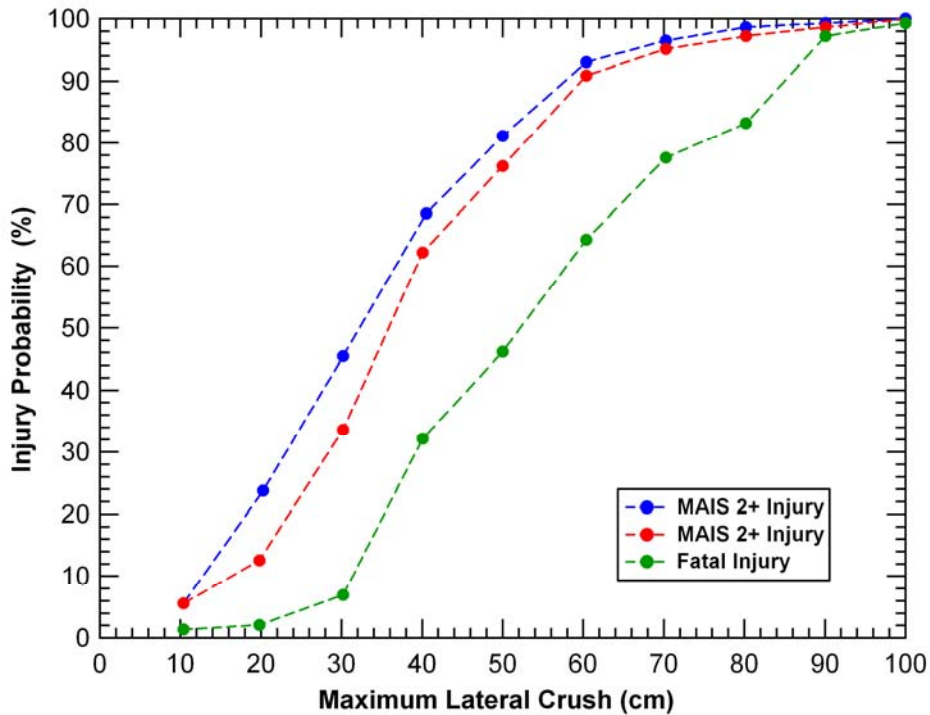


FIGURE 5 Frontal crush strength data for various road vehicles (18).



(a)



(b)

FIGURE 6 Injury potential as a function of lateral ΔV and crush intrusion (19): (a) injury versus lateral ΔV and (b) injury versus lateral crush.

No practical modifications can be made to the LRV design that will significantly influence the ΔV experienced by the car in a direct impact scenario. Therefore, the objective is to reduce the crush intrusions for a given collision severity. From damage observations on automobiles struck by LRVs, there is often significant potential to reduce the resulting crush intrusions. Cars have virtually no crush space on the sides, so some intrusion into the occupant compartment is inevitable. The objective is to maintain as much space as possible around the occupants.

If the front end of the LRV is properly designed, the LRV will be geometrically compatible with the car side structures in a collision. Similarly, the bumper can be designed with a stiffness that is compatible with the automotive lateral crush strengths. In this case, the LRV should be no more aggressive a collision partner than another automobile for a given value of ΔV . From Figure 6(a), a lateral ΔV of 25 km/h (16 mph) results in a low probability of fatality. In addition, this collision severity has less than a 50% probability resulting in a moderate or greater injury (corresponding to an injury on the maximum abbreviated injury scale of 2 or greater). This is a reasonable target for the corresponding level of protection that can be achieved from the design of the LRV bumper and front end structures.

In addition to geometric effects, an energy absorbing bumper has the potential to further reduce the intrusions into cars that are struck by LRVs. The difficulty is developing this energy absorption within the reasonable engineering constraints of the LRV design. The typical approach suggested for this energy absorption system is a bumper on the front of the LRV with an energy absorber that is replaceable, or more likely, recoverable. The concept is very close to the typical bumper and isolator systems found in automobiles.

If we consider a collision that produces a ΔV of 25 km/h (16 mph) for a 1360-kg (3,000-lb) mid-size car, the collision energy is approximately 32 kJ (24,000 ft-lb). The appropriate force levels for the LRV energy absorber can be selected to be compatible with frontal crash forces of automobiles. From Figure 6(b), the force profile should increase up to a maximum of approximately 400 kN as the bumper is pushed back. Assuming that a bumper stroke of 100 to 200 mm is possible on the LRV, a reasonable estimate of the energy that could be dissipated by the LRV bumper is on the order of 20 to 40 kJ. Thus, if properly designed, the bumper system will dissipate a significant fraction of the collision energy. Obviously, more detailed analyses will be required to determine the optimum characteristics of the LRV bumper system. The analyses need to include the range of collision severities that will be experienced, the range of vehicles on the roads, and non-ideal collisions at different angles and positions relative to the automotive center of gravity and axis. However, there is clearly potential to absorb a significant fraction of the crush energy for many collisions with automobiles. This energy dissipation will result in reduced crushing of the automobile and reduced intrusions into the passenger compartment.

The other concern that needs to be addressed for adding a bumper system to the LRV is that it does not increase the injury potential in other collision scenarios. If we consider a symmetric collision between two identical LRVs, the crash energy that needs to be dissipated is

$$E = \frac{1}{4} M_1 V_o^2$$

where V_o is the LRV closing speed and M_1 is the mass of a single LRV. For a collision between two 45,000-kg (100,000-lb) LRVs both equipped with bumpers capable of dissipating 30 kJ, the

closing speed can be as high as 8.3 km/h (5.1 mph) with no damage to either vehicle. Thus the bumper system would act as the first level of CEM for LRV–LRV collisions. Additional energy dissipation in more severe collisions will require a forward cab crush zone.

LRV–LRV COLLISIONS

Although the collisions between two LRVs are rare, these collisions can be the most severe in terms of velocity change for the LRV passengers or potential crush of the operator volume. As a result, the collision needs to be considered as part of the safety standard and CEM design.

A better understanding of the crash behavior of existing vehicles can be obtained when the results of collisions are studied and analyzed. As a result of the safe operating conditions for light rail systems, these collisions are quite rare. In addition, information from accidents is often sensitive; thus pictures and details are difficult to obtain. Nonetheless, it has been possible to gather some examples of accidents occurring with modern low-floor LRVs (LFLRVs) (17). One particular accident of interest occurred in Germany between two modern LFLRVs equipped with energy absorbing bumpers. The following incident is a typical collision scenario that provides insight into the crash behavior of a modern LRV.

The collision of interest occurred in Berlin between car number 1007 traveling at 48 km/h (29 mph) and car number 1045 standing at a station with the parking brake applied. The collision damage to the two vehicles is shown in [Figure 7](#). These vehicles are from the standard GT6 series built by MAN/AEG/ADtranz/Bombardier in Nuremberg, Germany. As built the AWO weight is 31,200 kg (68,800 lb) and the vehicle design buff load is 160 kN (36,000 lb). Thus the buff strength is approximately one half of the vehicle weight (0.52 g) for this design. The specifics of the collision are as follows:

- Injuries: 14 minor injuries;
- Damage: Bumpers and energy absorbing elements sacrificed (energy-absorbing bumper unit: 260-mm stroke prior to impact with cab front and 7-kJ energy absorption in each bumper); and
- Significant structural damage to both vehicles (cab crush distances in each vehicle, estimated from comparison of the crash photos with the vehicle general arrangement drawing, are less than 500 mm).

A simple collision analysis can be used to estimate the crash forces (or accelerations) of the vehicles. Using the energy balance in the collision, for two equal weight vehicles (one stationary one moving), half of the initial kinetic energy will be absorbed by crush deformations and the remaining half will be in the residual kinetic energy of the two vehicles. Using an impact velocity of 48 km/h and a vehicle mass of 31,200 kg gives the initial impact energy of 2.76 MJ. As a result, approximately 690 kJ will be absorbed by crushing in each cab. Assuming 0.50-m crush distance in each cab, the average crush force in each cab is 1.4 MN corresponding to a crash deceleration of approximately 4.5 g (44 m/s).

The first observation about this collision is that the vehicles performed very well with only minor injuries produced by a relatively serious collision (2.8 MJ of collision energy). The second observation is that the buff strength requirement for the vehicle has very little to do with the overall collision response. Although this was approximately a 0.5-g buff strength design, the

actual crush force levels were approximately an order of magnitude above the buff specification. This example illustrates that when CEM requirements are specified correctly, the buff strength specification is not important to ensure crash safety.

SECONDARY IMPACTS OF OCCUPANTS WITH LRV INTERIORS

The final level of safety for LRV operators and passengers is obtained by protecting against secondary impacts. Secondary impact injuries occur when the crash environment creates a discrepancy between the motion of the vehicle and the motion of the occupants. If the occupant collides with structures inside the LRV at sufficiently high relative velocity, secondary impact injuries will result. Protection against these types of injuries is often classified as vehicle interior crashworthiness. Interior crashworthiness methodologies include design of interior padding, elimination of sharp objects and hard surfaces, optimization of seating configurations, and technologies used extensively in the automotive industry such as seat belts and airbags.

International efforts to develop standards for interior crashworthiness have been primarily for the heavy rail or high speed railroad operations (5). LRV operational requirements can add complexity to the interior crashworthiness issues due to the larger number of standing occupants and differences in efficient interior layout and seating configurations. Detailed standards for LRV interior crashworthiness are currently outside the scope of the structural safety standards being developed in the United States. However, the topic will be discussed briefly in this section.



FIGURE 7 Comparison of vehicle damage produced by the collision: (a) Vehicle 1007 (GT6) and (b) Vehicle 1045 (GT6).

Occupant response and injury potential in rail transportation can be analyzed using various modeling approaches. The simplest of these approaches is to perform simple injury assessments based on the crash acceleration environment and established injury criteria. An example of this approach for the heavy rail industry is an injury assessment based on secondary impact velocity (SIV) (20). The SIV is defined as the relative velocity at which the occupant strikes the interior surface of the vehicle. The relative velocity develops as the rail vehicle decelerates and the unrestrained occupant in the vehicle continues to travel at the initial vehicle velocity immediately prior to impact. The analysis methodology is to integrate the crash environment to obtain both the relative crash velocities and displacements between the vehicle and occupants. The corresponding SIV is plotted versus displacement and injury potential is determined from the SIV that corresponds to the occupant free travel distance. The occupant free travel distance is a function of the vehicle interior geometry and seating configurations.

The injury criteria developed in the heavy rail community show that occupant fatalities can be prevented using standard seating and interior arrangements if the secondary impact velocities are below 29 km/h (18 mph). The primary accident scenario in the light rail environment capable of producing this level of SIV is a collision between two similar LRVs at a closing speed of 58 km/h (36 mph) or greater. This severity of collision has an extremely low probability of occurrence given the typical operating conditions of most LRV systems. The more common accident scenarios involve impacts with vehicles that are lighter (road vehicles) or with other LRVs at lower collision velocities. As a result, for most LRV collision scenarios, the occupant SIV will be well below the 18 mph threshold for which conventional seating and traditional rail interior design methodologies are sufficient.

CONCLUSION

The development of a safety standard for U.S. LRVs has been a difficult process as a result of conflicting viewpoints. Foremost among these are the competing approaches of the traditional higher strength 2-g buff load LRVs currently in operation in the United States versus designs that are more consistent with LRVs used in international markets that allow for potential reductions in vehicle weight and cost. An important objective for the standards is to provide a level of safety that is at least equal to current practice. It is believed that introducing CEM design principles will result in an overall improvement in safety for LRV operations. However, the determination of vehicle safety is difficult with issues such as vehicle compatibility between new designs and the older vehicles currently in operation.

Although the U.S. LRV safety standard development process has been slow, there has been significant progress. Among the significant progress is a growing recognition of the potential for improved safety using CEM design principles and an increased emphasis on the importance of protection in collisions between LRVs and automobiles. With increased application of modern crashworthiness engineering, there is significant potential to develop a U.S. LRV safety standard that will both reduce equipment and operational costs and save lives.

REFERENCES

1. Cléon, L.-M. "3. Résistance Passive Application au TGV 2N." *Revue Générale des Chemins de Fer*, Gauthier-Villars, 199, pp. 45–58.
2. Dannawi, M., E. Demonsant, and A. Wiart. "2. Absorption D'énergie et Simulation Numérique de Choc." *Revue Générale des Chemins de Fer*, Gauthier-Villars, 1993, pp. 35–44.
3. Lagneau, H. "4. Résistance Passive Application aux Matériels de la Vie Quotidienne." *Revue Générale des Chemins de Fer*, Gauthier-Villars, 1993, pp. 59–64.
4. Lewis, J. H.. Development of a Structural Specification for Crashworthy Rail Vehicles. In *Crashworthiness and Occupant Protection in Transportation Systems*, Proceedings of the 1995 ASME International Mechanical Engineering Congress and Exposition, Vol. 210, 1995, pp. 1–16.
5. *Safety Management Information Statistics 1997 Annual Report*. Report Nos. FTA-MA-26-5002-99-01, DOT-VNTSC-FTA-99-3. U.S. Department of Transportation, March 1999.
6. Transit Cooperative Research Program (TCRP) Report 69, *Light Rail Service: Pedestrian and Vehicular Safety*. National Academy Press, 2001.
7. National Transit Database Data, Annual Data Tables. <http://www.ntdprogram.com/>.
8. Federal Transit Administration State Safety Oversight Program, 2003 Annual Report. <http://www.transit-safety.volpe.dot.gov/>.
9. Bureau of Transportation Statistics. National Transportation Statistics 2005, U.S. Department of Transportation. http://www.bts.gov/publications/national_transportation_statistics/2005/.
10. Light Rail Collisions, 2005. http://cfapp.rockymountainnews.com/news/light_rail.html.
11. ATOC Vehicles Standard, "Vehicle Interior Crashworthiness," AV/ST9001, Issue 1, 2002.
12. Kirkpatrick, S. W., M. P. Schroeder, and J. C. Valdés Salazar. Developing Guidelines for Crashworthiness of Light Rail Vehicles in Mixed Fleet Operations. Proc., ASME International Mechanical Engineering Congress and Exposition, New Orleans, Louisiana, November 17–22, 2002.
13. Light Rail Train Crushes Automobile That Gets in the Way; Four Injured. *Sacramento Bee*, October 20, 2004.
14. Swanson, J. D. Establishing the Needs: What Must We Design For? Presented at RT-1 CEM Subcommittee Meeting, Colorado Springs, Colo., Sept. 30–Oct. 2, 2003.
15. Summers, S. M., A. Prasad, and W. T. Hollowell. NHTSA's Research Program for Vehicle Aggressivity and Fleet Compatibility. National Highway Traffic Safety Administration, Paper No. 249.
16. Grzebieta, R., C. Tingvall, and G. Rechnitzer. Geometric Compatibility in Near Side Impact Crashes. Monash University Accident Research Centre, Monash University, Clayton, Australia.
17. Swanson, J. Running Safety and Light Rail Vehicles 2. Presented at APTA Commuter Rail/Rail Transit Conference, Baltimore, Md., June 9–13, 2002.
18. Summers, S., A. Prasad, and W. T. Hollowell. NHTSA's Vehicle Compatibility Research Program. SAE Paper No. 1999-01-0071.
19. Arbelaez, R. A., B. C. Baker, and J. M. Nolan. Delta Vs for IIHS Side Impact Crash Tests and Their Relationship to Real-World Crash Severity. Insurance Institute for Highway Safety, Paper No. 05-0049.
20. Parent, D. Session 1—Overview of CEM: Occupant Protection. Presented at FRA/FTA Crash Energy Management Technology Transfer Symposium, San Francisco, Calif., June 29–July 1, 2005.

REGULATIONS AND STANDARDS

The German Regulatory System

ADOLF MÜLLER-HELLMANN
Association of German Transport Undertakings

The German Regulatory System

Contribution to the Joint International Light Rail Conference

A World of Applications and Opportunities

9 – 11 April 2006 St. Louis (USA)

Professor A. Mueller-Hellmann

Director of the Association of German Transport Undertakings

1

Verband Deutscher Verkehrsunternehmen 



DC-powered tramways, light rail systems, subways, and railways in Germany.

Source: Elektrische Bahnen 03/2006

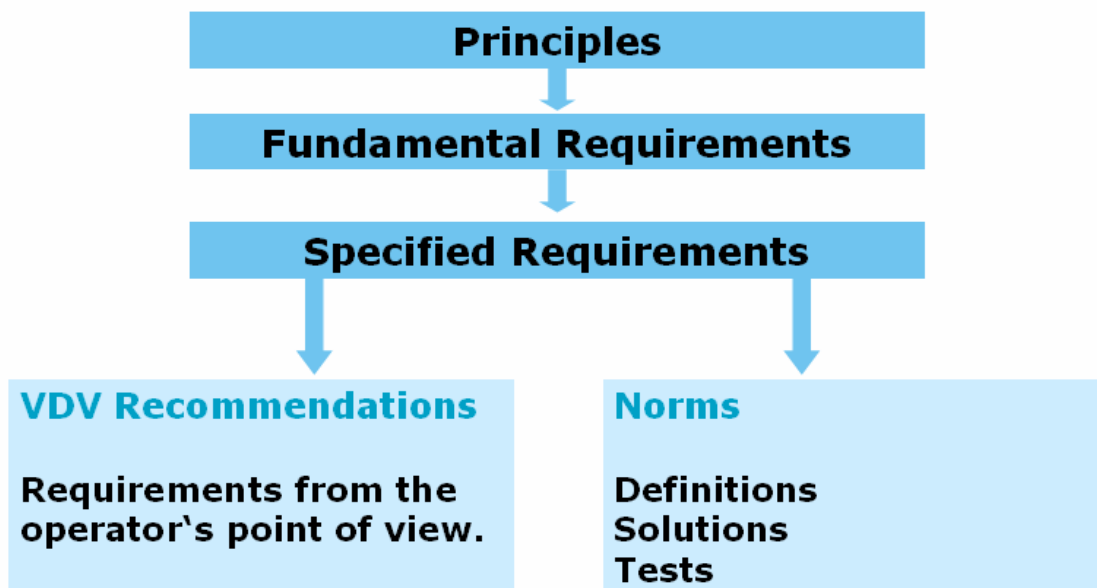
Legal Framework

The legal framework for light rail in Germany is clearly defined by the Passenger Transport Act (PBefG), most recently amended on August 26, 1998, and especially by the Regulation on Construction and Operation of Tramways (BOStrab) of 11 December 1987.

Safety Measures and Smooth Operation

- Guaranteeing safety and smooth operation has always been a primary goal of the laws, regulations, directives, and standards applying to public transport.
- This principle is consistently upheld in the current versions of these rules.
- For example, approval for providing transport by light rail (meaning among other things for construction, operation, and routes) is only granted if the safe, efficient operation of the system concerned is guaranteed and provided that the companies and officials in charge of running the business are reliable and technically qualified to do so (Passenger transport act PBefG).

Structure of the Rules

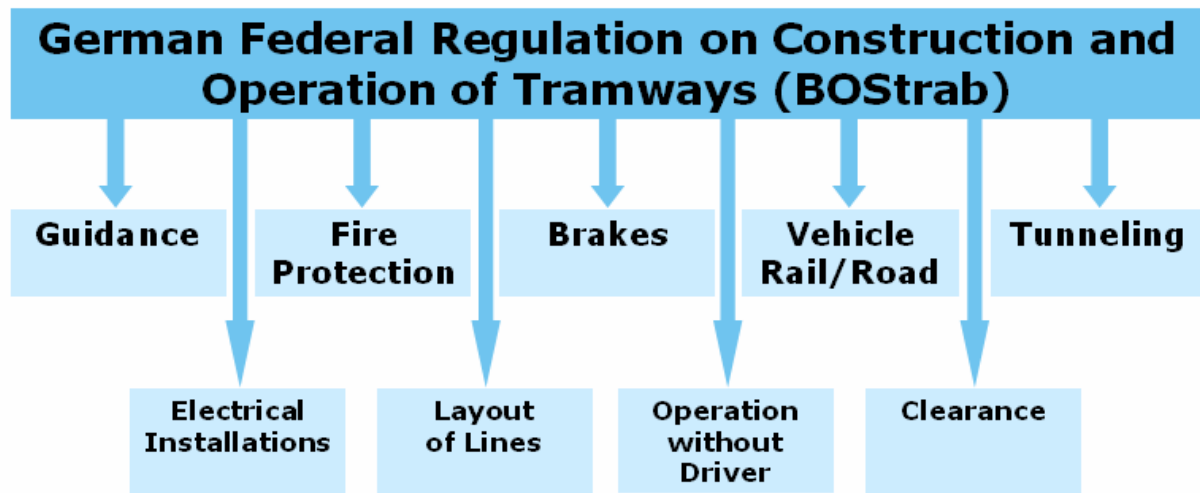


German Federal Regulation on Construction and Operation of Tramways

Contents

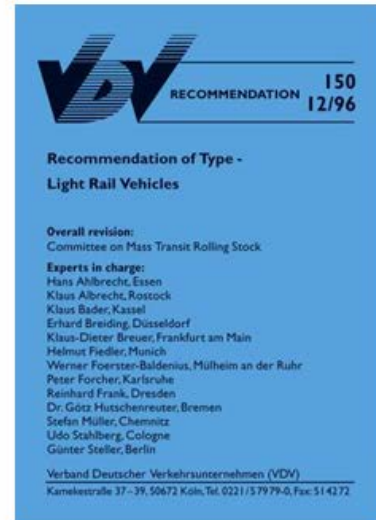
First Part	General
Second Part	Operating Management
Third Part	Operating Staff
Fourth Part	Operational Installations
Fifth Part	Vehicles
Sixth Part	Operation
Seventh Part	Procedural Formalities
Eighth Part	Noncompliance, Conclusion, and Transitional Arrangement
Appendices	

Directives of the German Federal Regulation on Construction and Operation of Tramways (BOStrab)



VDV Recommendations

These publications are aimed mainly at transport companies, but much of their subject matter is also relevant to other interested parties, such as vehicle manufacturers, parts manufacturers, urban transport principals, transport authorities, road-building authorities, planners, engineers, and so forth.



VDV Recommendations

VDV recommendations are not binding on either its member companies or third parties, but they are widely accepted as "the state of the art." This is largely because the transport companies' expertise and practical experience find their way directly into the subject selection and contents of the recommendations through interdisciplinary work in the VDV committees or the participation of third parties.



Supervisory Structures

The issuing of licenses and the supervisory role (meaning the monitoring and enforcement of rules and the terms and conditions associated with the awarding of a license) are government responsibilities placed in the hand of public agencies. The authorities are appointed by the respective regional governments.

Supervisory Structures

The Technical Supervisory Agency, the authority specified by the regional government, supervises the administrative and technical approach of light rail operators. The construction documents for operating facilities and vehicles are, for example, reviewed by this authority. In addition, the authority also oversees the construction of facilities.

Assuring Safety

The management of the transport company bears particular responsibility for creating and observing a high level of safety when operating light rail services. The chief operating superintendent in particular is responsible for ensuring the safe, smooth running of overall operations. His ability to run such operations must be verified by examination, and his appointment must be confirmed by the Technical Supervisory Authority.

Assuring Safety

The chief operating superintendent's essential duties also include drawing up instructions for the BOStrab rules in accordance with the operational requirements and ensuring that they are adhered to. He has to inform the Technical Supervisory Authority about the instructions he draws up and about accidents and unusual incidents.

Definition of Light Rail Transit Systems (1)

The term "**light rail**" per se is not standardized in the legal framework in Germany at all.

Instead, it is encompassed by the generic term "**tram**" as defined in the passenger transport act.

Definition of Light Rail Transit Systems (2)

Under that law, trams are railways which as

- "**Road-dependent railways**"

- Use the space provided for traffic on public roads and are adapted to the particular requirements of road traffic in terms of their structural and operational facilities and their mode of operation; they have "track formations flush with the road" whose tracks are embedded in road surfaces or pavements.
- Have a "separate track formation" located in the space provided for traffic on public roads and separated from the rest of traffic by stationary barriers.

Definition of Light Rail Transit Systems (3)

and which as

■ "Independent railways"

- Are designed as an elevated or underground railway; they have "independent track formations" (separate right of way), meaning they are independent of other traffic by virtue of their location or construction type.

Definition of Light Rail Transit Systems (4)

Use of the term "**light rail**" has become customary for referring to more advanced trams, which are largely separated from other traffic and have modern guidance, safety, and dispatching systems.

Approval of Driverless Operation

The Regulation on Construction and Operation of Tramways (BOStrab) together with the Directive on Driverless Operation in accordance with BOStrab and the VDV-Recommendation 399—Requirements for Facilities Ensuring the Passengers' Safety at Stations with Driverless Operation—form a comprehensive framework for the approval of Driverless Operation, as shown in Copenhagen and Nuremberg.

BOStrab Directive on Driverless Operation

Preliminary Directive on Driverless Operation in accordance with the German Federal Regulation on Construction and Operation of Tramways (BOStrab)

Table of Contents

1. Scope
 2. Checking the Clearance
 3. Operation
 4. Track Formation
 5. Stations
 6. Vehicles
- Notes

§ 16 (9) Track formations

Where Driverless Operation is used, unauthorised entry, passage over and use of the formation must be prevented by enclosure or other means.

Track Formation

The requirement made in Section 16 (9) of BOStrab **is considered to be fulfilled** if enclosures of the track formation or other constructions are so designed and dimensioned that persons and items carried or used by these persons cannot reach the track formation negligently.

Enclosures or other constructions shall be designed and dimensioned in accordance with the kind, use and location of the ground next to the track formation. Enclosures or similarly acting constructions shall have a **height of at least 1.2 m.**

§ 53 (1), (2) Staffing of Trains

Every train, while moving, must be staffed by a driver with route knowledge.

As an exception, trains on railways with independent formations need not be staffed by drivers, provided that

- The area within the structure gauge is **regularly** checked to be free of persons or objects which may interfere with safe operation.

Checking the Clearance

The requirement made in Section 53 (2) of BOStrab **is considered to be fulfilled** if the clearance of the tracks for passenger transport is checked as follows:

- a) **Once a day**; if the operation rests for some time, the inspection has to be carried out when the operation is started again;
- b) After events which might result in a restriction of the clearance.

§ 56 (3) Defective Trains

Where Driverless Operation is in use, or where safety zones (e.g., walkways) are unavailable, precautionary procedures must be taken to ensure that passengers may be **promptly** rescued from stranded trains.

Plan for the Rescue of Passengers

A plan is to be prepared for the rescue according to Section 56 (3) of BOStrab, in which particularly the following is to be laid down:

- a) Measures required due to the respective operating conditions,
- b) The control room which is instructed to initiate the measures.

A guide time of **half an hour** is to be taken as a basis for the beginning of the rescue at the train.

§ 31 (5) Stopping places (stations)

Where Driverless Operation is concerned, special provisions must be made at stations to ensure that persons are not endangered by moving trains.

Stations

The requirement made in Section 31 (5) of BOStrab **is considered to be fulfilled** provided that

- a) For the track area that can be reached from the platform, provision is made with automatically acting equipment that stops the trains immediately if there are persons in the track area,
- b) For the track area that can be reached from the platform, provision is made with automatically acting equipment that disconnects the contact line voltage if there is a risk of touching live parts,
- c) ...
- d) ...

VDV Recommendation 399



Requirements for Facilities Ensuring the Passengers' Safety at Stations with Driverless Operation

REGULATIONS AND STANDARDS

UNIFE
European Technical Standards

BERNARD VON WÜLLERSTORFF
Union of the European Railway Industries



St. Louis, April 11, 2006

Bernard von Wullerstorff



- 1) Who and what is UNIFE
- 2) Current standardization process in Europe
- 3) Manufacturers' needs and expectations
- 4) Some examples
- 5) Conclusion.... The end

UNIFE represents the interests of the RAILWAY MANUFACTURING INDUSTRY

- **Trend setting global industries**

World market share of 70%

- **Total turnover €50–60 billion (2003)**

➔ More than 130,000 people directly employed in the EU

- **Global presence**



1) Trends in the Railway Market

- Consolidation without sufficient rationalization
- Price reduction over the past 10 years by up to 30%
- Lack of harmonization in products, safety, and conformity assessment
- Innovation
- Challenges in infrastructure financing

2) Current Standardization Process

The New Approach in Europe (since 1985):

- Legislative harmonization is limited to the “essential requirements,” these being obligatory and formulated in general terms;
- Detailed technical specifications necessary for the implementation of directives is entrusted to the European voluntary standards organizations like CEN, CENELEC + ETSI;
- The standards are not mandatory, but products manufactured according to such “harmonized” standards give a “presumption of conformity;” and
- Compliance results in the right of the product to bear the “CE” marking of conformity and market release throughout Europe.

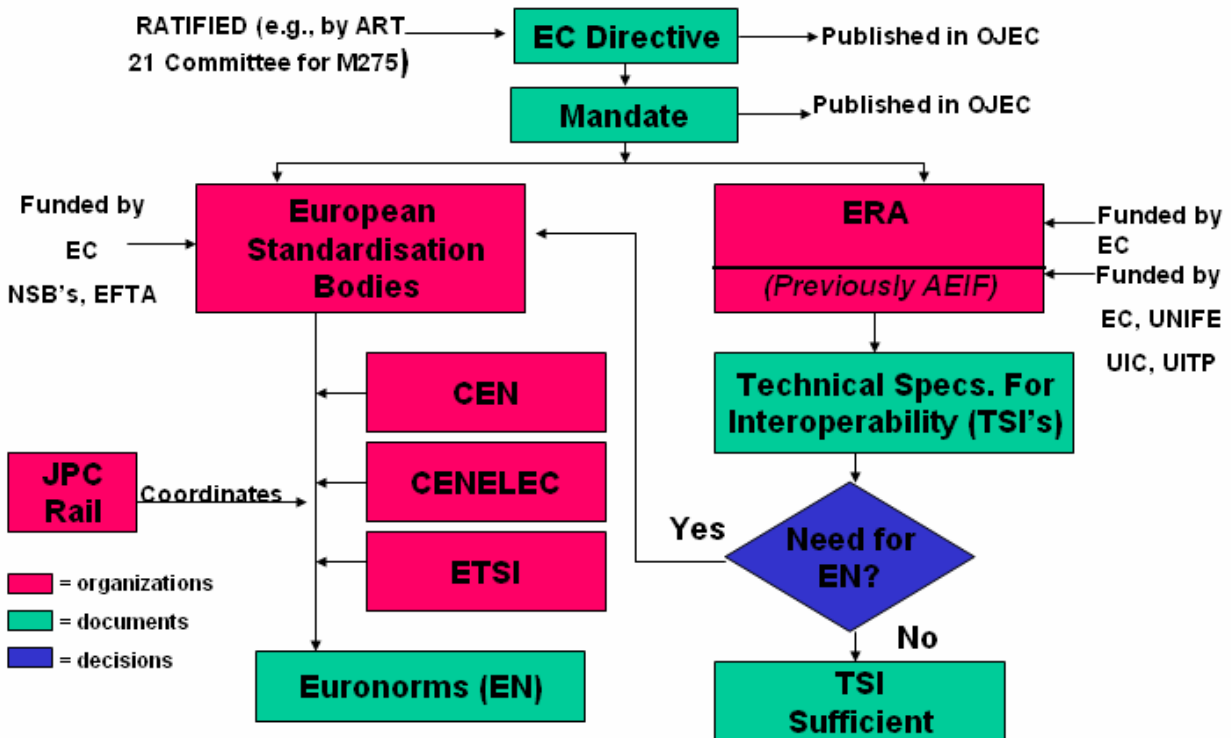
The following conditions apply:

- Mandate
- Publication reference in the Official Journal
- Implementation as a national standard in at least one Member State

2) Who and Where?

- CEN (*European Committee for Mechanical standardization*), CENELEC (*European Committee for Electrotechnical Standardization*), and ETSI (*European Telecommunications Standards Institute*) are the only 3 European Standards (EN) writing bodies
 - CEN TC256 is responsible for all Railway mechanical standards
 - CENELEC TC9X for Railway electrical standards
 - ETSI for telecommunication standards
- These standards apply to a market with 490 million people

2) Decision-Making Flowchart



2) EU Standardization Process

How does/should it work?

- **Openness and transparency:** Interested stakeholders may take part in the work; representation is **secured primarily through the national standards bodies** (in policy-making bodies and technical committees).
- **Consensus:** Standards are developed on the basis of **voluntary agreement** between all parties.
- **National commitment and technical coherence:** Formal adoption of European Standards is **decided by a weighted majority vote of the National Members** and is **binding on all of them**. They must **implement the standards at national level** and **withdraw conflicting standards**.
- **Integration with other international bodies:** Standardization is expensive and time consuming. International coordination has traditionally worked more effectively on the electrical side (with IEC) than on the mechanical side.

2) Some Challenges

TIME FACTOR:

- Sometimes it can take a long time to produce standards – **anywhere from 3 to 10 years**, but
- **Tremendous progress** has been made these last years, **resulting in a very significant improvement in standards production, in terms of time to delivery and quality**

QUALITY/ SYSTEM APPROACH:

- The somewhat extreme example of the EN 45545 on fire protection might therefore be perceived as a symbol of an already forgotten past.
- However the origins of the problems that were encountered are still present in **inadequate CEN/CENELEC working procedures** as well as in the **insufficient support given to CEN/CENELEC** by the representative professional associations of the sector.

3) Manufacturers' Expectations

WHY DO WE NEED BROAD BASED STANDARDS?

- Removal of technical and commercial barriers
- Product synergies through interchangeable subsystems (modularity)
- Maintenance synergies
- Improved reliability and safety
- It's the only way to achieve a system approach
- Stop wasting everyone's money when having to design to a vast array of specifications!



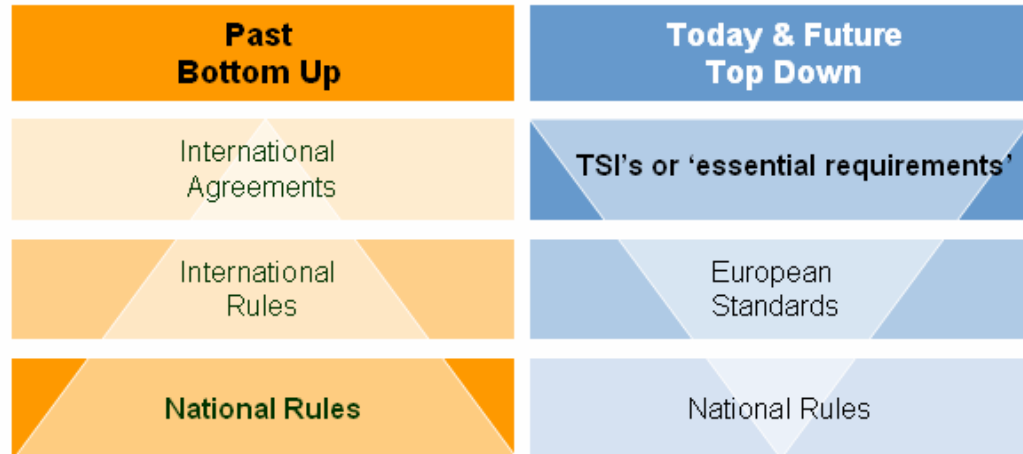
Win-win for both manufacturers and operators

CHALLENGES:

- Speedy time to market and market oriented standards - harmonization at affordable cost!
- Standardization is still too nationalised, even, and especially in Europe
- Make more efficient use of the available industry resources
- Produce standards suitable for their intended application (i.e.: properly extend their scope to mass transit)

3) Or in Other Words:

Harmonization means “cultural change in working together”



4) Fire Safety Standard EN 45545: The Story

- Start of the works 15 years ago in April 1991.
- Involvement of up to 42 experts from 12 countries, about 100 2-day meetings.
- Average participation of 50% of the experts, six of them remaining today from the original group!!!
- Directly interested parties (operators and manufacturers) in minority in the group.
- Illegitimate decision-making process in the group based on voting on a per-country basis, resulting in a total lack of evaluation of the costs of the standard as well as of its benefits in terms of system safety improvement.

4) EN 45545: Present Situation

- Part 1, General: rejected at formal voting stage in 2004
- Part 2, Materials Selection: Received a negative appraisal at the enquiry stage in 2005
- Part 3, Partitions: Rejected at formal voting stage
- Part 5, Electric Equipment (CENELEC): Adopted as a TS
- Other parts pending

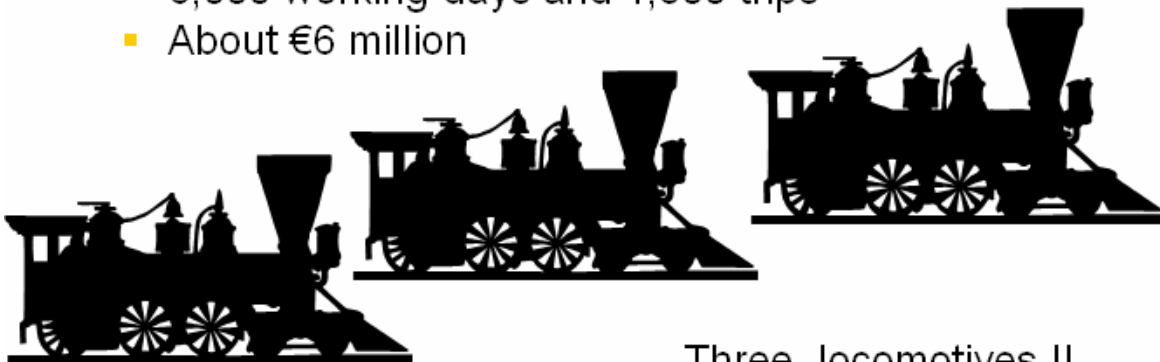
RESULT → **rejected**

WHY?

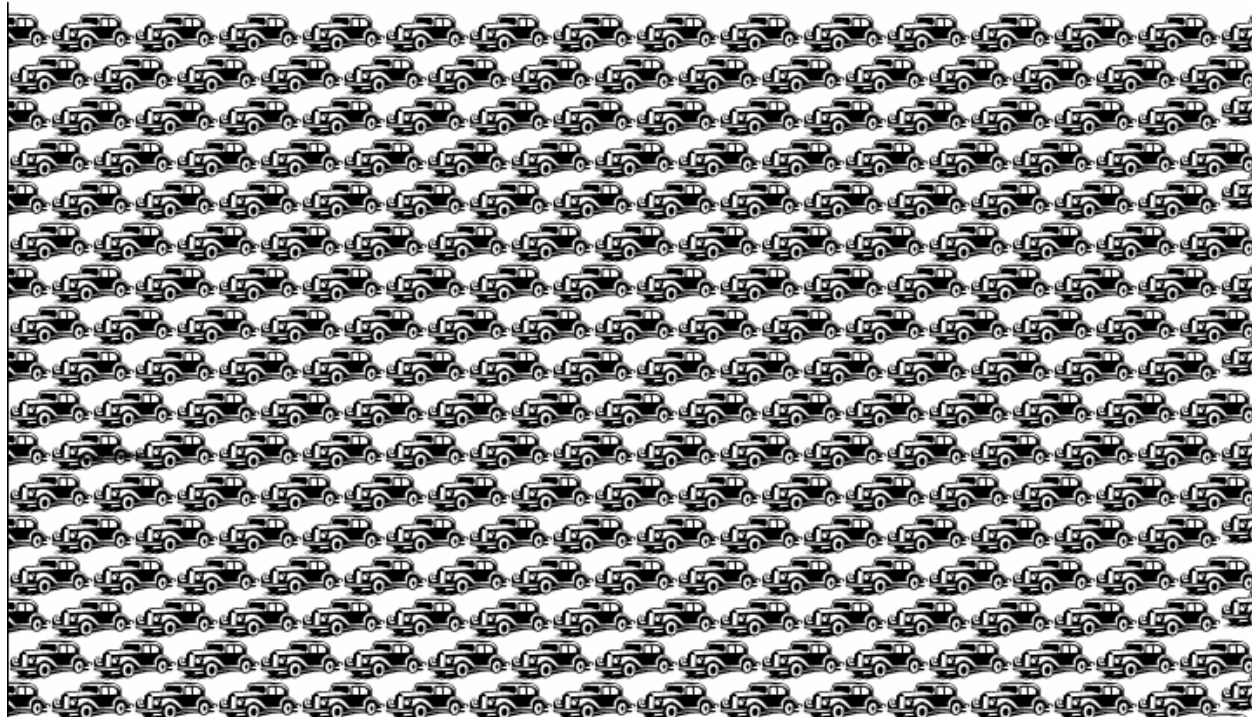
- No one ever performed a system analysis
- **Furthermore, the extension, or “mutation” of these requirements to the mass transit and LRT market has been totally left to the so called experts, who were not necessarily always representative of the mass transit sector.**
- **One crazy result: new light rail vehicles in Spain had to by law install fire doors between the driver and the rest of the vehicle (law is now changed after realizing it was nonsense).**

4) Estimated Total Cost When Achieved

- About 120 meetings of 2 days each, involving an average of about 25 experts.
- 6,000 working days and 1,500 trips
- About €6 million



4) Or 300 Cars !!



4) Positive Examples

- **The advisory team on fire protection**
 - But it would have been better if the team had been formed from the beginning
- **The rebuilding** by UNIFE and its members **in two meetings of the draft standard on crashworthiness**, based here also on a **renewed analysis of the system** by a core group of experts (industry and operators)



More generally, the ways of working are changing, whereby the manufacturers are making their voice heard more effectively

5) Conclusions

- **Standardization is a must for the manufacturing industry**
- **Standardize what's necessary—no more, no less**
- **Standards have to be produced rapidly**
- **Standardization only works if the operators also increasingly standardize their operating rules**



Win-win for the entire industry

Light Rail Transit and Bus Rapid Transit

LIGHT RAIL TRANSIT AND BUS RAPID TRANSIT

A Comparative Discussion of the Light Rail Transit Mode and the Bus Rapid Transit Initiative

JACK W. BOORSE
Parsons Brinckerhoff

Bus rapid transit (BRT) has sometimes been portrayed as a technology that is essentially equivalent to light rail transit (LRT), but which can be implemented at considerably less capital cost. That portrayal is not broadly accepted by transit professionals. This paper addresses this issue by first documenting the nature of each of the two alternatives, including the citation of examples, and proposing a formal definition for BRT to complement those of LRT. It defends BRT as a legitimate and discrete application of the bus mode. The discussion identifies technologies that are sometimes incorrectly characterized as BRT or LRT. It then discusses advantages and disadvantages of tangible and some intangible characteristics of each of the alternatives. The paper concludes by arguing that a comparison of the two in the abstract is not valid and that each should be evaluated in the context of the environment in which it would be constructed.

INTRODUCTION

Almost immediately upon the promotion of the bus rapid transit (BRT) initiative a few years ago questions arose as to whether BRT might be a viable, or even a preferable, alternative to the light rail transit (LRT) mode. Professional opinion is mixed. To date there has not been a decisive answer to that question and this discussion suggests that perhaps there should not be.

Nevertheless, if these questions are to be pursued, the two subjects must be evaluated and compared and to do that, those engaged in any such pursuit need to understand fully what each is—and what each is not. All too often modes labeled as LRT or BRT are actually something else. No valid comparison can be conducted until the subjects are clearly understood. The first element of this discussion addresses that need.

WHAT IS LRT?

During the first quarter of the 20th century electric railway transit (ERT) flourished around the globe. In North America, except for the pioneer subway and elevated lines in Boston, New York, and Philadelphia and the network of elevated railways in Chicago, the tracks of the ERT systems of that era were constructed at ground level. The majority were installed along the beds of public streets, not all of which were paved. Wires were strung above the tracks to deliver electric power to the rail cars. These ERT lines became known as trolley or streetcar systems. Those that connected two or more population centers were sometimes called interurbans.

Then, as roads were dramatically improved through massive government intervention and automobiles became more available and affordable, the market for trolley car transport was diminished. During the decade leading up to World War II it was determined that many lines, and even some entire systems, no longer required the carrying capacity of rail cars and could be adequately served by lower capacity buses, rolling on roads that were maintained at public expense.

For the duration of that war shortages of materials (particularly rubber) arrested the development of the bus mode, but expansion resumed after the end of hostilities. By the late 1950s the trolley mode had largely come to be regarded as passé and it vanished from many North American cities.

Around the three-quarter point in the 20th century some transit professionals began to recognize (or admit) that the basic transport abilities embodied in the trolley/streetcar/interurban mode were still of value and should not be lost. However, at that time the mode was still regarded as something obsolete that had been superseded by the bus mode. It was broadly assumed that any attempt to revive it would be viewed by the public, and hence by their elected representatives, as retrogressive.

Nevertheless, that recognition by the professional community of the latent value of the mode bloomed into an initiative to do just that, but very selectively and cautiously. It entailed the identification of those elements of the mode that might be truly obsolete vis-à-vis those that give it value, and then the refinement and enrichment of the latter, using state-of-the-art technology. Another part of the task was to seek out appropriate venues for retention and modernization of the surviving systems as well as potential new applications.

The initiative had many challenges, not the least of which was how to label the mode. In that era it was generally assumed that the traditional trolley or streetcar names should not be used. The new name that emerged from the initiative was “light rail transit” and the press, the politicians and the public quickly embraced it.

The initiative proved to be highly successful. Now, three decades later, there are more than 20 LRT systems in North America and that number continues to grow. At present, three entirely new systems are under construction and many of the existing networks are experiencing continuing expansion or upgrading. Still others are in various stages of planning. The mode bounced back from near oblivion and now enjoys widespread popularity.

But, something else bounced back—the terminology. A new line in downtown Portland, sporting the very latest in ERT rolling stock, is called the Portland Streetcar. On the five lines in Philadelphia where for years the rail cars were labeled with the clumsy name “subway–surface cars,” new directional signing and informational material now identify them as trolleys. From its inception in 1982, the San Diego LRT system has been known as the San Diego Trolley. A number of other systems use the terms streetcar and trolley generically in published literature and press releases. The point is that these labels are once again acceptable and sometimes desirable.

In a manifestation of the adage that declares imitation to be the most sincere form of flattery, dozens of tour operators now use scaled-down diesel buses that are camouflaged with a hokey body style to provide “trolley” or “streetcar” rides for sightseers. It is ironic that buses, once widely viewed as superior to trolleys or streetcars, now masquerade as trolleys for the purpose of improving their image in order to attract more passengers.

The return of respectability for the traditional names for the mode presents an opportunity to establish an easy method—one that could not be used in 1975—for determining what is, and is not, LRT. It is really quite simple. If a line or system is in fact a version of something that could

legitimately be identified as streetcar, trolley, or interurban, then it is LRT. That linkage does not preclude applying the label to versions of the mode that have been improved beyond the level of the ancestral types. This method of identification is completely consistent with the formal definitions of LRT that appear in the glossaries quoted below.

Transportation Research Board

Light Rail Transit: A metropolitan electric railway system characterized by its ability to operate single cars or short trains along exclusive rights-of-way at ground level, on aerial structures, in subways, or occasionally, in streets, and to board and discharge passengers at track or car floor level.

American Public Transportation Association

An electric railway with a “light volume” traffic capacity compared to heavy rail. Light rail may use shared or exclusive rights-of-way, high or low platform loading, and multicar trains or single cars. Also known as streetcar, trolley car, or tramway.

Not all current LRT systems make full use of the versatility of the mode, but they all possess the latent ability to operate in any or all of the designated potential settings should the need arise. For example, the initial LRT systems serving Portland and San Diego had no underground stations, but now they do. The addition of those new environments presented no deterrent to the use of the externally powered electric rail cars already in service on these two systems.

A review of the operating environments of trolley–LRT systems, past and present, reveals their demonstrated capability of operating both coupled and individual cars at ground level on in-street and off-street trackage, on aerial structures, and in lengthy tunnels with stations without creating any health hazards. The surface and elevated trackage of numerous systems and the underground segments of the Boston, Newark, and Philadelphia networks exemplify these abilities. Although not identified as LRT during their heyday because the term had not yet been coined, that is what the ancestral trolley systems were.

WHAT IS NOT LRT?

Not surprisingly, the success of the LRT initiative generated some tendency to overuse the label. The process of clarifying the identity of the mode entails sorting out erroneous applications of the name.

One of the significant characteristics of LRT is its ability to operate in roadway lanes also open to general traffic, or to cross them at grade. In essence, this requires delivering traction power to the rail cars via overhead wiring wherever they operate in that environment. Rail modes that are dependent upon a traditional third rail or “people movers” propelled by linear induction are not LRT. The hardware configuration at track level that these modes require for distribution of traction power is incompatible with the roadway surface needed by vehicle traffic.

The exotic, and grossly overrated, monorail mode has been characterized as light rail on more than one occasion. This is particularly curious considering the complete inability of monorail trains to interface with roadway traffic.

In concluding this first element of the discussion that has focused on LRT and in order to segue to the second element, BRT, it is important to note that LRT does not purport to be “rapid transit.” This does not mean that LRT cars and trains are incapable of traveling at high speeds. Where appropriate, they can reach, or exceed, the speed of buses. In the underground section of the Dallas LRT system trains reach speeds of 100 km/h (62 mph). Some ERT cars of the mid-20th century (before the LRT label was born) routinely traveled at 145 km/h (90 mph) on interurban trackage. At the other end of the spectrum is the 16 km/h (10 mph) speed limit, imposed by California state regulations, of LRT trains as they travel through the pedestrian mall in downtown San José, offering a useful rail transit service that is definitely not rapid. Operating speed is not a determinant for qualifying a rail facility as LRT.

WHAT IS BRT?

Just as the light rail transit name and its LRT nickname quickly caught the public fancy following its introduction, so has the appellation bus rapid transit and its nickname BRT. However, public understanding of the term is still quite vague.

The term “rapid transit” is traditionally applied to a rail transit mode that provides service in the higher speed ranges. The common practice for more than a century has been to apply it to rail operations on exclusive rights-of-way that were substantially—in most cases, entirely—free of traffic impediment. With a few isolated exceptions, it has served as a synonym for elevated, subway, and metro.

The emergence of the BRT initiative and its use of the rapid transit term for a non-rail mode has affected this tradition. In retrospect, to avoid causing the confusion that might now exist, a better term might have been *rapid bus transit*, but that opportunity has passed and the BRT label is now established. Furthermore, some BRT facilities do provide expeditious travel of a caliber approaching that of higher speed rail lines.

As the various operations are vetted it becomes apparent that BRT is not a separate, freestanding mode, but more in the nature of a variety of applications the bus mode. Nevertheless, even as a subset of the bus mode, BRT does deserve a legitimate place in the pantheon of metropolitan transit services and it needs a formal definition.

In TCRP Report 90, BRT is described as

. . . a flexible rubber-tired rapid-transit mode that combines stations, vehicles, services, running ways and Intelligent Transportation Systems (ITS) elements into a integrated system with a strong positive identity that evokes a unique image.

It is interesting that this description focuses on the image that is called up without addressing the basic matter of rapidity. The emphasis on appearance and the lack of specifics invites services that are primarily cosmetic or only marginally better than traditional bus lines to don the “rapid transit” mantle. An overly broad application of the term to mediocre services could have the effect of denigrating applications of BRT concepts that truly provide superior service. To address that concern the following definition is offered:

Bus Rapid Transit: Any operation of buses at a significant speed on roadways, or sections of roadways, that are physically and effectively separated from general

traffic and which may include features to expedite the discharge and boarding of passengers at stations.

The classifications used in the balance of this discussion are based on this proposed definition. It is contemplated that both the content of the definition, and the elements of this discussion that are based on it, will stimulate debate.

One of North America's newest BRT facilities is a segment of the "Silver Line" in Boston. At present, it comprises a roadway in a tunnel that is directly connected to an at-grade roadway, both of which are exclusive to buses. At the outer end of the surface roadway there is a signalized intersection with a public street. There are three underground stations and one surface station just beyond the street intersection. The segment, between the underground terminus and the signalized intersections, is unquestionably BRT.

The line is served by dual-mode vehicles that function as an electric trolleybus (ETB) while running on the exclusive roadways. Those buses assigned to routes that extend beyond the roadways equipped with the overhead wires retract their trolley poles and continue onto the public highways propelled by a diesel engine.

Nearby, but not contiguous with the facility described above, there is another bus service also called the "Silver Line." The buses on that line operate curbside lanes of a public street that have been designated for exclusive bus use and in which parking and curbside loading are forbidden. The combustion engine buses operating in those lanes are afforded some degree of traffic signal priority at intersections. The eligibility of these segments for classification as BRT is addressed subsequently.

As with those on the segment with the tunnel, the buses serving this on-street route continue beyond the zone with exclusive lanes and travel on public roadways where they mix with general traffic. On both of the facilities that are labeled as a Silver Line the operations in lanes that are open to general traffic are not materially different from those of non-Silver Line routes using those lanes.

In metropolitan Pittsburgh there are three "busways." They are roadways that were constructed for the exclusive use of buses and their inception pre-dates the coining of the BRT label. These roadways are largely at ground level and include intermediate stations. Some sections are above or below grade. Each of these exclusive roadways, which allow the buses to travel without interference from general traffic, can be classified as BRT.

One of the three busways connects with a tunnel under Mt. Washington that had long been part of the region's trolley system and which was modified in the 1970s so that buses could also utilize it. Consequently, it is now both an LRT and a BRT facility.

Unfortunately the introduction of buses has, to some extent, degraded the quality of the rail service through the tunnel. All of Pittsburgh's buses are powered by combustion engines and emit exhaust. The resulting impact on the air quality is, at times, very noticeable to BRT and LRT passengers. However, their exposure to those emissions is minimized because there are no stations within the tunnel. Stations are located in the open, beyond the ends of the underground section.

Substantially all of the bus routes using the Pittsburgh busways continue beyond their limits and travel on public streets. There are some line segments where buses are provided with exclusive lanes, but much of the street operation is in mixed traffic, which often includes buses on other routes that do not use the busways.

Ottawa has developed a network of busways that include on-line stations and serve as trunks for routes extending beyond the exclusive roadways. There is no underground running. As with the Boston and Pittsburgh systems, the operations on reserved roadway segments should be considered to be BRT.

There are other busways in North America, some, but not all, of which carry the BRT label. In the interest of brevity descriptions of these facilities have not been included in this discussion. The three systems discussed above contain most of the features of the other BRT applications.

WHAT IS NOT BRT?

Unfortunately, the popularity of the BRT label, as with the LRT label, has led to its overuse and misuse. Some operations that have been given the name are not deserving of it.

All of the North American BRT systems have routes that extend beyond the limits of the exclusive facility. A bus operation in general traffic lanes, even if the vehicles are painted with a distinctive motif and perhaps have some traffic signal priority, is not BRT.

There is some debate as to whether the operation in reserved curb lanes should be categorized as BRT. This may depend upon the purity of the reservation. There is often difficulty with the enforcement of the parking and loading prohibitions that are an essential component of that concept. Curb lanes may also be used by general traffic when executing right turns, legally or illegally, at a cross street. Such encroachments can significantly impair the ability of the buses in the curb lane to provide speedy transit service.

This is not to say that a curb lane restricted to bus operations should not be classified as a BRT facility in any circumstance. Curb lanes that are reserved for bus operations are much more likely to be free of illegal encroachment if they are “contra-flow,” i.e., the buses travel in the direction opposite to that of general traffic in the adjacent lanes. Motorists are much more hesitant to park or load in a restricted curb lane, even for brief periods of time, when it would require traveling on the wrong side of the road, against the flow of traffic. However, opportunities to implement contra-flow lanes are limited since such traffic patterns can only be established on streets that are, or can be made, one-way.

If exclusive lanes can be established in the center of the street, where there would be little incentive to park or load and where it would be much easier to provide physical separation, their classification as BRT would be much more defensible. An installation of that type would be very analogous to a median LRT trackway.

COMPARISON OF LRT AND BRT

As previously noted, the foregoing descriptions of the natures of LRT and BRT that are intended for clarification will probably also generate some debate. Be that as it may, they provide the basis for the third and core element of this discussion, a comparison of the two options.

Unquestionably, LRT and BRT are both potentially useful metropolitan transit tools, but they are different tools. To explain this point there is temptation to use the “apples and oranges” cliché, but a better analogy might be a wrench versus a pair of pliers. For certain tasks either tool might suffice, and in those situations the merits and shortcomings of each tool can be compared

directly and evaluated definitively. But, there are other tasks for which one or the other might be poorly suited or even unusable. It depends strongly on the situation being addressed and the goals that are being pursued. Each option has advantages and disadvantages.

LRT ADVANTAGES

The factors favoring LRT derive largely from two principal characteristics. They are (a) the use of external electric power and (b) the use of the traditional, proven, and perfected technology of flanged steel wheels rolling on two steel rails.

Externally powered, electric rail cars emit no harmful substances into the environment through which they pass. They can operate in lengthy tunnels and serve indoor stations with no impact on air quality. This feature is also useful in terminal areas where on-board air conditioning and heating equipment can remain functional during layovers without dependence upon an idling engine. This is particularly important if the layover is in a confined area.

The electricity itself can be generated from non-petroleum energy sources that are less dependent on foreign supply and some of which might be renewable. The costs of these sources are also likely to rise at a rate slower than that of petroleum.

LRT cars and trains do not require elaborate, climate-controlled buildings for overnight storage to assure their operability in the morning. Unlike combustion engines, electric motors are essentially unaffected by the normal range of atmospheric temperatures. Even when exposed to temperatures as low as -30°C (-22°F) they start the instant that electricity is fed to them.

There are other characteristics of electric traction motors that, in concert with an external power source, enhance the productivity of LRT cars and trains. When departing from a passenger stop excellent acceleration can be achieved and on uphill tracks operating speed can be maintained because electric motors can be routinely overloaded for intervals of several minutes without damage. Combustion engines lack that capability. Any resulting shorter travel time translates into cost savings. A quicker ride is also passenger pleasing, which could translate into increased revenue.

An external power source can also reduce energy costs through re-use of electricity. When decelerating or descending gradient electric motors can function as generators and feed power back in the distribution system for use by other cars on the line.

When properly designed and maintained, the steel-on-steel combination provides superior ride quality. More significantly, rail guidance allows the formation of multicar trains that can be operated by one person, which measurably improves labor productivity and capacity.

The benefit deriving from the rail element of LRT that may be the most important is also the one that is least quantifiable. Apparently, the sectors of the business community that recognize the commercial value of transit service also appreciate the “promise of permanence” that is conveyed by a rail line. The construction of a rail facility represents a major investment that will likely be there for a half-century or longer. That then instills confidence in the private sector that they would be investing in a dependable transit facility if they build along the line. This attribute of LRT is confirmed by a variety of developments that have emerged along several LRT systems.

LRT DISADVANTAGES

The primary disadvantage of LRT is capital cost. Rail cars cannot operate beyond the limits of their trackage. If service from a trunk line is to be extended onto several branches, each one must have its own electrified tracks and stations. This would apply even if it would operate streetcar-style, mixed with general traffic in a paved lane. In those situations it would have the added disadvantage of lacking the maneuverability to bypass a disabled or illegally parked vehicle.

In certain cases the visual impact of overhead wiring is considered to be a meaningful disadvantage. Unfortunately, there was not an early recognition of this concern by some designers of the newer North American LRT lines. There are existing installations where the overhead wire is visually obtrusive. Subsurface traction power distribution, with no overhead wiring, was used for many years on the streets of London, New York, and Washington, D.C. Whether it could be reconstructed and operated successfully in contemporary urban conditions is debatable. A newer version, intended to be compatible with 21st century street conditions, has been implemented in Bordeaux, France. To date it has not proven to be completely successful. At the same time, elsewhere in Europe, there are numerous examples of reliable overhead power distribution systems with very minimal visual impact.

BRT ADVANTAGES

The major factor favoring BRT over LRT is a generally lower construction cost per route meter of line because its infrastructure is less elaborate. This lessens the demands upon the transit agency's capital budget.

Buses can travel beyond a BRT facility without the requirement of specialized infrastructure. There is no significant additional capital cost resulting from establishing multiple routings using public streets. This ability often increases opportunities to provide a higher proportion of passengers with a single-seat ride than would be economically practical with LRT.

Because the infrastructure for BRT, as compared with that associated with LRT, may be less elaborate and does not need to extend over the entire length of a route, construction can often be carried out quicker and with less disruption.

BRT DISADVANTAGES

Factors disfavoring BRT are probable higher operating costs, as compared with LRT. A significant operating cost component of both the bus and rail modes is labor. Buses require one operator per vehicle, which limits labor productivity. Rail cars do not have that limitation because of their ability to operate as trains. While it might be claimed that the routine operation of buses in trains with electronic guidance is possible, such operations are still experimental. The feasibility of the concept in the real world is yet to be proven. Unless and until it is, the concept of operating buses in trains should not be included in any comparison of rail and bus modes.

To some extent, this disadvantage of higher operating labor costs is offset by the lower labor costs associated with infrastructure maintenance. Buses, when traveling beyond the limits of their dedicated facilities, utilize infrastructure for which the transit operating agency has no

maintenance responsibility. There are maintenance costs, but they are not charged against the bus service.

Another operating cost component is energy. While all energy costs are rising dramatically, it is almost certain that the price of petroleum and other substances used to fuel combustion engines will rise faster than that of electricity, the “fuel” used by LRT.

Some of the energy-related shortcomings of BRT could be overcome by utilizing electric trolleybuses or dual-mode vehicles in lieu of buses totally dependent upon combustion engines. It is also noted that “hybrid” buses that are propelled by an electric motor that can be fed by a large on-board storage battery, recharged by regenerative braking, have some of the characteristics of electric trolleybuses. They still emit pollutants into the air, but to a lesser extent than buses powered directly by a combustion engine and dependent entirely upon friction braking. Unfortunately, the resulting energy saving is partially nullified by the additional energy used to haul the weighty battery.

BRT could offer some promise of permanence, but it is unlikely to be as strong as that conveyed by a rail line. A fully exclusive busway does entail substantial investment and seemingly could be viewed as a long-term commitment to provide attractive transit service. In theory, they are potential generators of development, although some of these facilities may be too new to provide an accurate barometer of the degree to which they would do that. A cursory review of some of the more seasoned busways does not reveal any outstanding examples of major developments that they spawned.

Where routes using a busway continue beyond the limits of the exclusive facility and operate on public streets (with or without reserved lanes and traffic signal priority) they could be vulnerable to re-routing or discontinuance. Such retrenchments would not result in the abandonment of any substantial infrastructure. Bus services beyond a dedicated infrastructure are less likely to stimulate development than are rail extensions.

CONCLUSION

For more than a century, the externally powered electric railway car, an essential element of an LRT system under its traditional and contemporary names, has been a useful and marvelously versatile metropolitan transit tool. A variety of design options for both rolling stock and infrastructure were developed in the course of the 20th century, largely in the first and last quarters. The credentials of the mode are solid.

The combustion engine bus came on the scene about 35 years after the electric rail car. Advances such as the use of lower pollution fuels and hybrid electric drive are recent and are still being improved. With regard to the infrastructure component, there was no significant development of busways until the last quarter of the 20th century. The concept of blending vehicle and infrastructure components as a coordinated initiative emerged only a few years ago. The résumé of BRT is growing, but it is still somewhat thin.

At the moment there is considerable enthusiasm for BRT, largely because it is sometimes perceived as a new option that was not previously available. That is reinforced by another perception that BRT is always less expensive than LRT. Quips such as “the bus that thinks it’s a tram” may be considered cute, but they are simplistic and do not reflect a high level of professional evaluation.

It is the responsibility of transportation professionals to provide technical support and advice to the decision-makers. Toward that end, it is suggested that there are two challenges that deserve immediate and robust attention.

For proponents of LRT a major challenge to is to address aggressively the issue of capital cost of both rolling stock and infrastructure. These have risen at a rate well beyond that of normal inflation. The perception is that LRT is significantly costlier than BRT. Allegations of overdesign, sometimes called “gold plating,” should be explored and acknowledged or refuted. If the former is confirmed it needs to be addressed.

For proponents of BRT a challenge is to determine if it can be a meaningful tool in land use development as LRT has already proven to be. There are busway projects that were implemented well before the BRT label was coined and are now seasoned transit facilities. The effect of their presence and any “promise of permanence” is now measurable. If BRT is as effective as LRT in this regard that finding needs to be documented.

The question, “Which is better, LRT or BRT?” cannot be answered in the abstract. To have validity a comparison of the two must be evaluated for their suitability for a specific application.

The forgoing discussion has identified matters that should be taken into account when analyzing specific corridors or areas that are candidates for improved transit facilities. It is offered as an aid to transport professionals and others involved in the decision-making process.

LIGHT RAIL TRANSIT AND BUS RAPID TRANSIT

Comparative Performance of Public Transport in U.S. New Start Rail Cities Versus Bus-Only Cities

LYNDON HENRY

Capital Metropolitan Transportation Authority

This study explores some performance differences of public transport in major U.S. urban areas that have emphasized new start rail transit development, including light rail transit (LRT), in comparison with urban areas that have emphasized public transport development with buses only, including bus rapid transit (BRT). There is an ongoing need to assess the performance of major new capital-intensive rail transit investments. In addition, rail critics have recently begun asserting that some cities operating only buses, including BRT, exhibit more significant performance gains than those of rail transit cities—suggesting that rail investment is a waste or even a disaster. This study examines those issues.

Available statistical data from the FTA's National Transit Database, examined over a study period from the mid-1990s through 2003, is analyzed to contrast U.S. cities with new start rail systems (i.e., installed since the mid-1970s) with approximately four dozen major cities operating bus-only transit services. The study concludes that U.S. cities with new start rail systems, on average, have outperformed bus-only cities in terms of growth in ridership and passenger miles. Measured in "constant" dollars, operating and maintenance expenses per passenger mile declined for the cities operating both rail and bus systems, but rose in the cities operating buses only. In 2003, overall operating cost per passenger mile in the cities with new start rail transit systems was only about 74% of that in cities operating only buses. The analysis suggests that the investment in new start rail transit projects has been justified, in that these new rail transit systems overall seem to have outperformed comparable bus-only cities, and to have helped produce a more positive transit system performance.

INTRODUCTION

Over the past several decades, a growing number of American cities have been planning and installing new rail transit systems—most of them light rail transit (LRT)—on the premise that these systems will yield an array of valuable benefits. Among these benefits, significant gains in transit ridership, enhanced overall transit system attractiveness, and improved financial performance have been expected.

How well have new rail systems, installed in the current era, measured up? There is an ongoing need to assess the performance of major new capital-intensive rail transit investments.

In addition, some prominent rail critics have begun asserting that, on average, cities operating only buses, including bus rapid transit (BRT), exhibit more significant performance gains than those of rail transit cities. Thus, they suggest, rail investment is a waste or even a disaster.

For example, Randal O'Toole—in commentaries which have seen wide dissemination both domestically and abroad—presents a ferocious attack on America's major urban rail transit systems, which he characterizes as “Great Rail Disasters.” His views have been presented in two major publications:

- *Great Rail Disasters* (<http://americandreamcoalition.org/1-2004.pdf>) (1); and
- *Rail Disasters 2005* (<http://americandreamcoalition.org/RD2005.pdf>) (2).

In the latter publication, O'Toole contrasts ridership trends in the United States over the period 1983–2003 for 23 urban areas operating both rail and bus services, and eight urban areas with bus-only transit. In O'Toole's selected group of bus-only urban areas—Austin, Texas; Charlotte, North Carolina; Eugene, Oregon; Houston, Texas; Las Vegas, Nevada; Louisville, Kentucky; Phoenix, Arizona; and Raleigh–Durham, North Carolina—staggering increases in both rider trips (boardings) and passenger miles were presented as evidence that bus service alone could perform as well as rail. In the case of Austin, for example, trips increased by over 522% and passenger miles by nearly 640% during the two-decade period. In Las Vegas, the increases were even more breathtaking: 1,239% in trips, and over 1,161% in passenger miles.

However, as Todd Litman of the Victoria Transport Policy Institute (VTPI) notes, O'Toole carefully “cherry picks” his data and analysis methods to achieve results that justify his desired conclusions. Litman's dissection of O'Toole's arguments is elaborated in his study, “Evaluating Rail Transit Criticism,” available on the VTPI website: <http://www.vtpi.org/railcrit.pdf> (3).

His criticism of O'Toole is also summarized in an article, “Randal O'Toole's Great Rail Disaster: Ideological Train Wreck Disguised as ‘Research Study,’” available on the Light Rail Now (LRN) website: http://www.lightrailnow.org/features/f_lrt_2005-04.htm (4).

Recounting Litman's arguments, the LRN article points out that O'Toole's contrast of transit ridership trends between carefully selected groups of rail-and-bus cities and bus-only cities during the last two decades “is an unfair comparison, because the cities that expanded rail transit were generally large, mature, and slow-growing cities that experienced slow or negative population growth during the broad period O'Toole selected (although in recent years most have gained population), while those selected with all-bus system expansions were rapidly growing cities experiencing rapid population growth, where in some cases the transit systems grew from tiny or nearly non-existent to medium-size, and thus, not surprisingly, experienced major transit ridership growth.” Despite O'Toole's skewing of his “all bus-only” cases in this manner, the article notes that “in absolute terms rail transit cities have experienced significant ridership growth during the last few years, due to a combination of expansion and other ridership incentives.”

Another major problem of O'Toole's study is that it covers a period—1983–2003—during much of which several of the newer rail systems he disparages did not even exist. A more reasonable and valid analysis addressing the impact of rail transit at least would examine data for a period in which the rail systems actually were operating in the urban areas being scrutinized.

CURRENT STUDY OBJECTIVES AND PARAMETERS

The present study has sought to assess overall transit system performance in urban areas with major new (since the 1970s) capital-intensive rail transit investments—i.e., new-rail-start urban areas previously without rail transit service at the time these projects were installed. Thus urban areas with “legacy” rail systems (such as New York City; Chicago, Illinois; Philadelphia, Pennsylvania; Boston, Massachusetts; and San Francisco, California) have been excluded [unfortunately, this also encompasses the PATCO Highspeed Line connecting Philadelphia with its New Jersey suburbs, and the Bay Area Rapid Transit (BART) rapid rail system in the San Francisco Bay Area]. This focus on rail new start cities has also seemed appropriate in view of the need to address the criticisms of rail opponents, whose attacks have primarily focused on disparaging transit performance in urban areas with new rail starts, and attempting to forestall further new rail projects.

Rail transit systems considered include LRT, rail rapid transit (RRT), and regional passenger rail (RPR, commonly called “commuter rail”). Systems included in this study functioned as line-haul commutation-type lines at least 5 mi in length in these urban areas. Thus, small circulator or shuttle services, special-purpose systems (such as airport peplemovers), and recreational operations were excluded.

Performance has been examined in terms of trends in total transit system ridership, financial performance, and “overall transit system attractiveness” (measured in terms of per-capita use of the transit system). In order to avoid problems such as those exhibited in O’Toole’s studies the researcher has focused on the period 1996–2003, using agency profile data from the National Transit Database (NTD) of the FTA (5). This has enabled the examination of data, readily available online, for an extended period during which the overwhelming majority of new U.S. rail systems have been operating.

The NTD Annual Report is based on mandatory information provided by all transit agencies in a standardized format, and includes profiles for each transit agency filing an NTD annual report for the 2003 report year. A profile consists of general, financial, and modal data, as well as performance and trend indicators. For the 2003 report year 622 transit agencies submitted reports to the NTD.

The NTD also provides population data for UZA (urbanized area) population. The data were scrutinized carefully to avoid double or triple counting population in metropolitan areas with more than one transit system.

In a study such as this, urban area size must be considered, particularly since transit tends to perform marginally better in larger cities than in smaller cities. The cities operating both rail and bus examined in this study are generally over one million in population, whereas the group of bus-only cities includes a number that are below a million.

Unfortunately, since most of the United States’s largest cities now have some form of rail transit, limiting the study only to cities with rough population parity would reduce the bus-only group to a number so small that comparative results would be questionable on that basis. Furthermore, rail critics have not followed any such limit in similar comparisons of rail versus bus-only cities.

In addition, while there are minor performance differences on the basis of size, these seem generally marginal. For example, Montgomery, Alabama, the smallest of the bus-only areas in the analysis with a 2003 UZA population of 196,892, exhibited an average operating expense in that year of \$4.71/trip and \$1.14/passenger mile; in comparison, Columbus, Ohio, a

much larger bus-only city with a UZA population of 1,133,193, exhibited average expenses of \$4.20/trip and \$1.11/passenger mile. While some weaknesses in any comparison can be expected, these differentials do not seem sufficient to disqualify the comprehensive analysis of a wide variety of urban areas performed in the course of this study.

Almost all the new rail systems were in operation over the period examined (1996–2003). Exceptions are the Salt Lake City, Utah, TRAX LRT system and the Seattle–Tacoma, Washington, Sounder regional passenger (commuter) rail system, both launched in 2000; accordingly, both those urban areas have been excluded.

In some cases, urban areas jointly served by new rail starts (e.g., Los Angeles–San Bernardino–Riverside, California, and Miami–Ft. Lauderdale, Florida) have been combined in this analysis. The “rail and bus” urban areas, with years of first rail operation, and rail modes in service, are listed in [Table 1](#).

Transit data and trends in these rail new start urban areas were contrasted with those in 48 bus-only urban areas (some of which, like Houston and Minneapolis, Minnesota, have subsequently installed their own new rail starts, or begun projects to do so). It should be noted that a number of urban areas were omitted for various reasons. In some cases, NTD agency profile data for the systems in question were not available or inconsistent (e.g., Las Vegas, Eugene, Charleston). In some cases, core cities were already served by “legacy” rail transit (RPR), thus making their bus-only status dubious (e.g., Hartford and New Haven, Connecticut; Providence, Rhode Island; Wilmington, Delaware; and Trenton, New Jersey). Similarly, Ft. Worth, Texas, has been excluded, since the Trinity Railway Express service was extended to it in 2001. The bus-only urban areas selected in this analysis are listed in [Tables 2](#) through [13](#) below.

TABLE 1 New Start Rail Cities Studied

Urbanized Area	First Rail Opened	Rail Modes
Atlanta	1979	RRT
Baltimore	1983	RRT, LRT, RPR
Buffalo	1985	LRT
Dallas	1996	LRT, RPR
Denver	1994	LRT
Los Angeles	1990	LRT, RRT, RPR
Miami–Ft. Lauderdale	1984	RRT, RPR
Portland	1986	LRT
Sacramento	1987	LRT
St. Louis	1993	LRT
San Diego	1981	LRT, RPR
San José	1987	LRT, RPR
Washington, D.C.	1976	RRT, RPR

TABLE 2 Rail and Bus Cities: 1996 Size and Performance Data

Urbanized Area	UZA 1996	Millions of 1996...		
		Trips	Passenger Miles	O&M (\$)
Atlanta	2,157,806	144.8	659.9	222.5
Baltimore	1,889,873	101.2	502.1	253.0
Buffalo	954,332	27.6	82.0	66.0
Dallas	3,198,259	48.5	186.5	145.8
Denver	1,517,977	69.9	298.2	158.7
Los Angeles	12,573,142	483.6	2,112.6	991.8
Miami-Ft. Lauderdale	3,152,794	106.3	545.9	250.3
Portland	1,172,158	71.4	273.2	144.8
Sacramento	1,097,005	25.2	110.1	61.6
St. Louis	1,946,526	52.2	233.6	118.7
San Diego	2,348,417	66.7	358.1	119.2
San José	1,435,019	49.0	194.8	156.5
Washington, D.C.	3,363,031	319.5	1,505.2	661.5
TOTALS	36,806,339	1,565.9	7,062.2	3,350.4

O&M: operations and maintenance

TABLE 3 Rail and Bus Cities: 2003 Size and Performance Data

Urbanized Area	UZA 2003	Millions of 2003...			
		Trips	Passenger Miles	O&M (\$)	O&M 2003 (1996\$)
Atlanta	3,499,840	142.8	724.6	312.5	245.7
Baltimore	2,076,354	111.7	637.0	360.2	283.2
Buffalo	976,703	24.1	73.4	78.8	61.9
Dallas	4,145,659	76.5	403.4	303.7	238.8
Denver	1,984,889	78.6	383.2	260.1	204.5
Los Angeles	13,296,303	600.0	2,709.6	1,389.2	1,092.1
Miami-Ft. Lauderdale	4,919,036	87.8	476.9	353.9	278.2
Portland	1,583,138	98.5	414.9	245.1	192.7
Sacramento	1,393,498	28.9	124.7	109.5	86.1
St. Louis	2,077,662	48.1	272.1	174.8	137.4
San Diego	2,674,436	74.5	405.0	178.8	140.6
San José	1,851,704	47.5	220.1	310.2	243.9
Washington, D.C.	3,933,920	395.2	2,004.9	904.1	710.8
TOTALS	44,413,142	1,814.2	8,849.8	4,980.9	3,915.8

TABLE 4 Rail and Bus Cities: Ridership Performance

Urbanized Area	Trips/ cap. 1996	Trips/ cap. 2003	Passenger Miles/cap. 1996	Passenger Miles/cap. 2003
Atlanta	67.1	40.8	305.8	207.0
Baltimore	53.5	53.8	265.7	306.8
Buffalo	28.9	24.7	85.9	75.2
Dallas	15.2	18.5	58.3	97.3
Denver	46.0	39.6	196.4	193.1
Los Angeles	38.5	45.1	168.0	203.8
Miami–Ft. Lauderdale	33.7	17.8	173.1	96.9
Portland	60.9	62.2	233.1	262.1
Sacramento	23.0	20.7	100.4	89.5
St. Louis	26.8	23.2	120.0	131.0
San Diego	28.4	27.9	152.5	151.4
San José	34.1	25.7	135.7	118.9
Washington, D.C.	95.0	100.5	447.6	509.6
TOTALS	42.5	40.8	191.9	199.3

TABLE 5 Rail and Bus Cities: Financial Performance

Urbanized Area	O&M/ Passenger Miles 1996	O&M/ Passenger Miles 2003	O&M/ Passenger Miles 2003 (1996\$)
Atlanta	\$0.34	\$0.43	\$0.34
Baltimore	\$0.50	\$0.57	\$0.44
Buffalo	\$0.80	\$1.07	\$0.84
Dallas	\$0.78	\$0.75	\$0.59
Denver	\$0.53	\$0.68	\$0.53
Los Angeles	\$0.47	\$0.51	\$0.40
Miami–Ft. Lauderdale	\$0.46	\$0.74	\$0.58
Portland	\$0.53	\$0.59	\$0.46
Sacramento	\$0.56	\$0.88	\$0.69
St. Louis	\$0.51	\$0.64	\$0.50
San Diego	\$0.33	\$0.44	\$0.35
San José	\$0.80	\$1.41	\$1.11
Washington, D.C.	\$0.44	\$0.45	\$0.35
TOTALS	\$0.47	\$0.56	\$0.44

TABLE 6 Rail and Bus Cities: Change in Ridership Performance, 1996–2003

Urbanized Area	% Change Trips	% Change Passenger Miles	% Change Trips/cap	% Change Passenger Miles/cap
Atlanta	-1.4	9.8	-39.2	-32.3
Baltimore	10.4	26.9	0.6	15.5
Buffalo	-12.7	-10.5	-14.5	-12.5
Dallas	57.7	116.3	21.7	66.9
Denver	12.4	28.5	-13.9	-1.7
Los Angeles	24.1	28.3	17.1	21.3
Miami–Ft. Lauderdale	-17.4	-12.6	-47.2	-44.0
Portland	38.0	51.9	2.1	12.4
Sacramento	14.7	13.3	-10.0	-10.9
St. Louis	-7.9	16.5	-13.4	9.2
San Diego	11.7	13.1	-1.8	-0.7
San José	-3.1	13.0	-24.6	-12.4
Washington, D.C.	23.7	33.2	5.8	13.9
TOTALS	15.9	25.3	-4.0	3.9

TABLE 7 Rail and Bus Cities: Change in Financial Performance, 1996–2003

Urbanized Area	% Change O&M (\$)	% Change O&M (1996\$)	% Change O&M/Passenger Miles	% Change O&M/Passenger Miles (1996\$)
Atlanta	40.4	10.4	26.5	0.0
Baltimore	42.4	11.9	14.0	-12.0
Buffalo	19.4	-6.2	33.8	5.0
Dallas	108.3	63.8	-3.8	-24.4
Denver	63.9	28.9	28.3	0.0
Los Angeles	40.1	10.1	8.5	-14.9
Miami–Ft. Lauderdale	41.4	11.1	60.9	26.1
Portland	69.3	33.1	11.3	-13.2
Sacramento	77.8	39.8	57.1	23.2
St. Louis	47.3	15.8	25.5	-2.0
San Diego	50.0	18.0	33.3	6.1
San José	98.2	55.8	76.3	38.8
Washington, D.C.	36.7	7.5	2.3%	-20.5
TOTALS	48.7	16.9	19.1	-6.4

TABLE 8 Bus-Only Cities: 1996 Size and Performance Data

City	UZA 1996	Millions of 1996...		
		Trips	Passenger Miles	O&M \$
Akron	527,863	5.4	18.2	20.5
Albuquerque	497,120	6.8	22.9	17.4
Ann Arbor	222,061	4.2	13.3	14.5
Augusta	118,829	1.3	4.4	2.6
Baton Rouge	365,943	4.2	11.5	4.8
Birmingham	622,074	3.0	13.7	8.8
Charlotte	455,597	11.8	44.9	22.0
Chattanooga	296,955	2.5	12.4	8.0
Cincinnati	1,212,675	30.2	138.7	64.0
Colorado Springs	352,989	3.6	18.2	7.3
Columbus	945,237	17.7	72.7	46.9
Dayton	613,467	15.4	34.9	42.2
Des Moines	293,666	3.8	3.7	8.9
Detroit	3,697,529	58.2	241.1	178.9
El Paso	571,017	15.8	78.8	25.6
Harrisburg	292,904	3.1	8.9	6.1
Honolulu	632,603	69.1	313.0	97.7
Houston	2,901,851	80.8	401.4	191.3
Indianapolis	914,761	12.1	53.2	25.6
Jacksonville	738,413	8.8	46.2	25.1
Kansas City	1,275,315	14.4	47.9	38.2
Knoxville	304,466	1.7	4.9	\$6.8
Lansing	265,095	4.0	15.2	13.8
Little Rock	305,353	3.8	13.0	6.6
Louisville	754,956	17.9	58.3	34.8
Madison	244,336	10.0	36.7	24.4
Memphis	825,193	12.0	64.7	24.2
Milwaukee	1,226,293	60.0	169.6	89.5
Minneapolis	2,079,676	61.9	250.4	130.6
Montgomery	210,007	0.7	2.2	2.6
Nashville	573,294	8.0	37.1	15.7
Oklahoma City	784,425	3.5	13.7	10.3
Omaha	544,292	5.2	20.0	13.9
Orlando	887,126	15.7	103.2	42.5
Peoria	242,353	1.9	9.8	5.1
Phoenix	2,006,239	32.9	126.9	60.1
Raleigh-Durham	511,280	9.8	39.2	20.5
Reno	213,747	8.4	27.8	14.8
Richmond	589,980	15.7	35.1	20.0
Rochester	619,653	12.9	40.6	30.1
St. Petersburg	820,180	8.1	37.8	26.0
San Antonio	1,129,154	38.7	156.7	75.6
Shreveport	256,489	4.3	17.9	6.0
Spokane	279,038	8.4	39.0	30.7
Tampa	888,530	9.0	43.6	31.4
Toledo	489,155	4.5	20.5	16.8
Tucson	579,235	17.9	64.0	26.9
TOTALS	35,178,414	749.1	3,047.9	1,636.1

TABLE 9 Bus-Only Cities: 2003 Size and Performance Data

City	UZA 2003	Millions of 2003...			
		Trips	Passenger Miles	O&M \$	O&M 2003 (1996\$)
Akron	570,215	6.3	23.3	27.9	21.9
Albuquerque	598,191	7.8	21.4	24.3	19.1
Ann Arbor	283,904	4.3	13.9	21.0	16.5
Augusta	335,630	1.0	5.5	3.3	2.6
Baton Rouge	479,019	4.7	14.8	11.2	8.8
Birmingham	663,615	3.8	18.3	15.2	11.9
Charlotte	758,927	18.9	100.0	57.4	45.1
Chattanooga	343,509	2.4	11.3	11.0	8.6
Cincinnati	1,503,262	24.1	132.2	73.3	57.6
Colorado Springs	466,122	3.4	12.3	9.3	7.3
Columbus	1,133,193	15.8	60.4	70.6	55.5
Dayton	703,444	13.7	46.0	52.7	41.4
Des Moines	370,505	4.2	24.0	12.9	10.1
Detroit	3,903,377	48.5	259.3	278.2	218.7
El Paso	674,801	11.1	61.8	37.3	29.3
Harrisburg	362,782	2.6	10.4	12.4	9.7
Honolulu	718,182	69.8	311.7	135.9	106.8
Houston	3,822,509	77.4	425.1	280.2	220.3
Indianapolis	1,218,919	11.3	57.5	38.9	30.6
Jacksonville	882,295	9.7	68.2	61.6	48.4
Kansas City	1,361,744	13.6	53.7	53.4	42.0
Knoxville	419,830	2.6	7.2	10.6	8.3
Lansing	300,032	8.7	27.2	26.8	21.1
Little Rock	360,331	3.2	12.0	9.1	7.2
Louisville	863,582	13.3	49.0	50.2	39.5
Madison	329,533	11.2	35.2	36.3	28.5
Memphis	972,091	13.0	65.9	46.9	36.9
Milwaukee	1,308,913	58.2	162.2	134.5	105.7
Minneapolis	2,388,593	72.2	319.7	237.8	186.9
Montgomery	196,892	0.4	2.1	3.9	3.1
Nashville	749,935	6.8	33.8	27.1	21.3
Oklahoma City	747,003	4.1	21.4	15.9	12.5
Omaha	626,623	4.7	16.5	18.0	14.2
Orlando	1,157,431	22.7	147.1	81.7	64.2
Peoria	247,172	1.8	11.3	10.5	8.3
Phoenix	2,907,049	45.2	171.7	152.3	119.7
Raleigh–Durham	829,323	13.2	52.0	36.8	28.9
Reno	303,689	8.0	26.2	24.2	19.0
Richmond	818,836	12.2	42.0	30.5	24.0
Rochester	694,396	13.6	50.9	46.4	36.5
St. Petersburg	1,237,403	9.7	49.6	37.4	29.4
San Antonio	1,327,554	40.3	161.9	97.7	76.8
Shreveport	275,213	2.9	13.5	8.0	6.3
Spokane	334,858	8.1	37.2	35.3	27.8
Tampa	824,936	9.8	46.1	33.5	26.3
Toledo	503,008	4.4	20.6	25.0	19.7
Tucson	720,425	16.9	62.4	41.2	32.4
TOTALS	42,598,796	761.6	3,375.8	2,565.6	\$2,017.0

TABLE 10 Bus-Only Cities: Ridership Performance

City	Trips/cap. 1996	Trips/cap. 2003	Passenger Miles/ cap. 1996	Passenger Miles/ cap. 2003
Akron	10.2	11.0	34.5	40.9
Albuquerque	13.7	13.0	46.1	35.8
Ann Arbor	18.9	15.1	59.9	49.0
Augusta Ga	10.9	3.0	37.0	16.4
Baton Rouge	11.5	9.8	31.4	30.9
Birmingham	4.8	5.7	22.0	27.6
Charlotte	25.9	24.9	98.6	131.8
Chattanooga	8.4	7.0	41.8	32.9
Cincinnati	24.9	16.0	114.4	87.9
Colorado Springs	10.2	7.3	51.6	26.4
Columbus	18.7	13.9	76.9	53.3
Dayton	25.1	19.5	56.9	65.4
Des Moines	12.9	11.3	12.6	64.8
Detroit	15.7	12.4	65.2	66.4
El Paso	27.7	16.4	138.0	91.6
Harrisburg	10.6	7.2	30.4	28.7
Honolulu	109.2	97.2	494.8	434.0
Houston	27.8	20.2	138.3	111.2
Indianapolis	13.2	9.3	58.2	47.2
Jacksonville	11.9	11.0	62.6	77.3
Kansas City	11.3	10.0	37.6	39.4
Knoxville	5.6	6.2	16.1	17.1
Lansing	15.1	29.0	57.3	90.7
Little Rock	12.4	8.9	42.6	33.3
Louisville	23.7	15.4	77.2	56.7
Madison	40.9	34.0	150.2	106.8
Memphis	14.5	13.4	78.4	67.8
Milwaukee	48.9	44.5	138.3	123.9
Minneapolis	29.8	30.2	120.4	133.8
Montgomery	3.3	2.0	10.5	10.7
Nashville	14.0	9.1	64.7	45.1
Oklahoma City	4.5	5.5	17.5	28.6
Omaha	9.6	7.5	36.7	26.3
Orlando	17.7	19.6	116.3	127.1
Peoria	7.8	7.3	40.4	45.7
Phoenix	16.4	15.5	63.3	59.1
Raleigh–Durham	19.2	15.9	76.7	62.7
Reno	39.3	26.3	130.1	86.3
Richmond	26.6	14.9	59.5	51.3
Rochester	20.8	19.6	65.5	73.3
St. Petersburg	9.9	7.8	46.1	40.1
San Antonio	34.3	30.4	138.8	122.0
Shreveport	16.8	10.5	69.8	49.1
Spokane	30.1	24.2	139.8	111.1
Tampa	10.1	11.9	49.1	55.9
Toledo	9.2	8.7	41.9	41.0
Tucson	30.9	23.5	110.5	86.6
TOTALS	21.3	17.9	86.6	79.2

TABLE 11 Bus-Only Cities: Financial Performance

City	O&M/Passenger Miles 1996	O&M/Passenger Miles 2003	O&M/Passenger Miles 2003 (1996\$)
Akron	\$1.13	\$1.20	\$0.94
Albuquerque	\$0.76	\$1.14	\$0.89
Ann Arbor	\$1.09	\$1.51	\$1.19
Augusta	\$0.59	\$0.60	\$0.47
Baton Rouge	\$0.42	\$0.76	\$0.59
Birmingham	\$0.64	\$0.83	\$0.65
Charlotte	\$0.49	\$0.57	\$0.45
Chattanooga	\$0.65	\$0.97	\$0.76
Cincinnati	\$0.46	\$0.55	\$0.44
Colorado Springs	\$0.40	\$0.76	\$0.59
Columbus	\$0.65	\$1.17	\$0.92
Dayton	\$1.21	\$1.15	\$0.90
Des Moines	\$2.41	\$0.54	\$0.42
Detroit	\$0.74	\$1.07	\$0.84
El Paso	\$0.32	\$0.60	\$0.47
Harrisburg	\$0.69	\$1.19	\$0.93
Honolulu	\$0.31	\$0.44	\$0.34
Houston	\$0.48	\$0.66	\$0.52
Indianapolis	\$0.48	\$0.68	\$0.53
Jacksonville	\$0.54	\$0.90	\$0.71
Kansas City	\$0.80	\$0.99	\$0.78
Knoxville	\$1.39	\$1.47	\$1.15
Lansing	\$0.91	\$0.99	\$0.78
Little Rock	\$0.51	\$0.76	\$0.60
Louisville	\$0.60	\$1.02	\$0.81
Madison	\$0.66	\$1.03	\$0.81
Memphis	\$0.37	\$0.71	\$0.56
Milwaukee	\$0.53	\$0.83	\$0.65
Minneapolis	\$0.52	\$0.74	\$0.58
Montgomery	\$1.18	\$1.86	\$1.48
Nashville	\$0.42	\$0.80	\$0.63
Oklahoma City	\$0.75	\$0.74	\$0.58
Omaha	\$0.70	\$1.09	\$0.86
Orlando	\$0.41	\$0.56	\$0.44
Peoria	\$0.52	\$0.93	\$0.73
Phoenix	\$0.47	\$0.89	\$0.70
Raleigh–Durham	\$0.52	\$0.71	\$0.56
Reno	\$0.53	\$0.92	\$0.73
Richmond	\$0.57	\$0.73	\$0.57
Rochester	\$0.74	\$0.91	\$0.72
St. Petersburg	\$0.69	\$0.75	\$0.59
San Antonio	\$0.48	\$0.60	\$0.47
Shreveport	\$0.34	\$0.59	\$0.47
Spokane	\$0.79	\$0.95	\$0.75
Tampa	\$0.72	\$0.73	\$0.57
Toledo	\$0.82	\$1.21	\$0.96
Tucson	\$0.42	\$0.66	\$0.52
TOTALS	\$0.54	\$0.76	\$0.60

TABLE 12 Bus-Only Cities: Change in Ridership Performance, 1996–2003

City	% Change Trips	% Change Passenger Miles	% Change Trips/cap	% Change Passenger Miles/cap
Akron	16.7%	28.0%	7.8%	18.6%
Albuquerque	14.7%	-6.6%	-5.1%	-22.3%
Ann Arbor	2.4%	4.5%	-20.1%	-18.2%
Augusta	-23.1%	25.0%	-72.5%	-55.7%
Baton Rouge	11.9%	28.7%	-14.8%	-1.6%
Birmingham	26.7%	33.6%	18.8%	25.5%
Charlotte	60.2%	122.7%	-3.9%	33.7%
Chattanooga	-4.0%	-8.9%	-16.7%	-21.3%
Cincinnati	-20.2%	-4.7%	-35.7%	-23.2%
Colorado Springs	-5.6%	-32.4%	-28.4%	-48.8%
Columbus	-10.7%	-16.9%	-25.7%	-30.7%
Dayton	-11.0%	31.8%	-22.3%	14.9%
Des Moines	10.5%	548.6%	-12.4%	414.3%
Detroit	-16.7%	7.5%	-21.0%	1.8%
El Paso	-29.7%	-21.6%	-40.8%	-33.6%
Harrisburg	-16.1%	16.9%	-32.1%	-5.6%
Honolulu	1.0%	-0.4%	-11.0%	-12.3%
Houston	-4.2%	5.9%	-27.3%	-19.6%
Indianapolis	-6.6%	8.1%	-29.5%	-18.9%
Jacksonville	10.2%	47.6%	-7.6%	23.5%
Kansas City	-5.6%	12.1%	-11.5%	4.8%
Knoxville	52.9%	46.9%	10.7%	6.2%
Lansing	117.5%	78.9%	92.1%	58.3%
Little Rock	-15.8%	-7.7%	-28.2%	-21.8%
Louisville	-25.7%	-16.0%	-35.0%	-26.6%
Madison	12.0%	-4.1%	-16.9%	-28.9%
Memphis	8.3%	1.9%	-7.6%	-13.5%
Milwaukee	-3.0%	-4.4%	-9.0%	-10.4%
Minneapolis	16.6%	27.7%	1.3%	11.1%
Montgomery	-42.9%	-4.5%	-39.4%	1.9%
Nashville	-15.0%	-8.9%	-35.0%	-30.3%
Oklahoma City	17.1%	56.2%	22.2%	63.4%
Omaha	-9.6%	-17.5%	-21.9%	-28.3%
Orlando	44.6%	42.5%	10.7%	9.3%
Peoria	-5.3%	15.3%	-6.4%	13.1%
Phoenix	37.4%	35.3%	-5.5%	-6.6%
Raleigh–Durham	34.7%	32.7%	-17.2%	-18.3%
Reno	-4.8%	-5.8%	-33.1%	-33.7%
Richmond	-22.3%	19.7%	-44.0%	-13.8%
Rochester	5.4%	25.4%	-5.8%	11.9%
St. Petersburg	19.8%	31.2%	-21.2%	-13.0%
San Antonio	4.1%	3.3%	-11.4%	-12.1%
Shreveport	-32.6%	-24.6%	-37.5%	-29.7%
Spokane	-3.6%	-4.6%	-19.6%	-20.5%
Tampa	8.9%	5.7%	17.8%	13.8%
Toledo	-2.2%	0.5%	-5.4%	-2.1%
Tucson	-5.6%	-2.5%	-23.9%	-21.6%
TOTALS	1.7%	10.8%	-16.0%	-8.5%

TABLE 13 Bus-Only Cities: Change in Financial Performance, 1996–2003

City	% Change O&M \$	% Change O&M 1996\$	% Change O&M/ Passenger Miles	% Change O&M/ Passenger Miles 1996\$
Akron	36.1%	6.8%	6.2%	-16.8%
Albuquerque	39.7%	9.8%	50.0%	17.1%
Ann Arbor	44.8%	13.8%	38.5%	9.2%
Augusta	26.9%	0.0%	1.7%	-20.3%
Baton Rouge	133.3%	83.3%	81.0%	40.5%
Birmingham	72.7%	35.2%	29.7%	1.6%
Charlotte	160.9%	105.0%	16.3%	-8.2%
Chattanooga	37.5%	7.5%	49.2%	16.9%
Cincinnati	14.5%	-10.0%	19.6%	-4.3%
Colorado Springs	27.4%	0.0%	90.0%	47.5%
Columbus	50.5%	18.3%	80.0%	41.5%
Dayton	24.9%	-1.9%	-5.0%	-25.6%
Des Moines	44.9%	13.5%	-77.6%	-82.6%
Detroit	55.5%	22.2%	44.6%	13.5%
El Paso	45.7%	14.5%	87.5%	46.9%
Harrisburg	103.3%	59.0%	72.5%	34.8%
Honolulu	39.1%	9.3%	41.9%	9.7%
Houston	46.5%	15.2%	37.5%	8.3%
Indianapolis	52.0%	19.5%	41.7%	10.4%
Jacksonville	145.4%	92.8%	66.7%	31.5%
Kansas City	39.8%	9.9%	23.8%	-2.5%
Knoxville	55.9%	22.1%	5.8%	-17.3%
Lansing	94.2%	52.9%	8.8%	-14.3%
Little Rock	37.9%	9.1%	49.0%	17.6%
Louisville	44.3%	13.5%	70.0%	35.0%
Madison	48.8%	16.8%	56.1%	22.7%
Memphis	93.8%	52.5%	91.9%	51.4%
Milwaukee	50.3%	18.1%	56.6%	22.6%
Minneapolis	82.1%	43.1%	42.3%	11.5%
Montgomery	50.0%	19.2%	57.6%	25.4%
Nashville	72.6%	35.7%	90.5%	50.0%
Oklahoma City	54.4%	21.4%	-1.3%	-22.7%
Omaha	29.5%	2.2%	55.7%	22.9%
Orlando	92.2%	51.1%	36.6%	7.3%
Peoria	105.9%	62.7%	78.8%	40.4%
Phoenix	153.4%	99.2%	89.4%	48.9%
Raleigh–Durham	79.5%	41.0%	36.5%	7.7%
Reno	63.5%	28.4%	73.6%	37.7%
Richmond	52.5%	20.0%	28.1%	0.0%
Rochester	54.2%	21.3%	23.0%	-2.7%
St. Petersburg	43.8%	13.1%	8.7%	-14.5%
San Antonio	29.2%	1.6%	25.0%	-2.1%
Shreveport	33.3%	5.0%	73.5%	38.2%
Spokane	15.0%	-9.4%	20.3%	-5.1%
Tampa	6.7%	-16.2%	1.4%	-20.8%
Toledo	48.8%	17.3%	47.6%	17.1%
Tucson	53.2%	20.4%	57.1%	23.8%
TOTALS	56.8%	23.3%	40.7%	11.1%

STUDY RESULTS: URBAN AREA GROUPS

In [Tables 2](#) and [3](#) for rail and bus, and [Tables 8](#) and [9](#) for bus-only, present basic, raw data from the NTD on UZA population, plus millions of unlinked trips and passenger miles, and operations and maintenance (O&M) expenses (in millions of dollars). The tables for 2003 ([Tables 3](#) and [9](#)) also present calculated O&M expenses expressing the costs for that year in 1996 dollars (1996\$). Thus, financial trends in “constant” dollars can be assessed.

In [Tables 4](#) and [10](#), calculated measures of ridership performance—trips per capita and passenger miles per capita—for each of the 2 years are presented for both groups of urban areas. To some extent, this per-capita index can also be considered a measure of the “attractiveness” of the system to the public, since more intensive per-capita usage of the transit system suggests greater acceptance of the system by the public in the given urban area.

In [Tables 5](#) and [11](#), calculated measures of financial performance are presented, in terms of O&M per passenger mile—a reliable and widely accepted gauge of measuring the cost with respect to actual transportation service delivery. In these tables, O&M costs per passenger mile are also expressed in “constant” 1996 dollars.

[Tables 6](#) and [12](#) present the percentage change in ridership performance over the 7-year study period. This includes the percentage of change in unlinked trips, passenger miles, trips per capita, and passenger miles per capita.

Finally, [Tables 7](#) and [13](#) present the percentage change in financial performance over this period. This includes the change in O&M expenses, both “raw” and adjusted in terms of “constant” (1996) dollars; and the same in terms of O&M per passenger mile.

Comparing the two groups of urban areas, one finds striking differences. These can be summarized as follows:

Ridership Performance

The bus and rail group experienced a ridership increase in unlinked trips averaging nearly 16%, while the bus-only group experienced an average increase of only 1.7%; in other words, the rail and bus cities saw ridership (boardings) grow at over *nine times* the rate in the bus-only cities. In terms of passenger miles, the rail and bus group experienced an increase averaging over 25%, while the bus-only group averaged 10.8%—less than half the rate of increase in this metric. These comparisons are summarized graphically in [Figures 1](#) and [2](#).

Public Attractiveness

In terms of per-capita performance as a measure of general attraction to and use of public transport by the urban area public, both groups experienced a decrease. However, the loss by the rail and bus group (−4.0%) was only one-fourth that of the bus-only group (−16.0%). On the other hand, in terms of passenger miles per capita, the rail and bus group experienced a modest gain of nearly 4%, while the bus-only group lost more than 8%. These comparisons are summarized graphically in [Figures 1](#) through [4](#).

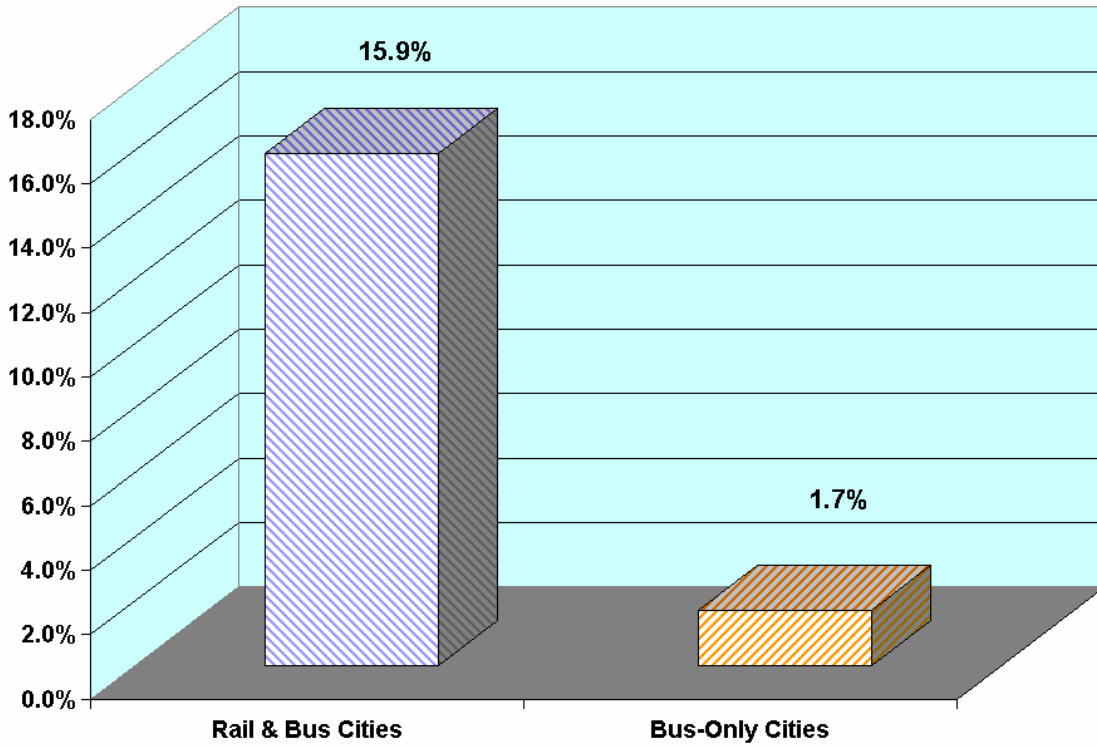


FIGURE 1 Change in rider-trips, 1996–2003.

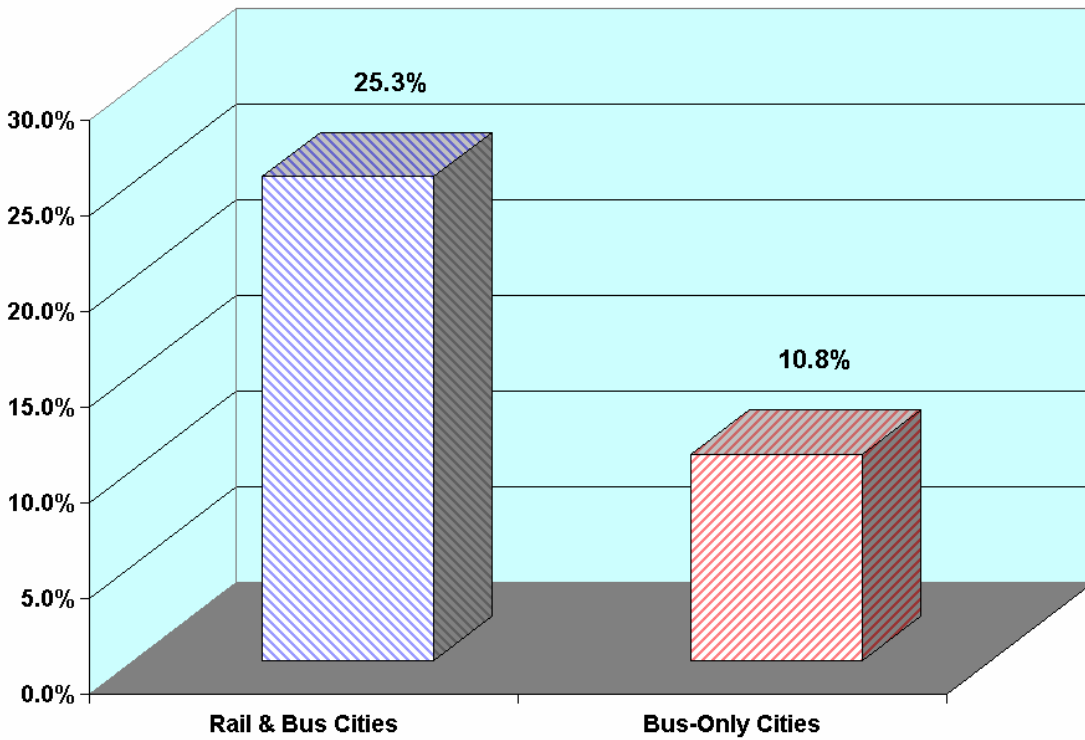


FIGURE 2 Change in passenger miles, 1996–2003.

Financial Performance

In this metric, the rail and bus group of urban areas exhibited a substantial advantage over the bus-only group. For both groups, O&M costs, in both “raw” and “constant” dollar terms, increased substantially, as might be expected with the expansion of transit services to respond to population growth and other dynamics (although the rate of O&M expenses growth for the bus-only group was nearly 38% higher than that of the rail and bus group). However, in terms of O&M per passenger mile, the rail and bus group showed a distinct advantage—a significant *decline* of over 6% in “constant” (1996) dollar terms, compared with a substantial increase of over 11% for the bus-only group. It is also worth noting that, measured in “constant” dollars the average cost per passenger mile in the rail and bus cities was nearly 27% below that of the bus-only cities. These comparisons are summarized graphically in Figures 5 and 6.

While it was not possible to include Austin in the full bus-only group analysis, it was of interest to study the performance of this all-bus system (Capital Metro) at least for the period 1997–2003, especially in view of O’Toole’s emphasis on this city’s substantial transit ridership growth. (Unfortunately, data for two other important urban areas in O’Toole’s study—Las Vegas and Eugene—were not available for this period.) The Austin urbanized area grew in population from 562,008 to 901,920 in this period, but a comparative per-capita analysis is not appropriate because 1997 population data remain the same as 1996 in the NTD data.

Tables 14 and 15 present data for selected items for the Austin urbanized area. To

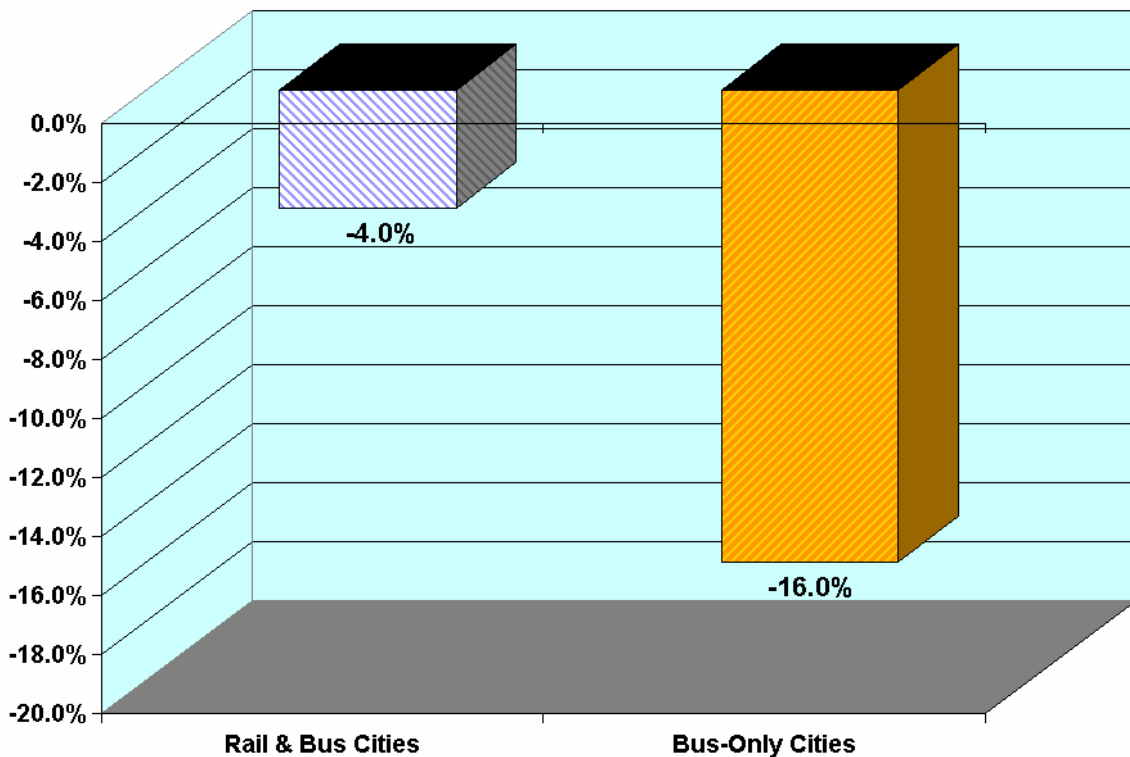


FIGURE 3 Change in rider trips per capita, 1996–2003.

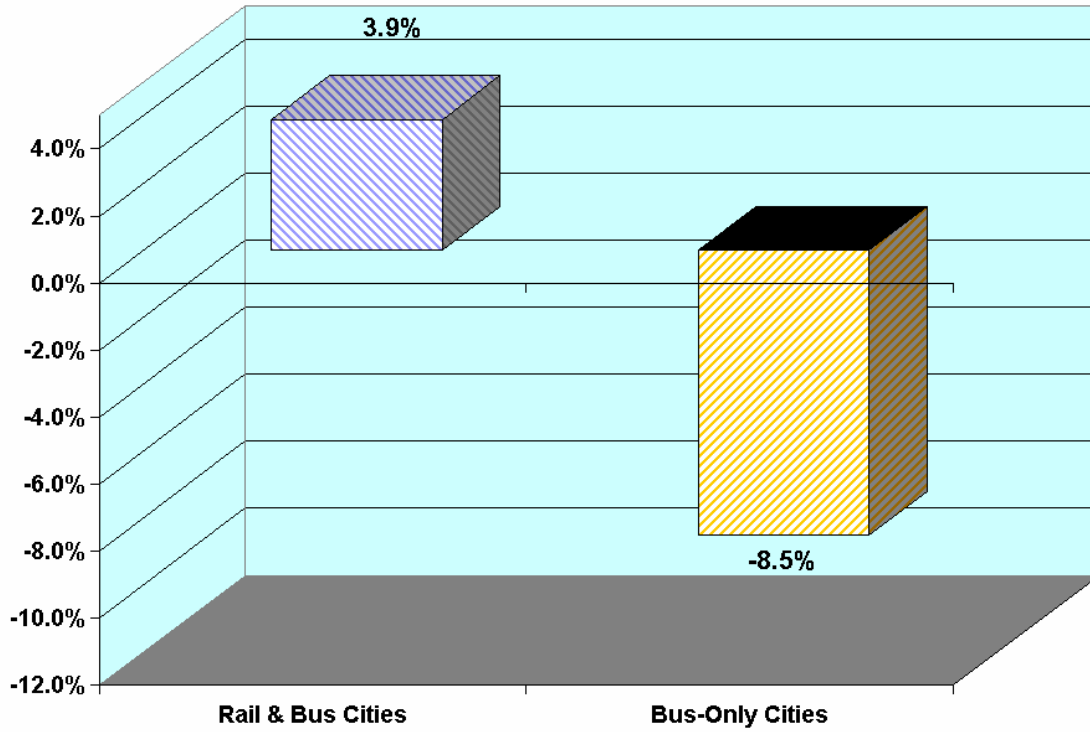


FIGURE 4 Change in passenger miles per capita, 1996–2003.

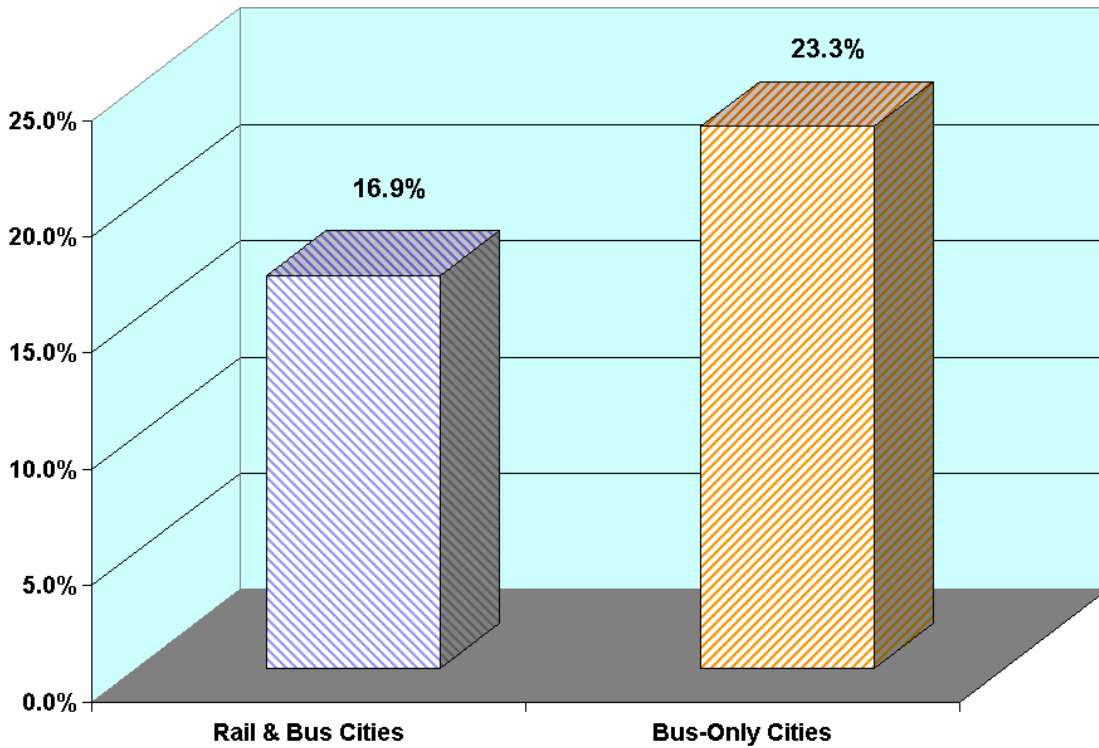


FIGURE 5 Change in O&M costs, 1996–2003 (constant 1996 dollars).

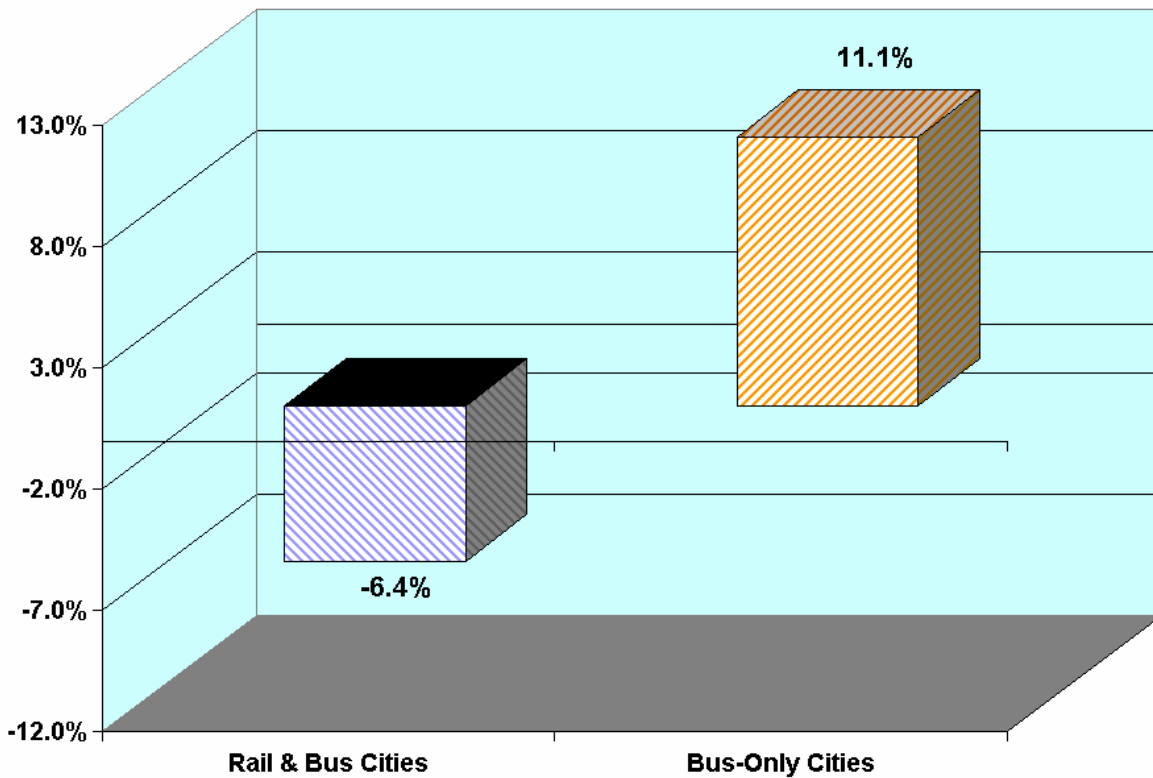


FIGURE 6 Change in O&M costs/passenger mile, 1996–2003 (constant 1996 dollars).

TABLE 14 Austin: Key Performance Data

	1997	2003
Trips (millions)	32.5	37.2
Passenger miles (millions)	107.7	124.5
O&M (\$millions)	\$69.3	\$107.6
O&M (1997\$, millions)	\$69.3	\$87.6
O&M/passenger miles \$	\$0.64	\$0.86
O&M/passenger miles (1997\$)	\$0.64	\$0.70

TABLE 15 Austin: Percentage Change, 1997–2003

	Period	Annual Average
Trips	14.5%	2.6%
Passenger miles	15.6%	2.6%
O&M/passenger miles (1997\$)	9.4%	1.6%

compare with the rail and bus cities (parallel to O'Toole's comparison), the percentage change for the 6-year period was converted to annual percentage change. The results can be summarized as follows:

Ridership Performance

The bus and rail group experienced a ridership increase in unlinked trips averaging 2.3% annually; in contrast, Austin's all-bus average was slightly greater at 2.6%. In terms of passenger miles, the rail and bus group experienced an increase averaging 3.6% annually; this compares with Austin's annual average of 2.6%. Basically, by these metrics, Austin's all-bus transit systems seems to have performed reasonably well, compared both to national all-bus systems and to rail and bus systems.

Financial Performance

In this measure, the rail and bus group of urban areas again exhibited a substantial advantage in comparison with Austin. In terms of O&M per passenger mile, the rail and bus group showed a significant *decline* of over 0.9% annually. In comparison, Austin exhibited an increase averaging about 1.6% per year.

CONCLUSIONS

This analysis has found that U.S. urban areas with new start rail systems, as well as bus services, on average, have outperformed bus-only urban areas in terms of growth in ridership and passenger miles, both absolutely and in terms of these measures per capita. Furthermore, financial performance of total public transport in the cities operating both rail and bus transit was also found to be superior to that of the cities with buses only. Measured in "constant" dollars, O&M expenses per passenger mile declined for the cities with both rail and bus, but rose in the all-bus cities. In 2003, overall operating cost per passenger mile in the cities with new start rail transit systems was only about 74% of that in cities operating only buses.

While a number of additional variables may affect these data and metrics, this analysis tends to refute the criticism that the installation of new rail transit systems imposes financial liabilities on cities and their existing transit systems. In addition, the analysis suggests that the investment in new start rail transit projects has been justified, in that these new rail transit systems overall seem to have outperformed comparable bus-only cities, and to have helped produce a more positive transit system performance; and, furthermore, that rail transit is attractive both to passengers and to the public at large.

REFERENCES

1. O'Toole, R. *Great Rail Disasters: The Impact of Rail Transit on Urban Livability*. Issue Paper 1-2004, February 2004. <http://americandreamcoalition.org/1-2004.pdf>.

2. O'Toole, R. *Rail Disasters 2005: The Impact of Rail Transit on Transit Ridership: An Update to Great Rail Disasters*. American Dream Coalition, June 2005. <http://americandreamcoalition.org/RD2005.pdf>.
3. Litman, T. *Evaluating Rail Transit Criticism*. Victoria Transport Policy Institute, Feb. 6, 2006. <http://www.vtpi.org/railcrit.pdf>.
4. Randal O'Toole's 'Great Rail Disaster': Ideological Train Wreck Disguised as "Research Study." *Light Rail Now*, November 2005. http://www.lightrailnow.org/features/f_lrt_2005-04.htm.
5. *Transit Agency Profiles*. Federal Transit Administration National Transit Database, 1996, 2003.

LIGHT RAIL TRANSIT AND BUS RAPID TRANSIT

Bus Rapid Transit
An Option Worth Considering—Lessons from TransMilenio

ARTURO ARDILA
Universidad de Los Andes

**BRT: An Option Worth Considering.
Lessons from TransMilenio**

Arturo Ardila, Ph.D.
Assistant Professor
Universidad de Los Andes

UITP TRB LRT Conference 2006, Saint Louis

Bogotá

- Capital of Colombia
- 2,600 m above sea level
- 7 million inhabitants
- Very dense city: 16,500 hab/km² or 42,000 hab/mi²



BOGOTA



The Bogotá Story

Buses in Mixed Traffic



The Bogotá Story

Buses in Mixed Traffic

- Extreme competition in the market
- Oversupply of buses
- Inflated fare
- Low level of service

The Bogotá Story

Metro Proposal

- One line
- 30 km
- 30 stations
- \$3 billion initial cost estimate
- Concession
- 8% of total transit demand
- Cancelled in 2000 for political reasons



The Bogotá Story

Transmilenio

- Stage 1
 - 25 mi
 - Exclusive lanes for buses
 - Stations
 - Articulated buses
 - Control center (AVL)
 - Automated fare collection
 - Customer oriented



The Bogotá Story

Transmilenio

- Stage 1
- 470 articulated buses
 - 163 passengers
- 235 feeder buses
 - 100 passengers



The Bogotá Story

Transmilenio

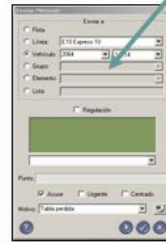
Operations Control



Software



Hardware



Communications



CONTROL CENTER



Ground Control

The Bogotá Story

Transmilenio

- Stage 1
 - Infrastructure: \$213 million
 - Buses: \$115 million
 - Net of buses:
 - \$5.9 million per km
 - \$9.9 million per mi



The Bogotá Story

Transmilenio

Results

- Stage 1:
790,000 pax/day
- Stage 1 and 2:
1.1 million pax/day
- 65 km or 40.6 mi.
- 700 articulated
buses



The Bogotá Story

Transmilenio

Results

- 42,000 pax/h
per direction
- 26 kmh or
16.2 mph
- 27,000 pax/mi
of network
- 17,000 pax/km
of network



The Bogotá Story

Transmilenio

Cost distribution:

- 37% busways, stations, pedestrian overpasses
- 40% general traffic lanes
- 11% right-of-way acquisition
- 12% environmental and social mitigation



The Bogotá Story

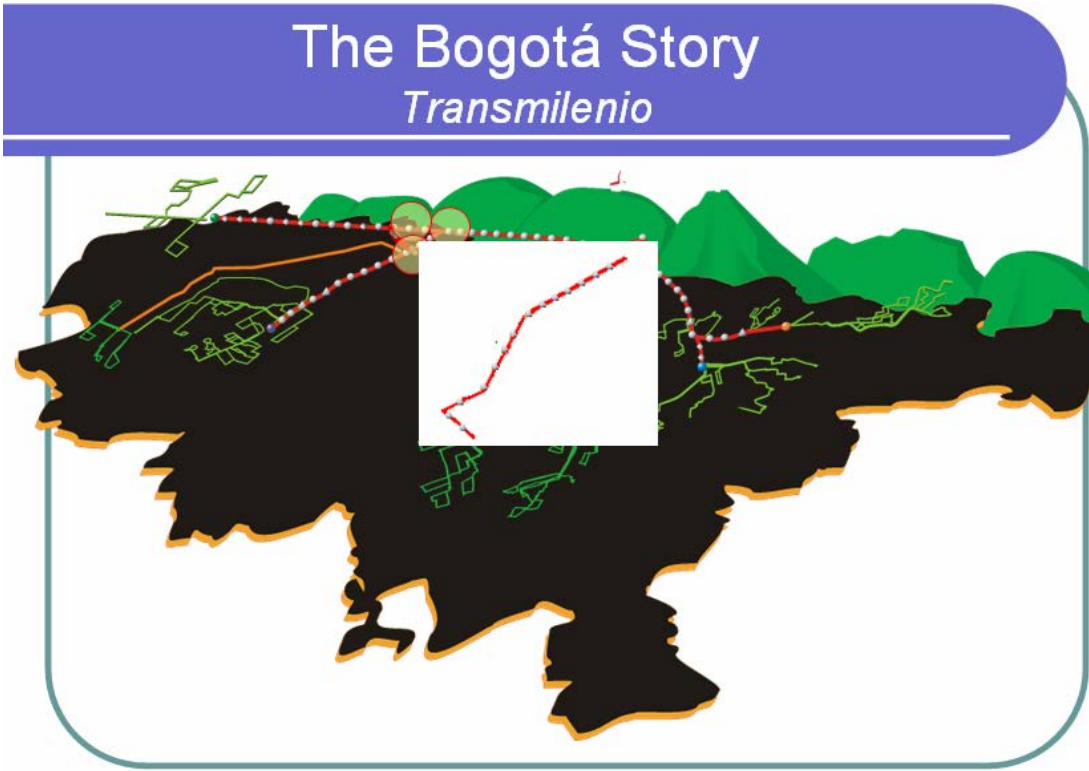
Transmilenio

Other indicators:

- Private operators of buses
- Fare \$0.40
- 1,600 pax/day/bus
- Highly profitable
- Fare covers capital and variable costs
- No O&M subsidies



Patio de la 80 – Bogotá (Colombia)



The Impact of Transmilenio on Demand

Attribute	Non Transmilenio Rider (\$/h)	Transmilenio Rider (\$/h)
Walking-in time	18.51	5.35
Waiting time	16.07	1.33
Travel time	3.91	1.19
Walking out	15.03	4.23

Source: Lleras (2002)

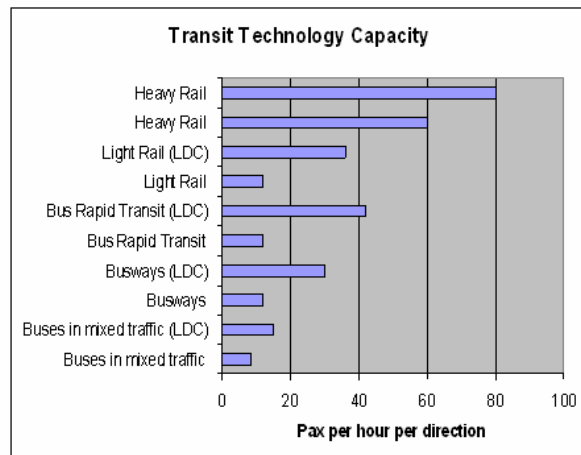
Transmilenio *The Lessons*

- BRT is able to provide a high level of service
- BRT costs \$5 to \$20 million per km
- BRT offers a larger coverage for same budget



Transmilenio *The Lessons*

- BRT offers similar capacity to LRT and most MRT



Transmilenio *The Lessons*

- BRT is highly flexible
- BRT is able to incorporate old bus operators into new system
- BRT is profitable and requires no operational subsidies



Transmilenio *The Lessons*

- BRT is worth considering a part of a mass transit network
 - Backbone element
 - Complementary element



LIGHT RAIL TRANSIT AND BUS RAPID TRANSIT

TEOR
The Rouen Case

WERNER KUTIL
Veolia TCAR/Transport



TEOR m-e-t-r-o-b-u-s **The Rouen Case**



Saint Louis, Missouri
April 11, 2006

Werner Kutil
TCAR / Veolia Transport
Rouen / France





CONTENTS

- * **Rouen Metropolitan Area PT-Network**
- * **1st investment: Two LRT lines in 1994**
- * **2nd investment: Three BRT lines in 2001**
 - => Reasons for the choice
 - => Objective
 - => Realization
 - => Results



ROUEN METROPOLITAN AREA

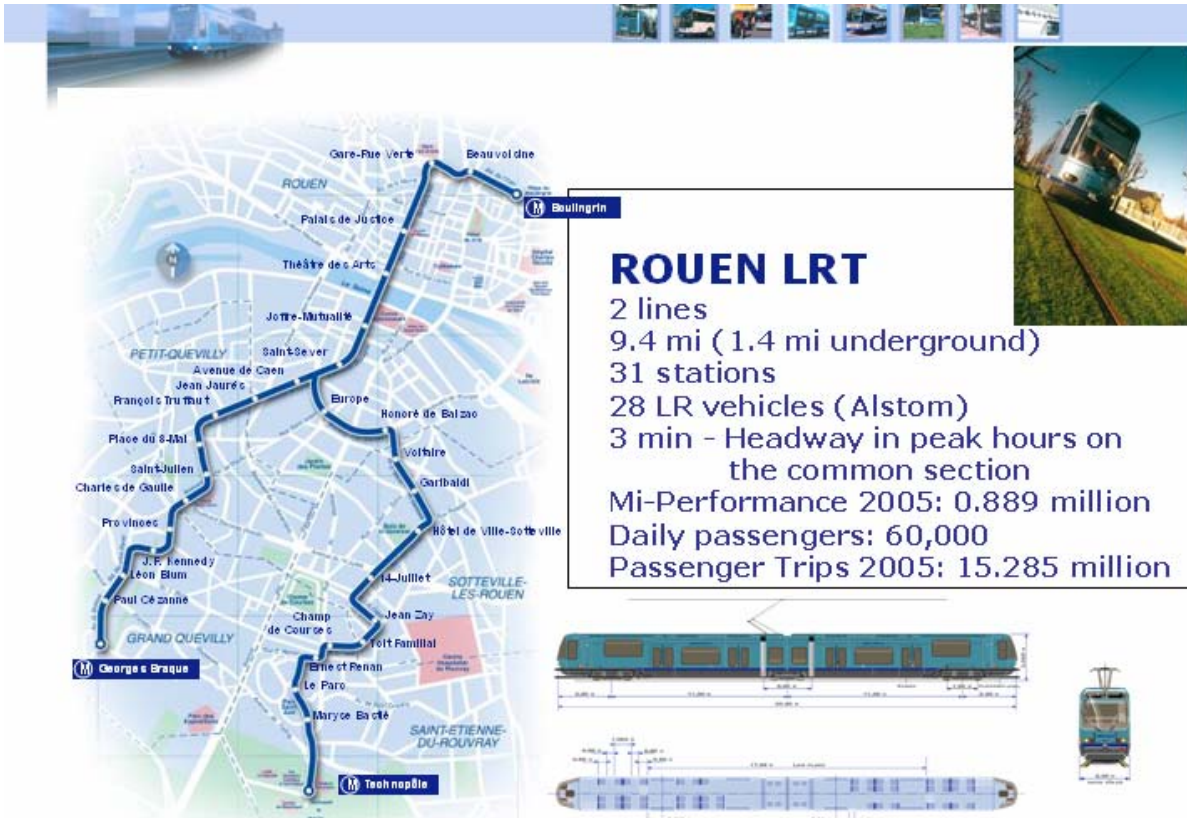


Area	124 mi ²
Number of municipalities	37
Number of inhabitants	393,643

Public Transportation Authority: Agglo. de Rouen
Haute Normandie

Operator: TCAR/Veolia Transport

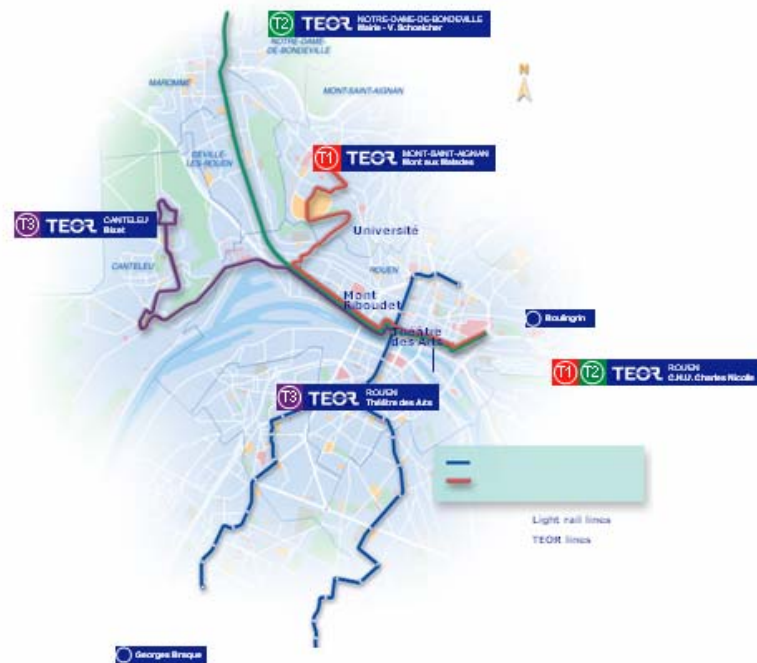
- * 2 Light rail lines
- * 3 BRT lines
- * 34 Bus lines
- * 31 School Bus lines
- * Services for people with reduced mobility
- * 5 taxi lines

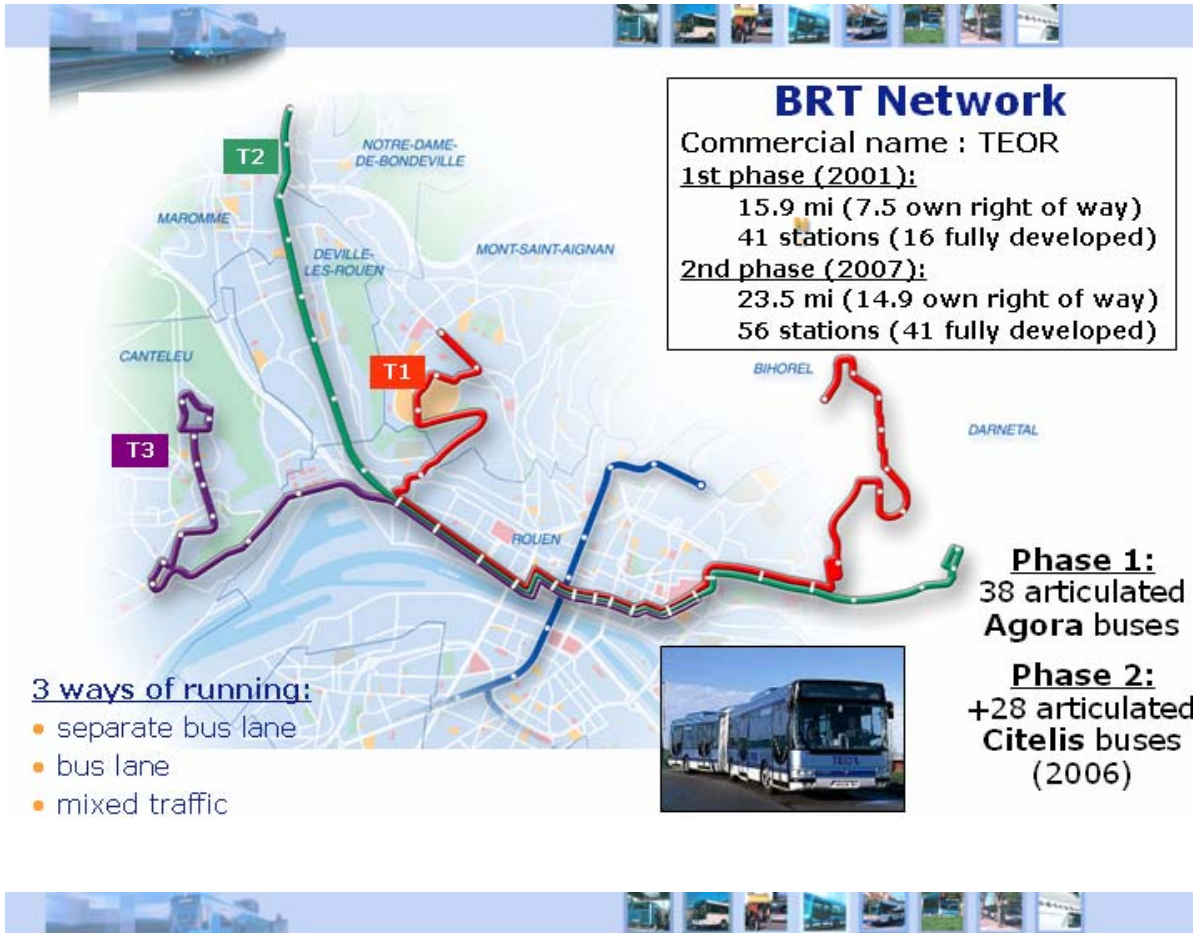


ROUEN LRT

- 2 lines
- 9.4 mi (1.4 mi underground)
- 31 stations
- 28 LR vehicles (Alstom)
- 3 min - Headway in peak hours on the common section
- Mi-Performance 2005: 0.889 million
- Daily passengers: 60,000
- Passenger Trips 2005: 15.285 million

LRT and BRT in Rouen





Reasons for the Choice

Why a BRT after a first investment in LRT?

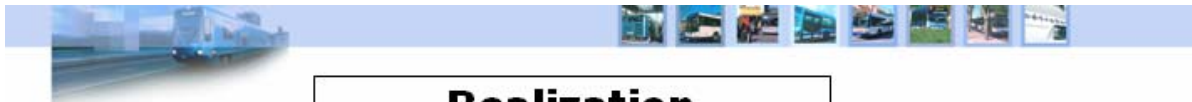
- * Construction costs per mile divided by 5;
- * Operation costs per mile divided by 1.4;
- * Total construction period divided by 2;
- * Slopes of the line to Rouen plateaus (up to 10%);
- * Lower demand than on the North South axis; and
- * Flexibility of the bus—is able to go out of the system in order to serve areas with lower demand.



Objective

BRT with the same service quality as LRT

- * **Commercial speed (expected for 2007: 12.5 mph)**
- * **Regularity**
- * **Accessibility**
- * **Comfort of waiting time**
- * **Integration in the city**
- * ...



Realization

Commercial speed – Regularity – Punctuality – Flexibility

★ Reserved lanes

★ Segregated lanes



★ Average station spacing : 0.3 miles

★ Automatic ticket vending machines in station (end of 2006)



★ Priority at traffic lights



Realization

Accessibility

- ★ Platform height 0.89 foot—
Optical guidance
- ★ Guaranteed docking
with almost any gap
- ★ Full accessibility
to stations

This section illustrates the realization of accessibility features for light rail transit. It includes a photograph of a blue light rail vehicle at a station platform with a yellow optical guidance line on the ground. Another photo shows a close-up of a person's feet on a yellow tactile strip at the vehicle's entrance. A third photo shows a wide, accessible station platform with a blue shelter and a crosswalk.



Realization

Waiting comfort

- ★ Same stations as for LRT
Quality design for the insertion in the city
Visual recognition of TEOR infrastructure
- ★ Interchange Terminal
5 bus lines, 3 BRT lines
and a P&R for 1000 cars
- ★ Real time passenger
information in station

This section illustrates the realization of waiting comfort features. It includes a photograph of a light rail vehicle at a station platform with a blue shelter. Another photo shows a large interchange terminal building with a blue light rail vehicle in front. A third photo shows a real-time passenger information display board with the following text:

T2	HD-DE BONDEVILLE	2MN
T1	MONT AUX MALADES	3MN
T3	BIZET	8MN



Main Characteristics of the TEOR System

- **Dedicated right-of-way bus corridors/lanes**
- **Regular articulated Agora/Citelis buses**
- **Virtual optical on-street guidance system**
- **Reorganization of the bus lines**
- ...



TEOR

Line specifications	December 31, 2005
Number of lines	3
Number of vehicles	
• "Agora" articulated buses	38
Number of fully developed stations	16 on 41
Routes length	15.9 mi

Operation figures relative to the year 2005

Headways	
• peak hours	3-ft headway on the common section 6- to 9-ft headway on each line
• off peak hours	4-ft headway on the common section 9- to 11-ft headway on each line
Vehicle x miles	0.980 million
Daily passengers:	32,000
Passenger trips 2005	7,040 million



Results (Ridership)

Passenger trips (validations)

	<u>In 2000</u>			
Bus :	23.1			
LRT :	15.2	38.3 M		
	<u>In 2005</u>			
Bus :	17.9			
LRT :	15.3	40.3 M	+ 5.2 %	
BRT 1st phase:	7.1			
	<u>Expected in 2007</u>			
Bus :	~ 15			
LRT :	~ 15.3	45.3 M		+ 17.5 %
BRT 2nd phase:	~ 15			

LIGHT RAIL TRANSIT AND BUS RAPID TRANSIT

BRT System in Seoul

SUN GU JEONG

Seoul Metropolitan Government

Hi Seoul

BRT System in Seoul

Jeong, Sun Gu
Director-General of Transportation Bureau
Seoul Metropolitan Government
11 April 2006

 **Seoul Metropolitan Government**

Contents

- I. Public Transportation in Seoul**
- II. BRT System in Seoul: Present and Future**
- III. Effects of the BRT System**
- IV. Future Plans: Networking Subways, BRT, and LRT**

I Public Transportation in Seoul



I Public Transportation in Seoul

1. Seoul: Overview

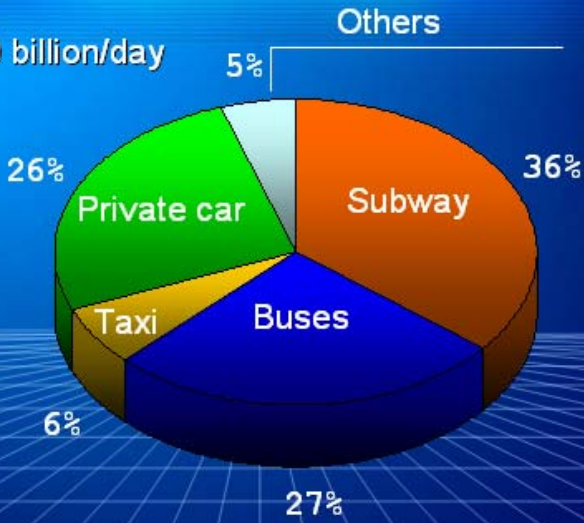
- Population: 10.4 million (1/4 of Korea)
- Area: 605.52 km² (0.6% of Korea)
- Budget: US\$14 billion per year



I Public Transportation in Seoul

2. Mode Share

- Total mode trip: 30 billion/day





Mode	Share (%)
Subway	36%
Buses	27%
Private car	26%
Taxi	6%
Others	5%

I Public Transportation in Seoul

3. Subway (Heavy Rail Transit)

- Line No. 1~8
 - Line No. 9 is under construction and will open in 2009.
- Total Length: 287 km
- Station : 263 units
- Passengers : 6.2 million/day


Map of Seoul Subway

I Public Transportation in Seoul

4. Bus (Including BRT)

- Total Lines: 402
 - Trunk Lines: 104
 - Feeder Lines: 267
 - Wide-area Lines: 26
 - Circular Lines: 5
- Number of Vehicles: 7,792
- Lanes of BRT: 7 lanes (53.8 km)
- Passengers: 4.5 million/day



I Public Transportation in Seoul

5. Subway-Bus Network System

- **Subway-Bus network system in Seoul:**
 - Subway and buses are linked systematically and
 - It is convenient to use public transportation in Seoul.

- **Integrated fare system of the public transportation:**
 - Accumulated distance-based fare, regardless of the modes and
 - Free of charge for transfers among the modes within 10 km.

- **Smart Card System: T-money card:**

 - Passengers can pay transit fare with a unified card when transferring among different modes.



II BRT System in Seoul: Present and Future



II BRT System in Seoul : Present & Future

1. Link: The Exclusive Median Bus Lanes

- The exclusive Median Bus Lanes: 7 lanes (53.8 km)
 - Buses run on the median lanes of roadways
 - Bus stops are also located in the middle of the road
 - Vehicles other than buses are not allowed to use the Median Bus Lanes

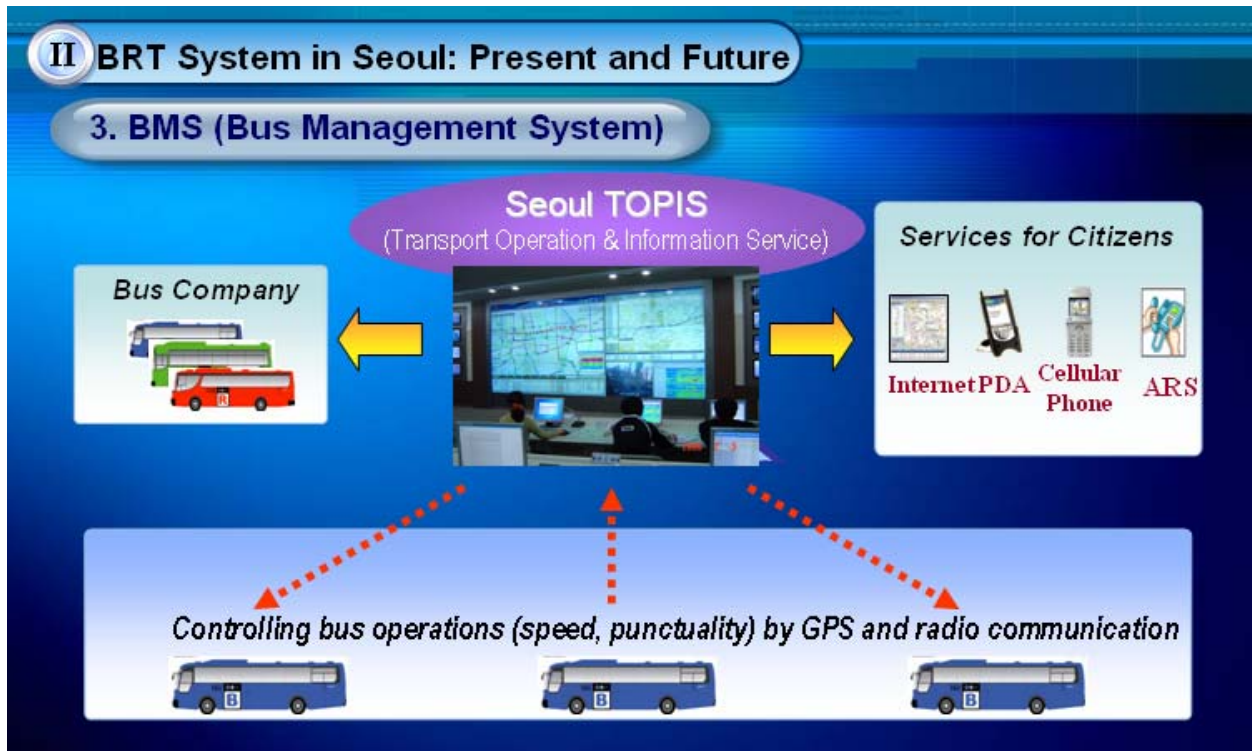


II BRT System in Seoul: Present and Future

2. Mode: Four Colored and High-Quality Buses

- Four different-colored buses by their function
 - Passengers can easily recognize the bus they are using
- High-quality buses for the convenience of the passengers
 - Articulated buses
 - Low-floor buses
 - CNG buses





II BRT System in Seoul: Present and Future

4. Easy transfer system

Transfer centers

- Allowing convenient transfers from BRT to feeder buses, subway, or national railways



Cheongnyangni Transfer Center



Yeouido Transfer Center

II BRT System in Seoul: Present and Future

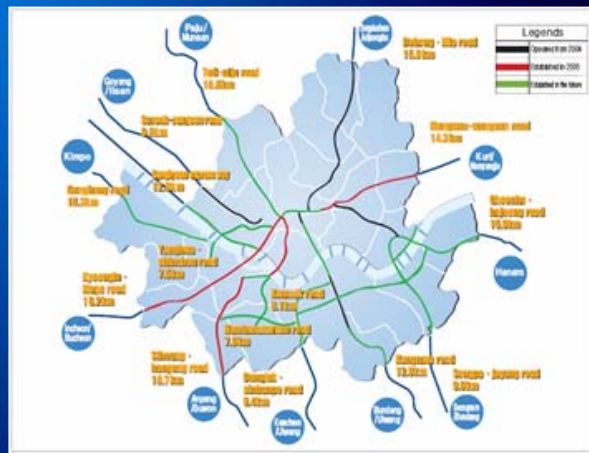
5. Extension of BRT lanes

Plans of the BRT extension in Seoul



Plans of the BRT extension to satellite cities

- Lanes of BRT: 22 Lanes (540.4km)
- Period of construction: 2006~2012
- Source of revenue:
Local gov. 60% + Central gov. 40%



II BRT System in Seoul: Present and Future

6. Upgrading of BRT: Nan-gok Line

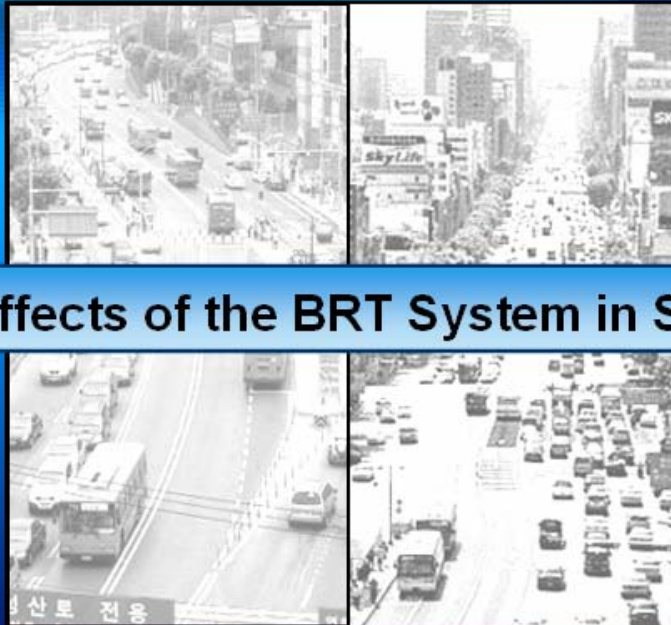
- Nan-gok Line system will be the highest grade of BRT system.
- Nan-gok Line system will have an electronic guidance system.
 - It can be driven automatically via magnetic markers in the road surface.

Nan-gok Line: Overview

Line	L = 3.1 km, six stations
Period	July 2005~ June 2008
System	GRT (Guided Rapid Transit)
Cost	US\$ 258 million (including the cost of widening roadways)



III Effects of the BRT System in Seoul



III Effects of the BRT System in Seoul

1. Increase in Speed

- BRT has improved speed even in congested corridors

Congested Corridors	Before (km/h)	After (km/h)	Comparison (km/h)
Dobong-mia Lane	9.0	30.8	+ 21.8(242%)
Susaek-seongsan Lane	7.5	20.2	+ 12.7(169%)
Cangnam Lane	9.1	17.4	+ 8.3(91%)

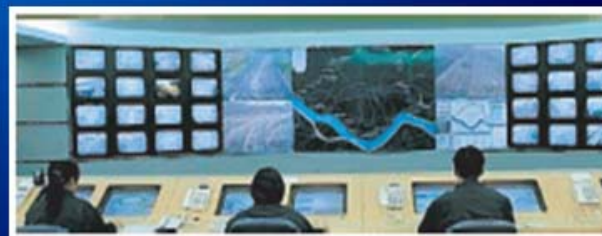


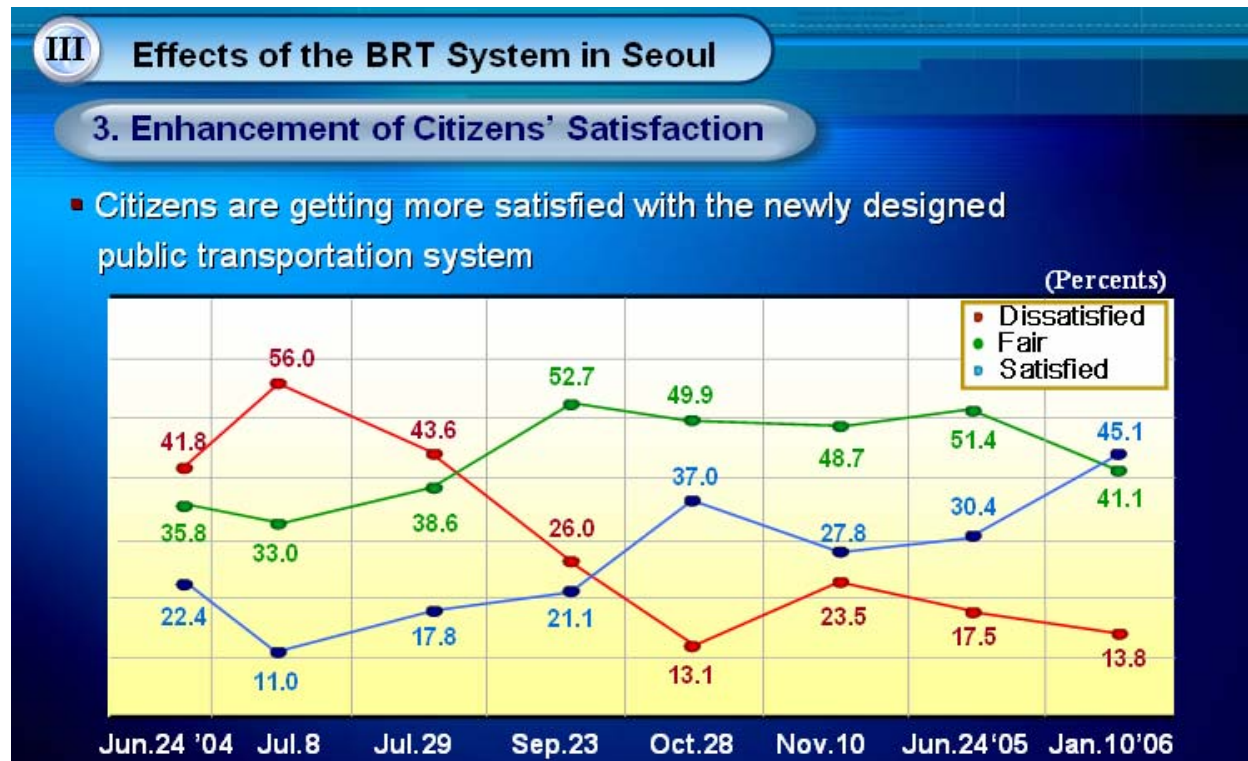
III Effects of the BRT System in Seoul

2. Punctuality

- Buses arrive on time

Lane	Length (km)	Travel Time (min)	Bus Arrival Time Deviation (min)	Car Arrival Time Deviation (min)
Dobong-mia	15.2	44.3	2.7	15.3
Susaek-seongsan	6.8	18.1	1.2	15.6
Kangnam	4.8	16.7	1.3	4.6





III Effects of the BRT System in Seoul

4. Safety

- Reduction in the occurrence of bus accidents in BRT lanes

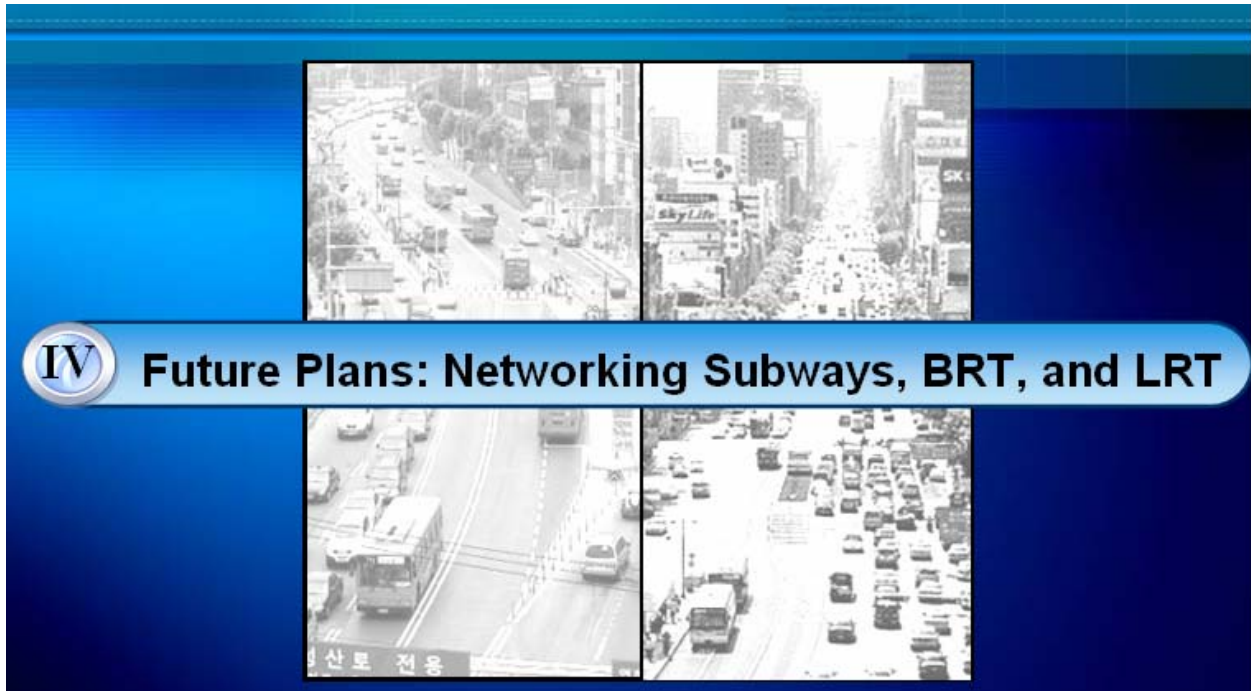
	Before (Jul '03~Jun'04)	After (Jul'04~Jun'05)	Comparison
Case of accident	410	354	-56 (-13.6%)

- However, the total number of accidents in BRT lanes had increased at early stage of implementation.
 - Due to passenger car drivers' inexperience with the BRT system and passengers jaywalking in an attempt to access the bus stop in the middle of the road

	Before (Jul '03~Jun'04)	After (Jul '03~Jun'04)	Comparison
Case of accident	1,069	1,111	+42 (+3.9%)

- In order to work out such problems, various measures have been taken.
 - Installation of safety fences, central reserves, safety campaigns, etc.

As a result, the number of the accidents in BRT lanes has decreased lately.



IV Future Plans: Networking Subway, BRT, and LRT

1. Plans of Subway, BRT, and LRT

▪ **Future plans for Seoul's public transportation**

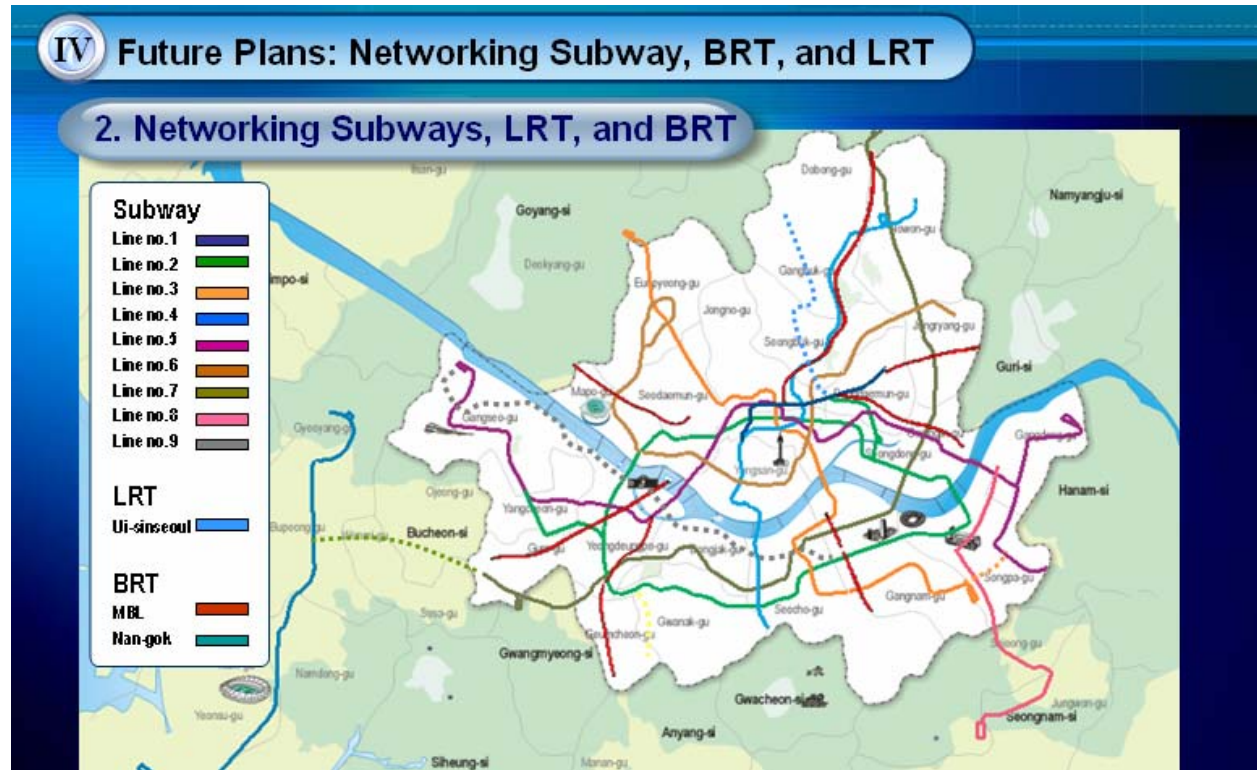
Subway Line No. 9 (new/25.5 km), Line No. 3 (extension/3 km), Line No. 7 (extension/3 km)

BRT Nine lanes in the city (137.4 km), 22 lanes in the suburbs (540.4 km)

LRT Ui-sinseoul Line (10.7 km), five other lines (about 50 km) under examination

▪ **The mutual complement between the modes of transit**

- If all the plans are carried out, it will bring about a better networking system of Seoul's public transportation through the mutual complement between the modes of transit.



Accessibility

ACCESSIBILITY

The LibeRTiN Recommendations

JOHAN VAN IEPEREN

LibeRTiN

LibeRTiN is a project funded by the European Commission aimed at contributing to lifting obstacles to the establishment of a truly European Internal Market for Light Rail Transit (LRT) Systems. The main goal of LibeRTiN was to search for sectorwide consensus in fostering simplification, modularization, and interchangeability of light rail subsystems, with the active support of the light rail operators and light rail manufacturers through their relevant associations, UITP (International Association of Public Transport) and UNIFE (Association of the European Railway Industries). This activity had the objective of increasing the cost effectiveness and reliability of light rail systems for Europe's citizens.

LibeRTiN is a follow-up activity of MARIE (MASS Rapid transit Initiative for Europe), the first attempt at a joint development between operators and manufacturers in the late 1990s, and is embedded in ERRAC strategy as the "light rail part" of it. ERRAC, the European Rail Research Advisory Council, is the "technology platform" for European rail research (www.errac.org).

LibeRTiN, finishing in February 2005, constitutes only a first step within the necessary work for overcoming technical barriers to establish a fully-fledged internal market for LRT systems.

The output of the various working groups underlines the joint efforts by manufacturers, operators and other stakeholders and has demonstrated open-mindedness, frankness and the willingness to achieve measurable results for the entire industry. The recommendations from most of the different groups will unquestionably contribute to an improved business environment resulting in more simple, harmonized solutions that will increase reliability and rationalize manufacturing processes. The outcome will be more cost-effective light rail systems and vehicles, and better profitability for manufacturers.

During the project, the business climate of the light rail sector has gone through some challenging times. More often than usual manufacturers and operators have been negatively portrayed in the headlines of both the trade press and the general finance media. This rather depressed climate could be felt during the LibeRTiN work

Beyond the concrete results and contractual output of the project, LibeRTiN has fully fulfilled the objective of a thematic network, i.e., providing a tool and a climate to foster dialogue in a particular sector. The work, meetings, and discussions have proven extremely instrumental in helping participants to better understand each other's concerns and constraints. Some recent initiatives are an indirect result of LibeRTiN to help introduce recommendations at specific national levels and help overcome regulatory obstacles. One example is the recent set-up of UK Tram and the LRT Forum.

**FIGURE 1**

Above and beyond all the technical issues, UITP and UNIFE firmly believe that the LibeRTiN results will be beneficial to all the stakeholders, as they are based on a mutual understanding for achieving a common goal, namely to make public transportation attractive for users, reliable for operators, and profitable for manufacturers and investors.

OBJECTIVES AND STRATEGIC ASPECTS

Besides the objectives already mentioned above, further priority aims were addressed:

- To promote the attractiveness, affordability, flexibility and sustainability of tramway/light rail systems by reducing the costs of modular components, harmonizing operating rules and procedures, and enhancing system performance,
- Analysis of differing regulations and barriers to the creation of an internal market for tramway/light rail equipment based on a review of the OIM report (Obstacles to Internal Market Study, starting point for LibeRTiN) including additional consensus building and based on the prioritization of focus items,
 - Selection of LRT topics for harmonization and standardization,
 - Analysis of priorities for harmonization and standardization of selected topics,
 - Proposing and evaluating draft standards for the selected topics (based on the OIM report),
 - Proposing tender document formats.

LIBERTIN METHODOLOGY

The process of building consensus over thirty months consisted of three phases. The first phase (thematic focusing) concentrated mainly on selecting topics and establishing the framework for the activities; phase two (intermediate consensus building) deepened the topics and, in the third phase (final consensus building), the topics were concluded. All phases included the involvement and necessary input of a great many external experts in the LRT domain.

Main Topic Results

The following 10 topics (shown in red) have been investigated in detail (Figure 2):

Working groups (WG) for each of the 10 topic areas were established. The output of these groups is of varying nature and includes:

- Official requests for changes to existing standards sent to CEN/CENELEC (official standardization bodies at the European level), or advice to existing CEN/CENELEC working groups in order to cover adequately the LRT sector. It is expected that CEN will call on UITP and UNIFE to provide the necessary expertise to the working groups.
- Recommendations directly applicable voluntarily by the LRT sector (e.g., access, derailment, etc.). For this, the joint UITP/UNIFE recommendations are the output.
- General discussion and conclusions to pursue efforts. A WG of UITP consisting of manufacturers (Alstom, Bombardier, and Siemens) and operators has already confirmed the urgency to pursue on the items tender and gauging.

For all categories, a critical aspect is the level of commitment that the UITP and UNIFE members will apply to the recommendations. As the two main partners of the LibeRTiN consortium, UITP and UNIFE will endeavor to convince their respective membership of the added value of the LibeRTiN output. It is currently proposed to organize a ceremony involving the highest representatives of both organizations (and a European Commission representative) on the occasion of the UITP world congress in Rome, at the end of the light rail session on June 8, 2005.

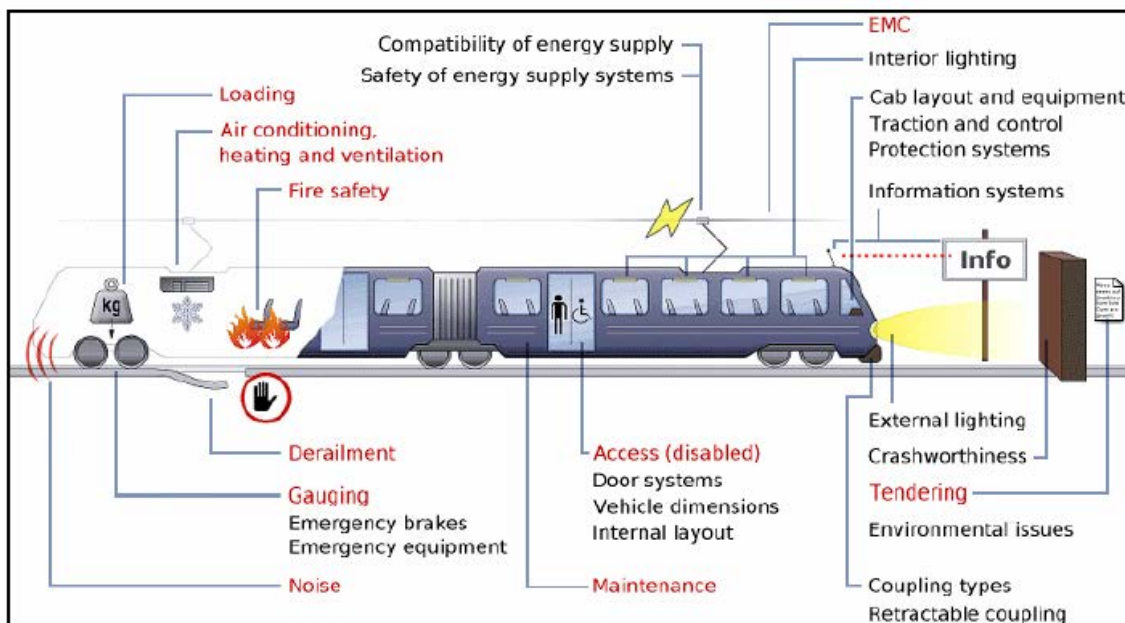


FIGURE 2 Main topic results.



FIGURE 3

The following briefly states the results of the LibeRTiN topics. For full details, please refer to the single-topic reports (www.libertin.info).

Access

Status Reached: UITP/UNIFE Recommendation

The system approach, clearly supported by the experts, caused the access topic to become very comprehensive. Accordingly, the recommendations are numerous and extensive. One of the main results is the recommendation on the boarding and alighting vertical step and horizontal gap issue (Figure 4):

Both Step and Gap Between 0 and 50 mm

- In exceptions allow a horizontal gap of up to 75 mm and a maximum negative step of up to 25 mm.
- The use of boarding devices is required in case the horizontal gap is above 75 mm or the vertical step is above 50 mm or below –25 mm.
- Failing to comply with either of the above makes the system inaccessible.

The difference between “hard” and “nice to have” recommendations, which depended on the impact of cost drivers, was indicated by a rating from 1 (hard) to 4 (nice to have).

Derailment Prevention and Ride Quality

Status Reached: UITP/UNIFE Recommendation

The major part of this effort has been focused on producing a specification of the vehicle-track interface, which will facilitate derailment prevention and ride quality with standard vehicle designs. Further work is required to specify all parameters.

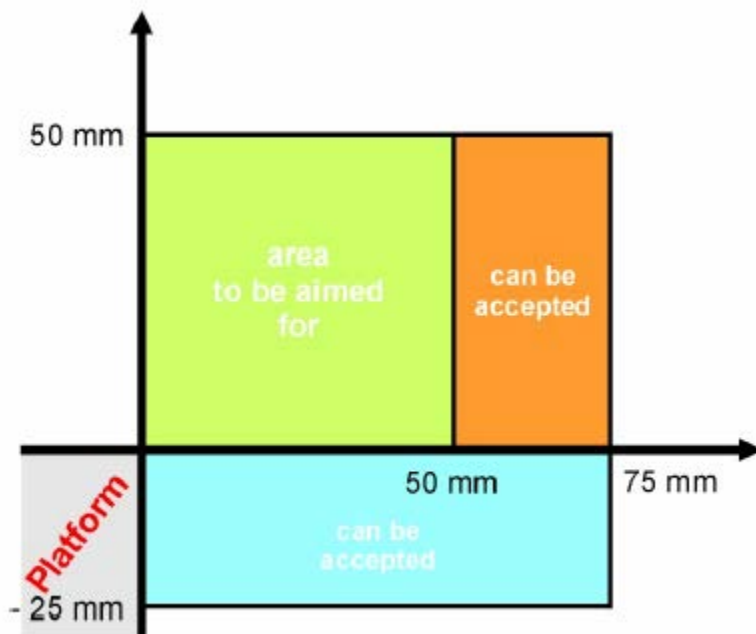


FIGURE 4 Boarding and alighting vertical step and horizontal gap recommendation.

There is no consensus on how ride quality should be specified or measured for light rail vehicles (LRVs), or on the related issue of the specification and measurement of track quality. Further work is suggested to address the specification and measurement of track quality on light rail networks, to consider the dynamic loading imposed by LRVs, and to assess whether the best practices regarding wheel profiles should be included.

The main German regulations on wheel–rail interface were translated into English, as well as a summary of the German regulations on track geometry. Availability of such consolidated knowledge can be beneficial to newcomers. However, discussions have shown that sometimes psychological and cultural barriers still prevent the flow of information or dissuade the adoption of “somebody else’s practice.”

Heating, Ventilation, and Air Conditioning

Status Reached: UITP/UNIFE Pre-Agreement on Fundamental Interface Specifications

Heating, ventilation, and air conditioning (HVAC) systems have been identified as cost drivers for LRVs and the need for standardization was stated by the main stakeholders of the light rail market. Therefore the main target was to build consensus between operators, vehicle manufacturers and HVAC system suppliers regarding cost reduction, modularity and harmonization of system requirements. If possible this work should lead to standardized HVAC systems that can operate on a “plug and play” basis with standard electrical, mechanical, and logical interfaces.

The main results of the topic group can be summarized as follows:

- Consensus about a performance calculation model reflecting the LRV market and operational practice.
- Preparation of a decision basis for the CEN working group to integrate this model in prEN 14750.
- Definition of dimensions and conceptual approach of the mechanical interface, including assembly principles.
- Recommendations regarding the electrical interface and acoustic requirements.

Through increased communication efforts with vehicle manufacturers, the result of these discussions can be better enforced. Furthermore, a norm initiative at CEN should be started using these results. Current experts have expressed their eagerness to follow up and continue the momentum. The results of this WG will also be incorporated by the MODURBAN-project.

Loading Parameters

Status Reached: Input to Standardization Process, Scope Document to CEN

The topic group reached agreement that the existing standard (EN 12663) should include a fixed value for loading parameters in relation to LRVs. The aim was to help planners distinguish between loading parameters for vehicle structural design, planning of line capacity, and planning of timetables. For the latter two there exists the UITP recommendation, Topic 35.

For vehicle structural design, EN 12663 must be used and should be changed as follows:

The maximum loading capacity will be calculated based on the number of available seats (mass of a passenger) and the surface of the standing area (mass per m²) of the vehicles. This first option is also in line with BOStrab standards and DIN 25008 (on calculation of rail vehicle masses).

A copy of this document has been provided to the European standardization body CEN (TC 256 WG 2). The group has raised the question of the applicability of dynamic loads (as proposed for heavy rail) to LRV, which will be included in the next version of standard EN 12663.

Fire Safety

Status Reached: Direct Input to CEN Standardization Process

Topic of discussion was the prEN45545 which does not clearly take into account the specifics of LRVs. It was established by the manufacturers that the standard in its current form is too complex to implement and prevents a positive impact on cost savings. Consensus was reached to ask CEN to add or amend a specific category covering the majority of light rail systems.

A letter was sent to CEN to ask for a new category dedicated to tramways:

Vehicles with no on-board fuel supply, with easy passenger evacuation and good communications equipment...

As a result of the LibeRTiN work, UNIFE and UITP member's experts and the two associations decided to take the lead in the follow-up of the improvement of the standard as one subject for future activities with CEN.

Structure Gauging

Status Reached: Input to Standardization Process Due to Start

Meetings with CEN were held and discussions with experts took place on what the specifics of LRVs are and how they will and have been taken into account in the standard definition.

The structure of the CEN standard was discussed. This future standard will be divided in three major parts:

- The first one will be dedicated to the generalities for infrastructure, rolling stock, profiles and the associated calculation rules.
- The second part will give the rolling stock dimensioning rules and methods (UIC rules and others with the objectives to give a common rule for all existing calculation methods other than UIC).
- The third part will give the infrastructure dimensioning rules.

After further discussions, consensus was reached that several gauging classes should be defined, ideally 2, or max 3 classes related to the insertion capacity in the urban area. Any future call for tender will need only to specify which class is required and the manufacturer will immediately know which of their vehicles can fit.

This system would be useful not only for new systems, but also as guidance for existing systems performing track replacements and modernisation works. Given the long life cycle of infrastructure subsystems, it is vital to start as early as possible to define two or three gauging categories so that within 20 to 25 years, systems may be compliant.

Maintenance Management

Status Reached: UITP/UNIFE Recommendation

Maintenance management affects design and contract policy, capital and operating costs, service reliability and quality at all stages in the life of a light rail project.

The topic report describes fully the current status and developments, best theory and practice of all relevant issues of the topic, and serves as practical guidelines to help new or existing light rail systems reduce their life-cycle costs (LCC) and so to improve their viability. There are two main themes:

- The theory and practice of LCC in actual contracts, advantages and disadvantages, and application to whole or parts of new or existing systems; maintenance management systems (MMS); and reliability, availability, maintainability, safety (RAMS), and their associated computer-based systems.
- Expert international practical experience of various technical measures to reduce vehicle and fixed equipment maintenance costs and the scope for further study.

The most important recommendations (dos and don'ts) are as follows:

- Do enforce information flow within your maintenance organisation and back to the manufacturer regarding operational and maintenance performances! It will enable you and your partners to improve the system.
- Do integrate maintenance cost considerations in your purchase decision! The maintenance cost over the lifetime are in general higher than the investment cost.
- Do not write the LCC/RAMS part of your specification in a hurry (or copy and paste)! Take your time to reflect your individual boundary conditions, possibilities and necessities regarding these issues; it will prevent you from incomparable offers and doubled efforts during negotiation.
- Do not require something that you are not prepared (in advance) to verify during operation!
- Do predefine failure categories and its "owner"! This will help you later to manage your verification and prevent you from many discussions.
- Do not be afraid of the topic! There exist simple and smart solutions to handle the topic without spending too many efforts.

Tendering Procedures

Status Reached: Intermediate UITP/UNIFE Recommendation

The group developed a procurement process model to simplify the tender documentation which exploits the standards being developed across Europe but is independent of contract type.

A key function of the model is to enable system interfaces and dependencies to be managed throughout the procurement process since the majority of problems stem from poor management at the tender stage. The model can be used to guide promoters through the procurement of vehicles, infrastructure, system management, sub-systems or complete systems.

Suppliers and promoters alike see the benefits of a simplified process particularly in improving the uniformity and compliance of responses.

Further work remains to be done to complete the model and test its robustness, which is outlined in the Masterplan for Future Research. To ensure consistency for further work and to avoid further fragmentation, the provisional results are owned jointly by UITP and UNIFE. Their use is, of course, in the public domain, but any change or development can only be agreed jointly by the two organizations (change control management).

EMC (Electromagnetic Compatibility) and Noise

Two working groups (EMC and noise) encountered more difficulty than expected in organizing their work. Unsurprisingly, the output of these working groups, despite early and significant efforts from the whole consortium, is not as advanced as expected, and the consortium decided that a topic report could not be disseminated to the light rail community due to the low added-value of the results achieved.

For the noise WG, it was the general opinion among experts that the main problems were on the curving noise and vibrations and structure-borne noise raising from light rail transport. It was assumed that recommendations to the prEN ISO 3095 were needed in order to improve the

applicability for LR applications and it was initially thought that this could be based on the German recommendation VDV 154, which has been endorsed by UITP as a basis for recommended limit values. At the end of the process this basis was deemed unsatisfactory.

It was agreed at this stage that the prEN ISO 3095 should be the basis also for exterior noise testing of light rail rolling stock.

However, UNIFE believes that the application of VDV 154 is *not suitable* for European-wide light rail noise standard. The industry rejects the recommended values of VDV 154 for a number of reasons (of cost and technical nature) and has formed a working group (in cooperation with VDB—the German association of railway industries) to influence and discuss further work. It is trusted that this will build consensus on future limit values of LRV noise as well as measurement procedures and conditions of noise and wheel–rail roughness. Additionally, the techniques for measuring and evaluating wheel and rail roughness should be clearly specified in order to achieve robust noise results in different environments. This should be an important topic for discussion between the industry and operators in order to achieve future consensus.

DISSEMINATION

Since LibeRTiN was a thematic network, its primary purpose was not to carry out any research work, rather to disseminate achieved results in various ways.

The LibeRTiN website, also used for dissemination purposes, will still be available even after the project has finished.



FIGURE 5

CONCLUSIONS

The efforts of LibeRTiN have been very necessary and helpful. Fostering communication between the different stakeholders was achieved and there is widespread recognition for the light rail thematic network under its name: LibeRTiN. The level of visibility and support of the project within the LRT domain has reached a very high level.

Nearly all groups produced tangible results, some by giving direct input to the standardization process, others by preparing recommendations especially useful to potential new systems and finally by helping to point out undesirable effects of new standardization projects.

It is believed that the difficulties in achieving consensus in some topics can be attributed to the following sector-specific problems and contributed to the discussion about a potential future urban rail directive which led to a European public consultation, between December 20, 2004, and mid-March 2005:

A lack of a European “spirit”—some operators do not see any quickly achievable benefit from European harmonization projects, so they ask: why contribute time and money?

The fragmentation of the market is actually very large, with more than 170 networks in an enlarged European Union, and a wide variety of national cultures.

It has been realised during LibeRTiN that in some areas voluntary agreements were not sufficient to overcome some obstacles and that community legislation was the only way to achieve an appropriate level of technical harmonization in a number of areas (e.g., Crashworthiness, Power Supply, System Performance). Therefore UITP and UNIFE joined forces to support the commission in drafting a proposal for a directive on urban rail, which was the basis for the public consultation phase. This initiative has a direct relationship with LibeRTiN.

The proposed directive makes up an overall regulatory framework for technical harmonization which will be detailed partially by using the output of LibeRTiN working groups. Both initiatives are therefore complementary. For instance, the essential requirements of the draft Directive are based strongly on a proposal that was initiated and developed with the LibeRTiN consortium.

It was a strong feeling within the LibeRTiN group that the urban sector was, at the beginning of ERRAC (European Rail Research Advisory Council), a second priority for European rail research and only given limited scope within the SRRA (Strategic Rail Research Agenda). However, some of the key priorities for research (notably modularisation, research on materials, production functions, environmental aspects, intelligent mobility and safety) are exportable to the LRT domain. The linkages between these and ERRAC research priorities and the areas for further research proposed by LibeRTiN are pointed out clearly in the LibeRTiN master plan for future research (this is an internal report to the EC).

What has become very clear is that the implementation of a truly European internal market for light rail must be seen as a long-term process. LibeRTiN helped to start this, but further initiatives will be necessary.

It was the aim of this project to promote the harmonization process in the European light rail sector. Issues that have to be considered in this context are the diversity of light rail systems in the various European countries, different laws and national standards, new developments in the industry and the sometimes heavy rail predominant composition of CEN/CENELEC working groups.

Some final project-specific conclusions can be drawn:

The 10 LibeRTiN working groups which tried to achieve consensus on a European level were the main focus of the project, so how can the results be assessed, what goals of the project have been reached?

- The interest in LibeRTiN was not as high in France or Germany as in other countries, especially in the UK, Spain, Italy, Norway, etc. It seems to be a structural problem that in those countries with more know-how and numerous systems the interest in harmonization on a European level was rather limited. In these countries, LibeRTiN was often seen as an additional burden following the motto, “yet another European initiative which will only mean additional work.” It is obvious that the added value of a project like LibeRTiN is higher for countries which do not have a great deal of experience in light rail, and that the countries having more experience do not regard highly the possibility to promote this experience throughout Europe. However, this possibility is seen more and more as an opportunity in the increasing competition in the sector, as it allows competitors to influence the regulations in their own interest. In the last phase of the project, several European operators became very active in the different LibeRTiN WGs.

- Not all WGs could deliver tangible results when measured against the goals of the project. However, this is not very surprising when considering the complexity and fragmentation of the market. LibeRTiN could not change old habits in all cases, but could at least begin to identify problem areas over a range of topics.

- Other LibeRTiN topic groups (fire safety, gauging) provided input to the existing CEN/CENELEC WGs to ensure that light rail will be adequately taken into account. This somewhat sped up the CEN-process and while it does not sound spectacular, it was a necessary and worthwhile activity.

- Especially the topic groups on access, derailment prevention and ride quality, loading parameters, and HVAC reached sensible and usable results.

- Other groups compiled recommendations. The group on the tendering process surely was the most disputed one. It is a fact that this group was UK dominant due to the fact that problems are most pressing in this country. However, the mere existence of LibeRTiN facilitated progress in the UK, which is also in the spirit of European harmonization, and interesting proposals have been achieved. It has to be accepted that this topic is only at the beginning of the “road to European consensus” and it remains to be seen which common goals can be reached.

- One of the major achievements by LibeRTiN is that experts from operators and manufacturers joined discussions on all 10 topics; issues were discussed without focusing on different interests (as far as this was possible). At the beginning of the project, the industry was still very skeptical and dealing with its own problems; however a large part of the manufacturing industry was eventually convinced that a participation in LibeRTiN was also in its own interest.

- One issue which was clearly underestimated at the start of the project was the language barrier. Where non-native speakers were asked to contribute to discussions on complex technical issues experts were understandably somewhat reluctant to participate, possibly because some technical vocabulary was not available. This problem increased when native speakers were leading such workshops. Possibilities to reduce such problems should be assessed for any future project.

Thanks to the personal involvement of most experts, the results of 30 months of the LibeRTiN project have clearly yielded positive and far-reaching outcomes, despite the challenges that were encountered.

ACCESSIBILITY

Fare, Ticketing, and Information Systems in Singapore

Providing Accessibility to All

BOON LENG GOH
Land Transport Authority

INTRODUCTION

Singapore Mass Rapid Transit (SMRT) had been using a magnetic ticketing system when the mass rapid transit (MRT) line was first implemented in the late 1990s. Subsequently, buses were revamped to add on with the magnetic ticketing system to form an integrated ticketing system in Singapore. Commuters can transfer between train and buses using a single ticket while achieving cost saving through transfer rebate.

In 2002, after 3 years of development, the Land Transport Authority (LTA) rolled out the Enhanced Integrated Fare System (EIFS) or ez-link as it is popularly known. EIFS cost S\$300 million to build and aims to provide an efficient and accessible ticketing system to the public transport users in Singapore.

EIFS replaces the magnetic ticket with a contactless smart card (CSC). This was introduced in the bus, MRT, and light rapid transit (LRT) systems simultaneously. It significantly changed the way Singaporeans pay for fares, in particular for buses.

The objective of my presentation today is to share Singapore experience in providing a convenient and accessible fare collection and ticketing system for all.

The accessibility of the Singapore fare and ticketing system can be demonstrated in the following areas:

- Benefits of EIFS over magnetic ticketing system,
- System equipment overview,
- Benefits to commuters,
- Nontransit application,
- Meeting future challenges, and
- Integrating private and public transport to form a common payment platform.

BENEFITS OF EIFS OVER MAGNETIC TICKETING SYSTEM

Prior to April 2002, commuters used magnetic ticket (known as farecards) as the ticketing medium to travel between buses and MRT. The magnetic ticketing system, however, has the following limitations:

- Gate throughput is relatively low, generally between the speed of 20–25 passengers/min;
- Top-up of tickets is allowed at limited MRT stations and bus interchanges via the ticket

sales office (TSO);

- Ticket is easily corrupted by magnetic fields; and
- Due to its limitation in security and memory, magnetic media cannot be extended to non-transit use.

EIFS on the other hand provides more flexibility by using a CSC as the ticket medium. It facilitates faster travel by allowing commuters to process through the gates at a higher speed. It provides seamless travel between transit systems of different operators, commuters do not need to exit from one MRT line to travel to other line. Transfer between bus and rail was made easy using the ez-link card.

With the higher security and flexibility of the ez-link card, top up is made available in an extensive network across the island through ticketing machines and sales offices. New top-up facilities have been expanded to retail outlets such as 7-Eleven convenience stores, McDonald's, and auto top up system using credit card. The extensive card services network is demonstrated by the drop in the single trip ticket usage from 12% to 4% of the total daily transit trips.

As CSC uses an electronic chip to store ticketing information and purse value, the corruption rate of tickets is lower than magnetic tickets.

In a survey of commuters, 75% of the one thousand respondents found paying fares by ez-link effective.

EIFS SYSTEM EQUIPMENT

System Overview

EIFS architecture comprises 5 tiers linked through the network, the highest being the card manager, where daily transactions generated by the buses, rail, and non-transit systems are uploaded, cleared, settled, and apportioned. The card manager is responsible for the issuance of ez-link cards and the float of the card is held by the appointed issuer bank, Citibank.

Tier 4 consists of the bus and rail acquirers. The acquirers are responsible to acquire transactions generated from its respective service providers and ensure that they are uploaded to the card manager. It distributes relevant configuration information from the card manager to the respective lower tier systems.

Tier 3 is the service provider tier, where both rail and bus operator central servers are located. These servers allow the bus and rail operators to manage their operation by controlling, monitoring and configuring the system. It uploads transactions generated by the devices in Tier 1 and downloads configuration information from the upper tiers.

The bus depot computers and rail station computers are located in Tier 2. This tier sub-distributes the operation to a smaller entity such as station or depot level for ease of monitoring and control.

Tier 1 consists of devices that interface with the public; these include automatic gates, ticketing machines, bus processors and sales machines. The devices will ensure cards are processed according to its business rules and transactions are uploaded. This is the tier that directly interacts with the commuter and is greatly enhanced in EIFS to serve the public.

Bus System

One of the benefits of the bus system is that commuters need not remember the fare to be paid. During boarding, the commuter flashes the ez-link card on the bus entry processor (BEP) near the front door of the bus and the processor will register the entry stop. On alighting, he flashes the ez-link card on the bus exit processor at the rear and fare will be calculated and deducted from the card. To better serve the commuter, BEP can also be used as the exit processor, hence commuters can exit from the front door when the bus is full of passengers. Commuters can choose to pay cash if they prefer but at a higher fare to discourage cash payment.

The bus system uses state-of-the-art technology in tracking bus position for determining fare. The system is known as vehicle location system (VLS). The VLS makes use of both distance tracking and the Global Positioning System (GPS) to determine the position of the buses along the routes; it then updates the bus stops counter which is used for fare calculation. This eliminates the need for bus captains (drivers) to upstage the bus stop counters; consequently, they can concentrate on driving and on providing a better service.

BEP allows auto top-up of the ez-link card, which is linked to the user's bank account. When the value of the card is zero or less, the BEP automatically tops up the card with preset value.

The BEP allows faster and easier boarding of buses, thus reducing waiting time for commuters.

General Ticketing Machine

More than 400 general ticketing machines (GTM) are being deployed in the rail networks. GTM is a multifunction machine with objectives to provide accessible top-up points and other services to the commuter throughout the transit system. Following are the main features of the GTM:

1. Standard ticket mode—For purchase of single or multiple trips ticket. Commuters using single trip ticket will have to pay for a deposit, which is refundable through the machine at the end of the trip. This mode also allows top-up of new trips on the ticket.

2. Integrated mode—In addition to the standard ticket mode feature, it allows the purchase and top-up of loyalty tickets, commonly known as store value tickets. The integrated mode facilitates easy and auto top-up, such as enabling or disabling and amending of the easy or auto top-up feature on the card.

3. Exit mode—For remote farelines and LRT stations that are unmanned, there is a need to allow commuters to upgrade problem tickets or to purchase exit tickets for lost tickets. GTM provides such a service in exit mode. In such case, GTM is positioned between the free and paid area with a swing gate that can switch between integrated and exit mode. A call button is also provided for the commuter to seek help.

Customer Service Machine

A customer service machine (CSM) is located in the Transitlink TSO and supplements the ticketing machine. It is a manned machine used to issue loyalty tickets, sell concession tickets, add value to ez-link cards, analyze tickets, and refund tickets. It also provides additional services such as selling of the Transitlink guide (a bus and rail guide), phone card, etc.

The CSM serves commuters who require manual services such as refund of cards and purchase of concession cards. It also serves commuters who are less literate or are uncomfortable to interface with machine.

Passenger Service Machine

A passenger service machine (PSM) is located in the station control room. It provides the same service as the CSM except that it serves both the paid and free sides of the fareline, thus allowing commuters to upgrade problem tickets. The PSM interacts with the commuter through voice announcement on the transactions performed and visual display of card information on the passenger display unit.

In addition to card services, PSM performs control and monitoring of AFC devices in the station.

Fare Gates

The main function of the gate is to validate, calculate, and deduct the appropriate fare for the journey. It allows fast and efficient processing of the ticket for commuters to enter and exit the transit system. One major validation is the check for blacklisted cards. Upon detection of a blacklisted card, the gate will follow the action table to determine if the card will be blocked from further usage.

Wide gate is provided in all transit stations for handicapped commuters or commuters with luggage, stroller, or trolley. The wide gate has a wide passage of 1,200 mm to accommodate huge luggage, wheel chairs, strollers, and trolleys.

BENEFIT TO COMMUTERS

Integrated Fare System

The public transport in Singapore is built with one integrated fare structure. The integrated fare has benefited commuters by providing flexibility and easy accessibility to the system in the following areas:

- Provides a common stored value ticket with distance related fares which allow different rates to be set for various services and modes.
- Singapore transit network comprises the East–West Line, the North–South Line, and the Bukit Panjang LRT operated by SMRT; and the North–East line, the Punggol LRT, and the Sengkang LRT operated by SBS Transit. Commuters have the convenient to transfer between the transit system run by the two operators without having to exit and re-enter the system. Fares collected are apportioned between the two operators in the back end without any inconvenience to the commuters and is completely transparent to them.
 - Transfer rebates are given between services and modes so that network rationalization does not unduly penalize commuters when they travel in the same direction, within the same journey.
 - Once a commuter commences a journey, he should be allowed to complete the

journey even though he has insufficient value on the card as long as he commences with a positive value.

- Allows for concession travel for certain groups such as students, senior citizens, and National Service men and specifically allows for seasonal passes to be incorporated on the same stored value card for convenience, and to reduce cost.
- Easily understood by the complete spectrum of the population, i.e., user-friendly even to the less literate. Most importantly, the remaining value can be easily read at MRT gates, bus validators and ticket machines, which in addition provide a log of the last 20 transactions.
- Provides full security by ensuring all tickets are recorded and tracked online by a back end system so that all transactions are fully accounted and fraudulent activities easily detected. Blacklist is activated within 24 h. Hence the commuter is fully assured of system integrity.
- Continues to allow for cash payment.

Multipurpose

Beyond public transport, ez-link would enable commuters to pay not just transport fares, but other goods and services, too. So the system's architecture had catered for micropayment applications to enable commuters to pay for other non-transit services such as payment for movie tickets, payphones, and security access.

Scalability

To cope with the expanding rail network, the system would offer scalability. The magnetic card system has a limitation on number of fare stages and memory space can only take 4 million transactions a day as compared to 12 million transactions a day using the EIFS. It also allows for much smaller fare increments as compared to the magnetic system (1c versus 5c) so that fare increases can be more gradual.

Lower Ticket Corruption Rate

The CSC is more reliable and durable than the magnetic farecard, with a failure rate of one in 200,000 as compared to one in 5,000 for magnetic farecards. The recurring overall cost of card replacement is substantially reduced, resulting in reduction in maintenance cost, and inconvenience caused by frequent replacement in the case of magnetic cards.

Unlike the old magnetic ticket validators, which are subject to frequent wear and tear of mechanical moving parts in the automatic gate, the CSC readers only have static parts. Correspondingly, commuters do not need to replace the card frequently due to wear and tear.

Better Efficiency

The system uses GPS to automatically update the fare stage, which enables accurate fare deduction on alighting. In addition, drivers can better concentrate on driving, enhancing safety for bus passengers.

Manual counting of bus commuters by surveys has given way to automatic extraction of data from the EIFS system. Operators need not spend additional manpower on data collection.

With the CSC system, bus commuters do not need to know the exact fare for each trip with entry/exit processing. It has also resulted in significant fare leakage savings for bus operators.

The EIFS provides greater flexibility in setting fares and benefits the commuters in fare adjustment.

Faster Boarding and Alighting Time on Trains and Buses

The time taken for passengers to board a bus has been halved. If passengers use cash and magnetic farecards to board a bus, the number of people who can board the bus in 1 min will be 12 and 15 respectively. In contrast, 30 persons can board a bus in 1 min if the ez-link card is used. Hence dwell time at bus stops is also reduced by faster entry and exit of commuters.

As for the transit system, for every 25 persons using the magnetic farecards to enter the fare gates, 50 persons can do so using the ez-link card. The benefits are fairly obvious in the bigger stations during peak periods.

Extensive Top-Up

The widespread availability of top-up points was one of the key benefits in the SMRT network. Self-service top-up facilities using either cash or a bank card have been provided at about 400 machines located in the transit stations throughout the network and are available 18 h daily.

There are also sales offices which sell, top-up, and handle problem cards.

Auto top-ups of cards are also provided by linking to either the bank account or credit card. One of the unique features of the auto top-up is the ability to link the ez-link card to the holder's bank account at the ticketing machine electronically almost instantaneously, thereby eliminating the lengthy manual application process.

The auto top-up feature is useful, especially for student where their ez-link card can be linked to the parent's bank account for automatic top-up at gates and buses. In spite of its convenience and with more than 90% of Singapore adults holding bank cards, auto top-ups only accounted for 3% of the total top-up population.

Data Mining Capability for Strategic Planning

EIFS' capability and capacity to capture the transactions made through the system has given the LTA a comprehensive database to tap on for strategic planning, route planning, and target setting so as to improve public transport services. For instance, through the data collected from EIFS, we are able to track and improve the traveling time spent on public transport by monitoring the percentage of journeys completed in less than 45 min.

A separate data warehouse was developed to fully exploit the data extracted from the EIFS system and is well utilized by planning and regulatory departments within LTA.

NONTRANSIT APPLICATIONS

The ez-link card was developed in line with the government's vision for Singapore to have more cashless transactions. Beyond payments for transport, the ez-link card can be used in a diverse range

of applications and systems.

To meet these objectives, LTA set up a wholly owned subsidiary, ez-link Pte Ltd., to oversee the sale and distribution and manage the ez-link cards for public transport travel and other commercial purposes. The subsidiary subsequently signed an agreement with a payment services provider to proliferate the use of the card as a multipurpose stored value card.

The various non-transit applications that have been developed and implemented using the ez-link card are:

- Student identity cards in schools;
- Access control—office access management system and hotel room access keys;
- Cashless payment in food chains (e.g., McDonald's) and school canteens;
- Attendance tracking;
- Buying of movie tickets;
- Payment of fines in libraries;
- Resource booking in schools; and
- Corporate ID security access.

MEETING FUTURE CHALLENGES

In every system, there will be shortfalls and areas for improvement; we are looking in the following areas of improvement.

Cost of Cards

The initial choice of cards was influenced by reliability and high performance in the transit environment even though it was proprietary and relatively costly. This decision has been justified by the hassle-free experience for the commuter over the past 3 years. However, as the commuter only made a small refundable deposit for the card, the card base grew rapidly to 7 million even though the regular users were about 2 million.

Obviously, many commuters were just buying multiple cards and this arrangement could not be sustained, without significant losses being sustained by the card manager. Hence it was decided in 2003 to charge the commuter the nonrefundable cost of the card, which initially drew strong reaction from the public. It was gradually recognized that the commuter ultimately bears the cost of the card directly or indirectly through transaction fees. Monthly card sales reduced to more realistic level after the full card costs were charged.

In response to public demand for lower cost cards, development work was undertaken to introduce other card types, in particular the Type B cards, which will be reflected in lower cost and more beneficial features for the user. In a small but significant step, in 2003, Singapore became the first country in the world to accept both low-cost Type B cards for single trips and Type C cards in transit.

Further, LTA together with other interested government bodies in Singapore have developed standards for an open system for payment with contactless cards (based on Type B standards). This would allow entry of other card issuers with minimal technical barriers. As a result, the public will have more choice of card issuers offering differing benefits. The EIFS system is currently being reengineered to accept open standard and a multiple card issuers environment.

The Alternative to Cash

With the exception of a few killer applications, the acceptance of stored value cards for payments is currently low, which is in line with global experience. Further, ez-link is one of the few systems in the world where the bank is the issuer for a predominantly transport card and consequently subject to stringent regulatory requirements. These require the introduction of highly secure tamper-resistant payment terminals, stringent key management, and enhanced system security.

On the positive note, the ez-link card will have the distinct advantage of not being limited to micropayment but extended to general payment as well. So the additional investment will be justified if the ez-link card is successful in penetrating about 30% of the cash payment transactions volume currently estimated at US\$12 billion.

While this may seem a daunting task, the recent success of the contact stored value card (cashcard) used for the payment of car park charges proves that it is not difficult to change the public mindset provided there are sufficient benefits in the alternative payment method. The car park and road pricing transactions using the contact cashcard are currently half that of public transport using the ez-link card but expected to exceed it within 4 years.

INTEGRATE PUBLIC AND PRIVATE TRANSPORT TO FORM A COMMON PAYMENT PLATFORM

The potential of CSC is overwhelming and its capability to extend into the private transportation system is being explored by LTA. One of the areas that could benefit all is to extend the system to collect toll for private vehicles.

The current in-vehicle units (IU) in cars used for electronic road pricing and car parks (which are also supplied by LTA) can only accept a bank-issued contact card (the card manager is known as NETS). This card is essentially proprietary, with very limited intelligence, security, and consequently with very high reliance on fixed gantries for processing. The contact technology offered by banks is also dated. Hence, from both card and terminal viewpoint, the current system is due for replacement.

LTA is developing a new IU for electronic road pricing which will be intelligent and secure and with open standards. It offers the following benefits:

- Wider choice of card suppliers and consequently card issuers specifically for Type B contactless cards;
- The IU in taxis can be used for acceptance of payment by passengers with the appropriate card so no additional payment terminals are required;
- Reduces reliance on gantries (the contactless solution requires less processing at the gantries);
- Allows an easier upgrade path to gantry—less GPS-based electronic road pricing systems;
- The IU software is programmable and upgradeable which will allow changes to be made by LTA without dependence on external parties;
- Allows for grace period if card is not inserted;
- Automated deduction of fines and charges;

- Will progressively eliminate contact card interface—as a result, IU construction will be cheaper and simpler; and
- Allows auto top-up (such as credit card or GIRO) feature—the motorist will be relieved of the need to be concerned about insufficient value on the card.

So essentially we will provide a common reader/terminal platform for public transport, cars, taxis, and retail payments. Consequently by 2008, we will effectively open an US\$3 billion market for cashless payments (including public transport, road pricing, carparks, and taxis) initially with two issuers, ez-link and NETS. The ensuing competition should provide the impetus for a more pervasive cashless environment in Singapore, which benefits both commuters and service providers.

ACCESSIBILITY

Creating Accessibility Without Low-Floor Technology**JEFF LAMORA***Utah Transit Authority***UTA SERVICE BACKGROUND**

The Utah Transit Authority (UTA) is a multimodal transit agency in the Salt Lake City metropolitan area known as the Wasatch Front. UTA provides service 7 days a week to five counties along the Wasatch Front and has a service area of approximately 1,400 mi² (3,626 km²). UTA currently provides bus, light rail, paratransit, and van pool service for approximately 120,000 passengers per weekday. UTA is also in the construction phase of a 43-mi (69-km) commuter rail system that will extend from Salt Lake City to the north.

UTA opened the TRAX light rail line in December of 1999 with the construction of the 17-mi (27.3-km) North–South line that extends from downtown Salt Lake City to the south to Sandy, Utah. In 2001, UTA opened the 2.5-mi (4-km) University Line that extends from downtown Salt Lake east to the University of Utah. Then in 2003, the 1.3-mi (2.1-km) Medical Center extension was constructed through the University of Utah to the university’s hospital and medical facilities. The system has greatly exceeded projections and the success continues today as ridership increases and light rail has become a staple of the community.

The TRAX system consists of 24 stations, four of which are shared between the North–South and University lines in the downtown area. Eleven of the suburban stations have designated park-and-ride facilities. There are more than 4,000 parking stalls at the 11 park-and-ride lots. Parking is free at park-and-ride lots along the North–South line (payment is required at one shared park-and-ride facility on the University Line). There is also space at each park-and-ride lot for drop-off passengers as well as bus transfers. Statistics have shown that nearly all of the park-and-ride lots are at or are over capacity on the average weekday. This includes parking for the general public as well as parking for disabled passengers.

TRAX provides service 7 days a week. Monday through Thursday service begins at 5:30 a.m. and ends at midnight. Service for Friday and Saturday begins at 5:30 a.m. and extends to 2:00 a.m. Sunday service is provided from 9:30 a.m. to 9:30 p.m. The TRAX designated corridor portion is a shared track with freight service at night, when transit service is not running.

In design of the system, UTA chose not to pursue the design of low-floor vehicles but rather to purchase high-floor SD100 vehicles from Siemens.

UTA currently has 23 SD100 vehicles, 17 Siemens SD160 vehicles, and 11 Urban Transportation Development Corporation (UTDC) vehicles in service, for a total of 51 vehicles.

UTA has designed a system of accessibility for disabled passengers at stations and park-and-ride lots that has proven to be quite successful. The system includes the design of access ramps on station platforms, wheelchair-friendly park-and-ride lots and stations, and the adaptation of vehicles that were not formerly compatible to UTA’s accessibility system. UTA has also worked with the local disabled community to gather input and give them an opportunity to make suggestions for changes to components of the system that may need improvement. The

result has been a light rail system that is not only 100% accessible and compliant with the Americans with Disabilities Act (ADA), but also has been very successful and popular with the disabled community in Salt Lake City.

Table 1 shows how the number of access ramp passengers has increased as TRAX has grown over time. This is not only a result of expansion of the light rail system, but is also clearly a product of good customer service and implementation of a proven system of accessibility.

PLANNING OF THE SYSTEM

In order to meet federal requirements for the U.S. Department of Transportation and FTA, and to be in compliance with the ADA guidelines, UTA must make all components of the system accessible and inclusive for those individuals with disabilities. The options for providing such accessibility were widespread and several issues had to be considered. UTA invited the disabled community to provide input and to help determine the type of system to use. Other light rail systems from around the country were examined and considered prior to making a decision.

Other options that were under consideration at the time of design include the use of vehicle lifts similar to those used by San Diego Trolley and similar to UTA buses. There was a comfort in the disabled community with the familiarity of the lifts. The concern was that the amount of time to use a lift would potentially delay the system, particularly if there were multiple people using the lift at one station. Also, the potential for failure is higher as Salt Lake City's climate varies greatly from day to night and from season to season.

A second option was to provide lifts on the station platforms that would bring disabled passengers to the floor height. This method was more costly and climate was again a factor in choosing not to use a lift.

The design and purchase of low-floor cars was also an option, but the cost was too high. The number of vehicles procured or other components of the system would have been compromised for the purchase of the low-floor vehicles and the decision was made to purchase traditional high-floor vehicles.

Ultimately, UTA chose the system of access ramps on station platforms and manual bridgeplates on the vehicles. The disabled community in Salt Lake was in agreement with this choice. The system was simple, easy to use, and also cost effective.

TABLE 1 UTA Access Ramp Boardings

Year	Wheelchair Boardings	Other Access Ramp Boardings	Total Access Ramp Passengers
2000	9,034	8,315	17,349
2001	12,709	10,909	23,618
2002	21,238	18,161	39,399
2003	24,338	22,447	46,785
2004	25,418	20,514	45,932
2005*	26,939	25,011	51,951

* Denotes projection based on data through September 2005 and past trends.

UTA's Cooperation with the Disabled Community

UTA has been very active in working with the disabled community to ensure that the TRAX system is one that is inclusive. In addition to getting feedback from the disabled community prior to service, UTA has created a citizens advisory group known as the Committee on Accessible Transportation (CAT). The purpose of CAT is to give the public disabled community an opportunity to advise UTA on accessibility issues that deal with facilities, equipment, service, plans, and programs to assure nondiscrimination of qualified people with disabilities. Meetings are held at least once per month, where individuals have the opportunity to make suggestions and give input to UTA.

A number of changes have taken place as a result of the CATs suggestions. Additional and better signage on access ramps for TRAX, and the design and construction of shelters on access ramps on the North–South Line are two examples. The CAT is also given the opportunity to review the design of any new projects and provide input that would make the design more functional for disabled passengers. This gives the disabled community the opportunity to suggest changes to components that may not be ideal, and also gives UTA the opportunity to be more sensitive to their needs.

ACCESSIBILITY ELEMENTS

Current System

Currently, all disabled passengers are required to complete an eligibility process with UTA in order to receive an eligibility card. This card gives the individual the right to use UTA's services for disabled passengers, including the access ramps at TRAX station platforms.

All 11 of UTA's park-and-ride facilities were designed to conform to ADA standards. Design features within each park-and-ride lot include curb-cuts at transition points from parking lot to sidewalk and extra-wide sidewalk width at bus transfer points and at many locations where there is accessible parking.

UTA has met or even exceeded the minimum required number of accessible stalls and van-accessible stalls at each park-and-ride lot. In one case, the number of accessible stalls was increased to provide adequate parking for the increased demand at that lot. Sidewalks throughout all of the park-and-ride lots meet all ADA width and grade requirements. For lots that are large, UTA has also included signs directing individuals to the designated accessible parking area, where designated parking is not obvious upon entering.

In all locations, parking for disabled persons is provided in a location that is quickly and easily accessible to and from each station. Access is provided with extra-wide sidewalks to station entrances and at-grade paneled crossings from the parking lot to the station platform.

Access Ramps

With the use of high-floor cars, UTA needed an ADA approved way to get passengers to the floor level of the vehicles without the use of stairs. UTA accomplished this by designing a system with access ramps at each TRAX station platform. UTA's entire fleet of light rail vehicles has stairs at all doors and would not be accessible to disabled passengers without the use of a ramp.

UTA designed a system of access ramps on station platforms to quickly and efficiently load and unload persons with disabilities. This has worked well in getting wheelchairs to the height of seating within the vehicle without waiting for a mechanical lift, and without the use of low-floor vehicles. [Figure 1](#) shows a disabled passenger waiting for an approaching train on an access ramp at a downtown Salt Lake City station.

There is one access ramp located on each end of the platform, providing access to the first door of the train in each direction. For example, the access ramp for the northbound North–South train is provided on the north end of the platform to access the first door of the operating end of the train. The southbound access ramp is conversely located on the south end of the platform. This provides quick and easy access to the access ramp from parking areas as well as bus bays. With only a few exceptions, station fencing forces passengers to access the station from the crossings on ends of the platform. This provides a controlled, safe, and ADA-compliant way to station access ramps for all passengers.

All of UTA’s access ramps meet the ADA standards for grade, width, and turning radius. Because of the variability of climate in Salt Lake City, all of the ramps are made of concrete and have heating coils embedded in the surface to ensure adequate traction in cold weather months. Additionally, all ramps at all of the stations have shelters with tinted glass to help protect individuals waiting for the train from precipitation, wind, and the heat of the sun in warm weather months.



FIGURE 1 A disabled passenger waits for an approaching train at an access ramp.

Ramps are designed to meet all ADA standards and are at least 36 in. (914 mm) in width. Some of the ramps have a landing that is 48 in. (1219 mm), and a switchback with a flat surface that is halfway to the top of the ramp. The grade of the ramp is no steeper than 1 ft vertically (0.31 m) for every 12 ft horizontally (3.66 m). At the top of the ramp there is a covered, flat surface waiting area. The area is large enough (approximately 13 ft x 5 ft 8 in. or 4 m x 1.75 m) so that individuals are able to pass one another and move aside while other passengers are boarding and alighting the train.

There is an opening at the top of the ramp that is about 7 ft in width. Tactile stripping and a yellow line are provided at the edge of the opening for further awareness, and individuals are audibly reminded to stay behind the yellow line while waiting for the arrival of the train. Signage on the ramps provides a reminder that ramps are for disabled passengers only. They are positioned at a height that is easily viewed by a person walking up the ramp or seated in a wheelchair.

At stations that are end-of-line destinations, there is the need for a double-access ramp to allow trains to enter and exit on either side of the platform. At these locations, a mirror image access ramp is provided at both ends of the station for accessibility in all directions. Space is left between the access ramps or crossings are located next to the ramps to provide passengers with access to the stations' exit and entrance.

UTA's stations are approximately 400 ft (122 m) in length, which is long enough to accommodate a four-car train. With the use of longer platforms, stations are less impacted by the addition of the access ramp on the platform. The access ramp does not block the use of any door. This means, there is more platform space provided for persons boarding and alighting at all doors of the train.

Vehicle Description

The 40 Siemens vehicles have eight doors, four on each side. UTA currently uses a system of bridgeplates that are located on both operating ends of each vehicle. There is one bridgeplate for each door on both ends of the vehicle for a total of four per car. The 11 UTDC vehicles are being upgraded with the identical accessibility system as the Siemens vehicles.

At times when any particular end of any vehicle is not the operating end of the train, the bridgeplates are folded up against the stairwell wall and locked into place. They are then out of the way of passengers using the stairs. That door then operates as any other door on the train and the stairwell is open for passengers to use for boarding and alighting the train. [Figure 2](#) shows the bridgeplate folded up and locked in the up position, allowing passengers to use the door by ascending the stairs. This is important to operations because all vehicles are able to travel in any direction, at any point in a train-set without compromising the use of any of the doors.

On the end of the vehicle or train that is currently being operated, the bridgeplates are placed in a down position. There is a spring hinge on the bridgeplate that allows it to be unfolded and locked in the down position. This covers the stairwell and the activation of an electrical circuit takes that door out of service to passengers that use the stairs.

The bridgeplate on the opposite side of the train is also in the down and locked position to ensure persons do not fall down into the stairwell on the other side. This also provides additional space in the front of the train for maneuvering of wheelchairs or a waiting area while on the train.



FIGURE 2 Passengers board a train at a door where the access ramp is not being used and the bridgeplate is locked in the up position.

Additional space is provided in the first set of seats, which fold up allowing wheelchairs to ride. This space provides a secure designated seating area within the train for those using the access ramp. There is enough space at the end of the train for at least six small wheelchairs.

From the cab of the train, the operator can provide access to all doors except those with the bridgeplate down. When there is a need to alight a passenger using the access ramp, the operator pushes an “Access Left” or “Access Right” button to open the door where the bridgeplate has been placed in the down position. The operator then exits the cab and manually unfolds the bridgeplate onto the access ramp. This provides access from the inside of the vehicle to the top of the access ramp. The disabled passenger travels down the ramp to the surface of the station platform where he or she can either transfer to another train, or exit the station.

When picking a person up from the access ramp, the operator will perform that same process to allow them onto the train. They will exit the cab, place the bridgeplate in the down position, allow them to enter the train and be seated, or place their wheelchair in one of the designated wheelchair areas in the first set of seats. The operator then asks the individual at which stop they are going to alight. If the passenger does not or cannot convey their desired stop to the operator, there is an “ADA Request” button in the ADA seating area that can be pushed by the individual to alert the operator of the desired stop. Inside the cab there is a light that

illuminates, labeled “ADA Request,” to remind or alert the operator of the requested stop.

The amount of time that is typically required for the operator to exit the cab, place the bridgeplate in the down position, and allow the individual to enter or exit the train is approximately 30 s. This is the approximate desired time for a typical stop, so there is usually little to no delay to scheduled time points. Delays can happen if an individual has difficulty maneuvering within the train or if there are multiple wheelchairs getting on or off.

Figure 3 shows the use of the manual bridgeplate by the operator. The customer simply walks into the vehicle and the bridgeplate is retracted into a vertical position. The yellow “Stop Request” button can also be seen in this picture on the vertical handrail. When the button is pushed, the operator is alerted to the stop request by the illumination of a light on the dashboard.



FIGURE 3 An operator lowers the bridgeplate to allow access for a disabled passenger to the vehicle.

UTDC Vehicle Upgrade

In 2002 and 2003, UTA received 29 used vehicles from the Santa Clara Valley Transportation Authority (VTA) in San Jose, California. VTA was purchasing a fleet of low-floor vehicles and UTA took the opportunity to expand their fleet faster than otherwise possible. Although the UTDC vehicles are compatible with the TRAX system in many ways, they need to be upgraded to function on the UTA system. One of the features that has been upgraded is the use of the access ramp. While in San José, the vehicles were accessed by a bridgeplate mechanism on the station rather than from the vehicle side as done at UTA. Therefore, UTA has designed and installed bridgeplates for the vehicles so they are compatible with the existing TRAX system. This upgrade has created a system that as far as the public is concerned is identical to those used on the Siemens vehicles. All of the TRAX system stops and vehicles function the same way. This helps to ensure that the public is comfortable with the UTDC vehicles, which is important for system consistency and reliability.

Potential Issues of Current System

The light rail system generally runs smoothly and has been well received by the disabled community in the Salt Lake Area. Like any system that can be used, there are potential issues that have been associated with the access ramps and bridgeplates.

The most common issue is that persons who do not have an eligibility card use the access ramp. This requires the operator to exit the cab and allow them on the train using the bridgeplate. In most cases, the operator simply explains UTA's policy or gives the passenger an information card and the individual exits the train using one of the doors with an open stairwell.

The most frequent violators of the access ramp are persons with strollers. UTA's policy with strollers is that they must be folded up and carried onto the train through a door with stairs. This helps to ensure there is enough space for individuals that need to use the access ramps. Passengers are sometimes frustrated with the policy until they fully understand that the system is in place to provide access to disabled passengers and that disabled passengers do not have any other options for boarding.

Another potential problem with the access ramp system is that when individuals are making a directional transfer from the North–South train to the University Line train or vice-versa, they are required to travel the length of the platform. While trains do wait for transfers, this can cause a delay to the system while waiting for passengers to change ends of the station. Transfer time is built into the schedule to limit problems for access ramp passengers, so this is rarely a problem for schedule and is more of an inconvenience for the disabled.

Operationally, the access ramps provide a consistent stopping point for operators. They are required to line up the front door of the train with the opening of the access ramp. UTA has found this procedure promotes consistency on the platform from train to train and from operator to operator. One negative of the access ramps is when there is a reverse running situation. Since there are double access ramps only at the end-of-line stations, operators must stop twice to board and alight disabled passengers, when reverse running.

For example, if a train is reverse running northbound on the southbound track, the access ramp is on the south end of the station platform. The train would typically pull forward to the north end of the platform for its station stop, but there is no access ramp on the north side of the station on the southbound track side of the platform. Therefore, trains must first stop at the near

end, or in this case, the south end access ramp to allow the disabled persons to board or alight the train. They must then pull forward to the north end of the station to allow the remaining passengers to board and alight. At stations that are close to grade crossings or intersections in the downtown area, the train hangs into the roadway while positioned at the access ramp. This has been shown to cause a slight delay to cars, but is not a safety issue as crossing gates remain down and traffic signals are delayed for cross streets. Fortunately, reverse running scenarios are rare and there are not disabled passengers at every station stop, so this generally is not a problem.

Finally, the issue of crowding creates another potential problem with the access ramp system. Because disabled passengers are limited to a single door of any one train, there are times when there are several wheelchairs on the train at one time. During these times, there may be a delay while passengers maneuver in and out of the train. Many times the operator is able to assist passengers by helping them on and off the train, thus limiting any delay that may occur. There have been occasions where there simply is not enough room for all of the access passengers in the designated seating area. This situation however is similar to a crowded train at any other door, and passengers are asked to wait for the next train. This type of delay is very rare as well and has the potential of occurring no matter what system of accessibility is in place.

The overwhelming majority of disabled passengers have no problems with the system. Typically when problems do occur, they are a result of inexperienced riders or passengers that have misunderstood policies. This has been shown to be true with all passengers, not just those passengers using the system of accessibility.

CONCLUSION

UTA has provided a simple, clear, and functional system of accessibility for the TRAX light rail system. By providing clear direction to areas of park-and-ride lots with signage, easy access from buses and parking areas to station platforms, and using a system of access ramps and bridgeplates, one hundred percent of UTA's TRAX system is accessible.

UTA has made a conscious effort to create a system of accessibility that is inclusive to the disabled public. By working with the disabled community with the creation of the CAT and responding to public requests, UTA is well thought of. Surveys, direct contact with the disabled community, and the increase in ridership have shown that there is general support of the TRAX system in Salt Lake City.

The results of such a system have produced a significant increase in the number of disabled passengers. While overall ridership has more than doubled from 2000 (6,120,665) to 2005 (12,300,000 projected, based on previous years' trends; the access ramp boardings have tripled from 17,350 to nearly 52,000). This is equivalent to approximately one access ramp passenger for each trip on both the North-South lines and the University Line in each direction. This shows that the disabled community has continued to gain confidence in the safety and reliability of the system provided.

Estimates have shown that as many as 95% of future light rail procurements will be low-floor vehicles. Although UTA may choose to follow this trend some day, the use of access ramps and bridgeplates has shown how successful this system can be without the use of low-floor technology. TRAX is an example of how the ADA requirements, good design, and good customer service result in an inclusive, successful, and accessible system.

RESOURCES

American Public Transportation Association. *2005 Public Transportation Fact Book*, 56th Edition, April 2005, pp. 88–89.

Americans with Disabilities Act Homepage. *United States Department of Justice, ADA Standards for Accessible Design*, <http://www.usdoj.gov/crt/ada/adahom1.htm>. Accessed November 3, 2005.

Utah Transit Authority Homepage. *Utah Transit Authority Paratransit Information*, <http://www.rideuta.com/paratransit/>. Accessed November 10, 2005.

ACCESSIBILITY

Trends in Light Rail Accessibility

THOMAS G. MATOFF
LTK Engineering Services

Trends in Light Rail Accessibility

Tom Matoff
LTK Engineering Services



A World of Applications & Opportunities



AMERICAN
PUBLIC
TRANSPORTATION
ASSOCIATION

Accessibility—Many Aspects:

Accessibility—Many Aspects:

- **Vehicle–Platform Interface**

Accessibility—Many Aspects:

- **Vehicle–Platform Interface**
- **Platform–Urban Environment Interface**

Accessibility—Many Aspects:

- **Vehicle–Platform Interface**
- **Platform–Urban Environment Interface**
- **Customer-Friendly Fare Collection**

Accessibility—Many Aspects:

- **Vehicle–Platform Interface**
- **Platform–Urban Environment Interface**
- **Customer-Friendly Fare Collection**
- **Transit Network Considerations**

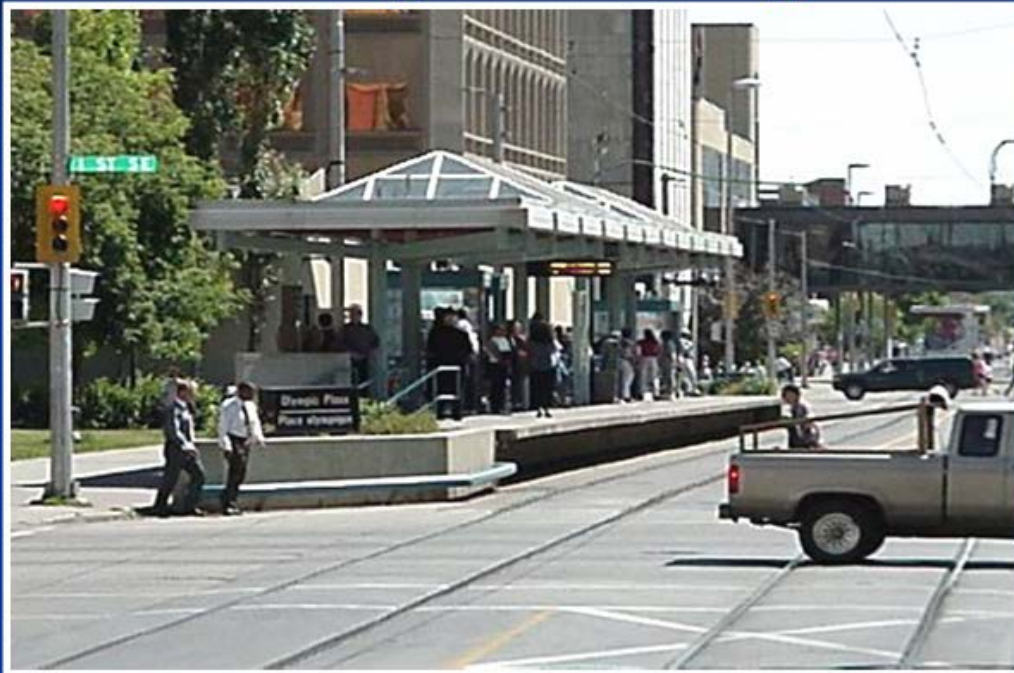
CALGARY: High Floor/High Platform



CALGARY: High Floor/High Platform



CALGARY: High Floor/High Platform



ST. LOUIS: High Floor/High Platform



ST. LOUIS: High Floor/High Platform



SAN DIEGO: High Floor/Low Platform



SAN DIEGO: High Floor/Low Platform



SALT LAKE: High Floor/Low Platform



SALT LAKE: High Floor/Low Platform



SALT LAKE: High Floor/Low Platform



DALLAS: High Floor/Low Platform



DALLAS: High Floor/Low Platform



DALLAS: High Floor/Low Platform



PORTLAND: Low Floor/Low Platform



PORTLAND: Low Floor/Low Platform



PORTLAND: Low Floor/Low Platform



PORTLAND: Low Floor/Low Platform



Light Rail System Access

LRV Floor/ Platform Levels	Car/Platform Interface	Station/Area Interface

Light Rail System Access

LRV Floor/ Platform Levels	Car/Platform Interface	Station/Area Interface
High Floor/ High Platform		
High Floor/ Low Platform		
Low Floor/ Low Platform		

Light Rail System Access

LRV Floor/ Platform Levels	Car/Platform Interface	Station/Area Interface
High/High	LEVEL	STAIRS, RAMP, or LIFT
High/Low		
Low/Low		

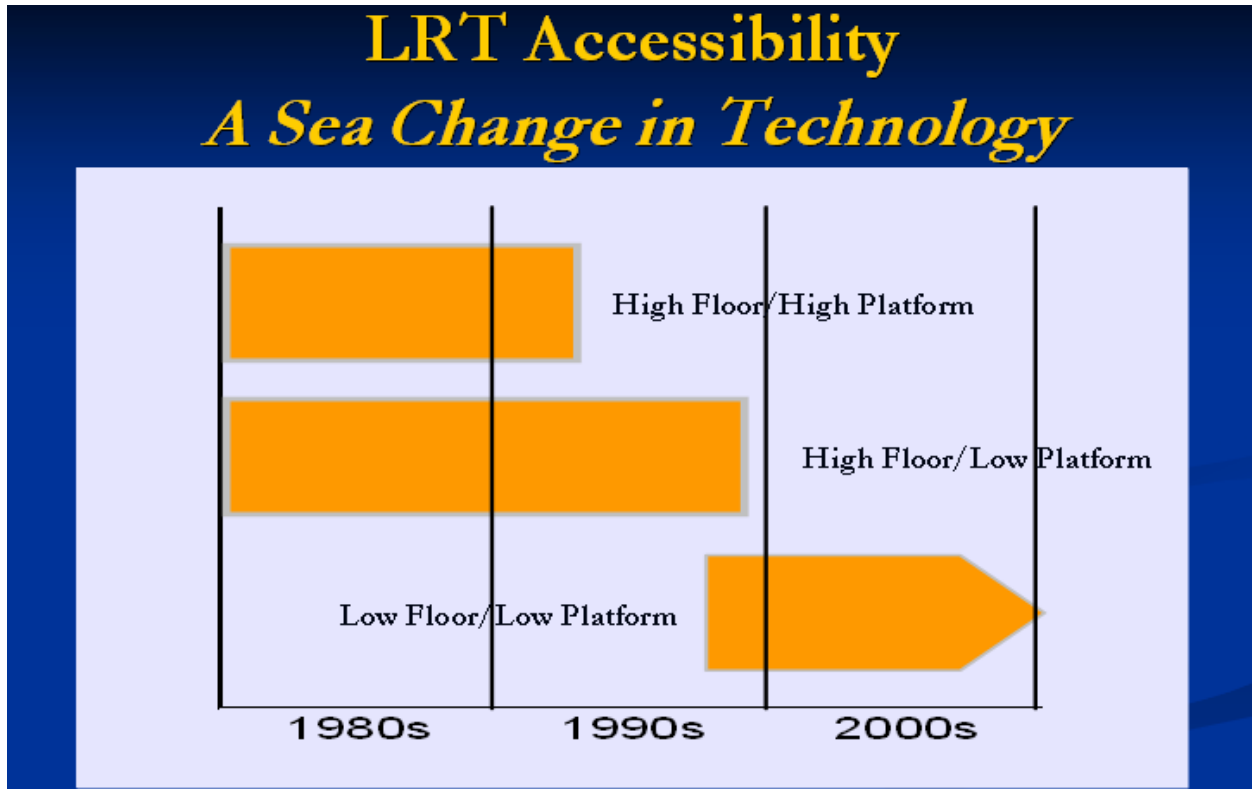
Light Rail System Access

LRV Floor/ Platform Levels	Car/Platform Interface	Station/Area Interface
High/High	LEVEL	STAIRS, RAMP, or LIFT
High/Low	LRV STEPS, RAMP, or LIFT	LEVEL
Low/Low		

Light Rail System Access

LRV Floor/ Platform Levels	Car/Platform Interface	Station/Area Interface
High/High	LEVEL	STAIRS, RAMP, or LIFT
High/Low	LRV STEPS, RAMP, or LIFT	LEVEL
Low/Low	LEVEL	LEVEL

What has been the trend
of accessibility design
policy?



New Start Accessibility Trends

Car/Platform	To 1980	1981–1990	1991–2000	2000 +
High/High	1	3	1	0
High/Low	—	4	4	0
Low/Low	—	0	1	5
Period	1	7	6	5
Convert	—	0	1	3
Total	1	8	14	19

New Start Accessibility—Trend Status

Car/Platform	As Built	Conversions	Total
High/High	5	0	5
High/Low	8	-4	4
Low/Low	6	+4	10

Approaches to Low-Floor Conversion

- San Jose: All-at-Once Conversion
 - Stations and fleet

Approaches to Low-Floor Conversion

- **San Jose: All-at-Once Conversion**
 - Stations and fleet
- **Portland:**
 - Convert all stations, fleet by increments

Approaches to Low-Floor Conversion

- **San Jose: All-at-Once Conversion**
 - Stations and fleet
- **Portland:**
 - Convert all stations, fleet by increments
- **San Diego:**
 - Convert one line's stations, fleet by increments

Approaches to Low-Floor Conversion

- **San Jose: All-at-Once Conversion**
 - Stations and fleet
- **Portland:**
 - Convert all stations, fleet by increments
- **San Diego:**
 - Convert one line's stations, fleet by increments
- **Dallas:**
 - Test fleet conversion/expansion
 - Full fleet and station conversion to follow

VTA Low-Floor LRV



VTA Low-Floor LRV



DART—New Center Unit



DART—New SLRV



DART SLRV—Center Unit



DART SLRV



**Remember—Accessibility
means more than
hardware and
infrastructure.....**

Accessibility—Don't Forget!

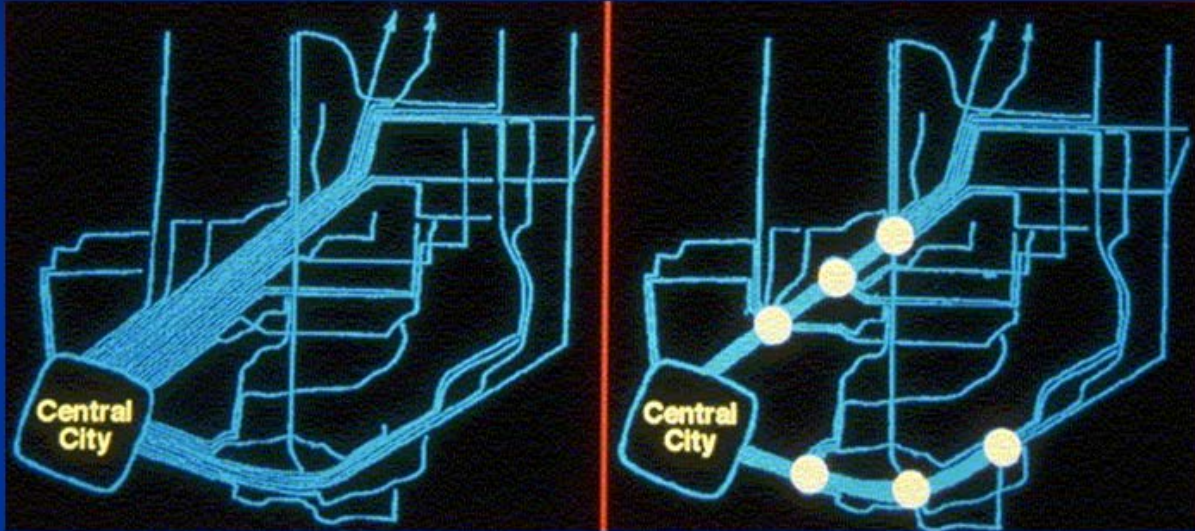
We are in the Barrier-Removal Business

- **Customer-Friendly Fare Collection**
- **Transit Network Considerations**

Customer-Friendly Fare Collection

- **Barrier-free**
- **Self-service, proof of payment**
- **Nearly universal in Western Europe**
- **Chosen for every new North American LRT and commuter rail system**

Northeast Sacramento with LRT *Multimodal, Multidestinational System*



Before—Radial Bus Lines

After—LRT/Bus Network

Convenient Transfers *Bern, Papiermühle*



Cross-Platform: Good



**Cross-Platform with
Low-Floor Trains and
Buses: Better!**



Streetcars

STREETCARS

Applying the Versatility of Streetcar Technology to North American Urban Transit

LYNDON HENRY

Capital Metropolitan Transportation Authority

This study examines emerging streetcar technology from the standpoint of best practices and versatility of deployment in Europe, Australia, and North America, and evaluates the potential for utilizing this mode more extensively, flexibly, and creatively in North American applications to enhance mobility and urban development. The cost of high-performance electric light rail transit, usually designed for higher-speed regional service, has climbed such that this mode is now often perceived as less accessible to the resources of smaller transit agencies or less suitable for some lower-traffic corridors. Streetcar technology, however—particularly the rapid streetcar concept—may offer some versatility in addressing these drawbacks, reducing the costs of new starts while providing higher levels of service than bus alternatives. Furthermore, streetcars may offer versatility for addressing the needs of cities to improve urban livability and fulfill urban redevelopment objectives. Prospects for the creative and versatile use of streetcar technology for meeting the needs of smaller urban areas and lower-traffic corridors for quality transit may be enhanced in the United States by the new Small Starts program for projects requiring less than \$75 million in federal funding.

INTRODUCTION

The cost of high-performance electric light rail transit (LRT), usually designed for higher-speed regional service, has climbed to such a point that this mode is now often perceived as less accessible to the resources of smaller transit agencies or less suitable for some lower-traffic corridors. As an earlier analysis by the present author has observed, “The relentless escalation of design features, infrastructural requirements, and project costs for new-start light rail transit ... systems has been a matter of increasing concern to transportation professionals and decision-makers pursuing viable public transport options for North American cities” [L. Henry, *Rapid Streetcar: Rescaling Design and Cost for More Affordable Light Rail Transit* (presented at APTA 2004 Rail Transit Conference, Miami, Fla., June 2004)].

Citing an alarming jump in LRT unit costs, Richard D. Pilgrim of URS/BRW, Inc., in his paper, *Are We Pricing Light Rail Transit Systems Out of Range?* (presented at the 8th Joint Conference on Light Rail Transit in Dallas, Texas, November 2000), noted that planners considering New Start alternatives routinely were relying on these relentlessly escalating cost data from other cities to estimate costs in their own studies. This led him to warn that “conclusions of some of those studies may result in LRT alternatives being set aside because expected costs appear to be too high.”

CONCEPT OVERVIEW AND HISTORY

Most recent new LRT installations in North America have followed a high-end model—what might be called an *interurban* or *light metro* design formula. This model tends to work well in fairly heavy-traffic corridors and on routes requiring higher speeds to connect far-flung suburban and exurban cities and towns.

But, for lighter and medium-traffic corridors, especially in smaller cities, the design features and costs of interurban–light metro-style LRT have been daunting—often leading local planners to abandon electric LRT visions and turn to alternatives such as bus rapid transit (BRT) or non-electrified rail modes.

Meanwhile, the streetcar—a seemingly new form of LRT (actually, an historically long-proven mode that has reemerged)—is now attracting attention. A somewhat smaller and slower version of LRT, streetcars so far have mostly been assigned to relatively leisurely circulator or shuttle-type applications in a few central cities; however, this mode clearly has potential for more diverse and higher-performance types of service. Indeed, there are examples—mainly outside North America—where it is so deployed.

Recognition of this potential of streetcar technology for more versatile and high-performance deployment has led to an innovative approach to the planning of new LRT systems—the rapid streetcar concept. Drawing upon already proven, existing LRT and streetcar (tramway) practices and technology currently used abroad in cities in Europe, Australia, and elsewhere, and in North American systems such as those now operating in Toronto, Boston, Philadelphia, Portland, Tacoma, Little Rock, and (until the Hurricane Katrina disaster) New Orleans, this concept may offer some potential for reducing LRT system project costs, while retaining operational cost efficiencies, rendered through the use of larger vehicles, multiple-unit trains, and electric propulsion—in a service package attractive to passengers and the general public, and conducive to achieving urban environmental and development goals. In addition, prospects for the creative and versatile use of streetcar technology for meeting the needs of smaller urban areas and lower-traffic corridors for quality transit may be enhanced in the United States by the new Small Starts program for projects requiring less than \$75 million in federal funding.

Historically, the rapid streetcar concept revives the original roots of the LRT concept itself—a 1970s revival of the technology of streetcars and interurban trolleys which once permeated North American cities and provided fast, convenient public transport links to smaller communities. However, while surface electric urban and interurban railway transport had almost totally been expunged from North America, much of this transport mode had been maintained and even upgraded abroad, especially in Europe, and this began to interest American transit professionals.

As early as 1962, European streetcar evolution attracted the attention of public transport planner H. Dean Quinby. In his article, *Major Urban Corridor Facilities: A New Concept*, published in *Traffic Quarterly* (April 1962), Quinby described what he perceived as a basically new form of transit emerging in a number of West German, Swiss, Belgian, Netherlands, and Swedish cities—the result of the efforts of transit agencies in these cities to upgrade their legacy tramway (streetcar) systems following World War II. Gregory L. Thompson, in an historical overview presented to the National Light Rail Transit Conference in 2003 (*Defining an Alternative Future: Birth of the Light Rail Movement in North America*, 9th National Light Rail Transit Conference, *Experience, Economics and Evolution: From Starter Lines to Growing*

Systems, Portland, Oregon, November 16–18, 2003) notes that, while the rebuilding of these tramways had been taking different forms in various northern European cities, Quinby “discerned two attributes common to most of the rebuilding efforts that together constituted ... the emergence of a new transit concept”:

One was capacity enhancement with emphasis on larger cars, operation of cars in trains, and much greater door capacity with new fare systems to make use of that capacity. The result was that for the first time surface transit could engorge and disgorge large volumes of passengers at intermediate stops quickly. The other was speed enhancement, achieved through traffic engineering and light infrastructure investments, with short applications of heavy infrastructure investment in critical areas.

Eight years later, another LRT pioneer, Stewart F. Taylor, also brought attention to innovative tramway practices and designs in Europe in his landmark article, *The Rapid Tramway: A Feasible Solution to the Urban Transportation Problem*, also published in *Traffic Quarterly* (Vol. 24, No. 4, October 1970, pp. 513–529). Taylor was convinced that northern European tramway transformations and developments held substantial promise for improving public transport in urban areas in North America.

A central objective of these and other researchers following tramway development abroad was to provide predominantly surface-routed rail service at modest cost. With its renewed focus on the possibilities of modern streetcar technology, the rapid streetcar concept appears to have some potential for achieving these original aims. Electric streetcar (tram-type) rail vehicles, rather than being confined solely in street alignments to relatively slow circulator, shuttle, or feeder-type services, would be deployed in some types of alignments and operating practices currently envisioned for higher-level, interurban-type light rail vehicles (LRVs) (i.e., the current standard). Streetcars operating up to 40–45 mph (65–75 km/h) in reserved lanes, median reservations, or exclusive rights-of-way, as well as in mixed traffic, could provide modestly faster service attractive to shorter-distance commuters, while rendering operational cost savings (compared with bus service) through the use of larger transit vehicles (especially articulated cars) and multiple-unit (MU) entrainment of cars.

This type of operation can be found in European and other cities which operate basically tramway (streetcar) types of LRT systems. For example, [Figure 1](#) illustrates a new Melbourne Combino tram running on a segment of exclusive right-of-way.

Somewhat less costly infrastructure and vehicles, and various cost-saving techniques, have the potential of lowering system costs and improving affordability of LRT in lower-traffic corridors, while retaining many of the advantages of rail transit that have proven attractive to the public. A cursory, preliminary analysis suggests that rapid streetcar might be a viable modal alternative to meet corridor-type travel needs for new starts in smaller, medium-sized, or lower-density urban areas.

LRT streetcars typically have less total capacity and lower speeds than larger, more powerful LRVs designed for faster interurban–suburban [mainly suburbs-to-central business district (CBD)] services. However, as discussed below, for some fixed-guideway applications, appreciably higher speeds are not absolutely essential.



FIGURE 1 Melbourne tram on exclusive alignment.

(Photo by William D. Fedor, June 2004.)

RESCALING LRT SYSTEM DESIGN

Typical design concepts for LRT systems seem to be predicated on the assumption that the service must compete with private motor vehicles traveling at freeway speeds—thus, running way geometry and rolling stock capable of achieving speeds in the range of 55–70 mph have been assumed. For longer-distance routes, catering to longer trip lengths, this is probably a valid assumption. However, starter systems serving lighter-traffic corridors, especially in smaller cities, may not require such high speeds to attract ridership adequate to meet cost-effectiveness criteria and to achieve other developmental goals.

This is especially true when one realizes that many alignments of new LRT systems are increasingly placed in public thoroughfare rights-of-way. A 2003 article titled, *Light Rail Use of Surface Streets and Arterials: On the Increase?* published on the *Light Rail Now!* website (http://www.lightrailnow.org/facts/fa_lrt011.htm), enumerates the proportions of total LRT route in such alignments for a wide range of North American LRT projects. [Table 1](#) displays some examples.

In many cases, where operations are in the right-of-way of streets or major arterials, speeds higher than 40–45 mph (65–75 km/h) are inappropriate (or illegal). Furthermore, projected ridership volumes may not require vehicular capacities comparable to those of the heavier system model typical of most recent previous major LRT installations (e.g., Dallas, Salt Lake City, Houston, Minneapolis). This would allow planners to take advantage of smaller, slower, and generally less costly streetcar rolling stock, and to provide somewhat shorter and less expensive passenger boarding platforms.

Implementing the rapid streetcar concept requires a serious rescaling or reframing of traditional notions of the performance expectations and investment magnitude of LRT. In some recent planning studies, designing for the worst-case scenario seems to have become a norm. Furthermore, in terms of an array of amenities and attractive features, the incorporation of

TABLE 1 LRT Alignments in Public Thoroughfares

LRT System	Proportion in Thoroughfares
Portland MAX	More than 28%
Sacramento	Nearly 23%
San Jose	Nearly 56%
Dallas	More than 20%
Salt Lake City	Nearly 19%
Tacoma	100%
Houston	100%
Minneapolis	Nearly 22%
Phoenix (planned)	More than 95%
Seattle (planned)	More than 32%

“maybe nice to have” in some cases seems to have become “absolutely must have.” There is also a kind of snowball effect, alluded to by Richard Pilgrim in his paper, cited above, that “an especially difficult problem is encountered in pre-New Start cities, where study data from other cities is used to estimate costs during planning studies.” In other words, any higher costs incurred in previous LRT projects often tend to become incorporated in the basis for estimating costs for the next project.

An example of this is what appears to be the almost total elimination of consideration of single-tracking (or gantlet-tracking) as an option in system design to attenuate cost in many planning studies (such as Alternative Analyses and DEIS studies). Many systems-level designers typically seem to assume fully double-tracked starter systems, with fullsize, interurban-style LRVs, high-level performance expectations, and other major features.

The use of features such as single-tracking and gantlet-tracking—certainly, operational compromises—in appropriate situations undoubtedly was an important factor helping hold down the initial startup costs of earlier “bare bones” new LRT starts in the United States, such as those in San Diego and Sacramento. Baltimore and Denver likewise incorporated single-tracking segments in their “starter system” designs. All of these New Start projects had severe budget constraints, but also a “get the job done” attitude that focused on a foot-in-the-door approach to establishing rail transit, at least at a very basic level of service.

However, it is also important to note that, while single-track construction may be useful in reducing start-up costs, its usefulness may be short-term. For example, the systems in San Diego, Sacramento, and Baltimore eventually outgrew the constraints of single-tracking, both in terms of ridership demand and operational efficiency, and all or most of the original single-track sections have been subsequently double-tracked.

Considerations of alignment geometry also factor into the issue of design/cost minimization versus performance optimization. Certainly, minimizing curve radii and vertical gradients is desirable, but often this somewhat flexible goal is rigidified into restrictive rules. If necessary to stay within cost, design, or environmental constraints, LRT—and particularly streetcars—can technically negotiate much tighter curvatures and steeper gradients than commonly assumed by some planning and engineering professionals.

Another consideration for in-street alignments is curbside versus street-center (or median) operation. With a few exceptions, planners have tended to avoid curbside running, mainly because of problems with right-turning traffic and driveway conflicts. However, curbside routing

has cost-saving advantages—particularly the ability to use sidewalks as passenger waiting and boarding areas, and elimination of costly traffic-control and pedestrian-safety techniques associated with station platforms located in the center of streets. Curbside routing is working well in such LRT installations as Denver and Portland (both the MAX interurban LRT and the Portland Streetcar), and should be considered more seriously for rapid streetcar projects.

A minimalist approach to project scope is also useful. LRT transportation projects seem to inspire ancillary urban-redevelopment or urban-rehabilitation projects that often tend to become merged with the LRT project, raising its ostensible cost. Certainly, it is laudable that LRT tends to stimulate such additional efforts for community improvement. But planners and decision makers must examine whether such projects are truly integral with and essential to the mobility improvements intended by the transit project.

As much as possible, construction methods and practices which have significant potential for lowering costs should be considered. For example, in the case of the Portland Streetcar, the shallow-slab construction method proved to be a major cost-saving technique for in-street construction. As described in this author's earlier rapid streetcar paper (cited above), a major advantage of this construction method is the minimization of subsurface utilities relocation. Furthermore, another benefit is faster installation time. Depending on location, shallow-slab track has been installed in lengths from as short as three blocks up to six blocks at a time, with work duration ranging from 2 to 3 weeks per section. Compared with conventional LRT construction, cost savings experienced in the Portland Streetcar project were dramatic. Track installation costs were found to be one-half to one-third those of the usual, deep-excavation, heavier method of construction. [Technical and cost information from discussions with representatives of LTK Engineering and Portland Streetcar personnel, 2000–2005, and *Faster, Cheaper Construction for Austin's Light Rail System? Light Rail Progress* (fact sheet), June 7, 2000.]

For a smaller city, with lower ridership expectancies and greater budget limitations, as well as lighter-traffic corridors in major cities (even those already with some form of rail transit), some of these design and construction considerations may be useful. A budget-conscious, bare-bones design approach, centered on streetcar rather than heavier LRT technology, may represent a more cost-effective option for providing higher-quality service at reasonable cost. The rapid streetcar concept is intended to help facilitate a kind of reform in the whole approach to installing LRT—a downscaling, in effect, to provide additional options for different applications where appropriate.

RAPID STREETCAR STATION DESIGN

In Europe, simpler LRT station or stop designs are widespread. LRT surface stations in a number of European cities, representing minimal design and cost while still providing a high degree of functionality, can be viewed, for example, in the *LRT: Surface Stations* section of the *Light Rail Now!* website at http://www.lightrailnow.org/facts/fa_photo_menu.htm#lrt-surface-stns.

Some downscaling of station–stop design may also be useful in rendering more affordable, cost-effective LRT projects better scaled to the needs of smaller cities or lighter-traffic corridors. The concept involves rescaling many stations to become more like *transit stops* rather than elaborate structures or civic monuments.

Station Amenities

Greater consideration should be given to minimizing amenities such as passenger waiting shelters and station furniture. Instead of elaborate roofs over platforms, simple bus-stop-style waiting shelters may be adequate to meet the needs of the transit service and its passengers. And, while support of the local artistic community is a noble practice for any public agency, heavy investment in “station art,” which drives heavier station design and diverts funds from more cost-effective mobility-related investments, is a practice which merits thoughtful re-examination. While artwork at stations may be limited (to perhaps 1% to 2% of total budgets), it may drive other design and cost impacts (e.g., increased security and maintenance to protect and preserve the artwork).

The stations for the Portland Streetcar represent excellent examples of a low-cost but functional approach. [Figure 2](#) shows a simple streetcar stop (station), with waiting shelter, and raised platform for floor-level boarding.

Onboard Versus Station-Located Ticket Vending Machines

Passenger-proof-of-purchase (PPOP) fare collection (also known as “self-service” or “honor system”) has proven to be cost-effective in enabling passengers to board through multiple doors or all cars of a train. However, this method, widely used in Europe and now the standard for new LRT systems in North America, requires ticket vending machines (TVMs) that are readily accessible to passengers. Traditionally, these have been located exclusively on station platforms.

A case can be made for placing TVMs aboard LRVs (and streetcars) for user-friendliness and convenience to passengers. This could be done in addition to having on-platform TVMs at selected, appropriate stops. However, consideration should be given, in lower-traffic situations (to which the rapid streetcar concept is particularly applicable), to placing TVMs almost exclusively aboard the vehicles. In this scenario, station-located TVMs would be kept to a minimum, perhaps only at the busiest stations.



FIGURE 2 Portland streetcar at station stop.
(Photo by Darrell Clarke.)

TVMs in stations invoke additional infrastructure to protect the machines from weather, and security measures. Placing them aboard vehicles would enable substantial downscaling of station design in most cases (although it is obvious that there is a cost tradeoff in having a TVM aboard every vehicle versus having them at every station). A further advantage is that cash handling and TVM servicing can be performed in the shop, eliminating the need to send maintenance crews around to stations.

Onboard TVMs are used with success on the Portland Streetcar. [Figure 3](#) shows one of these onboard TVMs mounted on the inside sidewall near a doorway. In addition, they are widely used in major cities abroad, including Berlin, Düsseldorf, Köln (Cologne), Munich, Vienna, Amsterdam, Lisbon, and Melbourne.

Evidently, the PPOP system with onboard TVMs works smoothly in virtually all deployments, in these and other cities of various sizes and levels of public transport traffic (author's personal experience, 1978–1985, 2003–2005, and discussions with participants of the Eurotrams and LRTA onboard discussion lists, 2003–2005.)

Boarding Accessibility and ADA Compliance

Station boarding platforms, especially in compact central areas, present a major issue of expense. Traditional, standard design of LRT stations includes a platform intended to accommodate the full length of the longest trains operated. Also, these platforms are typically built to the lowfloor standard of 350 mm, or about 13-3/4 in.

While certainly less than the high platforms intended for high-floor level boarding, this design still entails substantial investment. In addition to the cost of the platform itself, the approximately 14-in.-high slab of concrete presents an obstacle to traffic and pedestrian movement. In addition, it often incurs drainage problems, especially when it is incorporated into sidewalks.

There are possibilities for minimizing platform design for lowfloor boarding which could dramatically reduce the cost of providing stations, especially in central areas and densely developed urban neighborhoods, where design challenges are most difficult and cost tends to be highest. First, for LRT on non-exclusive alignments, full level-boarding through all doors has



FIGURE 3 TVM in Portland Streetcar.

(Photo by Lyndon Henry.)

not been a requirement of ADA; thus, accessible boarding through the front door of the car is a possibility—effected either via a wheelchair lift, or a 11- to 14-in. (277- to 353-mm) raised platform at the front door location. Second, the platform does not necessarily have to be built to a full 350-mm (ca. 14-in.) height.

Compliance with the Americans with Disabilities Act (ADA) is a critical consideration. According to *Title 49 CFR Part 38*, ADA Accessibility Specifications for Transportation Vehicles Subpart D—LRVs, Para. 38.83(b)(8), Platform Entrance Ramp:

The entrance ramp, or loading-edge barrier used as a ramp, shall not exceed a slope of 1:8 measured on level ground, for a maximum rise of 3 inches [76 mm], and the transition from the station platform or roadway to ramp may be vertical without edge treatment up to 1/4 inch [6 mm]. Thresholds between 1/4 inch [6 mm] and 1/2 inch [13 mm] high shall be beveled with a slope no greater than 1:2.

The use of movable bridgeplates between the car floor and the platform or sidewalk results in a situation where a platform or sidewalk is only about 10.5-in. (267-mm) high is required. This is the method of access and ADA compliance used in Portland, on both MAX LRT and streetcar systems. Bridgeplates deployed from the railcar doors provide a compliant 1:8 rise for 3 in. (76 mm) over a 24-in. (605-mm) length, up to the car floor. [Figure 4](#) shows a closeup of the retractable ramp on a Portland streetcar being used by a deboarding passenger.

Furthermore, as noted above, while floor-level boarding is one option for compliance with ADA, it is not necessarily required for all doors of all cars in a train. In Europe, many LRT tramway operations expect ambulatory passengers to board from street level, and this is possible in low-floor cars, with a single step. [Figure 5](#) shows passengers boarding a low-floor Darmstadt tram from street level (although ADA would require either a floor-level platform or wheelchair lift at one door of the car). With some provision for ADA-compliant level boarding, a street-boarding option for fully ambulatory passengers could be considered within the rapid streetcar concept.



FIGURE 4 Retractable ADA-compliant ramp on Portland streetcar.
(Photo by Lyndon Henry.)



FIGURE 5 Darmstadt: street-level boarding of low-floor tram.

(Photo by C. J. Wansbeek.)

In curbside alignments, such as in narrow inner-city streets, to minimize station or stop construction cost, consideration could be given to building out a 10.5 in. (265 mm) to 14-in. high (ca. 350 mm) “bulb” from adjacent sidewalks, to serve only the first door of the first car of each train. Another advantage of this procedure is that it could minimize impacts such as elimination of parking spaces. Passengers not needing level boarding would have the option of boarding through other doors of the car/train simply by stepping up from the street, as in Europe (and on some CBD segments of the San Diego Trolley).

Similarly, to reduce platform construction and associated costs at outlying and suburban stops, 10.5 to 14 in.-high (265–350 mm) platforms might be provided only at the ends of station platforms (e.g., each end of an island platform), rather than throughout a 200- or 300-ft (60- or 90-m) platform (see [Figure 6](#)). This would form a short platform to provide ADA compliance for boarding a low-floor vehicle—somewhat comparable in function to the high-pedestal boarding used with high-floor cars in Sacramento, Denver, Dallas, Salt Lake City, Baltimore, etc. In effect, this method of ADA access would blend boarding techniques used in those LRT systems with the low-floor, short-bridge method used in Portland for both the MAX (interurban-type) and streetcar LRT systems. It would provide, in effect, a “micro-high” platform at each end of the station, but it would not require special placement of the car/train, or special deployment of traps, ramps, or other hardware. In MU streetcar trains, ADA-compliant access to other cars could be effected by advancing the train forward, whenever necessary, so one or more similar doorways of other entrained cars are, each in turn, aligned with the floor-level platform section; in practice, the need for this procedure appears to be acceptably rare.

It should be noted that low-floor cars with level boarding are not the only option for streetcar operation. Onboard lifts—used on some systems—are another possibility for ADA-compliant access. For example, this method has been used with success for over two decades by the San Diego Trolley. In addition, the new RTA/Brookville cars for New Orleans (now undergoing rehabilitation after flood damage) provide onboard lifts which seem to provide a viable means of wheelchair access and ADA compliance.

In Little Rock, the River Rail heritage-style streetcars provided by Gomaco also use wheelchair lifts for ADA compliance. These standard bus-type lifts seem extremely efficient and appear to work well for the system. [Figure 7](#) shows a wheelchair passenger boarding one of the Little Rock River Rail cars.

The onboard lift eliminates considerable onsite additions to station construction and costs (albeit adding, of course, cost per vehicle). Depending on the application, the net benefits may outweigh the costs and liabilities. One major advantage is that (unlike common level-boarding systems with uniformly floor-level platforms) stops or stations can be placed at curves. As discussed further below, this can be a major advantage in some circumstances. There are some disadvantages, however.

First, wheelchair lifts, such as those used in buses, tend to be somewhat expensive and to require high maintenance. The trend within the transit industry now is to procure low-floor buses in order to speed boarding by all passengers, and to use simpler flip-out ramps for mobility-impaired riders. The equivalent trend in LRT, including streetcars, is the low-floor car with retractable ramps, as described above. For heritage-type cars with high floors, however, a conventional full lift may be the only option for this method of boarding.

Another significant drawback is that operation of the lift requires train operator assistance



FIGURE 6 Diagram of two-car streetcar train at partially raised platform.



FIGURE 7 Little Rock: wheelchair passenger boarding streetcar.
(Photo by Lyndon Henry.)

and consumes time. While operation of the Little Rock streetcar lift seems impressively fast, safe, and efficient, in a system with heavy traffic and frequent wheelchair boardings, lift deployment and operating time could become a problem.

An additional drawback is that some current lift designs monopolize an entire car doorway. In the case of the RTA/Brookville car, each car has three doors on each side, with the center door allocated to the lift. This eliminates several additional seat positions with relatively little operational deployment. However, the lift used in Little Rock's River Rail cars easily folds out of the way (as on buses) and keeps the doorway available for general boarding.

However, another advantage of the onboard lift approach is that it has some flexibility. It can be used with station platforms of varying heights, as well as on curves. Thus, this method of ADA access, despite its drawbacks, needs to be given a very serious re-look by planners. It should be noted that even low-floor buses typically use some form of lift to board wheelchair passengers, and if buses can do it, why not LRT?

The ability to locate stations on curves is a distinct advantage which can simplify alignment location challenges as well as design, and lower costs dramatically. The use of "micro-high" platforms, as well as onboard lifts, may offer a design alternative in this respect. [Figure 8](#) shows a Vienna low-floor streetcar boarding a wheelchair-bound passenger at a station located on a curve.

AVAILABLE STREETCAR ROLLING STOCK

A particular advantage for streetcar technology is the increasing variety of off-the-shelf rolling stock becoming available. Some examples can be viewed in the LRT: LRV Options for Medium-Capacity Applications section of the *Light Rail Now!* website at: http://www.lightrailnow.org/facts/fa_photo_menu.htm#lrt-medium-capacity.



FIGURE 8 Vienna tram boarding wheelchair passenger in station on curve.
 (Photo by Akos Varga.)

Skoda/Inekon Streetcar for Portland and Tacoma

Clearly, in terms of streetcar rolling stock, LRT planners are finding a growing array of options. In the United States, rolling stock is becoming available in two, somewhat polarized styles—modern and heritage. Modern cars are represented by the Inekon/Skoda streetcar for Portland and Tacoma, and the Ostrava/Inekon Trio car (ordered for both Portland and Washington), both built in the Czech Republic. So far, this type of car for the U.S. market has incorporated an articulated design. Car length is about 20 m (66 ft), compared with about 75–90 ft for a larger, interurban or light metro-style LRV. The Skoda car's width of 2.46 m (8 ft 1 in.) is somewhat narrower than the 8.5–9.0 ft (2.6–2.7 m) typical of larger LRVs. The following specifications for the Skoda/Inekon streetcar (see Figure 2) give a general idea of typical parameters and capabilities of this type of rolling stock:

- Size and appearance: length 20.1 m (66 ft), width 2.46 m (8 ft 1 in.), double-articulated body with modern styling;
- Capacity: 29 seats with up to 127 standees ($6/\text{m}^2$);
- Doors: three per side;
- ADA accessibility: low floor with retractable ramps at doors;
- Maximum gradient: 9%;
- Maximum speed: 70 km/h (43 mph) design; 50 km/h (31 mph) governed;
- Acceleration: average 1.3 m/s/s (3.0 mph/s); and
- Minimum turning radius: 18 m (60 ft).

Modern streetcars tend to cost substantially less than larger, “standard” LRVs. For example, in 2006 dollars, the unit cost of the Skoda/Inekon car, in the small quantity delivered to Portland and Tacoma, would be about \$2.3 million. This is at least \$1 million lower than the price of \$3.5–4.0 million per unit common for larger LRVs—albeit, of course, for less passenger capacity per car (and a somewhat lower-performance car). (Informational packet distributed by Portland Streetcar Project at Portland Poster Session, 9th National Light Rail Transit Conference, *Experience, Economics and Evolution: From Starter Lines to Growing Systems*, Portland, Oregon, November 16–18, 2003.)

New Orleans Regional Transit Authority/Brookville PT-2000 Streetcar

Heritage streetcars can be rehabilitated older rolling stock, such as the Presidential Conference Committee (PCC) cars used in San Francisco and Kenosha, Wisconsin, or newly manufactured cars with an historically accurate appearance, such as the Gomaco cars in Little Rock and Tampa, and the 21st-century version of the heritage Perley Thomas traditional streetcar (PT-2000) built by the New Orleans Regional Transit Authority (RTA) in partnership with Brookville Equipment Corp. While these PT-2000 cars suffered serious flood damage in the aftermath of Hurricane Katrina, they also illustrate typical rolling stock choices that could be suitable for a rapid streetcar installation:

- Size and appearance: length 47 ft 6-1/4 in. (14.4 m), width 8 ft 5 3/4 in. (2.6 m), with rigid-body “historic” styling for compatibility with existing fleet of original Perley Thomas cars; however, car can be modified in dimensions and fitted with modern-styled body;
- Capacity: 40 seats with up to 70 standees (crush) or 32 (average);
- Doors: three per side;
- ADA accessibility: one middle door lift per side;

- Propulsion: four 60-hp DC electric motors in two PCC-type articulated trucks with regenerative braking; AC motors an option;
- Antilock braking with automatic sand drop;
- Maximum speed: computer-limited to 35 mph (45 mph for Riverfront line); higher speed possible;
- Acceleration: average 2.5 mph/s (1.1 m/s/s, computer selected); and
- Minimum turning radius: 28 ft (8.5 m) in yard, 50 ft (15.2 m) in service.

The RTA/Brookville car, built to exceptional standards of durability and longevity, is also less costly than a more commonly deployed LRV, but for less capacity and somewhat lower performance. In 2006 U.S. dollars, the RTA/Brookville model streetcar would probably be priced in the range of approximately \$1.5 million each (for an order of perhaps two dozen vehicles).

Gomaco Streetcar for Tampa

As previously noted, Gomaco has also provided heritage-style streetcars for American operations. Gomaco's Birney-style design (see [Figure 7](#)) is an attractive product, and reportedly is costing less than \$1 million per unit in small orders (however, Gomaco has relied on the use of used streetcar trucks and motors, the supply of which may be limited). Some of the following selected specifications for the Tampa car can be considered roughly typical:

- Size and appearance: length 49.75 ft (15.1 m), width 8 ft 6 in. (2.6 m), height 12.51 ft (3.75 m), with rigid-body Birney-style heritage styling;
- Capacity: 44 seats with up to 44 standees;
- Propulsion: Peter Witt-style trucks/motors from ATM Milan, Italy; 30-hp GE traction motors, 650 volts, air/friction brakes, K-35 air compressor, TransTechnik inverter; and
- Maximum speed: 30 mph (50 km/h).

It can be seen that, while each vehicle is somewhat smaller than a standard LRV (such as has been deployed in most recent North American new starts), capacity is still substantial compared with even an articulated bus. Furthermore, either streetcar option is capable of MU operation. Therefore, capacity could be increased with no increase in platform labor cost.

What this means is that lighter-traffic corridors and smaller cities have an option for lower-cost, lighter-capacity, somewhat slower cars which, compared with buses, may offer higher capacity and, under stop-and-go conditions, somewhat better performance.

STREETCAR DEVELOPMENT BENEFITS

Lower LRT Capital Cost

The rapid streetcar concept appears to hold serious potential for significant reductions in the implementational capital costs of LRT projects. As of early 2003, the capital cost of the Portland Streetcar—including rolling stock and maintenance and operational facilities as well as trackage, power system, and traffic control–signal system, totaled \$56.9 million for a 2.4-mi (3.9-km) bidirectional route. (Informational packet distributed by Portland Streetcar Project at Portland Poster

Session, 9th National Light Rail Transit Conference, Experience, Economics and Evolution: From Starter Lines to Growing Systems, Portland, Oregon, November 16–18, 2003). In 2006 dollars, that calculates to approximately \$26 million per mile, or \$16 million per km—a remarkably low cost for a rail system installed entirely in city streets (usually by far the most expensive form of surface construction). Certainly, this cost will vary from area to area and among different route configurations and levels of scale, but the Portland data suggest that some of the procedures suggested in this discussion could bring down LRT costs dramatically.

Heritage streetcar systems have been installed for even less, albeit with significant single-track construction. For example, in 2006 dollars, the Little Rock River Rail line would cost about \$8 million per mile (\$5 million per kilometer). Tampa's would cost about \$16 million per mile (\$10 million per kilometer). However, such a very low-cost approach, with single-tracking and similar cost-constraining features, might be a plausible way to install an initial project that could then (hopefully) prove its value and win political support for upgrading and expansion.

Potentially Lower Unit Operating Costs

Rapid streetcar systems would seem to have potential for lowering the unit operating costs of transit service compared with bus alternatives, in part because of lower platform labor costs per passenger and particularly per passenger-mile (although available data relate to high-performance LRT services rather than streetcar). In this respect, National Transit Database (2003) data seem to suggest that LRT can reduce these unit costs in some cases. For example, average systemwide LRT costs per passenger-mile are lower than those of bus in Boston, Cleveland, Dallas, Denver, Los Angeles, Philadelphia, Portland, Sacramento, St. Louis, Salt Lake City, San Diego—the overwhelming majority of cities where both modes are operated. To the extent that a rapid streetcar operation would incorporate similar cost-saving features (e.g., peak MU operation, if appropriate), it is plausible to anticipate similar unit cost reductions.

Multiple Benefits of Rail Transit

The rapid streetcar concept seems to hold promise for providing other benefits of rail transit, possibly attracting higher ridership compared with bus alternatives. Both the Portland Streetcar and the Tacoma Link streetcar have met their ridership goals. (Informational packet distributed by Portland Streetcar Project at Portland Poster Session, 9th National Light Rail Transit Conference, Experience, Economics and Evolution: From Starter Lines to Growing Systems, Portland, Oregon, November 16–18, 2003; and Gary Cooper and Thomas B. Furmaniak, Portland Streetcar: A Two-Year Report Card, also at the 9th National Light Rail Transit Conference.) Some of these additional benefits include:

- Zero-emission vehicles,
- Quieter operation,
- Greater compatibility with pedestrianized urban environments,
- Spacious interior accommodations with a generally smoother ride quality,
- Improved transportation safety,
- More understandable, consistent route structure,
- More reliable, dependable service, and
- Potentially faster service speed compared with similar bus service configurations.

Transit-Oriented Development

The prospect of transit-oriented development (TOD) and urban economic redevelopment seems to be a major consideration motivating much of the interest in streetcar development. TOD has reportedly been the preeminent driving force behind the Portland Streetcar project and is considered its major success. Gary Cooper of the City of Portland and Thomas B. Furmaniak of LTK Engineering Services discussed the Portland Streetcar's impact on TOD in their paper, *Portland Streetcar: A Two-Year Report Card*, cited above. They noted that, in addition to achieving impressive ridership growth,

the streetcar line continues to serve as an important element of the city's plans to strengthen existing neighborhoods, create new ones, and reduce dependence on automobile travel. Anecdotally, new housing and commercial developments along its path are thriving in what is an otherwise lackluster local economy; people are making lifestyle choices in which the streetcar is one of their choices for travel, including their work and school trips; and they are reducing use of their automobiles. Likewise, existing businesses along the line and new business locating there are advertising their proximity to it.

The streetcar line has been a catalyst for development. Initially, this was focused on the Pearl District, an urban renewal area of former railroad yards and abandoned warehouses near the middle of the line and now the scene of explosive housing growth and neighborhood development. However, there have been numerous buildings and land parcels elsewhere along the line which have capitalized on the line's popularity. Through the first quarter of 2003, more than 40 new construction or renovation projects valued at over \$1 billion have been started along the line, with more on the drawing board.

Likewise, Tacoma's streetcar (Tacoma Link) appears to be having a major impact on adjacent development. In *Tacoma Link: The Little Tram That Could*, the *Light Rail Now!* website (http://www.lightrailnow.org/news/n_tac003.htm) reports that

improving mobility options and reducing street and parking congestion have been only one of the major goals of the Tacoma Link streetcar system. Another critical objective has been to stimulate vigorous real estate development and contribute to the ongoing revitalization of downtown Tacoma. This strategy apparently has been meeting with overwhelming success.

Helped substantially by the streetcar construction project and the advent of regional "heavy" rail passenger service, Tacoma's downtown had been experiencing a kind of rebirth even before the Tacoma Link service started. But since the LRT service began in late August, things have really been booming for businesses that managed to endure the long wait.

The article concludes that Tacoma Link is

...another clear example of the amazing and unique power of rail transit—even a tiny tramway or streetcar system—to pull motorists out of their cars, and to pull in new

business development as transit-oriented development to help achieve urban revitalization goals.

Heritage systems, such as the Little Rock and Tampa streetcar systems, also appear to be having success in attracting significant new development near their stations and along their lines.

CONCLUSION: RAPID STREETCAR CONCEPTS IN ACTION

The practices behind the rapid streetcar concept—particularly, deploying streetcars/trams as more than just a slow circulator looping around downtowns—have long been in effect in Europe. For example, [Figure 9](#) shows a Skoda Astra tram speeding through a road intersection on a rural private right-of-way outside Ostrava.

Currently, the Portland Streetcar itself is undergoing expansion that in effect will turn it into a version of rapid streetcar. An incremental 0.6-mi extension connects the streetcar's street-bound alignment, from the previous River Place-area stub terminus at SW River Parkway and SW Moody to SW Gibbs, mostly utilizing the former Willamette Shore Trolley railway right-of-way. This represents the line's first departure from in-street running in mixed traffic to the use of a reservation or exclusive alignment, where speeds of 35–40 mph could regularly be achieved. Ultimately, planners hope to extend the Portland Streetcar further in a southerly direction along the Willamette River shore toward the suburban community of Lake Oswego.

These extensions—almost entirely on existing railway right-of-way—will qualitatively change the streetcar system's function from a simple, slow circulator in mixed traffic to a medium-speed semi-interurban service, resembling higher-performance LRT. Thus, the extension program appears to represent the first de facto implementation in the United States of the rapid streetcar concept—the deployment of electric streetcar or tramway-type rail vehicles in alignments and operating practices typical of higher-level, interurban-type LRVs.



FIGURE 9 Tram on rural right-of-way near Ostrava.
(Photo: LRТА.)

In making use of new developments in streetcar technology, and offering a minimalist approach to LRT installation with an array of simple, workable, cost-reducing approaches, and procedures, the rapid streetcar concept appears to represent an avenue for lowering the cost of LRT new starts in smaller cities and lighter-traffic corridors. Possibly more competitive with modal alternatives such as quality bus (BRT), rapid streetcar also seems to offer a substantial array of potential benefits which, combined with lower costs and an ability to attract significant ridership, suggests that appropriate projects may be more cost-effective than either higher-performance LRT or BRT for certain applications.

STREETCARS

Evaluation of Multiple-Unit Streetcar Operation in Toronto, Canada**AMER SHALABY****KENNY LING***IntelliCAN Transportation Systems Inc.***JIM SINIKAS***Toronto Transit Commission*

This study investigates the customer service impacts of converting the operation of Toronto Transit Commission's (TTC's) 504 King streetcar route from single unit to multiple-unit operation using a microscopic traffic simulation model. The 504 King is the TTC's busiest surface transit route, carrying about 50,000 transit riders on a typical weekday. As 504 King operates in mixed traffic, it is affected by traffic congestion, left-turning vehicles blocking the tracks and long traffic signal delays. Currently, this high-frequency route suffers from major reliability problems including streetcar bunching and gapping. Consequently, many streetcars have to be short turned to fill gaps and provide adequate service in the most heavily used segment of the route. These operating problems and route management measures result in poor customer service on this route and must be tackled from two angles. Firstly, steps must be taken to reduce the magnitude and variability of delays and secondly, the impacts of such delays must be reduced. This study investigates the impacts of the latter through coupling of individual streetcars to increase the vehicle capacity while reducing the frequency of the service. To estimate the impact of this measure, a state-of-the-art modeling tool was applied to replicate the existing and proposed scenarios. The model was developed and calibrated using field data. It successfully captures the relationship between passenger service times with the corresponding transit vehicle load. The results indicate that operating streetcars in multiple units leads to a reduction in headway variability, fewer transit customers left behind at stops due to overcrowding, less onboard crowding, less bunching, and less short-turning of streetcars.

BACKGROUND AND OBJECTIVES

This paper reports on a study carried out recently to address reliability problems experienced on the 504 King streetcar route in Toronto, Canada. 504 King, shown in [Figure 1](#), is a U-shaped route that operates through four subway stations and through the central business district in downtown Toronto. The two subway stations at the ends of the route feature a fare paid free-flow transfer while the two stations in the central business district require a paper transfer to board. 504 King is the busiest TTC (Toronto Transit Commission) surface route, with a daily ridership of about 50,000 passengers. The route traverses a total of 102 intersections, 32 of which are signalized. In an effort to reduce the magnitude and variability of signal delays, the TTC has implemented transit signal priority at 27 intersections. The five intersections not equipped with



FIGURE 1 The 504 King streetcar route.

transit signal priority feature near-sided stops with lengthy and highly variable passenger service times which make them poor candidates for signal priority. The route includes 114 stops in both directions, virtually all of which are near-sided (i.e., stops located just upstream of the corresponding intersection). During the morning peak period, which is the period studied in this work, the scheduled service is every 2 min employing CLRVs (Canadian light rail vehicles). The roads on which 504 King operates feature a four-lane cross-section with streetcars operating in the median lanes and shared with through and left-turning vehicles.

The King streetcar route suffers from major reliability problems which result in very poor customer service. These problems include frequent bunching and gapping, and short-turning of streetcars (more than 25% of the streetcars are short turned during the morning peak), leading to overcrowding and passengers being left behind at stops. It is noteworthy that the morning peak passenger volumes at the peak load point call for a 2.5-min headway based on TTC's load standards. However, 25% more service than required was added to the route, reducing headway from 2.5 to 2 min, to reduce the number of customers left behind at stops by overcrowded streetcars. Although the increased service has increased passenger carrying capacity and reduced the number of passengers left behind at transit stops than would have been the case with a 2.5-min headway, it has made the route even less stable and has likely aggravated the problem of bunching and increased the number of short turns. Routes with frequent service such as this are very unstable and even "normal" minor delays can cause the route to break down. For example, with 504 King providing service every 2 min, a 1-min delay incurred by one streetcar is equivalent to the streetcar running 50% behind schedule. Theoretically speaking, there would be 50% more passenger demand at the downstream stops of the route. With more passengers, the passenger service time (dwell time) would increase, resulting in the streetcar falling further behind and the following streetcar(s) catching up.

Maintaining uniform spacing between streetcars is very important to the operation of very frequent transit routes, particularly streetcar routes. Although it may seem simple, it is a challenging task due to the numerous uncontrollable factors involved in the daily streetcar operations. Such factors include traffic signal delays, general traffic friction delays, weather, congestion, surge in passenger demand, pedestrian movements, on-street parking, auto collisions, and the inability of lightly loaded streetcars to leap-frog overcrowded ones. The combined effect of these factors leads to headway variability bunching, the need to short-turn streetcars, overcrowding, passengers being left behind at stops, etc. Unfortunately, these are daily occurrences on the 504 King streetcar route.

Ideally, an upgrade of this high-frequency route to an LRT-type or subway-like operation involving higher degrees of separation from other traffic including a change in fare collection strategy to reduce passenger service times would reduce the effect of the abovementioned factors. However, this is not likely to happen on 504 King due to road width and funding constraints. Consequently, other measures and operating strategies must be considered to improve reliability in a mixed traffic or semi-exclusive operating environment. These measures fall into two categories; those that reduce the magnitude and variability of delays to transit and those that reduce the impacts of such delays on the transit service and allow it to recover. TTC has already implemented signal priority to reduce the magnitude and variability of traffic signal delay and has commissioned another study to conduct microsimulations to evaluate the passenger service delay reductions associated with converting to a proof of payment (POP) fare collection system from the current pay-as-you-enter system. The subject of this study focuses on the latter category, whereby individual streetcars would be coupled to allow for widening of the headway and reducing the probability that relatively minor “normal” delays would cause the service to break down. This strategy is referred to as multiple-unit (MU) operation. The strategy of reducing the frequency of a route to improve customer service seems counterintuitive as one would think that the more frequent a service the better it would be for customers. This is true, up to a point, as a route can be so frequent that even minor normal delays can cause it to break down. The rationale is to reduce the effects of small service disruptions (e.g., delays due to traffic signals, passenger demand, etc.) and reduce bunching and overcrowding by providing more time cushion between successive streetcars so as to absorb small variations in headways, thus leading to more stable operation. The objective of this study is to evaluate the MU operation on the 504 King streetcar route relative to the existing single-unit operation using a state-of-the-art microsimulation model.

MICROSIMULATION MODEL DEVELOPMENT

Analytical methods are available for the assessment of various transit operational strategies along arterial roads (1,2). One approach that is being used increasingly for traffic and transit operational analysis is microsimulation modeling. This study adopts the microsimulation modeling approach. The study made use of an elaborate microsimulation model of the 504 King streetcar route developed for a recent study which evaluated the performance impacts of transit signal priority along the route (3). The model was developed using Paramics (4, 5, 6) a suite of high-performance software tools for microscopic simulation of realistic traffic and transit networks. In the model, individual vehicles are represented in fine detail for the duration of their entire trip, providing accurate traffic flow, transit time and congestion information, as well as

enabling the modeling of the interface between driver–vehicle units and transit priority. The model was further calibrated based on recent transit operational data provided by the TTC for this study. In addition, this study made several software enhancements in order to meet specific needs of the analysis.

Software Enhancements

The first enhancement was related to the effect of vehicle loading on dwell time. It was expected that the crowding conditions of the streetcar would have an impact on the boarding and alighting time per passenger. The rationale was that as the streetcar becomes more crowded, passengers start to encounter difficulty boarding, moving within and alighting from a streetcar, resulting in an increase in passenger service delay. While it can be argued that passenger service time is a necessary component of a transit service, it is a delay to transit riders that are not using this time to board or alight. In order to represent properly the relationship between the current streetcar loading and boarding time per passenger, field studies were carried out. The intent was to calibrate a model to capture the relationship between streetcar loading and passenger service time, with this mode to be incorporated into the microsimulation model, thus improving its sensitivity to the effects of crowding on streetcar performance. This was deemed important in this study, since the MU strategy was expected to reduce crowding aboard streetcars.

To calibrate the model, extensive data were collected through ride checks (by two individuals, one near the front door and one near the rear door) during the morning peak period (i.e., between 7:30 a.m. and 9:30 a.m.) over 2 days. The data collected included loading of the streetcar at each stop, number of passengers boarding, boarding time, number of passengers alighting, and alighting time. The average boarding time per passenger was calculated as the boarding time taken divided by the number of boarding passengers.

A linear regression analysis was performed on the set of data collected in the field. A few data points representing outliers (e.g., a passenger spending unusually long time asking the driver while blocking the way for the following passengers) were not included in the analysis. [Figure 2](#) shows the graph of boarding time per passenger versus streetcar loading. The boarding time per passenger ranges from 2.1 s to 4.1 s. From the graph, there is no clear pattern when the streetcar loading is still rather low. However, as the streetcar loading increases to a certain number, a pattern starts to form showing a more noticeable relationship between boarding time per passenger and streetcar loading. In fact, it is expected that the boarding time per passenger should stay more or less uniform when the streetcar loading is low (i.e., with seats still available), and increases thereafter due to crowding effects. The graph shows this general pattern.

The study developed a regression model which was later incorporated in the microsimulation model for the study analysis. Data points representing streetcars with low vehicle loads were removed, using a threshold of 45 passengers which was found to be reasonable. [Figure 3](#) shows the relationship between boarding time per passenger and streetcar loading with such data points removed. A linear regression model was calibrated on this isolated data set, and the R^2 value was 0.71. The calibrated model is:

$$(\text{Boarding Time per Passenger}) = (0.0369) * (\text{Streetcar Loading}) + 0.9864$$

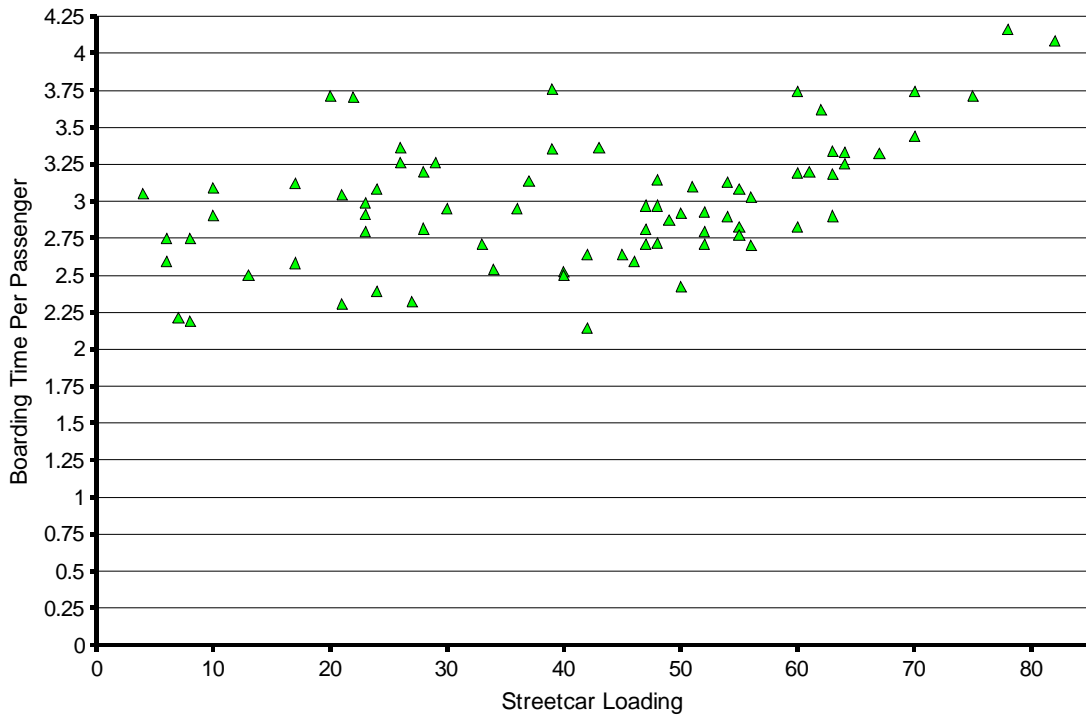


FIGURE 2 Boarding time per passenger versus streetcar loading.

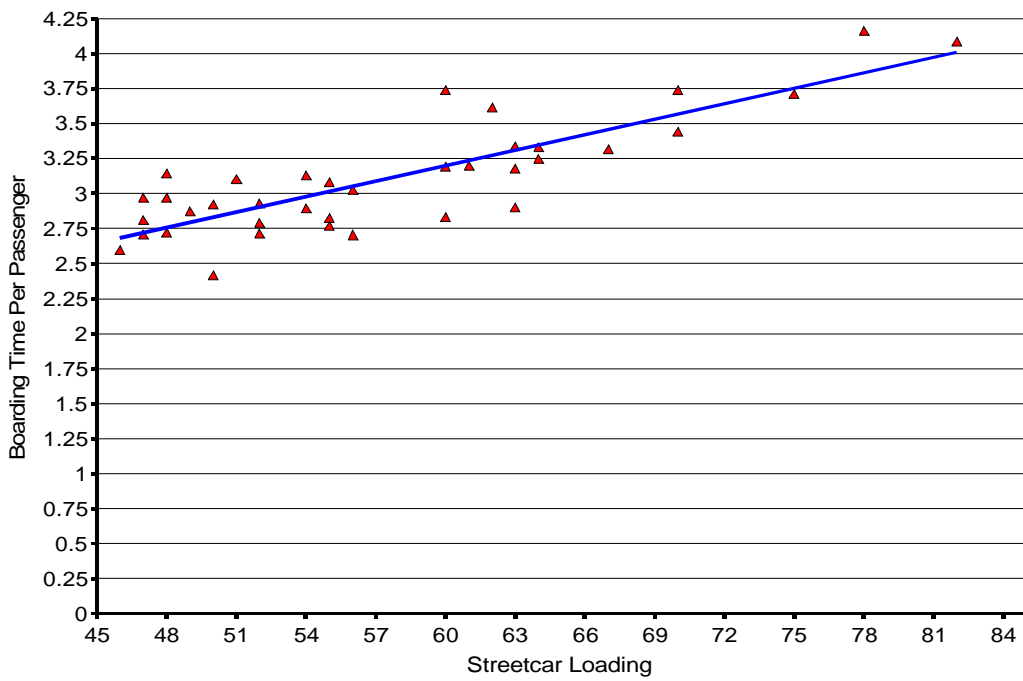


FIGURE 3 Regression model of boarding time per passenger versus streetcar loading.

An average value of 2.65 s was used as the boarding time per passenger in the model whenever the current passenger loading was equal to or less than 45. For loadings greater than 45, the above equation was utilized by the simulation model to calculate the boarding time per passenger and its associated dwell time.

The second software enhancement made in this study was related to the gathering of output data from the microsimulation model for the evaluation of scenarios. Specifically, some of the project-specific evaluation measures (e.g., number of passengers left behind at stop because of overcrowding, time-space diagram of transit vehicles, etc.) cannot be captured directly through the default functions provided by Paramics. Thus, a tailor-made plug-in program was coded into Paramics (using its advanced programming interface) to enhance the model's capability in the area of output data collection and processing. In addition, the plug-in program incorporated the regression model discussed earlier. [Figure 4](#) illustrates the overall flowchart of the plug in.

SCENARIOS MODELED

Four scenarios were modeled in this study. These include:

- Base case (with scheduled headway of 2 min—existing conditions): All streetcars along the route are single-unit CLRV with a practical capacity of 102 passengers per streetcar.
- Base case (with scheduled headway of 2.5 min): All streetcars along the route are single-unit CLRV with a practical capacity of 102 passengers per streetcar. This scenario represents the streetcar operation with the headway based on the loading standards and passenger volumes at the maximum load point.
- MU operation (with scheduled headway of 4 min): All streetcars along the route are double-unit CLRV with a practical capacity of 204 passengers per streetcar. This scenario represents the proposed MU operation in the morning peak period.
- MU operation (with scheduled headway of 5 min): All streetcars along the route are double-unit CLRV with a practical capacity of 204 passengers per streetcar. This scenario of MU operation corresponds to the second scenario.

A total of 23 simulation runs were made for each scenario and the output data were gathered for the scenario evaluation.

RESULTS AND DISCUSSION

This section presents the results of the 1st and 3rd scenario shown above, with the focus placed on the direct comparison of existing operation and proposed MU operation given the same fleet size. The results are focused on the reliability and level of service pertaining to the eastbound direction (which is the morning peak flow direction). Other results (i.e., 2nd and 4th scenarios and westbound direction) generated in this study can be found in the final technical report by Ling and Shalaby (7). Different types of graphs and tables are presented to illustrate the results in a clear and meaningful way. The evaluation was carried out based on the analysis of

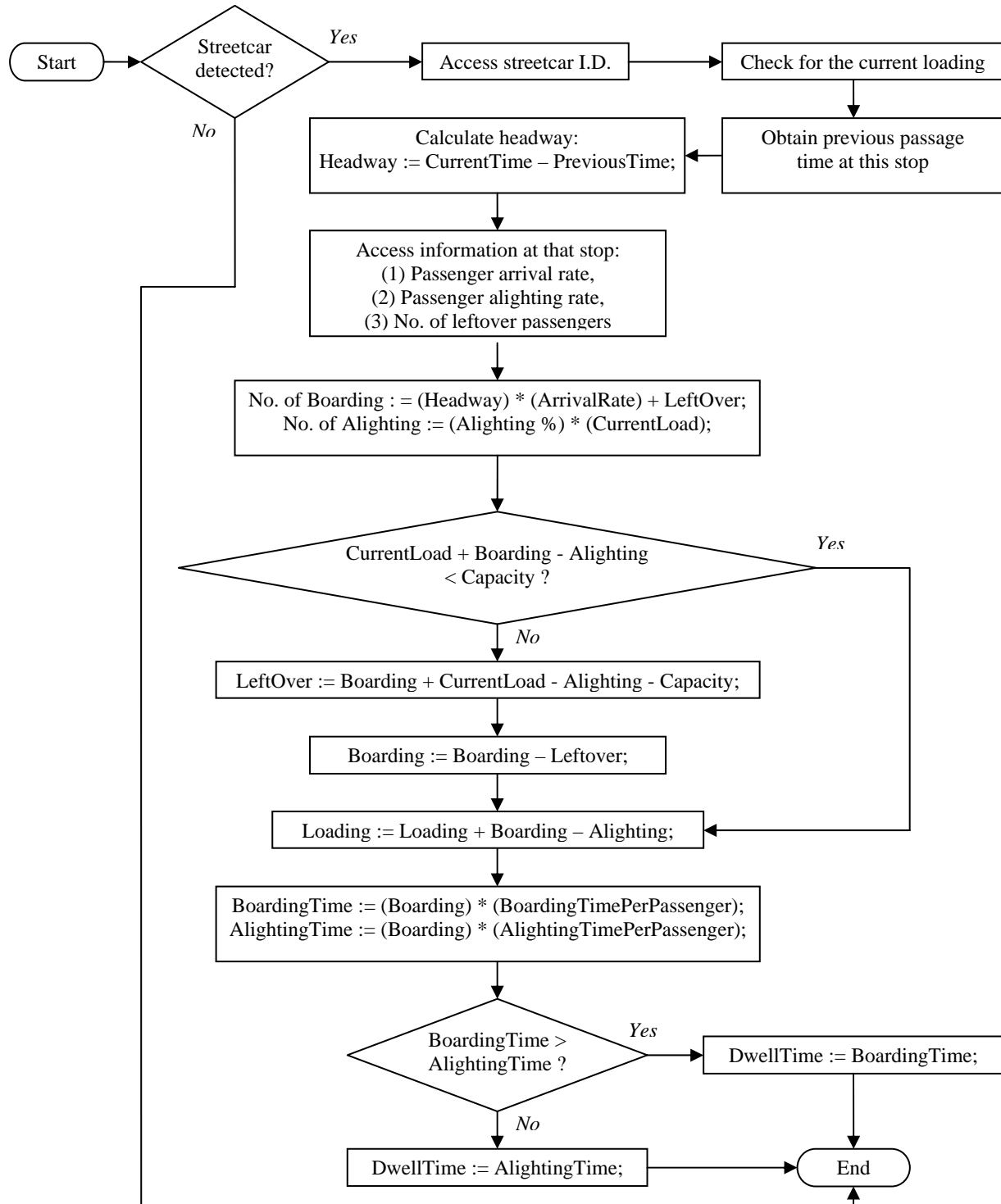


FIGURE 4 Flow chart of the plug-in program.

- Time–space diagrams for a typical day;
- Crowding conditions at peak load stop;
- Headway variability;
- Frequency of bunching;
- Number of customers left behind by overcrowded streetcars; and
- Overall corridor statistics.

Time–Space Diagrams for a Typical Day

The TTC assigns route supervisors at critical locations to monitor surface transit operation and implement operation control strategy to rectify problems that may lead to further deterioration of service. In the case of the 504 King route, a route supervisor is usually located in the vicinity of University Ave. Whenever a long headway is observed, the supervisor would usually instruct the operator of one or more streetcars behind the gap car (the first car after a long gap) to short-turn before the end of the route (i.e., Parliament at King for the eastbound direction and Roncesvalles at Queen for westbound direction). The number of streetcars to be short turned depends obviously on how often the route experiences large gaps in service. The rule of thumb used is that any headway greater than 1.5 times the scheduled headway will trigger a short turn. The rationale is that those streetcars, carrying a gap that is significantly greater than the scheduled headway, will continue to fall further behind schedule because of longer passenger service delays from higher-than-normal passenger demand at downstream stops. As this streetcar continues to fall further behind, following streetcars will soon catch up. It is not uncommon to see three or more 504 King streetcars bunched following a long gap in service. The purpose of short turning is to fill such gaps in the opposite direction (note that there are fixed number of streetcars circulating the route in both directions) with these short-turning vehicles aimed at recovering the scheduled frequency of service in the busiest segment of the route.

Figures 5 and 6 present the time-space diagram for the single-unit streetcars operating with a 2-min headway and the MU streetcars operating with a 4-min headway with field supervision, respectively. Note that each diagram represents a typical day of peak period operation of the corresponding scenario (recall that for each scenario there were 23 simulation runs, each providing one possible time–space diagram).

As shown, the time–space diagram under MU operation has individual streetcar trajectories spaced out more evenly compared with the corresponding single-unit scenarios, implying more uniformly distributed headways. Furthermore, the frequency of bunching (as indicated by very closely spaced lines) is much lower under the MU scenario. The lines tend to pack closely together towards the end of route under the base case, whereas the lines of the MU scenario are still able to maintain reasonable spacing.

Although the model did not take into account the actions of route supervisors, the time–distance diagrams illustrate the likely intervention of route supervisors to short turn streetcars. Those streetcars that the route supervisor would likely short turn are identified with a circle in the diagram.

Under the existing single-unit operating strategy, with 2-min headway, eight short turns would likely be required to maintain adequate service in the busiest segment of the route (see Figure 5) while under MU operation, with a 4-min headway, only two short turns would likely be required (see Figure 6).

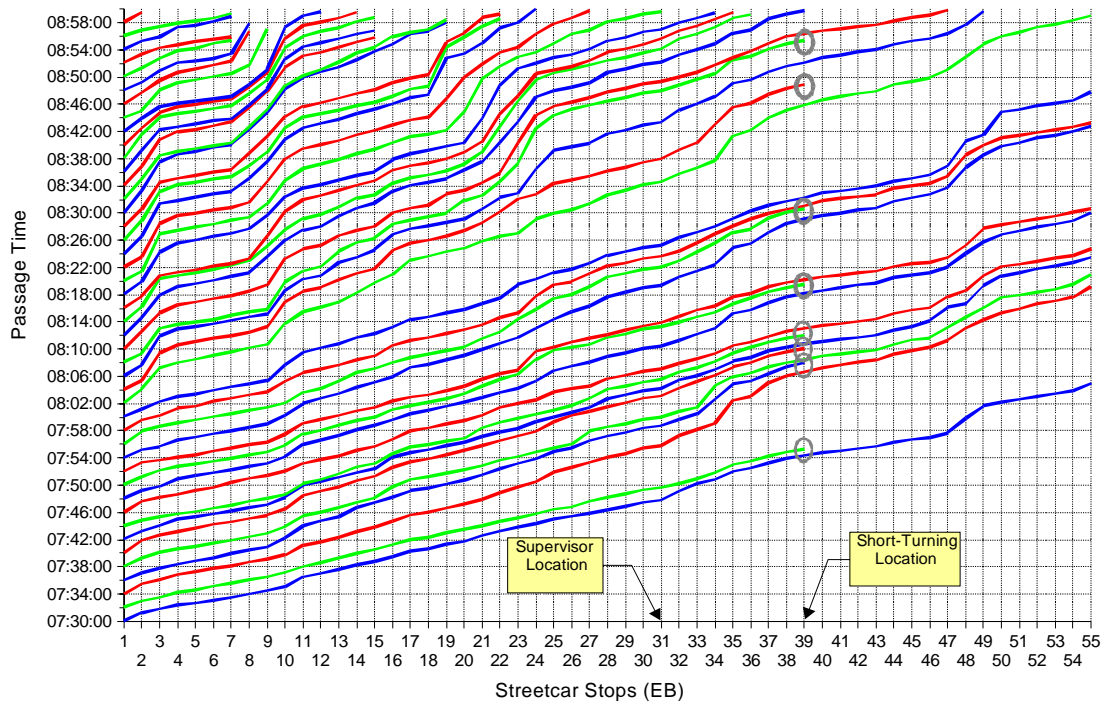


FIGURE 5 Time-space diagram of base case (2-min headway-EB, supervised).

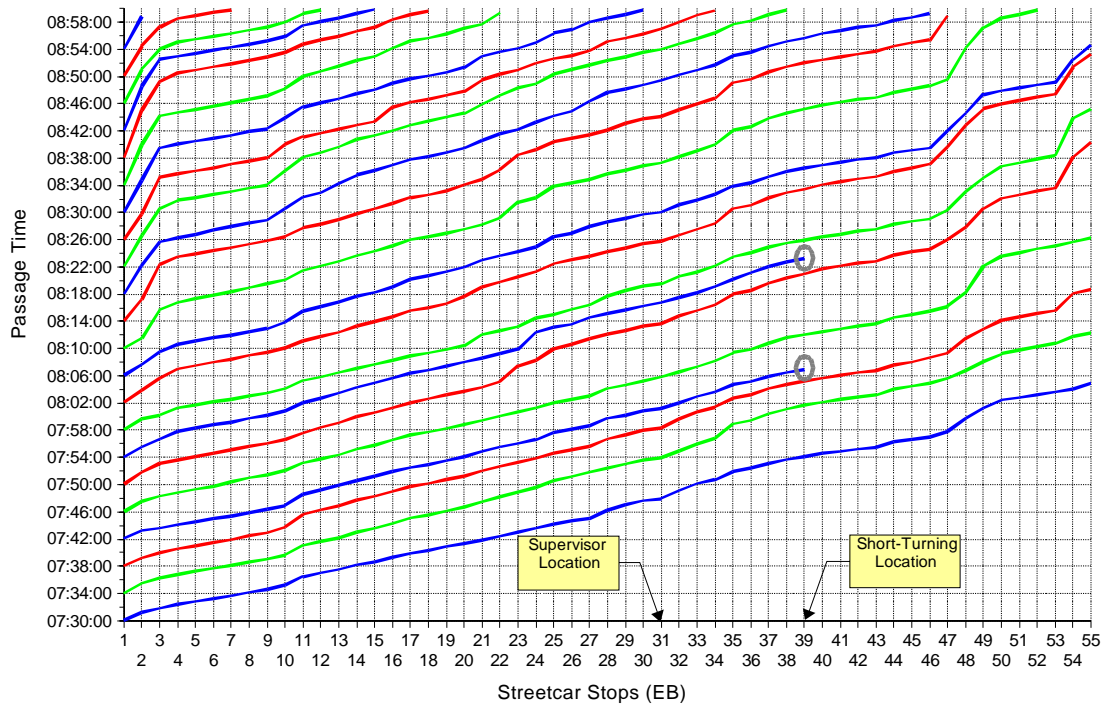


FIGURE 6 Time-space diagram of MU scenario (4-min headway-EB, supervised).

In general, the simulations show that MU operation with longer headways will result in more uniform service, less bunching and fewer short turns, compared to the single-unit operation with shorter headways.

Crowding Conditions at Peak Load Stop

Through measuring the streetcar loads at the peak load point of the 504 King streetcar route, one can evaluate the performance of the base case and the MU scenario from the passenger perspective. Figure 7 shows the crowding conditions measured at the Bathurst stop over the morning peak hour for the eastbound direction. There is a dotted line on the graph that indicates the TTC load standard for peak period CLRV streetcar routes (i.e., 72.5% of the practical capacity of the vehicle). Each vertical bar represents an individual streetcar run and the crowding condition is defined as the number of passengers on board divided by the practical capacity of the streetcar (i.e., 102 passengers for single unit and 204 passengers for MU operation). Note that the number of vertical bars is different in each set because of the difference in the scheduled headway, i.e., frequency of service.

Figure 7 shows six streetcar runs in the base case which have loads exceeding the load standard, and three of the runs are at their practical capacity. Whereas under the MU scenario with 4-min headway, only three streetcar runs have loads around the load standard, and none is 100% full. Also, the MU operation with 4-min headway has fewer streetcar runs carrying loads at the extreme ends of the distribution. In other words, the loading among the streetcar runs

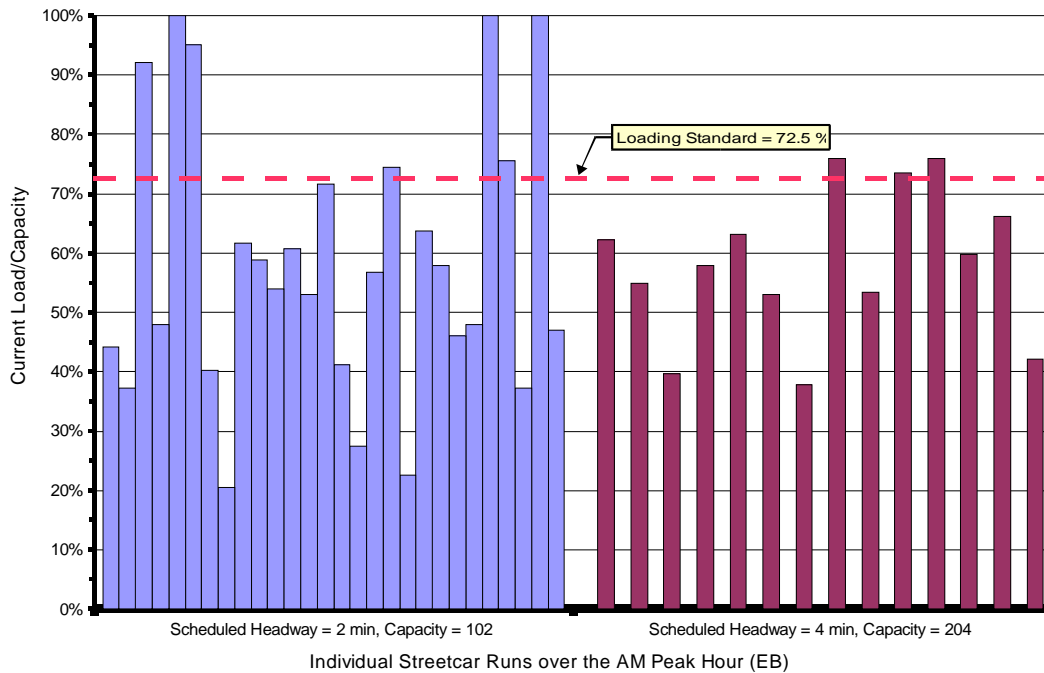


FIGURE 7 Crowding conditions at Bathurst (EB peak load stop).

observed under the MU scenario is more stable than the base case, and passengers are more evenly distributed among streetcars servicing the route. As a result, given the same fleet size, the overall level of crowding can be reduced by switching from single-unit operation to MU operation and doubling the headway.

Headway Variability

Normally, headway variability is assessed through calculating the standard deviation of headway. This is a good way for comparing scenarios featuring the same scheduled headway. However, the scenarios as defined in this study feature different scheduled headways, and as such it is not appropriate to use solely the standard deviation of headway for scenario comparison. In order to make a proper comparison, the coefficient of variation is used instead. It is basically a normalized statistic calculated through dividing the standard deviation of headway by the scheduled headway.

The seven transit stops as shown in Figure 8 are the typical time-point locations of 504 King. By determining the coefficient of variation of headway at these locations, one can obtain a fairly accurate estimation of the overall level of service reliability along the route. Figure 8 illustrates that the headway variability of the MU scenario measured at those transit stop locations is constantly lower than that of the base case. Note that the calculation here makes use of the results of all 23 simulation runs for each scenario.

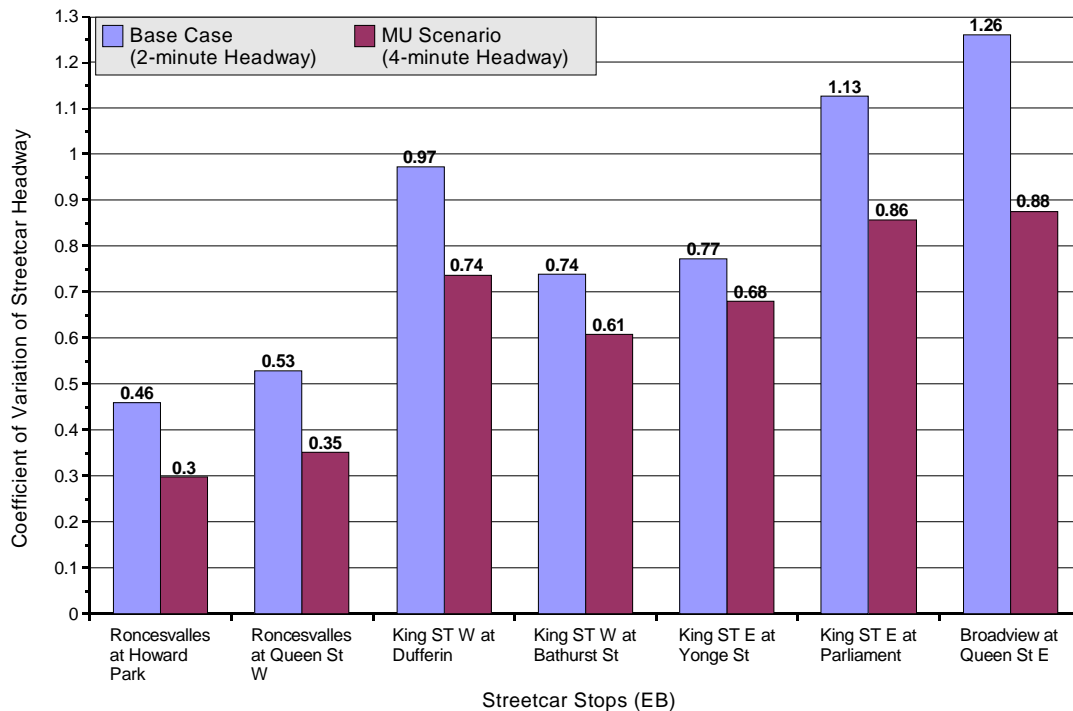


FIGURE 8 Streetcar headway variability (EB).

Streetcars are released at the terminal regularly. However, due to the influence of external and uncontrollable factors, the headway between streetcars starts to fluctuate as they travel down the route. In fact, [Figure 8](#) illustrates this pattern of increasing headway variability with distance from the starting terminal. For instance, a streetcar can easily be delayed at traffic signals, by traffic congestion, left turning autos or unusually long passenger service times. Assuming a uniform passenger arrival rate and a scheduled frequency of 2 min, a mere 30-s delay may lead up to a 25% increase in passenger demand at the next stop. The resulting surge in passenger demand is very likely to further delay the vehicle. Not only is this streetcar affected, but the one coming after has an increased likelihood to catch up with the current one since most of the passengers at that stop have already been picked up.

Frequency of Bunching

Bunching is one of the consequences of large headway variability on a high-frequency transit route. As mentioned previously, streetcar bunching is usually formed when one or more streetcars catch up to the streetcar ahead running behind schedule. Not only does streetcar bunching lower the quality of transit service, it is an obvious sign of inefficient transit operation. The frequency of bunching is considered a good indicator of the ability of MU operation to improve transit service. Since the scenarios under comparison feature different scheduled headways, it is not appropriate to define bunching as an absolute value (e.g., 30 s). Obviously, the probability of having actual headways less than 30 s (which is indicative of bunching) under a scenario of short scheduled headway (e.g., 2 min) is higher than the corresponding probability under a scenario with a longer scheduled headway (e.g., 2.5 min). To remove the inherent bias towards this evaluation, bunching is defined as a relative value, which is 0.5 times of the scheduled headway.

After averaging the results based on 23 simulation runs, the frequency of bunching at each transit stop is plotted in [Figure 9](#). Each line on the graph represents a particular scenario. As shown, the line representing the MU scenario consistently lies below the base case. That indicates the MU setup can effectively lower the frequency of bunching over the entire route. At some of the transit stops, the frequency of bunching is even decreased by 4 to 8 times.

Number of Customers Left Behind

Customers are left behind at a stop when a streetcar arriving at a stop is loaded to its practical capacity and waiting customers cannot board, thereby having to wait for a following streetcar with reserve capacity. The capacity of a single streetcar in the model is fixed at 102, which is considered as the practical capacity. In the ideal scenario where transit vehicles always arrive at the transit stops on schedule, customers should not be left at stops because the schedule is based on a load standard that is about 72% of the practical capacity. During the morning peak period, 504 King has about 25% more service than warranted even by the load standards to reduce the number of customers left waiting at stops because of overcrowding. Given the above, there should be more than enough service to accommodate passenger demand without overcrowding even with some delays and variability in customer arrivals.

However, the many uncontrollable external factors which affect streetcars operating in mixed traffic cause uneven distribution of passenger loads on streetcars servicing the route, resulting in some streetcars being unable to pick up all of the customers waiting at some stops.

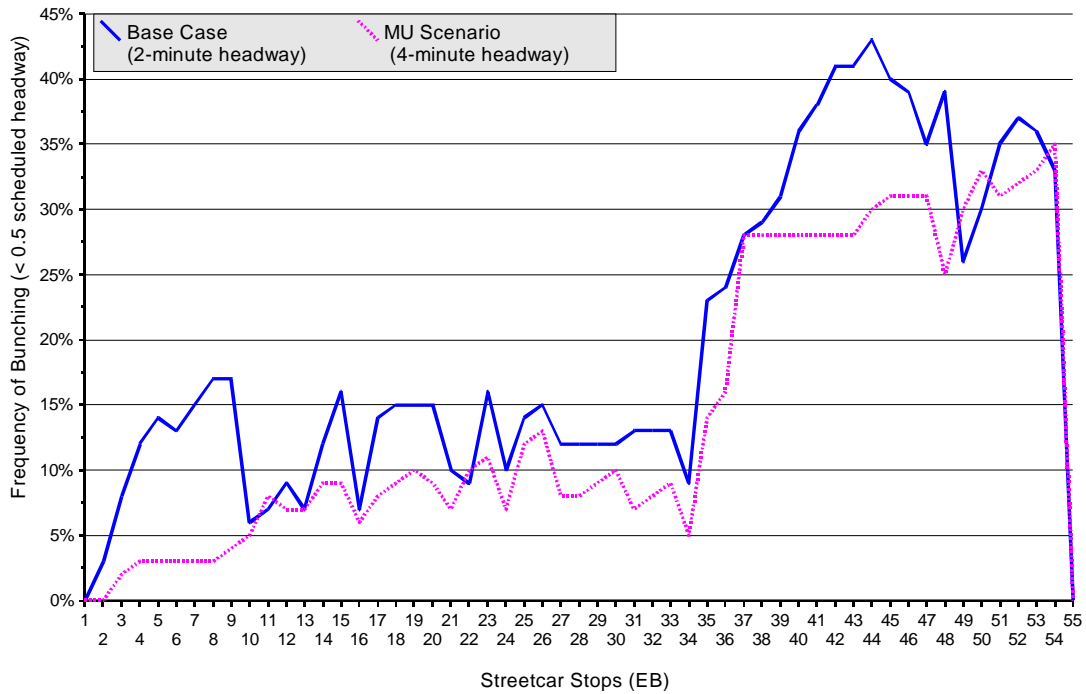


FIGURE 9 Frequency of bunching at various streetcar stops (EB route).

Thus the average number of customers left behind is an indication of the variability of individual streetcar loads as well as customer dissatisfaction at being left behind by overcrowded streetcars. A decrease in the variability of loading will lessen the likelihood of extreme streetcar loading (i.e. almost fully loaded) and consequently decrease the number of customers left behind.

The number of customers left behind for all scenarios (averaged over 23 simulation runs) within the morning peak period at affected transit stops are plotted in Figure 10. The transition from single-unit (base case) to MU scenario shows a substantial decrease in the number of customers being left behind, and in some high-demand stops, no customers are left behind at all. From the above, it can be concluded that the MU operation with wider headway can reduce the number of customers left behind at stops in the vicinity of the peak load point(s) during the morning peak hour.

Overall Corridor Statistics

Table 1 shows the overall corridor statistics of the 504 King streetcar route under operating scenarios that were modeled. Some operating characteristics that were recorded from the model include the trip running time, coefficient of variation of headway, frequency of bunching, average number of customers left at stops, round trip running time, average speed of transit and traffic etc. These statistics are the average values based on the results of 23 simulation runs and for all stops (by direction) combined. The results are grouped under the base case scenario and the MU scenario.

Based on the load standard and existing passenger demand at the peak load point of the 504 King streetcar route, a scheduled headway of 2.5 min is warranted. However, at such a

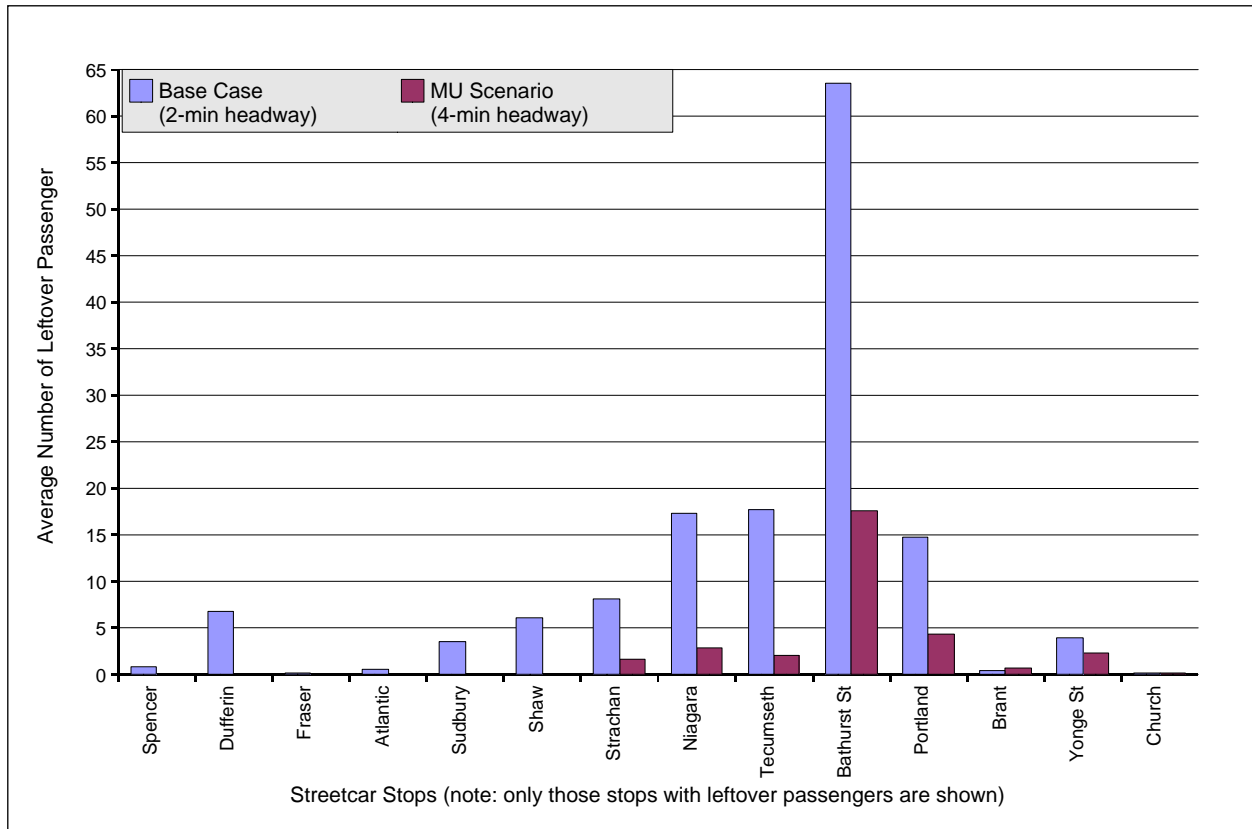


FIGURE 10 Average number of leftover passengers (8:00 a.m.–9:00 a.m., EB).

TABLE 1 Overall Corridor Statistics

	Base Case (Scheduled Headway of 2 min.)		Multiple-Unit Scenario (Scheduled Headway of 4 min.)	
	Westbound	Eastbound	Westbound	Eastbound
Average One-way Trip Running Time	54 min 7 sec	52 min 36 sec	50 min 16 sec	50 min 33 sec
Std Dev of One-way Trip Running Time	5 min 11 sec	5 min 57 sec	4 min 24 sec	5 min 46 sec
Average Headway	148.2 sec	168.9 sec	298.1 sec	316.2 sec
Coefficient of Variation of Headway	0.9642	0.9029	0.6374	0.7119
Average Transit Service Frequency	24.3	21.3	12.1	11.4
Person Throughput	1823	1598	1815	1710
Frequency of bunching (< 0.5 scheduled headway)	20.4%	15.1%	14.5%	12.1%
Expected Waiting Time	142.98 sec	153.31 sec	209.6 sec	238.2 sec
Avg Vehicle Load	36.4	31.6	70.6	58.4
Coefficient of Variation of Vehicle Load	0.5343	0.7155	0.5086	0.6769
Average number of Leftover Passengers	38	144	5	32
Cycle Trip Running Time (including 2 minutes layover time)	108 min 43 sec		100 min 49 sec	
Fleet Size Required	55		52	
Average Speed of Transit	12.31 km/h		13.98 km/h	
Average Speed of All Traffic	14.73 km/h		16.20 km/h	

frequency many customers were being left behind at transit stops near peak load points because of overcrowding that results from even relatively minor headway variability. As a result, more streetcars were added to the route to reduce the number of customers being left behind resulting in a scheduled headway of 2 min (base case) during the morning peak period.

The results show that MU operation will result in reduced trip running time over the existing single-unit operation. The average westbound trip times decreased from approximately 54 min to 50 min while the eastbound trip time decreased from approximately 52.5 min to 50.5 min. The trip time decrease is partially due to the reduction in headway variability. With smaller headway variability, streetcars can arrive at transit stops more regularly which reduces the likelihood of lengthy passenger service times associated with streetcars carrying a large gap. This reduction in headway variability is reflected in the reduction of coefficient of variation of headway from the existing single-unit operation to the MU operation.

Streetcar bunching has been plaguing the 504 King streetcar route consistently throughout the day resulting in large gaps in service followed by overcrowded streetcars leaving waiting customers behind and causing frustration. Overall, the frequency of bunching drops from 20.4% under the existing single-unit operation to 14.5% with MU operation.

Finally, the overall average speed of transit and all traffic increases slightly from the existing case to the MU scenario. The simulations indicate that MU operation is also beneficial to general traffic. As 504 King streetcars operate in mixed traffic and serve customers from the sidewalk, all following traffic is required to stop during passenger service activity. Consequently, any reductions in the duration of passenger service activity will generate reductions in other vehicle stops. As MU operations would decrease the number of transit vehicles by half with no associated increase in passenger service time per vehicle, fewer automobiles would be stopped. Furthermore, the reduction in overcrowding and the resultant decrease in passenger service time associated with overcrowding would further improve traffic flow along the route as the duration of stops would decrease.

SUMMARY, CONCLUSIONS, AND RECOMMENDATIONS

A microscopic simulation model was applied to simulate the existing streetcar operation along the King St. A plug-in program was developed exclusively for this study to accurately reflect the local passenger boarding behavior and was incorporated into the simulation model. The results suggest that there is a linear relationship between the boarding time per passenger and the current loading of streetcar beyond a threshold loading value.

The simulation results show that under the existing base case configuration (i.e., single unit operation), the reduction of scheduled headway from 2.5 min to 2 min results in less crowding and fewer customers left at stops by overcrowded streetcars. However, the benefits of operating the streetcars with an even shorter headway are offset by increased headway variability, increased bunching, and increased need of short-turning. Reducing bunching, onboard crowding, and the need to short-turn streetcars on frequent streetcar routes can be done through MU streetcar operation with wider headways.

The proposed configuration of MU streetcar operation was set up and evaluated carefully through the same microsimulation model. The MU setup was attained through the coupling of streetcars in units of two and doubling the existing scheduled headway. The passenger boarding behavior model was adjusted to reflect the two-door boarding. Data from the simulations were

used to create various graphs and tables to allow a comparison of the two types of operations. Given the same fleet size, the change from single-unit to MU operation results in a decrease in headway variability, substantially fewer customers left behind at stops, less onboard crowding, less bunching, and reduced need of short-turning. For such a high-demand service in mixed traffic operation and subject to numerous exogenous factors (e.g., traffic signals, left turns, traffic congestion, etc.), MU operation with wider headway allows streetcars to better absorb small deviations from the scheduled headway and as such yields a more stable operation, without having to increase service above that warranted by the load standards as is done on the 504 King streetcar route.

REFERENCES

1. *Transit Capacity and Quality of Service Manual, 2nd Edition*. Transportation Research Board of the National Academies, Washington, D.C. 2003, p. 572.
2. *Operational Analysis of Bus Lanes on Arterials*. TRB, National Research Council, Washington, D.C., 2000, p. 70.
3. Shalaby, A., B. Abdulhai, and J. Lee. Assessment of Streetcar Transit Priority Options Using Microsimulation Modelling, Special Issue on Innovations in Transportation Engineering, *Canadian Journal of Civil Engineering*, Vol. 30, No. 6, 2003, pp. 1–10.
4. Quadstone Limited. *Modeller Reference Manual of Quadstone Paramics V4.2.*, Scotland, December 2003, pp. 11–172.
5. Quadstone Limited. *Modeller User Guide of Quadstone Paramics V4.2.*, Scotland, December 2003, pp. 4–119.
6. Quadstone Limited. *Programmer User Guide of Quadstone Paramics V4.2.*, Scotland, December 2003, pp. 6–29.
7. Ling, K., and A. Shalaby. Evaluation of Multiple-Unit Streetcar Operation: A Case Study of the 504 King Route. Technical Report prepared for the Toronto Transit Commission, July 2004, pp. 4–52.

STREETCARS

Streetcar Modernization in CEEC

MICHAL POSPISIL

Dopravní Podnik Praha

Streetcar Modernization in CEEC

Saint Louis, Missouri
April 2006

UTP


Dopravní podnik hl. m. Prahy,
akciová společnost

Cegelec
Solutions & Services

Countries in Our Presentation

- 
- Armenia
 - Azerbaijan
 - Belarus
 - Bosnia-Herzegovina
 - Bulgaria
 - Croatia
 - Czech Republic
 - Estonia
 - Georgia
 - Hungary
 - Latvia
 - Poland
 - Romania
 - Russia
 - Serbia
 - Slovakia
 - Turkey
 - Ukraine

Streetcar Systems in CEEC

- In **169 towns** of **18 countries**
- Total length of networks (routes) **7,750 km**
- Very **important role** of streetcar systems in public transport in most of these towns
- Limited private car ownership

Streetcar Producers

- Production of streetcars based on PCC principles—requirements on modern streetcar
- Main producers of streetcars in CEEC:
 - **CKD Tatra** (Czech Republic)—
 - About 17,000 streetcars from 1952 till 2002 (PCC-based type), more than 25,000 from the start of production
 - **Ust-Katav** (Russia)
 - About 16,000 streetcars since 1969



Local Streetcar Producers

- Local producer of streetcars:
 - **Waggonfabrik** Gotha (Germany, former GDR)
 - **Konstal** Chorzow (Poland)
 - **Tramkar** Sofia (Bulgaria)
 - **Faur** Bucharest (Romania)
 - **Public Transport Works** St. Petersburg (Russia)
 - **Janko GredeljWorks** Zagreb (Croatia)
 - **INEKON** Trams Ostrava (Czech Republic)
 - **SKODA** TRANSPORTATION (Czech Republic)

Streetcar CKD Tatra Type T3



- The most of streetcars in CEEC are of CKD Tatra type T3 or derived from ones of non-CKD Tatra production.

- 11,353 pieces of CKD Tatra T3 type were exported in Soviet Union from 1963-1987.



Situation on the Market

- After collapse of Communism and the Soviet Union, the following events were very important in CEEC:
 - To prevent decline or closure of streetcar systems;
 - To improve and develop existing streetcar systems;
 - The economic conditions in individual countries were very different;
 - No possibility to buy large number of new cars; and
 - Modernization is the most important way to solve the situation.



Possibilities
Overhaul or modernization?

- **General overhaul**
- **Vehicle modernization—traction package**
- **Vehicle modernization—central low-floor section**
- **Articulated vehicle of two single cars**
- **Second-hand streetcar purchase**



Streetcar Modernization
Transport Authority Prague

Important Points of the Streetcar Modernization

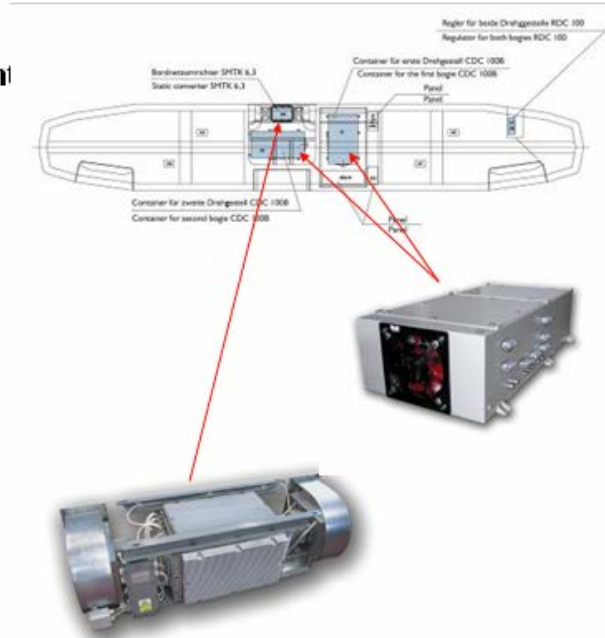
Electrical Part



- Traction converter TV Progress
- Static converter SMTK 6,3
- New side switchboard
- New arrangement of driver's control desk
- Back running stand
- Information system
- Passenger clearance system
- New door drives

Main Components of the Traction Equipment

- **TV Progress**
IGBT-based traction equipment (DC Drive System)
- **Static converter SMTK 6,3**
- **Microprocessor and Analog Regulator**
- **Skip-skid protection**
- **Diagnostic equipment**



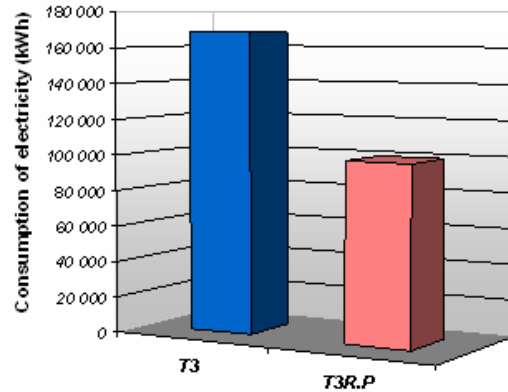
Electricity Savings after Modernization

- Comparison of electricity consumption at the 50,000 km yearly traffic capacity

Streetcar type	T3 (Accelerator)	T3R.P (TV Progress)
Electricity consumption	168 350 kWh	99 220 kWh



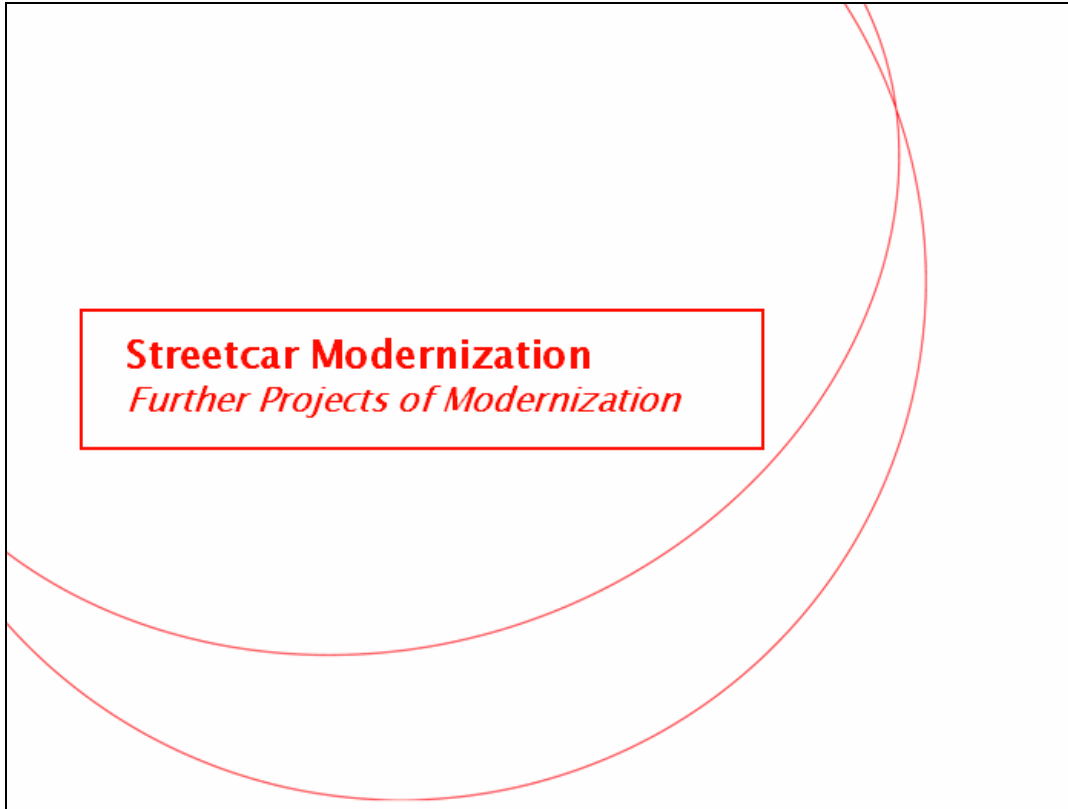
- Electricity consumption of vehicle T3R.P is **1.98 kWh/km**
- Yearly saving is **69,150 kWh**
- Electricity saving is **40%** compared with T3 with accelerator



Further Advantages of the Modernization

- High reliability
- Higher serviceability
- Independent steering of single bogies
- Higher running comfort of both passengers and driver
- Contactless execution
- High short-circuit and transient phenomena resistance
- Extension of streetcar service life
- Lower purchase costs compared with a new streetcars





Further Projects of Modernization

Streetcar Type of KT8.N2

KT8D5 Bi-directional three-section streetcar

Low floor section

DC drive TV PROGRESS
New control system
Static converters
Camera system
Air conditioning system

KT8.N2

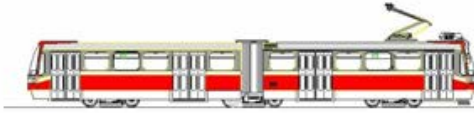
Further Projects of Modernization

Streetcar Type of KT8.N2

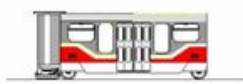
- **Traction equipment 2 x TV Progress**
- **Static converters 2x SMTK 6,3**
- **Static converter 1x SMTS 7,5**
- **Low-floor middle part with a ramp for wheelchairs**
- **Air conditioned driver's cabin**
- **Camera system**

Further Projects of Modernization *Streetcar Type of K3R.N – DPMB Brno (CZ)*

K2 articulated streetcar two bogies motorized

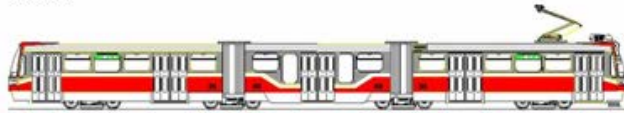


Low-floor
section



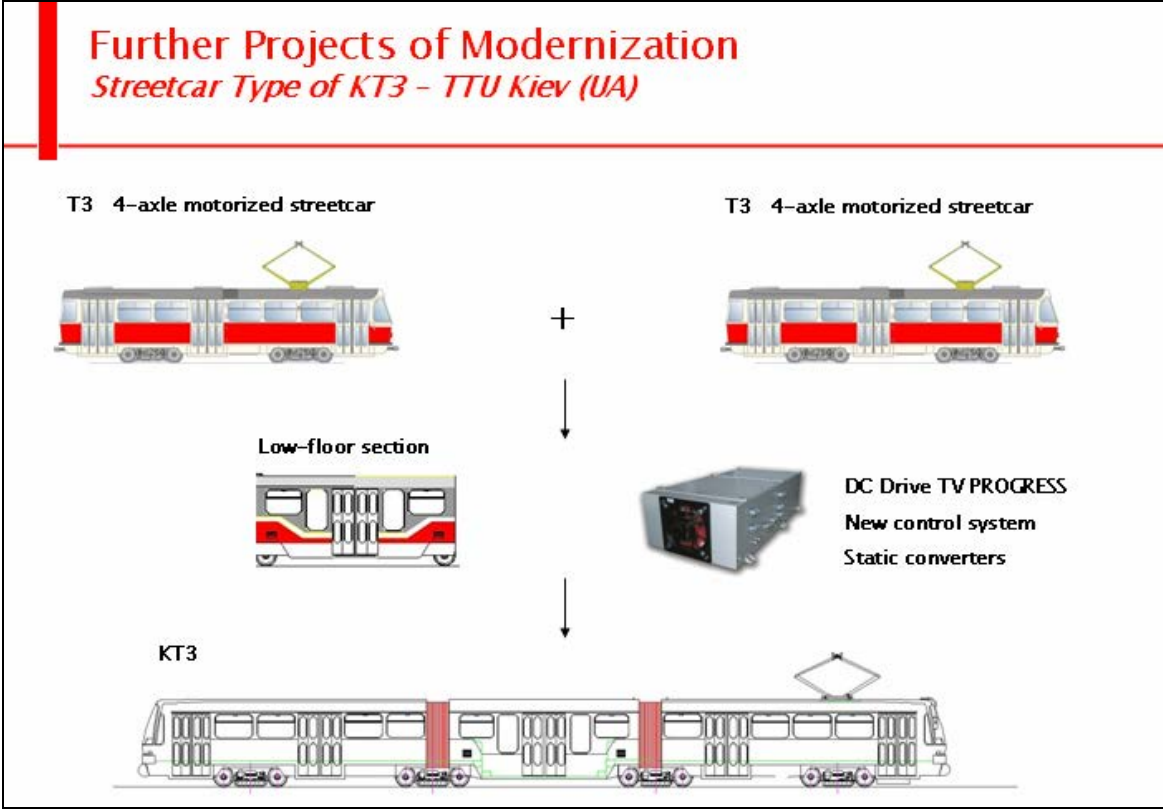
DC drive TV PROGRESS
Supervisory control system
Static converter

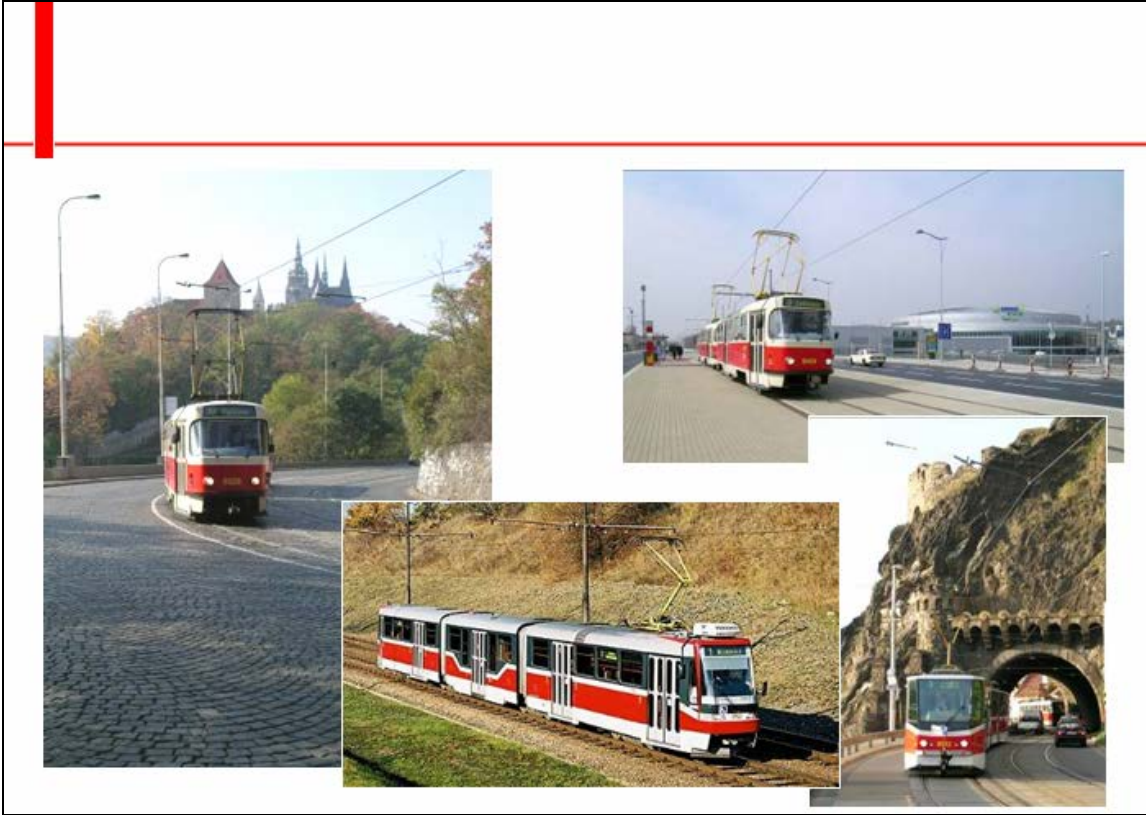
K3R.N



Further Projects of Modernization *Streetcar Type of K3R.N – DPMB Brno (CZ)*







STREETCARS

Fitting the Streetcar into a Built Urban Environment

JAMES H. GRAEBNER

Lomarado Group

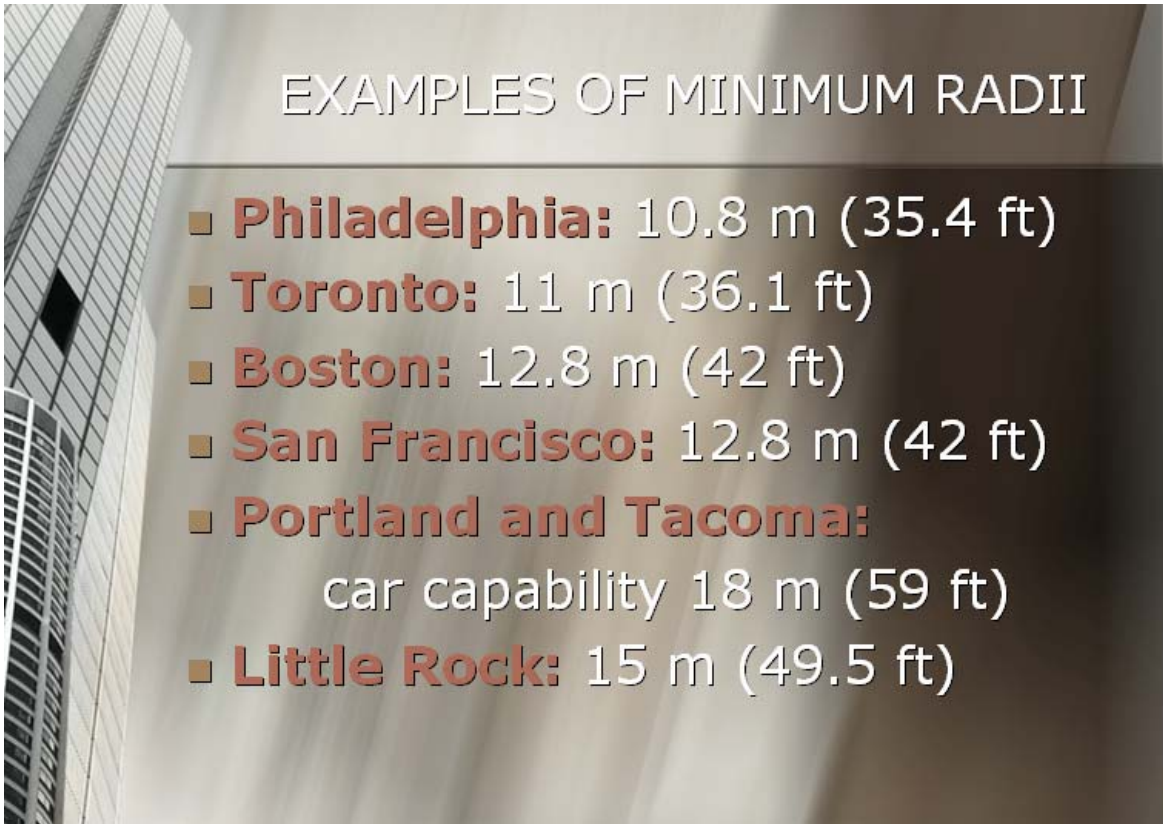


KEY ELEMENTS OF FIT

- Track
- Power System
- Passenger Stops
- Operations
- Neighborliness

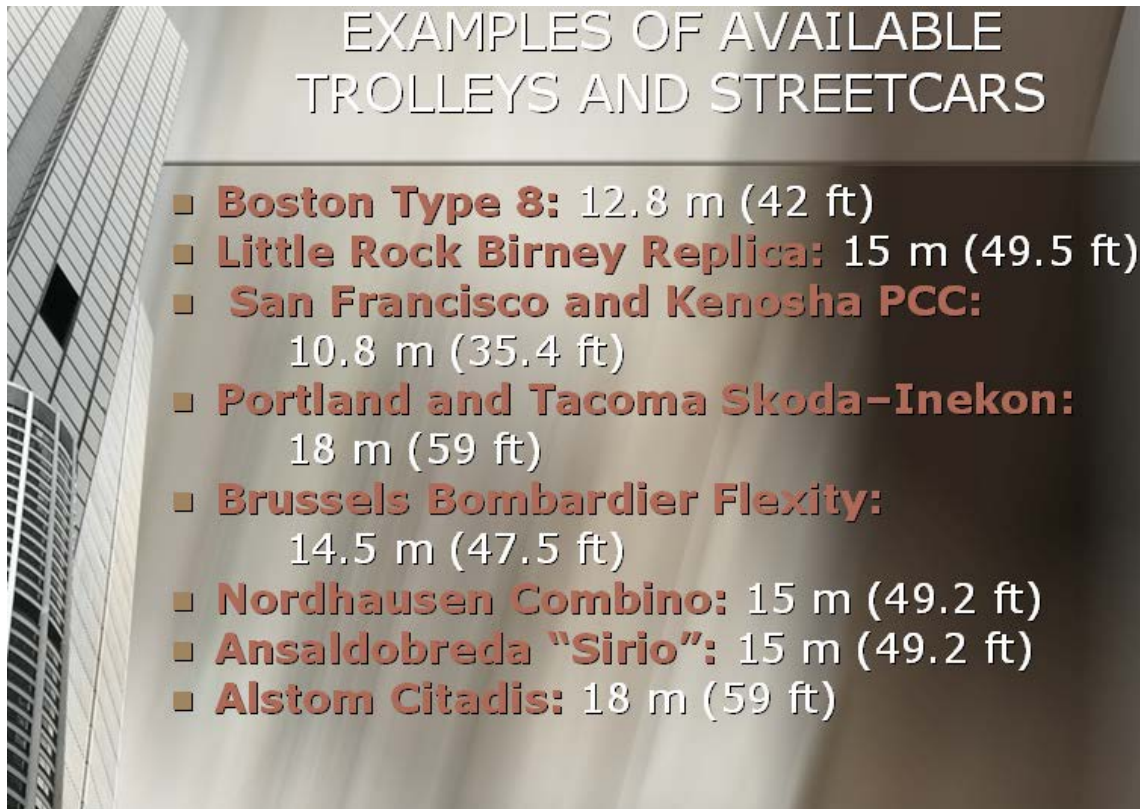
TRACK

- Curves
- Grades



EXAMPLES OF MINIMUM RADII

- **Philadelphia:** 10.8 m (35.4 ft)
- **Toronto:** 11 m (36.1 ft)
- **Boston:** 12.8 m (42 ft)
- **San Francisco:** 12.8 m (42 ft)
- **Portland and Tacoma:**
car capability 18 m (59 ft)
- **Little Rock:** 15 m (49.5 ft)



EXAMPLES OF AVAILABLE TROLLEYS AND STREETCARS

- **Boston Type 8:** 12.8 m (42 ft)
- **Little Rock Birney Replica:** 15 m (49.5 ft)
- **San Francisco and Kenosha PCC:**
10.8 m (35.4 ft)
- **Portland and Tacoma Skoda-Inekon:**
18 m (59 ft)
- **Brussels Bombardier Flexity:**
14.5 m (47.5 ft)
- **Nordhausen Combino:** 15 m (49.2 ft)
- **AnsaldoBreda "Sirio":** 15 m (49.2 ft)
- **Alstom Citadis:** 18 m (59 ft)



POWER SYSTEM

- Simple Suspension
- Joint Use of Poles
- Minimize the Cobwebs



PASSENGER STOPS

- ADA Compliance
- Simplicity
- Frequency
- Location





NEIGHBORLINESS

- Being a Good Neighbor
- Noise and Vibration
- Construction Time
- Aesthetics



LESSONS LEARNED

- Rail is not limited to **BIG CITIES**
- Streetcars **CAN** be built inexpensively
- Streetcars can catalyze urban economic redevelopment
- Streetcars can be integrated into a **Built Urban Environment...** though it requires **SPECIAL CARE!!**







Meet-the-Authors Poster Session

MEET-THE-AUTHORS POSTER SESSION

How Much Do We Really Know?
*An Evaluation of Past and Current Research Regarding the Costs
and Benefits of the Hiawatha Light Rail Line*

GAVIN POINDEXTER
JOHN O'CONNELL
University of Minnesota

In 2004, the Hiawatha Light Rail Line (Hiawatha LRT) began service connecting downtown Minneapolis, eleven neighborhoods, the Minneapolis–St. Paul International Airport, and the Mall of America. Like many major public infrastructure investments, the line was a contentious issue. Future LRT lines, commuter rail, and bus rapid transit (BRT) lines are planned in the region, requiring a thorough assessment of the degree to which the Hiawatha LRT is meeting its goals. Consequently, decision makers need carefully designed evaluations of this line as they consider future transit investments. This paper discusses strategies under consideration to analyze and evaluate the economic and social impacts by first examining how evaluations have been performed in similar environments, accounting for differences in mode types, and then analyzing which methods may be most suitable to evaluate the Hiawatha LRT.

First, we consider many of the challenges involved with attributing a variety of changes to the Hiawatha LRT. These challenges include defining the appropriate impact area and time frame for measuring changes in social and economic conditions in the corridor.

Second, we offer a framework to understand myriad concerns. Such issues include the need to measure both generative (e.g., travel time savings and decreased cost of production) and distributive (e.g., changes in land use and shifts in retail sales) effects. We describe a variety of approaches for doing so, including surveys, interviews, and quasi-experimental comparisons, that employ longitudinal data and the necessary statistical controls. Various tools, including travel demand models, econometric models, hedonic price models, and utility choice models, are discussed as they apply to evaluating the Hiawatha LRT.

Third, we discuss the availability of data, data collection methods, and comments on the quality of available data. Such discussion explores appropriate time periods for analysis of the Hiawatha LRT, the methods for determining the populations that are affected by the Hiawatha LRT, and the selection of appropriate controls. Finally, we consider ways in which key groups interested in evaluating the LRT, such as Hennepin County, the Metropolitan Council, and the University of Minnesota, can work together to share data and produce a more comprehensive analysis and evaluation of the LRT.

INTRODUCTION

When government agencies make large infrastructure investments it is necessary to evaluate whether it was a good investment of public dollars. This is even more important when the project involves a new technology or has some other unique aspect that might be repeated elsewhere in the Twin Cities of Minneapolis–St. Paul or the country. The Hiawatha Light Rail Line (Hiawatha LRT), like many large investments, required the coordination of a diverse group of stakeholders—both governmental and nongovernmental organizations. It is also important that these groups continue to be involved in the evaluation. This paper details the strategies being used to assist in this coordination and to evaluate the economic and community impacts of the Hiawatha LRT.

In the case of the Hiawatha LRT, many stakeholder groups strongly desired nonduplicative evaluations of the Hiawatha LRT. Several groups, including the City of Minneapolis, City of Bloomington, Hennepin County, Metropolitan Council, Metro Transit, and the University of Minnesota, immediately stepped up to shape the evaluations of the Hiawatha LRT. Currently, each is working to expand their capabilities to quantify the impacts of the Hiawatha LRT through increased experience and collaboration. The agencies decided that it would be best if they worked together to establish common ground. The first phase of this process was to identify previous, current, and future evaluations of the impacts of the Hiawatha LRT. Additionally, these agencies worked together to identify sources of collected data which could be analyzed to shed light on the impact of the Hiawatha LRT. This group was not formed to limit the research and evaluations done on the Hiawatha LRT, but rather to increase the awareness of the research that is being done. Through increased awareness of Hiawatha LRT evaluations, the shared knowledge will augment collaboration of information and resources.

BACKGROUND

History

The Twin Cities, like many other major cities in the United States, developed around streetcars. The last of the original streetcars in the Twin Cities discontinued service in 1954 (1). Light rail transit (LRT), which is in some ways is the modern-day streetcar, continues to make a resurgence not only in the Twin Cities but in cities throughout the United States (2). In 2004, the Hiawatha LRT began service, connecting downtown Minneapolis, 11 neighborhoods, the Minneapolis–St. Paul International Airport, and the Mall of America. Prior to the 1950s the Minnehaha Street Car line ran parallel to the current alignment of the Hiawatha LRT, just a few blocks east of a substantial portion of the line.

Future Plans

The Twin Cities Metropolitan Council, as part of its 2030 Transportation Policy Plan (3), identified eight corridors that could be used for transit ways. Five of the transit ways identified are designed to bring people into and out of downtown Minneapolis; two are designed to bring people to and from downtown St. Paul; and the final transit way identified would act as a connector between downtown Minneapolis and downtown St. Paul. By the spring of 2005, two of the transit ways had opened (Hiawatha LRT and high-occupancy toll lanes on I-394). Some of the funding has been secured for

phase one of the Northstar commuter rail line, running from downtown Minneapolis to Big Lake. The next 30 years will be a time of rapid transit expansion in the Twin Cities metro region (3). With this expansion of transit, the need for standard measures of the impacts arises. This paper presents the evaluations of the Hiawatha LRT so that they may be used as a model for evaluating other transitways here in the Twin Cities.

Corridor

The Hiawatha Corridor has long been considered a key transportation corridor in the Twin Cities because it connects downtown Minneapolis with the Minneapolis–St. Paul International Airport and the southeastern suburbs. Plans to turn the Hiawatha corridor into a major transportation corridor have changed over the years. Ideas have included building a freeway, light rail, or BRT. In the past, plans were abandoned in the face of neighborhood pressure.

Stations

The stations along the Hiawatha LRT are often grouped into four groups when discussed for the purposes of evaluation: Downtown stations, Minneapolis neighborhood stations, government property, and Bloomington stations (see [Figure 1](#)).

The downtown stations are some of the busiest stations along the Hiawatha LRT. Approximately 150,000 people work in downtown Minneapolis; downtown is also home to around 22,000 people (4). There are many businesses, events, restaurants, and bus lines within easy walking distance of the Hiawatha LRT stations. However, as it is a large concentration of businesses, the influence of the national economy and regional market makes determining the impacts of the Hiawatha LRT difficult in downtown Minneapolis. There is no other part of the metropolitan region that is comparable and there is also the possibility of other factors playing a significant role in the vitality of downtown Minneapolis.

The demographics around the Minneapolis neighborhood stations change as one travels south along the Hiawatha LRT, with the population becoming wealthier, less racially diverse, and less densely populated. Next to the Cedar Riverside station, the furthest north of the neighborhood stations, are high-rise housing complexes, which contain approximately 1,250 partially subsidized units. Single-family homes and a large regional park surround 50th Street Station, the furthest south of the Minneapolis neighborhood stations.

The stations located on government property include the Ft. Snelling park and ride, VA medical center, and both airport terminals. While these four stations are extremely busy stations, they are used primarily as either employment centers or parking lots for those who work in downtown and use the Hiawatha LRT to commute to work. It is difficult to measure the economic and community impacts. For the most part, the benefit of these stations will not be concentrated on the immediate surrounding area but will be more spread out over people who live and work throughout the metro area.

The three stations in Bloomington are unlike the stations in Minneapolis because they are located in a low-density auto-dominated suburban environment with very few residents. The Mall of America Station is located in a parking ramp. The 28th Street Station is a park-and-ride station. Bloomington Central Station is a unique station because the station was built in the middle of a large parking lot. The large parking lot is currently being redeveloped into a large-scale transit-oriented development (TOD), which is designed to be the “Third Downtown” for the Twin Cities (5).

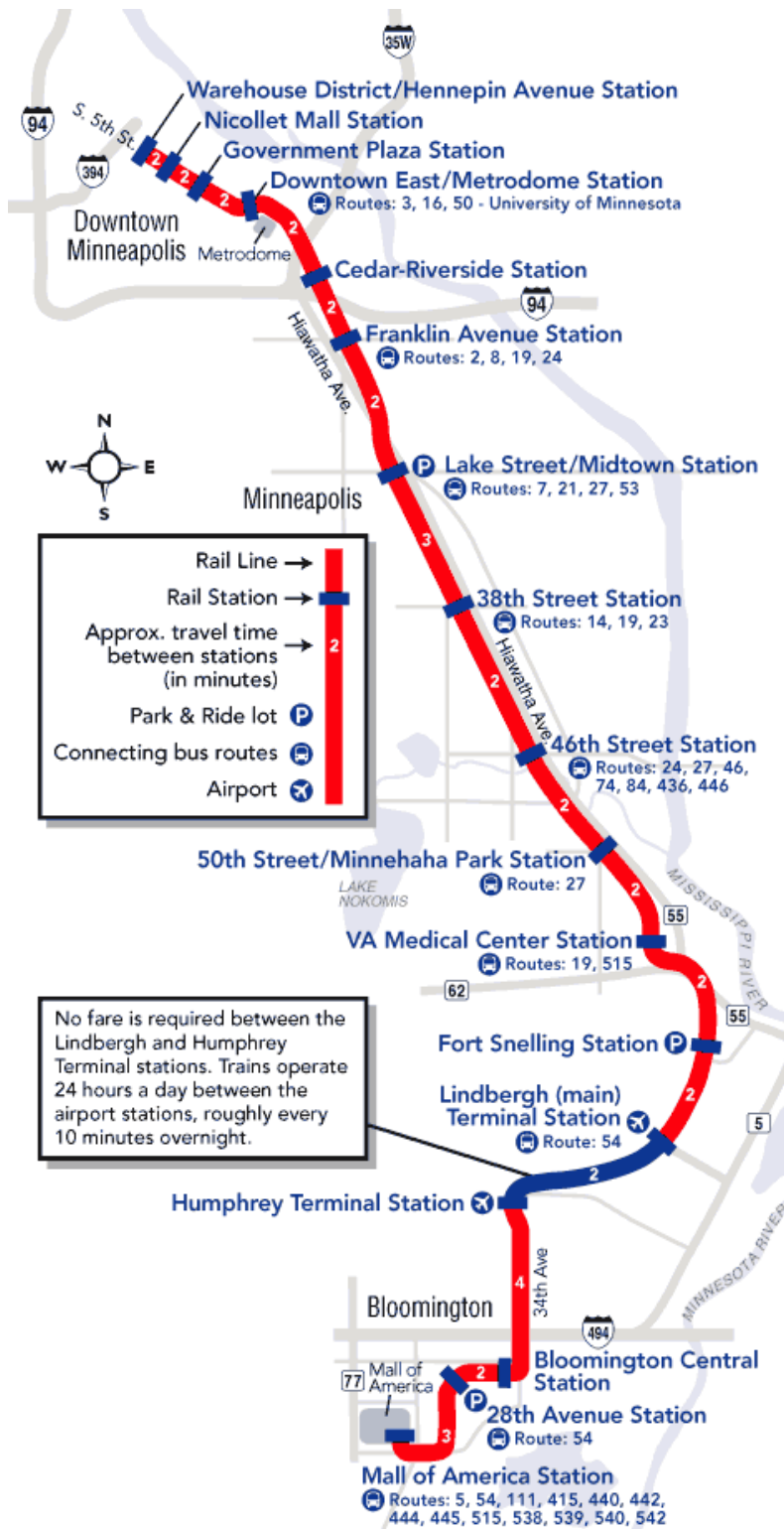


FIGURE 1 Map of Hiawatha LRT.

EVALUATIONS

Need for Evaluations

There is little empirical evidence that policy makers can use to make decisions about the future of LRT in the Twin Cities. In order to develop the empirical evidence we turn to evaluation theory. Mel Mark argues that evaluation theory “most importantly, functions as a guide to practice,” and that “evaluation theories are a way of consolidating lessons learned, that is, of synthesizing experience” (6). Empirically, evaluation theory helps determine the worth, merit, and value of a project by providing a method to summarize data that has been collected in regards to a project. Patton lays out guidelines for evaluation of a major project.

- Find people who need or care about the evaluation.
- Identify users of the program and locate enthusiastic people who will remain committed.
 - Decide the quantity, quality, and timing of contact with intended users. Sensitivity to their schedules and lives should be considered.
 - Build and sustain interest in the project among users and evaluators.
 - Implement a communication plan. Use evaluator’s people skills to navigate conflicts and political quagmires.
 - Include all stakeholders in the process. Some projects will have multiple levels of stakeholders who may only want to be involved to a limited degree. Tailor communication to accommodate them (7).

These six principles apply to the evaluations of the Hiawatha LRT at various levels. The Metropolitan Council, Metro Transit, Hennepin County, the cities of Minneapolis and Bloomington, and the University of Minnesota are each assessing, through various methods, the impacts of the Hiawatha LRT. Depending on the aspect that is measured, there are different stakeholders and users to be considered for the evaluation. For example, the University of Minnesota, with assistance from Metro Transit, is analyzing impacts on travel behavior of neighborhood residents. Metro Transit is also conducting a study looking at the mode share along the Hiawatha Corridor.

There is a recognized interest in sharing information and having different agencies build off each other’s research. However, this becomes more difficult because there is no desire to have a central authority assigning specific evaluations to each agency. Instead, Hennepin County and the University of Minnesota are working to improve communication between researchers from various agencies regarding past, current, and future evaluations of the Hiawatha LRT.

Specifically, the University of Minnesota, in partnership with Hennepin County, is developing an inventory to inform all interested parties of data currently being collected that are potentially valuable to the evaluation of the Hiawatha LRT. As such, the University of Minnesota and Hennepin County are engaged in an ongoing dialogue with various city and regional agencies to that end. This dialogue is the foundation for continued communication about evaluations of the impacts of the Hiawatha LRT. Agencies that are interested in evaluating the Hiawatha LRT are working together to determine specific impacts of the Hiawatha LRT they would like to evaluate. Having an inventory of evaluations being done by other agencies enables

them to make informed decisions about how they could contribute to the overall knowledge of the impacts of the Hiawatha LRT.

EVALUATION CONSIDERATIONS

Study Area

Different agencies have chosen to use different methods to define the station areas. For its evaluations, Metropolitan Council defines study areas based on traffic analysis zones (TAZ) around the Hiawatha LRT. Metropolitan Council made this decision so that their findings will be comparable with estimates prior to construction of the Hiawatha LRT. Researchers at the Humphrey Institute at the University of Minnesota define the study area using buffers from the Hiawatha LRT station. The University of Minnesota is more concerned about measuring impacts at different distances from the station, and at what threshold there is no longer a measurable difference. They intend to look at impacts in a buffered area from the stations of 400, 800, and 1,600 m in network distance. These distances were selected because major transit destinations need to be within a half-mile to have an impact on pedestrian walking (8, 9).

Time

Policy makers use evaluations to shape the direction and scope of transit planning and often the palpable public desire for immediate results shapes policy discussion. However, transit solutions, particularly large-scale infrastructure development, often require long-run evaluations. Therefore, two different viewpoints surround the debate. The first is that an evaluation should take place as soon as possible after the completion of the infrastructure development. For example, Metroa in Chicago conducted a short-run evaluation for the North Central Service Line. This viewpoint acknowledges the immediate public desire to determine if the project was worth the investment and the need to have the most current information available to shape public policy. In addition, the costs and benefits that occur as a direct result of the infrastructure project (e.g., increased congestion) might be mitigated by other factors (e.g., increase or decrease of a certain business activity), the longer the infrastructure is in place.

A long-term evaluation allows a sufficient amount of time to pass after the infrastructure project is complete before assessing the impacts. Land use, density, and the real estate market take several years before fully responding to the infrastructure project. Landis and Cervero used a long-run evaluation in their report, *Twenty Years of BART: Land Use and Development Impacts* (10).

In the case of the Hiawatha LRT, evaluators are planning several studies now or in the near future. Currently, there is also an effort to preserve data and information used in these studies for future researchers if, and when, they choose to conduct long-term research looking back on the impacts of the Hiawatha LRT. There is a desire to create a regularly updated library of data on the Hiawatha LRT and other transit ways in the Twin Cities so that necessary information will be available to researchers in the future. For example, the Metropolitan Council's Before and After Study looks at all building permits issued 5 years prior to construction, during construction, and 5 years after completion. However, at this time there is no central repository for data of this nature. The goal of this library would be two-fold: first, to keep

the reports and findings of the Metropolitan Council and others conducting evaluations; and second to provide data that were used to develop their findings. This would allow researchers more freedom as they evaluate the Hiawatha LRT in the future. In addition to storing the data used in current studies, the agencies need to collaborate on developing a system that preserves these data. Furthermore, they need to continually collect data in the future so that in 2024 researchers can conduct a “Hiawatha at 20” study.

METHODS TO CONDUCT ANALYSIS

Primary Data

For many of the studies of the Hiawatha LRT it is/was necessary to collect primary data. Metro Transit's study, *Vehicle Occupancy and Bicycle/Pedestrian Activity*, involved counting the number of vehicles traveling along Hiawatha Avenue in each direction, the number of people in each vehicle, as well as counting pedestrian and bicycle trips. Metro Transit conducted this study both before and after operation of the Hiawatha LRT.

Other studies such as ridership counts and license plate surveys require the collection of primary data. They also provide interesting information about the use of the Hiawatha LRT. It is possible that primary data will be culled from future traffic counts, if we decide that information is necessary before 2008.

Surveys

Surveys are a good way to measure public perception and to gather information about why people are using the LRT. Several surveys have been conducted as part of the evaluation of the Hiawatha LRT. The first survey of riders was collected primarily to determine who was riding the Hiawatha LRT as a marketing tool for Metro Transit. Metro transit did another survey of riders of both the LRT and buses to analyze travel behavior. Laverny-Rafter, from the University of Minnesota, conducted a survey of neighborhood residents assessing both neighborhood impressions and travel behavior.

Interviews

Interviews are another way to gather public perception and other qualitative data. In the case of the Hiawatha LRT, interviews were used in a study done by Douma, Poindexter, and Patterson from the Humphrey Institute, which examined the planning process for the station areas. Drawbacks to this method include increased costs, time spent, and little (if any) quantifiable data. However, interviews can take the research in a new direction or shed new light on the project. Often the information gathered from interviews cannot be gained in any other manner.

Secondary Data

Secondary data need to be gathered from many sources, both public and private. Everything from property value, rate of land sales, to crime rate is already being collected. In some cases, agreements for data sharing will need to be created because of confidentiality considerations.

Fortunately in the Twin Cities, various agencies desire to share information. Various government agencies collect a wide assortment of data related to the economic and community impacts of the Hiawatha LRT. Government agencies from the federal level down to the local level collect information about the economic conditions within their region as well as various measures of the community.

It is important to remember that there are many private agencies that are also collecting data about changes in neighborhoods and trends in regional markets. Organizations such as the Minneapolis Area Association of Realtors have a database that provides some of the best information about housing, home prices, and rate of sales for the homes in the Twin Cities Metropolitan area. It is important when looking for data sources to remember that private organizations are collecting data that can be useful when conducting evaluations.

IMPACTS OF LIGHT RAIL

Studies of the Hiawatha LRT have been divided into economic, community, and travel impacts. Economic impacts should assess changes in property value, building permits, housing units, employment, and retail sales. Community impacts should assess demographics, overall changes in the level of crime, and emergency response times. Travel impact studies should assess changes in travel time, mode share, traffic patterns, travel behavior, and parking. Combining each study area into a more composite picture sheds light on the community and economic well-being of the area around the Hiawatha LRT (see [Figure 2](#)).

Economic Impacts

Major infrastructure projects like the Hiawatha LRT often affect the economic conditions of the areas around them. Economic impact assessments are an essential part of a comprehensive evaluation of infrastructure projects (11–15). The economic indicators assessed in the evaluation of the Hiawatha LRT include property value, land use/investment, employment, housing, and retail sales.

Property Value

Many people claim that building Hiawatha LRT will increase property value around station sites. There is some anecdotal evidence that supports this claim. However, in multiple instances businesses next to stations have closed since the opening of the LRT—however, this is not as widely publicized. Regarding development around LRT, there is a belief in the “if we build it they will come” philosophy. This, in short, describes the popular notion that the LRT transit system will necessarily attract the investment capital of developers; however, this may not always be the case. Moreover, local governments are looking towards LRT as a way to increase their property tax base. The two preferred quantitative methods used to determine changes in property value are either a longitudinal study or a hedonic model.

Longitudinal Metropolitan Council, as part of its Before and After Study, is assessing the change in property values within TAZs around the LRT stations compared to changes in property value in the rest of Minneapolis and Bloomington. For this study, Metropolitan Council is

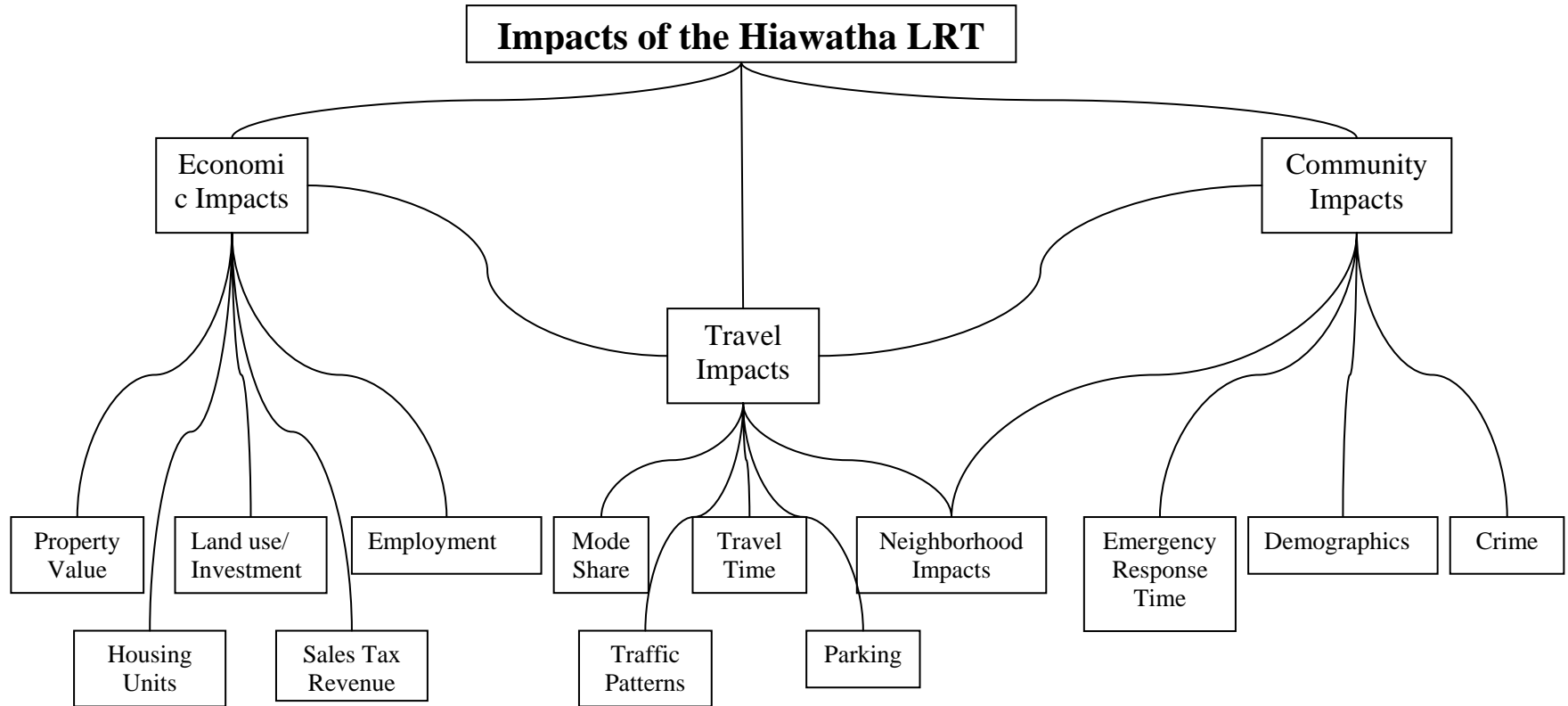


FIGURE 2 Overview of the impacts being evaluated.

analyzing 5 years before the construction of the Hiawatha LRT, during construction, and 5 years after the beginning of operations of the Hiawatha LRT. They are using the assessed property value collected by the Minnesota Department of Revenue. The data have been controlled for differences in each city's assessing practices.

Hedonic Model A hedonic model is an attempt to determine the impact that individual factors have on market prices (most likely in our case the sale price of a home). In order to build a hedonic model it is important to have a good understanding of what factors tend to affect local housing markets. The best sources of information include local realtors. In the Twin Cities the realtors are represented by the Minneapolis Area Association of Realtors (MAAR). MAAR tracks hedonic factors through the North Star Multiple Listing Service. MAAR tracks many attributes of a home that would be difficult, if not impossible, to gather from other sources, such as the number of square feet of the home, the number of bedrooms, bathrooms, age of house, and number of garage stalls. These variables, among others, affect the price of a home not usually tracked by the assessor's office or other governmental entities. Other attributes are also important to the model including: network distance to parks, network distance to freeway on ramps, quality of schools, racial make-up of the neighborhood, and income level of the neighborhood. These variables, and possibly others, determine the impact that access to the Hiawatha LRT has on single-family residential property value. The power of the hedonic model is that it provides the amount of variance in the residential property value that is explained by the proximity to the Hiawatha LRT.

Measuring Property Value Two sources for measuring property value are most commonly used, each with benefits and drawbacks. First, is the assessed value. The assessed value is beneficial because it is available for every parcel of land and is updated on a regular basis. However, one drawback is that property values are based on the assessor's judgment, and usually not the price that buyers are willing to pay for the property. Specific formulas could unintentionally multiply the effects of a few home sales—inflating or deflating the value of the neighboring properties. Repeating this process several times in a given area can result in incorrect conclusions.

Second, is the "market value" of the property—the price at which properties actually sell. Here, the value of the home is not created by a formula or an estimate. Rather, market demand for the property drives the value. However, market value is not available for every parcel as it only becomes available when a parcel is sold. Some parcels may not be sold for more than 20 years while others might be sold every few years. Inconsistency in the rate of sales makes it impossible to get a representative sample of market values at any given time.

Either of these methods can be used for longitudinal study. However, market value must be used for hedonic models (16, 17). Using assessed values in a hedonic model would mask the effect of the LRT because it is indeterminable whether changes in values are the impression of the assessor or the actual effect of transit. For instance, if the assessor is taking into account recent studies about the impact of LRT on property value s/he may adjust the model accordingly. A hedonic model built off assessed values would show this increase in value added by the assessor not the LRT. It could then be used as justification to adjust the value of land around other LRT stations, multiplying the effect and misleading both the assessors and the public about the effect that LRT has on property values.

Qualitative Qualitative methods also provide insights into why people choose to live near Hiawatha LRT stations. Researchers will conduct a survey asking new residents why they choose to move into Hiawatha Corridor. While this will not provide a quantifiable measure, it will serve to confirm or call into question the results of the quantitative studies. It could also provide information about who is choosing to live in and around the Hiawatha LRT and help to shape public policy to encourage the aspects of the Hiawatha Corridor that are perceived as positive by the new residents.

Land Use/Investment

The Metropolitan Council is conducting an ongoing study that began in 1996 and will continue through 2009, examining the investment by the private sector along the Hiawatha Corridor. The study examines investment by the private sector along the Hiawatha Corridor and collects data from building permits using TAZs as the unit of analysis. Specifically, Metropolitan Council is tracking building permits which detail the amount of money invested in the corridor. However, permits in Minneapolis do not differentiate between land-use types. In order to determine land use, the Metropolitan Council is linking the building permits with tax classification for the property.

While doing an evaluation of a major infrastructure project it is important to determine who gains and who loses. In Portland, evidence shows that different types of land uses thrive as a result of their proximity to LRT, while other land uses do not (13). In Portland, it appeared as though multi-family residential and commercial land uses thrived from close proximity to LRT. Conversely, industrial land uses were negatively affected by close proximity to LRT (13). This raises the question whether these trends apply only to Portland and if they are also evident in the Twin Cities. In other words, is the relationship between LRT and land use isolated or part of a larger, national trend? In the Portland case, they compared the actual number of permits of each land use type compared to the expected number of permits—assuming uniform distribution of the permits.

Employment

The Metropolitan Council is tracking employment in the corridor. The evaluation takes into account two main sources of data to include the Minnesota Department of Employment and Economic Development (DEED) and the Local Employment Dynamic (LED). DEED provides detailed employment information throughout the corridor whereas the LED is a new program run by the Census Bureau. However, its viability depends on the availability of funding. The LED breaks down jobs into high-, medium-, and low-pay scales. Combining the LED with DEED information creates a more complete picture of the type of jobs that are being lost or created in the corridor. Discussions are ongoing in regards to the analysis of employment by industry using the North American Industrial Classification System codes. However, it is unclear at this point if confidentiality limitations will make this impossible.

Housing Units

Metro Transit originally estimated that the number of housing units within the corridor would increase by 7,150 by 2020 (18). To determine the change in the number of housing units,

Metropolitan Council is working with city assessors to track the net change in housing units and is collecting building and demolition permits over several years. The permits will be compared longitudinally to determine the net loss and gain of office, retail, industrial, single-family, and multi-family space in the station areas. Permit information can also be used to determine the net loss or gain in the number of housing units in the station areas similar to what was done in the *BART at 20* study (12)

Sales Tax Revenues

Presently, there are no ongoing studies tracking the effect of the Hiawatha LRT on sales tax revenue however conversations are ongoing about the possibility of pursuing studies in the future. In order to measure the effect that the Hiawatha LRT might have on retail sales, a longitudinal analysis should look at sales tax revenues along the Hiawatha LRT corridor. Changes in sales tax revenues along the corridor can be compared to changes in sales tax revenues in Minneapolis and the greater metropolitan area. This controls for changes in the economic conditions of the metropolitan area.

In other cities, there are mixed outcomes regarding the impact of LRT on retail sales, which has raised serious questions concerning the impact of the Hiawatha LRT on retail sales. A study done in Buffalo, New York, concluded that the attractiveness of the shopping center was the most significant factor in consumer decisions as to where to shop, not the mode of transportation (11). Moreover, it found that most people were generally willing to shop within 20 min of their home (11). In Dallas, retail sales in the central business district increased dramatically faster than retail sales in the rest of Dallas shortly after the operation of Dallas Area Rapid Transit LRT began (14).

Community Impacts

As Forkenbrock notes, the community and social impacts of any transportation project take numerous forms (15). Furthermore, a thorough review of transit costs and benefits proves useful when assessing the needs of the existing community. For the Hiawatha LRT project, much of the current analysis has focused on economic impacts, leaving considerable room for future analysis of community impacts. As a result, the future study of community impacts must depend on increased inter-agency collaboration. Presently, studies that are planned or in the planning phase include: demographic analysis, crime comparisons, and effects on emergency response time.

Demographics

Neighborhood Is the neighborhood gentrifying? Is the standard of living for the neighborhood residents going up? Or does the presence of the Hiawatha LRT have no measurable effect on the neighborhood? Census data will be used to answer these and other questions, because of its accessibility, low-cost, and completeness. Demographic changes often take several years to evolve. The next Census data will not be available until 2010 and will provide the first chance to really study what, if any, effect the Hiawatha LRT has had on the demographic composition of the surrounding neighborhoods.

Hiawatha LRT Users Metro Transit asks basic demographic questions as part of its ridership surveys. Many of their survey questions reflect information already gathered by the U.S. Census, and will offer points of comparison.

Crime

There are concerns among neighborhood residents that the addition of the Hiawatha LRT into their neighborhood will only exacerbate existing crime conditions. Yet, there is no evidence, at least presently, to suggest either a positive or a negative correlation between the Hiawatha LRT and criminal movement and activity into surrounding neighborhoods. However, without a thorough analysis of crime statistics, it will be impossible to provide definitive answers concerning the relationship between the Hiawatha LRT and crime. Determining LRT impacts on the type and frequency of criminal activity involves working with the Minneapolis and Bloomington Police Departments. A longitudinal analysis of the data will provide information about the impacts of the LRT on crime. This process will involve tracking the amount and type of crime that occurs in the station areas overtime.

Emergency Response Time

Anytime there is a change in the signal priority system for emergency vehicles, there is a need to measure the impact that the change has on emergency response time. After the Hiawatha LRT opened, fire chiefs at Minneapolis stations near the LRT line were asked to record delays in response time due to trains. The results of this evaluation were then taken to Metro Transit and an agreement was worked out, whereby the call now goes to a fire station on either side of the tracks and if the train does not delay the first responder, the second is called off. With this new coordination in place, it is now appropriate to evaluate the effect of the signal changes on response time.

To do this we could compare the response times before the LRT, after the LRT began operation, and after changes to the emergency response policy. For purposes of the evaluation, emergency responders will measure the response times for calls in the 50th, 75th, and 90th percentiles for response time. This will minimize the effect of outliers and is in line with how emergency response times are tracked across the rest of Minneapolis and Bloomington.

Congestion and Travel Impacts

It is important to measure the impact of the Hiawatha LRT on congestion because many transit advocates claim that congestion management is a primary societal benefit. In addition, just under \$50 million of construction costs of the Hiawatha LRT came from a Federal Air Quality and Congestion Mitigation grant (18). As a result, one of the compliance requirements of receiving the funding was a Before and After Study that measures the Hiawatha LRT's impact on congestion. In order to measure the impact that the Hiawatha LRT had on congestion, proxy measures were used. These included the travel time, mode share, traffic patterns, travel behavior, and parking.

Travel Time

When measuring the change in travel time as a result of a new transit infrastructure it is important to look not only at the travel time for those who are using the transit system, but also the travel time for people who choose not to use transit. It is also important that travel-time evaluations measure door-to-door (from place of residence to work) and not exclusively drive time or time on the train. Researchers from the University of Minnesota are working on a larger study of travel time from origins to destinations throughout the Twin Cities. This study assesses walking, bicycling, and transit. Specifically, the study evaluates the access to destinations after Hiawatha LRT began operating.

Mode Share

Metropolitan Council, as part of the Before and After Study, looked at the impact of the Hiawatha LRT on mode share within the Hiawatha Corridor. The measurements include counts of the number of vehicles along Hiawatha (TH55), number of passengers per vehicle (person trips), and the number of pedestrians and bicyclists along the corridor (19, 20). This information, combined with ridership counts for the Hiawatha LRT, provides total mode share along the corridor. However, because the sampling method was different between the ridership on the LRT and all other modes, any direct comparison between them is suspect.

Traffic Patterns

In addition to the studies conducted by Metro Transit, Minnesota Department of Transportation (MnDOT) records traffic counts on roads in the Metro Area. MnDOT's traffic counts allow for both a longitudinal and discrete examination of traffic amounts throughout the corridor. Moreover, these studies enable comparisons between the numbers of vehicles traveling in the Hiawatha Corridor with the number of vehicles traveling in other corridors. Relative change in traffic counts can be calculated as well.

Neighborhood Impacts

From a social justice standpoint of equity and efficiency it is important to know what communities the Hiawatha LRT is affecting and how they are being affected. Just because the Hiawatha LRT is having a large number of riders, it does not necessarily follow that the neighborhoods along the Hiawatha LRT are supplying the riders. Possibly, a majority of the users are suburban residents who travel into the city, using the train to avoid higher parking prices downtown. For this reason, Laverny-Rafter and his graduate Transit Planning and Management Class at the University of Minnesota administered a survey to residents who lived within a half a mile of four of the Minneapolis neighborhood stations. Additionally, Metro Transit administered surveys to its riders to determine their travel patterns and the impact that transit has on their travel behavior. These surveys looked at changes in travel behavior after the completion of the Hiawatha LRT.

Parking

Metro Transit has conducted two separate studies looking at the parking in park-and-ride lots and on the neighborhood streets around the stations. In March of 2005, Metro Transit added the Hiawatha LRT park-and-rides to their ongoing evaluation of its park-and-ride facilities. The study involves counting the number of vehicles in the park-and-ride lots (21). Also in March of 2005, Metro Transit conducted a second study completed in multiple stages recording license plate numbers that linked vehicles in the park-and-ride lots and streets around stations to where the vehicle is registered.

CONCLUSION

Presently, little empirical evidence exists for policy makers and transit planners as they continue to make decisions about the future of LRT in the Twin Cities. Particular stakeholders with considerable influence and interest include Metropolitan Council, Metro Transit, Hennepin and Ramsey Counties, and the Cities of Minneapolis, Bloomington, and St. Paul. Through coordinated efforts, these diverse agencies have worked, and will continue to work, towards developing comprehensive evaluations of the economic and community impacts of the Hiawatha LRT. Most importantly, there remains a considerable desire for coordination in the overall evaluation of the Hiawatha LRT. While these agencies pursue their own separate evaluations, they still benefit from a collaborative working environment. For example, Metro Transit ridership surveys provided information about riders of the Hiawatha LRT and their travel behaviors. The University of Minnesota surveyed neighborhood residents, collecting information about their travel behavior. These two studies provide information about travel patterns in the Hiawatha corridor. Each study provides particular insights into impacts of the Hiawatha LRT, but together they present a more complete picture.

Additionally, the University of Minnesota and Hennepin County continue to collaborate on constructing an inventory of all relevant research pertaining to the Hiawatha LRT. The inventory provides researchers from a variety of agencies and sectors with information about existing data and the ability to gather additional and complementary information to the existing data. Moreover, the inventory aims to cut down duplicative research. Thus, researchers can target limited research money more efficiently.

To sum, these agencies share resources to answer common questions concerning the impacts of the Hiawatha LRT while maintaining the freedom to pursue any individual research questions. Collaboration, while maintaining individual autonomy, allows agencies within the local government, the University of Minnesota, and future stakeholders to build investigative capacities and the public knowledge regarding the impacts of the Hiawatha LRT.

REFERENCES

1. Minnesota Transportation Museum, Inc. Minnesota Transportation Museum, Inc. <http://www.mtmuseum.org/>. Accessed: December 19, 2005.
2. Campion, D. R., et al. Light Rail Transit: Future Opportunities and Changes. *TR News: Transportation in the New Millennium*. CD-ROM. Committee on Light Rail Transit, Transportation

- Research Board, National Research Council: Washington, D.C., 1999.
<http://gulliver.trb.org/publications/millennium/00066.pdf>.
3. Twin Cities Metropolitan Council. *2030 Transportation Policy Plan*. 2004.
 4. Census Transportation Package. U. S. Census Bureau: 2000.
 5. EDAW, Pickard Chilton Architects Inc and URS. *Bloomington Central Station: Master Plan Summary and Design Guidelines*. Draft 2005.
 6. Mark, M. The Evaluation Exchange. *Evaluation Theory or What Are Evaluation Methods for?* Vol. 12, No. 2, 2005.
 7. Patton, M. *Utilization-Focused Evaluation*. 3rd ed. Sage, Thousand Oaks, Calif., 1997.
 8. Atash, F. Redesigning Suburbia for Walking and Transit: Emerging Concepts. *Journal of Urban Planning and Development*, Vol. 120, 1994, pp. 48–57.
 9. Pushkarev, B., and J. Zupan. *Urban Space for Pedestrians: A Report of the Regional Plan Association*. The MIT Press, Cambridge, Mass., 1975.
 10. Landis, J., and R. Cervero. Twenty Years of BART: Land Use and Development Impacts. *Transportation Research A*, Vol. 31, No. 4, 1997, pp. 199–219.
 11. Berechman, J., and R. E. Paaswell. Rail Rapid Transit Investment and CBD Revitalisation: Methodology and Results. *Urban Studies*, Vol. 20, No. 4, 1983, pp. 471–486. <http://taylorandfrancis.metapress.com/openurl.asp?genre=article&eissn=1360-063X&volume=20&issue=4&spage=471>.
 12. Cervero, R. *BART at 20: Land Use and Development Impacts*. Institute of Urban and Regional Development, University of California at Berkeley, Calif., 1995.
 13. Hanley, P., and G. Knaap. The Spatial Reconfiguration of the Portland Metropolitan Area: A Preliminary Assessment and Baseline Analysis. Proc., Conference on Transportation, Land Use and Air Quality, American Society of Civil Engineers, Portland, Oreg., 1998.
 14. Weinstein, B. L., and T. L. Clower. *The Initial Economic Impacts of the DART LRT System*. University of North Texas: Economic Development and Research, Dallas, Tex., 1999. <http://www.unt.edu/cedr/dart.pdf>.
 15. Forkenbrock, D. J., S. Benschhoff, and G. E. Weisbrod. *NCHRP Web Document 31: Assessing the Social and Economic Effects of Transportation Projects*. TRB, National Research Council, Washington, D.C., 2001.
 16. California Center for Innovative Transportation at the Institute of Transportation Studies at the University of California at and Committee on Planning and Economics of the American Society of Civil Engineers. Hedonic Pricing. August 5, 2004. http://www.dot.ca.gov/hq/tpp/offices/ote/Benefit_Cost/calculations/hedonic.html. Accessed: Dec. 28, 2005.
 17. King, D. M., and M. Mazzota. Ecosystem Valuation. http://www.ecosystemvaluation.org/hedonic_pricing.htm. Accessed Dec. 28, 2005.
 18. Metro Transit Hiawatha Line. Metro Transit, 2005. <http://www.metrotransit.org/improvingTransit/hiawathaLightRail.asp>. Accessed Dec. 19, 2005.
 19. URS. *Hiawatha LRT Vehicle Occupancy and Pedestrian/Bicycle Count Study: Final Report*. Prepared for Metro Transit, Minneapolis, 2004.
 20. Traffic Data, Inc. *Hiawatha Light Rail Transit Vehicle Occupancy and Pedestrian/Bicycle Study*. Minneapolis, Minn., 2005.
 21. Metro Transit Service Development Route and System Planning. *2005 Annual Park-and-Ride System Survey*. Metro Transit, 2005.

MEET-THE-AUTHORS POSTER SESSION

Safety of Noncompliant Passenger Rail Equipment

ALAN J. BING

ICF Consulting

THOMAS TSAI

Federal Railroad Administration

DAVID NELSON

KKO and Associates

RONALD A. MAYVILLE

R. A. Mayville & Associates, Inc.

To meet service needs, several rail transit systems have considered the concurrent shared track operation of non-FRA-compliant passenger equipment with limited conventional rail freight services. A major barrier to implementing such operations is concern over safety, especially in collisions between freight and noncompliant passenger equipment. This study analyzes the safety of concurrent shared track operations, including a preliminary hazard assessment and risk analysis. The analysis was supported by a one-dimensional collision analysis of noncompliant vehicle collisions between similar vehicles, as well as between the noncompliant vehicle and conventional freight cars and locomotives. The risk analysis was applied to a hypothetical shared operation representative of existing and planned noncompliant services. The results showed that, although the addition of limited freight service (two round trips per day) increased the risk of accident casualties among passenger train occupants by between 10% and 20%, several options are available to fully mitigate this increased risk. These options include adding a second track to a single-track system and applying one of several alternative train control systems to reduce collision risks. Although the analysis was highly simplified, the results are sufficiently encouraging to warrant continued research on this type of shared track operation.

This was a research study only, and there has been no change in current FRA and FTA policy regarding shared operations or in the FRA waiver process required by that policy.

INTRODUCTION

As interest in passenger rail service has grown in many metropolitan areas of the United States, transportation planners have found that existing rail corridors are attractive locations for the construction of new passenger rail lines. With the evolution of freight railroad operations, many such corridors have the physical space or line capacity available for a new passenger rail service. However, limited freight operations may continue in the corridor, and it is necessary to ensure that these operations do not impact the safety of the proposed passenger operation.

In some cases, a proposed operation will use conventional railroad commuter equipment that is fully compliant with applicable FRA safety regulations (FRA undated), so that no restrictions are on concurrent operations of passenger and freight trains on the same track. Alternatively, the operators may be interested in using light rail or similar passenger vehicles that do not comply with FRA requirements for rail passenger cars (FRA 1999). The reasons for this preference include:

- Planned street running on part of the route, with tight curves and a preference for full or partial low floors for ease of access.
- Ability to gain cost, reliability, and service quality benefits by using proven vehicle designs from overseas or other U.S. operators.
- Permit interoperability with an existing light rail system.
- Lack of suitable FRA-compliant passenger car designs.

Concern over the safety of shared operations involving light rail vehicles (LRVs) and conventional rail freight service led to a joint policy statement by FRA and FTA (FRA 2000). Under the joint policy, details of proposed shared track plant, equipment, and operations must be submitted to FRA in a waiver request. To date, FRA has only granted waivers for shared track operations where the passenger and freight services are subject to strict time-of-day separation.

In spite of the safety concerns, interest persists in concurrent shared track operation of compliant and noncompliant vehicles, primarily because time-of-day separation does not always meet the service requirements of the two operators. The passenger operator may wish to offer late night or early morning service to meet customer needs, leaving insufficient time for nighttime freight operations. The benefits of operating daytime freight service include avoiding night shift work, having more flexibility to mesh with long-haul freight operations, and, for the freight shipper, having staff on hand to receive and dispatch railcars.

OBJECTIVES AND SCOPE

The research described in this paper was aimed at exploring the safety of concurrent shared track operations of conventional freight trains and noncompliant passenger vehicles on the same track by identifying and evaluating risk mitigation measures that would provide an equivalent safety level as with the same passenger service without concurrent freight operations. The study builds on past work on shared track operations, notably the TCRP reports by Phraner and Roberts (1999), Phraner (2001), and Phraner (2002). The approach to using risk assessment for rail corridor safety evaluation also builds on past research and analysis, of which the most comprehensive is the series of risk and collision analyses to evaluate the safety performance of noncompliant Talgo trains used in intercity passenger services (U.S. Department of Transportation 1999).

The scope of the analysis was limited to the most likely shared track scenario, having the following characteristics:

- The noncompliant vehicles and the rail service are representative of those used or proposed for light rail passenger service in North America.

- Given a preference for existing vehicle designs, major structural change to passenger vehicle car bodies to improve crashworthiness is not considered as a risk mitigation option.
- The passenger service shares track with a typical low-density local freight service making a small number of trips per day.

CHARACTERISTICS OF NONCOMPLIANT VEHICLES AND OPERATIONS

Current and planned shared track operations in the United States were surveyed to define representative noncompliant vehicles and services for the risk analysis. Five systems were surveyed, comprising those in Baltimore, Maryland; Oceanside, California (in construction); Salt Lake City, Utah; San Diego, California; and southern New Jersey.

The survey showed a wide variety of vehicle characteristics reflecting the needs of individual services, as well as the origin of specific design selected by the systems. No national standards exist for LRVs in the United States, although those developed by the California Public Utilities Commission (CPUC 2000) are used in California and have been adopted by some systems outside California. All the systems use two-section articulated vehicles, supported on three trucks.

Considerable variation in infrastructure details among the systems also exists. Common factors are that most of the systems have some street running in a downtown area and operate under regular railroad operating rules with automatic block signals (ABS) or centralized traffic control (CTC) over lines shared with freight service. Only one system (southern New Jersey) has automatic train stop. Freight service varies between three and 10 round trips per week over the shared tracks.

The survey's results were compared with applicable FRA regulations (FRA undated and FRA 1999). This comparison showed that there are two main areas of noncompliance:

- Car body structural strength: LRV buff strength and other key structural strengths are 25% to 40% of the minimum FRA requirements as given in *49 CFR Part 238*, potentially increasing structural damage and occupant casualties in collisions.
- Glazing requirements: Forward-facing windows on LRVs are usually designed to FRA requirements in *49 CFR Part 223*, but side-facing windows on most vehicles use automotive standard glazing rather than the high-impact glazing of FRA requirements. Because automotive glazing can be broken in an emergency, FRA-style removable windows are not required.

A number of key differences exist in both vehicle design and the operating environment that affect accident risks, unrelated to regulatory compliance. Differences that tend to lower accident likelihood or severity include higher braking rates for LRVs, lower train mass, and lower top and average speeds. Differences that tend to increase accident likelihood or severity include higher traffic density (trains/hour), more standee passengers, and the use of longitudinal seating in some car designs.

REPRESENTATIVE SHARED TRACK OPERATION

Details of a representative shared track operation were developed to use as the basis for the risk assessments. The representative operation is typical of existing and planned shared track operations, assuming that concurrent freight and passenger service is allowable. The operation, however, differs from any actual existing or planned service, so that the analysis results cannot be interpreted as applying to any real system.

Table 1 provides selected details of the representative shared track system before risk mitigation measures are applied.

The passenger operation comprises 72 round trips per weekday with the 10-min peak service and 48 round trips per weekday with the 15-min interval peak service. Peak service is assumed to operate between 6:00 and 9:00 a.m. and 4:00 and 7:00 p.m. Passenger loadings were adapted from data on a real planned operation, as shown in Table 2.

TABLE 1 Characteristics of Representative Shared Track Operation

Characteristic	Infrastructure and Operations Details
Track Sharing Arrangement	Shared track with concurrent freight and passenger operations in off-peak periods.
Track Configuration	Downtown—Single track loop and short double track section, with street running. Total length 1 mi. Shared track—Single track 8.5 mi long with two or three passing sidings as dictated by proposed passenger headways. Sidings are lengthened to 2,500 ft to accommodate freight trains
Passenger Operations	10- to 15-min peak headways. 20- to 30-min off-peak headways. Weekend service would be off-peak headways 6 a.m. to 12 a.m.
Freight Operations	Freight operator makes one or two round trips in off-peak hours, when passenger trains are operating on longer headways. Freight trains originate at outer end of line, collect outbound cars at industry siding, and take them to the interchange yard near city center. Exchange outbound for inbound cars at yard and return through industry siding to point of origin.
Passenger Car	Siemens SD-100 LRV in one-, two-, and three-car trains.
Freight Train	Single GP locomotive with up to 25 cars of general freight, predominately flat cars of lumber and boxcars of building supplies.
Signal System	CTC
Track	FRA Class III FRA Class III
Maximum Speeds	60 mph passenger. 30 mph freight during midday period.
Workforce	Separate passenger and freight workforces.
Rule Book	NORAC

TABLE 2 Passenger Train Average and Maximum Occupancy

Passengers	Peak Hours/Direction		Off-Peak Hours/Direction	
	Average	Maximum	Average	Maximum
Seated	81	105	35	70
Standing	12	34	1	4
Total	93	139	36	74

Maximum loadings occur only on inbound trains in the morning peak and outbound trains in the evening. Outbound trains in the morning and inbound trains in the evening are counted as off-peak trips in calculating average loadings. In common with other commuter operations, train loading is at its lightest at the suburban end of the route and reaches a maximum after the last station before the downtown station. The maxima shown in the table are for the busiest route segment on shared track.

Passenger loading is a critical parameter, as injury risk in an accident is proportional to the number of passenger and crew on the train. There is a greater chance of a large number of injuries with a crowded train.

Freight trains operate during off-peak hours between passenger trips. Because of the time taken at station stops, the average speed of passenger and freight trains is approximately the same.

RISK ANALYSIS APPROACH

Figure 1 illustrates the general approach used for risk analysis of a rail corridor, which shows the principal steps in the analysis.

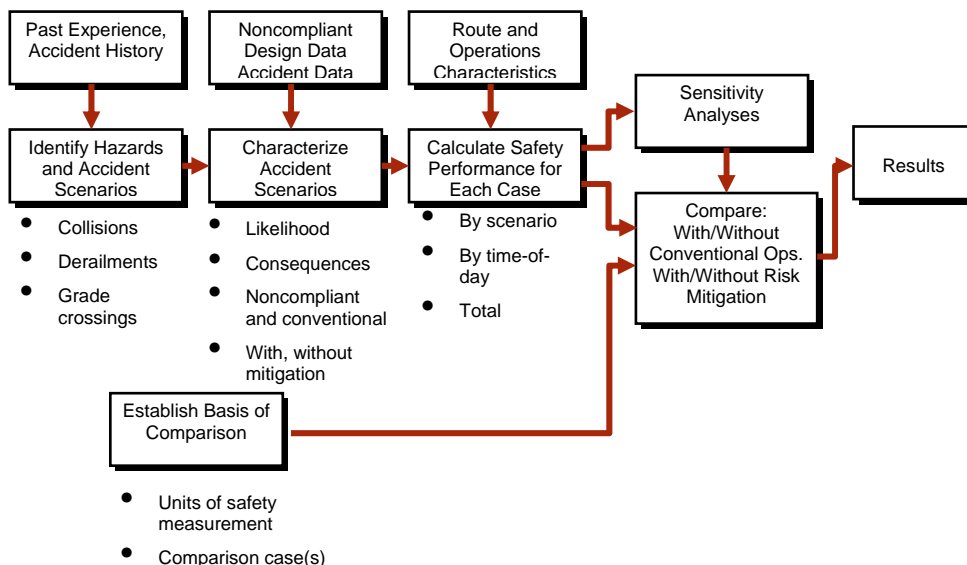


FIGURE 1 Flow chart for analysis of noncompliant passenger service.

The following details the steps in the risk analysis.

Identify Accident Scenarios

At the top level, rail corridor accident scenarios always include collisions of various types, derailments, and grade-crossing accidents. Each scenario is divided into several subscenarios, with the level of detail dependent on the purpose of the analysis. For example, a study of the benefits from crashworthiness improvements would focus on different types of train-to-train collision, whereas an analysis focusing on vehicle and track inspection methods would look at derailment causes in detail.

Characterize Accident Scenarios

In a quantitative risk analysis, hazards (accident scenarios) are characterized by two parameters:

- **Likelihood**—A measure of how often the scenario will be experienced as a function of exposure (for example, collisions per million train miles).
- **Consequence**—A measure of the severity of an individual accident. Consequences in rail corridor risk assessments are typically measured by injuries and fatalities to train occupants, railroad employees, or bystanders, or by a financial measure that combines property damage or delay costs with injury and fatality costs.

Risk from each accident scenario is then the product of multiplying likelihood and consequences.

Characterizing accident scenarios is usually the most challenging and time-consuming part of a risk assessment. Statistical analysis of past accidents is the first choice, but such data are often unavailable or incomplete. Statistical analysis is then supported by other methods, such as engineering analyses, operations simulations, surveys of railroad professionals, and analysts' experience and judgment.

Document Route and Operating Conditions

Accident likelihood and consequences depend on route and operating conditions, such as speed, traffic density, number of tracks, and signal system, which can vary by location along the route and by time period (such as peak and off-peak passenger service). Accident likelihood and consequence values are calculated for each combination of conditions and tabulated for use in the risk calculation.

Calculate Safety Performance and Make Comparisons

A spreadsheet model is used to calculate risk by accident scenario, route segment, and time period, in total. In this analysis, risk results are presented as the estimated number of accidents, injuries, and fatalities by scenario and in total over a 10-year period. The longer period is chosen to avoid presenting only very small numbers, which may be difficult to comprehend. Using these results, comparisons may be made between different vehicle, infrastructure, and operating alternatives.

ACCIDENT SCENARIOS

Accident scenarios were identified with the aid of a fault tree for accidents in passenger rail operations and knowledge of the details of the hypothetical operation as described in Section 4. The following details the specific accident scenarios used in this analysis.

Scenario 1: Collisions Between Rail Vehicles

Scenario 1A: Collisions Between Trains Occupying the Same Track

These include basic head-on and rear-end collisions between trains and side collisions between the lead vehicle of one train and the side of another train. These collisions are most commonly caused by operator error and occasionally by the failed brakes, signal systems, or communication systems. Collision risk is considered for all the situations that could arise in concurrent shared track operations of different vehicles types, including:

- Collisions between similar noncompliant trains,
- Collisions between a noncompliant train and a freight locomotive, and
- End-on and side collisions between a noncompliant train and a freight car.

Scenario 1B: Collisions with Equipment Intruding from an Adjacent Track

These collisions can occur when passenger or (more commonly) freight or work equipment intrudes from an adjacent track (for example, due to a derailment on the adjacent track, a shifted load, careless use of work equipment, or a vehicle that is not positioned in the clear near a turnout).

Scenario 2: Derailment of the Noncompliant Train

A train leaving the track without involvement of another train causes a derailment. Mechanical failures of vehicle or track components or excessive speed are typical derailment causes. In some cases, derailments are followed by a collision with rail equipment on an adjacent track, resulting in consequences similar to same-track collisions.

Scenario 3: Obstruction Collisions

Obstruction collisions are collisions with objects on the track or thrown at a train. Most obstruction collisions are minor, with local damage only to the front of the leading car. Objects placed on the track or thrown at trains by vandals are a significant factor. In a few cases, obstruction collisions can cause a derailment, leading to consequences comparable to other derailments.

Scenario 4: Rail–Highway Grade Crossing Collisions

Grade crossing collisions are when a train strikes a highway vehicle or user at a rail–highway grade crossing. The cause of most grade crossing accidents is the failure of a highway user to obey crossing warning system indications or to take proper precautions. Highway vehicles

becoming stuck or stalling on a crossing or being prevented from exiting the crossing by road congestion are the second most common causes. In a few cases, failure of the crossing warning systems causes the crossing collision.

ANALYSIS CASES

Risk analyses were carried out for a series of analysis cases aimed at first establishing base case risk and then the risk associated with concurrent shared track operations before and after the implementation of risk mitigation measures. Base case risk results were compared with those with concurrent operations to determine what risk mitigation measures are needed to meet equivalent safety criteria.

Primary Base Case

This is the base passenger operation with time-of-day separation using a representative noncompliant vehicle, as indicated in Section 4. Freight operations, if any, take place at night when passenger operations are closed down.

Variants on the Base Cases

These cases comprise passenger service and infrastructure alternatives to the primary base case to illustrate the range of risk that can exist among currently acceptable operations. The variants are increasing service intervals to 15 min in the peak and 30 min off-peak, replacing single track with double track throughout and varying the number of grade crossings.

Shared Track Operation with Noncompliant Vehicles Without Risk Mitigation

This operation comprises passenger service with noncompliant vehicles as defined in the base case, plus one freight train round trip during off-peak passenger service operating periods. In the absence of risk mitigation, an increase in overall absolute and normalized risk to train occupants will occur.

Variants on Concurrent Shared Track Operations

These cases analyze the effect on incremental risk of additional freight operations. The variants are to add a second off-peak freight round trip and add freight service to an industry siding on the shared line. Adding the visit to an en-route industry siding adds to risk as a result of more complex freight train movements and movements on adjacent track, which could lead to intrusion accidents.

Risk Mitigation Cases

These cases analyze shared track operation with the addition of selected risk mitigation actions, singly and in combination. The objective of this part of the analysis is to identify the most attractive options for offsetting the additional risk of adding freight service. Risk mitigation measures include:

- Adding alternative train control systems.
 - Enhanced automatic train stop (ATS) system that provides a warning of a more restrictive signal or approaching civil speed limit, plus initiates emergency braking (on the noncompliant train) if a train passes a stop signal. Transponders are used for track-to-train communication.
 - Train protection and warning system (TPWS), as installed on U.K. rail lines. TPWS provides the same functionality as the enhanced ATS, with the addition of speed traps located approximately 1,500 ft before a block or interlocking signal or start of a permanent civil speed restriction. If speed exceeds a set value at the speed trap, the system initiates a non-cancelable penalty brake application.
 - Full traditional automatic train control (ATC), combined with cab signals, as installed on the Northeast Corridor. This system provides a continuously updated display of approaching signal aspects, combined with enforced compliance of speed reductions in response to approach, and restricting aspects. Traditional ATC does not enforce an absolute stop at an interlocking signal.
 - A full function positive train control (PTC) system, comparable to those currently under development for freight or passenger service outside the Northeast Corridor region. Examples are Amtrak's Incremental Train Control System and Burlington Northern Santa Fe Railroad's Electronic Train-Management System. PTC systems enforce authority limits, speed limits, and work zone restrictions.

Other train control alternatives exist, using traditional and new technologies, but all fall within the performance range represented by these four systems.

- Replacing the original single track with double track.
- Improving passenger vehicle interiors to reduce the chance of secondary collision injuries.
- Selected combinations of mitigation measures.
- Sensitivity cases to examine the effects of varying key risk parameters. Sensitivity analysis enabled the analyst to see whether uncertainty in risk parameters can have a critical effect on results and conclusions. If results are very sensitive to a specific parameter, either a conservative conclusion is appropriate, or additional research and analysis to better estimate the parameter are required.

CHARACTERIZING ACCIDENT SCENARIOS

The analysis to estimate accident likelihood and consequences by accident scenario started with an analysis of conventional commuter rail accidents. Use was made of a pre-existing database derived from FRA data (FRA-RAIRS) of approximately 1,600 passenger train accident reports over 15 years from January 1, 1986, to June 30, 2001. Additions to the FRA data provided information on the type of passenger train and vehicles involved, and the operating environment. An associated database provided passenger rail operations data, such as train miles by train type and operating environment.

A subset of these data for commuter operations other than those on the high-speed Northeast Corridor was used to calculate accident rates (per million train miles) and average accident consequences for the accident scenarios defined in Section 6 of this paper. Then numerous adjustments were applied to the accident rates and consequence values to obtain

corresponding estimates of rates and consequences for the service using noncompliant vehicles as defined in Section 4. Some of the key adjustments were derived as follows.

- Simplified one-dimensional collision analyses were carried out to compare the consequences of collisions between conventional commuter trains, collisions between trains of noncompliant vehicles, and collisions between noncompliant vehicles and conventional freight equipment. The results were used to obtain adjusted train-to-train collision rates and consequences. This analysis also reflected the differences in speed, mass, and braking performance between commuter rail and the representative noncompliant operation.
- A reduction in accident rates was applied to adjust for the fraction of commuter rail accidents taking place in major passenger terminals, such as Penn Station, New York, which have no parallel on the noncompliant operation.
- An adjustment for variations in traffic density and the number of tracks primarily derived from a *Transportation Research Record: Journal of the Transportation Research Board* paper (Martland et al. 2001), with further adjustments based on empirical data.
- An increase to reflect the application of train control systems on a substantial fraction of the commuter rail operations included in the data. The representative noncompliant operation is equipped with CTC only in the base case, leading to a higher collision rate than that for systems in the database.

The end result of all these adjustments was a set of accident rates and consequences for the base case as shown in [Table 3](#).

The sources and methods outlined above were also used to derive accident rates and consequence values for the various analysis cases when freight service is added and when the various risk mitigation measures are implemented. In particular, the one-dimensional collision analysis was used to estimate the consequences of collisions between noncompliant vehicles and freight equipment, and the Martland analysis for traffic density variations affecting a few passenger trips that were moving concurrently with a freight train trip. In the case of enhanced train control systems, accident rate estimates were guided by past experience in corridor risk analyses and the data developed by the Volpe National Transportation Center and others to

TABLE 3 Base Case Accident Rates and Consequences

Accident Scenario		Accident Rate (trains in accidents per million train miles)	Consequences per Accident	
Ref	Scenario		Injuries	Fatalities
1A	Same track collision 10-min peak service	0.162	0.200	0.0040
	Same track collision 20-min off-peak service	0.114	0.200	0.0040
1B	Intrusion collision	0.010	0.100	0.0020
2	Derailment	0.060	0.030	0.0010
3	Obstruction collision	0.129	0.006	0.0002
4	Grade crossing collision	0.070	0.012	0.0004

support PTC cost–benefit analyses. Table 4 gives the specific values used to estimate accident rates with train control systems.

ANALYSIS RESULTS

Table 5 shows the results from the base case analysis for the exclusive passenger operation with no freight service. The data are for 10 years of operation.

The results show that grade crossing accidents (reportable as train accidents) far outnumber other accident types. Most are minor, but there are enough more serious accidents for grade crossing accidents to be the second highest cause of injuries and fatalities, after train-to-train collisions. Relatively few collisions occurred, but the consequences of collisions are sufficiently severe for them to dominate injuries and fatalities. The remaining accident scenarios are much less significant.

Tables 6 and 7 summarize the principal analysis results for the shared passenger and freight operation, with and without mitigation.

The numbers give the estimated number of accidents, injuries, and fatalities in 10 years of operating freight and passenger service for the most important analysis cases. The primary impact of both adding freight service and implementing the risk mitigation measures is on train-train collision accidents. Adding freight service increases the number of collision accidents and the associated injuries and fatalities. Conversely, implementing the risk mitigation measures reduces collision-related accidents, injuries, and fatalities. As collision accidents are reduced, grade crossing accidents tend to dominate. It may be more cost effective to implement safety

TABLE 4 Train Control System Performance

Accident Scenario	Percent Reduction in Accidents by Train Control System			
	Enhanced ATS	TPWS	ATC/ATS	Full-Function PTC
Train–Train Collision	25%	45%	60%	80%
Intrusion Collision	0%	10%	20%	30%
Derailment	0%	0%	5%	20%

TABLE 5 Base Case Analysis Results for Accidents, Injuries, and Fatalities

Accident Scenario	10-Year Estimates		
	Accidents	Injuries	Fatalities
Train–Train Collision	0.51	5.06	0.101
Intrusion Collision	0.038	0.18	0.004
Derailment	0.23	0.33	0.011
Obstruction Collision	0.49	0.14	0.005
Grade Crossing Collision	2.68	1.52	0.051
Totals	3.95	7.22	0.171

TABLE 6 Estimated Accidents, Injuries, and Fatalities for Each Analysis Case

Analysis Cases	10-Year Estimates		
	Accidents	Injuries	Fatalities
Base Case	3.95	7.22	0.171
2 RT Freight Service without Mitigation	4.01	7.99	0.198
2 RT Freight Service with Double Track	3.72	5.06	0.135
2 RT Freight Service with TPWS	3.87	5.37	0.141
2 RT Freight Service with ATC/ACS	3.65	4.47	0.121
2 RT Freight Service with Full Function PTC	3.50	3.24	0.093
2 RT Freight Service with Double Track and TPWS	3.60	3.77	0.106
2 RT Freight Service with Double Track and ATC/ACS	3.65	3.30	0.095
2 RT Freight Service with Double Track and Full-Function PTC	3.50	2.66	0.081

TABLE 7 Estimated Percentage Change in Accidents, Injuries, and Fatalities for Each Analysis Case

Analysis Cases	Percentage Change from Base Case		
	Accidents	Injuries	Fatalities
Base Case	0%	0%	0%
2 RT Freight Service without Mitigation	2%	11%	16%
2 RT Freight Service with Double Track	-6%	-30%	-21%
2 RT Freight Service with TPWS	-2%	-25%	-18%
2 RT Freight Service with ATC	-8%	-38%	-29%
2 RT Freight Service with PTC	-11%	-55%	-46%
2 RT Freight Service with Double Track and TPWS	-9%	-48%	-38%
2 RT Freight Service with Double Track and ATC	-8%	-54%	-44%
2 RT Freight Service with Double Track and PTC	-11%	-63%	-53%

improvements at grade crossings rather than the more costly higher performance train control systems.

For ease of comparison between base case results and the results of the risk mitigation cases, [Table 7](#) shows the results as a percentage change on the base case.

These results show that a significant increase in risk occurs when freight service is added, even though there are only two daily freight round trips compared with over 70 passenger train round trips. The reason for the large increase is the relatively more severe consequences of collisions between a noncompliant passenger vehicle and conventional freight equipment.

Table 7 also shows that this risk increment can be fully mitigated by adding a second track, thereby reducing traffic density and avoiding many potentially conflicting train movements, or by adding one of several alternative train control systems. TPWS clearly meets the minimum requirement of reducing estimated injuries and fatalities well below base case levels, and the other train control alternatives provide still larger benefits.

The final report for the study includes further details of the risk analysis and the results obtained (Bing et al. 2005).

CONCLUSIONS AND RECOMMENDATIONS

Overall, the study determined that the primary area of concern with concurrent shared track operations is the number and severity of collisions between noncompliant vehicles and conventional freight cars and locomotives. Risk analysis showed that the incremental risk from these operations can be mitigated by practical risk mitigation measures, provided that freight operations are confined to a small number of trips during off-peak hours. The conclusions may be summarized as follows:

- For the representative 9-mi-long single track light rail service operating at 20-min off-peak headways, the introduction of two off-peak freight round trips sharing track with light rail trains over 8 mi of the route adds marginally but measurably to the risk of an accidental event, injury, fatality, and catastrophe for the passenger rail service.
- Any substantial investment in track capacity and/or advanced train control technology to reduce the likelihood of train-to-train collisions would reduce the risk of an accident, injury, or a fatality to levels well below those expected before the limited freight service was introduced onto the line.
- A combination of investments in advanced train control systems and track capacity would reduce the overall likelihood of an accident, injury, fatality, and catastrophe by approximately 50%, compared with base case conditions before the introduction of the freight service.
- The most effective individual risk mitigation measure is double tracking, if the system was originally single track. Double tracking provides multiple benefits; in addition to reducing accident risk, system capacity and reliability will improve.
- Installing a train control system comparable to the United Kingdom's TPWS is sufficient to offset the incremental risk of adding freight service. Full function PTC or traditional ATC/ACS systems also provide more than sufficient mitigation and would be options, especially if the freight locomotives were already equipped for operation on connecting railroads.

The results of the analysis suggest overall that safe concurrent shared track operation of passenger service with low-density freight service is feasible and that further research is justified. Much more detailed and thorough analyses, however, are required to provide a high level of assurance that the operation will be adequately safe. Further research is recommended as follows.

Recommendations directly related to shared operations include the following:

- Carry out detailed three-dimensional crush and collision analyses of collisions between a train made up of representative noncompliant vehicles and freight cars and locomotives. In particular, an analysis of the most worrisome collision between an empty freight car and a noncompliant vehicle must be included. Experience has shown that the lighter vehicle in a collision is more likely to override a heavier vehicle, potentially causing very severe damage.
- Develop improved accident scenario characteristics for representative noncompliant vehicle operations. Accident likelihood and consequence data used in this analysis were based on commuter rail data, in the absence of readily accessible noncompliant data. Such data exist but

are scattered among individual rail systems, as well as state and federal agencies. An effort to assemble these data and compare with those used in this analysis is recommended.

- The open interior layout of noncompliant vehicles and the presence of standees may increase the risk of occupant injuries from secondary collisions. A review of interior layouts and standee risks is recommended to identify risk areas and suggest improvements.

Recommendations related to risk analysis in general include the following:

- Develop a methodology for analyzing catastrophic accident risks for rail passenger operations. The majority of fatalities and a significant fraction of injuries occur in a few catastrophic accidents (those with multiple fatalities). An analysis was attempted in this project, but the results added little insight, and a better approach is needed.
 - Build on past efforts to develop a risk analysis manual for passenger rail operations.
 - Further study and analysis of intrusion accident risks in shared track and shared corridor operations.
 - A detailed study and comparison of acceptability criteria. The apparent acceptability of a given operation is strongly dependent on the base case selected as the measure of acceptability. The safety performance of existing operations, however, can vary substantially, and it is not always clear what would be an acceptable safe standard of comparison.

ACKNOWLEDGMENTS

The authors acknowledge the sponsorship and support of FRA's Office of Research and Development, especially that of Claire Orth, Chief of the Equipment and Operating Practices Division. Valuable help was also provided by other FRA and Volpe National Transportation Center staff and by the rail transit community.

RESOURCES

- Bing et al. Safety of Non-Compliant Passenger Rail Equipment. FRA Report DOT/FRA/ORD-05-xx, 2005.
- CPUC. Safety Rules and Regulations Governing Light Rail Transit. California Public Utilities Commission, General Order 143-B, January 2000.
- FRA Undated. *Code of Federal Regulations*, Title 49, Parts 200-299, Railroad Safety Standards and Regulations (current issue).
- FRA-RAIRS. Railroad Accident/Incident Reporting System Database. Annual tabulations of reports on railroad accidents, railroad incidents, and grade crossing accidents available for on-line queries or download.
- FRA 1999. Passenger Equipment Safety Standards: Final Rule. Federal Railroad Administration, 49 CFR Part 238 and related Parts. *Federal Register*, Vol. 64, No. 91, May 12, 1999.
- FRA 2000. Shared Use of the Railroad Tracks of the General Railroad System by Conventional Railroads and Light Rail Transit Systems; Notice and Final Rule. FHWA and FTA, *Federal Register*, Vol. 656, No. 132, July 10, 2000.
- Martland, C. D., Y. Zhu, Y. Lahrech, and J. M. Sussman. Risk and Train Control: A Framework for Analysis. *Transportation Research Record: Journal of the Transportation Research Board*, No. 1742, TRB, National Research Council, Washington, D.C., 2001, pp. 25-33.

- Phraner, S. D., R. T. Roberts, P. K. Stangas, K. A. Korach, J. H. Shortreed, and G. J. Thompson. *TCRP Report 52: Joint Operation of Light Rail Transit or Diesel Multiple-Unit Vehicles with Railroads*. TRB, National Research Council, Washington, D.C., May 1999.
- Phraner, S. D. Supplementing and Updating TCRP Report 52: Joint Operation of Light Rail Transit or Diesel Multiple Unit Vehicles with Railroads. *TCRP Research Results Digest 43*, TRB, National Research Council, Washington, D.C., September 2001.
- Phraner, S. D. Germany's Track Sharing Experience: Mixed Use of Rail Corridors: Report of the Spring 2000 Mission. *TCRP Research Results Digest 47*, TRB, National Research Council, Washington, D.C., March 2002.
- USDOT. Talgo Train Operations on U.S. Railroad Corridors. DOT Docket Management System Reference FRA-1999-6404, Item 86 and Item 87.

MEET-THE-AUTHORS POSTER SESSION

Surface Rail Service and Surface Transit Ridership *A Statistical Inquiry*

CARL L. NATVIG

Municipal Transportation Agency

For this study, time series data for the period from 1929 to 1969 were used to include the three major events which are generally considered to have most greatly influenced transit patronage during the decline of the transit industry, the Great Depression, World War II, and the postwar collapse of the industry, and to cover an adequate number of years to obtain significant statistical results. The variables studied were those generally considered to have influenced the decline of transit ridership during this period including fare levels, price deflated fares (1958 \$), auto registrations, per capita price deflated (1958 \$) income, the price of gasoline, national population, surfaced roads, and total road miles. In addition, time series data for transit service variables including streetcar vehicle miles, trolley coach vehicle miles, motor coach vehicle miles, rapid transit vehicle miles, and route miles were analyzed.

Average fares for each year were calculated by dividing total industry revenue by total patrons. Price deflated fares and average gas prices were also calculated using the 1958 price deflators for 1929 through 1969.

To determine the effect of the conversion of the streetcar mode to trolley coach and motor coach and later from streetcar and trolley coach to motor coach, the percentages of total surface vehicle miles and total vehicle miles were calculated for each mode. Total U.S. surface transit patronage was used for the dependent variable. If the percentage of service miles provided by rapid rail was included as an independent variable, total transit patronage was used as the dependent variable.

For additional verification of the national data analysis, the same analysis was performed using time series data from the San Francisco Municipal Railway for the period from 1946 to 1969. Since the Market Street Railway, a private company, prior to the 1944 city buy-out and merger of the two systems provided the majority of service, service data for the Market Street Railway system were not available.

FINDINGS

No set of variables provided a high multiple regression correlation for the entire 1929 to 1969 period. However, it was found that by dividing this time period into the 1929–1945 Depression and War periods and the 1946–1969 postwar collapses, very high multiple correlation coefficients with very high statistical significances for the mode variables could be found by using two different sets of variables.

1946–1969 Patronage Collapse

In this period, surface transit patronage plunged from 20.537 billion riders to 5.823 billion riders per year. The statistic correlation story for this period is simple. By far, the most highly correlated variable is streetcar vehicle miles as a percentage of total surface vehicle miles as a leading variable. That is the patronage numbers for 1947 through 1969 correlated with the percentage of vehicle miles provided by streetcars numbers from 1946 through 1968 with a multiple regression correlation of 0.9982 and an F-ratio of 5888. The coefficient of regression was found to be positive with a change of 489 million patrons for each 1.0% change in the percentage of vehicle miles provided by streetcar with an intercept of 5001 million patrons. Using the concurrent data for 1947 through 1969 slightly lowered the correlation to 0.9982 and the F-ratio to 5736, but increased the coefficient of regression to 562 million patrons per 1.0% shift in the streetcar variable with an intercept of 4976. Adding any of the variables listed above lowered both the multiple correlation of the equation and the significance of the streetcar variable with the exception of the trolley coach percent mileage variable. Adding more years to the beginning of the time series lowered the multiple correlation coefficient of the regression equation successively and substantially. Shortening the time series from either end of this time series did not substantially change the multiple correlations or the coefficient of regression.

Adding the variable for trolley coach vehicle miles as a percentage of surface vehicle miles slightly reduces the multiple correlation to 0.998 and the F-ratio to 4614 with an almost unchanged streetcar coefficient of 550 million patrons and a trolley coach coefficient of 77 million patrons for each mode shift of 1.0% in vehicle miles with an intercept of 4.62 billion patrons.

The streetcar variable can also be divided into percentage of miles provided by PCC and older type streetcars. This was accomplished by apportioning the percentage of vehicle miles provided by streetcars according to the number of President's Conference Committee (PCC) cars in the industry fleet relative to the total streetcar fleet. This method is somewhat imprecise and there was probably some variance in the quality of the older cars remaining in the fleet as well as variance in the density of patronage demand from system to system where the different types were used. However, splitting the streetcar variable into two variables for the 1947 to 1969 period only reduced the multiple correlation to .99880 and the F-ratio to 4172 with a coefficient of regression for the PCC variable of 695 million patrons and for the old-type streetcar variable of 543 million patrons for each 1.0% shift in the percentage of service provided by each mode with an intercept of 4.49 billion patrons.

1929–1945 Depression and War Years

Surface patronage in this period fell from 14.414 billion patrons to 9.194 billion patrons in just 4 years at the depth of the Depression in 1933 and then rose to 20.556 billion patrons at the end of World War II in 1945, peaking at 20.815 billion patrons in 1947. Undoubtedly, unemployment, reduced incomes, in the Depression and then greatly increased incomes, employment leading up to the war, followed by gas and tire rationing during the war pushed transit patronage up. The decreased use of the automobile between 1929 and 1933 as incomes dropped, followed by increasing use of the auto as incomes and employment rose from 1933 through the beginning of the war, had first a positive effect on patronage followed by a negative effect. Of the variables tested, the variables which were found to produce the highest multiple correlation with high

significance for each variable for the period 1929 through 1945 were price deflated average revenue per patron, i.e., average fares, U.S auto registrations, price deflated per capita income, motor coach vehicle miles as a percentage of surface vehicle miles, trolley coach percent miles, and PCC percent miles. Adding to or replacing any of these variables with any of the variables listed above reduced the multiple correlations and reduced the significance of the other variables. Adding more years to the time series also reduced the multiple correlations and the significance of these six variables. The streetcar mode variable is not included in the equation as it is a reciprocal of the other three variables. If the motor coach variable is replaced with the old-type streetcar variable, the coefficients of regression remain about the same except that the old-type streetcar variable coefficient is positive. The rapid transit variable is not significant since there was very little change in service for this mode during the period from 1929 to 1969. The multiple regression correlation was 0.9991 with an F-ratio of 946. The coefficient of regression for each of these variables was as follows:

- Price deflated average fares: –1307 million patrons per one cent of fare increase.
- U.S automobile registrations: –967 patrons per auto registration.
- Price deflated per capita income: 12.68 million patrons per dollar.
- Motor coach % miles: –143.94 million patrons per 1.0% mode shift in % of total surface vehicle miles.
- Trolley coach % miles: 955.17 million patrons per 1.0% mode shift in % of total surface vehicle miles.
- PCC streetcar % miles: 774.28 million patrons per 1.0% mode shift in % of total surface vehicle miles.
- Intercept: 37990 million patrons.

For this period, this equation predicts that each of these variables would have had a substantial impact on transit patronage as shown in [Table 1](#) below. The reader can best ascertain the full complexity of the influences of these variables through the Depression and war years by inspecting the predicted patronage values caused by each of the variables on a year-by-year basis in [Exhibit 1a](#). ([Click here to link to external appendix of data files.](#))

TABLE 1 Predicted Change in Patronage Caused by Variables 1929–1945

Variables	PD Fare	U.S. Autos	PD Income	MC % Surface Miles	TC % Surface Miles	PCC % Surface Miles	Predicted	Actual	Diff.
Change in Patrons: 1929–1945 Elasticities	834	–2260	5149	–4512	4472	2348	6032	6142	–110
For 1% Change of X	–0.6%	–1.2%	1.0%	–0.7%	4.6%	3.8%			

Though the above equation accurately predicts surface patronage throughout this period, with the exception of the mode variables, the predicted patronage for the other variables, fares, autos, and income are wildly inaccurate if projected through 1969 (see [Exhibit 1a—click here for link](#)).

San Francisco 1946–1969

From 1946 to 1952, the percentage of service provided by streetcar in San Francisco declined from 66.9% of total vehicle hours to 13.1%. From 1946, trolley coach percentage of total service increased from 2.7% to 36.7% in 1952 and motor coach service increased from 27.9% to 50.2% in 1957. With the exception of one route, the B-Geary, the heaviest line in the city, which converted in 1956 to motor coach, reducing the percentage of service by streetcar to 12.2%, there were no other changes in the streetcar or trolley coach modes. The four cable car routes were combined into three and substantially truncated in 1956. Interestingly, in contrast to the national trends, the total vehicle hours were only modestly reduced in San Francisco from 3.22 million to 2.82 million vehicle hours over this entire period.

Revenue patronage declined from 232.6 million in 1946 to 157.1 million in 1953, 141.0 million in 1957, and 142.2 million in 1969.

Percentages of total vehicle hours were used instead of percentage of vehicle miles because these indexes provided slightly higher correlations. In addition to the percentages of vehicle hours provided by each mode, total vehicle hours, San Francisco fares, price deflated fares, population, and automobile registrations along with U.S. price deflated income and average price deflated gasoline prices were evaluated.

Three variables, price deflated fares, percentage of vehicle hours provided by streetcars, and total system vehicle hours, were found to yield the highest correlation with a high significance for each variable. The multiple regression correlation was 0.9977 with an F-ratio of 1436. Adding or substituting any of the other variables into the equation reduced the multiple correlations and the significance of the variables. The coefficients of regression for each of the variables were –4.60 million revenue patrons for each one-cent fare increase, 1.144 million revenue patrons for each 1.0% change in the percentage of service provided by streetcars, and 41.97 revenue patrons per system vehicle hour with an intercept of 75 million revenue patrons.

During this period, 31% of total vehicle hours were converted to trolley coach versus only 22% to motor coach. However, none of the trolley coach lines were later converted to motor coach, as was the case for most other trolley coach lines in other cities. If the streetcar variable is replaced with the trolley and motor coach percentage of total system vehicle hours variables, the multiple regression correlation was 0.9971 with an F-ratio of 814. The coefficients of regression for each of the variables were –4.15 million revenue patrons for each one cent fare increase, –1.285 million revenue patrons for each 1.0% change in the percentage of service provided by trolley coaches, –0.977 million revenue patrons for each 1.0% change in the percentage of service provided by motor coaches, and 41.91 revenue patrons per system vehicle hour with an intercept of 176 million revenue patrons.

The negative coefficient for trolley coaches is higher than for motor coaches. The reason for this is that the streetcar routes converted to trolley coach were the heaviest routes in order to take advantage of the existing capital investment in the electrical power distribution system. As demonstrated in the analysis of the national data, the streetcar was nearly eight times more effective in attracting riders than the trolley coach, even though the trolley coach was shown to

be more attractive than the motor coach. Hence, even though the trolley coach may have been more effective in retaining patronage, there were more passengers per vehicle hour on the streetcar routes converted to trolley coach than motor coach. Later conversions in San Francisco of the #1 and #3 trolley coach lines temporarily in 1969, and the conversions of the #55 and #24 motor coach lines in 1981 and 1983 indicated that trolley coaches attract about 10% more riders than motor coaches.

DISCUSSION

Pre-1946 Versus Postwar Correlations

As described above, in the period from 1929 to 1945, the mode conversion variables do not become significant until the factors of fares, automobile availability, and income are included in the equation, whereas, in the postwar years, the streetcar variable, i.e., the conversion from streetcar to bus, accounts for essentially 100% of the decline in transit patronage from 1946 to 1969. There are three general factors, which may be considered in this regard. First, the Depression caused huge swings in income, employment, and the availability of autos for transportation by causing people to give up their autos at the bottom of the Depression around 1933. Also, because incomes were low during the Depression, fares were a significant factor in determining patronage. Second, World War II first increased incomes, employment, and, thus, the need for transportation as the war approached as well as during the war, and then reduced auto availability through rationing during the war. For evaluating the effects of the Depression and the war on transit patronage, the results of this analysis suggest that the fares, auto registrations, and per capita income adequately account for these two major historic forces. Also, per capita income appears to be an adequate proxy for employment in this period for this analysis. After the war, the Depression and rationing were over and auto registrations and income begin a gradual and uninterrupted climb. The third major factor differentiating the pre-1946 period from the post-1946 period is the shift in character of the streetcar conversions.

Though a detailed property-by-property analysis of the character of the equipment and densities of patronage on the routes converted on a year-by-year basis is outside of the scope of this enquiry, some general observations can be made. First, in the beginning of the conversions in the late 1920s and the 1930s, the most likely candidates for conversion would be the more lightly patronized lines. Secondly, the most dilapidated cars using the most run-down track would also be ripe candidates for conversion to bus, whereas, by the postwar years, the remaining streetcars would have been the best patronized and, hence, the most economical. Converting these routes would have had a much more dominant impact on overall transit patronage with more patrons per percent of total system service with greater network effects. At the same time, real fares were not changing very much and new auto registrations were mostly in the suburbs where transit service was thin or had never existed.

Streetcar Patronage Elasticities

The coefficients of regression for percentage of total surface vehicle miles provided by old-type cars, trolley coaches, and PCC streetcars, which correspond to very high patronage mode conversion elasticities for these modes nationally between 1929 and 1945 and for the streetcar

variables for both the San Francisco and the national data, are noteworthy. For example, the coefficient for the streetcar variable as a leading variable for the time series from 1947 to 1969 indicates that a conversion of 1.0% of total surface vehicle miles to motor coach would result in a loss of 2.4% of total surface patronage in 1946 and 8.4% in 1969. Using the 1929–1945 regression coefficients, in 1945, a 1.0% conversion from old-type cars to motor coaches would result in a patronage loss of 0.7%, but a gain of 4.6% if converted to trolley coach or a gain of 3.8% if converted to PCCs. In San Francisco, a conversion of 1.0% of vehicle hours from streetcar on average would produce a revenue patronage loss of 0.49% in 1946 and 0.82% in 1969 according to the regression formula.

Essentially, the reason that the relationship between the percentage of service provided by the modes and the number of patrons is shown to be highly linear in these three regressions is most likely that over these time periods, the conversions shifted from lighter lines to the heavier lines. In the pre-1946 period, the industry was still dominated by private companies, which were still covering operating costs from the fare box, and still saw itself as continuing in business and was looking for the best ways to reduce costs and increase revenue. For these reasons, the lines converted to motor coach would tend to be the less profitable lines in order to reduce costs. The new trackless, trolley coaches were seen as a means of eliminating pavement, track, and vehicle maintenance costs while attracting more riders to modern new vehicles. The new PCCs were also seen as smoother, quieter, faster, and, therefore, more attractive to riders than the older cars. At the same time, trolley coaches and PCCs were a little more expensive to obtain and were therefore more likely to be used on the more heavily used and, therefore, more profitable systems and routes. After the war, conversions from streetcar, mostly to motor coach, were wholesale regardless of the density of patronage. Also, direct losses in patronage due to conversions would have secondary effects on other connecting routes, as well as the vicious cycle effects of reduced patronage causing reductions in service frequency, which would cause further losses in patronage, which would cause more service reductions and losses on feeder lines, and so forth. Patronage would have held up on routes and systems which retained streetcars and then plunged when conversions took place. Tennyson documents over a dozen examples where patronage plummeted to a fraction of preconversion levels within only a few years after abandonment of streetcar service.

Hence, 1% of vehicle miles could represent more than 1% of total patronage when the density of the routes plus the secondary effects is taken into account.

In the case of San Francisco, the elasticities are lower for several reasons. First, 67% of the service was streetcar in 1946, 13% in 1952; both high patronage and lighter lines were converted at the same time. Second, service levels remained comparatively constant, even increasing a little initially to account for the lower capacity of 37-ft buses compared to wider and longer 50-ft streetcars, essentially eliminating the vicious circle effect of succeeding service cuts. Also, nearly two-thirds of the conversions were to the more attractive trolley coaches, which were retained to the present, further blunting the effect of the conversions and lowering the secondary effects and the resulting elasticities of conversion.

Also, most importantly, the extraordinary successes of many new light rail lines resulting in the doubling or even tripling of patronage such as with the new Interstate Line in Portland, Oregon, or the San Ysidro line in San Diego reinforce the plausibility of the high elasticities found in this historical analysis.

Streetcar Costs

It has often been contended that a major factor in the decision to convert to bus was the lower operating cost of motor coaches even in the gasoline bus era. Motorbus advertisements of the time touted the lower cost per vehicle mile of motor coaches relative to streetcars.

Notwithstanding the fact that 50-ft by 9-ft streetcars had considerably more capacity than the then available 37-ft by 8.5-ft buses, that the motor buses were operated on lighter lines with fewer stops per mile, and thus, fewer driver and maintenance hours per mile, and that the two-staff crews on streetcars were rapidly disappearing, this matter bears some attention. A detailed operating cost analysis and comparison is outside the scope of this paper; however, the ready availability from the American Public Transportation Association (APTA) Fact Books for this period of total industry employment mandates a forthright review. For the period 1946 to 1969, a positive regression correlation of 0.9816 with an F-ratio of 582 was found. The coefficient of regression was a change of 109,172 annual patrons per employee for each 1.0% shift in the percentage of surface vehicle miles by streetcar with an intercept of 52,975 patrons per employee. Between 1946 and 1969, annual patrons per employee dropped from 89,547 to 55,395.

One might consider the possibility that as patronage declined, the passengers per vehicle simply declined as well. However, since with the motor coach mode there is no fixed capital plant for right of way such as track, wire, or power substations, there is little availability of economy of scale with the motor coach mode as there might be with the streetcar mode. The two more likely explanations for the decline of patrons per employee with the conversions to motor coach are that the less attractive motor coach mode reduced the more choice sensitive off-peak patronage or that motor coaches overall were simply more expensive to operate per patron due to higher maintenance or slower overall operating speeds. Streetcars operate almost exclusively in the center of the street, and, therefore, save some time by not having to pull in and out of curb stops. Also, the 50% more powerful PCC streetcars were 3 to 4 s faster per stop than any motor coaches available until 1969, when San Francisco purchased V-8 powered diesel buses.

CONCLUSIONS

This paper has investigated the historic and catastrophic decline in transit patronage between 1929 and 1969 and the statistical relationship of this decline to the major change in mode, which took place in this period as the streetcar was almost entirely replaced by the motor coach. The mode variables were defined as the percentage of total surface mileage provided by the three basic surface modes, the streetcar, the trolley coach, and the motor coach. The streetcar variable was further split into the PCC (modern streetcar circa 1936 to 1952) and the older-type cars to further distinguish the relative importance of vehicle quality on patronage. Expressing the mode variables as percentages of total service effectively allows for the measurement of the correlation and of the rate of conversion against the rate of decline of transit patronage using multiple regression analysis. Other time series data for variables generally believed to be contributing to the decline of transit were evaluated including fares, auto registrations, per capita income, gasoline prices, surfaced road mileage, and U.S. population. As a case study comparison to the national data analysis, similar data for the San Francisco Municipal Railway were analyzed for

1946 through 1969, which covers the major conversion to trolley coach and motor coach and the major concurrent decline in patronage for that system.

For the national data, the regression equations with the highest correlations were found by dividing the time series into 1929–1945 and 1946–1969 periods. Throughout the whole period, the streetcar, old-type, or modern PCC, and the trolley coach were positively correlated while the motor coach was negatively correlated. For the 1946–1969 period, equations, which included only the streetcar variables or the streetcar variable plus the trolley coach variable, produced the highest multiple correlation coefficient. In the 1929–1945 period, the Depression and World War II clearly had important impact on transit patronage as evidenced by the fact that the best equations were developed by adding time series data for fares, auto registrations, and per capita income to the mode variables for motor coaches (or old-type cars), PCCs, and trolley coaches. Neither population growth, gas prices, nor roads were significant variables for any period.

Since the multiple correlation coefficients for the equations described in this enquiry were found to be 0.9977 or better, and each of the variables was found to be significant in the equations, these findings would appear to be definitive for the 1929 to 1969 time period. By including variables for price deflated fares and total vehicle hours with the streetcar percentage of vehicle hours in the San Francisco equation, comparable results were found for San Francisco, thereby confirming the national aggregate data.

It has been contended by some that the opportunities provided by rising income in combination with better roads and automobiles led after World War II to the decline in transit patronage and to the move to the low-density suburbs, which were difficult to serve with fixed route transit, especially rail transit, which was too inflexible to serve new markets. This hypothesis may explain why transit had limited success in expanding into the suburbs. However, it does not explain why transit experienced such enormous declines on established routes serving higher density, established neighborhoods, offices, and businesses. In fact, this analysis shows that auto registrations and income were insignificant in comparison to the streetcar conversions in the decline of existing transit systems. It is more likely that the abandonment of the relatively comfortable streetcar lines initially made the auto more attractive even in the more difficult and costly operating environment for autos in the cities. When the conversions began, the vicious cycle of abandonment of streetcar service, followed by patronage losses, more service cuts, and the succeeding cycles of more traffic congestion, ensued. Once access to the central cities was permanently impeded, the spread of suburban development was further accelerated.

It has also been postulated that the streetcar lines were converted to motorbus in response to declining patronage and resulting rising unit costs. The fact that patrons per employee are nearly perfectly negatively correlated with the rate of conversion to motor coach from 1946 to 1969 places that concept in question. Nonoperating costs such as franchise fees, pavement maintenance (not required for motor coach operation by most municipalities), or the need to replace worn-out capital plant, such as track, wire, or electrical power equipment could have been cost factors influencing the decision to convert. Even this is disputable since these assets have a very long life. For example, the San Francisco Municipal Railway's track and electrical equipment for its five remaining streetcar lines, among the heaviest of the original system, were not replaced until the 1970s. Much of this equipment had remaining life, but federal money was available for the first time, and it was not certain whether such funding would continue to be available.

Since it is easy for passengers to stop using public transit when it becomes less attractive, while it would be difficult for a transit operator to convert routes in lock step with patronage declines, the high correlation between patronage and the rate of conversion from streetcar to motor coach and the slightly higher correlation with the streetcar variable as a leading variable from 1946 to 1969 leads to the ineluctable conclusion that the conversion of the streetcar systems to motor coach directly caused the entire loss of transit patronage after World War II. This probable cause and effect relationship is further verified by the San Francisco time series regression analysis in the case studies performed by Tennyson, and the outstanding successes of new light rail and streetcar lines built in the past few decades.

The better of the older type streetcars, the PCCs, and the new light rail vehicles or streetcars are much smoother, wider, and quieter, as well as fume-free in comparison to even new motor coaches. There is little, if any, difference between the ride provided by new motor coaches and any of the air-ride suspension coaches of the 1950s. In total, the electric streetcar eliminates most of the physical discomforts and vibrating, weaving, bouncing, jouncing, and tossing indignities of riding bus public transit. In sum, these comfort factors appear to transcend a major threshold that determines the decision to use public transit. The findings of this historical analysis in combination with the continuing success of new electric light rail and streetcar projects should give transit planners and government officials and leaders added confidence that building new surface rail transit projects will continue to be the most effective means of substantially increasing transit patronage at reasonable cost.

APPENDIX

[Click here for link to external files of data.](#)

[Exhibit 1 Predicted Patronage Values in Millions, 1929–1969.](#)

[Exhibit 2 Surface Transportation Patrons, 1929–1969.](#)

[Exhibit 3 U.S. Surface Vehicle Use, 1929–1969.](#)

RESOURCES

Annual Report, San Francisco Municipal Railway, 1959–1970.

Economic Report of the President, 1970.

Fact Book, American Public Transit Association.

Tennyson, E. L. Impact on Transit Patronage of Cessation or Inauguration of Rail Service. In *Transportation Research Record 1221*, TRB, National Research Council, Washington, D.C., 1989, pp. 59–70.

MEET-THE-AUTHORS POSTER SESSION

Implementing a Winning Approach to Good Facility Design

JON CLAUDE HOLLER

RICHARD G. SHIFFER

RNL Design

Millions of capital dollars are spent every year in transit agencies across North America to design and build new or refurbished transit operations facilities. In addition, most agencies spend thousands of dollars a year for facility operating expenses, including utilities, maintenance, and custodial services. In fact, facilities management is one of the larger expense items in any agency budget.

So how can transit agencies, or any other owner for that matter, assure themselves that they are spending their capital dollars wisely for well-designed facilities?

With more than 45 years of collective experience with designing transportation operations and maintenance facilities, the authors will present important issues that must be considered to make the design and construction of any transportation operations and maintenance facility a success.

Good design requires a thorough programming effort that defines owners' goals and vision for the project, the functions of the facility, and the project budget. Most importantly, owners should recognize that well-designed facilities do not require bigger budgets. Well-designed buildings consider operations and maintenance costs over the life cycle of the building, appropriate materials, the effect of the aesthetics and functionality of the building on both the people who work within the facility as well as the surrounding neighborhoods, and flexibility and adaptability to future technologies and needs.

Achieving good design requires a design firm that will dedicate staff experienced with transit operations and maintenance facilities, integration of the design process between all of the stakeholders involved, and an owner commitment to seeing the project through.

WHAT IS GOOD DESIGN?

For starters, it is important to recognize what good design is. Some might say that it is all about aesthetics and how a building fits into the neighborhood and its community. Others may say that it is all about the function of the building, and how well the work flows. Still others might argue that it has something to do with the building being constructed within the agency's budget. In reality, good design includes all of these, and even more, but one thing that everyone should understand is that good design does not have to cost more than mediocre, or even bad design. In fact, when long-term operating costs are factored in, bad design typically costs more than good design. So what is good design and how can managers assure themselves that they are indeed getting good design? This paper will define the many different attributes of good design, all of which must come together for a truly successful and well-designed building.

MEETING THE CLIENTS' NEEDS

Every building project, whether a new operations and maintenance facility, administrative headquarters, or even for a remodel of the parts room or a portion of the office area, should start with an identification of the needs of the client and the ultimate function for which the design is intended, as well as its desired look and feel and appeal to the owner, end-user and community. This statement of needs should be documented as part of what is called a facility program. A well-written facility program includes the following:

- The owner's goals and vision for the project;
- A functional description of the facility:
 - A description of all the spaces needed to meet the functional needs, including the area in square feet or square meters;
 - The functional relationships of spaces necessary for proper interaction;
 - The type of building systems (type and levels of lighting, welding outlets, vehicle exhaust, etc.) required in each space; and
- The project budget.

Depending on the size of the project, the facility program may include more or less, but every project should start with a documented identification of needs. This document then becomes the standard for whether the design meets the intended purpose, and every designer should pay particular attention to it to ensure that clients' needs are met.

FUNCTIONAL DESIGN

Louis Sullivan, one of America's most famous architects, once made the profound statement that *form follows function*, meaning that, as Sullivan wrote, if "a building is properly designed, one should be able with a little attention, to read through that building to the reason for that building." However, not all designers hold to Sullivan's premise, causing some buildings being designed with little thought to the way the building will be used. In these cases, a building's form might be established first, and then the designer adjusts the interior space to make it work for the client.

The form and function of a building is no more important than in a transit operations and maintenance facility, where an efficient workflow and good, safe circulation is paramount. An effective designer will study vehicle circulation patterns and understand proper workflow and movement of parts to achieve good design and a highly functional transit facility.

AESTHETICS

A well-designed building should invoke a sense of pride and be considered a positive feature of the community. Most everyone knows the NIMBY acronym—Not in My Back Yard. But why don't people want certain types of buildings to be located near their homes or businesses? Some of it has to do with the noise or additional traffic that will be generated by the facility, but many times, the perceived lack of good aesthetics plays a significant role in the attitude as well.

Most architects would agree that every, or most every, building project should contribute to enhancing the community in which it is located. No one wants to see an “eyesore” in his or her community yet every community seems to have them. Unfortunately, many operations and maintenance facilities, be it a rail or bus facility, or a municipal yard, are often thought to be “poor neighbors”.

Many times this comes from trying to meet a client’s functional needs by designing the simplest, most economical building, while thinking only of first-time capital costs. A common misunderstanding is that the most economical building to build and operate is generally considered to be a rectilinear building with a uniform height. Yet consideration of the overall operations costs of the building during its life span often makes it clear that this is not the best design approach. Designing a building at the same height requires the building to have a constant high volume. Over the life cycle of the building, the heating and air conditioning of this higher volume of air will result in higher utility costs.

The simple “boxy” approach typically does not aesthetically benefit the surrounding area and neighbors. A good design may incorporate a varied building height that adds visual interest and reflects the functions inside. For instance, the highest height is needed in heavy maintenance bays where bridge cranes are used, or over a mezzanine. Building heights can be reduced over office and locker room areas, or in the light repair bays. Changing building height not only reduces the volume, but also affords the opportunity to introduce clerestory (high window) glazing into the high bay areas where the roof levels change. This can provide additional natural lighting to enhance the work areas while saving utility costs.

CONTEXT WITHIN THE SURROUNDING AREA—SPACE AND SIZE

Just about every building constructed becomes part of something larger than itself. For instance, most homes are part of a neighborhood. Most high-rise office buildings are located in a central business district and are therefore part of the city’s center and identity. Likewise, most transit buildings are part of something larger than themselves, either as part of a community, a neighborhood, or regional development.

It is therefore important that these transit facilities “fit” within with the area where they will be constructed. Contextual architecture is truly that...a project made to “fit” within the context of the neighborhood or community. Good design is necessary to make sure the fit is appropriate. The example of the flat roof building may be adjusted to fit to its surroundings by addressing the size and scale of the building. More sculptural roof forms can be utilized rather than a simple flat roof, which may be more aesthetically pleasing and in context to the surrounding area. The graceful curved roof of the Regional Transportation District’s (RTD) Elati Light Rail Maintenance Facility located at the Denver–Englewood city lines in Colorado (see [Figure 1](#)) shows how this curved form not only adds visual interest but also provides the highest volume where it is needed over the maintenance bays, while bringing the overall height of the building down to a pedestrian scale at the front entrance.



FIGURE 1 The curved roof form of the Elati Light Rail Facility is an example of form following function that complements its surroundings.



FIGURE 2 The Park City Transit Center in Utah respects the surrounding area's historical and topographical contexts.

APPROPRIATE MATERIALS

Building cost is always affected by the type of materials chosen for the facility, but too often the initial costs are the only ones considered. Yet it is a known fact that buildings constructed of high-quality materials such as brick or stone will last much longer than less expensive materials like wood or metal siding. However, just using an expensive exterior material does not assure better design. In fact, the design of the RTD Elati project was actually enhanced by using less expensive materials in appropriate places. Originally conceived as a precast concrete and brick building, the designers changed the exterior materials above the 8-ft level to insulated metal panels. The reason for the change was two-fold. First, the insulated metal panels had a lower

initial cost, which helped meet the owner's budget while still providing long-term usefulness. Only the material above eight feet was changed because lower level materials require high impact resistance. The second reason for utilizing the metal panels was that they were much easier to sculpt into the desired curved shape. This allowed the designers to utilize a double curving clerestory window, which follows the curve of the roof on top and the curve of the metal panels on the bottom. The clerestory windows also bring in natural light. The employees at Elati notice the difference according to the owner Engineering Manager Jerry Nery. "The mechanics are the ultimate end-users of this facility and are impressed with the lighting, along with the openness of the pit areas," Nery said. Still, the Elati facility is an example of form following function that, according to Englewood Community Development Director Bob Simpson, is "a valuable and attractive asset for the neighborhood" (1).

MINIMIZE OPERATING COSTS

Good design should always consider long-term operating costs and be responsible to the environment. According to the United States Green Building Council (USGBC), buildings utilize approximately 40% of all energy in the United States, and are responsible for more than 50% of waste in U.S. landfills (2). A building designed only with initial costs in mind will generally have much less efficient mechanical and electrical systems included, requiring higher energy costs to operate over the life of the building. Well-designed buildings utilizing natural daylighting techniques and energy efficient building systems are providing significant savings in operating costs to owners every year over the life of the building. However, the exact cost savings will depend on the specific parameters involved with each individual project. An excellent resource for understanding sustainable design and its effect on operating costs is Davis Langdon's 2004 Costing Green: A Comprehensive Cost Database and Budgeting Methodology (available from the USGBC at https://www.usgbc.org/Docs/Resources/Cost_of_Green_Full.pdf #search='Costing%20Green:%20Davis%20Langdon') (3).

LEED™ Certification

The new East Valley Bus Maintenance Facility in Tempe, Arizona, now under construction, is an example of a facility designed with long-term operating costs in mind. The facility is targeting Leadership in Energy and Environmental Design (LEED) Silver/Gold certification from the USGBC and the design incorporates many energy-efficient systems. Sustainable design strategies on this project include:

- Reclamation and reuse of 90% of the bus wash water (remaining 10% is evaporative or drip runoff);
- Evaporative cooling of maintenance areas;
- Underfloor air distribution system in the administration building to reduce energy usage by up to 47%;
- Evaporative media at chilled water cooling equipment in the administration building to reduce initial air temperature;
- Low flow/dual option plumbing fixtures and waterless urinals;

- Energy efficient emergency generation equipment;
- Sensor-activated lighting in offices to reduce energy consuming artificial lighting;
- Sensor-activated light shutoffs in offices;
- Recycled content in all carpet, tile, millwork, and ceiling finishes;
- Low volatile organic compounds (VOC) -emitting paint for all interiors;
- Reduced window openings at east and west to reduce heat gain;
- Double-pane/low-e glazing to reduce heat gain;
- Natural lighting into all regularly occupied spaces;
- Decomposed granite parking lot surface to reduce heat islands and runoff;
- Oil/water separate to filter storm runoff;
- Highly reflective roofing membrane for flat roofs;
- Metal canopies to reduce heat island effect;
- Fabric shade canopies at the administrative areas to reduce heat gain; and
- Drought-resistant native landscaping.

Sustainable Design Without LEED Certification

The Elati Light Rail facility was designed with sustainability in mind but without any formal process or standard to meet the USGBC LEED certification. However, a review of the Elati design against the current LEED-NC rating system indicates that the building could possibly have achieved a LEED Certified rating—particularly if LEED certification was a project objective at the time of design. Owners may forgo the certification process because of the costs involved, yet still see the benefits of sustainable design. Some approaches at Elati included:



FIGURE 3 Resalvaged materials—including steel from the old Mile High Stadium—were reused at Elati.

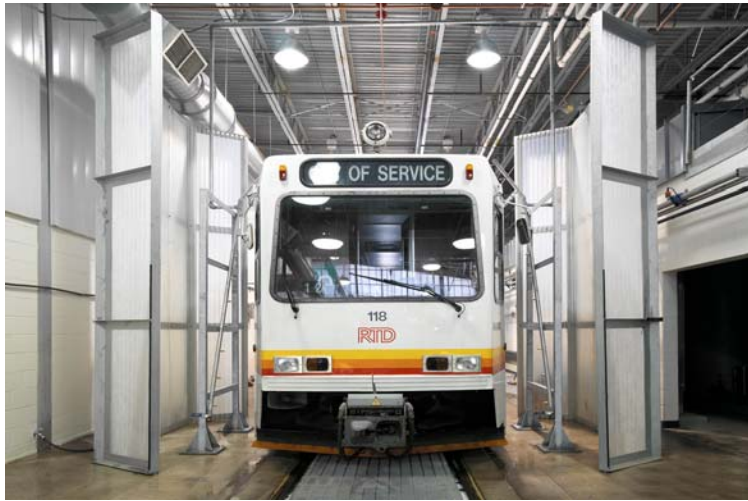


FIGURE 4 Water reduction—recycling water at the light rail vehicle train wash.

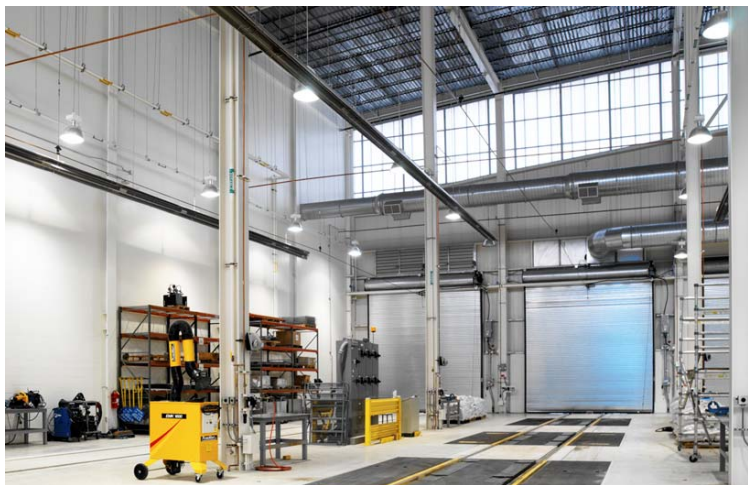


FIGURE 5 Daylighting—use of large clerestory windows and glazing.



FIGURE 6 Local and regional materials—use of local masonry and other local materials.



FIGURE 7 Low-emitting interior materials—use of low-VOC finishes such as flooring, adhesives, and paint.

Functionally Well-Designed Buildings Also Contribute to the Bottom Line

Buildings that are well designed specifically to meet functional operation requirements are less expensive to operate as well. If a parts room in a maintenance building is not properly located, it can cost a mechanic 30 s of extra time to retrieve a part. If the fuel/service area of an operations and maintenance facility is not properly located, a bus may have to travel an additional 200 m just to fuel and wash. These inefficiencies create wastes of time and fuel, which over time may cost an owner thousands of dollars in operating costs.

Technology, Adaptability, and Flexibility

Properly designed buildings should be built to last for at least 50 to 100 years. Unfortunately many buildings in the United States do not have this long life span. When one looks at buildings in Europe one sees buildings that have been in use for hundreds of years. However, when thinking more long-term, one must also consider flexibility and adaptability in the design, as advances in technology change and improve every year. Buildings now need to be able to change too, not only to accept new programs and ways of doing business, but also to accept different and more advanced communication and data systems.

Productivity and Worker Satisfaction

One final area in which good design saves owners money can be found in the area of employee productivity and retention. Well-designed buildings lead to greater worker satisfaction and greater employee retention, again providing cost savings to owners in the recruitment and training of new employees. An operations and maintenance building designed for functionality keeps the worker in mind. When employees truly enjoy their work environment, and if it is safe and more efficient, employee morale is improved, absenteeism is reduced and employee retention is improved.

ACHIEVING GOOD DESIGN

So how does one achieve good design? How can an owner that wants to build a good building actually get a good building? How can an owner make sure that their new building will really work functionally as it is intended, and that it is an aesthetically attractive facility that the employees are proud to call home?

Selecting the Right Design Firm

For starters, hire the right design firm. There are many such highly qualified design firms that can do a good job. Just remember that people design buildings, not companies. So when interviewing architects or engineers the most important factor is the individuals assigned to the project. Are you getting the best, most experienced individuals in the firm, or is the firm relying upon its experience but assigning much younger and inexperienced personnel to the job?

Owners should strive to hire a firm, or team of firms, that not only has the experience in similar projects, but whose staff members have the same experience. Pay attention to the

character of the individuals assigned to the project. Do these individuals exhibit a willingness to listen? Do they appear to be good communicators? Could you be comfortable working with them, and especially with their assigned project manager, in the long term? Finally, check references. Take the time to have someone call and check references both for the firm and for the individuals on the team. A project in a brochure may look pleasing, but does it work well, was the client satisfied?

Integrated Design Process

Going through a building project can be a fun and rewarding experience or it can be a difficult and tough process. Designing your building should be satisfying and positive, but it does require a commitment to what at times may be hard work. To make it fun and rewarding, owners need to be involved. Therefore, when selecting the design firm with which to work, spend some time discussing the firms' intended design approach or process of design. Some architects and/or engineers truly enjoy working *with* their clients, while others tend to work *for* them. The difference is that those who work *with* their clients will generally spend more time with them, and will be honest about challenges and work more collaboratively. Architects or engineers that work *for* their clients tend to work more independently and then meet with their clients to review and *sell* their ideas. Nobody knows your business like you do, and it is very important that owners are actively involved in the project.

Stay Involved

Finally, owners must stay involved for the long haul. Most building projects take a minimum of two to three years to complete and it is important for the owner to stay involved throughout the entire planning, design and construction effort. This does not mean that the actual owner, or executive director, must take on a day-to-day role, but rather an appointed responsible individual who knows the business, and understands facility operations, and has the authority to make decisions for the owner. Owners must be aware that design is a fluid process and decisions made one day may need to change down the road due to a variety of issues such as budgetary reasons, or code interpretations, or simply because new information shows that a better solution is available. For this reason, it is very important that the owner be involved throughout the process, and reviews all documents submitted. This allows an owner to maintain control over a project, ensuring the designer is keeping the big picture goals in mind. However, on the flip side, it is important for the owner to keep an open-minded attitude towards the design process, as too many restrictions on a designer can limit possibilities and options. Owners should attend the architect/engineer's design team coordination meetings as well as the contractor's construction coordination meetings, and be actively involved throughout, to maintain a full understanding of the process and progress.

GOOD DESIGN—YOU CAN'T AFFORD NOT TO HAVE IT

In summary, all owners should strive for building better buildings. One can't afford not to. Does designing better buildings cost more? It all depends on how one views the initial costs versus the costs of the building over its life cycle. When the design is done properly, it shouldn't cost

more—it should cost less. Done wrong, it can be expensive, cause problems for staff and be an ongoing drain on the bottom line. When design is done well, it can be an economical asset that can reduce operating costs, increase employee satisfaction and provide a public relations value that enhances your agency's image.

REFERENCES

1. Kristof, N., and J. Seward. On the Right Track. *Architect Colorado*, Summer 2005, Vol. 1, No. 2, pp. 12–15.
2. U.S. Green Building Council, www.usgbc.org.
3. U.S. Green Building Council, [https://www.usgbc.org/Docs/Resources/Cost_of_Green_Full.pdf#search='Costing%20Green:%20Davis%20Langdon\)](https://www.usgbc.org/Docs/Resources/Cost_of_Green_Full.pdf#search='Costing%20Green:%20Davis%20Langdon).

MEET-THE-AUTHORS POSTER SESSION

Analysis of St. Louis MetroLink Performance**EDSON L. TENNYSON***Professional Engineer*

In 1946 St. Louis Public Service Company, the eighth largest transit system in the United States, was a highly respected metropolitan operation. In 1993 the St. Louis transit system was no longer among the 30 largest systems. The precipitous decline paralleled a 61% decline in the City of St. Louis population, offset by only modest suburban population growth. In an effort to restore transit viability to the St. Louis metropolitan area, an 18-mi light rail transit line was inaugurated in 1993 utilizing abandoned railroad facilities, including a downtown tunnel and Mississippi River bridge. The new light rail line connected Lambert Airport in Missouri with East St. Louis, Illinois. The results were immediate and positive. Patronage exceeded comfortable car capacity. More cars were acquired. Voters in Illinois and Missouri voted funding to expand light rail 17 mi into Illinois and 8 mi into suburban Missouri. Transit use increased 40%. Light rail carried 49% of the region's transit passenger miles in only 25% of the area. The cost of service slowed its inexorable rise as light rail moved people for 25 cents per passenger mile, down from 51 cents by bus in 1993. With fewer trunk lines and more feeder routes, bus service costs increased to 80 cents per passenger mile. Casualties declined significantly. St. Louis again has a functional transit system.

INTRODUCTION

In 1946 as World War II gasoline rationing ended and automobile production resumed, the St. Louis Public Service Company (the transit system) was the eighth largest system in the United States and was respected as a leader in the transit industry. Together with the Cleveland, Pittsburgh, Toronto, and Washington, D.C., transit systems, they produced the Haberle Annual Report, a confidential forerunner of the National Transit Data Base, to assist management with improvements. The City of St. Louis contained 856,796 population in 1950 (1).

In 1959 consultants reported that St. Louis Public Service led the nation in progressive transit management with 300 streamlined street cars and the largest fleet of air-conditioned express buses in the nation (2), but ridership had fallen 5% (3). The 1960 population of St. Louis was 750,026, down 12.5% in 10 years. County population grew slightly.

In 1966 streetcars were eliminated. The rapid loss of ridership continued faster than the city's loss of population until 1993, when the FTA no longer listed St. Louis among the 30 largest transit systems in the United States. By 1990 the city's population had fallen to only 396,685. The city's loss of 54% of its population was accompanied by an 84% loss of transit passengers despite some suburban growth. (The 1946–1956 data do not include the suburban electric railway service to Madison and Granite City, Illinois.) After 1963 the Bi-State Development Agency (BSDA) acquired the transit system and did serve Illinois, but this change was not significant in trending. In 1946 East St. Louis in St. Clair County was served separately by East St. Louis City Lines, Inc. (4).

Suburban population in the St. Louis Metropolitan Area grew but not as much as typical suburban areas. St. Louis City, St. Louis County, St. Charles, and St. Clair counties had 1,911,217 population in 2000. This includes most of the transit service area. The BSDA lists its service area population as 1,562,961, four and one-half times the city population. In 1960 the city and three-county population was 1,836,804. Growth over 20 years was only 4%.

When St. Louis Public Service sold its operation to BSDA in 1963, BSDA assumed responsibility for the provision of public transit service with the necessary public subsidies to sustain it. The rapid decline slowed at this point but continued (see [Figure 1](#)).

Alarmed by the drastic decline in St. Louis population and transit service, civic authorities worked diligently to rejuvenate the city and its transit system. They built the Arch on the mighty river, Busch Stadium, and Kiehl Center. They completely rebuilt Union Station as a successful commercial center. To secure these civic improvements better public transit was deemed essential. Citizens formed the Committee for Modern Transit to stimulate interest. Engineering studies were undertaken. Railroad mergers and reorganizations had left a major old Mississippi River rail-highway bridge (Eads Bridge) unused by rail, and the former Wabash Railroad (Cannonball) line from Union Station to St. Charles County was idle. Planning work developed the concept that the bridge and idle rail line could be converted into a viable rapid transit operation using the abandoned downtown railroad subway to connect to the Eads Bridge. Newer high rail loads would not fit through the old tunnel. Lambert Airport was not far from the Wabash (Norfolk Southern) Railroad right-of-way.

A question arose about the value of transit on the Eads Bridge to East St. Louis. That unfortunate city's population had dropped from 75,600 in 1950 to only 41,000 in 1990. Some questioned the idea of rail transit to such a city, but the Mississippi River was a great natural barrier and its bridges were overloaded. Modern Transit thought rail transit could help. So many people had switched from buses to automobiles that street and freeway capacity was overloaded despite the decline in population. Putting the idle rail space on the bridge to work seemed useful to some. St. Clair County (East St. Louis) bus riders could avoid the bridge and city traffic delays with the attendant operating costs. Many wondered whether anyone would park and ride in East St. Louis because it was a crime mini-center. It was not thought to be a viable idea, but East St. Louis did not want to be excluded.

LIGHT RAIL

The engineering studies looked at the success of new light rail operations in San Diego, Calgary, Edmonton, Pittsburgh, Portland, and Sacramento and attempted to determine whether those experiences were applicable to St. Louis. It appeared likely. The studies recommended high-platform stepless boarding as in Calgary, Edmonton, and Los Angeles with cars to match. The abandoned railroad lines were ideal for use between East St. Louis, downtown, West End, and the University of Missouri at St. Louis. New right-of-way parallel to the Mark Twain I-70 Freeway was necessary to reach Lambert Airport with a major park-and-ride station at North Hanley Road in Bel-Ridge. Very few highway grade crossings would be involved. Except for these few grade crossings, the MetroLink project would be rail rapid transit rather than light rail. The difference is very minor in this case.

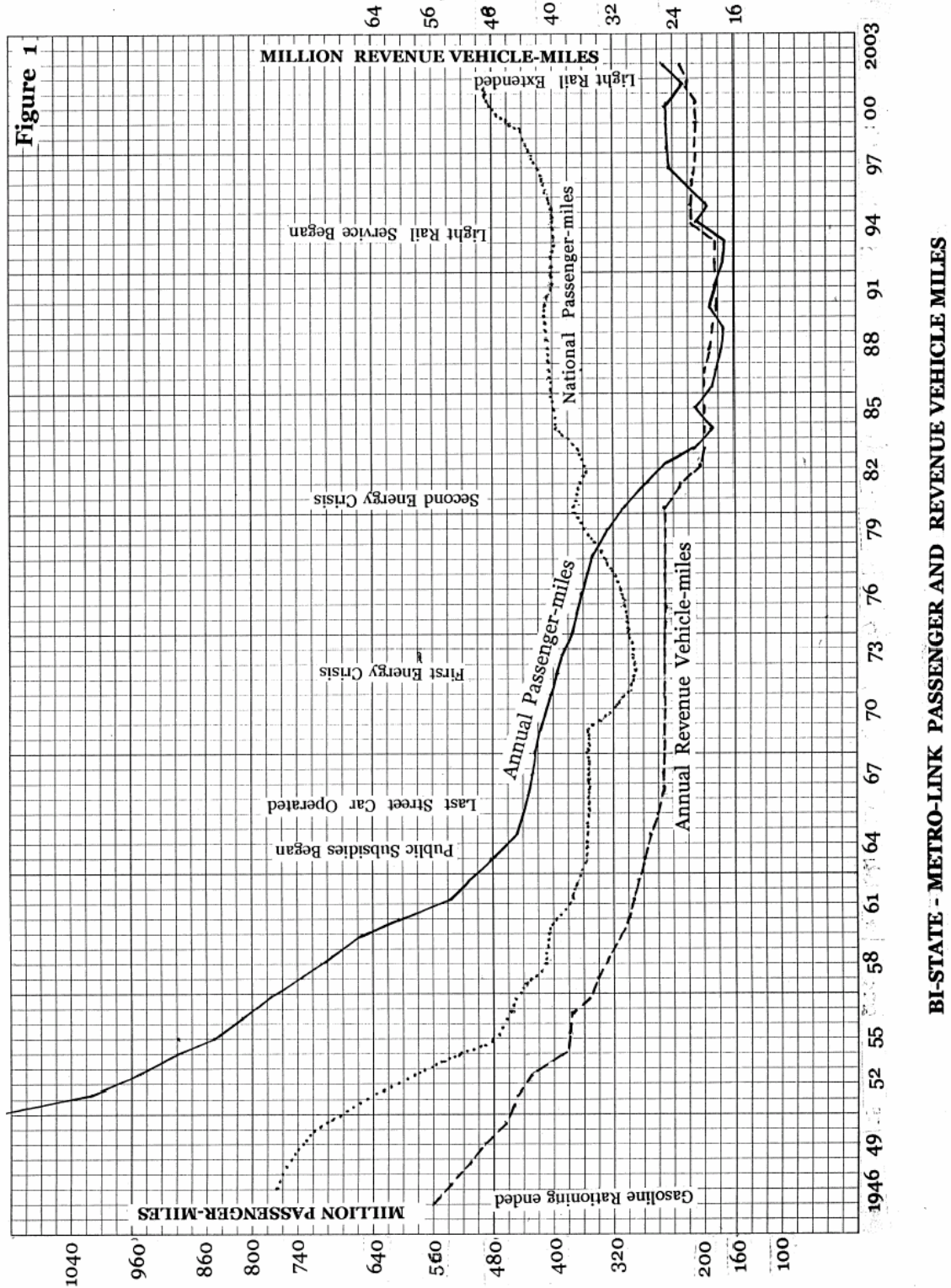


FIGURE 1 Bi-State MetroLink passenger-miles and revenue vehicle miles.

FUNDING

Funding MetroLink seemed insurmountable. The heavily subsidized bus service consumed all available funds. The impoverished city had insufficient funds. The Urban Mass Transit Act of 1964 as amended authorized 80% of the necessary investment, but the \$350 million project would require \$70 million of state and local funding. The State of Missouri was sufficiently rural to discourage urban transit funding and the local governments were impoverished.

The City of St. Louis did own the MacArthur rail-highway bridge across the Mississippi River and some of the abandoned rail right-of-way. Astute local planning conceived the strategy of exchanging (swapping) the city's MacArthur Bridge for the railroad's Eads Bridge so the city could contribute the Eads Bridge and the right-of-way to the project as the local funding share to match the federal grant. The Terminal Railroad agreed as they used the city's bridge rather than their own to obtain higher clearances. St. Louis had appraisals made to certify that the Eads Bridge and the right-of-way were worth more than \$70 million. Doubters thought that this was not legitimate local funding but the federal government ruled that it was. The project was approved for federal funding subject to the rules and regulations.

The project would include 18 mi (29 km) of route and 31 Siemens articulated light rail cars with a shop and yard just west of Union Station. The project would cost just under \$20 million per mile including cars or \$17 million per mile excluding the light rail vehicles. To contain costs, the cars would be similar to Pittsburgh's and used rail from the Illinois Central Railroad's rationalization program would be permitted (5).

To augment the local economy the MetroLink light rail project would serve Eighth and Pine downtown, the Convention Center, Busch Stadium, Kiehl Center, Union Station, and LaCledé's Landing. To the west, it would serve Grand Boulevard with its crosstown buses, Central West End on King's Highway with its upscale development, famous Forest Park, a huge active city open space, Delmar Boulevard (the former suburban railroad station), Wellston, St. Charles Rock Road, the University of Missouri at St. Louis with two stations, North Hanley Road, and Lambert Airport's two terminals. East St. Louis would get two stations, one downtown at Fifth and Missouri with a bus and park-and-ride terminal and one on the Illinois riverfront for recreation.

In a very conservative effort to avoid exaggeration and disappointment, the city promised only 17,000 weekday passengers after a year of service but bought sufficient cars for 30,000 weekday passengers. On July 31, 1993, service began.

ST. LOUIS METROLINK LIGHT RAIL TRANSIT EXPERIENCE

In fiscal year 1993, Bi-State transit use had fallen to 173.6 million annual passenger miles served by 18.5 million bus miles, only 9.4 passenger miles per bus mile. To be reasonably effective, a bus operation should carry 12 or more passenger miles per bus mile as Baltimore, Foothill, Houston, New Jersey Transit, Philadelphia, San Diego Transit, and Seattle do (6).

In 1959, St. Louis had planned an extensive network of bus rapid transit (7) and bus stations were built on the Daniel Boone and Mark Twain freeways, I-64 and I-70 (8). Over the years since, these once hopeful services have declined precipitously to a small fraction of their original use.

With light rail, it was planned to fully integrate buses with rail, with buses feeding into

rail stations with more cross-county coverage and less duplication of parallel routes. Because there was insufficient funding to start light rail service, the economy of coordination was fortuitous. Light rail cut the Route 4–Natural Bridge Avenue bus time of 50 min from North Hanley Road to 25 min, a 50% reduction (5).

Theoretically, saving 25 min should increase patronage 75% in the area directly served. With light rail, 13 bus routes were eliminated, 20 were revised to connect with rail, and nine new routes were added. All told, 34 bus routes were connected to light rail (9).

Light rail opened with a 7.5-min peak headway with every 15 min off peak. Within 2 months, this was changed to every 10 min all day (10). Off-peak travel was heavier than expected. After the novelty of MetroLink wore off, ridership settled down to an average of 27,120 passengers per weekday with 8.7 million for the 1st year without reaching Lambert Airport (11). A cemetery delayed access to the airport. Ridership increased to 36,742 on the average weekday after service reached the airport (12), which was more than twice the public relations promise of 17,000 but almost exactly what St. Louis planner Margaret Simkovsky predicted independently.

While MetroLink diverted 5,700 weekday passengers from bus service (13), bus ridership dropped only 2,000 per weekday. The revised bus service attracted 3,700 new riders each weekday in addition to the 21,425 new light rail passengers.

In 1995, MetroLink patronage grew to 37,041 weekday passengers of which only 7,779 were former bus riders; 29,262 (79%) were new to transit (14). With light rail service in 1995, bus service was expanded another 4,100 weekday bus miles. System patronage was 26% higher than with all-bus service in 1993.

Because of the double counting of passengers who transfer between rail and bus, passenger miles provide a better measure of actual travel. This also recognizes the difference between short downtown and long suburban trips. In 1993, the Bi-State transit system recorded 173.58 million bus passenger miles. With light rail added, system travel grew to 198.58 million annual passenger miles—up 14%. The increase in the light rail MetroLink corridor was much larger as 79% of the passengers were new to transit. This approximates 1,800 passengers one-way in the peak hour, equal to the full automobile capacity of two lanes of city arterial street in each direction. Downtown business was so pleased with MetroLink that they paid for free service in the downtown area during the lunch period (15).

Bus service was also improved with the advent of light rail. Annual bus mileage increased from 18.47 million in 1993 to 19.3 million in 1995 plus the 2.5 million new car miles. System service increased 18%. The load factor decreased from 9.4 passenger miles per bus mile to 9.1 passenger miles per vehicle mile—a loss of 3% at first—but it brought an increase of 14% in passenger miles. New service often requires at least 18 months to mature.

With time and experience MetroLink patronage continued to grow, reaching 95.9 million passenger miles in 1998, up 42% over 1995. System passenger miles also increased 42% over 1993, the nadir, and passenger miles per vehicle mile grew to 11.6, up 23% and very close to the ideal of 12 or more (16).

REVENUES

Passenger revenue is also essential to a transit system with expenses to cover. With light rail, revenue increased from \$22.17 million in 1993 before MetroLink to \$28.28 million in 1998, an

increase of 28% and the highest level since gasoline and auto rationing during World War II (Figure 2). Inflation as well as more riders provided the added funds (Table 1). Operating costs increased 34%, of which 14% is estimated to have been caused by inflation (Table 2). The revenue-to-cost ratio declined from 26% in 1993 to 24% in 1998 because of expanded bus service and inflation. The actual cost of moving people was 51 cents per passenger mile in 1993 and declined 6% to 48 cents in 1998 despite 14% inflation. Clearly, light rail was improving the efficiency of the system despite the increase in bus service and the new MetroLink service.

Light rail demonstrated a far more cost-effective operation than the system as a whole. In 1998, the cost of operating MetroLink was only 20 cents per passenger mile when bus service was costing 66 cents per passenger mile, more than triple light rail unit cost. The light rail load factor was 37 passenger miles per car mile, but bus service attracted only 8 passenger miles per bus mile, down from 9.4 before MetroLink. Light rail had become the backbone of the transit system.

EXPANSION

From 1998 to 2001, conditions remained fairly stable except for gentle inflation. During 2001, the MetroLink operation was doubled in length as voted by residents of St. Clair County, Illinois. The rail line was extended from East St. Louis 17.4 mi (28 km) to Belleville and the Southwest Illinois College with a second phase of 3 more miles (5 km) to Scott Air Force Base. Again, abandoned railroad right-of-way was utilized for much of the route. An investment of \$339 million was made, \$19.8 million per mile. With only 258,729 population in 2000 on 673 mi², this is very low density territory for public transit. Farmland was traversed but Belleville has 41,410 people. St. Louis County, which excludes the city, has only 506 mi² with four times St. Clair's population.

The St. Clair County extension is expected to serve 14,500 weekday passengers and has initially attracted 9,230 (17). Growth of one-third to maturity would provide 12,300, but suburban development in St. Clair may accelerate with improved transit service. The rail passenger mile count grew 32.6% from 95 million in 2000 to 126.7 million in 2002.

Ironically, the passenger count declined with the significant St. Clair County extension, demonstrating the fallacy of boarding counts other than for individual routes. The initial rail system provided only two stations in Illinois, one on the riverfront and one nearby at Fifth and Missouri in East St. Louis. Most local Illinois bus routes were terminated at the East St. Louis MetroLink station to provide a quicker and more efficient trip across the river into St. Louis. This doubled the passenger count on all of the passengers making the transfer. Eight years later, the MetroLink extension gave many of these transfer passengers a direct ride to and from their home communities, eliminating the double count. The passenger mile tally fully and correctly reflects the actual travel, up 32.6%. Light rail average trip length increased from 4.6 mi to 5.5 mi with the St. Clair extension, up 20%.

With MetroLink thus extended, many bus riders from Washington Park, Fairview Heights, Swansea, and Belleville got a direct rail ride to St. Louis without transfer, thus reducing bus ridership for mutual benefit. Passengers do not have to transfer and the taxpayer does not have to pay for the unneeded bus service. Service was not reduced, however. It was redeployed to bring transit service to more people. Bus miles were decreased only 1.6 million miles in 2002 but rail miles were increased 2.3 million miles with larger vehicles which operate with less subsidy per passenger.

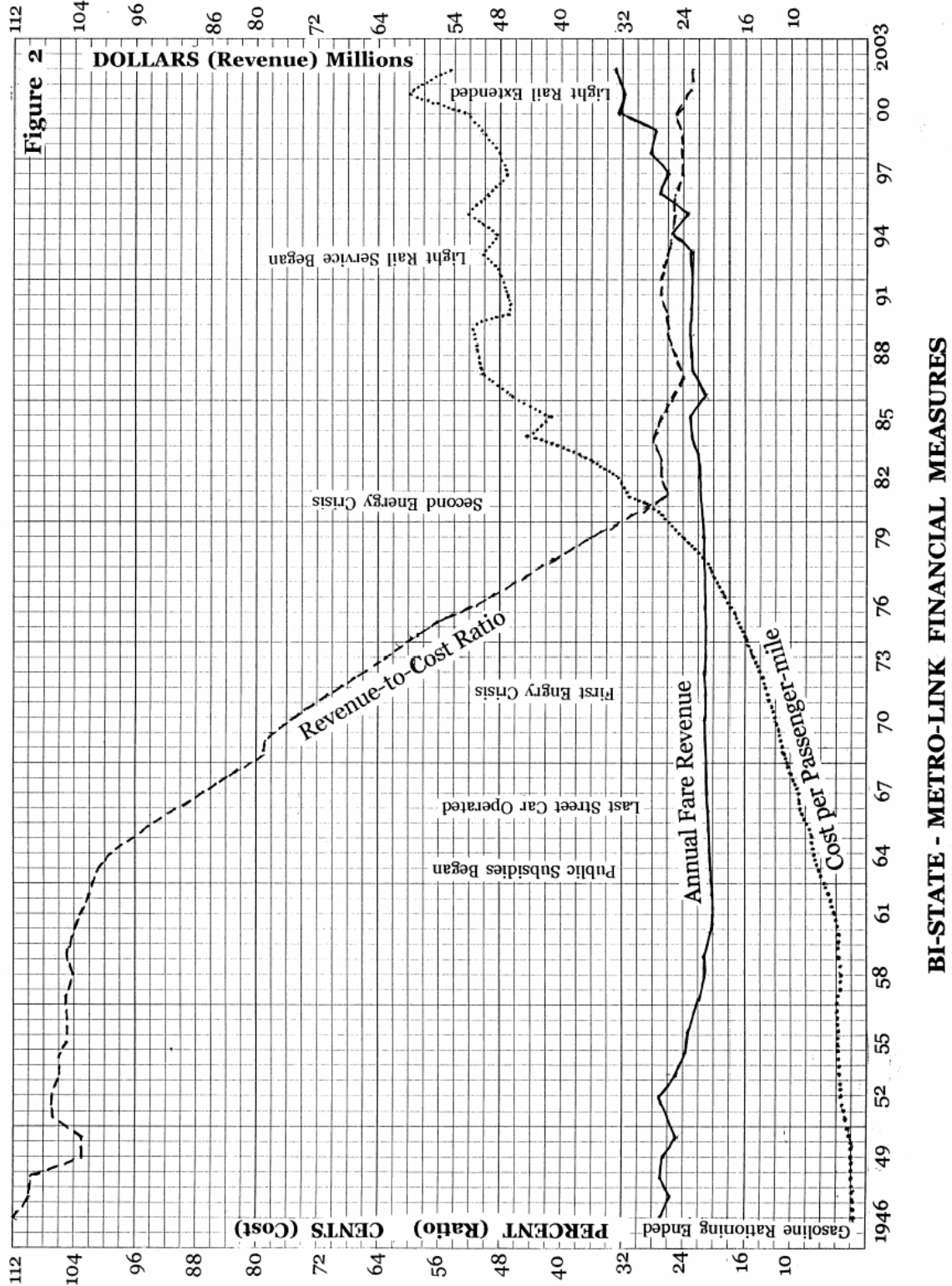


FIGURE 2 Bi-State MetroLink financial measures.

**TABLE 1 Bi-State MetroLink Performance Data, 1991 to 2002:
Revenue, Revenue-Cost Ratio, and Employee Productivity**

Table 1

BI-STATE METRO-LINK PERFORMANCE DATA 1991 to 2002

YEAR	BI-STATE METRO-LINK PERFORMANCE DATA 1991 to 2002		REVENUE TO COST RATIO		EMPLOYEES		PASSENGER-MILES per EMPLOYEE	
	BUS	RAIL	BUS	RAIL	BUS	RAIL	BUS	RAIL
1991	\$ 23,198,048	0	27 %	0	1,544	0	119,823	0
1992	\$ 22,895,366	0	27 %	0	1,486	0	120,088	0
1993	\$ 22,173,125	0	26 %	0	1,500	0	115,721	0
1994	\$ 20,180,927	\$ 3,491,273	23 %	30 %	1,501	0.93	111,329	457,813
1995	\$ 18,766,572	\$ 7,069,084	21 %	48 %	1,470	0.129	89,086	524,219
1996	\$ 18,257,344	\$ 7,711,645	20 %	49 %	1,440	0.169	98,199	467,560
1997	\$ 18,742,248	\$ 8,118,812	20 %	47 %	1,518	0.164	96,256	533,317
1998	\$ 19,227,153	\$ 8,525,480	19 %	44 %	1,595	0.159	94,316	603,211
1999	\$ 20,570,895	\$ 9,483,488	20 %	49 %	1,580	0.164	95,886	583,041
2000	\$ 21,914,638	\$ 10,441,435	20 %	53 %	1,597	0.191	95,534	499,094
2001	\$ 21,013,298	\$ 10,883,265	18 %	48 %	1,650	0.216	80,533	442,412
2002	\$ 20,162,978	\$ 12,068,098	19 %	35 %	1,449	0.286	90,163	443,107

SOURCE: FTA NTDB section 15 Reports

**TABLE 2 Bi-State MetroLink Performance Data, 1991 to 2002—
Passenger Miles, Passengers, Costs and Service Miles**

Table 2

BI-STATE METRO-LINK PERFORMANCE DATA 1991 to 2002

YEAR	BI-STATE METRO-LINK PERFORMANCE DATA 1991 to 2002		REVENUE PASSENGERS		OPRTN & MINTNC COSTS		REVENUE VEHICLE MILES	
	PASSENGER-MILES	RAIL	BUS	RAIL	BUS	RAIL	BUS	RAIL
1991	185,006,500	0	46,578,500	0	\$ 86,903,388	0	18,358,779	0
1992	178,451,500	0	42,584,900	0	\$ 86,062,075	0	18,611,728	0
1993	173,582,057	0	40,485,809	0	\$ 88,213,626	0	18,472,140	0
1994	167,105,200	42,576,600	39,912,600	8,004,900	\$ 89,042,500	\$ 11,494,200	19,240,700	1,769,500
1995	130,957,034	67,624,222	38,680,630	12,488,222	\$ 89,436,415	\$ 14,715,802	19,296,269	2,527,182
1996	141,799,109	79,017,559	37,607,202	12,870,102	\$ 90,576,888	\$ 15,620,289	18,866,248	2,512,918
1997	146,116,687	87,404,465	38,586,742	13,715,196	\$ 94,699,500	\$ 17,424,780	18,730,057	2,543,464
1998	150,434,266	95,910,549	39,566,282	14,560,291	\$ 98,762,590	\$ 19,229,272	18,593,867	2,574,011
1999	151,500,067	95,618,755	38,550,909	14,363,028	\$ 104,455,090	\$ 19,404,819	18,655,681	2,551,245
2000	152,567,076	95,326,967	37,535,536	14,165,766	\$ 110,147,585	\$ 19,590,366	18,717,495	2,528,479
2001	132,878,727	95,560,930	36,202,222	14,288,992	\$ 114,052,018	\$ 22,658,283	19,371,759	2,861,190
2002	130,646,641	126,728,607	32,293,128	14,680,213	\$ 106,484,704	\$ 34,025,318	17,785,969	5,156,197

SOURCE: FTA NTDB section 15 Reports

OTHER FACTORS

In addition to costs, revenues, and passenger miles, productivity, reliability, and safety of transit service are important factors that affect the public and must be considered when providing transit service. In 1993, pre-MetroLink, Bi-State moved 115,721 passenger miles per employee, which is just slightly below average for bus transit systems. In 1998, with the first 18 mi (29 km) of light rail, labor productivity increased 21% to 140,497 passenger miles per employee. With labor costing over 75% of transit's total operating costs, this is a significant improvement. MetroLink produced almost half a million annual passenger miles per employee, while buses dropped to only 95,000 in their expanded but supporting role. In 2002, with only one-fourth of the service area, light rail moved 49% of the region's transit passenger miles (18).

Safety concerns are raised when people travel at high speeds in vehicles—accidents do happen. In 1993, Bi-State transit buses suffered five casualties (injuries and fatalities) per million passenger miles. In 1998 with light rail, bus casualties increased to six per million because of lighter passenger loads, but MetroLink suffered only 0.3 casualties per million passenger miles, far less than the national average and unusually favorable. In the years 1997–1999, there were 0.44 casualties per million passenger miles, still very favorable. With the St. Clair extension, the rail casualties increased to 1.2 per million, as compared with 7.9 for buses. These increases suggest a tightening of reporting discipline. The cost of Bi-State accidents and casualties at 1.5 cents per passenger mile compares very favorably with 7.5 cents by automobile (19) (Table 3).

Service reliability is also a matter of interest to patrons and revenue retention. In 1993, prerail, Bi-State transit provided 48,404 passenger miles between service interruptions. With the diversion of some passengers to light rail, bus service reliability declined to 33,062 passenger miles between interruptions, then to 30,404 with further MetroLink expansion. Light rail reliability in 1998 was 404,686 passenger miles between interruptions. With new cars breaking in on the extended line, rail reliability fell to 298,779 in 2002. Clearly, light rail provided much improved reliability with 99% on-time performance compared to 91% for bus service (20).

Energy consumption is also a critical national concern with oil supply and greenhouse gas problems. With light rail carrying 126.7 million passenger miles in 2002, it produced the equivalent of 53 passenger miles per gallon, assuming 14 kilowatt hours equals 1 gallon out on the road. Bus service produced only 25 passenger miles per gallon. Automobiles produce only 23 passenger miles per gallon (21). Based on 21% of light rail passengers coming from buses, this suggests that 26.5 million annual passenger miles are saving 560,000 gallons of motor fuel per year. With the other 100 million rail passenger miles having come from automobiles, a saving of 2.48 million gallons of motor fuel is probable. The total saving is 3 million gallons per year worth \$5 million a year assuming gasoline prices drop slightly from late 2004 levels. Air pollution is related to fuel consumption so an improvement in air quality should be apparent with light rail. The operation of MetroLink's first 18 mi (29 km) was estimated to remove 14 tons of hydrocarbons annually from the air, plus 94 tons of carbon monoxide and 7 tons of nitrous oxides (5).

Light rail does not depend on oil for much of its energy, which comes primarily from abundant coal, clean nuclear energy, or natural gas. Calgary has contracted to operate its extensive light rail system on wind power, which produces no pollution at all.

TABLE 3 Bi-State MetroLink Performance Data, 1991 to 2002: Casualties, Productivity, and Population

Table 3

BI-STATE METRO-LINK PERFORMANCE DATA 1991 to 2002

YEAR	BI-STATE METRO-LINK PERFORMANCE DATA 1991 to 2002 CASUALTIES			BI-STATE METRO-LINK PERFORMANCE DATA 1991 to 2002 CAS'LTY / MIL PAS-MI			COST PER PASSENGER-MILE			PASNGR-MILS/VEHCL-MILE			POPULATION SERVED		PASGR-MILES per CAPITA
	BUS	RAIL	RAIL	BUS	RAIL	RAIL	BUS	RAIL	RAIL	BUS	RAIL	RAIL	BUS	RAIL	
1991	1 101	0	0	5.95	0	0	47.0 cents	--	--	10.1	--	--	2,307 900	77.3	
1992	1 249	0	0	7.00	0	0	48.2 cts	--	--	9.6	--	--			
1993	0 887	0	0	5.11	0	0	50.8 "	--	--	9.4	--	--			
1994	0 993	0.26	0.61	5.94	0.61	0.61	52.7 "	27.0 cents	8.7	8.7	24.1				
1995	1 138	0.53	0.78	8.69	0.78	0.78	68.3 "	21.8 "	6.8	6.8	26.8				
1996	1 283	0.80	1.01	9.05	1.01	1.01	63.9 "	19.8 "	7.5	7.5	31.4			see note	
1997	1 100	0.55	0.63	7.53	0.63	0.63	64.8 "	19.9 "	7.8	7.8	34.4			note	
1998	0 917	0.29	0.30	6.10	0.30	0.30	65.7 "	20.0 "	8.1	8.1	37.3				
1999	0 842	0.49	0.51	8.81	0.51	0.51	68.9 "	20.3 "	8.1	8.1	37.5				
2000	0 766	0.68	0.71	5.02	0.71	0.71	72.2 "	20.5 "	8.2	8.2	37.7				
2001	1 044	1.17	1.22	7.86	1.22	1.22	85.8 "	23.7 "	6.9	6.9	33.4				
2002	1 026	1.55	1.22	7.85	1.22	1.22	81.5 "	26.8 "	7.3	7.3	24.6			1,562 961	164.7

RCE: FTA NTDB section 15 Reports

NOTE: The population served base changed from 1990 to 2000 so that the official counts do not relate similarly to the transit service area. To correct this distortion, the City of Saint Louis, Saint Louis, Saint Charles and Saint Clair County populations provide a more accurate base for the riding habit. They include most of the transit service area. The 1990 population was 1,865,796. The 2000 population was 1,911,200. The annual passenger-miles per capita increased 41 percent from 95.6 in 1992 to 134.7 in 2002.

CONSTRUCTION COSTS

MetroLink cost \$725 million to put in service with more to come. Was it worth it? Now serving 126.7 million annual passenger miles at an annual operating cost of \$34 million in 2002, the amortization of the investment will add \$18 million per year for a total cost of \$52 million annually. The amortization is based on the useful life of the assets less salvage value. Land does not depreciate. Shop buildings should be good for at least 50 years; cars, tracks, and power systems for 40 years; and lesser items for 30 years. Opportunity costs are not included because they are not usually included in the cost of alternative facilities.

At \$52 million, MetroLink was costing 41 cents per passenger mile in 2002. Including amortization of buses and garages for 26.5 million passenger miles (21% of MetroLink), bus service would cost 74 cents per passenger mile, based on 50.8 cents prerail adjusted upward to 64 cents for inflation plus 10 cents for amortization (22) (Figure 3). The 2002 cost of bus service instead of light rail would have been \$8.75 million more than light rail. The 21% bus share of the rail investment is \$3.8 million per year. The return on this portion of the light rail investment is 5.7%.

For the 79% of MetroLink travel that came from automobiles, there are also savings. In 2001, automobile costs were reported to be 47.4 cents per passenger mile plus downtown parking costs for 9,885 automobiles (Ballston Common Mall Parking Garage, Arlington, Virginia, Nov. 1, 2004), which adds \$14.8 million per year to the \$6.4 million a year saved on automobile use. Without including highway expansion for the added travel, this provides a 3.7% return on the investment. The overall return is estimated at 4.1%.

In addition to these savings, the cost of equivalent highway capacity is significant. New urban highway capacity cannot be supported by user charges, unless cross-subsidized. A typical inner urban freeway may cost an average of \$17 million per lane mile where property values are high and bridges with interchanges are frequent. [For example, the Maryland Inter-County Connector, I-370, cost \$1.7 billion for 17 mi (Maryland State Highway Administration, Baltimore, Maryland, 2004).] To cover the most heavily traveled 17 mi (28 km) of the MetroLink route, a freeway for the light rail volume of travel (four lanes) would probably cost roughly \$1.16 billion, 60% more than all 38 mi (62 km) of MetroLink. The property and environmental damage such an urban freeway would cause is incalculable. It is reasonable to assume that MetroLink has saved \$435 million of highway cost net after providing light rail funding. This is a hypothetical 56% saving after deducting 4% for user fee contributions. With two-thirds of the 126 million annual passenger miles on the hypothetical freeway using 73 million vehicle miles per year, user fee taxes would be only \$1.32 million per year. Annual amortization would be \$39 million.

Property values may also be impacted by MetroLink. Reinvestment in the Wellston area offers an example. Local business improved. Lunch-time customers at Union Station increased 15% since the opening of MetroLink and St. Louis Center, a downtown mall, recorded a more than 30% increase in foot traffic. Luxury apartments near the alignment are full (23).

CONCLUSIONS

The MetroLink light rail system has been highly successful in improving the St. Louis transportation network. Casualties have been reduced, transit travel has increased markedly, bus

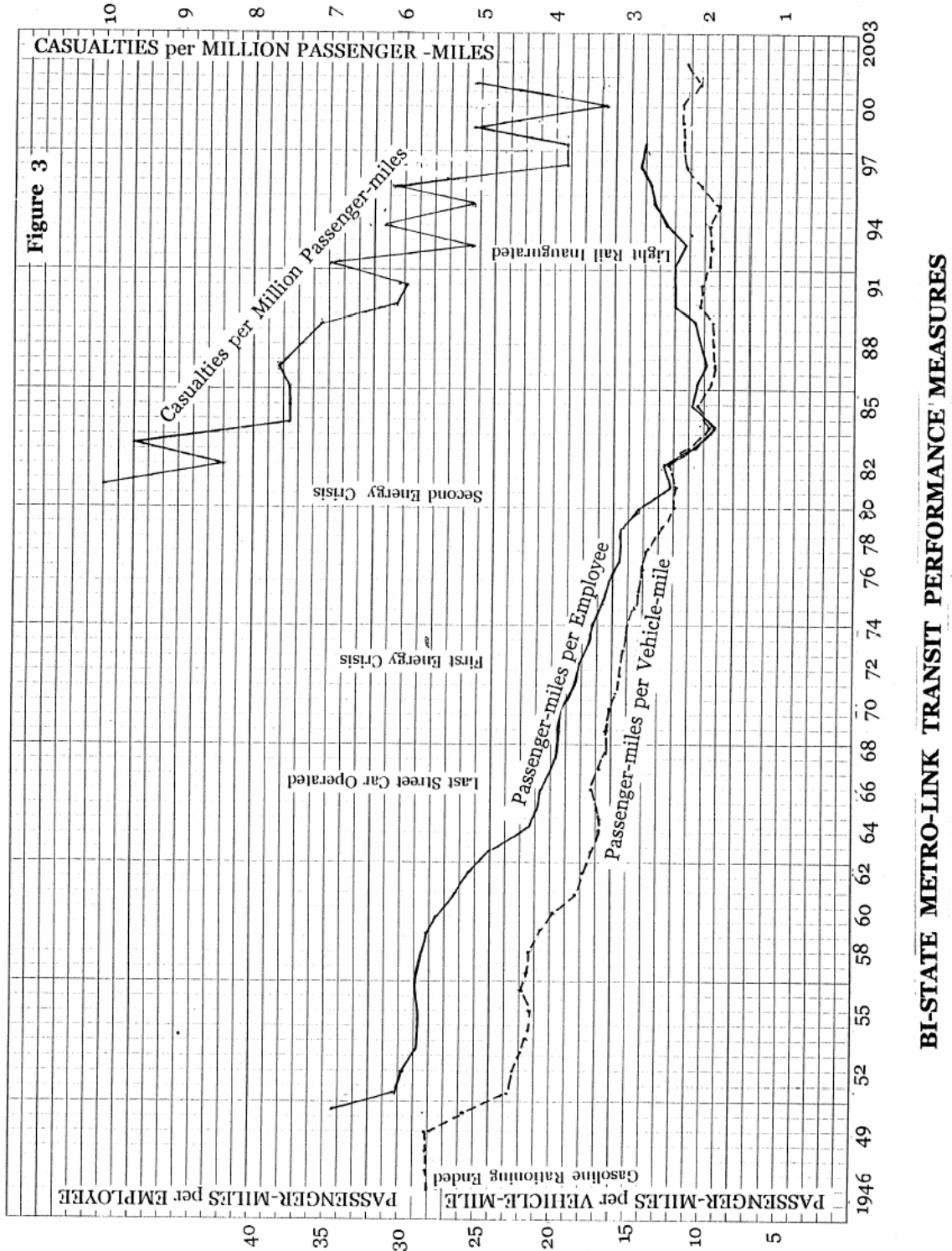
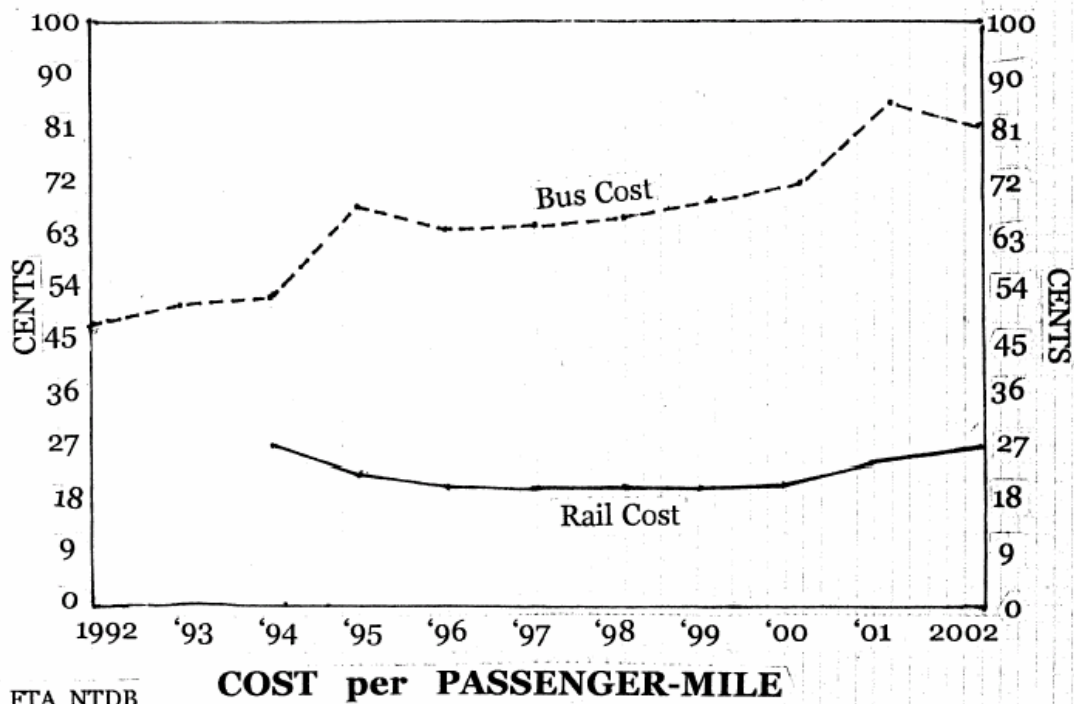


FIGURE 3 MetroLink casualty rates and operating efficiency.

service has improved, operational costs per passenger mile have been sharply reduced (Figure 4), service reliability has been improved, fare revenue has increased to the highest level since 1946, employee productivity has increased, and the city has gained economic activity in the service area. Clearly, light rail has had a positive impact on the St. Louis metropolitan area. In 1995, U.S. Secretary of Transportation Federico Pena stated that MetroLink was “the best new light rail system in the country.” The American Consulting Engineers’ Council concurred by presenting their Grand Conceptor Award to MetroLink (24).

To confirm fully the acceptance of MetroLink in St. Louis, the construction of 8 more miles (13 km) of new route is now well under way, fully funded by local funds, unwilling to wait for future federal aid. This new Cross-County Metro will serve University City, Clayton (the county seat), Brentwood, Richmond Heights, Webster Groves, and Shrewsbury on I-44 (Figure 5).



SOURCE: FTA NTDB

FIGURE 4 St. Louis MetroLink passenger miles and costs by bus and rail.
(Source: FTA National Transit Data Base.)

Figure 5

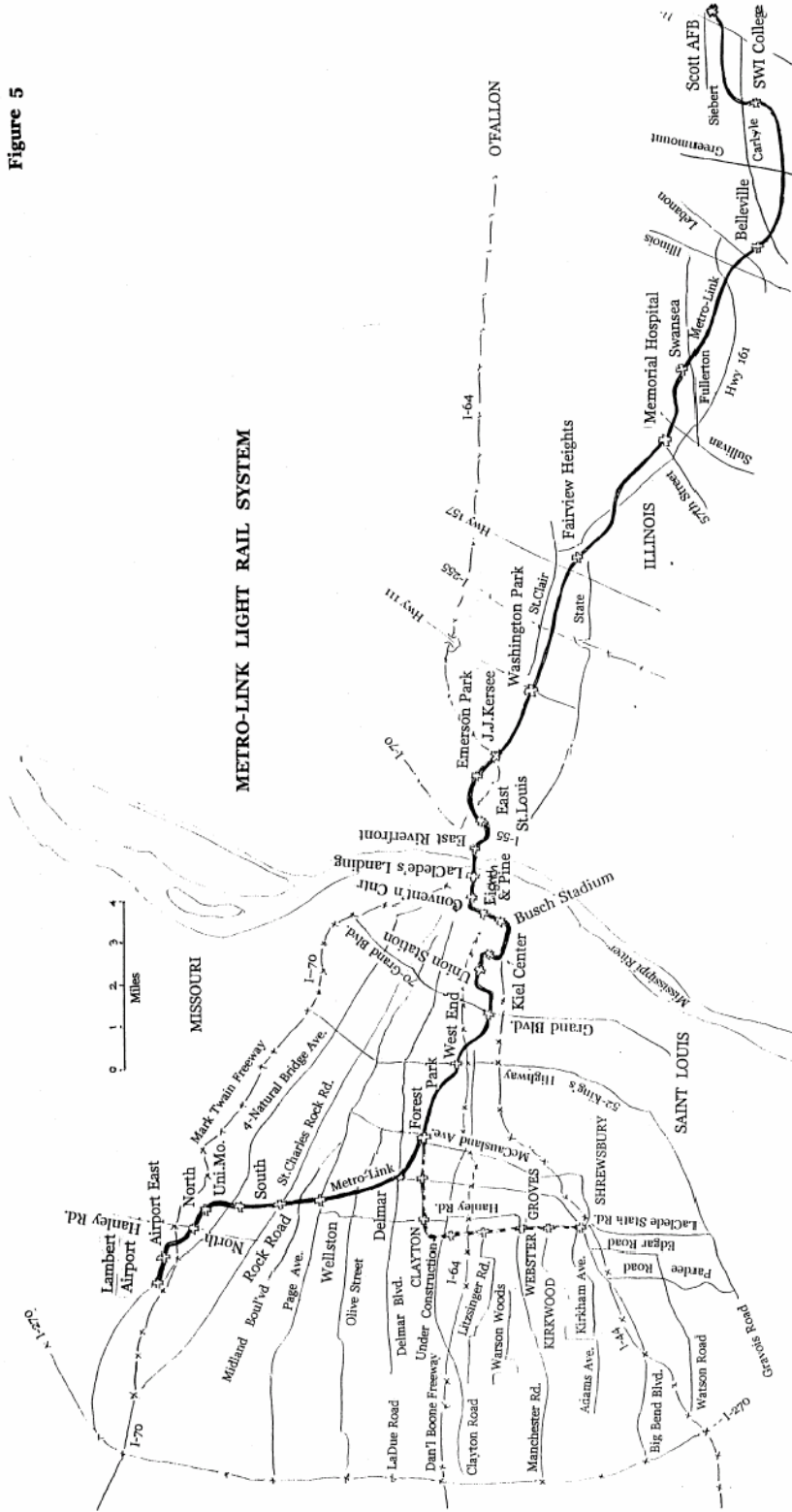


FIGURE 5 Bi-State MetroLink Light Rail System map.

REFERENCES

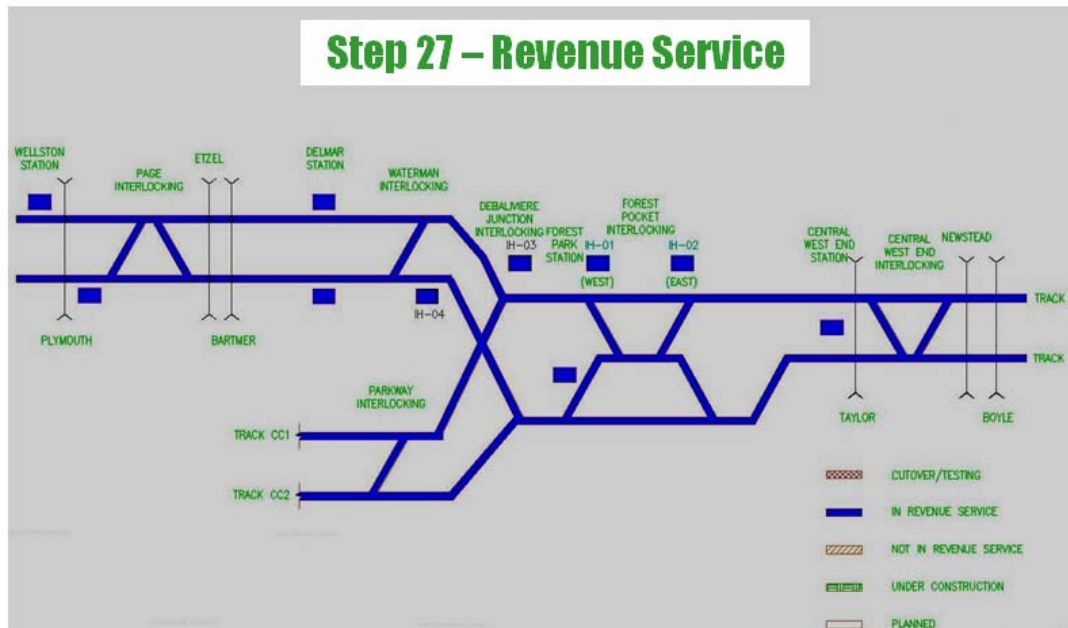
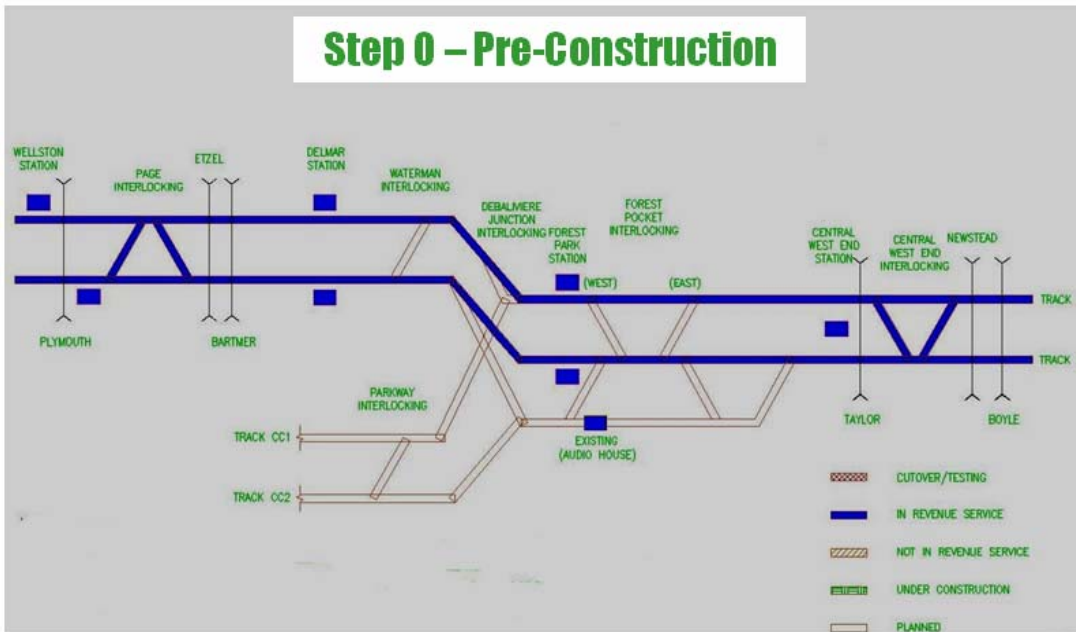
1. United States Census, Department of Commerce, Washington, D.C.
2. *Annual Report*, St. Louis Public Service Co., St. Louis, Mo., 1959, inside cover.
3. St. Louis Public Service Co. *Moody's Investment Manuals*. New York, 1952 and 1962.
4. *1944 Mass Transit Directory*. Kenfield Davis Publishing Co., Chicago, Ill., 1944.
5. *Light Rail News*, TRB, National Research Council, Washington, D.C., Vol. 8, No. 2, 1993.
6. National Transit Data Base, Federal Transit Administration, Washington, D.C., various years.
7. *Annual Report*, St. Louis Public Service Co., St. Louis, Mo., 1959, p. 5.
8. *Annual Report*, St. Louis Public Service Co., St. Louis, Mo., 1959, p. 3.
9. *Railway Age*, Simmons-Boardman Publishing Co., New York, March 1996.
10. MetroLink Time Tables, Bi-State Development Agency, St. Louis, Mo., 1993.
11. National Transit Data Base, Federal Transit Administration, Washington, D.C., 1994.
12. National Transit Data Base, Federal Transit Administration, Washington, D.C., 1996.
13. National Transit Data Base, Federal Transit Administration, Washington, D.C., 1995.
14. Neff, J. W. Prior Transit Mode of Rail Transit Passengers. Presented at 77th Annual Meeting of the Transportation Research Board, Washington, D.C., 1998.
15. Bus and MetroLink Customers Market Research Survey, Winter 1993, Bi-State Development Agency, St. Louis, Mo., 1994.
16. National Transit Data Base, Federal Transit Administration, Washington, D.C., 1998.
17. Weekday Passenger Boarding Count, Bi-State Development Agency, St. Louis, Mo., 2001.
18. *Fact Book 2004*. American Public Transportation Association, Washington, D.C., Tables 84 and 136, pp. 60 and 94.
19. *Fact Book 2004*. American Public Transportation Association, Washington, D.C., Table 68, p. 48.
20. *Passenger Transport*. American Public Transportation Association, Washington, D.C., August 14, 1995.
21. Selected Motor Vehicle Statistics. *World Almanac*, Funk and Wagnall, Mahwah, N.J., 2002.
22. National Transit Data Base, Saint Louis Profile, Federal Transit Administration, Washington, D.C., 2002.
23. *St. Louis Business Journal*, St. Louis, Mo.
24. Passenger Transport, American Public Transportation Association, Washington, D.C., June 12, 1995.

MEET-THE-AUTHORS POSTER SESSION

MetroLink Light Rail System

CHRIS RIMSKY
MIKE PIERCE
MetroLink

The Beginning and the End





Junction

Before...

During...

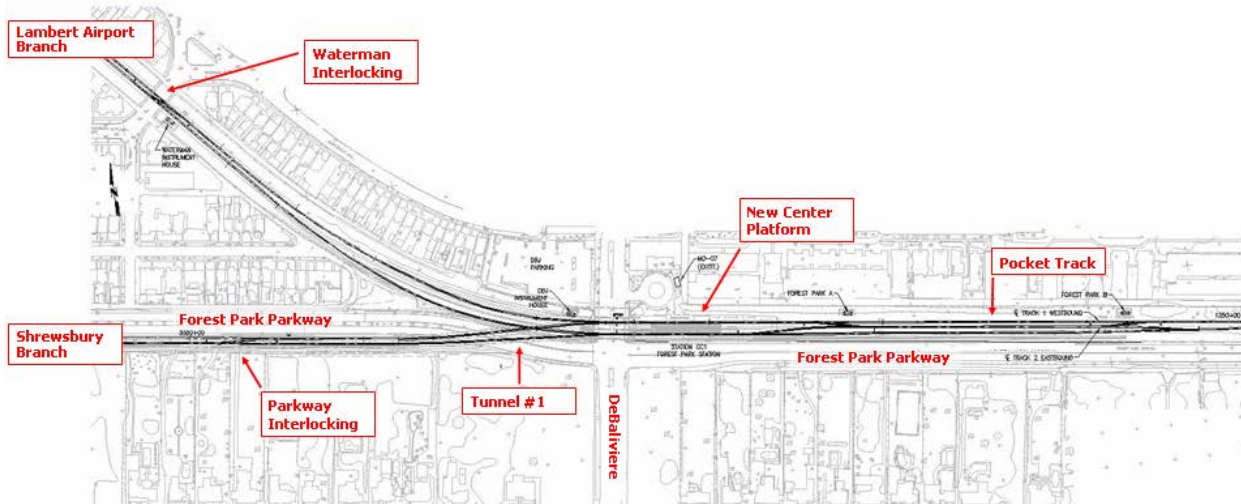
After





Junction: Plan View

“Threading the Needle”



Financing and Controlling Capital Costs

FINANCING AND CONTROLLING CAPITAL COSTS

Getting to Groundbreaking *Top 10 Challenges in Federally Funded Transit Projects*

GRETCHEN J. VON GROSSMANN
WENDY RIGGS-SMITH
Parsons Design for Transportation

All public transportation authorities and their consultants face one significant challenge in the process of developing and implementing a transportation project. That challenge is navigating a project through a Finding of No Significant Impact (FONSI) and on to breaking ground.

Through 15 years of experience, as planners, urban designers, and architects working with transit clients throughout the country for the development of transportation projects, we have found time and again that there are 10 issues—alone or in combination—that consistently challenge a project’s ability to first achieve a FONSI and then to put a shovel in the ground and begin construction. Anticipating these Top 10 issues, understanding them and knowing how to

1. It will always take longer than you think.
2. Failure to be thorough in public process and agency coordination can kill your project.
3. The project proponent must be the project’s greatest advocate.
4. Do your homework before you begin, and never stop for the project’s duration.
5. Property acquisition is a special challenge.
6. Beware historic and cultural resources: impacts to parklands, historic buildings, and archaeological sites.
7. The project proponent must actively manage its consultants.
8. Do not neglect design in the earliest stages of project development.
9. Do not underestimate the cost of construction, and the cost of quality, durable construction.
10. When things go wrong (and at some point, they will), panic and finger-pointing are counterproductive.

GETTING TO GROUNDBREAKING: TOP 10 CHALLENGES IN FEDERALLY FUNDED TRANSIT PROJECTS

Transit projects are complicated things, complicated by

- Their large scale and high cost;
- The varied vehicles, clearances and circulation patterns they must support;
- The widely ranging stakeholders;

- The varied professions and large number of people and agencies required to plan, design and implement them;
- The layers of technical problem-solving required;
- The limits of the real world of space (right of way) and budget (construction, operating and maintenance);
- How long they take and the consequences of passing time—increased cost and lost momentum;
- The complexity of permitting; and
- The search for and management of funding sources.

All public transportation authorities and their consultants face one significant challenge in the process of developing and implementing a transportation project. That challenge is navigating a project through a FONSI—and on to breaking ground.

Through 15 years of experience, as planners, urban designers and architects working with transit clients throughout the country for the development of transportation projects, we have found time and again that there are 10 issues—alone or in combination—that consistently challenge a project’s ability to first achieve a FONSI and then to put a shovel in the ground and begin construction.

In our experience, the greatest advantage a project proponent may achieve along the long path of project development is to respect the challenges ahead, using foresight to gear up for a long process that will require persistence and determination. Anticipating these Top 10 issues, understanding them and knowing how to navigate a project through and around them is critical to project success. The following discussion of the ten challenges typical on transit projects is meant to structure that foresight and lend a roadmap for navigating past the challenges.

A final thought—the methods we present are not a cure-all, but merely best management practices. They are not ranked in any way; any one of these ten challenges may still stop or delay your project. It is our assertion that these suggestions will diminish the risk, increase the effectiveness of the project development process and improve your odds of getting to ground-breaking.

Let’s begin.

Challenge 1: It Will Always Take Longer Than You Think

Transit projects take a long time—from start to finish—because of the coordination required of so many people, interests, and technical issues. There are no shortcuts on transit projects. Taking shortcuts puts the project at risk of a missed step or missed piece of information that proves to be a fatal flaw at worst or a setback at best. Even when you dot your i’s and cross your t’s, there will be unavoidable hurdles to overcome. Use precision, carefulness, methodical project development and thorough communications to minimize the hurdles.

Don’t shortchange the time necessary for the intangible aspects of project development—the coordination and communication involved in complicated tasks like environmental analysis, interagency participation and review, agency approvals, permitting and public participation. Communications among humans is an imperfect science, and nothing works like repetition, which requires time and patience.

Even slow-moving projects can be problematic. Often projects become rushed due to ticking funding clocks—that is, funding due to expire in short order. If project start or progress is

postponed because attention is elsewhere, there may not be sufficient time left to develop the project to be eligible for the next round of funding. Beware of procrastination.

For each error or misstep made in haste, time—and costs!—are added to the project. The most budget-conscious strategy to adopt is to invest the time and effort to do things right the first time.

Finally, history is an essential foundation to build and maintain over the course of development. These projects take a long time. Over time, it is easy for participants to forget which alternatives were evaluated and why certain decisions were made, and when players change those new to the project will question project evolution until they are brought up to speed. Don't underestimate the value of project institutional memory, often embodied in project staff who have been around to witness it all. Without them, it is easy to lose track of the decision-making process and to find a project repeating the same thing two or more times.

Challenge 2: Failure to Be Thorough in Public Process and Agency Coordination Can Kill Your Project

Getting a project implemented requires coordination of a wide range of interests, and that requires frequent and regular outreach that might seem tantamount to handholding. In actuality, it is good communications practice and an invaluable investment in project success. At each step in communication, the project is gaining support and building project advocates. Assume from the outset that the only way to bring to light the issues that could delay your project is by talking to agency representatives and stakeholders over and over and over again. No matter what stage your project is at, there is always going to be one more issue you don't know about yet that is coming at you—suddenly a new agency or stakeholder weighs in—and it is only by minimizing these risks that your project stands a chance. Is it time consuming and expensive? Sure it is, but it is far less expensive than the fatal flaw or deal breaker that surprises you too late if you fail to be thorough.

To address *permitting and coordinating agencies*, ranging from FTA, FWA, U.S. Department of the Interior (DOI), U.S. Environmental Protection Agency (EPA), state, regional or county regulators, to local representatives—ranging from the mayor's office to all pertinent planning, permitting, engineering, and operations departments—the key here is to know their expectations. If you are submitting to a regulatory agency, make sure of the following:

- They are aware of the project from the very beginning.
- You take the time to sit down with them and walk them through the project goals and development (a little time invested here can save tremendous time down the road).
- You discuss with them the submittals (or series of submittals) you are working towards and understand what their expectations, schedule and requirements are for the process and the product.
- They are included throughout project development.
- You pay close attention to protocols when several agencies are coordinating.

Build a working relationship with agencies and treat them as the project partner they are to facilitate processes and minimize setbacks when problems arise.

In regards to public process: Outreach to residents, neighborhood groups, advocacy groups, businesses and their organizations, and elected and appointed officials. Often what

steals the focus in public process is the naysayer. A very small group of people—even just one person—is capable of killing a project if they are savvy in utilizing political channels. This challenge, especially the surprise naysayers that can appear near the end of the project or process, may be avoided by running an inclusive and rigorous public process from project inception.

To focus on the naysayers is to miss or be sidetracked from the true opportunities of public process. Including stakeholders as project partners in a meaningful way builds a solid foundation of support and champions for your projects, so that even if naysayers appear late in the process, there are enough people who value the project that the influence of naysayers is minimized. Further, the information from stakeholders is generally invaluable for crafting the best solutions. Eliciting that input is best achieved in interactive events at which project professionals listen—gathering input, being rigorous in response to questions and comments, and facilitating group decision-making and project direction.

Still, there will always be one or two naysayers that pose difficulties for your project. Work with them, do not exclude them. Learn their specific issues and respond to them with solutions or education or a reasonable discussion of trade-offs. Focus on the importance of project objectives, developed by proponent and community interests together, and how to achieve them, rather than arguing the merits of technical details that often filibuster the process. If you work towards an acknowledgement on participants' part that the project may not be perfect but is still a good project, while not necessarily gaining their full support you will earn their understanding and acceptance as things move forward.

Finally, steering committees are an excellent tool in project development, serving as an intermediary between larger community interests and the project. In order to be effective, there are two factors:

1. The steering committee must be assembled in a way that is representative of the interests in the community and agencies, to the extent possible. A cross-section of representatives from community groups is often a good way to accomplish this. In this way the Committee will in themselves represent the issues to be addressed in the project—business interests, regulatory, residents, environmentalists, etc.—but will also serve as the projects most effective ambassadors to others with similar concerns.
2. The mission of the steering committee must include participating in the public outreach and education with the project and its progress. This vastly expands the network outreach, by creating additional “faces” and committed representatives of the project.

A steering committee should not exceed 15 people, or decision making by the entity will be too complicated. From project outset have the group agree to objectives and rules of order, and have them commit to the process rather than an outcome in order to reduce the impacts of preconceived notions.

Finally, never assume you have support. Make sure, at every step in your project and right up until ribbon-cutting, that you continue to communicate with a broad range of stakeholders!

Challenge 3: The Project Proponent Must Be the Project's Greatest Advocate

Another key to effective public process is that the project proponent must be its greatest

advocate, consistently demonstrating commitment to the value of the project. Every project requires strong advocates that are committed to the success of the project for the duration of the project process. Although there must be others too, no advocate is as important as the project proponent. It is perceived as a sign of weakness if the entity responsible for initiating and overseeing a project is not a strong and vocal advocate, much like a manager that does not advocate for her or his staff. A municipality, county, state or transit agency cannot pass that responsibility to the consultant. Consultants do not have the mandate and authority of the voters – agencies do. Agencies must demonstrate leadership on behalf of their project, and advocate within their communities and amongst other public agencies.

Under this leadership, other advocates will be important and easier to nurture. Look for candidates among your steering committee, politicians representing constituencies to be served, grassroots community organizations, business leaders and elsewhere. By making public outreach a consistent effort for the project duration, you will develop a network of contacts early, keep them informed of project developments and progress throughout, utilize their knowledge and build project advocates.

Challenge 4: Do Your Homework Before You Begin and Never Stop Throughout the Project's Duration

Transit projects require a consistently high level of effort over years to implement. There is little relief, or chance to stop or let up. It isn't over until ribbon-cutting, and without diligence, problems crop up that slow progress and increase budgets, or delays grow longer than they need to be. Doing homework means following up on outstanding issues or deliverables, researching the latest in construction and planning processes, anticipating and providing information needed to facilitate decision-making, staying in touch with funding agencies, being thorough and consistent in your public outreach, and regularly tracking progress, budgets, and schedules. Perhaps the most important component of doing your homework is to stay up to date in the various forms of communications—returning phone calls, e-mails, even updating project websites and newsletters. Doing homework is a challenge with limited agency budgets and staff, but still crucial.

Challenge 5: Property Acquisition Is a Special Challenge

If the site desired for the facility is not owned by the proponent, it will almost always be the critical path item. The valuation and appraisal process mandated by federal regulation takes time, allowing for circumstances to evolve, either in escalating price, new strategy or reduced desire to sell. The nature of real estate as an investment makes acquisition negotiations contentious as owners hold out for the highest price. Even if the property is owned by a sister agency, cold feet are common once an acquisition process is begun as is the desire to hold out for the best opportunity. Over and over we have seen projects delayed years while acquisition processes sort themselves out or as the preferred site is not acquired or sold to another party.

Do not assume the project will happen as planned on a given parcel unless or until your agency owns it. Always maintain a strong second strategy for implementation on land your agency does or could more easily control.

Challenge 6: Beware of Historic and Cultural Resources: Impacts to Parklands, Historic Buildings, and Archaeological Sites

Potential impacts to historic and cultural resources are subject to a separate review process under Section 106. Resources of historic value are under the jurisdiction of the State Historic Preservation Office (SHPO) presiding, which has final say for Section 106 approvals. Anything more than 50 years old—pre-1955, which for some of us does not seem that long ago—may be considered historic. This includes not only buildings and archaeological artifacts, but also infrastructure—utility poles, bridges, and rails, for example.

Impacts are not necessarily dependent on the resource being on-site or adjacent. Anything within view of the site may be impacted, and noise, traffic, water and air quality impacts may affect resources that are quite remote.

Know the review processes required by Section 106 reporting and 4(f) permitting as well as the jurisdiction of the SHPO or their designated representatives, and the protocol of communications. Procedurally, though not always in practice, only the federal project proponent may coordinate directly with the SHPO. Where historic and cultural resources are suspected to be of issue, the local project representative must work with the federal agency to engage the SHPO early in the project.

Challenge 7: The Project Proponent Must Actively Manage Its Consultants

My father always told me, “No one will look after your best interests as well as you will.” The local project proponent and its staff understand the project objectives, requirements, constraints and best interests better than anyone else. Leaving project development and decision-making to the consultants without regular agency review and direction can result in the project moving a distance down an inappropriate path. Additional time and money must then be spent to bring it back to the correct track. In the worst case, if not corrected in time, the proponent may end up with a product that does not meet its needs—an expensive mistake.

Have a consistent and strong review presence as project information develops. Make sure that all of the appropriate staff are able to comment at each step in the process. Spend the time early in a project to make the right decisions because changes made early in a project tend to have smaller impacts and are much less expensive in terms of schedules and budgets than later changes. Early, smaller changes also preserve the good will of the community, preserving their faith in the process and project team. Early input saves consultants from spinning wheels and pursuing wrong directions.

Timely decision making is essential to allow your consultant team to meet their deadlines and commitments. Don't delay your review comments and do not hesitate to engage your staff and consultants in the review process. Much can be effectively resolved if the right people spend time around the table together.

How you manage your consultant is important as well. It is in your best interest to direct your consultant's staffing of your work; unless you do, there may be high rates of turnover and extended periods of “catch up” that slow the progress of the project, or unqualified people assigned to tasks.

Monitor your consultant's progress through their budget, especially in comparison to progress to interim or final product submissions and deadlines. If you perceive that the level of effort is not sufficient to meet a deadline and time is running out, or a majority of the budget is

spent without sufficient progress towards completion, work with the consultant to get the project back on track.

Most important is to foster a sense of teamwork among the proponent, the consultants, and associated agencies and community interests. These projects are difficult to implement and it takes many people working together to achieve them. A team that shares a common goal and vision for the project, for the difference it can make in a community, may reduce the obstacles and move things forward on a smoother path.

Challenge 8: Do Not Neglect Design in the Earliest Stages of Project Development

Design is an essential tool in site selection, to confirm site feasibility in terms of size and configuration. Testing alternative sites by drawing scaled conceptual designs and circulation plans allows you to see if there is adequate site access and program fit, sufficient space to maneuver vehicles, if circulation paths makes sense, and to gain a sense of possible impacts to abutters or nearby uses. A common error that we've seen in projects is to select a site that really isn't large enough, then invest many design dollars trying to make it work, and construction dollars in a facility that is not large enough the day it is built.

Good design is also an important mitigation tool when historic resources are part of the project or in the vicinity. When in the pursuit of SHPO Section 106 approvals, materials, scale, façade patterns become important tools in addressing concerns and reducing or eliminating impacts.

It is important to note that good design does not happen in an instant, it evolves over time. Make sure you give your design consultant enough time to investigate all alternatives and be thorough and precise in decision-making, because if dimensions aren't nailed down and the best floor plan doesn't happen sooner, it will happen later and cause delays and budget overruns.

Challenge 9: Do Not Underestimate the Cost of Construction and the Cost of Quality, Durable Construction

Recent increases in cost of construction materials (wood, concrete, steel) mean that construction is more expensive than ever before. The effort to bring these projects to fruition is not worthwhile if design and durable, quality materials are value-engineered away as the project budget meets constraints. It is better to create a smaller, quality facility than a larger one that is uninviting and apt to show signs of wear soon after opening—requiring expensive maintenance and repairs throughout its life.

Do your research and make sure from the very first vision of your project that your budget and available funding are in line with a facility of the scope and scale you anticipate. Confirm cost and budget numbers at each stage of planning and design, and compare the numbers to similar projects under construction. Assume from the very beginning that quality materials are an investment that will minimize maintenance and operating costs—enhancing the success of your facility in ways that will pay back over and over again.

Also, consider that time is money. Any hurdle on this list may add time to project development, and that delay adds to the project and construction costs. Expect these additional expenses because no project is able to maintain its original schedule over the long term.

**Challenge 10: When Things Go Wrong (and at Some Point They Will),
Panic and Fingerpointing Are Counterproductive**

These complicated projects are being shepherded by large groups of red-blooded, fallible humans, and missteps are generally unintentional and regretted, and often without cause and inevitable; in these cases, punishment serves no purpose and is often counter-productive, eroding trust among the team of people who must continue to work closely together in challenging circumstances. Instead, devote energy to getting the project back on track. Pool resources among proponent staff, consultant staff, agencies, and steering committees as appropriate to determine the most efficient way to navigate the project around whatever obstacle has arisen.

In summary, these challenges may sound simple but they deserve respect and attention. When things go wrong, it will fall into one of these categories, and when things go very wrong, it will be because of one of these principles. That is not to say that they are insurmountable, and it is our hope this discussion and foreshadowing will give any project an advantage in getting to ribbon-cutting. To review:

1. It will always take longer than you think.
2. Failure to be thorough in public process and agency coordination can kill your project.
3. The project proponent must be the project's greatest advocate.
4. Do your homework before you begin, and never stop for the project's duration.
5. Property acquisition is a special challenge.
6. Beware historic and cultural resources: impacts to parklands, historic buildings, and archaeological sites.
7. The project proponent must actively manage its consultants.
8. Do not neglect design in the earliest stages of project development.
9. Do not underestimate the cost of construction and the cost of quality, durable construction.
10. When things go wrong (and at some point they will), panic and finger-pointing are counterproductive.

FINANCING AND CONTROLLING CAPITAL COSTS

How to Raise Your Investment Money

JAMES QUINLAN

Railway Procurement Agency

**How to Raise Your
Investment Money**

James Quinlan
B. Arch MA MAPM



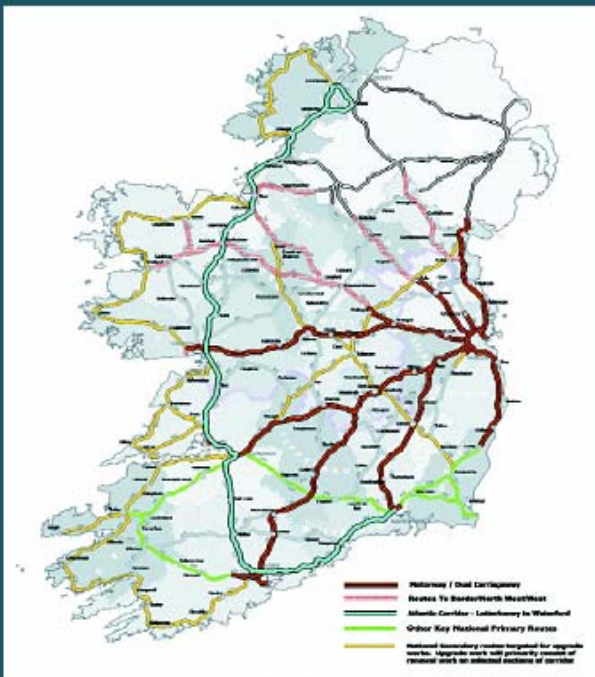


Railway Procurement Agency: “Enabling Agency”
 Established December 28, 2001: “Semi-State”
 Board of Directors and Chairman

120 staff

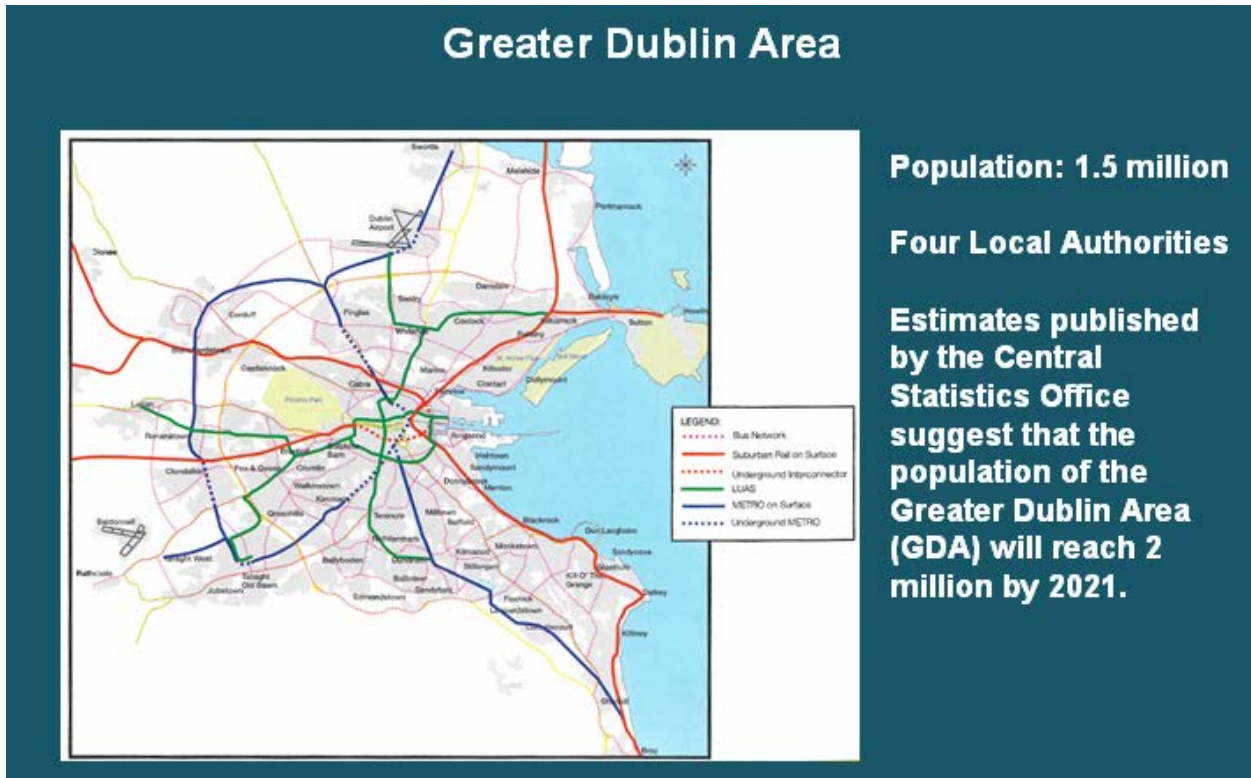
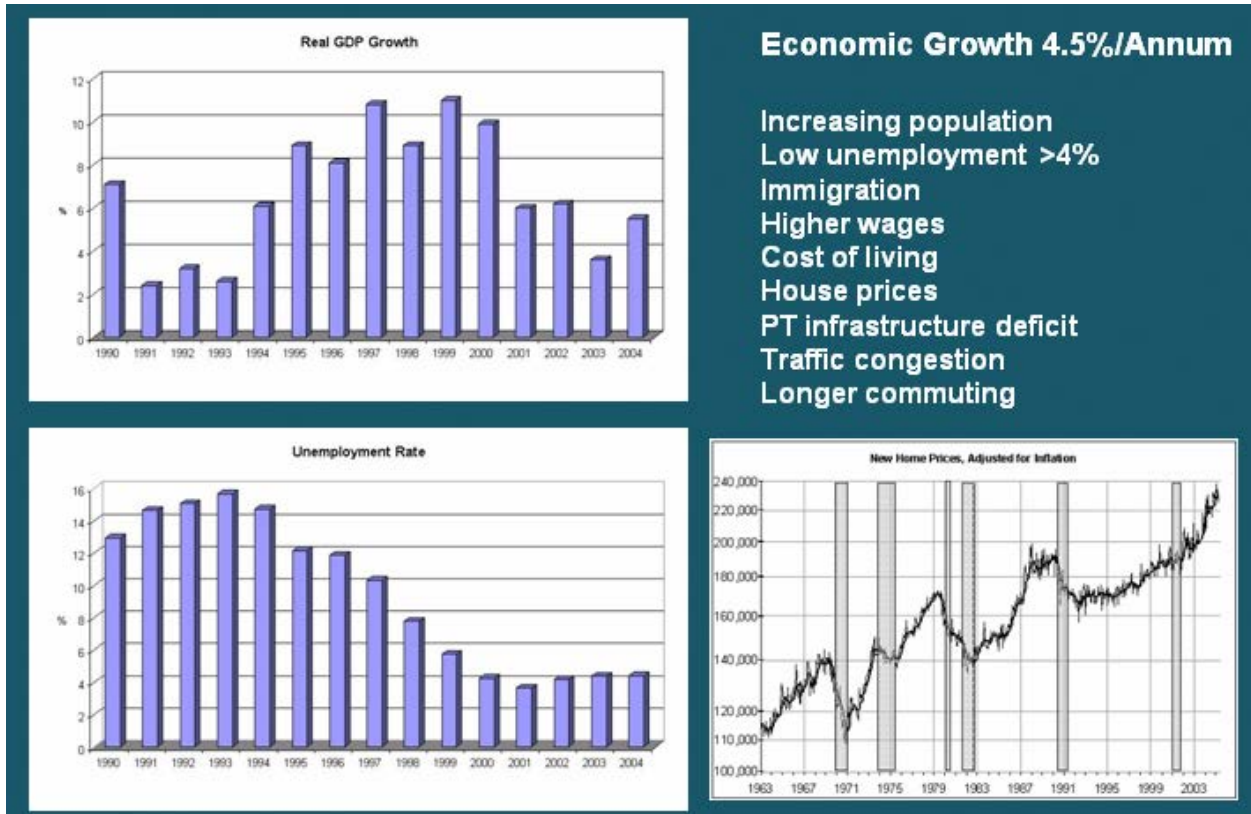
Transport (Railway Infrastructure) Act—2001:

- Procure and develop LRT and Metro
- Enter PPP arrangements
- Deliver integrated ticketing system
- Operate LRT and Metro systems (with private partners)

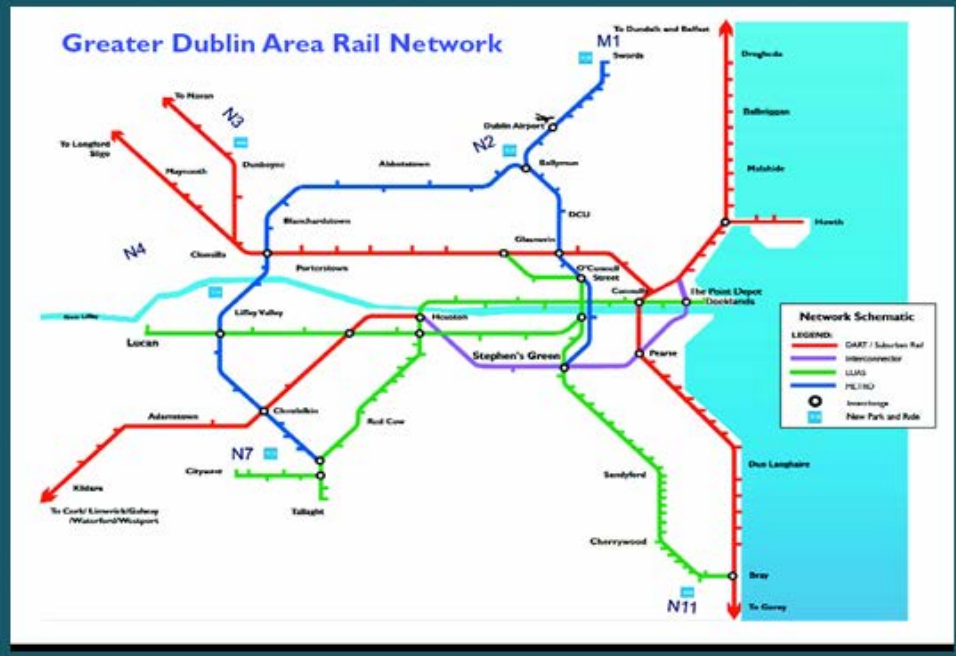


Year	Series (K)
1995	3601.3
1996	3626.1
1997	3664.3
1998	3703.1
1999	3741.6
2000	3789.5
2001	3847.2
2002	3917.2
2003	3978.9
2004	4043.8
2005	4130.7

IRELAND'S population is expected to rise to 5 million in the next 15 years



Transport 21 Strategic Plan—Rail Infrastructure for GDA



Transport 21 Statistics

- €34 billion in period 2006 to 2015. €26 billion will be direct Exchequer funding and about €8 billion will be through public–private partnerships
- 175 million extra public transport users
- 75 million extra suburban rail passengers
- City Centre to Dublin Airport in 17 min by Metro
- 80,000 more bus passengers per day
- 80 million Luas and Metro passengers per annum
- 7 new Luas projects
- Dublin rail journeys—DART, Luas, Metro, Suburban—in zero or one change of train
- Doubling of park-and-ride sites in Dublin to 74
- 70 km of QBC in Cork
- 187 new rail carriages
- €9 million per annum for Rural Transport Initiative
- 850 km of dual carriageway, 2+1 and single carriageway roads

Current Luas System Opened in 2004: Two Lines

Red Line

- Length: 15 km
- Stops: 24

Green Line

- Length: 9 km
- Stops: 13
- 40 Alstom Citadis Trams
- Operator: Connex 5-year franchise



Patronage

- 22.2 million passenger journeys in 2005
- 920,000 passengers per route kilometer
- 25% of Luas passengers transferred from private cars
- 10% are new trips
- 58% have come from other public transport
- 7% previously walked or cycled

Fare box income exceeded costs in first year
– modest profit



Expanding the Network

New Luas lines

- Line B1 Sandyford to Cherrywood
- Line BX Connecting both lines in the City Centre
- Line B2 Cherrywood to Bray
- Line A1 Belgard to Citywest
- Line C1 Connolly to Docklands
- Line F line to Lucan
- Line D City Centre to Liffey Junction

Metro

- Metro North—City Centre to Swords via Airport
- Metro West—Orbital metro Tallaght to Ballymun
- Metro North—17-km system underground/at grade/elevated—“Stadbahn” concept



Funding the Expansion: Supplementing Exchequer Funds

Capturing added value of development by the use of levies

Densification of development—maximize levy and patronage

Cash alternatives—property in lieu, infrastructure, design costs

Betterment—recovery of costs from utilities

Funding Options

- Section 49 development levies
- Section 25 levies
- Direct developer contributions
- Exploitation of residual lands/system assets
- PPP arrangements
- Direct exchequer funding



Luas Line B1

Sandyford to Cherrywood

9 km

11 stops

Section 49 levy and developers contribution

**New district centre
other developments**



PLANNING AND DEVELOPMENT ACT 2000, SECTION 49 – SUPPLEMENTARY DEVELOPMENT CONTRIBUTION SCHEME Luas Line B1

- **Applies within an area of 1,992 ha, a catchment approximately 1 km on either side of the proposed line. 530 ha of land within this catchment is potentially available for development.**
- **Residential densities average of 50 units per hectare. Average commercial plot ratios of 1:1.4**
 - **Residential: €250,000 per gross site hectare.**
 - **Commercial: €570,000 per gross site hectare.**
- **Duration of the scheme 25 years; administered by local authority**
- **Anticipated income from levies and developers direct contribution represents 50% of capital required.**
- **Exempt developments: domestic house extensions; public utilities, schools, community and youth centers; large-scale recreational developments (golf courses, sports pitches, tennis complexes), excluding buildings and ancillary facilities**
- **Planning Authority collects levies and transfers monies collected, within 1 month of receipt to the Railway Procurement Agency.**
- **Payable at commencement of development or phased as agreed with the Planning Authority**

Developers Contributions

- **Planning permission for second phase of new town centre at Cherrywood conditional on public transport infrastructure being implemented.**
- **Levy scheme in place based on revision to local authority development plan (not Railway order).**
- **Consortium of landowners redeveloping large area formed a company; Rathdown Light Rail (RLRL) to promote scheme; RPA Design costs were paid by RLRL.**
- **Alignment of new roads/plots and integration of new development taken account of during design process.**
- **Lands required for Luas to be provided under bilateral agreement: RLRL lands represent 59.5% of land to be acquired.**
- **Elevated structure to be constructed by developer.**
- **Future alignment through development identified and preserved.**
- **Separate agreements with multiple owners; Railway Order not submitted until all signed.**
- **Developers direct contributions and levies represent 50% of costs of the line.**

Line C1
Connolly to the Point

1.5 km
3 stops

"Special Planning Zone" Levy

Brownfield developments



Dublin Docklands Development Authority—Luas Line C1

- Estimated annual patronage: 1.85 million passengers onto the Luas network increasing to 2.2 million on completion on other networks
- Special Planning Zone administered by the Dublin Docklands Development Authority (DDDA) under Section 25 Powers
- Accelerated planning process if compliant with master plan—“Fast track” no appeal—Compliant scheme exempted development
- Capital cost estimate for Luas €65.05 million (2005 prices)
- Levy agreement between RPA and DDDA on administration details



Dublin Docklands Development Authority Act, 1997

- Levy scheme estimated to raise €23 million
- Lands for Luas conditioned in Section 25 to be FOC to RPA.
- Levy to be paid for the entire development on commencement of construction and collected for further 15 years after completion and opening of the line but some levy payments only collectable when premises become occupied
- Planning applications to city council referred by condition for levy
- Rates will be subject to the Wholesale Price Index in future years.
- A minimum levy rate applied to all development in the area but varies depending on proximity to alignment

Area and Type of Development	Rate
Grand Canal Dock Commercial Property	€12.78 per m ²
Grand Canal Dock Residential Units	€1102.00 per unit
North Lotts Commercial Property	€26.84 per m ²
North Lotts Residential Units	€2308.00 per unit

Line A1 Extension to Citywest

Line A1
Belgard to Citywest

3.2 km
5 stops

Developers
contributions

No Section 49 levy
contribution is up front.



CITYWEST—OVERVIEW

- 80 companies from nine different nationalities, e.g., AOL, AIB, Alcatel, ESAT BT, Independent News & Media plc, Nortel, Pfizer, Roche, SAGE, SAP, Unilever
- Employment Statistics (source DHP)
 - 2005 = 6,000
 - 2010 = 12,000
 - 2016 = 21,000

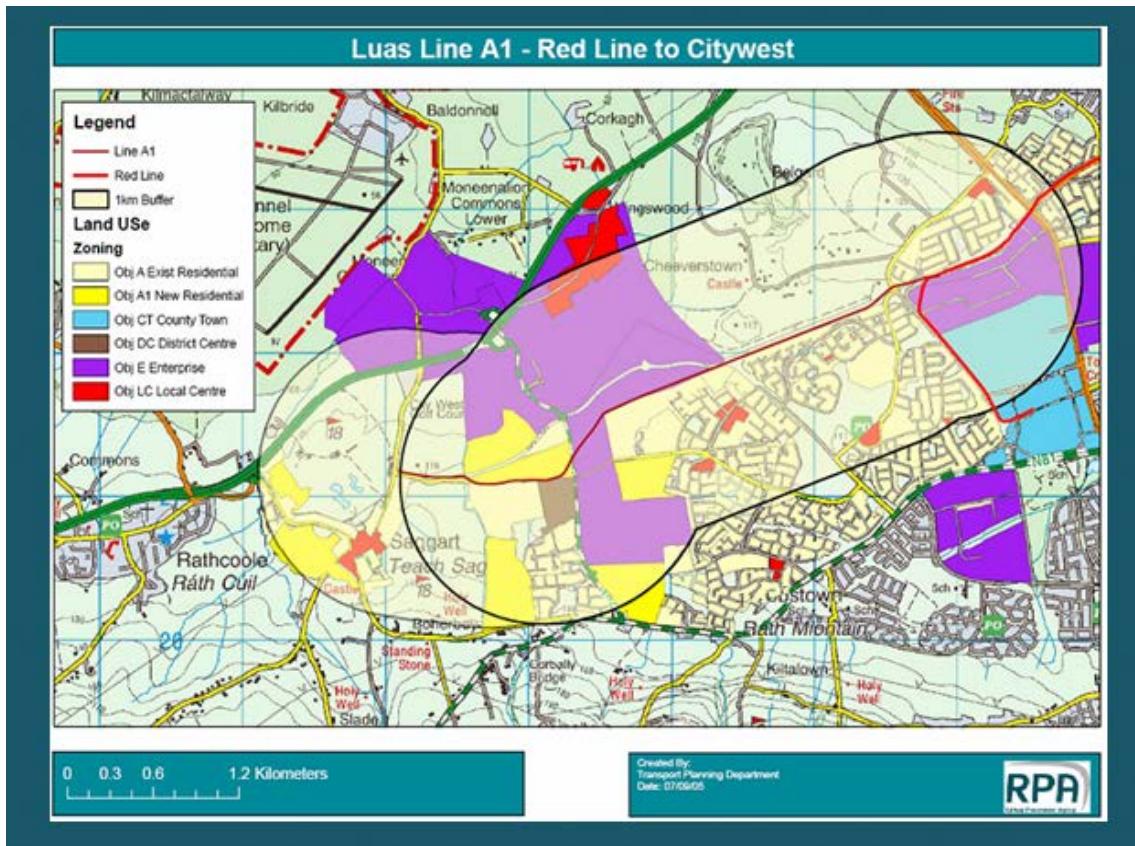


Line A1 Citywest

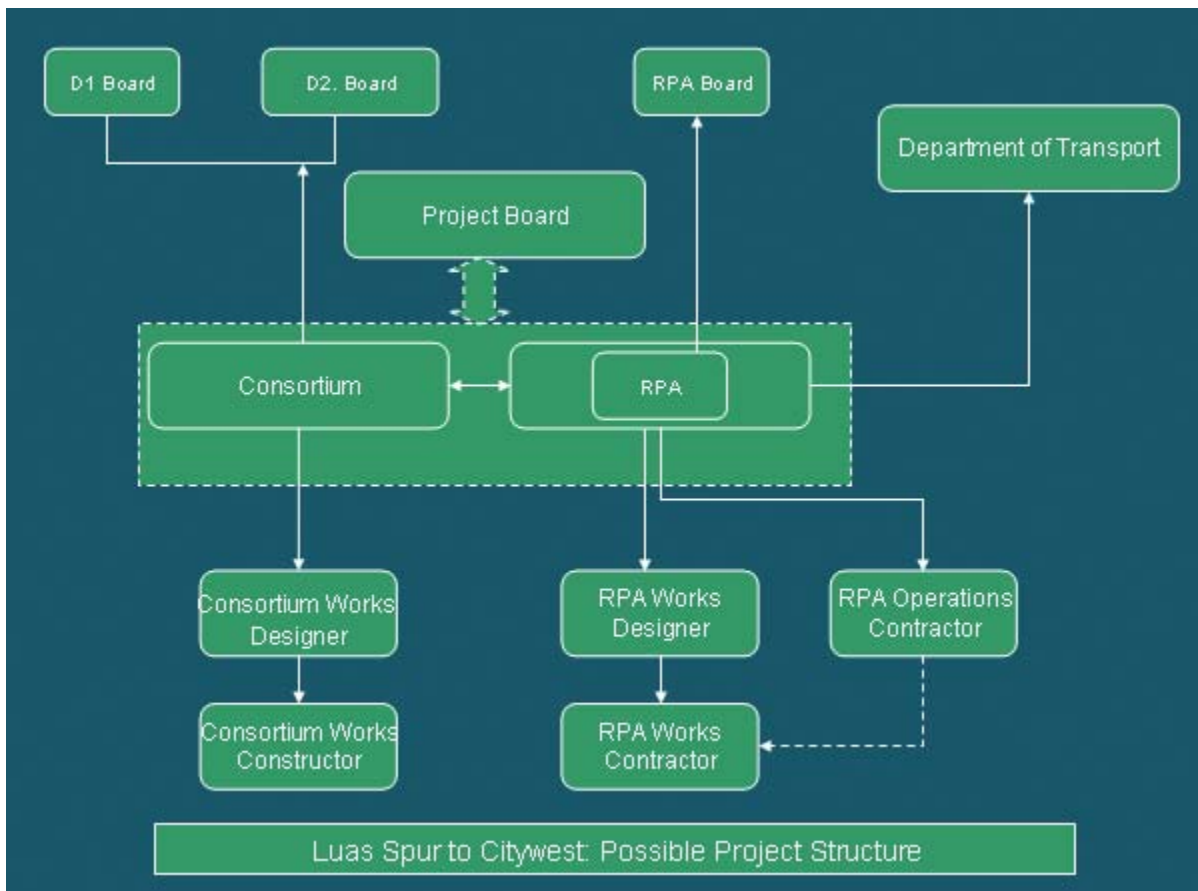
RPA forecasts that demand for Luas from both Tallaght and Citywest will be strong and suggest Luas Line A1 could add up to 3.5 million passengers onto the network in 2016.

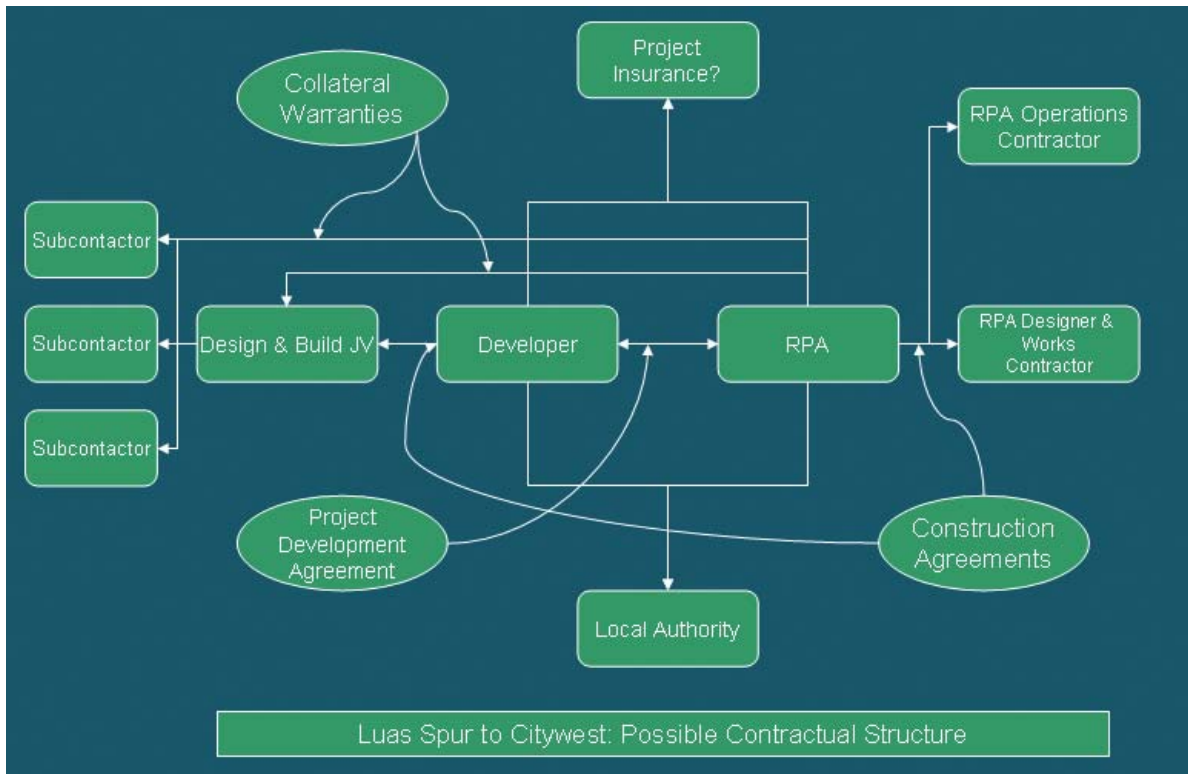
Capital Cost

- **RPA initial estimate of the capital cost of Line A1 is approx €90 million (ex-VAT, 2005 prices)**
- **Developer's propose to contribute the delivery of works estimated at €28 million, land, and a defined contribution of €5 million.**
- **Comparison underway with Section 49 scheme which could potentially capture other development**



- **Private consortium (property developers) is proposing to part design, part build, and part fund elements (namely civil works and land provision)**
- **The consortium propose to**
 - Deliver all the land within its control (to negotiate with third parties (local authority and others) to acquire lands where required),
 - Main Civils works:
 - PW to within 200 m of existing operational Red Line,
 - Platform construction including furniture
 - OCS-integrated design and OCS poles ("dead" works)
 - EIS
 - Park & Ride (350 spaces)
 - €5 million fixed contribution
- **RPA will deliver the remaining elements to provide a service to Citywest:**
 - Systems
 - Signals
 - Connection to running line





DUBLIN METRO NORTH - OPTIONS

Metro North

20,000 passengers per direction, per hour

Growth forecast for Dublin Airport: 30 million passengers by 2016

Metro North

Emerging preferred Alignment

- 11.4 km
- 10 stations
- Six underground






Funding Metro North

- **PPP private finance;**
- **Developer contributions**
 - **DTZ report on behalf of RPA (2002)**
 - Section 49 of the Planning and Development Act 2000; and
 - Direct developer contributions.
- **Government policy to fund through PPP mechanism**
- **Mix of debt and equity**
- **Key PPP drivers**
 - Value for money
 - Delivery on time and on budget
 - High service levels
 - No payment if service not delivered
 - Whole life approach to asset maintenance and operations
 - Innovation

PPP Risk Ownership Matrix

RISK CATEGORY	RPA	PRIVATE PARTNERS	SHARED
Land Acquisition	✓		
Planning/Railway Order			✓
Utilities			✓
Design, Construction and Supply		✓	
Commissioning, Operating and Maintenance		✓	
Demand			✓
Residual Value		✓	
Technology and Obsolescence		✓	
Legislative		✓	
Regulatory			✓
Environment		✓	
Financial		✓	

Market to be consulted before finalising PPP risk apportionment

Developer Contributions

- DTZ Report—Key Findings
 - Increased development density
 - Development will be brought forward as a consequence of Metro
 - Increased business potential and growth
 - Stimulate retail development
 - Greatest value capture through Section 49 levies
 - Significant impact on property values within 1 km of stations

Section 49 Contributions

- Negotiations well advanced with local authority on northern section of Metro Line
- Levies must be linked directly to increase in land values
- Recognise Section 49 levy will always be competing with other levies and taxes
- Estimates of contributions are wide ranging

Source: DTZ Sherry Fitzgerald analysis for RPA

Direct Developer Contributions

- Negotiations underway with specific developers along the route
- Funds will be additional to those raised under Section 49
- Developers incentivized by rezoning and substantial increases in densities

Source: DTZ Sherry Fitzgerald analysis for RPA

Potential to raise in excess of €100 million in capital contributions

Exploitation of Resources/Assets

- **Residual lands following compulsory purchase**
 - Sale
 - Redevelop
- **Lands purchased specifically for ancillary development**
 - Joint developments
 - Own funded developments
- **Retail opportunities**
 - Kiosks
 - Vending machines
 - Technology—WiFi, broadband on board, video screens
- **Advertising**
 - On board
 - At stops
 - Hoardings
 - Tram wraps
- **Infrastructure**
 - Spare duct capacity
 - Park and Ride
 - Vehicle hire

Levy Issues

- **Levy Fatigue**
 - Local authority reluctant to impose levy for rail on top of other levies already in place for water, drainage, and other municipal services
 - Concerns about “damping down” development
 - Multiple and overlapping Section 49 schemes due to parallel or adjacent projects
- **Administration**
 - Collection mechanisms
 - Interest
 - Repayments if project collapses or is dropped
 - Cash flow

Luas is the Irish word for **SPEED**



For more information see

- www.luas.ie
- www.rpa.ie
- www.dto.ie
- www.transport.ie
- www.connex.ie

FINANCING AND CONTROLLING CAPITAL COSTS

Funding Engineering

RAMON ESCALES

TRAM



8th Light Rail Conference
Saint Louis, Missouri, April 9–11, 2006
LRT: A World of Applications and Opportunities

FUNDING ENGINEERING




FINANCING & CONTROLLING CAPITAL COSTS
Ramon Escales, April 11, 2006

Engineering	I	Funding Engineering	
TRAM	II	TRAM Projects	
Risk	III	Risk Allocation	
Scheme	IV	Final Scheme	


Funding Engineering

Engineering	<u>Final Goal:</u> Win the tender	
TRAM	<u>Strategy:</u> Attractive bid	
Risk	<u>Financial Tactics:</u>	
Scheme	1) <i>Optimize financial costs</i> 2) <i>Long-term debt</i>	

Funding Engineering

	Construction	Operation							
Engineering	<table border="1" style="width: 100%; border-collapse: collapse;"> <tr> <td style="text-align: center; width: 50%;">CAPITAL EXPENDITURES</td> <td style="text-align: center; width: 50%;">EQUITY</td> </tr> <tr> <td></td> <td style="text-align: center;">DEBT</td> </tr> </table>	CAPITAL EXPENDITURES	EQUITY		DEBT	<table border="1" style="width: 100%; border-collapse: collapse;"> <tr> <td style="text-align: center;">REVENUES</td> </tr> <tr> <td style="text-align: center;">O&M EXPENSES</td> </tr> <tr> <td style="text-align: center;">EBITDA</td> </tr> </table>	REVENUES	O&M EXPENSES	EBITDA
CAPITAL EXPENDITURES		EQUITY							
	DEBT								
REVENUES									
O&M EXPENSES									
EBITDA									
TRAM									
Risk									
Scheme									

TRAM Projects



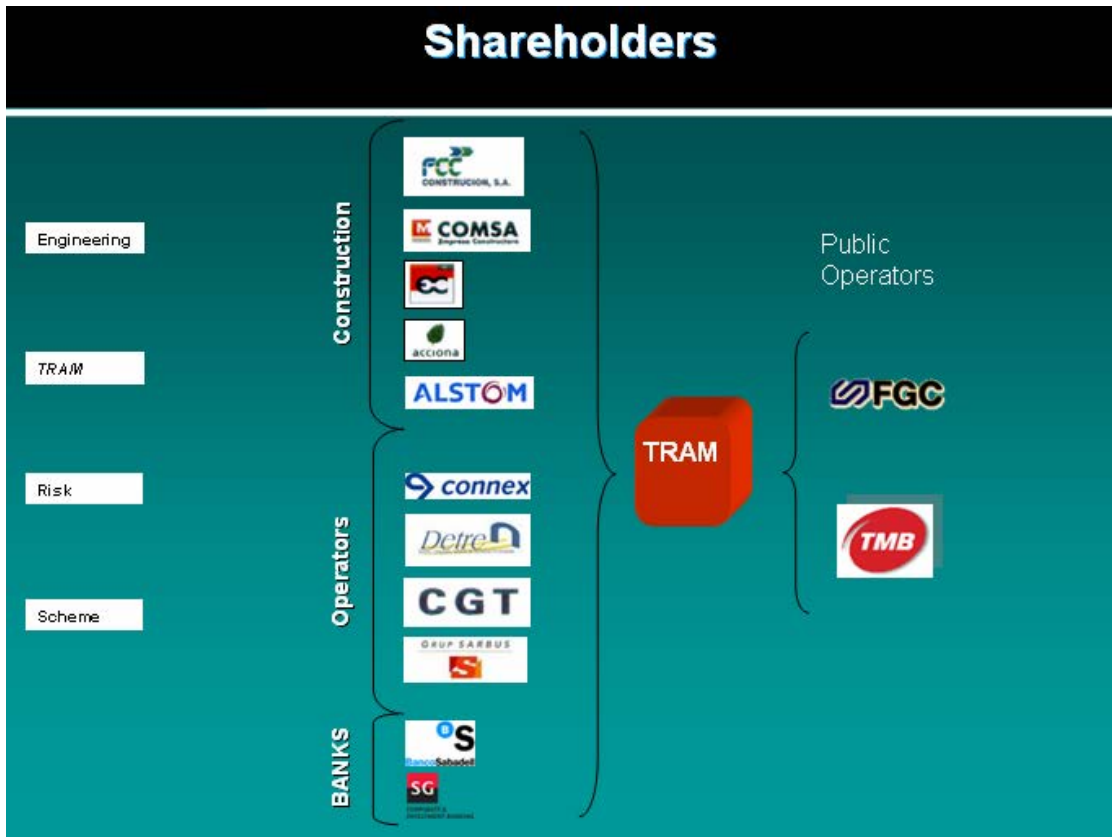
DIAGONAL-BAIX LLOBREGAT TRAMWAY

START OF COMMERCIAL OPERATION:
PHASE 1: APRIL 2004
Patronage (working avg. Total) = 46k / 11M

SANT MARTÍ-BESÒS TRAMWAY

START OF COMMERCIAL OPERATION:
PHASE 1 (FORUM 2004): MAI 2004
Patronage (working avg. Total) = 10k / 2M

	DIAGONAL-BAIX LLOBREGAT	SANT MARTÍ-BESÒS
LENGTH	15,8 Km.	14,1 Km.
STOPS	28	27
AVGE. PATRONAGE	16,9 M USERS/YEAR	10,2 M USERS/YEAR
INVESTMENT	300 Million €	250 Million €



Operation Risks

Engineering

TRAM

Risk

Scheme



O&M Costs	=> O&M Contractor
Traffic	=> Administration support / audited ratios
Availability	=> O&M Contractor
Termination	=> Spanish law

Financial Risks

Engineering

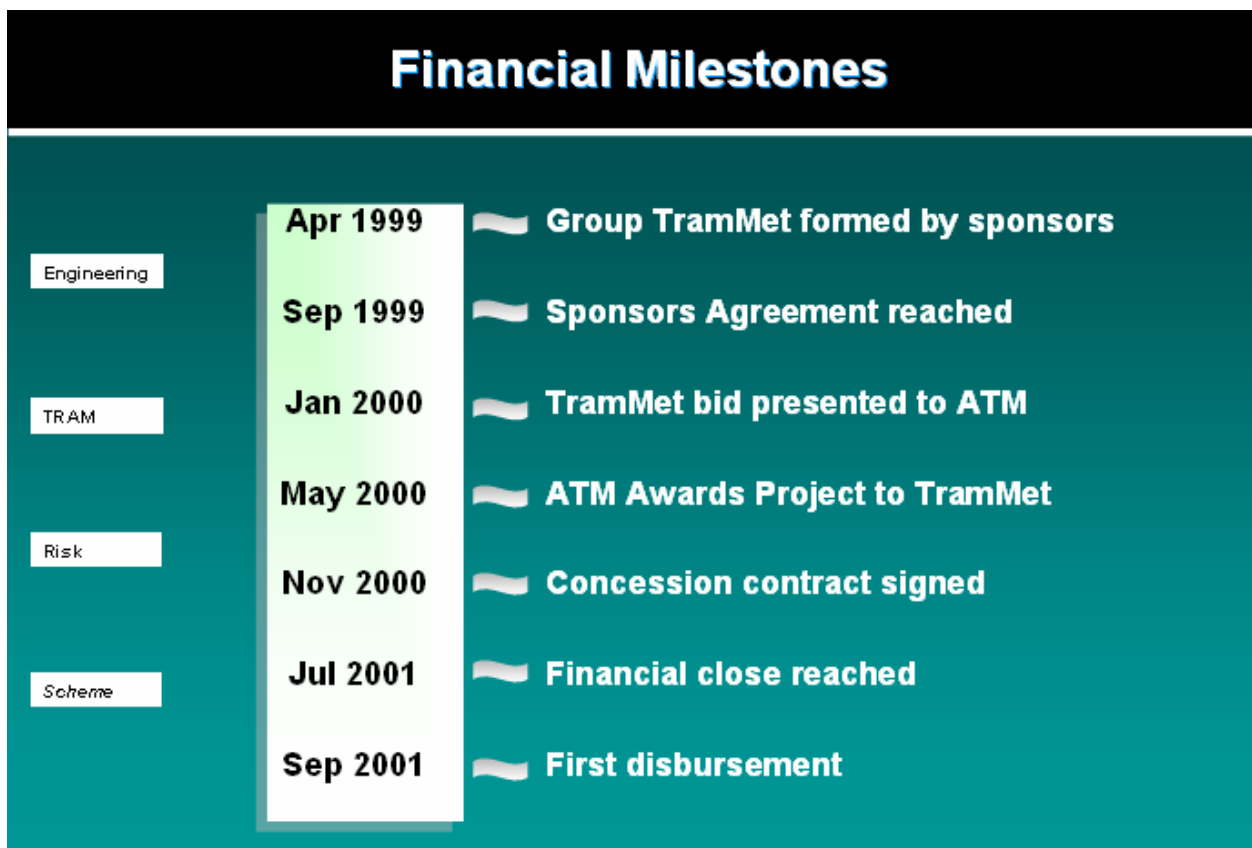
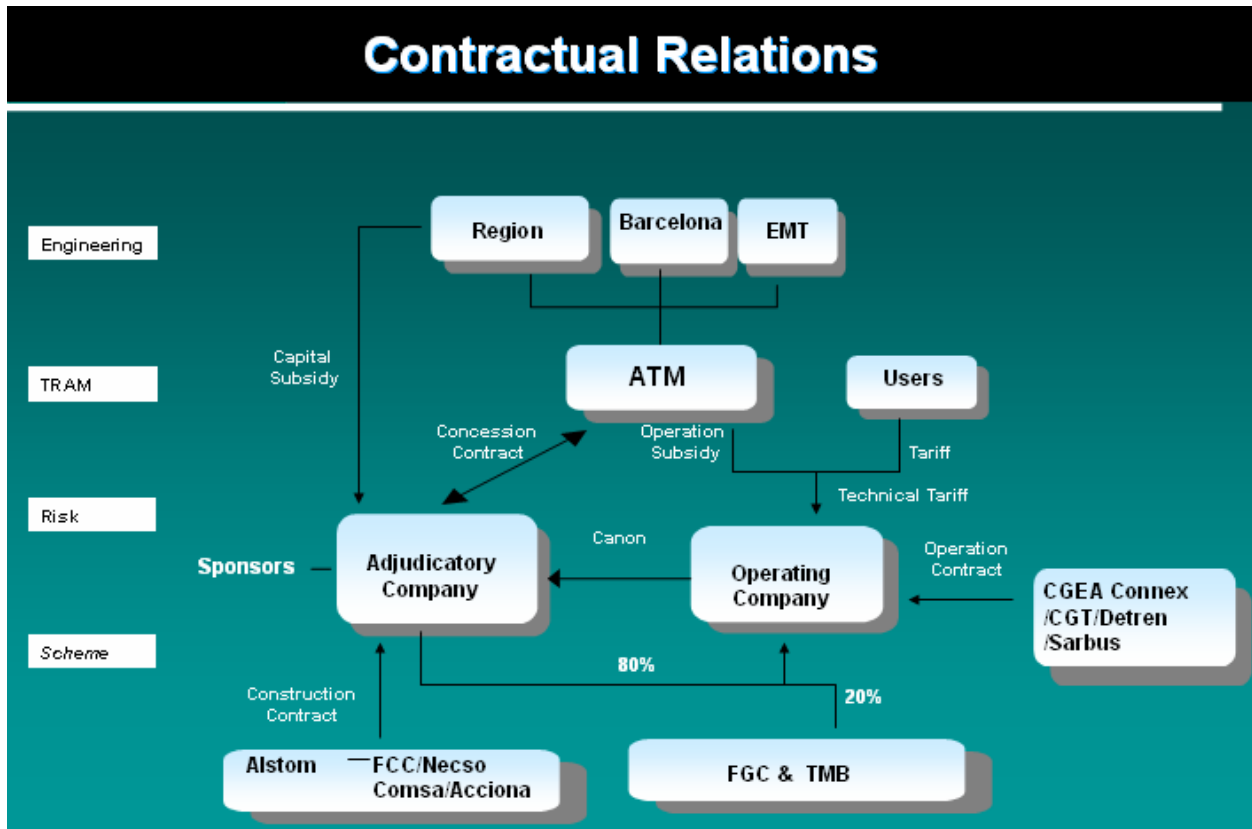
TRAM

Risk

Scheme

Counterparty Administration	=> Regional Government
Interest rates	=> Fixed interest rates






Final Scheme

<u>INVESTMENTS</u>			
Engineering	CONSTRUCTION	266,78	87,8%
	FINANCIAL COSTS	34,10	11,2%
	OTHERS	3,14	1,1%
TRAM		304,02	100,0%

<u>ORIGINS</u>			
Risk	EQUITY	33,76	11,1%
	EIB DEBT	136,10	44,8%
	PROJECT DEBT	89,00	29,3%
	VAT	22,92	7,5%
	OTHERS	22,92	7,3%
Scheme		304,02	100,0%




FINANCING AND CONTROLLING CAPITAL COSTS

Calgary's CTrain *Effective Capital Utilization*

NEIL MCKENDRICK

DAVE COLQUHOUN

BOB CHARLES

JOHN HUBBELL

Calgary Transit

The City of Calgary, a rapidly growing Canadian city of nearly 1 million people, has developed a very effective and efficient public transit system with three light rail transit (LRT) lines forming its backbone. Today, Calgary Transit carries nearly 500,000 daily passengers and nearly half of these customers use LRT for all or part of their journey. In the 1960s, foresight and planning by city leaders identified the need for a high-capacity transit system to reduce the impact of building roads. Although a decision to build LRT was not made until 1976, transit corridors were reserved for some form of high-capacity transit lines as major roads were planned and new communities were being built. After considerable study, LRT was selected as having the greatest potential of attracting users by providing a rapid, reliable, and comfortable trip. LRT also offered lower operating costs and the ability to encourage development that would support transit use.

Today, Calgary's LRT has the highest ridership (both in total and on a per-capita basis) of any North American system. This success has been achieved with a modest level of investment in comparison to costs of other recent LRT systems. Capital costs have been minimized and the effectiveness of the LRT mode has been optimized. This paper explains how Calgary has realized these achievements and become a leader in the transit industry.

CALGARY OVERVIEW

Calgary is a city of nearly 1 million people situated in the Rocky Mountain foothills of southern Alberta. The foundation of Calgary's economy is agriculture, energy, and tourism. Today, Calgary is home to the second-highest concentration of corporate head offices in Canada representing finance, oil and gas, transportation, and manufacturing industries.

Founded in 1876, Calgary has experienced steady growth with the population doubling in the past 30 years. The city has developed around a concentrated downtown core that has over 112,000 jobs and 12,000 residents located within a 3.5 km² (1.3 m²) area. Radiating away from the downtown to the north, west, and south is a crescent of relatively low-density residential communities. The northeast and southeast areas are home to a rapidly growing industrial sector that provides about one third of the city's jobs.

LRT DEVELOPMENT

Planning for rapid transit began in the 1960s. A number of options including heavy rail and busways were considered. In 1976 the decision was made to invest in light rail transit (*L*). In advance of light rail transit (LRT) an express bus system (Blue Arrow) was introduced in four main transportation corridors primarily to serve the downtown. The Blue Arrow service, which included park-and-ride lots and supporting feeder bus services, promoted the development of transit ridership in these corridors prior to construction of Calgary's current three LRT lines. Blue Arrow service still operates in the southwest sector of the city.

The LRT system, or CTrain as it is known in Calgary, began operations in 1981 with the opening of the 12.9-km (8-mi) South LRT line. The Northeast line followed in 1985 and the first section of the Northwest line was opened in 1987 just prior to the 1988 Olympic Winter Games. Subsequent extensions of the Northwest and South lines occurred in 1990, 2001, 2003, and 2004. Today, Calgary's CTrain system stretches 42.1 km (26 mi) with 25 suburban stations and 11 downtown platforms (see [Figure 2](#)). This represents a total investment of over \$1 billion (CDN). The three LRT legs are operated as two lines—a combined South and Northwest line and the Northeast line that currently terminates at the west end of the downtown. The three lines share the 7th Avenue transit mall in the downtown. As a result of recent rapid growth, the CTrain and bus services are currently operating at capacity during peak periods. In the next 10 years, an additional \$1 billion will be invested in expanding and maintaining bus and LRT infrastructure.



FIGURE 1 Calgary skyline.



FIGURE 2 Calgary CTrain primary network.

LRT Operating Environment

Planning for LRT was done when Calgary’s population was less than half a million. In order to maximize the length of the system with the funds available, Calgary’s LRT was based on a more affordable, surface-running design, common in European cities, rather than more expensive grade-separated concepts.

Today, Calgary’s LRT consists of 42.1 km (26.3 mi) of double track, with approximately

- 82% at-grade surface operation in a protected right of way,
- 8% in tunnel,
- 5% on bridges, and

- 5% within the downtown transit mall.

Twenty-five of the system's 36 stations are located in the suburban area and are spaced approximately every 1.6 km (1 mi). The design and scale of suburban stations vary depending on their immediate environment and passenger volumes. Stations range from simple in-community platforms with at-grade customer access (see [Figure 3](#)) to large enclosed steel and glass structures with elevators and escalators (see [Figure 4](#)). Most stations have bus terminals and park-and-ride lots. Of particular note is the design of the Northwest line. As it leaves the downtown it runs alongside a residential street then passes through the heart of a college campus before entering the median of an expressway.

Outside of the downtown, LRT operates in a mixed environment consisting of community streets, major roads, and a railway right of way. The suburban LRT right of way is generally protected with a combination of fences and barriers. LRT receives priority at all at-grade roadway crossings outside of the downtown with protection provided by traffic signals and typical railway crossing gate arms, lights and bells. Bridges and tunnels are used sparingly to grade separate some major roadways, significant features, or for alignment directional changes. In the downtown, LRT operates on the 7th Avenue transit mall that is shared with buses and emergency vehicles. The 11 downtown stations are simple side-loading platforms located next to the sidewalk in the curb lane with LRT tracks located in the center lanes (see [Figure 5](#)). Downtown platforms are spaced about every other block, alternating between eastbound and westbound stops. Train operation in the downtown is governed by traffic signals that are optimized to allow LRT to travel between stations without stopping.



FIGURE 3 Community station—Banff Trail NW line.



FIGURE 4 Brentwood Station with park-and-ride in expressway median.



FIGURE 5 Downtown platform on 7th Avenue.

LRT Success Story

Since the beginning of LRT service in 1981, Calgary's CTrain has proven that the significant investment was worthwhile. LRT was selected because it would provide a cost-effective means of delivering an attractive, high-capacity service with a higher level of reliability, speed, and comfort compared to conventional bus service. As well, LRT was seen as an important tool to influence supportive, higher-density land use development along transit corridors.

A high level of ridership is a key indicator of success. In its first year LRT carried over 40,000 daily passengers. This has grown significantly as the system has been extended to keep up with a rapidly growing city. Daily ridership now exceeds 220,000 averaging over 600 boardings per operating hour. During peak times, passenger boardings range between 720 and 780 per operating hour. The only challenge for the system is that current crowded conditions during peak times are deterring ridership growth. More trains will be added beginning in 2006 to address this problem.

The LRT system has contributed significant benefits to the city's urban form, particularly in the downtown. In the early 1970s, it was recognized that transit would have to play a major role in transporting workers to and from the downtown. To reduce the demand for roads, the City of Calgary adopted a policy that limited the amount and location of downtown parking. In recent years, development has consumed most former surface parking lots in the downtown and parking space is limited. Much of the strategically located structured parking is managed by the City of Calgary. The combination of high-priced, long-stay parking rates and limited roadway capacity encourage travel to the downtown by transit.

Today, LRT plays a significant role in allowing Calgary Transit to carry over 42% of Calgary's 112,000 downtown workers. Peak hour travel by LRT entering the downtown is equivalent to the capacity of about 16 free-flow traffic lanes. As well, high-density residential development is now occurring immediately west and south of the downtown. As a result, LRT has helped to shape Calgary's downtown and LRT ridership benefits from this high-density development.

LRT does not just serve downtown travel. During peak hours, 25% of LRT trips are heading away from the downtown, many towards jobs in the northeast and southeast or classes at postsecondary schools in the northwest. LRT reduces the roadway infrastructure required to serve these areas as well. Although transit supportive land use in the suburban areas has been slow to develop, suburban office buildings and apartment buildings have recently begun to appear next to LRT stations.

LRT Role in Calgary Transit Service

In the past 10 years Calgary has experienced significant growth. Since 1995, city population has risen by 23% but even more dramatic has been the 45% increase in transit ridership. In 2005 Calgary Transit will carry over 82 million annual trips and LRT has played a major role in accommodating the increased demand for transit travel. Calgary's LRT and bus services are fully integrated with LRT lines serving a large segment of the developed area of the city. In the three LRT corridors, LRT provides a high-capacity service while buses serve local destinations and provide "feeder" services to LRT stations. Over 50% of LRT customers travel to and from the CTrain by bus. LRT provides an attractive mode for customers traveling to the downtown or to cross-town destinations since service is frequent (every 5 min in peak periods and 10 to 15 min

in off peak) and direct with travel times that are competitive with auto travel. This overall transit system design offers significant operational efficiencies with lower capacity buses being used for shorter local trips and LRT carrying large volumes over longer distances.

CAPITAL COST OF LRT

Was LRT a wise investment? A 2001 report by the United States General Accounting Office (GAO), *Mass Transit: Bus Rapid Transit Shows Promise* (2), suggests that for many cities, bus rapid transit (BRT) may be a more cost-effective alternative than LRT for providing higher capacity transit service. This report found that BRT system capital costs, in the cities under review, ranged from a low of \$200,000 to \$55 million per mile while capital costs for LRT systems varied between \$12.4 and \$118.8 million per mile. Information from the GAO report is provided in [Table 1](#). This compares the capital costs for construction of LRT in 15 North American cities since 1978. Comparative information for Calgary and Edmonton LRT systems has been added. Capital costs shown here have been translated to year 2000 U.S. dollars to facilitate comparison. Costs include land for rights-of-way, track work, stations, structures, signals, power, vehicles, maintenance facilities, and project oversight.

Calgary's LRT ranks in the top third of these LRT systems on the basis of lowest capital cost per mile. However, this is only one measure of success. Table 1 also includes average

TABLE 1 Capital Cost Comparison of Light Rail Systems (in 2000 U.S. Dollars)

City	Total cost (year of expenditure)	Year of Line Opening	Total Cost in 2000 Million U.S. \$	Total Length Miles	Cost per Mile 2000 Million US \$	Weekday Boardings 2000	\$/Week Day Passenger
Sacramento, CA	\$199.0	1987, 1998	\$262.1	20.6	\$12.7	28,800	\$9,100
Baltimore, MD	\$470.3	1992, 1997	\$536.5	29.4	\$18.2	25,600	\$21,000
St. Louis, MO	\$348.0	1993	\$395.3	19.0	\$20.8	31,700	\$12,500
Salt Lake City, UT	\$312.5	1999	\$320.2	15.0	\$21.4	21,300	\$15,000
Denver, CO	\$292.3	1994, 2000	\$305.4	14.0	\$21.8	29,400	\$10,400
Calgary, AB	\$543 (CDN)	1981, 1987, 1990	\$446.2	18.2	\$24.5	187,700	\$2,400
San Diego, CA	\$776.4	1981, 1986	\$1,295.2	46.8	\$27.7	82,600	\$15,700
San Jose, CA	\$725.0	1981, 1999	\$882.6	28.6	\$30.9	31,800	\$27,800
Pittsburgh, PA	\$540.0	1985	\$780.0	25.2	\$31.0	24,100	\$32,400
Edmonton, AB	\$310 (CDN)	1978 to 1992	\$319.0	7.6	\$41.7	36,000	\$8,900
Portland, OR	\$1,245.5	1986, 1998	\$1,400.4	32.7	\$42.8	71,100	\$19,700
Dallas, TX	\$840.0	1996, 1997	\$909.6	20.0	\$45.5	38,100	\$23,900
Los Angeles, CA	\$1,675.0	1990, 1995	\$1,934.8	42.0	\$46.1	81,900	\$23,600
N.E. New Jersey	\$992.1	2000	\$992.1	10.0	\$99.2	22,400	\$44,300
Buffalo, NY	\$510.6	1984	\$760.5	6.4	\$118.8	23,800	\$32,000

Sources: GAO-01-984, *Bus Rapid Transit Shows Promise*, American Public Transportation Association Ridership Statistics, Calgary Transit, Edmonton Transit.

weekday boarding passengers for these LRT systems as reported to the American Public Transportation Association and from transit property data sources for year 2000. The last column indicates the average capital cost expended to carry a weekday passenger by dividing total capital cost by average weekday boardings. These data show that Calgary's LRT system stands out as being up to 18 times more cost effective when implementation costs are expressed on a per passenger basis!

It is evident that these cities have experienced a wide range of LRT capital costs per mile. The reasons for this wide disparity are likely associated with factors such as the type of LRT rights of way (surface, bridges, tunnel), number, scale and design of stations, types and number of vehicles, and land costs. The balance of this paper is devoted to examining the reasons for Calgary's capital cost efficiencies and high degree of effectiveness.

FACTORS CONTRIBUTING TO CALGARY TRANSIT COST EFFICIENCY

Planning and Design

As noted earlier, planning for LRT began in the late 1960s when the City of Calgary was developing a future transportation plan. It was concluded that transit would be required to play a major role if the city was to avoid the costs and environmental impacts associated with a freeway-based transportation network. In 1976, after considerable study, including visits to European cities, Calgary selected LRT over a bus-based transit system. LRT was selected because it offered a more cost effective, reliable, and comfortable means of moving large volumes of people. As well, LRT would have a greater likelihood of attracting transit supportive development along its route.

During this time, the city was experiencing significant growth with new residential areas developing in a radial pattern away from the downtown. The need for a five-legged LRT network was identified during land use and transportation planning for future city growth. As part of this process, LRT lines were planned along major transportation corridors with an emphasis on serving travel to the downtown.

LRT planning began with the reservation of rights of way in the five major transportation corridors (south, northeast, northwest, southwest, and north). The need for a sixth LRT line was identified in 1987 and planning for this future line is nearing completion. Acquisition of rights of way for LRT has come through city purchase and acquisition of land aided by the land development and building approval processes. In the northeast and northwest quadrants, a wide median was reserved for LRT during the construction of major roads and freeways. A lease agreement was negotiated with the Canadian Pacific Railway to allow the construction of most of the South LRT along an existing railway alignment that bisects large residential developments in south Calgary. Similar corridors have been planned in the southwest, southeast, and north-central areas of the city.

A policy goal to have transit carry 50% of all work trips to and from the downtown was adopted to limit the number and scale of roadways required to serve this high density area. This policy was reinforced by the downtown parking policy discussed previously. These policies have resulted in a concentrated, high-density employment center that is arguably the economic center of Western Canada. Control and limitation of parking has led to high parking prices that discourage auto trips and encourage transit use by downtown workers.

To maximize the return on investment, Calgary adopted design principles that were intended to minimize construction and operating costs while maximizing the effectiveness of service and the length of the system that could be built with the available funds. These elements are summarized below:

- Strategic location of LRT lines.
 - LRT lines are located to serve large residential communities and business districts.
 - LRT alignments and stations are located to intercept established and forecast travel patterns within major transportation corridors.
 - LRT stations are integrated with adjacent land use.
 - LRT stations are a focal point of local bus services.
- Design stations to reflect the local environment and expected passenger volumes:
 - A common, utilitarian station design was adopted. Simple side-loading platforms were used where there was no requirement to protect customers from an adjacent railway or major road. Precast concrete platforms with modest shelters were used in the downtown. Stations located in roadway medians are more substantial.
 - Initially, stations were built to accommodate three-car trains but track design permits expansion to five-car length platforms. Today, new stations are being built to handle four-car trains and older stations are being retrofitted to four-car lengths.
- Provide LRT with priority over traffic outside of the downtown and maximize surface and at-grade operation:
 - Tunnels and bridges are used only where necessary.
 - Most roadways are crossed at-grade with LRT receiving priority and protection using traffic signals, gates, flashing lights, and bells (see [Figure 6](#)).
 - Average station spacing is 1.5 to 2 km (1 to 1.5 mi) to minimize stops, travel time and infrastructure.
- Protect the right of way to maximize operating speed:
 - The LRT right of way is protected from pedestrian or vehicle intrusion using fences, barriers, and bollards. This concept allows LRT to operate at speeds of up to 80 km/h (50 mph) outside the downtown. The downtown transit mall is designed to restrict pedestrian crossings to signalized intersections allowing trains to operate at up to 40 km/h (25 mph).
- Minimize infrastructure by using a downtown surface transit mall instead of a subway:
 - An at-grade transit mall was established by using an existing downtown avenue. Trains operate in conjunction with optimized traffic signals (no priority). The transit mall concept was selected to minimize construction and operating costs. Subway costs, approximately 10 times that of a surface line, were avoided.
 - LRT stations are located adjacent to or as part of the sidewalk, thereby maximizing accessibility, security and minimizing cost.
 - A free fare zone along the transit mall heightens the attractiveness of the system for short trips and provides a key service to support downtown businesses.
- Provide a feeder bus network with priority access to stations:



FIGURE 6 Suburban roadway crossing.

- Each station is served by a number of feeder bus routes that also serve adjacent communities and employment areas.
 - Bus stops are located as close as possible to the station entrance to minimize passenger walking distances.
 - Passenger information is generally provided through posted schedules and maps rather than electronic systems.
- Implement a self-serve fare system:
 - Over 70% of Calgary Transit customers use prepaid fares (tickets and monthly passes). This is encouraged via price and convenience. Prepaid fares minimize fare collection infrastructure and costs, but a limited number of ticket vending machines at each station allow customers to use cash.
 - Transit security personnel (protective services) conduct random fare inspections and provide passenger and facility security. Fare evasion rates are audited each year and are generally less than 2%.
- Manage the supply of park and ride:
 - By policy, the amount of park and ride is limited to approximately 15% to 20% of peak hour and peak direction transit trips leaving a community. Limiting the supply of park and ride reduces system cost, supports the feeder bus service and minimizes the amount of land required at a station.

Vehicle Procurement

The first 27 LRT cars were assembled in Calgary by Calgary Transit staff under the supervision of the supplier's (Siemens-Duwag) staff. Some of the Siemens staff stayed with Calgary Transit after the cars were completed. Three of these employees are still working for Calgary Transit 25 years later! Many of the Calgary staff hired to construct the initial LRT cars are now in senior maintenance positions. This experience was invaluable for learning the intricacies of the vehicles. As well, this familiarity with the supplier has allowed Calgary Transit to maintain an extensive communications network that has enabled countless technical and supply issues to be resolved.

For new vehicle purchases, Calgary Transit does not have the facilities to continue onsite assembly. However, Calgary Transit employees are sent to oversee and participate in the assembly of new vehicles at the supplier's factory. This same practice is followed during the manufacturing of other key system components such as special trackwork and major components. The continued practice of establishing a personal network with suppliers ensures that the vehicles and parts are built to specification while maximizing quality and providing training and equipment familiarization for Calgary Transit staff.

Light rail vehicles (LRVs) are essentially "off the shelf." New vehicle purchases have been negotiated with the original supplier without a tendering process to minimize lead time and costs.

A Conservative, No-Frills Approach

To enhance reliability and contain costs, Calgary Transit philosophy is to use basic, proven technology. For example, storage yards and garage track are not automated, vehicles are not air conditioned, onboard passenger information is provided using manually operated voice recordings, vehicle destination signs are not electronic, and there are no centralized onboard vehicle diagnostics. As well, there is a general policy of continuing to maintain existing technology rather than replacing items even as newer technology becomes available.

Supplier Relations and In-House Teams

LRT is not a high-volume industry and there are many specialized parts and equipment required to support an LRT system. Knowledge of the marketplace is essential to identifying areas where reliability and cost savings can be realized. Calgary Transit is able to shop the world to seek and cultivate relationships with suppliers of unique items ranging from vehicle parts to special trackwork. Trackwork, that is both standard North American and European design, is acquired from various suppliers. A small in-house maintenance team, augmented by local contractors, looks after installation (see [Figure 7](#)). A network of suppliers has been established to support other specialized aspects of LRT maintenance. For example, the Munich transit system overhauls traction motors, Alstom (Calgary) is overhauling bogey frames on the older LRVs, while Soiltech (German distributor) has provided a large percentage of parts for the older LRVs. Bombardier is among the companies being sought to provide other replacement parts.

Traction power and signals are supplied and installed by other City of Calgary departments. Use of in-house expertise permits the establishment of partner relationships and service agreements. This allows other departments to take ownership of various aspects of

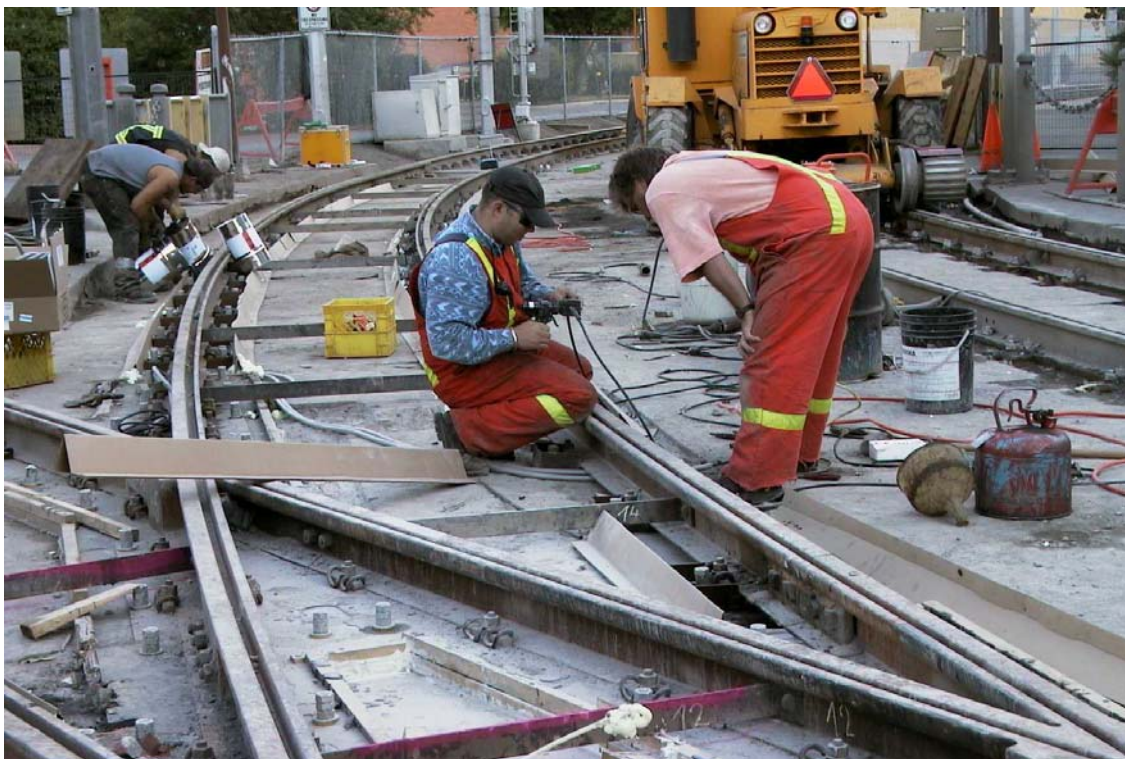


FIGURE 7 Calgary transit LRT staff replacing trackwork.

system construction and maintenance while maximizing the city's investment in staff training, expertise, and equipment.

New Facility Design and Construction

Expansion of Calgary's LRT system has been ongoing for the past 6 years after a 10-year pause. Since 2001, Calgary Transit has doubled its investment in LRT with extensions totaling 9 km (5.6 mi) and five stations being constructed. A new LRV maintenance facility and two new stations are currently in the design and construction phases. The City of Calgary Transportation Infrastructure Division is a key partner in the designing and building of new facilities. An in-house LRT construction coordination committee provides Calgary Transit staff with input at all stages of the design, construction, and final inspection of these projects. Standardization is a key objective in this process particularly when dealing with different contractors and suppliers. Materials and designs are selected to minimize cost, maximize life and utility, and facilitate eventual replacement.

A process of community involvement is used in new station design. Urban design and architectural principles have been used to integrate LRT within community and business areas. Involving citizens and business owners in this process enables the local community to express their needs and influence facility design. This process is critical to addressing and resolving local uncertainty and opposition. However, care must be taken to manage this process otherwise costs can escalate when unnecessary frills are allowed to creep into the designs.



FIGURE 8 New Fish Creek Lacombe Station on south line in railway right-of-way.

Ongoing Assessment and Maintenance

A regular program of infrastructure assessment is used to develop preventative maintenance and refurbishment programs. This includes well thought out vehicle maintenance schedules, station upgrades, and electrical plant refurbishing. Calgary Transit conducts regular assessments to determine the condition of all assets and infrastructure and to forecast expected life. This information is used to create budgets and programs for life cycle maintenance programs.

Operating Costs

Although this paper has focused on capital costs, it is noteworthy that the effectiveness of Calgary's LRT has resulted in a low operating cost per passenger. For 2005, the average hourly operating cost of LRT is approximately \$163.00 (US\$139.40). This figure includes operating, maintenance and utility costs. With an average of 600 boarding passengers per operating hour the average cost per LRT passenger is only \$0.27 (US\$0.23). In comparison, the average cost for bus passenger boardings is approximately \$1.50 (US\$1.28) or almost six times the cost of carrying an LRT passenger. Of course buses have considerably lower capital cost and have different capabilities.

CONCLUSION

Calgary's CTrain has the highest ridership of any North American LRT system. For a prairie city with a population of just under a million, this is a significant achievement. A comparison of LRT systems built prior to 2001 shows that Calgary's LRT development costs are among the lowest of 15 North American cities. More important is that Calgary's LRT has achieved a very high level of ridership.

This very effective and efficient LRT system comes as a result of key planning, design, construction, and operating principles. Rights of way were reserved as new development proceeded away from the city center so that LRT would serve major travel corridors. A predominately at-grade design with a protected right of way was implemented to optimize the length of the system, while maximizing operating speed and accessibility. Vehicles purchased were a proven design. A utilitarian approach has carried through most aspects of the system and vehicles although materials were chosen for function and durability. Calgary Transit planning, operating, and maintenance staff has been an integral part of all phases of design and construction of track, stations, and vehicles. Maintenance practices have followed the same philosophy.

Downtown land use and parking policies have further strengthened the role of LRT and allowed the development of a compact and vibrant city center. As well, location of LRT lines in proximity to other major developments has enabled LRT to provide an attractive alternative to autos and reduced the environmental impact of urban travel. LRT and bus services are integrated to maximize the effectiveness of each mode.

This combination of planning, design, construction and maintenance principles has produced an LRT system that provides a tremendous return on investment. Ridership response has validated these decisions. Today, LRT is the backbone of a very successful transit service. Calgaryans have embraced the CTrain and there is public and political support for continued expansion of existing LRT lines and development of the remainder of the system.

REFERENCES

1. *Light Rail Transit for Calgary* (CALTS 38), City of Calgary, 1976.
2. *Mass Transit—Bus Rapid Transit Shows Promise*. GAO-01-984, United States General Accounting Office, 2001.

Operations, Supervision, and Service Quality

OPERATIONS, SUPERVISION, AND SERVICE QUALITY

Service Planning on Hudson–Bergen Light Rail

The Systems Engineering Basis

ALFRED E. FAZIO

Southern New Jersey Rail Group

Networked rail transit systems present scheduling and operational issues which are significantly more challenging than railways which are comprised of a series of individual, point to point lines. The recent trend in North American light rail transit (LRT) is for systems which were conceived and constructed to relatively simple configurations to evolve into relatively complex networks. These networks include trunk lines with multiple branches, complex junctions, and full or partial loop operations. An accompanying trend is the inclusion of full train control systems incorporating automatic train protection—advanced train control on light rail and the use of complex track and interlocking configurations. For such systems, scheduling for reliable high density operations requires a priori analysis of the capabilities of the engineering systems; this analysis must include such items as interlocking configurations and the headway design of the train control system. This paper provides a case study describing the methods utilized for service scheduling on the Hudson–Bergen Light Rail, which is a high technology, high service density light rail system having a moderately complex network configuration. Schedule making is a complex exercise which includes evaluation of cycle times, equipment utilization and run cuts. This paper does not discuss schedule making, rather it describes the systems engineering analysis which is a separate and distinct exercise from schedule making, and which must, in fact, serve as a prerequisite to schedule making.

TRANSIT NETWORKS

The reliable operation of a high-density (i.e., short headway) service on a transit system which is of a network configuration presents special challenges. Networked transit systems refer to those systems with combinations of the following attributes:

- Complex junctions between lines,
- Service over a main route from multiple branches,
- Full or partial loop operation, and
- Special services—e.g., short turns or expresses.

And Vuchic (*1*) provides a methodology for characterizing and quantifying the complexity of transit networks and discusses, in a general sense, the complexities associated with a networked system. With its multiple branches and complex junctions, and with its five independent services, Hudson–Bergen Light Rail (HBLR) is considered a relatively complex network by these criteria.

A major aspect of achieving high service quality on a networked system is the analytical development of sustainable service schedules. These schedules must be based on a priori analysis of the system engineering attributes of the network. Items to be addressed in this evaluation include;

- The performance of critical engineering systems—e.g., vehicle and train control;
- Imbalanced demand on different branches of a line;
- Capacity reductions at junctions or mid-line terminals, and distribution of this capacity among feeder lines;
- Concepts for train management/dispatch (e.g. how to manage trains which arrive at a junction out of slot); and
- The general level of operational stability which can be sustained under minor and major perturbations.

These are certainly NOT new concepts, as Bion Arnold's classic evaluation of performance of New York's original Interborough Rapid Transit subway will attest (2); but this type of analysis, has to some extent, become a lost art.

The use of advanced or railroad technology compounds the scheduling challenge; schedule making on a highly networked streetcar system that operated by line-of-sight rules was a far simpler challenge than faced on many modern, technology intensive light rail systems. Complexities associated with the latter include, for example, interlocking configurations and throughputs, and the headway performance of advanced train control (ATC) and automated train protection (ATP) systems. Personnel at older highly networked transit systems, e.g., New York City Transit Authority, Port Authority Trans Hudson, and Chicago Transit Authority have many years of scheduling precedent and historical analysis leading to what is often an intuitive understanding of the network's ability to perform to a given schedule. Many new systems, which were originally conceived and constructed as point-to-point lines, are now evolving into collections of point-to-point lines. For systems comprised of collections of individual lines, scheduling remains relatively straight forward. Other systems, however, have become relatively complex networks, which are operated by organizations which have no source of institutional knowledge of system performance under a variety of schedules. For these railways, a systems-engineering-based analysis of performance is an essential prerequisite to schedule making. For reasons discussed below this is particularly the case for North American light rail systems.

EVOLUTION OF LIGHT RAIL TRANSIT INTO LIGHT RAPID NETWORKS

In North America typical new start light rail transit (LRT) systems of the 1980s and 1990s were arranged as point-to-point lines. While they enjoyed significant portions of exclusive or semi-exclusive right of ways, the balance of the systems' technology employed was essentially that of a high-performance streetcar. Systems such as San José, San Diego, Edmonton, and Sacramento employed simple automatic block signal systems, utilized relatively small vehicles which operated at maximum speeds of 50 to 55 mph, and service plans were based on peak headways in excess of 5 min. In the past 10 years, many North American LRT systems are evolving to what may be referred to as light rapid. Such railways are characterized by the following:

- Employment of increasing advanced rail system technology, particularly with respect to train control and interlocking design. This progression of technology is largely driven by the real and perceived requirements of system safety and essentially represents the incorporation of significant elements of rapid transit design practice into light rail systems.
- Evolution of route structures into network configurations. This is driven by the mode's popularity and the relatively low cost (when compared to rapid transit) of adding branches to existing trunk lines.
- Reduced headways, coupled with larger, faster vehicles. The consequence of this, coupled with the installation of ATP–ATC is that the scheduled headways are increasing approaching the theoretical system design headways.

Examples of relatively simple light railways which are evolving into “Light Rapid” networks include San Diego, St. Louis, Sacramento, and Calgary, while many new start systems, e.g., Hudson–Bergen and Baltimore, were initially conceived and deployed in a light rapid format.

To summarize, the peculiar challenge faced scheduling and operations on many LRT systems can be summarized as follows:

- LRT is more likely than rapid transit to evolve into networked configurations.
- LRT is increasing its utilization of application design practices and of engineering systems which were originally developed for rapid transit. This is particularly the case for train control and interlocking design.
- There is an ever-increasing requirement to schedule service on core segments at, or close to, the line segments, practical throughput capacity.
- Given these challenges the systems engineering analysis used as the basis for service scheduling on HBLR may provide a useful contribution to industry practice.

SYSTEMS CHARACTERISTICS OF HUDSON–BERGEN

HBLR operates along North Jersey's Hudson River waterfront. The system presently serves four cities in Hudson County, and multiple extensions into Bergen County are in design or planning. HBLR can be considered to be a light rapid system which was deployed and is operated under a design–build–operate–maintain process. [Figure 1](#) provides a system map which includes potential future extensions. [Figure 2](#) provides the anticipated peak hour services (routings and trains per hour) that are anticipated for the future “full build-out” operation, which includes an extension beyond Tonelle Avenue. This paper describes the approach taken to development of full built-out (i.e., maximum utilization) operations.

HBLR is designed to high-performance electric railway standards, e.g., a cab, no-wayside signal system designed for 90- to 120-s headways, full reverse signaling, centralized supervisory control, and FRA Class 4 (80 mp) track. The vehicle is a high-performance, double-articulated, low-floor light rail vehicle (LFLRV) capable of speeds up to 64 mph, although current MAS is set at 57 mph. LRVs are 90 ft in length and are capable of operating in three-car revenue consist. They are equipped with ATP–ATC. Fazio (3) provides additional information regarding the HBLR system design.

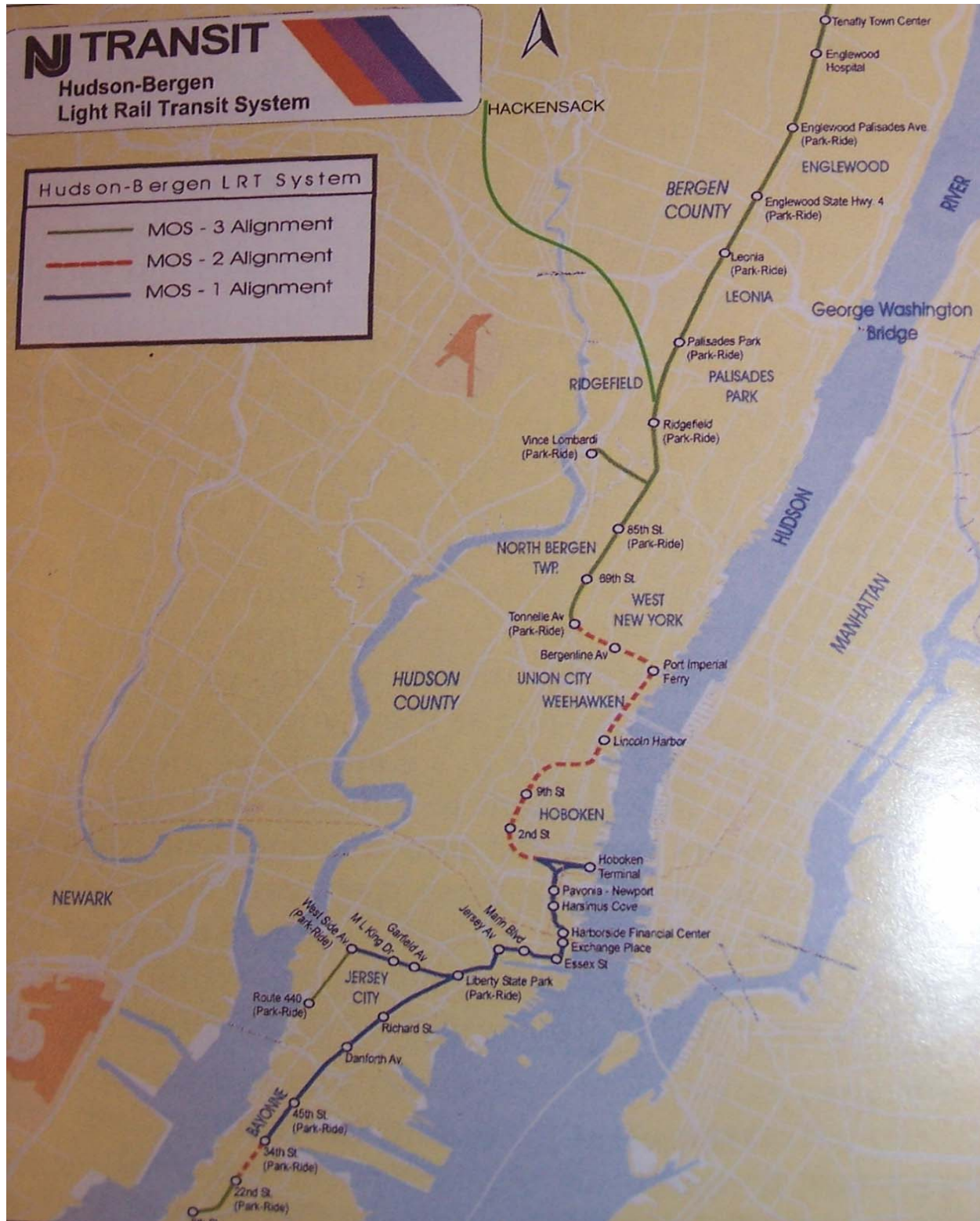


FIGURE 1 System map, HBLR.

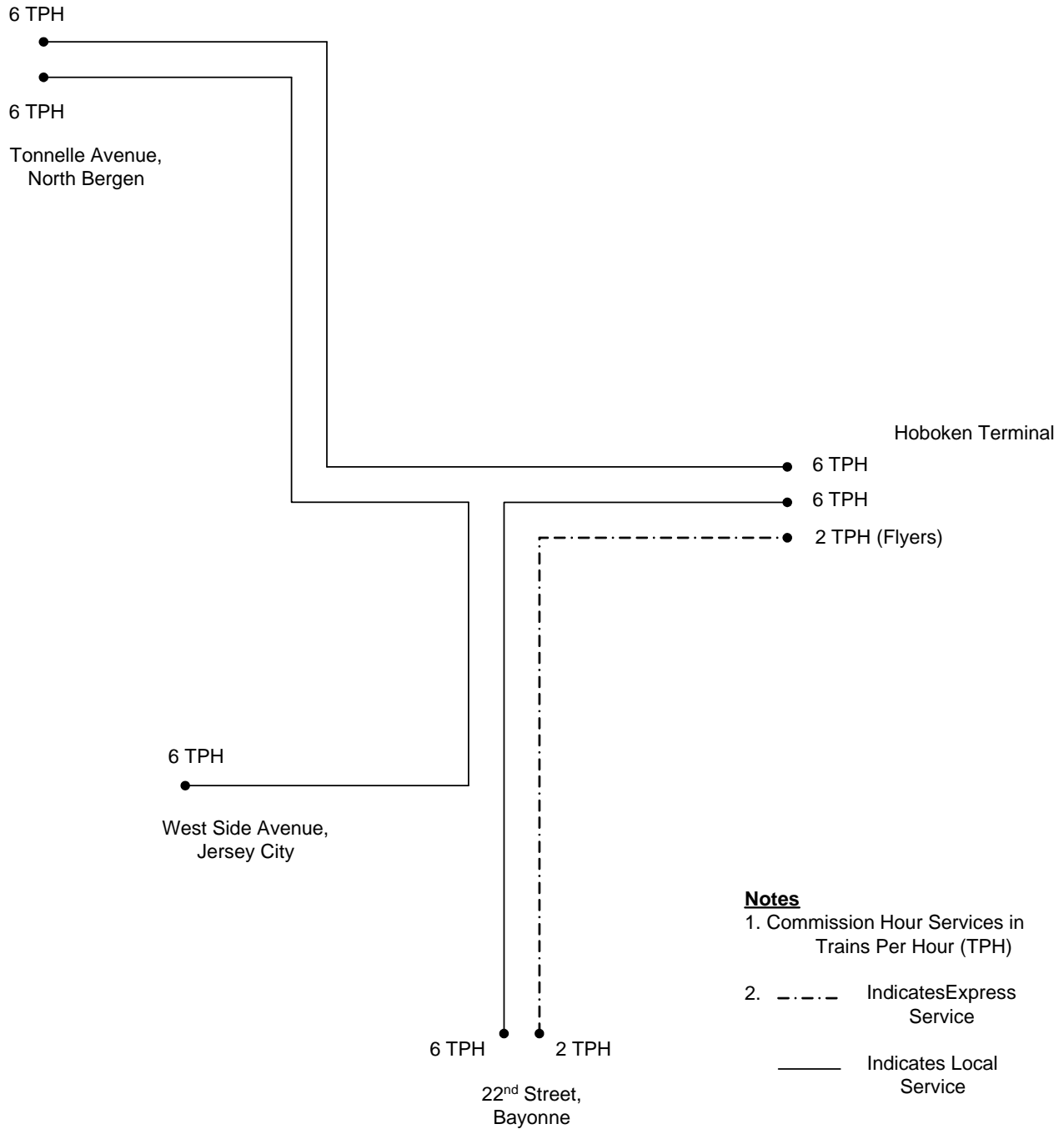


FIGURE 2 Service levels in May 2006.

HBLR’s relatively complex route structure includes a three-way, at-grade, signalized junction at the “wye” consisting of adjacent interlockings (DeKalb and Erie), and a relatively proximate three-track, stub-ended terminal at Hoboken. The terminal interlocking, Lack, is located approximately 1,300 ft from the eastern limit of DeKalb interlocking. Each of these locations is to be a capacity limiting point. In addition, they are sufficiently close to cause a mutual drawdown effect with regard to maximum throughput; this territory is designated as the Hoboken

Terminal District and is illustrated in Figure 3. The triple-track segment of the River Line (which includes the express overtake zone) is also within drawdown range (albeit the impact is not as severe) of DeKalb interlocking. The junction of the West Side and Bayonne branches at Y-North interlocking together with Liberty State Park Station also is a capacity limiting point, but is sufficiently distant from the wye to not cause drawdown.

The other factors governing HBLR capacity analysis are the routing complexity of the maximum service plan and the high-density (i.e., short-headway) operation to be provided under this plan (4). The five services which are ultimately anticipated and serve as the basis of this analysis are illustrated in Figure 4 and include

- Bayonne Local—operating from Bayonne to Tonnelle Avenue @ 5 trains per hour (tph).
- West Side Local—operating from West Side Avenue to Hoboken @ 5 tph.
- Bergen County Local—operating from points north of Tonnelle Avenue (to be determined) to Liberty State Park @ 5 tph.
- Bayonne Flyer—a zone express, operating between Bayonne and Hoboken @ 2 tph.
- Bergen Zephyr—a special express, operating from points north of Tonnelle Avenue (to be determined) and Hoboken @ 3 tph.

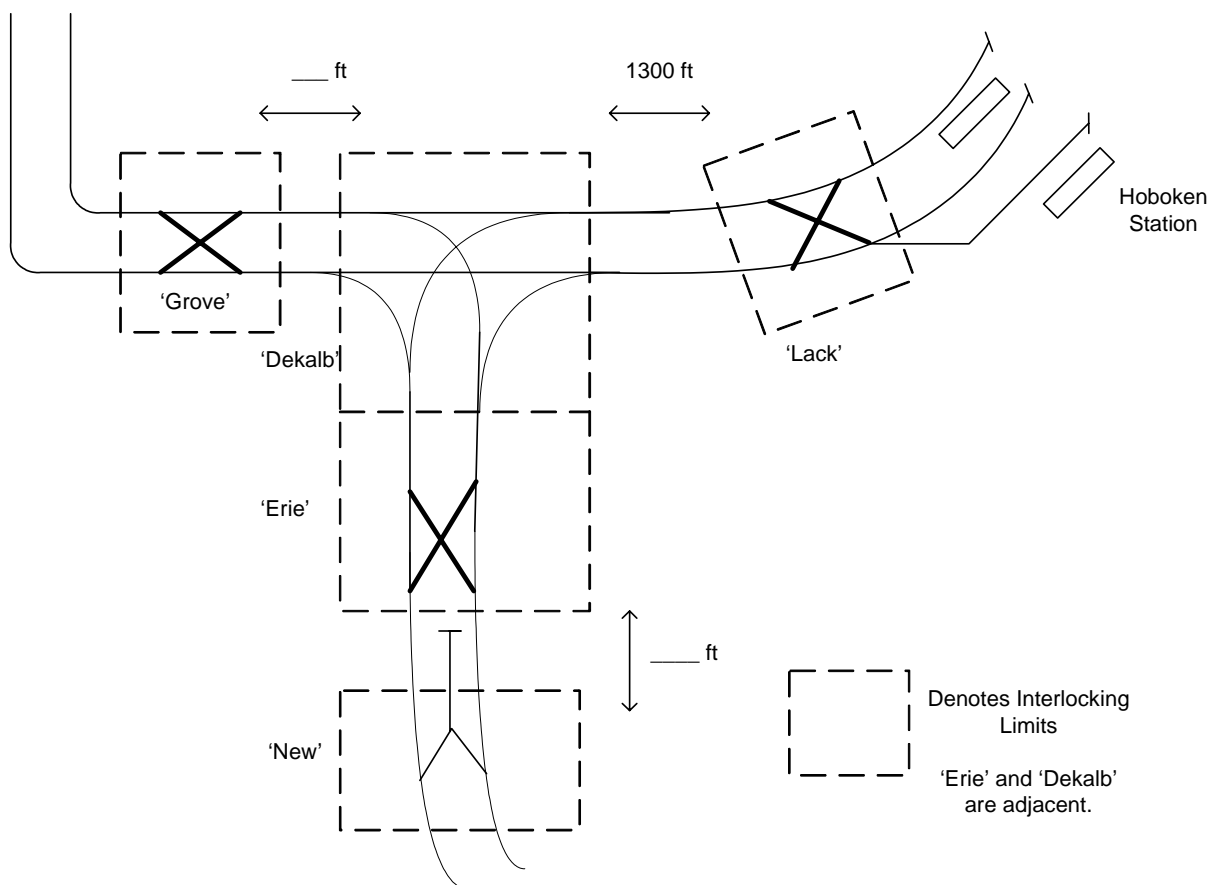


FIGURE 3 Schematic of the Hoboken Terminal District.

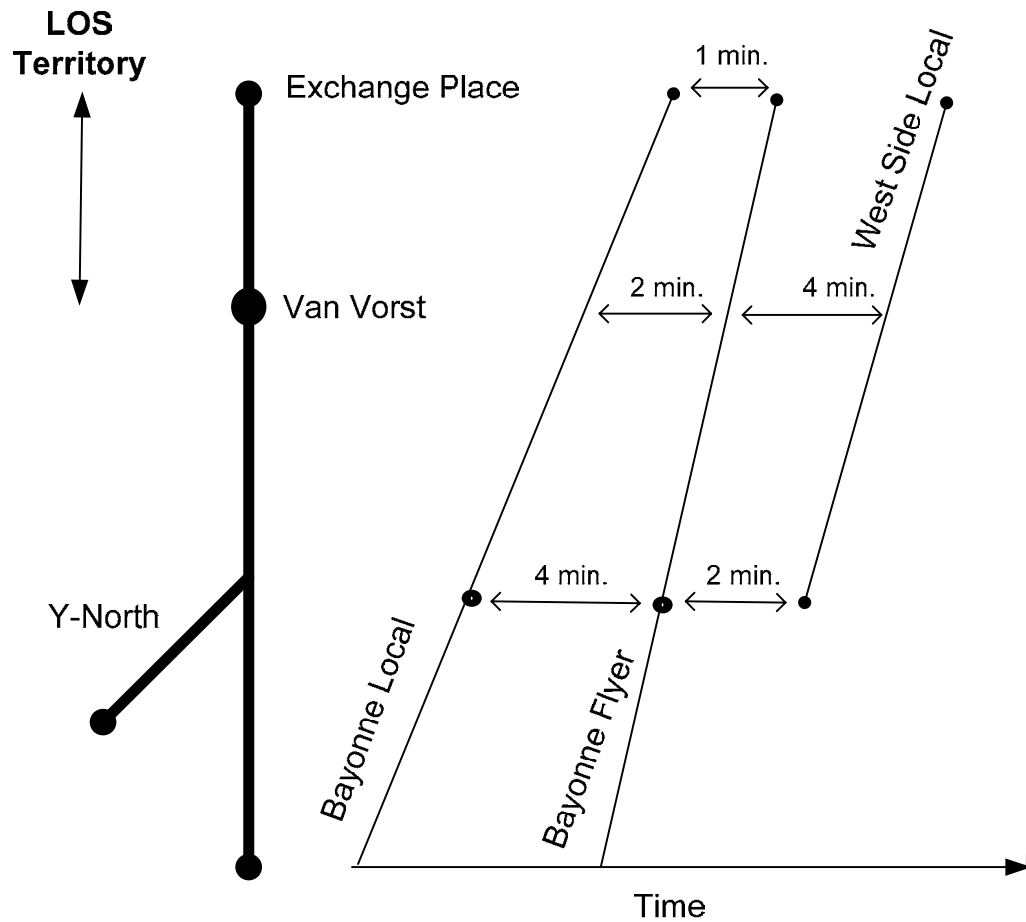


FIGURE 4 Route schematic at maximum service levels.

Under almost any service plan the wye represents the system-wide (i.e. most restrictive) limiting point. This particular service plan requires a large number of individualized route manipulations at the wye, which further limits capacity based on signaling, civil speeds, and the time required for manipulation of turnouts and the display of signals. Consequently the systems analysis initially evaluated performance of the wye.

GENERALIZED METHODS OF ANALYSIS FOR TRANSIT NETWORKS

Engineering Systems Which Critically Influence Service Scheduling

While many of a railway’s engineering systems influence operational capability, the following systems have the most significant impact on capacity.

- Train control, including the design headway along the line (i.e., within automatic territory or so-called way capacity), the headway design at stations, and interlocking design.
- Vehicle, including service acceleration and service braking rates, emergency braking criteria (safe braking distances), and door configuration (station dwells).
- Track, including maximum design speed, civil speed restrictions due to alignment, configuration at interlockings (e.g., location of clearance locations required to permit sectional release logic), and special configurations at stations.

A high-density railway must consider the design of these systems and the consequences of this design to headway as measured by mere seconds. Consider, for example, the analysis performed for design of the subway car door configuration for New York City's Independent Subway in the 1930s (5). This analysis estimated that use of four doors per 60-ft car would reduce station dwells by 5 s when compared to the previous design by the Brooklyn Rapid Transit Company of three doors per 67-ft car. At 30 trains per hour, a savings of 5 s was equivalent to gaining one extra slot per hour.

The ergonomics design associated with a capacity limiting point, e.g., positioning and preview of wayside signals, as well as the method of display of cab aspects and the available speed commands require consideration in evaluating the capacity performance of a limiting point.

Computations

The methods of analysis included the following:

1. *Development of analytical stringlines (i.e., time–distance plots) for movement of single trains.* These are precisely drawn and the inclusion of head end and rear end of individual trains is necessary to evaluate high-density train movements through limiting points, particularly where movements are made at low speed. Two of the three routes at the wye are, for example, restricted to 10 mph (14.5 fps) operation due to curvature. A three-car train requires approximately 20 s for its own length to traverse a given location in the wye.

2. *Addition of signal control lines to the stringlines* This enables the plotting of the following train's movement as governed by signal control. On signalized railways, it is necessary to add signal control to the conventional time-distance (stringline) diagrams in order to gain a complete understanding of the railway's performance under high-density operations. The criteria for the movement of the following train can then be applied to the specific schedule for a pair of trains. The Bayonne Flyer stringline is illustrated as an example in [Figure 5](#). The operational criterion for the Flyer is that it operates between 21st Street and Exchange Place on a clear aspect, i.e., the highest obtainable aspect for the local conditions unimpeded by the train ahead. Note that this cab aspect may vary from 55 mph to 15 mph depending on local conditions, but that the Flyer is scheduled to avoid the signal control of the train ahead at all times.

A similar consideration exists at junctions; the criterion applied to the wye and to Lack is that no train would be scheduled against a stop signal—i.e., as a minimum condition, a 15-mph or 10-mph cab would be available to an arriving train. The wye is further constrained by the close clearances, which must be incorporated in the route fouling protection, and which inhibit the ability to employ sectional releasing in the interlocking design. Provision of appropriate safe braking distance at DeKalb requires that a northward train be held at Erie's home signal if

DeKalb is occupied. This extension of the DeKalb signal control into Erie further degrades the capacity of the wye.

Incorporation of three of the influences of signalization (i.e., signal control lines, desired minimum aspect, interlocking fouling configurations) is absolutely essential if the analysis is to accurately predict railway performance under high-density train operations.

3. *Degradation of train movement.* This is implemented according to protocols reflective of realistic train operation. This degraded operation represents the average or mean value of an operational parameter and as such, does not include randomization (i.e., variance from mean value). The treatment of 10-mph curves on the wye provides an example. Under the initial design the lowest available non-zero cab aspect was 15 mph. Using the applicable safe braking model, the runaway speed for a 15 mph cab is 24 mph, more than double the posted speed, and above the safe (i.e., overturning) speed for that curve. Under such a design, this location would have been designated as a target enforcement location in HBLR's program of efficiency checks; wayside radar would have been utilized on a spot basis to enforce the 10 mph posted speed. The consequence of this would have been that train operators would be likely to operate well below 10 mph, and a throughput analysis was done assuring a 7 mph (1014 fps) operation. That is, in mathematical terms, the expected or mean value of speed of a train in these curves was anticipated to have been 7 mph under a design which required radar enforcement of safe speed in a 10-mph curve. The expected distribution of speeds about the mean value of 7 mph (e.g., what percentage of trains would traverse this curve at speeds of 6 mph or 8 mph), is a factor that would be considered in a stochastic simulation; the use of the 7 mph (i.e., the likely speed) for all trains is what is referred to as the degraded deterministic analysis. This greatly reduced capacity, and as a result of this analysis, the system design was changed. A 10-mph cab aspect was added, as was full guarding (i.e., check rails) of the curves to prevent wheel climb. With the addition of the 10-mph aspect and check rails, the ATC protected the safe speed and use of wayside radar was not required. As a result, the average operator was assumed to handle the train at 9 mph (13.0 fps) through this curve. This is a primary example of the relationship between the design of engineering systems and train operations; in this case these included the ergonomics of manual train operation, the addition of a 10-mph cab, full guarding of the curve, and the operating practice to be used for speed enforcement.

The governing move at the wye is for northward trains that enter at Erie and are routed to Tonnelle Avenue. This route is approximately 800 ft in length. [Table 1](#) gives the times required for this move for the standard two cars consist which is to be utilized during peak hours for all trains operating south of Hoboken.

As [Figure 4](#) indicates, this particular movement is to be scheduled 10 times per hour. The difference between the theoretical deterministic time and the degraded deterministic time (for 15-mph aspect) is 29 s; at 10 tph this is equivalent to 290 s, or nearly two lost headways for the south (Newport) leg of the wye (17 tph total). The redesign and revision of the engineering system reduces the loss between theoretical and degraded to only 8 s per trip. This illustrates the importance of considering ergonomics and operational performance during engineering designs.

4. *Use of interlocking clocks.* Train movements at critical points are evaluated using a graphical analysis which indicates the time of occupancy in a clock format. For terminal stations, these clocks include platform occupancy diagrams. For critical junctions the concept of an interlocking clock was developed; this is discussed later.

TABLE 1 Analysis of Single Train Operating through wye

Mode of Operation	Speed		Time for 800 ft (seconds)	Time for Two Car Consist to Traverse (seconds)	Loss of Shunt and Set New Route	Total (Seconds)
	mph	(fps)				
Theoretical	10 mph	(14.7)	54	12	7	73
Degraded w/15-mph cab aspect	7	(10.3)	78	17	7	102
Degraded w/10-mph cab aspect	9	(13.2)	61	13	7	81

Importantly, the methods described in this section remain deterministic; randomization is not employed through this stage of the analysis. An all too common error is to employ the randomization associated with computer simulations prior to achieving a deterministic, analytical understanding of the performance of the integrated engineering systems. The comprehensive deterministic solution is prerequisite to meaningful simulation and randomization.

Application of Computation to a Transit Network

The method of applying these analyses to a transit network is stepwise:

1. *Identify each limiting point.* The severity of a particular point may well be related to the service plan—e.g., routing permutations at a given interlocking or stopping patterns if express service is operated.
2. *Compute local solutions.* A stand-alone analysis of each limiting point is performed, according to the methods described above; this includes application of the given degradation protocol. Each limiting point is optimized—i.e., trains are assumed to arrive at the boundaries of the limiting points at the optimal times in order to maximize throughput at that particular location. (This is referred to as the local or independent solution.)
3. *Identification of drawdown relationships between limiting points.* This depends on the proximity, running time, systems design (e.g. are two limiting points separated by street running with LOS operation), and scheduling philosophy (e.g., is schedule pad to be added and permitted to be consumed) between limiting points. Where drawdown exists, only one of the two limiting points can be optimized. The local solutions are matched and train arrivals or departures are coupled between the two locations.
4. *Iterative solution.* The entire network is balanced. That is, the deviation of optimum performance is distributed in order to provide the optimum network solution. Note that this remains a deterministic analysis.
5. *Perform a stochastic analysis.* Once the network operations are analyzed and fully understood, simulation programs are beneficial to evaluate random aspects associated with the service plan. (Variances from mean values of such items as operator actions, vehicle accelerations, station dwells, terminal departures, and street operations may be simulated by a

variety of models, or the influence of these factors may be estimated by experience or historical observations.)

APPLICATION TO HBLR

The limiting points for the HBLR network are the wye (DeKalb and Erie interlockings), Lack interlocking in combination with Hoboken Terminal, and Y-North (junction of the Bayonne and West Side branches and yard lead) interlocking. Although the three roads section is a critical schedule point, its design is such that it does not act as a capacity limiting point. The full build-out service pattern was selected for a variety of reasons (existing ridership, future ridership, geopolitical, financial, as well as operability). The plan called for an almost uniform splitting of trains entering the wye from each branch to one of the two outlet routes. This requires the manipulation of signals and turnouts for *each* train movement; this service pattern, combined with that location's physical characteristics and signal configuration, caused the wye to become the systemwide capacity limiting point. Consequently, the systems analysis initially optimized throughput at the wye, and then reviewed the performance of the balance of the network. HBLR is scheduled as a transit system, not a railroad; that is, headways (intervals), not individual train movements, are the basis for developing schedules. This greatly eases the analysis, since once a peak hour pattern is developed, it can be repeated.

The stringline or control line analysis of the wye indicated that the deterministic degraded train movements (on alternating routes and including such items as loss of shunt timing for track circuits and route setup at 7 s) could be scheduled on 2-min intervals. There would be five services to be scheduled under this service plan. With 2 min per train movement (i.e., 2-min slots) and five services, a 10-min cycle would be theoretically possible, but would not be realistic. Recovery time would be required based on stochastic factors impacting train movement, particularly since trains entering Erie from the south would be traversing the roughly 1-mi segment of mixed traffic (highway) operations.

The probability density function (pdf) of train arrivals from south of Erie would be expected to vary on the order of 60 to 90 s (nearly one full slot), from their schedule time at Erie, based on the timing of the highway traffic signals. Based on the records of train movements over the initial operating segments, the stochastic factors were incorporated by adding one empty slot per cycle; this would allow delays which occurred within a cycle to be rectified during this empty slot and would generally prevent perturbations within one cycle from propagating to the following cycle. This factor is extremely important (i.e., damping of perturbations) to system stability over a 2- or 3-h peak period. The five active slots and one recovery slot led to a 12-min clock for the wye. Thus the basis for scheduling the entire HBLR network was the utilization of a 12-min clock at the wye. This clock, illustrated in [Figure 5](#), is repeated five times per hour and is based on operating 10 trains per 12 min. Trains operate as paired parallel movement, with a maximum of 2 min assigned per movement; the time between scheduled movements (assuming no trains are scheduled against a stop signal) is extremely tight, varying from 80 to 117 s. Train operation can not be reasonably sustained at these allowances over a 2- or 3-h peak period, particularly in a system without automatic train operation that includes a section of mixed traffic operations. The 2 min empty slot provides clear out and recovery time. Note that the criterion that no train be scheduled against a stop signal is a basis for analysis; the random nature of train arrivals at the wye will cause some trains to operate into a stop signal, even with this criterion.

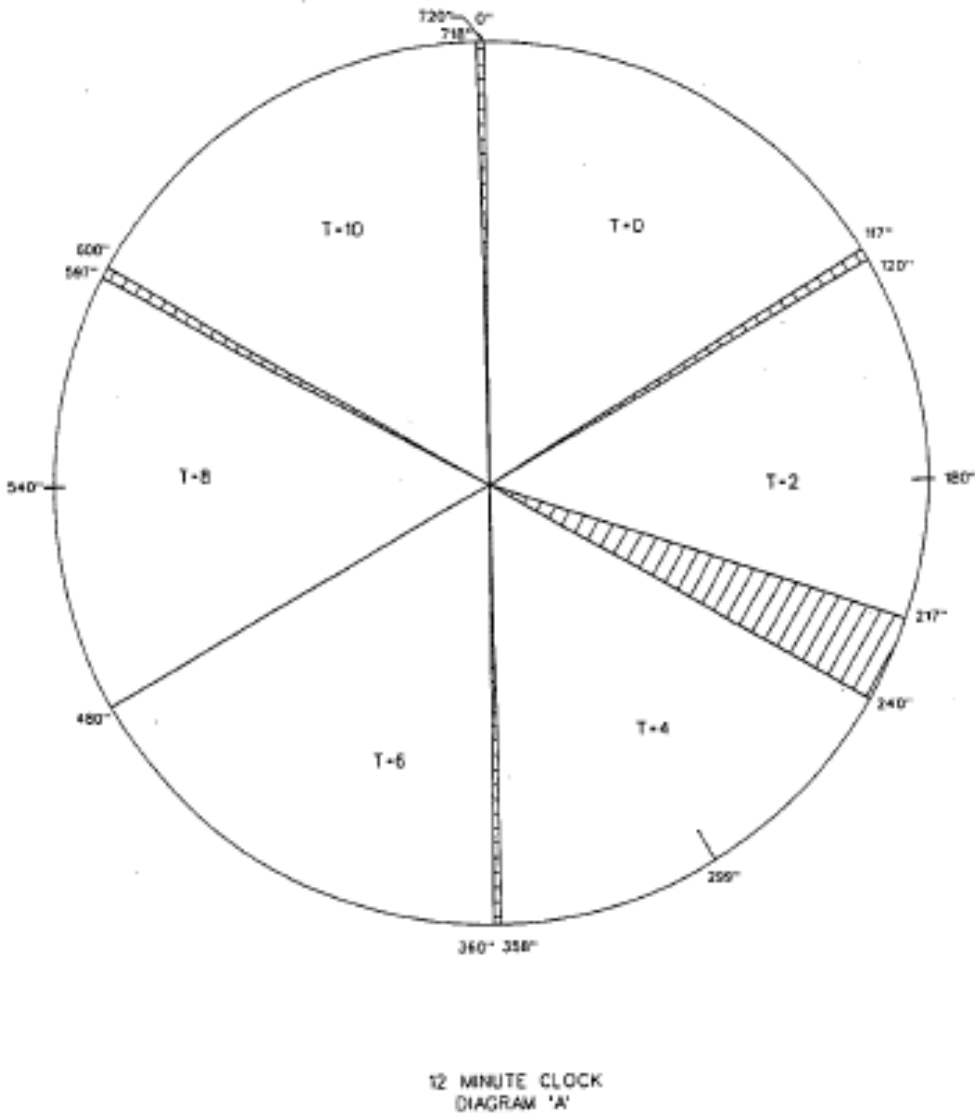
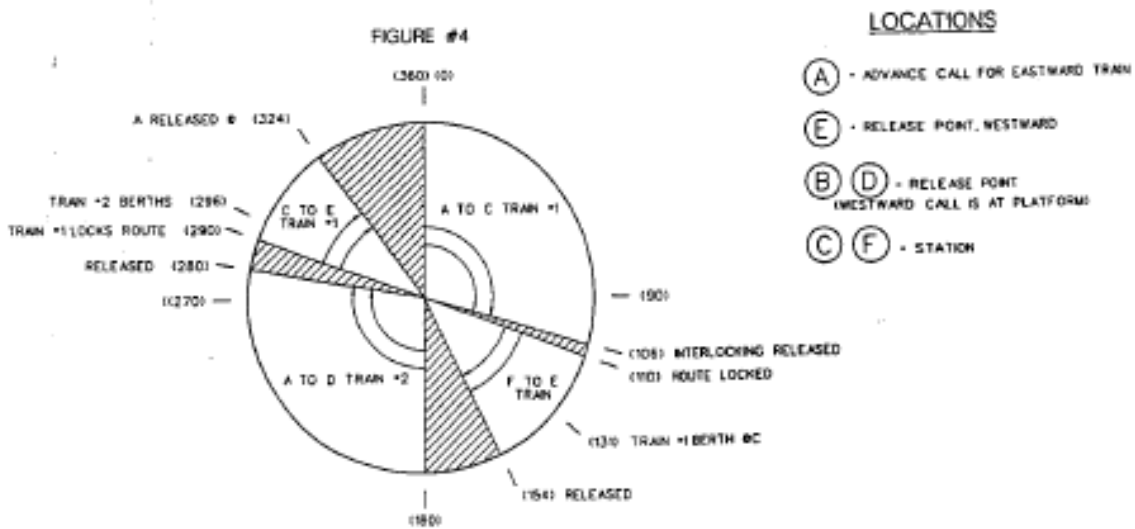
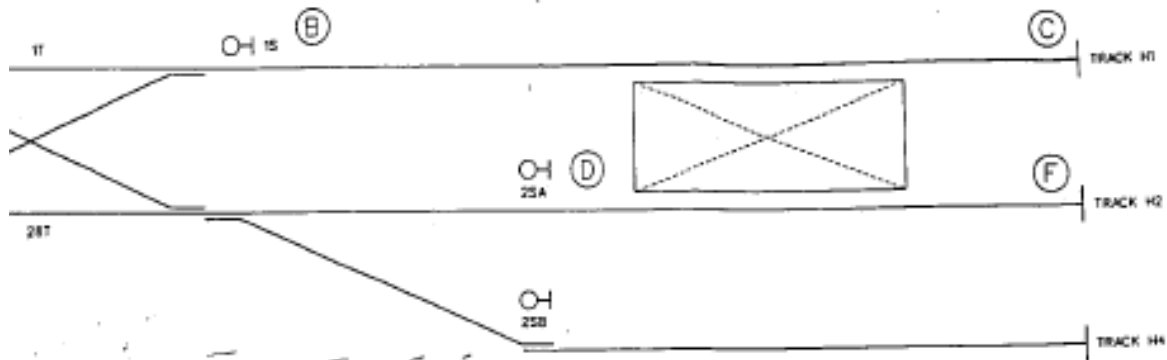


FIGURE 5 Clock for the wye.

Each line feeding the wye is capable of sustaining a 20 tph operation, thus providing a requirement for a 60 tph throughout at the wye. By virtue of this analysis, however, the wye would not be scheduled at great than 50 tph. Similar, independent analyses were performed at both Y-North and Lack/Hoboken Terminal. The latter was found to be capable of supporting the 20 tph per direction goal. Unfortunately, the drawdown effect between the wye and Hoboken is extremely severe due to the proximity, high train density, and absence of parallel movement capability in the design of Lack. The boundary conditions between the two limiting points were found to be highly incompatible; the wye would serve a train to Lack at a time when it could not be accepted. The proximity of the two locations greatly inhibits the use of schedule slack as a means of matching boundary conditions. The decision was made to schedule the system with

optimum performance at the wye and with available performance at Lack–Hoboken. Under this approach, the capacity at Hoboken drops to 15 tph. Figures 6 and 7 depict the movements at Hoboken under independent (local) analysis and with train movements matched at the wye. A similar analysis was performed for the three roads (overtake) territory. The order and spacing of trains required to implement an overtake of three roads were found to match reasonably well with movements at the wye. Minor adjustments would be made to the schedules at the wye,



ASSUMPTIONS

1. EASTWARD ADVANCE CALL 4BT, NW PUSH BUTTON REQUEST BY RTC AT STATION
 2. TWO CAR TRAINS
 3. DERATED SPEEDS AT 4 MPH, 13 MPH, 8 MPH AND 23 MPH
- NOTE: A TO D AND B TO E ARE PARALLEL MOVES BUT CANNOT BE MADE CONCURRENTLY.

FIGURE 6 Clock for Lack and Hoboken Terminal, local solution.

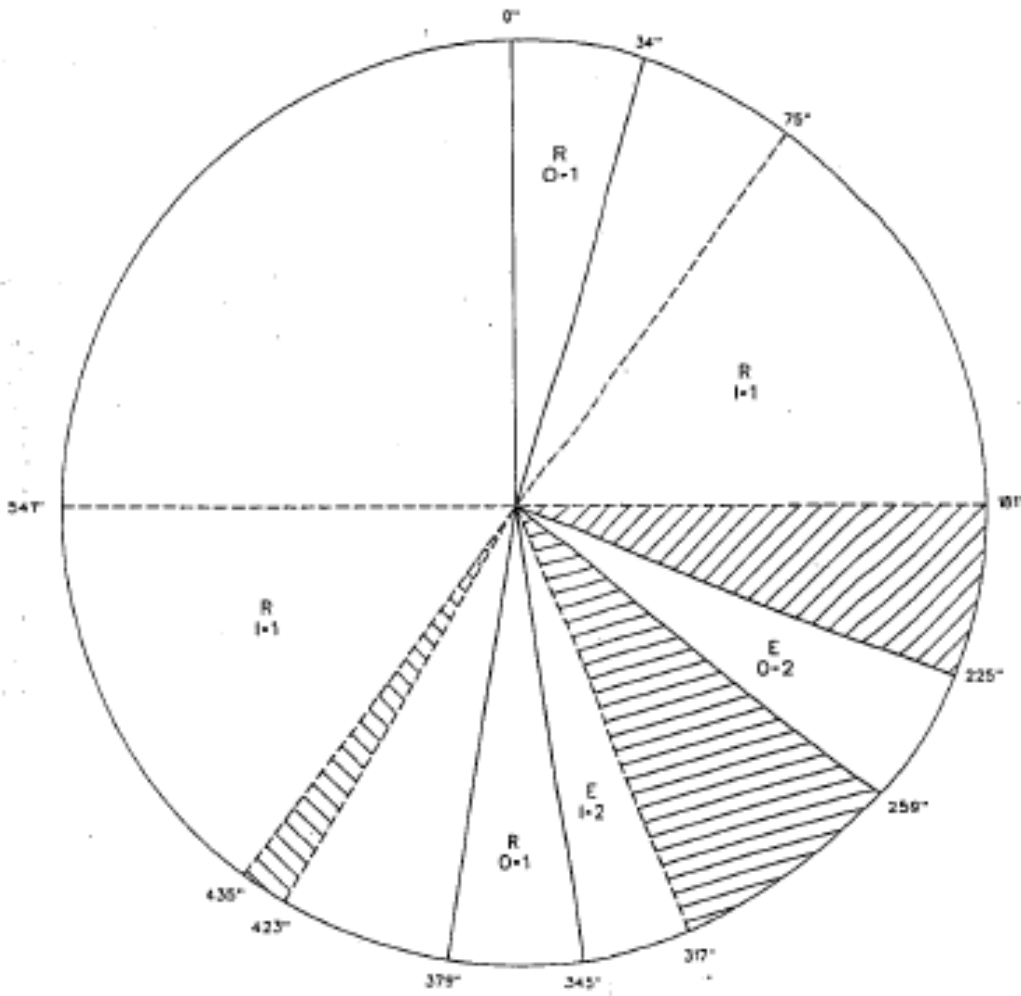


TABLE "A"

FROM	DEPARTS	CLEAR
R → H	75	181
H → R	0	34
E → H	317	423
H → E	225	259
R → H	435	541
H → R	345	379

NOTES:

- SOLID LINES ARE OUTBOUND (SOUTH OR WEST)
- DOTTED LINES ARE INBOUND (EAST)
- R - RIVER LINED TRAIN
- E - EIRE LINED TRAINS
- 1 - BERTHED ON TRACK #1
- 2 - BERTHED ON TRACK #2
- O - OUTBOUND
- I - INBOUND

FIGURE 7 Clock for Lack and Hoboken Terminal influenced by the optimized wye.

all of which would be consistent with the 12-min clock. As previously mentioned, Y-North is sufficiently distant from the wye to be scheduled independently. Thus 20 tph can be scheduled at this location in parallel moves.

The systems analysis of the HBLR network described in this paper also benefited the following actions:

- Decisions regarding the asymmetry of headways for each branch of the wye. The required asymmetry was placed to enhance the two express services—i.e., Bayonne Flyer and Bergen Zephyr.
- Dispatching patterns are indicated in the operating plan. Senior train controllers participated in this analysis, thus providing them with a firm understanding of the operating concepts prior to the initiation of full service.
- The schedule, which was largely driven by the systems engineering configuration led, in turn, to modification/improvements to the configuration on a local basis, as required enhancing the ability to operate this schedule.

CONCLUSIONS AND SUMMARY

The following conclusions are suggested:

- As LRT systems grow, they are likely to evolve into complex networks, and are also more likely to utilize rapid transit engineering practices and tight headways i.e. be configured as regional rail networks while designed and operated as rail rapid transit.
- The service scheduling process will, as a consequence, become more complex, and must be rooted in sound engineering and transportation analysis. This analysis must be a prelude to actual schedule making—i.e., the conventional practice of schedule making occurs following the completion of this analysis.
- The use of methods described in this paper—i.e., the development of a deterministic analysis of the performance of the transit network, which is degraded, according to a defined set of protocols, is a prerequisite to simulations which incorporate randomization of train performance.

Proper adherence to the analytical methods described in this paper optimizes total system performance, while providing transportation management with achievable service level and quality goals.

REFERENCES

1. Vuchic, V. *Urban Transit, Operations, Planning and Economics*, Hoboken, N.J., 2005.
2. Bion, J. A. *The Capacity of the Subway*.
3. Fazio, A. E. "Relationship between Light Rail Systems Design and Systems Operations," *Journal of Transportation Engineering*, May/June 2004.
4. Mos-2/1 Combined Service Plan. Internal Report issued by Hudson–Bergen Light Rail, March 2003.
5. *Municipal Engineers' Journal*.

OPERATIONS, SUPERVISION, AND SERVICE QUALITY

A Wide Array of Operation Models
From On-Sight to Full Driverless

GÉRARD GABRIEL

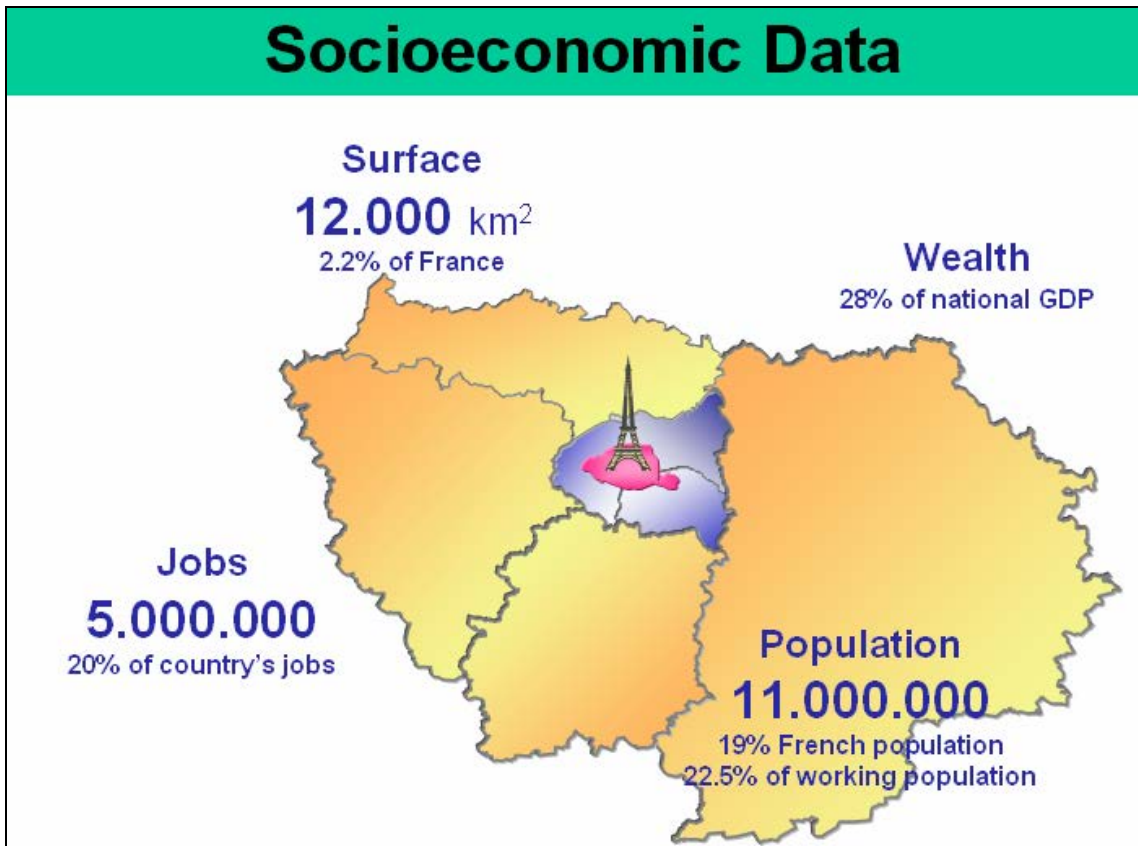
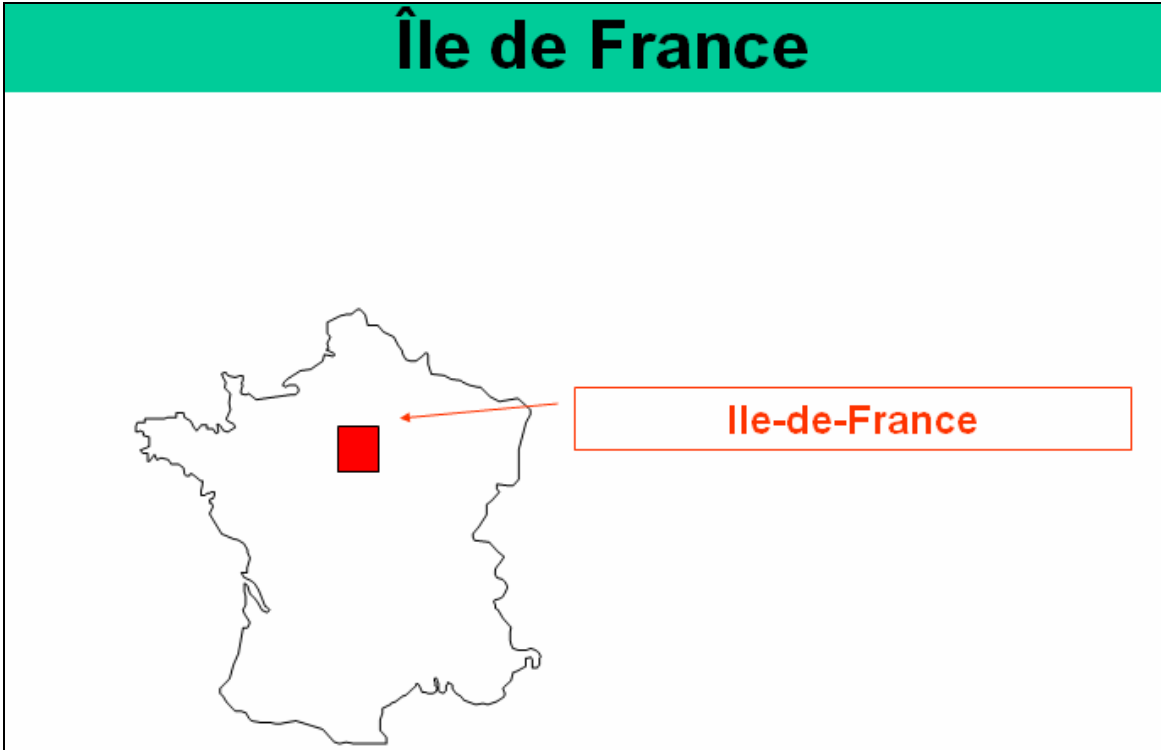
Régie Autonome des Transports Parisiens

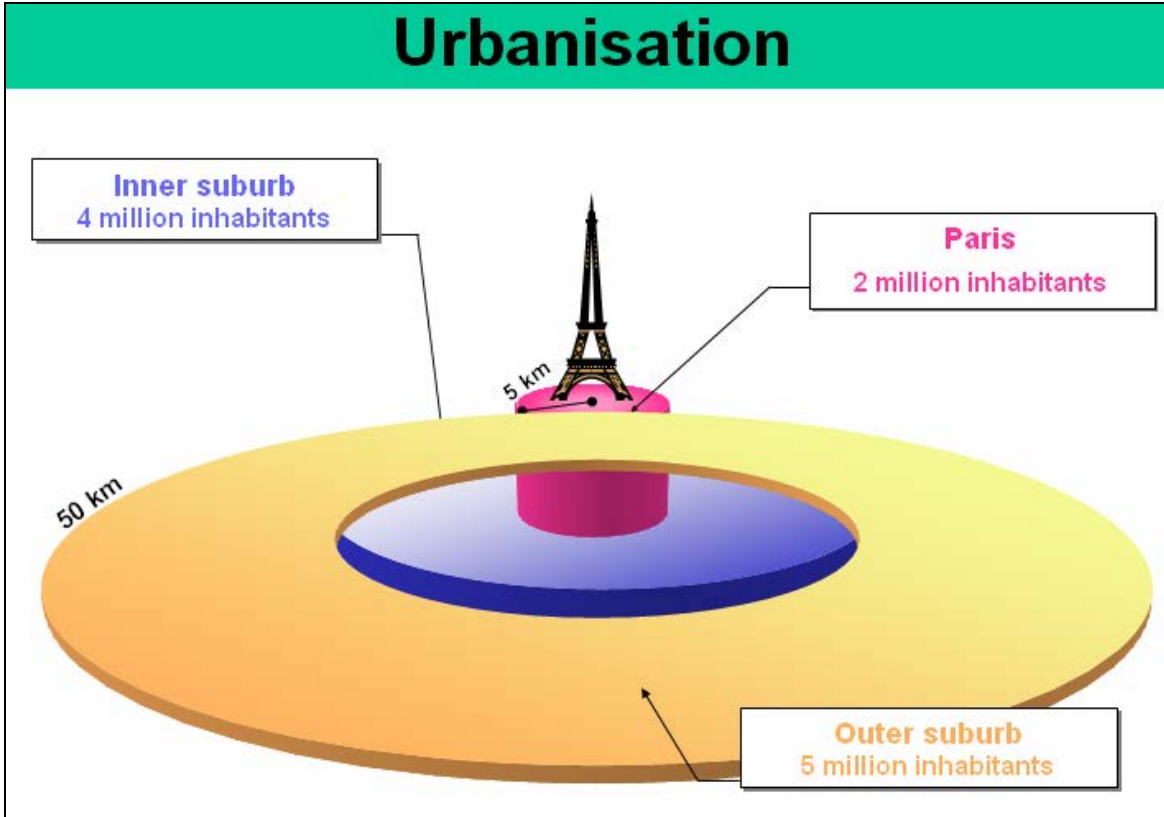


Table of Contents

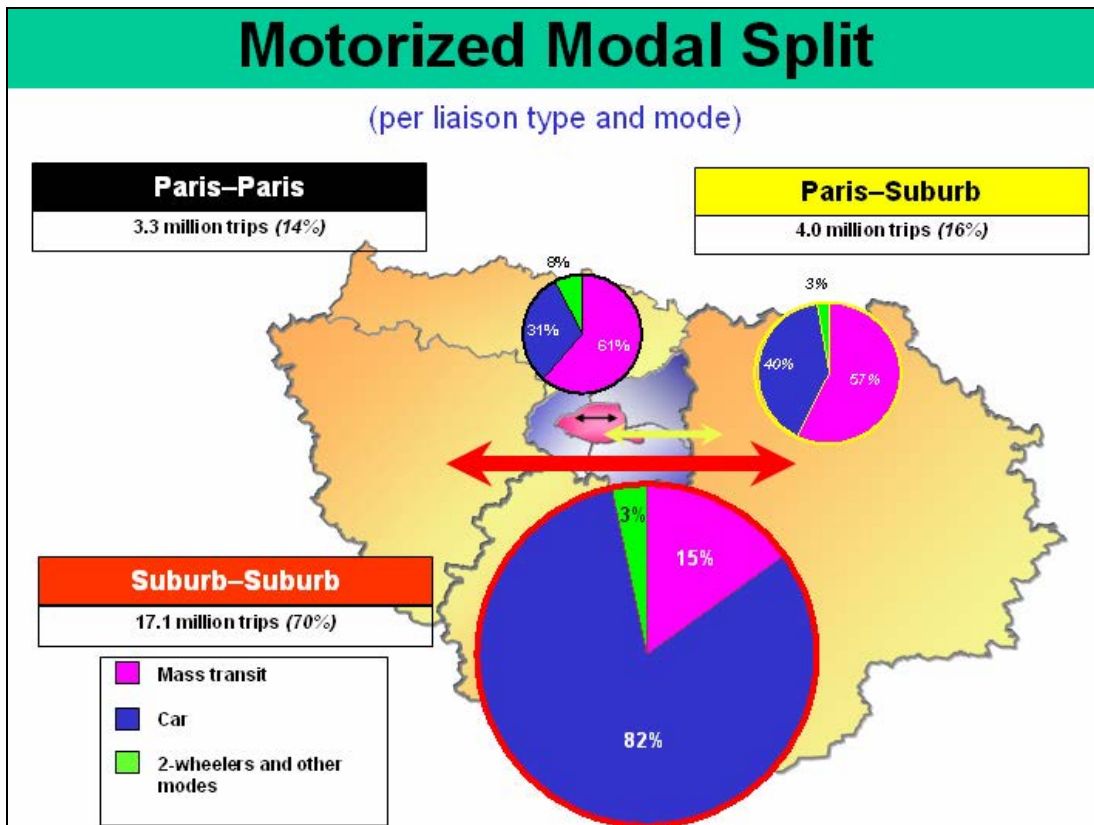
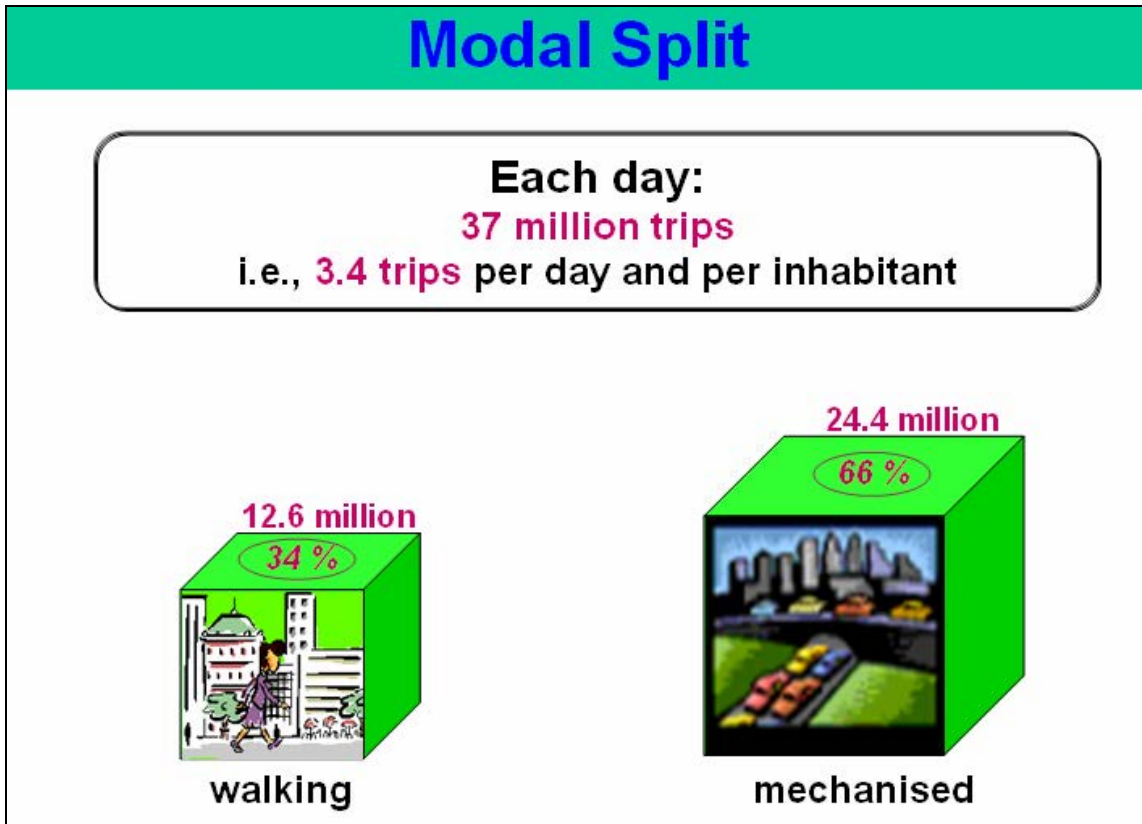
1. Presentation of Île de France
2. Passenger transport in Île de France
3. RATP today
4. The operation modes in use
5. Examples of evolution:
 - OURAGAN on metro line 13
 - Full automation on metro line 1

ILE DE FRANCE





Passenger Transport in Ile-de-France




RATP today

RATP

- A **multimodal public company** providing public transport (metro, commuter trains, LRT, bus)
- Mission statement: **plan, build, operate**, and **maintain** lines and installations
- **Modal split** of public transport in Ile-de-France


Operator	Percentage
RATP	78%
SNCF	15%
Private operators (Optile)	7%

The Networks




Metro

- 14 lines
- 300 stations
- 210 km of lines
- 3570 cars
- 25 km/h commercial speed
- 1335 millions travellers/year
- 5 millions trips/day




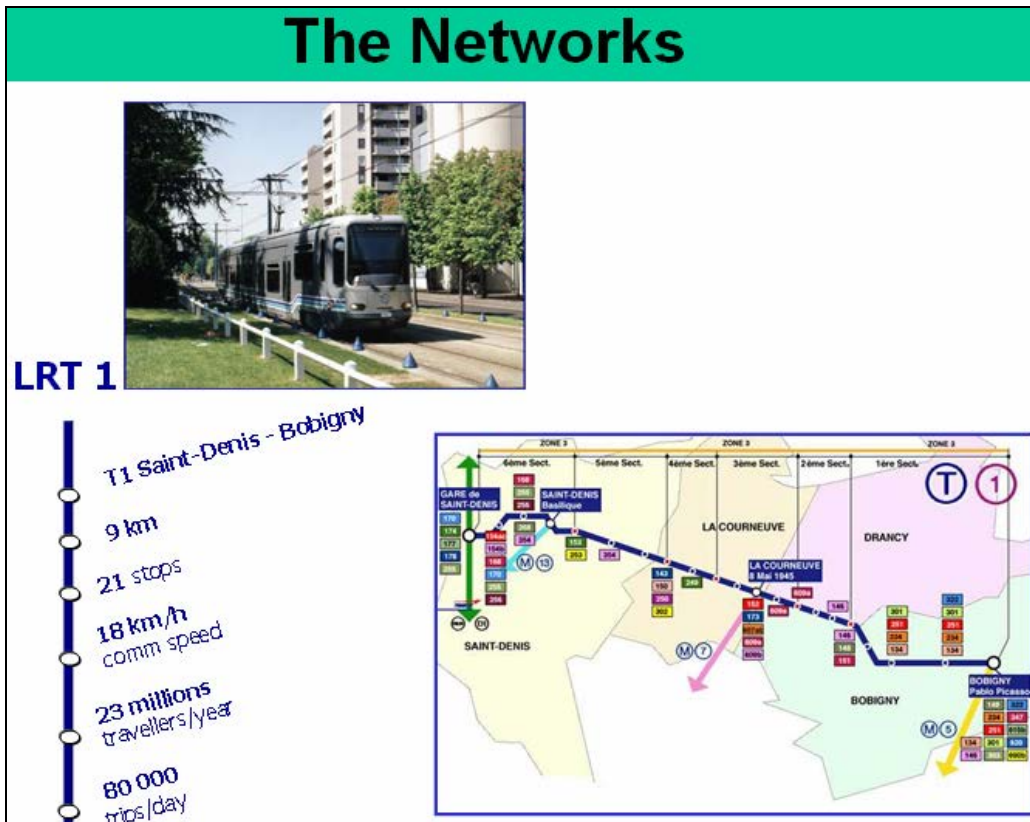
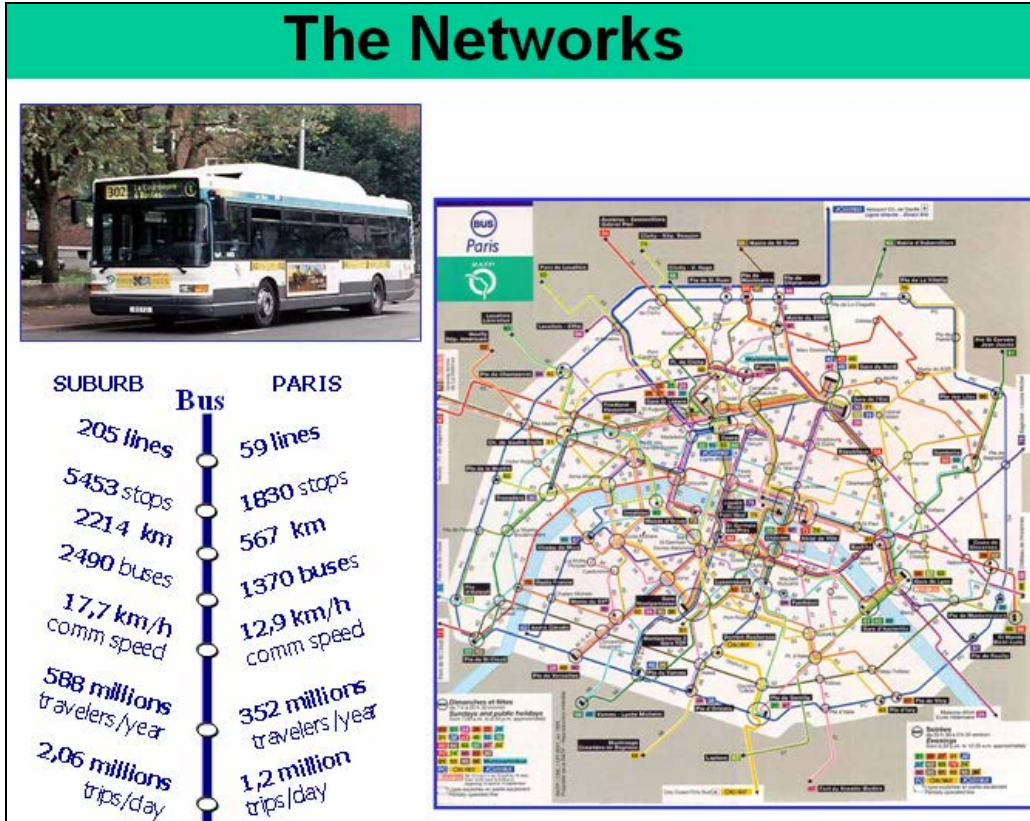
The Networks

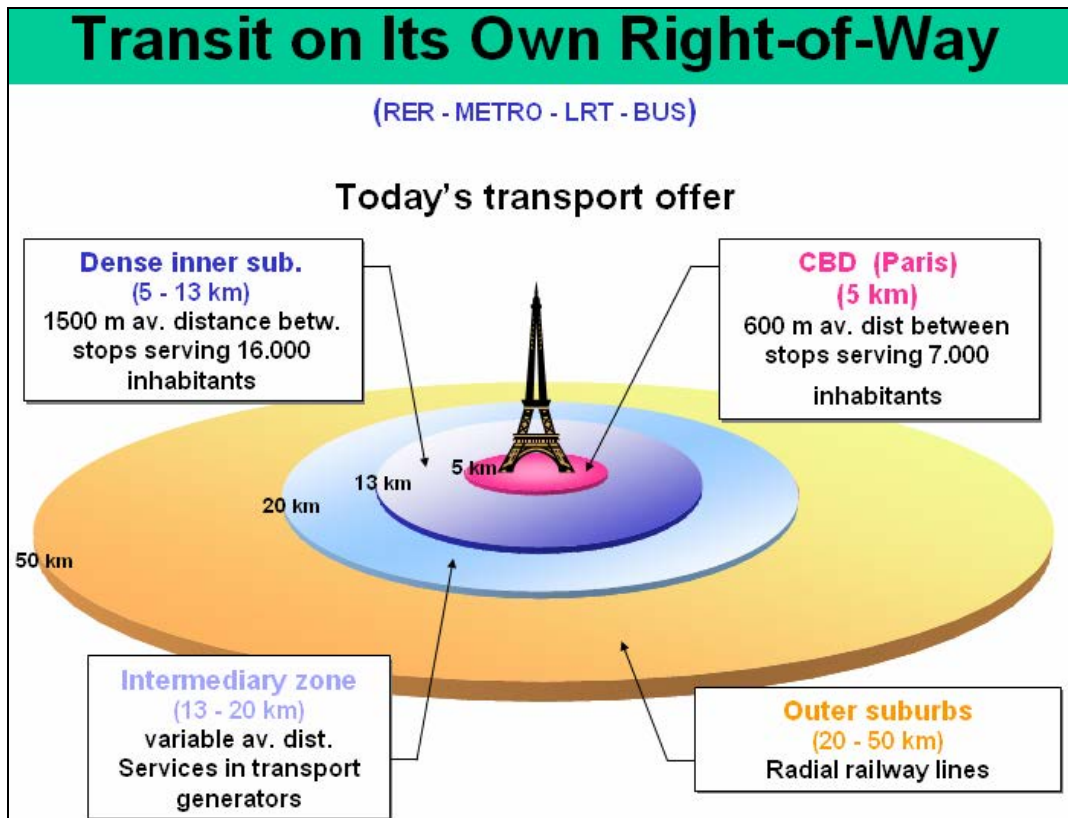
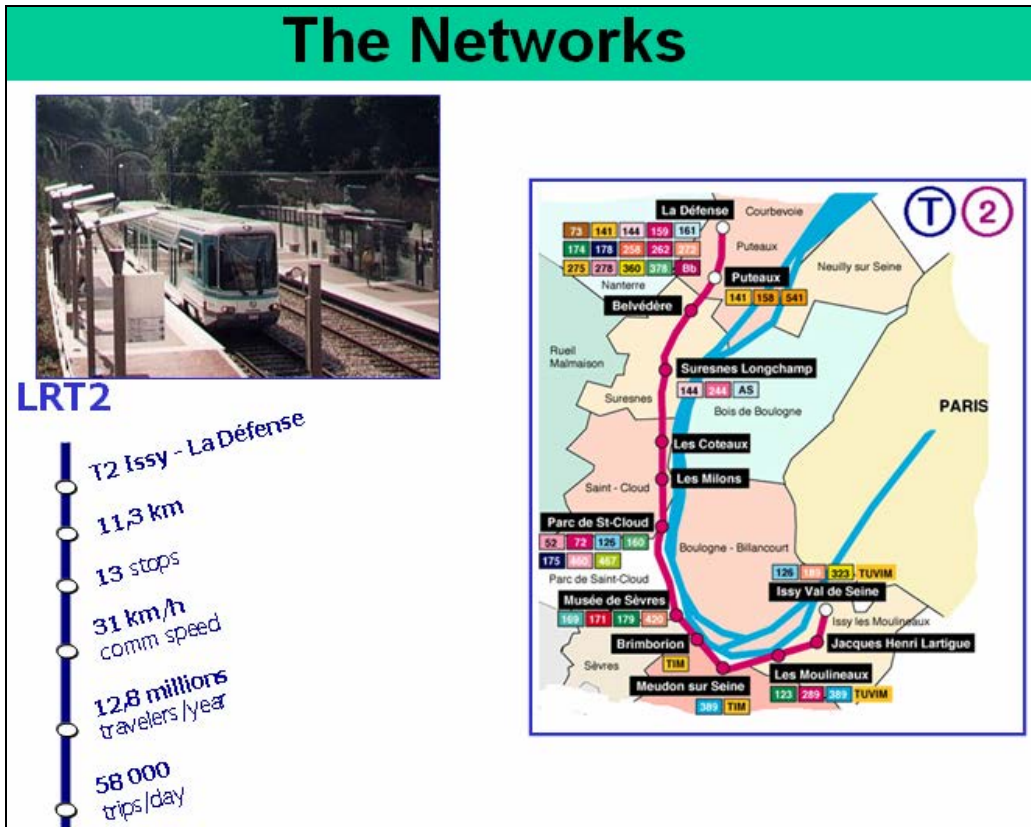


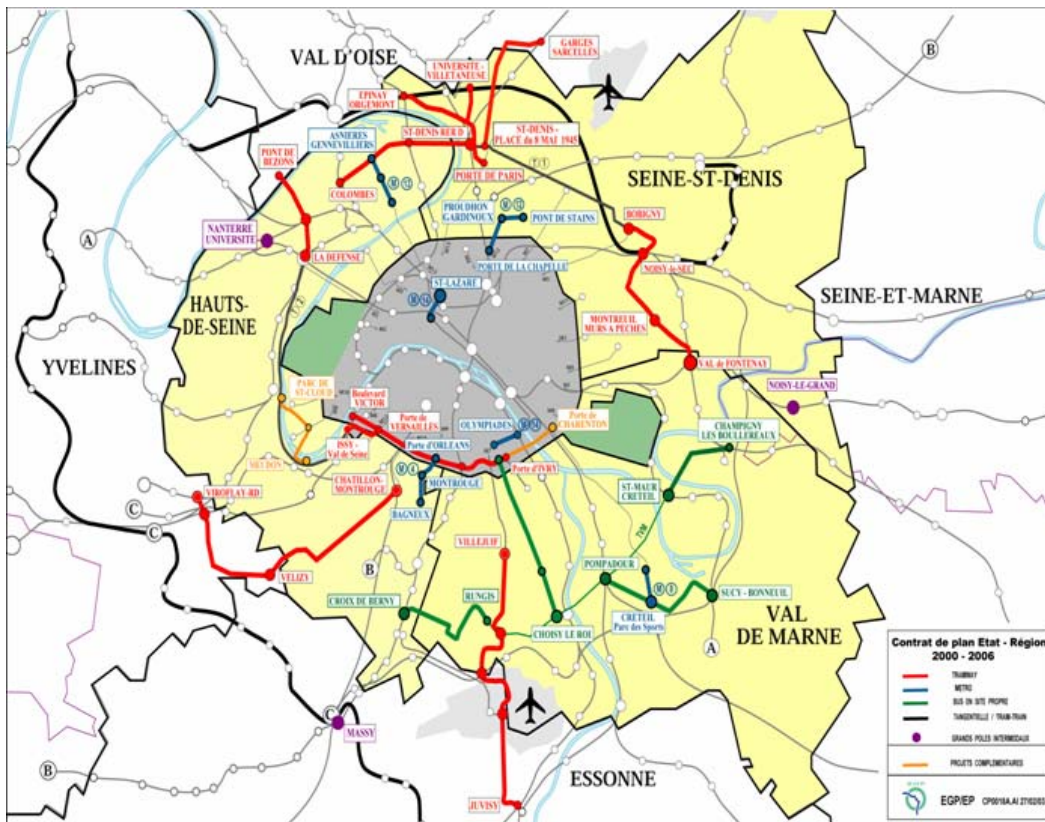
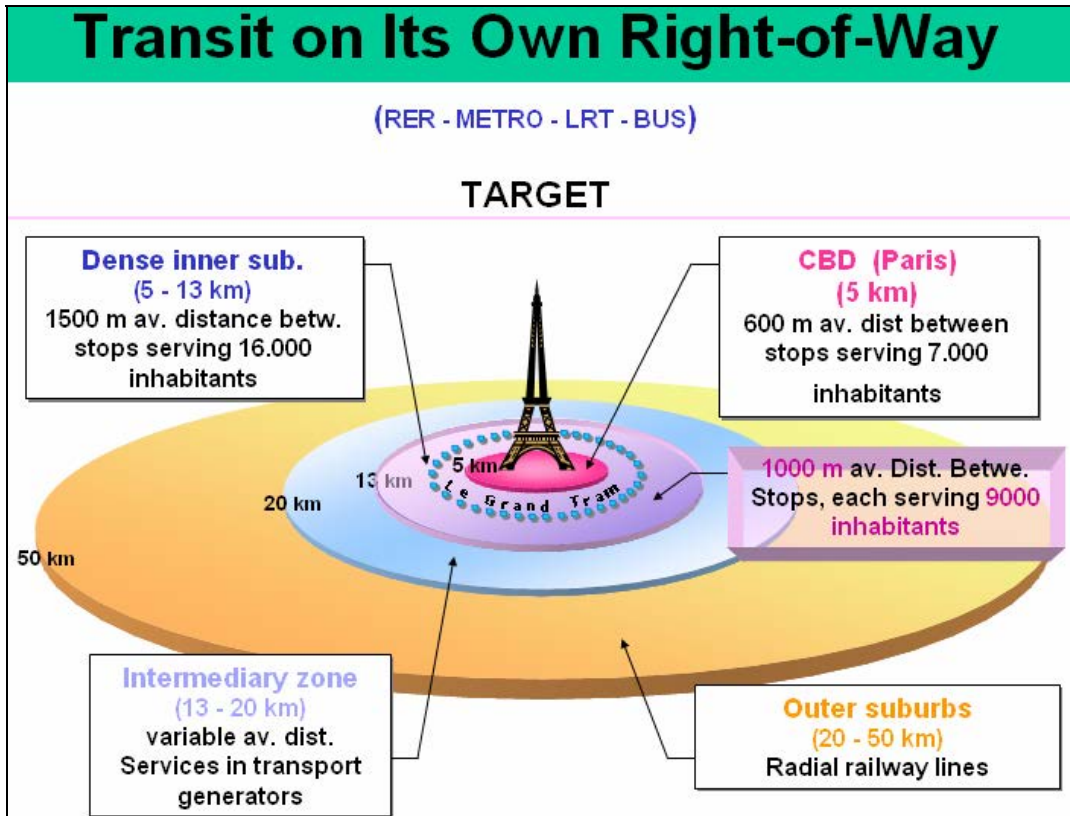
Commuter trains

- Lines A + B
- 66 stations (34 + 32)
- A 75 km B 40 km
- 45 km/h commercial speed
- 438 millions travelers/year
- 1,67 million trips/day









Operation Modes

- On-sight driving
 - Bus, LRT
- Controlled manual drive
 - Punctual control
 - Continuous control (OURAGAN)
- Automatic drive (ATO)
 - Travellers related operations done by driver
- Full driverless automation

2 retrofitting examples for metro:

- Ouragan system on line 13
- Full automation of line 1

OURAGAN System on Metro Line 13

Line 13: Overcrowded

- North–South line with branches: 22.5 km
- Average loading factor: 106%
- Minimum headway: 105 s
- Trains per hour: 34
- Capacity: 19,516 passengers/hour

Ligne 13: Objective

- Minimum headway: 90 s
- Number of trains per hour: 40 (+6)
- Capacity: 22,960 passengers/hour

OURAGAN Line 13 : Characteristics

- Way-side signaling for emergency/degraded mode
- Elimination of way-side signaling equipment
- On-board signaling
- Continuous speed control

Modernization and Automation of Metro Line 1

Why Full Driverless Automation?

- **To meet demand variations (off-peak, night, or weekends) due to**
 - **Numerous sight-seeing attractions and**
 - **Events in the vicinity of line 1.**

- ➔ **Full driverless automation allows for quick supply adaptation.**

Metro Line 1: A Vital Corridor in Île-de-France

- **3 departments, 6 municipalities, 6 districts served**
- **16.6 km**
- **25 stations, interchange to 11 metro lines, commuter trains A, B, C, and D, LRT2, 2 SNCF stations, 3 multimodal transit centers**
- **725,000 passengers/day**
- **12.4% of total metro traffic**
- **Headway: 1 ft 45 in. in peak hours; 3 ft 20 in. in off peak; 7 ft 45 in. evening.**
- ➔ **Line 1 is the most heavily used out of 14; use is constantly increasing (+15% in 5 years)**

Why Automation for Line 1 ?

- **One of the most heavily used all day long.**
- **Atypical line with strong demand variations.**
- **Rubber-tired trains, similar to trains on Line 14 (already driverless).**
- **Easy and affordable automation.**

Expected Benefits

- **Commercial speed of 30 km/h, i.e., 10% increase:
➔ 2, 419,000 service hours saved.**
- **Suppression of delays due to passengers or unsocial behaviors:
➔ 114, 000 h saved for users of Line 1.**
- **Capacity increased from 23,500 to 25,000 passengers in PH, i.e., 6% increase.**
- **820,000 hours saved yearly on RER and metro trips due to decrease of waiting time for connections in off-peak hours.**

OPERATIONS, SUPERVISION, AND SERVICE QUALITY

Light Rail Transit in Calgary

The First 25 Years

JOHN HUBBELL
DAVE COLQUHOUN
Calgary Transit

In the past 25 years, the City of Calgary has invested approximately \$1 billion (Canadian dollars) in developing a three-leg, radial light rail transit (LRT) system that is closely integrated with an extensive bus network. Currently, the LRT system consists of 42.1 km of double track, 116 light rail vehicles and carries over 220,000 boarding passengers each weekday.

This paper will examine the impact of LRT on travel behavior in Calgary and the planning and operational lessons learned over 25 years of operation. The lessons encompass systems planning and design, market segmentation and access mode planning, transit-oriented development, and personal security, in addition to overall experience gained with LRT operations.

INTRODUCTION

Calgary is Canada's fourth largest city with a population of approximately 1 million people. The city has a diversified, robust economy which is based on its position as the headquarters for Canada's energy industry, and as a growing business and financial center and intermodal transportation hub within Western Canada. During the past decade, Calgary's population has increased by 23% while Calgary Transit annual ridership increased by nearly double this rate (45%) to over 82 million annual revenue trips. As a result of this rapid growth, existing light rail transit (LRT) and bus services are operating near capacity during peak travel periods and the City of Calgary is embarking on a 10-year, \$1-billion capital investment program (Canadian dollars) to extend existing LRT lines and expand its LRT and bus fleet.

It is projected that Calgary's population will grow to 1.25 million over the next 20 years because of its economic potential, geographic position, and desirability as a place to live. In managing future growth, the city has committed to follow "smart growth" principles in its decision-making processes to ensure its urban form and transportation system are sustainable from an environmental, social and economic perspective.

Urban Form and Governance

The urban form of Calgary's development is a concentrated city center bounded on the north, west, and south by a large crescent of low-density residential suburbs. A band of industrial land extends along the east side of the city.

There is a distinct pattern of employment location in Calgary. Approximately 24% of city employment is located in the downtown, 34% in the east industrial area, and 42% is distributed

throughout the remainder of the city. Strategic policies have encouraged the concentration of employment in the downtown to support a high level of transit service. However, suburban development trends have created strong cross-city travel patterns between low density residential development on the west side of the city and industrial areas on the east side, which are difficult to serve efficiently with public transit service. With the limited number of expressway standard, east-west roads, cross-city traffic congestion is a problem for many Calgarians.

Calgary is a “unicity” in the sense that it is an urbanized area surrounded by agricultural or country residential areas. This situation allows the city council to exercise almost complete control over its urban environment, including its transportation system. The consolidation of land use, roadway, and transit planning functions within the city administration also facilitates the integration of transportation modes and coordination of land use and transportation planning decisions. These factors have contributed to the development of a successful, integrated LRT and bus system.

SYSTEM DEVELOPMENT

Discussion

The concept of a balanced transportation strategy encompassing roads, transit, walking, and cycling has provided the context for transportation planning in Calgary since the mid-1960s. Although the definition of “balance” has varied since the term was first introduced, the concept of utilizing each mode to its best advantage has remained constant over the years.

In 1968, the first comprehensive transportation plan was prepared for the City of Calgary, incorporating a balanced plan of freeways and four heavy rail transit lines that were to be implemented over the next 20 years (1). The proposed road plan included new freeways on the north and south sides of the Bow River and 10 new river-crossing bridges, most of which would connect directly into the downtown. The high-priority rapid transit corridors in the south and northwest were approved in principle by city council, which allowed protection of the right-of-way and commencement of land acquisition. However, components of the proposed freeway network plan quickly encountered strong public opposition.

In 1973, a report, *A Balanced Transportation Concept for the City of Calgary*, was completed. Its primary function was to develop a policy combining and coordinating transportation improvements. A road construction program on a much smaller scale than envisioned in the 1968 plan was proposed. The report also recommended a change in direction of transit planning toward consideration of options for an intermediate capacity, rapid transit system. With a population of less than 470,000, it was concluded that Calgary could not support an extensive, grade-separated rapid transit system. Instead, the city began to look more closely at the surface-running street car and light rail systems in Europe as a model for implementing a higher-capacity transit service in Calgary.

To position the city for eventual implementation of a rapid transit system, a new Blue Arrow express bus service was recommended, paralleling the proposed rapid transit lines. The Blue Arrow expresses included complimentary park-and-ride and feeder bus routes to mimic the characteristics of the future rapid transit system that was envisioned. Within the downtown, steps were taken to develop the centrally located 7th Avenue corridor as a future rapid transit route by increasing bus route density and augmenting bus throughput by implementing a peak period

contra-flow bus lane in a one-way, mixed-traffic operation. This action established a foundation for eventual conversion of 7th Avenue to exclusive transit operation.

Figure 1 illustrates the Blue Arrow Express system that was in place in 1981, prior to the implementation of LRT.

Between 1975 and 1977, several studies were undertaken to evaluate rapid transit options for Calgary and to analyze the impact of transit versus roadway expansion in south Calgary (2,3). The studies concluded that forecast growth in south Calgary could not be accommodated by road improvements alone and implementation of a high-capacity transit service was essential. A detailed comparison of LRT versus curbside bus lanes and a dedicated busway was conducted for the south corridor. The analysis concluded that the capital cost of a LRT and busway system would be similar but that LRT offered significant advantages over the other options in regard to speed and service reliability, reduced operating costs, impact on the downtown road system and urban environment, and ability to achieve a more compact urban form.

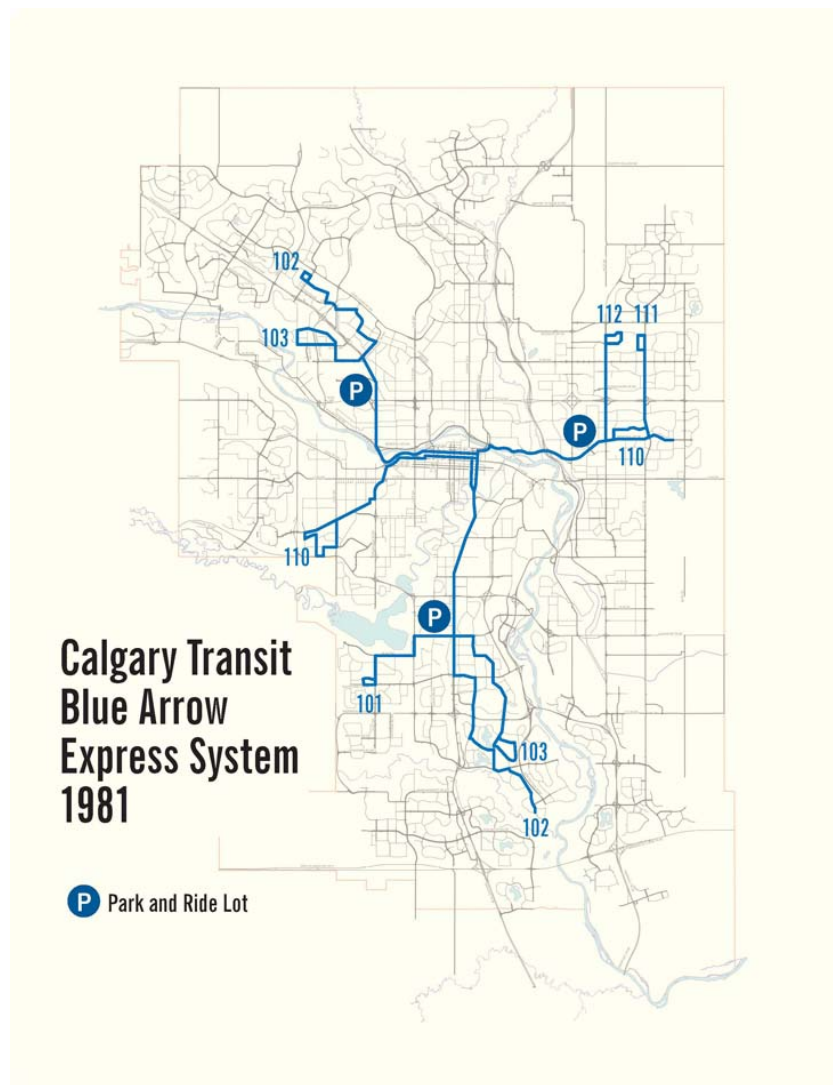


FIGURE 1 Calgary Transit Blue Arrow Express System, 1981.

In 1976, the city council approved the LRT concept in principle, which included plans for a possible five-leg LRT network, and directed the administration to proceed with functional planning for a south LRT line. However, following the 1976 municipal election, the new city council requested that an independent review be undertaken to verify the appropriateness and costs of LRT in the south corridor. This review endorsed the construction of the proposed south LRT line. As a result, the city council in 1977 gave approval to proceed with the implementation of LRT.

The initial 12.9-km (7.7-mi) south LRT line, extending from Anderson Road to downtown, opened for revenue service in May 1981, on schedule and within budget, and soon achieved its forecast ridership target of 40,000 boarding passengers per day. Based on the positive ridership results and strong public acceptance of the LRT concept, the city council directed that planning studies be undertaken to finalize the route for the second priority LRT leg, which would serve two major postsecondary education institutions and communities in northwest Calgary. However, significant public opposition was encountered in regard to the recommended LRT alignment through the inner-city community of Sunnyside, located immediately north of downtown. While extensive community consultation on this issue was taking place, implementation priority was shifted to the northeast line whose right-of-way had been protected in the median of arterial roadways planned in this area. The 9.8-km (5.9-mi) northeast line opened in 1985, sharing a downtown section with the south line.

The 1988 Winter Olympics gave impetus to resolving community opposition to the northwest line, which served important venues at the university and McMahon Stadium for the games. The 5.8-km (3.5-mi) line was opened in 1987 and connected to the south line. A further 0.8-km (0.6-mi) extension of the northwest line to Brentwood opened in 1990, providing improved terminal connections and park-and-ride facilities.

Following 1990, plans for further LRT expansion were suspended for a nearly a decade as a result of an economic downturn and reduction in urban funding grants from the Province of Alberta. However, a new cycle of strong population growth in the mid-1990s resulted in significant growth in roadway and transit use and increased public perception of the need for investment in new transportation infrastructure. In 2000, the Province of Alberta agreed to allocate 5 cents per litre from the existing Provincial tax collected on gas and diesel fuel consumed in Calgary toward new transportation infrastructure. This new funding enabled the city to revive its LRT expansion program by approving a multiphase extension of the south LRT line to Fish Creek–Lacombe Station (2001), Somerset–Bridlewood Station (2004), and Dalhousie Station in the northwest (2003).

The resulting LRT system which is in place today consists of two lines—south to northwest (Somerset to Dalhousie) and northeast (Whitehorn to downtown) (see [Figure 2](#)). Over the past decade, LRT ridership has increased by 120% to over 220,000 weekday boarding passengers (611 boarding passengers per revenue operating hour), including 25,000 passengers within the downtown free-fare zone on 7th Avenue.

In 2004, the Province of Alberta announced a new Alberta Municipal Infrastructure Program worth \$886 million over 5 years for the City of Calgary. The city council has determined that 70% of this funding (\$620 million) will be allocated to transportation infrastructure upgrades in Calgary. As well, the government of Canada has introduced a new Gas Tax Fund for “environmentally sustainable” urban infrastructure totaling \$141 million and an additional \$48 in special funding for transit projects in Calgary. When this new investment is combined with other funding sources such as the Provincial fuel tax, city parking revenue,

developer funded acreage assessments for new suburban growth, and city debt financing, \$1.8 billion in funding will be available for new transportation infrastructure in Calgary over the next decade.

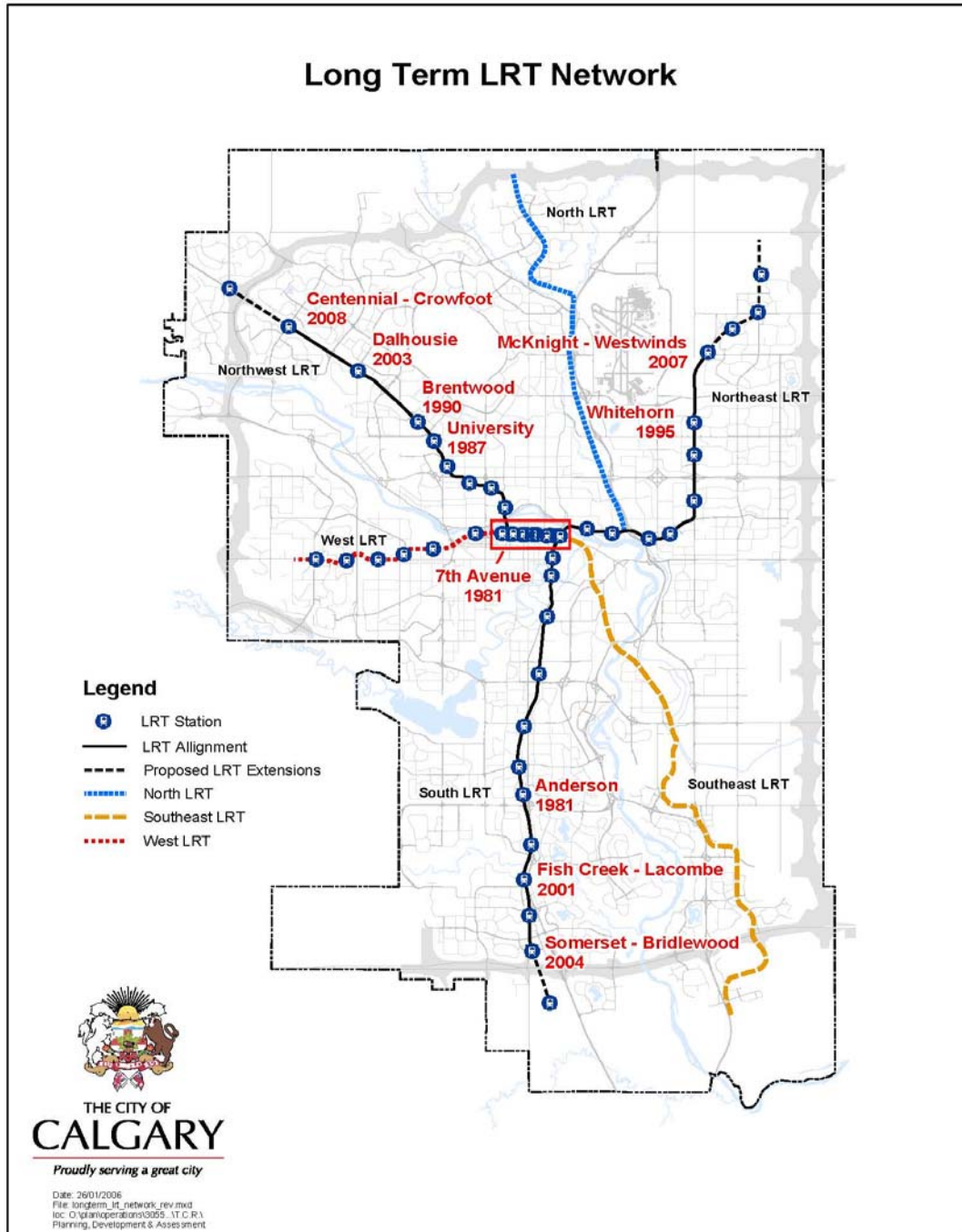


FIGURE 2 Long-term LRT network, City of Calgary.

One of the key policies of the Calgary Transportation Plan is that “the city investment in transit and roads will be approximately equivalent.” The proposed city capital budget for 2006 to 2015 includes 47% funding for roads and 53% funding for transit. The approved transit investment strategy includes plans to accelerate completion of the primary LRT network by extending the northeast line to McKnight–Westwinds Station (2007) and the northwest LRT line to Centennial–Crowfoot Station (2008). Additional investments are planned to commence expansion of the LRT platforms to accommodate four-car train operation, construct a new LRT maintenance facility, expand the LRT fleet by 40% (40 cars) and the bus fleet by 42% (330 buses).

Recent planning studies (4,5) have identified that a network of six LRT lines will be necessary to accommodate a future city population of 1.5 million. A conceptual representation of this network is presented in [Figure 2](#).

Lessons Learned

1. **Find champions.** Strong and consistent support from senior administration and politicians is essential to long-term success. Elected officials must be made aware of the benefits of investing in public transit and develop budget guidelines for appropriate funding levels for roads and transit expansion. Effective stakeholder engagement is essential to build and maintain public support for transit investment.

2. **Build the right project.** Develop rock-solid ridership and cost estimates and choose the appropriate transit technology. Calgary Transit has accurately estimated LRT ridership by drawing on experience with the Blue Arrow Expresses, which formed a prototype for the LRT service. Realistic ridership estimates have been based on output from the city’s regional transportation model and experience with earlier LRT extensions. Strict adherence to a philosophy of using basic, proven technology (e.g., LRT cars are without automated diagnostics, automated passenger counting, air conditioning) and utilitarian design (e.g., primarily surface operation) has minimized the cost and risks associated with system development and has enabled the LRT extensions to be delivered on time and within budget.

3. **Build the project right.** Adhere to your vision for LRT development and take advantage of LRT design flexibility by developing surface operations wherever possible. Work with traffic engineers to integrate surface LRT operations within road rights of way and determine an appropriate level of transit priority for your LRT system. A comprehensive, integrated approach to transportation and land use planning, which Calgary has achieved through “unicity” governance and administration, is critical to the success of LRT.

4. **Identify and protect future land requirements.** Long-range plans should be developed to protect LRT right of way, including station areas and land for park and ride, feeder bus facilities, and transit-oriented development (TOD) development.

5. **Develop the corridor concept.** Use express buses or bus rapid transit and park and ride to develop ridership in future LRT corridors.

6. **Think 50 to 100 years ahead.** Design, construct, and maintain vehicles and infrastructure in consideration of life cycle expectations. Understand the logistics and impact of system maintenance and expansion during current operations.

7. **Strategic operating and staffing decisions.** Understand that the skill sets and interests of planners, designers, and builders are fundamentally different than operators and maintainers. Create separate position classifications and seniority for LRT and bus operators and mechanics.

Minimize dependence on performing maintenance and system expansion during non-revenue hours. Learn to conduct right-of-way maintenance work under traffic.

TRANSIT-ORIENTED DEVELOPMENT

The City of Calgary has adopted many policies that relate to transportation choices, transit use, quality of life, and urban form. The Calgary Plan (1998), Calgary Transportation Plan (1995), Sustainable Suburbs Study (1995), Transit Friendly Design Guidelines (1995), and Transit-Oriented Development Guidelines (2004) contain policy directions to encourage transit use, make optimal use of transit infrastructure and improve the quality of the urban environment.

The focus of many of Calgary's land use policies over the past 20 years has been to preserve the downtown's unique role as a major employment centre and to attract new high-density residential development within the downtown and within close walking distance of LRT stations and major bus corridors. In response to growing traffic congestion, the city has incorporated direction in its strategic land use and transportation policy plans to encourage a shift in the location of new suburban employment from the east to the west side of the city and existing and proposed LRT stations. This strategy is aimed at moving jobs closer to residential areas and decreasing commute distances, encouraging greater use of walking, cycling and transit for work trips, and making more efficient use of the off-peak direction of travel on transit and roadways.

Performance of Downtown TOD Policies

Calgary has a well-defined, intensively developed downtown incorporating 120,000 jobs, 12,000 residences, 32 million square feet of office space, plus hotels and retail spaces, within only 3.6 km² (approximately 1.4 mi²).

Calgary's present transportation policies are designed to alter the modal split in favor of public transit, with the long-term objective of accommodating 50% of downtown work travel by LRT and bus services. The cornerstone of the policies for downtown transportation is the gradual reduction in the availability of long-term parking relative to downtown growth. The current Land Use Bylaw requirements for office buildings specify one parking stall per 140 m² (1,500 ft²) of net floor area. For the downtown core area, which has restricted vehicular access because of the 7th Avenue LRT corridor and restricted road access on the 8th Avenue pedestrian mall, the city has a cash-in-lieu program of on-site parking. The Calgary Parking Authority, operated by the city, uses funds collected through this program to construct parking structures in designated corridors on the periphery of the downtown core. These structures are connected to the office and retail core by an extensive, elevated walkway system known locally as the Plus 15 network.

Figure 3 summarizes the changes in parking supply, employment, and modal split to the downtown between 1964 and 2004. The total number of long-term parking stalls has continued to decline in relation to downtown employment growth, which has increased monthly parking costs to an average of \$250—the highest rate in Canada. The interaction of downtown parking policies with strategic decisions to expand LRT and bus service instead of expanding downtown road access has resulted in a significant increase in the transit modal split from 37% in 1996 to over 42% in 2005. There has also been an increase in walking and cycling to downtown with the construction of new high-density residential development within and close to downtown and both transit passengers and auto drivers are traveling before and after the peak hours. All these

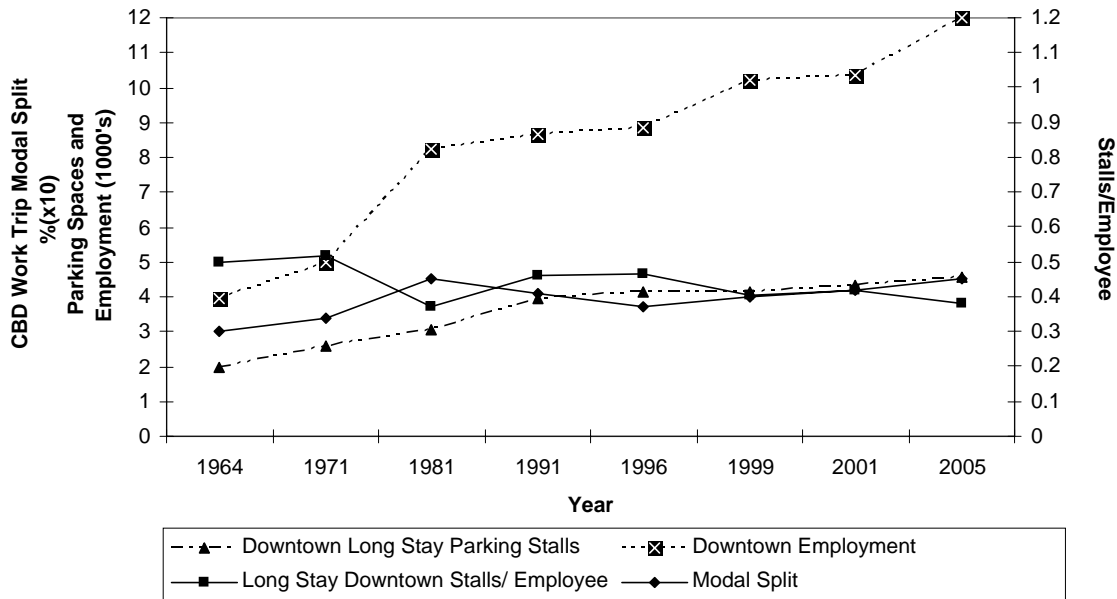


FIGURE 3 Work trip modal split, City of Calgary central business district.

changes enabled the downtown workforce to grow by 18,000 jobs since 1992 without building any new roads into downtown.

Figure 4 illustrates the 25-year growth trend in LRT system ridership. Over the past decade, LRT ridership has increased from 33.1 million to 52.6 million annual boarding passengers (+59%). Current weekday LRT ridership has surpassed 220,000 boarding passengers day. On average, the three LRT lines carry 130,000 people in, out, and through the downtown, about 13,000 in the peak hour alone. Since the inception of LRT service, each new LRT line or LRT extension has produced a 15% to 20% increase in corridor ridership, resulting from the diversion of previous auto drivers to transit. Annual LRT boardings per track kilometer have increased from 1 million to 1.2 million since 1995. Further ridership growth is constrained by system capacity limitations; however, 33 new cars have been ordered to address this problem.

Currently, the average hourly operating cost of LRT is approximately \$163, including operating, maintenance, and utility costs. With an average of 600 boarding passengers per revenue operating hour, the average cost per LRT passenger is only \$0.27. In comparison, the average cost per bus passenger boarding is approximately \$1.50, or almost six times the cost of carrying an LRT passenger.

Performance of Suburban TOD Policies

In contrast to its experience with downtown TOD policies, the city has had mixed success in its efforts to shift the location of new suburban employment to proposed employment centers and promote more compact development in new suburban communities.

Major employment centers which were identified in the 1995 Calgary Transportation Plan in the south and northwest are now fully developed as “big box” retail areas with little or no

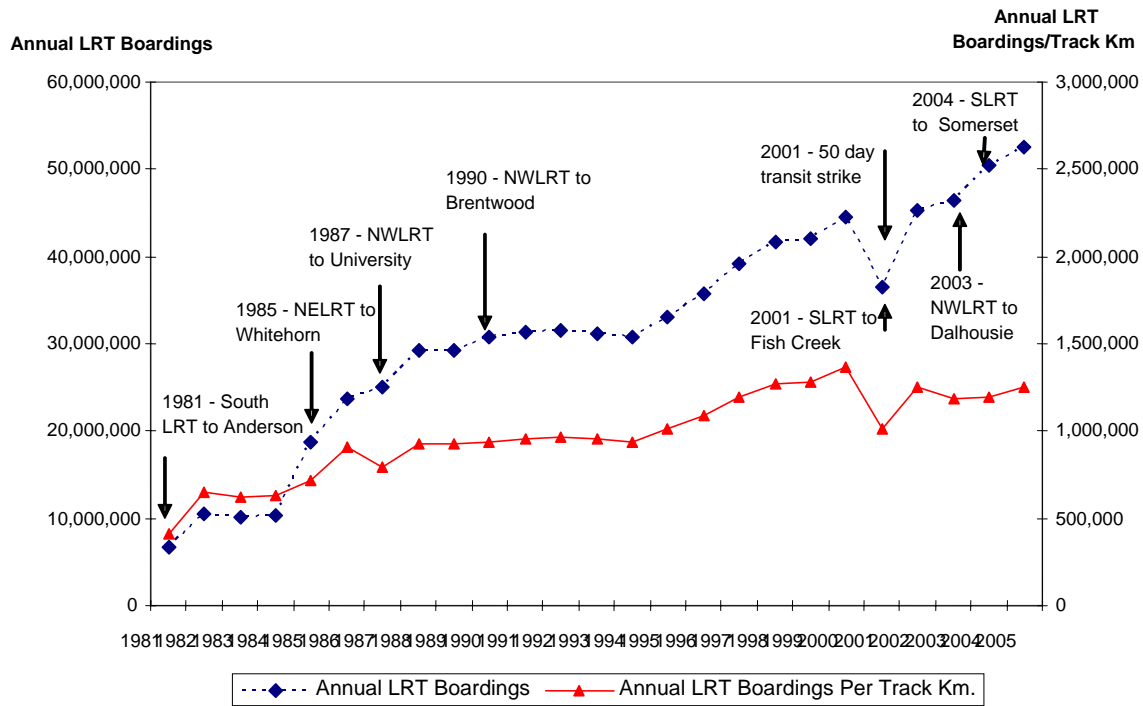


FIGURE 4 Annual LRT boardings, City of Calgary.

office space (see Figure 5). The recent job growth numbers show that employment growth continues to be focused on the east side of the city, which is exacerbating east–west roadway congestion.

Some positive trends have been seen in regard to new residential development. In the past five years, approximately one-third of all new housing starts in Calgary have been multi-family. While new suburban home development continues to be primarily single-family homes, approximately half of new multifamily housing starts have occurred in new communities. As a result, most communities are achieving the approved minimum density targets of six to eight units per acre and some developers are seeking approval to increase the density ranges.

Some high-density residential, office, and retail development has occurred adjacent to existing LRT stations at Lions Park (northwest), Stampede–Elton (South), Southland (South), and Franklin (Northeast). However, expectations of substantial new developments at the LRT stations have not been achieved and developer interest in pursuing TOD at the stations has only recently started to gain momentum as traffic congestion increases and citizens start to recognize the value of living and working close to the LRT system. The limited success achieved to date in achieving new employment centers and TOD at LRT stations is due in part to the lack of an implementation strategy. For example, the city was presented with an opportunity in the mid-1990s to acquire property for an employment center in south Calgary but declined due to reluctance to front-end the cost of land acquisition and hold it until a market for higher density developed. Other opportunities have been lost due to market dynamics, which have created an immediate demand for retail development in areas that were identified as employment centers. Public opposition to higher density land uses adjacent to established residential areas has also eliminated opportunities for higher density development in some areas.

Fortunately, the city has learned from this experience and is planning or undertaking new TOD developments by utilizing some of its own land holdings in LRT station areas. One such development is “The Bridges,” which will occupy a 37 ac. (15 ha) site adjacent to Bridgeland–Memorial Station, providing up to 1,500 new residential units as well as new retail and office uses. The city is also partnering with provincial and federal government and the development industry to revitalize the east end of downtown, adjacent to the LRT system, through strategic use of city-owned land and Tax Increment Funding development fees. Other city properties located adjacent to several of the south LRT stations (i.e., Heritage, Anderson, Fish Creek–Lacombe and Shawnessy) will also be marketed for mixed-use TOD in the near future. The City has also prepared reports on TOD best practices and development guidelines to guide development and educate the public and elected officials on the benefits of intensifying land uses adjacent to the LRT stations (6,7).

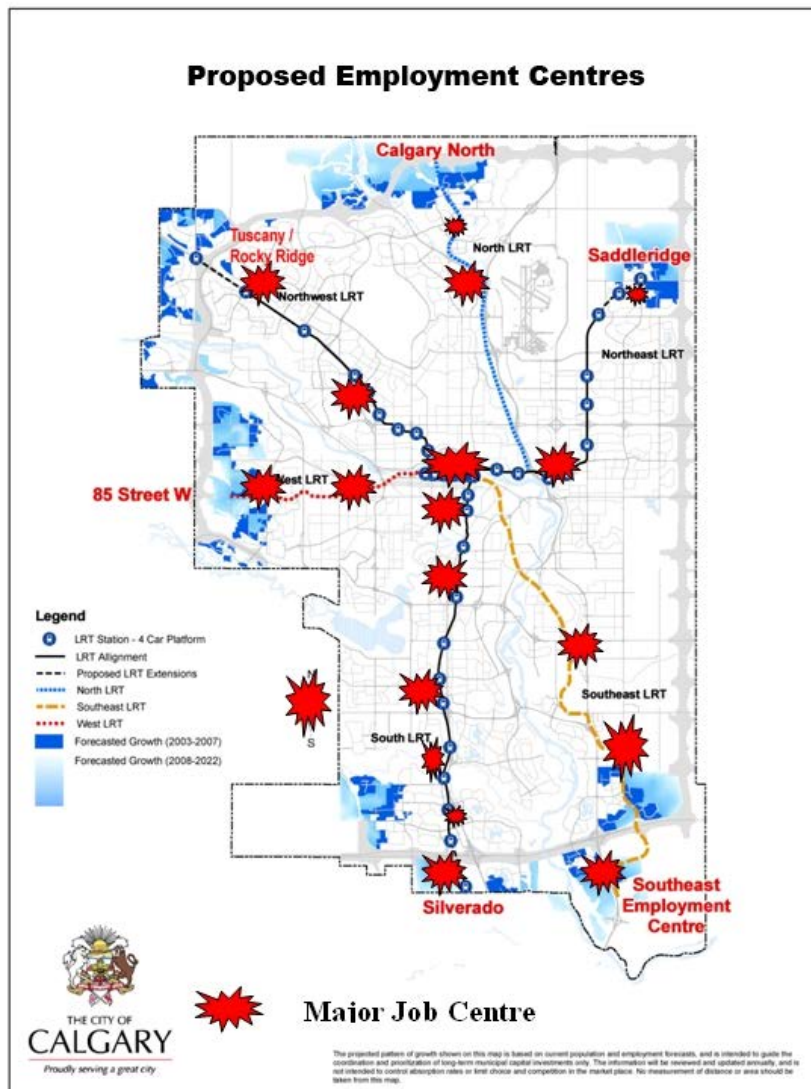


FIGURE 5 Proposed employment centers, City of Calgary.

Lessons Learned

1. **Plan an integrated policy solution.** Develop integrated land use, development (TOD), road, parking, and transit policies. LRT has had a positive impact on increasing the modal split for downtown work travel when supportive policies are working together to manage the supply of long-term downtown parking, road capacity, and transit service.

2. **Achievement of TOD requires political commitment and collaboration with private sector developers.** Proactive land acquisition and land banking by the city can facilitate development or protect future options for employment centers. In most cases, developed land uses are very long term; therefore, the cumulative impact of incremental, poor land use decisions is significant. It is critical that cities show leadership in supporting TOD by locating some of their business functions in these developments, expediting approval of TOD and consideration of financial incentives (i.e., business tax breaks for TOD tenants, tax increment financing).

SYSTEM DESIGN AND OPERATIONS

Calgary's LRT system currently consists of 42.1 km (26.3 mi) of double track, of which 87% is surface operation, 5% is on grade-separated bridges and 8% is underground. Surface LRT operations have been adapted to operate in city streets (e.g., downtown Calgary), within an existing railway corridor (e.g., the south corridor), in the median of an expressway and major arterial roadway (e.g., the northeast and northwest corridor), and within existing communities and educational institutions on an exclusive right of way or parallel to existing local streets (e.g., the northwest corridor).

Outside the downtown, train movements are controlled by an automatic block signal system that allows only one train to occupy each section of track. At grade-level crossings outside the downtown, trains pre-empt the normal operation of traffic signals to allow uninterrupted movement between stations. Grade-level roadway and pedestrian crossings are protected by LRT gates, bells, flashing lights, pedestrian crosswalk heads and gates, which is consistent with leading safety measures. Currently, the gate warning time is about 22 s, with an additional 10 to 15 s for the gates to ascend and the warning lights and bells to turn off. In the northeast corridor, the operation of the traffic signals at the 10 grade-level intersection crossings on 36th Street is designed so that preempted traffic movements (e.g., north and south left turns) are reserviced if a preset green time has not been met once the train clears the intersection. The maximum operating speed of trains along 36th Street is 80 km/h, whereas the posted roadway speed is 60 km/h.

Within the downtown, the LRT operates along the 7th Avenue transit corridor, in a line-of-sight operation, with buses and emergency vehicles. The maximum LRT operating speed on 7th Avenue is 40 km/h. Cross-street traffic and train and bus movements are controlled by conventional traffic signals which operate in a 90-s fixed-time cycle, which allows sufficient time for trains to stop and unload at a platform and travel to the next station. This operation facilitates the movement of trains between stations on 7th Avenue in synchronization with other traffic signals located throughout the downtown.

Transit Safety

Providing a safe journey for our customers is the number one priority of Calgary Transit. Each weekday, there are nearly 500,000 individual boardings on Calgary Transit's 828 buses and 116 LRT cars. To deliver customers to their destinations, Calgary Transit buses travel over 140,000 km on city streets each day, stopping at some of the more than 5,000 bus stops. LRT cars travel over 12,000 km daily to serve passengers traveling between the 36 stations.

Calgary Transit has a rigorous program aimed at accident prevention and investigation. Reporting of all accidents is a requirement of all staff. Reports are completed each time that a transit vehicle makes contact with another vehicle, pedestrian or object. Passenger injuries (mostly trips, slips, and falls while boarding or alighting) are recorded.

Table 1 provides information on the rate of reported vehicle and pedestrian accidents. The rates of vehicle collisions per million kilometers of travel and the number of passenger injuries per million boardings are very low. It should be noted that these data do not segregate accidents or injuries by severity. In general, the safety record of the LRT system is more favorable than bus.

Lessons Learned

- 1. Surface LRT operations can be safely and effectively integrated within city streets by using conventional traffic, pedestrian and railway controls.**
- 2. LRT signal preemption in arterial streets provides reduced transit travel time without compromising roadway safety.**
- 3. LRT is safer than bus.** On the basis of Calgary Transit's experience, LRT vehicle collision and passenger accident rates are significantly lower than those for the bus system.
- 4. Systems fail—manage failure.** Design your LRT system with replacement in mind and embrace formal asset management principles as soon as possible. Five to ten year forecasts of resources necessary to ensure stable infrastructure are mandatory for good management of the system. Key maintenance people should be in place during the system design and construction stages. Numerous design and construction deficiencies can be avoided with this approach.

In Calgary's operating and weather environment, the need for major infrastructure replacement increased exponentially during the 20- to 25-year age window. Good ride quality and wear characteristics in the LRT environment demand track tolerances well beyond those in the typical mainline heavy rail environment. Track designers and constructors with bona fide

TABLE 1 Calgary Transit LRT and Bus Collisions and Passenger Accidents

	1995	2005
Collisions per million km		
Bus Collisions	23.0	17.8
LRT Collisions	11.3	10.3
Passenger Accidents per million boardings		
Bus Passenger Accidents	5.6	1.6
LRT Passenger Accidents	.40	0.06

LRT experience should be engaged in design and construction, wherever possible. Locate facing point switches and bi-directional interlocked signaling to facilitate maintenance and failure management.

STATION DESIGN

The experience gained from construction and operation of each of the LRT lines has resulted in changes in the scale and design of Calgary's LRT stations.

The initial south LRT line included six center-load stations which can be accessed by enclosed stairways and a single set of escalators at the north end of the platforms. No provision was made in the station design for elevators or ramp facilities to accommodate persons with disabilities.

The design of the northeast LRT leg incorporates the LRT tracks in the median of an expressway and a major arterial roadway. The seven center-load stations on this line are fed by overhead pedestrian bridges which are accessible by stairways and ramps. An elevator, two escalators and stairway are provided in the station to accommodate access between the fare processing area and the LRT platform. Access to the platforms incorporates alternate end loading at successive stations. Placement of the access points at opposite ends of alternate platforms improved the evenness of passenger loads in the three-car train sets, resulting in better equipment utilization and passenger comfort compared with the same end-loading pattern on the south LRT.

The design of the northwest LRT line incorporates several sections of in-community track alignment parallel within and parallel to local residential streets and presented an opportunity to design low-scale local stations with grade-level pedestrian access crossing both the inbound and outbound tracks to the platforms. Each station reflects the local character of the community in scale, design, and materials. To accommodate customer access, railway signals, staggered pedestrian bedstead barriers, and pedestrian gates are used. Large signs warn customers to look both ways for approaching trains.

The low-scale platform design and grade-level pedestrian access provide significantly improved customer access in relation to the other station designs. Positive customer feedback led Calgary Transit to incorporate new at-grade crossings at each of the south LRT platforms to improve accessibility. For safety reasons, the new pedestrian crossings allow pedestrians to cross the southbound track only, in front of the stop position for trains. Pedestrian access is controlled by railway signals and staggered bedstead railings.

Similar grade-level connections have been incorporated at several new LRT platforms. For safety reasons, Calgary Transit encourages the practice of allowing grade-level crossings of both tracks in front of a station platform to avoid conflicts between pedestrians and approaching trains or staggering the location of side-load stations to provide connections at the stop position between the platforms.

Lessons Learned

1. Minimize station access time where possible with grade level access to stations.
2. Integrate the scale and design of stations with adjacent land uses.
3. Design to the highest barrier-free accessibility standards possible.

4. Invest time, effort, and funds to ensure the station design functions well, is intuitive, understandable and creates a “significant place” in the community from a customer perspective.
5. Alternate end loading should be incorporated at successive centre-load stations to balance customer loads between cars in the train consist and achieve more efficient use of available capacity.
6. Manage customer confidence by using Crime Prevention through Environmental Design principles, visible security presence, security monitoring equipment, lighting, good information, and positive messaging to manage customer confidence.

ACCESS MODE PLANNING

Access mode planning for Calgary’s LRT system accommodates a comprehensive range of access modes (i.e., walking, cycling, auto, feeder bus); however, first priority is given to ensuring effective integration of feeder bus networks with the LRT. At suburban LRT stations, over 50% of customers typically access the station by feeder bus. Together, the LRT system and connecting feeder bus network form a highly integrated system which services the demand for downtown work trips and crosstown travel to suburban employment, educational, and shopping destinations.

To allow reasonable opportunities for private vehicle access to the LRT stations, park and ride and auto passenger drop-off facilities are provided at suburban stations. The amount of parking provided at LRT stations is set to comply with established policies which specify that 15% to 20% of projected ridership be accommodated by the park-and-ride access mode. The calculation of park-and-ride demand considers the number of residents living within the catchment area of the station; the number of transit trips made external to the community by the residents, the percent of transit trips which access the station by auto, and the efficiency of the parking lot. External parking demand generated by residents outside of Calgary is also considered. Currently there are a total of 11,200 park-and-ride stalls at 17 stations throughout the LRT system, with an estimated overall utilization rate of 95%.

The actual calculation for park-and-ride demand is based on the following formula:

Park-and-Ride Demand =

	Park-and-Ride Catchment Population—based on full build-out
× 0.35	Transit Trip Generation Rate—each resident is estimated to make 0.35 trips per weekday
× 0.8	External Trips—80% of trips will leave community
× 0.5	One-way Travel Factor—one stall is required for round trip
× 0.15 – 0.2	Park-and-Ride Access Share—15% to 20% will use park and ride
÷ 1.2	Auto Occupancy Factor—on average there will be 1.2 persons per auto using park and ride
÷ 0.95	Parking Lot Efficiency Factor—some stalls may not be available due to poor parking
÷ 1.2	Stall Turnover Rate—stalls may have more than single use per day.

It is acknowledged that at some LRT stations that there is greater demand for parking than the amount supplied. However, attempting to satisfy this demand would be prohibitively expensive, consume significant land area that could be better used for TOD, and contribute to traffic issues in adjacent communities. As well, increased parking supply would result in reduced demand for feeder bus service. This would reduce the financial support needed to sustain bus routes that serve non-LRT travel to local destinations such as school and shopping activities.

Lessons Learned

1. Plan to accommodate a full range of access modes—walking, cycling, feeder bus, private automobile, and taxi.
2. Good feeder bus service is critical to LRT success. Integration of LRT and bus service enhances the potential of the system to attract downtown and crosstown work trips and nonwork travel to suburban destinations.

CONCLUSION

The first 25 years of LRT development and operations in Calgary have been a significant public transit success story, and the next 25 years will focus on life cycle maintenance of the fleet and infrastructure, and expanding the role of LRT in Calgary.

LRT has become the backbone of the Calgary Transit system and ridership has grown dramatically over the past decade as a result of comprehensive, coordinated policies to manage urban form, downtown parking supply, and ensure balanced investment in roadway and transit infrastructure. Integration of the LRT system with other modes of travel has created an environment which supports further development of the transit market. Experience has demonstrated that LRT systems can be successfully integrated into the right of way of city streets and the city has adopted strategies which give priority to LRT vehicles in mixed traffic environments. Other lessons relating to station design and personal security have improved the safety and operation of the LRT system.

The success of Calgary's LRT system is best reflected by the fact that LRT expansion and increased capital investment in transit is consistently a top-of-mind request in all citizen satisfaction surveys that the city has undertaken in the last decade. City council has responded by committing significant funding over the next 10 years to undertake an aggressive LRT capital program which will focus on four initiatives:

1. Complete the primary LRT network by extending the northeast and northwest legs.
2. Increase network capacity by expanding the LRT fleet and begin expansion of platforms to accommodate four-car train operation.
3. Develop future LRT corridors by expanding bus rapid transit service in the southwest, southeast, and north-central corridors, parallel to future LRT routes.
4. Sustain current LRT fleet and infrastructure by undertaking critical life-cycle maintenance of major system components.

REFERENCES

1. *Calgary Transportation Study (CALTS)*, City of Calgary, 1968.
2. *Comparison of Exclusive Busways and Light Rail Transit in the Macleod Trail Corridor (CALTS 37)*, City of Calgary, 1976.
3. *Light Rail Transit for Calgary (CALTS 38)*, City of Calgary, 1976.
4. *Calgary Transit 20 Year Capital Plan*, City of Calgary, 2004.
5. *Strategic Development of Calgary's CTrain System*, City of Calgary, 2004.
6. *Transit-Oriented Development Best Practices Handbook*, City of Calgary, 2004.
7. *Transit-Oriented Development Policy Guidelines*, City of Calgary, 2004.

Appendixes

APPENDIX A

**Transportation Research Board
2007 Executive Committee***

Chair: Michael D. Meyer, Professor, School of Civil and Environmental Engineering, Georgia Institute of Technology, Atlanta

Vice Chair: Linda S. Watson, Executive Director, LYNX–Central Florida Regional Transportation Authority, Orlando

Executive Director: Robert E. Skinner, Jr., Transportation Research Board

Michael W. Behrens, Executive Director, Texas Department of Transportation, Austin

Allen D. Biehler, Secretary, Pennsylvania Department of Transportation, Harrisburg

John D. Bowe, Regional President, APL Americas, Oakland, California

Larry L. Brown, Sr., Executive Director, Mississippi Department of Transportation, Jackson

Deborah H. Butler, Vice President, Customer Service, Norfolk Southern Corporation and Subsidiaries, Atlanta, Georgia

Anne P. Canby, President, Surface Transportation Policy Project, Washington, D.C.

Douglas G. Duncan, President and CEO, FedEx Freight, Memphis, Tennessee

Nicholas J. Garber, Henry L. Kinnier Professor, Department of Civil Engineering, University of Virginia, Charlottesville

Angela Gittens, Vice President, Airport Business Services, HNTB Corporation, Miami, Florida

Genevieve Giuliano, Professor and Senior Associate Dean of Research and Technology, School of Policy, Planning, and Development, and Director, METRANS National Center for Metropolitan Transportation Research, University of Southern California, Los Angeles (Past Chair, 2003)

Susan Hanson, Landry University Professor of Geography, Graduate School of Geography, Clark University, Worcester, Massachusetts

James R. Hertwig, President, CSX Intermodal, Jacksonville, Florida

Gloria J. Jeff, General Manager, City of Los Angeles Department of Transportation, California

Adib K. Kanafani, Cahill Professor of Civil Engineering, University of California, Berkeley

Harold E. Linnenkohl, Commissioner, Georgia Department of Transportation, Atlanta

Sue McNeil, Professor, Department of Civil and Environmental Engineering, University of Delaware, Newark

Debra L. Miller, Secretary, Kansas Department of Transportation, Topeka

Michael R. Morris, Director of Transportation, North Central Texas Council of Governments, Arlington

Carol A. Murray, Commissioner, New Hampshire Department of Transportation, Concord

John R. Njord, Executive Director, Utah Department of Transportation, Salt Lake City (Past Chair, 2005)

Sandra Rosenbloom, Professor of Planning, University of Arizona, Tucson

Henry Gerard Schwartz, Jr., Senior Professor, Washington University, St. Louis, Missouri

Michael S. Townes, President and CEO, Hampton Roads Transit, Virginia (Past Chair, 2004)

C. Michael Walton, Ernest H. Cockrell Centennial Chair in Engineering, University of Texas, Austin

Marion C. Blakey, Administrator, Federal Aviation Administration, U.S. Department of Transportation (ex officio)

Joseph H. Boardman, Administrator, Federal Railroad Administration, U.S. Department of Transportation (ex officio)

Rebecca M. Brewster, President and COO, American Transportation Research Institute, Smyrna, Georgia (ex officio)

George Bugliarello, Chancellor, Polytechnic University of New York, Brooklyn; Foreign Secretary, National Academy of Engineering, Washington, D.C. (ex officio)

Sandra K. Bushue, Deputy Administrator, Federal Transit Administration, U.S. Department of Transportation (ex officio)

J. Richard Capka, Acting Administrator, Federal Highway Administration, U.S. Department of Transportation (ex officio)

Thomas H. Collins (Adm., U.S. Coast Guard), Commandant, U.S. Coast Guard, Washington, D.C. (ex officio)

James J. Eberhardt, Chief Scientist, Office of FreedomCAR and Vehicle Technologies, U.S. Department of Energy (ex officio)

Jacqueline Glassman, Deputy Administrator, National Highway Traffic Safety Administration, U.S. Department of Transportation (ex officio)

Edward R. Hamberger, President and CEO, Association of American Railroads, Washington, D.C. (ex officio)

Warren E. Hoemann, Deputy Administrator, Federal Motor Carrier Safety Administration, U.S. Department of Transportation (ex officio)

John C. Horsley, Executive Director, American Association of State Highway and Transportation Officials, Washington, D.C. (ex officio)

John E. Jamian, Acting Administrator, Maritime Administration, U.S. Department of Transportation (ex officio)

J. Edward Johnson, Director, Applied Science Directorate, National Aeronautics and Space Administration, John C. Stennis Space Center, Mississippi (ex officio)

Ashok G. Kaveeshwar, Administrator, Research and Innovative Technology Administration, U.S. Department of Transportation (ex officio)

Brigham McCown, Deputy Administrator, Pipeline and Hazardous Materials Safety Administration, U.S. Department of Transportation (ex officio)

William W. Millar, President, American Public Transportation Association, Washington, D.C. (ex officio) (Past Chair, 1992)

Suzanne Rudzinski, Director, Transportation and Regional Programs, U.S. Environmental Protection Agency (ex officio)

Jeffrey N. Shane, Under Secretary for Policy, U.S. Department of Transportation (ex officio)

Carl A. Strock (Maj. Gen., U.S. Army), Chief of Engineers and Commanding General, U.S. Army Corps of Engineers, Washington, D.C. (ex officio)

* Membership as of April 2006.

APPENDIX B

**American Public Transportation Association
Board of Directors**

EXECUTIVE COMMITTEE

President: William W. Millar

Vice President—Member Services: Anthony M. Kouneski

Officers

Chair: Howard Silver, Board of Directors, Golden Empire Transit District

First Vice Chair: Michael S. Townes, President/CEO, Hampton Roads Transit

Secretary/Treasurer: Paul P. Skoutelas, Senior Vice President and Principal Consultant,
Parsons Brinckerhoff

Immediate Past Chair: Richard A. White, Washington Metropolitan Area Transit Authority

Vice Chairs

Business Members: Kim R. Green, Vice President, GFI-GENFARE

Business Member-at-Large: William D. Lochte, Principal, Silver Lake Enterprises, Inc.

Bus and Paratransit Operations: Fred M. Gilliam, President/CEO, Capital Metropolitan
Transportation Authority

Canadian Members: Gary W. McNeil

Managing Director and CEO, GO Transit

Commuter and Intercity Rail: Kathryn D. Waters, Vice President, Commuter Rail and
Railroad Management, Dallas Area Rapid Transit

Government Affairs: Christopher P. Boylan, Deputy Executive Director, Corporate Affairs and
Communications, Metropolitan Transportation Authority

Human Resources: Jeanne Krieg, Chief Executive Officer, Eastern Contra Costa Transit
Authority

Management and Finance: Vacant

Marketing and Communications: David L. Turney, Chairman, CEO and President, DRI-RTI

Rail Transit: Michael P. DePallo, Director and General Manager, PATH

Research and Technology: John M. English, General Manager, Utah Transit Authority

Small Operations: Jeffrey A. Nelson, General Manager, Rock Island County Metropolitan Mass
Transit District

State Affairs: Allen D. Biehler, P.E., Secretary of Transportation, Pennsylvania Department of
Transportation

Transit Board Members: Mattie P. Carter, Commissioner, Memphis Area Transit Authority

BOARD MEMBERS

Paul J. Ballard
 J. Barry Barker
 Doran J. Barnes
 Bruno A. Barreiro
 Stephen R. Beard
 Allen D. Biehler
 Carolyn G. Biggins
 Christopher P. Boylan
 Roosevelt Bradley
 John A. Brooks
 Michael T. Burns
 Joseph A. Calalorese
 Donna K. Carter
 Mattie P. Carter
 Flora M. Castillo
 Denis Clements
 Pasquale T. Deon, Sr.
 Michael P. DePallo
 William J. Deville
 Lisa L. Dickerson
 Sandy Draggoo
 Richard C. Ducharme
 Beverly J. Duffy
 Albrecht P. Engel
 Robert L. Flanagan
 Nathaniel P. Ford, Sr.
 Irene French
 Paul Geisel
 Fred M. Gilliam
 Daniel A. Grabauskas
 Kim R. Green

Fred Hansen
 Huelon A. Harrison
 Gilbert L. Holmes
 Mark E. Huffer
 Angela S. Iannuzziello
 John M. English
 Daniel G. Kelleher
 Joel Keller
 Ronald J. Kilcoyne
 Jeanne Krieg
 Gladys W. Mack
 William D. Lochte
 Thomas E. Margro
 Richard Marin
 Clarence W. Marsella
 Frank T. Martin
 Richard J. McCrillis
 Gary W. McNeil
 John M. Meister
 David W. Mikoryak
 Faye L. M. Moore
 Mary Morrow
 Hugh A. Mose
 Donald N. Nelson
 Jeffrey A. Nelson
 Gordon A. Nevison
 Steve New
 Joyce F. Olson
 Frank Otero
 Carl L. Palmer
 Melinda K. Perkins
 Joe Pirzynski

Nicholas E. Promponas
 Joe Murray Rivers
 Janet S. Rogers
 Irwin Rosenberg
 Richard L. Ruddell
 Ghassan Salameh
 Larry E. Salci
 Michael A. Sanders
 Stephen E. Schlickman
 Carl G. Sedoryk
 Vickie Shaffer
 Howard Silver
 Paul P. Skoutelas
 Roger Snoble
 Dan Tangherlini
 Gary C. Thomas
 Michael S. Townes
 Claude Trudel
 David L. Turney
 Pierre Vandelac
 Cleopatra Vaughns
 Michael Walls
 Kenneth J. Warren
 George D. Warrington
 Kathryn D. Waters
 Linda S. Watson
 Richard A. White
 Curtis A. Wiley
 Frank J. Wilson
 John L. Wilson
 W. Randy Wright

APPENDIX C

International Union of Public Transport Executive Board

Secretary General: Hans Rat

Senior Director: Helga Severyns

Director of Corporate Development and the Corporate Office: Petra Mollet

Secretary General's Projects and Development Advisor: Yves Amsler

UITP President: M. Roberto Cavalieri, Amministratore Delegato, MET.RO S.p.A.–
Metropolitana di Roma, Roma, Italy

Vice Presidents:

Manfred Novy, Geschäftsführer, Verkehrsverbund Ost-Region GmbH, Wien, Austria

M. Alain Flausch, Administrateur Directeur Général, Societe des Transports Intercommunaux de
Bruxelles, Bruxelles, Belgium

Jurandir Fernando R. Fernandes, Presidente ANTP, Secretario de Estado dos Transportes
Metropolitanos, Governo Do Estado De Sao Paulo, Sao Paulo, Brazil

Richard Ducharme, Chief General Manager, Toronto Transit Commission, Toronto, Canada

M. Philippe Attey, Directeur Général, Societe Des Transports Abidjanais, Abidjan, Cote d'Ivoire

M. Raymond Hue, Président Directeur Général, Transports En Commun de L'agglomeration
Rouennaise, Rouen, France

Herr Dr. Peter Höflinger, Mitglied des Vorstands, Stuttgarter Strassenbahnen AG, Stuttgart,
Germany

Robert W. Huber, Executive-Vice-President Aesys SpA, Aesys–Rwh Intl, Ettlingen, Germany

Dmitry Gaev, Head, Moskovsky Metropolitan, Moskva, Russian Federation

Kyung Ho Kang, President, Seoul Metropolitan Subway Corporation, Seoul, South Korea

Albert Tortajada I. Flores, Director de Explotación, Ferrocarrils De La Generalitat De Catalunya,
Rubi (Barcelona), Spain

Ulrich Sinzig, Direktor, Vize-Präsident des Verwaltungsrates der Schweizerischen
Bundesbahnen, Aare Seeland Mobil AG, Langenthal, Switzerland

David Martin, Managing Director International, ARRIVA, Leicester, United Kingdom

APPENDIX D

Final Program

Click here to see the [Joint International Light Rail Conference Final Program.](#)

APPENDIX E

Transportation Research Information Service



Bureau of Transportation Statistics



TRIS *Online* v2.7
Basket Content List



Criteria: **Light Rail Transit**

AN: 01015590 A Streetcar Named Endure: Rail Transit in Philadelphia

Journal: Tramways & Urban Transit **Vol. 69 No. 817**

AUTHOR(S): Geoffrey, Skelsey's

00/00/2006

AN: 01015591 Yverdon-Ste Croix: Scenic Light Rail Survivor

Journal: Tramways & Urban Transit **Vol. 69 No. 817**

AUTHOR(S): Wansbeek, C. J.

00/00/2006

AN: 01016345 Innovative Intermodal Solutions for Urban Transportation Award: Developing Intermodal Traffic Signal Solutions for Portland, OR, USA

Journal: ITE Journal **Vol. 75 No. 12**

AUTHOR(S): Kloos, William C.

12/00/2005

AN: 01018514 Trolley in Transition: San Diego's Pioneering LRT is Becoming Technically Advanced, But It's Also Aging and Will Require Significant Investment Within the Next Few Years

Journal: Railway Age **Vol. 206 No. 12**

AUTHOR(S): Wolinsky, Julian

12/00/2005

AN: 01017702 Luas—A Great Success

Journal: Electric Railway **Vol. 50 No. 300**

AUTHOR(S): Frew, Iain D. O.

11/00/2005

AN: 01015022 Charlotte's Light Rail Line Draws Closer to Finish Line

Journal: Metro **Vol. 101 No. 10**

AUTHOR(S): Hirano, Steve

11/00/2005

AN: 01017019 Sacramento Extends Light Rail Service to Folsom

Journal: Passenger Transport **Vol. 63 No. 41**

10/17/2005

AN: 01016825 VTA Debuts Vasona Light Rail Oct. 1

Journal: Passenger Transport **Vol. 63 No. 39**

10/03/2005

AN: 01016826 Study Finds \$3.3 Billion in Investment Near DART Rail Stations

Journal: Passenger Transport **Vol. 63 No. 39**

10/03/2005

AN: 01005849 First Use of UHPFRC in Thin Precast Concrete Roof Shell For Canadian LRT Station

Journal: PCI Journal **Vol. 50 No. 5**

AUTHOR(S): Vicenzino, Enzo; Culham, Gerry; Perry, Vic H.; Zakariassen, Don; Chow, Terry S.

10/00/2005

AN: 01006563 SL Prepares for Smart Cards and Road Charging

Journal: International Railway Journal **Vol. 45 No. 10**

AUTHOR(S): Briginshaw, David

10/00/2005

AN: 01005736 An Examination of Successful Mixed Use in Transit Oriented Development as Conceptually Applied to the Proposed Ambassador Way Transit Station in Houston, Texas



PDF

AUTHOR(S): Davis, Tammye; Lewis, Carol A.

09/01/2005

AN: 01015004 Dallas Area Rapid Transit: Miles Ahead with Miles to Go

Journal: Mass Transit **Vol. 31 No. 6**

AUTHOR(S): Acken, Lori

09/00/2005

AN: 01015011 Drawing a Light Rail Line in the Sand: The Mid-City Exposition Line: How a Band of 13 Saved Mass Transit for Los Angeles's Westside

Journal: Mass Transit **Vol. 31 No. 6**

AUTHOR(S): Schurr, Arthur

09/00/2005

AN: 01010941 Seattle's North Link takes shape

Journal: Tunnels and Tunnelling International **Vol. 37 No. 9**

09/00/2005

AN: 01010965 New start for LA Metro contracting

Journal: Tunnels and Tunnelling International **Vol. 37 No. 9**

AUTHOR(S): Wallis, Shanni

09/00/2005

AN: 01010427 Luas : a great success

Journal: Electric Railway **Vol. 50 No. 299**

AUTHOR(S): Frew, Iain D. O.

09/00/2005

AN: 01010725 Houston Light Rail: The Culmination of 25 Years of Plan

Journal: Public Transport International **Vol. 54 No. 5**

AUTHOR(S): Luthi, Christine; Slaughter, Kimberly

09/00/2005

AN: 01010728 Bergen Opts for Light Rail

Journal: Public Transport International **Vol. 54 No. 5**

AUTHOR(S): Potter, T. J.

09/00/2005

AN: 01010750 Light Rail and BRT: Competitive or Complementary?

Journal: Public Transport International **No. 5**

AUTHOR(S): Vuchic, Vukan R.

09/00/2005

AN: 01010758 Milan Metro: Forty Years Old and Still Growing

Journal: Public Transport International **Vol. 54 No. 5**

AUTHOR(S): Kluzer, Ettore

09/00/2005

AN: 01010759 Orleans Line 2: A Tramway Named Future

Journal: Public Transport International **Vol. 54 No. 5**

AUTHOR(S): Lemaigen, Charles-Eric; Magnon-Pujo, Andre

09/00/2005

AN: 01005462 As Attitudes Change, Engineers See an Industry Evolve: Light Rail, Bus Rapid Transit and Alternative Financing Help Projects

Journal: ENR **Vol. 255 No. 6**

AUTHOR(S): Cho, A.; Illia, T.; Powers, E. M.; Steakley, L.

08/08/2005

AN: 01005525 Puerto Rico's Tren Urbano Represents Historical Landmark for Island Nation

Journal: Metro **Vol. 101 No. 7**

08/00/2005

AN: 01005529 'Small Starts' in Position to Overtake Larger Counterparts

Journal: *Metro* **Vol. 101 No. 7**

AUTHOR(S): Henke, C.

08/00/2005

AN: 01009192 San Diego welcomes trolley line extension

Journal: *Passenger Transport* **Vol. 63 No. 28**

AUTHOR(S): Anderson, Troy

07/11/2005

AN: 01009623 Why the light rail crisis?

Journal: *Electric Railway* **Vol. 50 No. 298**

AUTHOR(S): TRANSIT

07/00/2005

AN: 01005435 Parking's Key Role in Fastracks

Journal: *Parking* **Vol. 44 No. 6**

AUTHOR(S): Dawe, P.

07/00/2005

AN: 01003557 Fixing Faults with Fasteners

Journal: *Railway Age* **Vol. 206 No. 7**

AUTHOR(S): Judge, Tom

07/00/2005

AN: 01014765 Big Cities to Be Equipped with Metros

Journal: *Rail and Public Transport* **No. 25**

07/00/2005

AN: 01003623 Metro St. Louis: A Legacy of Growth

Journal: *Mass Transit* **Vol. 31 No. 4**

AUTHOR(S): Roembke, Jackie

06/00/2005

AN: 01005315 Bay Area Transit Plans in Focus: Muni's Alignment Improvements

Journal: *Tunnels and Tunnelling International* **Vol. 37 No. 6**

AUTHOR(S): Connor, P

06/00/2005

AN: 01005341 T Stands for Tutor: Engineers and Builders on T-Rex Learn Lessons About How to Coordinate a Megaproject

Journal: *Roads and Bridges* **Vol. 43 No. 6**

AUTHOR(S): Walker, D.

06/00/2005

AN: 01000914 Optimal Urban Rail Transit Corridor Identification within Integrated Framework Using Geographical Information Systems

Journal: Journal of Urban Planning and Development **Vol. 131 No. 2**

AUTHOR(S): Verma, A.; Dhingra, S. L.

06/00/2005

AN: 01002222 Istanbul Plans Major Rail Network Expansion

Journal: International Railway Journal **Vol. 45 No. 6**

AUTHOR(S): Briginshaw, David

06/00/2005

AN: 01002260 Making the Case for Light Rail in Britain

Journal: International Railway Journal **Vol. 45 No. 6**

06/00/2005

AN: 01002348 Still a Pioneer

Journal: Railway Age **Vol. 206 No. 6**

AUTHOR(S): Wolinsky, Julian

06/00/2005

AN: 01002652 Innovations at Work: Transit and the Changing Urban Landscape

Journal: Mass Transit **Vol. 31 No. 4**

AUTHOR(S): Moscoe, Gregg; Sturges, Dan; Henke, Cliff

06/00/2005

AN: 01001699 Fleet Stats '05: Relative Strength in Numbers

Journal: Progressive Railroading **Vol. 48 No. 5**

AUTHOR(S): Foran, Pat

05/00/2005

AN: 01001700 High Hopes at the Port Authority of Allegheny County, They're Dedicated to Landing Dedicated State Funds

Journal: Progressive Railroading **Vol. 48 No. 5**

AUTHOR(S): Claypool, A.

05/00/2005

AN: 01001948 Integrating Services

Conference: 2005 Bus and Paratransit Conference Proceedings

AUTHOR(S): Beveridge, Cheryl

05/00/2005

AN: 00989411 Increasing the 'Green' on Mass Transit Machines

Journal: Trains **Vol. 65 No. 5**

AUTHOR(S): Craghead, AB

05/00/2005

AN: 01001382 Innovations at Work: What's New in Rail?

Journal: Mass Transit **Vol. 31 No. 2**

AUTHOR(S): Wilkins, Van; Lundquist, Lori

04/00/2005

AN: 00989388 Japanese Tunneler Digs in for Seattle Light Rail Project

Journal: ENR **Vol. 254 No. 12**

AUTHOR(S): McFall, K.

03/28/2005

AN: 00989082 Next Stop: Jamaica

Journal: Civil Engineering **Vol. 75 No. 3**

AUTHOR(S): Cracchiolo, A. G.; Leone, S.

03/00/2005

AN: 01000976 Light Rail, Tram Tack and Turnout Geometry Measurement and Diagnostic Tools

Conference: Urban Transport XI: Urban Transport and the Environment in the 21st Century

AUTHOR(S): Madejski, J.; Wadhwa, L. C.

03/00/2005

AN: 01001082 Recognizing Excellence in Transportation Planning

Journal: Public Roads **Vol. 68 No. 5**

AUTHOR(S): Parker, Truphelia M.

03/00/2005

AN: 01000500 LRT Is Changing the Face of French Cities

Journal: International Railway Journal **Vol. 45 No. 3**

AUTHOR(S): Knutton, Mike

03/00/2005

AN: 01010767 Light Rail European Experiences

AUTHOR(S): Hanssen, J. U.; Bekken, J. T.; Fearnley, N.; Steen, A. H.

02/00/2005

AN: 00986839 The Future for Rail in Southeast Asia

Journal: International Railway Journal and Rapid Transit Review **Vol. 45 No. 2**

AUTHOR(S): Powell, J. B.

02/00/2005

AN: 00996597 Agreement Reached on Extending Sound Transit's Light Rail to Airport

Journal: Passenger Transport **Vol. 63 No. 4**

01/24/2005

AN: 00996588 Light Rail Operators Lead the Field in Houston

Journal: Passenger Transport

01/10/2005

AN: 00984793 [Light Rail Report 2004: Mass Transit's Annual Overview](#)

Journal: [Mass Transit Vol. 30 No. 8](#)

AUTHOR(S): Wilkins, V.

01/00/2005

AN: 00985408 [How Light Rail Systems Have Enhanced Grade Crossing Safety](#)

Journal: [Metro Vol. 101 No. 1](#)

AUTHOR(S): LeSage, J.

01/00/2005

AN: 00994970 [Wood That Could: New Jersey Finds the Right Timber for Light Rail Construction.](#)

Journal: [Transportation Management + Engineering](#)

AUTHOR(S): Gale, Lori

00/00/2005

AN: 00994971 [Rio De Janeiro: City of Contrasts, Quality Metro](#)

Journal: [Tramways and Urban Transit.](#)

AUTHOR(S): Wansbeek, C. J.

00/00/2005

AN: 00994972 [Egypt: Four Tramways Are Now Five!](#)

Journal: [Tramways and Urban Transit](#)

AUTHOR(S): Desart, Roland Dussart; Russell, Mike

00/00/2005

AN: 00994973 [PORTO: We Never Closed](#)

Journal: [Tramways and Urban Transit](#)

AUTHOR(S): Russell, Mike

00/00/2005

AN: 00994652 [WIEN: Welcome to Ulf City!.](#)

Journal: [Tramways and Urban Transit](#)

AUTHOR(S): Wansbeek, C. J.

00/00/2005

AN: 00994653 [Paris: More Trams in 2006 and More on the Way](#)

Journal: [Tramways and Urban Transit](#)

AUTHOR(S): Wansbeek, C. J.

00/00/2005

AN: 00994768 [Nottingham: What's Stopping Expansion?](#)

Journal: [Tramways and Urban Transit](#)

00/00/2005

AN: 00994769 [Welcome to Ulf City!](#)

Journal: [Tramways and Urban Transit.](#)

AUTHOR(S): Wansbeek, C. J.

00/00/2005

AN: 00994770 [Egypt: Tramways from Another Era.](#)

Journal: [Tramways and Urban Transit](#)

AUTHOR(S): Desart, Roland Dussart; Russell, Michael

00/00/2005

AN: 00996678 [Stray Current Control in D.C. Mass Transit Systems](#)

Journal: [IEEE Transactions on Vehicular Technology.](#)

AUTHOR(S): Cotton, Ian; et al.

00/00/2005

AN: 00996681 [Zurich: Top City, Thanks to Light Rail.](#)

Journal: [Tramways and Urban Transit.](#)

AUTHOR(S): Moglestue, Andrew

00/00/2005

AN: 00996682 [Sao Paulo: New Metro Is Racing Ahead.](#)

Journal: [Tramways and Urban Transit.](#)

AUTHOR(S): Wansbeek, C. J.

00/00/2005

AN: 01000578 [Show Me: Innovation in Urban Transportation](#)



PDF

Journal: [Community Transportation Vol. 23 No. 3](#)

AUTHOR(S): Wilson, Beth; Sampson, Rich; Bogren, Scott

00/00/2005

AN: 01000603 [Transport of Delight: The Mythical Conception of Rail Transit in Los Angeles](#)

AUTHOR(S): Richmond, Jonathan

00/00/2005

AN: 01002256 [LEOLINER: The Low-Floor Light Rail Vehicle from Leipzig, Germany](#)

Journal: [Rail Engineering International Vol. 34 No. 1](#)

AUTHOR(S): Jacob, Dietmar

00/00/2005

AN: 01002624 [Porto Prize: Strengthening the Luiz I Bridge](#)

Journal: [Bridge Design and Engineering No. 39](#)

AUTHOR(S): Cross, Barry

00/00/2005

AN: 01002129 [Rail/Wheel Practices to Improve Ride Quality](#)

Conference: [Rail Transit Conference Proceedings, 2005](#)

AUTHOR(S): Dwyer, James D.

00/00/2005

AN: 01002131 Port Authority of Allegheny County Communications System Evolution

Conference: Rail Transit Conference Proceedings, 2005

AUTHOR(S): Macko, William A.

00/00/2005

AN: 01002132 Developing Equipment Standards for the Vintage Trolley Field

Conference: Rail Transit Conference Proceedings, 2005

AUTHOR(S): Smatlak, John

00/00/2005

AN: 01002133 Cost Effective Program Management Strategies for the T-REX Project in Denver

Conference: Rail Transit Conference Proceedings, 2005

AUTHOR(S): Clarke, Richard F.

00/00/2005

AN: 01002135 AirTrain Regional Airport Access

Conference: Rail Transit Conference Proceedings, 2005

AUTHOR(S): Davidson, Robert I.

00/00/2005

AN: 01002138 Sixty-Year Life Cycle Cost Analysis for Metropolitan Atlanta Rapid Transit Authority (MARTA) Transit System

Conference: Rail Transit Conference Proceedings, 2005

AUTHOR(S): Tinubu, Soji; Allen, Davis

00/00/2005

AN: 01002143 Cooperative Effort Among Small Light Rail Properties to Control Costs of Maintenance and Overhauls

Conference: Rail Transit Conference Proceedings, 2005

AUTHOR(S): Campbell, Mitchell; Frohnsdorf, Klaus; Mack, Lloyd; Price, Jim

00/00/2005

AN: 01002147 Diamond Ramping to Reduce Noise and Vibration

Conference: Rail Transit Conference Proceedings, 2005

AUTHOR(S): Prael, Fred; Marsh, Philip

00/00/2005

AN: 01002150 Effectiveness of Ballast Mats in Reducing Ground-Borne Vibration Generated by Passing Trains

Conference: Rail Transit Conference Proceedings, 2005

AUTHOR(S): Balachandran, Chetlur G.

00/00/2005

AN: 01002159 The Design/Build Decision: Lessons Learned from the Hiawatha Light Rail Project

Conference: Rail Transit Conference Proceedings, 2005

AUTHOR(S): Burns, John R.

00/00/2005

AN: 01002164 System Safety and Security Certification in Action: Managing DART Extension Projects

Conference: Rail Transit Conference Proceedings, 2005

AUTHOR(S): McKay, Timothy; Bourlon, Richard R.; Nation, Fariba K.
00/00/2005

AN: 01002165 Pittsburgh's Historical Past: Meeting Today's Challenges

Conference: Rail Transit Conference Proceedings, 2005

AUTHOR(S): Smith, Kevin P.; Galindo, Eduardo; Smitley, Larry G.
00/00/2005

AN: 01002167 Union/Management Career Ladder Partnerships: Alternative Funding for Transit Maintenance Training

Conference: Rail Transit Conference Proceedings, 2005

AUTHOR(S): Williams, Robert F.
00/00/2005

AN: 01002170 Light Rail Transit Case Studies

Conference: Rail Transit Conference Proceedings, 2005

AUTHOR(S): Lee, Reed Everett; Ecker, Cassandra
00/00/2005

AN: 01002171 Super Resilient Rail Fixation Systems to Reduce Squeal Noise, Vibration, and Rail Corrugation

Conference: Rail Transit Conference Proceedings, 2005

AUTHOR(S): Vanhonacker, P.; Van Leuven, Andre
00/00/2005

AN: 01002174 Tailor-Made: The Successful Implementation of Pittsburgh's Safety and Security Certification Program

Conference: Rail Transit Conference Proceedings, 2005

AUTHOR(S): Zamiska, Michael J.; Cephas, Michael J.
00/00/2005

AN: 01002176 Multimodal Analysis of Atlanta's Northwest Transit Corridor: A Case for Defining Modes as Technology–Service Pairs

Conference: Rail Transit Conference Proceedings, 2005

AUTHOR(S): Allen, Duncan W.
00/00/2005

AN: 01002179 Norfolk Light Rail System Alternative Land Use Forecast

Conference: Rail Transit Conference Proceedings, 2005

AUTHOR(S): Amoruso, Ray; Nelson, Eric
00/00/2005

AN: 01002182 Port Authority of Allegheny County's New North Shore Connector LRT Project — "Gateway Station, a New Destination"

Conference: Rail Transit Conference Proceedings, 2005

AUTHOR(S): Marinzel, Jerome

00/00/2005

AN: 01002183 Designing Value into Los Angeles' Gold Line and Exposition Line Light Rail Transit Systems

Conference: Rail Transit Conference Proceedings, 2005

AUTHOR(S): Sandberg, Joel; Burner, Chris; Born, Monica

00/00/2005

AN: 01002189 A New Direction in Light Rail Maintenance Facility Design

Conference: Rail Transit Conference Proceedings, 2005

AUTHOR(S): Shiffer, Dick

00/00/2005

AN: 01003457 CCAP Transportation Emissions Guidebook



HTML

00/00/2005

AN: 01004221 Utah Transit Authority's Connection Protection System: Perceptions of Riders and Operators

Journal: Journal of Public Transportation **Vol. 8 No. 3**

AUTHOR(S): Cluett, Chris; Jenq, Jeffrey H.; Saito, Mitsuru

00/00/2005

AN: 01005623 Rotterdam, Trams Now—People Later!

Journal: Tramways and Urban Transit **Vol. 68 No. 809**

AUTHOR(S): Wansbeek, C. J.

00/00/2005

AN: 01005624 Zurich: The Cobra Rules, All Above Ground

Journal: Tramways and Urban Transit **Vol. 68 No. 809**

AUTHOR(S): Moglestue, Andrew

00/00/2005

AN: 01005383 Maintenance Staffing Levels for Light Rail Transit

Journal: TCRP Synthesis of Transit Practice **No. 61**

AUTHOR(S): Stanger, Richard

00/00/2005

AN: 01006823 Capacity and Cost Comparisons of Rapid Transit Modes

Conference: ITE 2005 Annual Meeting and Exhibit Compendium of Technical Papers

AUTHOR(S): Evans, John E. Jay IV

00/00/2005

AN: 01006855 Deployment of MUTCD Light Rail Traffic Control Devices to Improve Safety at At-Grade Light Rail Crossings in Baltimore, Maryland
Conference: ITE 2005 Annual Meeting and Exhibit Compendium of Technical Papers
AUTHOR(S): Sabra, Ziad A.; Sulibhav, Govind
00/00/2005

AN: 01005940 Design, Development and Use of the Concrete for the Superstructure of the Viaduct Section of the Docklands Light Railway Extension, London
Conference: Seventh International Symposium on the Utilization of High-Strength/High-Performance Concrete
AUTHOR(S): Best, J. M.; Maynard, S. R.; Kay, E. A.
00/00/2005

AN: 01005949 The First Use of UHPC Technology for an Innovative LRT Station Canopy Shawnessy, Calgary, Alberta
Conference: Seventh International Symposium on the Utilization of High-Strength/High-Performance Concrete
AUTHOR(S): Perry, V.; Zakariasen, D.
00/00/2005

AN: 01006068 Does the DFT Really Have a Clue?—The Department for Transportation Has Taken Another Hammering for Its Muddled Thinking and Lackluster Support for Light Rail
Journal: *Tramways and Urban Transit* **Vol. 68 No. 810**
AUTHOR(S): Young, Tony
00/00/2005

AN: 01006069 Bern: RBS Is the Best in Swiss Quality
Journal: *Tramways and Urban Transit* **Vol. 68 No. 810**
AUTHOR(S): Wansbeek, C. J.
00/00/2005

AN: 01006070 Madrid: 'Instant' Tramway by 2007
Journal: *Tramways and Urban Transit* **Vol. 68 No. 810**
AUTHOR(S): Wansbeek, C. J.
00/00/2005

AN: 01006103 Nice: Surviving the Corruption Scandal: A Major French Scheme Has Been Thrown into Chaos After the Main Contractor Admitted Fraud
Journal: *Tramways and Urban Transit* **Vol. 68 No. 811**
AUTHOR(S): Wansbeek, C. J.
00/00/2005

AN: 01006105 Turkish Transit Scene
Journal: *Tramways and Urban Transit* **Vol. 68 No. 811**
00/00/2005

AN: 01006174 [Light Rail: What Every Modern City Needs to Prosper](#)

Journal: [Tramways and Urban Transit](#) **Vol. 68 No. 812**

AUTHOR(S): Walmsley

00/00/2005

AN: 01006175 [Trondheim, the System That Refused to Die](#)

Journal: [Tramways and Urban Transit](#) **Vol. 68 No. 812**

AUTHOR(S): Kjenstad, Rune

00/00/2005

AN: 01006176 [Sao Paulo Commuter Rail Strong Again](#)

Journal: [Tramways and Urban Transit](#) **Vol. 68 No. 812**

AUTHOR(S): Wansbeek, C. J.

00/00/2005

AN: 01006177 [The Secretive Tramways of North Korea](#)

Journal: [Tramways and Urban Transit](#) **Vol. 68 No. 812**

AUTHOR(S): Rappelt, Rudolf

00/00/2005

AN: 01006264 [Szeged: Trams in the City of Sunshine](#)

Journal: [Tramways and Urban Transit](#) **Vol. 68 No. 813**

AUTHOR(S): Varga, Ak?os

00/00/2005

AN: 01006265 [Potsdam: Living with the Troubled Combino](#)

Journal: [Tramways and Urban Transit](#) **Vol. 68 No. 813**

AUTHOR(S): Wansbeek, C. J.

00/00/2005

AN: 01006289 [Trekking Through the Urals](#)

Journal: [Tramways and Urban Transit](#) **Vol. 68 No. 813**

AUTHOR(S): Russell, Mike

00/00/2005

AN: 01006290 [King's Trams: Modernity Is Today's Watchword in Potsdam, But the Tramways of the Soldier King's City Are Fully Aware of Their 125-Year History and Celebrated with Aplomb in May](#)

Journal: [Tramways and Urban Transit](#) **Vol. 68 No. 813**

AUTHOR(S): Russell, Mike

00/00/2005

AN: 01006354 [A Flashback to Days Gone By](#)

Journal: [Elevator World](#) **Vol. 53 No. 9**

AUTHOR(S): Caporale, Robert S.

00/00/2005

AN: 01006410 [Dublin to Get Six New Luas Lines?](#)

Journal: [Tramways and Urban Transit](#) **Vol. 68 No. 814**

00/00/2005

AN: 01006412 [Lisboa: The Other Tram Museum](#)

Journal: [Tramways and Urban Transit](#) **Vol. 68 No. 814**

AUTHOR(S): Russell, Mike

00/00/2005

AN: 01010439 [UK-Tram: The Answer to Light Rail's Growing Pains?](#)

Journal: [Tramways and Urban Transit](#) **Vol. 68 No. 815**

AUTHOR(S): Walmsley, David

00/00/2005

AN: 01010440 [The New Face of Eastern Germany](#)

Journal: [Tramways and Urban Transit](#) **Vol. 68 No. 815**

AUTHOR(S): Buckley, Richard

00/00/2005

AN: 01010441 [Aarau: Light Rail Is Alternative to Chaos](#)

Journal: [Tramways and Urban Transit](#) **Vol. 68 No. 815**

AUTHOR(S): Wansbeek, C. J.

00/00/2005

AN: 01010442 [Nordhausen Tram Trains Rule O.K.](#)

Journal: [Tramways and Urban Transit](#) **Vol. 68 No. 815**

AUTHOR(S): May, Jack

00/00/2005

AN: 01011148 [Transport Policy: Take a Lesson from London](#)

Journal: [Tramways and Urban Transit](#) **Vol. 68 No. 816**

AUTHOR(S): Pourbaix, Jerome

00/00/2005

AN: 01011149 [Neuch^atel: Swiss Lakeside City with Tram-Train Ambitions](#)

Journal: [Tramways and Urban Transit](#) **Vol. 68 No. 816**

AUTHOR(S): Wansbeek, C. J.

00/00/2005

AN: 01011157 [Making the Light Rail Connection: Expanded Service Adds 5.3 Miles to System](#)

Journal: [Transit California](#)

AUTHOR(S): Collins, Gail

00/00/2005

AN: 01011158 [Seattle's North Link Takes Shape](#)

Journal: [T&T North America](#) **Vol. 18**

00/00/2005

AN: 01011159 [New Start for LA Metro Contracting](#)

Journal: [T&T North America](#) **Vol. 18**

AUTHOR(S): Wallis, Shani

00/00/2005

AN: 00996579 [Twin Cities' Metro Transit Extends Hiawatha Line](#)

Journal: [Passenger Transport](#)

12/06/2004

AN: 00984790 [Modernizing Beantown's "T"](#)

Journal: [Railway Age](#) **Vol. 205 No. 12**

AUTHOR(S): Luczak, M.

12/00/2004

AN: 01002206 [The Bergen Light Rail Project Quality Control](#)

AUTHOR(S): Johansen, K. W.; Larsen, O. I.

12/00/2004

AN: 00994429 [Athens Trams Trump Autos](#)

Journal: [International Railway Traveler](#)

11/00/2004

AN: 00984021 [Community Outreach Strategies Reduce Friction in Rail Projects](#)

Journal: [Metro](#) **Vol. 100 No. 10**

AUTHOR(S): Hirano, S.

11/00/2004

AN: 00984677 [A Vision for Light Rail Transit: Linking Up with Intelligent Transportation Systems](#)



[PDF](#)

Journal: [TR News](#) **No. 235**

AUTHOR(S): Bruun, E.

11/00/2004

AN: 00982228 [Returning to the Rails: Charlotte, N.C., Prepares to Launch Commuter Light Rail Service—On a Right-Of-Way Still Intact After 60 Years](#)

Journal: [Trains](#) **Vol. 64 No. 10**

AUTHOR(S): Robl, E. H.

10/00/2004

AN: 00980285 [CONNEX Connects Commuters Down Under](#)

Journal: [Mass Transit](#) **Vol. 30 No. 6**

AUTHOR(S): Gardner, M.

10/00/2004

AN: 00993702 Asian Centres: Kuala Lumpur

Journal: Electric Railway

AUTHOR(S): Observer

09/00/2004

AN: 00980334 Transportation Systems

Journal: IEEE Vehicular Technology Society News **Vol. 51 No. 3**

AUTHOR(S): Glickenstein, H.

08/00/2004

AN: 00978834 City of Rail

Journal: Railway Age **Vol. 205 No. 8**

AUTHOR(S): Luczak, M.

08/00/2004

AN: 00958394 Dallas Rail Service Helps Seniors Stay Active

Journal: Passenger Transport

07/12/2004

AN: 00958770 Minneapolis Light Rail Transit Begins Service

Journal: Urban Transportation Monitor

07/09/2004

AN: 00958294 Hiawatha Line Returns Rail Service to Minneapolis..

Journal: Passenger Transport

07/05/2004

AN: 00958295 Calgary Transit Celebrates Opening of Two New Light Rail Stations

Journal: Passenger Transport

07/05/2004

AN: 00959047 Docklands Grows and Grows

Journal: Electric Railway

AUTHOR(S): Transit

07/00/2004

AN: 00959070 Making New Connections: Airport Rail Links in the United States

Journal: Japan Railway and Transport Review,

AUTHOR(S): Lin, Kenneth

07/00/2004

AN: 00976233 Athens Races to Beat Olympics Deadline

Journal: International Railway Journal and Rapid Transit Review **Vol. 44 No. 7**

AUTHOR(S): Bennett, S.

07/00/2004

AN: 00976709 An Industry Transformed

Journal: Metro Vol. 100 No. 6

07/00/2004

AN: 00976778 Rail Revival: After a Half Century, Minneapolis Reenters the Transit Rail Market to Serve Growing Pool of Downtown Commuters

Journal: Progressive Railroading Vol. 47 No. 7

AUTHOR(S): Claypool, A.

07/00/2004

AN: 00958138 Santa Clara VTA Opens Extension

Journal: Passenger Transport

06/28/2004

AN: 00958093 Overbrook Line Returns to Service in Pittsburgh

Journal: Passenger Transport

06/21/2004

AN: 00958700 New Transportation System and Urban Transportation System: Special Report

Journal: Japanese Railway Engineering

06/00/2004

AN: 00958701 Next Generation of Urban Traffic Systems: Experience and Perspective for Future Expansion

Journal: Japanese Railway Engineering

AUTHOR(S): Matsumoto, Akira

06/00/2004

AN: 00958704 Development of Low-Floor Light Rail Vehicle

Journal: Japanese Railway Engineering

AUTHOR(S): Masuda, Tamotsu

06/00/2004

AN: 00958706 Contact-Wireless Tramcar Using Rechargeable Lithium Ion Battery

Journal: Japanese Railway Engineering

AUTHOR(S): Ogasa, Masamichi; Sameshima, Hiroshi

06/00/2004

AN: 00976227 Portland, Oregon

Journal: Mass Transit Vol. 30 No. 4

AUTHOR(S): Lundquist, L.

06/00/2004

AN: 00979190 Analysis of the Impact of the MRT System on Accessibility in Singapore Using an Integrated GIS Tool

Journal: Journal of Transport Geography Vol. 12 No. 2

AUTHOR(S): Zhu, X.; Liu, S.

06/00/2004

AN: 00957454 **DHS Issues Rail Transit Security Directive**

Journal: *Passenger Transport*

05/31/2004

AN: 00979930 **Effects of Light Rail Transit on Traffic Congestion**



PDF

AUTHOR(S): Chandler, C.; Hoel, L. A.

05/17/2004

AN: 00987774 **Evaluation of Utah Transit Authority's Connection Protection System**



HTML

05/12/2004

AN: 00988043 **Evaluation of Utah Transit Authority's Connection Protection System**



HTML

05/12/2004

AN: 00979087 **Economic and Regeneration Impacts of Croydon Tramlink**

Conference: *Urban Transport X. Urban Transport and the Environment in the 21st Century*

AUTHOR(S): Siraut, J.

05/00/2004

AN: 00977842 **Sustainable Transport Policies in Japanese Cities: Barriers to Implementation**

Conference: *Urban Transport X. Urban Transport and the Environment in the 21st Century*

AUTHOR(S): Kuriyama, K.; Donghai, C.; Kato, H.; Sugimoto, J.; Black, J.; Hayashi, Y.

05/00/2004

AN: 00977878 **Integrating a Modern Light Rail Transit (LRT) System into an Historic City Center**

Conference: *Urban Transport X. Urban Transport and the Environment in the 21st Century*

AUTHOR(S): Campodonic, M.; Cohen, R.

05/00/2004

AN: 00978852 **Peru on a Path to Sustainable Mobility**

Journal: *Public Transport International* **Vol. 53 No. 3**

05/00/2004

AN: 00958459 **Riding N.E.T.**

Journal: *Electric Railway*

AUTHOR(S): Transit

05/00/2004

AN: 00973690 A Breakthrough Year?

Journal: Railway Age Vol. 105 No. 5

AUTHOR(S): Vantuono, W. C.

05/00/2004

AN: 00973892 Light Rail Comes to Minneapolis

Journal: Planning Vol. 70 No. 5

AUTHOR(S): Newberg, S.

05/00/2004

AN: 00973902 Relationship Between Light Rail Systems Design and System Operations

Journal: Journal of Transportation Engineering Vol. 130 No. 3

AUTHOR(S): Fazio, A. E.

05/00/2004

AN: 00974396 Two-Point Landing: Agencies Promote Transit-Oriented
Development to Increase Ridership, Revenue

Journal: Progressive Railroading Vol. 47 No. 5

AUTHOR(S): Claypool, A.

05/00/2004

AN: 00975253 Back on Track

Journal: Civil Engineering Vol. 74 No. 5

AUTHOR(S): Brown, J. L.

05/00/2004

AN: 00958840 Clang, Clang, Clang Goes the Trolley—Again

Journal: Rail Travel News

AUTHOR(S): Maylath, Ken

04/30/2004

AN: 00956882 TRIMET to Open Interstate Max Line on May 1

Journal: Passenger Transport

04/26/2004

AN: 00972963 New Jersey's Innovators

Journal: Railway Age Vol. 205 No. 4

AUTHOR(S): Vantuono, W. C.

04/00/2004

AN: 00972965 Dublin Prepares to Open First Light Rail Lines

Journal: International Railway Journal and Rapid Transit Review Vol. 44 No. 4

AUTHOR(S): Briginshaw, D.

04/00/2004

AN: 00972966 Light Rail Makes Its Mark in the Texan Oil Capital

Journal: *International Railway Journal and Rapid Transit Review* **Vol. 44 No. 4**

AUTHOR(S): Lecher, T.; Yakistan, M.

04/00/2004

AN: 00974342 The Challenge of Bringing Light Rail to the Twin Cities

Journal: *Metro* **Vol. 100 No. 3**

04/00/2004

AN: 00957060 First Ride on the River Line

Journal: *Rail Travel News*

AUTHOR(S): Scull, Theodore W.

03/31/2004

AN: 01010692 Survey of Transit and Rail Freight Interaction

AUTHOR(S): Liu, Rongfang

03/31/2004

AN: 00956412 New Jersey Transit Launches River Line March 13

Journal: *Passenger Transport*

03/15/2004

AN: 00955878 Houston LRT Continues to Experience High Accident Rate at Crossings

Journal: *Urban Transportation Monitor*

03/05/2004

AN: 00971134 Factors Influencing Light Rail Station Boardings in the United States

Journal: *Transportation Research. Part A: Policy and Practice* **Vol. 38 No. 3**

AUTHOR(S): Kuby, M.; Barranda, A.; Upchurch, C.

03/00/2004

AN: 00971379 Tying It All Together

Journal: *Civil Engineering* **Vol. 74 No. 3**

AUTHOR(S): Gale, L.; Hsu, R.

03/00/2004

AN: 00979192 Using GIS to Generate Mutually Exclusive Service Areas
Linking Travel On and Off a Network

Journal: *Journal of Transport Geography* **Vol. 12 No. 1**

AUTHOR(S): Upchurch, C.; Kuby, M.; Zoldak, M.; Barranda, A.

03/00/2004

AN: 00970880 Houston In Transit: Against All Odds

Journal: *Railway Age* **Vol. 205 No. 2**

AUTHOR(S): Vantuono, W. C.

02/00/2004

AN: 00971014 Precast Concrete Light Rail System Provides Mass Transit Solution for JFK International Airport

Journal: PCI Journal Vol. 49 No. 1

AUTHOR(S): Rodriguez, J. M.; Hridayati, M.; Taddeo, A.; Parks, J. K.
02/00/2004

AN: 00955128 Fatalities at LRT Crossings Still a Problem at Many Locations

Journal: Urban Transportation Monitor

01/23/2004

AN: 00955129 Light Rail Line Opens in Houston

Journal: Urban Transportation Monitor

01/23/2004

AN: 00954758 Houston Celebrates New Year With Light Rail Debut

Journal: Passenger Transport

01/05/2004

AN: 00971026 Tram and Light Rail Systems in Europe: Current Situation, Perspective, and Market Volume

Journal: Public Transport International Vol. 53 No. 1

AUTHOR(S): Dauby, L.
01/00/2004

AN: 00971028 The Growing Role of Mobility on Chinese Urban Rail

Journal: Public Transport International Vol. 53 No. 1

AUTHOR(S): Lawrence, T.
01/00/2004

AN: 00971061 Transport and City Competitiveness: Literature Review



PDF

AUTHOR(S): Davies, L.; Banister, D.; Hall, P.
01/00/2004

AN: 00966859 Light Rail Update 2003



HTML

Journal: Mass Transit Vol. 29 No. 8

AUTHOR(S): Schumann, J.
01/00/2004

AN: 00966860 Multimodal Rapid Transit Grows in Ottawa



HTML

Journal: *Mass Transit* Vol. 29 No. 8

AUTHOR(S): Wilkins, V.

01/00/2004

AN: 00968843 Raising Light Rail in Arizona

Journal: *Metro* Vol. 100 No. 1

AUTHOR(S): Hirano, S.

01/00/2004

AN: 00969240 Turning Plans into Reality Is a Slow Process

Journal: *International Railway Journal and Rapid Transit Review* Vol. 44 No. 1

AUTHOR(S): Briginshaw, D.

01/00/2004

AN: 00973593 Annual Report on New Starts: Proposed Allocations of Funds for Fiscal Year 2005

01/00/2004

AN: 00975316 The San Jose Case Study: Ohlone–Chynoweth Station.

In The New Transit Town: Best Practices In Transit-Oriented Development

AUTHOR(S): Breznau, S.

00/00/2004

AN: 00976019 Traveler Response to Transportation System Changes.

Chapter 3: Park-And-Ride/Pool



PDF

Journal: *TCRP Report* No. 95

AUTHOR(S): Turnbull, K. F.; Pratt, R. H.; Evans, J. E., IV; Levinson, H. S.

00/00/2004

AN: 00977264 Interlocal Agreements: Confusion to Clarity—The Salt Lake City Experience

Conference: *Rail Transit Conference*

AUTHOR(S): Allegra, M.; Meyer, S.; Pett, K.; Grodner, M.; Robertson, M.

00/00/2004

AN: 00977265 Los Angeles Metropolitan Transportation Authority Grade Crossing Policy: Reducing Uncertainty and Defining Scope and Cost for Light Rail Transit/Roadway Crossings

Conference: *Rail Transit Conference*

AUTHOR(S): Ogden, B. D.

00/00/2004

AN: 00977267 Getting It Right In Light Rail: Analysis of UK Performance

Conference: Rail Transit Conference

AUTHOR(S): Humphreys, E.

00/00/2004

AN: 00977271 Project Highlights of the Los Angeles Gold Line LRT

Conference: Rail Transit Conference

AUTHOR(S): Born, M.; Burner, C.

00/00/2004

AN: 00977272 City Of Edmonton's Newest Extension: Seeing The Light
at the End of the Tunnel

Conference: Rail Transit Conference

AUTHOR(S): Becker, B.; Griffith, B.

00/00/2004

AN: 00977274 Providing Train Vibration Isolation to a Hospital a Case Study: Eight Years Later

Conference: Rail Transit Conference

AUTHOR(S): Walker, W. D.; Campbell, E. E.

00/00/2004

AN: 00977275 Shredded Tires as a Vibration Mitigation Technique for LRT

Conference: Rail Transit Conference

AUTHOR(S): Bacus, T. P.; Gharabegian, A.

00/00/2004

AN: 00977276 "Fix It First": Dorchester Red Line Stations: Reinvesting in the
Infrastructure—The Evolution of a Capital Investment Benefiting Community and State

Conference: Rail Transit Conference

AUTHOR(S): Boylan, B. J.

00/00/2004

AN: 00977279 DART Expansion: Structural Elements of the New Corridors

Conference: Rail Transit Conference

AUTHOR(S): Rodriguez, J. D.

00/00/2004

AN: 00977280 Evaluating Operational Capacity of Alternative Rail Terminal Designs

Conference: Rail Transit Conference

AUTHOR(S): Dure, D.; Golovitcher, L.

00/00/2004

AN: 00977281 MARTA's Armour Rail Services Facility Planning, Design and Construction

Conference: Rail Transit Conference

AUTHOR(S): Barnhill, J. S.; Buchanan, T. R.

00/00/2004

AN: 00977282 Cermak (Douglas) Branch Blue Line Rehabilitation
Conference: Rail Transit Conference
AUTHOR(S): Schriks, R.
00/00/2004

AN: 00977283 Harrison Curve Realignment Project
Conference: Rail Transit Conference
AUTHOR(S): Schriks, R.
00/00/2004

AN: 00977284 Trackway Renovations: Phase II (TRII) Program
Conference: Rail Transit Conference
AUTHOR(S): Patel, N. P.; Lyle, S.; Free, G.
00/00/2004

AN: 00977285 Design Considerations for TVS to Limit the Consequences of
Chemical and Biological Releases in Enclosed Transit Stations
Conference: Rail Transit Conference
AUTHOR(S): Miclea, P. C.
00/00/2004

AN: 00977286 Short Tunnel Ventilation Analysis
Conference: Rail Transit Conference
AUTHOR(S): Harris, K. J.; Robinson, M. S.
00/00/2004

AN: 00977287 Wide-Area Gigabit Ethernet System for LRT Communications
Conference: Rail Transit Conference
AUTHOR(S): Martinez, B.; Thomas, J. L.
00/00/2004

AN: 00977291 Modern Streetcar Systems: Who's Next?
Conference: Rail Transit Conference
AUTHOR(S): Furmaniak, T. B.
00/00/2004

AN: 00977292 New Orleans: Not Your Same Old Streetcar!
Conference: Rail Transit Conference
AUTHOR(S): Drake, A. S.; von Dullen, E.; Dobbs, D.; Henry, L.; Conrad, L.
00/00/2004

AN: 00977293 Rapid Streetcar: Rescaling Design and Cost for More Affordable Light Rail Transit
Conference: Rail Transit Conference
AUTHOR(S): Henry, L.
00/00/2004

AN: 00977294 The Return of the Streetcar to Western Europe

Conference: Rail Transit Conference

AUTHOR(S): Huet, J.; Semaly, E.

00/00/2004

AN: 00977295 A First Look at the New 1500 VDC Light Rail Vehicle in Seattle

Conference: Rail Transit Conference

AUTHOR(S): Porter, D. L.; Sanders, D. W.; Simmonds, W. M.

00/00/2004

AN: 00977305 Design and Contracting Strategy for a Short Tunnel in Mixed Ground Conditions

Conference: Rail Transit Conference

AUTHOR(S): Washuta, A. S.

00/00/2004

AN: 00977307 Light Rail Safety Education

Conference: Rail Transit Conference

AUTHOR(S): Kaldenbach, I.

00/00/2004

AN: 00977308 Turnkey Update: The Success Story of the Houston Light Rail Project

Conference: Rail Transit Conference

AUTHOR(S): Lohmann, M.

00/00/2004

AN: 00977310 Voice, Video, and Data Convergence for Expo Line

Conference: Rail Transit Conference

AUTHOR(S): Bhanji S.; Harris-Gifford, M.

00/00/2004

AN: 00959511 "Tram-Trains": Are They the Saviour for Local Railways?

Journal: Tramways and Urban Transit

AUTHOR(S): Steel, Andrew

00/00/2004

AN: 00959512 Mulhouse: Another Bold French Tramway

Journal: Tramways and Urban Transit

AUTHOR(S): Wansbeek, C. J.

00/00/2004

AN: 00954293 Gera: Small City Where Trams Are Crucial

Journal: Tramways and Urban Transit.

AUTHOR(S): Wansbeek, C. J.

00/00/2004

AN: 00954294 [Frankfurt-Am-Main: The Revolution Begins](#)

Journal: [Tramways and Urban Transit](#).

AUTHOR(S): Buck, S. D.

00/00/2004

AN: 00957776 [Close Tramways? Don't Fall into the Bus Trap!](#)

Journal: [Tramways and Urban Transit](#).

AUTHOR(S): Young, Tony

00/00/2004

AN: 00957777 [Barcelona: Teething Troubles Ironed Out](#)

Journal: [Tramways and Urban Transit](#)

AUTHOR(S): Wansbeek, C. J.

00/00/2004

AN: 00957778 [Urban Landmarks: The Stop the People Started](#)

Journal: [Tramways and Urban Transit](#)

AUTHOR(S): Richeux, Stephan

00/00/2004

AN: 00957779 [COTTBUS: A Centenary Created from Scratch!](#)

Journal: [Tramways and Urban Transit](#)

AUTHOR(S): Russell, Mike

00/00/2004

AN: 00957780 [Infrastructure Solutions for Connecting a Whole Region to a City Centre—Taking the Example of Chemnitz.](#)

Journal: [Railway Technical Review](#).

AUTHOR(S): Gottschalk, Gert

00/00/2004

AN: 00957872 [Dublin Luas: It's Open for Business!](#)

Journal: [Tramways and Urban Transit](#).

AUTHOR(S): O'Reilly, Tom

00/00/2004

AN: 00957873 [Innsbruck: Tramway Fit for the Modern Age](#)

Journal: [Tramways and Urban Transit](#)

AUTHOR(S): Deacon, Ray

00/00/2004

AN: 00957874 [Portland: Now There Are Four Light Rail Lines](#)

Journal: [Tramways and Urban Transit](#)

AUTHOR(S): Lietwiler, Charles

00/00/2004

AN: 00957940 Nice: Pioneer of Battery Power Low-Floor Trams

Journal: Tramways and Urban Transit

AUTHOR(S): Wansbeek, C. J.

00/00/2004

AN: 00957941 Genbeve: Where To Go, and What You'll See

Journal: Tramways and Urban Transit

AUTHOR(S): Kellett, Norman

00/00/2004

AN: 00957988 Roma: Light Rail Policy Is a Muddle

Journal: Tramways and Urban Transit

AUTHOR(S): Wansbeek, C. J.

00/00/2004

AN: 00979345 Dresden: Welcome to Light Rail City

Journal: Metro Report : A Railway Gazette Yearbook **Vol. 160**

AUTHOR(S): Muller-Eberstein, F.

00/00/2004

AN: 00979346 Indicative Costings Can Support Light Rail Decision-Making

Journal: Metro Report: A Railway Gazette Yearbook **Vol. 160**

AUTHOR(S): Boejharat, R.

00/00/2004

AN: 00979347 Innovation on Trial in Paris Suburbs

Journal: Metro Report: A Railway Gazette Yearbook **Vol. 160**

AUTHOR(S): Masse, J. P.

00/00/2004

AN: 00979348 ALACANT: Light Rail Takes Shape Along the Coast

Journal: Metro Report: A Railway Gazette Yearbook **Vol. 160**

AUTHOR(S): Domine, V.

00/00/2004

AN: 00979349 Berlin: Restoring a Divided Tram Network

Journal: Metro Report: A Railway Gazette Yearbook **Vol. 160**

AUTHOR(S): Predl, W.

00/00/2004

AN: 00979350 Jakarta: Commuter Rail Development Resumes

Journal: Metro Report: A Railway Gazette Yearbook **Vol. 160**

AUTHOR(S): Hata, T.

00/00/2004

AN: 00979351 Kuala Lumpur: Urban Operations Come Together
Journal: Metro Report: A Railway Gazette Yearbook **Vol. 160**
AUTHOR(S): Salleh, R. A. H.
00/00/2004

AN: 00979352 Minneapolis–St. Paul: Hiawatha Joins the Light Rail Family
Journal: Metro Report: A Railway Gazette Yearbook **Vol. 160**
AUTHOR(S): Marie, J.
00/00/2004

AN: 00979353 Oslo: Investment Package Triggers Upgrade
Journal: Metro Report : A Railway Gazette Yearbook **Vol. 160**
AUTHOR(S): Jackson, C.
00/00/2004

AN: 00979354 Pittsburgh: Overbrook Line Is Ready to Roll
Journal: Metro Report: A Railway Gazette Yearbook **Vol. 160**
AUTHOR(S): Skoutelas, P. P.
00/00/2004

AN: 00979355 Salt Lake City: Back on Track in the West
Journal: Metro Report: A Railway Gazette Yearbook **Vol. 160**
AUTHOR(S): English, J. M.
00/00/2004

AN: 00979356 Santiago: Metro Supports Integration Strategy
Journal: Metro Report: A Railway Gazette Yearbook **Vol. 160**
00/00/2004

AN: 00979357 Sao Paulo: Enhancing the City's Image
Journal: Metro Report: A Railway Gazette Yearbook **Vol. 160**
AUTHOR(S): Borges, P.
00/00/2004

AN: 00979358 Seoul: Setting Sights on Further Expansion
Journal: Metro Report: A Railway Gazette Yearbook **Vol. 160**
AUTHOR(S): In-Keun, L.
00/00/2004

AN: 00979359 Shanghai: Growing Metropolis Depends on Expanding Metro Network
Journal: Metro Report: A Railway Gazette Yearbook **Vol. 160**
00/00/2004

AN: 00979373 Over 2000 km Under Construction
Journal: Metro Report: A Railway Gazette Yearbook **Vol. 160**
AUTHOR(S): Granthan, A.
00/00/2004

AN: 00978894 The New Light Rail Transit Systems of Athens, Greece

Journal: Rail Engineering International Vol. 33 No. 3

AUTHOR(S): Pyrgidis, C.; Stathopoulos, A.

00/00/2004

AN: 00983784 Burnham's Manila

Journal: Planning Vol. 70 No. 11

AUTHOR(S): Goodno, J. B.

00/00/2004

AN: 00980011 Transit: Intermodal Transfer Facilities, Rail Transit, Commuter Rail, Light Rail, Ferry, and Major Activity Center Circulation Systems

Journal: Transportation Research Record: Journal of the Transportation Research Board, No. 1872

00/00/2004

AN: 00980017 Planning for the First Light Rail Transit System in Korea:

Jeonju Light Rail Transit Project

Journal: Transportation Research Record: Journal of the Transportation Research Board, No. 1872

AUTHOR(S): Shin, Y. E.; Vuchic, V. R.; Sin, P.-S.; Eun, C.-G.

00/00/2004

AN: 00980192 Why Wait for the Train? Bus Rapid Transit as a First or (Maybe) Final Step

Conference: Bus and Paratransit and Bus Rapid Transit Conference

AUTHOR(S): Shelden, M.

00/00/2004

AN: 00986797 Attractive and Effective Light Rail Traffic. The Properties, Functions and Potential of Modern Light Rail for Urban and Regional Passenger Transport

AUTHOR(S): Hedstroem, R.

00/00/2004

AN: 00987944 The JFK International Airport: Airtrain JFK Terminal at Jamaica, Queens, NYC

Journal: ASCE Geotechnical Special Publication No. 126

Conference: Geotechnical Engineering for Transportation Projects. Proceedings of Geo-Trans 2004

AUTHOR(S): Sandiford, R. E.; Brusey, W.; Law, S.; Sheth, R.

00/00/2004

AN: 00987967 Development of the Tire Shred Underlayment to Reduce Groundborne Vibration from LRT Track

Journal: ASCE Geotechnical Special Publication No. 126

Conference: Geotechnical Engineering for Transportation Projects. Proceedings of Geo-Trans 2004

AUTHOR(S): Wolfe, S. L.; Humphrey, D.N.; Wetzel, E.D.

00/00/2004

AN: 00988013 I-25 TREX Project: O-Cell Tests and Drilled Shaft Design Recommendations

Journal: ASCE Geotechnical Special Publication **No. 126**

Conference: Geotechnical Engineering for Transportation Projects. Proceedings of Geo-Trans 2004

AUTHOR(S): Attwooll, B.

00/00/2004

AN: 00988024 A New Type of Tapered Steel Pipe Pile for Transportation Applications

Journal: ASCE Geotechnical Special Publication **No. 126**

Conference: Geotechnical Engineering for Transportation Projects. Proceedings of Geo-Trans 2004

AUTHOR(S): Horvath, J. S.; Trochalides, T.; Merjan, S.

00/00/2004

AN: 00988624 Colorado Type 7 and 10 Rails Under High Test Level Loads

Journal: ASCE Geotechnical Special Publication **No. 126**

Conference: Geotechnical Engineering for Transportation Projects. Proceedings of Geo-Trans 2004

AUTHOR(S): Chang, N.-Y.; Oncul, F.; Wang, T.; McMullen, M.; Abu-Hejleh, N.; Greer, M.

00/00/2004

AN: 00988625 Earthworks for the Channel Tunnel Rail Link High Speed Railway, UK

Journal: ASCE Geotechnical Special Publication **No. 126**

Conference: Geotechnical Engineering for Transportation Projects. Proceedings of Geo-Trans 2004

AUTHOR(S): Phear, A.; O'Riordan, N.

00/00/2004

AN: 00988664 Unique Control of Post-Construction Settlement

Journal: ASCE Geotechnical Special Publication **No. 126**

Conference: Geotechnical Engineering for Transportation Projects. Proceedings of Geo-Trans 2004

AUTHOR(S): Milton, M. N.; Young, L. W.

00/00/2004

AN: 00988776 Transportation Management. In *Handbook of Transportation Engineering*

AUTHOR(S): Whaley, G. L.

00/00/2004

AN: 00987545 An Evaluation of the Traffic and Financial Performance of the MRT-3 Light-Rail/Metro Line in Manila



PDF

Journal: World Transport Policy & Practice **Vol. 10 No. 4**

AUTHOR(S): De Langen, M.; Alzate, E.; Talens, H.

00/00/2004

AN: 00994812 Los Angeles' New Transit Corridor Mixes Rail With NABI BRT Vehicle

Journal: Metro

00/00/2004

AN: 00994669 Hope for Light Rail...If the Books Balance

Journal: Tramways and Urban Transit

AUTHOR(S): Bartlett, Norman

00/00/2004

AN: 00994670 New Orleans: Streetcars Return to Canal Street

Journal: Tramways and Urban Transit

AUTHOR(S): Lietwiler, C. J.

00/00/2004

AN: 00956121 Bern: The Swiss Tram Revival Reaches the Capital

Journal: Tramways and Urban Transit

AUTHOR(S): Wansbeek, C. J.

00/00/2004

AN: 00956122 Bordeaux: Pioneering Is Paying Dividends

Journal: Tramways and Urban Transit

AUTHOR(S): Wansbeek, C. J.

00/00/2004

AN: 00956161 Back on Track: Minneapolis, Which Last Heard the Clangor of Electric Streetcars in 1954, Is Proving Once Again That History Repeats Itself

Journal: Civil Engineering

AUTHOR(S): Brown, Jeff L.

00/00/2004

AN: 00956296 Marseille: Tramway in Just Three Years!

Journal: Tramways and Urban Transit

AUTHOR(S): Wansbeek, C. J.

00/00/2004

AN: 00956297 Sassari: Trams Where You Wouldn't Expect Them

Journal: Tramways and Urban Transit

AUTHOR(S): Wansbeek, C. J.

00/00/2004

AN: 00954319 UK LRT: Ignore the Merchants of Doom!

Journal: Tramways and Urban Transit

AUTHOR(S): Lucas, Caspar

00/00/2004

AN: 00954320 Dessau: A Modest City Doubles Its Light Rail Network

Journal: Tramways and Urban Transit

AUTHOR(S): Wansbeek, C. J.

00/00/2004

AN: 00954321 [Chemnitz: It's Moving Up the Light Rail League](#)

Journal: [Tramways and Urban Transit](#)

AUTHOR(S): Wansbeek, C. J.

00/00/2004

AN: 00954529 [Genaeve: Tramway Expansion Is Making Up Lost Ground](#)

Journal: [Tramways and Urban Transit](#)

AUTHOR(S): Wansbeek, C. J.

00/00/2004

AN: 00954530 [Leipzig: Launching the Budget-Priced Leoliner](#)

Journal: [Tramways and Urban Transit](#)

AUTHOR(S): Taplin, M. R.

00/00/2004

AN: 00954541 [Lisboa: Three-Line Tramway South of the Tagus](#)

Journal: [Tramways and Urban Transit](#)

AUTHOR(S): Wansbeek, C. J.

00/00/2004

AN: 00954542 [Porto: A New Metro in Double Quick Time](#)

Journal: [Tramways and Urban Transit](#)

AUTHOR(S): Buckley, Richard

00/00/2004

AN: 00954604 [Light Rail: Making Urban Transport More Attractive.](#)

Journal: [Japan Railway and Transport Review](#)

AUTHOR(S): Laconte, Pierre

00/00/2004

AN: 00954605 [When Will Japan Choose Light Rail Transit?](#)

Journal: [Japan Railway and Transport Review](#)

AUTHOR(S): Utsunomiya, Kiyohito

00/00/2004

AN: 00954606 [Strategic Justification of Three Existing Modes of Transportation in Rouen](#)

Journal: [Japan Railway and Transport Review](#)

AUTHOR(S): Hue, Raymond

00/00/2004

AN: 00954607 [Manchester Metrolink Tram System](#)

Journal: [Japan Railway and Transport Review](#)

AUTHOR(S): Tyson, William

00/00/2004

AN: 00954608 Izmir Metro: Story of a Successful Engineering Project

Journal: Japan Railway and Transport Review

AUTHOR(S): Aykar, Emre

00/00/2004

AN: 00954609 Trams Making Way for Light Rail Transit

Journal: Japan Railway and Transport Review

AUTHOR(S): Hattori, Shigenori

00/00/2004

AN: 01002883 International Mass Transportation Program

Conference: Second International Conference on Urban Public Transportation Systems: Ensuring Sustainability Through Mass Transit

AUTHOR(S): Daguillard, Rita

00/00/2004

AN: 01003202 Design Build of the New Mississippi Outfall, Denver, Colorado

Conference: Pipelines 2004: What's on the Horizon?

AUTHOR(S): Kaneshiro, Jon Y.; Piek, M. Luis; Cotton, George; Stift, Michael T.

00/00/2004

AN: 01000648 The Light Rail Transit Project of Houston, Texas, USA: Phase 1

Journal: Rail Engineering International Vol. 33 No. 2

00/00/2004

AN: 01000148 Design of Cantilever Soldier Pile Retaining Walls in Stiff Clays and Claystones

Conference: GeoSupport 2004: Innovation and Cooperation in the Geo-Industry

AUTHOR(S): Sisson, Richard C.; Harris, Clint J.; Mokwa, Robert L.; Turner, John P.

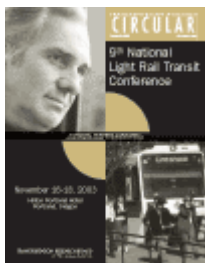
00/00/2004

AN: 01000161 "Value Engineering...?" During Construction

Conference: GeoSupport 2004: Innovation and Cooperation in the Geo-Industry

AUTHOR(S): Bedian, Maral Papazian; Turner, John P.

00/00/2004



9th National Light Rail Transit Conference

TRB Transportation Research Circular E-C058 includes the proceedings of the 9th National Light Rail Transit Conference held November 16–18, 2003, in Portland, Oregon. The ninth national conference focuses on the planning, design, construction, operation, maintenance, and administration of LRT systems.

<http://trb.org/publications/circulars/ec058/ec058.pdf>

APPENDIX F

RESEARCH PROGRESS

Search Projects > Results

Subject Category: All Categories and Keywords (Title or Abstract): "LIGHT RAIL TRANSIT"

Number of matches: 20

Design, Operation, and Safety of At-Grade Crossings of Exclusive Busways

Abstract: Exclusive busways in separate rights-of-way (ROW) frequently have at-grade crossings with roadways or pedestrian and bicycle facilities. Buses are sometimes given preferential crossing priority, similar to that given for light rail transit (LRT). Although individual transit systems have developed their own design criteria, no generally accepted guidelines exist. Research is needed to determine what operational planning and functional design treatments are appropriate to enhance safety and to maximize throughput of transit passengers for at-grade crossings of exclusive busways. This research also may contribute to the development of national guidelines on operational planning and functional design of busways. The objective of this project is to develop guidance for operational planning and functional design of at-grade crossings of exclusive busways in physically separated ROWs. The purpose of this research is to enhance safety at crossings for pedestrians, bicyclists, motorists, and transit passengers while maximizing the throughput of transit passengers.

Start date: 2004/9/29

End date: 2005/12/28

Status: Active

Source Organization: Transit Cooperative Research Program

Development of Crash Energy Management Performance Requirements for Light-Rail Vehicles

Abstract: The primary objective of this research is to provide technical assistance to enable the ASME RT-1 Committee and its Crash Energy Management (CEM) Subcommittee to determine reasonable performance requirements for dynamic crush behavior for LRV-to-LRV collisions based on a CEM approach that minimizes the probability of injury and fatality for a range of light rail vehicle (LRV) designs under various high-risk collision scenarios. As a secondary objective, the ASME RT-1

Committee and its CEM Subcommittee seek information and guidance on the technical feasibility and practicality of CEM zones to mitigate damage and human injury in roadway vehicles during LRV–roadway vehicle collisions. This research will support the current ASME RT-1 effort to develop an ASME structural safety standard for LRVs. The research should determine through engineering analyses (e.g., computer simulations) the relationships between crush behavior and the risk of occupant injury and fatality over a range of possible LRV designs and LRV-to-LRV collision scenarios. Suggestions should be provided for defining vehicle dynamic strength requirements. The research should use nonlinear, dynamic computer modeling to estimate the LRV-to-LRV crush behavior and the buff strength of several current LRV designs to assist in understanding the implications of considering a change in design requirements from static strength to CEM. It is not anticipated that computer simulation validation tests will be required for any part of this research; however, existing results of relevant tests previously performed by others may be considered. In addition, it is not anticipated that detailed computer simulations will be required for the secondary objective regarding LRV–roadway vehicle collisions. Rather, it is desired that guidance in this area can be developed based on available information and less rigorous technical analyses.

Start date: 2005/9/22

End date: 2006/12/21

Status: Active

Source Organization: Transit Cooperative Research Program

ITS Rail/Bus Integration Project: Connection Protection

Abstract: The objective of this project is to further integrate advanced traveler information system with the automated connection protection system now operating in Salt Lake City’s light rail system, to provide patrons with real-time, up-to-date information on scheduled light rail system arrival and departure times, as well as emergency messages and system notifications. Connection Protection/BusLink is a successful example of an integrated technology-based project designed to improve transit system performance and customer satisfaction. ITS America awarded this Light Rail to Bus Connection Protection Project the 2003 Best of ITS Award. The Connection Protection transit system was up and running during the 2002 Winter Olympics Games in Salt Lake City and declared a great success—effectively carrying more than 4 million Olympic riders.

Start date: 2002/9/1

End date: 2003/8/31

Status: Active

Source Organization: Federal Transit Administration

Security System Guidelines: Rail Vehicles

Abstract: The objective of this project is to develop guidelines for rapid and LRT vehicles that a transit agency may incorporate into its operations and future purchasing decisions to strengthen security. The Volpe National Transportation Center, in cooperation with rail transit system operators, will identify rail vehicle characteristics that can be modified to improve security for riders and employees. Railcar elements under review include passenger compartment–train operator intercom system, door opening system, equipment box, and other railcar elements. Transit operators will provide the industry review and comments for this project.

Start date: 2002/11

End date: 2003/11

Status: Active

Source Organization: Federal Transit Administration

Traffic Signal State Transition Logic Using Enhanced Sensor Information

Abstract: The objective of this project is to develop traffic signal state transition logic that innovatively employs sensor information. The logic will serve to improve the safety and mobility of vehicles, pedestrians, trains, and light rail transit. The project is not intended to develop a fully implementable product but to prove the concept and justify its further development for implementation.

Start date: 2003/4/23

End date: 2005/5/24

Status: Active

Source Organization: National Cooperative Highway Research Program

Safety and Security Technical Support

Abstract: The Safety and Security Technology Program places special emphasis on the evaluation and deployment of state-of-the-art technologies and other innovative enhancements that promote public health and transit safety. This technical assistance effort will provide the resources necessary to encourage transit professionals in developing an awareness and culture of technology transfer activities and actively foster and disseminate research results and best practices associated with proven safety and security technologies. Promotional materials is intended to energize the industry in the deployment of proven safety and security technologies, such as the application of four quadrant highway–rail grade crossing gates integrated into a vehicle detection system. This grade crossing technology has been successfully demonstrated to enhance safety at light rail grade crossings. By actively fostering and mainstreaming the gated technology

to transit agencies will enhance the safe operation of LRT nationwide.

Start date: 2002/9

End date: 2003/9

Status: Active

Source Organization: Federal Transit Administration

Community Visualization in Design of Light Rail Transit-Oriented Development

Abstract: The University of Kentucky Transportation Center will develop and test innovative applications of technologies for dynamic community visualization in the planning and design of LRT stations and transit-oriented development (TOD) around stations. The Transit Authority of River City, the major transit system in the Louisville, Kentucky, area, will test the system for enhancing the quality and effectiveness of its community-based transit planning process at the detailed local level with a dynamic planning and design system. To test the system this will be accomplished through the use of 3-D and virtual reality simulations of alternative solutions and scenarios, and an electronic scoring system to facilitate citizen input. This iterative process will be embedded in the overall planning process for a light rail line through Louisville and will yield new insights in combining community development techniques with multicriteria decision making and cutting-edge computer graphics. The goal is to show how these tools and techniques can be used advantageously by public transit agencies in addressing their community planning and design issues for transit stations.

Start date: 2001/12/6

End date: 2003/6/5

Status: Active

Source Organization: Transit Cooperative Research Program

Audible Signals for Pedestrian Safety in LRT Environments

Abstract: The objective of this research is to develop a guidebook on the use of audible signals and related operating procedures for pedestrian-crossing safety in a LRT environment. The research will address (1) integration of these audible devices with other crossing measures (e.g., signage, channelization, warning and control devices) to maximize safety; (2) pedestrian crossings in various environments (e.g., low-speed street running, at highway–rail grade crossings in semi-exclusive ROWs, and at stations); (3) on-vehicle and wayside audible signals; and (4) the needs of disabled individuals.

Start date: 2003/10/3

End date: 2006/4/2

Status: Active

Source Organization: Transit Cooperative Research Program

Update the “Traveler Response to Transportation System Changes” Handbook (DOT-FH-11-9579)

Abstract: This project will (1) conduct research on five additional topics specified by the project panel from Phase I of Project B-12; (2) finalize the research on five original phase topics: park-and-ride/park-and-pool, busways and express bus, transit information and promotion, land use and site design, and parking management and supply; and (3) update information on the 12 original topics if new information becomes available during the project continuation. The objective of this project is to build on the results of Phase I and to continue to develop an up-to-date and expanded handbook on the traveler response to transportation system changes.

Start date: 1999/10/5

End date: 2004/2/29

Status: Active

Source Organization: Transit Cooperative Research Program

National Bus Rapid Transit Institute

Abstract: This project provides support to Center for Urban Transportation Research (CUTR) of the University of Florida for the administration and operation of the new National Bus Rapid Transit (BRT) Institute, as well as for the conduct of workshops, and the evaluation of BRT systems. The institute will conduct new research in areas related to BRT and develop best practices manuals to assist current BRT Consortium members and others in the deployment and operation of BRT systems. The National BRT Institute was established to supplement the FTA BRT Initiative, and to serve as a national resource to transportation professionals and others. The institute provides a center for research, training, and technology transfer, as well as technical assistance and evaluation of existing and proposed BRT projects. The National BRT Institute was established jointly by CUTR and the Institute for Transportation Studies at the University of California, Berkeley. The Institute’s mission is to facilitate the sharing of knowledge and innovation for increasing the speed, efficiency, and reliability of high-capacity bus service through the implementation of BRT systems in the United States. BRT is a fully integrated, bus-based rapid transit service that combines most of the qualities of LRT with the flexibility and lower operating, maintenance, and capital cost of buses. It uses flexible service and advanced technologies to improve customer convenience and reduce delays. This is a congressionally directed project.

Start date: 2001/7

End date: 2003/7

Status: Active

Source Organization: Federal Transit Administration

Fixed Guideway Capital Cost Study: Research in Progress

Abstract: This project will provide FTA with additional capital cost information for understanding national norms. Data on commuter rail and heavy rail systems will be added to a database which contains costs of LRT systems, busways, and automated guideway systems. Areas which have implemented or are developing these systems will be involved.

Start date: 1992/10

Status: Active

TRB Accession Number: 630045

Source Organization: Federal Transit Administration

South Natomas TMA Circulator: Research in Progress

Abstract: Planning will be conducted for a local circulator service designed to connect an office park complex with existing light rail and bus service. South Natomas is a rapidly growing suburb of Sacramento, California, where local developers, employers, and commercial property owners have formed the South Natomas Transportation Management Association to alleviate traffic congestion and meet air quality standards.

Status: Active

TRB Accession Number: 643906

Source Organization: Federal Transit Administration

DBE Participation in Portland Westside Light Rail Project: Research in Progress

Abstract: Traditionally, the Portland, Oregon, area has had difficulty in meeting disadvantaged business enterprise (DBE) requirements because of the limited number of DBEs in the area. At the same time, Tri-County Metropolitan Transportation District (Tri-Met) does not have the staff resources to help DBEs participate in large projects such as the Westside Light Rail Project. This project enlarges the pool of qualified DBEs. The project objective is to use planning, capital and technical assistance programs to develop partnerships with economically disadvantaged communities to determine the design, operation, and employment in transit-related services. This project provides management and technical services to DBEs participating in the Westside Project.

Start date: 1994/3

Status: Active

TRB Accession Number: 676871
Source Organization: Federal Transit Administration

Light Rail Crossing Gates for Left-Turn Lanes: Research in Progress

Abstract: Accident records for the Los Angeles Metro Blue Line indicate that numerous train–vehicle collisions take place at grade crossings where streets run parallel to LRT tracks and motorists make left turns across the tracks. Where crossings are controlled by traffic signals only, Metro Blue Line has experienced numerous train–vehicle collisions. The use of four-quadrant gate systems at grade crossings offers an approach for eliminating or minimizing accidents without the high costs and community impacts of grade separation. This project will investigate the application of railroad gates and other types of “pop-up” barriers for left turns made from streets running parallel to the tracks at light rail crossings. In addition, the research also supports the efforts of the Los Angeles County Metropolitan Transportation Authority to evaluate the use of a video-imaging vehicle detection system in conjunction with full closure crossing gates at a highway–railroad grade crossing.

Start date: 1995/2
Status: Active
TRB Accession Number: 723682
Source Organization: Federal Transit Administration

Portland Rail-Volution Conference Video: Research in Progress

Abstract: The objective of this project is to support the efforts of Tri-Met to produce a 12- to 15-min video depicting the success of light rail and transit mall in the Portland metropolitan area. The video will also highlight the overall benefits that Oregon has experienced in terms of extensive land use planning and urban growth strategies. The professionally produced video will be used in the opening session of the Rail-Volution Conference.

Start date: 1995/8
Status: Active
TRB Accession Number: 724318
Source Organization: Federal Transit Administration

Fare Evasion

Abstract: The aims of this project are as follows: (1) to determine the true rate reason, trends and causes of fare evasion on Edmonton Transit, bus, and LRT systems; (2) to develop programs and recommendations to curb some of the fare evasion encountered;

and (3) to reduce fare evasion to an acceptable level (which needs to be determined). The bus system and LRT system will be looked at separately to determine if there is a difference and the reasons why.

Start date: 1993/11

End date: 1994/10

Status: Active

TRB Accession Number: 755868

Source Organization: TRIP, Research Projects from the ITRD Database

Enhanced Preemption Capability for Traffic Signal Controllers

Abstract: The City of Calgary operates an at-grade median running LRT system in the 36 STR N.E. corridor. The train preempts 11 traffic signals while it is traveling at speeds of up to 80 km/h. Conventional preemption features of a NEMA controller are inadequate in addressing this particular situation. The City of Calgary developed an add-on electronic “black box” that makes logical decisions on how to return from preempt. In this manner, side street movements and advance main street left turns are rescheduled if a predefined percentage of green time has not been displayed. In other words, the preempt return phase dynamic as opposed to being fixed. At present, the black box decision logic is being enhanced and incorporated into the LMD 9200 traffic signal controller by PEEK Traffic under a contract. A revised system arterial software package is being modified to oversee the traffic signal control. The enhanced preempt features can also be used by the fire department, police, and other emergency vehicles as well as by transit service.

Start date: 1993/11

End date: 1999/12

Status: Active

TRB Accession Number: 758123

Source Organization: TRIP, Research Projects from the ITRD Database

Turnkey Project Demonstration Program Support

Abstract: The FTA Turnkey Project Demonstration Program was established under the Intermodal Surface Transportation Efficiency Act of 1991 to determine if the turnkey procurement method can advance new technologies and produce cost savings on new transit projects through improved project management and control. Congress authorized FTA to undertake at least two transit projects demonstrating turnkey procurement practices. This project provides management oversight services for three of the five FTA-sponsored turnkey projects currently underway: Bay Area Rapid Transit San Francisco International Airport Extension, New Jersey Hudson–Bergen LRT, and San Juan Tren Urbano Rail Transit. Management oversight activities include project development and management control of each phase of the project, including reporting on construction

financing, cost control and other elements as well as development of a Turnkey Best Practices Manual. This project will assist FTA in monitoring turnkey projects and evaluation efficiencies.

Start date: 1998/9

Status: Active

TRB Accession Number: 784282

Source Organization: Federal Transit Administration

Transit Safety and Security Survey

Abstract: Ridership on public transportation systems is likely to decline if patrons lack a sense of safety and security. Transit agencies not only must be concerned with transit service, but also with crime and passenger safety. Under this project, surveys will be conducted of how transit customers and employees perceive the state of public safety and security on city buses, light rail, and subway systems. Data will be collected and analyzed to provide a better understanding of the perceived state of safety and security concerns of transit riders and employees. The survey results will provide FTA and transit agencies with reliable and accurate information on the perceived condition of safety and security of local transit.

Start date: 2000/9

Status: Active

TRB Accession Number: 816689

Source Organization: Federal Transit Administration

Creating Livable Communities Through LRTt: Research in Progress

Abstract: Under this project, CMT will develop and administer a survey to assess the residents' knowledge and perceptions of the linkage between livable communities and transit-oriented development (TOD), develop and distribute educational materials; and heighten public awareness of livable communities and the benefits of TOD through targeted public meetings. The attitudinal research will assist in developing a public awareness campaign that ties the transit system together, promotes its connection with better land use decisions, and highlights the benefits of developing livable communities with LRT. Research results will be used to engage the public in the merits of an integrated transit system and TODs. The campaign will work on promoting the basics of a transit system, as well as tying into the benefits of developing livable communities with LRT.

Start date: 2000/7

Status: Active

TRB Accession Number: 816724

Source Organization: Federal Transit Administration

RESEARCH LINKS

Transportation Research Board (TRB)

www.trb.org

Transit Cooperative Research Program (TCRP)

www.trb.org/crp/about/divd.asp

American Public Transportation Association (APTA)

www.apta.com

International Association of Public Transport (UITP)

www.uitp.com

Federal Transit Administration (FTA)

www.fta.dot.gov

Metro St. Louis

www.metrostlouis.org

APPENDIX G

Future Meetings

TRANSPORTATION RESEARCH BOARD

Calendar of future events: <http://www.trb.org/calendar/>

AMERICAN PUBLIC TRANSPORTATION ASSOCIATION

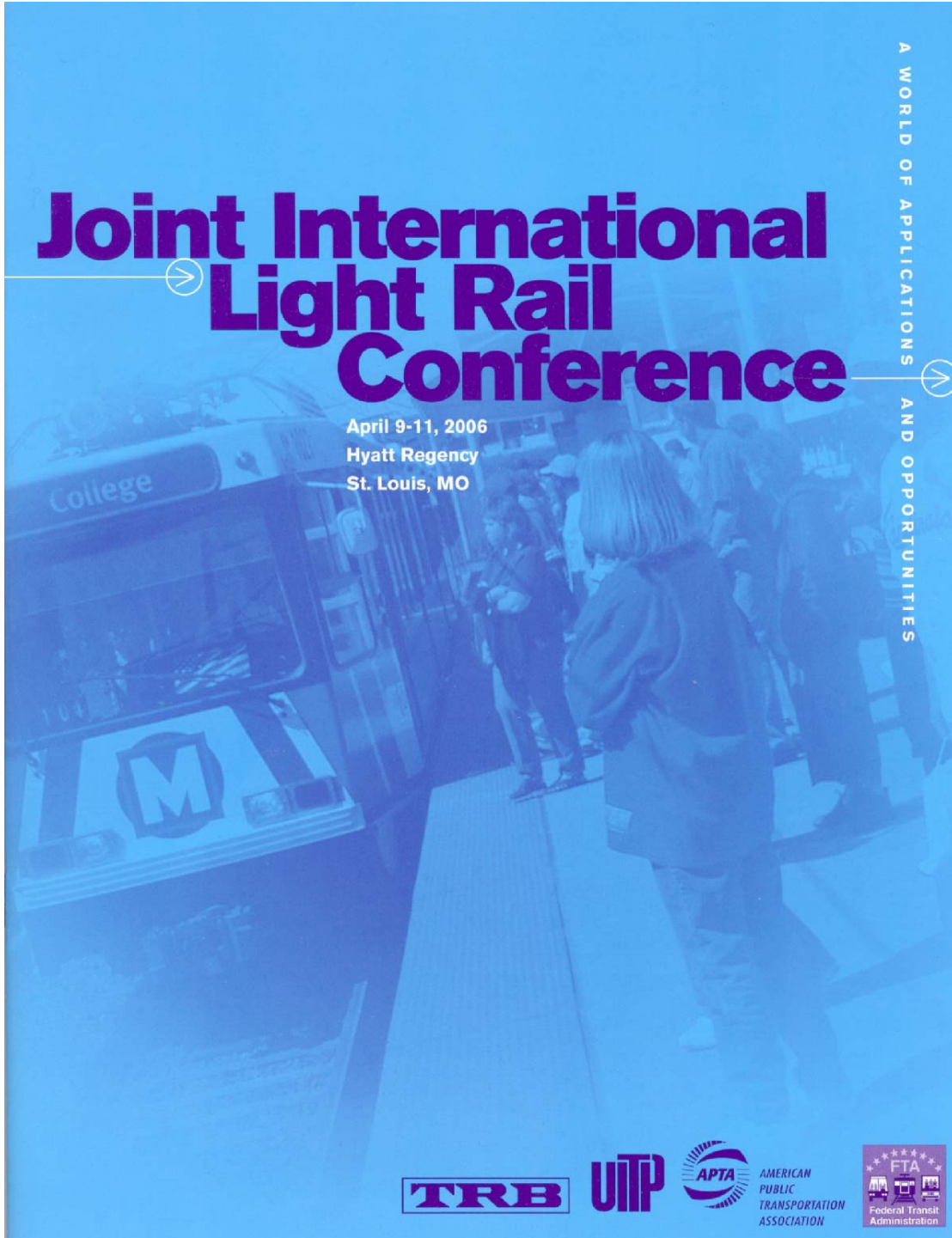
Calendar of future events: http://www.apta.com/conferences_calendar/

INTERNATIONAL UNION OF PUBLIC TRANSPORT

Calendar of future events: <http://www.uitp.com/events/index1.cfm>

APPENDIX H

Program Cover



THE NATIONAL ACADEMIES

Advisers to the Nation on Science, Engineering, and Medicine

The **National Academy of Sciences** is a private, nonprofit, self-perpetuating society of distinguished scholars engaged in scientific and engineering research, dedicated to the furtherance of science and technology and to their use for the general welfare. On the authority of the charter granted to it by the Congress in 1863, the Academy has a mandate that requires it to advise the federal government on scientific and technical matters. Dr. Ralph J. Cicerone is president of the National Academy of Sciences.

The **National Academy of Engineering** was established in 1964, under the charter of the National Academy of Sciences, as a parallel organization of outstanding engineers. It is autonomous in its administration and in the selection of its members, sharing with the National Academy of Sciences the responsibility for advising the federal government. The National Academy of Engineering also sponsors engineering programs aimed at meeting national needs, encourages education and research, and recognizes the superior achievements of engineers. Dr. William A. Wulf is president of the National Academy of Engineering.

The **Institute of Medicine** was established in 1970 by the National Academy of Sciences to secure the services of eminent members of appropriate professions in the examination of policy matters pertaining to the health of the public. The Institute acts under the responsibility given to the National Academy of Sciences by its congressional charter to be an adviser to the federal government and, on its own initiative, to identify issues of medical care, research, and education. Dr. Harvey V. Fineberg is president of the Institute of Medicine.

The **National Research Council** was organized by the National Academy of Sciences in 1916 to associate the broad community of science and technology with the Academy's purposes of furthering knowledge and advising the federal government. Functioning in accordance with general policies determined by the Academy, the Council has become the principal operating agency of both the National Academy of Sciences and the National Academy of Engineering in providing services to the government, the public, and the scientific and engineering communities. The Council is administered jointly by both the Academies and the Institute of Medicine. Dr. Ralph J. Cicerone and Dr. William A. Wulf are chair and vice chair, respectively, of the National Research Council.

The **Transportation Research Board** is a division of the National Research Council, which serves the National Academy of Sciences and the National Academy of Engineering. The Board's mission is to promote innovation and progress in transportation through research. In an objective and interdisciplinary setting, the Board facilitates the sharing of information on transportation practice and policy by researchers and practitioners; stimulates research and offers research management services that promote technical excellence; provides expert advice on transportation policy and programs; and disseminates research results broadly and encourages their implementation. The Board's varied activities annually engage more than 5,000 engineers, scientists, and other transportation researchers and practitioners from the public and private sectors and academia, all of whom contribute their expertise in the public interest. The program is supported by state transportation departments, federal agencies including the component administrations of the U.S. Department of Transportation, and other organizations and individuals interested in the development of transportation.

www.TRB.org

www.national-academies.org



TRANSPORTATION RESEARCH BOARD

**500 Fifth Street, NW
Washington, DC 20001**

THE NATIONAL ACADEMIES™

Advisers to the Nation on Science, Engineering, and Medicine

The nation turns to the National Academies—National Academy of Sciences, National Academy of Engineering, Institute of Medicine, and National Research Council—for independent, objective advice on issues that affect people's lives worldwide.

www.national-academies.org