

A Review of United States Air Force and Department of Defense Aerospace Propulsion Needs

DETAILS

289 pages | 6 x 9 | PAPERBACK

ISBN 978-0-309-10247-6 | DOI 10.17226/11780

AUTHORS

Committee on Air Force and Department of Defense Aerospace Propulsion Needs,
National Research Council

BUY THIS BOOK

FIND RELATED TITLES

Visit the National Academies Press at NAP.edu and login or register to get:

- Access to free PDF downloads of thousands of scientific reports
- 10% off the price of print titles
- Email or social media notifications of new titles related to your interests
- Special offers and discounts



Distribution, posting, or copying of this PDF is strictly prohibited without written permission of the National Academies Press. (Request Permission) Unless otherwise indicated, all materials in this PDF are copyrighted by the National Academy of Sciences.

A REVIEW OF
UNITED STATES AIR FORCE
and
DEPARTMENT OF DEFENSE
Aerospace Propulsion Needs

Committee on Air Force and Department of Defense
Aerospace Propulsion Needs

Air Force Studies Board

Division on Engineering and Physical Sciences

NATIONAL RESEARCH COUNCIL
OF THE NATIONAL ACADEMIES

THE NATIONAL ACADEMIES PRESS
Washington, D.C.
www.nap.edu

Copyright National Academy of Sciences. All rights reserved.

THE NATIONAL ACADEMIES PRESS 500 Fifth Street, N.W. Washington, DC 20001

NOTICE: The project that is the subject of this report was approved by the Governing Board of the National Research Council, whose members are drawn from the councils of the National Academy of Sciences, the National Academy of Engineering, and the Institute of Medicine. The members of the committee responsible for the report were chosen for their special competencies and with regard for appropriate balance.

This is a report of work supported by Grant F49620-01-1-0269 between the U.S. Air Force and the National Academy of Sciences. Any opinions, findings, conclusions, or recommendations expressed in this publication are those of the author(s) and do not necessarily reflect the view of the organizations or agencies that provided support for the project.

International Standard Book Number-10 0-309-10247-2

International Standard Book Number-13 978-0-309-10247-6

Limited copies are available from:

Air Force Studies Board
National Research Council
500 Fifth Street, N.W.
Washington, DC 20001
(202) 334-3111

Additional copies are available from:

The National Academies Press
Box 285
500 Fifth Street, N.W.
Washington, DC 20055
(800) 624-6242 or (202) 334-3313
(in the Washington Metropolitan Area)
<http://www.nap.edu>

Copyright 2006 by the National Academy of Sciences. All rights reserved.

Printed in the United States of America

THE NATIONAL ACADEMIES

Advisers to the Nation on Science, Engineering, and Medicine

The **National Academy of Sciences** is a private, nonprofit, self-perpetuating society of distinguished scholars engaged in scientific and engineering research, dedicated to the furtherance of science and technology and to their use for the general welfare. Upon the authority of the charter granted to it by the Congress in 1863, the Academy has a mandate that requires it to advise the federal government on scientific and technical matters. Dr. Ralph J. Cicerone is president of the National Academy of Sciences.

The **National Academy of Engineering** was established in 1964, under the charter of the National Academy of Sciences, as a parallel organization of outstanding engineers. It is autonomous in its administration and in the selection of its members, sharing with the National Academy of Sciences the responsibility for advising the federal government. The National Academy of Engineering also sponsors engineering programs aimed at meeting national needs, encourages education and research, and recognizes the superior achievements of engineers. Dr. Wm. A. Wulf is president of the National Academy of Engineering.

The **Institute of Medicine** was established in 1970 by the National Academy of Sciences to secure the services of eminent members of appropriate professions in the examination of policy matters pertaining to the health of the public. The Institute acts under the responsibility given to the National Academy of Sciences by its congressional charter to be an adviser to the federal government and, upon its own initiative, to identify issues of medical care, research, and education. Dr. Harvey V. Fineberg is president of the Institute of Medicine.

The **National Research Council** was organized by the National Academy of Sciences in 1916 to associate the broad community of science and technology with the Academy's purposes of furthering knowledge and advising the federal government. Functioning in accordance with general policies determined by the Academy, the Council has become the principal operating agency of both the National Academy of Sciences and the National Academy of Engineering in providing services to the government, the public, and the scientific and engineering communities. The Council is administered jointly by both Academies and the Institute of Medicine. Dr. Ralph J. Cicerone and Dr. Wm. A. Wulf are chair and vice chair, respectively, of the National Research Council.

www.national-academies.org

**COMMITTEE ON AIR FORCE AND DEPARTMENT OF
DEFENSE AEROSPACE PROPULSION NEEDS**

KENNETH E. EICKMANN, *Chair*, U.S. Air Force (retired)
DONALD W. BAHR, Independent Consultant
DILIP R. BALLAL, University of Dayton, Ohio
YVONNE C. BRILL, Independent Consultant
DENNIS M. BUSHNELL, NASA Langley Research Center
PAUL G.A. CIZMAS, Texas A&M University
CHARLES H. COOLIDGE, EADS North America Defense Company
DAVID E. CROW, University of Connecticut
THOMAS W. EAGAR, Massachusetts Institute of Technology
GERARD W. ELVERUM, Independent Consultant
CARL E. FRANKLIN, International Falcon Associates, Inc.
FRANK C. GILLETTE, Independent Consultant
EDWARD M. GREITZER, Massachusetts Institute of Technology
JEFFREY W. HAMSTRA, Lockheed Martin Aeronautics Company
BERNARD L. KOFF, TurboVision
MITSURU KUROSAKA, University of Washington, Seattle
D. BRIAN LANDRUM, University of Alabama, Huntsville
IVETT A. LEYVA, Microcosm, Inc.*
LOURDES Q. MAURICE, Federal Aviation Administration
NEIL E. PATON, Liquidmetal Technologies
LAWRENCE P. QUINN, Aerojet
ELI RESHOTKO, Case Western Reserve University (emeritus)
KENNETH M. ROSEN, General Aero-Science Consultants, LLC
ROBERT L. SACKHEIM, NASA George C. Marshall Space Flight
Center**
BEN T. ZINN, Georgia Institute of Technology, Atlanta

Staff

JAMES C. GARCIA, Study Director
DANIEL E.J. TALMAGE, JR., Program Officer
CARTER W. FORD, Research Associate
WILLIAM E. CAMPBELL, Senior Program Associate
LAINITA R. JONES, Senior Program Assistant
LINDA D. VOSS, Technical Writer

*Affiliation to April 6, 2006.

**Affiliation to May 5, 2006.

AIR FORCE STUDIES BOARD

LAWRENCE J. DELANEY, *Chair*, Independent Consultant
R. NOEL LONGUEMARE, *Vice Chair*, Independent Consultant
FRANK J. CAPPuccio, Lockheed Martin Aeronautics Company
THOMAS DARCY, EADS North America Defense Company
STEVEN D. DORFMAN, Air Force (retired)
PAMELA A. DREW, Boeing Integrated Defense Systems
KENNETH E. EICKMANN, Independent Consultant
JOHN V. FARR, Stevens Institute of Technology
RAND H. FISHER, Titan Corporation
JACQUELINE GISH, Northrop Grumman Corporation
KENNETH C. HALL, Duke University
WESLEY L. HARRIS, Massachusetts Institute of Technology
LESLIE KENNE, LK Associates
DONALD J. KUTYNA, Independent Consultant
TAYLOR W. LAWRENCE, Raytheon Company
GREGORY S. MARTIN, GS Martin Consulting
DEBASIS MITRA, Bell Laboratories
CHANDRA N. KUMAR PATEL, University of California, Los Angeles
RICHARD R. PAUL, The Boeing Company
ROBERT F. RAGGIO, Dayton Aerospace, Inc.
GENE W. RAY, GMT Ventures
ELI RESHOTKO, Case Western Reserve University (emeritus)
LOURDES SALAMANCA-RIBA, University of Maryland, College Park
MARVIN R. SAMBUR, Independent Consultant
LYLE H. SCHWARTZ, Independent Consultant
EUGENE L. TATTINI, Jet Propulsion Laboratory

Staff

MICHAEL A. CLARKE, Director
JAMES C. GARCIA, Senior Program Officer
DANIEL E.J. TALMAGE, JR., Program Officer
CARTER W. FORD, Research Associate
CHRIS JONES, Financial Associate
LaNITA R. JONES, Senior Program Assistant
LaSHAWN N. SIDBURY, Program Associate
DEANNA P. SPARGER, Program Administrative Coordinator
WILLIAM E. CAMPBELL, Senior Program Associate

Preface

This study responds to a request by the Deputy Assistant Secretary of the Air Force for Science, Technology, and Engineering (SAF/AQR) and the Director of Defense Research and Engineering (DDR&E) that the National Research Council (NRC) evaluate the U.S. aerospace propulsion technology base to determine if efforts under way will support necessary warfighter capabilities to 2020. The current national context for the study includes fuel prices at historically high levels, ever-increasing costs for sustaining aircraft, a decreasing domestic launch capability, and uncertainty about the availability of U.S. citizens to perform the requisite research on propulsion. All of these factors are of critical importance to U.S. national security. The committee sincerely hopes that this report—the culmination of an extremely intense effort—will enable the Air Force and Department of Defense (DoD) to make informed decisions on future aerospace propulsion needs. As chair, I want to applaud the committee members for their commitment and diligence during the study that enabled us to complete the task successfully. I also want to express the members' thanks to the Air Force and DoD for their dedicated support throughout the study and for the efforts of National Research Council staff consisting of Michael Clarke, Jim Garcia, Daniel Talmage, Carter Ford, LaNita Jones, Bill Campbell, Liz Fikre, and Anderson intern Dionna Ali.

Kenneth E. Eickmann, *Chair*
Committee on Air Force and Department of Defense
Aerospace Propulsion Needs

ROLE OF THE BOARD

The Air Force Studies Board (AFSB) was established in 1996 by the National Academies at the request of the Air Force. The AFSB brings to bear broad military, industrial, and academic scientific, engineering, and management expertise on Air Force technical challenges and other issues of importance to senior Air Force leaders. The board discusses potential studies of interest, develops and frames study tasks, ensures proper project planning, suggests potential committee members and reviewers for reports produced by fully independent ad hoc study committees, and convenes meetings to examine strategic issues. The board members listed on page vi were not asked to endorse the committee's conclusions or recommendations, nor did they review the final draft of this report before its release. Board members with appropriate expertise may be nominated to serve as formal members of study committees or to review reports.

Acknowledgment of Reviewers

This report has been reviewed in draft form by individuals chosen for their diverse perspectives and technical expertise, in accordance with procedures approved by the National Research Council's (NRC's) Report Review Committee. The purpose of this independent review is to provide candid and critical comments that will assist the institution in making its published report as sound as possible and to ensure that the report meets institutional standards for objectivity, evidence, and responsiveness to the study charge. The review comments and draft manuscript remain confidential to protect the integrity of the deliberative process. We wish to thank the following individuals for their review of this report:

Peter M. Banks, Independent Consultant,
Edgar Choueiri, Princeton University,
Earl H. Dowell, Duke University,
Kenneth C. Hall, Duke University,
Hans G. Hornung, California Institute of Technology,
Kenneth K. Kuo, Pennsylvania State University,
Carl J. Meade, Northrop Grumman Corporation,
Michael M. Micci, Pennsylvania State University,
Robert E. Schafrik, GE Aircraft Engines, and
William A. Sirignano, University of California, Irvine.

Although the reviewers listed above have provided many constructive comments and suggestions, they were not asked to endorse the conclusions

or recommendations nor did they see the final draft of the report before its release. The review of this report was overseen by Louis J. Lanzerotti, New Jersey Institute of Technology. Appointed by the National Research Council, he was responsible for making certain that an independent examination of this report was carried out in accordance with institutional procedures and that all review comments were carefully considered. Responsibility for the final content of this report rests entirely with the authoring committee and the institution.

Contents

| | |
|---|----|
| SUMMARY | 1 |
| 1 OVERVIEW | 11 |
| Background, 11 | |
| Study Tasks, 11 | |
| Capabilities-Based Planning, 12 | |
| Propulsion Research, 17 | |
| S&T Funding, 18 | |
| The Committee’s Judgment, 19 | |
| The Reliance Program, 19 | |
| Air-Breathing Propulsion Systems, 20 | |
| Challenges Facing Air-Breathing Propulsion Systems, 20 | |
| Characteristics of Aircraft Needed by Warfighters in 2020, 20 | |
| Large Gas Turbine Engine Programs, 23 | |
| Small Gas Turbine Engine Programs, 29 | |
| Expendable Turbine Engine Programs, 31 | |
| Other Technology Programs for Aerospace Propulsion, 32 | |
| Rocket Propulsion Systems for Access to Space, 35 | |
| Anticipated Military Spacelift Propulsion Needs and | |
| Identification of Critical Technologies, 35 | |
| Current Technology for Large, First-Stage (Core), Liquid | |
| Propellant Booster Engines, 37 | |

| | |
|--|--|
| Current Technology for Large, First-Stage, Strap-on, Solid Propellant Motors, 38 | |
| Current Technology for Delta IV and Atlas V Second Stages: RL-10 Family of Engines, 39 | |
| Propulsion Needs and Propulsion Technologies for Responsive Spacelift, 40 | |
| Initiatives for Developing New Aerospace Propulsion Technology, 46 | |
| The U.S. Rocket Propulsion Industry, 48 | |
| Rocket Propulsion Systems for In-Space Operations, 50 | |
| Current Propulsion Technologies, 51 | |
| Current Propulsion Research, 53 | |
| Critical Needs for Meeting In-Space Propulsion Goals, 55 | |
| Propulsion Systems for Strike and Tactical Missiles, 56 | |
| IHDRPT Goals for Improving Missile Propulsion, 56 | |
| Current HDRPT Research, 57 | |
| Two Potentially Transformative Concepts, 59 | |
| Outlook for All Rocket Propulsion Systems: Access to Space, In-Space Operations, and Airborne Missiles, 60 | |
| Cross-cutting Technologies, 60 | |
| Investment Strategy Options, 61 | |
| References, 64 | |

**Chapters 2-7 and Appendixes A-E are reproduced
on the CD-ROM that contains the full report
but are not included in the printed report.**

| | |
|---|------------------------------------|
| 2 | MILITARY PROPULSION NEEDS |
| | Background |
| | Global Strike |
| | Global Mobility and Airborne C4ISR |
| | Cross-Cutting Capabilities |
| | Reliability and Maintainability |
| | Rotorcraft |
| | Small Unmanned Aircraft Systems |
| | Economics of Turbine Engines |
| | Space |

- Summary
- References

- 3 AIR-BREATHING PROPULSION
 - Introduction
 - Large Gas Turbine Engine Programs
 - Engine Development Programs
 - IHPDET and VAATE Demonstrator and Research Programs
 - Component Improvement Programs
 - Derivative Engine Programs
 - Small Gas Turbine Engine Programs
 - Engine Requirements and Development
 - Component Improvement Programs
 - Derivative Engine Programs
 - Engine Demonstration Programs
 - Expendable Turbine Engine S&T Programs
 - Other Technology Programs
 - Ramjet and Scramjet Engine Programs
 - Pulse Detonation Engine Programs
 - High-Thrust Electric Propulsion
 - High-Energy-Density Materials as Propellants
 - Turbine Combustors
 - Distributed Propulsion
 - References

- 4 ROCKET PROPULSION SYSTEMS FOR ACCESS TO SPACE
 - Introduction
 - Current Capabilities of Large Launch Vehicles
 - Delta IV Family of Vehicles
 - Atlas V Family of Vehicles
 - Booster Engines for Large Launch Vehicles
 - First-Stage, Liquid Propellant
 - First-Stage, Strap-on, Solid Propellant
 - First-Stage, Strap-on, Liquid or Solid Propellant
 - Hybrid Propellant Strap-ons
 - Second-Stage Engines
 - Small to Medium-Sized Launch Vehicles
 - Existing Vehicles
 - Vehicle in Development

- FALCON Small Launch Vehicles
 - Air-Based Vertical Launch Concept
 - Multimission Modular Vehicle Air-Based Launch
 - ORS Requirements
 - Affordable Responsive Spacelift Vehicle
 - Initiatives to Establish New Propulsion Technology Base
 - National Aerospace Initiative
 - Integrated High-Performance Rocket Propulsion Technology
 - Air Force Research Laboratory Efforts Under IHPRPT
 - Contractor Efforts Under IHPRPT Funding
 - Other Efforts Under Government or Industry Funding:
 - New Engine Designs and New Propellants, Feed Systems, Pressurization, and Materials
 - Apparently Superior Foreign Technologies
 - Defining DoD and Air Force Needs for Propulsion Technology and Tools
 - Systems Engineering
 - Modeling and Simulation
 - Rocket Engine and Motor Test Beds
 - Important Technologies for Propulsion Systems
 - Areas That Need More Attention
 - Physical and Thermodynamic Properties of Fuels and Oxidizers
 - Propulsion Elements
 - Reliability of the Supply Base
 - Leveraging Opportunities for Access-to-Space Propulsion
 - Low-Cost, Responsive Launch Vehicles
 - Propulsion Technologies Developed by NASA
 - Status and Capabilities of the U.S. Rocket Propulsion Industry
 - References
- 5 ROCKET PROPULSION SYSTEMS FOR IN-SPACE OPERATIONS AND MISSILES
- Introduction
 - Current State of the Art in On-Orbit Propulsion
 - Chemical Propulsion
 - Electric Propulsion
 - Promising Technologies for On-Orbit Propulsion and for Tactical and Strike Missiles
 - IHPRPT Targets for Propulsion Performance

- Chemical Propulsion
 - Electric Propulsion
 - Propulsion for Strike and Tactical Missiles
 - Critical Technology Needs That Call for More Attention
 - Specific Needs
 - Other Needs
 - SCARLET: An Existing Technology That Could Be Leveraged
 - Current Work on Propulsion
 - Solid Propellant Motors
 - Hybrid Motors
 - Gelled Propellant Motors
 - Opportunities for Transformation in Accomplishing Responsive
 - Global Reach and ABM Missions
 - Air-Based Vertical Launch Concept
 - Multimission Modular Vehicle Concept
 - Critical Enabling Technologies
 - Final Observation
 - References
- 6 CROSS-CUTTING TECHNOLOGIES
- Introduction
 - Fuels
 - Gas Turbines
 - High-Altitude, Long-Endurance Unmanned Aircraft Systems
 - Expendable Missiles with Turbine Engines
 - Hypersonic and Scramjet Vehicles
 - Pulsed Detonation Engines
 - Combined Cycle Engines
 - Liquid Hydrocarbon Propellants for Rockets
 - Modeling and Simulation of Complex Hydrocarbon Fuels
 - Fuel Cost and Logistics Barriers and Alternative Fuels
 - Materials
 - High-Temperature Structural Materials
 - Combustion and Thermal Management
 - References
- 7 STRATEGIES, ISSUES, AND FUNDING TRENDS
- Maximizing the Return on Investment
 - Using the Air Logistics Center to Enhance Technology Transition

- Spiral Development
- Government and Industry Collaboration
 - Shortening the Demonstration Time
 - Reliance Program
- Innovative Contracting Mechanisms
- Mitigating Technology Risks
- Additional Issues
 - Infrastructure
 - Education
 - Basic Research
- Leveraging Other National Resources
- Foreign Aerospace Propulsion Efforts
 - Gas Turbine Engines
 - Pulse Detonation Engines and Rockets
 - Ramjets
 - Hypersonics
 - Rockets
 - Space Propulsion
- Environmental Issues
- Past and Projected Funding for S&T
- References

APPENDIXES

- A Biographical Sketches of Committee Members
- B Meetings and Speakers
- C Site Visits
- D Background Information on the Delta IV and Atlas V Families of Large Launch Vehicles
- E Background Information on FALCON Launch Vehicle Concepts

Acronyms

| | |
|-------|---|
| AATE | Affordable Advanced Turbine Engine |
| ABM | antiballistic missile |
| ABVL | air-based vertical launch |
| ACS | assembly and command ship |
| AEDC | Arnold Engineering Development Center |
| AFOSR | Air Force Office of Scientific Research |
| AFRL | Air Force Research Laboratory |
| AFSB | Air Force Studies Board |
| AFSPC | Air Force Space Command |
| AIAA | American Institute of Aeronautics and Astronautics |
| AMROC | American Rocket Company |
| AoA | analysis of alternatives |
| AP | ammonium perchlorate |
| AR | nozzle area ratio |
| ARES | Affordable Responsive Spacelift (vehicle) |
| AT&L | acquisition, technology, and logistics |
| BAE | British Aerospace |
| BMDO | Ballistic Missile Defense Organization |
| C4ISR | command, control, communications, computers, intelligence, surveillance, and reconnaissance |
| CADB | Chemiautomatics Design Bureau |

| | |
|--------|--|
| CADM | computer-aided design and manufacturing |
| CCA | cooled cooling air |
| CDR | critical design review |
| CEV | crew exploration vehicle |
| CFD | computational fluid dynamics |
| CIP | Component Improvement Program |
| CMC | ceramic matrix composite |
| CNT | carbon nanotube |
| COBRA | Co-optimized Booster for Reusable Applications |
| CONOPS | concept of operations |
| CRRA | capabilities review and risk assessment |
| CSAR | Center for the Simulation of Advanced Rockets |
| CUIP | Constellation University Institutes Project |
| CVC | constant volume combustor |
| | |
| DARPA | Defense Advanced Research Projects Agency |
| DCR | dual-combustor ramjet |
| DDR&E | Director of Defense Research and Engineering |
| DoD | Department of Defense |
| DOE | Department of Energy |
| DTAP | Defense Technology Area Plan |
| | |
| ECEP | engine capability enhancement program |
| EELV | evolved expendable launch vehicle |
| EHF | extremely high frequency |
| EMA | electromechanical actuator |
| EMDP | engine model derivative program |
| EMTVA | electromechanical thrust vector assembly |
| EOP | Executive Office of the President |
| EP | electric propulsion |
| EPDM | ethylene propylene diene monomer |
| ESA | European Space Agency |
| ETO | Earth-to-orbit |
| | |
| FAA | Federal Aviation Administration |
| FADEC | fuel-authority digital engine/electronic control |
| FALCON | Force Application and Launch from the Continental United States |
| FATE | Future Affordable Turbine Engine |

| | |
|-------------------------------|---|
| FBM | fleet ballistic missile |
| FCS | Future Combat Systems |
| FEM | finite-element model |
| FY | fiscal year |
| | |
| GE | General Electric |
| GEM | graphite epoxy motor |
| GITVC | gas injection thrust vector control |
| GLOW | gross liftoff weight |
| GOTChA | goals, objectives, technical challenges, and approaches |
| GTE | gas turbine engine |
| GTO | geosynchronous transfer orbit |
| | |
| H ₂ | hydrogen |
| H ₂ O ₂ | hydrogen peroxide |
| HAN | hydroxylammonium nitrate |
| HCV | hypersonic cruise vehicle |
| HEDM | high-energy-density materials |
| HiReTS | high Reynolds number thermal stability |
| HiSTED | High-Speed Turbine Engine Demonstration |
| HPDP | hybrid propulsion development program |
| HTPB | hydroxyl-terminated polybutadiene |
| HTV | hypersonic technology vehicle |
| HUMS | health and usage monitoring system |
| HyCAUSE | hypersonic collaboration between Australia and United States experiment |
| HyFly | Hypersonics Flight Demonstration |
| HyTech | hypersonic technology |
| HyTOP | Hybrid Technology Options Project |
| | |
| I_{sp} | specific impulse |
| IBR | integrally bladed rotor |
| IC | internal combustion |
| ICAO | International Civil Aviation Organization |
| ICBM | intercontinental ballistic missile |
| IHPRPT | Integrated High-Payoff Rocket Propulsion Technology |
| IHPTET | Integrated High-Performance Turbine Engine Technology |
| IM | insensitive munitions |
| IOC | initial operational capability |

| | |
|-------------------------------|---|
| IPD | integrated powerhead demonstrator |
| IR&D | independent research and development |
| ITAPS | integrated total aerospace power system |
| ITEP | Improved Turbine Engine Program |
| JASSM | joint air-to-surface standoff missile |
| JCIDS | joint capabilities integration and development system |
| JHL | joint heavy lift |
| JSF | Joint Strike Force |
| JTAGG | joint turbine advanced gas generator |
| lbf | pound force |
| lbf/sec | pound force per second |
| LEO | low Earth orbit |
| LH ₂ | liquid hydrogen |
| LISA | Laser Interferometer Space Antenna |
| LOx | liquid oxygen |
| LP | launch platform |
| ManTech | Manufacturing Technology |
| MBSAT | Mobile Broadcasting Satellite |
| MHD | magnetohydrodynamic |
| MMH | monomethylhydrazine |
| MMMV | multimission modular vehicle |
| MON | mixed oxides of nitrogen |
| M&S | modeling and simulation |
| MSFC | Marshall Space Flight Center |
| N ₂ H ₄ | monopropellant hydrazine |
| N ₂ O | nitrous oxide |
| N ₂ O ₄ | dinitrogen tetroxide |
| NAI | National Aerospace Initiative |
| NASA | National Aeronautics and Space Administration |
| NEXT | NASA's Evolutionary Xenon Thruster |
| NGLT | Next-Generation Launch Technology |
| NO _x | nitrogen oxides |
| NPSH | net positive suction head |
| NRC | National Research Council |
| NSSK | North-South station keeping |

| | |
|---------|--|
| NSSS | National Security Space Strategy |
| OAM | orbit adjust module |
| OC-ALC | Oklahoma City Air Logistics Center |
| OEM | original equipment manufacturer |
| ORS | operationally responsive spacelift |
| ORSC | oxygen-rich staged combustion |
| OSC | Orbital Sciences Corporation |
| OSD | Office of the Secretary of Defense |
| OSP | Orbital Suborbital Program |
| OSTP | Office of Science and Technology Policy |
| OUSD | Office of the Undersecretary of Defense |
| P_c | chamber pressure |
| PBR | Presidential Budget Request |
| PDE | pulsed detonation engine |
| PDR | pulsed detonation rocket/preliminary design review |
| PDW | pulse detonation wave |
| POM | program objectives memorandum |
| POSS | polyhedral oligomeric silsesquioxane |
| PPT | pulsed plasma thruster |
| PPU | power processing unit |
| PR | propulsion and power |
| PRV | personnel recovery vehicle |
| psi | pounds per square inch |
| psia | pounds per square inch absolute |
| P-STAR | propulsion sizing, thermal analysis, accountability, and weight relationship first-order modeling tool |
| RATTLRS | Revolutionary Approach to Time-Critical Long-Range Strike |
| RCE | reaction control engine |
| REAP2 | Rocket Engine Advancement Program |
| R&D | research and development |
| RDT&E | research, development, testing, and evaluation |
| RDX | royal demolition explosive |
| ROM | rough order of magnitude |
| SAF | Secretary of the Air Force |

| | |
|----------|--|
| SCARLET | solar concentrator array with refractive linear element technology |
| SCAT | secondary combustion augmented thruster |
| SDD | system design and development |
| SECDEF | Secretary of Defense |
| SED | single-engine demonstrator |
| SFC | specific fuel consumption |
| SFS | sequential feed system |
| SHFE | small heavy fuel engine |
| SHP | shaft horsepower |
| SLBM | submarine-launched ballistic missile |
| SLI | Space Launch Initiative |
| SLV | small launch vehicle |
| SMART 1 | small missions for advanced research in technology 1 |
| SMP FY06 | <i>Strategic Master Plan for FY06 and Beyond</i> |
| SPT | stationary plasma thruster |
| SRB | solid rocket booster |
| SRM | solid rocket motor |
| SSME | space shuttle main engine |
| S&T | science and technology |
| STOL | short takeoff and landing |
| STOVL | short takeoff and vertical landing |
| SVTI | Space Vehicle Technology Institute |
| | |
| TARA | technology area review and assessment |
| TBC | thermal barrier coating |
| THAAD | terminal high-altitude area defense |
| TM | thermal management |
| TOW | tube-launched, optically tracked, wire-guided missile |
| TPA | turbopump assembly |
| TRL | technology readiness level |
| TVC | thrust vector control |
| T/W | thrust to weight |
| | |
| UAH | University of Alabama at Huntsville |
| UAS | unmanned aircraft system |
| UCAV | unmanned combat air vehicle |
| UCC | ultracompact combustor |
| UER | unscheduled engine removal |

ACRONYMS

xxiii

| | |
|--------|--|
| USAF | U.S. Air Force |
| USET | upper-stage engine technology |
| VAATE | Versatile, Affordable, Advanced Turbine Engine |
| VaPak | vapor pressurization technology |
| V/STOL | vertical or short takeoff and landing |
| VTOL | vertical takeoff and landing |
| XIPS | Xenon Ion Propulsion System |

Summary

THE BOTTOM LINE

Additional emphasis must be placed on propulsion research or the technological lead of the United States will almost certainly cease to exist. Competing demands for national resources, coupled with reductions in industry investments in propulsion research, have created a near crisis. Compounding the situation is the change in how the Department of Defense (DoD) determines requirements. This determination is now based on capabilities rather than on perceived threats, which means that developers have to spread resources over a broader range of potential systems. As a result, new systems may not get the needed funding to reach maturity.

The Air Force annual science and technology (S&T) investment in propulsion is about \$300 million. This number reflects applied research (6.2) and early advanced development (6.3) funding; basic research funding (6.1) for propulsion is accounted for separately. In its recent budget requests, the Air Force did not project its level of propulsion S&T investment to change much in future years. Air Force funding accounts for roughly two-thirds to three-fourths of the overall DoD investment in this area, which is also fairly flat at around \$400 million per year. But flatness is not indicative of the true picture, particularly in 6.2 budgets, which can cover laboratory payroll and administration costs as well as additional internal taxes, items that have increased significantly and squeezed funds available for real S&T.

Because projected investments are flat—they do not even cover inflation—one can expect only incremental improvements in technology. Anything revolutionary could come only at the expense of existing programs or would require funding above and beyond projections. Research funding (6.1 and 6.2) is vital to the warfighter since such research is the source of new ideas and technologies and promotes the education of new engineers and scientists in aerospace propulsion.

DoD future-force planning is immature and the S&T planning process is insufficient to identify short-, medium-, and long-term propulsion requirements to provide the warfighting capabilities needed for the late 2010s. The DoD Defense Science and Technology Reliance program does not address propulsion in a coherent manner; rather, propulsion efforts are subsets of other specialty areas. Further, products of the Reliance process are only recommendations and have no binding effect on service S&T priorities and investments.

The study statement of task required the committee to “identify technical gaps and suggest rough order of magnitude (ROM), specifically applied S&T investments in these areas of propulsion.” The committee based its ROM estimates on its collective judgment, which, in turn, was based on the members’ extensive experience and expertise in aerospace propulsion. By definition, these estimates are rough; however, the committee believes each is reasonably within the correct order of magnitude. In its recent budget requests, the Air Force did not project changing its investment in propulsion S&T in future years much from its current level. The committee believes this investment needs to be increased if technical gaps are to be filled.

KEY RECOMMENDATIONS

The committee’s key recommendations are listed below. Supporting discussion for the recommendations is provided in Chapters 2-7 of the report, and the recommendation numbers here in the Executive Summary correspond to their numbers there.

Military Propulsion

Recommendation 2-1. DoD should develop strategy documents containing clear guidance on future required capabilities in all system development areas and should pursue funding to achieve those capabilities.

Air-Breathing Propulsion

Recommendation 3-1. To accelerate the development of new engine technologies, the Air Force gas turbine S&T funding should be increased significantly, from approximately \$100 million annually to a level that reflects buying power at the time when the F-15 and F-16 engines were being developed. Top priority should be given to overcoming the technology barriers that will have the largest impact on future weapons systems:

- Compressor discharge temperature limits,
- Turbine inlet temperature limits,
- High-temperature, high-heat-sink fuels for thermal management,
- Lightweight structures, and
- Signature control.

Some of these barriers apply as well to ramjet/scramjet systems.

Recommendation 3-2. The Air Force and DoD should execute a total system engineering process starting with a preliminary design to establish project feasibility when undertaking any new propulsion development program.

Recommendation 3-3. DoD should restore gas turbine S&T funding under the Versatile, Affordable, Advanced Turbine Engine (VAATE) program to the original planned level. VAATE should address the primary risk areas necessary to advance jet engine technology, which include a robust engine demonstrator program and key producibility challenges.

Recommendation 3-4. DoD should sustain the current funding for the Component Improvement Program to ensure solutions to operational problems and safety issues and the development of future upgrades.

Recommendation 3-5. DoD should reinstate an engine model derivative program (EMDP) to speed the transitioning of technology to the legacy fleet to improve safety, reliability, and affordable readiness for DoD. An earlier EMDP demonstrated its utility and value for the current fleet of engines, most of which were developed spirally through this program or similar programs in the commercial sector.

Recommendation 3-6a. The Army should consider combining its Affordable Advanced Turbine Engine (AATE) demonstration program and its unfunded Improved Turbine Engine Program, also targeted at 3,000 shaft horsepower (SHP).

Recommendation 3-6b. The Army should ensure that the size of the Future Affordable Turbine Engine (FATE) program, which remains undecided, is suitable for the demonstration of a 10,000-SHP class small gas turbine. The FATE demonstration could then form the basis for a new engine for a future heavy-lift helicopter mission or the Joint Unmanned Combat Air System mission.

Recommendation 3-6c. In addition to developing two new small gas turbines, DoD should carefully investigate innovative ways to integrate advanced engines and advanced vehicle propulsion systems. Examples here include novel inlets, exhausts, IR suppression systems, particle separators, integrated flight/engine controls, and systems to manage component health.

Recommendation 3-7. Given the criticality of the high Mach number cruise missile, DoD should support the success of these system demonstrations by funding programs to ensure the availability of high-temperature materials.

Recommendation 3-8. DoD should develop a strategy to exploit the synergies between the hypersonics programs in each of the Services for the benefit of DoD, in the form of a common technology and cost savings. There are alternative solutions for both time-critical, hardened targets and flexible space warfare, and these should also be studied and compared with the scramjet solution.

Recommendation 3-9. DoD should invest in several critical technologies that will impact all types and classes of propulsion systems: high-temperature materials, including high-temperature blade/vane materials and coatings; high-temperature and high-heat-sink fuels; lightweight structures; and accurate analytical modeling.

Recommendation 3-10. DoD should continue to invest enough in emerging propulsion technologies to preclude technological surprise. These

technologies have the potential to provide niche propulsion capabilities (e.g., for unmanned aircraft systems), future revolutionary alternatives, and improvements to gas turbine engines and conventional rockets. Current DoD funding levels for emerging propulsion technologies should be maintained or increased, and a high-level advisory body should periodically review the effort to ensure quality.

Rocket Propulsion for Access to Space

Recommendation 4-1. The Air Force should place a high priority on developing an integrated total system engineering process using quantitative life-cycle mission success as the selection criterion for near-term, highly leveraged engineering technology funded by the Air Force. This process is crucial to defining justifiable total system architectures, rocket propulsion systems requirements, and critical technologies for military space transportation to support the Air Force Space Command's *Strategic Master Plan FY06 and Beyond*.

Recommendation 4-2. DoD should begin work relatively slowly, investing about \$5 million per year, in the committee's judgment, on technology development for an advanced-cycle booster engine that could provide the basis for a new far-term access-to-space vehicle.

Recommendation 4-3. DoD should place a high priority on development of a new medium-thrust (50,000-80,000 lb) upper-stage LO_x/H₂ engine to assure the nation's strategic access to space. The cost of developing such an engine through its initial operational capability (IOC) is estimated by the committee at \$150 million to \$250 million, providing the design does not try to push new technologies to their limits.

Recommendation 4-5. In September 2005, the Defense Advanced Research Projects Agency (DARPA) downselected to just one company for Phase 2B. DARPA should continue to fund and monitor this company to completion of the Force Application and Launch from the Continental United States (FALCON) program objectives. The Air Force should evaluate the propulsion technologies to be demonstrated for the air-launched FALCON vehicle and include them in total system studies of options for operationally responsive spacelift (ORS) vehicles.

Recommendation 4-6. The Air Force and DoD should sponsor a detailed system engineering study to fully understand the transformational potential of cost-effective, operationally responsive launch of small, micro-, and nanosatellites (particularly for large-number satellite arrays) utilizing air-based vertical launch concepts. The propulsion technologies that are needed to take full advantage of such launch platforms should be identified and developed.

Recommendation 4-8. The Air Force should develop in-house test beds for liquid, solid, and hybrid rocket motors. Because limited funding seems to be at least part of the reason this is not being done, the Air Force should seek to increase the funding for both liquid and solid rocket test beds at the Air Force Research Laboratory (AFRL).

Recommendation 4-12. DoD and the Air Force should fund a program to explore various approaches to creating storable oxidizers that would significantly enhance rocket performance with different storable fuels. This program should utilize a consortium of academic, industry, and government laboratories to pursue highly innovative concepts for achieving this breakthrough.

Recommendation 4-15. The Air Force and DoD should devote more of their annual S&T rocket propulsion budget resources over the next few years to rocket propulsion; to technologies that would enable the successful introduction of mission-based ORS; and to other flexible, small-satellite launch capabilities in the medium term. The committee's estimate of the additional focused investments is \$50 million to \$75 million annually.

Rocket Propulsion for In-Space Operations and Missiles

Recommendation 5-1. DoD should support extensive basic research and technology projects for various in-space propulsion thruster concepts and for in-space electric power generation and energy storage. This fundamental long-range support need not be tied to any specific mission or platform requirement. The current range of technical opportunities is so great that progress will be directly proportional to annual resource allocations over the next 10 years. The committee estimates that at least \$20 million should be considered as a yearly allocation in these areas.

Recommendation 5-2. DoD should fund total architectures and operations studies for various future DoD/Air Force missions to determine the advantages of on-orbit refueling capability. Future funded technology work should complete the validation of full operational design criteria for the transfer of hydrazine. Those basic design criteria should be expected to be applicable to other storable low-vapor-pressure fuels like monomethylhydrazine (MMH). A subsequent program should be instituted to extend the technologies to storable oxidizers such as mixed oxides of nitrogen (MON) and, finally, to liquid oxygen (LOx). The committee believes a funding level of \$10 million per year, in addition to that discussed in Recommendation 5-1, over the next 10 years would permit finalizing an IOC module for N_2H_4 and pursuing subsequent technology demonstrations with MON and LOx.

Recommendation 5-3. The Air Force and DoD should establish an explicit plan with appropriate funding to develop really capable in-house test beds for developing the technology for motors using solid propellants and engines using liquid propellants and for validating design criteria.

Recommendation 5-4. DoD should ensure that the development of advanced tactical missiles, responsive global-reach missiles, and antiballistic missiles (ABMs) satisfies four key requirements: effective energy/trajectory management, higher-energy-density performance, minimum smoke exhaust, and insensitive propellants. The S&T part of the DoD/Air Force strategic plan for missiles should focus on the technologies and design criteria necessary to meet these goals. The committee's estimate of annual funding that would be required to make reasonable progress in establishing advanced capabilities in these areas is \$20 million to \$30 million.

Cross-cutting Technologies

Recommendation 6-1. The Air Force should initiate a 5- to 7-year comprehensive program of fundamental fuels research. The goal of this program should be to study properties of smart fuel additives; surrogate fuels; synthetic fuel process technologies; synthetic fuels produced from feedstocks such as coal, oil shale, and biomass; and synthetic-conventional fuel blends. Systematic molecular and chemical kinetics modeling studies should be performed to establish a fundamental database of fuel and combustion properties.

Recommendation 6-2. The Air Force should fund manufacturing technology (ManTech) at a level sufficient to enable future advances in materials for propulsion technology.

Strategies, Issues, and Funding Trends

Recommendation 7-1. Engine test capabilities at the Oklahoma City Air Logistics Center (OC-ALC) should allow for engineering changes of existing hardware to be accomplished by the cognizant engineering authorities and, after configuration control board approval, for demonstrating the approved technology-enhanced hardware or accessory on the government test stand at OC-ALC. This would shorten the cycle time for introducing minor engineering improvements into the current legacy fleet of engines and reduce the overall costs to accomplish the qualification. Additionally, it would provide a test bed on which to qualify non-original-equipment-manufacturer (non-OEM) repaired or reengineered parts, new sources of repair, or non-OEM suppliers of parts.

Recommendation 7-2. DoD should change the way it manages, contracts for, and buys fuel for the existing fleet. Three years after a system enters into service, budgets for repairs, component improvement, and overall fuel cost should be transferred to the base that maintains the propulsion system. In addition, testing to qualify engine repairs and component improvements should be conducted at the facilities responsible for maintaining the engine.

Recommendation 7-3. The Air Force and DoD should apply spiral development to all weapons systems that are in service longer than it takes to develop a new generation of technology.

Recommendation 7-4. DoD should adopt commercial best practices to reduce costs and exploit the technical expertise of its research laboratories to enhance the integration process in its product centers and depots.

Recommendation 7-5. DoD and major propulsion contractors should define the process changes needed to produce 1- to 2-year technology demonstrations. Decreasing the interval between demonstrations of technology in major propulsion systems will increase the rate of technology development.

Recommendation 7-6. To reduce the cost of fuel burn and of sustaining the portion of the existing fleet that will be in service in 2020, DoD should develop innovative contracting methods to facilitate the incorporation of evolving technologies into existing engines.

Recommendation 7-7. AFRL should maintain a core competency in propulsion technologies by strengthening its unique infrastructure to meet future warfighter needs.

Recommendation 7-9. DoD should restore 6.2 and 6.3 technology development funding to levels that give buying power equal to the level that prevailed when the United States held an undisputed lead in engine technology—i.e., the time when the F100 and F110 engines were being developed. DoD should aggressively pursue strategies to reduce sustainment and other recurring costs. It should increase 6.1 funding commensurately.

Recommendation 7-10. The Director, Defense Research and Engineering (DDR&E) should undertake a focused effort on cataloging and making accessible the findings of past technology programs, perhaps even combining the VAATE, the Integrated High-Payoff Rocket Propulsion Technology, and the Integrated High-Performance Turbine Engine Technology databases at the lower taxonomy levels to enhance technology cross-fertilization. DDR&E should also establish a feedback process and facilitate a cross-cutting flow of S&T during the development, acquisition, and sustainment phases.

PRIORITIZATION OF COMMITTEE RECOMMENDATIONS

Table ES-1 shows the committee's prioritization, based on its members' collective judgment, of all recommendations contained in the report.

TABLE ES-1 Prioritization of Recommendations

| Near Term ^a | Medium Term ^b | Far Term ^c |
|------------------------|--------------------------|-----------------------|
| 2-1 (H) | 3-9 (H) | 3-6b (M) |
| 3-1 (H) | 4-2 (M) | 3-9 (H) |
| 3-2 (H) | 4-4 (M) | 3-10 (M) |
| 3-3 (H) | 4-7 (M) | 4-5 (M) |
| 3-4 (H) | 4-8 (H) | 4-6 (H) |
| 3-5 (H) | 4-10 (H) | 4-8 (H) |
| 3-6a (H) | 4-11 (M) | 4-12 (H) |
| 3-6c (M) | 4-12 (H) | 5-1 (H) |
| 3-7 (H) | 4-14 (H) | 5-2 (M) |
| 3-8 (H) | 4-15 (H) | 7-4 (H) |
| 3-9 (H) | 5-1 (H) | 7-7 (H) |
| 4-1 (H) | 5-2 (M) | 7-8 (H) |
| 4-3 (H) | 5-3 (H) | 7-9 (H) |
| 4-4 (M) | 5-5 (M) | 7-11 (H) |
| 4-6 (H) | 5-6 (M) | |
| 4-9 (H) | 5-7 (H) | |
| 4-10 (H) | 7-4 (H) | |
| 4-12 (H) | 7-5 (H) | |
| 4-13 (H) | 7-7 (H) | |
| 4-14 (H) | 7-8 (H) | |
| 5-1 (H) | 7-9 (H) | |
| 5-4 (M) | 7-11 (H) | |
| 5-7 (H) | 7-12 (H) | |
| 6-1 (H) | | |
| 6-2 (H) | | |
| 7-1 (H) | | |
| 7-2 (M) | | |
| 7-3 (H) | | |
| 7-4 (H) | | |
| 7-5 (H) | | |
| 7-6 (H) | | |
| 7-7 (H) | | |
| 7-8 (H) | | |
| 7-9 (H) | | |
| 7-10 (M) | | |
| 7-11 (H) | | |
| 7-12 (H) | | |

NOTE: H, high priority; M, medium priority. Some recommendations are applicable across all terms.

^aLess than 2 years.

^b2-5 years.

^cMore than 5 years.

1

Overview

BACKGROUND

Study Tasks

Because rocket and air-breathing propulsion systems are the foundation on which planning for future aerospace systems rests, the Deputy Assistant Secretary of the Air Force for Science, Technology, and Engineering (SAF/AQR), with support from the Director, Defense Research and Engineering (DDR&E), asked the Air Force Studies Board (AFSB) of the National Research Council (NRC) to review and comment on the planning for propulsion development that is under way at the Department of Defense (DoD) and the commercial technical base for these air-breathing and rocket engines that allow access to space and for in-space propulsion systems (see Box 1-1 for the study's statement of task). This full-spectrum propulsion study assesses the existing technical base in these areas and examines the future Air Force capabilities the base will be expected to support; it also defines gaps and recommends where future warfighter capabilities not yet fully defined could be met by current science and technology (S&T) development plans. The recommendations in this report may shape DoD engine development planning for the next 15 years and, possibly, military capabilities beyond that.

BOX 1-1
Statement of Task

The NRC will:

- Catalog anticipated military propulsion, spacelift, and in-space propulsion needs out to the year 2018.
- Review current and future planned civil, commercial, and defense S&T activities in the areas of propulsion, including turbine propulsion, spacelift, and in-space propulsion (2004-2018).
- Identify technical gaps and suggest rough order of magnitude (ROM), specifically applied S&T investments in these areas of propulsion.
- Identify specific opportunities for leveraging between the civil, commercial, and defense S&T activities in these areas of propulsion.
- Suggest strategies for future S&T activities in these three propulsion areas and the transition of these activities into potential military programs.
- Estimate the military capabilities that could be achieved at several different ROM levels of S&T investment in the areas of propulsion.

The report will discuss (1) the potential range of warfighter capabilities that may need to be addressed by the propulsion technical base; (2) the programs/activities under way in the technical base; and (3) an initial discussion of perceived gaps, inadequacies, disconnects, and/or omissions. The report will provide the NRC recommendations for dealing with these issues and a rough order of magnitude estimate of the investment needed to address them.

Capabilities-Based Planning

The committee soon discovered that the capabilities-based planning currently in use throughout DoD is still quite immature and does not allow propulsion needs to be easily determined (Bexfield and Disbrow, 2005).¹

¹Capabilities-based planning is a form of all-threats planning. It addresses growing uncertainty in the threat environment by using a wide range of possible scenarios to bound

Further, DoD's S&T Reliance planning process has been modified to adapt to the capabilities-based planning process, interrupting the technology area reviews and assessments for 1 year.

In addition, capabilities-based planning, which involves analyzing the alternatives for any given capability, does not specify system solutions until after the analysis is complete and a decision has been made. This methodology requires that the technical base programs funded within the S&T budget cover a broad spectrum of alternatives to enable potential future capabilities. Clearly, a technical base manager would seek maximum definition of the capabilities likely to be needed, while a capability definer, usually the warfighter, would like the technical base to be flexible and general enough to support any defined need. Unfortunately, at the present time, neither group can attain the clarity it would like, for a number of reasons.

With this reality in mind, the committee sought to determine the extent to which future capabilities can be clearly defined and how the propulsion technical base can be structured to realize them. One would expect to see a propulsion technical base consisting of numerous programs at technology readiness levels (TRLs) of 2 or 3 awaiting orders to be matured to TRL 6 or 7. To do this successfully, realistic development roadmaps and funding profiles for crossing the gulf between TRLs 3 and 6 would be developed and kept up-to-date to create a basis for program objectives memorandum (POM) development. If this were the real-world case, the committee's data-gathering efforts would have been relatively straightforward. However, the committee members assigned this task found, with a few exceptions, neither well-defined capabilities nor realistic technology transition planning.

For the purpose of this report and in lieu of clearly stated needed capabilities, the committee's analysis must be based on a great deal of informal and anecdotal information gathered through contacts with both capabilities planners and the technical base managers attempting to satisfy the planners and on briefings provided to the committee from the Services, DDR&E, the Defense Advanced Research Projects Agency (DARPA), the National Aeronautics and Space Administration (NASA), and various academic and

requirements and thereby reduce the tendency to fixate on a certain threat, location, or set of conditions. DoD has shifted during the past 4 years from the threat-based model that dominated defense planning in the past to a model focused on capabilities—a model that places emphasis more on how an adversary might fight rather than on who the adversary might be or where the war might occur. This model is designed to plan for uncertainty—the defining characteristic of today's strategic environment. A more detailed explanation of capabilities-based planning and processes is found in Chapter 2.

industry representatives. This is not to say that there are no documents that help define potential future technology developments. There are. In fact, one excellent example is the *Department of Defense Space Science and Technology Strategy*, cosigned by the Air Force Under Secretary and the DDR&E and discussed in Chapter 4 (DoD, 2004). However, in informal discussions with Air Force Research Laboratory (AFRL) and Air Force Space Command (AFSPC) personnel, it became obvious that this strategy was not the determinant of their marching orders and was considered to be only one out of several strategies in play. The committee concluded that even when clear direction exists, it is not always followed.

Air Force Vision 2020 Capabilities Review and Risk Assessments reviews the global strike, homeland security, global mobility, global persistent attack, nuclear response, and space and C4ISR tasks or missions. The capabilities required are (1) command and control; (2) intelligence, surveillance, and reconnaissance; and (3) force application and force projection. Based on its review of the Air Force Master Capabilities Library (USAF, 2005) and presentations made to it, the committee highlighted some of the missions for which propulsion capabilities will be needed in the 2020 time frame, along with particular requirements:

Global or Long-Range Strike

- Achieve desired effect(s) rapidly and/or persistently, on any target;
- With little or no warning time;
- In any environment, including those where weapons of mass destruction may be located; and
- Having been denied contiguous areas from which to operate.

Global Mobility and Airborne C4ISR

- Global mobility (airlift and air refueling)
 - Robust, sustained, adverse weather capabilities for deployment, employment, and redeployment and
 - Survivable in radio frequency, infrared, and directed-energy environments.
- Airborne C4ISR
 - Ability to shorten the kill chain by achieving better situational awareness;
 - Platforms that can persist for hours/days;

- Ability to operate from long distances; and
- Platforms that are globally connected (node in a sensors, datalink, and fused intelligence network).

Reliability and Maintainability

- Consider that 60 percent of present military aircraft inventories will still be in service in 2018;
- Use the Component Improvement Program (CIP) to replace low-reliability parts;
- Utilize evolutionary programs to develop reliable, efficient, low-cost turbine engines; and
- Minimize total life cycle cost.

Cross-cutting Capabilities/Needs

- Stealth/survivability;
 - Inlet/exhaust integration and flow control
- Increased ranges and payloads;
- Increased size of operational envelopes (missiles and air-breathing);
- Address power densities for sensor suites, directed-energy weapons; and
- Environmental factors (noise, emissions).

Rotorcraft

- Military uses 1960s and 1970s technology
 - DoD has elected to use commercial technology and
 - Commercial rotor technology not designed for DoD operating environments.
- Future needs for
 - Air Force: rapidly deployable, highly reliable, survivable, all-weather, long-range platforms;
 - Special operations, combat search and rescue, medium lift (e.g., noncombatant evacuation operation);
 - Miscellaneous support and force protection;
 - Army: responsive, deployable, agile, versatile, lethal, survivable, sustainable, and dominant anywhere;
 - More range and payload;

- Reduced logistics footprint; and
- Low operational and support costs.

Small Unmanned Aerial Systems

- Hovering/perching small unmanned aircraft systems (UASs) and micro-UASs
 - Micro: 1-3 nm range/day/fair wx, 0.5 lb payload, and field supportable;
 - Man-portable: 1-2 hr endurance, 1-2 lb payload, and field supportable; and
 - Tactical class: 10-12 hr endurance, 100 lb payload, and multimission.

Munitions

- Range of requirements from low speed, long endurance to high speed, long range;
- Small size, low observable;
- Long shelf life; and
- Increased power requirements (USAF, 2005).

Finding 2-1. Space strategy is clearly defined by the DoD Space Science and Technology Strategy. However, it is not being followed except as part of a broader set of strategies deriving from other considerations. There appear to be no similar documents at the level of the Office of the Secretary of Defense (OSD) that set forth the strategies for developing capabilities in other important areas such as aircraft systems and UASs.

Recommendation 2-1. DoD should develop strategy documents containing clear guidance on future required capabilities in all system development areas and should pursue funding to achieve those capabilities.

With a clearer understanding of the capabilities that are needed, technical base managers can reassess their programs to identify the program elements that will allow them to draw up the necessary technology transition roadmaps and funding profiles. Service leaders would then be in a much better position to assess alternative capabilities. The committee's judgments are based specifically on data gathered about propulsion technology devel-

opment and not on the broader aspects of technology development and transition. For example, specified propulsion capabilities for assured access to space—survivable, low-cost, and reliable launch systems to enable on-demand launch of payloads to any orbit and altitude required—would be sufficient to focus propulsion research and development. However, the committee fears that basing important analyses of alternatives on less than fully considered cost and schedule realities does not serve decision makers well.

Propulsion Research

It is clear to the committee that unless additional emphasis is placed on propulsion, the technological lead the United States has enjoyed for so long, and perhaps taken for granted, will cease to exist. This very complex issue will become obvious to anyone who reads this report, and the decrease in funding for propulsion research in this country and the narrowing of the technological lead this country enjoys over other countries cannot be ignored. The culmination of a number of events, some interdependent and others independent, has gotten us to this point. The demands for resources for everything from fighting the war on terror; responding to natural disasters like the tsunami in Indonesia and Hurricane Katrina at home; to modernizing our military forces, health care, and education have made it very difficult to maintain funding for propulsion research. That fact, coupled with reductions in industry investments in propulsion research, has created a near crisis.

Engine original equipment manufacturers (OEMs) historically invested a percentage of their engine sales in research for the next-generation engine. Significant reductions in military engine acquisitions for many years and the downturn in commercial sales since 9/11 have contributed greatly to this situation. Compounding the situation is the above-mentioned change in how DoD determines its requirements, from a threat-based system to a capabilities-based system. Although this change was made in response to the uncertainty surrounding any given threat and the need to be able to respond to an increasing variety of threats, it makes the job of the research and development (R&D) community much more difficult. In the past, this community could develop a propulsion system for a given threat, or at least devote its resources to such an undertaking. Today, it must spread its resources over a number of systems that have the potential to provide a given capability. As a result, none of these systems may get the priority or funding they need to reach maturity and provide the capability needed.

S&T Funding

The Deputy Assistant Secretary of the Air Force for Science, Technology, and Engineering (SAF/AQR) told the committee at its first meeting that the Air Force annual S&T investment in propulsion and power (PR) was about \$300 million and was not likely to change much in future years.² This number reflects funding for 6.2 and 6.3 research only. Any 6.1 propulsion-related funding is accounted for separately as part of basic research, which is administered by the Air Force Office of Scientific Research (AFOSR). The overall DoD funding includes Army, Navy, and DARPA funding as well as funding for programs emanating directly from DDR&E. The Air Force funding in PR makes up between 66 and 75 percent of the overall DoD investment in this area. In FY04 and FY05, Air Force funding for PR was \$291 million and \$297 million, respectively, as the result of congressional add-ons to the Presidential Budget Requests (PBRs) of \$251 million and \$234 million. The Air Force projects increases in PBRs from \$252 million in FY06 to \$305 million in FY11. The overall DoD investment in PR from FY04 to FY07 remains fairly flat at around \$400 million to \$410 million except for a spike to \$440 million in FY05.³

The flatness of the numbers does not give a true picture, however, particularly for 6.2 work, where the budgets in gas turbine technology from FY02 to FY06 were fairly flat but cover AFRL payroll and administration costs. While the amounts for in-house R&D remained fairly flat, the amounts for industrial R&D fell precipitously over the FY02-FY06 period. The committee finds that there has already been significant erosion of the U.S. lead in propulsion technology and that a flat budget will lead to further erosion.

Because the investments projected through FY07 are flat—they do not even cover inflation—one can expect only incremental improvements in technology over this period. Anything revolutionary would have to be funded at the expense of existing programs or would require additional

²Jim Engle, Deputy Assistant SAF/AQR, discussion with the committee on March 1, 2005.

³The principal Air Force and DoD-funded PR programs include the Integrated High-Performance Turbine Engine Technology (IHPTET) program, the Versatile, Affordable, Advanced Turbine Engine (VAATE) program, the High-Speed Turbine Engine Demonstration (HiSTED) program, the Revolutionary Approach to Time-Critical Long-Range Strike (RATTLRS) program, the Hypersonics Flight Demonstration (HyFly) program, and the Force Application and Launch from the Continental United States (FALCON) program.

funding. Funding for 6.1 and 6.2 research is vital to the warfighter since such research is the source of new ideas and technologies and educates new engineers and scientists in aerospace propulsion.

The Committee's Judgment

The study statement of task required the committee to “identify technical gaps and suggest rough order of magnitude (ROM), specifically applied S&T investments in these areas of propulsion.” The committee based its ROM estimates on its collective judgment, which, in turn, was based on the members’ extensive experience and expertise in aerospace propulsion. By definition, these estimates are rough; however, the committee believes each is reasonably within the correct order of magnitude. In its recent budget requests, the Air Force did not project changing its investment in propulsion S&T in future years much from its current level. The committee believes this investment needs to be increased if technical gaps are to be filled.

The Reliance Program

The DoD Science and Technology Reliance program (the Reliance Program) was originally mandated by the Service Assistant Secretaries to focus resources on propulsion requirements and capabilities (DMR 922) as part of the 1989 Deputy Secretary of Defense challenge to the Services to increase efficiency in research, development, testing, and evaluation (RDT&E). As discussed in Chapter 2, the committee heard anecdotally from informed sources that the Air Force was the lead service in work on propulsion for the Reliance Program. Since the Air Force has been by far the largest investor in the S&T arena in air-breathing propulsion and rocket propulsion, the committee felt this information made sense. However, when the committee reviewed the Reliance Program it found no mention of a lead service for propulsion. In fact, the Defense Technology Area Plan (DTAP) divided responsibility for propulsion among four panels: air platforms, nuclear technology, space platforms, and weapons.

The committee believes that having propulsion spread over different DTAP panels results in overlapping, unfocused efforts on the part of the various Services as well as the panel subject areas. Further, the panels’ efforts do not set any priorities for DoD technology objectives. The Reliance Program, as presently structured, also does not give the panel chairs the authority they need to achieve cooperation and discipline in Reliance

Program execution. Overall, the present Reliance Program organizational construct tends to inhibit the maturation of propulsion efforts, from basic research (6.1) to applied R&D (6.2, 6.3) and demonstrations (6.2, 6.3), and the coordination of their funding across DoD.

AIR-BREATHING PROPULSION SYSTEMS

Challenges Facing Air-Breathing Propulsion Systems

The Air Force is transitioning to a capabilities-based planning model. DDR&E presented capabilities requirements for the 2020 time frame for four warfighting scenarios: traditional, irregular, catastrophic, and disruptive (Sega, 2005). The propulsion challenges are discussed in Box 1-2. The committee looked at DDR&E's capabilities requirements and the capabilities of the current operational systems that will still be in service in the 2020 time frame to define the technology requirements, the opportunities for technology improvement, and opportunities to leverage different business approaches to meet the needs of 2020 warfighters.

Characteristics of Aircraft Needed by Warfighters in 2020

From the information it had gathered, the committee was able to paint an overall picture of the 2020 warfighter's fleet powered by air-breathing propulsion systems:

- First, over 60 percent of the aircraft that will be used by the 2020 warfighter are in service today. If the Joint Strike Fighter (JSF) F-35 is included, then it would mean that over 80 percent of the 2018 fleet exists or is under development today. Additionally, the costs of sustaining and fueling this fleet are the two most expensive items in the budget and are growing rapidly.
- Second, time-critical targets and the expected decrease in the number of forward bases make high-speed aircraft a requirement for the 2020 warfighter. Two main types of propulsion systems not in operation today will be required to provide this speed capability: gas turbine engines (GTEs) that operate in the Mach 3.6 to 4.2 range and ramjets/scramjets that operate in the Mach 4.0 to 16 range. In fact, some capabilities may require combining cycle propulsion

BOX 1-2 Propulsion Challenges

Future U.S. armed forces must address an array of challenges that far surpass those faced in the past. Numerous security studies have described the evolving and transformational nature of the U.S. security environment. In response to these challenges, aircraft propulsion systems must evolve more rapidly than ever before. The four propulsion challenges are traditional, irregular, catastrophic, and disruptive:

- “Traditional” challenges require continued improvements in legacy performance metrics for GTEs. Some of these metrics are propulsion system thrust-to-weight (T/W) ratio, fuel consumption, life-cycle cost, and durability. Continued improvement of these metrics will allow the United States to maintain its technical superiority in GTEs and will provide an opportunity to reduce the cost of maintaining, supporting, and fueling currently fielded engines.
- “Irregular” challenges require improvements in propulsion system stealth, survivability, austere basing (e.g., short and vertical takeoff and landing), and greatly improved fuel economy for long loiter times. Propulsion systems optimized for UASs will also play a major role in this area.
- “Catastrophic” challenges require propulsion systems that power vehicles to high Mach numbers to counter time-critical targets. Propulsion systems for long-range strike missions must power manned vehicles, which cruise between Mach 2 and Mach 3.5. Hypersonic vehicles, which cruise between Mach 4 and Mach 16, are required to stand off and strike time-critical targets or to protect the homeland from incoming weapons.
- “Disruptive” challenges require propulsion systems to power vehicles for directed-energy weapons or to counter directed-energy weapons. Propulsion technologies such as integrated thermal and power management, high-heat-sink fuels, and large electrical generating capacity are required to meet these threats. These propulsion systems will also be required to power miniaturized, autonomous, networked sensor and/or weapon systems (adapted from Sega, 2005).

systems where both gas turbine and ramjets/scramjets are integrated into an overall propulsion system.

- Third, mobility and the ability to remain over the target or staging areas for an extended time require propulsion systems much more fuel-efficient than those in service today.

These three overarching characteristics of the 2018 warfighter's aircraft guided the committee as it reviewed existing and proposed programs and business models. The committee divided the gas turbine requirements into three classes of engine: large (more than 10,000 lb thrust), small (rotorcraft-type engines), and expendable (missile-type engines). It reviewed technology and business opportunities for existing propulsion systems, propulsion systems under development, and future propulsion systems for each engine class. It also reviewed ramjet and scramjet propulsion systems for both aircraft and missile applications.

The aircraft GTE has been continually evolving and improving since its introduction during World War II. Although significant advancements in fundamental engine performance parameters have been realized, there remains substantial potential for improvement beyond the state of the art. The efficiency of fielded military GTEs was improved by increasing compressor outlet temperature (T_3) and turbine inlet temperature (T_{41}). For example, the fuel efficiency of large turbofan engines has been improved, but only 38 percent of the gap between the first jet engines and the theoretical Brayton cycle limit has been eliminated. An additional 15 percent gain in fuel efficiency could be realized in large GTEs between now and the end of the 2020 planning horizon. Similarly, today's small turboshaft, turbojet, and expendable engines have increased specific horsepower, but by only 33 percent of the theoretical Brayton cycle limit. Between now and the end of the 2020 planning horizon, small GTE efficiency could be further improved by 30 percent. The committee believes that five technologies are critical to obtaining the improvements: (1) high-temperature compressor disk materials, (2) high-temperature turbine blade materials, (3) thermal management systems utilizing high-temperature, high-heat-sink fuels, (4) lightweight hot structures, and (5) signature controls.

Finding 3-1. Gas turbine engines will continue to play a dominant role in propulsion in future warfare. Their performance can be improved enough (15-20 percent) to meet a wide range of future warfighter needs if they are given adequate funding during the planning horizon. The FY06 President's

planned budget funding levels for gas turbine S&T in FY06 are one-half to one-third pre-FY00 levels. This level of funding will not produce engine technology that allows U.S. aircraft to dominate future air wars.

Recommendation 3-1. To accelerate the development of new engine technologies, the Air Force gas turbine S&T funding should be increased significantly, from approximately \$100 million annually to a level that reflects buying power at the time when the F-15 and F-16 engines were being developed. Top priority should be given to overcoming the technology barriers that will have the largest impact on future weapons systems:

- Compressor discharge temperature limits,
- Turbine inlet temperature limits,
- High-temperature, high-heat-sink fuels for thermal management,
- Lightweight structures, and
- Signature control.

Some of these barriers apply as well to ramjet/scramjet systems.

Recommendation 3-2. The Air Force and DoD should execute a total system engineering process starting with a preliminary design to establish project feasibility when undertaking any new propulsion development program.

Large Gas Turbine Engine Programs

Large GTEs are the backbone of the military aviation force that guards U.S. interests at home and abroad, and they play an enormous role in establishing U.S. air dominance at the battlefield. Owing to the technological superiority gained from programs such as IHPTET, current turbine engines have enabled U.S. forces to achieve air dominance in all recent conflicts. To maintain this edge, however, the United States must meet the increasing demand by the armed forces for more efficient, survivable, and lethal weapon systems. At the same time, the military needs to make those systems more affordable to minimize the impact of military demands on the federal budget. This may be accomplished through continual R&D in the turbine engine field.

A new generation of aircraft and propulsion systems technology is introduced to warfighters roughly every 25 years. Today the United States is

fielding state-of-the-art large GTEs for the F-22 and the F-35. The propulsion technologies in these engines are the result of roughly two decades of efforts by the IHPTET program,⁴ Manufacturing Technology (ManTech),⁵ other DoD programs, and NASA aeronautics programs (DSB, 2006). The resulting propulsion systems are technically, in the committee's view, approximately 10 years ahead of competing systems such as that in the Euro-Fighter, which does not allow it to supercruise or have thrust vectoring or stealth features. The level of Euro-Fighter engine technology is roughly equivalent to the technology levels in the most advanced F-15 engines (F100-PW-229 and F110-GE-129). This 10-year technology advantage is much smaller than the 20-year advantage in the 1970s, when the F-15 and F-16 were launched. Current DoD funding for gas turbine S&T is much less than in the 1990s, and if it is not increased, the United States will probably lose its GTE technical advantage, as has happened in civil aviation.

IHPTET and VAATE Demonstrator and Research Programs

Since turbine engines are so critical to the capabilities of military aircraft, DoD has pioneered many advances through demonstrator and research programs such as its preeminent turbine engine research programs IHPTET and VAATE. IHPTET, begun in 1988, reached its conclusion in 2005; VAATE, begun in 1999, extends to 2017.

⁴See, for example, the IHPTET Web site at <http://www.pr.af.mil/divisions/prt/ihptet/ihptet.html>. Last accessed on March 27, 2006.

⁵See, for example, the ManTech Web site at <https://www.dodmantech.com/>. Last accessed on March 27, 2006. ManTech is a program that develops new manufacturing processes for new technologies (DSB, 2006). During large system design and development (SDD) programs, there are usually new technologies proposed to save weight, cost, and performance or improve durability. For example, some recent programs have proposed integrally bladed rotors (IBRs), ceramic matrix composite (CMC) materials, and low-observable coatings. In addition, ManTech has been working on methodologies and manufacturing techniques to replace IBR blades in overhaul. During the prototype phase, CMCs and low-observable coatings are usually developed in the laboratory experimentally. ManTech is then chartered to take these laboratory experimental processes and transform them into a feasible production manufacturing process with demonstrated cost reductions and acceptable quality for production. During the planning process for SDDs, there are usually insufficient ManTech funds to properly develop and verify new manufacturing technologies. For example, the Air Force still has not developed a cost-effective process to replace blades on an IBR. Therefore, the burden will be on the overhaul facilities to develop this process, which will be very time-consuming and expensive and raise sustainment costs considerably.

Because IHPTET pervades the turbine engine S&T community, the committee examined its origin, organization, goals, products, and lessons learned to gain insight into the structure and likely success of VAATE. Based on this examination, the committee believes VAATE may achieve extremely efficient turbine engines that will double range or halve aircraft size, providing the Air Force with truly transformational capabilities that would affordably maintain U.S. military air superiority.

The key technologies include these:

- High-speed, expendable turbine engines can be carried by all bomber and fighter aircraft in the fleet. They provide tremendous standoff capability yet can strike targets at more than four times the speed of sound. This work provides a foundation for future man-rated, responsive propulsion to gain access to space.
- Adaptive cycle engines optimize performance across the aircraft flight envelope. In essence, this propulsion capability will have variable features that allow both responsive supersonic strike and persistent subsonic loiter in a single air vehicle. This propulsion concept offers benefits to power generation and thermal management.
- Compact, efficient, direct-lift engines enable short takeoff and landing (STOL) and short takeoff and vertical landing (STOVL) capabilities on future large transports. This will result in long-range, high subsonic cruise and short/vertical takeoff operations capability for future multimission mobility.

Technologies developed under the three VAATE focus areas will have direct commercial impact. The versatile core focus area will allow greater hardware commonality between military and commercial applications, reducing costs through economies of scale. The prognostics and health maintenance concepts developed in the intelligent engine focus area and many products of the durability focus area will directly benefit almost all commercial applications. Conversely, VAATE will pull from the commercial sector to leverage NASA work on minimizing the emissions and noise impacts of military aircraft. VAATE will also have similar spin-off benefits for turbine engines used in marine, ground transportation, and power-generation applications.

The original VAATE program, which would have allowed robust tech development, demonstration, and transition capability, was scheduled to be funded at \$145 million in FY06 and \$149 million in FY07. Turbine

engine S&T funding was cut drastically, to just under \$90 million in the FY06 PBR, a reduction of \$48 million from the FY03 PBR. The FY07 PBR is expected to remain at \$90 million. At that level, it will be difficult to demonstrate and transition turbine engine technology.

Finding 3-3. The committee concludes that the IHPTET program demonstrated several marked strengths that form a foundation for the continued success of VAATE. IHPTET transitioned performance, durability, and cost-reduction technologies for both fielded and developmental engines—in particular, the F119 engine for the F/A-22 and the F135 and F136 engines for the F-35 Joint Strike Fighter. VAATE’s focus on (1) optimization of the propulsion system at the air vehicle system level, (2) an “affordable capability” goal that includes both performance and cost metrics, and (3) planned synergy with civil aeronautics requirements and attention to dual-use goes beyond the IHPTET approach and is highly appropriate for the demanding yet uncertain requirements of the future.

On a very positive note, each VAATE contractor reviewed by the committee appeared to have a portfolio of advanced technologies planned for development and transition, all of them essential for giving the U.S. armed forces the ability to conduct their missions in an effective, timely, and affordable way with minimal human cost. VAATE’s payoffs are designed to be realized in both the long term, for new air systems now on the drawing board, and the near term, for systems currently fielded (e.g., the F-16 and F-18), in production (e.g. F/A-22), or in the system development phase (e.g., the F-35 Joint Strike Fighter).

While turbine engine requirements have increased considerably, DoD funding for new turbine engine research under VAATE has been dramatically cut. It is unlikely that VAATE’s goals—and along with them, the driving military capability—can be accomplished in the program time frame at the envisioned reduced funding level. Figure 1-1 shows the increase in turbine engine requirements over time.

Recommendation 3-3. DoD should restore gas turbine S&T funding under the VAATE program to the original planned level. VAATE should address the primary risk areas necessary to advance jet engine technology, which include a robust engine demonstrator program and key producibility challenges.

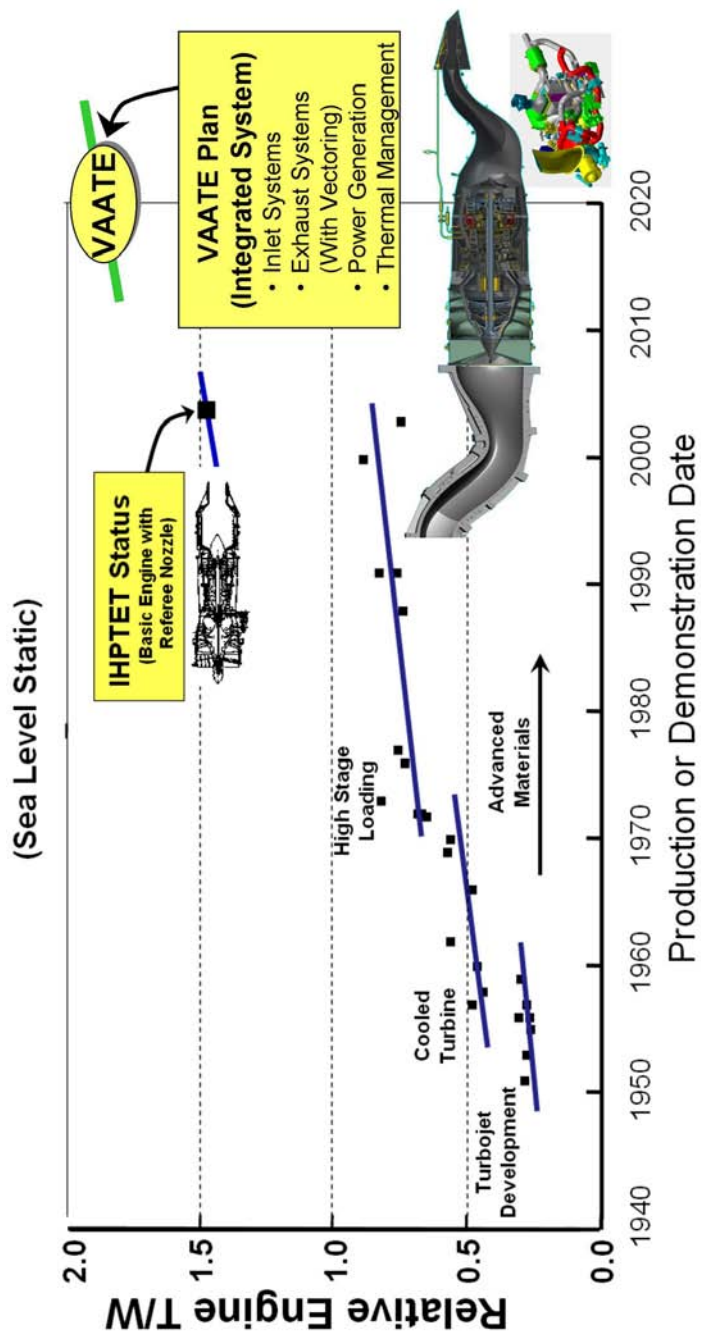

FIGURE 1-1 Progress in engine thrust. SOURCE: Personal communication from Larry Burns, AFRL, to NRC staff member Carter Ford on August 28, 2006. Approved for public release by AFRL/WS06-0065.

Component Improvement Programs

All of the military services are faced with huge and growing costs for sustaining the current fleet of aircraft. Over 60 percent of the expected warfighter's fleet of aircraft in 2020 is in existence or under development today. Near-term opportunities exist to incorporate existing GTE technologies into this fleet to significantly reduce the cost of sustainment and decrease the amount of fuel burned.

The committee saw many examples where CIPs, derivative engine programs, and engine capability enhancement programs (ECEPs) could yield sizable reductions in fuel burned, significantly improve performance, and greatly increase the time between shop visits.

History has shown that CIPs decrease Class A mishaps, increase time on the wing, decrease fuel burn, and extend service life. In most instances it can be readily shown that the costs of incorporating the existing technologies into the legacy fleet are rapidly recouped. In fact, programs of this type have historically returned \$8 to \$10 for every dollar invested in the sustainment and fuel burn of existing engines.

Finding 3-4a. The costs of fueling and sustaining the legacy fleet are the two highest annual propulsion costs faced by DoD.

Recommendation 3-4. DoD should sustain the current funding for the Component Improvement Program to ensure solutions to operational problems and safety issues and the development of future upgrades.

Derivative Engine Programs

DoD aircraft systems are continually modernized to remain viable and responsive to the warfighter's need. These upgrades address identified performance deficiencies or provide new mission capabilities. As aircraft capabilities grow, weight, drag, and electrical and mechanical power loads typically increase, which translates, in turn, to increased demands on the propulsion system. To accommodate these increased loads, the propulsion system must become more capable.

A proven, cost-effective, efficient approach to improving propulsion capability is to develop derivative versions of existing engines. This is done by transitioning newer technology into legacy propulsion systems to improve performance and power.

There is currently no active program for increasing the performance of legacy propulsion systems to replace the engine model derivative programs (EMDPs), which were canceled in 1998, resulting in two significant gaps in the DoD engine development process. The first gap is the inability to conduct timely propulsion system enhancement studies or to develop technology transition roadmaps to support and complement studies of aircraft modernization and capability growth prior to Acquisition Milestone A. The second gap is the lack of a demonstration process to mature the propulsion technology from technology readiness level (TRL) 6 (demonstration in a relevant system) to TRL 7 (demonstration through initial flight test). This gap increases the risk of incorporating new technology into the propulsion system or makes it impossible to do so after Acquisition Milestone B.

EMDPs were a cost-effective way to improve capabilities and decrease the cost of support. Funded EMDPs would ensure that the propulsion capability requirements are met in a timely and cost-effective way. New centerline engine developments cost billions of dollars and require more than 10 years to complete. Derivative engines often cost only hundreds of millions of dollars and require only 3 to 5 years to complete. This reduced cost and shorter time for development mitigates the cost and schedule risks of weapons system development.

Small Gas Turbine Engine Programs

This section reflects the committee's views on the status, requirements, and anticipated plans for small (500-15,000 shaft horsepower (SHP)) GTEs—turboprop and turboshaft—intended for use by DoD from now until 2020. The comments apply to propulsion systems for UASs, helicopters, and compound helicopters and tilt rotors. Turboshaft engines have broad applicability to a wide variety of systems used or anticipated by the Army, the Navy, the Air Force, the Marine Corps, and the Coast Guard.

Small Engine Requirements and Development

All of the helicopter and UAS turboshaft engines used by DoD were designed in the 1960s and 1970s. Since that time, few of the technologies developed by the joint turbine advanced gas generator (JTAGG), IHPTET, and other programs in materials, electronics, software, computational design tools, and network-centric warfare have found their way into turboshaft propulsion systems.

An important finding of the committee is that DoD could immediately benefit from technology that has been completed over the last 30 years by developing a new 3,000-SHP class turboshaft engine and a new 10,000-SHP class turboshaft engine. A modern 3,000-SHP class turboshaft engine could be applied to the Air Force's plan for a personnel recovery vehicle system, the Army's Apache AH-64 Block III and Blackhawk UH-60M helicopters, the Navy's SH-60 Sea Hawk, and the Marine Corps's UH-1Y and AH-1Z vehicles. Additionally, a modern 10,000- to 15,000-SHP class turboshaft engine would have an enormous positive impact on the design, performance, and cost of the emerging joint heavy lift (JHL) vehicle and on the Marine Corps's improved CH-53X helicopter, capable of performing well at high altitudes and high temperatures.

The 3,000- and 10,000-SHP engines could fulfill the 2020 requirements of all military services. Most of these requirements will be for rotary-wing manned helicopters and UASs.

Successful, affordable, and enduring warfighting performance for these systems will depend on modern turboshaft engines to satisfy the required capabilities for attack, reconnaissance, utility, and medium-cargo missions. All of these aviation systems incorporate engines that will be 50 to 60 years old in 2020 unless proactive steps are taken today.

Demonstration Programs

Past science and technology programs have demonstrated significant advances in the capabilities of turboshaft engines. Specific improvements are expected to lead to smaller, lighter, more affordable rotorcraft and UASs. The resulting systems will be far more capable, with significant improvements in the cost of operation and sustainment. It is clear that an incremental change in potential is available today and that continued investment is justified.

One of the last elements in the IHPTET program (expected to have run its course in 2005) is the JTAGG III demonstrator, which is being designed and built jointly by Honeywell and GE. (The goals of the IHPTET program are shown in Table 3-1 for Phases I, II, and III.) The technologies demonstrated are planned to directly support the planned Affordable Advanced Turbine Engine (AATE) and the Improved Turbine Engine Program (ITEP). The payoff for implementing JTAGG technology rather than that available with a simple derivative engine is huge. An

improvement of 30 percent in specific fuel consumption is shown for the relatively large turboshaft engine required to power the JHL vehicle.

Finding 3-6. Two new small military gas turbine engines—3,000-SHP and 10,000-SHP class—are needed to meet the mission requirements of all the military services. The U.S. military has not developed a new centerline engine in these classes since 1972. The technology level of the U.S. military GTEs in the small and expendable classes is roughly on a par with that of competing nations. This equivalence is driven not by available technology, however, but by the fact that no new military engines in these power classes have been fielded since the early 1970s. The technology and need exist to field new 3,000- and 10,000-SHP class gas turbines for helicopters and UASs.

Recommendation 3-6a. The Army should consider combining its AATE demonstration program and its unfunded ITEP, also targeted at 3,000 SHP.

Recommendation 3-6b. The Army should ensure that the size of the Future Affordable Turbine Engine (FATE) program, which remains undecided, is suitable for the demonstration of a 10,000-SHP class small gas turbine. The FATE demonstration could then form the basis for a new engine for a future heavy-lift helicopter mission or the Joint Unmanned Combat Air System mission.

Recommendation 3-6c. In addition to developing two new small gas turbines, DoD should carefully investigate innovative ways to integrate advanced engines and advanced vehicle propulsion systems. Examples here include novel inlets, exhausts, IR suppression systems, particle separators, integrated flight/engine controls, and systems to manage component health.

Expendable Turbine Engine Programs

Expendable GTEs are the prime propulsion systems for many cruise missile systems and some unmanned aircraft systems. Currently, expendable GTEs must be storable for a long time, fit into very small volumes, be characterized by high T/W ratios, operate over a wide range of Mach numbers,

and provide good fuel economy. In the committee's expert opinion, expendable engines used by DoD are as good as or better than those known to be used by other nations. Over the past two decades, IHPTET has been working on technology for expendable engines. Some of these technologies have been incorporated in the derivative engines that will power the planned joint air-to-surface standoff missile (JASSM). The better fuel economy of the expendable engine powering the JASSM is a major contributor to its longer range. However, "irregular" and "catastrophic" scenarios require a large increase in the Mach number range over which expendable engines must be able to operate. Standoff cruise missiles with operational Mach numbers of 4.0 or so are required for warfighter missions until 2020. After reviewing the program for demonstrating engines at high Mach numbers, the committee believes the demonstrations are well planned. However, given the criticality of high Mach number missiles to the 2020 warfighter, the committee suggests that DoD might wish to use ManTech funding to develop the high-temperature materials with consistent properties that will allow GTEs to operate at a Mach of about 4.25 and to ensure that the United States can supply these materials. This need is not unique to expendable GTEs but extends to all types of GTEs. The committee also notes that the high Mach demonstration program is success-oriented; that is, the program assumes success at all milestones, with little or no allowance for problems that might arise.

Finding 3-7. High Mach number cruise missiles will be critical to the 2020 warfighter. The VAATE and DARPA programs plan to demonstrate a Mach 4.25 expendable engine in 2008.

Recommendation 3-7. Given the criticality of the high Mach number cruise missile, DoD should support the success of these system demonstrations by funding programs to ensure the availability of high-temperature materials.

Other Technology Programs for Aerospace Propulsion

There is a general perception that aeropropulsion is a mature, plateau technology. This section on alternatives addresses several nascent and compelling revolutions in aeropropulsion. Beyond conventional rocket and GTE aeropropulsion in concept and timescale lies an emerging array of alternative aeropropulsion cycles, including hybrid rockets using highly

energetic fuels and oxidizers and propulsors applicable to in-atmosphere cruise and in some cases to Earth-to-orbit (ETO) and in-space propulsion. These frontier concepts are included in the NRC report *Materials Research to Meet 21st Century Defense Needs*. “In this case, the most important contribution of the panel may have been to identify opportunities that are not being pursued aggressively due to limited budgets and a current focus on immediate needs and near-term payoff” (NRC, 2003, p. 58). They satisfy in various ways DoD needs in 2018, which include on the one hand, increased range, loiter, timeliness, reliability, small-system performance, and flight envelope and, on the other, reduced observables and cost.

Alternative propulsion concepts are at various levels of maturity and application. The pulsed detonation engine (PDE) approach is in the laboratory and exploratory stage. Variants of electric propulsion are currently being applied to a subset of small air vehicles in an attempt to increase vehicle size and performance. Also applicable are back-to-the future approaches for significantly improving internal combustion engines using, for example, free piston devices or highly refined Wankel engines.

One exceedingly interesting, even revolutionary, possible source of energy for aeropropulsion, in addition to the ongoing research in high-energy-density materials (HEDM), is positrons. Positrons do not require the heavy shielding, power sources, or magnets associated with most earlier nuclear propulsion schemes. Their projected favorable safety characteristics would allow their application to in-atmosphere operation for both cruise and ETO. Isomers are similar in terms of radiation safety but have a somewhat lower energy density.

Ramjet and Scramjet Engine Programs

Scramjet propulsion is crucial for standoff strikes on time-critical and hardened targets, boost-phase intercept, and flexible access to space using airplanelike operations. Although the first patent on ramjet propulsion (René Lorin) dates as far back as 1913 and scramjet research started nearly 50 years ago, flight tests have occurred mainly in the last 15 years. Serious application efforts are under way in various countries.

Scramjet propulsion systems are applicable to missiles and to strike, reconnaissance, and ETO missions. Scramjets can fly at up to Mach 8 using hydrocarbon fuels and can far exceed Mach 8 using hydrogen fuels. Volume/weight/length-constrained, air-launched missiles with scramjet propulsion can fly twice as far as missiles using existing technology. Scramjets offer

(1) global reach (they can fly to anywhere on the globe in approximately 2 hours), (2) time-critical strike (they can reach targets hundreds of miles away in minutes), (3) enough kinetic energy to penetrate hardened targets, and (4) flexible access to space using airplanelike operations.

Air-breathing hypersonic propulsion currently faces a number of challenges: (1) combined cycle transition; (2) system thermal management (engine/vehicle); (3) high-temperature/lightweight materials; (4) flow/combustion numerical simulation and design sensitivity; (5) cooled leading edge for Mach numbers larger than 7; (6) miniaturization of the control and fuel system; and (7) need for a dual-mode scramjet flow path. Another challenge is the integration of the turbine-based combined cycle system and the rocket-based combined cycle system.

The Air Force is working on two scramjet programs: (1) the hypersonic technology (HyTech) single-engine demonstrator (SED), to be used on a liquid hydrocarbon scramjet engine with a solid booster, and (2) the Falcon, to be used on a hydrogen scramjet engine with a rocket motor. The Navy is working on the HyFly program, which is developing a hydrocarbon scramjet with a solid booster, and on the RATTLRS program, for a ramjet based on a turbojet engine. The Army is developing a Mach 12 hydrogen scramjet engine with a terminal high-altitude area defense (THAAD) missile booster.

To address the new threats, which include a hypersonic glide vehicle, a hypersonic powered vehicle, and a container-launched cruise missile, the Army is currently developing Mach 12 interceptor hypersonic projectiles in its Scramfire program. These systems are capable of variable velocity operation, are maneuverable, and can serve as an accelerator and/or a cruiser. The propulsion system is a scramjet engine that uses hydrogen fuels. Extensive experimental and numerical simulations are under way. The committee believes that this project is suitably funded to achieve its goals by 2009-2010.

Finding 3-8. Consistent with the National Aerospace Initiative (NAI), DoD has an active scramjet technology development effort. In the committee's opinion, the level of U.S. technology is on a par with or ahead of the competition. It is also the committee's opinion that more synergism among DoD's several scramjet efforts would allow DoD to meet the country's needs more economically and quickly.

The existing scramjet programs are well focused and address the DoD S&T strategy. NASA scramjet propulsion programs are being replanned. There is a need for a focused government-sponsored program like IHPTET/IHPRPT to develop scramjets. Such a program is needed to maintain the U.S. technology base, including both people and infrastructure. It also appears that maturation funding is inadequate to drive the implementation of scramjet propulsion.

Recommendation 3-8. DoD should develop a strategy to exploit the synergies between the hypersonics programs in each of the services for the benefit of DoD, in the form of a common technology and cost savings. There are alternative solutions for both time-critical, hardened targets and flexible space warfare, and these should also be studied and compared with the scramjet solution.

ROCKET PROPULSION SYSTEMS FOR ACCESS TO SPACE

Anticipated Military Spacelift Propulsion Needs and Identification of Critical Technologies

In early 2005 the U.S. Space Transportation Policy was signed by the President (NSPD, 2005). This policy reinforced the goals originally stated in the AFSPC *Strategic Master Plan FY06 and Beyond*: “AFSPC will sustain and modernize its current Satellite and Launch Operations into the Far-Term when it will transition to advanced capabilities” (AFSPC, 2003, p. 29).

The Air Force’s overarching need to have responsive access to space and to operate effectively in space under all realistic scenarios demands the establishment of requirements for (1) strategic and responsive spacelift total systems, (2) responsive on-board propulsion systems in space, and (3) return from space. Transformation in access-to-space or in-space operations will require using a total systems engineering process, with “mission success over the committed life of the system” as the primary criterion for selection among options for the system’s architecture and elements. The evolution of such a system engineering program, together with the validation of trade-off parameters using the supercomputing capabilities available today, would provide a powerful and objective quantitative tool for defining and evaluating low-risk, cost-effective total system concepts for strategic

and operationally responsive spacelift and in-space operations. For example, when carrying out systems engineering for access-to-space missions, the total system for accomplishing the mission must consider launch vehicle configuration (number of stages, reuse), launch locations (fixed or mobile, including from high-altitude aircraft), facility and logistical requirements, operations concepts (payload integration on launch-stand or preintegrated, attachable payload modules), technology validations that remain to be carried out, overall development schedules, life-cycle cost, industrial support viability, and so on.

Only the unbiased application of such a tool can provide a credible basis for justifying specific system requirements such as the number of stages, the choice of propellant, the extent of reusability, and the flexibility of launch locations. The process would allow establishing the quantitative risk assessment profiles needed for selecting total system options. The process would also allow setting propulsion-system-specific requirements and subsystem basic configurations. Then, design criteria can be specified that assure a subsystem option or function will serve its purpose. Identifying missing or unvalidated design criteria associated with propulsion systems for operationally responsive spacelife (ORS) would define critical gaps in the available technology base.

Finding 4-1. The committee does not believe that the Air Force will be able to reliably and cost-effectively transform U.S. military space transportation capabilities by focusing on pushing high-thrust rocket propulsion technologies to their limits. Even if the total systems optimization process is objectively carried out, the technologies it selects are unlikely to be (and need not be) transformational in themselves. It is more likely that any transformational access to space achieved during the planning period will be the result of creative total system architectures. Focusing Air Force resources on identifying the gaps in the critical design criteria for total systems-defined rocket propulsion elements will be crucial to success of the AFSPC *Strategic Master Plan FY06 and Beyond*.⁶

Recommendation 4-1. The Air Force should place a high priority on developing an integrated total system engineering process using quantita-

⁶There are a number of new propulsion technologies that do in fact have the potential to directly enable transformation of in-space rocket propulsion systems performance. They are discussed in Chapter 5, Rocket Propulsion Systems for In-Space Operations and Missiles.

tive life-cycle mission success as the selection criterion for near-term, highly leveraged engineering technology funded by the Air Force. This process is crucial to defining justifiable total system architectures, rocket propulsion systems requirements, and critical technologies for military space transportation to support the AFSPC *Strategic Master Plan FY06 and Beyond*.

Current Technology for Large, First-Stage (Core), Liquid Propellant Booster Engines

RS-68 Engine for Delta IV Launch Vehicle

In the early 1990s, Rocketdyne initiated development of the first new indigenous booster-class engine in the United States in more than 25 years, the RS-68. The RS-68 was ultimately selected to power the Delta family of evolved, expendable launch vehicles (EELVs) developed for the Air Force by the Boeing Space Systems Company.

The RS-68 is a conventional bell-nozzle booster engine that develops 650,000 lb of thrust at sea level and is the largest liquid oxygen/liquid hydrogen (LOx/LH₂) engine in the world today. It uses a simple, open gas generator cycle with a regeneratively cooled main chamber. It can be throttled to 60 percent of full power.

During the design and development phases, this engine was based on a simplified design philosophy that reduced parts count and production costs below those of the contemporary space shuttle main engine (SSME). The RS-68 engine has only 11 major components, which amounts to a reduction in parts compared to the SSME of over 80 percent and a reduction in hand-touched labor of 92 percent. The development cycle time was also much reduced, and nonrecurring costs were said to be one-fifth those for previous cryogenic engines. The engine was designed, developed, and certified in a little over 5 years and flew on the first Delta IV launch in late 2002.

RD-180 Engine for Atlas V Launch Vehicle

The engine that powers the first stage of the Atlas V EELV is the RD-180. The RD-180 is a two-thrust-chamber version of the original Russian RD-170 (four chambers) and offers the performance, operability, and reliability of the RD-170 in a size suited to the booster needs of the Atlas V EELVs.

The RD-180 is a total propulsion unit/engine system with hydraulics for control valve actuation and thrust vector gimbaling, pneumatics for valve actuation and system purging, and a thrust frame to distribute loads, all self-contained as part of the engine. The engine, which employs a LOx lead start, a staged combustion cycle, and a LOx-rich turbine drive, delivers 10 percent better performance than current kerosene (RP-1)-fueled operational U.S. booster engines and can provide relatively clean reusable operation (beyond one mission duty cycle).

Finding 4-2. The current family of U.S. EELV boosters does not need to be replaced for the next 15 to 20 years, nor are there plans to do so. Nevertheless several candidate designs were started under NASA's Space Launch Initiative (SLI) program in 2001.

Recommendation 4-2. DoD should begin work relatively slowly, investing about \$5 million per year, in the committee's judgment, in technology development for an advanced-cycle booster engine that could provide the basis for a new far-term access-to-space vehicle.

Current Technology for Large, First-Stage, Strap-on, Solid Propellant Motors

GEM 60 Rocket Motor for Delta IV M+ Launch Vehicle

ATK Thiokol (now Alliant Techsystems) originally developed the graphite epoxy motor (GEM) for the Delta II launch vehicle for the U.S. Air Force and Boeing. The GEM 40 is a highly reliable motor used on Delta II. The GEM 46 is a larger derivative—with increased length and diameter and with vectorable nozzles on three of the six ground-start motors—for use on the Delta III. The motor has also been used on the Delta II heavy-lift vehicle. The 70-ft GEM 60 provides auxiliary liftoff capability (in two or four strap-on motor configurations) for the Delta IV medium-plus-lift (M+) vehicles.

Aerojet Rocket Booster for Atlas V Launch Vehicle

The solid rocket strap-on booster motor for the Lockheed Martin Astronautics Atlas V EELV has been developed, flight qualified, and produced by Aerojet. This new generation of solid rocket motors provides

reliable, high-performance boosting power for the Atlas V medium- to heavy-lift expendable launch vehicle used by U.S. civil and military spacecraft launch programs as well as those of other countries.

The Aerojet solid rocket motor design for the Atlas builds on decades of flight design, testing, and real mission experience accrued by, among others, the Minuteman, Peacekeeper, and small intercontinental ballistic missile (ICBM) motors, as well as by Aerojet's extensive work on other propulsion and space systems and a wealth of associated flight-proven technologies.

The Atlas V family of launch vehicles will use from one to five strap-on solid rocket motors depending on the mission and the launch trajectory requirements. The solid rocket motors are ignited at liftoff and burn for over 90 sec; each motor provides a thrust in excess of 250,000 lbf. At about 94 sec into the flight, the solid rocket boosters are jettisoned sequentially.

Current Technology for Delta IV and Atlas V Second Stages: RL-10 Family of Engines

The RL-10 has evolved significantly over more than four decades. It began with a vacuum thrust of approximately 15,000 lb for the RL-10A-1. Through a series of modifications, the average thrust became 24,750 lb in the RL-10B-2. This engine has probably had every possible ounce of thrust wrung out of it, but that has reduced the safety margins for some of the failure modes. Significant improvements in performance and reliability could be achieved with a new engine-cycle design.

Currently, EELVs have only one basic second stage, the RL-10. The Delta IV of Boeing uses the RL-10B-2, while the Atlas V of Lockheed Martin uses the RL-10A-4-1 or -2. The basic RL-10 engine, developed by Pratt & Whitney in the late 1950s, was the world's first LO_x/LH₂-fueled rocket engine operated in space. Since the first successful launch of an Atlas/Centaur RL-10, Pratt & Whitney has developed nine different models of the RL-10 engine family. The RL-10 earned the reputation of being a reliable, safe, and high-performance cryogenic upper-stage engine for a wide variety of U.S. EELVs.

Finding 4-3. The technology for the RL-10A and RL-10B family of upper-stage engines is now more than 40 years old. Although numerous upgrades have been incorporated over the life of the engine, much of the design is now outdated. Because the second-stage engine for both EELVs comes from a single supplier, Pratt & Whitney, the Air Force is totally dependent on this

single contractor and engine for all large payload launches. Should a failure occur that involves the second-stage engine, all launches with these systems would probably be frozen until the root cause was identified and corrected, which could take a year or more. While the probability of such an event is not high, it is not zero. In a time of crisis, this could be extremely debilitating for the nation. The number of failures in recent years (and their cost) would seem to be another good reason for developing and qualifying a new engine that would be supplied by more than one manufacturer.

In addition, to make full use of the Delta and Atlas heavy vehicles, a higher-thrust engine is needed. To develop a new upper-stage engine for the nation's critical strategic launch vehicle fleet requires a major effort and an extended qualification program. The extremely high reliability demanded by a strategic launch capability means that a new engine development program cannot skimp on hardware or testing.

Recommendation 4-3. DoD should place a high priority on development of a new medium-thrust (50,000-80,000 lb) upper-stage LO_x/H₂ engine to assure the nation's strategic access to space. The cost of developing such an engine through its initial operational capability (IOC) is estimated by the committee at \$150 million to \$250 million, providing the design does not try to push new technologies to their limits.

Propulsion Needs and Propulsion Technologies for Responsive Spacelift

An important element of a transformed total access-to-space architecture would be the introduction of ORS vehicles early in the far term of the AFSPC *Strategic Master Plan for FY06 and Beyond* (AFSPC, 2003), sometimes referred to in this report as SMP FY06. Responsive spacelift is shown in the DoD space transportation roadmap, Figure 4-1. It was thought that two or three small launch vehicles would be flown in the demonstration phase, 2004 through 2009. Those small vehicles were under competitive demonstration within DARPA's FALCON program in 2005. Flight demonstrations were expected for only two concepts in 2006. Either or both of those concepts (SpaceX and AirLaunch) could evolve into small vehicle families able to satisfy early DoD needs for responsive access to space until subscale and full-scale ORS vehicles can be developed and qualified in the medium term and far term of the SMP FY06. Some of the vehicles initiated

under FALCON are expected to transition into cost-effective commercial launchers that could replace high-cost small vehicles.

FALCON Small Launch Vehicles

The DARPA/Air Force/NASA FALCON program started in August 2003. Its overall goal is to develop and validate in-flight technologies that will enable both near-term and far-term capabilities to execute time-critical, prompt, global-reach missions while at the same time demonstrating affordable and responsive spacelift. The technical underpinning of the FALCON program was that a common set of technologies could be matured in an evolutionary manner that would provide a near-term (circa 2007-2010) operational capability for responsive, affordable small-satellite spacelift and prompt global reach from the continental United States (or equivalent reach from an alternative U.S. base). These technologies might also enable the development of a reusable hypersonic cruise vehicle (HCV) in the far term (circa 2025).^{7,8}

There are two tasks in this program. Task 1 involves a small launch vehicle (SLV) and Task 2 involves a hypersonic technology vehicle (HTV). Two capabilities—placing small satellites or payloads into low Earth orbit (LEO) and performing HTV missions in a responsive manner together—are an important step in the evolution of ORS vehicles for the Air Force (DARPA, 2004).⁹

After the FALCON program is completed, DARPA will hand over the demonstration vehicle systems aspects to the AFSPC for operational system development and implementation. The winning vehicles may be allowed to contract directly with NASA or private entities (e.g., academia, industry, and other government agencies) to implement commercial launches.¹⁰

Finding 4-5. The FALCON program is an initial response to the need for low-cost, operationally responsive access to space. This program plans to perform in-flight validations of technologies leading to highly responsive

⁷For additional information, see http://www.darpa.mil/body/news/2003/falcon_ph_1.pdf. Last accessed on March 30, 2006.

⁸David Weeks, NASA Marshall Space Flight Center (MSFC), personal communication to committee member Ivett Leyva on May 18, 2005.

⁹Ibid.

¹⁰Ibid.

vehicles that can carry out time-critical, global-reach missions. The cost goal for FALCON-technology-based designs is \$5 million (2003 dollars) per launch. Current costs for similar payloads using available small and medium-size vehicles are \$20 million to \$30 million. Successful FALCON demonstration vehicles and, later, production vehicles would open the door to a larger market for commercial space payloads. An increased launch rate would allow for the increased production of SLVs, which in turn would lower the cost of the vehicles through true mass manufacturing. Also, if more satellites could be launched each year, they would not need to be designed for a 5- to 10-year lifespan but could instead be updated or replaced more often. In FALCON, cost is prized over performance.

Expendable vehicles using low-parts-count, pressure-fed liquid propulsion systems such as systems used for the AirLaunch FALCON demonstrator and the SpaceX vehicle can be developed for much less money than reusable ones. Depending on the annual flight rate, they can also cost less per flight.

Recommendation 4-5. In September 2005, DARPA downselected to just one company for Phase 2B. DARPA should continue to fund and monitor this company to completion of the FALCON program objectives. The Air Force should evaluate the propulsion technologies to be demonstrated for the air-launched FALCON vehicle and include them in total system studies of options for ORS vehicles.

As stated above, the overall goal of the FALCON program is to develop and validate, in flight, technologies that could provide both near-term and far-term capabilities to execute time-critical, prompt, global-reach missions from the continental United States (or equivalent reach from an alternative U.S. base) while also demonstrating affordable and responsive spacelift for a variety of small satellites. Achieving these capabilities is important for achieving the Air Force's overall goal of ORS vehicles and global precision strike.

Air-Based Vertical Launch

In the fall of 2005, another vehicle launch concept was disclosed that appears to have good potential for enabling the achievement of the above

capabilities for very fast and precise global and tactical strike and for responsive, cost-effective launch of satellites at the low end of the small satellite spectrum¹¹ into various LEOs (Smith, 2005). The idea of air-based vertical launch (ABVL), which resulted from trying to find solutions to the severe time and geographic constraints associated with ground-based, boost-phase ballistic missile defense, is to install a vertical launching system in a large-body aircraft. Such aircraft could be on station anywhere in the world where it is desired to optimize the chances of total mission success for the various applications.

The basic feasibility of an ABVL is being studied by BAE Systems and ATK Thiokol under a small DARPA contract. Beyond that, an integrated total systems engineering program is necessary to establish propulsion requirements that can exploit the responsiveness and potential for low-cost ABVL spacelift for small satellites. The concept is also of interest for prompt-reach missile applications (see Chapter 5). New technologies for modifications of existing designs for stage or missile boosters critical to meeting those propulsion requirements can then be defined and demonstrated.

Finding 4-6. Configurations for candidate launch vehicles (including parallel boosters or strap-on combinations), along with propulsion technologies such as propellant combinations (solids, storable liquids, gelled combinations, storable-oxidizer hybrids) and operating characteristics (including assured start-up profiles, thrust vector control, and rocket plume impingement patterns) need to be optimized to take full advantage of the potential new operationally responsive mission capabilities of aircraft-based vertical launch for small satellites, satellite arrays, and near-space military applications (see also Chapter 5).

Recommendation 4-6. The Air Force and DoD should sponsor a detailed system engineering study to fully understand the transformational potential of cost-effective, operationally responsive launch of small, micro-, and nanosatellites (particularly for large-number satellite arrays) utilizing ABVL concepts. The propulsion technologies that are needed to take full advantage of such launch platforms should be identified and developed.

¹¹Defined here as nano, micro, and <200 lb.

Operationally Responsive Spacelift Requirements

Department of Defense Space Science and Technology Strategy (DoD, 2004) states that assured access to space is the highest priority within the space support mission area and that a responsive space capability is directly coupled to both the space support and space force enhancement mission areas. An important element of a transformed total access-to-space architecture is the introduction of ORS vehicles early in the medium term (FY12 to FY17) of SMP FY06.

In the Air Force's proposed roadmap of ORS spirals (Figure 4-1), selected vehicles from the FALCON program described above would continue developmental and operational flights as part of the Air Force's SLV fleet into the far term (James, 2005). Each of the selected concepts would probably evolve into a family of fast-response, expendable vehicles having payload capabilities from 2,000 to 10,000 lb to LEO. The proposed roadmap also shows the start of full-scale development of an ORS vehicle in 2010.

Meeting the demanding objectives for ORS vehicles may necessitate a number of new propulsion subsystem technologies in addition to existing qualified subsystems. As discussed in some detail in the introduction to Chapter 4, an integrated total systems engineering process, whereby propulsion requirements for these vehicles are established and technologies critical to meeting those requirements are defined, is crucial to the success of any new launch-to-space or in-space vehicle program. Incorporating "mission success" as the primary selection criterion for this systems engineering process provides a powerful objective and quantitative tool for designing low-risk, cost-effective ORS concepts for Air Force future needs.

Integral to the total systems engineering process is verifying that the design criteria for all proposed critical technologies have been validated. This is the main thing that allows objective evaluations of development engineering schedule and cost risks and of propulsion systems' operational and life-cycle cost risks. It also permits objective, quantitative, and consistent analysis of the trade-offs among concepts across diverse propulsion systems. In selecting a propellant, for example, one would need to look at the trade-offs between pumps and pressure-fed; pressurization subsystems for either net positive suction head or propellant feed; optimization of chamber pressure and nozzle expansion ratios for first or second stages; expendable vs. reusable first and/or second stages; metals vs. composites for tanks and motor cases; ablative vs. cooled combustion chambers; and so on.

Most important, when rigorously applied, such a verification program would force identification of unvalidated design criteria associated with technologies for critical elements of unproven propulsion systems or for upgrades of existing propulsion subsystems. These unvalidated system element design criteria, which include criteria for the element's total operating environment, are the primary drivers of a development program's engineering, operational, and cost risks. In the past, designs accepted without a sufficient range of criteria validation were found to have been the first cause of catastrophic failures.

Affordable Responsive Spacelift Vehicle

In 2005, the Air Force embarked on a subscale vehicle demonstration and system concept validation program, Affordable Responsive Spacelift (ARES), which it plans to evolve into the ORS family of vehicles. The ARES program was planned to start in 2005. The Air Force has been working on conceptual systems engineering for ARES and has completed an initial group of concept systems engineering analyses. This has led to a basic architecture concept for having a reusable fly-back-to-launch-site, rocket-engine-powered first stage and an expendable rocket-engine-powered second stage. Air Force documents say the ARES Hybrid is the Vector 1 roadmap medium-term solution for a revolutionary spacelift capability. They also say that an ARES flight demo in 2010 will provide confidence in full-scale system costs and operability and allow fielding a system in an affordable fashion (James, 2005).

If the ARES system design has been selected via a total systems engineering process to provide confidence in the development of a full-scale vehicle, most of the critical technologies for the full-scale configurations are locked in by default. To proceed confidently with competitive conceptual designs for the vehicle prototype starting in 2005 and then implement a selected configuration development program starting in 2006, the selection of propulsion technologies might have benefited, from a total systems engineering perspective, from incorporating those technologies in existing qualified propulsion elements or those with extensive validating data.

The committee found no sign of any transformational or revolutionary technologies that were mature enough to be considered for ARES, so they would presumably not be used in the full-scale vehicle that is expected to emerge from the subscale demonstrator. Also, the committee could identify only two existing rocket engines that might meet the propulsion system

requirements for the ARES hybrid: the Aerojet AJ26-58/59, which would constrain the first stage to LO_x/RP-1, and the RL-10 family, which would constrain the second stage to LO_x/LH₂.

Another Air Force presentation recognizes this real situation and states as follows (Hampsten et al., 2005):

Remember . . . ARES-SD is the first phase of an acquisition program. [The] Air Force wants to achieve its goals using the lowest risk approach practical. ARES management team uses the term *technologies* in the generic sense of describing the technological means to an end. It is not intended to indicate specifically immature, “high-tech,” stretch design goals or high risk technologies. This is not a tech-push effort.

The committee concludes that ORS missions in the early part of the far term (FY18-FY30) will not have (and, in its opinion, need not have) revolutionary propulsion technologies. In fact, the various risks of committing to unvalidated technologies at this point are much greater than any potential gain in rocket propulsion system performance. If there is to be a revolutionary ORS capability in the medium term, it will come from very innovative total systems architecture and operations processes and from high margins against retained failure modes, not from revolutionary rocket propulsion systems.

Initiatives for Developing New Aerospace Propulsion Technology

National Aerospace Initiative

The NAI began in 2001 as a joint technology program by DoD and NASA. It is not to be thought of as a system development or acquisition program (NRC, 2004). “The goals of NAI are to renew American aerospace leadership; push the space frontier with breakthrough aerospace technologies; revitalize the U.S. aerospace industry; stimulate science and engineering education; and enhance U.S. security, economy, and quality of life” (NRC, 2004, p. 3). The initiative rests on three pillars: high-speed/hypersonic flight, access to space, and space technology. An NAI executive office was created to foster collaboration between NASA and DoD and develop goals, plans, and roadmaps for the three pillars. The goal was for NAI to start by identifying the capabilities needed for future systems; to use the goals, objectives, technical challenges, and approaches (GOTChA)

process to analyze the technology development challenges and options; to establish investment plans; and, finally, to coordinate the efforts of the involved parties to execute the technology plans (NRC, 2004).

The goals and direction of NAI changed on January 14, 2004, when President Bush announced a plan to develop and test a new crew exploration vehicle (CEV) by 2008 and to carry out human missions to the moon (circa 2014) and, later, to Mars (NRC, 2004). This vision for space exploration was announced after the committee had submitted its draft evaluation of NAI to external peer review.

NAI represents cooperation, better utilization of resources, and maximization of synergies. However, it is hard to identify how the money allocated for the NAI is being spent beyond the first layer of general funding. The recommendations and observations of the NAI evaluation committee are still valid. A continuous update of Air Force needs and their inclusion in future revisions of NAI plans or strategy would strengthen the initiative.

Although funding for the program has been severely limited, contractors have had considerable freedom to develop new technologies that could improve the performance and life of both solid and liquid rocket engines. The main difficulty voiced by several of the contractors is that there is no clear definition of Air Force needs.

Integrated High-Payoff Rocket Propulsion Technology

The IHPRPT program was initiated in 1994 and has been in place for a dozen years. It is a joint government-industry effort focused on affordable technologies for revolutionary, reusable, and/or rapid-response, global-reach military capabilities. It addresses sustainable strategic missiles, long life or increased maneuverability, spacecraft capability, launch vehicle propulsion, and high-performance tactical missile capability. It attempts to emulate the IHPTET program, which was successful in developing and testing new turbine engine technologies.

One significant limitation of the program is severe underfunding for component testing and validation. The uncertain and disappointing future for commercial launch opportunities and a lack of real requirements from DoD has discouraged the major rocket propulsion companies from investing their decreasing independent resources in new propulsion subsystems (NSPD, 2005). A clear expression of DoD needs would give the IHPRPT program more focus and streamline its efforts.

Finding 4-8. The AFRL Space and Missile Systems Division is undertaking a variety of interesting and potentially valuable in-house programs. It appears to be developing technology that will be very useful, such as predicting the existence of certain energetic compounds and their synthesis, determining the coking properties of hydrocarbon propellants, and developing combustion instability models. Unfortunately, there does not appear to be much in-house work in the liquid engines and solid motors areas. The more basic work seems to be of high quality, but its basic nature and not knowing where the Air Force wants to be in the future make it very difficult to set the priorities for these efforts or even determine if they are the best ones to undertake. A thorough review by outside experts might help in prioritizing the efforts.

Recommendation 4-8. The Air Force should develop in-house test beds for liquid, solid, and hybrid rocket motors. Because limited funding seems to be at least part of the reason this is not being done, the Air Force should seek to increase the funding for both liquid and solid rocket test beds at AFRL.

The U.S. Rocket Propulsion Industry

The U.S. rocket propulsion industry and associated space transportation business have been in a steady decline since the end of the Apollo program (~1972) and the cold war arms race. A turnaround in the propulsion and space transportation industry was expected in the wake of the space shuttle and International Space Station programs. The space shuttle program (or National Space Transportation System), which had to develop three new liquid rocket engines—the space shuttle main engine (SSME), the orbital maneuvering engine, and the reaction control engine—and the world's first large, segmented, and reusable-case solid rocket motor, did not reverse the decline after the Apollo era; it only slowed the rate of decline until the late 1970s.

In general, the development of rocket propulsion technology by the United States for all spaceflight applications has significantly lagged development by the rest of the world since the initial certification of the space shuttle. This lack of progress in rocket propulsion technologies over such a long period has resulted in several deficiencies in the nation's space program. Most notable is the reduced reliability of U.S. launch and space vehicles, as evidenced by the increased number of flight failures during the late 1990s and into this new decade, as well as the large loss of U.S. share of the world

market in both the space launch and spacecraft industries, with the U.S. share having fallen from about 80 percent in the late 1970s to less than 20 percent in 2002.

In the last three decades, only one new U.S. government-sponsored booster engine, the SSME, has been developed and gone through flight certification. Some significant upgrades have been incorporated into the SSME since the original certification for flight in the 1970s. These upgrades increased reliability and safety and somewhat increased mean time between engine refurbishments. They did not, however, appreciably advance rocket engine technology. Since the 1970s, the number of firms capable of major engine development has shrunk significantly. This industry downsizing, combined with consolidation, points to the diminution of U.S. ability to meet DoD's propulsion needs for a new ORS family of vehicles starting with ARES in about 2015. Basically, the nation's current capabilities in space propulsion and space transportation are but a fraction of the capabilities that were evolved starting in 1954 for the ICBM program and culminating in the early 1970s with the end of the Apollo program. Those programs helped the United States respond to international crises and eventually win the cold war.

Since 1980, only one new first-stage rocket engine has been developed in the United States. This engine, the RS-68, was funded primarily by Boeing Rocketdyne. It was developed as a low-cost, expendable booster engine for the Delta IV EELV. Engine performance of the RS-68 is poorer than that of the 1960s-era Saturn V second- and third-stage J2 engines, both of which were simple open-cycle, gas-generator-powered designs. However, by incorporating comprehensive modeling, computer-aided design/manufacturing, and advanced manufacturing technologies of the 21st century, the developer realized important advances in engineering methodology and capabilities. The latest manufacturing technologies would be very beneficial for production runs of, say, 30 to 50 engines per year. However, it turns out that the EELV program will require no more than 5 to 8 engines a year. Moreover, no commercial market for very large boosters ever materialized. So the RS-68 offers almost no unit cost advantage over older engines that are available from several countries.

While the United States developed almost no new booster rocket technology during the last 30-plus years, the new spacefaring nations of Europe, Asia (including India), and the Middle East have been developing their own new vehicle and propulsion systems to catch up. Along with the former Soviet Union, they are believed to have developed 40 to 50 new engines

using several propellant combinations in addition to LO_x/LH₂. Many of these engines can now be considered to be today's state of the art.

Based on these observations, it is probably no coincidence that the U.S. share of the space launch market has eroded badly in the last 40 years and along with it, U.S.-built launch vehicle reliability. Of the potential worldwide market for commercial launch systems of \$8 billion to \$10 billion per year, the United States now captures only about \$1 billion to \$2 billion.

A similar trend has been observed for the development of propulsion technology for upper-stage and in-space products. Advancements will be needed in both areas to enable the Air Force's future total capability missions. Most of the U.S. in-space propulsion developments in recent times have been privately funded, with some support from the government. However, most of the government-sponsored projects were stopped for one reason or another before any significant advances in technology readiness could be achieved.

Finding 4-15. The severe industry downsizing and consolidation causes concern about U.S. ability to meet the propulsion needs set forth in the SMP FY06 (AFSPC, 2003) for a new operationally responsive family of spacelift vehicles, starting with ARES in 2010 and ORS in 2015. DoD and Air Force commitment to fully develop these new robust launch vehicles might help rejuvenate the U.S. aerospace industry, provide more employment opportunities for young aerospace engineers, and reverse the current decline in rocket propulsion design, development, testing, and production capabilities. This in turn could create synergies and capabilities that would present future leveraging opportunities for the Air Force.

Recommendation 4-15. The Air Force and DoD should devote more of the annual S&T rocket propulsion budget resources over the next few years to rocket propulsion; to technologies that would enable the successful introduction of mission-based ORS; and to other flexible, small-satellite launch capabilities in the medium term. The committee's estimate of the additional focused investments needed is \$50 million to \$75 million annually.

ROCKET PROPULSION SYSTEMS FOR IN-SPACE OPERATIONS

All the U.S. military and civil strategic satellites and technology platforms require propulsion subsystems operating in space to provide the

impulse for adjusting velocity, changing orbit altitude, controlling attitude, station keeping, and deorbiting at the end of life. These propulsion needs are being satisfied currently by state-of-the-art chemical propulsion and, increasingly, by electric propulsion subsystems. Of note here is that the state of the art has been undergoing significant changes over the past 15 years and is therefore very advanced in many areas. For kilogram-class developmental satellites with unique mission capabilities, micropropulsion systems may be required for all maneuvers other than rapid inclination change.

However, in contrast to rocket propulsion for access to space and in near space, the potential for improving the performance of in-space thrusters and electric power generation and energy storage in space is still very great. Some of these technologies, such as various types of electrically powered thrusters or high-energy monopropellants, have the potential to directly enable transformational in-space capabilities for military systems. Air Force/DoD long-range plans have identified, and are working on, needs for many types of operational maneuvers in near space and in space. A systems architecture for seamless air-space operations will enable ORS.

Recommendation 5-1. DoD should support extensive basic research and technology projects for various in-space propulsion thruster concepts and for in-space electric power generation and energy storage. This fundamental long-range support need not be tied to any specific mission or platform requirement. The current range of technical opportunities is so great that progress will be directly proportional to annual resource allocations over the next 10 years. The committee estimates that at least \$20 million should be considered as a yearly allocation in these areas.

Current Propulsion Technologies

Chemical Propulsion

The conventional chemical liquid propellant propulsion systems now in use are either monopropellants or bipropellants. Liquid bipropellant systems are better performers but are more complex and deliver a fuel and oxidizer mixture that reacts chemically in the combustion chamber. Monopropellant systems provide a single propellant that decomposes at the catalyst bed of the combustion chamber. Widely used, highly reliable, state-of-the-art chemical systems are the monopropellant hydrazine (N_2H_4) and

bipropellant propulsion systems such as mixed oxides of nitrogen (MON) and monomethylhydrazine (MON/MMH). For orbit circularization and station acquisition, bipropellant engines containing MON/N₂H₄ are also in use.

Electric Propulsion

The expanding range of spacecraft size and the changes in the commercial spacecraft industry environment have presented new challenges to the chemical propulsion community. There has been a clear need to come up with better performing propellants and/or thrusters. The advent of power-rich spacecraft architectures opens up propulsion options that can provide both high power and high specific impulse (I_{sp}). One option, reducing the onboard propulsion system's wet mass requirement, could allow decreasing spacecraft mass or increasing payload. It could also allow placing greater demands on the propulsion system, including increased reposition or longer duration orbit maintenance, thereby increasing useful life. Another outcome of reducing the propulsion system's wet mass might be its enablement of a stepdown to a lower-weight-class launch vehicle. These performance enhancements targeted by commercial satellite owners are also desirable for military satellites. The propulsion industry has accepted these challenges and is transitioning to electric propulsion.

To ensure the broader application of ion or Hall thrusters, greater emphasis needs to be put on developing the components of the entire electric propulsion subsystem, which includes not only the thruster but also the propellant feed system and the power processing unit (PPU). Historically the PPU has been the dominant cost driver for electric propulsion systems because it calls for heavy power converters and thermal management systems. Aerojet Redmond designs and builds high-power converters to support the electric propulsion subsystems it manufactures. It is also working on a solar electric direct drive that uses a high-voltage solar array to provide power directly to a Hall thruster at voltages needed to drive thruster discharge. Qualification of a solar electric direct drive would greatly reduce the cost and weight of a Hall electric propulsion system while also reducing array size. Reduction in array size brings added savings in spacecraft weight. The potential payoff for direct drive makes this goal extremely worthy of pursuit.

Current Propulsion Research

In 1994, DoD, the Air Force, and NASA established the IHPRPT program. This joint government and industry effort includes developing technologies for extending the life of spacecraft and for in-space maneuvering of various assets. Performance metric goals for spacecraft propulsion under IHPRPT were defined. Many basic concepts already in use on commercial communication satellites were leveraged for the benefit of DoD and the Air Force and will continue to be exploited for IHPRPT.

Chemical Propulsion

Projects under IHPRPT at AFRL, NASA, and contracted to industry include alternative propellants for liquid propellant engines and combination thrusters having dual-mode capability.

Energetic Monopropellants. Research and development on several energetic monopropellants is under way in-house at Edwards Air Force Base and at Aerojet Redmond. Two of the propellants under study are hydroxylammonium nitrate and AF-315E. Their main theoretical advantages are higher density and higher I_{sp} (260-270 sec) than state-of-the-art hydrazine. They are claimed to be less toxic, but the relevance of this characteristic for military missions is unclear.

Combination Thrusters, Dual-Mode Capability. The first thruster designed to operate in either a bipropellant or monopropellant mode has been designated the secondary combustion augmented thruster (SCAT). In its monopropellant mode, it decomposes hydrazine in a catalyst-bed chamber. The decomposition products flow out through a second small chamber and exit through a conventional nozzle with an expansion ratio of about 100:1. In this mode the thruster has an I_{sp} of about 230 sec and can provide thrusts from 0.8 to 4.5 lb. In its bipropellant mode, N_2O_4 is turned on. It cools the second chamber, vaporizes, and then combusts the NO_2 vapor with the N_2H_4 decomposition products in the second chamber to produce an I_{sp} of about 325 sec up to 14 lb thrust. Because the second chamber is regeneratively cooled it can be made of nonrefractory metals such as nickel. This provides essentially unlimited operating life. Dual-mode capability provides opportunities for optimizing in-space operations.

On-Orbit Refueling: Orbital Express. Northrop Grumman Corporation and Boeing are finishing up the DARPA Orbital Express spacecraft contract to demonstrate the practicality of on-orbit refueling of spacecraft hydrazine propulsion systems. DARPA is interested in in-space refueling because some fully functional satellites had to be retired when the original propellant load carried into orbit with the satellite became exhausted. If spacecraft could be designed to be refueled in space, many could continue to operate for much longer times. The next important step would be to extend the technology to the transfer of MON and subsequently to LOx. A refuelable LOx/N₂H₄ system could be a transformational capability for in-space, high ΔV maneuvering of large platforms, space tugs, and fly-out weapons.

Recommendation 5-2. DoD should fund total architectures and operations studies for various future DoD/Air Force missions to determine the advantages of on-orbit refueling capability. Future funded technology work should complete the validation of full operational design criteria for the transfer of hydrazine. Those basic design criteria should be expected to be applicable to other storable low-vapor-pressure fuels like MMH. A subsequent program should be instituted to extend the technologies to storable oxidizers such as MON and, finally, to LOx. The committee believes a funding level of \$10 million per year, in addition to that discussed in Recommendation 5-1, over the next 10 years would permit finalizing an IOC module for N₂H₄ and pursuing subsequent technology demonstrations with MON and LOx.

Electric Propulsion

Electric propulsion projects already carried out or in progress under IHRPRT include the following:

- Orbit insertion: 4.5-kW Hall-effect thrusters, 25-cm xenon ion thruster, 20-kW Hall-effect thrusters, and XOCOT (type of pulsed plasma thruster).
- Orbit attitude/position changes: 200-W Hall-effect thrusters and 600-W Hall-effect thrusters.
- Propulsion systems used to propel fly-out and maneuvering of items: relatively high-thrust dual-mode thrusters.
- Altitude control: using micropulsed plasma and colloid thrusters.

Critical Needs for Meeting In-Space Propulsion Goals

At the present time, there is very little national effort in advanced in-space propulsion. There is almost no work on very high power (greater than 50 kWe) electric thrusters; in particular, there is almost no technology development under way on Lorentz force accelerators (electromagnetics), which offer higher thrust (1-5 lbf) as well as high I_{sp} (>5,000 sec). In addition, there is little investment in the companion areas of very high power sources and highly efficient energy storage systems to enable high-power, high-performance electric propulsion to function unimpeded by system power and energy constraints.

Air Force long-range planning will continue to evolve new needs for both strategic satellites and the responsive introduction and repositioning of tactical military satellites or space vehicles of various types. For repositioning large strategic capital assets, one could utilize an onboard, low-thrust, very high fuel efficiency electric propulsion system such as Hall-effect thrusters that would fire continuously to complete a large station change in weeks or months. Alternatively, one might use a modest-performance (330-360 sec) chemical propulsion thruster at 100-200 lb thrust. Velocity changes of hundreds of feet per second could be achieved in minutes to hours, permitting position changes of thousands of miles per day. A third way to implement large, rapid station changes would be to have a space tug with either high-performance electric propulsion for slow strategic moves or high-thrust, modest-performance chemical propulsion for responsive maneuvers.

Another important technology that would permit rapid multiple maneuvers of critical assets would be an on-orbit refueling system, such as was discussed under chemical propulsion, to resupply the propellants during or after changing station. The on-orbit refueling capability would enable a space asset to stay alive for as long as everything kept working functionally and to make as many rapid station changes as required. The committee recommended that DoD fund a significant program in this area (see Recommendation 5-2).

A near-term need is to characterize spacecraft/plume interactions. There is a study under IHPRT for in-space validation of modeling and simulation predictions of Hall thruster electromagnetic fields and plume interaction with spacecraft. A Northrop Grumman/Busek 300-W Hall electric thruster, which might provide some data to anchor the models, was planned for flight in 2006.

All electric propulsion thrusters at any power level need PPUs having greatly reduced mass per kilowatt. One promising approach to this is a solar-electric drive that uses a high-voltage solar array to provide power directly to a Hall thruster.

A larger industrial base than presently exists is required for assured production of complete electric propulsion systems (thrusters, feed, and PPUs). For Hall electric thrusters there appear to be two sources: Aerojet Redmond and Northrop Grumman/Busek. For ion thrusters the future is uncertain, because Boeing has sold its Torrance, California, electric propulsion facility to L-3 Communications.

PROPULSION SYSTEMS FOR STRIKE AND TACTICAL MISSILES

This section addresses propulsion technologies applicable to military airborne, extended-range strike and tactical missiles. Such missiles include surface-to-surface; surface-to-air; air-to-air; air-to-ground, extended-range global strike; and air-to-near space. Currently, almost all these missile types use standard Class 1.3 hydroxyl-terminated polybutadiene/ammonium perchlorate (HTPB/AP) propellant solid rocket motors. Very little new work has been conducted over the last 10-15 years to improve solid rocket motor propulsion systems for missiles by the S&T elements of the Services or by the OSD. Most of the IHPRPT funding for solid rocket technology has been for strategic sustainment to maintain some level of capability and industrial base. For one reason or another, none of the few advanced propulsion technologies that have demonstrated significant improvements has been transitioned into an operational system to date.

IHPRPT Goals for Improving Missile Propulsion

Most of the IHPRPT goals for improvements in propulsion systems for tactical missiles are proving to be somewhat unrealistic for the medium term. People talk about higher combustor operating pressures (>2,000 psia) and high-energy propellant formulations, but they cannot demonstrate them with acceptable margins. Solid propulsion technology has run into a ceiling dominated by throat erosion for the best materials that experts have devised. This same limit has prevented using a number of new high-energy propellants. By their very nature, tactical missiles have higher chamber tem-

peratures and higher throat velocities, and in many cases their products of combustion are chemically incompatible with nozzle materials, all of which results in unacceptable throat erosion.

The Army has done considerable work to demonstrate missile trajectory and energy management using storable gelled liquid propellants and pintle-in-the-throat throttleable solids. This work has achieved reasonable success in increased missile range, accuracy, and real-time retargeting. For example, using gelled propellants for energy-managed propulsion systems, the Army was able to flight demonstrate doubling the range of a tube-launched, optically tracked, wire-guided antitank missile from 4 to 8 km and hit the intended target. However, as already stated, these technologies have not yet been transitioned into any operational system.

Current IHPRPT Research

Missile propulsion technology work under IHPRPT is divided into three categories: solid propellant motors, hybrid rocket motors, and gelled propellant motors.

Solid Propellant Motors

Solid propellant technology work in-house at AFRL in solid motor design and hardware demonstrations appears to be minimal. Basic research in a number of very advanced areas is of high quality, however. An important IHPRPT project contracted to both Aerojet and Alliant TechSystems is to develop and validate advanced computational tools. The intent is to replace empirical models with more physics-based models. AFRL is also working on a demonstration solid propellant motor that incorporates a desubmerged lightweight nozzle, reduced part counts and fewer interfaces, a carbon-carbon exit cone, a wet-wound graphite/resin system, the elimination of dome reinforcements, strip-wound Kevlar ethylene propylene diene monomer (EPDM) rubber insulation, a Class 1.3, 90 percent solids HTPB/cyclotrimethylene trinitramine/royal demolition explosive (RDX) propellant, a consumable igniter, and a smaller electromechanical thrust vector assembly (EMTVA).

At the U.S. Army Missile Command, Huntsville, Alabama, solid propellant missile propulsion technology is focused on three high-leverage areas: controllable thrust propulsion (CTP), insensitive munitions (IM),

and new materials. Controllable thrust has the potential for significant system benefits. It can provide extended range and shorter time to target at mid-ranges in a single system. Controllable thrust systems also can reserve propellant energy for end-game performance. Thrust profiling for either ground- or airborne-launched missiles can be provided by using solid propellant motors with a variable area nozzle, hybrid solid fuel with gelled storable oxidizer, or gelled storable liquid propellants.

Hybrid Rocket Motors

Lockheed Martin Michoud Operations has worked on hybrid propulsion technologies since 1989. Because the fuel is inert, launch vehicles or missiles that use these propellant combinations can achieve good performance and gain the benefits of having a nonexplosive propellant combination. Controllable thrust hybrid rocket motors are being investigated by the Army. Two types of hybrid rockets have been considered: (1) a conventional hybrid rocket in which liquid or gelled oxidizer is injected into the port(s) of the solid-fuel grain or the fuel-rich propellant grain for combustion and (2) a gas-generator type of hybrid rocket in which the fuel-rich solid propellant grain burns in its own combustor and the discharged products are further burned with the oxidizer-rich gases in a postcombustor. In some special but rare cases, an inverse hybrid can be considered in which the solid grain is made of oxidizer-rich material and the injected liquid is a fuel-rich material. In the past, hybrids suffered from significant instability problems because of low regression rates. Recently, there have been several significant breakthroughs in hybrid technology at Lockheed Martin Michoud, Stanford University, and Orbitec. These hybrid technology advances with their inherent safety should greatly advance hybrid propulsion applications for space and missile systems.

Gelled Propellant Motors

Gelled propellants can meet field and aircraft operational and handling requirements. They have the potential of being inherently insensitive to IM threats because the fuel and oxidizer are stored in separate tanks. A throttling gel engine using a passive pintle demonstrated a turndown ratio of 12:1 while maintaining greater than 98 percent I_{sp} efficiency. Design criteria for gelled propellant propulsion systems for missiles of almost any size have been validated at Northrop Grumman Corporation. The critical

design element is a central injector with a single sleeve that permits throttling, no dribble face shutoff, and restart.

Recommendation 5-4. DoD should ensure that the development of advanced tactical missiles, responsive global-reach missiles, and ABMs satisfies four key requirements: effective energy/trajectory management, higher-energy-density performance, minimum smoke exhaust, and insensitive propellants. The S&T part of the DoD/Air Force strategic plan for missiles should focus on the technologies and design criteria necessary to meet these goals. The committee's estimate of annual funding that would be required to make reasonable progress in establishing advanced capabilities in these areas is \$20 million to \$30 million.

Two Potentially Transformative Concepts

There are a couple of potential opportunities for transforming how certain tactical, responsive global reach, and ABM missions could be achieved. One system concept utilizes self-contained ABVL modules. Another would make use of a multimission modular vehicle (MMMV). Both airborne launch concepts could transport rocket-powered missiles to high-altitude launch points at optimum geographic locations, enabling broad flexibility with respect to launch time, azimuth, orbital inclination, and time to target for missiles used for ABM missions, tactical support, or long-range global strike. Such concepts could provide a rapid response capability beyond what is available today to counter emerging threats. Launching missiles from a flying aircraft platform can dramatically improve both missile performance and time to target. High-altitude air launch allows the rocket to bypass the initial parts of a ground-launch trajectory, where combined negative effects can result in a velocity loss of around 3,500 feet per second.

Recommendation 5.6. The Air Force and DoD should sponsor a detailed system engineering study of using the MMMV air-based launch system for medium-sized missiles in combination with the air-based vertical launch study for various types and sizes of missiles called for in Recommendation 5.5, thereby ensuring that both studies are focused on the Air Force/DoD optimization criterion "mission success." The studies would identify the propulsion technologies (modifications or new concepts) that should be evolved in order to take full advantage of such air-based launch platforms for operationally responsive missions.

**OUTLOOK FOR ALL ROCKET PROPULSION SYSTEMS:
ACCESS TO SPACE, IN-SPACE OPERATIONS,
AND AIRBORNE MISSILES**

As shown in Tables 4-10 to 4-14, funding for technology programs such as IHPRPT and for sustaining improvements in propulsion engineering on various weapon systems now accounts for a much smaller fraction of the overall research and engineering (R&E) funding line. This limits the accomplishments of propulsion improvement efforts and minimizes the opportunity to train the next generation of designers and production specialists. Personnel demographics indicates that many individuals with critical skills in the development and production of large missiles and launch vehicles will retire in the same time frame. One outcome will be to limit the capabilities and flexibility of U.S. space assets that are crucial to support the warfighter and without which the national defense will be compromised. The consequences of this funding situation have been eroding U.S. aerospace capability for many years. Unless there is a serious commitment to reversing this trend, the ability of industry to provide the high-quality engineering and production capability for realizing the Air Force's medium- and far-term transformational in-space and missile goals will be at risk.

Cross-cutting Technologies

Fuel

Jet fuel costs have risen by a factor of 2.2 since 2004, and this rising cost of jet fuel is a major expenditure for warfighter support. Estimates are that the DoD fuel bill was \$6.8 billion to \$9.4 billion higher in 2005 than in 2004 due to fuel price hikes and the additional cost incurred in transporting fuel to the battlefield. Further, DoD is increasingly dependent on foreign sources of refined fuels and relies on supplies from refineries that are vulnerable to terrorist attacks. Finally, DoD needs to use fewer varieties of fuels to simplify logistics, and it needs high-thermal-stability fuels to facilitate the thermal management of aerospace vehicles.

Materials

The propulsion industry today, air-breathing and rocket, is taking advantage of materials and processing investments spurred by the ManTech

program of the past. In retrospect, the Services and DoD/DARPA funding spawned the entire aerospace materials supply chain that is in place today. As we look to the future with very limited and restricted ManTech, such investments are being driven by commercial engine needs and DoD is just tagging along. More of the advanced work will migrate offshore. For instance, SiC fiber used in highest temperature ceramic matrix composites (CMCs) is supplied from Japan, and TiAl processing is rapidly advancing in Europe. Since the DoD production base is not large, these new material technologies only become economical if there are commercial applications. This presents an opportunity for realistically planned ManTech programs that will provide baseline manufacturing technology for high-performance defense systems and also leverage requirements of the nondefense aerospace sector (DSB, 2006).

Recommendation 6-2. The Air Force should fund ManTech at a level sufficient to enable future advances in materials for propulsion technology.

Investment Strategy Options

The range of challenges facing the U.S. military over the next 15 years requires that the United States field air-breathing propulsion systems that cover the Mach number range from 0 to Mach 16 and rockets that provide cheap, reliable, and ready access to space. These requirements, which are greater than the United States has faced since World War II, come at a time when existing equipment is demanding an ever-increasing share of the DoD budget for fuel and sustainment and when S&T is receiving less than 1.5 percent of the DoD budget. Clearly, this situation calls for DoD to define and then implement an optimal investment strategy for its limited resources. The committee examined a number of strategies and found that while no single strategy was right for all programs, several did allow DoD to optimize the impact of its investment.

VAATE, like its predecessor IHPTET, utilizes and focuses all government and contractor independent R&D (IR&D) money and resources on the achievement of a common goal. No other DoD technology program has the reach or leverage of the VAATE program, whereby contractor IR&D funds are applied to extend government technology funding. An aggressive VAATE program is needed to meet the warfighter's capability requirements.

The focus and leverage of the IHPTET program allowed the United States to field the most advanced fighter engines (F135 and F136) in the world. The IHPTET investment strategy had three main characteristics: (1) it gave all government and contractor technology funds and resources a common set of goals, (2) it had a relatively stable funding profile consistent with the time frame for developing and demonstrating new technologies, and (3) it tracked investment versus achievement of the technical goal. VAATE improves on the IHPTET investment model: Not only does it maintain the three IHPTET characteristics, but it also focuses on system solutions (high-impact, integrated solutions) as opposed to specific gas turbine improvements and makes affordability a key metric.

A small share of the savings in sustainment and fuel costs of existing aircraft generated by IHPTET could be allocated to properly fund VAATE, which requires approximately \$300 million per year focused on warfighter needs if the United States is to maintain its lead in gas turbine propulsion.

The legacy fleet, which will make up over 80 percent of the 2018 warfighting capability (if the Joint Strike Fighter is included), needs drastic attention. In FY04, the cost to sustain the legacy fleet was \$4.2 billion, and assuming a fuel cost of \$1 per gallon, fuel amounted to an additional \$4.7 billion. In other words, in FY04 the cost of operating the legacy fleet was approximately two-thirds of the total DoD propulsion budget. These costs will continue to increase, because the DoD fleet will grow older and the true cost of fuel will be much, much higher than the assumed \$1 per gallon in FY04. Unless strong action is taken, the growing proportion of the DoD propulsion budget allocated for sustainment of the existing fleet and fuel for it will become a death spiral, with the portions of the budget allocated for procurement, development, and technology always decreasing. See Figure 7.1 for additional detail.

The committee found that the breakdown of the DoD budget for fuel, maintenance, and product improvement for different commands and Services is wasting potential opportunities to decrease the cost of sustainment and fuel (see Chapter 3 for examples). To illustrate: An engine program office that has money to improve an engine is disconnected from the budget for maintenance cost of the engine and also from the budget that buys fuel to operate the engine. The committee found many cases where this lack of connecting authority and responsibility was causing poor decisions on trade-offs that were meant to reduce the costs of sustainment and of fuel burned.

Connecting the authority to make small investments to improve legacy propulsion systems with the responsibility for reducing sustainment and fuel costs for the same systems would allow good investment decisions to be made. Today, since no one person or command is responsible for the total cost and investment, no such trades are made, or they are very infrequent. Budgets spent on sustainment and fueling of the legacy fleet leave no room for the acquisition of new aircraft or the development of technology.

Finding 7-1. History has demonstrated that the introduction of new technology into existing weapon systems—i.e., spiral development—can be a very cost-effective way to upgrade warfighting capability.

Recommendation 7-3. The Air Force and DoD should apply spiral development to all weapons systems that are in service longer than it takes to develop a new generation of technology.

History shows that spiral development has been applied to the important Air Force and Navy fighter engines. For example, propulsion systems for the F-16 and F-15 aircraft underwent spiral development programs to improve their thrust and reliability, a very cost-effective way to increase their warfighting capability. The main derivative programs for these engines (e.g., F100-220 and -229 versus the F100-100) bundled technology packages from IHPTET or IR&D programs to markedly enhance performance. Currently, DoD is not leveraging the major F-22 and F-35 propulsion investments by providing spiral development programs (e.g., EMDPs) to meet the requirements for other aircraft. For example, derivatives of the F119/F135 or F120/F136 engines are candidates to power future global strike aircraft. Spiral development is the most cost-effective way to maximize the effectiveness of long-lived weapon systems.

Commercial experience has demonstrated that the government is a very high-cost integrator. DoD has made progress over the past several years in adopting commercial best practices. Commercial best practices clearly set requirements and then contract with suppliers to meet those requirements.

Recommendation 7-4. DoD should adopt commercial best practices to reduce costs and exploit the technical expertise of its research laboratories to enhance the integration process in its product centers and depots.

The idea of a 1-year engine demonstrator program is a good one. The current trend is to move from IHPTET, where a major technology demonstration occurs every 1 to 2 years, to VAATE, where a major technology demonstration is planned once every 5 to 7 years. This long time between major technology demonstrations will accelerate the demise of the U.S. technology lead in propulsion systems.

Recommendation 7-5. DoD and major propulsion contractors should define the process changes needed to produce 1- to 2-year technology demonstrations. Decreasing the interval between demonstrations of technology in major propulsion systems will increase the rate of technology development.

Recommendation 7-6. To reduce the cost of fuel burn and of sustaining the portion of the existing fleet that will be in service in 2020, DoD should develop innovative contracting methods to facilitate the incorporation of evolving technologies into existing engines.

Finding 7-5. A focused effort, probably by DDR&E, to catalog and make accessible the findings of past technology programs would be highly useful.

Recommendation 7-10. DDR&E should undertake a focused effort on cataloging and making accessible the findings of past technology programs, perhaps even combining the IHPTET, IHPRPT, and VAATE databases at the lower taxonomy levels to enhance technology cross-fertilization. It should also set up a feedback process and facilitate a cross-cutting flow of S&T during the development, acquisition, and sustainment phases.

REFERENCES

Published

- AFSPC (Air Force Space Command). 2003. Air Force Space Command Strategic Master Plan FY06 and Beyond. October 1. Available online at <http://www.cdi.org/news/space-security/afspc-strategic-master-plan-06-beyond.pdf>. Last accessed on October 31, 2006.
- Bexfield, James, and Lisa Disbrow. 2005. MORS Workshop on Capabilities-Based Planning: The Road Ahead. Washington, D.C.: Military Operations Research Society. December. Available online at http://www.mors.org/publications/reports/2004-Capabilities_Based_Planning.pdf. Last accessed on August 9, 2006.

- DoD (Department of Defense). 2004. Department of Defense Space Science and Technology Strategy. Washington, D.C.: Defense Research & Engineering. July 31.
- DSB (Defense Science Board). 2006. The Manufacturing Technology Program: A Key to Affordably Equipping the Future Force. Washington, D.C.: Office of the Under Secretary of Defense for Acquisition, Technology and Logistics. February. Available online at http://www.acq.osd.mil/dsb/reports/2006-02_Mantech_Final.pdf. Last accessed on August 9, 2006.
- NRC (National Research Council). 2003. Materials Research to Meet 21st Century Defense Needs. Washington, D.C.: The National Academies Press. Available online at <http://newton.nap.edu/catalog/10631.html>. Last accessed on August 11, 2006.
- NRC. 2004. Evaluation of the National Aerospace Initiative. Washington, D.C.: The National Academies Press. Available online at <http://www.nap.edu/catalog/10980.html>. Last accessed on March 31, 2006.
- NSPD (National Security Presidential Directive). 2005. U.S. Space Transportation Policy. NSPD-40. January.
- USAF (U.S. Air Force). 2005. Master Capabilities Library.

Unpublished

- Hampsten, Ken, Jim Coney, and Gus Hernandez. 2005. "ARES subscale demo Phase I," Presentation to HLV Industry Day on March 7. Space and Missile Center. El Segundo, Calif., LAAFB.
- James, Larry D. 2005. "ARES Industry Day AFSPC," Presentation to HLV Industry Day on March 7. Space and Missile Center. El Segundo, Calif., LAAFB.
- Sega, Ron. 2005. "Department of Defense propulsion science and technology," Presentation to the committee on May 24.
- Smith, Scott. 2005. "Air-based vertical launch," Presentation to committee member Gerard Elverum on December 19.

**Chapters 2-7 and Appendixes A-E are reproduced
on the CD-ROM that contains the full report
but are not included in the printed report.**

Military Propulsion Needs

BACKGROUND

In their charge to the committee, the Air Force and the Director, Defense Research & Engineering (DDR&E), requested a detailed examination of the links that connect the propulsion technical base to needed future capabilities as defined. Capabilities-based planning, now currently being widely used throughout the Department of Defense (DoD), is a form of all-threats planning. It addresses the growing uncertainty in the threat environment by using a wide range of possible scenarios to bound requirements and thereby reduce the tendency to fixate on a certain threat, location, or set of conditions. Capabilities-based planning, which involves the analysis of alternatives (AoA) for any given capability, does not specify system solutions until after analysis is completed and a decision made.¹

This methodology requires that the technical base programs funded within the science and technology (S&T) budget cover a broad spectrum of alternatives to meet capabilities that could be needed one day. Clearly, the technical base managers would seek maximum definition of the capabilities likely to be needed, while the capability definers, usually the warfighters, would like the technical base to possess the flexibility and general wherewithal to support any defined need. Unfortunately, at the present time, neither group can attain the clarity it would like—for a number of reasons.

DoD has shifted during the past 4 years from the threat-based model that dominated defense planning in the past to a model based on capabilities—a model that focuses more on how an adversary might fight than specifically on who the adversary might be or where the war might occur. This model is designed to plan for uncertainty, the defining characteristic of today's strategic environment, which presents four kinds of challenges: traditional, irregular, catastrophic, and disruptive. Box 1-2 in Chapter 1 describes each kind and gives examples.

Neither the Joint Capabilities Integration and Development System (JCIDS) nor supporting activities such as science and technology comprehensive reviews of the Office of the Secretary of Defense (OSD) is mature, nor has either been fully implemented.² Technology area reviews and assessments (TARAs) are scheduled biennially resuming in 2006 (in 2005 they were cancelled). In addition, joint warfighting capability gaps based on future joint concepts have not yet been prioritized. A recent National Research Council (NRC) study called for the Navy to establish a formal science and technology mechanism that will identify and address naval aviation capability gaps (NRC, 2006).

In 1989, the Deputy Secretary of Defense challenged the services to create a new approach to increase efficiency in research, development, testing, and engineering (RDT&E) activities (DMR 922) (NRAC, 2002). In 1991, the Service Assistant Secretaries directed the implementation of the Defense Science and Technology Reliance Program (the Reliance Program, for short) under the Joint Directors of Laboratories, and from 1992 to 1994, the Defense Nuclear Agency (DNA), the Defense Threat Reduction

¹For additional description of capabilities-based planning, see Capabilities Based Planning Overview at [http://www.ojp.usdoj.gov/odp/docs/Capabilities Based Planning Overview.pdf](http://www.ojp.usdoj.gov/odp/docs/Capabilities%20Based%20Planning%20Overview.pdf). Last accessed on August 30, 2006.

²For more information on JCIDS, see http://www.dtic.mil/cjcs_directives/cdata/unlimit/3170_01.pdf. Last accessed on April 21, 2006.

Agency (DTRA), the Ballistic Missile Defense Organization (BMDO), and the Defense Advanced Research Projects Agency (DARPA) were added to the Reliance Program. In the late 1990s, joint integration, planning documentation, and an emphasis on warfighter requirements were also added to the program (CRS, 1999; Etter, 2002; Ray, 2005).

While it is widely asserted that the Air Force has been designated as the Reliance Program executive agent for propulsion, to the best of the committee's knowledge, no service has been so designated since propulsion has never been considered a single entity. In fact, historically, aerospace propulsion was treated as three separate areas: (1) aircraft propulsion (gas turbines), (2) rocket propulsion, and (3) other (generally high-speed, air-breathing ramjets, ducted rockets, etc). In the S&T arena, the Air Force has been by far the largest investor in both aircraft propulsion and rocket propulsion (Richman, 2005). Nonetheless, the other services make important investments in aircraft and rocket propulsion that are coordinated through various steering committees and formal agreements, which are described later (Richman, 2005).

In summary, DoD is in transition from threat-based defense planning to capabilities-based defense planning, and the capabilities that will be required during the study time frame (the late 2010s), as well as the associated activities, analyses, and documentation, are immature and there are numerous gaps in their assessment.

With this in mind, the committee sought to determine the extent to which future capabilities are clearly defined and how the propulsion technical base has been structured to realize them. One would expect to see a propulsion technical base consisting of numerous technology readiness level (TRL) 2/3 programs awaiting orders to be matured to TRL 6/7.³ To do this successfully, realistic development roadmaps and funding profiles for crossing the gulf between TRL 3 and 6 would have been drawn up and kept up to date to form the basis for program objectives memoranda (POMs).⁴ If this had been done, the committee's data-gathering efforts would have been relatively straightforward. In general, however, the committee members assigned this task found, with a few exceptions, neither well-defined capabilities nor realistic technology transition planning.

Given that there were no comprehensive or detailed statements of needed capabilities, the committee invited the Office of the Secretary of Defense (OSD), the DDR&E, the Joint Staff, the Army, the Navy and the Air Force to present capabilities requirements for the 2018 time frame and beyond for the four warfighting challenges listed in Box 1-2. The committee also received presentations from the National Aeronautics and Space Administration (NASA), DARPA, and various representatives of academia and industry.

America's Air Force Vision 2020 is illustrative of the DoD capabilities-based planning process. It lays out the Air Force concept of operations (CONOPS). Its capabilities reviews and risk analyses (CRRAs) review the task or missions: global strike, homeland security, global mobility, global persistent attack, nuclear response, space and command, control, communications, computers, intelligence, surveillance, and reconnaissance (space and C4ISR); and agile combat support (Mitchell, 2004). The capabilities required are command and control, intelligence, surveillance and reconnaissance, force application and force projection. A review of the Master Capabilities Library and the Air Force's presentations to the committee turned up several required propulsion capabilities and technical engineering goals for the time frame 2018 and beyond, some of which are shown in Figure 2-1 and discussed below.

³For clear definitions of technology readiness levels, please see <http://www.acq.osd.mil/actd/FY06/TRL50002R.doc>. Last accessed on April 21, 2006.

⁴An annual memorandum in prescribed format submitted to the Secretary of Defense (SECDEF) by the DoD component heads, which recommends the total resource requirements and programs within the parameters of SECDEF's fiscal guidance. The POM is a major document in the planning, programming, budgeting and execution process and is the basis for the component budget estimates. It is the principal programming document that details how a component proposes to respond to assignments in the Strategic Planning Guidance and Joint Programming Guidance and satisfy its assigned functions over the Future Years Defense Program. The POM shows programmed needs 6 years hence (i.e., in FY04, POM 2006-2011 was submitted). SOURCE: <http://akss.dau.mil/jsp/GlossaryAbbreviations.jsp?acronymId=1520>. Last accessed on April 21, 2006.

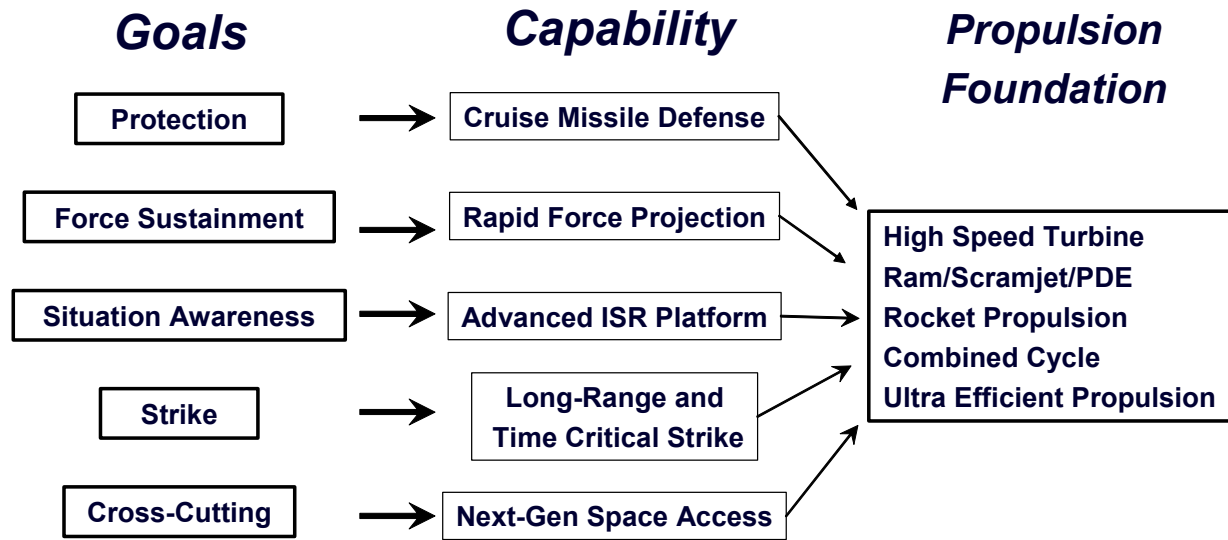

FIGURE 2-1 Propulsion research and engineering goals. SOURCE: Sega (2005).

Global Strike

Perhaps the most documented air-breathing capability is the long-range strike, which was the subject of multiple studies from FY01 to FY03. Rutledge (2005) defines it as the capability to achieve a desired effect(s) rapidly and/or persistently, on any target, in any environment, anywhere, at any time (Rutledge, 2005). To achieve long-range strike capabilities, DoD may leverage propulsion capabilities other than the traditional air-breathing approach. Moreover, a Long-Range Global Persistent Engagement Study, directed by the 2003 Defense Planning Guidance, highlights characteristics of future environments: little or no warning/build-up time; extensive denial of contiguous areas from which to operate, and possible chemical/biological contamination of the environments, which could influence possible capabilities solutions.

According to a 2004 study, the Air Force recognizes its need to upgrade long-range strike capabilities and has created two offices to focus its R&D efforts (Burdeshaw, 2004). Tasking and guidance for these offices were sent to the Air Force from the Office of the Under Secretary of Defense/Acquisition, Technology and Logistics (OUSD/AT&L) in November 2003. The Air Force was instructed to carry out the following tasks (Burdeshaw, 2004).

- Perform modeling, simulation, and analysis to identify important attributes and critical technologies.
- Develop a long-term S&T investment strategy that could allow transition to a development program in 2012-2015.
- Ensure that the investment strategy accounts for investments in related areas, such as C4ISR, and by other agencies (DARPA, NASA).
- Use a joint advanced strike technology approach.
- Augment its efforts with system-of-systems concepts following Air Force guidance.

Global Mobility and Airborne C4ISR

Global mobility operations require robust, sustained airlift and air refueling for deployment, employment, and redeployment. There must be an ability to operate in adverse weather with flexible, adaptable (payload/configuration) airframes capable of surviving in radio frequency, infrared, and directed-energy environments. Airborne C4ISR capabilities would shorten the kill chain by achieving

better situational awareness, faster decision times, and greater precision. Platforms are globally connected and able to persist (every platform is a node in a network of sensors, datalinks, and fused intelligence). Munitions are smarter, and the difference between reconnaissance/surveillance and strike is blurred in the case of armed unmanned aerial systems (UASs), which can persist for hours or even days.

Cross-Cutting Capabilities

Survivability implies, among other things, low-signature stealth, which in turn demands the integration of inlet and exhaust systems into the airframe and proper flow control. Increased range, payload and operational flight envelope are also cross-cutting capabilities, the need for which affects designs and technologies for missile propulsion capabilities across platforms. For example, the Navy is addressing requirements for additional power density for advanced sensor suites, radars, cooling systems and directed-energy weapons; it has also identified environmental factors (noise, emissions) as posing a growing challenge to the deployment and basing of Navy aviation platforms (Gorton, 2005).

Reliability and Maintainability

Not every new capability is the result of revolutionary technology. The Navy and the Air Force say that in 2018, 60 percent of the aircraft inventories will be made up of aircraft already in their inventories today. These factors underscore the importance of existing component improvement programs (CIP) which replace components having low mean time between failure with more advanced technology components and develop next-generation propulsion systems in an evolutionary manner.

For example, the joint government integrated high performance turbine engine technology (IHPTET) program initiated in the 1980s focused on doubling aircraft and missile propulsion performance while decreasing manufacturing and maintenance costs 35 percent by 2003. The F119 engine for the F/A-22, for example, benefits from a substantial number of advanced technologies from the IHPTET program: According to the Director of the Joint Systems Program, a robust and healthy IHPTET program is vital to the Joint Strike Fighter (Haven, 2004). An ongoing transformational technology program for turbine engines is the Versatile Affordable Advanced Turbine Engines (VAATE) program, which is focused on advanced technologies for total propulsion systems. This government–industry collaboration program develops, demonstrates, and transitions advanced, multiuse turbine engine technologies.

Rotorcraft

A number of the presentations and the information made available to the committee reported that most of the helicopter and UAS turboshaft engines in DoD service today use 1960s and 1970s technology. Significant advances in technology over the past 20-30 years would therefore enable dramatic improvements in range, payload, durability, and cost of operation. Yet DoD has apparently elected to depend on spinoffs from commercial developments to meet its rotary-wing mission requirements when in fact commercial turboshaft engines cannot stand up to the DoD operating environment and mission scenarios. The Navy, in particular, specified an operating environment that was not typical of a commercial environment, an environment that required rapid throttle changes and high power for takeoffs and landings as well as the ability to withstand corrosive sea spray, sand, and foreign object damage (FOD).

The capabilities the Air Force needs for rotary propulsion are listed in Box 2-1.

Box 2-1
Capabilities Needed by Air Force Rotorcraft and Missions They Will Carry Out

Rotorcraft capabilities that the Air Force will require in the near term include being rapidly deployable, highly reliable, survivable, all-weather, long-range platforms. These capabilities will serve missions including special operations, combat search and rescue, medium lift in support of noncombatant evacuation operation, humanitarian relief operations, and miscellaneous support to include range support, very important person special air mission, and force protection.

Combat radius is currently most demanding Air Force rotorcraft requirement. Currently, the candidates for personnel recovery vehicles cannot meet the combat radius key performance parameter of 325 nautical miles without significant reductions in payload/loiter. In addition, developments focusing on volume of fuel are increasing weight and expense and decreasing hover performance. A dramatic decrease in specific fuel consumption would supply the greatest benefit as decreasing fuel required decreases weight and improves hover. Lastly, a dramatic improvement in the Air Force and entire DoD medium-lift rotorcraft fleet would result in a turboshaft engine capable of 3,000 estimated standard horsepower performance and a 25 percent specific fuel consumption reduction from the current T700/CT7 family of engines.

SOURCE: Adapted from U.S. Air Force (undated).

The Army transformation plan calls for a force that is responsive, deployable, agile, versatile, lethal, survivable, sustainable and dominant at every point along the spectrum of operations, anywhere in the world. It calls for Army air platforms (manned and unmanned) that have greater range and payload capability and for aircraft that have a smaller logistics footprint to minimize operational and support costs. Figure 2-2 summarizes the Army rotary wing systems demands.

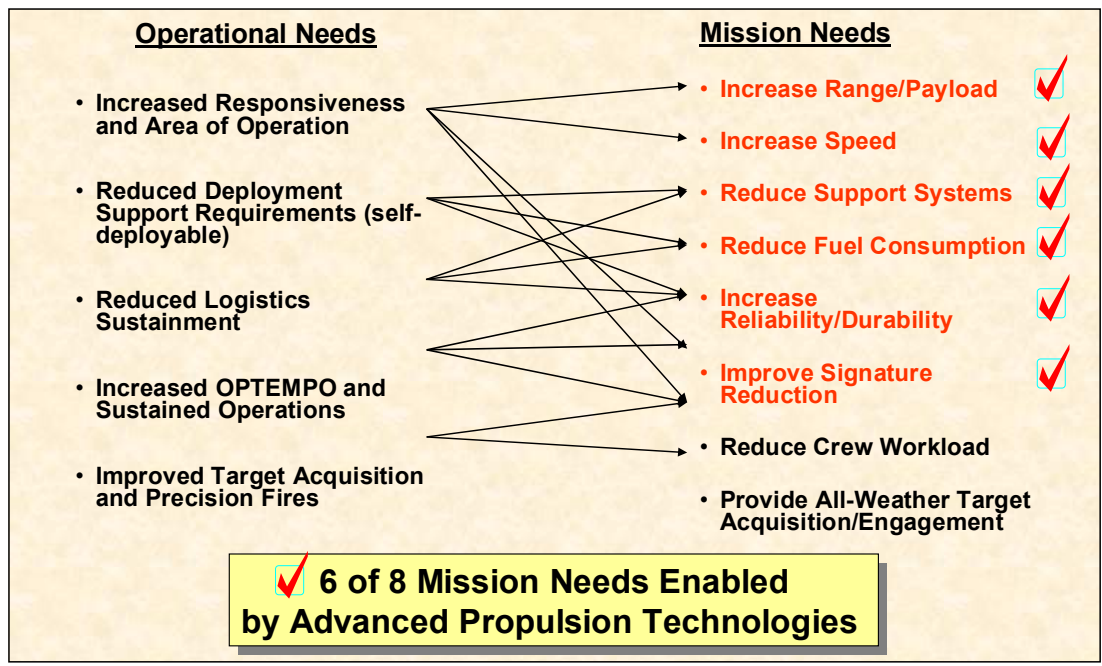

FIGURE 2-2 Rotary wing systems demands. SOURCE: Butler (2005).

Small Unmanned Aerial Systems

The Air Force has stated its capability needs in the 2012-2017 time frame and the 2018 and beyond time frame for hovering/perching unmanned aerial systems (UASs), micro UASs, and advanced versions of each as well as hypersonic munitions with hard target kill capability.⁵ These needs may be summarized as follows:

- Micro class: 1-3 nautical miles (nm) range, daytime, fair weather, 0.5 lb payload, field-supportable, unique fuel requirements.
- Man-portable class: 1-2 hr endurance, 1-2 lb payload, field-supportable, unique fuel requirements.
- Tactical class: 10-12 hr endurance, 100 lb payload, multimission.

U.S. Army UAS requirements are similar to those of the Air Force, as presented, and are shown in Figure 2-3.

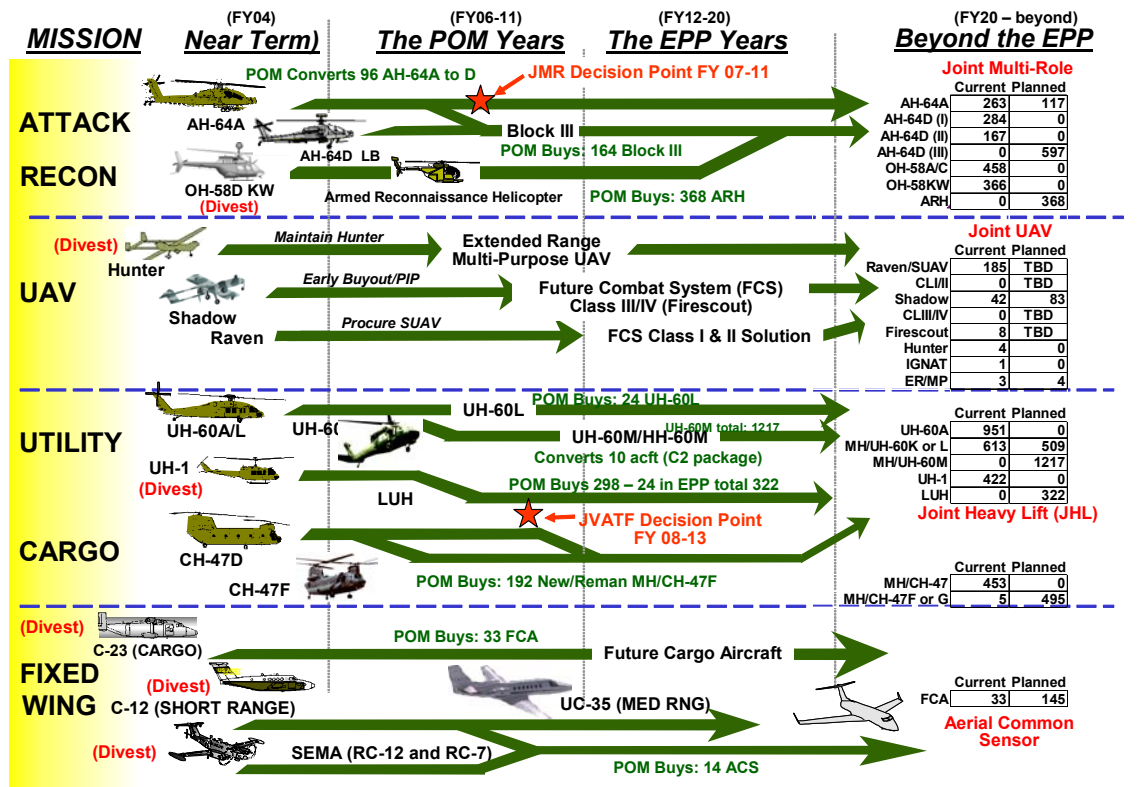

FIGURE 2-3 Army aviation modernization plan. SOURCE: Bolton (2005).

ECONOMICS OF TURBINE ENGINES

Of the roughly \$5.7 billion per year that DoD invests in turbine engines, sustainment (62 percent), acquisition (22 percent), development (14 percent), and S&T (2 percent) are the main components (Richman, 2005). Improving future turbine engine efficiency and mitigating and decreasing aircraft sustainment costs will continue to be key economic drivers for the Air Force and DoD budgets. The rising

⁵For additional information, see *Unmanned Aircraft Systems Roadmap 2005-2030*. 2005. Washington, D.C.: Office of the Secretary of Defense. August 4. Available online at <http://www.acq.osd.mil/usd/Roadmap%20Final2.pdf>. Last accessed on November 3, 2006.

cost of fossil fuels, their availability and their dependence on them were a frequent theme throughout the study. For example, in FY03, the Air Force alone consumed 3.2 billion gallons of fuel at a cost of \$5 billion, and fuel costs have doubled since September 11, 2001 (Sega, 2006). In addition, DoD spends approximately \$50 billion to \$75 billion per year on sustaining more than 49,000 turbine engines on more than 25,000 aircraft (Haven, 2004). These costs will likely continue to rise.

SPACE

The *Department of Defense Space Science and Technology Strategy* is the exception proving the rule that DoD has not been able to articulate warfighter requirements. This document is very specific about future space propulsion requirements (DoD, 2004). Assured access to space focuses on providing responsive space support through the development and demonstration of technologies that enable the unimpeded rapid deployment of space systems using next-generation and generation-after-next launch systems. Access to space can be assured through sufficiently robust, resilient, and flexible launch vehicles; improved launch infrastructure; and ranges that support expanded space operations, including horizontal launch capability and/or mobile launchers. An ability to sortie into space to any desired altitude and orbit will enable truly revolutionary operational space concepts. Resources will also be focused on manufacturing and producibility to get improved reliability and lower cost (DoD, 2004).

Table 2-1 lists the requirements for assured access to space, responsive space capability, assured space operations, and enhanced spacecraft technology. In each case, requirements for the next 5 years and requirements for 2020 and beyond are shown.

TABLE 2-1 Summary of Space Propulsion Requirements

| Goal | Next 5 Years | 2020 or Beyond |
|-----------------------------|--|--|
| Assured Access to Space | Low-cost and reliable small payload launchers capable of placing 500-kg-class payload into low-Earth orbit | Survivable, low-cost, and reliable launch systems to enable on-demand launch of payloads to any orbit and attitude required |
| Responsive Space Capability | Rapidly operable spacecraft | Rapidly operable sophisticated spacecraft of any size |
| Assured Space Operations | Detect, identify, and characterize natural and man-made objects, threats, and attacks Minimize interruptions to operations Protection and countermeasures for enhanced survivability | Complete space situational awareness Uninterrupted operations Deny adversary's use of space |
| Spacecraft Technology | Technologies needed to enable next-generation systems Concepts and algorithms to maximize utility of current systems Miniaturized and multifunctional components to enable small satellites Efficient orbit transfer, maneuver and station keeping On-orbit assessment of satellite servicing and repair | Technologies needed to enable generation-after-next systems Real-time adaptation of missile profile using reconfigurability and reprogrammability On-orbit large-structure development, assembly, and repair On-orbit upgrade |

SOURCE: DoD (2004).

First, assured access to space is defined as:

Assured access to space focuses on providing responsive space support through the development and demonstration of technologies that enable the unimpeded rapid deployment of space systems using

next-generation and generation-after-next launch systems. Access to space can be assured through sufficiently robust, resilient, and flexible launch vehicles; launch infrastructure; and ranges that support expanded space operations, to include horizontal launch capability and/or mobile launchers. An ability to sortie into space to any desired altitude and orbit will enable truly revolutionary operational space concepts. Resources should also be focused upon manufacturing and producibility that results in improved reliability and lower cost (DoD, 2004, p. 3).

Second, responsive space capability is defined as:

Responsive space capability focuses on providing space support and force enhancement through the development and demonstration of technologies enabling the timely employment of space-based assets, including streamlined design, improved manufacturing techniques enabling prompt fabrication and testing, rapid processing before launch and/or reduced time from storage to launch. Responsive space systems seek to deliver capabilities that can be tailored for mission specific needs, be available on-demand, and augment the existing space infrastructure and/or reconstitute degraded space capability in time of crisis. These satellite systems must also be activated and begin operations shortly after arrival in orbit (DoD, 2004, p. 3).

Third, assured space operations is defined as:

Assured space operations is focused on space control through the development and demonstration of technologies that ensure freedom of action in space and denial of the same to adversaries. Space systems, both on-orbit and ground support equipment, must be able to operate under adverse conditions and threats, include the use of countermeasures, and/or utilize concepts that provide an unwarned and unexpected presence to guarantee the survivability of essential space missions. Proactive capabilities based upon dominant space situational awareness that permit effective defensive and offensive counterspace should also be developed to assure space superiority (DoD, 2004, p. 4).

Fourth, spacecraft technology is defined as:

Spacecraft technology focuses on providing space support, force enhancement, and space control through the development and demonstration of technologies enabling transformational spacecraft, sensor, and payload capability. Continued advancement of fundamental satellite bus technologies, such as material science, miniaturization of components, and standardized “plug and play” components enable new capabilities and lowers the cost of utilizing space. Satellite propulsion and power systems must deliver greater performance and efficiency. Data storage and processing techniques should be enhanced to enable larger and more efficient on-board data processing. Dramatic increases should be pursued to expand the spatial resolution, spectral acuity, and temporal persistence of sensors. To expand synchronization of platforms, sensors, and operations, dedicated efforts to develop more precise space clocks are critical, particularly in the performance of secure communications. Along with improvements to current systems and techniques, new sources and methods must be pursued to achieve transformational capabilities (DoD, 2004, p. 5).

The Air Force and the Air Force Space Command (AFSPC) further refine the nation of operationally responsive spacelift (ORS) to include the ability to provide launch within hours instead of days (with storable fuels), and airplanelike operations, and to be economical, survivable, interoperable, and flexible. The AFSPC spacelift roadmap is shown in Figure 2-4. Each bar in the figure represents planned incremental capability (spiral development). Additional capabilities needed are in-space maneuvering of satellites as well as microsatellites, replace and repair on orbit, and protection (defense) of U.S. and allied satellites.

The Air Force has identified another set of mixed systems for the future: maneuverable near-space vehicles that can operate for extremely long times and that include lighter-than-air vehicles and gossamer aircraft. The Air Force also identifies a class of reusable orbital vehicles that possesses the following

characteristics: responsiveness, extremely long range, single stage, horizontal takeoff and landing, and two stages, one of them air-breathing.

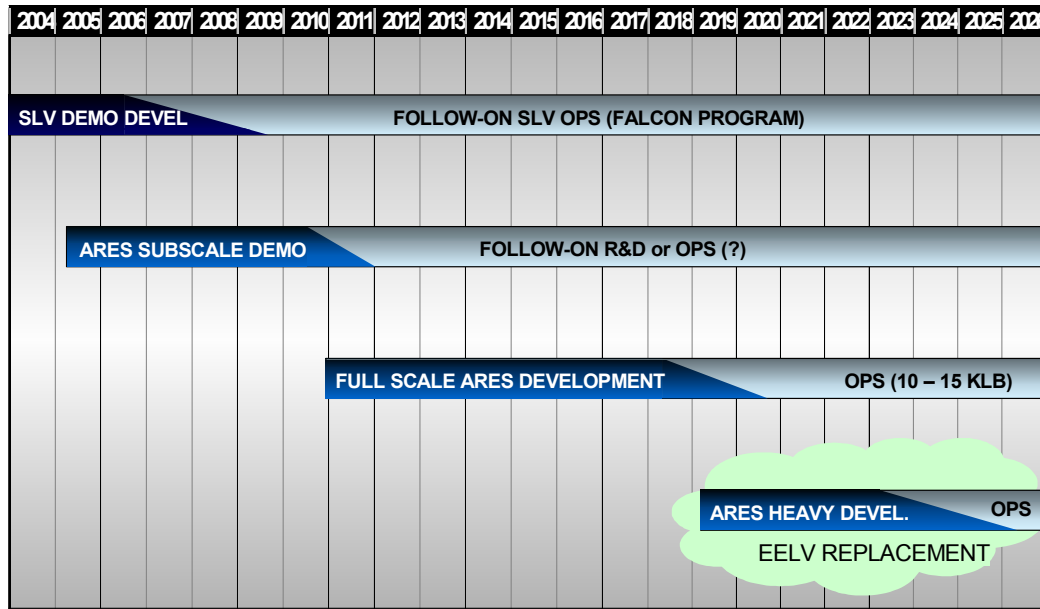

FIGURE 2-4 Spacelift roadmap. SOURCE: James (2005).

SUMMARY

Given the paucity of clearly stated needed capabilities, the committee's analysis for this report must be based on a great deal of informal and anecdotal information gathered through contacts with capabilities planners and the technical base managers who are attempting to satisfy the planners and from briefers to the committee from the services, DDR&E, DARPA, NASA, and various academic institutions and private companies. This is not to say that there are no documents that help define potential future technology developments. There are. In fact, one excellent example is discussed in Chapter 4. A space strategy was clearly defined in a recent document co-signed by the Undersecretary of the Air Force for AT&L and the DDR&E. However, in informal discussions with AFRL and AFSPC personnel, it became obvious that this strategy was not the sole determinant of their marching orders and was considered to be only one of several strategies in play. The conclusion, then, is that even when clear direction exists, it is not always followed. With a clearer understanding of the capabilities that are needed, the technical base managers can reassess their programs to identify the program elements that are needed to draw up technology transition roadmaps and funding profiles. Service leaders would then be in a much better position to assess capability alternatives. The committee's judgments are derived specifically from data gathered about propulsion technology development and not from data on the broader aspects of technology development and transition. However the committee fears that basing important AoAs on less than fully considered cost and schedule realities does not serve decision makers well.

Finding 2-1. Space strategy is clearly defined by the *Department of Defense Space Science and Technology Strategy*. However, it is not being followed except as part of a broader set of strategies deriving from other considerations. There appear to be no similar OSD-level documents that define strategies for achieving capabilities in other important areas, such as aircraft systems and UASs.

Recommendation 2-1. The DoD should prepare strategy documents containing clear guidance on future required capabilities in all system development areas and seek funding to achieve those capabilities.

(Note: this opinion was derived specifically from data gathered about propulsion technology). For example, the specification of propulsion capabilities for assured access to space—survivable, low-cost, and reliable launch systems to enable on-demand launch of payloads to any orbit and altitude required—would be sufficient to focus propulsion R&D.

REFERENCES

Published

- Burdeshaw Associates, Ltd. 2004. White Paper on Long-Range Strike. June.
- CRS (Congressional Research Service). 1999. Defense Research: A Primer on the Department of Defense's Research, Development, Test and Evaluation (RDT&E) Program. Washington, D.C.: Library of Congress. July 14. Available online at http://www.globalsecurity.org/military/library/report/crs/97-316_990714.pdf. Last accessed on April 21, 2006.
- DoD (Department of Defense). 2004. Department of Defense Space Science and Technology Strategy. Washington, D.C.: Defense Research and Engineering. July 31.
- Etter, Delores. 2002. Defense science and technology. Pp. 167-181 in AAAS Science and Technology Policy Yearbook 2002. Albert H. Teich, Stephen D. Nelson, and Stephen J. Lita, eds. Available online at <http://www.aaas.org/spp/yearbook/2002/ch18.pdf>. Last accessed on April 21, 2006.
- NRAC (Naval Research Advisory Committee). 2002. Science and Technology Community in Crisis. Available online at http://www.onr.navy.mil/nrac/docs/2002_rpt_st_community_crisis.pdf. Last accessed on April 21, 2006.
- NRC (National Research Council). 2006. Identification of Promising Naval Aviation Science and Technology Opportunities. Washington, D.C.: The National Academies Press. Available online at <http://www.nap.edu/catalog/11566.html>. Last accessed on August 30, 2006.
- Sega, Ron. 2006. Air Force Energy Strategy. Washington, D.C.: Office of the Undersecretary of the Air Force. April 19. Available online at <http://www.desc.dla.mil/DCM/Files/Dr%20Ronald%20Sega%20-%2019%20Apr%2006-V2.ppt>. Last accessed on August 13, 2006.

Unpublished

- Claude Bolton, "Army Rotorcraft Modernization Plan Progress," Presentation given by Assistant Secretary of the Army for Acquisition, Logistics & Technology on plans for Army Aviation Modernization. Available online at https://acc.dau.mil/simplify/ev.php?ID=68994_201&ID2=DO_TOPIC. Last accessed on June 4, 2006.
- Gary Butler, "Rotocraft Propulsion Technology," Presentation to the committee on May 24, 2005.
- Charles Gorton, "NAVAIR Presentation," Presentation to the committee on May 24, 2005.
- Brenda Haven, "Turbine Engine Technology: An Air Force Perspective," April 23, 2004.
- Larry James, "ARES Industry Day AFSPC," Presentation to Air Force Space Command on March 7, 2005.
- Darphaus Mitchell, "Capabilities-Based Planning: The Road Ahead," Presentation to the Military Operations Research Society on October 19-21, 2004. Available online at <http://www.mors.org/meetings/cbp/presentations/Mitchell.pdf>. Last accessed on April 20, 2006.
- Karen Ray, "Defense Science and Technology Reliance," Presentation to the committee on August 16, 2005.
- Michael Richman, "Department of Defense Propulsion Science and Technology," Presentation to the committee on March 1, 2005.
- Lynda Rutledge, "Air Armament Capability for the Future," Presentation to the Precision Strike Summer PEO Forum on July 28, 2005. Available online at

http://www.dtic.mil/ndia/2005precision_strike_peo/rutledge.ppt#316,17,LONG RANGE STRIKE.

Last accessed on July 11, 2006.

Ron Sega, "Department of Defense Propulsion Science and Technology," Presentation to the committee on May 24, 2005.

U.S. Air Force. "Rotocraft Propulsion Technology," Undated.

3

Air-Breathing Propulsion

INTRODUCTION

Future U.S. armed forces must address an array of challenges that far surpass those faced in the past. Numerous security studies have described the evolving the U.S. security environment and its demand for transformational solutions. The security environment requires the United States to field propulsion systems that cover the entire Mach number range, up to Mach 16. This range of propulsion systems is greater than all the systems the U.S. has produced since World War II. Budget constraints mean that the Department of Defense (DoD) must use derivatives of existing engines to satisfy most new requirements, aggressively work on improving components to save money to pay for sustainment and fuel for existing engines, and increase propulsion science and technology (S&T) funding to meet the wide range of threats. In response to the challenges described in Box 3-1, aircraft propulsion systems must evolve more rapidly than ever before.

Box 3-1 Four Kinds of Challenges

The kinds of challenges are traditional, irregular, catastrophic, and disruptive.

- “Traditional” challenges require continued improvements in legacy performance metrics for gas turbine engines (GTEs). Some of these metrics are propulsion system thrust-to-weight (T/W) ratio, fuel consumption, life-cycle cost, and durability. Continued improvement of these metrics will allow the United States to maintain its technical superiority in GTEs and will provide an opportunity to reduce the cost of maintaining, supporting, and fueling currently fielded engines.
- “Irregular” challenges require improvements in propulsion system stealth, survivability, austere basing (e.g., short and vertical takeoff and landing), and greatly improved fuel economy for long loiter times. Propulsion systems optimized for UASs will also play a major role in this area.
- “Catastrophic” challenges require propulsion systems that power vehicles to high Mach numbers to counter time-critical targets. Propulsion systems for long-range strike missions must power manned vehicles, which cruise between Mach 2 and Mach 3.5. Hypersonic vehicles, which cruise between Mach 4 and Mach 16, are required to stand off and strike time-critical targets or to protect the homeland from incoming weapons.
- “Disruptive” challenges require propulsion systems to power vehicles for directed-energy weapons or to counter directed energy weapons. Propulsion technologies such as integrated thermal and power management, high-heat-sink fuels, and large electrical generating capacity are required to meet these threats. These propulsion systems will also be required to power miniaturized, autonomous, networked sensor and/or weapon systems.

SOURCE: Adapted from Ron Sega, DDR&E, DoD propulsion science and technology, Presentation to the committee on May 24, 2005.

Gas turbine engines (GTEs) for aircraft GTE have undergone continual evolution and improvement since their introduction during World War II. As shown in Figure 3-1, fundamental engine performance parameters have been significantly advanced. However, there remains substantial potential for improvement beyond the current state of the art for fielded military engines, which must undergo further technological development to boost efficiency by increasing compressor inlet temperature (T_3) and turbine inlet temperature (T_4). For example, as shown in Figure 3-1, for large turbofan engines, fuel efficiency has improved only to the extent of closing 38 percent of the gap between the first jet engines and the theoretical Brayton cycle limit. An additional 15 percent fuel efficiency is expected to be realized in large gas turbines between now and the end of 2020 (planning horizon). Similarly, the specific horsepower of small turboshaft, turbojet, and expendable engines has increased, but only to 33 percent of the theoretical Brayton cycle limit. It is foreseen that between now and the end of the 2020 planning horizon, small gas turbine efficiency will be further improved by 30 percent. The committee believes that five technologies are critical for obtaining the improvements: (1) high-temperature compressor disk materials, (2) high-temperature turbine blade materials, (3) thermal management systems utilizing high-temperature, high-heat-sink fuels, (4) lightweight hot structures, and (5) signature controls.

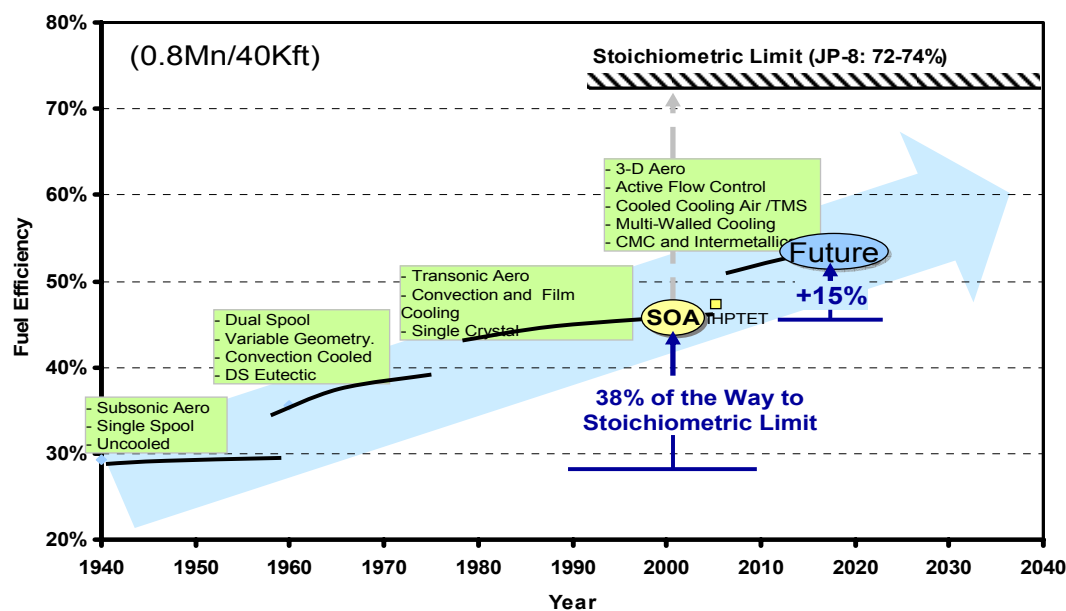

FIGURE 3-1 Progress in turbine engine fuel efficiency. Note: The green boxes in the figure suggest some of many ways in which efficiency could be (or actually was) improved. SOURCE: AFRL (2005a).

Three nearly simultaneous cutbacks to major gas turbine S&T programs have reduced total U.S. funding to between one-half and one-third of pre-FY00 levels. This total comprises funding for the versatile, affordable, advanced turbine engines (VAATE) program, the Integrated High Performance Turbine Engine Technology (IHPTET) program (see Figure 3-2), and the manufacturing technology (ManTech) program and takes into account the National Aeronautics and Space Administration's (NASA's) decision to drastically reduce aeronautics funding. (NASA traditionally invested approximately \$100 million per year in gas turbine S&T.)

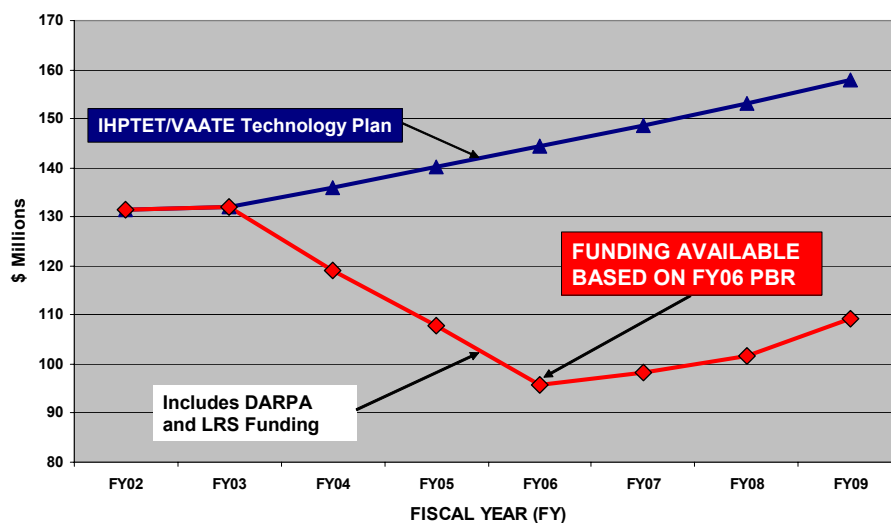

FIGURE 3-2 Engine technology funding. SOURCE: Larry Burns, “Current/future turbine engine technology investment plans and VAATE,” Presentation to the committee on April 5, 2005.

ManTech materials funding, which received between \$70 million and \$110 million annually until 1995, have fallen to levels averaging \$50 million annually. The FY05 amended program objective memorandum (APOM) and beyond projects levels slightly below \$40 million. The net result of these three reductions is that total annual funding has been reduced from approximately \$300 million to approximately \$100 million. At this reduced level, new technologies will be demonstrated at the systems level every 5 to 7 years instead of the 2- to 3-year demonstration cycles before FY00. In addition, the current VAATE program does not allow for the manufacture of two engines in each propulsion class, and the ManTech funding does not allow building a base for the repetitive manufacture of the new materials required for advanced engines. These funding levels will not allow the United States to maintain its dominance of the battlefield air space.

Finding 3-1. Gas turbine engines will continue to play a dominant role in propulsion in future warfare. Gas turbines have the potential for achieving the significant improvement necessary to meet a wide range of future warfighter needs. Proper funding of gas turbine technology during the planning horizon can improve gas turbine performance by 15 to 30 percent. The FY06 Presidential Budget Request (PBR) funding for gas turbine S&T is one-half to one-third pre-FY00 levels. This level of funding will not produce engine technology that allows U.S. aircraft to dominate future air wars.

Recommendation 3-1. To accelerate the development of new engine technologies, DoD and the Air Force should increase funding for Air Force gas turbine S&T funding significantly, from approximately \$100 million annually to a level that reflects the buying power that prevailed when the F-15 and F-16 engines were being developed. First priority should be given to overcoming the technology barriers that will have the largest impact on future weapons systems:

- Compressor discharge temperature reduction,
- Turbine inlet temperature reduction,
- High temperature and high-heat-sink fuels for thermal management,
- Lightweight structures, and
- Signature control.

Some of these solutions apply as well to ramjet and scramjet systems.

LARGE GAS TURBINE ENGINE PROGRAMS

Engine Development Programs

Large GTEs are the backbone of the military aviation force that guards U.S. interests at home and abroad, and they play an enormous role in establishing U.S. air dominance at the battlefield. Due to technological superiority gained from programs such as IHPTET, current turbine engines have enabled U.S. forces to achieve dominance of the air in all recent conflicts. To maintain this edge, however, the United States must respond to the increasing demand by the armed forces for more efficient, survivable, and lethal weapons systems. At the same time, the military needs to make those systems more affordable to minimize their impact on the federal budget. This can only be done through continual R&D in the turbine engine field.

A new generation of aircraft and propulsion systems technology enters warfighter operation roughly every 25 years. Today the United States is fielding state-of-the-art large gas turbines in engines for the F-22 and the F-35. Propulsion technologies in these engines are the result of roughly two decades of technology development from the IHPTET program,¹ the ManTech program,² other DoD programs, and NASA aeronautics. In the committee's view, these propulsion systems are technically approximately 10 years ahead of competing systems such as the Eurofighter. That is, the technology level of the Eurofighter's engines does not allow the Euro Fighter to supercruise or have thrust vectoring or stealth features. Rather, the Eurofighter technology level is roughly equivalent to the levels in the most advanced F-15 engines (F100-PW-229 and F110-GE-129). This technology advantage has degraded relative to that which existed in the 1970s, when the F-15 and F-16 were launched. At that time, the technology advantage could be characterized as being 20 years ahead of the rest of the world. Current gas turbine DoD S&T funding has been greatly reduced relative to the 1990s level, and if it is not increased the United States probably will lose its gas turbine technical advantage, as happened in civil aviation as well.

Fighter Engines

The F119-PW-100 engine developed for the new F-22 fighter aircraft represents a culmination of technologies developed over the past 20 years. The requirements for this engine include reduced radar signature to improve survivability and stealth and thrust vectoring capability.

Another key requirement was that the engines provide enough thrust to allow supercruise above Mach 1, improving range beyond that of the current generation of fighter aircraft. A low-bypass afterburning turbofan cycle was selected to provide the high thrust requirement in the supersonic mode. Dual-channel, full-authority digital electronic controls and pitch vectoring nozzles were developed in time to be incorporated into the engine demonstrator program. After passing through the Mach 1 drag rise, the high turbine inlet temperature allows the F-22 to shut down the afterburner in the supersonic cruise mode for increased fuel efficiency and range. The IHPTET program played a key role in the development of the F119 engine beginning with the prototype PW 5000 demonstrator.

The F135 engine is a derivative of the F119 using the same core with modifications for the F-35 Joint Strike Fighter. This short-takeoff and vertical landing (STOVL) aircraft (Figure 3-3) was created to replace the AV-8V used by the Marine Corps. A novel configuration using a lift fan driven by the engine through a clutch and gearbox was developed to provide the required margin in the lift mode. This lift fan moves a larger volume of air at lower velocity, increasing propulsive efficiency and lift margin over the direct lift systems used in the AV-8V. During the maximum lift mode, the exhaust nozzle is vectored downward, and roll stability is controlled by the outboard compressor bleed nozzles. The power to drive the lift fan required a hotter high-pressure turbine and the addition of another low-pressure turbine stage (beyond what is contained in the F119 engine).

¹See, for example, the IHPTET Website at <http://www.pr.af.mil/divisions/prt/ihptet/ihptet.html>. Last accessed on March 27, 2006.

²See, for example, the ManTech Web site at <https://www.dodmantech.com/>. Last accessed on March 27, 2006.

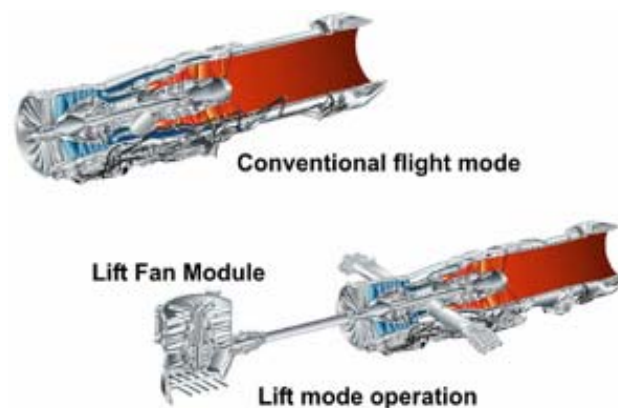

FIGURE 3-3 The F135-PW-600 STOVL propulsion system for the F-35 Joint Strike Fighter. SOURCE: Koff (2004).

An alternative engine for the F-35 aircraft, the GE F136, is being developed jointly by General Electric and Rolls Royce, in a 60/40 respective work split. This engine, a derivative of the GE F120 for the F/A-22 competition, features a conventional mixed-flow, augmented-turbofan configuration. This tri-Service configuration fits directly into the F-35 and is completely interchangeable with the Pratt & Whitney F135 engine. The degree of interchangeability of the F135 and F136 engines on the F-35 is by far the greatest of any fighter program to date.

The F119, F135, and F136 family of engines represents the state of the art in GTEs for fighter aircraft. The committee believes this technology is currently about 10 years ahead of the competing Russian and European engines.

Commercial and Transport Engines

The GE 90-115B is the world's newest and largest turbofan engine. It was certified in 2003 at 115,000+ lb of thrust at sea level. This engine is a growth derivative of the GE 90-94B, which has a 123-in. diameter fan and a bypass ratio of 8.4. The GE 90-94B is a two-spool engine with 22 turbomachinery stages, which is the same as the Rolls-Royce three-spool Trent 800.

Normally, a three-spool turbofan has fewer stages since each stage can operate close to the optimum aerodynamic loading. This was made possible since the GE 90 10-stage compressor has a pressure ratio of more than 20:1, which is the world's highest for aeronautical engines. The compressor technology was developed for the NASA GE E3 engine in the late 1970s and was ready for the B-777 competition in 1990. The composite fan blade technology was developed at GE over the past 45 years. In 1970, a composite first stage of the TF-39 fan was designed, manufactured, and tested. Then, although the rotor blades failed in a bird-strike test with 16 starlings, the technology effort was carried forward until success was realized.

Notable features include a 128-in. diameter (5 in. larger than the 90-94B) composite fan blade (an industry first) combining rearward sweep at the midspan and forward sweep at the tip. To drive this larger fan, which has 11 percent more flow than the GE 90-94B, the last stage was dropped from the compressor to increase the core flow and power. Increasing the core compressor exit flow is the same design strategy that was used to develop the higher thrust CF-50 engine from the TF-39/CF6 engine family. The overall pressure ratio of the GE 90-115 is more than 41 at sea level, which is among the highest for GTEs. Increasing GE 90-115B core power by removing a stage from the rear of the GE 90 compressor decreased the cruise bypass ratio from 8.4 to 7.1. State-of-the-art component efficiencies have been achieved using extensive three-dimensional analysis—computational fluid dynamics (CFD). The GE 90-115B is presently the most advanced commercial GTE in the world.

Figure 3-4 demonstrates the technology improvement path for GTEs that power subsonic aircraft. The potential increase in core thermal efficiency requires technologies that raise the limit for compressor discharge temperature barrier. Corresponding to the increase in compressor exit temperature technologies, for increases in turbine inlet temperature is also raised. Propulsive efficiency (η_p) increases are obtained by enabling the engine to accelerate an ever-increasing volume (mass) of air to speeds moderately higher than the aircraft forward speed. That is, propulsion efficiency is increased by increasing the engine bypass ratio (the volume of air that flows through the fan relative to that flowing through the engine core). Technologies that allow increased bypass ratio are lightweight structures, low-drag nacelles, and fan-driven gear systems.

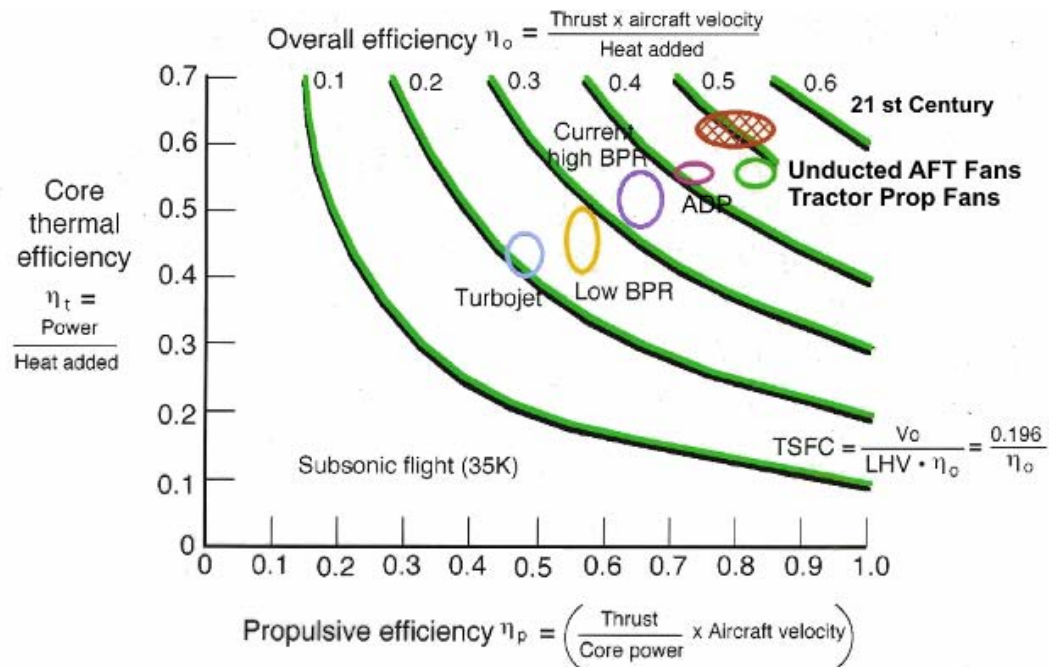

FIGURE 3-4 Overall engine efficiency is a product of thermal and propulsive efficiencies. SOURCE: Koff (2004).

The approximate expression of propulsive efficiency is as follows:

$$\eta_p = \frac{2}{1 + \frac{\text{jet velocity}}{\text{aircraft velocity}}}$$

This relationship shows that decreasing the ratio of engine jet velocity to aircraft flight speed increases the propulsive efficiency. A high-bypass turbofan engine has lower thrust per pound (air flow) but much lower jet velocity than turbojets or low-bypass turbofans. The increase in propulsive efficiency for these large, high-bypass turbofans is provided by a higher-airflow, low-velocity fan stream relative to the high-velocity exhaust from the core engine. Propeller aircraft engines still have bypass ratios that are five times greater than those of turbofans. In 1992, Pratt & Whitney tested a geared turbofan demonstrator with a bypass ratio of 12, achieving the world's lowest specific fuel consumption (SFC) for turbofan configurations.

Today's state-of-the-art engines have an overall engine efficiency of no more than 40 percent. The hatched region of Figure 3-4 has core thermal efficiencies of 65 percent and propulsive efficiencies of 85 percent. The overall efficiency of an engine with these individual efficiencies would be 54 percent,

approximately 35 percent greater than today's state-of-the-art engines. Engines that power fighters or supersonic aircraft require the same technologies to increase the core thermal efficiencies.

Recommendation 3-2. The Air Force and DoD should execute a total system engineering process starting with a preliminary design to establish project feasibility when undertaking any new propulsion development program.

IHPTET and VAATE Demonstrator and Research Programs

Since turbine engines are so critical to the capabilities of military aircraft, DoD has pioneered many advances through demonstrator and research programs such as the preeminent turbine engine research programs IHPTET and VAATE. The IHPTET program, begun in 1987, reached its conclusion in 2005. VAATE, begun in 1999, extends to 2017.

Because IHPTET pervades the turbine engine S&T community, the committee examined its origin, organization, goals, products, and lessons learned to gain insight into structure of VAATE and the latter's likelihood of success.

IHPTET Program

IHPTET concluded in 2005 after having made major progress toward the program goals. Table 3-1 summarizes the goals and progress for the IHPTET turbofan and turbojet class. Demonstration of a 70 percent improvement in T/W and a 60°F improvement in combustor inlet temperature is expected. Materials and cooling technology advancements enabling a 200°F improvement in T3 were analytically shown but not actually demonstrated during the program. The goals of decreasing production and maintenance costs by 20 percent (Phase II) and 35 percent (Phase III) was essentially met.

The committee's assessment of IHPTET was based on its own analysis as well as the consensus from industry and user community representatives. The primary strengths of IHPTET include the involvement of all pertinent parties from government and industry, the consistent focus on specific technical goals, and the continual refinement of a technology plan, governed by a rigorous and methodical process to trace investment to goal accomplishment. IHPTET embraced a robust engine demonstration program that enabled continual transition of high-TRL technologies to both fielded and developmental engines.

Even after the advances of IHPTET, there remains significant room for improvement in turbine engine cost, performance, and durability. In particular, over the VAATE timeframe, a 25 percent improvement in fuel efficiency appears achievable. Such improvement, applicable to civil as well as military aircraft, would have enormous impacts on vehicle size, range, payload, and support cost.

Although relatively stable, IHPTET funding was lower than required to execute the program as originally envisioned. The reduced funding level was inadequate to allow demonstration of all IHPTET goals, in particular, the combustor inlet temperature goal T3. Admirable progress was made on the other IHPTET goals given the funding realities. Materials technologies were inadequately advanced under IHPTET and will remain a significant challenge to achieving VAATE goals.

TABLE 3-1 Goals and Results of IHPTET at Program Conclusion

| Metric | Turbofan/Turbojet Goals | | | Results ^a |
|-----------------------------|-------------------------|----------|-----------|----------------------|
| | Phase I | Phase II | Phase III | |
| Thrust/weight ratio | +30% | +60% | +100% | +70% |
| Combustor inlet temperature | +100°F | +200°F | +400°F | +60°F |
| Production costs | N/A | -20% | -35% | -32% |
| Maintenance costs | N/A | -20% | -35% | -31% |

^aAt TRL 6.

VAATE Program

Building on the success and lessons of IHPTET, VAATE is addressing not only classic turbine engine component improvements but also the changing requirements of propulsion systems—specifically, higher altitude, higher Mach, and long-endurance applications.³ The VAATE program addresses all military and commercial aviation engine types, including turbofan and turbojet engines, turboshaft and turboprop engines, engines for unmanned air vehicles, and expendable missile engines.

VAATE has been structured to take advantage of the features that made IHPTET successful. These include coordination between DoD, NASA, academia, industry, the Federal Aviation Administration (FAA), and the Department of Energy (DOE), allowing the program to coordinate the strategy for gas turbine technology development at a national level while leveraging funding of the constituent organizations. VAATE has, appropriately, a broader scope than IHPTET in order to optimize the integrated propulsion system at the weapons-system level rather than just at the level of the engine turbomachinery itself. Toward this end, the main aircraft manufacturers are full partners on the VAATE industry team.

VAATE's focus on (1) optimization of the propulsion system at the level of the air vehicle system, (2) an affordable capability goal,⁴ including both performance and cost metrics, and (3) planned synergy and dual-use with civil aeronautics requirements goes beyond the IHPTET approach in a manner that is appropriate for the future. VAATE funding, however, is inadequate to accomplish the program as envisioned, particularly in regard to the critical TRL 6 engine demonstrations.

The evolving demands placed on the military will dictate a force structure that is leaner and less expensive but also more versatile, lethal, and survivable. Reflecting these requirements, the VAATE program aims by 2017 to improve the affordable capability of turbine engine propulsion systems 10-fold relative to the baseline year 2000 state-of-the-art systems. Capability in this context is technical performance, including thrust, weight, and fuel consumption. Cost is the total cost of ownership and includes development, procurement, and life-cycle maintenance cost (excluding fuel). The overall VAATE goal, the capability to cost index (CCI), is defined as the T/W ratio / specific fuel consumption (SFC) ratio / cost ratio.

The CCI approach has two key strengths. First, to promote optimization at the level of air vehicle system, VAATE, unlike IHPTET, allows CCI to capture the effects of advanced technology on airframe-mounted components of the propulsion system, such as the engine inlet or power and thermal management subsystems, as well as effects of traditional engine turbomachinery. (Consideration of airframe-mounted propulsion and power components were excluded from IHPTET.) VAATE might thus promote investment in a technology that actually increases engine flange-to-flange weight if that technology resulted in an overall improvement of installed propulsion system weight. For example, a variable- or adaptive-cycle engine installed in a Mach 2.5 cruise vehicle would weigh more than a fixed-cycle baseline engine but might allow far greater system-level weight reduction by eliminating variable geometry from the inlet. A second strength of the CCI approach is that each VAATE contractor is allowed to vary goal factors and thus tailor exactly how the overall CCI goal is achieved. As with

³See, for example, the VAATE Web site at <http://www.pr.af.mil/divisions/pr/vaate/vaate.htm>. Last accessed on March 27, 2006.

⁴“Affordable capability” is the ratio of propulsion system capability to cost.

IHPTET goals, the VAATE CCI goal is expressed incrementally across three phases of the program. Table 3-2 summarizes VAATE's goals for large turbofan and turbojet engines.

Rather than being organized by engine component, VAATE is organized into three broad focus areas: (1) versatile core, (2) intelligent engine, and (3) durability. For each area, detailed technology roadmaps have been developed that, taken together, lead to achieving the 10-fold improvement goal of the program. The core is the heaviest, most complex, and most expensive component of the propulsion system.

TABLE 3-2 Target Date for Achieving the CCI Goal for Large Turbofan and Turboshaft Engines

| VAATE | | |
|-------|------|----------|
| Phase | Year | CCI Goal |
| I | 2009 | 4X |
| II | 2013 | 6X |
| III | 2017 | 10X |

In the core, engine pressure, temperature, and rotational speed reach maximum value. Thus, the core is where technology advancement has the greatest payoff. The intelligent engine area concerns achieving the maximum utility from the engine through improved engine control systems, advanced prognostics and health maintenance, and system-level integration of the engine, airframe, and power management subsystems. The durability area reduces engine maintenance and part replacement costs by doubling component life while providing a significant increase in hot-time capability.

VAATE technology advancement culminates in demonstrations of the core and of the full propulsion system. The IHPTET program included a series of successful engine demonstrations as part of the joint turbine advanced gas generator (JTAGG) advanced development program, a joint Army, Navy, and Air Force effort managed by the Army Aviation Applied Technology Directorate. Demonstration of advanced VAATE technology is accomplished in 50- to 100-hr core and engine tests, leading to TRLs of 6 to prove out transition capability. The range of engine and airframe technologies of interest under VAATE is illustrated in Figure 3-5.

VAATE will continue to seek incremental improvements of key turbine engine metrics as well as to integrate advanced technologies. The ideal cycle based on stoichiometric (optimum) combustion properties can be used as an indicator of how current technology lags behind the theoretical limits in two key technology metrics—fuel efficiency and specific horsepower. Each of these metrics has a direct impact on propulsion system size, weight, and performance.

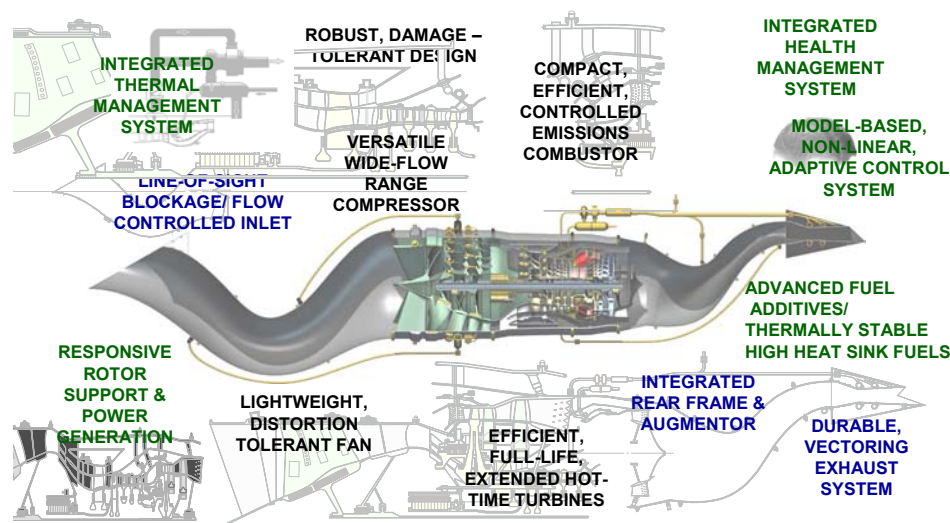

FIGURE 3-5 Total propulsion system advanced technologies. SOURCE: Burns (2005).

Each new improvement in turbine engine fuel efficiency since the 1940s has allowed stepwise increases in overall pressure ratio and turbine inlet temperature, resulting in improved fuel efficiency across a diverse range of engine applications. However, Figure 3-1 shows that current turbine engine fuel efficiency is only about 38 percent of the theoretical limits. It is expected that VAATE will achieve an additional 15 percent improvement in basic engine fuel efficiency. When combined with the other technologies in the VAATE program such as cooled air, liquid-vapor thermal management systems, and intermetallic materials, a 25 percent improvement in fuel efficiency is anticipated.

Specific horsepower is a similar measure of the level of turbine engine technology level. As shown in Figure 3-6, as with fuel efficiency, state-of-the-art specific horsepower improvements have closed only 33 percent of the gap between 1940s-era engines and theoretical limits. Under VAATE, technologies such as three-dimensional aerodynamics modeling, ceramic matrix composites, and intermetallic materials, active flow control, and cooled cooling air (CCA) will be matured to increase this capability another 56 percent.

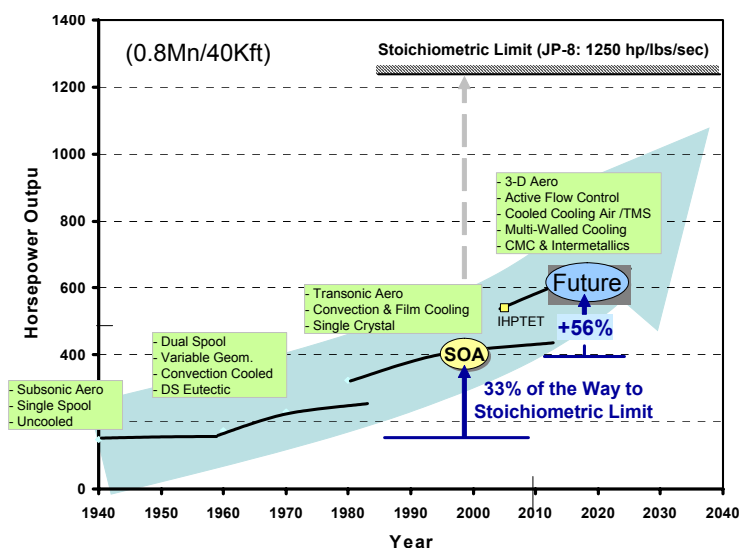

FIGURE 3-6 Progress in turbine engine horsepower output. The boxes suggest some of many ways in which horsepower could be improved or was actually improved. SOURCE: AFRL (2005a).

Gas turbine engine propulsion S&T is a foundational requirement for maintaining U.S. military supremacy. Various studies have shown that advances in propulsion technology can have an enormous impact on the construct, capability, and cost of future military air power. Future scenarios envision a responsive, lethal, survivable force involving diverse platform requirements, such as global strike, uninhabited air vehicles, advanced stealth combat, high Mach cruise, low cost access to space, and STOVL. VAATE will provide increased range, a smaller logistics footprint, increased readiness, improved noise, emissions, and observability (stealth), and high-speed endurance. In addition, it might provide the Air Force with truly transformational capabilities, which would affordably maintain U.S. military air superiority through extremely efficient turbine engines that will double range or halve aircraft size (see Figure 3-7).

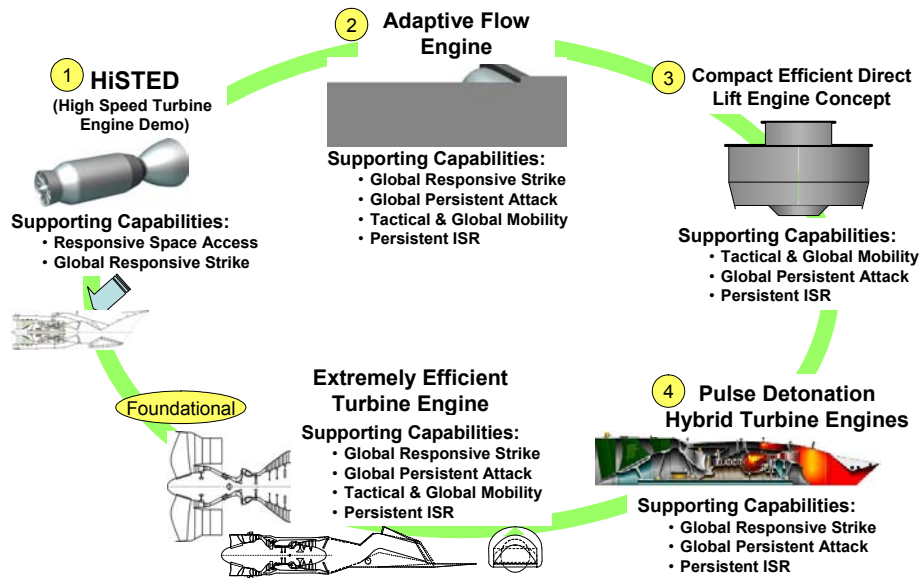

FIGURE 3-7 Turbine engine game-changing transformational concepts. SOURCE: Stricker (2005).

Key technologies include these:

- High-speed, expendable turbine engines can be carried by all bomber and fighter aircraft in the fleet. They provide tremendous standoff capability yet are capable of striking targets at more than four times the speed of sound. They also serve as the basis for responsive systems that will one day propel human beings into space.
- Adaptive-cycle engines optimize performance across the aircraft flight envelope. In essence, this propulsion capability will have variable features that allow both responsive supersonic strike and persistent subsonic loiter in a single air vehicle. Benefits for power generation and thermal management are an integral part of this propulsion concept.
- Compact, efficient, direct-lift engines enable short takeoff and landing (STOL) and STOVL capabilities on future large transports. This will result in long-range, high-subsonic cruise, and short/vertical take-off operations capability for future multimission mobility.
- Innovative concepts such as pulse detonation hybrid turbine engines could have dramatic impact on both performance and cost.

Technologies developed under all three VAATE focus areas will have a direct commercial impact. Versatile core will allow greater hardware commonality between military and commercial applications, thereby reducing cost through economies of scale. Prognostics and health maintenance concepts, developed in the focus area of intelligent engines, and many products from the focus area of durability will directly benefit almost all commercial applications. Conversely, VAATE will pull from the commercial sector to leverage NASA work on noise and emissions so that DoD assets will be able to operate all over the world without exceeding the environmental and noise limitations set by certain regulations. VAATE will also have similar spinoff benefits for turbine engines for marine, ground transportation, and power generation applications.

The original VAATE program, which would have allowed robust technology development, demonstration, and transition capability, was scheduled to be funded at the level of \$145 million for FY06 and \$149 million for FY07. Turbine engine S&T funding has been drastically reduced, however, to just under \$90 million in the FY06 PBR, a reduction of \$48 million from FY03. The FY07 budget is planned to remain stagnant at \$90 million. At the current level of planned funding, it will be difficult to demonstrate and transition turbine engine technology.

Figure 3-8 shows the turbine engine technologies needed to meet the Air Force CONOPS vision. There is a clear disjunct between the Air Force S&T funding (burdened) required for these technologies to reach TRL 6 and the amounts planned for Air Force turbine engine S&T for the 5-year defense plan. This bow wave of shortfalls will cascade into the future, eroding the U.S. lead in turbine technology and undermining U.S. military superiority.

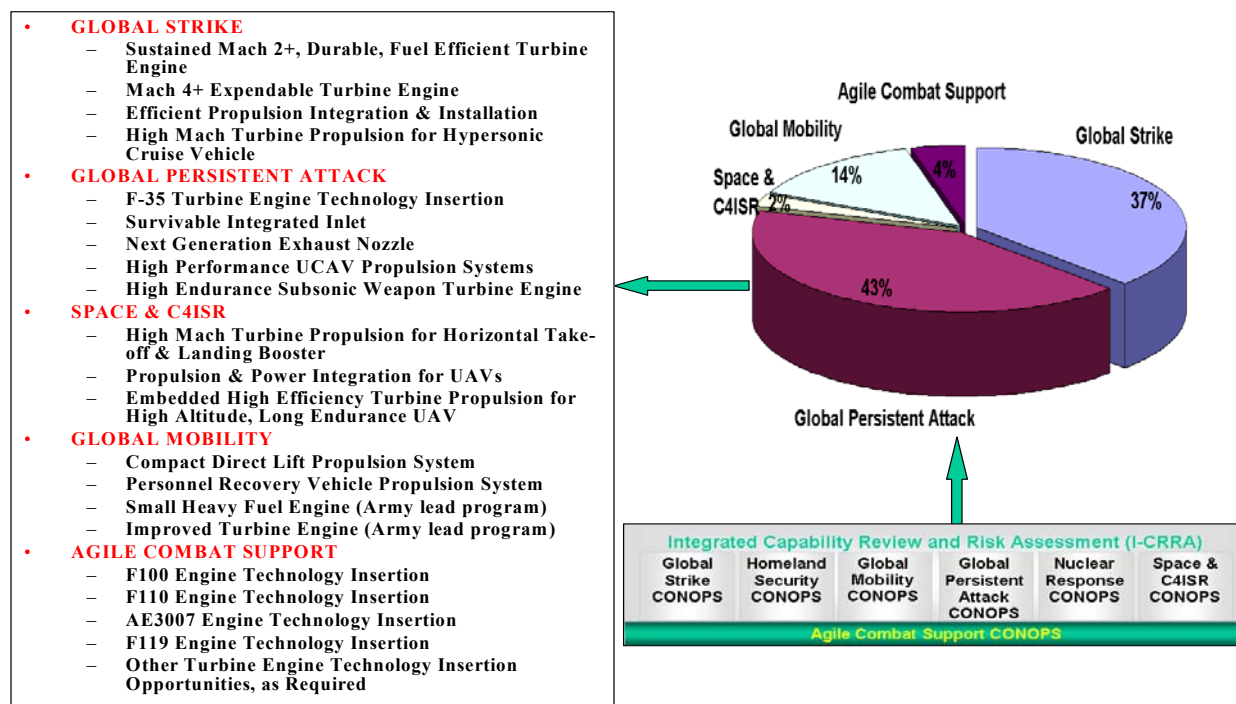

FIGURE 3-8 Turbine engine technologies needed to support the CONOPS vision. SOURCE: AFRL (2005b).

Finding 3-3. The IHPTET program demonstrated several marked strengths that form a foundation for continued success in VAATE. IHPTET transitioned performance, durability, and cost reduction technologies for both fielded and developmental engines—in particular, the F119 engine for the F/A-22 and the F135 and F136 engines for the F-35 Joint Strike Fighter. The VAATE focus on (1) optimization of the propulsion system at the level of the air vehicle system, (2) an “affordable capability” goal, including both performance and cost metrics, and (3) planned synergy and dual-use with civil aeronautics requirements goes beyond the IHPTET approach in a manner that would seem to be appropriate for the demanding yet uncertain requirements of the future.

On a very positive note, each VAATE contractor reviewed by the committee appeared to have a portfolio of advanced technologies planned for development and transition by the VAATE program. So far, the VAATE goals for improvement in fuel efficiency have been greater than the discontinuous improvements observed in other generations of turbine engine advances. VAATE’s payoffs are designed to be realized both in the long term, for new air systems now on the drawing board, and in the near term, for systems currently fielded (e.g., the F-16 and F-18), in production (e.g., the F/A-22), or still in development (e.g., the F-35 Joint Strike Fighter).

Recommendation 3-3. DoD should restore gas turbine S&T funding under the VAATE program to the original planned level. VAATE should address the primary risk areas necessary to advance jet engine technology, which includes a robust engine demonstrator program and key producibility challenges.

Component Improvement Programs

All of the military services are faced with huge and growing sustainment costs for the current fleet of aircraft. Over 60 percent of the expected 2020 warfighter's fleet of aircraft are in existence or under development today. Near term, GTE technologies could be incorporated into this fleet to significantly reduce the cost of sustainment and decrease the amount of fuel burned.

The committee saw many examples where component improvement programs (CIPs), derivative engine programs, and engine capability enhancement programs (ECEPs) could yield sizable reductions in fuel burned, significantly improve performance, and greatly improve the time between shop visits.⁵

History has shown that CIPs decrease Class A mishaps, increase time on the wing, decrease fuel burn, and extend service life. In most instances, it can be readily shown that the cost of incorporating existing technologies into the legacy fleet are rapidly recouped. In fact, historically, programs of this type have returned \$8 to \$10 in the form of savings on sustainment and fuel burn dollars for existing engines per dollar invested. However, the current structure of the DoD budget makes it difficult to properly attribute these savings.

The F119-PW-100 engine is a low-bypass, augmented turbofan engine currently in production to power the F/A-22 Raptor. The F119 engine, after more than a decade of engineering and manufacturing development, has achieved a much higher level of design maturity than fighter engines in previous development programs. By incorporating revolutionary technologies, robust principles of systems engineering, integrated product development, and improved modular design, the F119 is uniquely positioned to cost effectively perform far better than legacy fighter engine systems. The F119 benefited from low levels of CIP funding before achieving initial operational capability (IOC), but greater investment is required to accelerate the rate of maturation. Also, discoveries in accelerated mission testing, F-22 flight test, and initial operational test and evaluation have revealed unique challenges for the F119 engine, such as integrally bladed rotor (IBR) repairs, unique low observable (LO) parts repair and retention, augmentor and nozzle durability, and engine control complexity. CIP investments to date have not allowed the F119 program to achieve the validation and verification test goals needed to rapidly mature proposed fixes and repairs. On average, it takes 2 to 4 years to complete a CIP task. Only 193 repairs of 850 distress modes for the F119 have been carried out under CIP. At the present rate of repair, the capabilities for making repairs will not have been developed. 100 percent depot repair capability of known problems will not be achieved until FY17. Because the F/A-22 fleet will be much smaller than legacy fleets it replaces, the F/A-22 will require much greater system reliability and mission-capable rate than previous fighter systems to achieve its mission. Since the number of F119 engines scheduled to be returned to depots for maintenance will increase dramatically by FY10, shortfalls in repair capability will drive the need for additional expensive spare parts (IBRs and major low observable cases) and may impact the readiness of the F/A-22 aircraft. The F119 program could save significant life cycle costs with relatively small investments of CIP funds early in production and close to the IOC and would help ensure mission success for the F/A-22 Raptor fleet.

Finding 3-4a. The cost of fueling and the cost of sustaining the legacy fleet are the two largest items in DoD's annual propulsion budget.

Finding 3-4b. The component improvement program (CIP), set up for each engine type, model, and series by engine manufacturer, focuses on the improvement of individual hardware, controls, and accessories. The improved hardware or accessories are demonstrated on test engines either at the original equipment manufacturer (OEM) or at the Arnold Engineering Development Center with OEM oversight. The tests are conducted periodically and the engines are qualified for a particular mission. Such testing

⁵The CIP for turbine engine sustainment engineering, for instance, has been utilized effectively since its inception to address safety, reliability, and materiel obsolescence in fielded aircraft turbine engines. To improve the technology transition and cycle time for the incorporation of new and emerging technology, a lean approach is necessary and required.

would be appropriate as well for commercial engines used by the military and to which commercial components and technologies are applied to bring about improvement.

Recommendation 3-4. DoD should sustain the funding for the CIP to ensure solutions to operational problems and safety issues and the development of future upgrades.

Derivative Engine Programs

DoD aircraft systems are continually modernized to remain viable and responsive to the warfighter's need. These modernization upgrades address identified performance deficiencies or provide new mission capabilities. The growth of aircraft capability typically results in increased weight, drag, and electrical and mechanical power loads, which translate into increased demands on the aircraft propulsion system. To accommodate these increased demands, the propulsion system must become more capable.

A proven, cost-effective and efficient approach to providing increased propulsion capability is the development of derivative versions of existing engines. As illustrated in Figure 3-9, derivative engines are the result of transitioning newer technology into existing legacy propulsion systems to improve performance and power capability.

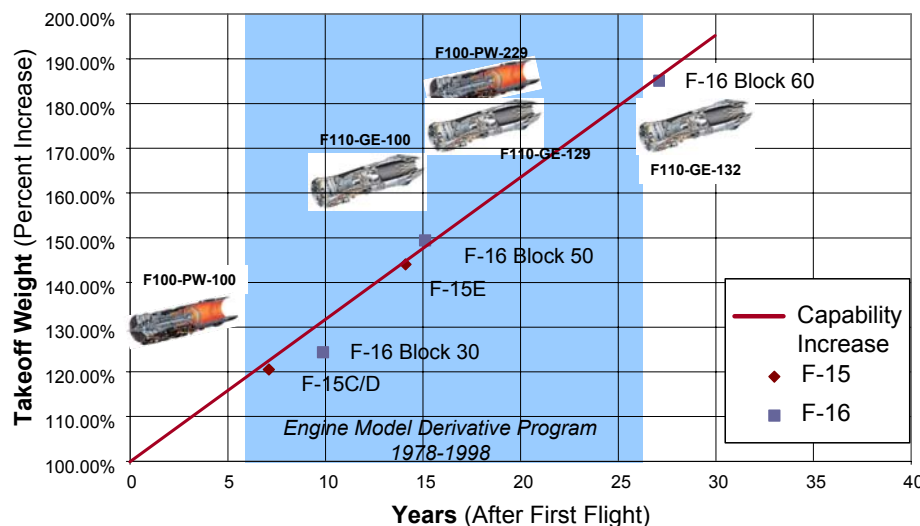

FIGURE 3-9 History of derivative engines. SOURCE: Personal communication between Mark Amos, Agile Combat Support Wing, Wright Patterson Air Force Base, and National Research Council staff member Carter Ford on July 7, 2006. Approved for public release by ASC Public Affairs. Disposition Date: 7/6/2006. Document Number ASC 06-0271.

There is currently no active programmatic vehicle for increasing the performance of legacy propulsion systems to replace the engine model derivative program (EMDP), which was canceled in 1998. Its cancellation has resulted in two significant gaps in the DoD engine development process. The first gap is the inability to conduct timely propulsion system enhancement studies and to develop technology transition roadmaps to support and complement aircraft modernization and capability growth studies prior to acquisition milestone A. The second gap is the lack of a process to demonstrate propulsion technology and thereby allow it to proceed from TRL 6 (demonstration in a relevant system) to TRL 7 (demonstration through initial flight test). This gap makes it more difficult to incorporate new technology into the propulsion system past acquisition milestone B.

EMDPs were a cost-effective way to improve capabilities and decrease the cost of supportability. For example, the derivative F100-PW-229 engine developed for the F-15E increased the capability of the aircraft and reduced the cost per flying hour by reducing the frequency of unscheduled and scheduled shop visits and reducing the incidence of Class A mishaps. Similarly, the F101, F110, and F108 common

core design has been a very cost-effective derivative engine that is providing power for a large range of aircraft.

DoD's new capability assessment process specifies weapon system requirements using the initial capability document and analysis of alternatives. However, requirements for propulsion system capabilities are derived from aeronautical performance requirements for weapons systems and from subsystem functional interface requirements. The systems engineering process may not generate quantitative propulsion system requirements until the weapon system enters system design and development. This time delay, coupled with the lack of a funded EMDP, is limiting the benefit that DoD could achieve from derivatives of existing engines.

Funded EMDPs would ensure that the propulsion capability requirements are met in a timely and cost effective way. New centerline engine developments cost billions of dollars and require more than 10 years to complete. Derivative engines often cost only hundreds of millions of dollars and require only 3 to 5 years to complete. This reduced cost and more timely approach mitigates the significant cost and schedule risks of weapon system development.

Several existing and emerging weapon systems would benefit from an active EMDP study. The maximum operating altitudes of A-10 and B-1B aircraft are limited by increases in aircraft weight and drag. The range and mission effectiveness of the B-52 and KC-135 could benefit from an upgrade of their existing propulsion systems or by reengineering with a newer class of high-bypass-ratio engines. Future weapon systems like J-UCAS and the next-generation, long-range-strike Phase II will require propulsion systems that can satisfy conflicting requirements for engine volume and cruise efficiency. These emerging weapon systems are also constrained by scarce resources and time, providing further incentive to pursue the more cost-effective and timely approach: the derivative engine.

Finding 3-5. The process of identifying, developing, demonstrating, and fielding a new technological capability needs to be revitalized and reinvigorated through a reinstated EMDP. The cycle time to accomplish the demonstration to fielding of technology can be reduced by 50 percent to take advantage of the emerging technologies to enhance reliability and eliminate obsolescence. Oftentimes, a technology has been demonstrated using laboratory funding to a TRL of 5 or 6 but requires a TRL of 7 or 8 to become a fielded application. If no OEM investment is made, or there is no government program office with technology maturation funding, the technology may languish, with potentially significant savings to the customer left on the table.

Besides reducing the cycle time for transitioning technology, technology, especially materials technology, is not shared between OEM's, except on rare occasions. Even though the technology has been through the development and maturation process and has been qualified and fielded, it is a difficult and grueling, if not impossible task for government engineers to get OEM technical buy-in and confidence.

Recommendation 3-5. DoD should reinstate an engine model derivative program (EMDP) to speed the transition of technology to the legacy fleet to improve safety, reliability and affordable readiness. An earlier EMDP demonstrated its usefulness and value for the current fleet of engines, most of which were developed spirally through it or similar programs in the commercial sector.

SMALL GAS TURBINE ENGINE PROGRAMS

This section reflects the views of the committee on the status, requirements, and anticipated plans for small (power range between 500 shaft horsepower (SHP) and 15,000 SHP) gas turbine engines intended for use by DoD from now to 2020. The comments apply to propulsion systems for UASs, helicopters, and compound helicopter/tilt-rotors. Turboshift engines have broad applicability to a wide variety of systems used by (or anticipated to be used by) the services.

The anticipated extensive use of military helicopters, tilt-rotors, and UASs in the future is well described by the roadmap prepared by the Office of the Secretary of Defense (OSD, 2005). Additionally, Joint Vision 2010 and Joint Vision 2020 summarize the military's plan for full-spectrum dominance in an

extremely lethal battlespace (CJCS, 1996; 2000). These requirements drive significant increases in speed, from today’s 160 kt (184 mph) up to 350 kt (403 mph), and significant increases in endurance and range (at least double that of today’s systems).

Engine Requirements and Development

All of the helicopter and UAS turboshaft engines in use by DoD were designed and built in the 1960s and 1970s. Since that time, few of the technologies developed by the JTAGG, IHPTET, or other programs in materials, electronics, software, computational design tools, and network-centric warfare have found their way into turboshaft propulsion systems.

Because of their size and usage, these military turboshaft engines have cooling, manufacturing, installation (they are often buried), and operational (sand, dust, ice) requirements very different from those of their commercial counterparts. While DoD can incorporate some improvements from the commercial sector, it must develop many of its own technologies and engines to satisfy military-unique requirements.

A major finding of the committee is that DoD could immediately benefit from work that has been done on technology over the last 30 years by developing a new 3,000-SHP class turboshaft engine and a new 10,000-SHP class engine. A modern 3,000-SHP class turboshaft engine would be applicable to the Air Force’s planned personnel recovery vehicle (PRV) system, the Army’s Apache AH-64 Block III and Blackhawk UH-60M helicopters, the Navy’s SH-60 Sea Hawk, and the Marine Corps’s UH-1Y and AH-1Z vehicles (specifications for the Apache and the Black Hawk are shown in Figure 3-10). Additionally, a modern 10,000-15,000-SHP class turboshaft engine would have an enormous positive impact on the design, performance, and cost of the emerging Joint Heavy Lift (JHL) vehicle and on the Marine Corps’s improved CH-53X helicopter capable of performing well at high altitudes and temperatures.

While the Army plans to increase its warfighting capability from development of the new 3,000-SHP class engine, the Air Force is looking toward propulsion improvements to increase helicopter capability. Currently, no PRV candidates can meet the combat radius key performance parameter of 325 nautical miles (nm) while maintaining payload and loiter. Propulsion improvements would greatly increase PRV range. A dramatic decrease in SFC (25 percent from current T700/CT7 family) would decrease fuel and weight and increase hover. A 3,000-SHP class engine would dramatically improve the capability and combat radius of the Air Force and DoD medium-lift rotary-wing fleet. Fuel savings will be greatly multiplied by savings in vehicle weight and cost as well as support structure (DSB, 2001).

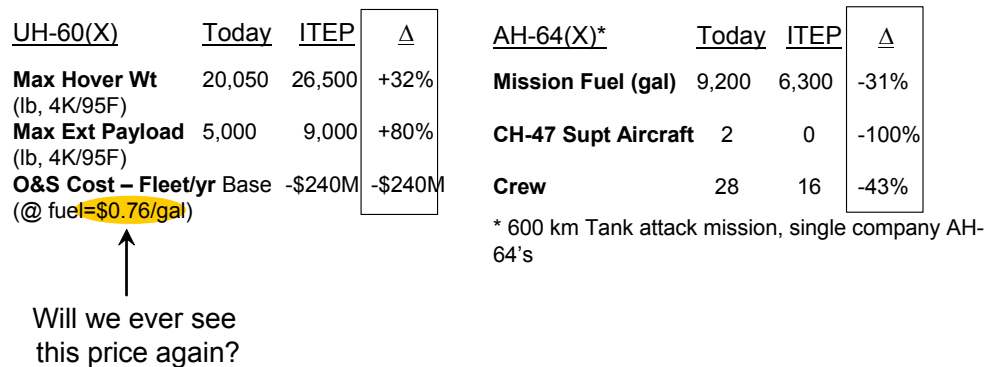

FIGURE 3-10 Derivative aircraft provide improved capability. SOURCE: Butler (2000).

These two new engines are consistent with the 2020 requirements of all military services. Important elements of the anticipated aviation modernization plan relating to turboshaft engines for each of the services are summarized below. Most of these needs will represent those of rotary-wing manned helicopters and uninhabited air vehicles (UASs). Successful, affordable, and enduring war-fighting performance for U.S. Army aviation systems necessitates modern turboshaft engines to satisfy the

requirements of attack, reconnaissance, utility, and medium-cargo missions. All of these aviation systems will incorporate engines that will be 50 to 60 years old in 2020 unless proactive steps are taken today.

The planned development of a JHL vehicle capable of supporting the deployment of the Future Combat Systems (FCS) is not covered in this review of the Army's needs. It is anticipated that FCS will require a vehicle capable of extended vertical takeoff and landing (VTOL) and the ability to lift a 20-ton payload, to cruise efficiently at about 250 kt, and to encompass a radius of action of at least 500 nm at 4,000 ft altitude on a hot (95°F) day.⁶ The resulting system is likely to have a gross weight of about 150,000 lb and to require a total installed power as high as 36,000 SHP. The Army is currently taking the lead in studying this important system. The resulting gross weight and cost of this vehicle will greatly depend on the level of technology introduced into its propulsion system (Scully, 2000).

The Marine Corps anticipates future requirements for an MV-22 tilt-rotor transport, a UH-1Y utility, an AH-1Z attack, and a heavy lift rotorcraft (either a CH-53X or a new JHL vehicle). All of these systems, as well as the fixed-wing KC-130, would benefit from development of the new class of turboshaft engines.

Component Improvement Programs

Industry has difficulty justifying repairs on many low-cost small parts for small gas turbine engines. GE reports that most complex repairs on the much-used T700/CT7 engines are for frames, essentially due to the higher cost of this type of repair, and that blisk⁷ repairs generally include the clipping and blending repairs.

The general feeling is that the advent of larger turboshaft engines, such as that for the JHL helicopter, will justify increased attention to the matter of maintenance. This would permit companies to leverage commercial repair development and to develop new and affordable repair procedures specific to the planned heavy lift engine. Finally, the community generally agrees that new repair procedures must be developed concurrently with the new product.

The advent of network-centric warfare and logistics suggests opportunities for propulsion system logistics and maintenance support never before possible. There is general consensus in the turboshaft engine industry that these technologies have potential merit, especially where data on engine and accessory health and the usage experienced are transmitted in real time by satellite, using a relatively high-bandwidth communication system, to the relevant logisticians, engineers, and suppliers. This information may provide useful diagnostic and prognostic information, thereby significantly impacting spares management, system availability, root cause failure analysis, and, certainly, direct operating costs.

Derivative Engine Programs

Companies continue to infuse technology enhancements into fielded DoD small gas turbines, and plans exist for the development of derivative engines largely intended to increase available power and to some extent improve component durability. An example is the application of advanced coatings to improve compressor erosion resistance in a severe sand- and dust-rich environment. These changes do not generally improve engine fuel consumption.

A typical example of this approach to derivative engine development is provided in Figure 3-11, which also illustrates how the hot-end technology and fully automated digital electronic control (FADEC) systems, originally developed for the commercial S-92 helicopter, are being infused into the T700 military product line. In this case, the technology originated in a commercial variant of the T700 turboshaft family and is now being retrofitted in the military product line.

⁶For more information on the JHL rotorcraft, see <http://www.defense-aerospace.com/cgi-bin/client/modele.pl?prod=62950&session=dae.15810530.1127168887.Qy87d8Oa9dUAADpX@2s&modele=release>; and on the JHL concept design and an analysis, see <http://www.globalsecurity.org/military/systems/aircraft/jhl-cda.htm>. Last accessed on June 4, 2006.

⁷Bladed disk.

Another example of a derivative turboshaft engine under development is the GE CT7-8C, currently in test development. This series, intended for use in the S-92, US101, and MH-60 helicopters, is an example of growth through technology infusion. Specifically, use of an advanced durable-hot-section, three-dimensional aerocompressor, and a 25 percent air flow growth (W_a) together with flying object damage (FOD)-resistant blades and a dual digital full authority electronic control allowed the CT7-8 to be certified in the 2,500-SHP class in 2000. The incorporation of a new three-stage power turbine has allowed the engine to enter the 3,000+ SHP class.

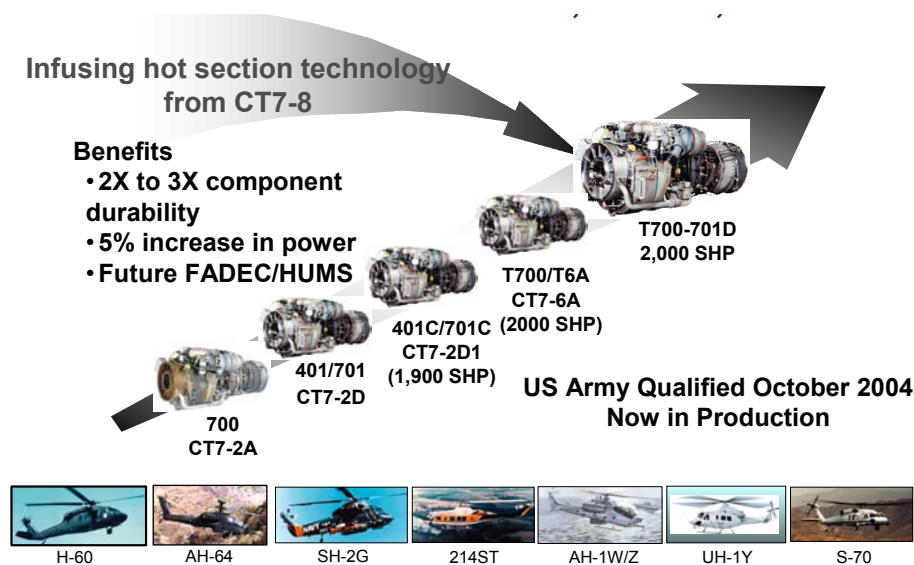

FIGURE 3-11 T700/CT7 1,500-2,000 SHP engines. HUMS, health and usage monitoring system. SOURCE: Personal communication from Tim Higgins, General Electric Aviation, to NRC staff member Carter Ford on September 19, 2006.

Once again, this kind of growth, while addressing immediate service needs, has not allowed the application of the technology necessary to improve SFC 25-35 percent. Application of this advanced technology is addressed in the Army's currently unfunded Improved Turbine Engine Program (ITEP), which will be discussed next.

A further example of a derivative program under serious consideration is the 8,000-SHP class GE38-3 engine. State-of-the-art, yet mature, technology was applied to engines whose roots go back 30 or 40 years to achieve a dramatic increase in reliability and maintainability and lower the operation and service cost. While the payoff is considerable, no formal commitment has been made to develop this engine.

Engine Demonstration Programs

Past science and technology programs have significantly advanced the capabilities of turboshaft engines. Specific improvements are expected to lead to smaller, lighter, and more affordable rotorcraft and UAS designs. The resulting systems will cost less to operate and sustain. It is clear that stepwise improvement in capabilities could be realized today and that continued investment is justified.

One of the last elements in the IHPTET program was to be the JTAGG III demonstrator being designed and built jointly by Honeywell and GE. The technologies demonstrated were planned to directly support the affordable advanced turbine engine (AATE) and ITEP. The differential payoff for implementing JTAGG technology rather than just that available with a simple derivative engine is large. An SFC improvement of 30 percent is shown for the relatively large turboshaft engine required to power the JHL aircraft.

The small heavy fuel engine (SHFE) program is funded and has been awarded to Honeywell. Its goal is a 700-SHP engine demonstrator. The demonstrator engine is targeted to run in 2006 with the program

continuing into 2007. Industry and the government are also planning for the AATE program, funding for which is expected to start in 2008. Included in the plans for AATE are advance turbine technologies, including an uncooled power turbine that would require deployment of either ceramic matrix composites (CMCs) or monolithic ceramic vanes and blades. It is anticipated that the GE 1800 engine will greatly surpass the incumbent T700 class engine. The engine size originally targeted here was about 1,800 SHP. However, consideration is being given to increasing the AATE to about 3,000 SHP.

Finding 3-6. Two new small military gas turbine engines are needed to meet mission requirements in all of the services. The U.S. military has not developed a new centerline engine in the small and expendable class since 1972. The technology level of the U.S. military gas turbine engines in these classes is roughly on par with that of the competition. This equivalence, however, is not driven by available technology but by the fact that no new military engines in these power classes have been fielded anywhere in the world since the early 1970s. Not only is there a need to field new 3,000- and 10,000-SHP class gas turbines for helicopter and UAS missions, but the technology to do so exists as well.

While gas turbines have very high thrust (or horsepower) per unit weight, their disadvantage is that their efficiency decreases when they are operated at suboptimal conditions. UASs, which operate in a broad range of conditions, including loitering, may benefit from a different type of engine. As shown in Figure 3-12, a turbocharged diesel, and quite possibly a turbo-compounded diesel, are alternatives for future long-endurance UASs (Bobula et al., 1986). Clearly, the historical advantages enjoyed by gas turbines due to their superb power to weight ratio might be eroded by the diesel or some other novel cycle with vastly superior SFC provided the mission is long enough. While the power to weight ratio achieved by these alternative concepts may never approach the ratio possible with the gas turbine, the SFC possibilities are very compelling. The challenge here is the incorporation of modern aerospace materials and the application of advanced turbomachinery elements and materials to these advanced engine concepts.

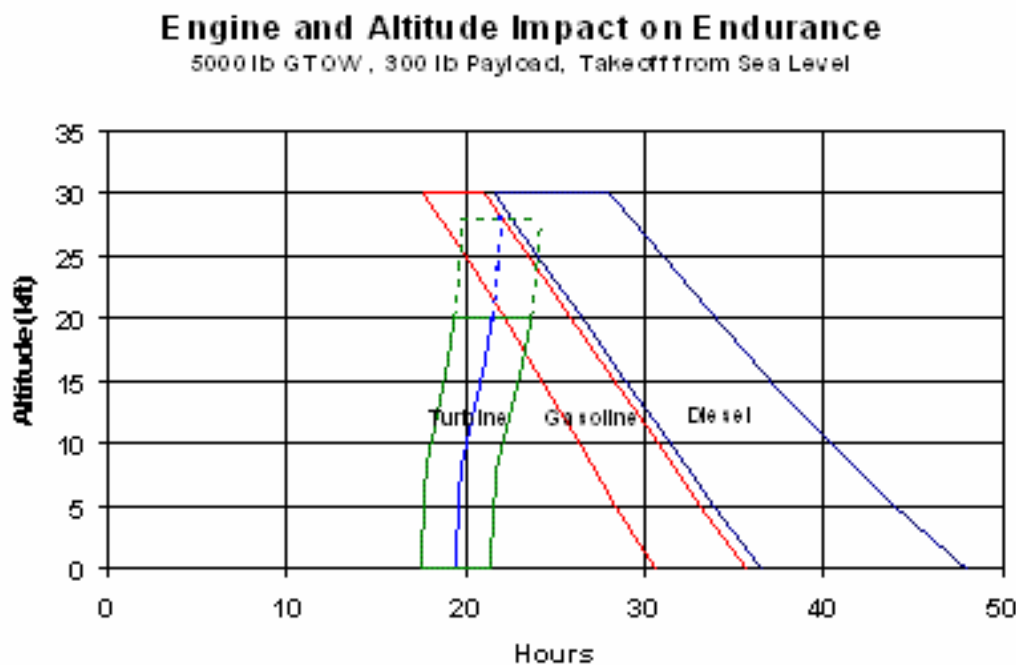

FIGURE 3-12 Impact of engine and altitude on endurance. SOURCE: DARPA (Undated).

Recommendation 3-6a. The Army should consider combining its Affordable, Advanced Turbine Engine (AATE) demonstration program and its unfunded improved turbine engine demonstration program, also targeted at 3,000 shaft horsepower (SHP).

Recommendation 3-6b. The Army should ensure that the size of the Future Affordable Turbine Engine (FATE) program, which remains undecided, is suitable for the demonstration of a 10,000-SHP class small gas turbine. The FATE demonstration could then form the basis for a new engine for a future heavy-lift helicopter mission or the Joint Unmanned Combat Air System mission.

Recommendation 3-6c. In addition to developing two new small gas turbines, DoD should carefully investigate innovative ways to integrate advanced engines and advanced vehicle propulsion systems. Examples here include novel inlets, exhausts, IR suppression systems, particle separators, integrated flight/engine controls, and systems to manage component health.

EXPENDABLE TURBINE ENGINE S&T PROGRAMS

Expendable gas turbine engines are the prime propulsion systems for many cruise missile systems and some unmanned vehicle aircraft. The current main requirements for expendable GTEs are long-term storability, operability over a wide range of Mach numbers, and good fuel economy. They are also subject to severe volume restrictions and severe thrust-to-weight restrictions. In the committee's expert opinion, expendable engines used by DoD are as good as or better than those of known competitors. Over the past two decades IHPTET has been developing technology for expendable engines. Some of these technologies have been incorporated in the derivative engines that will power the planned joint air to surface standoff missile (JASSM). The increased fuel economy of the expendable engine powering the JASSM is an important contributor to the missile's increased range. However, irregular and catastrophic threats require a great increase in the Mach number range over which expendable engines must be able to operate. Standoff cruise missiles operating at Mach 4.0 will be required for warfighter missions in 2020. IHPTET has been developing many of the technologies required for these high Mach operations. However, IHPTET was unable to produce a demonstration engine with Mach 4.25 capability. The VAATE program, in partnership with DARPA, plans to demonstrate engines that can power missiles to Mach 4.25. These demonstrations will occur around 2008. After reviewing the programs to demonstrate high Mach number engines, the committee believes the demonstrations are well planned. However, given the criticality of high Mach number missiles for the 2020 warfighter, the committee suggests two more items that DoD might do well to consider. The first is a need for ManTech funding for the high-temperature materials necessary for GTEs to operate at Mach 4.25. Such funding would ensure consistent material properties and that the United States is able to supply these materials. This need is not unique to expendable GTEs but extends to all types of GTEs. The committee also notes that the high Mach demonstration program is success-oriented; that is, the program assumes success at all milestones, with little or no allowance for problems that might arise.

Finding 3-7. High Mach number cruise missiles are critical to the 2020 warfighter. The VAATE and DARPA programs have plans to demonstrate a Mach 4.25 expendable engine in 2008.

Recommendation 3-7. Given the criticality of the high Mach number cruise missile, DoD should support the goals of these demonstration programs by funding work to ensure the availability of high-temperature materials.

OTHER TECHNOLOGY PROGRAMS

There is a general misperception that aerospace propulsion is a mature plateau technology. To refute that notion, this section looks at several nascent and compelling aerospace propulsion alternatives.

Beyond conventional rocket and GTE aerospace propulsion in both concept and time scale lies an array of emerging alternative propulsion cycles, including hybrids and in situ reheat; fuels and energy sources; and propulsors applicable to in-atmosphere cruise and in some cases to Earth-to-orbit (ETO) and in-space propulsion. These frontier concepts are described in the NRC report *Materials Research to Meet 21st Century Defense Needs*: "In this case, the most important contribution of the panel may have been to

identify opportunities that are not being pursued aggressively due to limited budgets and a current focus on immediate needs and near-term payoff” (NRC, 2003, p. 58). These alternatives satisfy in various ways the DoD needs of 2018, which include increased range, loiter, timeliness, reliability, small system performance, and flight envelope, and lower observables and cost.

Alternative propulsion concepts are at various levels of maturity and application. The pulse detonation engine (PDE) approach is in the laboratory and exploratory stage. Variants of electric propulsion are currently being applied to a subset of small air vehicles, with the aim of increasing vehicle size and performance. Also applicable are “back-to-the future” possibilities for major improvements in internal combustion engines, such as free-piston devices and highly refined Wankel approaches.

Finally, there is a plethora of advanced aero-technologies and hybridization approaches for optimizing aerospace propulsion. As an example of a hybrid cycle, wave rotor devices could replace the combustor and portions of the critical turbine and compressor stages in GTEs. The following subsections briefly describe the physics, benefits, applications, overall state of the art, and associated recommendations for each of these alternative approaches.

Ramjet and Scramjet Engine Programs

Scramjet propulsion is crucial for standoff strike of time-critical and hardened targets, boost-phase intercept, and flexible access to space using airplanelike operations (NRC, 1998, 2004). Although the first patent on ramjet propulsion was awarded in 1913 (Lorin) and scramjet research started nearly 50 years ago, research flight tests have occurred mainly in the last 15 years. Serious application efforts are under way in various countries.

For the same vehicle volume, air-breathing power systems have inherently greater combat range than conventional rocket (solid or liquid) power systems, since air-breathers carry only the fuel, not the fuel and oxidizer. Air-breathing gas turbine propulsion operates below Mach 4. However, between now and 2020, the warfighter will need to operate at up to Mach 12. Scramjets are the only alternative air-breathing power system above Mach 4.0 on the planning horizon.

Scramjet propulsion systems are applicable to missiles, strike, reconnaissance, and ETO applications. Scramjets can fly up to Mach 8 using hydrocarbon fuels and can far exceed Mach 8 using hydrogen fuels. They can fly twice as far as missiles of the same volume/weight/length that use existing rocket technology. Scramjets offer (1) global reach (anywhere on the globe in approximately 2 hours), (2) time-critical strike (they reach targets hundreds of miles away in minutes), (3) sufficient kinetic energy to penetrate hardened targets, and (4) flexible access to space using airplanelike operations.

The competitors of air-breathing hypersonic propulsion are (1) rocket engines with high-energy-density materials as propellants; (2) low-cost autonomous attack systems, which can “be there” rather than having to “get there fast”; (3) microrockets; and (d) hypersonic boost-glide.

The current challenges in air-breathing hypersonic propulsion include (1) combined cycle transition, (2) system thermal management (engine/vehicle), (3) high-temperature/lightweight materials, (4) flow/combustion numerical simulation and design sensitivity, (5) cooled leading edge for Mach numbers larger than 7, (6) control and fuel system miniaturization, and (7) dual-mode scramjet flow path development. Additional challenges include integration of the propulsion into both turbine-based and rocket-based combined-cycle systems.

Two programs are currently developing scramjet propulsion systems based on liquid hydrocarbon fuels: the HyTech single engine demonstrator (SED), sponsored by the Air Force and DARPA, and HyFly, sponsored by the Navy and DARPA.⁸ The near-term application of the Air Force scramjet is a long-range hypersonic cruise missile, while the far-term one is a strike-and-reconnaissance Mach 8 aircraft and affordable, on-demand access to space with aircraft-like operations. The objective of the Navy scramjet program is to demonstrate the hypersonic propulsion and vehicle characteristics of a solid-

⁸For additional information on the HyTech program, see <http://www.globalsecurity.org/military/systems/munitions/hytech.htm>. For additional information on the HyFly program, see <http://www.globalsecurity.org/military/systems/munitions/hyfly.htm>. Last accessed on August 11, 2006.

motor-boosted, hypersonic long-range strike missile that uses a dual-combustor ramjet (DCR) with an engine expected to accelerate the demonstrator to Mach 6 with a range of 600 nm. The DCR employs two air inlet systems. One feeds a subsonic gas generator in which a fuel-rich gas is generated. The gas is then coaxially mixed with supersonic air from the second inlet system. The diverging combustor section permits thermally choked operation as a ramjet but allows for transition to a supersonic combustion ramjet (scramjet).

The Force Application and Launch from Continental United States (FALCON) program is sponsored by the Air Force and DARPA (DARPA, 2004). Its goal is to develop and validate in-flight technologies that will enable both a near-term and far-term capability to execute time-critical, global-reach missions as well as to demonstrate affordable and responsive spacelift. The vision is to develop a hypersonic cruise vehicle (HCV) by 2025. The HCV will be a reusable autonomous aircraft capable of taking off from a conventional military runway and striking targets 9,000 nm away in less than 2 hours. The HCV will carry a 12,000-lb payload and will have a top speed of Mach 12. To achieve this speed, it will use scramjet engines burning liquid hydrogen. The FALCON program develops the systems required by the DoD for assured access to space.

To address the new threats, which include a hypersonic glide vehicle, a hypersonic powered vehicle, and a container-launched cruise missile, the Army is currently developing Mach 12 interceptor hypersonic projectiles in the Scramfire program. Scramfire is a 120-mm powered munition “that accelerates throughout flight to the target and offers increased velocity at the target for direct fire weapons or increased range for indirect fire” (NRC, 2004, p. 113). These systems are capable of variable velocity operation, are maneuverable, and can serve as an accelerator and/or a cruiser. The propulsion system is a scramjet engine that uses hydrogen fuels. Extensive experimental and numerical simulations are under way. The committee’s opinion is that this project is properly funded to achieve the project goals by 2009-2010.

The Mach 10 scramjet program HyCAUSE (hypersonic collaboration between Australia and United States experiment) is currently sponsored by DARPA and the Australian Hypersonics Initiative. The program involves the research, design, testing, and manufacture of all components involved in preparation for flight-testing a scramjet engine. A two-stage rocket booster will take the scramjet payload to an altitude of 315 km, and the experiment will be completed during the near-vertical reentry phase of the trajectory. The HyCAUSE objective is to conduct a controlled scramjet experiment at Mach 10.

In the last 2 years ramjet and scramjet technologies have matured at an accelerating pace. Single-digit-Mach-number free flights using a variety of fuels have demonstrated robust integrated engine and vehicle designs. For example, in 2004, NASA’s hydrogen-fueled X-43A flew successfully at Mach 7 and Mach 10. DARPA/ONR’s HyFly free-flight atmospheric scramjet test technique vehicle flew successfully at Mach 5.5 using liquid hydrocarbon fuel. DARPA’s ScramFire, a gun-launched, scramjet-powered projectile, flew at Mach 6 and Mach 8 using gaseous ethylene fuel. These three free flights have demonstrated completely successful applications of hypersonic technologies on experimental UAS, missile, and munitions platforms.

Major and difficult thermal management issues have been resolved. For example, in a follow-on activity to the AFRL robust scramjet program, an affordable, regeneratively cooled ramjet engine has been ground tested in a closed-loop system with the same hydrocarbon fuel stream used to both cool the engine walls and burn in the combustor. This milestone was achieved in 2005, at the NASA Langley Research Center test facility. The lightweight, circular-cross-section combustor sustained over 20 minutes of direct-connect test time at Mach 5 while remaining in pristine condition. This test-proven combustor design uses a conventional metallic structure and is readily manufactured (it progressed from conceptual design to test hardware in 7 months). In 2006, the same engine was tested over the Mach number range from 3.7 to 5.3 and showed robust performance at all simulated altitudes. This proven design will form the basis for an affordable approach that could quickly turn the challenge of a regeneratively cooled ramjet concept into a flight-ready engine.

Whereas previous flight activities were rocket-boosted or gun-launched to the ramjet/scramjet takeover condition, combined-cycle (turbine/ramjet) systems have been designed to achieve takeoff to hypersonic speeds in a single stage. A program for a turbine-based combined-cycle experimental aircraft

(the NASA X-43C) was well under way when it was cancelled in 2006 to free up funds for manned spaceflight initiatives. The X-43C utilized an integrated GTE with the ramjet/scramjet engine cycle. The gas turbine would have been used for takeoff to high supersonic speeds (above Mach 2.5). The X-43C program was designed and planned to test variable-geometry inlet architectures and nozzle arrangements and to examine their performance both analytically and experimentally. Mass injection precompressor cooling technologies were ground tested on an F100 jet engine, allowing it to easily operate at Mach 3.4, which is 35 per cent higher than its rated speed. This performance would have provided significant overlap of the turbine's higher speeds with the ramjet's lower speeds.

While aircraft applications of hypersonic flight have received more press, missile applications have been equally significant. Boost-to-cruise experiments using rockets to reach takeover speed have been successfully launched at Wallops Island Test Range. These sounding-rocket-class launches not only demonstrated scramjets they also paved the way to low-cost flight testing of hypersonic systems.⁹

Finding 3-8. Consistent with the National Aerospace Initiative (NAI), DoD has active scramjet technology development efforts. In the committee's opinion, the level of U.S. technology is on a par with or ahead of the competition. It is also the committee's opinion, however, that a more synergistic effort among DoD's several scramjet efforts would allow DoD to meet the country's needs more economically and quickly.

The existing DoD scramjet programs are well focused and address the DoD S&T strategy. NASA scramjet propulsion programs are being replanned. There is a need for a government-sponsored, focused program like IHPTET/IHPRPT to maintain the U.S. technology base for scramjets.

Recommendation 3-8. DoD should develop a strategy to exploit the synergies between the hypersonics programs in each of the services for the benefit of DoD as a whole and to achieve a common technology and cost savings. There are alternative solutions for both time-critical and hardened targets and flexible space warfare that should also be studied and compared with the scramjet solution.

Pulse Detonation Engine Programs

PDEs are devices in which the combustion process is accomplished in an unsteady way by a supersonic detonation wave. In its simplest form, a PDE combustion chamber is a straight tube filled with a fuel-air mixture. As the detonation wave occurs, the pressure changes with time at a given location and varies along the tube at a given time. This is in contrast to a gas turbine engine, in which the combustion process is nominally steady and constant through the combustion chamber.

The combustion cycle of a PDE has three different phases. In the initial phase, the fuel-air mixture enters the tube and is ignited. In the second phase, a detonation wave starts and propagates down the tube, moving supersonically with respect to the fluid downstream. (Valving is needed to support the propagation.) In the third phase, the hot combustion products in the tube exit at the downstream end, and the resulting low-pressure region causes a new charge of fuel and air to enter the tube so the cycle can start again.

Heiser and Pratt (2003) carried out instructive analyses of the theoretical performance potential for PDEs and compared it to Brayton cycle engines (the cycle for turbines, ramjets, and scramjets). They also assessed the decrease in performance for both cycles in the presence of representative component losses.

Though some progress has been made, many issues need to be resolved to transform PDEs into operational systems (Schauer and Stutrud, 2001; Dean, 2003; Santoro et al., 2003). Some of the issues have to do with the losses in the unsteady processes, including unsteady compression system exhaust effects, entrance valve losses (sudden expansion), detonation initiation without O₂, internal combustor losses (wall friction, heat transfer, protuberance drag), combustor exhaust valve losses, and unsteady, nonuniform expansion system entrance effects. There is also concern about the power density that can be achieved (i.e., the power per volume).

⁹Personal communication from Michael Wiedemer to committee member Ken Eickmann on August 23, 2006.

The committee feels that PDEs could turn out to be a niche application in the spectrum of DoD propulsion systems rather than a broad-based application that will change the landscape. The technology needs to progress from TRL 3 or 4 to TRL 6 before it can be applied. These engines may offer greatest potential in low-cost missiles for Mach numbers less than 4 rather than as a replacement for gas turbine engines or for high-speed Brayton cycle engines.

High-Thrust Electric Propulsion

Factors driving interest in electric propulsion as an alternative to GTEs and piston engines include the potential to eliminate CO₂ and nitrogen oxide (NO_x) emissions; up to a twofold increase in thermodynamic efficiency; potential improvements in cost, reliability, maintenance, and safety; reduced noise and thermal signature; efficiency at high altitudes; and the opportunity for distributed propulsion (utilization of propulsion for flow and vehicle control and drag reduction). High-thrust electric aerospace propulsion is at an early stage, with initial applications confined to small aeronautical vehicles. However, high-thrust electric aerospace propulsion is being increasingly applied to satisfy a number of DoD aeronautical mission requirements. “Each of the services has a vision for an all-electric future.... The Air Force and Navy have promoted visions of the all-electric aircraft and the all-electric ship” (NRC, 2003, p. 75).

Electrical Energy Generation, Storage, and Supply

Foremost among the approaches to generating electrical energy for aerospace propulsion are fuel cells, which exhibit high efficiencies, are easily scaled, can be nonpolluting or closed cycle, and can be applied in a distributed fashion. Of the myriad of fuel cell approaches, solid oxide is the favorite, and proton exchange membrane is a possibility. Solid oxide can be enhanced with a bottoming cycle, whereby waste heat is regenerated using either a turbine-based cycle or direct thermal-to-electric conversion via, for example, thermal diodes. Fuel cell efficiency, in kilowatts per kilogram, is an order of magnitude less than required for large aircraft, but various advanced technologies are projected to be able to narrow that gap. Longer term, the application of multiwalled nanotubes to fuel cells is projected to improve their performance by up to an order of magnitude.

For less stressing applications, batteries and capacitors (i.e., electrical storage devices) are employed. The object of intense research, storage capacities are improving rapidly. For high altitudes and balloons with their large external surface area, hybrid cycles using solar photovoltaics are useful. Long-term alternative sources for electrical energy include carbon nanotube (CNT) flywheels, off-board beamed microwave energy internalized via recently improved “rectennas,” and superconducting magnetic energy storage with CNT magnets. The latter, from very preliminary analyses, may ultimately provide energy densities approaching or surpassing the energy densities of chemical sources.

Fuels

The fuel of choice to power fuel cells is hydrogen. Biotechnology is enabling direct production of H₂ via photosynthesis. Nanotechnology is contributing options for producing hydrogen using solar energy. Materials research is providing extremely inexpensive (compared to silicon) photovoltaics, and recent efforts suggests that efficiencies up to twice that of silicon are possible. Commercial entities have begun to manufacture and market inexpensive photovoltaics incorporated in thin sheets and roofing shingles. The electricity produced could be used to produce hydrogen. In addition, there has been progress on the highly efficient photocatalysis of water using visible light for direct H₂ production.

Perhaps the most important outstanding issue with electric aerospace propulsion is hydrogen storage. Aside from cryostorage, advanced, emerging, and, possibly, more efficient approaches to hydrogen storage include CNT pressure vessels and adsorption storage within lithium nitride, graphite nanofibers, and CNTs. Additional H₂ storage options include densified, or slush, H₂ and ammonia. Alternative fuels

or sources of hydrogen, which have innate drawbacks related to emissions, include reformed hydrocarbons and methane.

Propulsors

The usual propulsor approach for electric aerospace propulsion is electric motors turning ducted fans (AGARD, 1985). Such motors are becoming increasingly efficient, with future expected efficiency on the order of 90 percent, from both a weight and energy standpoint, with superconduction as an emerging enhancer (Alexander, 2003). An alternative is to use electricity to heat air in a GTE device, for example. For the rocket application, electricity can be used to power a magnetohydrodynamic (MHD) base region accelerator. Estimates using off-board or microwave energy indicate an I_{sp} of up to 2,500 sec using such an MHD approach (Lindberry et al., 2002). The high-thrust MHD accelerator propulsor allows the separation of energy and propulsive mass (in lieu of fuel, which is burned and produces chemical energy). In one application, propulsive mass while in orbit could be scavenged from the upper atmosphere and then accelerated to produce high thrust via energy beamed to the vehicle from a separate orbiting beamer for planetary exploration or orbit changing. Ground-based beamers could also be used with an on-board MHD accelerator for ETO. Of note, Russia sponsors a ramjet/scramjet cycle where energy is taken out of the inlet with an MHD generator, shunted across the combustor, and fed back into the nozzle with an MHD accelerator, providing reduced shock compression losses and lower combustor Mach number.

Internal Combustion (Piston) Engines

Internal combustion (IC) piston engines powered the first two major development periods of heavier-than-air flight but were largely supplanted by GTEs, especially for larger air vehicles. The existing aeronautic IC engines are essentially 1960s designs and far behind automobile IC engines.

Current IC propulsion technology provides competitive performance for UASs at the lower subsonic speeds. As UASs and UCAVs become more important, requirements for range, loiter, and number of missions increase. Improving UAS IC engine propulsion technology could significantly contribute to improving UAS performance. Modern IC engine research efforts subsume advanced designs for diesel and Wankel engines and, more recently, free-piston approaches (including Sterling cycles). Twenty-year projections for IC engine R&D indicate SFC values of 0.3 at 1 lb/horsepower.

Finding 3-9. There is an emerging array of interesting alternative propulsion and energy storage approaches for the future such as PDEs and high-thrust electric propulsion. In addition, there is a plethora of fluid-dynamics-based propulsion hybrids and adjuncts, including distributed propulsion via “shirt-button” GTEs or small electric propulsors, for both propulsion and vehicle flow control and drag reduction. Given reasonable investment levels, electric aerospace propulsion might be ready for large aircraft by 2020 or so. Coordinating DoD’s electric aerospace propulsion work with other domestic efforts might allow DoD to make advances in those areas that would be enabling for its missions. Overall, electric propulsion is at a stage of development similar to that of GTEs in the late 1930s. For the inexpensive subsonic UAS portion of the mission spectrum, IC engines are of interest due to their projected SFC performance (0.3) and low cost.

Recommendation 3-9. DoD should invest in several critical technologies that will impact all types and classes of propulsion systems: high-temperature materials, high-temperature blade/vane materials and coatings, high-temperature and high-heat-sink fuels, lightweight structures, and accurate analytical modeling.

Recommendation 3-10. DoD should continue to invest enough in emerging propulsion technologies to preclude technological surprise. These technologies have the potential to provide niche propulsion capabilities (e.g., for unmanned aircraft systems), out-year revolutionary alternatives, and improvements to GTEs and conventional rockets. Current DoD funding levels for emerging propulsion technologies

should be maintained or increased and a high-level advisory body should periodically review this effort to ensure quality.

High-Energy-Density Materials as Propellants

Advanced propellants are required for enhanced range and loiter. Generally, five propellant technology developments have been pursued: monopropellants, alternative hydrocarbons, gelled hydrogen, metallized gelled propellants, and high-energy-density materials (HEDM).

Monopropellants are used for onboard propulsion systems on communications satellites and low-Earth-orbit (LEO) satellites and constellations. Endothermic hydrocarbon fuels are used as propellants because of their regenerative cooling capability and increased fuel density. The benefits of gelled hydrogen include better safety, less boiloff and slosh, and, in some cases, specific impulse increases. Also, gelled hydrogen increases density by about 10 percent, with the attendant reduction in area- and volume-related mass for subsystems (thermal protection system, structure, insulation, etc.). NASA has investigated O₂/H₂/Al and O₂/RP-1/Al propellant to validate elements of the combustion and fuel technology.

Palaszewski (2002) reported that NASA Glenn Research Center was working to produce combustion data for gelled and metallized gelled fuels using unique nanometer gellant particles and/or nanometer aluminum particles. The objective of NASA's joint research with the Air Force is to demonstrate metallized gelled fuel ignition characteristics for PDEs with JP/Al fuel.

For the future warfighter needs, HEDM offer much higher energy density than the propellants currently used for missiles, rockets, and scramjet propulsion. The kerosene liquid fuel RP-1 has an I_{sp} of 300 sec, that of hydrogen is 390 sec, and O₂/H₂ that is 430 sec. The goal for HEDM is at least 430 sec (for O₂/H₂ combination) but with higher overall propellant density. HEDM can maximize payload and minimize tankage weight. Toxicity and environmental impact could be a concern.

AFRL scientists (Christe et al., 1999; Vij et al., 2002) are conducting a relatively new line of research pursuing polynitrogens, or molecules made up exclusively of nitrogen atoms, that might be useful as chemical propellants. They have performed quantum-chemical calculations and predicted that the N₅ cation, or N₅⁺ (see Box 3-2) will likely be a particularly stable compound despite its extremely high heat of formation (+350 kcal/mol, or +5 kcal/g). If polynitrogen compounds are sufficiently stable, they could be monopropellants with over 200 percent greater energy density than hydrazine.

Box 3-2
AFRL Polynitrogen Research

AFRL scientists confirmed the identity of the new N_5^+ species by comparing its measured infrared, Raman, and nuclear magnetic resonance spectra with those predicted by calculations. They subsequently determined the crystal structure of $N_5^+Sb_2F_{11}^-$, which proved definitively that N_5^+ has the structure predicted by the calculations. Following the initial synthesis of $N_5^+SbF_6^-$, scientists improved the process to produce gram-scale quantities of high-energy-density oxidizers containing N_5^+ .

The predicted performance of the polynitrogen compounds for propulsion is given in Figure 3-13. The improvement in payload capability over standard propellants is nonlinear.

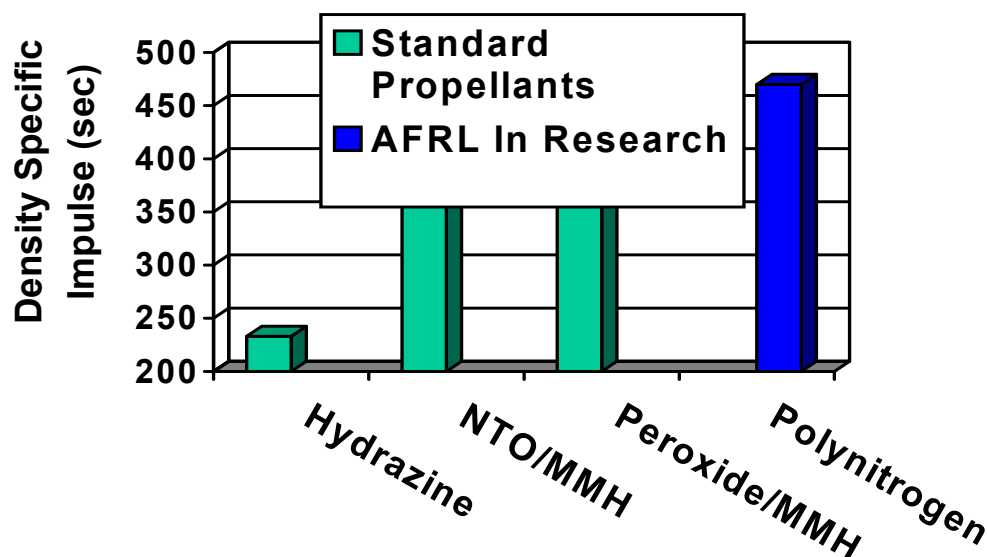

FIGURE 3-13 Predicted performance of polynitrogen over standard propellants. MMH, monomethylhydrazine; NTO, nitrogen tetroxide. SOURCE: Garscadden (2003).

Other avenues being pursued are the addition of cubane (C_8H_8) to hydrocarbon propellants to gain a 15 to 20 percent heavier payload. Nanotechnology may hold promise for next-generation HEDM such as exotic particles embedded in nanotube structures. Metal atoms stored in solid hydrogen are the ultimate step in the development of HEDM (Palaszewski, 1993).

Turbine Combustors

A turbine combustor is defined as a turbine in which fuel is injected and combustion takes place. The process of combustion in the turbine is called in situ reheat. The turbine combustor burns fuel with the purpose of maintaining the temperature throughout the turbine as close as possible to the turbine inlet temperature. A thermodynamic cycle analysis demonstrated a long time ago the benefits of using reheat in the turbine to increase specific power and thermal efficiency. Even better performance gains for specific power and thermal efficiency were predicted for gas-turbine engines when the turbine is coupled with a heat regenerator. Starting in the 1960s, several patents were awarded for different inventions that addressed various aspects of turbine reheat.

The turbine combustor has been shown theoretically to have lower specific fuel consumption than afterburners with almost as high a specific thrust (Liu and Sirignano, 2001). In spite of the theoretical benefits of turbine combustors, the technological challenges and the difficulty of predicting and understanding the details of the transport phenomena inside the reheat turbine precluded their

development until recently (Chambers et al., 2006). Currently AFRL has an active interest in this technology, while several engine manufacturers are pursuing their in-house R&D work.

Distributed Propulsion

The advent of high-thrust electric aerospace propulsion and MEMS-enabled “shirt-button” GTEs allows consideration of a wholly different class of synergistic integration of propulsion and airframe systems called “distributed propulsion.” Instead of, or as an adjunct to, the usual large installed engines or propulsion units, small electric thrusters, propulsors, or GTEs could be distributed to provide not only propulsion but also one or more of the following functions:

- Direct reenergizing of the boundary layer,
- Flow separation control,
- Powered lift/circulation control,
- Viscous drag reduction,
- Noise reduction/noise spectrum alteration,
- Vortex/vorticity control, including reduction in drag due to lift,
- Vehicle control/vectored thrust,
- Reduced signatures,
- Redundancy, for safety and reliability, and
- Lower propulsion costs by achieving commodity production rates.

The obvious downside to distributed propulsion is the expected degradation in overall propulsive efficiency attendant on unit size reduction and lower Reynolds number operation, along with consequent need for increased maintenance. However, this technology allows overall vehicle design in an open thermodynamic system, where the aerodynamics and propulsion disciplines can be simultaneously and synergistically integrated and optimized.

REFERENCES

Published

- AGARD (Advisory Group for Aerospace Research and Development Neuilly-Sur-Seine). 1985. Technical Evaluation Report on the Fluid Dynamics Panel Symposium on Aerodynamics and Acoustics of Propellers. AGARD-AR-213. July.
- Alexander, David S. 2003. “Advanced Energetics for Aeronautical Applications,” NASA/CR-2003-212169.
- Bobula, G.A., W.T. Wintucky, and J.G. Castor. 1986. Compound Cycle Engine Program. NASA TM 88879, USAAVSCOM Technical Report 86-C-37. November.
- Butler, Gary. 2000. “Common engine program: Technology needs/operational payoffs,” Presentation to the Turbine Engine Technology Symposium on September 13, 2000.
- CJCS (Chairman of the Joint Chiefs of Staff). 1996. Joint Vision 2010. Washington, D.C.: Office of the Secretary of Defense. July. Available online at <http://www.dtic.mil/jv2010/jv2010.pdf>. Last accessed on July 10, 2006.
- CJCS. 2000. Joint Vision 2020. Washington, D.C.: Office of the Secretary of Defense. May. Available online at <http://www.dtic.mil/jointvision/jv2020.doc>. Last accessed on July 10, 2006.
- Chambers, S., H. Flitan, P. Cizmas, D. Bachovchin, T. Lippert, and D. Little. 2006. The influence of in situ reheat on turbine-combustor performance. *Journal of Engineering for Gas Turbines and Power* 128(3): 560-572.

- Christe, Karl, William Wilson, Jeffrey Sheehy, and Jerry Boatz. 1999. N5+: A novel homoleptic polynitrogen ion as a high energy density material. *Angewandte Chemie International Edition* 38(13-14): 2004-2009.
- DARPA (Defense Advanced Research Projects Agency). 2004. FALCON (Force Application and Launch from CONUS) Task 1 Small Launch Vehicle (SLV)—PHASE II Program Solicitation Number 04-05. May 7. Available online at http://www.darpa.mil/tto/solicit/falcon_ph2slv.pdf. Last accessed on June 4, 2006.
- Dean, A.J. 2003. Recent Developments in Approaches to Pulsed Detonation Propulsion. 39th AIAA/ASME/SAE/ASEE Joint Propulsion Conference and Exhibit. AIAA 2003-4510.
- DSB (Defense Science Board). 2001. More Capable War Fighting Through Reduced Fuel Burden: The Defense Science Board Task Force on Improving Fuel Efficiency of Weapons Platforms. Washington, D.C.: Undersecretary of Defense for Acquisition, Technology, and Logistics. January. Available online at <http://www.acq.osd.mil/dsb/reports/fuel.pdf#search=%22More%20Capable%20War%20Fighting%20Through%20Reduced%20Fuel%20Burden%22>. Last accessed on August 30, 2006.
- Garscadden, Alan. 2003. A Physics Perspective on Future Propulsion Systems. International Air and Space Symposium and Exposition: The Next 100 Years. American Institute of Aeronautics and Astronautics.
- Heiser, William H., and David T. Pratt. 2002. Thermodynamic cycle analysis of pulse detonation engines. *Journal of Propulsion and Power* 18(1): 68-76.
- Koff, Bernard. 2004. Gas turbine technology evolution: A designer's perspective. *Journal of Propulsion and Power* 20(4): 577-595.
- Lineberry, J.T., J.N. Chapman, R.J. Litchford, and J. Jones. 2002. MHD augmentation of rocket engines using beamed energy. AIP Conference Proceedings, 664(1):280-291. First International Symposium on Beamed Energy Propulsion, Huntsville, Alabama, November.
- Liu, F., and W.A. Sirignano. 2001. Turbojet and turbofan engine performance increases through turbine burners. *Journal of Propulsion and Power* 17(3): 695-705.
- NRC (National Research Council). 1998. Review and Evaluation of the Air Force Hypersonic Technology Program. Washington, D.C.: National Academy Press. Available online at <http://www.nap.edu/catalog/6195.html>. Last accessed on August 9, 2006.
- NRC (National Research Council). 2003. Materials Research to Meet 21st Century Defense Needs. Washington, D.C.: The National Academies Press. Available online at <http://newton.nap.edu/catalog/10631.html>. Last accessed on June 1, 2006.
- NRC. 2004. Evaluation of the National Aerospace Initiative. Washington, D.C.: The National Academies Press. Available online at <http://newton.nap.edu/catalog/10980.html>. Last accessed on August 23, 2006.
- Office of the Secretary of Defense (OSD). 2005. Unmanned Aircraft Systems Roadmap 2005-2030. Washington, D.C.: Office of the Secretary of Defense. August 4. Available online at <http://www.acq.osd.mil/usd/Roadmap%20Final2.pdf>. Last accessed on August 16, 2006.
- Palaszewski, Bryan. 1993. Atomic Hydrogen Propellants: Historical Perspectives and Future Possibilities. 31st AIAA Aerospace Science Meeting. American Institute of Aeronautics and Astronautics.
- Palaszewski, Bryan A. 2002. Metallized Gelled Propellants: Historical and Future Developments. 8th International Workshop on Combustion and Propulsion. AIDAA, FiatAvio, Politecnico di Milano, and Università di Napoli.
- Santoro, Robert, Vigor Yang, Joseph Shepherd, and Chung Law. 2003. A Multidisciplinary Study of Pulse Detonation Engine Propulsion. Final Report for Award Number: ONR N00014-99-1-0744. January.
- Schauer, Fred, Jeff Stutrud, and Royce Bradley. 2001. Detonation Initiation Studies and Performance Results for Pulsed Detonation Engine Applications. 39th AIAA Aerospace Sciences Meeting and Exhibit. AIAA 2001-1129.
- Scully, Michael P. 2000. Parametric Sensitivity Analysis, Mission and Technology Trades. AHS Forum 56. American Helicopter Society.

Vij, Ashwani, James Pavlovich, William Wilson, Vandana Vij, and Karl Christe. Experimental detection of the pentaazacyclopentadienide (pentazolate) anion, cyclo-N5-. *Angewandte Chemie International Edition* 41(16): 3051-3054.

Unpublished

AFRL. 2005a. "Overview of Turbine Engine Future Performance Trends," Background information provided to the committee on June 2.

AFRL. 2005b. "NRC Propulsion Needs Study Report: Supporting Charts for Turbine Engine Technology Investment Needs," Background information provided to the committee in May.

Larry Burns. 2005. "Current/future turbine engine technology investment plans and VAATE," Presentation to the committee on April 5, 2005.

Ron Sega. 2006. "Department of Defense propulsion science and technology," Presentation to the committee on May 24, 2006.

Jeff Stricker. 2005. "Overview of turbine engine technologies, progress, and future opportunities," Presentation to the committee on April 5, 2005.

Rocket Propulsion Systems for Access to Space

INTRODUCTION

The U.S. Space Transportation Policy calls on the Secretary of Defense (SECDEF), in coordination with the National Aeronautics and Space Administration (NASA), to be responsible for assuring access to space for critical national security, homeland security, and civil missions. Assured access to space is defined as “a sufficiently robust, responsive, and resilient capability to allow continued space operations, consistent with risk management and affordability” (NSPD, 2005, p. 4). Such access will require maintaining a viable industrial and technology base.

The SECDEF is also called upon, before 2010, to begin a fundamental transformation in the U.S. capability for “operationally responsive access” to and use of space “that dramatically improves the reliability, responsiveness, and cost of access to, transport through, and return from space.” This requires a sustained technology development program to pursue research and technology development in in-space transportation capabilities, including automated rendezvous and docking and the ability to deploy, service, and retrieve payloads or spacecraft in Earth orbit.

The U.S. Space Transportation Policy calls for development of requirements, concept of operations, technology roadmaps, and investment strategy for next-generation space transportation capabilities within 2 years (NSPD, 2005).

The Air Force Space Command’s (AFSPC’s) Strategic Master Plan FY06 and Beyond states as follows: “AFSPC will sustain and modernize its current satellite and launch operations into the far term, when it will transition to advanced capabilities” (AFSPC, 2003, p. 29).¹

The Air Force’s overarching need to have responsive access to space and to operate effectively in space under all realistic scenarios will demand the establishment of requirements for (1) strategic and responsive spacelift total systems, for (2) responsive on-board propulsion systems in space and for (3) return from space. Transformation in access to space or in-space operations will be achieved only as a result of using a total systems engineering process incorporating mission success over the committed life of the system as the primary criterion when selecting among options for a required system’s architecture and elements. The evolution of such a system engineering program, and the validation of trade-off parameters using the supercomputing capabilities available today, would provide a powerful and objective quantitative tool to define and evaluate low-risk, cost-effective total system concepts for strategic and operationally responsive spacelift (ORS) and for in-space operations. “Mission success” is the most effective selection criterion in a total systems engineering process to establish an overall architecture and all the elements of a system. It can be defined as achieving the functional result we want, when we want it, for the price we committed to, and within the risk level profile we accepted for the

¹For responsive spacelift, the Air Force Space Command’s *Strategic Master Plan FY06 and Beyond* defines transformational capabilities as focused on rapid response, affordability, and payload capacity for warfighter operations (AFSPC, 2003).

program. Improvement in mission success achieves that functional result for a lower price and with less risk.

For example, when carrying out systems engineering for access-to-space missions, considerations that must be specified for a “total system” that will accomplish the mission are launch vehicle configuration (number of stages, reuse), launch locations (fixed or mobile, including from high-altitude aircraft), facility and logistic requirements, operations concepts (payload integration on launch stand or pre-integrated, attachable payload modules), technology validations still required, full development schedules, life-cycle costs, and industrial support viability.

Only the unbiased application of such a systems engineering program could provide a credible basis for specifying requirements like number of stages, propellant, and reusability or flexibility of launch locations. The systems engineering program would incorporate the ability to quantify relative risk and allow the selection of system options. Propulsion system requirements and basic configurations for propulsion subsystems would be an output of the process. Then, the design criteria can be set that, when satisfied, will assure that a subsystem performs as it should. Identifying missing or unvalidated design criteria associated with the selected propulsion systems for ORS would define the critical gaps in the technology base.

AFSPC’s evolving space operations plan encompasses both low- and high-tempo operations. Low-tempo operations generally involve the planned placement and support of strategic and capital assets. Those assets are usually large and are placed in various orbits, often in geostationary orbit (GEO).

High-tempo operations involve a quick response to a perceived threat buildup and may involve intensive launch and in-space operations lasting from days to months. DoD’s need for quick, responsive space launch under numerous scenarios drives its requirements for responsive spacelift, responsive stages in space, and responsive platforms with onboard propulsion systems. Those requirements, in turn, flow down via extensive systems engineering into a broad and demanding set of new requirements for propulsion systems for access to space and for in-space operations.

Figure 4-1 presents a roadmap setting out the Air Force’s plan to sustain and modernize its current satellite and launch operations into the far term, when it envisions transformational access-to-space capabilities. The roadmap shows the near-term phaseout of Atlas II/III, Delta II, and Titan IV from the Air Force launch vehicle operational mix. Therefore, the AFSPC’s Strategic Master Plan FY06 and Beyond (hereinafter referred to for convenience as SMP FY06) to sustain and modernize current satellite and launch operations into the far term will be implemented primarily using the Atlas V and Delta IV vehicles along with several smaller and medium-lift vehicles that are used by the Air Force but not shown in Figure 4-1.

The planned introduction and evolution of new small and mid-size launch vehicle capabilities are mapped in the Responsive Spacelift region of the roadmap. The new small vehicles planned for demonstration under the Force Application and Launch from the Continental United States (FALCON) program of the Defense Advanced Research Projects Agency (DARPA) are aimed at short-response launch times and low-marginal-cost launches. The Air Force intends to achieve the DARPA goals by using innovative but conventional rocket propulsion system elements, simple configurations, high safety margins against critical failure modes, and rapid-installation, standardized modules containing pre-checked-out payloads.

As shown in Figure 4-1, there is no current plan to replace either the Atlas V or the Delta IV until some time well beyond 2020. There are good reasons why this is realistic.

The capabilities required by the Air Force to deliver a mix of large payloads into the near-Earth region of space under the low-tempo operations scenario will be satisfied into the far term (beyond 2020) by modest continued evolution of the Atlas V and Delta IV configurations and upgrades of elements of their propulsion systems. The committee did not find any technologies currently in development or expected to be validated during the planning period for liquid- or solid-propellant, all-rocket (non-combined-cycle) propulsion systems for space access that would demonstrate enough improvement in performance or reduction in operational risks and costs necessary to justify the huge cost of a new centerline launch vehicle of the evolved expendable launch vehicle (EELV) class.

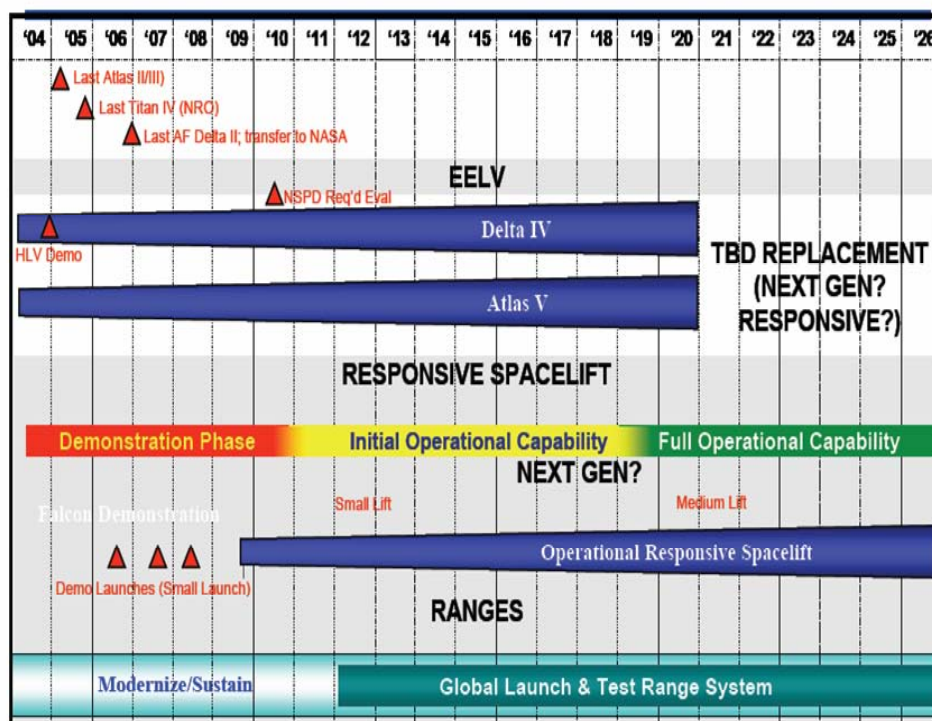

FIGURE 4-1 DoD space transportation roadmap. SOURCE: Knauf (2005).

Continued evolution of the technology used in materials, pumps, injectors, and thrust chambers and to improve engine thrust/weight, margins to failure modes, and other parameters of propulsion system elements will not enable truly transformational vehicle alternatives for any launch vehicles, large or small, in the near to medium term. Transformational technologies that can be envisioned for the far term are combined-cycle air/rocket engines that minimize the amounts of tanked oxidizers and/or very energetic, but stable and cost-effective new rocket fuels delivering low-molecular-weight combustion products. Such technologies, which might improve overall mission success by 25 to 50 percent, might justify investment in truly next-generation, large access-to-space vehicles to replace the Atlas V and Delta IV vehicles.

Finding 4-1. The committee does not believe that the Air Force will be able to reliably and cost effectively transform U.S. military space transportation capabilities by focusing on pushing high-thrust rocket propulsion technologies to their limits. Even if the total systems optimization process is objectively carried out, the technologies it selects are unlikely to be (and need not be) transformational in themselves. It is more likely that any transformational access to space achieved during the planning period will be the result of creative total system architectures. Focusing Air Force resources on identifying the gaps in the critical design criteria for total systems-defined rocket propulsion elements will be crucial to success of the AFSPC *Strategic Master Plan FY06 and Beyond*.²

Recommendation 4-1. The Air Force should place a high priority on developing an integrated total-system engineering process using quantitative life-cycle mission success as the selection criterion for near-term, highly leveraged engineering technology funded by the Air Force. This process is crucial to

²There are a number of new propulsion technologies that do in fact have the potential of directly enabling transformation of in-space rocket propulsion systems performance. They are discussed in Chapter 5, Propulsion Systems for In-Space Operations and Missiles.

defining justifiable total system architectures, rocket propulsion systems requirements, and critical technologies for military space transportation to support the Air Force Space Command's *Strategic Master Plan FY06 and Beyond*.

CURRENT CAPABILITIES OF LARGE LAUNCH VEHICLES

Delta IV Family of Vehicles

As shown in Figure 4-2, the Delta IV family of two-stage launch vehicles utilizes a common 5-m-diameter first stage powered by a single rocket engine (RS-68) operating on liquid oxygen (LOx) and liquid hydrogen (LH₂). The baseline two-stage vehicle designated Delta IV Medium has a 4-m-diameter second stage powered by a RL-10B-2 engine using LOx and LH₂. Three other configurations of Delta IV Medium vehicles offering progressively more payload weight to low Earth orbit (LEO) or geostationary transfer orbit (GTO) use Alliant Techsystems GEM 60 (60-in. diameter) graphite-epoxy solid propellant motors as strap-on boosters. The Delta IV Heavy uses three of the common 5-m-diameter first stages in parallel. The second stage uses the same longer 5-m-diameter tank used on the Medium+ (5, 2) and (5, 4) vehicles. The numbers in parentheses indicate the diameter of the second stage and payload fairing and the number of graphite epoxy motor (GEM) strap-ons, respectively.

This family of vehicles delivers from 20,000 to 48,000 lb to LEO (27.8°), or 9,300 to 28,000 lb to GTO. The propulsion system elements that essentially control performance and risks are the first- and second-stage engines and the solid propellant strap-on motors. These three propulsion systems are summarized in Appendix D.

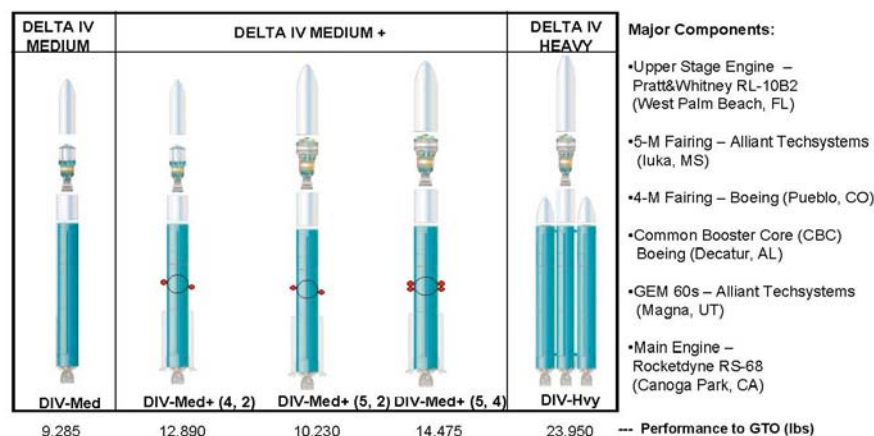

FIGURE 4-2 The Delta IV family of access-to-space vehicles. SOURCE: Knauf (2005).

Atlas V Family of Vehicles

The Atlas V family of two-stage launch vehicles shown in Figure 4-3 utilizes a 3.8-m-diameter common core first stage. The first stage uses a single rocket engine having dual-thrust chambers (RD-180) operating on LOx and kerosene. The baseline two-stage vehicle designated Atlas V 401 has a 3.05-m-diameter, 12.7-m-long Centaur second stage powered by a RL-10A-4-2 engine using LOx and LH₂. The 401 does not use a strap-on solid motor. The various Atlas V configurations available are designated as the 400 Series, the 500 Series, and a heavy lift vehicle (HLV) that was still in the design stage in 2005. The 400 Series has a 4-m-diameter payload fairing and the 500 Series provides a 5-m fairing. The Centaur stage can use either one or two RL-10A-4-2 engines. Depending on the mission, the 500 Series can be configured with from zero to five strap-on solid rocket motors (Aerojet Sacramento). Each motor provides about 254,000 lb thrust at liftoff.

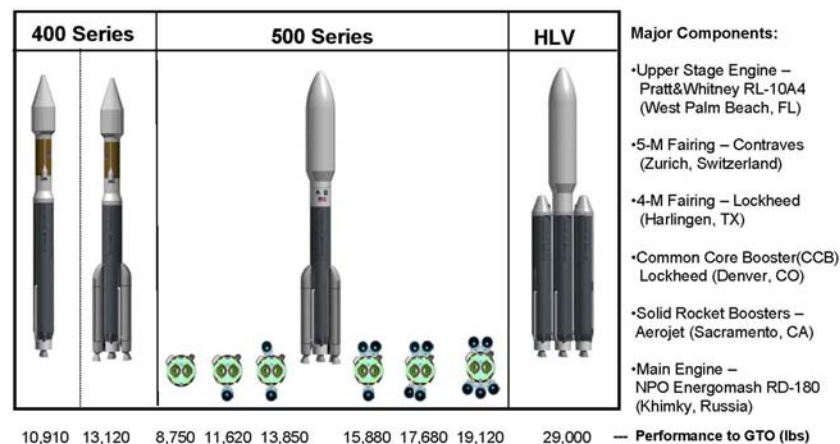

FIGURE 4-3 Atlas V family of access-to-space vehicles. SOURCE: Knauf (2005).

This 500 Series of vehicles can deliver from 20,000 to 45,000 lb to LEO (27.8°) or 8,750 to 19,100 lb to GTO. The propulsion system elements that essentially control the various configuration's performance and risks are the first- and second-stage engines and the solid propellant strap-on motors.

These three propulsion systems are summarized in Appendix D.

BOOSTER ENGINES FOR LARGE LAUNCH VEHICLES

First-Stage, Liquid Propellant

Delta IV: RS-68

In the early 1990s, Rocketdyne initiated development of the first new indigenous booster-class engine in the United States in more than 25 years, the RS-68. The RS-68 was ultimately selected to power the Delta family of EELVs developed for the Air Force by the Boeing Space Systems Company.

The RS-68 is the largest LO_x/LH₂ engine in the world today. It is a conventional bell-nozzle booster engine that develops 650,000 lb of sea-level thrust, the equivalent of 17 million horsepower (or 11 Hoover Dams at full power generation). The engine uses a simple, open gas generator cycle with a regeneratively cooled main chamber. The turbine exhaust gases can be vectored on command to provide roll control. The engine can be throttled to 60 percent of full power.

The simplified design philosophy behind this engine meant it had fewer parts and lower production costs than the contemporary space shuttle main engine (SSME). The RS-68 engine has only 11 major components, including the main combustion chamber, single oxygen and hydrogen turbopumps, gimbal bearing, injector, gas generator, heat exchangers, and fuel exhaust duct. This amounts to 80 percent fewer parts than the SSME and a reduction in hand-touched labor of 92 percent. The development cycle time was also much reduced, and nonrecurring costs were claimed to be reduced by a factor of 5 over previous cryogenic engines. The engine was designed, developed, and certified in a little over 5 years and flew on the first Delta IV launch in late 2002.

Atlas V: RD-180 Engine

The engine that powers the first stage of the Atlas V EELV is the RD-180. The RD-180 is a two-thrust-chamber version of the original Russian RD-170 (four chambers) that is used to power the first stage of the Yuzhnoye/Yuzhmash Ukrainian-manufactured Zenit launch vehicle. This engine provides the

performance, operability, and reliability of the RD-170 in a size (933,400 lbf of vacuum thrust) that meets the booster needs of the Atlas V version of the EELV (first used in the United States to successfully power all the Atlas III launches).

The RD-180 is an integrated propulsion unit/engine system with hydraulics for control valve actuation and thrust vector gimbaling, pneumatics for valve actuation and system purging, and a thrust frame to distribute loads, all self contained as part of the engine. The engine, which employs a LOx lead start, staged combustion cycle, and an LOx-rich turbine drive, delivers 10 percent better performance than the current operational U.S. booster engines fueled by kerosene rocket propellant-1 (RP-1) and can provide relatively clean, reusable operation (more than one mission duty cycle).

Finding 4-2. The current family of U.S. EELV boosters does not need to be replaced for the next 15 to 20 years, nor are there plans to do so. Nevertheless several candidate designs were started under NASA's Space Launch Initiative (SLI) program in 2001.

Recommendation 4-2. DoD should begin work relatively slowly, investing about \$5 million per year in the committee's judgment on technology development for an advanced-cycle booster engine that could provide the basis for a new far-term access-to-space vehicle.

First-Stage, Strap-on, Solid Propellant

Delta IV+: GEM-60

Alliant Techsystems, Inc. (ATK) originally developed the GEM strap-on solid rocket booster for the Delta II launch vehicle for the Air Force and Boeing. The GEM-40 is a highly reliable motor used on Delta II. The GEM-46 is a larger derivative—with increased length, diameter, and vectorable nozzles on three of the six ground-start motors—for use on the Delta III. The motor has also been used on the Delta II Heavy. The 70-ft GEM-60 motors provide auxiliary liftoff capability (in two or four strap-on motor configurations) for the Delta IV Medium Plus (M+) vehicles.

Atlas V: Aerojet

The solid rocket strap-on booster motors for the Atlas V were developed, flight qualified, and produced by Aerojet, Sacramento. This new generation of solid rocket motors provides reliable, high-performance boosting power for the Atlas V medium- to heavy-lift expendable launch vehicle used for U.S. civil and military spacecraft launch programs as well as for international and U.S. commercial satellite rockets.

The Aerojet solid rocket motor design for the Atlas builds on decades of flight design, test and real mission experience such as the series of Minuteman, Peacekeeper, and small intercontinental ballistic missile (ICBM) motors, as well as Aerojet's extensive work on other propulsion and space systems and a wealth of accompanying flight proven technologies.

The Atlas V family of launch vehicles will use from one to five strap-on solid rocket motors depending upon the mission and launch trajectory requirements. The solid rocket motors are ignited at lift-off and burn for over ninety seconds, each providing a thrust in excess of 250,000 lbf. At about 94 seconds into the flight, the solid rocket boosters are jettisoned sequentially.

First Stage, Strap-on, Liquid or Solid Propellant

One of the most effective ways to upgrade the payload capability of launch vehicles is to add strap-ons to the first stage. Solid strap-ons have been used frequently for this purpose, but liquids could also be employed. Some of the liquid propellant boosters currently being developed by the various FALCON contractors are of an appropriate thrust level and could be a low cost alternative to solids for this purpose.

New solid booster technologies under the Integrated High Payoff Rocket Propulsion Technology (IHRPT) program and, possibly, liquid propellant booster concepts that may be developed for a new Air Force responsive spacelift vehicle might be studied for this application.

Alternative Hybrid Propellant Strap-ons

Lockheed Martin Space Systems has worked on hybrid propulsion technologies since 1989. Its initial studies focused on replacing the solid rocket boosters on the space shuttle after the Challenger disaster. It worked with American Rocket Corporation (AMROC) during the DM-01, DM-02, and Hybrid Technology Options Project (HyTOP) motor development efforts, which eventually led to the Hybrid Propulsion Development Program (HPDP). Within the HPDP, Lockheed Martin tested numerous technologies that were developed under internal independent research and development (IR&D) funding and increased the technology maturity of numerous hybrid-based systems. Under the current FALCON program, it performed a number of tests to demonstrate stable hybrid rocket performance. The largest hybrid motor tested to date using the staged combustion system was the HPDP 250,000 lbf motor, which was approximately 72 in. in diameter and 30 ft long. The tests demonstrated that the system could be successfully scaled to high-thrust motors that could potentially be used for booster or first-stage applications.

Second-Stage Engines

RL-10

The RL-10 has evolved significantly over the past 42 years. It began in 1963 with a vacuum thrust of approximately 15 klb for the RL-10A-1. Through a series of modifications, the thrust evolved to an average thrust of 24.75 klb in the RL-10B-2. This engine has probably had every last possible ounce of thrust wrung out of it, but that accomplishment has reduced the margins of safety for some of the failure modes. Significant improvements in performance and reliability could be achieved with a new engine-cycle design.

Currently, the EELVs have only one basic second stage, the RL-10. The Delta IV uses the RL-10B-2, while the Atlas V uses the RL-10A-4-1 or 2. The basic RL-10 engine, developed in the late 1950s, was the world's first LOx/LH₂-fueled rocket engine operated in space. Since the first successful launch of an Atlas/Centaur RL-10 in November of 1961, Pratt & Whitney has developed nine different models of the RL-10 engine family. The RL-10 had earned the reputation of being a reliable, safe and high-performing cryogenic second-stage engine for a wide variety of upper stages on a large number of U.S. expendable launch vehicles.

Current RL10 engine models and their supported vehicles are RL-10A-4-2 (Atlas V), RL-10-4 and RL-10-4-1 (Atlas II, IIA, IIAS, III and IIIB) and RL-10A-3-A (Titan IVB). The full family of flight-certified RL-10-XX engines is listed in Table 4-1, along with the engines' respective key design features.

RL-10A-4-2. The RL-10A-4-2, used on the Centaur IIIB upper stage and the Atlas IIIB and Atlas V launch vehicle, is a LOx/H₂ closed expander. It is equipped with a single turbine and gearbox, which drive the two pumps. Additionally, the engine is equipped with dual direct spark ignition and can be flown with a fixed or extendible nozzle. The engine operates nominally with a chamber pressure of 610 psi and develops an I_{sp} of 451 sec.

RL-10B-2. The RL-10B-2 currently powers the second stage of the Delta III and the medium- and heavy-lift configurations of the Delta IV. It features the world's largest carbon-carbon extendible nozzle, with an expansion ratio of 285:1. This high-expansion nozzle enables it to operate nominally with a chamber pressure of 633 psi, and develops an I_{sp} of 465.5 sec.

TABLE 4-1 Comparison of RL10 Engine Models

| MODEL NO. | A-1 | A-3 | A-3-1 | A-3-3 | A-3-3A | A-4 | A-5 | A-4-1 | B-2 |
|---------------------------|----------|----------|----------|----------|----------|----------|----------|----------|----------|
| Vacuum thrust (lb) | 15,000 | 15,000 | 15,000 | 15,000 | 16,500 | 20,800 | 14,560 | 22,300 | 24,750 |
| Chamber pressure (psia) | 300 | 300 | 300 | 395 | 475 | 578 | 485 | 610 | 644 |
| Thrust/weight | 50 | 50 | 50 | 50 | 54 | 67 | | 61 | |
| Expansion ratio | 40:1 | 40:1 | 40:1 | 57:1 | 61:1 | 84:1 | 4.3:1 | 84:1 | 285:1 |
| Specific impulse (sec) | 422 | 427 | 431 | 442 | 444 | 449 | 368 | 451 | 466.5 |
| Flight certification date | Nov 1961 | Jun 1962 | Sep 1964 | Oct 1966 | Nov 1981 | Dec 1990 | Aug 1992 | Feb 1994 | May 1998 |

SOURCES: (1) NASA point paper "Space Propulsion Technology Necessary to Enable Human and Robotic Exploration Missions," p. 31, R.L. Sackheim et al. (2006), (2) Pratt & Whitney Web site, Pratt-Whitney.com, and (3) Purdue University, liquid rocket engines Web site, Purdue.edu.

Finding 4-3. The technology for the RL-10A and RL-10B family of upper-stage engines is now more than 40 years old. Although numerous upgrades have been incorporated over the life of the engine, much of the design is now outdated. Because the second-stage engine for both EELVs comes from a single supplier, Pratt & Whitney, the Air Force is totally dependent on this single contractor and engine for all large payload launches. Should a failure occur that involves the second-stage engine, all launches with these systems would probably be frozen until the root cause is identified and corrected, which could take a year or more. While the probability of such an event is not high, it is not zero. In a time of crisis, this could be extremely debilitating for the nation. The number of failures in recent years (and their cost) would seem to be another good reason for developing and qualifying a new engine that would be supplied by more than one manufacturer.

In addition, to make full use of the Delta and Atlas heavy vehicles, a higher thrust engine is needed. To develop a new upper-stage engine for the nation's fleet of strategic launch vehicles requires a major development effort and an extended qualification program. The extremely high reliability demanded by a strategic launch capability means that a new engine development program may not skimp on hardware or testing.

Recommendation 4-3. DoD should place a high priority on development of a new medium-thrust (50,000-80,000 lb) upper-stage LOx/H₂ engine to assure the nation's strategic access to space. The cost of developing such an engine through its initial operation capability (IOC) is estimated by the committee at \$150 million to \$250 million providing the design does not try to push new technologies to their limits.

Alternative Designs for Second-Stage Engines

Several government organizations have recommended that a new second stage engine be developed in the thrust class of 50,000 to 100,000 lb. Industry has responded, with Pratt & Whitney developing the RL-60; Rocketdyne the MB-60, and Aerojet the RS-60. Northrop Grumman also has a USET-funded program to design a 40,000 lb LH₂ engine. All of these are in various stages of development. The MB-60 has components at TRLs between 6 and 9 depending on the component. Pratt & Whitney teams with several international partners to work on the RL-60. Volvo is producing the nozzle while Ishikawajima-Harima Industries (IHI) is providing the hydrogen turbopump. The RL-60 chamber has been tested.

Aerojet has worked on the design of its AJ-60 concept but has yet to develop the hardware. It is, however, developing a model that is more heavily physics-based, which helps to mitigate the risk in full engine development, and is advancing the technology for virtual engine design.

All of these options offer more thrust than the RL-10 engine, which needs additional capability if heavier payloads are to be placed into higher orbits. New engine design options that appear to be most suitable for the Air Force and DoD missions are compared with the existing RL10A-4 in Figure 4-4.

| Engine | P&W RL-10A-4 | P&W RL 60 | Rocketdyne MB-60 | Northrop Grumman TR-40 | Aerojet AJ-60 |
|-------------------------|-----------------|---------------------|-------------------|------------------------|---------------|
| Thrust (Klb) | 22.3 | 60.0 | 60.0 | 40.0 | 60.0 |
| I_{sp} (secs) | 451 | 460 | 467 | | 461 |
| Mixture ratio | 5.5 | 5.8 | 5.4 | | |
| Chamber pressure (psia) | 620 | 1250 | 2000 | | 1800 |
| Weight | 375 | 1200 | 1300 | | |
| Area ratio | 84 | 285 | 300 | | 250 |
| Cycle | Closed expander | Closed expander | Expander bleed | Split expander | Expander |
| Status | Production | Preliminary testing | Component testing | Paper | Paper |

FIGURE 4-4 Upper stage engine options. SOURCES: (1) NASA point paper “Space Propulsion Technology Necessary to Enable Human and Robotic Exploration Missions,” p. 31, R.L. Sackheim et al. (2006), (2) Pratt & Whitney Web site, Pratt-Whitney.com, and (3) Purdue University, liquid rocket engines Web site, Purdue.edu.

However, most of these new second-stage engine design efforts are not fully funded. The development of a new rocket engine is a very expensive proposition, costing between \$150 and \$250 million, providing the design does not try to push new technologies to their limits. Therefore, the large liquid propellant rocket engine industry (now made up of only three companies) have not been able to justify committing large amounts of increasingly scarce internal resources to full development and qualification of any of these candidate concepts. Support by industry could increase differently if DoD were to commit to a serious, well-funded, long-term program for a new family of large, responsive spacelift vehicles to support major new total capability in-space architecture.

SMALL TO MEDIUM-SIZED LAUNCH VEHICLES

Existing Vehicles

Pegasus

The Pegasus is a vehicle launched in midair (via a modified Lockheed L-101 I aircraft) (OSC, 2000). Orbital Sciences Corporation (OSC) manufactures the three-stage, all-solid-propellant, three-axis stabilized vehicle. The Pegasus-XL vehicle, a stretched version of the original Pegasus vehicle, can place a 400- to 1,000-lb payload into low Earth orbit. The original version of the Pegasus was retired in 2000, and only the Pegasus-XL is used today.

The Pegasus-XL free falls for 4 seconds after release; then the first-stage solid rocket motor, manufactured by Alliant TechSystems, fires and burns. The delta-shaped wing produces lift, and the launch vehicle begins a 2.5 g force pull-up. Then the second-stage solid fuel motor ignites, and at approximately 2 minutes, the payload fairing is ejected. The second stage flies to an altitude of approximately 129 miles with a velocity of over 12,000 miles per hour. At the appropriate altitude to achieve the designated orbit, the third-stage motor ignites and burns for 1 minute and 6 seconds to place its payload into orbit.

NASA certified Pegasus to carry the highest value satellites (Category 3 certification) because of its excellent reliability record. Pegasus has launched its last 21 missions successfully. No Pegasus XL vehicles flew in 2004. On April 15, 2005, a Pegasus XL successfully launched the demonstration of autonomous rendezvous technology flight demonstrator vehicle for NASA (FAA, 2006).

Athena

The Athena I carries a payload of up to 1,750 lb and the Athena II, up to 4,350 lb.³ The Athena I and II use Thiokol's Castor 120 motor with 435,000 lb thrust for their first and first and second stages, respectively. The engine burns hydroxyl-terminated polybutadiene (HTPB, a polymer) propellant. The Athena I second stage and the Athena II third stage are powered by Pratt & Whitney's Orbus 21D, with a thrust of 43,723 lb. Athena I and II have a common orbit adjust module that houses the attitude control system and the avionics subsystem. The monopropellant hydrazine fuel (a liquid) attitude control system performs orbital injection corrections, roll control, velocity trim, and orbit circularizing maneuvers.

The first operational mission of the Athena, an Athena I, successfully launched the NASA Lewis satellite into orbit from Vandenberg Air Force Base in California, on August 22, 1997. The first Athena II was successfully launched from Cape Canaveral, in Florida, on January 6, 1998, sending NASA's Lunar Prospector spacecraft on its mission to study the moon. Subsequent successful missions include Athena I/ROCSAT-1 for the Republic of China on January 26, 1999, Athena/IKONOS for space imaging from Cape Canaveral on September 24, 1999, and Athena/Kodiak Star for NASA from Kodiak, Alaska, September 29, 2001.

The Athena I and II use a simple and reliable orbit adjust module (OAM) that can be adapted to many small launch vehicle configurations. The OAM houses the attitude control system and avionics subsystem (guidance and navigation, batteries, telemetry transmitters, command and destruct receivers and antennas) that are common to Athena I and Athena II. The OAM is located directly beneath the payload to perform the final orbit injection burns and any needed to put the satellite in the precise orbit. The OAM weighs 819 lb dry and can carry no more than 960 lb of hydrazine. After payload separation, the OAM performs a contamination and collision avoidance maneuver, distancing itself from the payload and burning any remaining fuel to depletion. The attitude control system, provided by Aerojet, uses off-the-shelf propulsion components. The propellant load is tailored to the specific mission.

Taurus

Taurus is a ground-launched version of the OSC's Pegasus rocket vehicle. It uses three stages of the Pegasus boosted by a large Castor solid propellant motor. It is designed to launch satellites up to 3,500 lb into LEO. Liftoff weight varies between 150,000 and 220,000 lb. It can be transported and launched from various minimally improved sites in the world.⁴

Four variants of the Taurus launch vehicle exist. The smallest version, known as the ARPA Taurus, uses a Peacekeeper first stage instead of a Castor 120 motor.

A second size uses the C-120 first stage and a slightly larger Orion 50S-G second stage. The Taurus XL uses the Pegasus XL rocket motors (Orion 50S-XL and Orion 50XL) and is considered a development-stage launch vehicle. The largest Taurus variant, the Taurus XLS, is a study-phase vehicle that adds two Castor IVB solid rocket boosters to the Taurus XL to improve payload by 40 percent over the standard Taurus. For all Taurus configurations, satellite delivery to a GTO orbit can be achieved with the addition of a Star 37FM perigee kick motor.

³For additional information, see <http://www.lockheedmartin.com/wms/findPage.do?dsp=fec&ci=11459&rsbci=0&fti=0&ti=0&sc=400>. Last accessed on March 30, 2006.

⁴For additional information, see the Taurus fact sheet at http://www.orbital.com/NewsInfo/Publications/Taurus_fact.pdf. Last accessed on November 19, 2006.

The Taurus system is evolving more responsive payload integration and launch operations. Second stages are integrated horizontally and payloads are integrated with the fairing in a separate area. This format for operations will be an almost mandatory part of the total system architecture of future operationally responsive launch systems.

Minotaur

For the Air Force's Orbital/Suborbital Program (OSP), Orbital developed the low-cost, four-stage small launch vehicle (SLV) Minotaur rocket using a combination of U.S. government-supplied Minuteman II motors as the vehicle's first and second stages and proven OSC space launch technologies (OSC, 2004). Minotaur's third and fourth stages, structures, and payload fairing are common with the Pegasus XL rocket. Its capabilities have been enhanced by adding improved avionics systems, including a modular avionics control hardware, which is used on many of OSC's suborbital launch vehicles. Minotaur is considered a small launch vehicle. It can lift 750 lb to a 400-nm, sun-synchronous orbit. This is roughly 1.5 times the Pegasus XL capability. All payload customers must be U.S. government agencies or be sponsored by such agencies. The Secretary of Defense holds approval power for each launch mission.

Sea Launch

In 1995 the Sea Launch Company, LLC, headquartered in Long Beach, California, was formed, with 40 percent owned by Boeing, 20 percent Kaevener (Norway), 25 percent Energia (Russia), and 15 percent Yuzhnoye/Yuzmash (Ukraine). The Sea Launch system combines launch, home port, and marine segments to offer a heavy-lift capability of 6,000 kg and injection into GTO from a performance-enhancing equatorial launch site. The launch segment consists of the Zenit-3SL rocket produced by Yuzhnoye/Yuzmash in Dnepropetrovsk, Ukraine; the Block DM-SL upper stage produced by Energia in Moscow; and payload accommodations produced by Boeing in Seattle. The first and second stages of the Zenit-3SL are powered by the RD-171 and RD 120 LOx/kerosene engines, respectively. The Block DM-SL upper stage is powered by the 11D58M LOx/kerosene engine. The payload accommodation module consists of a graphite epoxy 4-m diameter payload fairing and a payload interface adapter.

All launch vehicle processing, spacecraft processing, and payload encapsulation takes place at home port in Long Beach. Payload processing is managed by Astrotech in Sea Launch's payload processing facility. The marine segment consists of the launch platform (LP) and the assembly and command ship (ACS). The ACS encompasses the launch control center, range safety, a weather station, and accommodations for crew and customers. Operationally, the Zenit-3SL is integrated horizontally within the ACS then transferred to the LP. During the trip to the maritime equatorial launch site at 154° W (11 days for the LP and 8 for the ACS), launch operations and rehearsals are conducted to ensure crew readiness. On April 26, 2005, Sea Launch successfully delivered a Boeing 702 model spacecraft weighing 6,080 kg into GTO. The Boeing Sea Launch Web site indicates there were 22 successful launches from this system through June 2006.⁵

Finding 4-4. The Sea Launch operations concept could provide key advantages for a variety of small to medium-size launch vehicles and needs to be seriously considered as a viable launch vehicle for military geosynchronous payloads even though ownership is multinational. For GTO missions, launches are conducted from a point on the equator at approximately 154° W. This has two significant performance advantages. It allows Zenit to deliver spacecraft to a GTO transfer orbit at roughly 0° inclination, thus reducing the required spacecraft apogee burn and allowing the Zenit 3SL rocket to lift a heavier spacecraft mass or provide longer life in orbit. The maritime launch also nearly eliminates range safety

⁵For additional information, see the official Boeing Sea Launch Web site at <http://www.boeing.com/special/sea-launch/>. Last accessed on August 8, 2006.

concerns and the need to shape trajectory as no populated areas are near the launch site or the downrange impact areas.

Recommendation 4-4. DoD should incorporate this concept into some of the total systems architectures options to be studied for future operationally responsive access to space.

Vehicle in Development

Kistler K-1

The Kistler K-1 vehicle is a two-stage fully reusable vehicle that is being designed for 100 flights, a 9-day turnaround, and 3-day response. Both stages return to the launch site for refurbishment and reuse and use horizontal vehicle processing and checkout.

The K-1 uses the NK-33 engine that was developed by the Russians and designed for multiple starts with large margins for robustness. The K-1 vehicle uses three NK-33s in the first stage and one in the second stage. Both stages are returned to Earth by parachutes.

The NK-33 engine is the highest performance LOx/kerosene engine available. It has been extensively tested and was fully qualified for the Russian lunar program. It incorporates an Aerojet-developed state-of-the-art electronic controller, ignition system, restart capability, an electromechanical actuator control valve, and a gimbaling system. The verification engine modifications are complete, and six tests have been completed. The NK-43 was developed for altitude performance and is essentially an NK-33 with an increased nozzle expansion ratio.

Kistler has teamed with Rocketplane Ltd., Inc., of Oklahoma and will continue operations as Rocketplane Kistler. The Rocketplane Kistler team expects to provide unique suborbital and orbital commercial space transportation services for passengers and cargo through its fleet of highly reliable, cost-effective, and reusable aerospace vehicles. Kistler's successful restructuring should enable the company to complete the first K-1 vehicle, currently 75 percent complete, and conduct its first launch in 2007.

All license agreements are in place. There are 37 NK-33 and 9 NK-43 engines at Aerojet (equivalent to 180 missions) with ~40 engines still in Russia contracted to Aerojet. There is also a complete NK-33/43 engine design package at Aerojet with a technical support agreement in place and active. The Kistler K-1 vehicle, with its recoverable first and second stages and its available first- and second-stage engines, is an option as part of an advanced overall architecture for assured U.S. access to space.⁶

FALCON Small Launch Vehicles

As discussed earlier, a major element of a transformed total access-to-space architecture is the introduction of vehicles for ORS early in the far term of AFSPC's SMP FY-06. Responsive spacelift is shown in the DoD space transportation roadmap in Figure 4-1. In the demonstration phase, 2006 through 2009, the objective is to have two or three small launch vehicles be flown. Some of the vehicles initiated under FALCON are expected to transition into cost-effective commercial launchers that could replace high-cost small vehicles.

Background

The DARPA/Air Force/NASA FALCON program started in August 2003. The overall goal of the program is to develop and validate in-flight technologies that will enable both near-term and far-term capabilities to execute time-critical, prompt global-reach missions while at the same time demonstrating affordable and responsive spacelift. The fundamental underpinning of the FALCON program is the belief

⁶For additional information, see the official Kistler Web site at <http://www.kistleraerospace.com>. Last accessed on August 8, 2006.

that a common set of technologies can be matured in an evolutionary manner that will provide a near-term (2007-2010) operational capability for responsive, affordable spacelift and prompt global reach from a small satellite (smallsat) launched from the continental United States (or equivalent reach from basing outside of the continental United States). These technologies might also enable future development of a reusable hypersonic cruise vehicle (HCV) in the far term (circa 2025).^{7,8}

There are two tasks in this program. Task 1 is focused on a small launch vehicle (SLV) and Task 2 on a hypersonic technology vehicle (HTV). Together, the capabilities of placing small satellites or payloads into LEO and performing HTV missions in a responsive manner are an important step in the evolution of ORS capabilities for the Air Force (DARPA, 2004).⁹

The technologies for the launch vehicles needed to place a small payload into LEO or to place an HTV at its insertion point have enough in common that the design for both missions is encompassed within Task 1 (DARPA, 2004). For the first part of the mission, the top-level requirements for the operational system for the SLV are 1,000 lb payload (with the potential for an increase) to a 28.5° circular orbit, 100 nm altitude (baseline orbit for concept comparison) LEO (Weeks et al., 2005).¹⁰ The vehicle would have low recurring costs (less than \$5 million), reach alert status within 24 hr, and then launch within 24 hr.

For the hypersonic systems, the objectives are unpowered, maneuverable, hypersonic glide.¹¹ The vehicle would carry up to 1,000 lb of payload and have a minimum range of 3,000 nm. The reusable HCV would be an autonomous aircraft capable of taking off from a conventional military runway and striking targets 9,000 nm distant in less than 2 hr.

The first 6 months of the program (Phase I) were for concept development and identification of technologies. Phase II, which followed, was divided into three parts. Phase IIA covers authorization to proceed to preliminary design review (PDR). Phase IIB covers PDR to critical design review (CDR), and Phase IIC covers CDR to the demonstration flight of the small satellite spacelift mission.¹² In Phase IIC, final flight hardware will be built up and flown no later than FY08. Demonstration flights are expected to carry prototype autonomous flight safety systems and low-cost tracking and data relay satellite system transceivers.¹³

After the FALCON program has been completed, DARPA will hand over the demonstration vehicle systems aspects to the AFSPC for development and implementation of the operational system. It is possible that the winning vehicles can contract directly with NASA or private entities (e.g., academia, amateurs, and other government agencies) to arrange for commercial launches.¹⁴

Four Vehicle Concepts in Demonstration Phase in 2005

Figure 4-5 summarizes the four vehicle concepts in the demonstration phase in 2005. Each concept is discussed in more detail in Appendix E.

⁷For additional information, see http://www.darpa.mil/body/news/2003/falcon_ph_1.pdf. Last accessed on March 30, 2006.

⁸David Weeks, NASA Marshall Space Flight Center (MSFC), personal communication to committee member Ivett Leyva on May 18, 2005.

⁹Ibid.

¹⁰Ibid.

¹¹For additional information, see http://www.darpa.mil/body/news/2003/falcon_ph_1.pdf. Last accessed on March 30, 2006.

¹²David Weeks, personal communication to committee member Ivett Leyva on May 18, 2005.

¹³Ibid.

¹⁴Ibid.

It is worth mentioning that SpaceX has its own funding. DARPA funds only the demonstration flight and making the launch operations responsive. The vehicle has been under development for a couple of years but was lost as a consequence of fire during its maiden launch in 2006.¹⁵

FALCON is the first concrete program devoted to the realization of affordable and responsive spacelift. Each of the four contractors for Phase IIA, Task 1, worked on several technologies to meet these goals. Some of the key technologies being developed or optimized that could be modified for or transferred to other programs are ablative thrust chambers, pressurization systems (VaPaK, Tridyne, etc.), low-cost avionics, hybrid combustion (using a patented staged-combustion concept), and composite tanks. Ablative thrust chambers were used by at least two contractors as an alternative to actively cooled ones. Composites were also being looked at by at least two contractors to reduce weight. Hybrid combustion was being revisited via a patented staged-combustion concept to achieve both combustion stability and performance comparable to that of liquid-fuel rockets. Common to all contractors is the objective of low-cost operations, which drove all of them to find innovative ways of streamlining their manufacturing, integration, transporting, and storage processes.

Another observation is that the subsystems of all the vehicles are modular and should be scalable, although to different degrees. These qualities potentially make some of the vehicle first stages candidates for replacement strap-ons for the Atlas or Delta vehicle families. Also, scaled versions of some of the first-stage engines could potentially be used as larger-thrust second-stage engines. FALCON promises to foster a new approach that designs space launch vehicles for versatility from the very beginning.





| | |
|---|---|
| <p><u>Air Launch</u> Quick Reach, C-17 Launched, LOx/Propane, Self-Pressurizing, Liquid 2-Stage</p>  | <p><u>Lockheed Martin Michoud</u> Hybrid, LOx/HTPB, Creative CONOPS with Mobile Launch Infrastructure, Modular Simple Payload Integration</p>  |
| <p><u>Microcosm</u> Eagle, Tridyne Pressurization, LOx/Jet-A Propellant, Common Thruster Pods for Low-Cost, 240,000 lbf, First-Stage Thrust, 166,000 lb GLOW</p>  | <p><u>Space X</u> FALCON, Liquid Pump-Fed LOx/RP1, Reusable 1st Stage Launch via Transporter/Erector</p>  |

FIGURE 4-5 Vehicle characteristics for the four contractors in Phase IIA for DARPA FALCON program. SOURCE: DARPA (undated).

Programmatically, the FALCON approach has a lot of advantages. For example, the requirements were very few but very concise. This truly allowed for outside-the-box thinking, which is evident in the systems designed by the four contractors in Phase IIA, Task 1. The FALCON program also encourages

¹⁵For additional information, see the official SpaceX website at <http://www.spacex.com>. Last accessed on November 7, 2006.

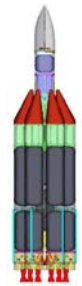
small companies to enter the space access business. Each of the four companies under Task 1 has committed to at least two new technologies to reduce the cost of access to space. In all cases, the system configurations being developed must allow scalability, to mid- and even heavy-lift vehicles. They entail also, to different degrees, modular rack-and-stack approaches. The FALCON program provides opportunities to eliminate technology risks for larger launchers. In its early phases it stimulated the design and demonstration of new, low-cost, responsive technologies for space access.

Finding 4-5. The FALCON program is an initial response to the need for low-cost, operationally responsive access to space. This program plans to perform in-flight validations of technologies leading to highly responsive vehicles that can carry out time-critical, global-reach missions. The cost goal for FALCON-technology-based designs is \$5 million (2003 dollars) per launch. Current costs for similar payloads using available small and medium-size vehicles are \$20 million to \$30 million. Successful FALCON demonstration vehicles and, later, production vehicles would open the door to a larger market for commercial space payloads. An increased launch rate would allow for the increased production of SLVs, which in turn would lower the cost of the vehicles through true mass manufacturing. Also, if more satellites could be launched each year, they would not need to be designed for a 5-10 year lifespan but could instead be updated or replaced more often. In FALCON, cost is prized over performance.

Expendable vehicles using low-parts-count, pressure-fed liquid propulsion systems such as systems used for the AirLaunch FALCON demonstrator and the SpaceX vehicle can be developed for much less money than reusable ones. Depending on the annual flight rate, they can also cost less per flight.

Recommendation 4-5. In September 2005, DARPA downselected to just one company for Phase 2B. DARPA should continue to fund and monitor this company to completion of the FALCON program objectives. The Air Force should evaluate the propulsion technologies to be demonstrated for the air-launched FALCON vehicle and include them in total system studies of options for ORS vehicles.

Air-Based Vertical-Launch Concept

As stated above, the overall goal of the FALCON program is to develop and validate, in flight, technologies that could provide both a near-term and a far-term capability to execute time-critical, prompt global-reach missions from the continental United States (or equivalent reach from basing outside the continental United States) while also demonstrating affordable and responsive spacelift for a variety of small satellites. Achieving these capabilities is an important early step in the evolution of ORS and global strike capabilities for the Air Force.

In the fall of 2005, another vehicle launch concept was disclosed that appears to have good potential for achieving some of the above capabilities—very fast, precision global and tactical strike and responsive cost-effective launch of satellites at the lower end of the smallsat spectrum¹⁶ into various LEOs (Smith, 2005). The concept grew out of efforts to find solutions to the severe time and geographic constraints associated with ground-based, boost-phase ballistic missile defense. The idea is to install a vertical launching system in a large-body aircraft. Such an aircraft could be on-station anywhere in the world it is needed. The system is illustrated in Figure 4-6.

¹⁶Defined here as nano, micro, and <200 lb.

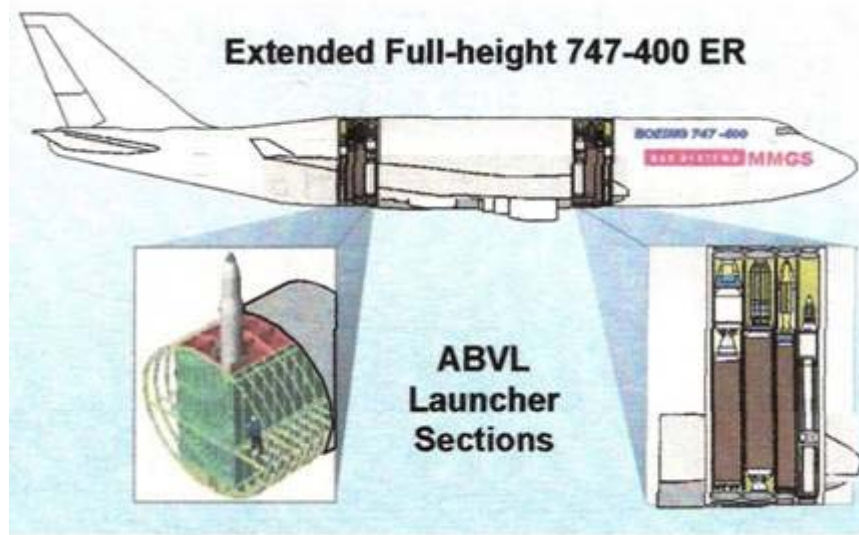

FIGURE 4-6 Air-based vertical launch system (ABVL). SOURCE: Smith (2005).

The launcher subsystem is completely removable from the aircraft. Installation of flight-ready missiles into the self-sufficient module and installation of that module into the large-body aircraft would be carried out in separate ground facilities.

For satellite applications the separate compartments can be of various widths to accommodate various launch vehicles. One possible launch vehicle for a 50-lb-payload smallsat that could be accommodated in a 747 is illustrated in Figure 4-7.

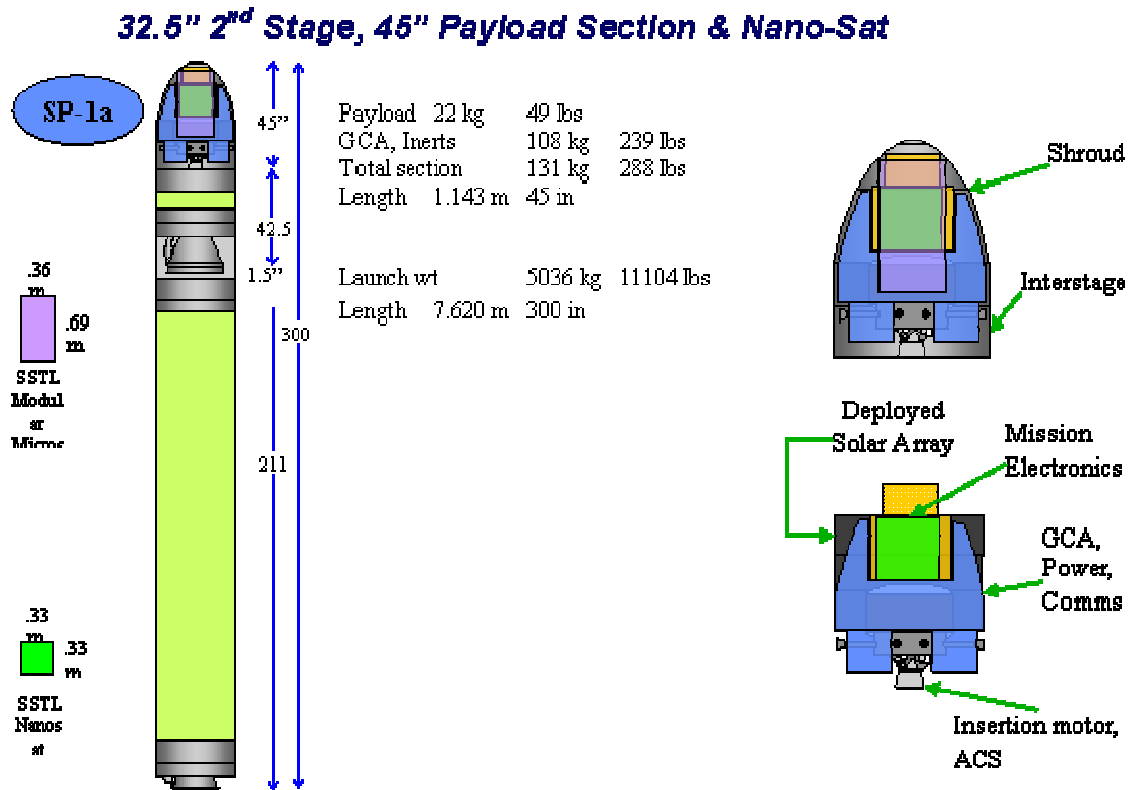

FIGURE 4-7 Space launched nanosatellite system, BAE Systems Model SP-1a. SOURCE: Smith (2005).

The feasibility of an ABVL is being studied by BAE Systems and ATK under a small DARPA contract. Beyond that, an integrated total systems engineering program would be necessary to establish propulsion requirements that can exploit the potential for responsiveness and low cost offered by such a system for small satellites. (The concept is also of interest for prompt-reach missile applications. See Chapter 5.) New technologies or modifications of existing stage or missile booster designs critical to meeting those requirements can then be identified, specified, and demonstrated.

Much of the launch dynamics and environment of an ABVL is very different from that of a ground-based launch, a Pegasus air launch, or the candidate FALCON vehicle Airlaunch, described above. Launching at high altitude (say, 45,000 ft) eliminates a large part of the Gt losses and a large part of the acceleration losses associated with ground launch (up to 3,500 ft/sec, depending on launch altitude and thrust/weight (T/W) ratio during the early part of the boost).¹⁷ The normally high L/Ds of launch vehicles are driven by the need for low-altitude drag and stability. Current large-body aircraft could accommodate many of the existing launchers for small missiles. However, this configuration may not fully exploit the launch concept given the individual space launch vehicle gross weights that could be supported in optimized launcher module volumes and the cargo capacity of the aircraft. On the other hand, the exit horizontal drag dynamics and subsequent pitch over to the optimum trajectory angle of attack would be heavily influenced by the launch vehicle's diameter and by the specific thrust/time ratio and thrust vector control that could be achieved by the initial boost propulsion system.

Finding 4-6. Configurations for candidate launch vehicles (including parallel boosters or strap-on combinations), along with propulsion technologies such as propellant combinations (solids, storable liquids, gelled combinations, storable-oxidizer hybrids) and operating characteristics (including assured start-up profiles, thrust vector control, and rocket plume impingement patterns) need to be optimized to take full advantage of the potential new operationally responsive mission capabilities of aircraft-based vertical launch for small satellites, satellite arrays, and near-space military applications (see also Chapter 5).

Recommendation 4-6. The Air Force and DoD should sponsor a detailed system engineering study to fully understand the transformational potential of cost-effective, operationally responsive launch of small, micro-, and nanosatellites (particularly for large-number satellite arrays) utilizing air-based vertical launch concepts. The propulsion technologies that are needed to take full advantage of such launch platforms should be identified and developed.

Multimission Modular Vehicle Air-Based Launch

A new multipurpose airframe design is under consideration for potential future applications by DARPA. Such an airframe, currently designated the multimission modular vehicle (MMMV), would have a detachable centerline payload. It might have a joined-wing configuration to support the centerline that would enable this concept. The airframe is designed in such a way that the centerline payload could be either a passenger- or cargo-carrying fuselage that could also be equipped with folded rotor blades for emergency separation or self-transport.

The MMMV concept could provide a transformational access-to-space capability for future medium to large satellites. The aircraft could be configured to transport rocket-powered, access-to-space vehicles to high-altitude launch points at ideal geographic locations. As described above for smallsats, this would afford tremendous flexibilities in launch time, azimuth, or orbital inclination for large satellites. Also, a specialized missile pod could be used for tactical, strategic, or even antiballistic missile defense, enabling a more rapid response to emerging threats more rapid than is available today. The versatility of a

¹⁷Losses of Gt are the result of the reduction by gravity of the vehicle acceleration produced by the vertical component of the engine thrust vector integrated over the angle of attack during the launch trajectory.

removable centerline payload is the key to this operational flexibility. The basic lifting aircraft configuration is illustrated in Figure 4-8. An MMMV carrying a medium to large spacecraft launch vehicle is depicted in Figure 4-9.



FIGURE 4-8 MMMV concept. SOURCE: NASA MSFC.



FIGURE 4-9 MMMV concept for medium to large spacecraft. SOURCE: NASA MSFC.

Finding 4-7. As discussed above for air-based vertical launch of small launch vehicles and missiles, candidate medium to large launch vehicle configurations and their propulsion technologies would need to be optimized to take full advantage of the potential for a modular configuration aircraft to transform mission capabilities by enabling high-altitude launch. Some of the propulsion technology aspects that need to be investigated include propellant combinations capable of long on-station standby (solids, storable fuels and oxidizers, gelled combinations, hybrids); first-stage chamber pressures and expansion ratios; and various operating characteristics, including assured start-up profiles, thrust to weight profiles, thrust vector control, and rocket plume impingement patterns.

Recommendation 4-7. The Air Force and DoD should combine a detailed system engineering study of the multimission modular vehicle air-based launch system for medium-sized vehicles with the study of air-based vertical launch for small vehicles called for in Recommendation 4-6. Air Force and DoD sponsorship would ensure they are focused on Air Force and DoD criteria for optimizing mission success. The study would identify propulsion technologies (modifications or new concepts) that should be evolved in order to take full advantage of such air-based launch platforms for both strategic and operationally responsive missions.

Operationally Responsive Spacelift Requirements

The DoD's Space Science and Technology Strategy states that assured access to space is the highest priority within the space support mission area, and a responsive space capability is directly coupled to both the space support and force enhancement mission areas (DoD, 2004). An important element of a transformed total access-to-space architecture is the introduction of ORS vehicles early in the medium term of the SMP FY06. Some of the missions driving the ORS architecture are indicated in Figure 4-10. In the Air Force's roadmap of ORS spirals (Figure 4-1), selected vehicles from the FALCON program, described above, would continue developmental and operational flights as part of the Air Force's fleet of small launch vehicles into the far term (James, 2005). Each of the selected concepts would probably evolve into a family of fast-response expendable vehicles that could launch payloads from 2,000 to 10,000 lb to LEO. The roadmap also shows the start of full-scale development of an ORS vehicle in 2010.

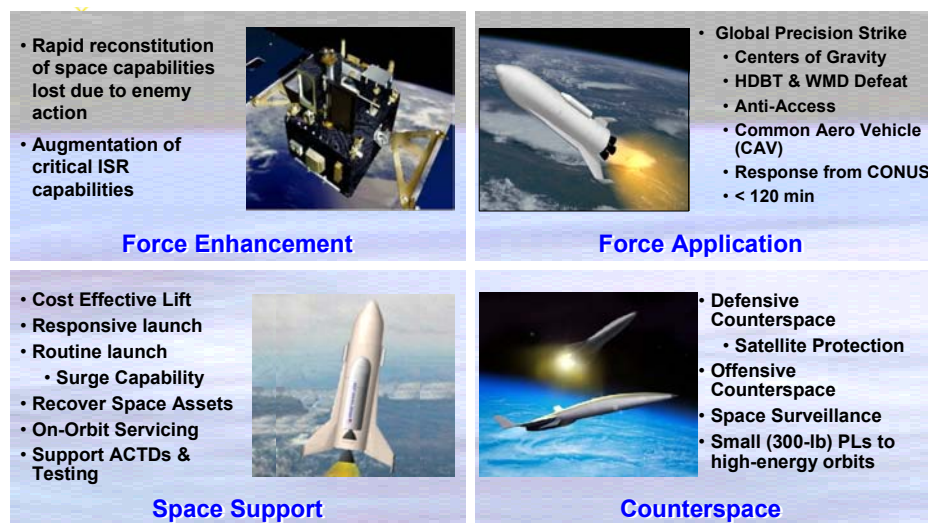

FIGURE 4-10 Missions in operationally responsive spacelift. SOURCE: Hampsten et al. (2005).

The objectives for ORS vehicles are shown in Figure 4-11. Meeting these objectives may necessitate a number of new propulsion subsystem technologies in addition to applicable existing qualified subsystems.

| Operational Parameters | ARES Subscale Demonstrator (SD) | ARES Full Scale Vehicle Operational System (OS) |
|-------------------------------|---|---|
| Turn-Around Time | 5 Flights, 10 Days, 15 People | 24-48 hours |
| Cost Objectives | Design to cost | Reduced Life Cycle Cost |
| Recurring Flight Cost* | Traceability to full scale ~ \$3 M /Flight for 10 Flights (Without Upper Stage) | 3x - 6x Reduction from current EELV-M launch costs ~ \$20 M /Flight (10 klb to LEO) (Including Upper Stage) |
| Operations | Two Tail Numbers Return-to-Base (RTB) Ops Representative Demo Team | Six Initial Tail Numbers Return-to-Base (RTB) Blue-suit Operators/Contractors Blue-suit Operators |
| Second Stage (Orbital Option) | Production ELV < \$5 M 2000 lbs to LEO / 28° Inclination | Production ELV < \$5-\$10 M 10-15K lbs to LEO/ 28° Inclination |
| Flights | First Flight – FY10 | First Flight – FY18 |

*Flight cost is for notional 10k vehicle

FIGURE 4-11 AFSPC operational objectives. SOURCE: Hampsten et al. (2005).

As discussed in some detail in the first section of this chapter, an integrated total systems engineering process in which propulsion requirements for these vehicles are established and technologies critical to meeting those requirements are defined is crucial to the success of any new launch-to-space or in-space vehicle program. Using “mission success” as the primary selection criterion for this systems engineering process provides a powerful quantitative tool for the design of low-risk, cost-effective ORS concepts for Air Force future needs.

For a specific mission defined by a set of requirements issued by a user program authority, “mission success” can be defined as achieving the functional result we want, when we want it, for the price we committed to and within the risk level profile we accepted for the program. In a total systems engineering process, “mission success over the required life of the system” can be the primary criterion for selection from among total configuration options. “Total configuration” encompasses a system’s overall architecture, including all of its major flight system elements, all of its required direct supporting elements, its required logistics architecture, and the supplier base.

For example, the configuration of the first stage of a new operationally responsive launch vehicle, including the design of its propulsion elements, would not be selected using conventional (but subjective and ineffective) criteria such as lowest weight. Instead, it would be selected by virtue of being an element of a particular total configuration option. “Mission success” would be characterized for each total system option as: “achieving the functional capability wanted with a specific schedule uncertainty profile (using a consistent methodology), a specific total-life-cycle price uncertainty profile (using a consistent methodology), and within the program authority accepted (not the lowest) quantitative risk uncertainty level profiles for functional performance and total systems operational reliability.” The options could then be selected based on the most advantageous mission success profile.

Some of the most critical design options for first-stage propulsion (e.g., expendable vs. reusable; storable vs. cryogenic propellants; thrust/ time ratios; and pumped vs. pressure fed) are completely entwined with the total system architecture, including such things as fixed, distributed, or mobile launch facilities, active mission launch rate, and yearly launch rates. Such characteristics would benefit from not being locked in before an objective total systems engineering process has been completed, including the validation status of the design criteria for all proposed critical technologies.

This is the dominant factor in making objective evaluations of the schedule and cost risks and for development engineering of the operational and life-cycle cost risks of the propulsion systems. It also permits quantitative and consistent comparisons of concepts across the broad trade-off space of propulsion systems. Propellant selection, for example, would require trades between pumped vs. pressure fed; pressurization subsystems for net positive suction head or propellant feed; optimization of chamber pressure and nozzle expansion ratios for first or second stages; expendable vs. reusable first and/or second stages; metals vs. composites for tanks or motor cases; ablative vs. cooled combustion chambers.

Most important, when rigorously applied, such a program would eliminate the identification of unvalidated design criteria associated with technologies for critical elements of conceptual propulsion systems or for upgrades of existing subsystems proposed for various candidate vehicles. These unvalidated system element design criteria (which include criteria for the element's total operating environment) are the primary drivers of a development program's engineering, operational, and cost risks. (In a number of past cases, the use of designs for which too few criteria had been validated was the first cause of catastrophic failures.)

Affordable Responsive Spacelift Vehicle

The Air Force has set up a program to demonstrate a subscale vehicle and validate the system concept. Called affordable responsive spacelift (ARES), the vehicle will be evolved into the ORS family of vehicles.

The ARES program evolution spiral was planned to start in 2005. The Air Force has been working on conceptual systems engineering for ARES and has completed an initial group of analyses. The result of the Air Force's current analysis is a basic architecture concept for a reusable, fly-back-to-launch-site, rocket-engine-powered first stage and an expendable, rocket-engine-powered second stage.

The Air Force believes the ARES hybrid is the medium-term solution for a revolutionary spacelift capability (James, 2005). It also foresees that an ARES flight demonstration in 2010 will provide confidence in full-scale system costs and operability and will enable fielding a system in an affordable fashion.

In the committee's opinion, if the ARES system design is to be selected via a total systems engineering process to provide confidence in full-scale vehicle development, it must essentially lock in most of the critical technologies for the full-scale configurations by default. To proceed confidently with competitive conceptual designs for a subscale demonstrator starting in 2005 and implementation of a selected configuration development program starting in 2006, the choice of propulsion technologies would benefit from being constrained by a total systems engineering process whose elements have been qualified or at least have extensive validating data.

The committee's review did not turn up any transformational or revolutionary technologies mature enough to be considered for ARES (and therefore for any full-scale vehicle that would be "justified" by the subscale demonstrator). Also, the committee could identify only two existing rocket engines that might meet the propulsion system requirements for the ARES hybrid: the Aerojet AJ26-58/59, which would constrain the first stage to LOx/RP-1, and the RL-10 family, which would constrain the second stage to LOx/LH₂.

New rocket engine designs such as those described below would have to be objectively compared to the Aerojet AJ26-58/59 and the RL-10 family. Only one of the engines has significant test data available. Total systems engineering dictates that all engine comparisons be based on rigorous objective assessment of forecasted performance, development cost and risks, operational characteristics, and logistic support required for new engine designs.

There could be many opportunities to be clever in configuring total access-to-space systems architectures for fixed and mobile (including air-based) launch locations, payload module integration, launch operations associated with both reusable and /or expendable vehicles. industrial support, parts and propellant storage and logistics, and so on. However, as stated above, the committee does not see any revolutionary technologies that could be incorporated into the vehicles' propulsion systems. Tanks and

feed systems may incorporate design improvements and eliminate known failure modes or improve margins, but they do not constitute revolutionary or transformational technologies. The propellant combinations that are realistically available to ARES are well known and have been in use for a long time. Based on “mission success” total system design criteria, the ORS missions out into the early part of the far-term (FY18-FY30) do not require revolutionary technologies to accomplish. In fact, at this point in time, the various risks of committing to unvalidated technologies are much greater than any overall gain claimed for system performance.

The Air Force recognized this real situation and stated as follows (Hampsten et al., 2005, p. 12):

Remember . . . ARES-SD is the first phase of an acquisition program. [The] Air Force wants to achieve its goals using the lowest risk approach practical. The ARES management team uses the term *technologies* in the generic sense of describing the technological means to an end. It is not intended to indicate specifically immature, “high-tech,” stretch design goals, or high-risk technologies. This is not a tech-push effort.

The committee concludes that ORS missions out into the early part of the far-term (FY18-FY30) will not have (and in the committee’s opinion do not need to have) revolutionary propulsion technologies. In fact, the various risks of committing to unvalidated technologies at this point in time are much greater than any potential gain in rocket propulsion system performance. If there is to be a revolutionary ORS capability in the medium term, it will be created by very innovative total systems architecture and operations processes and by high margins against retained failure modes, not by revolutionary rocket propulsion system technologies.

INITIATIVES TO ESTABLISH NEW PROPULSION TECHNOLOGY BASE

National Aerospace Initiative

The National Aerospace Initiative (NAI) began in 2001 as a joint technology initiative by the DoD and NASA. It is not, however, a program for system development or acquisition (NRC, 2004). In fact, “the goals of NAI are to renew American aerospace leadership; push the space frontier with breakthrough aerospace technologies; revitalize the U.S. aerospace industry; stimulate science and engineering education; and enhance U.S. security, economy, and quality of life” (NRC, 2004, p. 3). The initiative rests on three pillars: high-speed, hypersonic flight, access to space, and space technology. An NAI executive office was created to foster collaboration between NASA and DoD and develop goals, plans, and roadmaps for the three pillars. The idea was for NAI to start by identifying the capability objectives for the future systems; to use the goals, objectives, technical, challenges, and approaches (GOTChA) process to analyze the technology development challenges and options; to establish investment plans; and, finally, to coordinate the combined efforts of the involved parties to execute the developed technology plans (NRC, 2004).¹⁸ The elements of the NAI are shown in Figure 4-12.

¹⁸“The GOTChA process combines layered analysis (goals are analyzed to determine objectives, which are analyzed to determine technical challenges, and so on) and planning (projects are identified and roadmaps developed to address the challenges)” (NRC, 2004, p. 11).

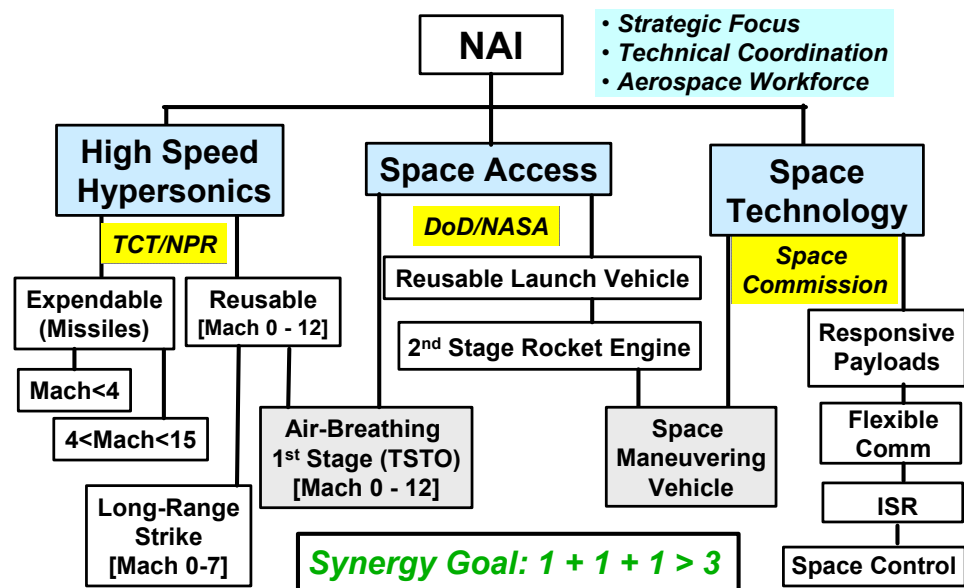

FIGURE 4-12 Technology framework for National Aerospace Initiative. SOURCE: Sega (2005).

During 2002, the NAI goals, definitions, and plans were further developed. In 2003, at the request of the Air Force and DDR&E, NRC empanelled the Committee on Review and Evaluation of the National Aerospace Initiative, which produced the report referred to here (NRC, 2004). That committee looked at only the first two pillars of the NAI, high-speed, hypersonic flight and access to space, and was tasked, in part, with the following:

To assist the Department of Defense (DoD), the services and agencies, and NASA by providing an independent evaluation of the feasibility of achieving the science and technical goals as outlined in the National Aerospace Initiative, the National Academies, under the leadership of the Air Force Science and Technology Board, will form a committee to answer the following general questions concerning the NAI:

1. Is NAI technically feasible in the time frame laid out?
2. Is it financially feasible in the same time frame?
3. Is it operationally relevant? (NRC, 2004, p. viii)

The NRC's NAI review committee agreed with the general goal of demonstrating technologies that greatly increase space access and reliability while reducing cost. However, the committee did not believe that all the payoffs would be realized in the announced time frames. It also found the access to space pillar underfunded. Specifically, NAI had envisioned a multiphase demonstration program (2008 and 2015) with increasingly capable reusable rockets, which in the committee's view was underfunded. The review committee found NAI operationally relevant, especially with respect to capability goals and missions such as ORS.

The review committee also looked at the activities of IHRPT when information was available to learn whether there were synergies and commonalities with the goals of NAI. However, NAI and IHRPT are separate programs and do not interact directly. According to the committee, the critical near-term technologies for the space access pillar are these:

. . . advanced materials for use in propulsion and thermal protection systems; integrated structures; electrical/hydraulic power generation and management technologies; software transportability; and error-free software generation and verification. Furthermore the development of computational analysis tools and methodologies should be emphasized—especially when coupled to test analysis and ground test facilities (NRC, 2004, p. 6).

It recommended that in the area of propulsion, research be done on engine reusability and reliability, which should include high-strength, LOx-compatible materials, and also materials that withstand hydrogen and hydrocarbon combustion. Other recommended material research areas were durable lightweight thermal protection, structural materials, and reusable propellant tanks (NRC, 2004).

The NRC’s NAI committee suggested that NAI integrate some of the available advances in intelligent sensors and thermal control components. Another recommendation was to focus on lowering the cost of aerospace software production. Attention should also be paid to vehicle health management technologies that increase safety and engine life and decrease maintenance costs (NRC, 2004).

According to the review committee, more aircraftlike operations require development of more robust vehicles, more efficient ground operations, and automated flight planning. If necessary, payload capability could be sacrificed for design robustness (NRC, 2004).

The goals and direction of NAI changed on January 14, 2004, when President Bush announced a plan to develop and test a new crew exploration vehicle by 2004, human missions to the moon (circa 2014), and, later, missions to Mars (NRC, 2004). This announcement was made after the committee had submitted its draft report for external peer review. Some of the changes that have occurred since 2004 can be seen in the evolution of the NAI roadmaps (Figures 4-13 and 4-14). As can be seen, the access to space and space technology pillars of NAI continue to evolve.

NAI represents cooperation, better utilization of resources, and maximization of synergies. However, it is hard to identify how the money from the NAI initiative is being spent beyond the first layer of general funding. The recommendations and observations of the NRC’s NAI committee, summarized above, still appear to be valid for the present study.

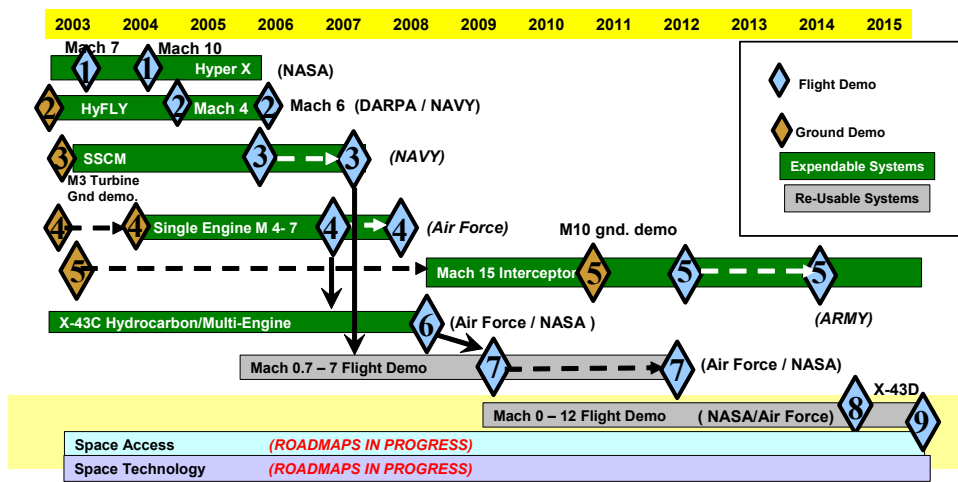

FIGURE 4-13 Updated NAI roadmap. SOURCE: Segal (2005).

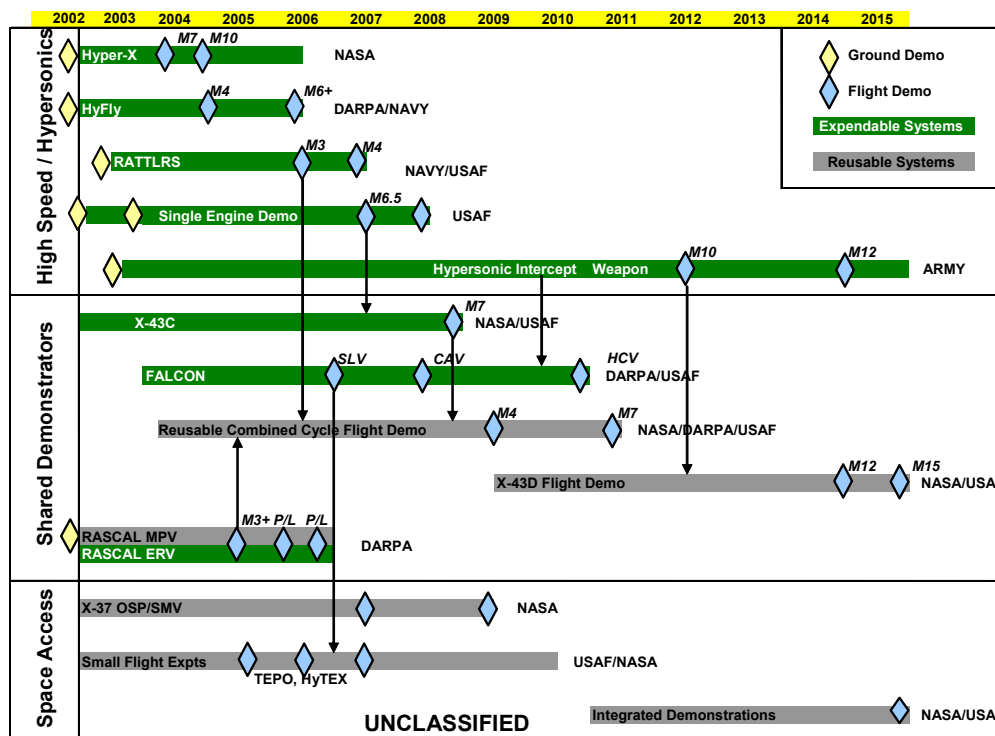

FIGURE 4-14 Test/demonstrator roadmap—high speed/hypersonics and space access, 2004. SOURCE: NRC (2004).

Integrated High-Performance Rocket Propulsion Technology

The IHRPT program was initiated in 1994 and has been in place for 12 years. It is a joint effort of government and industry focused on affordable revolutionary technologies for reusable, rapid-response, military global-reach capability. It addresses sustainable strategic missiles, the trade-off between long life and increased maneuverability, spacecraft capability, launch vehicle propulsion, and high-performance tactical missile capability. IHRPT attempts to emulate the metrics of the integrated high performance turbine engine technology (IHPTET) program, which succeeded in developing and testing new turbine engine technologies.

Although funding for IHPTET has been severely limited, contractors have had considerable freedom to develop new technologies that can improve the performance and life of both solid and liquid rocket engines. Several contractors say the main difficulty is that there is no clear definition of Air Force needs.

Specific performance goals have been established for each element of the program, some of which are summarized in Table 4-2.

TABLE 4-2 IHRPT Goals for Improvements in Boost and Orbit Transfer Propulsion

| Goal | 2000 | 2005 | 2010 |
|---|------|------|------|
| Reduce stage failure rate | 25% | 50% | 75% |
| Improve mass fraction (for solids) | 15% | 25% | 35% |
| Improve I_{sp} (sec) | 14 | 21 | 26 |
| Reduce hardware costs | 15% | 25% | 35% |
| Reduce support costs | 15% | 25% | 35% |
| Improve thrust to weight (for liquids) | 30% | 60% | 100% |
| Mean time between removal (mission life-reusable in number of missions) | 20 | 60 | 100 |

SOURCE: Huggins (2005).

The building block approach to planning for technology insertion seems to be working well, and there appears to be excellent cooperation between the Air Force and the contractors and between the Air Force and NASA. IHRPT provides a means for government and industry to evolve along a common path.

Another significant limitation is that component testing and validation are not sufficiently funded by the government. The uncertain outlook for commercial launch opportunities produced by this underfunding, together with the aforementioned failure of DoD to specify needs, has discouraged the large rocket propulsion companies from investing their own decreasing resources in new propulsion subsystems.

Air Force Research Laboratory Efforts Under IHRPT

Combustion Stability

The Air Force Research Laboratory (AFRL) is planning to upgrade its combustion stability models by including more physics in their development as well as their validation. The effort is not currently funded, although funding is being actively sought.

Nonequilibrium Flow

A number of programs are being conducted to validate direct simulation Monte Carlo models, examine advanced micropropulsion concepts and plume-spacecraft interactions, and model nonequilibrium flows in very small nozzles. A major effort is being undertaken to model capillary discharges.

Combustion Devices

A number of programs are being carried out in this area, including measuring the patterns of injectors, examining the mixing of supercritical flows, and developing injector design methodology. In addition, a high-heat-flux facility has been developed to measure the decomposition of some new and promising hydrocarbon fuels.

Solid Propellants

In-house testing of insulation materials and new oxidizers for solid propellants has been concluded, and current efforts are focused on supporting the land-based strategic deterrent. To this end, facilities to formulate and test new propellants being developed by industry are being upgraded.

Liquid Engine Technology

New hydrocarbon propellants that have been synthesized by laboratory chemists are to be tested in a small engine of about 1,000 lb thrust. The intent is to measure a variety of parameters. A basic effort is being undertaken to determine the effect of channel aspect ratio on the ability to cool rocket chambers. The effect of curvature on cooling ability will also be measured.

Materials Applications

Nanophase aluminum has better properties than standard aluminum. However, the consolidation of nanophase aluminum particles usually results in the growth of the grain boundaries and the loss of the improved properties. AFRL is attempting to consolidate these particles without inducing grain growth.

The relationship between structure and properties when polyhedral oligomeric silsesquioxane (POSS) is included in polymers is being investigated. POSS is being examined to see if it can be used as a

coating for solar cells that would allow them to survive in space. The intent is to see if the POSS would form a layer whose cracks would be self healing under the influence of atomic oxygen.

AFRL has developed a technique to densify carbon and carbon materials using high-carbon-content liquid materials along with a catalyst. This reduces the densification process time by a factor of 4 or more. Studies are ongoing to further understand how this technique carbonizes to improve the process.

Organometallics have been used in supercritical carbon dioxide (CO₂) to produce superior metal coatings on various substrates. A current study is attempting to determine the process parameters to characterize and improve the coating process.

Propellant Development

A significant amount of work has been conducted by AFRL at Edwards Air Force Base on the preparation of green propellants to replace hydrazine. These mono- and bipropellant materials promise to provide high-density impulse, surpassing the performance of the most commonly used toxic monopropellants and in some cases approaching that of toxic bipropellants. Current work assumes the use of hydrogen peroxide as the oxidizer. Essentially no work has been done on new oxidizers.

Finding 4-8. The AFRL Space and Missile Systems Division is undertaking a variety of interesting and potentially valuable in-house programs. It appears to be developing technology that will be very useful, such as predicting the existence of certain energetic compounds and their synthesis, determining the coking properties of hydrocarbon propellants, and developing combustion instability models. Unfortunately, there does not appear to be much in-house work in the liquid engines and solid motors areas. The more basic work seems to be of high quality, but its basic nature and not knowing where the Air Force wants to be in the future make it very difficult to set the priorities for these efforts or even determine if they are the best ones to undertake. A thorough review by outside experts might help in prioritizing the efforts.

Recommendation 4-8. The Air Force should develop in-house test beds for liquid, solid, and hybrid rocket motors. Because limited funding seems to be at least part of the reason this is not being done, the Air Force should seek to increase the funding for both liquid and solid rocket test beds at AFRL.

Contractor Efforts Under IHRPT Funding

Pratt & Whitney

Pratt & Whitney was one of the first companies to become involved in IHRPT, gaining three programs early on. One program was to develop a liquid hydrogen turbopump, the second was to develop an expander cycle combustion chamber, and the third was to combine these two into an advanced upper stage demonstration. Other components were being provided from other sources.

The liquid hydrogen turbopump was developed and tested more than 19 times, including several times when rotation was achieved. Unfortunately, the turbopump was damaged during some of the testing, as was the combustion chamber that had been developed. Because the program was hardware poor, the demonstration never came about. The two programs did, however, provide significant technical information that was fed into other IHRPT programs.

Rocketdyne

Rocketdyne has focused its IHRPT efforts on improving the performance and reliability of large liquid rocket propulsion systems, with emphasis on turbopumps and combustor reliability.

In the turbopump area, the company has had an effort on hydrostatic bearings for many years and now feels confident that it has the design tools to develop reliable turbopump bearings over a wide range

of sizes. Hydrostatic bearings have several advantages over conventional rolling-element bearings, including degreased coolant flow and longer life. Hydrostatic bearings were recently tested for a few seconds in the integrated powerhead demonstrator (IPD) (jointly with NASA), but much more testing is needed before they can be certified for flight. Rocketdyne has also pursued several other turbopump-related efforts, including turbine blade damping to reduce the risk of fatigue damage to blades and advanced high-strength materials for rotating machinery. The latter, if successful, would allow significantly higher speeds, particularly in smaller turbopumps.

There has also been work done on gas and gas main injector technology and oxygen-rich preburner technology, both of which offer performance improvements but require the development of oxygen-compatible materials. In the latter arena, high-specific-strength materials that are also oxygen compatible are required, and this has been a major challenge. However, significant progress has been made, and strength improvements of 40 to 50 percent have been demonstrated.

Development of improved design tools has been a major focus at Rocketdyne, with the emphasis on computational fluid dynamics (CFD) and thermal modeling. Some of these improved design tools were used in the development of the RS-68 (Delta IV) engine, and Rocketdyne estimated that the development cost of the RS-68 was reduced by a factor of 3 through the use of these tools. It further estimated that a sixfold cost reduction could be attained if critical skills and experienced staff could be retained for the next cycle of engine development programs.

Rocketdyne said that a big problem was that it had no clear picture of future Air Force needs in rocket propulsion. Rocketdyne management set a high priority on the retention of expert knowledge and on a ground demonstrator engine for testing advanced components.

Aerojet

Aerojet divides its IHRPT efforts into three areas: liquid propulsion, solid propulsion, and in-space propulsion. Each comprises a number of programs; the text below focuses on liquid propulsion and solid propulsion.

Liquid Propulsion. The programs in this area are for upper-stage engine technology (USET), liquid crystal polymers, the advanced lightweight chamber and nozzle, the reaction control engine (RCE), and the IPD:

- *Upper-stage engine technology.* This program, which has been under way since November 2003, aims to develop physics-based design tools and methodologies to replace empirically based design tools and to develop LH₂ turbopump assembly hardware for tool validation that supports IHRPT goals and technology insertion to replace the EELV RL-10. The program will shortly complete the CDR stage.
- *Liquid crystal polymer.* During the nearly 3 years that this program has been under way, it has been attempting to develop a liquid crystal polymer/composite braiding material system for a lightweight, low-cost duct that will meet the demanding environments in next-generation cryogenic engines.
- *Advanced lightweight chamber and nozzle.* This program aims to design, fabricate, and test hardware that can be used for four purposes: (1) to demonstrate single-bell and dual-bell operation in 40 K hot-fire testing at sea level, throttling the engine to determine flow field characteristics, and to anchor a CFD model; (2) to develop and demonstrate a high-temperature hot gas wall coating, to satisfy the IHRPT goal of 60 missions, for an RP-1 regeneratively cooled thrust chamber; (3) to demonstrate the effectiveness of multipoint film cooling and implement such cooling; and (4) to build a subscale titanium nozzle to demonstrate key manufacturing processes and design features.
- *Reaction control engine.* This relatively new program has the objective of demonstrating a TRL of 6 for LOx/ethanol auxiliary propulsion system.

- *Integrated powerhead demonstrator.* The objective of this program is to provide the combustion devices for the Air Force's IPD 250,000 lbf, LOx/hydrogen, full-flow staged combustion engine and test them at Stennis Space Flight Center. Several successful second ignition tests have been performed.
- *Thrust augmented nozzle.* This program aims to fabricate and test thrust augmented nozzle hardware to demonstrate the percent thrust augmentation and system benefits, including engine system thrust/weight and thrust/volume, engine operating pressure, and altitude performance.

Solid Propulsion. The programs in this area are Atlas V; IHRPT Phase IIB Demo (including SRM modeling and energetic propellants); sensor application and modeling; advanced second stage; FALCON small launch vehicle, and rocket system launch program flexseal.

- *Atlas V.* The objective of this program is to design, develop, and produce low-cost solid rocket boosters (SRBs) to support the EELV Atlas V launch vehicle program. The development of these motors was qualified in 2003. There have been three successful flights to date. Between 7 and 15 SRBs are expected to be produced every year through 2011. Currently a Block B upgrade qualification is under way. It addresses material obsolescence and incorporates robust nozzle features.
- *IHRPT Phase IIB demonstration motor.* To prepare for future booster motors expected to play a primary role in military, commercial, and NASA missions, this program is updating a small ICBM second stage with a new Class 1.3 HTPB propellant and composite case and nozzle. It will provide an updated motor incorporating the best technologies to support future missile defense, space launch, and nuclear deterrent booster systems. The motor will offer improved I_{sp} , longer life, higher T/W, and lower cost. It has a desubmerged lightweight nozzle, fewer parts and interfaces, a carbon-carbon exit cone, a wet-wound graphite/resin system, no dome reinforcements, strip-wound Kevlar ethylene propylene diene monomer (EPDM) insulation, a Class 1.3, 90 percent solids HTPB/RDX propellant, a consumable igniter, and a smaller electromagnetic thrust vector actuator.
- *Sensor application and modeling.* This program seeks to avoid missile failures by using sensors to measure aging properties without adversely impacting the structural or chemical integrity of a motor. This will be accomplished by conducting a literature search and evaluation of all available sensors, followed by downselection to mature sensors. Then, inert-propellant, 5-in., instrumented composite motor tubes for laboratory-scale work will be built and cast with defects. Based on the results of this, an inert-propellant, 10-in., instrumented motor case will be built and cast with and without defects. Testing will then determine whether the sensors can identify the defects.
- *Advanced second stage.* The program objective is to evaluate, develop, and demonstrate innovative solid rocket motor technologies in an advanced upper-stage configuration applicable to future advanced and affordable strategic strike systems. To accomplish this, the following steps will be taken: (1) conduct design trades/payoff analysis to evaluate technologies for a future second-stage system balancing cost and performance; (2) develop key solid rocket motor technologies and advanced manufacturing processes that are optimized on life-cycle costs to ensure an affordable future ICBM system; and (3) integrate technologies and processes in a full-scale demonstrator motor that will be tested at altitude operating conditions at the Arnold Engineering Development Center (AEDC). The program suffers, however, from severe underfunding in the areas of component testing and validation.
- *FALCON small launch vehicle.* The objective of this program is to design a reverse-dome/forced-deflection nozzle and a gas injection thrust vector control (GITVC) system for the second stage of the FALCON small launch vehicle. This will be accomplished by designing the second-stage composite case, producing two reverse-dome/force-deflection

nozzles and two GITVC systems consisting of eight valves and one controller, producing two second-stage composite motor cases, and providing support for systems engineering and for ground and flight test vehicle engineering.

- *Rocket system launch program flexseal.* This program converts surplus Minuteman II second-stage motors into first-stage suborbital launch boosters by modifying the fixed nozzle system so that it uses a flexseal movable nozzle and hydraulic actuation system, and it also provides technical support to ensure the thrust vector system meets evolving requirements for launch missions.

Northrop Grumman

Northrop Grumman is carrying out research and development across a broad spectrum of propulsion technologies. An important project related to access to space is the design of an advanced USET. Northrop Grumman was awarded a contract in September 2003 to develop tools and a full-scale modeling capability for upper-stage engines.

USET is a 5-year old IHPRT program, funded and managed by AFRL at Edwards Air Force Base, and slated to end in FY08. It has the primary goal of improving the software design and analysis tools used for advanced rocket engine development. An informal objective is to improve the interconnectivity, efficiency, and optimization routines of a group of presently diverse softwares such that the engine design, analysis, and optimization process will take one-tenth as long as it now takes and require one-tenth as much labor. The basic concept is to use the best of currently available commercial or university software programs—e.g., CFD++, ANSYS, SINDA-Fluent, ROCKETS, TDK, Visual DOC, and Concepts NRC Agile Engineering package for turbopump assembly (TPA) analyses—to institute automated input/output exchanges between the various software packages (via a commercially available wrapper program), and to institute a design-of-experiments/automated optimization/automated sensitivity analysis capability (via a commercially available optimizer program). A very limited amount of customized software code is expected to be required, but some existing codes are being improved and updated under USET (e.g., pump cavitation modeling).

While the initial USET development focuses on a LOx/LH₂ engine at 40,000 lbf, the contract specifically requires that the software tools be applicable to highly off-nominal run conditions, other propellants, different thrust levels, and other engine power cycles. At the end, this improved, coupled suite of design and analysis tools will be made available—under U.S. government control—to U.S. industry, academia, and DoD organizations to improve our nation's competitiveness in developing new rocket engines. The schematic in Figure 4-15 represents a standard split expander cycle rocket engine using series-driven turbopumps. Engine components in this figure are the LOx turbopump, LH₂ turbopump, regeneratively-cooled thrust chamber, split control valve, oxygen main valve, fuel main valve, and turbine bypass valves.

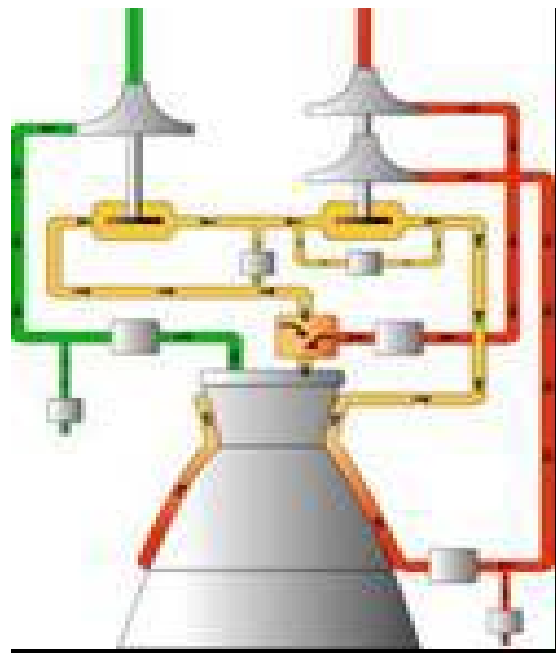

FIGURE 4-15 USET upper-stage schematic. SOURCE: Northrop Grumman Corporation.

A new high-performance 40,000-lbf-rated LH₂ turbopump will be built and tested to validate the improved suite of design and analysis software. Originally, an advanced regeneratively-cooled thrust chamber assembly was to have been built for a similar purpose, but this was struck from the program due to funding limitations. The only detail design work on the program is directed to the LH₂ TPA, and the only testing on the program will be on the LH₂ TPA. The budget allocated to Northrop Grumman's space technology effort for completing the USET program was about \$30 million. Additional information on USET can be obtained from AFRL at Edwards Air Force Base.

USET is an important step toward achieving the ultimate vision—computerized development of high-fidelity virtual engine designs that can be tested on a virtual test stand. It is anticipated that high-accuracy comparison of predicted performance with delivered performance, especially under transient and highly off-nominal run conditions, will become a reality. The funding and schedule constraints of the current USET contract preclude achieving this ultimate goal.

Finding 4-9. Funding the continued evolution of computerized high-fidelity designs for engines and propulsion systems that can be tested on a virtual test stand and then flown virtually could be one of the most cost-effective and highly leveraged investments that DoD and the Air Force could make. The potential for reducing the huge costs of cut-and-dried development of rocket engines and their associated propulsion systems is enormous when the time line is extended into the indefinite future. Compared to those savings, the expenses of making virtual rocket propulsion system design engineering a reality are almost trivial!

Recommendation 4-9. DoD and the Air Force should fund the continuing evolution and process validation of computerized high-fidelity virtual engine and propulsion system designs.

Other Efforts Under Government or Industry Funding: New Engine Designs and New Propellants, Feed Systems, Pressurization, and Materials

Four competing booster engine design and development programs were initiated and funded under the SLI at MSFC in 2001. Boeing Rocketdyne Power and Propulsion had two of the designs, the RS-83 (660,000 lb thrust LOx/LH₂) and the RS-84 (1,050,000 lb thrust LOx/RP-1). TRW Space and Electronics

of Redondo Beach, California (now Northrop Grumman) offered a LO_x/RP-1-fueled engine in the 1-million-pound-thrust class, which it named the TR-107. The Co-optimized Booster for Reusable Applications (COBRA) was a LO_x/LH₂-fueled engine in the 600,000-lb-thrust class that was to be designed and developed by a joint venture between Pratt & Whitney of West Palm Beach, Florida, and Aerojet of Sacramento, California.

RS-83 Engine, Boeing Rocketdyne

The Boeing Rocketdyne Propulsion and Power Company designed the RS-83 as a staged combustion LO_x/LH₂ main booster engine system with a simple fuel-rich preburner in place of the dual individual preburners on the SSME. Taking lessons learned from the first-generation reusable launch engine (the SSME is also manufactured by the Boeing Rocketdyne Propulsion and Power Company), the RS-83 engine was intended to be simpler to build and maintain and to be more controllable and reliable. Advanced design features included turbopumps with easy access and fabrication techniques using selectively net-shaped components made by powder metallurgy.

A conceptual diagram of the RS-83 is shown in Figure 4-16; the engine design performance and operating characteristics are summarized in Table 4-3.

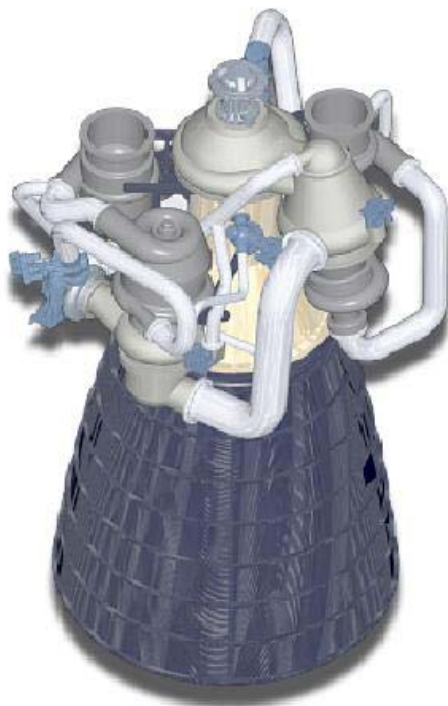

FIGURE 4-16 Conceptual design of the RS-83 engine. SOURCE: NASA.¹⁹

¹⁹NASA Stennis Space Center Propulsion Testing, https://rockettest.ssc.nasa.gov/ssc_ptd/images_sscptd/ssc_projects/rs83/rs-83_proe.jpg. Last accessed on September 19, 2006.

TABLE 4-3 RS-83 Engine Key Design Characteristics

| Characteristic | RS-83 | SSME (Block II) |
|---|-----------------|---|
| Thrust | | |
| sea level (lbf) | 66,800 | 393,800 at 104% |
| vacuum (lbf) | 749,600 | 448,800 at 104% |
| I_{sp} , vacuum (sec) | 445.7 | 452 |
| Chamber pressure (psia) | 2,800 | 2,994 |
| Mixture ratio (sea level, altitude) | 6.9:6.0 | 6.03:1 |
| Engine T/W, sea level | 55 | 73.12 |
| Area ratio | 40:1 | 69:1 |
| Mean time between removal (mission life-reusable in number of missions) | 50-100 missions | 100 missions |
| Catastrophic reliability | 0.999958 | 0.9999 |
| Throttling (% of thrust) | 50-100 | 67-104 (can go to 109 for abort contingencies) |

The program plan focused on the early development of critical engine components with the overall goal of identifying and reducing the risk associated with the development and testing of these elements. The engine design team identified five critical tasks to reduce component risk: (1) hydrogen-compatible materials, (2) turbine damping, (3) subscale liquid preburner, (4) electromechanical actuator (EMA) sector ball valve, and (5) integrated vehicle health monitoring safety and prognostic algorithms.

Unfortunately, NASA cancelled the RS-83 design and development program, along with the other three large reusable booster engine programs—XRS-2200, RD-146, and Fastrac and MC-1, mentioned above—that had been sponsored under the SLI when it redirected its program to reflect President Bush's space initiative, amended in January 2004.

RS-84 Engine, Boeing Rocketdyne

The RS-84 engine program was proposed as the first U.S. reusable hydrocarbon-fueled, oxygen-rich, staged-combustion liquid rocket engine. One of the primary goals of the engine development effort was to develop a highly reliable and low maintenance cost engine as a part of NASA's SLI for the next-generation reusable launch system. The Rocketdyne Propulsion and Power Division of the Boeing Company was awarded the contract to design the RS-84 prototype engine for NASA's Next Generation Launch Technology (NGLT) program. The kerosene-fueled RS-84 engine was one of several technologies competing to power NASA's next generation of launch vehicles.

The RS-84 engine development program was one of two competing efforts to develop an alternative to existing hydrogen-fueled engine technologies (e.g., SSME). The engine was to be fueled by kerosene, a relatively low-maintenance fuel with high performance and high density, meaning it takes a smaller fuel-tank to achieve greater propulsive force than other technologies. That benefit translates to more compact engine systems, easier fuel handling and loading on the ground, and shorter turnaround time between launches. All these gains, in turn, reduce the overall cost of launch operations, making routine space flight cheaper and more attractive to commercial enterprises. In addition, because it is not a cryogenic (extremely cold) fuel, like hydrogen, propulsion-related ducts, valves, lines, and actuators do not require insulation, saving weight and cost. Table 4-4 shows the proposed attributes of the RS-84 engine.

TABLE 4-4 RS-84 Engine Key Design Characteristics

| Characteristic | RS-84 | SSME (Block II) |
|-------------------------------------|-----------------------|--|
| Propellants | LOx/RP-1 ^a | LOx/LH ₂ |
| Thrust | | |
| sea level (lbf) | 1,064,000 | 393,800 at 104% |
| vacuum (lbf) | 1,130,000 | 448,800 at 104% |
| <i>I</i> _{sp} vacuum (sec) | 324 | 452 |
| Chamber pressure (psia) | 2,800 | 2,994 |
| Mixture ratio | 2.7 | 6.03:1 |
| Area ratio | 20:1 | 69:1 |
| Life | 100 missions | 100 missions |
| Throttling (% of thrust) | 65-100 | 67-104 (can go to 109 for abort contingencies) |

^aRP-1, rocket propellant 1, a special grade of kerosene suitable for rocket engines.

COBRA Engine, Pratt & Whitney and Aerojet

The COBRA program was initiated to develop one of the engines being considered by the SLI for use on a next-generation reusable launch vehicle. The goal of COBRA was to produce a rocket engine prototype that would be simple to operate, provide high reliability and a long life, and reduce cost per launch by virtue of being reusable. COBRA planned to incorporate a reusable, hydrogen-fueled liquid booster engine with a thrust of 600,000 lbf. The engine was to be developed by a joint venture between Aerojet and Pratt & Whitney Space Propulsion.

The COBRA design consisted of a single fuel-rich preburner, staged-combustion engine using LOx and LH₂ as propellants. The engine was to be designed to have a 100-mission life span with a 50-mission maintenance check-up interval. The design team planned to use an inherently reliable engine cycle and numerous state-of-the-art technologies derived from the SSME to fuse the knowledge and experience of the first-generation space shuttle program with second-generation research and technology development.

The COBRA engine was one of two hydrogen-fueled engine designs being evaluated for use as a first- or second-stage option for a next-generation reusable launch vehicle. Kerosene-fueled engines were also being considered for the first-stage booster. The engine's key design features are shown in Table 4-5; a schematic of COBRA is shown in Figure 4-17.

TABLE 4-5 COBRA Engine Key Design Characteristics

| Characteristics | Cobra | SSME (Block II) |
|------------------------------|--------------------------------|---------------------|
| Propellants | H ₂ /O ₂ | LOx/LH ₂ |
| Thrust (lbf) | | |
| sea level | 492,590 | 393,800 lbf at 104% |
| vacuum | 600,000 | 448,800 lbf at 104% |
| <i>I</i> _{sp} (sec) | | |
| sea level | 373.3 | 363 |
| vacuum | 454.7 | 452 |
| Chamber pressure (psia) | 3,000 | 2,994 |
| Mixture ratio | 6.0 | 6.03:1 |
| Engine T/W, at vacuum | 75 | 73.12 |
| Engine length (in.) | 180 | 169 |

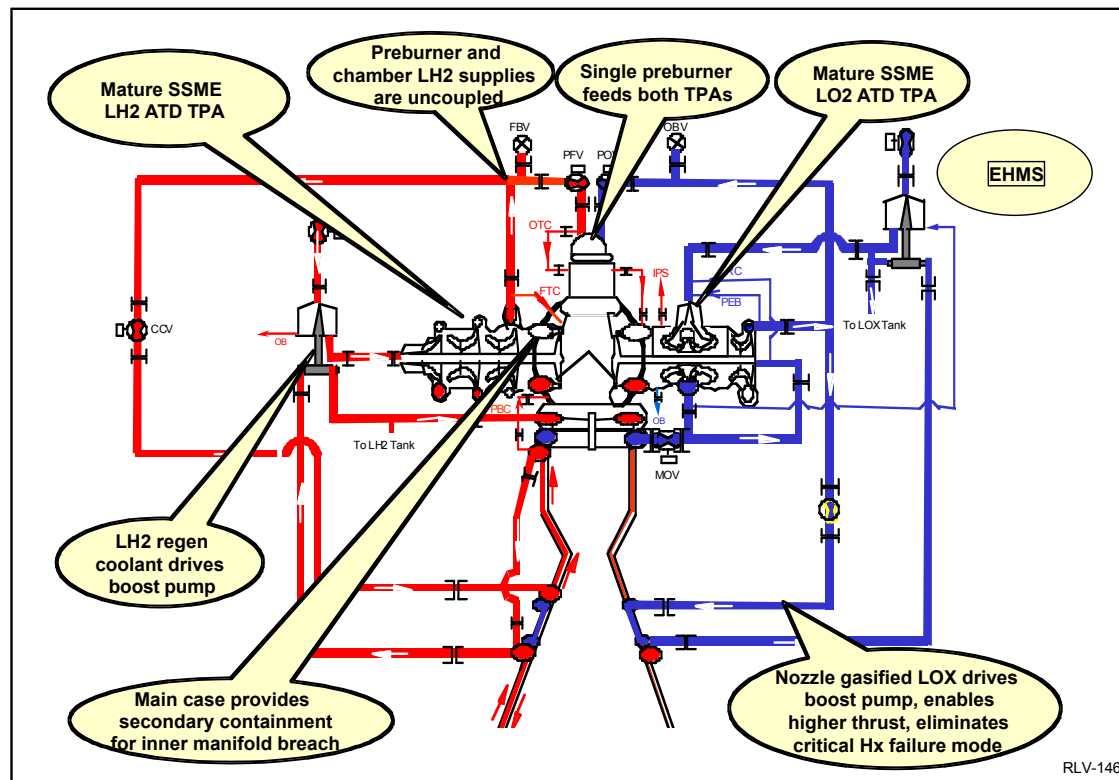

FIGURE 4-17 COBRA engine schematic. SOURCE: Pratt & Whitney.

XRS-2200 Engine, Boeing Rocketdyne

The aerospike engine (Figure 4-18) is a LO_x/LH₂ gas generator cycle engine. Each engine has a single oxidizer turbopump, a fuel turbopump, a gas generator, a combustion wave ignition system, 2 aerospike nozzle ramps, 10 thrust chambers (“thrusters”) per ramp, 2 redundant engine controller digital interface units, and associated plumbing, valves, and EMAs. Table 4-6 summarizes the XRS-2200 key engine characteristics.

TABLE 4-6 Key XRS-2200 Engine Characteristics

| Characteristic | Value |
|---------------------------------------|------------|
| Sea-level thrust (lbf) | 206,800 |
| I_{sp} at 100% and MR 5.5 (sec) | 332 |
| Mixture ratio (MR) | 4.5-6.0 |
| Chamber pressure (psia) | 830 |
| Throttling (% of thrust) | 57-100 |
| Differential throttling (% of thrust) | ±15 |
| Dimensions (in.) | |
| Forward end | 134W x 90L |
| Aft end | 42W x 90L |
| Forward to aft | 90 |

Individual thrust cells for each ramp

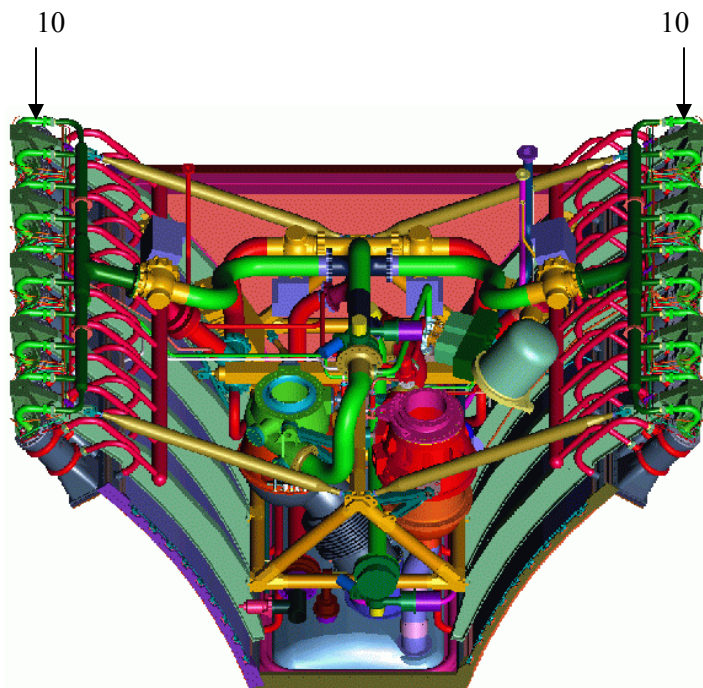

For a total of 20 individual thrust cells per engine.

FIGURE 4-18 XRS-2200, single-engine computer-aided design and manufacturing drawing. SOURCE: Boeing Rocketdyne.

The X-33 program, which began in July 1996, was a half-scale prototype of Lockheed Martin's proposed single-stage-to-orbit (SSTO) concept, named the VentureStar. The program was set up as a unique cooperative agreement with Boeing Rocketdyne as the supplier of the XRS-2200 linear aerospike engine. Two of these engines were to be used to power the X-33 on suborbital flights to demonstrate the technology needed to proceed with the full-scale VentureStar.

A larger version of the XRS-2200 intended for the VentureStar vehicle was designated the RL-2200. It was designed for a sea-level thrust of 431,000 lb. Seven of these engines would have been used to lift the 2.2 million lb (GLOW) vehicle.

The philosophy of the X-33 program was to accept increased risk in order to achieve lower costs and quicker schedule. To do so, the XRS-2200 program relied heavily on the experience gained from Rocketdyne's testing of a linear test bed engine from 1970 to 1972. Where possible, the X-33 program used existing hardware and/or designs. The turbopumps and the gas generator were based on J-2 and J-2S engines. Component testing was used for design development, proving margins, and qualifications. Software was tested with hardware-in-the-loop. Single engine testing on the Stennis Space Center's A-1 test stand was used to verify the design. The two flight engines, in their dual-engine configuration, had had a short ignition test and were about to start acceptance testing when NASA decided not to renew its involvement in the cooperative agreement.

RD-0146 Engine, Pratt & Whitney

In addition to the RL-10 family of LOx/LH₂ cryogenic upper-stage engines and the new RL-60, a higher thrust upper-stage engine currently under limited early development in-house, Pratt & Whitney

offers another cryogenic upper-stage engine, designed and developed by a highly experienced Russian maker of cryogenic engines. This engine, designated the RD-0146, is manufactured by Chemiautomatics Design Bureau (CADB) of Veronezh, Russia.

The engine produces 22,000 lb thrust at a minimum vacuum I_{sp} of 451 sec. The RD-0146 is an expander cycle configuration with a wide operating range, including the capacity for many firings (restarts) in space. CADB also produces the RD-0120 cryogenic engine, which is the core booster engine for the Russian high-performance Energia launch vehicle, which was used to launch the Russian BURAN autonomous space shuttle. Pratt & Whitney is the distributor for this engine and claims that it stands behind the stated performance and operating characteristics as summarized in Table 4-7.

TABLE 4-7 RD-0146 Key Design Characteristics

| Characteristics | Value |
|-----------------------------------|----------------------|
| Thrust (lb) | 22,000 |
| Weight (lb) | 534 |
| I_{sp} , vacuum (minimum) (sec) | 451 |
| Cycle | Full expander |
| Propellants | LH ₂ /LOx |
| Mixture ratio | 6.0 |
| Restarts | Multiple |

Furthermore, it claims that it will make the necessary modifications and certify the engine for any U.S. application and supply the production flight engines, as required.

With the recent about-face in NASA's approach to its next-generation launch vehicle architecture, the four engines started under SLI remain essentially prototype concepts. It remains to be seen whether any of them or their derivatives will be attractive for a second-generation ORS. As stated in Recommendation 4-2, some of these large-engine concepts may be candidates for a long-term booster engine technology development program aimed at far-term replacement vehicles for Atlas and Delta.

TR-106 and TR-107 Engines, Northrop Grumman

Northrop Grumman has carried out the detailed design of a 1-million-lb-thrust booster rocket engine utilizing LOx/HC propellants as part of NGLT under NASA's SLI. The authorization to proceed on this design was awarded in March 2003. The primary goal for the TR-107 engine program was to continue development of an engine that would increase the safety, reliability, and affordability of next-generation reusable space launch and transportation vehicles.

TR-106. Starting in the late 1990s, Northrop Grumman Space Technology (then TRW) undertook, using company funds, to design and build a large engine that could operate on either LOx/LH₂ or LOx/RP-1. The engine was expected to replace solid propellant booster strap-ons with liquid propellant stages having on-command throttling shutdown and even restart. Liquid propellants were considered safer and more environmentally friendly. The engine also was envisioned for powering the first stage of expendable, or fly-back, boosters.

The engine designed and demonstrated in this effort was designated the TR-106. It had a planned sea-level thrust of 650,000 lb and was to be either pressure fed or operated with gas-generator-driven turbopumps in the propellant lines. The center pintle injector incorporated in the TR-106 engine can operate equally well using LOx with RP-1, ethanol, propane, methane, or LH₂. This basic injector technology has a 40-year history of producing high-performance and totally stable combustion without baffles or quarter-wave acoustic chambers in engines with thrust ranging from 100 lb to 650,000 lb (Yang and Anderson, 1995; Yang et al., 2003).

The concept was originally developed at Space Technology Laboratories (STL) in 1960 as a 20:1 throttling injector for a 500-lb-thrust space-maneuvering thruster using dinitrogen tetroxide (N₂O₄) with

monopropellant hydrazine (N_2H_4). That throttling design was scaled up to 10,000 lb thrust with 10:1 throttling using N_2O_4 with N_2H_4 50-UDMH 50 (Aerozine-50) and was used in the lunar module descent engine (LEMDE) for the Apollo program. A fixed-thrust version of the engine was used on the second stage of Thor-Delta in the 1980s, where it accomplished more than 65 completely successful launches.

In the competition for the LEMDE between 1962 and 1964, STL explained to Northrop Grumman and NASA the reason for the engine's bomb-demonstrated dynamic stability characteristics. The LEMDE combustor satisfied a fundamental design criterion: It did not provide significant energy sources in the antinode regions of a resonant chamber mode. Furthermore, it satisfied another criterion by putting almost all of the combustion energy source close to the nodal regions of any potentially destructive chamber mode. Satisfying this criterion assures the dynamic stabilization of initiating disruptions that always occur in a rocket combustion chamber.

For practical design reasons, and to throttle that engine with a single moving injector part while controlling the injector face heat transfer, the central injection criterion for stabilizing the first tangential mode (transverse or spinning) was best satisfied by a single coaxial pintle element. In fact for practical configuration and fluid dynamic reasons, such central element injection has also been demonstrated to dynamically stabilize the first radial mode.

The same basic pintle injector geometry has been tested at thrusts of 40,000 and 250,000 lb operating with $N_2O_4/A-50$; at 50,000 lb with $LOx/RP-1$; and at 40,000 and 650,000 lb with LOx/LH_2 . The basic central injector element scales essentially photographically—that is, for a given injector pressure drop, thrust is proportional to the square of pintle injector diameter, from 10,000 to 1 million lb thrust. The cutaway in Figure 4-19 is for a throttling high-thrust configuration and would look much the same at any thrust level.

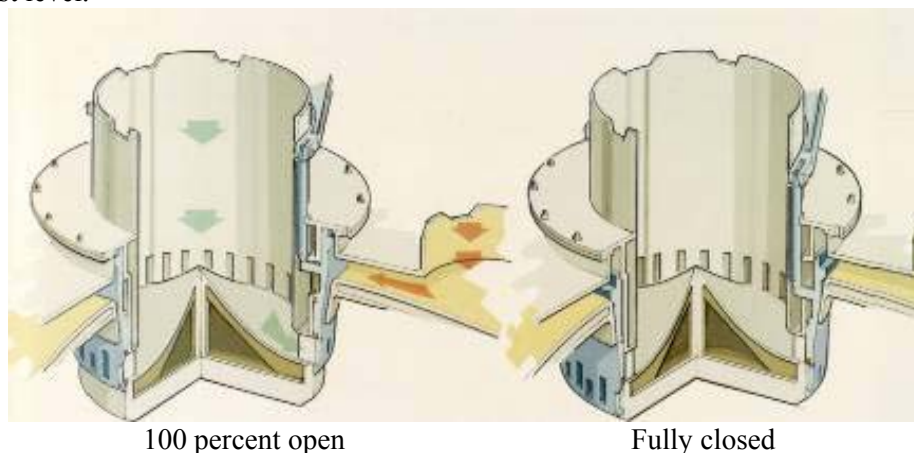

FIGURE 4-19 Cutaway design of TR-106 engine. SOURCE: Northrop Grumman (TRW).

The 650,000 lb thrust TR-106 engine is shown in Figure 4-20. This injector technology has been demonstrated also with H_2O_2 and ethanol for storable propellant upper-stage and in-space applications. In 40 years of firings at every thrust level and with every propellant combination, there has never once been a case of combustion instability with this centrally located single-pintle injector.



FIGURE 4-20 650,000-lb thrust TR-106 engine. SOURCE: Northrop Grumman.

TR-107. As stated earlier, a primary goal for NASA's SLI contract for the TR-107 program was to continue development of an engine that could increase the safety, reliability, and affordability of next-generation reusable space launch and transportation vehicles. The contract specified that a high-pressure oxygen-rich staged-combustion (ORSC) cycle was to be used with the propellants LOx/RP-1.

In its earliest concept phase, the TR-107 had a central pintle injector for both the main combustion chamber and the LOx-rich preburner. However, performance and risk analyses soon indicated that the main injector should switch to a distributed coaxial multielement design, given that a single ORSC preburner would be used to drive both the fuel and the oxidizer turbopumps. The oxygen-rich preburner (basically a gas generator) retained the pintle injector because its size was within the pintle injector LOx/RP-1 test database and because Northrop Grumman wanted to retain the inherent stability of the pintle injector. It also wanted to give the preburner throttling capability for mission flexibility and to allow future growth.

The TR-107 engine was one of several SLI candidate engines (some of which were described above) that could be used to provide primary propulsion for the Earth-to-orbit (ETO) stage of future reusable launch vehicles. Several primary technology objectives of the TR-107 program were accomplished before the SLI efforts were terminated:

- Successful demonstration of a duct-cooled chamber, which eliminates the need for conventional cooling channels;
- Successful demonstration of the preburner pintle injector and propellant mixing, which stabilizes throttling and enables slow, controlled-start-up transient performance;
- Specification of properties for materials compatible with oxygen-rich environments, which eliminates the need for additional coatings and liners;
- Incorporation of mature combustion devices that minimize parts count for greater reliability and operability; and
- Systems-engineered design optimization to minimize cycle pressures, which provides margin to increase engine life. Additional design details of the engine are shown in Figure 4-21.

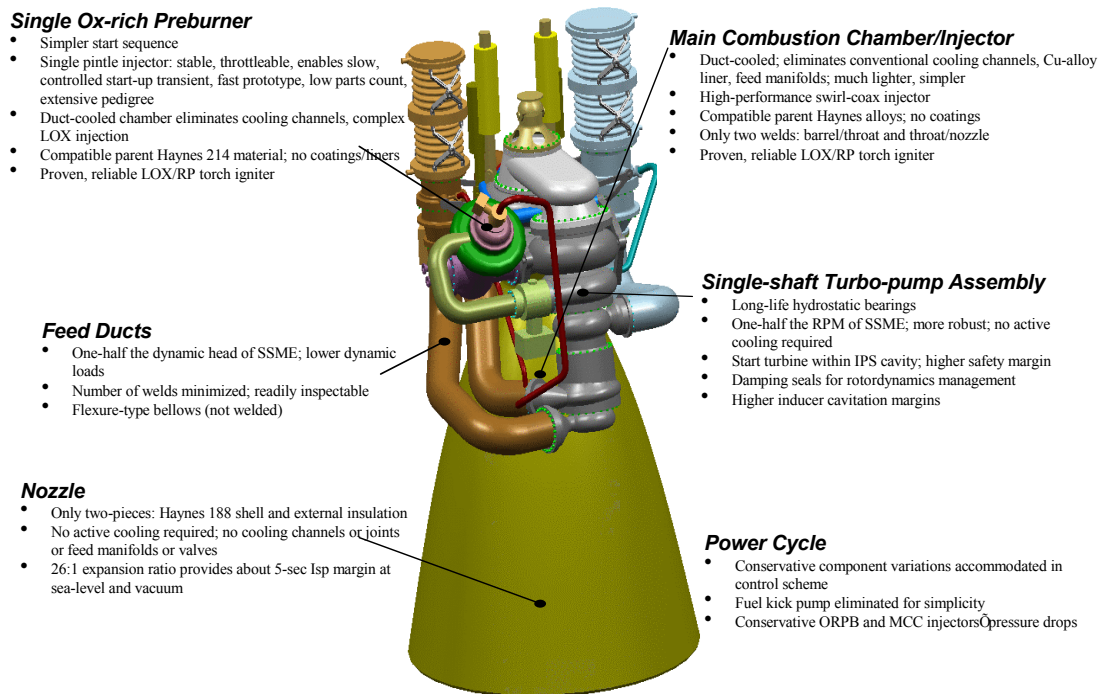

FIGURE 4-21 Details of the TR-107 engine. SOURCE: NASA, Marshall Space Flight Center.

The central pintle injector technology is also used in the engines for the FALCON program by SpaceX (with LOx/RP-1) and by AirLaunch (with LOx/propane). It has been used in every Northrop Grumman (TRW) in-space bipropellant maneuvering engine and in the alternate current thrusters on dozens of major satellites. Because it can operate with nearly any propellant combination, engines incorporating it are excellent candidates for either the reusable booster or second stage of ARES or future ORS using simple gas-generator, driven propellant-line pumps.

Fastrac and MC-1 Engine, NASA

In the late 1990s, an in house rocket engine design and development project was initiated at NASA MSFC to give the younger propulsion engineers some real hands-on hardware experience. The objectives of this project were ultimately to design, build, test, and evaluate a 60,000-lbf LOx/RP-1 low-cost, full-up rocket engine (prototype-level) to be demonstrated in a test bed. Senior MSFC management believed that a number of the capable young rocket propulsion engineers who had joined the MSFC team had never, in a decade, participated in the development of a rocket engine or even seen one. It was felt that a test bed/prototype engine design and hardware project, conducted entirely inhouse, would be very effective in training and preparing these young engineers, under the guidance of a few experienced rocket development engineers at MSFC, to participate in future NASA rocket development and flight hardware procurement.

The project was first called the Fastrac engine and conducted according to all the NASA design and development ground rules and project criteria. However, just before the formal Fastrac preliminary design review, the engine requirements were changed in a major way so that it could be applied to the reusable X-34 of the Pathfinder/X-vehicle demonstrator program, and the engine was renamed the MC-1. Eventually, the X-34 flight demonstrator program was cancelled by NASA, and all further work on the Fastrac/MC-1 engine was terminated. The X-34 was cancelled owing to NASA's decision to terminate all activities associated with SSTO next-generation launch vehicles. The Air Force subsequently declined to pick up or fund any follow-on work.

Some good technology was developed on this Fastrac engine project, the most notable of which was the low-cost Barber Nichols fuel and oxidizer pump assembly. These pumps were well along in their development and readiness for incorporation in the flight MC-1 engine. When the in-house MSFC project was terminated, the turbopump assembly elements were eventually shifted for use on two current new, small, low-cost, launch vehicle development projects jointly sponsored by DARPA, the Air Force Space and Missile Systems Center, and NASA. Those two projects are part of the FALCON small launch vehicle program.

Barber Nichols TPA elements are currently being used by the SpaceX version of FALCON to pump propellants to its 75,000 lbf LOx/RP-1 Merlin first-stage liquid booster engine (operating at 850 psia) and by Lockheed Martin Michoud to pump LOx to the first and second stages of the hybrid rocket motor for its version of the FALCON launch vehicle. Some of the background and results of the original NASA MSFC Fastrac turbomachinery development program are summarized next.

The original goal of the Fastrac turbomachinery program was to reduce the unit cost and the lead time required to produce turbomachinery for rocket engines. The major vendors involved with the fabrication of hardware for the turbomachinery are summarized in Table 4-8.

TABLE 4-8 TPA Major Vendors

| Vendor | Responsibility |
|------------------------|-------------------------|
| Summa | Engine prime contractor |
| Barber Nichols | TPA pump subcontractor |
| Howmet Inc. | Investment castings |
| EG&G | Bellows seals |
| Wollaston Alloys, Inc. | Sand castings |
| Walcolmanoy | Brazing |
| Barden | Bearings |

As program requirements evolved for the Fastrac engine, thrust was increased to 24,000 lb and, finally, to 60,000 lb. At the 60,000-lb thrust level, the target first unit cost for the required turbomachinery was \$300,000, with a target production unit cost of \$150,000. To achieve lower cost and faster acquisition time, the critical design team pursued a reduced-part-count design. As part of this approach it decided that the oxidizer and the fuel pumps would be placed on a common shaft and driven by a single turbine. The basic performance requirements for the TPA are listed in Table 4-9.

TABLE 4-9 Basic Performance Requirements for the Fastrac/MC-1 Barber Nichols TPA

| Part | Specification |
|---------------------------|---------------------|
| Oxidizer pump | |
| Fluid | LOx |
| Inlet pressure (psia) | 46.0 |
| Discharge pressure (psia) | 919.0 |
| Mass flow rate (lbm/sec) | 138.61 |
| Fuel pump | |
| Fluid | RP-1 |
| Inlet pressure (psia) | 28.0 |
| Discharge pressure (psia) | 959 |
| Mass flow rate (lbm/sec) | 63.96 |
| Turbine | |
| Fluid | Combustion products |
| Speed (rpm) | 20,014 |
| Inlet pressure (psia) | 550 |
| Discharge pressure (psia) | 65 |
| Inlet temperature (°R) | 1600 |
| Mass flow rate (lbm/sec) | 7.1 |

The turbopump for the MC-1 engine is a common shaft design with the oxidizer pump located forward, the fuel pump amid shaft, and the turbine in the aft. The oxidizer and the fuel pumps comprise an axial flow inducer followed by a radial flow impeller. The oxidizer pump has an axial inlet, while the fuel pump has a plenum inlet fed by two inlets 180° apart. The turbine section is composed of a single-stage transonic impulse stage with a bladed disk turbine wheel followed by a set of exit guide vanes. The turbine has a plenum inlet and an axial discharge. Rolling element bearings support the pump rotor.

This arrangement allowed the elimination of a turbine wheel, a turbine housing, and hot gas ducting between turbines. Engine system benefits of this design include elimination of support brackets for an additional turbopump assembly, a requirement for only one turbine discharge duct, and reduced potential for operational runaway of either pump. Along with the benefits came several issues that had to be addressed. The most notable of these were the compromise in shaft speed needed to place both pumps on the same shaft driven by a single turbine, the design of the inlet for the fuel pump, and thermal conditioning of the TPA prior to engine start.

After the decision was made to have a common shaft, the arrangement of the elements on the shaft had to be set. The LOx pump was placed on one end of the shaft and given an axial inlet. This was done because the LOx pump had more stringent suction performance requirements, and this arrangement optimized the ability to meet those requirements. If the fuel pump had been placed on the opposite end of the shaft, it also could have had an axial inlet; however, maintaining the concentricity of the housings with the turbine in the middle was a major concern. The pumping elements were placed back to back to assist in managing the axial thrust in the TPA. The plenum inlet and axial discharge to the turbine were chosen to assist with engine packaging. The gas generator is connected directly to the inlet of the turbine inlet manifold and the turbine discharge is routed down the side of the engine's nozzle.

Most of the TPA components are fabricated from Inconel 718. Housings are conventional vacuum investment castings. A cross section of the Barber Nichols TPA is shown in Figure 4-22. Modifications of this basic turbopump design are incorporated as line pumps on one of the FALCON small vehicles.

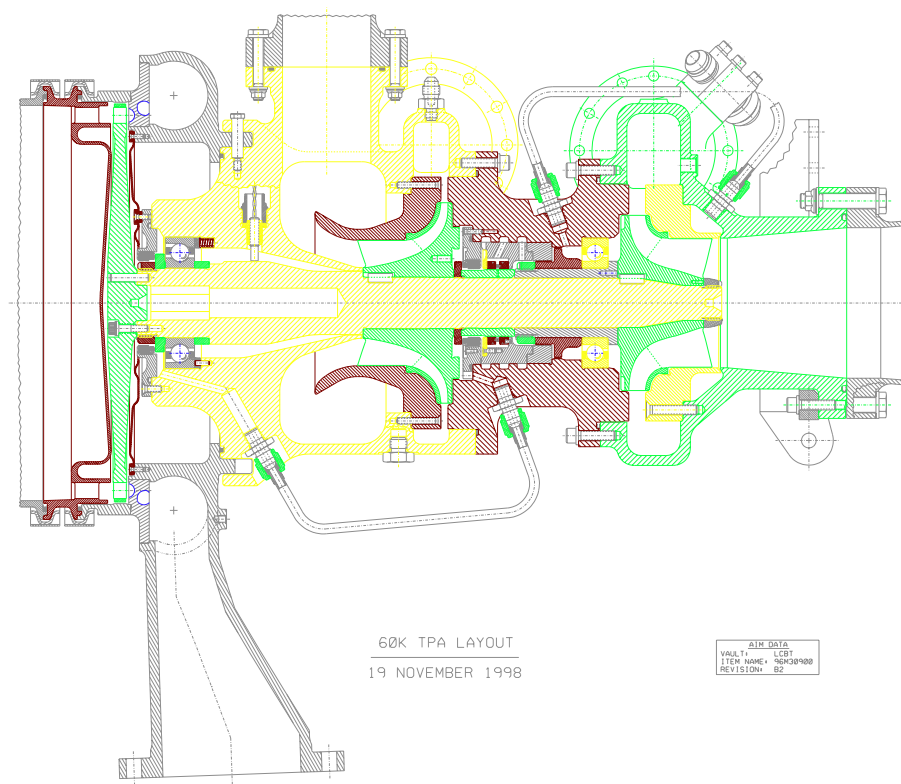

FIGURE 4-22 MC-1 Barber Nichols TPA. SOURCE: NASA, MSFC.

Materials and Chamber Cooling, Pratt & Whitney

Pratt & Whitney is working on advanced high-temperature aluminum alloys. Initial characterization indicates their specific strength is 2.5 times as great as that of current steel jackets at elevated temperatures. The company is investigating structurally compliant chamber walls to accommodate increasing pressures and thermal stress and to supply the required cooling characteristics.²⁰

Sequential Feed System, University of Alabama in Huntsville

Current launch vehicles, missiles, and high-performance upper stages using liquid propellants rely on either pressure-fed or turbopump systems. As shown in Figure 4-23, in-space liquid rocket engines with relatively low total impulse, low pressure, and low thrust typically use conventional pressure-fed systems.

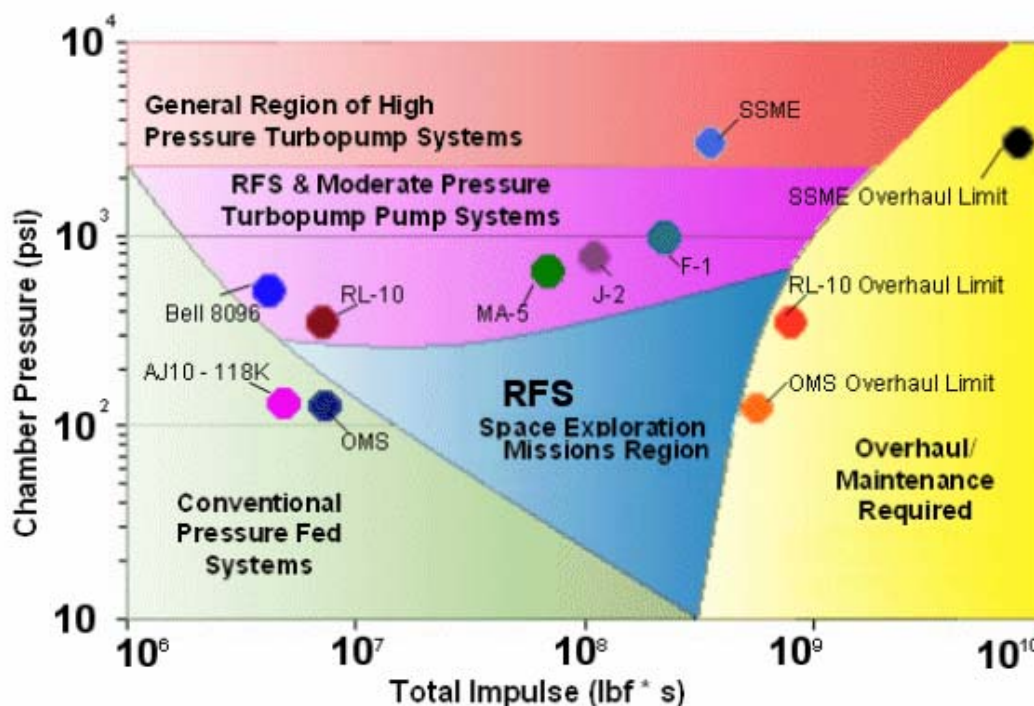

FIGURE 4-23 Representative regions of application for pump-fed, sequential feed, and turbopump systems. SOURCE: Department of Mechanical and Aerospace Engineering, University of Alabama in Huntsville.

Conventional pressure-fed systems are low cost, relatively heavy, and very reliable. They typically deliver relatively low payload mass. Systems with higher total impulse currently use turbopumps, which are relatively light but expensive and which to date are not available for low-thrust (1,000-5,000 lb), in-space systems or for moderately sized missiles. Turbopumps typically provide a relatively high delivered payload. An alternative approach, the sequential feed system (SFS),²¹ offers a means of reducing the cost and weight and improving the reliability and performance of launch vehicles, missiles, and upper-stage and in-space propulsion systems. McDonnell Douglas, which originally conceived and patented the SFS, donated its rights to the SFS concept to the University of Alabama in Huntsville (UAH), which has developed a system sizing code, a full-scale SFS test bed, and the design for an advanced version of the

²⁰Notes taken from site visit to Pratt & Whitney Space Propulsion, West Palm Beach, Florida, on May 18, 2005, by committee members Yvonne Brill and D. Brian Landrum.

²¹Also referred to as reciprocating feed systems (RFS).

SFS, including integrated valves. Results of these studies show that the weight of the SFS-delivered payload rivals, and can exceed, that of turbopump systems. With its failsafe capability, the SFS offers an approach deserving of further consideration.

The basic concept relies on relatively small conventional propellant tanks and valves that are sequentially filled and pressured to a relatively high pressure. The propellant is then expelled to the engine and the small tanks are vented and refilled from large main tanks, which are operated at low pressure. Typically, the system uses three tanks but has an intrinsic failsafe capability in that it can operate with just two tanks. Steady, controlled flow and rapid, deep throttling have been demonstrated with flow rates commensurate with 20,000-lb-thrust engines in a test bed built as a collaborative effort with NASA's MSFC. Further studies are continuing. The SFS uses relatively low-mass, low-pressure main tanks for the fuel and oxidizer, connected with two or three small, high-pressure fuel and oxidizer tanks. The small tanks alternately expel propellant, vent, and are then refilled and pressurized in sequence, to maintain steady and/or modulated high-pressure flow to the engine. The SFS relies on this sequential process to provide liquids at high pressure; there is no mechanical pump hardware involved, since the SFS comprises valves and small tanks. Analysis to date shows that for low pressures and low total impulse, the conventional pressure-fed systems would be used. For moderate to high engine pressures, and for high total impulse (with attendant large propellant masses and large tanks), then both SFS and turbopump systems would be preferred. Only with very high chamber pressures would the turbopump system offer a weight savings relative to the SFS. Other benefits include built-in redundancy and fail-operational modes, which offer improved system reliability and improved propellant management in a microgravity environment.

NASA and several companies have approached UAH about using the SFS on launch vehicle concepts to address affordable responsive spacelift (ARES) requirements (Blackmon and Eddleman, 2005).

Apparently Superior Foreign Technologies

The committee looked at foreign (Russian, Chinese, and Indian) rocket and launch vehicle technologies to determine whether some of them were significantly superior to available U.S. technologies. The apparent growth in Chinese capabilities appears to be tied partially to the transfer of technology from Russia. In addition the Russians have sold an LOx/LH₂ upper stage to the Indian program, which could significantly increase its capability. Reverse technology transfers, however, have significant limitations.

Foreign booster engines include the NK-33 and the RD-180, provided through Pratt & Whitney. The NK-33 inventory has been completely acquired by Aerojet. Pratt & Whitney is in the process of completing technology transfer from NPO Energomash with a goal to co-produce the engine by 2010-2012. Although both parties have signed the transfer contracts, there have been cases where these contracts have been terminated prior to total transfer.

The only foreign upper-stage engine identified is the Russian RD-0146, made by CADB. Pratt & Whitney has agreements for procurement and possible production of this engine in the United States. The performance of this LOx/LH₂ expander cycle engine is similar to that of the RL-10.²²

From these sources it does not appear that foreign launch vehicles are using propulsion technologies that represent state-of-the-art advances over technologies used by the United States. Both the Chinese and Indian contenders have bustling launch vehicle programs, and the Russian engineering influence is clearly seen in the product. The United States is already aware of the performance advantages offered by some rockets from the former Soviet Union, and U.S. companies like Boeing (whose Sea Launch, for example,

²²*Aviation Week's* annual aerospace source book gives a comprehensive listing of current U.S. and foreign launch vehicles. More in-depth data on these launchers is also available in *International Reference Guide to Space Launch Systems*, published by the American Institute of Aeronautics and Astronautics.

used the Zenit), International Launch Services (Proton), and Lockheed Martin (its Atlas V uses RD-180) have incorporated these engines.

DEFINING DOD AND AIR FORCE NEEDS FOR PROPULSION TECHNOLOGIES AND TOOLS

Systems Engineering

Meeting the objectives of ARES and ORS vehicles for first, second, and—conceivably—third stages may necessitate a number of new rocket propulsion subsystem technologies in addition to those that exist in applicable qualified subsystems or that are embodied in the designs of the new conceptual engines. A rigorously disciplined, integrated total systems engineering process is required from the very start in order to outline the total mission trade space and to select propulsion system requirements for each stage of each total vehicle system concept. This engineering process dictates that the primary criterion for defining these requirements be “mission success.” Because overall mission success is critically dependent on all of the engineering design considerations discussed below, the process must have continuous feedback from each of these design activities as they are evolved.

First is the definition of rocket propulsion concepts and technologies capable of meeting those tiered-down requirements. Crucial to an integrated total systems engineering process for assuring success is forcing the explicit identification of the design criteria validation status of all proposed critical technologies. This identification is the dominant factor in making objective evaluations across a broad propulsion systems trade space of development engineering schedule and cost risk and of subsequent propulsion systems’ operational and life-cycle cost risks.

Identifying the unvalidated design criteria associated with all propulsion systems concepts proposed to meet Air Force new ARES and ORS vehicle needs would define high-priority propulsion technologies programs requiring immediate DoD/Air Force investments. Such technologies are not likely to be transformational, given the existing ORS roadmap, but they are absolutely crucial to the success of ARES/ORS.

The committee’s rocket panel has identified two technology areas as important tools and elements of the design criteria database.

Integrated Totals Systems Engineering Process

Because it can determine how the DoD/Air Force technology mix should be restructured to effectively support ORS, one of the highly-leveraged critical technologies requiring immediate effort is the further evolution of an integrated total systems engineering process, with mission success as the primary selection criterion (See Recommendation 4-1).

Virtual Rocket Engine Design and Testing

Funding the continued evolution of computerized high-fidelity virtual designs for engine and propulsion systems that can be tested on a virtual test stand and ultimately in virtual flight could be one of the most cost-effective highly leveraged investments that DoD and the Air Force ever make. The potential for reducing the huge costs associated with the usual cut-and-dried development of rocket engines and their propellant systems is great when the time line is extended into the indefinite future.

According to a paper to be published in the fall of 2006, advanced software simulation tools have helped to reduce cost and development time for new propulsion systems by allowing the design team to perform dynamic system analysis before the hardware is fabricated (Sackheim, 2006). These tools provide valuable design insight and can speed system optimization, moving it forward to the early phases of the development program. An optimized system normally results in a simpler, more reliable design

with significantly lower development costs. The ability to adequately model hardware and systems also speeds the development process and reduces the number of test-fail-fix-test cycles (see Box 4-1).

Box 4-1
Virtual Testing as an Enabler for the RS-68 Rocket Engine

The J-2 engine, developed in the mid-1960s, was used on the second and third stages of the Saturn V rocket. During development of the RS-68 engine, currently used in the Delta IV common booster core, scaling data from the base J-2 engine in combination with modeling and simulation tools were used to reduce duration of the test-fail-fix-test cycles by approximately one-half (Wood, 2002). This approach was also used to reduce development costs for the SSME Block-II engine and is being used in the development of the J-2X engine planned for use on the NASA crew launch vehicle upper stage.

This observation on the cost-driving characteristics of the hardware applies to recurring operational costs for expendable launch vehicles as well. The average recurring cost breakdown for the Atlas, Centaur, Delta II, Titan II, and Titan IV launch vehicles is approximately 71 percent for the vehicle hardware. Of that hardware costs approximately 54 percent is driven by propulsion elements (engines, strap-on boosters, etc.), not including the tanks, which are classified as part of the vehicle structure for bookkeeping purposes. So here again, a concerted effort to reduce engine costs will also greatly reduce the recurring and developmental costs of the expendable launch vehicle. Furthermore, it can be shown that engine costs are mostly a function of operating chamber pressure and parts count, both of which basically are a strong function of the type of power cycle (i.e., pressure-fed, gas generator, expander, or staged combustion).

From the above key points, it should be readily apparent that simplified engine designs and existing databases, in combination with the extremely advanced analysis and modeling tools based on the advanced CFD codes now available, should go a long way toward reducing the developmental and recurring costs of booster and upper-stage engines for future expendable heavy-lift launchers and in-space and descent/ascent engines and systems for human spacecraft (Sackheim, 2006).

Modeling and Simulation

There are three levels of modeling and simulation (M&S) tools: system, engineering, and research.

- *System level.* Although system-level tools model a broad range of primary and subcomponent systems and are relatively fast, they tend to have low order accuracy and use empirically based global design relations (e.g., total engine mass based on chamber pressure). Engine design inputs are typically parameters such as specific impulse and T/W. Many of the existing codes incorporate models for cost and reliability. However, because these models have generally been validated for engines and launch vehicles that are similar to existing configurations, they may produce inaccurate results for new systems under consideration. Performance, cost, and reliability data are especially lacking for reusable rocket engines and launch vehicles of interest to the Air Force.
- *Engineering level.* Engineering-level tools incorporate a mix of analytical techniques with empirical corrections (fudge factors). These models are typically one-dimensional but relatively fast. They often rely on databases, especially for performance, cost, and reliability, and many of these models are proprietary, with databases specific to a particular company's engines and launch vehicles.
- *Research level.* Research codes are primarily used in academic and government research labs. These codes include fundamental physical models that provide more accurate results than empirical-based engineering codes. However, research codes are often focused on isolated, or

uncoupled, phenomena (combustion, fluid dynamics, finite-element models, etc.). They typically require a significant level of user experience in grid generation, computational convergence, and the like. They may require significant computer resources such as supercomputers or large, distributed computer architectures (clusters).

Current Status of Air Force M&S Tools

Current Air Force M&S codes and environments are typically 30-40 years old, empirically based, and often use one-dimensional analyses. Many of them require extensive experience (knowledge of nuances and rules of thumb) to effectively run. The various discipline codes (fluids, thermal, finite element models, etc.) are generally stand-alone, with no integration or interfaces. The bottom line is that Air Force M&S tools are aging and are limited in their ability to support an integrated design process. M&S tools for air-breathing vehicles appear to be well ahead of those for rockets and launch vehicles. A significant upgrade effort in the rocket area is needed. This is becoming even more critical as the aerospace workforce ages. New M&S tools must capture the technical expertise of rocket design for future novice engineers (Huggins, 2005).

Air Force-Funded M&S Initiatives

Under IHRPT, AFRL is leading a baseline study using M&S tools to evolve a current three-stage solid rocket launch vehicle into an advanced two-stage vehicle. Optimizing of the trajectory (range) drives the design. A solid rocket motor spreadsheet was used to investigate the effects of propellant density on I_{sp} . The study also used the Integrated Solid Modeling Analysis Tool and the Integrated Propulsion Analysis Tool for liquid engine performance estimates. The effort included enhancing the capabilities of the POST2 trajectory code and allowing it to run on a personal computer (Hilton, 2005).

As discussed earlier, AFRL is managing an IHRPT/USET program led by Aerojet and Northrop Grumman to improve the computational design and analysis tools used for advanced rocket engine development. This includes improving interconnectivity and efficiency while providing optimization capabilities. The effort is using commercial/university software programs and is upgrading existing codes in selected areas. One of these areas is turbopump analysis and design. A small business, C&R Technologies, is upgrading software to analyze secondary flows from a thermal/fluid perspective. This includes labyrinth seals, hydrostatic and other bearings, and system-level performance aspects such as torque, pressure drop, choking, dissipation, axial thrust, and radial torque for start-up events (Hilton, 2005).

NASA P-STAR Code

The bulk of NASA systems analysis work until now has been focused at the vehicle level. Only top-level propulsion requirements have been addressed through parameters such as T/W and I_{sp} . NASA has developed several comprehensive tools (Generic, ROCETS, etc.), but they are not flexible enough to allow rapid engine trade studies. The Propulsion Sizing, Thermal, Accountability, and Weight Relationship Model (P-STAR) is being developed and used by NASA's Space Transportation Directorate at MSFC. P-STAR is a flexible and scalable propulsion system design model that provides first-order engine balance, thermal balance, reliability/safety assessment, credible weight estimate, and cost prediction. The P-STAR physics-based environment includes approximately 70 Excel worksheets with add-ins, virtual basic code, and data tables that are subject to International Traffic in Arms Regulations and/or contractor proprietary rules (Leahy, 2005).

For rocket engine analysis and design, the code uses a bottom-up approach. The user specifies the thrust, chamber pressure, nozzle area ratio, and mixture ratio. Models such as the Chemical Equilibrium Analysis code are then used to compute engine performance parameters such as I_{sp} . P-STAR includes a library of engine cycles for boosters, upper stages, and orbital maneuvering systems (Leahy, 2005).

NASA/University of Alabama in Huntsville

Overall launch systems development cost can be substantially minimized by optimizing propulsion system components using historical engine data, a propulsion thermochemical code, and optimization tools and techniques. A joint effort between the University of Alabama in Huntsville (UAH) and NASA MSFC is attempting to fully integrate key propulsion variables such as I_{sp} , engine mass, gross liftoff weight (GLOW), nozzle area ratio (AR), chamber pressure (P_c), initial T/W (T_{wi}), and oxidizer/fuel (OF) ratio into a model for closed-loop analysis of launch vehicle concepts. The model process flow has been demonstrated for a SSTO system using liquid oxygen (LOx) and LH₂. Generic algorithm solvers are used for concept optimization (Shelton et al., 2005).

Figure 4-24 illustrates the calculation of higher level engine performance parameters by using P_c , AR, OF ratio, and the Cequel thermochemical code. This methodology has not been used previously to design and optimize a closed-loop system.

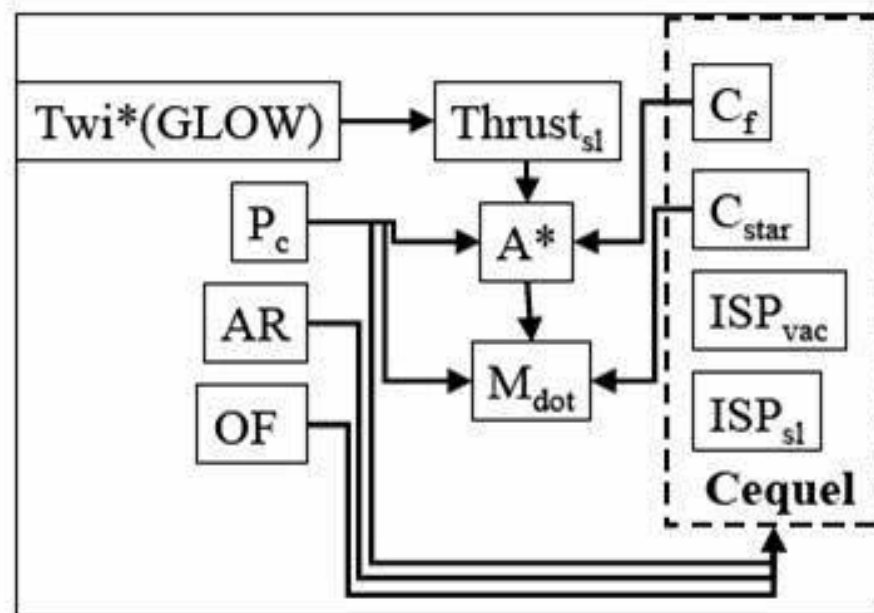

FIGURE 4-24 Engine design using fundamental parameters and thermochemical codes. SOURCE: Shelton et al. (2005).

The Cequel output and input structure designed in the linkages proved that a true closed-loop system produces the results in a much more efficient way. The alternative to integrating thermochemical results into the model is to use databases and extrapolate the results for a given input condition. A key aspect of the model was which of the two methods was used—parameters of the system or propulsion variables produced in the design process—to determine engine mass (Shelton et al., 2005).

NASA Constellation University Institutes Project

The main goal of the Constellation University Institutes Project (CUIP) is to provide the NASA Constellation Systems within the Exploration Systems Mission Directorate with the products of long-term

research and development.²³ The original three CUIP groups were the Institute for Future Space Transport, led by the University of Florida; the Space Vehicle Technology Institute (SVTI), led by the University of Maryland; and the Rocket Engine Advancement Program (REAP2), led by UAH. As of August 2006, the CUIP consortium consists of 18 universities, led by the Johns Hopkins University Applied Physics Lab, managed by NASA, and advised by a board that includes the Air Force Office of Scientific Research (AFOSR), AFRL, and the major commercial engine and launcher manufacturers. The member universities are divided into five virtual institutes based on the following technical areas: thrust chamber assembly, propellant storage and delivery, structures and materials for extreme environments, reentry aerothermodynamics, and systems analysis. The member universities currently receive approximately \$8 million dollars of NASA funds.

One of the CUIP goals is to enable the use of CFD and computational structural design tools for multidisciplinary simulation and design of rocket engines, including the performance, life, and stability of the thrust chamber assembly and the supporting infrastructure. This includes increasing the fidelity, robustness, and accuracy of these tools and implementing a rigorous verification and validation process (AIAA, 1998). Different levels of simulation are addressed starting with the complete engine system and then decomposing it into subsystems (e.g., injector faceplate), model problems (e.g., a single injector element), and unit problems (e.g., mixing). Increasingly complex benchmarking experiments are performed to provide experimental data for the simulation readiness level of the computational codes and physical submodels.

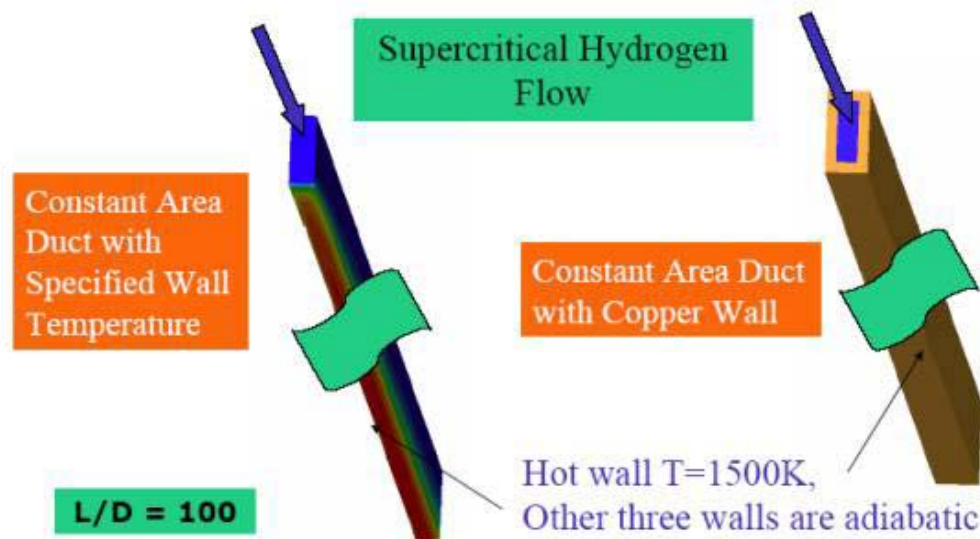

FIGURE 4-25 Calculation of conjugate gradient heat transfer for supercritical hydrogen in a high-aspect-ratio copper cooling tube. SOURCE: University of Alabama in Huntsville.

An example of a CUIP problem with a model, shown in Figure 4-25, involves calculating conjugate gradient heat transfer for supercritical hydrogen in a high-aspect-ratio copper cooling tube. A companion experiment has been developed to provide benchmark data.

²³For more information on CUIP, see its official Web site at http://microgravity.grc.nasa.gov/Exploration/external/cuip_about.htm. Last accessed on August 8, 2006.

University of Illinois at Urbana-Champaign Center for Simulation of Advanced Rockets

The U.S. Department of Energy (DOE) Accelerated Strategic Computing Initiative/Academic Strategic Alliances Program encouraged the University of Illinois at Urbana-Champaign to establish the Center for Simulation of Advanced Rockets (CSAR) in 1997.²⁴ The goal of CSAR is the detailed, whole-system simulation of solid propellant rockets from first principles under both normal and abnormal operating conditions. The design of solid propellant rockets is a sophisticated technological problem requiring expertise in diverse subdisciplines, including the ignition and combustion of composite energetic materials; the solid mechanics of the propellant, case, insulation, and nozzle; the fluid dynamics of the interior flow and exhaust plume; the aging and damage of components; and the analysis of various potential failure modes. These problems are characterized by very high energy densities, extremely diverse length and time scales, complex interfaces, and reactive, turbulent, and multiphase flows.

CSAR is composed of nine research teams to address the specific needs of each aspect of the simulation. The team responsibilities are (1) combustion modeling and corresponding codes for simulating the burning of composite propellant and the thermo-mechanical behavior of energetic materials; (2) hydrodynamical modeling and corresponding codes for simulating the interior cavity flow and exhaust plume; (3) solid-mechanical and thermal modeling and corresponding codes for simulating the case, nozzle, insulation, and propellant; (4) performance evaluation and tuning of individual component codes as well as the integrated system code; (5) parallel numerical algorithms and algorithms for mesh generation and adaptive refinement; (6) identifying test problems for system and component code verification and validation; (7) physical coupling and time stepping; (8) software integration to define software and data interfaces for coupling component codes; and (9) modeling and corresponding codes for assessing various failure modes and the effects of aging and damage on constituent materials.

Pratt & Whitney

Pratt & Whitney Space Propulsion has been updating its collaborative analysis and design processes for complex systems, with a focus on propulsion and power for use in an integrated concurrent engineering analysis and design approach. This integrated total aerospace power system (ITAPS) environment focuses on the formulation and validation of methodologies and processes that create a responsive and rapid advanced design and analysis environment for evaluating aerospace systems. Based on experience in the synthesis of all subsystems on military and commercial aircraft, ITAPS uses an integrated approach to examining system architectures, mission requirements, and the interaction of all the elements of an aerospace system (i.e., propulsion, power, electrical systems, vehicle sizing, and vehicle flight performance) (Joyner and McGinnis, 2004). The ITAPS approach is based on the integration of multidisciplinary design analysis tools to evaluate all manner of aerospace vehicle systems. These systems include lower-level coupled subsystems (e.g., the engine health management system, power and power management systems, and the propulsion system) and higher-level total systems like expendable and reusable launch systems with all their subsystem elements. The design integration of these “systems of systems” is examined at a higher system level using Phoenix Integration’s ModelCenter software.

²⁴Detailed information on this center and its simulation efforts is available at http://www.csar.uiuc.edu/F_info/AboutCSAR.htm#Intro. Last accessed on August 28, 2006.

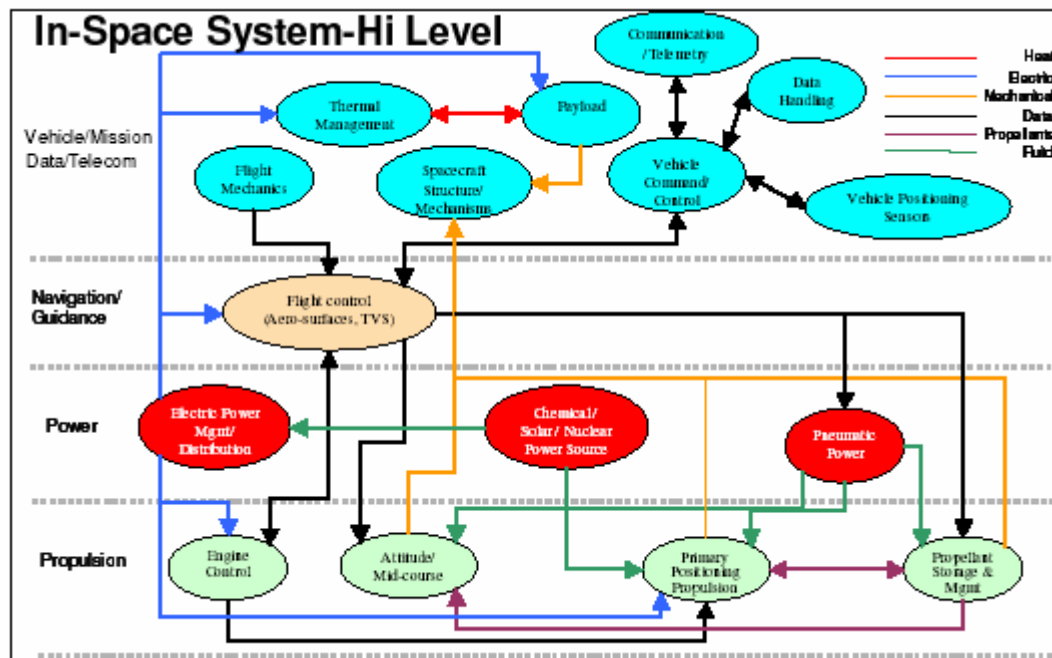

FIGURE 4-26 ITAPS functional analysis program. SOURCE: Joyner and McGinnis (2004).

As shown in Figure 4-26, subsystem functional elements are determined and then the functional interdependencies are identified. The functional description at the system level is used to define the functional modeling requirements that make up an ITAPS integrated model. Detailed models for subsystems can be easily integrated into the simulation architecture. These models can be incorporated as spreadsheets, empirical engineering codes, or structured CFD codes. This allows rapid synthesis and evaluation of the functional attributes of an aerospace system (Joyner and McGinnis, 2004).

Lockheed Martin Space Systems

With independent R&D funds and through their participation in the DARPA FALCON program, Lockheed Martin Space Systems Company has developed a hybrid rocket design tool. The tool has been validated through the testing of various scale boosters and calibrated for multiple port configurations.

Finding 4-10. The Air Force and NASA efforts to go from empirical-based codes to physics-based codes are very important. Without disputing the niche applications for empirical-based codes, physics-based codes have broader ranges of applicability and generally give more accurate results. Using commercially available and proven codes makes the results gotten by any entity more easily understood and comparable with other results, since more people are familiar with the capabilities and limitations of commercial codes. Also, the commercial suppliers bear most of the cost of keeping their codes up to date and compatible with the latest computational capabilities. This is a very important enabling technology.

The Air Force needs conceptual vehicle design tools to conduct honest broker assessments of the system benefits of propulsion technology in a timely manner and to evaluate concepts proposed by industry. This includes M&S tools that facilitate comparative trade-offs of potential propulsion concepts (e.g., cycles and fuels) and component technologies (e.g., turbopumps vs. pressure-fed). Ability to design and analyze new virtual engine concepts is also needed. The tools would benefit from being multidisciplinary (capable of being used for coupling fluids, structures, cost, and reliability, for instance).

The growing capabilities and declining costs of computer resources mean it is now possible to incorporate higher fidelity, physics-based analysis codes into a total architecture systems engineering approach. However, the models must be validated, necessitating investment in tests of subcomponents and rocket engines in a range of physically correct operating environments. As the workforce ages, it is necessary to capture their technical expertise for future generations of engineers.

Recommendation 4-10. Because the development of the required quantitative systems engineering and design tools requires a national team approach, the Air Force and DoD should provide the leadership to assure that this critical capability becomes the very best in the world. DoD should provide a significant fraction of the resources necessary to accomplish this goal. As the primary members of the national team, the Air Force and DoD should provide mission definitions and system requirements to interactively identify and prioritize tool capability requirements. The Air Force should establish a process for maintaining and upgrading modeling and simulation tools. Commercial code developers (e.g., FLUENT, ANSYS) can provide interfaces and proven algorithms. Universities and government research laboratories can provide new models incorporating fundamental physics (e.g., large eddy simulation). Finally, industry can provide cost, operations, and practical subsystems models. One possible approach is to establish a consortium consisting of universities, companies, and academic institutions under Air Force leadership with an approach similar to the National Project for Applications-Oriented Research in CFD Alliance.²⁵ The resultant world-class enhanced modeling and simulation capabilities would provide the Air Force and DoD with a transformational process for objectively identifying and prioritizing their research and technology investments.

Rocket Engine and Motor Test Beds

Flexible, responsive test beds for large engines and solid-propellant motors are needed to enable ORS success. In today's market environment, rocket propulsion contractors can no longer support large engine testing facilities and test beds. Limited funding is one of the main reasons that this is not being done at the present time.

Important Technologies for Propulsion Systems

System Health Monitoring

If the Air Force intends to develop reusable rocket engines for ORS, then it is imperative that vehicle health management technologies be developed to monitor propulsion systems in flight, determine if problems are in the making, and, hopefully, have on hand options to resolve them before they become catastrophic events. All health status data must be provided to the turnaround launch site if fast rework and turnaround times are to be achieved.

Liquid Propellant Rocket Engines

DoD and the Air Force need to focus on technologies for propulsion systems that use liquid propellant. Other than the IPD currently being tested under NASA limited funding at Stennis Space Center, DoD is not funding any technology development that looks at, for example, new pumps, turbines, advanced power cycles such as oxidizer-rich staged combustion, single preburners, or expander cycles operating at higher pressure and with better performance than the RL-10. Although a number of detailed designs for these elements have been incorporated into conceptual engines, the designs have not been validated and they must therefore be considered as too risky to be committed to ARES. Where to focus DoD funding should be determined by the results of ARES systems engineering. The propellant needs to

²⁵For additional information on NPARC, please see <http://www.arnold.af.mil/nparc/>. Last accessed on August 28, 2006.

be selected early on, since it will probably have the most influence on the operational factors involved in total mission success.

Upper-Stage Engines

USET is an important step in achieving the computerized, high-fidelity virtual engine designs that can be tested on a virtual test stand. It is anticipated that close correspondence between predicted performance and delivered performance, especially under transient and highly off-nominal run conditions can become a reality. However, achieving this goal is highly unlikely given the funding and schedule constraints of the current USET contract. Because this program is one of the key elements of a total architecture systems engineering process and can have a huge impact on the development schedule and cost of ARES, it needs to be realistically supported in the immediate future.

Reusable Booster Engines

To develop a first-stage reusable engine for the ARES subsystem demonstrator, it would be extremely useful to take all of the lessons learned during the development, certification, and upgrades of the SSME, which is the only flight-demonstrated, reusable booster rocket engine in the world, and see what can be applied to ARES booster engine needs. Committee members who visited the Rocketdyne site reported that this had been done in great detail for the Delta IV RS-68 engine and the RS-83 and RS-84 next generation of reusable engines being designed for the NASA SLI and NGLT programs. Pratt & Whitney and Aerojet reported the same approach for their COBRA design for the same program.

Advanced Pumps, Turbines, and Power Cycles

Other than the IPD currently being tested under NASA funding at Stennis, little new engine design or development work is being funded by DoD. Much effort is needed to validate design criteria for advanced pumps, turbines, new power cycles such as oxygen-rich staged combustion, single preburners, high-pressure (greater than the RL-10), high-performance expander cycles, and other engine system elements. The validation of technologies such as these will be crucial for the success of new rocket engines that can meet the performance and risk objectives of ARES and future ORS.

New Propellants

Energetic yet insensitive propellants will be needed to develop low-cost, high-energy propellants for use in both solid propellant motors and liquid propellant engines. Prospects for the introduction of very high bond energy fuels in the near term seem doubtful. Higher density, higher I_{sp} monopropellants may evolve first, but even if one of them is validated it could take many years to establish a reliable industrial facility for producing it at an acceptable cost. The most significant problem facing future higher energy density systems is developing appropriate materials, because nearly all such fuels will have to operate at higher chamber and nozzle temperatures to produce even equivalent I_{sp} owing to the higher molecular weight of their combustion products. Nevertheless, a strong, continuous effort is required just to come up with options for the far term.

Effects of Solid Propellant on Motor Aging

Better technologies for measuring aging need to be developed for solid rocket motors. Surveillance techniques are required so that individual motors that have aged out can be identified and removed from inventories.

Storable Propellants

Several storable oxidizers and fuels that have been used by the United States for both launch vehicles and in-space propulsion systems for more than 55 years are toxic. Because of this, they are considered difficult and expensive to handle safely for certain types of missions (primarily manned and civilian-operated launches). New less toxic oxidizers and fuels that can be stored for indefinite periods both on the ground and in space could enhance the chances of mission success. Such propellants should have nearly the same performance—e.g., I_{sp} , density I_{sp} , safety, handling, and operation—as current combinations. For some applications, high specific density impulse may offset the higher specific impulse of nonstorables.

New Hydrocarbon-Fueled Rockets

Rocket engines using advanced hydrocarbons will require stable operation. Current stability models are still of only limited usefulness for real engine design. More physics-based models are needed. It would be cost prohibitive now to carry out hundreds of tests such as were carried out for the development of the F-1 engine. In addition, the hydrocarbon fuels need to be thoroughly characterized because variables can have critical impacts on stability limits. Researchers need to do trade studies of the impact on performance of using different fuels, including fuels with different density and energy contents. Managers must also consider the cost of the infrastructure for making a particular fuel available to a launch site vs. the loss of performance of using other more widely available fuels.

Ablation Rates

Better characterization and optimization of ablation rates for different materials are needed. The Office of Naval Research has a program under way with which some synergy might be possible, but the thrust levels involved in that program are much smaller than those of SLVs. An urgent problem to be solved is finding the transfer functions for the rates as a function of pressure, mixture ratio, geometry, and so on.

For ablative nozzles, both the selection of materials and the manufacturing process are important for the final performance of the nozzles. Continuing work on technology in both areas will be required to accommodate new propellant characteristics.

Applying Lessons from SSME to New Designs

The SSME is the only mission-demonstrated reusable booster rocket engine in the world. The information gained from that experience base regarding technology limits, failure modes, manufacturing issues, ability to control the engine configuration after high-stress reuse, and other problems needs to be explicitly applied to the conceptual design phase of ARES reusable booster engine candidates. Of course, many of the lessons learned from SSME apply mainly to the LOx/LH₂ propellant combination.

As described earlier, there are three large existing engines with potential for reuse as boosters plus four engines that can be scaled up and have some potential for reuse. Several totally new engine concepts where designs have different levels of maturity and that incorporate technologies using different propellants and having different levels of design-criteria validation were also discussed.

Recommendation 4-11. The Air Force should develop two reusable liquid propellant first-stage rocket engines for the ARES demonstrator launch vehicle. The design of these engines should take advantage of all the engineering lessons learned during the development, certification, and extensive upgrades of the SSME. To permit the Air Force to have dual-source propulsion systems for ARES and subsequent ORS vehicles, two engine design concepts should be selected based on different propellants and configurations having functional and hardware failure modes as different as possible.

AREAS THAT DESERVE MORE ATTENTION

Physical and Thermodynamic Properties of Fuels and Oxidizers

In 2004, the Joint Army, Navy, NASA, Air Force (JANNAF) Liquid Propulsion Systems Committee formed a panel on hydrocarbon fuels to investigate current models for RP-1 properties and develop modern specifications for heat of combustion, viscosity, density, and thermal stability. That committee recommended that thermal stability testing include the jet fuel thermal oxidation tester method traditionally used for jet fuels and the high Reynolds number thermal stability (HiReTS) method. The HiReTS method had never before been applied to RP-1. There are only two operational HiReTS testers, one at the Southwest Research Institute in San Antonio, Texas, and the other at the UAH. UAH is performing HiReTS tests on traditional RP-1 with low sulfur and various additives (red dye).

NASA Glenn Research Center has an ongoing program for characterizing the thermal response of hydrocarbon fuels. This effort includes use of a heated tube facility to study thermal stability, coking, and the heat transfer properties of jet fuels and RP-1. Trade studies are needed on the performance impact of using different fuels to meet specific missions, including variability in properties such as density and energy content.

Storable Oxidizers

Updating the physical and thermodynamic properties of oxidizers that are indefinitely storable in space using practical thermal control systems (or that could be made storable) is considered an enabling technology for many on-orbit applications.

With the launch of the last storable-oxidizer Titan IV in 2005, all remaining major U.S. liquid-propellant launch vehicles use LOx for the oxidizer. This cryogenic fluid requires special high-maintenance storage and handling equipment along with a large team of engineers and trained technicians at every launch site. These issues were a primary reason that the Thor and Atlas and Titan I ballistic missiles were phased out in favor of the Titan II, which used storable oxidizer, and Minuteman-type missiles, which used solid propellant. For the same reasons, the cost and risks of achieving full-time readiness to fuel and launch ORS systems at a large number of sites worldwide will be very high if the vehicles are committed to using LOx.

A number of storable oxidizers are candidates for ORS in the optimization of mission-success-based total systems engineering. For example, the reasons NASA does not like N_2O_4 for reusable shuttle operations are not compelling for ORS-type military missions. An alternative to pure N_2O_4 is a 65/35 mixture of N_2O_4/N_2O . This storable oxidizer with RP fuels can produce a quite high specific density impulse. The adaptation of high-energy, storable oxidizers to boosters and upper stages could be one of the few technology areas that might have the potential to engender a transformative storable system for rocket-propelled access to space or near space.

One approach to consider is the encapsulation by means of nanotechnology of high-energy, non-liquid oxidizer molecules stable-slurried in medium-performance liquid oxidizers such as H_2O_2 or N_2O_4 .

Examination of the work in nanotechnology energetics for explosives and monopropellants at Pennsylvania State University and the University of Southern California could be starting points for an R&T program focused on high-energy, storable liquid oxidizers.

Finding 4-12. A program is needed to explore various approaches to creating storable oxidizers that would provide significantly increased rocket performance with different storable fuels.

Recommendation 4-12. DoD and the Air Force should fund a program to explore various approaches to creating storable oxidizers that would significantly enhance rocket performance with different storable fuels. This program should utilize a consortium of academic, industry, and government laboratories to pursue highly innovative concepts for achieving this breakthrough.

Materials

Input on materials issues as they affect rocket propulsion was received from all of the contractors visited and from the Materials and Manufacturing Directorate of the AFRL. Major efforts are ongoing at Aerojet, Rocketdyne, and Pratt & Whitney, with less ambitious efforts at other contractors.

Materials are frequently a pacing factor in the development of advanced propulsion systems, and rocket engines are no exception. On the LOx side, improved high-strength nickel-based alloys are in the early stages of development, but much more testing and validation is required. Nanocrystalline aluminum alloys also show promise for pump components and lines. On the fuel (hydrocarbon) side, improved titanium alloys could be developed for pump components.

Unlike aircraft gas turbines, the turbine section of the turbopump operates at relatively low temperatures but much higher pressures. This is because the turbine is operating either fuel-rich or LOx-rich. The higher pressures produce operating conditions much different from those in a conventional aircraft gas turbine.

Thermal barrier coatings for copper alloy combustion chamber walls could reduce thermal strains and, in addition, mitigate coking issues. This is an area of research that would be particularly well suited to a consortium approach, as mentioned earlier. Availability of high-conductivity copper alloys (NASA-Z for example) is also a continuing issue and needs to be addressed.

For SRMs, organic matrix composites have been developed that have resulted in significant performance improvements. However, fiber availability continues to be a problem, and rayon for nozzle applications is now sourced overseas. Improved nondestructive inspection systems are in various stages of development, but validation of these approaches to avoid the destructive testing of aging SRMs is a priority.

For in-space propulsion, development of oxidation-resistant materials is a priority. In particular, materials having the performance of Ir/Re alloys but at a lower cost are needed. Improved high-temperature insulation materials are also needed. Ceramic matrix composites (CMCs) are a potential candidate for this application and are also being considered for cooled combustion chambers.

Finding 4-13. All of these materials requirements for in-space propulsion need to be balanced against the changing and maturing Air Force and DoD needs and then adequately funded to assure a TRL level of 6 or higher by 2018.

Recommendation 4-13. A consortium of industrial partners and the government would appear to be the optimum solution in several of these areas and was demonstrated to be effective for the development of turbine engine materials and processes.

Propulsion Element Technologies

Turbopumps

A turbopump is one of the most highly stressed components of a rocket engine and therefore one of the most trouble prone. Bearings and seals operate in a relatively hostile environment and at very high speeds, with rapidly changing load transients. There are issues with rotordynamic instability, fatigue, oxidation, hydrogen embrittlement, and cavitation. Many of these problems are addressed analytically with existing tools with varying degrees of uncertainty. However, extensive testing is still required in most cases to establish design criteria, performance spreads, and failure mode margins, particularly if multiple reuse is contemplated. As virtual engine capabilities evolve, much of the expensive and time-consuming early cut-and-dried testing of turbopump components can be eliminated. Significant testing will still be necessary, but it will be focused on final qualification of flight hardware and establishing risk uncertainty profiles. Eventually, that test data bank will upgrade the virtual engine design capability so

that narrowing the risk uncertainty profile of final flight engines (integrated with their propulsion systems) can be done with minimal losses of expensive hardware at greatly reduced test program duration and cost.

The Air Force USET team has chosen a variety of software from various subcontractors as the basis for turbopump analysis and design. There are two USET contracts, one with Northrop Grumman and one with Aerojet, both with the same goals: to develop models for turbopump analysis and design.

In addition, the skills required to design a high-performance turbopump are very specialized and must be learned on the job. Critical skills retention is a major issue for the nation if the capability to design future rocket launch systems is to remain world-class.

Hybrid Technology

Insulation materials compatible with hybrid combustion products need to be improved to accomplish run-to-empty (i.e., no residual fuel) operation. Future hybrid motor insulators need to serve as a structural element during the initial burn, when the chamber pressure loads are highest and to withstand erosion when exposed. Materials testing in a relevant environment will allow minimizing fuel residuals and decrease the inert mass devoted to insulation.

Test data indicate that nozzle throat materials typically used for solid propulsion systems, such as three-dimensional carbon-carbon and ATJ graphite, erode relatively quickly in a high-pressure hybrid combustion environment. Significant erosion of the nozzle throat does not affect the hybrid fuel burn rate, but it does reduce the nozzle expansion ratio and chamber pressure as a function of time, which eventually degrades performance. Either future nozzle materials that are more compatible with hybrid propulsion need to be identified and developed or cooling techniques, such as film cooling with fuel or oxidizer, need to be employed to reduce throat erosion rates well below 5 mil/sec for long-duration motor burns.

Reliability of the Supply Base

The committee visited more than 10 contractors serving DoD and NASA as suppliers of rocket engines and rocket engine components. All of the contractors expressed concern about the viability of the supply base, particularly in the area of specialized materials. Some of the specific supply base issues of concern to contractors pertained to the following materials:

- High-conductivity copper base alloys for combustion chambers,
- Advanced titanium alloys,
- Rayon fiber for composite rocket motor casings, and
- Ceramic matrix composites.

Many of these materials are required only for rocket engine applications, resulting in limited and disjointed demand.

Finding 4-14. Advanced materials are required for the continued development of high-performance rocket propulsion systems, and certain of these materials have specialized uses in rocket engine applications. Availability of these advanced, but specialized, materials will be key to the success of future space initiatives. The cost of developing and qualifying some of these new materials and maintaining qualified suppliers could probably be reduced by forming appropriate industry-government consortia.

Recommendation 4-14. DoD and the Air Force should take the lead in establishing viable methods to achieve availability and assured continuous supplies of critical materials and items, including new ablative materials for thermal insulation and new materials for ITE nozzles for high-temperature and high-pressure applications.

LEVERAGING OPPORTUNITIES FOR ACCESS-TO- SPACE PROPULSION

Leveraging resources, data, and technology development available from DARPA, NASA, industry, and academia could reduce the time and costs to the Air Force of developing certain technologies for smallsat launch vehicles, ARES, and future ORS systems.

Low-Cost, Responsive Launch Vehicles

The DARPA FALCON program goals were aimed at revolutionizing the way the United States designs and builds launch vehicles so that they would have more aircraft-like operations while still being cost-effective. In September 2005, DARPA downselected to AirLaunch for Phase IIB. Perhaps some of the propulsion system modules to be demonstrated could be modified, combined, and/or scaled to leverage the development of propulsion systems for ARES and, eventually, for some of the ORS vehicles. Some of the AirLaunch data might be leveraged to support other air launch concepts such as airborne vertical launch and multimission modular vehicles. Other small, expendable launch vehicles being developed by industry—for example, SpaceX—could also provide an opportunity for supplying technologies for small access-to-space vehicles for the Air Force.

Propulsion Technologies Developed by NASA

The current launch vehicle architecture being evolved by NASA does not offer many propulsion elements for direct leveraging. However NASA's fundamental R&D programs and extensive library of design criteria should offer many opportunities to leverage systems engineering and vehicle design tools, physics modeling, new materials, and other technologies.

If more industry groups would commit to ARES as a start toward new access to space, they could end up by developing and launching small affordable payloads and satellites. This in turn could stimulate the market and increase the U.S. annual launch rate. The overall cost of producing and launching expendable vehicles would be reduced through economies of scale from the increased production of more of the same basic vehicles. Affordable access might rejuvenate the U.S. aerospace market and reverse the current decline. A reinvigorated interest in launch vehicle design and development would increase competition within the industry and lead to more employment opportunities for young aerospace and propulsion engineers. This in turn would evolve synergies and capabilities that would present future leveraging opportunities for the Air Force in evolving its access-to-space total architecture.

STATUS AND CAPABILITIES OF THE U.S. ROCKET PROPULSION INDUSTRY

The U.S. rocket propulsion industry and associated space transportation business have been in a steady state of decline since the end of the Apollo and the ICBM cold war missile race era (circa 1972). A turnaround in the propulsion and space transportation industry was expected after the space shuttle and, subsequently, the International Space Station programs were authorized to proceed. The shuttle program of the National Space Transportation System, which had to develop three new liquid rocket engines—the SSME, the orbital maneuvering engine, and the RCE—and the world's first large, segmented, reusable-case solid rocket motor, did not reverse the decline from the Apollo era; it only slowed the rate of decline until the late 1970s (see Tables 4-10 through 4-14).

TABLE 4-10 Historical Trends in National Rocket Propulsion Funding as a Percentage of Apollo Program Peak Funding by Year

| Year | Share of Peak Funding (%) | Comments |
|------|---------------------------|---|
| 1967 | 100 | Apollo peak propulsion effort. |
| 1970 | 80 | Beginning of post-Apollo slow down (after Apollo-11, first lunar landing). |
| 1972 | 20 | Apollo essentially finished. Shuttle or NSTS era begins. |
| 1982 | 17 | Propulsion for shuttle does not turn around the rate of propulsion R&D decline but merely slows down the rate of decline. |
| 1986 | 35 | 2 year funding spike from Strategic Defense Initiative (Star Wars) funding infusion. |
| 1990 | 15 | Funding profile bottoms out. |
| 1997 | 15 | Propulsion R&D funding stays flat at minimal levels. |
| 2001 | 23 | New NASA R&D propulsion initiatives for SLI and NGLT Pathfinder, X-33, X-37, etc. are funded for a while. |
| 2005 | 10 | All NASA propulsion initiatives are terminated except IPRHPT, minimal propulsion R&D funding for U.S. government. |

SOURCE: Sackheim (2006).

TABLE 4-11 U.S. Rocket Engine Developments from 1955 to 2005

| Period | Number of New U.S. Engines Developed and Flown | Comments |
|-----------|--|--|
| 1955-1962 | 9 | Perceived ICBM gap missile crisis with USSR post-Sputnik response. |
| 1963-1967 | 14 | Continued buildup of U.S. ICBM missile capabilities. Apollo race to the moon against USSR. |
| 1968-1972 | 2 | Post-Apollo slowdown. Standardization of SLVs. |
| 1973-1984 | 6 | Space shuttle propulsion development, some SLV upgrades. |
| 1985-1987 | 3 | Shuttle upper-stage motor, PAM-A, PAM-D, etc., but all solids. |
| 1988-2001 | 0 | No new U.S. launch vehicle engines, rest of world develops 40-50 new engines. |
| 2002-2005 | 1 | RS-68 for Delta IV. |

SOURCE: Sackheim (2006).

TABLE 4-12 Cancelled Propulsion Programs

| Engine Program | Application | Company | Customer | Program Maturity | | | | | | | | | |
|-----------------|---------------------------------|----------------------------|----------|------------------|-----------------------|-----------------------|-----------|---------------|------------------------|--------|------------|----------|--|
| | | | | Program Maturity | Component Development | Demonstration Testing | Protoqual | Qualification | Full Scale Development | Flight | Production | Costs \$ | |
| Transtar | Upper Stage | Aerojet | A/F | | | | | | | | | | |
| Up-rated OME | Shuttle | Aerojet | NASA | | | | | | | | | | |
| XLR-132 | High Performance Upper Stage | Rocketdyne And Aerojet | A/F | | | | | | | | | | |
| XLR-134 | Cryogenic Upper Stage | Aerojet | A/F | | | | | | | | | | |
| STME | Low Cost Booster Engine for NLS | Rocketdyne P&W and Aerojet | NASA | | | | | | | | | | |
| STBE | Low Cost Booster Engine for ALS | Rocketdyne P&W and Aerojet | NASA | | | | | | | | | | |
| LOCUS | Low Cost Upper Stage | Aerojet | A/F | | | | | | | | | | |
| Agema-2000 | Low Cost Upper Stage | ARC and Aerojet | A/F | | | | | | | | | | |
| X-33 RCS | Low Cost RCS Engines | Aerojet | NASA | | | | | | | | | | |
| Cobra | RLV Booster Engine | P&W and Aerojet | NASA | | | | | | | | | | |
| ARRE | Advanced Peroxide Upper Stage | Aerojet | A/F | | | | | | | | | | |
| RS-83 | RLV Booster Engine | Rocketdyne | NASA | | | | | | | | | | |
| FFSC | Reduced to IPD | Rocketdyne | A/F NASA | | | | | | | | | | |
| RBCC | ? ? ? | Rocketdyne Aerojet P&W | A/F NASA | | | | | | | | | | |
| TBCC | ? ? ? | G.E. | A/F NASA | | | | | | | | | | |
| RS 2200 | X-33 Linear Aerospoke | Rocketdyne | NASA | | | | | | | | | | |
| Fastrac | Whatever Works (Bantam, X-34) | MSFC | NASA | | | | | | | | | | |
| SSME, Block III | Shuttle | Rocketdyne | NASA | | | | | | | | | | |
| RS84 | | Rocketdyne | NASA | | | | | | | | | | |
| TR107 | | TRW | NASA | | | | | | | | | | |
| Non-Toxic RCS | | TRW | NASA | | | | | | | | | | |

SOURCE: Sackheim (2006).

TABLE 4-13 NASA and Support Contractor Employment 1960-2000

| Period/Year | Number of Employees, Average over the Period | Number of NASA Employees over the Period | Program/Era |
|-------------|--|--|----------------------------------|
| 1960 | 120,000 | 20,000 | Apollo |
| 1967 | 395,000 | 30,000 | Apollo |
| 1972-1985 | 130,000 | 35,000 | Post-Apollo shuttle, etc. |
| 1987-1995 | 230,000 | 20,000 | International Space Station |
| 1996-2002 | 180,000 | 20,000 | Fits and starts: SLI, NGLT, etc. |

SOURCE: Sackheim (2006).

TABLE 4-14 Total NASA Space Transportation Budget 1959-2000 (billion FY97 dollars)

| Period/Year | Budget | Comments |
|-------------|--------|---|
| 1959 | 2.0 | Start of NASA |
| 1965 | 14.5 | Apollo peak |
| 1970 | 2.5 | Apollo roll-off |
| 1974-1982 | 5.5 | Shuttle |
| 1982-1990 | 6.5 | Shuttle continuation plus International Space Station |
| 1994 | 5.2 | Shuttle sustaining |
| 2000 | 4.0 | Shuttle plus some ELVs |

SOURCE: Sackheim (2006).

In the United States, the development of technology for rocket propulsion, for all spaceflight applications has significantly lagged behind that in the rest of the world since the initial certification of the space shuttle. This lack of progress in advancing rocket propulsion technologies over such a long period has resulted in several deficiencies in today's U.S. national space program. Most notable is the reduced reliability of U.S. launch and space vehicles, as evidenced by the increased number of flight

failures during the late 1990s and into this new decade, as well as by the country's shrinking share of the global market in both the space launch and spacecraft industries. The U.S. launch market share fell from about 80 percent in the late 1970s to less than 20 percent worldwide in 2002 (Sackheim, 2006). Again, in 2005, the U.S. market share was only about 25 percent of the launches conducted worldwide (~15 out of 58). Of these, about half the U.S. launches used Russian engines (i.e., RD-180) and major Russian/former Soviet Union components, and in some cases, complete vehicles (e.g., Zenit for Boeing Sea Launch and Protons for Lockheed Martin/ILS Khrunichev).

In the last three decades, only one new U.S. government-sponsored booster engine, the SSME, has been developed and gone through flight certification. Some significant upgrades have been incorporated into the SSME since its original certification for flight in the 1970s. These upgrades increased reliability and safety and somewhat increased mean time between engine refurbishment. They did not appreciably advance rocket engine technology. Since 1970, the number of firms capable of major engine development has shrunk significantly. This industry downsizing, combined with consolidation, points up the diminution of the nation's ability to meet DoD's propulsion needs for a new ORS family of vehicles starting with ARES around 2015. Basically, our current capabilities in space propulsion and space transportation are but a fraction of the capabilities we amassed starting in 1954 with the ICBM programs and culminating about 1970 with the end of Apollo programs. These programs helped the United States to respond to international crises and to eventually win the cold war.

Since 1980 only one new first-stage rocket engine has been developed in the United States. This engine, the RS-68, was funded primarily by Boeing Rocketdyne Propulsion and Power. It was developed as a low-cost expendable booster engine for the Delta IV EELV. Engine performance of the RS-68 is poorer than that of the 1960s-era Saturn V second- and third-stage J-2 engines, both of which were simple open-cycle, gas-generator-powered designs. However, important advancements in engineering methodology and capability were made by the developer through incorporation of comprehensive modeling, computer-aided design/manufacturing, and advanced manufacturing technologies of the 21st century. This later manufacturing technology would be very beneficial in production runs of, say, 30 to 50 engines per year. However, it turns out the EELV program will require no more than five to eight engines a year. The near-term commercial space marketplace for very large boosters has not materialized. As a result, the RS-68 offers almost no unit cost advantage over older engines that are available in several places in the world today.

While the United States has developed almost no new booster rocket technology during the last 30 years or more, the new spacefaring nations of Europe, Asia (including India), and the Middle East have been developing their own new vehicle and propulsion systems to catch up. They, along with the former Soviet Union, are believed to have developed 40 to 50 new engines using several propellant combinations in addition to LO_x/LH₂. Many of these engines can now be considered to be today's state of the art.

Based on these observations, it is probably no coincidence that both the total U.S. share of the space launch market and the reliability of U.S.-built launch vehicles have eroded badly in the last 40 years. In the commercial space marketplace alone, the United States now captures only about \$1 billion to \$2 billion out of a potential worldwide commercial launch market of \$8 billion to \$10 billion per year.

A similar trend has been observed in development of the upper-stage and in-space propulsion technology products. Advancements in both will be crucial for future Air Force capabilities. Most of the U.S. in-space propulsion developments in recent times have been privately funded with some support from the government. Even here, most of the government-sponsored projects were stopped for one reason or another before any significant advances in technology readiness could be achieved.

Finding 4-15. The severe industry downsizing and consolidation causes concern about U.S. ability to meet the propulsion needs set forth in the SMP FY06 (AFSPC, 2003) for a new operationally responsive family of spacelift vehicles, starting with ARES in 2010 and ORS in 2015. DoD and Air Force commitment to fully develop these new robust launch vehicles might help rejuvenate the U.S. aerospace industry, provide more employment opportunities for young aerospace engineers, and reverse the current

decline in rocket propulsion design, development, testing, and production capabilities. This in turn could create synergies and capabilities that would present future leveraging opportunities for the Air Force.

Recommendation 4-15. The Air Force and DoD should devote more of the annual S&T rocket propulsion budget resources over the next few years to rocket propulsion technologies that would enable the successful introduction of mission-based ORS, and to other flexible, small-satellite launch capabilities in the medium term. The committee's estimate of the additional focused investments needed is \$50 million to \$75 million annually.

REFERENCES

Published

- AFSPC (Air Force Space Command). 2003. Strategic Master Plan FY06 and Beyond. Peterson Air Force Base, Colorado. Available online at <http://www.peterson.af.mil/hqafspc/library/AFSPCOffice/Final%2006%20SMP--Signed!v1.pdf>. Last accessed on March 30, 2006.
- AIAA. 1998. Guide for Verification and Validation of Computational Fluid Dynamics Simulations, AIAA-G-077-1998.
- Blackmon, James B., and D. Eddleman. 2005. Reciprocating Feed System as an Alternative to Turbopump and Conventional Tank Pressurization Propulsion Systems. Propulsion Research Center White Paper, Department of Mechanical and Aerospace Engineering, University of Alabama in Huntsville. March.
- DARPA (Defense Advanced Research Projects Agency). 2004. FALCON Force Application and Launch from CONUS: Small Launch Vehicle (SLV) Phase II. Program Solicitation Number 04-05 Task I. May 7. Available online at http://www.darpa.mil/tto/solicit/falcon_ph2slv.pdf. Last accessed on March 30, 2006.
- DoD (Department of Defense). 2004. Department of Defense Space Science and Technology Strategy. Washington, D.C.: Defense Research and Engineering. July 31.
- FAA (Federal Aviation Administration). 2006. U.S. Commercial Space Transportation Developments and Concepts: Vehicles, Technologies, and Spaceports. Office of Commercial Space Transportation. January. Available online at <http://ast.faa.gov/files/pdf/newtech2006.pdf>. Last accessed on March 30, 2006.
- Hampsten, Ken, Jim Ceney, and Gus Hernandez. 2005. ARES Subscale Demo Phase I. Presentation to ARES Industry Day, El Segundo, Calif. March 7.
- James, Larry. 2005. ARES Industry Day Welcome and Introductions. Presentation to ARES Industry Day, El Segundo, Calif. March 7.
- Joyner, C. Russell, and Patrick M. McGinnis. 2004. The Application of ITAPS for Evaluation of Propulsion and Power at the System Level. AIAA Paper 2004-3849.
- Knauf, Jim. 2005. DoD Space Transportation Perspective. Presentation to the First Meeting of the NASA Exploration Transportation Strategic Roadmap Federal Advisory Committee, Orlando, Fla., February 3-4. Available online at http://www.hq.nasa.gov/office/apio/pdf/cev/11_dod_perspective.pdf. Last accessed on March 30, 2006.
- NRC (National Research Council). 2004. Evaluation of the National Aerospace Initiative. Washington, D.C.: The National Academies Press. Available online at <http://www.nap.edu/catalog/10980.html>. Last accessed on March 31, 2006.
- NSPD (National Security Presidential Directive). 2005. U.S. Space Transportation Policy. NSPD-40. January.
- OSC (Orbital Sciences Corporation). 2000. Pegasus Users Guide. August. Available online at <http://www.orbital.com/NewsInfo/Publications/peg-user-guide.pdf>. Last accessed on March 30, 2006.

- OSC. 2004. Minotaur Users Guide. October. Available online at http://www.orbital.com/NewsInfo/Publications/Minotaur_Guide.pdf. Last accessed on March 30, 2006.
- Sackheim, Robert. 2006. The status of propulsion in the U.S. today. *Journal of Propulsion and Power*. November.
- Shelton, J.D., R.A. Frederick, Jr., and A.W. Wilhite. 2005. Launch Vehicle Propulsion Design with Multiple Selection Criteria. AIAA Paper 2005-3581. July.
- Weeks, David, Steven H. Walker, and Robert L. Sackheim. 2005. Small satellites and the DARPA/Air Force FALCON program. *Acta Astronautica*: AA2399.
- Wood, Byron. 2002. Propulsion for the 21st Century—RS-68. AIAA Paper 2002-4324.
- Yang, Vigor, and William E. Anderson, eds. 1995. *Liquid Rocket Engine Combustion Instability*. Washington, D.C.: American Institute of Aeronautics and Astronautics. December.
- Yang, Vigor, Mohammed Habiballah, James Hulka, and Michael Popp, eds. 2003. *Liquid Rocket Thrust Chambers: Aspects of Modeling, Analysis and Design*. Reston, Va.: American Institute of Aeronautics and Astronautics. February.

Unpublished

- Roy Hilton. "Vehicle system M&S and assessments," Presentation to the committee on April 14, 2005.
- Mike Huggins. "IHRPT overview," Background information provided to the committee on April 14, 2005.
- Joe Leahy. "P-STAR: A propulsion sizing, thermal analysis, accountability, and weight relationship first-order modeling tool," Background information provided to the committee on March 30, 2005.
- Ron Sega. "National Aerospace Initiative update," Presentation to the committee on March 1, 2005.
- Scott Smith. "Air-based vertical launch," Presentation to committee member Gerard Elverum on December 19, 2005.

5

Rocket Propulsion Systems for In-Space Operations and Missiles**INTRODUCTION**

Current and future strategic and warfighter needs for satellites and in-space vehicles exist in the following areas:

- x Strategic assets for communication, early warning, Earth observation, navigation, reconnaissance, surveillance, and weather;
- x Technology development work in space; and
- x Responsive space operations.

All DoD and other U.S. strategic satellites and technology platforms require propulsion subsystems operating in space to provide the impulse necessary to adjust velocity, change orbit altitude, and provide attitude control, station keeping, and end-of-life deorbit. These propulsion needs are being satisfied currently by state-of-the-art chemical propulsion, and, increasingly, by electric propulsion subsystems. It should be noted here that the state of the art has been undergoing major changes over the past 15 years and therefore represents a very advanced capability in many areas. For the kilogram-weight-class satellites with unique mission capabilities that are being developed, micropropulsion systems may be all that is required for maneuvers other than rapid inclination change.

However, in contrast to rocket propulsion for access to space and near space, the range of potential improvements for in-space propulsion thruster performance and for electric power generation and energy storage is still very large. Some of these technologies, such as various types of electrically powered thrusters or high-energy monopropellants, have the potential to be transformational for in-space military systems capabilities.

Air Force and DoD long-range plans have identified some needs and are still working out other needs for many types of operational maneuvers in space and near space. The systems architecture for seamless air-space operations has been termed operationally responsive spacelift (ORS). The elements of the ORS architecture are depicted in a very general form in Figure 5-1.

As indicated in Figure 5-1, the Air Force will continue to identify needs for responsive and rapid introduction or repositioning of military satellites or space vehicles of various types for surveillance, defensive or offensive deployment, access to local theater military operations, and, secondarily, for situational awareness. There are a number of approaches to meeting these various military needs. For large strategic and capital assets, one could utilize an onboard, low-thrust, highly fuel-efficient system such as a Hall-effect thruster that would fire continuously to complete a large station change or a repositioning maneuver at high specific impulse (I_{sp}) (2,000 to 3,000 sec). However, large assets accomplish such maneuvers with velocity changes measured in feet per second per hour and would take weeks to travel, say, 10,000 mi.

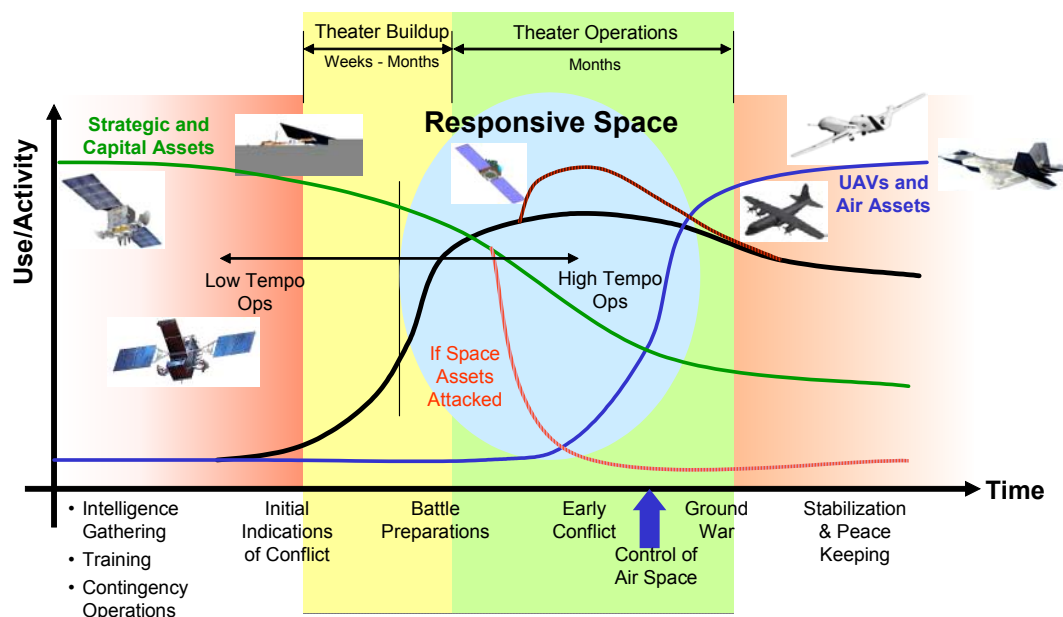

FIGURE 5-1 Responsive space utility. SOURCE: James (2005).

A second approach would be to use a moderate-thrust (100-200 lb), modest-performance chemical propulsion thruster at 350-360 sec I_{sp} , such as liquid oxygen (LOx)/monopropellant hydrazine using a cryocooler to keep the LOx from boiling away. Velocity changes of hundreds of feet per second can be achieved in minutes to hours, depending on the propellant mass available, for platforms of thousands of pounds, permitting position changes of thousands of miles per day. With higher thrust levels, maneuvering times could be quite rapid.

One important technology that would permit multiple maneuvers of critical assets would be an on-orbit refueling system to resupply the propellants while changing stations. The on-orbit refueling capability would enable the space asset to stay alive as long as everything kept working and to make as many rapid station changes as required. The capability for on-orbit docking and refueling will be demonstrated with hydrazine and high-pressure helium in space by the end of 2006.

A third approach to implementing rapid station changes would be to have a large (perhaps refuelable on orbit) space tug with high-performance electric propulsion for slow strategic moves or a high-thrust, modest-performance chemical system for responsive maneuvers. Or, a tug could have some combination of propulsion systems on board that would allow it to fly up, dock with a key space asset, and move it to the desired new operational location. The tug could then de-mate from the spacecraft and fly on to reposition other assets as needed. This approach would entail a small fleet of permanently based space maneuvering tugs that would have no function other than to rapidly maneuver space assets to new stations. The fleet would have its own dedicated guidance, navigation, and control and telemetry/command system. The tugs themselves could also be refuelable on orbit to extend their lifetimes.

Of course some combination of the above approaches for slow or rapid maneuvering and repositioning could be adopted to provide more robust and flexible capabilities, better survivability, and longer life.

Recommendation 5-1. DoD should support extensive basic research and technology projects for various in-space propulsion thruster concepts and for in-space electric power generation and energy storage. This fundamental long-range support need not be tied to any specific mission or platform requirement. The current range of technical opportunities is so great that progress will be directly proportional to annual

resource allocations over the next 10 years. The committee estimates that at least \$20 million per year should be considered as a yearly allocation in these areas.

CURRENT STATE OF THE ART IN ON-ORBIT PROPULSION

This section of the report discusses the current state of the art in on-orbit propulsion systems. Newer technology in progress at various government and industrial organizations is presented in the next sections.

Chemical Propulsion

The conventional chemical liquid propellants now in use are either monopropellant or bipropellant. Liquid bipropellant systems are better performers but are more complex and deliver a fuel and oxidizer mixture that reacts chemically in the combustion chamber. Monopropellant systems provide a single propellant that decomposes at the catalyst bed of the combustion chamber. Widely used, highly reliable state-of-the-art chemical systems are the monopropellant hydrazine (N_2H_4) and bipropellant propulsion systems such as mixed oxides of nitrogen (MON) and monomethylhydrazine (MMH). For orbit circularization and station acquisition, bipropellant engines using MON/ N_2H_4 are also in use.

Monopropellants

Monopropellant hydrazine thrusters have typical performance characteristics as follows:

- Thrust range: 0.025-125 lbf
- Isp range: 225-239 lbf-sec/lbm
- Restart capability: 750,000 starts at 50 lbf
- Pressure operating range: 350 psia blowdown at 100 psia
- Radiative thermal control

There are three manufacturers of catalytically decomposed monopropellant hydrazine engines in the United States: Aerojet, in Redmond, Washington; American Pacific, in Niagara Falls, New York; and Northrop Grumman Space Division, in Redondo Beach, California.

Bipropellants

The bipropellant chemical propulsion system MON/MMH has typical performance characteristics as follows:

- Thrust range: 0.4-5 lbf
- Isp range: 250-295 lbf-sec/lbm
- Restart capability: multiple
- Pressure operating range: 350 psia blowdown at 100 psia
- Radiative thermal control

In this same thrust class, an innovative bipropellant thruster, secondary combustion augmented thruster (SCAT), has been flight qualified and flown. This thruster operates in the bipropellant mode on MON/ N_2H_4 until the oxidizer is expended and then operates as a monopropellant thruster until all the fuel is expended. Northrop Grumman is the sole supplier for this engine.

The bipropellant chemical propulsion systems MON/MMH and MON/ N_2H_4 , high thrust, are used in liquid apogee engines. They have the following typical performance characteristics:

- Thrust range: 100-110 lbf
- Isp range: 305-326 lbf-sec/lbm
- Restart capability: multiple
- Engine inlet operating pressure: 250 psia
- Radiative/film thermal control

MON/MMH liquid apogee engines are typically used in combination with the low-thrust MON/MMH thrusters used for on-orbit propulsive functions. MON/N₂H₄ liquid apogee engines are advantageous for spacecraft propulsion systems that use monopropellant hydrazine or electrothermal hydrazine or hydrazine arcjet thrusters for on-orbit propulsive functions. The same three manufacturers make low- and high-thrust bipropellant engines: Aerojet, in Redmond, Washington; American Pacific, in Niagara Falls, New York; and Northrop Grumman Space Division, in Redondo Beach, California.

Electric Propulsion

The expanding range of spacecraft sizes and the changes in the commercial spacecraft industry environment have been presenting new challenges to the chemical propulsion community. There has been a clear need for higher performance propellants and/or thrusters. The advent of power-rich spacecraft architectures provides opportunities to take advantage of various propulsion options that can provide both high power and high I_{sp} . Reducing an onboard propulsion system's wet mass requirement can either decrease total spacecraft mass or increase payload capacity. In addition, greater demands can be placed on the propulsion system, including more calls for repositioning or longer duration orbit maintenance, increasing useful life. Another option enabled by a reduced wet mass might be a stepdown to a lower-weight-class launch vehicle. These performance enhancements, which are of great interest to commercial satellite owners, are also desirable for military satellites. The propulsion industry has accepted these challenges and is transitioning to electric propulsion. The extent to which the commercial satellite industry has embraced electric propulsion is evident from Figure 5-2, which shows all the operational satellites using electric propulsion as of June 2006. The thrusters shown in the figure, which will be discussed in more detail in the following paragraphs, are of several types: electrothermal hydrazine thrusters (EHTs), hydrazine arcjets, gridded ion thrusters, Hall-effect thrusters (HETs), and pulsed plasma thrusters (PPT).

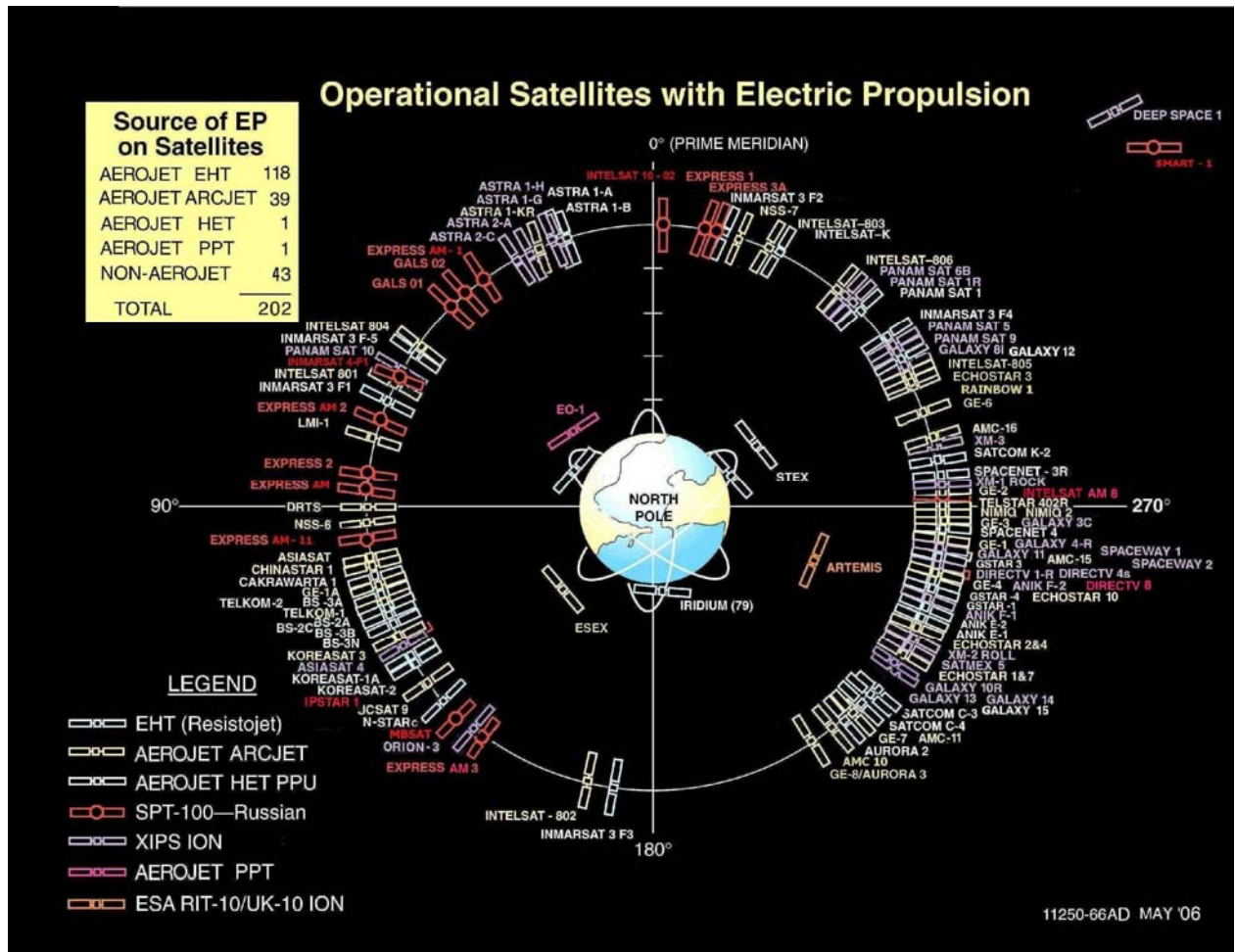

FIGURE 5-2 Operational satellites with electric propulsion. SOURCE: Aerojet (2006).

Electrothermal Thrusters

Starting with the implementation in the 1980s of EHTs on INTELSAT V and RCA AstroElectronics communication satellites, a 30 percent improvement in performance, from an I_{sp} of 225 sec to an I_{sp} of 295 sec, was achieved with this thruster type, which electrically heats the decomposition products of catalytically decomposed monopropellant hydrazine to higher chamber temperatures. Without the complexity of carrying an oxidizer on board, this I_{sp} is competitive with low-thrust bipropellant systems (0.4 to 5 lbf), which provide an I_{sp} of 295 sec. TRW Space and Communications (now Northrop Grumman), Redondo Beach, built the EHTs for INTELSAT V. At present it does not manufacture this thruster type. The EHTs that are currently in use (see Figure 5-2) are manufactured by Aerojet Redmond. A schematic of the Aerojet Redmond EHT and its characteristics are shown in Figure 5-3.

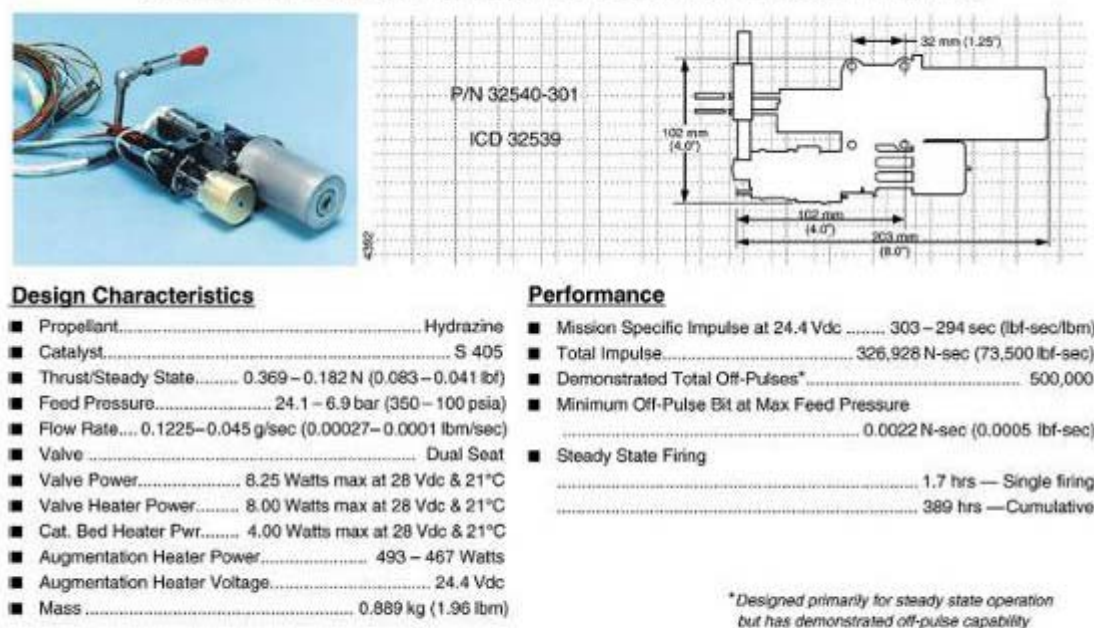

FIGURE 5-3 Aerojet MR-501B electrothermal hydrazine thruster (EHT). SOURCE: Aerojet (2004b).

Arcjets

In the early 1990s, Lockheed Martin utilized a new thruster, the hydrazine arcjet for North-South station keeping (NSSK) on its geostationary orbit satellites. The early R&D (through preflight qualification) on the hydrazine arcjet was done at NASA Glenn Research Center. The current production arcjet thrusters are manufactured by Aerojet Redmond. The Lockheed Martin series 7000 satellites use the Aerojet MR 509 hydrazine arcjet system (1.8-kW power level, I_{sp} of 502 sec). The arcjet continues to evolve with the latest Lockheed satellite bus, the A2100 satellites, which utilize the MR-510 arcjet system (2.2-kW, 582-sec nominal I_{sp} thrusters) for NSSK. Again, the arcjet thruster takes advantage of the higher satellite power available to substantially increase the performance over catalytic hydrazine ($I_{sp} = 225$ sec to $I_{sp} = 570$ to 600 sec). A schematic of the MR-510 and its characteristics are shown in Figure 5-4.

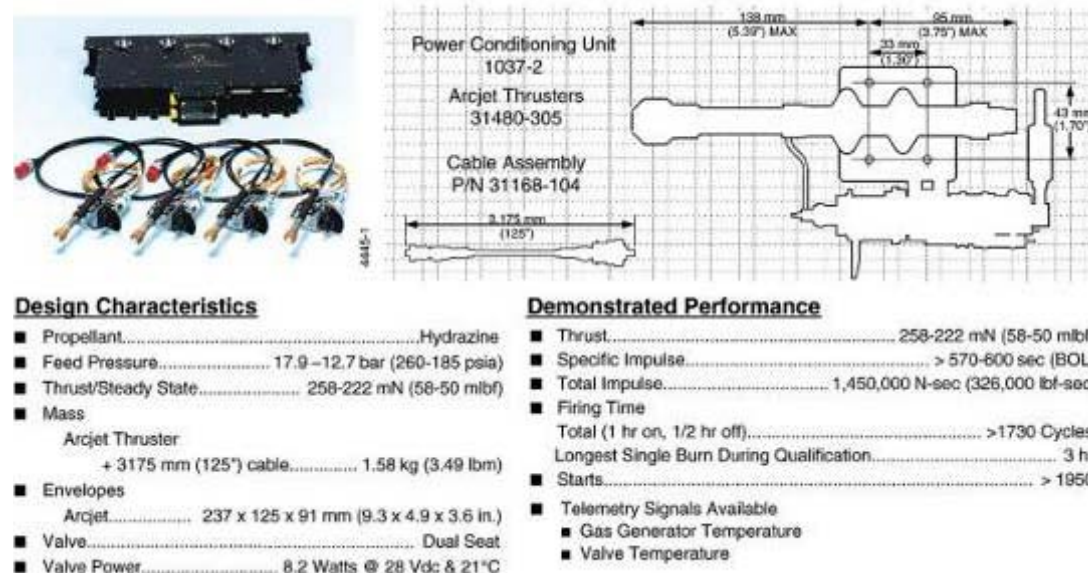

FIGURE 5-4 MR-510 arcjet thruster and cable assembly. SOURCE: Aerojet (2004b).

Ion Thruster Systems

In the late 1990s, Boeing Electroynamics (formerly Hughes Space and Communications) successfully introduced the Xenon Ion Propulsion System (XIPS), a xenon propellant gridded ion thruster, on its BSS 601HP and BSS 702 commercial communications geosynchronous G satellites. The XIPS thruster schematic is shown in Figure 5-5. Boeing Electroynamics XIPS thruster technology was recently purchased by L-3 Communications' Electron Technologies, Inc., which presently manufactures thrusters for both satellites.

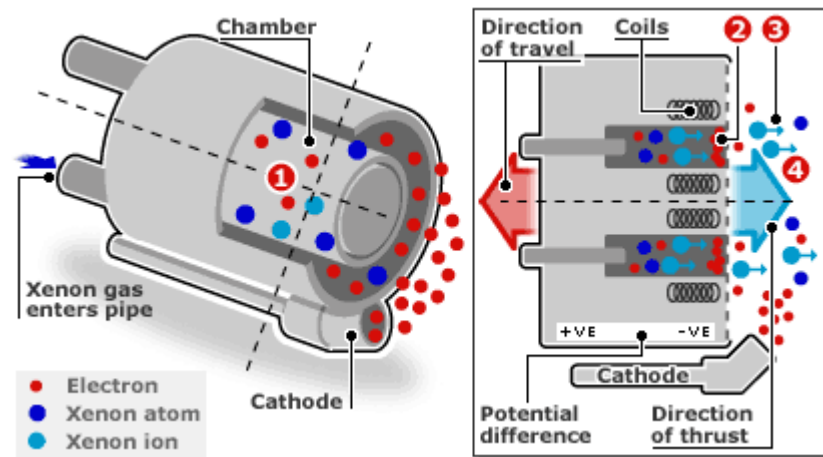

FIGURE 5-5 XIPS thruster schematic illustration. SOURCE: *Encyclopedia of Astrobiology, Astronomy, and Spaceflight* (Undated).

The thruster consists of a discharge hollow cathode, three-ring magnetic cusp confinement, a three-grid accelerator, and neutralizer hollow cathode. The three-grid accelerator used in the 25-cm thruster utilizes shaped molybdenum grids with approximately 11,000 apertures to produce the high perveance (72 pervs at full power) xenon ion beam. The XIPS 25-cm ion thrusters and the associated power supplies operate in two modes: 2.2 kW for typical on-orbit functions and 4.4 kW for raising the orbit. The high-power mode utilizes about 4.5 kW of bus power to produce a 1.2-kV, 3-Å ion beam. The thruster in this

mode produces 165 mN thrust at an I_{sp} of about 3,500 seconds. The high-power mode is used exclusively for the orbit insertion phase, which greatly reduces the amount of chemical propellant carried by the spacecraft for this task. Nearly continuous operation in the high-power mode for 500 to 1,000 hours is required, depending on the launch vehicle and satellite weight.

A low-power mode, in which the thruster consumes about 2.2 kW of bus power, is used for the station-keeping function. In the low-power mode, the beam acceleration voltage is kept the same, and the discharge current and gas flow are reduced to generate a 1.2-kV, 1.43-Å beam. In this mode, the thruster produces 79 mN of thrust. Since the beam voltage remains unchanged for the high-power mode and the thruster mass utilization efficiency is nearly the same, the specific impulse degrades only slightly compared to the high-power mode, to about 3,400 sec. Typical performance parameters of the 25-cm thruster used on the BSS 702 satellites are summarized in Table 5-1.

TABLE 5-1 Typical Parameters of the 25-cm XIPS Thruster

| | Low-Power Station Keeping | High-Power Orbit Raising |
|-----------------------------------|------------------------------|-----------------------------|
| Active grid diameter (cm) | 25 | 25 |
| Average I_{sp} (sec) | 3,400 | 3,500 |
| Thrust (mN) | 79 | 165 |
| Total power consumed (kW) | 2.2 | 4.5 |
| Mass utilization efficiency (%) | 80 | 82 |
| Typical electrical efficiency (%) | 87 | 87 |

SOURCE: Goebel et al. (2002).

The state of the art on the XIPS is described by Chien et al. (2006). The Boeing 702 spacecraft has a chemical propulsion liquid apogee engine, but use of the high-power mode of XIPS in the orbit insertion phase greatly reduces the wet mass carried by the spacecraft for this task. The high I_{sp} of the ion engines for NSSK results in an additional large saving in propulsion system wet mass over on-orbit systems, which use mono- or bipropellants for this function.

The military Gapfiller satellite, which launches in 2007, will use the 25-cm thruster version of XIPS. Aerojet also has a major development effort in xenon ion thruster system technology. It is completing the thruster, propellant management, and digital control systems designs on the 0.5-7.5 kW NASA Evolutionary Xenon Thruster (NEXT) effort, led by NASA Glenn Research Center. L-3 Communications Electron Technologies, Inc., is developing the power processor. The NEXT system, when qualified, will provide much greater capability for Discovery-class solar electric propulsion missions. The 40-cm NEXT will also be available for other spacecraft applications.

Hall-Effect Thrusters

In 1990, the Science and Technology Directorate of the Ballistic Missile Defense Organization (BMDO) took the lead in identifying advanced spacecraft propulsion technology developed in the former Soviet Union with potential applications for U.S. government and commercial missions. It identified the Russian Hall thruster technology as being particularly promising (Sankovic et al., 1997). In 1971, the Russians flew the first Hall thruster—sometimes called a stationary plasma thruster (SPT)—on the METEOR spacecraft. Over the next two decades several dozen 0.66-kW SPT-70 thrusters were used operationally in space. BMDO procured three versions of the 1.5-kW Hall thruster for evaluation: (1) SPT 100, (2) T100, and (3) TAL D-55. This procurement provided three sources of Hall thrusters for U.S. propulsion companies. Hall system thruster development has gone forward at Aerojet Redmond, Busek, Loral Space Systems, and Pratt & Whitney.

Use of Hall thrusters for satellite NSSK promises great savings in wet mass over mono- or bipropellant chemical propulsion systems. An overview of the underlying physics is available in Kaufman (1985).

A typical propellant for a Hall thruster is a high-molecular-weight inert gas such as xenon. A power processor is used to generate an electrical discharge between a cathode and an annular anode, through which the majority of propellant is injected. A critical element of the device is the incorporation of a radial magnetic field, which serves to impart an azimuthal drift to the electrons coming from the cathode and to retard their flow to the anode. The azimuthally drifting electrons collide with the neutral xenon, ionizing it. The xenon ions are then accelerated electrostatically from the discharge chamber by the electric potential maintained across the electrodes by the power processor. The velocity of the exiting ions, and hence the I_{sp} , is governed by the voltage applied to the discharge power supply and is typically 15,000-16,000 m/sec at 300 V.

The first flight of a Hall thruster on a U.S. spacecraft was in 1998 on Space Technology Experiment (STEX), a Naval Research Laboratory spacecraft. In 2004, Loral launched the Mobile Broadcasting Satellite (MBSAT), a geosynchronous satellite that uses four Faekel SPT-100 Hall thrusters for NSSK. The performance characteristics of the SPT-100 class of thrusters are shown in Table 5-2.

TABLE 5-2 Characteristics of SPT-100 Hall-Effect Thrusters

| Characteristic | Value |
|----------------|--------|
| Propellant | Xenon |
| Thrust (mN) | 80 |
| Power (kw) | 1.35 |
| I_{sp} (sec) | 1,600 |
| Efficiency (%) | 50 |
| Life (hr) | >7,000 |

SOURCE: Sankovic et al. (1993).

Aerojet Redmond has completed flight qualification of the BPT-4000, shown in Figure 5-6, for the Lockheed Martin build of the Air Force advanced EHF satellites. These Hall thrusters will be operated at two thrust levels, a high thrust for partial orbit transfer and lower thrust for station-keeping requirements. Launch date is projected as the fourth quarter of 2006.

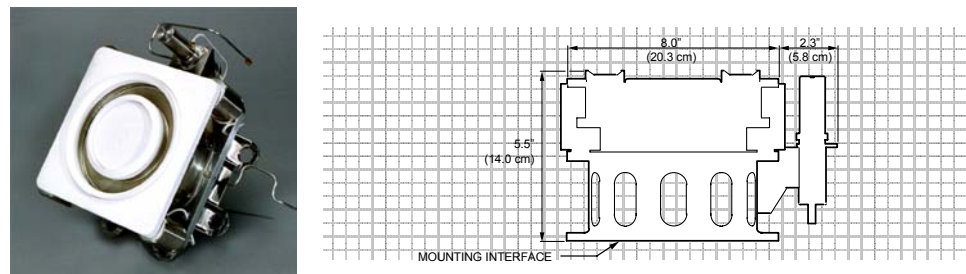

Design Characteristics

- Propellant Xenon
- Mass (Thruster & Cathode) <7.5 kg
- Envelope Dimensions 16 x 22 x 27 cm
- Nominal Input Power 3000 or 4500 Watt
- Nominal Voltage 300 or 400 Volt

Status

- 6000 Hour Accelerated Life Test Program Complete
- Qual Level Vibration and Shock Testing Complete

Performance

- | | 3.0 kW | 4.5 kW |
|--------------------------------------|------------------------------|---------------|
| ■ Thrust (300 Volts) | 194 mN | 294 mN |
| ■ Thrust (400 Volts) | 168 mN | 254 mN |
| ■ Specific Impulse (300 Volts) | 1769 sec | 1844 sec |
| ■ Specific Impulse (400 Volts) | 1969 sec | 2076 sec |
| ■ Life | >6000 hr | |
| ■ Total Impulse | >4.6 x 10 ⁶ N-sec | |
| ■ On/Off Cycles | >6000 cycles | |

FIGURE 5-6 Aerojet dual mode BPT-4000 Hall effect. SOURCE: Aerojet (2005b).

The availability of flight-qualified, flight-proven ion and Hall thrusters can be expected to increase the manifesting of these technologies because they have higher I_{sp} than chemical propulsion systems. Each type of electric-powered thruster has its area of applicability. Ion engines can deliver higher I_{sp} and are

well suited to missions with high ΔV requirements. In addition to satellite NSSK and partial orbit transfer requirements, Hall thrusters would be suitable for applications such as Earth transfer missions. In fact, the European Space Agency's (ESA's) Small Missions for Advanced Research in Technology 1 (SMART 1) mission has already successfully implemented this technology. SMART 1 is a small lunar orbiter that was launched in September 2003 as an auxiliary payload on the Ariane 5. It uses a 1.4-kw Hall thruster and reached the first moon orbit in December 2004. Due to the mass limitation of the spacecraft and the consequent limitation in the electrical power, the thruster used on SMART 1 is a scaled-down version of the PPS-1350 thruster developed and qualified by SNMECA (France) for geosynchronous missions. SMART 1 used its thrusters in a variable power mode (450 to 1,220 W) in this application, which serves as a benchmark for other Earth-to-orbit (ETO) missions using electric propulsion.

Two companies, Moog and Vacco Industries, are leading efforts to produce propellant management components and feed systems for flight electric propulsion systems. They are also developing next-generation designs that will trim the weight of the propellant management system. Moog was the supplier of the xenon propellant management assembly that is flight operational on the Loral MBSAT. Currently, Vacco Industries provides the propellant management system components for the BSS 702 satellite XIPS. It is in the process of qualifying highly integrated chemically etched propellant management (CHEMS) xenon-latch-valve modules for the Lockheed Martin advanced EHF satellite.

To ensure broader application of Hall thrusters, and ion thrusters as well, more attention needs to be paid to developing the components of the entire electric propulsion subsystem, which includes not only the thruster but also the propellant feed system and the power processing unit (PPU). Historically the PPU has been the dominant cost driver for electric propulsion systems because of the requirement for heavy power converters and thermal management systems. Aerojet Redmond designs and builds high-power converters to support the electric propulsion subsystems it manufactures. It is also working on the development of solar-electric direct drive, i.e., using a high-voltage solar array to provide power directly to a Hall thruster at voltages needed to drive thruster discharge. Qualification of the solar-electric direct drive would greatly reduce the cost and weight of a Hall electric propulsion system, while reducing array size. Reduction in array size results in an added savings in spacecraft weight. The potential payoff for direct drive makes this a goal extremely worthy of pursuit.

Additional weight savings could be obtained with direct drive using power from advanced solar arrays now available commercially, such as ENTECH/ABLE's Solar Concentrator Arrays with Refractive Linear Element Technology. Such an array provided the 2.7-kW power source for the successful Deep Space 1 basic mission and its extended mission to the comet Borrelly in 2001 (Jones et al., 1996). ENTECH/ABLE also has available a next-generation array, which is a stretched-lens array. The synergy of coupling flight-proven, advanced-array technologies with direct drive for Hall thrusters needs to be explored.

To satisfy increasing demand, a larger industrial base is needed than now exists for the manufacture of electric propulsion systems and components. L-3 Communications Electron Technologies, Inc., and Aerojet Redmond appear to be the only commercial sources for gridded ion thrusters and power converters. Aerojet is the only U.S. source that has qualified Hall thruster hardware. In addition to the dual-thrust 4.5-kW Hall thruster under contract to Lockheed Martin for the EHF satellite, Aerojet has fabricated and tested a 2.2-kW Hall thruster flight prototype unit. Busek is developing low-power Hall thrusters with IHRPT funding; Busek designs are discussed under "Electric Propulsion" in the IHRPT Targets section. Excellent R&D on ion and Hall thrusters and power-conditioning units is being conducted at NASA Glenn Research Center, but there needs to be more transfer of technology to companies that can build the product.

Propulsion for Microsatellites

There is presently a substantial interest in microsatellites: satellites with masses from 50 to 100 kg. For example, microsatellites could be used for missions requiring formation flying, precise attitude control, or trajectory correction. Design and implementation of the micronewton-thrust propulsion systems required for precision control is especially challenging given the mass, volume, and power

constraints that come from the satellite's small size. The most promising technologies under investigation to date for near- and intermediate-term military applications appear to be micronewton PPTs, colloid thrusters and ion thrusters, and both ion grid thrusters and Hall effect thrusters. The following discussion describes the characteristics of a colloid thruster and several PPTs that have been flown or are nearly flight ready. The investigation of micropropulsion is ongoing at NASA's Jet Propulsion Laboratory (3-cm-diameter xenon ion thruster), at L-3 Communications Electron Technologies (8-cm-diameter xenon ion thruster), at Stanford University (micro-Hall thruster), and at many other university sites, but these microelectric propulsion concepts are not sufficiently far along to be considered for near- or intermediate-term flight application.

Pulsed Plasma Thrusters

The Aerojet PPT, designated PRS-1, was successfully flown on the NASA Goddard Earth Observing EO-1 spacecraft. This PPT relies on the Lorentz force generated by an arc passing from anode to cathode and the self-induced magnetic fields to accelerate a small quantity of chlorofluorocarbon propellant. Teflon has been used as the propellant to date. Pulsed electromagnetic thruster systems consist of accelerating electrodes, an energy storage unit, a power conditioning unit, an igniter supply, and a propellant feed system.

During operation, an energy storage capacitor is first charged to between 1 and 2 kV and an ignition supply is then activated to generate low-density plasma, which permits the energy storage capacitor to discharge across the face of the Teflon propellant bar. The peak current level is typically between 2 and 15 kA, and the arc duration is between 5 and 20 microsec. The pulse cycle can be repeated at a rate compatible with the available spacecraft power. The propellant feed system consists of a negator spring that pushes the solid Teflon bar against a stop on the anode electrode.

The characteristics of the PRS-1 pulsed plasma system, flown on the EO-1 spacecraft, are shown in Table 5-3, along with those of a microthrust PPT system built by the University of Washington.¹

TABLE 5-3 PPT Performance Characteristics

| Characteristic | EO-1 ^a | Dawgstar ^b |
|--|---|--|
| Maximum input power (W) | 70 (1 thruster; EO-1 operations); 100 design | 15.6 (2 thrusters; slow charge) 36.0 (2 thrusters; fast charge) |
| Thrusters per system | 2 | 8 |
| Total system impulse (N-sec) | 1,850 (EO-1 propellant load) >15,000 (system life) | >1,500 |
| Impulse bit (μ N-sec) | 90-860, throttleable | 66 \pm 4 |
| Pulse energy (J) | 8.5-56, throttleable | 4.9 |
| Maximum thrust (μ N) | 860 (EO-1); 1.2 (design) | 200 (high-speed mode) |
| Specific impulse (sec) | 650-1,350 | 332 \pm 40 |
| Thrust to input power ratio (μ N/W) | 12.3 | 9.7 |
| Total mass (kg) | 4.9 (2 PPTs, 1 PPU, and propellant) | 4.2 (8 PPTs, 1 PPU, and propellant) |
| Propellant | PTFE | PTFE |
| Propellant mass (kg/thruster) | 0.07 (as fueled) | 0.07; 0.56 kg/system |

^aSOURCE: Benson et al. (1999).

^bSOURCE: Rayburn et al. (2000).

The PRS-1 has demonstrated control of the spacecraft pitch with the momentum wheels completely disabled, including during image acquisition with the Advanced Land Imager instrument. On-orbit tests have demonstrated no detectable electromagnetic interference with the spacecraft, spacecraft communications, or the payload instrument.

¹A prototype of this system was to be flown on the Dawgstar nanosatellite, which is currently in storage waiting for a launch opportunity.

Busek has also developed a micropulsed plasma thruster that will provide attitude control on the FalconSAT-3 spacecraft when it is launched in 2006. Spacecraft and thruster plume interactions will also be measured on FalconSAT-3. The characteristics of Busek's thruster are shown in Table 5-4, which shows Busek's colloid thruster as well.

TABLE 5-4 Characteristics of Colloid and Micropulsed Plasma Thrusters

| | Colloid Thruster | Micropulsed Plasma Thruster |
|-------------------------|------------------|-----------------------------|
| Dry mass (kg) | 3.0 | 0.7 |
| I_{sp} (sec) | 1,000 | 800 |
| Minimum impulse-bit | 0.1 N-sec | 75 μ N-sec |
| Power (W) | 25 | 10 |
| ΔV (m/sec) | 360 | 375 |
| TRL | 7 | 7 |
| Demonstration satellite | NASA ST7 | FalconSAT-3 |

SOURCE: Randolph et al. (2006).

Colloid Thrusters

For the last several years, Busek has been developing colloid thruster technology with Small Business Innovation Research funding and a contract to provide microthrusters for the NASA ST7 technology demonstration mission. Busek's micronewton colloid thrusters will be part of a disturbance reduction system on the ESA's Laser Interferometer Space Antenna (LISA) mission, planned for a 2009 launch. The LISA mission has nanometer precision pointing control requirements. The Busek thruster has demonstrated remarkable range, precision, and controllability in the micronewton regime, with single spray sources providing thrust in the 0.3 to 3 μ N range, with nanonewton resolution (Randolph et al., 2006). Response time across the full thrust range is between 2 and 3 sec, achieved via a microvalve, while fine adjustments, performed by varying acceleration voltages, may be realized in milliseconds.

PROMISING TECHNOLOGIES FOR ON-ORBIT PROPULSION AND FOR TACTICAL AND STRIKE MISSILES

IHRPT Targets for Propulsion Performance

The Integrated High-Payoff Rocket Propulsion Technology (IHRPT) program of DoD, the Air Force, and NASA is a joint government and industry effort focused on developing technologies for military global reach, strategic missiles, long life or spacecraft capability, and tactical missiles. The IHRPT goals for increases in propulsion-related performance are shown in Table 5-5.

TABLE 5-5 IHRPT Goals for Propulsion-Related Performance Improvement (percent)

| Metric | IHRPT Phase | | |
|--|-------------|----------|-----------|
| | Phase I | Phase II | Phase III |
| $I_{tot}/mass_{wet}$ (electrostatic/electromagnetic) | 20/200 | 35/500 | 75/1,250 |
| I_{sp} (bipropellant/solar thermal) | 5/10 | 10/15 | 20/20 |
| Density I_{sp} (monopropellant) | 30 | 50 | 70 |
| Mass fraction (solar thermal) | 15 | 25 | 35 |

SOURCE: Huggins (2005).

Chemical Propulsion

Alternative Propellants for Liquid Propellant Engines

R&D is under way in-house at Edwards Air Force Base and at Aerojet Redmond on several energetic monopropellants that could be used for orbit circularization, orbit altitude/position changes, fly-out and

maneuvering, and attitude control. Objectives of the R&D are given in Table 5-6. Hydroxylammonium nitrate (HAN) and AF-315E are two of the propellants under study. Their main advantages are higher density impulse than state-of-the-art chemical mono- or bipropellant systems and lower toxicity. Aerojet is experimenting with various blends to achieve a balance between safety of handling and performance. Phase II potential has not been realized yet at the thruster level. Theoretical performance calculations indicate an I_{sp} of 250-270 sec. Measured I_{sp} to date is approximately 10 percent below that level.

TABLE 5-6 Objectives of Alternative Propellant Research

| Activity | Objective |
|--|--|
| Phase II demonstration | To demonstrate technologies that enable realization of USAF IHRPT Phase II goals with improved I_{sp} , longer life, higher T/W, and lower cost |
| Liquid engine alternative propellant development program (LEAP-DP) | To develop and demonstrate a catalytic engine for AF-M315E monopropellant that delivers IHRPT Phase II performance To design and fabricate a 25-lbf heavyweight workhorse thruster and flight-weight thrusters To hot-fire demonstrate flight-weight thruster with AF-M315E monopropellant |
| Energetic propellants | To develop and demonstrate the scale-up of energetic propellant formulations |

There are at least three main technical challenges associated with HAN-type propellants: (1) selection of suitable chamber materials for the thrusters, because the high-performance blends run hotter than monopropellant hydrazine, (2) the high temperatures needed on the catalyst bed for initial startup, and (3) ignition delay problems. These challenges are solvable, but solutions to the challenges of large-scale propellant production and long-term material compatibility are elusive. These designer monopropellants may fill a niche mission need such as low ΔV for small spacecraft applications, but existing state-of-the-art bipropellant systems are competitive in performance with HAN, and MON/MMH systems bring with them a history of proven performance and reliability. However, HAN and AF-135E may reduce the propulsion weight, potentially increasing the payload, since they require only one feed system and tank instead of two for the bipropellant systems.

Combination Thrusters with Dual-Mode Capability

The SCAT is the first thruster designed to operate in either a bipropellant or a monopropellant mode. In its monopropellant mode, it decomposes hydrazine in a catalyst-bed chamber. The decomposition products (NH_3 , N_2 , and H_2) flow out through a second small chamber and exit through a conventional nozzle with an expansion ratio of about 100:1. The conventional monopropellant N_2H_4 thruster has an I_{sp} of about 230 sec and can provide thrusts from 0.8 to 4.5 lb. This system has been under development for years at Northrop Grumman Corporation.

In its bipropellant mode, N_2O_4 is turned on to cool the second chamber. It vaporizes and then combusts the N_2O_4 vapor with N_2H_4 in the second chamber to produce an I_{sp} of about 325 sec. Because the second chamber is regeneratively cooled it can be made of nonrefractory metals such as nickel. This provides essentially unlimited operating life. In its bipropellant mode, the thruster can produce 4.0 to 14 lb thrust. Northrop Grumman is developing higher thrust versions and is also exploring other propellant combinations.

SCAT's combination of operating modes permits the most efficient use of onboard propellant, providing greater mission flexibility. SCAT allows a single engine to burn either hydrazine (monopropellant mode) or hydrazine and N_2O_4 (bipropellant mode); this means that the oxidizer tank can be fully depleted and then the fuel tank can be fully depleted. Such total utilization of available propellant is not possible with any other bipropellant thruster. SCAT also has a very wide range of allowable mixture ratio (0.95 to 1.6), so it becomes much easier to balance oxidizer usage and fuel usage over a

mission (unlike common liquid apogee engines, which have very tight limits on operating mixture ratio—for example, 1.0 ± 0.05).

On-Orbit Refueling: Orbital Express

Northrop Grumman Corporation and Boeing are working on a DARPA contract, DARPA Orbital Express Spacecraft, to demonstrate the practicality of on-orbit refueling of spacecraft propulsion systems. DARPA is interested in in-space refueling because some satellites with full functionality get retired because the original propellant load carried into orbit with the satellite is exhausted. If spacecraft can be designed to be refueled in space, many could continue to operate for much longer periods. To date, the United States has not been successful in the robotic transfer of fuels in space. The design criteria to be established by Orbital Express will involve the following:

- An efficient zero-gravity propellant transfer pump system accomplishing the transfer with minimal venting of propellants and pressurant gases,
- No dribble from quick-disconnect fittings,
- Reuse of pressurant gases, and
- Completely autonomous operations.

A primary requirement is to have no spacecraft contamination occur during or following the transfer. Figure 5-7 shows a hydrazine propellant transfer system to be tested in orbit. This demonstration in space is scheduled to be done in late 2006.

Finding 5-2. The present plan is to demonstrate the transfer of hydrazine only. The subsequent transition to a fully operational hydrazine transfer docking satellite and autonomous servicing system could have important benefits for assembly command ship and orbit adjustments of future Air Force satellite constellations. Some assets could be launched into orbit without needing an onboard propellant capacity to support all of the missions the space vehicle may be capable of carrying out. There would also be great benefits to extending the technology to the transfer of MON and subsequently, LOx. A LOx/N₂H₄ system would enable the in-space maneuvering of large platforms and space tugs.

Recommendation 5-2. DoD should fund total architectures and operations studies for various future DoD/Air Force missions to determine the advantages of on-orbit refueling capability. Future funded technology work should complete the validation of full operational design criteria for the transfer of hydrazine. Those basic design criteria should be expected to be applicable to other storable low-vapor-pressure fuels like monomethylhydrazine (MMH). A subsequent program should be instituted to extend the technologies to storable oxidizers such as mixed oxides of nitrogen (MON) and, finally, to liquid oxygen (LOx). The committee believes a funding level of \$10 million per year, in addition to that discussed in Recommendation 5-1, over the next 10 years would permit finalizing an initial operational capability module for N₂H₄ and pursuing subsequent technology demonstrations with MON and LOx.

On-Orbit Fluid Transfer – Orbital Express

NEXTSat Fluid Transfer System (FTS) -
Simulated client propulsion system

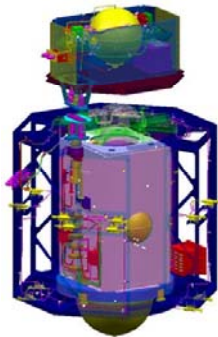

ASTRO Servicing Vehicle Fluid Transfer
and Propulsion System (FTAPS)
- Active portion of fluid transfer system
- 6-DOF propulsion system

- **Key on-orbit demonstrations:**
 - Closed loop transfers - propellant in, pressurant back using fluid pump
 - Ullage recompression - no pressurant exchange using pressure supply
 - Fluid gauging - multiple methods
 - Autonomous fluid transfer operations
- **Major development items:**
 - Servicing interface electronics (SIE) – five module IA-based design
 - Fluid coupling – dual-valve, motor-driven design
 - Flow sensor – passive flow measurement device
 - Fluid pump – STS-derived hydrazine pump
 - Fluid transfer tank – surface tension PMD design

FIGURE 5-7 Orbital Express demonstration vehicle. SOURCE: Northrop Grumman.

Electric Propulsion

It is evident from the applications (see Figure 5-2) that a real payoff can be achieved by electric propulsion on orbit. Under IHRPRT, the Air Force has grouped new concepts for in-space electric propulsion systems into four types:

- Type A, orbit insertion and circularization
 - 4.5-kW Hall-effect thruster
 - 25 cm gridded xenon ion thruster
 - 20-kW Hall-effect thruster
 - XOCOT (type of pulsed plasma thruster)
- Type B, orbit attitude and position changes
 - 200-W Hall-effect thruster
 - 600-W Hall-effect thruster
- Type C, propulsion systems used to propel fly-out and maneuvering of items
 - Dual-mode thruster
- Type D, attitude control
 - Micropulsed plasma thruster
 - Colloid thruster

Each category has defined technology projects under way or planned, with the exception of Type C, which may be a mixed chemical-electric propulsion system. Thruster development and qualification in each category is appropriate. Many of the concepts in the four types are already in use on commercial communication satellites, giving the Air Force leveraging opportunities.

The statuses of the 4.5-kW Hall-effect thruster and the 25-cm gridded xenon ion thruster have already been given. Other projects going forward are investigations and developments to scale Hall-effect thrusters to higher power, from the current 4.5 kW to 20 kW (by 2009) and, eventually, 500 kW. A major issue for both the gridded ion and Hall-effect thrusters is extending the lifetimes as propellant throughput requirements increase. Several Air Force and NASA contracts are under way for carbon-carbon ion optics and carbon grid materials. Successful development of carbon grids promises to increase the operating life

of a NASA Solar-Electric Propulsion Technology Application Readiness (N-STAR) engine by a factor of 5 to 10 and to allow increasing the thrust and I_{sp} by up to 60 percent.

For Hall-effect thrusters, NASA Glenn is investigating ways to mitigate the life-limiting mechanism of Hall thrusters, which is the erosion of the discharge chamber where the plasma is ionized and accelerated. If the concepts being pursued are successful, the lifetime of Hall thrusters will be extended beyond the 8,000- to 10,000-hr lifetimes presently available.

Additional areas of concern associated with electric propulsion are plume effects and the deposition of materials on spacecraft parts. AFRL is providing the code for Lockheed Martin to model and simulate the interactions between the 4.5-kW Hall thruster and the spacecraft. AFRL is also using modeling and simulation to predict Teflon deposition on FalconSAT-3 from its PPT thrusters. These predictions will be validated in orbit when the FalconSAT-3 is launched.

The IHRPT Phase II goal of achieving a 35 percent increase in I_{tot}/M_{wet} was demonstrated by thruster lifetime tests on a Busek 200-W Hall thruster, which completed approximately 1,500 hr of total firing time. No change in performance was observed over the lifetime. The 200-W Hall-effect thruster and a Busek 600-W Hall thruster could be used for drag make-up, station keeping, repositioning, and orbit transfer of a microsatellite. Characteristics of the 200-W and 600-W thrusters are shown in Table 5-7.

TABLE 5-7 Characteristics of 200-W and 600-W Thrusters

| Characteristic | Hall-Effect Thrusters | |
|------------------------------|-----------------------|-------|
| | 200W | 600W |
| Dry mass (kg) | 6.1 | 10.2 |
| I_{sp} (sec) | 1,400 | 1,700 |
| Thrust (mN) | 13 | 36 |
| Minimum impulse bit (mN-sec) | 5 | 30 |
| Power (W) | 200 | 600 |
| ΔV (m/s) | 4,000 | 4,400 |

SOURCE: Sackheim (2006).

Although the propulsive needs and the thrusters to satisfy those needs have been put into four categories, it is assumed that for any new mission the overall requirements will be evaluated before specific thruster types are selected. While one type of thruster may be best for, say, attitude control, because it has a much higher I_{sp} than is achievable with a chemical system, the dry mass of too many different propulsion systems might outweigh the advantages of higher I_{sp} .

Propulsion for Strike and Tactical Missiles

Missile propulsion is a very important application of rocket propulsion for many types of DoD weapons. All the warfighting Services (the Army, the Air Force, the Navy, and the Marine Corps) rely heavily on various types of rocket-propelled missiles for both defensive and offensive purposes. Currently, the largest category of missions in which missiles are used is tactical missions. The missiles include surface-to-surface; surface-to-air; air-to-air; air-to-ground, and they are launched from all types of platforms toward all types of platforms in all known media—space, air, land, on the water, and under water.

Currently, almost all these missile types except the Navy's submarine-launched ballistic missiles/fleet ballistic missiles (SLBMs/FBMs) use standard Class 1.3 (hydroxyl-terminated polybutadiene/ammonium perchlorate (HTPB/AP) solid propellant rocket motors. All Navy SLBM/FBM submarine-launched missiles (i.e., Trident class) utilize Class 1.1 double-base, solid propellant rocket motors. Very little new work, other than some advanced materials for lighter weight cases and nozzles and some limited ingredients to minimally improve propellant characteristics and to replace obsolete ingredients, has been conducted over the last 10-15 years to improve solid rocket motor propulsion systems for missiles by the S&T elements of the Services and the Office of the Secretary of Defense

(OSD). The IHRPT program has supported some explicit advanced missile propulsion research and technology (R&T) activity to achieve some significant payoffs, but these are proving to be somewhat unrealistic for application in the medium term. Most of the IHRPT support for solid rocket technology has been for strategic sustainment to maintain some type of solid rocket motor strategic capability and industrial base.

The Navy has done some work with much higher combustor operating pressures (between 2,000 and 3,000 psia), but this work has not been very successful, owing to the extremely erosive and destructive forces on the nozzle, especially at the throat. The Army has also done some advanced work to achieve trajectory and energy management using gelled (conventional storable liquids) propellants and pintle-in-the-throat throttleable solids. Also, work has been done by both the Army and the Navy to integrate minimum-smoke, minimum-signature propellants, but at the cost of performance and durability. This work has achieved some success in various areas, especially in increased missile range, accuracy, and real-time retargeting, using gelled propellants for energy-managed propulsion systems. For example, the Army was able to flight demonstrate doubling the range of a tube-launched, optically tracked, wire-guided missile (TOW) antitank missile from 4 km to 8 km and still hit the intended target.

For one reason or another, none of these improved propulsion technologies or any other propulsion technology advancements of any note has so far been transitioned into any operational system. Such transitioning clearly needs to be achieved if the military is to develop more capable, smarter, troop-friendlier, and safer defensive and offensive missile systems (as listed above) for future critical DoD missions.

As mentioned in the description of the IHRPT program in Chapter 4, the program is a joint government and industry effort focused on affordable technologies for revolutionary, reusable, and/or rapid response military global reach capability. IHRPT goals for improvements in propulsion systems for tactical missiles are shown in Table 5-8.

TABLE 5-8 IHRPT Goals for Improving Propulsion for Tactical Missiles (percent improvement)

| Goal | 2000 | 2005 | 2010 |
|---|------|------|------|
| Improve delivered energy | 3 | 7 | 15 |
| Improve mass fraction without TVC/throttling ^a | 2 | 5 | 10 |
| Improve mass fraction with TVC/throttling | 10 | 20 | 30 |

^aTVC, thrust vectoring control.

SOURCE: Huggins (2005).

These are extremely difficult goals, and most of them are proving to be somewhat unrealistic for the medium term. The solid propulsion industry and technology groups have run into a ceiling when it comes to increasing chamber pressures as a way to increase delivered impulse per unit volume in tactical missiles. That ceiling is dominated by the throat erosion that occurs with the best materials that experts have been able to devise. It has prevented using a number of high-energy new propellants, which have inherently higher chamber temperatures and higher throat velocities; in many cases, as well, their products of combustion are chemically incompatible with nozzle materials, all of which results in unacceptable throat erosion. People speak of solutions, but they are unable to demonstrate them with acceptable margins. This is the primary need area for new technology conceptual thinking and investment. Case weights, TVC, control systems, turn-down ratios, etc. will all improve with normal investment, but major increases in density I_{sp} without incurring significant increases in operational risks remain elusive.

CRITICAL TECHNOLOGY NEEDS THAT CALL FOR MORE ATTENTION

A number of important engineering data and technology improvement needs could be made a significant part of the basic science and technology (S&T) program for electric propulsion called for in Recommendation 5-1. The prioritization and scheduling of work to address these needs within the overall S&T budget could come out of an objective review of Air Force in-space mission plans. Specific

technologies would be identified based on systems engineering analysis optimized for those missions. The committee now describes those needs but does not give specific recommendations.

Specific Needs

Near Term

One goal of IHPRPT Phase II is to characterize spacecraft/plume interactions. There is a near-term need for in-space validation of modeling and simulation predictions of Hall thruster plume/spacecraft interaction. The successful June 2006 flight of a Northrop Grumman/Busek 200-W Hall electric thruster may provide some data to anchor the models.²

Far Term

- *System-level tasks.* For all electric propulsion thrusters at any power level there is a need for developing PPUs and propellant management technologies and for assessing spacecraft integration issues.
- *Reducing the mass of PPUs.* The most promising approach to this appears to be a solar-electric drive that uses a high-voltage solar array to provide power directly to a Hall thruster. Increased funding is needed to advance this technology.
- *Hall thruster life.* The life of Hall thrusters is being limited by the erosion of the discharge chamber in which the plasma is ionized and accelerated. Erosion is attributed to ion bombardment of the chamber by energetic particles. Erosion of the magnetic circuit elements alters the topography and changes the thruster's operational characteristics. Some potential solutions should be further investigated:
 - Develop chamber materials to lower sputter yield,
 - Increase the radial thickness of the channel,
 - Control the plasma magnetically,
 - Move ion acceleration outside the thruster plane,
 - Refresh channel material as the discharge channel erodes. In the ceramic thruster concept, the boron nitride channel is extended to protect the magnetic components.
- *Hall thruster propellant options.* Investigate replacing xenon with krypton. Krypton is attractive for missions requiring both high I_{sp} and high-propellant throughput. An issue for further investigation is whether krypton would be preferred to xenon at the thruster power levels now chosen for xenon Hall thrusters.

Other Needs

Industrial Base

A bigger industrial base than presently exists is required to assure the production of complete electric propulsion systems (thrusters, fuel, and PPUs). For Hall electric thrusters, there appear to be two sources: Aerojet Redmond and Northrop Grumman/Busek. L-3 Communications Electron Technologies, Inc., and Aerojet Redmond are sources for gridded ion thrusters.

²For additional information on the successful June 2006 flight of the 200-W Hall thruster, see the Air Force Research Laboratory web site at <http://afrlhorizons.com/0001/t.html#Aug06>. Last accessed on November 22, 2006.

Higher Power Electric Propulsion

Development of operational electric propulsion systems at significantly higher power levels, from 10 to 150 kW, requires a coordinated research, design, and systems engineering effort. There are many development stages that must be sequentially accomplished. Success will require broader participation from NASA centers, DoD, and industry.

SCARLET: An Existing Technology That Could Be Leveraged

Power sources are especially critical to electric propulsion. The solar concentrator arrays with refractive linear element technology (SCARLET) is a concentrator solar array for space applications that uses linear refractive Fresnel lenses to focus sunlight onto spaced rows of solar cells. The technology has been flight qualified and flown on Deep Space 1, and its in-space performance was validated. The advantage is that for a given power level the SCARLET optical system reduces the required solar cell area by a factor of approximately 7. The decreased cell area significantly reduces solar array cost and weight, especially for high-radiation environments where thick cell cover glass is required. Use of this technology might enable more powerful Hall thrusters.

CURRENT WORK ON PROPULSION

The IHPRT missile propulsion technologies are grouped under three propellant categories: solid propellant motors, hybrid motors, and gelled propellant motors.

Solid Propellant Motors*Air Force Research Laboratory*

At AFRL, in-house work in solid motor design and hardware demonstrations appears to be minimal. Basic, essentially research-level work in a number of very advanced areas seems to be of high quality. However, the committee does not have enough information about the actual future requirements for DoD and Air Force airborne missiles, particularly for responsive near-space operations, to allow it to objectively prioritize these projects.

Past in-house work at AFRL dealt with testing insulation materials and testing new oxidizers for solid propellants. All of this work has been concluded. Current efforts are concentrating on preparations to support the Land-Based Strategic Deterrent. To this end, facilities are being upgraded to formulate propellants in-house and to test the new propellants that will be developed by industry.

Finding 5-3. The committee perceives a very important need for the AFRL at Edwards to have really capable in-house test beds in order to develop solid motor and liquid propellant engine technology and to validate design criteria. It appears that limited funding is at least part of the reason that this is not being done at the present time.

Recommendation 5-3. The Air Force and DoD should establish an explicit plan with appropriate funding to develop really capable in-house test beds for developing the technology for motors using solid propellants and engines using liquid propellants and for validating design criteria.

Phase III Solid Rocket Motor Modeling

No significant changes to solid rocket motor models have been made for 20 years. The intent of this program is to develop and validate the computational tools needed to support IHPRT Phase III goals: a 35 percent improvement in mass fraction, 26 percent improvement in specific impulse, 35 percent reduction in hardware, operational, and support costs, and a 75 percent reduction in stage failure rate. The

intent is to replace empirical models with more physics-based models. The goals of the programs are to conduct trade studies at the system, subsystem component, and material levels to refine technology selection and evaluation, to develop and validate the advanced computational tools needed to support design/analysis of advanced concepts, to identify and correct deficiencies in material property information needed to support program objectives, to perform initial validation of motor component materials and design suitability to meet Phase III goals through Battlefield Artillery Tactical Engagement System (BATES) motor tests, and, finally, to update three candidate motor designs.

Characteristics of Energetic Propellant

Little work has been done recently on trying to obtain energetic propellants. The objective of this program is to rectify that lack by developing and demonstrating the scale-up of energetic propellant formulations. The steps to be undertaken include a literature search and evaluation of ingredients, followed by ingredient downselection. Then, a small amount of mix will be formulated. Pint mixes will be next, followed by scale-up of select formulas to 1 gal. Then, 5-gal mixes will be made. The program will conclude with 15-lb BATES motor firings.

Sensor Application and Modeling

This program seeks to avoid missile failures by using sensors to measure aging properties without adversely impacting the structural or chemical integrity of a motor. This will be accomplished by conducting a literature search and evaluation of all available sensors, followed by downselection to mature sensors. Then, inert-propellant 5-in. instrumented composite motor tubes for laboratory-scale work will be built and cast with defects. Based on the results of this, an inert-propellant 10-in. instrumented motor case will be built and cast with and without defects. Testing will then determine whether the sensors can identify the defects.

Alliant Techsystems

Alliant Techsystems (ATK) is a leader in solid rocket propulsion, composite structures, munitions, precision capabilities, electronics, navigation, communications, and hypersonic research. It has significant technology programs in solid rockets. Its efforts range from developing mathematical and analytical models and exploring the basic science of materials to developing components of all kinds to conducting integrated demonstrations. These programs are both internally and externally funded, with some cooperative agreements in place for joint development efforts. ATK has been an active participant in the IHPRPT program since its inception and has demonstrated Phase I performance for both boost and orbit transfer motor types. ATK is nearing completion of an IHPRPT Phase II boost demonstration program and is actively working on component development for Phase III. Figure 5-8 identifies the areas where ATK is developing technologies that address critical problems or limitations of current solid rocket motors and missile systems.

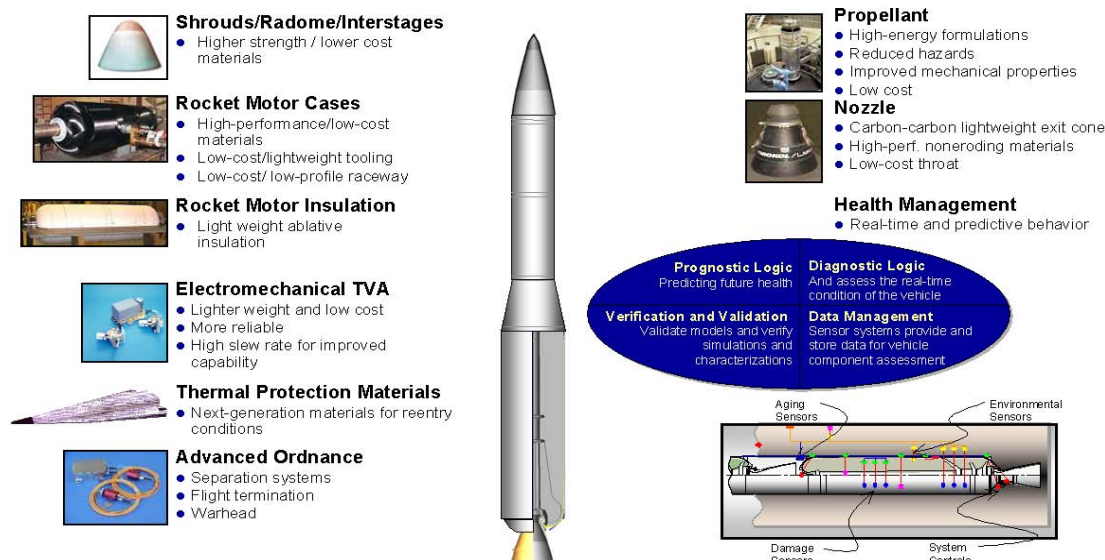

FIGURE 5-8 Technologies at ATK. SOURCE: ATK Tactical Systems Company.

Tactical Missiles

ATK Tactical Systems Company, in Rocket Center, West Virginia, is a part of ATK's Precision Systems group; it focuses on tactical propulsion programs—advanced medium-range air-to-air missile, Sidewinder, Sea Sparrow, TOW missile, ballistic trajectory extended-range munitions, Maverick, and Hellfire. This facility also undertakes metal parts manufacture, laser ordnance, warhead loading, fuses, and missile manufacturing (the advanced antiradiation guided missile, an advanced version of the high-speed antiradiation missile). Technology programs at ATK Tactical Systems focus on tactical propellants and controllable motor configurations as well as on variable-flow ducted rocket ramjets.

ATK Elkton, located in Elkton, Maryland, is a part of ATK's Advanced Propulsion and Space Systems group. ATK Elkton specializes in missile defense axial and divert propulsion (the third stage and kill vehicle for the Standard Missile 3; the second and third kinetic energy interceptor stages; the Orbus 1A, which is the second and third stage of the ground-based midcourse defense boost vehicle plus, and divert propulsion for the Multiple Kill Vehicle). ATK Elkton also produces STAR space motors and stages. Elkton's tactical products include small tactical motors and gas generators for the Navy that are used in vertical launch antisubmarine rockets and Harpoon missiles.

U.S. Army Missile Command

U.S. Army missile propulsion technology is focused on three high-leverage areas: controllable thrust propulsion, insensitive munitions (IM), and new materials. These areas are described below.

Controllable Thrust. Controllable thrust has the potential for significant system benefits. It can provide extended range and shorter time-to-target at middle ranges in a single system. Controllable thrust systems can reserve propellant energy for endgame performance. They can meet system requirements while being IM-compliant. Logistics costs can be reduced by replacing currently deployed single-use systems with single controllable-thrust missiles, which are flexible enough to meet evolving system requirements.

Controllable thrust for either ground- or air-launched missiles can be provided by three technologies:

- Storable liquid propellant systems provide total thrust flexibility at high combustion efficiency. Liquid propellants for tactical missiles have not found favor with any of the Services and will not be discussed further in this report.
- Gelled propellant motors provide total thrust flexibility at high combustion efficiency and meet IM requirements by storing fuel and oxidizer in separate tanks. The Army's gelled propellant controllable thrust systems will be discussed below.
- Solid propellant motors using a variable area nozzle can provide some flexible thrust capability and sensitivity of the solids at lower operational temperature.

A minimum-signature, Class 1.3 propellant with a variable area nozzle demonstrated a 50-sec test with multiple thrust variation, no gas leakage, and minimal hardware degradation. Trade studies have shown that pulsed solids can increase range 15 to 30 percent over boost-sustain systems. Static testing has shown successful pulse motor tests without barriers and low-pressure smoldering with a return to full-boost thrust. In addition to the Army in-house program at Huntsville, Aerojet and ATK have contributed to recent advances in controllable thrust solid technology. Controllable thrust systems are being considered for upgrades for three emerging missile systems in the FY08-FY10 time frame.

Insensitive Munitions. The challenge for solid propellant formulators is that high-energy propellants generally yield more violent IM test results. There is no such thing as an IM propellant formulation. IM, however, is a system issue and can be achieved by case material and engineering design. Current minimum-signature solid propulsion development includes the development of less-sensitive propellant formulations, case materials, and case venting.

New Materials. As a part of the Ordinance Environmental Program, the Army is developing a non-Pb, minimum-signature, Class 1.3 solid formulation. The goals for the new solid propellant formulation include a specific impulse range of 230-240 lbf-sec/lbm, a burning rate of 0.2-0.6 in./sec at 1,000 psi, a burning rate exponent >0.5 , and a dependence of motor chamber pressure on initial propellant temperature of >0.15 percent per Fahrenheit degree. The plan is to reach a TRL of 6 by the end of FY08.

Hybrid Motors

U.S. Army Hybrid Controllable Thrust Motor

A hybrid propulsion system is being evaluated as an IM-compliant alternative to nonammonium perchlorate solid propulsion systems. As shown in Figure 5-9, two types of hybrid rockets have been considered: (1) a classical hybrid rocket (conventional design) in which liquid or gelled oxidizer is injected into the port(s) of the solid-fuel grain or the fuel-rich propellant grain for combustion and (2) a gas-generator type of hybrid rocket in which the fuel-rich solid propellant grain burns in its own combustor and the discharged products are further burned with the oxidizer-rich gases in a post combustor. In some special cases, an inverse hybrid can be considered, in which the solid grain is made of oxidizer-rich material and the injected liquid is a fuel-rich material. This design option is rarely used. The separation of oxidizer and fuel reduces the sensitivity of the propulsion system to external stimuli for improved IM characteristics developed under internal independent research and development (IR&D) funding and increases the TRLs of numerous hybrid-based systems.

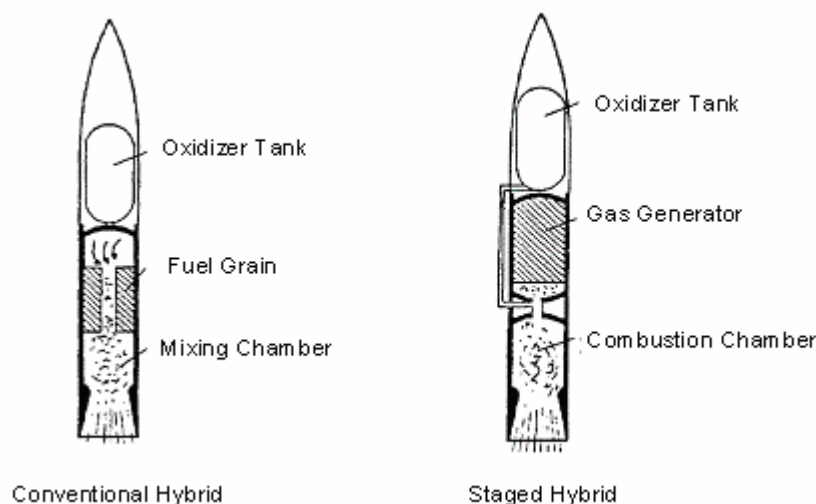

FIGURE 5-9 Hybrid missile concepts. SOURCE: Morrison (2005).

Lockheed Martin Space Systems Company

Lockheed Martin Space Systems Company (LMSSC) has worked on hybrid propulsion technologies since 1989. Its initial studies were focused on replacing the solid rocket boosters on the space shuttle after the Challenger disaster. It worked with American Rocket Company (AMROC) during the DM-01, DM-02, and hybrid technology options project (HyTOP) motor developments, which eventually led to the hybrid propulsion development program (HPDP). Within the HPDP, LMSSC tested numerous technologies that were hybrid-based systems.

Hybrid Technology Performance

The I_{sp} of the hybrid propellant combination used for the LMSSC FALCON stages at various expansion ratios is shown in Figure 5-10. Because the fuel is inert, launch vehicles or missiles that use these propellant combinations can achieve good performance and gain the benefits of having a nonexplosive propellant combination. LMSSC claims that its staged combustion system helps this propulsion system to achieve the maximum efficiency possible with hybrids. Data from testing indicate that the system is efficient enough and stable enough to be competitive with liquid- and solid-based propulsion systems.

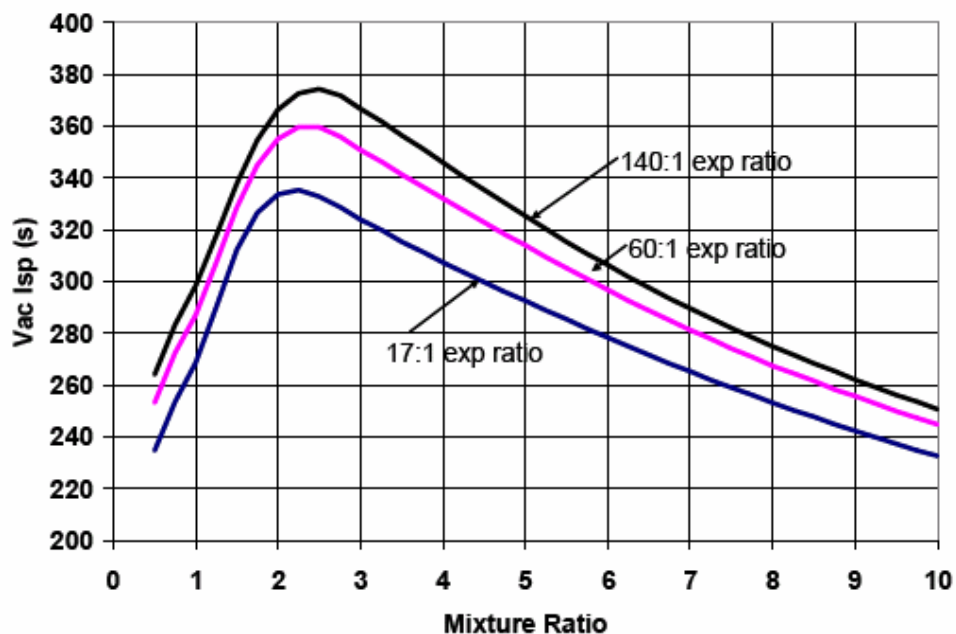

FIGURE 5-10 Hybrid motor performance at different expansion ratios. SOURCE: Lockheed Martin Space Systems Company.

Current Hybrid Technology

Lessons learned from data gathered for AMROC, HyTOP, IR&D and HPDP indicated that heat had to be added to the forward end of a hybrid motor to ensure stability and high efficiency in hybrid motors. LMSSC developed and patented an active approach, the staged combustion system (U.S. Patent 5,794,435), to accomplish this task. Figure 5-11 shows the staged combustion concept for hybrid motors.

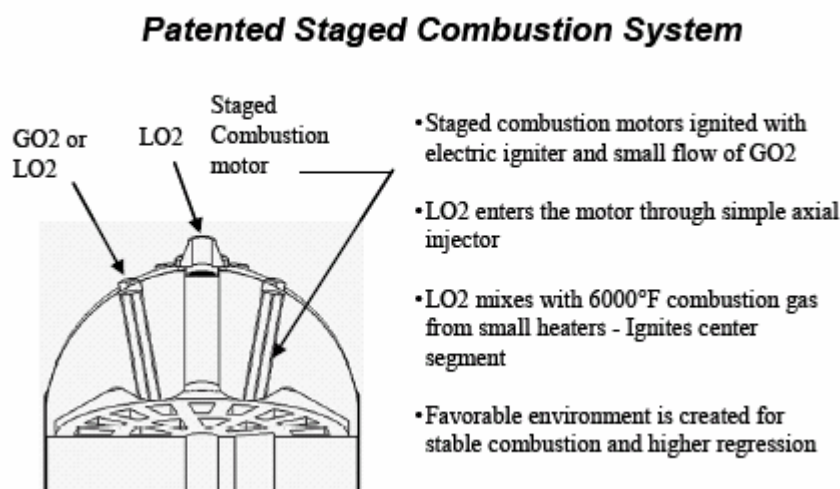

FIGURE 5-11 Staged combustion approach for hybrid propulsion systems. SOURCE: Lockheed Martin Space Systems Company.

To demonstrate the effectiveness of this concept, a series of tests were performed at various thrust levels, ranging from 1,500 lbf to 250,000 lbf. The first test of the series served as an unstable baseline test that was ignited using triethylaluminum/triethylborane (TEA/TEB). The same motor was retrofitted with

the staged combustion system and showed significantly higher performance and stability within 2.5 percent of the average chamber pressure (typical solid propulsion stability is 5 percent of the average chamber pressure). Figure 5-12 shows the results from the testing of these 1,500 lbf motors at MSFC during the HPDP.

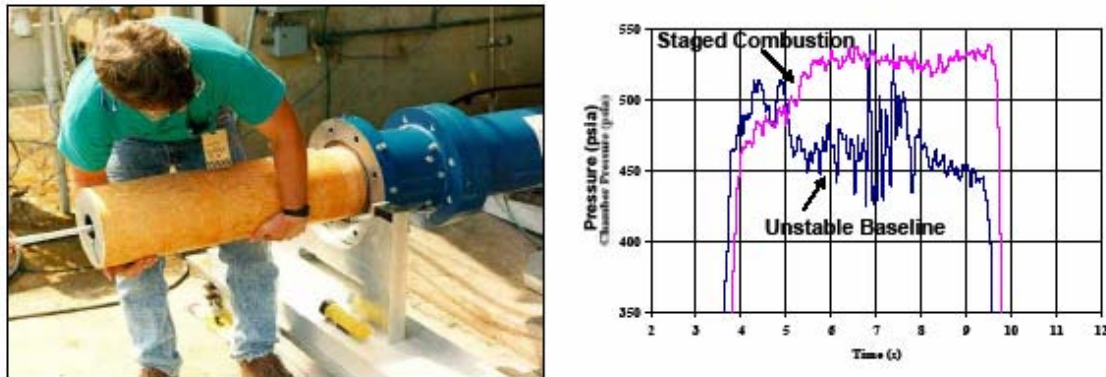

FIGURE 5-12 Staged combustion approach provided stable combustion and increased performance in the 11-in. diameter hybrid motors. SOURCE: Lockheed Martin Space Systems Company.

A unique approach, which is currently used on LMSSC's FALCON SLV first- and second-stage hybrid motors, is to employ a multirow, multiport hybrid fuel grain that allows for increasing the diameter of the vehicles beyond what could have been achieved with the single-row technology used during the HPDP. An enabling technology for this type of design is an improved hybrid fuel, which was developed under IR&D by Lockheed Martin, allows for approximately 10 times more propulsive power than the hybrid sounding rocket fuel and enables the fuel webs to become very thin prior to failure during the burn, which, in turn, allows for minimum residuals. LMSSC conducted several successful tests that advanced the state of the art for hybrid rocket motors. The most significant of these tests was a 120-sec test firing of a 30,000-lb-thrust hybrid motor at AFRL on June 10, 2005. The test, conducted as part of the FALCON SLV program, was the second SLV hybrid motor firing that LMSSC carried out that year at AFRL test stand 2-A. The company conducted six more tests in 2006. These tests demonstrated the use of a hybrid rocket fuel-rich motor in a gas generator to drive a pump turbine and tested new high-performance fuels, advanced nozzle materials, and the dramatic improvements in performance and stability enabled by the GO_x-rich upstream staged-combustion preburner.

Enabling Technologies for Hybrid Propulsion Systems

Enabling technologies for (1) storable oxidizers; (2) minimizing residual fuel grain; (3) motor insulation compatible with hybrid combustion products; and (4) materials for the nozzle throat that inhibit erosion will be important for hybrid propulsion systems. For example, the hybrid motor technology planned at Lockheed Martin includes the development and use of storable oxidizers, higher-density-fuel formulations, programmable start/stop and restart capability, and mission-specific ability to throttle.

Filled ethylene propylene diene monomer (EPDM) insulators have been proved adequate for solid propulsion systems. With hybrid systems, rubber-based insulators act as fuel and have been shown to erode relatively fast when exposed to hybrid exhaust constituents. Insulation materials compatible with hybrid combustion products need to be improved to accomplish the run-to-empty goal. Future hybrid motor insulators will need to serve as a structural element during the initial burn, when the chamber pressure loads are highest, and will need to withstand erosion when exposed. Material testing in a relevant environment will enable minimum fuel residuals and lower the overall mass of inert insulation material.

Test data indicate that the nozzle throat materials typically used for solid propulsion systems, such as three-dimensional carbon-carbon and ATJ graphite, erode fairly quickly in a high-pressure environment

containing the combustion products of hybrid motors. Rapid nozzle throat erosion does not affect the hybrid fuel burn rate, but it does reduce the nozzle expansion ratio and chamber pressure as a function of time, which eventually degrades performance.

Nozzle materials that are more compatible with hybrid propulsion systems will have to be identified and developed. Alternatively, cooling techniques, such as film cooling with the fuel or the on-board oxidizer, could be employed to reduce throat erosion rates well below 5 mil/sec. This will be necessary for long-duration missile motor burns.

Residual hybrid fuel on an upper stage translates directly to payload mass, which contributes to the physical size of a hybrid missile propulsion system as compared with a solid or liquid stage. Reducing the amount of fuel residual will decrease the physical size of hybrid propulsion systems, making them comparable to other systems. Future hybrid fuel grains will need to be tailored for the fuel webs to merge as a function of time to drive the fuel residual share well below 2 percent of the total fuel on board. Also, fuel structural strength will need to be improved and long-duration testing will be required to advance the current state of the art.

Gelled Propellant Motors

Gelled propellant motors can provide total missile thrust flexibility at high combustion efficiency and meet IM requirements by storing fuel and oxidizer in separate tanks. Controllable thrust can provide significant system benefits. It can provide extended range and shorter time-to-target at midranges in a single system and can reserve propellant energy for endgame performance. Gelled propellants can meet operational and handling requirements. Gel propulsion for airborne missiles has the potential to be inherently insensitive to IM threats because the fuel and oxidizer are stored in separate tanks. Gel propulsion systems have passed bullet impact, slow cook-off, fast cook-off, and shaped-charge jet IM tests. Logistics costs can be reduced by substituting a single controllable-thrust missile for currently deployed single-use systems. They are flexible enough to meet evolving airborne missile system requirements.

U.S. Army, Huntsville, Alabama

Gel propulsion systems have flown successfully during two tests of systems to integrate future missile technology and have demonstrated operability at minus 40°C while maintaining 96 percent of ambient thrust and 97 percent of its ambient-density specific impulse. A throttling gel engine using a passive pintle demonstrated a turndown ratio of 12:1 while maintaining >98 percent I_{sp} efficiency.

In addition to the Army in-house program, Northrop Grumman, Aerojet, Stone Engineering, and the ORBITEC-CFDRC team have contributed to recent advances in gel propulsion technology.

Northrop Grumman Corporation

Solid propellant motors have been almost universally used in tactical aircraft-borne missiles. Generally these solid motors are simple fixed-thrust booster stages. Flexible flight profiles and endgame maneuvers are not well suited to solid propellant motors. Although solid propellant motors with variable plug nozzles can be throttled and can sometimes be shut down and restarted, their operating profile throughout a long fly-out mission is quite limited. Storable liquid propellant rocket motors have much more flexibility in operating profiles. However, handling and leakage have always been of concern. Also, liquid propellant systems tend to have lower density. Because aircraft-borne missiles are usually volume constrained by aircraft configuration, lower density can mean the aircraft is not able to carry as much total impulse. Although the I_{sp} of liquid propellant can be higher than that of the best solid propellants, their density impulse may only just match that of solids.

The development of gelled-liquid propellants over the last 20 years has provided attractive options for very demanding flight profiles. Gel-propellant formulations with very-high-density specific impulse have been demonstrated. These gels have the physical consistency of heavy toothpaste and can be stored

indefinitely with no leakage. In fact, they can be frozen at extremely low temperatures and then rapidly thawed out for use with no detrimental effects. They also do not have the time-dependent deterioration issues experienced by most solid propellant grains and case bonds.

Under high shear loads, gelled propellants behave like normal liquids. They can be throttled, shut off, and restarted when using the right type of injectors. They can be pulsed with variable off times up to almost any value demanded.

Design criteria for gelled-propellant rocket systems for missiles of almost any size have been validated at Northrop Grumman Corporation. The critical components of a system are these:

- A special injector that permits throttling and no-dribble shutoff and restart,
- A coaxial-piston bipropellant tank system, and
- A gas-generator-piston pressure system.

The key technology for enabling the flexible multistart and thrust profile tailoring is a face shutoff injector. For this application, a single central-element pintle injector turns out to be ideal. With a single sleeve, both the oxidizer and fuel can be throttled while maintaining absolute control of the mixture ratio at all thrust levels, and the engine can be shut off at the face so that neither gelled propellant can evaporate at shutdown. This injector is essentially the same as the type used for the Lunar Module descent engine. It delivers efficient combustion with absolute dynamic stability. A cutaway illustration of an injector with a face shutoff configuration is shown in Figure 5-13.

Finding 5-4. The very high packaging density and optimized thrust profiles possible with these gelled propellant systems can significantly increase the range for a given fly-out missile envelope. This can also be an advantage for in-space fly-out missiles or responsive space tugs.

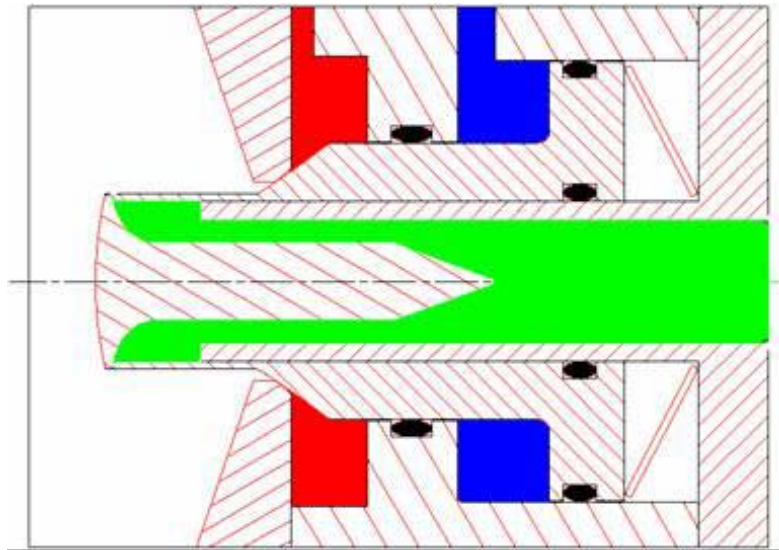

FIGURE 5-13 Controlling sleeve shown in shutoff position (center flow is oxidizer; flow around the sleeve is fuel). SOURCE: Northrop Grumman Corporation.

Recommendation 5-4. DoD should ensure that the development of advanced tactical missiles, responsive global-reach missiles, and antiballistic missiles (ABMs) satisfies four key requirements: effective energy/trajectory management; higher-energy-density performance; minimum smoke exhaust; and insensitive propellants. The S&T part of the DoD/Air Force strategic plan for missiles should focus on the technologies and design criteria necessary to meet these goals. The committee's estimate of annual

funding that would be required to make reasonable progress in establishing advanced capabilities in these areas is \$20 million to \$30 million.

OPPORTUNITIES FOR TRANSFORMATION IN ACCOMPLISHING RESPONSIVE GLOBAL REACH AND ABM MISSIONS

There are a couple of opportunities for transforming the means by which certain responsive global reach and ABM missions can be achieved. Two concepts for space access launch vehicles were described and discussed in Chapter 4. The BAE Systems concept utilizes self-contained air-based vertical launch (ABVL) modules. The second system, under study by DARPA and NASA, makes use of a multimission modular vehicle (MMMV). Both air-based launch platforms could transport rocket-powered missiles to high-altitude launch points at desired geographic locations. Both would enable tremendous flexibilities in launch time and azimuth (orbital inclination) for missiles for ABM missions, tactical support, or long-range global strike. Such platforms could provide a faster response to emerging threats than is available today.

AIR-BASED VERTICAL LAUNCH CONCEPT

Launching missiles from a flying aircraft platform could dramatically improve the delivery of a warhead and decrease the time to target. High-altitude air launch allows a rocket to bypass the initial parts of a ground-launch trajectory. This part of the trajectory is where the missile's orientation is mostly vertical and where the gravity \times time losses in delivered impulse are the greatest. These losses are compounded by the reductions in thrust and specific impulse that rocket engines experience at high ambient pressures. In addition, the integrated drag losses between the ground and 40,000 feet are great. The combined effects could reduce velocity by about 3,500 feet per second. Also, even if a ground launch takes place in the best geographic location, which is not likely, the time to reach 40,000 feet can be 20 to 40 seconds. This time difference could be crucial for a boost-phase ABM mission.

Furthermore, vertical launch vs. air drop can cut many seconds off the fly-out time to target from a platform at a given location, velocity, and altitude. In the BAE concept, missiles are preloaded in a self-contained, installable vertical launch module. The module can accommodate many missiles of several types. This could permit multiple targeting for strike and tactical battlefield support. Some potential mission capabilities of a joint strike air network architecture are depicted in Figure 5-14.

MMGS GS/PGA Ground Attack Concept

Defeat ground targets with Precision Guided Munitions (PGMs) delivered quickly from great standoff

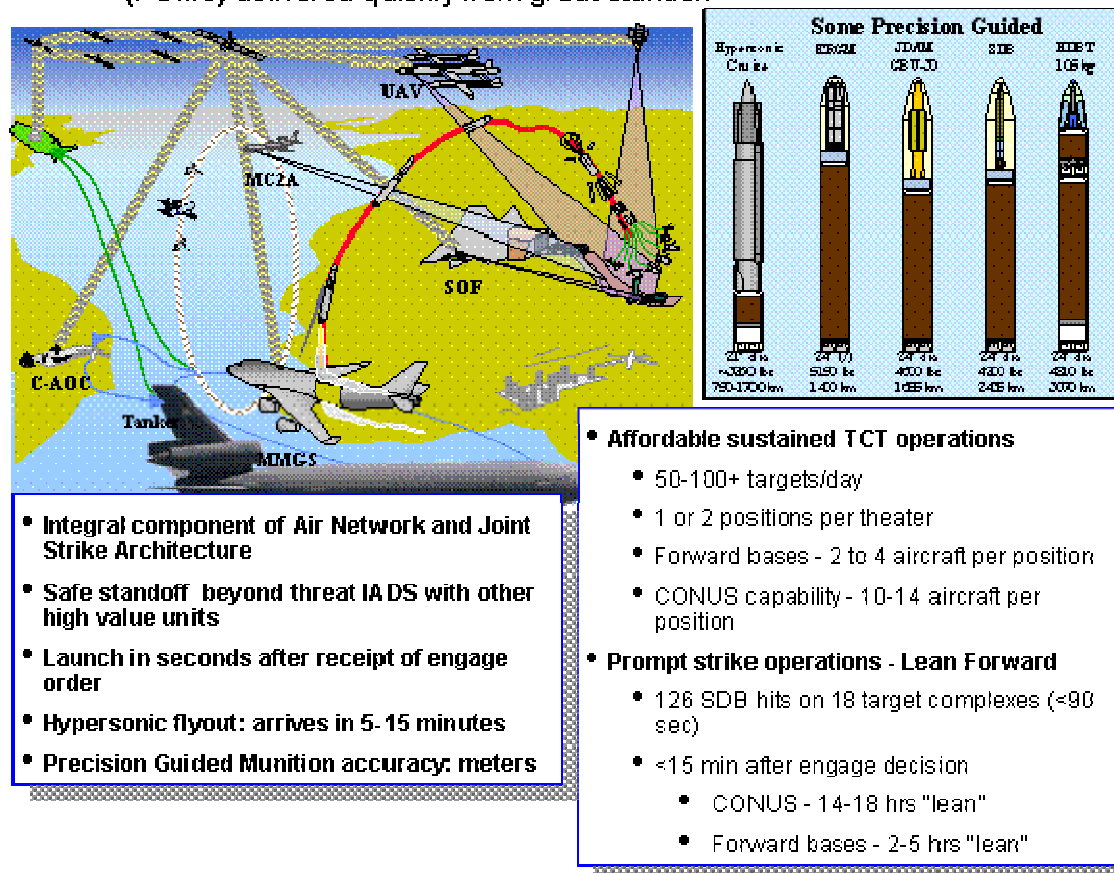

FIGURE 5-14 Multimission global shield using some precision guided missiles. SOURCE: Smith (2006).

Finding 5-5. Much of the launch dynamics and environment of an air-based vertical launch is very different from a ground-based launch, a Pegasus launch, or the candidate FALCON AirLaunch vehicle, described in Chapter 4. Characteristics for candidate missile propulsion systems (including parallel booster or strap-on combinations), along with propulsion technologies such as propellant combinations (solids, storable liquids, gelled combinations, and storable oxidizer hybrids) and operating characteristics (including assured start-up profiles, thrust vector control, and rocket plume impingement patterns) need to be optimized to take full advantage of the potential new operationally responsive mission capabilities of ABVL for global strike and near-space military applications. To exploit this launch concept, one of first technology demonstration efforts should obtain some data on launch environment dynamics needed to carry out system trades.

Recommendation 5-5. The Air Force should sponsor basic missile/environment dynamics measurements and detailed system engineering studies to fully understand the transformational potential of utilizing air-based vertical launch concepts for various types and sizes of prompt-response military missiles. The propulsion technologies that need to be evolved to take full advantage of such launch platforms should be identified and developed.

MultiMission Modular Vehicle Concept

The new multipurpose airframe design under consideration by DARPA for future applications, currently designated the multimission modular vehicle (MMMV), is described in Chapter 4. The airframe is designed in such a way that the centerline payload could be either a self-contained launching pod for multiple medium-sized missiles or a single large missile. Either configuration could also be equipped with folded rotor blades for emergency separation or self-transport.

The MMMV concept could also provide a transformational missile launching capability for large or small missiles. The aircraft can be configured with a specialized missile pod. Like the airborne vertical launcher it could transport larger rocket-powered missiles to high-altitude launch points at optimum geographic locations. The versatility of a removable centerline, self-contained, operational launcher module is key to this system's high load capacity and operational flexibility (see Figure 5-15).

Finding 5-6. Missile configurations and propulsion technologies would need to be optimized to take full advantage of the transformational potential of aircraft configured to launch missiles at high altitudes. Some of the propulsion technologies that need to be investigated include propellant combinations capable of long on-station standby (solids, storable fuels and oxidizers, gelled combinations, hybrids); first-stage chamber pressures and expansion ratios; and various operating characteristics, including assured start-up profiles, T/W profiles, thrust vector control, and rocket plume impingement patterns.



FIGURE 5-15 MMMV with missile launcher. SOURCE: NASA MFSC.

Recommendation 5-6. The Air Force and DoD should sponsor a detailed system engineering study of using the Multi-Mission Modular Vehicle air-based launch system for medium-sized vehicles could be combined in combination with a study on using air-based vertical launch for small vehicles, ensuring they are focused on Air Force/DoD mission success optimization criteria. The studies would identify the propulsion technologies (modifications or new concepts) that should be evolved in order to take full advantage of such air-based launch platforms for operationally responsive missions.

Critical Enabling Technologies

Critical enabling technologies for substantial improvement of missile propulsion operational capabilities should be redoubled to find new energetic propellants and heat- and chemicals-resistant

materials that have the potential to more fully enable DoD ground and airborne missile applications. These two areas are discussed below.

New Energetic Propellants

Prospects for the search for energetic yet insensitive propellants in the near term seem poor. Monopropellants with higher density I_{sp} may evolve first, but even if one is validated it can be expected to take many years to establish a reliable industrial product capability at an acceptable cost.

Chamber and Nozzle Throat Materials

A major problem limiting the future use of any new energetic propellants even if they become available is the lack of materials that are resistant to chemical attack and to erosion at high temperatures. The high temperatures achieved by energetic propellants will produce the same molecules as are produced by other fuels, including CO₂, H₂O, N₂, and CO. The requirement for low erosion materials is a result of the higher temperatures achieved by these propellants.

Finding 5-7. If the DoD and the Air Force are going to realize any transforming options in the specific performance profiles of tactical missiles in the far-term, a well-funded, continuous effort in energetic fuels and resistant materials is required.

Recommendation 5-7. DoD and the Air Force should fund the search for new high-energy propellants and development of very-high-temperature, chemical-attack-resistant, low-erosion-rate materials.

FINAL OBSERVATION

Actual funding levels for technology programs such as IHRPT and for sustaining and improving the engineering on tactical and strategic missiles have dropped well below the original planned funding levels. This limits the accomplishments of propulsion improvement efforts and minimizes the ability to train the next generation of designers and production specialists. Personnel demographics predict the retirement of individuals with critical skills in the development and production of large missiles and launch vehicles in this same time frame. The consequences of this situation have been eroding U.S. aerospace capability for many years. Unless a serious commitment to reversing this trend is made, the ability of the industry to provide the high-quality engineering and production capability necessary to realize the Air Force's medium- and far-term goals for access to space, in-space operations, and missiles must be considered at risk.

REFERENCES

Published

- Benson, S. W., L.A. Arrington, W.A. Hoskins, and N.J. Meckel. 1999. Development of a PPT for the EO-1 Spacecraft. AIAA-99-2276. June.
- Chien, Kuei-Ru, William G. Tighe, Thomas A. Bond, and Rafawl Spears. 2006. An Overview of Electric Propulsion at L-3 Communications Electron Technologies, Inc. AIAA Paper 2006-4322.
- Encyclopedia of Astrobiology, Astronomy, and Spaceflight (undated). Available at <http://www.daviddarling.info/encyclopedia/X/XIPS.html>. Last accessed on June 16, 2006.
- James, Larry. 2005. HLV study and analysis industry day welcome and introductions," Presentation to ARES Industry Day, El Segundo, Calif., March 7.
- Jones, F., D. Murphy, D. Allen, L. Caveny, and M. Piszczor. 1996. SCARLET: High-Payoff, Near Term Concentrator Solar Array. AIAA Paper 96-1021.
- Kaufman, H.R. 1985. Technology of closed-drift thrusters. AIAA Journal 23(1): 78-87.

- Randolph, Thomas M., John K. Ziemer, Vlad Hruby, Doug Spence, Nate Demmons, Tom Roy, Bill Connolly, Eric Ehrbar, Jurg Zwahlen, Roy Martin, and Chas Gasdaska. 2006. Microthrust Propulsion for the Space Technology 7 (ST7) Technology Demonstration Mission. AIAA Paper 2006-4320.
- Rayburn, C., M. Campbell, A. Hoskins, and J. Cassady. 2000. Development of a Micro-PPT for the Dawgstar Nanosatellite. AIAA Joint Propulsion Conference. July.
- Sankovic, J., L.H. Caveny, and P. Lynn. 1997. The BMDO Russian Hall Electric Thruster Technology (Rhett) Program: From Laboratory to Orbit. AIAA Paper 97-2917.

Unpublished

- Aerojet. 2004. Redmond Operations Datasheets.
- Aerojet. 2006. Redmond Operations Capabilities 2006-H-3029. July.
- Mike Huggins, Air Force Research Laboratory. "IHRPT overview," Background information provided to the committee on April 14, 2005.
- Michael Morrison, United States Army. "Propulsion overview and roadmap," Presentation to the committee on June 23, 2005.
- Scott Smith, BAE Systems. "Air-based vertical launch," Background information provided to the committee on January 6, 2006.

6

Cross-cutting Technologies

INTRODUCTION

This chapter discusses two technology areas that have the potential to yield dramatic improvements in aerospace propulsion—namely, fuels and materials. While the ensuing discussion and recommendations are related primarily to air-breathing propulsion, advances in fuels and materials research are applicable also to access-to-space and in-space propulsion; those applications are discussed in Chapter 4 and Chapter 5.

FUELS

Gas Turbines

One key to improved warfighter design and performance will be the total integration of a vehicle and its propulsion system. Figure 6-1 demonstrates a systems-level approach to total vehicle design, including thermal loads, energy transfer, and control systems.

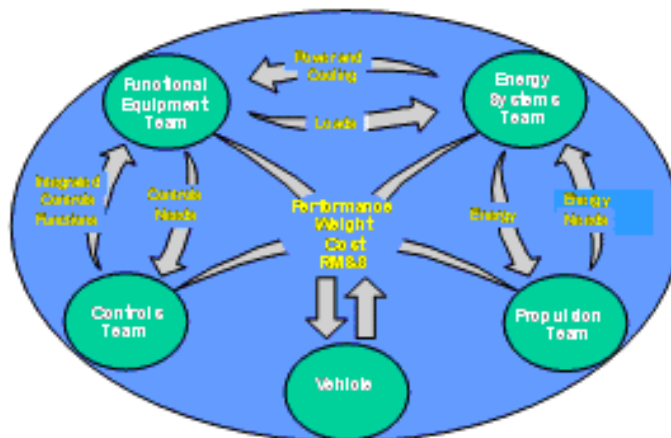

FIGURE 6-1 A systems-level approach to warfighter design. SOURCE: Burkhard (2003).

Another important issue is fuel efficiency, because a reduction in specific fuel consumption (SFC) enhances range and payload and decreases fuel costs. Gas turbines operate on constant pressure Brayton cycles, and to improve the Brayton cycle thermal efficiency requires higher turbine inlet temperatures. Not only do higher engine operating temperatures demand high-heat-sink fuels capable of cooling hot section components to preserve life and durability, but significant material barriers also prevent achieving higher turbine inlet temperatures. One way to circumvent this problem is to use a fuel to cool the cooling

air, thereby enhancing its heat sink, decreasing its mass flow, and improving engine SFC. At the same time, employing cooled cooling air (CCA) might enhance the turbine blade thermal gradient and accelerate thermal fatigue, which means the turbine materials would need better low-cycle fatigue capability. Future development of low-fuel-consumption engines with CCA or engine power generation for directed-energy weapons will dramatically increase the heat load rejected to the fuel. The fuel heat sink requirement is shown in Figure 6-2.

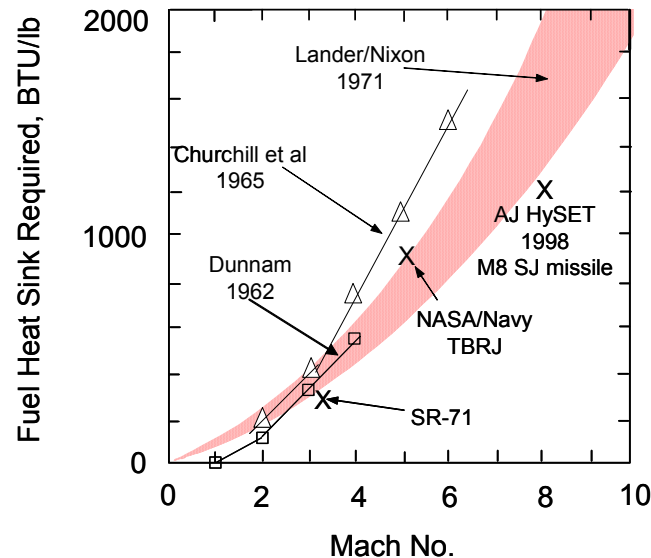

FIGURE 6-2 Fuel heat sink requirements vs. Mach. SOURCE: Edwards (2003).

The thermal management challenge is exacerbated at higher Mach numbers, where fuel temperatures can exceed 900°F at Mach 4 and 1300°F at Mach 7 (hypersonic). The problem is not the high fuel temperatures per se—it is preventing any resulting fuel system deposit (coking) from crippling the operation of the engine and limiting its life. The quality of a fuel is measured by a rule-of-thumb bulk and wall temperature limit corresponding to 2,000+ hours of fuel system life. Thus, the development and use of high-heat-sink fuel for thermal management is a paramount challenge. Research into fuel additives and deoxygenation systems is required to increase fuel system life, which is typically a few hundred hours, by an order of magnitude at temperatures above 500°F.

The Air Force Research Lab (AFRL) high-heat-sink fuel program seeks to increase the thermal stability of JP-8 from its current operating temperature of 325°F to 550°F (120 percent higher heat sink) and eventually to perfect the fuel designated as JP-900 for the hypersonic flight regime. Ideal gas turbine fuel attributes are envisioned in Figure 6-3.

Jet fuels are complex, and technology transition often involves multiple partners such as engine companies, airframers, fuel system suppliers, additive manufacturers, university researchers, the Air Force Petroleum Office, the Defense Energy Support Center, and the Air Force system program offices. Also, coordination with commercial aviation and industry through the International Air Transport Association, the American Society for Testing and Materials, the Federal Aviation Administration, and the North Atlantic Treaty Organization is required. Interchangeability of military and commercial fuels is a key logistical benefit.

AFRL has been conducting research in the following areas to enhance fuel thermal stability using fuel deoxygenation, advanced additives, and surface coatings:

- Evolving technologies such as nanoparticles could allow developing the JP-900 type fuel. Nano fuel technology shows promise in enabling advanced smart additives. Advanced fuel system

sensors (such as might be used for onboard monitoring of fuel system health) might also benefit from advances in nano fuel technology.

- Modeling of fuel oxidation and deposition would enhance the development and optimization of thermal management systems. Such modeling might allow predicting time-dependent location and quantity of deposition.
- Investigation of the effect of deposit formation on spalling and heat transfer coefficients, which in turn affect the CCA and the thermal management system, is critical to reducing turbine blade cooling air mass flow and improving engine SFC.

Attributes:

- **Efficient & Operable Over a Wide Range**
 - Multi-service/commercial capable fuel
 - High heat sink for thermal management
 - Low temperature capable
 - Barrier coating compatible
 - Non-petroleum fuels (fuel flexibility)
- **“Best Value” Cost**
 - Low cost additives vs specialty fuels
 - Fuel cost 20-50% of O&S cost, JP-7 cost ~ 3X JP-8, plus significant logistics impact
 - Modular, easily maintained, interchangeable
 - Reliable
- **Maintenance Free Focus**
 - On demand additive injection
 - Coke tolerant designs
- **Environmentally Friendly**
 - 60% of 2000 level emission reduction parameter (NO_x, CO, particulate matter)

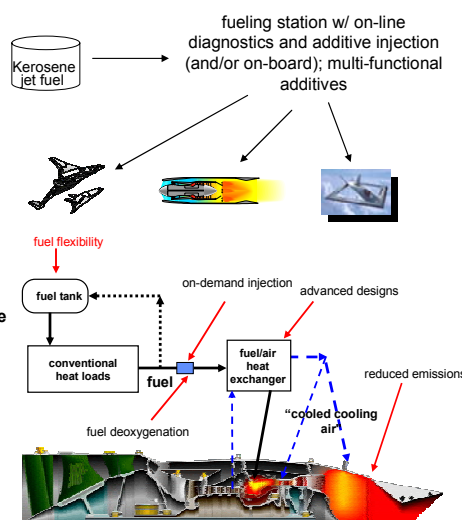

FIGURE 6-3 Gas turbine fuel vision. SOURCE: Edwards (2005).

Fuel freezing is of concern for extended-duration, high-altitude flight missions such as loitering by unmanned aircraft systems (UASs) and transpolar commercial flights. Additive formulations need to be developed to extend the lower limit of operability of JP-8, from -52°C to -60°C and lower at modest additive concentrations (ppm).

High-Altitude, Long-Endurance Unmanned Aircraft Systems

These types of aircraft missions challenge the fuel at both ends of the temperature spectrum. Long-endurance aircraft imply low SFC, which in turn implies high cycle temperature. In contrast, the fuel in the wing tanks will be cold-soaked at temperatures of -53.6°C (-65°F) or so. At that temperature, conventional jet fuel is solidly frozen. Although additives are being developed, current practice requires undesirably high concentrations ($\sim 4,000$ mg/L) to be effective. A much better solution would be an additive at a concentration of 250 mg/L, similar to the existing JP-8+100 additive. In addition, there is a gap in our understanding of the chemistry and physics of long-chain paraffins “freezing out” of the fuel, which controls the lower temperature limit of the fuel during use. Current aircraft such as the Global Hawk are pushing the low-temperature limits of JP-8. Aircraft using fuels that are not logistically supportable (such as the Predator, which uses avgas) present technical challenges. Additives that have different functionalities at different operating conditions (smart additives) would improve both the low- and high-temperature properties of jet fuels.

Small UASs powered by spark ignition engines or more efficient diesel engines will require alternative or diesel fuels with good flowability for a high-altitude, extended-loiter mission. Such fuels need to be developed to meet future warfighter needs.

Expendable Missiles with Turbine Engines

The key drivers for missile fuels are their low-temperature properties (due to long cold soak on-wing) and their high density (due to volume limitations on fuel storage). JP-10 (a single-component hydrocarbon, exo-tetrahydrodicyclopentadiene, with an impressively low freezing point of -110°F) is the current state-of-the-art missile fuel. Boron slurry fuels offer improved theoretical performance over JP-10 in terms of energy density but have poorer combustion efficiency and less efficient handling and stability. Therefore, a key technology challenge is the development of high-energy fuel that has an ultralow freezing point.

Hypersonic and Scramjets Vehicles

In many ways, liquid hydrogen is the ideal fuel; however, it has two major drawbacks from a military perspective—low density (1/12 that of jet fuel) and extreme cryogenic storage requirements. The use of liquid hydrocarbon fuels like JP-7 solves the logistics issues but raises two other important issues: (1) relatively slow combustion and long ignition delays in contrast with air speed through a hypersonic combustor and (2) limited regenerative cooling capability. The technical problem of flame stabilization needs to be solved. Fuel regenerative cooling capability above 1000°F is (again) limited by coking that occurs within 1 hour. A promising approach has been the use of wall-coated catalysts to enhance fuel cracking reactions while minimizing carbon formation. Until now catalyst selection has been largely empirical, as there is a poor understanding of the impact of fuel system conditions on catalyst performance. Thus, there is an urgent need to develop high-heat-sink hydrocarbon fuels, alternative fuels, suitable catalysts, and fuel systems.

Pulsed Detonation Engines

It is anticipated that pulse detonation engines (PDEs) will be regeneratively cooled. The fuel issues will therefore be similar to those for gas turbine engines (GTEs)—namely, minimizing coking and fuel system deposition in JP-8 fuel and maximizing system life.

Combined Cycle Engines

There are apparent payoffs for using the same fuel for both cycles in combined-cycle engines (one set of tanks, one fuel system/pump, etc.). Accordingly, the use of a highly thermally stable kerosene (jet) fuel for rocket- and turbine-based combined cycle engines would seem to be a good idea, and the technical challenge will be to optimize the combined-cycle performance using a single fuel.

Liquid Hydrocarbon Propellants for Rockets

For many rocket applications where propellant density is important—such as small rockets and the first stages of multistage vehicles—liquid hydrocarbon propellants are preferred to higher performance liquid hydrogen. The key issues for hydrocarbon propellants are performance (specific impulse) and stability during regenerative cooling. Hydrocarbons are relatively poor performers compared to hydrogen, with the key challenge being effective ways to add energy to the hydrocarbon without compromising the stability of the propellant during use. The current approach pursued by NASA and the Air Force is to add strain energy to the propellant by forming three-carbon rings and triple bonds. The key gap is in understanding how to add this energy without destabilizing the molecule to the point that it falls apart inside the fuel system rather than inside the combustion chamber. This is mainly a concern for rocket engines that are fuel-cooled (i.e., regeneratively cooled) since the heat is not lost to the cycle.

Current NASA and DoD research in hydrocarbon regenerative cooling has identified improvements to the current hydrocarbon propellant RP-1 to improve its regenerative cooling performance, but the

search for a usable high-energy hydrocarbon propellant is still in its infancy. Because of uncertainties in funding, NASA's role in this effort is unclear.

Modeling and Simulation of Complex Hydrocarbon Fuels

Military and commercial jet fuels contain thousands of hydrocarbons, with the mixture loosely bounded by specification requirements for boiling range, low temperature and combustion properties, and some composition limits. The complexity of these fuels has created significant gaps in the knowledge we need for modeling their physical, chemical, and combustion properties. Chemical kinetic modeling of jet fuel combustion represents a significant technical barrier to the development of better fuels and additives.

Fuel Cost and Logistics Barriers and Alternative Fuels

As described at the beginning of this chapter, fuel cost is one of the largest single contributors to aircraft operating cost and is therefore a key factor in the selection of a fuel. To reduce its dependence on foreign oil, DoD has initiated a Clean Fuels Initiative.¹ DoD intends to encourage industry to produce clean fuels from secure, diverse domestic resources for use in all military tactical vehicles, aircraft, and ships to reduce its dependence on foreign oil, its supply chain vulnerabilities, and pollutant emissions.

DoD has been working toward a more universal (single) battlefield fuel that will be usable in current and legacy systems and also in the next generations of hybrid propulsion, fuel cells, and hypersonic vehicles. For example, nine fuels are provided to U.S. forces operating in the Middle East and Afghanistan, creating supply chain inefficiencies. Therefore, DoD and the Department of Energy (DOE) are jointly working to develop, test, certify, and use jet fuels derived from coal, natural gas, and oil shale (e.g., via the Fischer-Tropsch process and coal liquefaction) and to assess their national security benefits and weigh them against cost and availability concerns. Production of jet fuels from these sources is feasible, but a number of technical hurdles remain. These include improving the lubricity, seal swell, and storage stability of these fuels and evaluating their combustion performance.

Recommendation 6-1. The Air Force should initiate a 5- to 7-year comprehensive program of fundamental fuels research. The goal of this program should be to study properties of smart fuel additives, surrogate fuels, synthetic fuel process technologies, synthetic fuels produced from feedstocks such as coal, oil shale, and biomass, and synthetic-conventional fuel blends. Systematic molecular and chemical kinetics modeling studies should be performed to establish a fundamental database of fuel and combustion properties.

MATERIALS

Advances in new materials have been an important factor in aerospace propulsion systems ever since the Wright brothers used a lightweight, age-hardening aluminum alloy in their Wright Flyer engine in 1903.

High-temperature cobalt base and nickel base alloys have allowed improving the performance and efficiency of the turbine section of GTEs for the last 50 years, through progressive increases in turbine inlet temperature. These increases have also been aided by improved cooling schemes, single crystal technology, and thermal barrier coatings. Significant improvements have also been made in materials for other sections of the engine, including compressor and disk materials, combustor materials, and bearing materials. As shown in Figure 6-4, further increases in turbine inlet temperature will have to await either significantly improved cooling of the first- and second-stage metallic blades or the incorporation of a

¹More information on the Clean Fuels Initiative may be found at <http://www.westgov.org/wieb/meetings/boardsprg2005/briefing/ppt/congressionalbrief.pdf#search=%22harrison%20clean%20fuels%20initiative%22>. Last accessed on August 30, 2006.

totally new class of materials, such as ceramic matrix composites (CMCs) or nanoscale carbon-tube-based materials.

Data from Dr. B. L. Koff, Pratt & Whitney, 1996

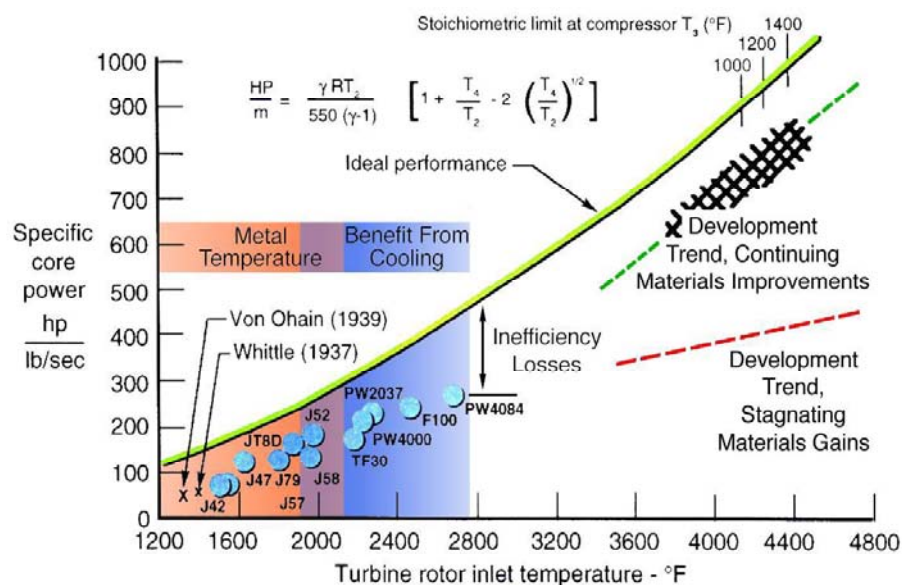

FIGURE 6-4 Materials and core engine performance. SOURCE: Hardwick (2005).

With respect to current Air Force requirements, materials in today's commercial engines are primarily stressed during takeoff and spend most of their life at much cooler cruise conditions. Military engines have temperature spikes corresponding to throttle excursions, but still most of the time the engine materials would not be highly stressed unless the air vehicle was in constant maneuver. The picture for extended supersonic operation is far different. In conceptual long-range-strike aircraft, the hot section materials spend most of their life at high temperatures and high stresses. This is a completely new regime for materials, and old solutions will not suffice under these new conditions. Degradation modes related to fatigue, creep, and environmental attack (such as hot corrosion) interact at these conditions to greatly affect component durability. In addition, the use of CCA would exacerbate the thermal gradients and, accordingly, the material challenge.

Materials limitations have also impacted the development of rocket propulsion systems, though in somewhat different ways. High turbine-inlet temperatures are not required in pump-fed rocket engines, and conventional nickel base superalloys are generally adequate for turbopumps. However, combustor temperatures, heat fluxes, and pressures are all much higher than in gas turbines, requiring either highly conductive, actively cooled structures for high-thrust engines or exotic Pt/Ir alloys running at very high temperatures for in-space engines. Other materials issues of significance include bearing materials, ablative materials, and lightweight, high-strength materials for solid rocket motor cases and ducts.

The problem of material erosion is a generic one that also affects key components in GTEs, such as compressor and turbine blades as well as rocket throats. To be sure, the solution will be different, but the need for a fundamental understanding of erosion mechanisms would be a shared need. The investigative tools developed for nanotechnology can be applied to greatly extend our understanding of erosion mechanisms and, more broadly, surface science and tribology.

The propulsion industry today, air-breathing and rocket, is taking advantage of materials and processing investments spurred by the Manufacturing Technology (ManTech) program (DSB, 2005). In retrospect, funding by the Services and DoD/ Defense Advanced Research Projects Agency (DARPA) has spawned the entire aerospace materials supply chain that exists today. As we look to a future with very limited and restricted ManTech funding, such investments are being driven by commercial engine needs, with DoD tagging along. More of the advanced work will migrate offshore. For instance, SiC fiber used

in highest temperature CMCs is supplied from Japan, and TiAl processing is rapidly advancing in Europe. Since the DoD production base is not high, these new material technologies become economical only if there are commercial applications. So there is an opportunity for realistic planning of ManTech programs that will provide baseline manufacturing technology for high-performance defense systems and will also leverage requirements of the nondefense aerospace sector.

Recommendation 6-2. The Air Force should fund ManTech at a level sufficient to enable future advances in materials for propulsion technology.

High-Temperature Structural Materials

Advances in materials for turbine engines over the past 60 years have led to higher operating temperatures that, in turn, have produced higher efficiency. However, engine technology for air-breathing engines is now pushing physical limits in both materials and design.

Current engines rely on nickel base superalloys for reusable engines and carbon/carbon composites for expendable engines. Over the past 40 years, the time between engine overhauls has increased from 500 hours to more than 10,000 hours. Metals are used for critical structural applications because of their ductility, toughness, and fracture resistance. Ceramics, although capable of significantly higher operating temperatures than metals, are too brittle for structural applications where damage tolerance is required.² A flaw the size of a human hair can degrade the strength of a ceramic by 10- to 100-fold, whereas the toughness of metals tolerates imperfections of up to a millimeter or even more. This flaw size is readily detectable by standard nondestructive test techniques: The maximum allowable flaws in ceramics are not readily detectable.

Unfortunately, most metal oxides and metal sulfides are much more stable than the metals themselves. As a result, high-temperature metals are alloyed, metallized, and coated with ceramics to improve durability. Aluminum and chromium are the principle alloying elements that produce a protective oxide scale on the metal surface. Aluminum, chromium, and platinum are the principle metallizing layers, while ceramic coatings are deposited by various methods. Nickel-base alloys containing large amounts of aluminum and chromium are the most widely used high-temperature structural materials in air-breathing engines today.

At temperatures exceeding eight-tenths of the melting temperature, or $0.8 T_{\text{melt}}$,³ all materials, even ceramics, lose their long-term strength. This phenomenon whereby a material will slowly change shape at elevated temperatures, is called creep. Current nickel base alloys, which melt at 2450°F (2900° Rankine) and operate at 2000°F (2460° Rankine), are already operating at $0.85 T_{\text{melt}}$. Thus, the workhorse engine material is pushing above its practical temperature limit.

As shown in Figures 6-5 and 6-6, refractory metals (e.g., molybdenum, niobium, tantalum, and tungsten) have much higher melting temperatures and creep strength than nickel and have been effectively added to nickel-base superalloys to improve high-temperature mechanical properties. Considerable effort has been and is being made to qualify these metals for high-temperature, long-term structural use in air. Unfortunately, the chemical bonding that gives them superior melting temperatures is the same chemical bond that has an extremely strong affinity for oxygen, sulfur, and carbon. These materials must be coated and the coatings must be perfect; if they are not, even minute imperfections in the coating can cause loss of protection and catastrophic oxidation of the airfoil.

²Although resistive to oxidative attack, ceramics are still subject to environmental degradation. For instance, silicon-containing materials undergo surface recession in combustion environments due to chemical reaction of the silica scale with water vapor (Si hydroxides, such as $\text{Si}(\text{OH})_4$, are formed through a hydrolysis reaction whereby SiO_2 reacts with H_2O to form volatile Si hydroxides. Thus, these materials must be protected with an environmental barrier coating for extended use at high temperature (see <http://www.grc.nasa.gov/WWW/RT2002/5000/5160lee.html>). Also, many ceramic materials undergo allotropic phase transformations, with associated changes in dimensions, physical, and mechanical properties that make them difficult to use in high-temperature structural applications, especially those that are subjected to thermal gradients.

³ T_{melt} must be calculated on an absolute temperature scale, such as Kelvin or Rankine, rather than Celsius or Fahrenheit.

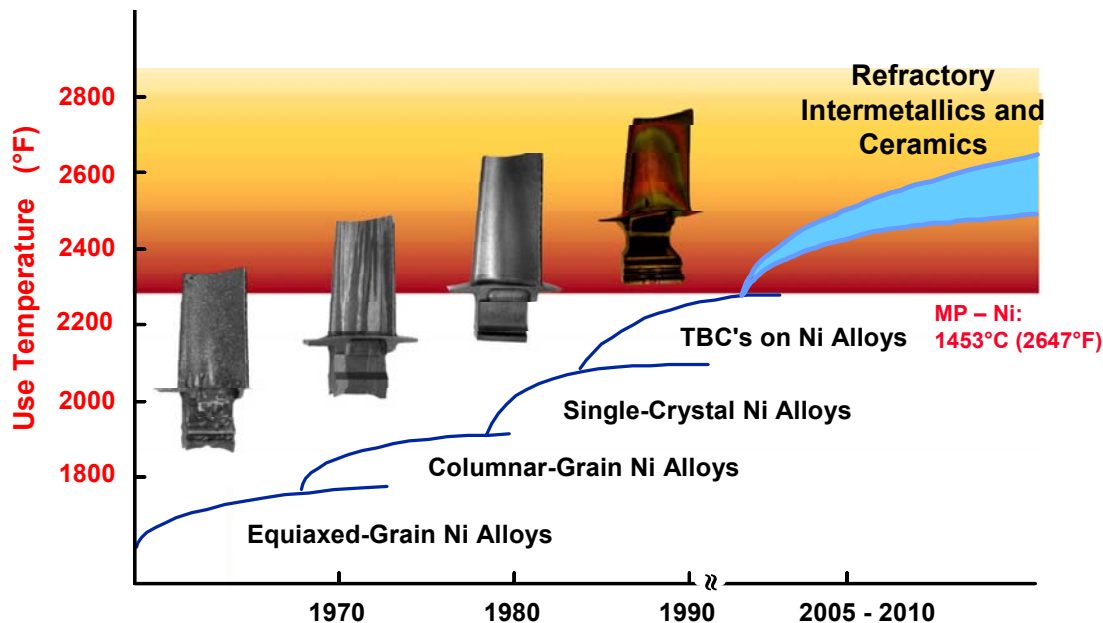

FIGURE 6-5 Advances in turbine blade alloys. SOURCE: Hardwick (2005).

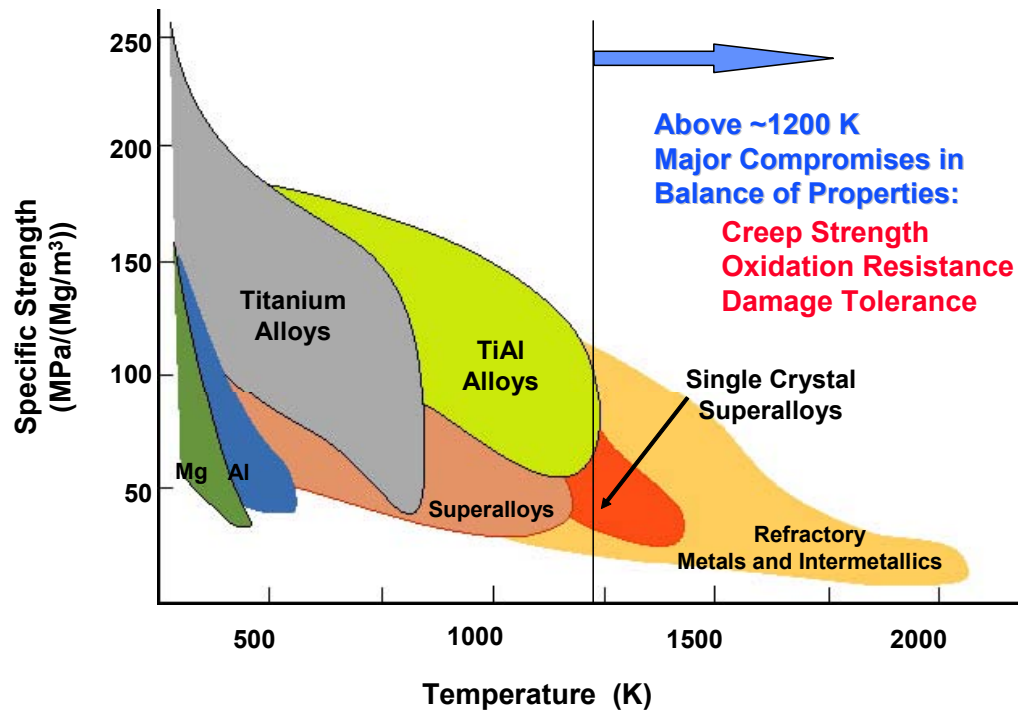

FIGURE 6-6 Strengths of advanced metallic materials. SOURCE: Hardwick (2005).

As the temperature increases, the number of metal systems available for use decreases. As technology edges toward the melting temperature of the nickel base superalloys, future improvements will require combinations of refractory metals coated with multiple layers of oxidation-resistant metals and ceramics to achieve the balance of high-temperature strength, damage tolerance, and oxidation resistance that nickel alloys have provided up to 2300°F. A quantum jump in the operating temperature of turbine blades will require a new base material other than nickel, yet only platinum has the balance of properties

required for operation at higher temperatures. The refractory metals will require new coating technologies to make them suitable for use in air-breathing engines. Ceramics will require structural support from metals to provide damage tolerance.

Intermetallics have been studied extensively for more than three decades and now show some promise as high-temperature disk materials. Titanium alloys replaced aluminum as the skin material for aircraft at high Mach numbers. But development of higher-temperature, lightweight skins will become more critical as speed and flight duration both increase.

The much higher temperature capability and high wear resistance of ceramics foretells their expanded use in the future as thermal barrier coatings, in the combustor, and in engine bearings. Only ceramics and CMC materials have the high-temperature strength for the hottest sections of engines for Mach numbers above 4 or 5. Owing to the low damage tolerance of the ceramics, these materials will require backup support from metals with lower temperature capabilities. These support metals will require active cooling and designs that permit substantial thermal expansion differences. As the materials requirements become more demanding, the designs become more complex, which escalates the cost of the system. One way to control costs is to focus on smaller-scale engine applications. Development of high-Mach-number, high-payload, man-rated applications could be delayed until the materials are proven in smaller, non-man-rated, high-Mach-number applications.

Fortunately, most of the most demanding temperatures will occur in engines that do not require long-term service and are not man-rated. Carbon/carbon composites and ceramics will find increasing use in systems that do not require safety and reliability levels deemed appropriate for humans. Knowledge gained from these short-term engines will eventually be transferred to long-term man-rated engine designs.

Combustion and Thermal Management

Augmentor Combustion Instability

Augmentor stability problems can be grouped into two areas: static stability and dynamic stability. Static stability is loosely defined as the ability to light the augmentor and ignition and to maintain the flame at lean blowout. Dynamic stability is the coupling between heat release and pressure fluctuations. One technical challenge is to develop a physics-based (rather than empirical) understanding of augmentor combustion instability. Computational fluid dynamics (CFD) and advanced diagnostic capability can be key to meeting this challenge.

Augmentor combustion is sensitive to fuel/air ratio, spray dynamics, atomization, and evaporation. Another parameter is vortex shedding. The time-dependent nature of vortex shedding and its effect on the time-dependent nature of the fuel and air at the flame are poorly understood. Currently, a transfer function for the feedback mechanism between heat release and pressure fluctuations is calibrated from rig or engine data. These calibrated models do not fare well when extrapolated outside the range where they were validated.

Fuel Injection and Mixing

Future high-performance combustors will employ supercritical injection of endothermically cracked fuel products of JP-8. Thus, rapid innovative mixing methods using CFD-large-eddy simulation modeling tools, improved endothermic models, and new fuel deposition and thermal breakdown mechanisms must be developed. Also, the compressor, combustor, and turbine interaction needs to be studied as a system.

Reactive-Film Cooling Studies

The demand for greater engine efficiency is driving future aircraft engines toward higher total temperature and higher fuel-air ratio. The radiative heat transfer to the combustor wall represents over 60 percent of the total heat flux, leading to the need for a radiation barrier coating on the combustor liner.

Such high-performance engines are facing additional durability issues related to heat release through the turbine as energetic species emitted from the combustor are further oxidized. The problem needs to be addressed for design and control of reactive cooling techniques employing endothermically cracking JP-8 fuel.

Combustor Structure and Durability

There is a need to develop a set of acceptance criteria for combustor liner life measurements, instantaneous thermal and transient loading of CMC combustors and turbine vanes, and modeling and simulation of CMC life and crack predictions.

Advanced Laser-Based Instrumentation for Diagnostics and Control

Advanced instrumentation is a key enabler for active control schemes, engine health monitoring, condition-based maintenance, and intelligent engines. Advanced instrumentation and control need to be developed for high-pressure, high-temperature combustion processes. Advanced laser instrumentation capable of operating above 10 atm and 500°C is required. Improving performance, reducing pollutant emissions, tailoring military signature, and enhancing reliability, maintainability, and affordability all demand a complete and predictive understanding of the chemistry and physics that drive gas-turbine combustors, augmentors, pulsed detonation engines (PDEs), scramjets, and other current and next-generation systems.

Future Innovative Concepts

Figure 6-7 shows the desired combustor attributes of future designs. Two innovative combustor concepts are being pursued: constant volume combustor (CVC) and the ultracompact combustor (UCC). Another combustor attribute, not included in Figure 6-7, is a SiC/SiC combustor liner that shows much greater temperature capability than a metal liner.

CVC technology shows the potential to benefit military and commercial turbofan engines and industrial power generation gas turbines. Analytical proof-of-concept studies have claimed for aircraft up to 20 percent fuel savings, a 70 percent NO_x reduction, and a 25 percent engine weight savings. CVC offers features superior to PDEs, and the substantial pressure gain across the combustion system improves SFC by 5 percent or more (Akbari et al., 2004). A wave rotor eliminates valve losses and places pulsed combustion within the device's channels to isolate pressure waves from perturbing either the compressor or the turbine. Also, use of a wave rotor simplifies the fueling and ignition systems. Finally, since the combustion charge remains at high temperature, but only for a short duration, NO_x formation is significantly reduced.

The UCC concept combines a combustor with compressor exit guide vanes and turbine inlet guide vanes, leading to a compact engine core (Sturgess et al., 2005). This UCC concept is too immature to permit any realistic comparisons of its emissions characteristics with those of other engines.

Small scale, real-time staging provides an enhanced Aero Design Space for superior performance and reduced exhaust emissions

Attributes:

- **Sustained Performance Over Wide Operating Range**
 - Optimal fuel air ratio modulation
 - Accelerated reaction rates / combustion
 - Increased Mach # / flame stabilization
 - Dual fuel system capable (liquid, supercritical)
- **Maintenance Free Emphasis***
 - Robust erosion & fatigue resistant design
 - Active health control compatible
 - Common gov/industry repair (if required)
* 4000 hr mil use life
- **Environmentally Friendly**
 - Invisible exhaust emissions
 - Reduced NOx, CO, particulate matter
 - Civil emissions compliant capable
- **“Best Value”**
 - Integrated aerodynamics (compressor, nozzle)
 - Reduced engine length, diameter, weight
 - Modular and interchangeable

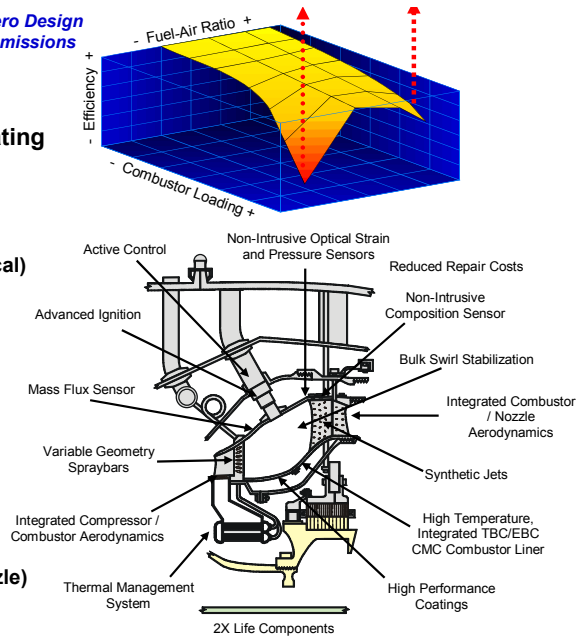

FIGURE 6-7 Desired combustor attributes. SOURCE: Arana (2005).

Air Vehicle/Engine Thermal Management

The vehicle heat loads shown in Figure 6-8 represent the power needs of directed-energy weapons and short takeoff and vertical landing lift equipment where applicable; avionics and health monitoring systems; more electric aircraft (engine start, flight controls etc.); composite airframes (with nonconvective surfaces); reduced vehicle size (UAS, microUAS); bearing/lubricant systems; and environmental subsystem cooling.

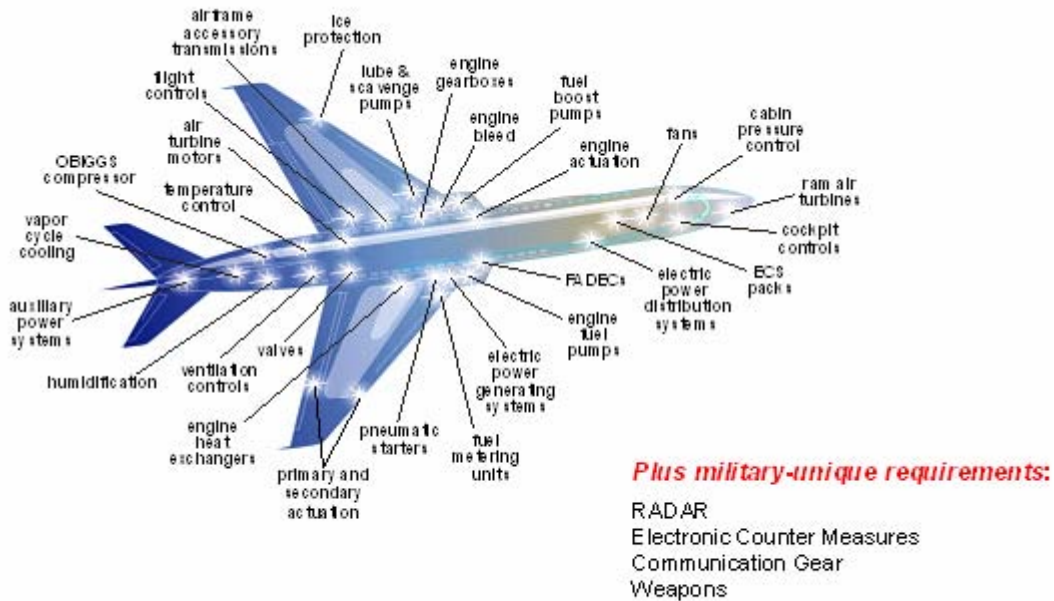

Figure Courtesy of Hamilton Sundstrand

FIGURE 6-8 Air vehicle heat loads. SOURCE: Burkhard (2003).

Also, the air vehicle mission profiles bound thermal management options. For example, a long-range supersonic aircraft cruising at 50,000 ft with Mach greater than 2 has a high heat load but also a high fuel heat sink capacity, whereas a loitering unmanned combat air vehicle has a high heat load but a low (available) fuel heat sink. The engine trends affecting thermal management are higher turbine inlet temperatures, higher performance, and high-heat-sink fuels. To meet these thermal demands requires the following:

- Integrated cooling schemes (CCAs),
- High-heat-sink fuels,
- Reduced waste heat generation,
- High-temperature materials,
- Novel cooling strategies (endothermic, phase-change materials), and
- A systems analysis thermal management approach based on warfighter needs.

Thermal management involves air/air, fuel/air, air/oil, and fuel/oil heat exchange. The candidate thermal sinks are the external environment, fan/compressor discharge air, unburned fuel, and CCA. Future warfighter design needs will include mitigating techniques such as self-cooling components, on-demand pumping, and multiple heat sinks to aggressively manage all heat generated.

Fuel is typically treated as the most desirable heat sink for aircraft and engine waste heat, but inadequate integration of the thermal management system can compromise aircraft operability. For example, aircraft have been fielded that are required to land with 500 lb of fuel in the tanks for thermal management, which directly reduces payload. In another aircraft, fuel must be chilled prior to being loaded onto the aircraft to allow sufficient ground hold time to perform equipment checks. This is logistically unacceptable. Future low-fuel-consumption engines with CCA and/or engine power generation for directed-energy weapons will dramatically increase the heat load to be rejected to the fuel (and the penalties for poor system integration). This is a system-level concern throughout an aircraft's mission.

As for the fuel itself, the challenge lies not in achieving the high fuel temperatures but in preventing any fuel system deposit formation (coking) from crippling the operation of the engine and limiting its life. Additives and fuel deoxygenation have been demonstrated to increase fuel system life by greater than an order of magnitude at temperatures above 500°F. Pratt & Whitney has successfully run a JT15D engine with JP-8 fuel at 600°F for more than 50 hours using a prototype fuel stabilization unit. In the past, such engine conditions would have required an expensive specialty fuel like JP-7.

Fuel flows and heat loads vary throughout an aircraft's time in the air (and on the ground). This thermal management challenge is exacerbated at higher Mach numbers, where fuel temperatures can exceed 900°F at Mach 4 and 1300°F at Mach 7 (hypersonic). AFRL is leading an industry consortium in the development and application of open-architecture thermal management system modeling tools to better identify air vehicle thermal management problems in the design phase. The key advance here is cooperative use of the modeling tools by the manufacturers of the airframes (Lockheed, Boeing, and Northrop Grumman), the engines (Pratt & Whitney, GE, and Allison), and the subsystems (Honeywell and Hamilton Sundstrand). An integrated approach to warfighter requirements reduces fuel usage and takeoff gross weight and provides significant heat rejection to fuel on landing. Figure 6-9 shows other benefits.

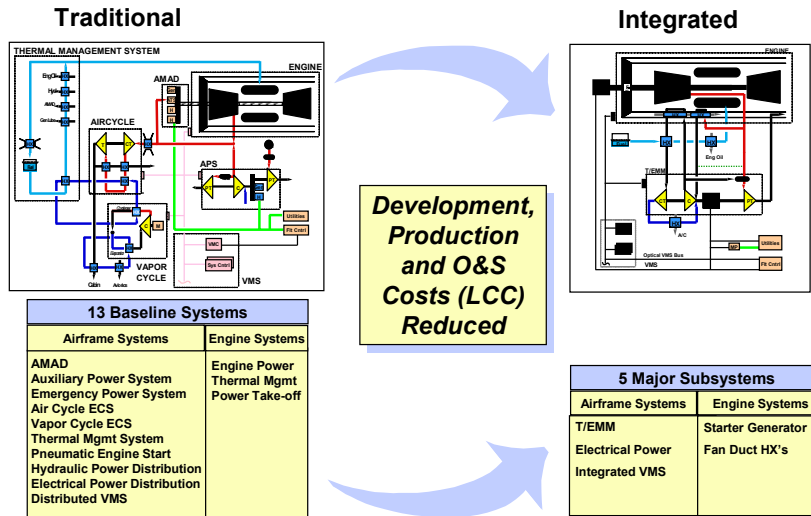

FIGURE 6-9 Benefits to the warfighter of an integrated design approach. SOURCE: Burkhard (2003).

REFERENCES

Published

- Akbari, Pezhman, Razi Nalim, and Norbert Müller. 2004. A Review of Wave Rotor Technology and Its Applications. International Mechanical Engineering Congress. American Society of Mechanical Engineers. Anaheim, California. November.
- Burkhard, Alan. 2003. Total Vehicle Thermal Integration Presentation to the von Ohain Fuels and Combustion Center Workshop on Thermal Management of Aerospace Vehicle. Dayton, Ohio, November.
- DSB (Defense Science Board). 2005. The Manufacturing Technology Program: A Key to Affordably Equipping the Future Force. Office of the Under Secretary of Defense (Acquisition, Technology, and Logistics). February. Available online at http://www.acq.osd.mil/dsb/reports/2006-02_Mantech_Final.pdf. Last accessed on August 21, 2006.
- Edwards, Tim. 2003. Liquid fuels and propellants for aerospace propulsion: 1903-2003. Journal of Propulsion and Power 19:1089-1107.
- Sturgess, G.J., Joseph Zelina, Dale Shouse, and W.M. Roquemore. 2005. Emissions reduction technologies for military gas turbine engines. Journal of Propulsion and Power 21(2): 193-217.

Unpublished

- Carlos Arana, Air Force Research Laboratory. "Combustion systems science and technology," Presentation to the committee on April 5, 2005.
- Tim Edwards, Air Force Research Laboratory. "Aerospace fuels/thermal management," Presentation to the committee on April 5, 2005.
- Dallis Hardwick, Air Force Research Laboratory. "Gas turbine engine materials," Presentation to the committee on April 5, 2005.

7

Strategies, Issues, and Funding Trends

MAXIMIZING THE RETURN ON INVESTMENT

The Department of Defense (DoD) has used long-term funding (10-15 years) of the Integrated High Performance Turbine Engine Technology (IHPTET) program—now the Versatile Affordable Advanced Turbine Engines (VAATE) program—and the Integrated High Payoff Rocket Technology (IHPRPT) program as its key strategy for advancing aerospace propulsion. This strategy—long-term, stable funding—has succeeded by enabling incremental advances. These advances notwithstanding, the committee has been asked to examine some alternative strategies.

Using the Air Logistics Center to Enhance Technology Transition

The component improvement program (CIP) for aircraft turbine engines has been utilized effectively to address safety, reliability, and materiel obsolescence in fielded engines. To improve technology transition and cycle time for incorporating new and emerging technology, a lean approach is required.

Recommendation 7-1. Engine test capabilities at the Oklahoma City Air Logistics Center (OC-ALC) should allow for engineering changes of existing hardware to be accomplished by the cognizant engineering authorities and, after configuration control board approval, for demonstrating the approved technology-enhanced hardware or accessory on the government test stand at OC-ALC. This would shorten the cycle time for introducing minor engineering improvements into the current legacy fleet of engines and reduce the overall costs to accomplish the qualification. Additionally, it would provide a test bed on which to qualify non-original-equipment-manufacturer (non-OEM) repaired or reengineered parts, new sources of repair, or non-OEM suppliers of parts.

Recommendation 7-2. DoD should change the way it manages, contracts for, and buys fuel for the existing fleet. Three years after a system enters into service, budgets for repairs, component improvement, and overall fuel cost should be transferred to the base that maintains the propulsion system. In addition, testing to qualify engine repairs and component improvements should be conducted at the facilities responsible for maintaining the engine.

In addition, there are only a small number of OEMs for engines, and each OEM has its own very specialized technical support team. Not only does an OEM fund some of its own work—known as independent research and development (IR&D)—it also receives funding for exploratory or advanced development research from the Air Force Research Laboratory (AFRL) or other service laboratories. The applicability and transition of the technology developed, if not restricted by proprietary rights or licensing agreements, lags significantly from one OEM's engine program to another OEM's engine program.

Spiral Development

History shows that spiral development has been applied to many of the Air Force and Navy fighter engines.^{1,2} For example, the propulsion systems for the F-16 and F-15 aircraft underwent spiral development to increase their thrust and reliability. Spiral development has proven to be a very cost-effective way to greatly increase the warfighting capabilities of these aircraft. The major derivative programs of these engines (e.g., the F100-220 and F100-229 versus the F100-100) bundled technology packages from IHPTET or IR&D programs to markedly improve performance. Currently, DoD is not leveraging the large F-22 and F-35 propulsion investments by providing spiral development programs to meet the requirements of these aircraft. For example, derivatives of the F119/F135 or F120/F136 engines should be considered as prime candidates to power the Global Strike aircraft.

Finding 7-1. History has demonstrated that the introduction of new technology into existing weapon systems—i.e., spiral development—can be a very cost-effective way to upgrade warfighting capability.

Recommendation 7-3. The Air Force and DoD should apply spiral development to all weapons systems that are in service longer than it takes to develop a new generation of technology.

GOVERNMENT AND INDUSTRY COLLABORATION

The committee visited most of the aerospace propulsion companies to inquire about commercial best practices and technology capabilities and to observe and study how their strategic plans incorporated these technologies into their products to improve thrust and durability and to reduce fuel consumption and weight. In most cases, the engineering processes of these companies had standard tasks like risk reduction and design review that were more in depth than the Air Force's current specification reviews—namely, preliminary design review and critical design review. A number of the companies had paperless manufacturing process sheets and paperless inspection process standards. In most cases, all of the tools were controlled in kit form, with each tool having its place in the kit, and the process could not move forward until the kit tools were used, placed back in the kit and accounted for. Again, in most cases, these processes and best practices were put in place to reduce cost and manpower and to allow the companies to be world-class competitors.

Recommendation 7-4. DoD should adopt commercial best practices to reduce costs and exploit the technical expertise of its research laboratories to enhance the integration process in its product centers and depots.

Shortening the Demonstration Time

The committee and the presenters had different views on the 1-year engine demonstrator. Some of the presenters doubted that engines could be tested in 1 year simply because there would not be enough time to complete such testing. However, committee members argued that engines or engine components could be tested in 1 year if the effort was well focused, planned out (including contingency), and

¹In the mid-1980s, Barry Boehm, then a chief scientist at TRW, Inc., devised spiral development as a way to reduce risk on large software projects. Although Boehm devised it for software engineering, the DoD has adapted the spiral development technique as part of its evolutionary acquisition strategy to get newer technologies into large platforms, such as assault vehicles and computer systems, much more quickly. More information on the spiral development methodology may be found at the Carnegie Mellon Software Engineering Institute Web site, at <http://www.sei.cmu.edu/cbs/spiral2000/february2000/BoehmSR.html>. Last accessed on August 8, 2006.

²Also known as “evolutionary acquisition,” spiral development is an acquisition strategy that defines, develops, produces or acquires, and fields an initial hardware or software increment (called a phase or block) of operational capability (OUSD AT&L, 2003).

executed. In the 1960s, 1-year testing programs were done routinely. In multiyear programs especially, frequent testing is an effective way to keep the program energized.

Recommendation 7-5. DoD and major propulsion contractors should define the process changes needed to produce 1- to 2-year technology demonstrations. Decreasing the interval between demonstrations of technology in major propulsion systems will increase the rate of technology development.

Reliance Program

In response to the Deputy Secretary of Defense's challenge to the services in 1989 to create a new approach that would increase efficiency in research, development, testing, and engineering (RDT&E), the Service assistant secretaries mandated the Defense Science and Technology Reliance Program (Reliance Program) to focus resources on propulsion requirements and capabilities (DMR 922). As mentioned in Chapter 2, the committee heard anecdotally from knowledgeable, informed sources that the Air Force was the lead service in propulsion for the Reliance Program. Since the Air Force has been by far the largest investor in the science and technology (S&T) arena in both aircraft propulsion and rocket propulsion, the committee felt this made sense. However, a review of the Reliance Program failed to identify a lead service for propulsion. In fact, the program divides propulsion into subordinate elements as reflected in the Defense Technology Area Plan (DTAP) panels: air platforms, nuclear technology, space platforms, and weapons (Ray, 2005).

Finding 7-2. The committee believes that having propulsion segmented in different DTAP panels results in overlapping, unfocused efforts from one Service to the next and from one panel to the next. Further, the panels' efforts do not produce a prioritized list of defense technology objectives. The Reliance Program, as presently structured, also does not give the panel chairs the necessary authority to enforce cooperation and discipline in program execution. Moreover, the program published its last Science and Technology Strategy in 2000. Overall, the present Reliance Program organizational construct tends to inhibit the maturation and coordination of funding for propulsion efforts from basic research to applied R&D and demonstrations across DoD.

INNOVATIVE CONTRACTING MECHANISMS

This section discusses the issues and opportunities associated with a large and growing portion—sustainment—of DoD expenses for aircraft propulsion systems. As shown in Figure 7-1, approximately \$4.2 billion of the total \$7.1 billion annual DoD gas turbine propulsion budget is spent on the sustainment of existing engines. In addition, fuel for the existing fleet (assuming a very conservative \$1/gallon) is estimated from FY04 data to cost \$4.7 billion annually.

The projected weapon system force structures for the next 15 to 20 years indicate that current systems will dominate and that new systems will be acquired at slower rates and smaller numbers than the legacy fleets they replace. This will lead to ever-increasing aging of the DoD gas turbine fleet. By 2020 most of the existing gas turbine propulsion systems will have reached or exceeded their design life and will need service life extensions. Unless strong action is taken, the growing proportion of the DoD propulsion budget allocated to sustainment of and fuel for the existing fleet will become a death spiral, wherein the portions of budget allocated to technology and development budgets must be always reduced.

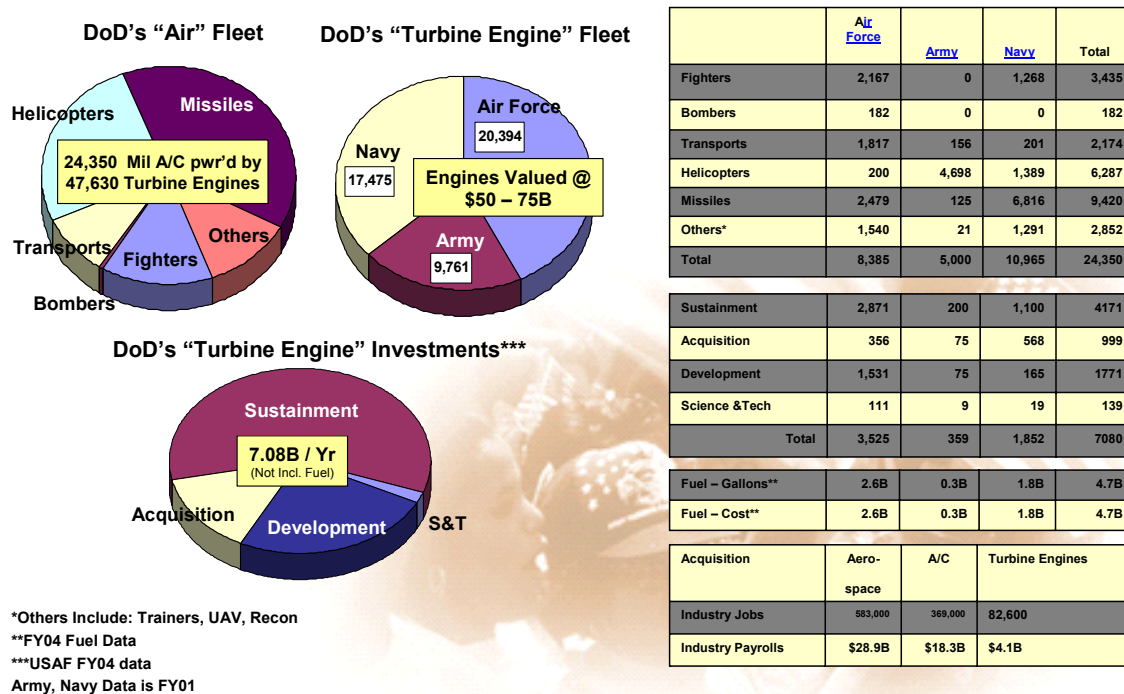

FIGURE 7-1 Investment in turbine engines by DoD. SOURCE: Burns (2005).

Reducing the costs of sustainment and fuel therefore becomes a dominant issue. In many cases new business models may be required to capture the opportunities. However, the new business practices coupled with modest investments would have high leverage since approximately 60 percent of all DoD propulsion funding, not counting fuel costs, is dedicated to sustainment. Current business practices, with different funding sources for CIPs, depot maintenance, and support on the one hand and operational fuel cost on the other, create artificial roadblocks preventing maximum return from past S&T investments.

An example of the need for innovative contracting is the TF33 upgrade program to reduce fuel consumption on the B-52. CIP funding is only able to provide a digital engine control, a fuel management unit, and a compressor gas path outer case seal, which together reduce the specific fuel consumption (SFC) by 1.5 percent. However, a 6 percent reduction in fuel consumption could be realized if other improvements developed by the engine OEM through completed S&T programs could be transitioned to the TF33 engine. Current CIP funding is inadequate to cover the cost of such transitioning. Under an alternative innovative contracting model, the engine OEM could be asked to produce the detailed design at no cost. The engine depot would purchase the parts by means of a performance-based logistics process, perform the engine upgrade, and test the engines to verify component improvement. In exchange, the Air Force would reimburse the OEM with 25 percent of the net fuel savings over the life of the aircraft. An additional 25 percent of the savings would be awarded to the S&T community, and the rest of the savings would be realized by the fuel community. This model could incorporate off-the-shelf improvements and produce great savings for DoD.

An example of the need for incorporation of new technologies is the Air Force's F108 engine in the KC-135. The F108 is the military version of the CFM56 and much older in configuration than the CFM56 commercial engine fleet. The commercial CFM56 engines have a utilization rate of 3,000 hours/year and are overhauled and upgraded to the latest configuration approximately every 3 years (at the life limit of 9,000 hours). These upgrades address items critical to flight-safety, unscheduled engine removals (UERs), durability improvements, and fuel economy. Since the Air Force's utilization rate is 500 hours/year, the 9,000-hour life upgrade occurs only every 18 years unless driven by UER or safety items. Even when returned to the depot prior to the 9,000-hour limit, the engines are not upgraded to the latest configuration but are returned to service in their original configuration or with minimal upgrades to fix the source problem. A complete rather than partial upgrade to the latest commercial configuration anytime

overhaul is required would reduce the fuel burned and enable the engine to stay on wing longer, with improved safety and performance, thereby saving overall support cost.

Recommendation 7-6. To reduce the cost of fuel burn and of sustaining the portion of the existing fleet that will be in service in 2020, DoD should develop innovative contracting methods to facilitate the incorporation of evolving technologies into existing engines.

MITIGATING TECHNOLOGY RISKS

Under the current DoD acquisition process for new big aerospace systems (i.e., aircraft of all kinds, missiles, launch systems, complete space systems of all types), the choice of concept approach—that is, how they propose to meet the top-level mission requirements and needs—is left entirely to the large prime contractors (e.g., Boeing, Lockheed-Martin, Raytheon, Northrop Grumman). There is very little incentive for these large companies to take additional risks by inserting significant new technologies. They would rather use as much commercial off-the-shelf hardware, software, and other equipment as possible so that they get to production as quickly as possible and start marking up their prices to make large profits on high volume sales. Developing new technologies to increase the probability of meeting mission requirements just increases the financial risks early in the program and presents the risk of cancellation (by Congress if no one else) if the developments issues and problems get too large during the DDR&E phase of the respective projects.

There are numerous examples of risk aversion throughout the recent history of government procurements. The tremendous pressure to avoid the risk of developing new technologies to meet new mission needs (because of the potential financial risk to the contractor) has caused propulsion technology to atrophy. A remedy for this barrier to the use of new technologies to enable or enhance mission capabilities is to provide explicit financial incentives to prime contractors and to openly assume more of the early development financial risks (Jobo, 2003).

The development and fielding of a new DoD space system might exemplify how this would work in terms of new procurements. Since all the launch vehicle capabilities are set for the next 15 or 20 years through the mandated use of evolved expendable launch vehicle (EELVs) in that time frame, the amount of mass injected into low Earth orbit (LEO) is therefore also fixed for that time frame. The only way to increase useful payload mass for accomplishing the mission with increased margins and reliability would be to incentivize the use of new spacecraft bus technologies such as structure, power and propulsion (which together make up 80-90 percent of the mass injected into operational orbit) so that the payload fraction can be increased to 50-70 percent of the injected mass. This would stimulate the development and insertion of new technologies that will achieve such as much higher specific mass (power/weight), more advanced power sources, and energy storage systems, and better-performing in-space propulsion systems such as high-power plasma accelerator thrusters. Government customers must offer these incentives if they wish to mature key new spacecraft technologies for important defense missions in a reasonable period of time without putting all the risk on the prime contractors.

ADDITIONAL ISSUES

This section describes various important topics not covered elsewhere in the report: (1) infrastructure needs for aerospace propulsion, (2) education requirements, (3) basic research requirements, (4) leveraging national resources for world-class aerospace propulsion, (5) foreign efforts in aerospace propulsion, and (6) related environmental issues.

Infrastructure

Gas Turbine Research

The lead organization within DoD for the development of advanced aerospace propulsion technologies is the AFRL, which maintains key research facilities and technical expertise necessary for the development of advanced turbine engines. As with access-to-space and in-space propulsion research, AFRL may leverage NASA research activities related to gas turbine engines (NRC, 2006a). The gas turbine industry has progressively decreased its experimental infrastructure over the past two decades, relying on AFRL to support the complex experimentation necessary to overcome key technical barriers. Many of the AFRL's research facilities are 20 or more years old and need major improvements to meet the development needs of future warfighters. Infrastructure improvements will be needed in terms of increased airflow and temperature; increased drive horsepower, fuel supplies at maximum pressure and temperature; common adaptive hardware to accommodate transient inlet temperature, pressure, and velocity profiles; and quick-response, real-time nonintrusive (laser) instrumentation and data acquisition. Technology facilities that are among the candidates for construction or upgrade to meet future warfighter needs are listed here, along with some cost estimates.

- *Compressor Research Facility and an aeronautics laboratory.* A national facility for full-scale demonstration of innovative compressor designs would provide low-cost proof-of-concept tests. Estimated operation and ongoing upgrade cost: \$4.5 million per year.
- *National combustor development facility.* AFRL and Arnold Engineering Development Center (AEDC) have jointly indicated a desire to perform the validation for VAATE combustors for propulsion systems for future warfighter systems such as Joint Strike Fighter (JSF), long-range strike, and Joint-Unmanned Combat Air System in an efficient, affordable, common national facility to be located at AEDC. Estimated cost: \$6 million per year.
- *National Aerospace Fuels Research Complex.* AFRL has the only aircraft fuel system simulator in the United States that is used for fundamental research, exploratory development, and in-house development of advanced fuels, additives, and fuel system components. This versatile facility is in need of annual upgrade. Estimated cost: \$900,000 per year.
- *Aerothermal Research Facility.* This facility is critical for studying turbine blade loading, testing high-temperature blade designs, and studying blade heat transfer. Estimated upgrade costs: \$1.3 million per year.
- *Turbine Engine Fatigue Facilities.* Used for structural evaluation and life assessment of hot section components. This facility is a key asset for achieving predictions of turbine airfoil life. Estimated costs: \$300,000 per year.

Fuels Research

Jet fuel costs have more than doubled since 2004, and this rising cost of jet fuel is a large expenditure for DoD. Estimates show that the DoD fuel bill is \$6.8 to \$9.4 billion per year higher (compared with 2004) due to fuel price hikes and the additional cost of transporting fuel to the battlefield. Finally, DoD needs to operate with a smaller variety of fuels for better logistics, and it needs advanced fuels for the thermal management of aerospace vehicles.

To develop advanced fuels requires state-of-the-art analytical chemistry laboratory facilities, small-scale, well-controlled engineering test apparatus, large-scale extended duration facilities, and smaller-scale aircraft fuel system simulators. Most fuels research facilities have been closed or mothballed recently, and the AFRL fuels research facility is over 20 years old. Suggested gaps are these:

- *Fuels analysis facility.* The successful development of advanced fuel and sensor technologies requires analysis of chemical and physical properties of fuel. Quantitative analysis facilities need

upgrading to maintain state-of-the-art capabilities. Annual investment in this activity would be \$3.2 million.

- *Equipment for synthesizing additives.* Synthesis of novel chemical additives that improve the operating characteristics of hydrocarbon fuels requires the ability to study wide ranges of chemical functionalities. Equipment such as standard reaction/distillation system hardware and oligomer and polymer synthesis hardware is required for synthesizing smart additives. Annual investment in this activity would be roughly \$3.0 million.
- *Fuel thermal stability studies.* Test facilities and instrumentation are required to study the thermal stability of high-temperature aerospace fuels for thermal management and characterizing nanotechnology-based sensors. Establishing a modeling and simulation facility composed of a Beowulf Cluster would significantly enhance current capabilities for developing and using computational tools. Annual investment in this activity would be about \$1.8 million.

Hypersonics Research

Only a few hypersonic high-enthalpy facilities exist in the United States. They all suffer from various limitations. Facilities used to test scramjet engines for relatively long duration are vitiated (impure) air tunnels in which the free stream contains combustion products and in which the enthalpy is limited to below Mach 8. The shock tunnels and expansion tunnel at the Calspan-University of Buffalo Research Center, Inc., the Caltech T5 shock tunnel, and the General Applied Sciences Laboratory expansion tube range in enthalpy up to Mach 20, but are all short-duration facilities (1 to 10 msec) and also have other limitations, including free stream dissociation.

An example of a successful and ongoing collaborative hypersonic test facility is the 1-MW radiatively driven hypersonic wind tunnel/MARIAH II (Mansfield et al., 2005). MARIAH II partners the AEDC with other groups to develop a long-duration, true-enthalpy, clean-air, high-Mach-number hypersonics testing capability. The enabling concepts under development for this capability include cold air storage at ultrapressure with energy addition downstream of the throat to obviate containment of high pressure and hot air via high-energy electron beams to Mach 12 with subsequent magnetohydrodynamic acceleration for Mach 15.

Finding 7-2. Detailed measurements in the free stream and in the flow fields of tested articles, particularly in the engine combustor, could provide essential data for validating simulation methods. A further technology shortfall is an inadequate knowledge of reaction rates, in particular the coupling of vibrational excitation, dissociation, and surface chemistry. Ground testing using hypersonic high-enthalpy facilities is needed to develop numerical simulation tools that take proper account of high-enthalpy effects. Such tools can then be used with greater confidence in the design and preparation of flight tests.

Recommendation 7-7. AFRL should maintain a core competency in propulsion technologies by strengthening its unique infrastructure to meet future warfighter needs.

Over 3 years, \$13 million per year should be added to the AFRL propulsion and power 6.2 budget for gas turbine facilities, \$8 million per year for fuel research, \$8 million per year for a hypersonics research facility, and \$2 million per year for numerical simulation tool development to achieve the critical additions and improvements to AFRL infrastructure identified in this study.

Education

The current and planned levels of DoD science and technology (S&T) programs are greatly reducing the number of trained propulsion workforce in the United States (NRC, 2001). Planned DoD S&T funding is one-half to one-third of FY00 levels, but when Air Force fixed costs are taken into account, the effect on university and contractor manpower is magnified.

This finding strikes to the very heart of the country's technical advantage and is not easily reversed. S&T programs are the main training ground for all levels of propulsion engineers and scientists. The major reductions in S&T programs since FY00 are negatively impacting not only the rate of development in basic areas such as materials, computational fluid mechanics, structures, controls, health monitoring, and prognostics, but also the number and the quality of people who are attracted to these fields. Reduced government support in S&T has resulted in the downsizing of university programs in the propulsion area that will eventually result in an unacceptable shortage of well-trained young engineers. The committee believes this loss in number and quality of people to be the worst long-term effect of the current DoD funding profile. The committee urges DoD to aggressively pursue strategies to reduce sustainment and other recurring costs so that more funding can be applied to investing in the technology base that supports the future and return the S&T funding to world-class levels.

The Commission on the Future of the United States Aerospace Industry (Walker et al., 2002) recommended that the federal government significantly increase its investment in basic aerospace research. The commission went on to say that investment "enhances U.S. national security, enables breakthrough capabilities, and fosters an efficient, secure and safe aerospace transportation system." The committee's concerns are further supported by the statistics below and reinforced by some recent studies (Gibbons, 2004; NRC, 2004, 2006b):

- Over 26 percent of the aerospace workforce will be eligible for retirement in 2008.
- The proportion of aerospace workers 30 years old or younger dropped from 18 percent in 1987 to 6.4 percent in 1999 (NRC, 2004).
- Aerospace engineering degrees awarded during 2003-2004 were as follows: B.S., 2,232; M.S., 915; and Ph.D., 210. The share of doctorates awarded to U.S. citizens declined from 54.4 percent to 42 percent between 1999 and 2004.

Further, to continue the development of young propulsion professionals, the studies cited above put forward a set of objectives (Walker et al., 2002; Gibbons, 2004; NRC, 2004, 2006b):

- Develop, fund, and implement a mentoring program for young engineers.
- Provide scholarships and fellowships to pursue advanced degrees in aerospace propulsion.
- Sustain robust S&T projects in basic and applied research to attract, train, and retain highest caliber young engineers and scientists.
- Increase the recruitment of young U.S. citizens educated and trained in mathematics, science, and engineering disciplines into propulsion engineering.

Finding 7-3. It is critical that the government provide the resources needed to maintain and improve university education and research programs that train undergraduate and graduate propulsion engineers. Funds are needed for developing innovative educational programs, such as distance learning, in the area of propulsion. Additionally, the government should provide fellowships for promising students in graduate school, fund a robust, long-term S&T propulsion program that will employ graduating engineers, and maintain and upgrade university propulsion research facilities.

Recommendation 7-8. DoD should increase S&T funding levels to support warfighter needs. It should ensure that significant portions of propulsion S&T funds continue to support research at universities. This has the additional benefit of training a cadre of future government and industry S&T professionals as well as supporting research facilities at those institutions.

Basic Research

Technology is an enabler for advances in aircraft engines and missiles capabilities, and much of the technology is underpinned by basic research. Examples of basic research advances that have made the

transition into design include computational procedures for the design of complex three-dimensional turbomachinery, directionally solidified turbine blades leading to single crystal airfoils and blades, and the software and hardware for full-authority digital electronic engine controls. Basic research, conducted not only at AFRL and the main DoD laboratories but also at many world-class academic institutions and at a smaller number of industrial R&D laboratories, provides the essential foundation on which to develop and validate component and propulsion system design. According to the AFRL, for turbine engines to provide the capabilities needed by future warfighters, basic research should undertake the following (AFRL, Undated):

- Need better life prediction for components
 - Do not have a full understanding of heat transfer in turbines
 - Do not have validated life prediction tools
 - Do not have control strategies for improved life
- Need to identify robust turbine engine component loading limits and establish the potential for flow control to exceed those limits
 - Compressors, turbines, combustors
 - Need for studies to be completed in compressible flow environments
- Need to address thermal management for high Mach applications
 - Need bearing thermal management capabilities high Mach engines
 - Need clean-burning, nonfouling, high-heat-sink fuel technologies
- Need to establish the potential for pulse detonation technology to improve propulsion system affordability and meet performance goals
- Need 6.2 funds for industry development of technologies for VAATE II and III
- Need turbine engine approaches to drive airborne megawatt power systems
- Need to establish role of advanced turbine engine technology for small weapon system propulsion
- Need to consider technologies that could have impacts beyond 2017

To address these challenges, research on high-impact technology research programs are under way in-house at AFRL/PR. The research falls in three VAATE focus areas—durability, versatile core, and intelligent engines (AFRL, Undated):

- Durability
 - Turbine engine structural dynamics, and
 - Turbine high-stage loading and heat transfer.
- Versatile core
 - Combustion research and diagnostics development,
 - Compact core technologies,
 - Pulsed detonation technology development,
 - Emissions reductions via fuel additives,
 - High-heat-sink fuels,
 - Enhanced low-temperature fuel performance,
 - Smart fuel technologies, and
 - Ultimate liquid lube system for large turbofan/turbojet engines.
- Intelligent engines
 - Assessment of advanced turbine engine technology,
 - Mechanical systems prognostics for intelligent engines,
 - Innovative aero approaches for compressor high-stage loading,
 - Bearing performance and model validation, and
 - Augmentor high-impact technologies (AFRL, Undated).

This research is accomplished through individual projects with three key elements:

- Fundamental approach to long-term technical challenges;
- Modeling and simulation to reduce costs and to promote a scientific approach; and
- Critical experimentation to validate and refine models.

These projects focus on enabling high-risk, high-payoff concept development along with basic research investigations to overcome technical barriers that hinder breakthrough technology development. However, enabling research efforts such as these (see Box 7-1) have been declining over the last decade because the available funding cannot support them. It is critical that industry be provided 6.2 (applied research) funding to pursue high-risk, high-payoff technology programs if far-term, game-changing capabilities are to be provided to the warfighter.

Key areas for basic research on propulsion technologies, such as the technologies for gas turbine engines (GTEs) discussed in Chapter 1, are the following:

- *Modeling and simulation.* New methods for using modeling and simulation not only in design but also in development. The goal is to have more effective processes both to get from idea to actual system development and to enable root cause diagnosis and the addressing of problems that occur later in the development cycle.
- *Intelligent components and intelligent engines.* These include not only smart components that improve performance but also enhanced capabilities in health monitoring and prognostication (including sensors and actuators) that will improve safety and reduce ownership cost.
- *Ensuring robustness to variability.* This includes designing engines and components to tolerate variability, either from the manufacturing process or from field usage. Potential benefits include enhanced durability and operability and decreased cost.
- *Materials.* A quantum jump in the operating temperature of turbine blades above 2300°F will require a new base material other than nickel; to date, only platinum has the balance of properties required for operation at higher temperatures. Future propulsion materials requirements include improved material systems for disks and airfoils together with coatings that will withstand the operational stresses and degradation modes at these high temperatures. Coatings are important to protect the underlying material from environmental degradation, but these coatings may be prime-reliant, which means that failure will be imminent after loss of coating integrity; this poses operational constraints, which may, however, be obviated to some degree by prognosis. The conventional screening of new material chemistry needs to be replaced by analytical materials modeling tools whose results can be verified by targeted experiments (NRC, 2006a). The direction in advanced technology for ceramic materials is away from monolithic structural ceramics to ceramic matrix composites (CMCs) that have inherent toughness. Much research is taking place on these materials.
- *Distributed propulsion.* This includes research on arrays of propulsors highly integrated into, and synergistic with, the airframe flow, to provide incremental changes in aircraft performance.

Box 7-1

Example of Breakthrough Basic Research: Positron Propulsion

There is an exceedingly revolutionary, far-term fuel/energy source on the horizon: positrons. Research on the main enabler of this concept, the long-term storage of positrons as positronium, is in progress. In terms of energy density, positrons are eight orders of magnitude more energetic than chemical fuels. The energy density of chemical sources is approximately 50 MJ/kg. Nuclear energy densities are 10 million times those of chemical energy. Antimatter energy density is 180 MJ/μg. This unprecedented energy density could be utilized for a wide spectrum of applications, military as well as commercial and industrial. The technology could enable deep space propulsion using positron thermal

rockets to replace the proposed nuclear thermal rockets. One key aspect of positron energy is that when an electron and positron annihilate, the gamma photons produced are too weak to cause photonuclear effects, so positron annihilation would produce no nuclear residue.

The basic technologies for conducting positron research are production, moderation, storage, and conversion. The most common way to make positrons is to accelerate a beam of electrons into a heavy metal target (e.g., tungsten), generating the positrons by bremsstrahlung and pair production mechanisms. Another way is to use a deuteron accelerator and a diamond (carbon) target to make radioactive nitrogen, which decays to produce positrons. Personnel at the University of California at Riverside are proposing a modification of the deuteron accelerator approach that promises a significant increase in the positron production rate.

Most methods of positron production produce them at very high energies. To be useful, positrons need to be slowed or moderated. A popular way to moderate positrons is to impact a positron beam into a heavy metal target and let elastic and inelastic scattering slow the positrons. Typical efficiencies of this process are approximately 10^{-5} (one out of 100,000 positrons survives). The energy is typically reduced from 1 MeV to 1 to 10 eV. These slow positrons are electromagnetically manipulated into various forms of positron traps. An alternative method of moderation, which uses solid neon, has a moderation efficiency of 5×10^{-3} (0.005), nearly a hundredfold improvement. AFRL Munitions Directorate personnel are building an experiment using solid hydrogen that promises a 10- to 100-fold improvement over neon (i.e., an efficiency of between 5×10^{-2} and 5×10^{-1}). These experiments are projected for the 2006 to 2007 time frame.

Positrons are usually stored as a bare, positively charged plasma in electromagnetic devices called Penning traps. However, one of the most exciting facets of positron research is storing neutral positronium atoms. The neutrality of positronium solves the problem of Coulomb repulsion. A positronium atom is a bound state of an electron and a positron. Its structure and physics are much like those of a hydrogen atom with the proton replaced by a positron. Positronium atoms left to themselves will annihilate in less than 142 nsec. Chiueh (1997) and Shertzer et al. (1998) say that long-lived positronium may be possible by applying large crossed (perpendicular) electric and magnetic fields to positronium. They indicate that positronium may be stabilized for up to a year with 10-T magnetic fields and 10^4 V/cm electric fields. Recently, government contractors have found very long stabilization times at field strengths of 3 T and approximately 10^3 V/cm. Positronics Research LLC and AFRL are working with DARPA to fund and perform experiments that will store energy at densities 15 times that of chemicals. This effort will be in collaboration with the Chemical Division of Argonne National Laboratory, which will modify its linear accelerator to provide positrons for DARPA's positron storage and production program.¹

¹For additional information, see http://www.nasa.gov/mission_pages/exploration/mmb/antimatter_spaceship.html. Last accessed on June 4, 2004.

Finding 7-4. It is the view of the committee that basic research is not a linear process. Thus, it sees opportunities for basic research as not limited to resolving problems at low technology readiness levels (TRLs) but also possibly present at system levels (TRL 6, for example). To capitalize on these opportunities, there needs to be substantive engagement between researchers (university, company, or government) and the development community. In addition, since these problems are likely to span disciplines, multidisciplinary research teams rather than the traditional academic single investigators are increasingly becoming the most effective way to attack important research issues.

Recommendation 7-9. DoD should restore 6.2 and 6.3 technology development funding to levels that give buying power equal to that which prevailed when the United States had held an undisputed lead in engine technology—i.e., the time when the F100 and F110 engines were being developed. DoD should aggressively pursue strategies to reduce sustainment and other recurring costs. It should increase 6.1 funding commensurately.

LEVERAGING OTHER NATIONAL RESOURCES

The Air Force, Navy, and Army needs for space operations and space-based warfighting capabilities have much in common with the needs of NASA's space exploration program and commercial space propulsion technology needs.

The various technology elements or building blocks for keeping our leadership in air and space also have many needs in common. For example, both air-breathing and rocket propulsion must solve critical problems in the area of high-strength, high-temperature, corrosion-resistant materials for turbine blades to allow higher turbine inlet temperatures and thereby enhance performance. Rather than having air-breathing and rocket propulsion engineers pursue totally independent, and sometimes redundant, technical approaches, cross fertilization between the two propulsion technologies could result in earlier, more efficient, more economical problem solutions. Leveraging resources and data as well as technology across the different DoD services, NASA, industry, and academia could lower the cost and time of developing any new technology and lessen the burden on any one branch of service of taking on entire technology/vehicle development programs. The JSF is a great example of combining efforts, requirements, and resources to decrease the cost of developing a state-of-the-art multifunctional aircraft. Leveraging across the Services, industry, and academia could be a game changer that would let us sustain our superiority in air and space. This is especially critical in today's environment of reduced budgets and increased foreign competition in air-breathing and space-access technologies, where many of the foreign development efforts are more heavily subsidized than those in this country.

Perhaps the simplest way to leverage technology is to directly transfer mature technologies. There are numerous candidates for such transfers from government to industry and vice versa. Take, for example, electric propulsion. Aspects of this technology were developed by industry and subsequently flight proven by a myriad of commercial satellites. Electric propulsion is ready to transition to military satellites. On the other hand, the solar concentrator array with refractive linear element technology (SCARLET) program, which is a useful power source for electric propulsion, has been flight demonstrated by the government and could be transformed to the commercial satellite sector.

Programs that span military branches, industry, and academia—for example, the IHPTET program, the IHRPT program, and the VAATE program—are great examples of sustained R&D programs that have allowed the contracting parties to work through known propulsion barriers for several years. This approach of sustained funding and lessons learned through the years could serve as a model for future propulsion development programs. Already, there are plans to possibly transfer some of the knowledge gained in IHPTET to the areas of power generation and ground transportation. Also, as IHRPT comes to an end, perhaps we can look at the three programs as a model for the next combined effort for rocket development.

Scramjet development, which is expected to lead to several combined-cycle engines for future space launch vehicles, is being pursued concurrently by DoD, the Air Force, the Navy, and the Army under different programs. This committee thinks there is an opportunity to have more active communication and cooperation between the services and other interested government agencies to find out if there are common technology areas where resources and successful results can be shared. The needs for space operations and space-based warfighting capabilities for the Air Force, the Navy, and the Army have much in common with the needs of NASA for its space exploration program and those of companies that use in-space propulsion.

A different aspect of leveraging resources is the flow of information across the military branches. In some of the meetings attended by this committee, it became apparent that more cross-communication was needed across the different services. Perhaps there should be an interdisciplinary team that keeps all branches up to date on the ongoing efforts, goals, and directives across the government and industry and academia. This committee could be formed from the Reliance Program. Another way of achieving cross-communication is through aggressive archiving and accessing of data. People who have been in the space business for more than 40 years see the same technologies resurface from time to time and, more importantly, the same mistakes being made by younger engineers who do not know of the previous

efforts. Some of this waste of financial and intellectual resources could be avoided by making accessible the results of past projects, even ill-fated ones.

Finding 7-5. A focused effort, probably by DDR&E, to catalog and make accessible the findings of past technology programs would be highly useful.

Recommendation 7-10. The Director, Defense Research and Engineering (DDR&E), should focus on cataloging and making accessible the findings of past technology programs. It could perhaps combine the databases of VAATE, Integrated High-Payoff Rocket Propulsion Technology (IHPRPT), and Integrated High-Performance Turbine Engine Technology (IHPTET) at the lower taxonomy levels to enhance technology cross fertilization. DDR&E should also establish a feedback process and cross-cutting flow of technology development that comprises the S&T, development, acquisition, and sustainment phases.

Finding 7-6. The technology maturity steps conceived by the Air Force seem to proceed in one direction from 6.1 research through sustainment. Rather they should form a closed loop. The committee sees a tremendous advantage in having open and active communication between S&T through acquisition and sustainment, as shown in Figure 7-2. For example, S&T researchers, who are some of the brightest engineers and scientists in this country, could certainly contribute to the optimization, redesign, or modification in the development, acquisition, and sustainment phases of the ideas they converted into technologies in the first place. In the past, the Air Force had a design team that drew up the system configuration requirements for the technologies the Air Force would pursue. This capability has been lost, and today it is the contractors that put together the system architecture.

Recommendation 7-11. The Air Force should establish within each major program office an in-house design group to bring it better overall insight into the systems it is acquiring and guide it in directing its resources from S&T through sustainment to meet the system requirements it has laid out. The Air Force would execute the active closed-loop communication between the technology steps.

The discussion above deals with the benefits of leveraging to the military. Leveraging can also benefit the commercial sector. NRC (2001, p. 8) states as follows:

Commercial aerospace exports, which are dependent in large measure on the technology base that is in turn supported by the Air Force, are traditionally by far the largest positive contributor to the U.S. balance of trade.

Cutting-edge aerospace products will continue to be essential to U.S. dominance of the twenty-first century battlespace.... [However,] the overall positive aerospace trade balance has fallen by about 35 percent since 1998 (Douglass, 2000a).

Development Stages

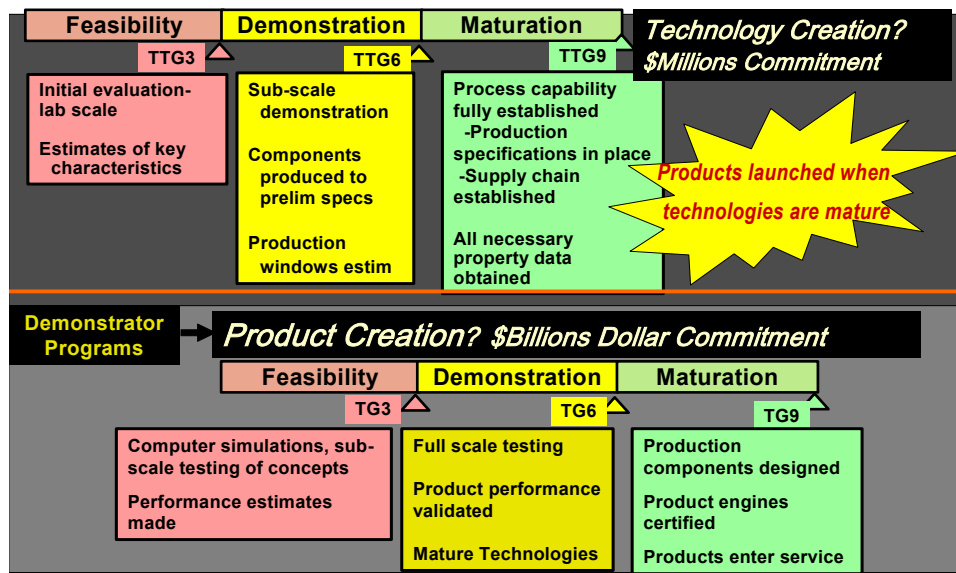

FIGURE 7-2 Proposed flows of technology development and product development. SOURCE: Schafrik (2005).

Figure 7-3 further illustrates the positive balance of trade that the aerospace industry enjoys. In good times, leveraging is wise. In the current S&T climate, leveraging may not be sufficient but is nonetheless necessary.

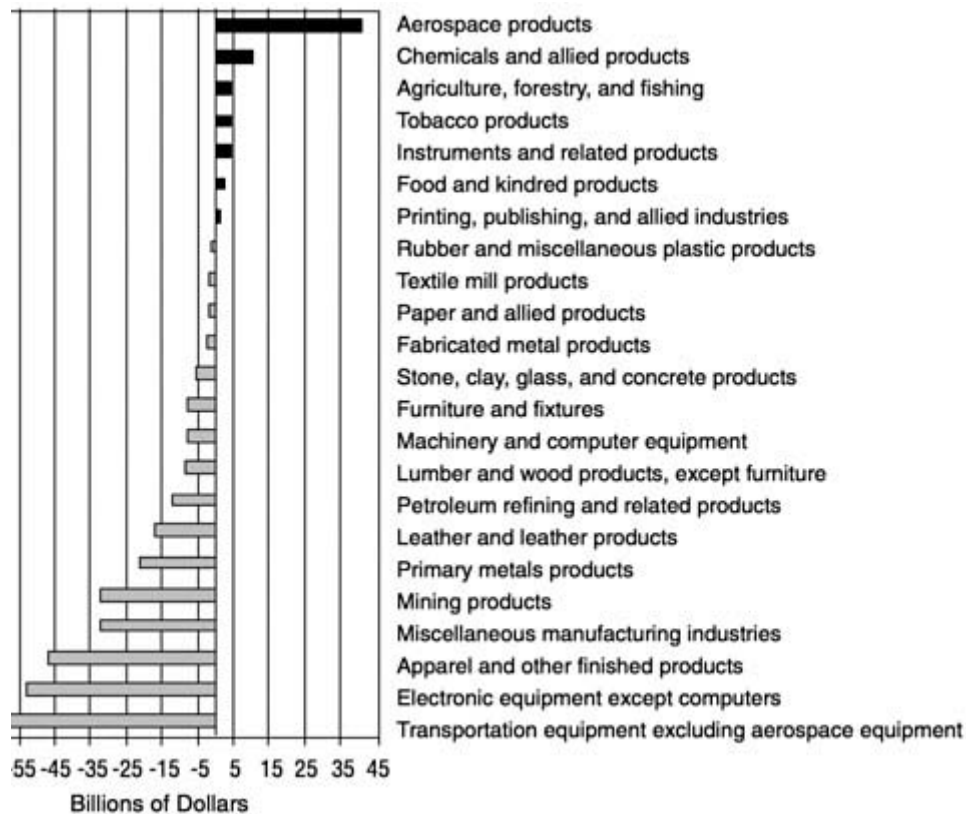

FIGURE 7-3 Balance of trade by industry, 1998. SOURCE: Douglass (2000b).

FOREIGN AEROSPACE PROPULSION EFFORTS

Gas Turbine Engines

A GTE industry is both a military and economic power enabler.³ Four countries currently design and build large modern GTEs: France, Russia, the United Kingdom, and the United States. While the United States is generally dominant, Russia's GTE industry is reemerging. The United Kingdom and France, and indeed the European Union are heavily investing in GTE research and could achieve parity with the United States in one or two decades.

China and India are rapidly evolving. China in particular is making great strides and appears to have a long-term strategy to become a propulsion power. They should have the resources in terms of both skills and funds to achieve this goal.

Several countries have limited capabilities, such as component design, including the Czech Republic, Germany, Italy, Spain, Sweden, and Japan. Many others have some limited manufacturing capabilities, including Iran and Serbia. The dividing line is the difference between world-class, high-temperature military and commercial GTEs and throwaway, small GTEs. Entering the market for small throwaway engines is much easier with widespread proliferation of the necessary technologies.

Russia is relying on life cycle cost as a critical and major technology driver, a marked difference from the Soviet era, when the engines could not run very long between overhauls. It is also teaming with others (China, Europe). Teaming with Russia could help China realize its ambitions. Russia has the capability, but it may take 20 years to attain parity with the United States. Its economy is strengthening, particularly due to its oil and other energy reserves, and its technology could spread to other countries.

The United Kingdom is emphasizing GTE R&D. Rolls-Royce develops large world-class commercial engines on a par with those of GE, in particular the GE 90. The U.K. military programs tend to be cooperative ventures.

France appears to place more emphasis on military engines, for which it has an indigenous design and development ability. The M88 is France's most advanced production fighter engine. Aside from SNECMA, Turbomeca, Microturbo, and ONERA (the French aeronautics and space research center) are strong entities. A large portion (80 percent) of French research works on life-cycle cost, noise abatement, fuel consumption improvement, and emissions reduction. SNECMA is teaming with GE on CFM56 (a program of the U.S. and French governments), and Pratt & Whitney is teaming with Japanese and European companies on the successful V2500 engine. In many cases it is difficult to distinguish national borders, because programs cut across countries and corporations. While some laws prevent technology export, such laws are generally weakening. Moreover, it is difficult to limit the export of know-how as people become more mobile.

China is working hard to develop its own industry. The national objective is to become world class. There is evidently a comprehensive plan in place. China has completed its first indigenous development program and transitioned an engine to production. China has growing resources—in terms of both people and funds—and a long-range vision.

The United States maintains a lead of a decade (or more) in R&D. Europe poses a current threat in the commercial arena. The United States is a leader in some emerging fields, such as fuel cells and more electric aircraft, but others are catching up. It is unclear if VAATE is the whole answer. It certainly does not cover the environmental technologies that are arguably the key to winning the commercial race. The European Union is seeking pre-eminence in aerospace. Commercially, it is either there or close. It has an articulated and well funded program, the Advisory Council for Aeronautics Research in Europe (ACARE), and clear goals. By contrast, NASA is floundering in aeronautics. The impact on military GTE capabilities of losing (or, arguably, of having already lost) commercial leadership in GTE (and commercial aircraft in general) is unclear. It is likely that we will not know this for decades. Probably

³This section is based, in part, on discussions with representatives of the National Air and Space Intelligence Center at the University of Dayton on October 20, 2005.

owing to a combination of workforce and marketing requirements, several U.S. multinational companies—among them, GE and Pratt & Whitney—have set up centers of excellence in the European Union, Russia, China, and India. These centers employ the best brainpower available in those countries and are training the future aeropropulsion workforces. In the long term, this will sharpen competition for U.S. exports and shrink the U.S. lead in commercial aeropropulsion.

Finding 7-7. The committee found that the United States still maintains a lead in military GTE—probably about half a generation. In commercial GTEs, the United States has parity, but this position is eroding. The United States is on a par with the rest of the world for scramjets, solid rockets, electric propulsion, and pulse detonation engines (PDEs). It lags behind other countries in ramjets and liquid rockets.

Pulse Detonation Engines and Rockets

No one has an operational pulse detonation engine (PDE) or pulse detonation rocket (PDR), but they are a hot topic for research, with some 19 countries at least somewhat involved. The cost of PDE/PDR research is lower than the cost of research on GTEs. PDEs and PDRs still have many technical hurdles to overcome but are a promising new technology for some applications.

Russia's research in this arena is more fundamental (basic) than that in other countries. France, Japan, and Russia are developing applications. The French seem to be moving toward development and are collaborating with the Russians. They are arguably the most likely to have the first operational PDE. They have a plan and resources. The Japanese are also heavily into PDE research.

PDEs are a serious possibility for low-cost missiles, and the French and Chinese are traditionally missile exporters. The committee expects that PDEs could be deployed in 10-20 years, probably on swarms of unmanned aerial systems (UASs) and missiles. The United States is nominally at par with the rest of world in PDE research.

The Europeans dominate in the somewhat related area of internal combustion aero engines.

Ramjets

More than 13 countries are working on ramjets. The key players are China, France, Germany, India, Japan, Russia, Taiwan, and the United States. The Europeans are the world leaders—especially the French in liquid fueled ramjets. The Russians are key players in other areas. There are operational systems in India and many other countries. The Germans have boron-fueled versions. India is developing systems based on Russian technology. The Chinese have an indigenous program based on Russian designs. The Japanese have efforts on liquid-fueled ramjets and are working on a hydrocarbon-fueled air turbo-rocket. Taiwan has a world-class research institute and is working on a system. Others, including Iran, Israel, Netherlands, South Africa, South Korea, and the United Kingdom, are also pursuing capabilities. As many as five new systems could become operational within the next 10 years. The United States does not have operational parity in ramjets. The AA-12 ramjet derivative is an answer to the United States advanced medium-range air to air missile.

Hypersonics

There are a number of hypersonic systems in R&D, but nothing is near deployment. Options include hydrogen and hydrocarbon scramjets, rocket-based combined-cycle engines and turbine-based combined-cycle engines. Russia is the leader, with France next in line. Australia, China, Germany, India, Japan, and are also coming along. The United States is arguably on a par with or somewhat ahead for hydrogen and hydrocarbon systems.

Rockets

From the 1990s until today, many players have entered the field, including India, Iran, North Korea, and Pakistan.

When the United States is compared with the rest of world in rockets, it can be seen to be largely still in the 1970s, and the Russians have been and remain ahead. The United States routinely purchases Russian designs, components, and whole engines. It has parity in deployed systems and is doing research on solids, but it is not doing well on propellant design (the United States has 35 propellant chemists who can be put to work on this problem versus thousands in China). In liquid rockets, the United States is lagging and could continue to lag. The U.S. programs were turned on and off while the Russians kept moving ahead. For liquid boost and hydrogen systems, the United States and Russia have very similar levels of technology. Russians systems represent the state of the art in LOx/HC. In upper stage rockets, the competition is a little bit ahead of the United States.

If IHPRPT Phase III is accomplished, U.S. capabilities will greatly improve. But it is unlikely, with present investments, that it will achieve Phase II before 2015, and it is unlikely to even get to Phase III. With IHPRPT investments, the United States will get close in solids but have a shortfall in tactical systems.

This is an area that requires serious study and committed investment.

Space Propulsion

For in-space propulsion, the United States abandoned Hall thrusters and the Russians took over. The United States has now pursued the technology for 10 years and has achieved parity in thrusters and has surpassed in power processing units. Overall, it has parity for in-space electric propulsion.

ENVIRONMENTAL ISSUES

Historically, DoD has invested little in engine emissions technology, deferring to NASA investments and expertise in this area. However, in recent years, much concern has been expressed over emissions from high-performance military aircraft. While DoD aircraft equipped with afterburners do meet the latest International Civil Aviation Organization (ICAO) standards, the ICAO threshold may not be sufficient, because military bases are required to meet National Ambient Air Quality Standards. Thus, research into clean fuels, fuel additives, and emissions of nitrogen oxides (NO_x) is required. Some key technical challenges remain, including (1) increased engine performance without higher NO_x, (2) increased combustor loading without affecting ignition and combustion stability, and (3) decreased combustor cooling without impacting durability and life. Also of note is the issue of compliance with the numerous international environmental laws and regulations on aerospace fuels.

Finding 7-8. Environmental restrictions require the military to have a national security exemption for the use of JP-8 fuel in tactical vehicles in the United States. Additives and F-T type fuels that lack aromatic content have the potential to reduce soot and particulate emissions in a number of aircraft and engines in a cost-effective manner. Aircraft signature can be significantly decreased by soot-reducing additives, and the life of thermal barrier coatings can be significantly enhanced. The Environmental Protection Agency set particulate matter 2.5 (particles smaller than 2.5 μm in diameter) standards in 1997. A key technical barrier is the lack of knowledge about which processes can control soot formation and the effects of additives.

Warfighter aircraft performance improves at higher cycle temperatures and pressures, both of which increase NO_x emissions. For example, increasing the cycle temperature to achieve 10 percent higher thrust can increase NO_x emissions as much as eightfold. Modeling of turbulent combustion processes and active control is required to study the effects of pressure, temperature, and lean blowout on carbon monoxide (CO), unburned hydrocarbon, and NO_x emissions.

Recommendation 7-12. DoD should add \$2 million per year to the combined 6.1 and 6.2 funding in environmental issues to perform research into clean jet fuels, fuel additives, TBC life, and gaseous and particulate emissions.

PAST AND PROJECTED FUNDING FOR S&T

The United States has the technical capability to field the most advanced gas turbine engines in the world for both fighter and transport aircraft. However, the U.S. technology lead has decreased in the last 20 years and, in the committee's opinion, now amounts to only 10 years or so.

Development costs grow and qualification schedules slip when key technologies are not in hand at program launch. The adage "technology must lead the commitment" was coined over 40 years ago after several major engine development programs suffered serious setbacks. The National Aerospace Plane vehicle, which has so far cost \$2 billion, is a good example of a development program launched without the supporting technology in hand.

Advanced technology demonstration has slowed down in the military. The DoD S&T budget for propulsion has been cut to the point that the technology demonstration cycle time has lengthened from 2 or 3 years in the 1990s (which led to the F/A-22 and F-35 engines) to between 5 and 7 years in the VAATE program. This longer time between technology demonstrations will greatly slow the rate of technology incorporation into gas turbine engines and place the U.S. technology lead at grave risk.

DoD investment leads and leverages outlays by the U.S. industrial base for turbine engines. Without substantial DoD long-term investment, industry is likely to invest only in turbine engine S&T that maximizes its near-term profits. Of all the services, the Air Force has the highest stake in maintaining turbine engine superiority and therefore contributes about 80 percent of the DoD S&T funding for turbine engines. Yet, of the approximately \$7 billion FY04 DoD investment for turbine engine acquisition, sustainment, development, and S&T, Air Force S&T funding was only 1.8 percent—\$138 million (burdened) in FY03.

In discussing funding, one must distinguish between Air Force funding and overall DoD funding. The latter includes Army, Navy, and DARPA funding as well as funding for programs emanating directly from (DDR&E). The Air Force funding in PR accounts for roughly two-thirds to three-quarters of the overall DoD investment in this area. Within the Air Force, work related to aerospace propulsion is also conducted in materials and manufacturing and air vehicles.

The Deputy Assistant Secretary of the Air Force for Science, Technology, and Engineering (SAF/AQR) told the committee at its first meeting that the Air Force annual S&T investment in propulsion and power (PR) was about \$300 million and was not likely to change much in future years.⁴ This number reflects 6.2 and 6.3 funding only. Any 6.1 propulsion-related funding is accounted for separately as part of basic research, which is administered by the Air Force Office of Scientific Research (AFOSR).

The propulsion budgets for FY04 onward are shown in Table 7-1. In FY04 and FY05 the Air Force PR funding levels were, respectively, \$291 million and \$297 million as the result of congressional additions above the Presidential Budget Requests (PBRs) of \$251 million and \$234 million. The Air Force projects outyear increases in PBR from \$252 million in FY06 to \$305 million in FY11.

On the other hand, the overall DoD investment in PR over FY04 to FY07 is fairly flat, at \$400 million to \$410 million except for a spike of \$440 million in FY05. The principal differences between Air Force and DoD funding are in turbine engine technology—IHPTET, VAATE, a high-speed turbine engine demonstrator, and revolutionary approach to time-critical, long-range strike (RATTLRS)—and in hypersonics—e.g., hypersonics flight demo (HyFly), and Force Application and Launch from the Continental United States (FALCON).

⁴Jim Engle, Deputy Assistant Secretary of the Air Force for Science, Technology, and Engineering (SAF/AQR), discussion with the committee on March 1, 2005.

TABLE 7-1 DoD and Air Force Propulsion S&T Budgets for FY04 to FY07 (thousands of dollars)

| PE | BPAC | Description | FY04 DoD | FY04 AF | FY05 DoD | FY05 AF | FY06 DoD | FY06 AF | FY07 DoD | FY07 AF |
|--------------------|-------|--|-------------|------------|-------------|------------|-------------|------------|-------------|------------|
| 62203F | Total | | 126,295 | 132,918 | 107,523 | 115,360 | | | | |
| 3012 | | Advanced propulsion technology | 16,681 | 13,094 | 18,876 | 23,974 | | | | |
| 3048 | | Fuels and lubrication | 17,540 | 16,098 | 14,371 | 16,255 | | | | |
| 3066 | | Turbines engine technology | 31,341 | 34,345 | 32,095 | 31,600 | | | | |
| 3145 | | Aerospace power technology | 36,155 | 44,152 | 30,134 | 29,025 | | | | |
| 4847 | | Rocket propulsion technology | 24,578 | 25,229 | 12,047 | 14,506 | | | | |
| 62500 PR | Total | | 56,562 | 49,699 | 41,458 | 46,078 | | | | |
| 5026 | | Rocket propulsion component technology | 51,862 | 49,521 | 41,212 | 45,839 | | | | |
| 5027 | | High-speed air-breathing propulsion technology | 4,700 | 178 | 246 | 239 | | | | |
| 63216F | Total | | 86,720 | 86,050 | 77,268 | 86,690 | | | | |
| 2480 | | Aerospace fuels & atmospheric | 3,352 | 371 | 196 | 2,834 | | | | |
| 3035 | | Aerospace power technology | 3,207 | 5,250 | 4,028 | 5,588 | | | | |
| 4921 | | Aircraft propulsion subsystems Int | 26,887 | 22,420 | 18,430 | 14,172 | | | | |
| 4922 | | Space and missile rocket propulsion | 11,649 | 5,986 | 6,627 | 4,784 | | | | |
| 5098 | | Advanced aerospace propulsion | 14,433 | 26,069 | 23,212 | 33,780 | | | | |
| 681B | | Advanced turbine engine gas generator | 27,192 | 25,954 | 24,775 | 25,532 | | | | |
| 63500F | 5033 | Rocket Propulsion Demonstration | 21,161 | 28,484 | 25,347 | 27,543 | | | | |
| Total | | | 390,000 | 290,738 | 445,000 | 297,151 | 251,596 | 275,671 | | |
| Adds | Hyp | | 0 | 991 | | | | | | |
| Adds | Pwr | | 12,391 | 20,418 | | | | | | |
| Adds | Rckt | | 21,926 | 29,588 | | | | | | |
| Adds | Turb | | 5,343 | 12,092 | | | | | | |
| Adds | Total | | 39,660 | 63,089 | 0 | 0 | | | | |
| % of Total | | | 14% | 21% | 0% | 0% | | | | |
| Total without Adds | | | 251,078 | 234,062 | 405,000 | 275,671 | | | | |
| 6.2 | Total | | 182,857 | 182,617 | 148,981 | 161,438 | | | | |

| | | | | | | | | | | | | | |
|------------|---------|---------|---------|---------|---------|---------|---------|--------|---------|--|--|--|--|
| 6.3 | Percent | | | | | | | | | | | | |
| | Total | 62.9% | 107,881 | 61.5% | 114,534 | 59.2% | 102,615 | 58.6% | 114,233 | | | | |
| | Percent | 37.1% | | 38.5% | | 40.8% | | 41.4% | | | | | |
| Edwards | Total | 109,250 | 109,220 | 109,220 | 85,233 | 85,233 | 85,233 | 92,672 | | | | | |
| | Percent | 37.6% | | 36.8% | | 33.9% | | 33.6% | | | | | |
| Wright | Total | 181,488 | 187,931 | 166,363 | 182,999 | 166,363 | 182,999 | | | | | | |
| | Percent | 62.4% | | 63.2% | | 66.1% | | 66.4% | | | | | |
| Turbines | Total | 155,000 | 180,000 | 163,000 | 165,000 | 163,000 | 165,000 | | | | | | |
| | Percent | 106,312 | 99,188 | 99,188 | 89,867 | 89,867 | 89,867 | 90,393 | | | | | |
| | Percent | 36.6% | | 33.4% | | 35.7% | | 32.8% | | | | | |
| Rockets | Total | 85,000 | 85,000 | 85,000 | 85,233 | 85,000 | 85,000 | | | | | | |
| | Percent | 109,250 | 109,220 | 109,220 | 33.9% | 33.9% | 35,000 | 33.6% | | | | | |
| | Percent | 37.6% | | 36.8% | | 33.9% | | 33.6% | | | | | |
| Power | Total | 40,000 | 50,000 | 35,000 | 35,000 | 35,000 | 35,000 | | | | | | |
| | Percent | 39,362 | 49,402 | 49,402 | 34,162 | 34,162 | 34,162 | 34,613 | | | | | |
| | Percent | 13.5% | | 16.6% | | 13.6% | | 12.6% | | | | | |
| High speed | Total | 110,000 | 130,000 | 122,000 | 130,000 | 122,000 | 130,000 | | | | | | |
| | Percent | 35,814 | 39,341 | 39,341 | 42,334 | 42,334 | 42,334 | 57,993 | | | | | |
| | Percent | 12.3% | | 13.2% | | 16.8% | | 21.0% | | | | | |

Notes:

All DoD numbers are approximate,
 FY04 and FY05 numbers are actual,
 and
 FY06 and FY07 numbers are PBR.

The flatness of the numbers, however, is not indicative of the true picture, particularly in the 6.2 budgets. For example, Table 7-2 shows the breakdown of 6.2 funds in the gas turbine technology budgets from FY02 to FY06. Funding for 6.2 is the seed funding for the advancement of game-changing technology readiness prior to engine demonstration. The totals for lines 62203F/3066 plus 62203F/3048 taken together are fairly flat. However the 6.2 budgets also cover AFRL payroll and administration costs as well as additional internal taxes. The lowest three lines in the table show what is left for R&D. In-house R&D totals again are fairly flat, but the amounts for industrial R&D fall precipitously over the FY02 to FY06 period, as also shown in Figure 7-4. At this reduced level it is impossible to achieve the advances in capabilities that the Air Force needs to maintain air superiority. This confirms the statements to the same effect in Chapter 3 of this report.

A consensus of the committee is that there has already been a significant erosion of the U.S. lead in propulsion technology and that a flat budget will lead to further erosion if these trends are not immediately reversed.

Since the projected investments through FY07 are flat—they do not even cover inflation—one can expect only incremental improvements in technology over this period. Anything revolutionary would have to be at the expense of existing programs or would require funding above the projected levels. Research funding (6.1 and 6.2) is vital to the warfighter since it is the source of new ideas and technologies and promotes the education of new engineers and scientists in aerospace propulsion.

It is painful to contemplate the consequences of further budget reduction from the present marginal levels of investment. In the event of budget reduction, funding priority in the 6.2 and 6.3 programs will be directed to warfighter needs. Again, 6.1 funding is extremely important for the reasons stated above.

TABLE 7-2 6.2 Funding for Turbine Engine Technology Development (millions of dollars)

| Budget Item | FY02 | FY03 | FY04 | FY05 | FY06 ^a |
|----------------------------------|------|------|------|------|-------------------|
| 62203F/3066 | 43.4 | 38.7 | 32.2 | 32.7 | 33.5 |
| Payroll/administration | 17.6 | 18.9 | 17.5 | 18.9 | 19.5 |
| Taxes to Air Force, AFRL, and PR | 2.6 | 2.3 | 2.3 | 3.7 | 4.5 |
| In-house R&D | 4.6 | 5.0 | 4.2 | 4.9 | 6.4 |
| Industry R&D | 18.6 | 12.5 | 8.2 | 5.3 | 3.1 |
| 62203F/3048 | 9.7 | 15.3 | 14.7 | 12.5 | 14.4 |
| Payroll/administration | 6.0 | 6.5 | 7.9 | 7.5 | 7.7 |
| Taxes to Air Force, AFRL, and PR | 0.7 | 0.8 | 0.9 | 1.3 | 2.0 |
| In-house R&D | 3.1 | 4.8 | 3.2 | 3.0 | 3.8 |
| Industry R&D | 0.0 | 3.2 | 2.7 | 0.7 | 0.9 |
| Total 6.2 for in-house R&D | 7.7 | 9.8 | 7.4 | 7.9 | 10.2 |
| Total 6.2 for industry R&D | 18.6 | 15.7 | 10.9 | 6.0 | 4.0 |
| Total 6.2 for R&D | 26.3 | 25.5 | 18.3 | 13.8 | 14.2 |

^aIn FY06 \$1.2 million for technicians no longer covered as part of AFRL taxes.

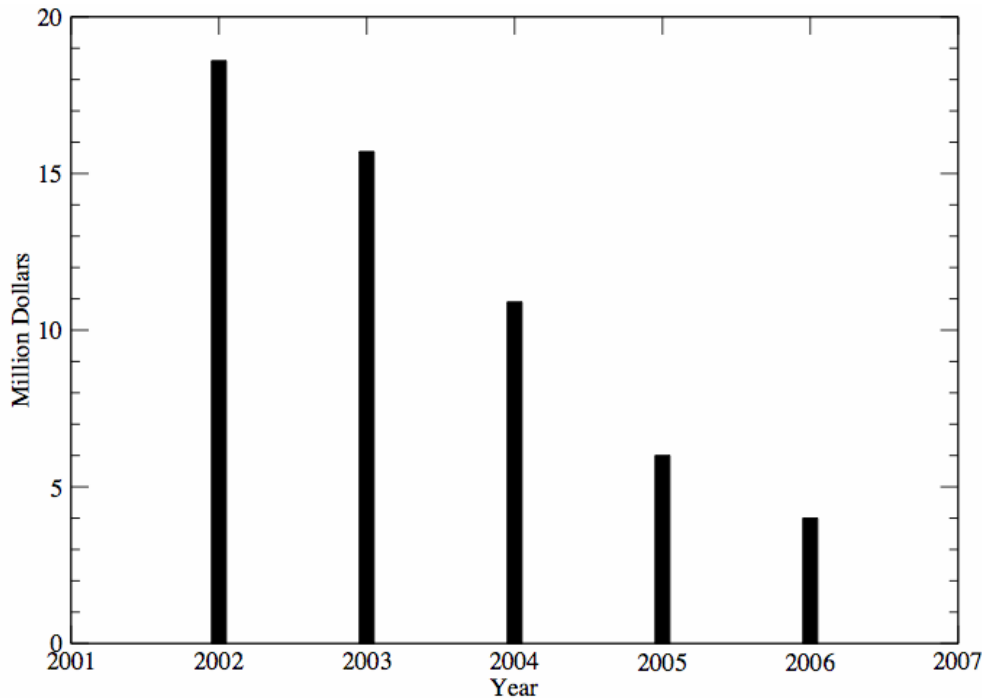

FIGURE 7-4 Technology development funding (6.2) for industry R&D on turbine engines. SOURCE: AFRL.

REFERENCES

Published

- Chiueh, Tzihong. 1997. Exotic atom: Double-helix positronium. *Chinese Journal of Physics* 35(4): 344-352.
- Douglass, John W. 2000a. President, Aerospace Industries Association. 106th Congress: Industry tallies major gains on aerospace issues. *AIA Update* 5(6):2.
- Gibbons, Michael T. 2004. The Year in Numbers. American Society of Engineering Education. Available online at <http://www.asee.org/about/publications/profiles/upload/2004ProfileIntro2.pdf>. Last accessed on March 29, 2006.
- Jobo, Ronald. 2003. Applying the lessons of “Lean Now” to transform the U.S. aerospace enterprise: A study guide for government lean transformation. Cambridge, Mass: Massachusetts Institute of Technology. August 23. Available online at http://lean.mit.edu/index.php?option=com_docman&task=doc_view&gid=244. Last accessed on August 9, 2006.
- Mansfield, D.K., P.J. Howard, J.D. Luff, R.B. Miles, G.L. Brown, I.G. Girgis, R.J. Lipinski, G.E. Pena, L.X. Schneider, J. Grinstead, and R. Howard. 2005. The 1-MW Radiatively Driven Hypersonic Wind Tunnel Experiments Final Report. Arnold Air Force Base, Tenn.: Arnold Engineering Development Center.
- NRC (National Research Council). 2001. Review of the Future of the U.S. Aerospace Infrastructure and Aerospace Engineering Disciplines to Meet the Needs of the Air Force and the Department of Defense. Washington, D.C.: National Academy Press. Available online at <http://www.nap.edu/books/0309076064/html>. Last accessed on June 16, 2006.
- NRC. 2004. Evaluation of the National Aerospace Initiative. Washington, D.C.: The National Academies Press. Available online at <http://www.nap.edu/catalog/10980.html>. Last accessed on March 29, 2006.

- NRC. 2006a. Decadal Survey of Civil Aeronautics: Foundation for the Future. Washington, D.C.: The National Academies Press. Available online at <http://newton.nap.edu/catalog/11664.html#toc>. Last accessed on August 21, 2006.
- NRC. 2006b. Rising Above the Gathering Storm—Energizing and Employing America for a Brighter Economic Future. Washington, D.C.: The National Academies Press. Available online at <http://fermat.nap.edu/catalog/11463.html>. Last accessed on March 29, 2006.
- OUSD AT&L (Office of the Secretary of Defense for Acquisition, Technology, and Logistics). 2003. Manager's Guide to Technology Transition in an Evolutionary Acquisition Environment. Washington, D.C.: Office of the Secretary of Defense for Acquisition, Technology, and Logistics. January 31. Available online at <https://www.dodmantech.com/pubs/MgrGuideToTechTrans.pdf>. Last accessed on August 9, 2006.
- Schafrik, Robert. 2005. Materials Modeling and Simulation: Pathway to Radical Innovation. International Workshop on Accelerated Radical Innovation, March 10-12. Toledo, Ohio: College of Engineering, University of Toledo.
- Shertzer, J., J. Ackermann, and P. Schmelcher. 1998. Positronium in crossed electric and magnetic fields: The existence of a long-lived ground state. *Physical Review* 58(2): 1129-1138.
- Walker, Robert S., F. Whitten Peters, Buzz Aldrin, Edward M. Bolen, R. Thomas Buffenbarger, John W. Douglass, Tillie K. Fowler, John J. Hamre, William Schneider, Jr., Robert J. Stevens, Neil deGrasse Tyson, and Heidi R. Wood. 2002. Final Report of the Commission on the Future of the United States Aerospace Industry. November. Available online at <http://www.ita.doc.gov/td/aerospace/aerospacecommission/AeroCommissionFinalReport>

Unpublished

- Larry Burns. AFRL/PRT overview/introductions. Presentation to the committee on April 5, 2005.
Karen Ray, Defense science and technology reliance: Reliance planning process
- John Douglass. 2000b. Briefing to the Committee on the Future of the U.S. Aerospace Infrastructure and Aerospace Engineering Disciplines to Meet the Needs of the Air Force and the Department of Defense, on January 27, 2000.

Appendixes

Appendix A

Biographical Sketches of Committee Members

Kenneth E. Eickmann, *Chair* (U.S. Air Force, retired), whose leadership accomplishments include having led the federal rescue and recovery efforts following the 1995 bombing of Oklahoma City's Alfred P. Murrah Building, served as the director of the Construction Industry Institute (CII) at the University of Texas (UT) at Austin from June 1998 to October 2003. CII, a nonprofit research institute, is the principal national forum for the multitrillion-dollar-a-year construction industry. The more than 100 member companies of the institute are dedicated to improving the cost, schedule, quality, safety, security, and operability of constructed facilities. CII annually funds \$5 million in research at 30 U.S. universities to improve the total quality and cost effectiveness of the construction industry. General Eickmann's recent accomplishments include selection as a distinguished engineering graduate of the University of Texas; selection for membership of the National Academy of Construction; selection as chairman of a General Officer Red Team, formed to review the logistics transformation efforts of the U.S. Air Force; and selection to serve on a National Research Council committee formed to evaluate the feasibility of achieving the science and technology requirements implied in the National Aerospace Initiative. He completed 22 assignments, including a stint from 1994 to 1996 as commander, Oklahoma City Air Logistics Center, Tinker Air Force Base. His last assignment on active duty was commander, Aeronautical Systems Center, Wright-Patterson Air Force Base. As commander, he chaired a consortium partnering the U.S. Department of Defense, the aerospace industry, and the Massachusetts Institute of Technology to increase competitiveness in the aerospace industry. General Eickmann currently serves as the vice chairman of the Texas Engineers' Task Force on Homeland Security and recently formed an executive placement company, The Eickmann Group, dedicated to the placement of retired military leaders in industry. General Eickmann earned a B.S. in mechanical engineering from UT at Austin in 1967, an M.S. in systems engineering from the Air Force Institute of Technology in 1968, and is a graduate of the University of Michigan Executive Business Program and the John F. Kennedy School of Government at Harvard University. He has expertise in propulsion engineering, materials science and engineering, military systems acquisition, and systems engineering.

Donald W. Bahr (NAE) was manager of the combustion technology operation at GE Aircraft Engines (GEAE) for more than 20 years prior to his retirement. He joined GEAE in 1956 as a combustion research engineer. As manager of combustion technology, he was responsible for the design, development, and certification of a variety of combustion systems used in both commercial and military aircraft turbine engines as well as combustion systems used in industrial turbine engines. Mr. Bahr served as the GEAE representative on several national and international government-industry committees concerned with the promulgation of regulations for aircraft and industrial turbine engine emissions. Mr. Bahr holds six issued patents. Since 1994, he has been active as a consultant and has also served on several National Research Council committees. Mr. Bahr graduated from the University of Illinois with a B.S. degree in chemical engineering and from the Illinois Institute of Technology with M.S. degrees in chemical engineering and gas technology. He is a fellow of the American Society of Mechanical Engineers (ASME) and the American Institute of Aeronautics and Astronautics (AIAA). He is a member of the General Electric

Propulsion Hall of Fame. His expertise is in propulsion engineering, thermodynamics, aerodynamics, gas turbine combustion, and fuels technologies.

Dilip R. Ballal graduated from the Cranfield Institute of Technology with a Ph.D. in mechanical engineering. Currently, he is head of the Energy and Environmental Engineering Division at the University of Dayton. As division head, Dr. Ballal has overall responsibility for the direction and successful completion of basic and applied research in aerospace fuel science, fuels engineering, combustion, environmental engineering, modeling and simulation, and energy conservation. He joined the university in April 1983 as the leader of aerospace fuels and combustion group in the Research Institute. He has over 35 years of research experience in academia and industry. Dr. Ballal is also the Hans von Ohain Distinguished Professor in mechanical and aerospace engineering and director of the von Ohain Fuels and Combustion Center at the University of Dayton. His expertise in fuels, combustion, and emissions requirements of advanced propulsion systems has led to improvements in gas turbine combustor technology.

Yvonne C. Brill (NAE) graduated from the University of Southern California with an M.S. in physical chemistry. She is currently a consultant specializing in satellite technology and space propulsion systems. After retiring from the International Maritime Satellite Organization (INMARSAT) in 1991, where she was propulsion manager for the INMARSAT-2 satellite system, she served from 1991 to 1994 as a member of several National Research Council committees evaluating pertinent space transportation systems. From 1994 to 2001 she was a member of the NASA Aerospace Safety Advisory Panel. She also provided extensive technical support services on communication satellites to Telenor (Oslo, Norway) and Shinawatra Satellite Co. Ltd. (Bangkok, Thailand) during their procurements of satellites in the United States. Earlier experience included working for a number of different corporations on the design and testing of ramjet and turbojet engines, launch vehicle and solid propulsion apogee motor stage selection, and the design and implementation of onboard propulsion for satellites. Ms. Brill is a fellow of the AIAA and the Society of Women Engineers (SWE). She is a member of the National Academy of Engineering and the Women in Technology International Hall of Fame. Among her awards are the AIAA 2002 Wyld Award in rocket propulsion, the IEEE 2002 Dr. Judith A. Resnik Award, and the NASA Distinguished Public Service Medal in 2001. Her expertise is in space science, space astronautics, rocket/missile propulsion, and spacecraft/satellite propulsion.

Dennis M. Bushnell (NAE) graduated from the University of Virginia with an M.S. in mechanical engineering. Mr. Bushnell is currently responsible for technical oversight and advanced program formulation for NASA Langley Research Center, with technical emphasis in atmospheric sciences and structures, materials, acoustics, flight electronics/control/software, instruments, aerodynamics, aerothermodynamics, hypersonic air-breathing propulsion, computational sciences and systems optimization for aeronautics, spacecraft, exploration and space access. He is a member/fellow of the National Academy of Engineering, ASME, AIAA, and the Royal Aeronautical Society. He has expertise in propulsion engineering, thermodynamics, aerodynamics, systems engineering, and rocket propulsion engineering.

Paul G. A. Cizmas graduated from Duke University with a Ph.D. in mechanical engineering and materials science. Dr. Cizmas is currently associate professor in the aerospace engineering department of Texas A&M University. Prior to joining Texas A&M he was a senior engineer/scientist at the Science and Technology Center of the Westinghouse Electric Corporation. His research interests concentrate on the numerical simulation of steady and unsteady transport phenomena for propulsion, fluid-solid interaction, combustion and computational fluid dynamics. His expertise is in propulsion engineering, thermodynamics, and aerodynamics.

Charles H. Coolidge is vice president of Air Force programs at EADS North America Defense Company. He retired from the U.S. Air Force in 2004, with his last assignment as vice commander of headquarters Air Force Materiel Command, Wright-Patterson Air Force Base. The command conducts research, development, testing, and evaluation and provides the acquisition management and logistic support necessary for Air Force weapons systems to operate in peace and war. General Coolidge graduated from the U.S. Air Force Academy in 1968 and has served in various operations and staff positions throughout his career. In operations, he served as a flight commander, operations officer, squadron commander, wing vice commander, wing commander, and director of operations and logistics. He has commanded three Air Force wings and served on the staffs of four major air commands. He also served on the Joint Staff and was the Joint Staff representative to the U.S.-U.S.S.R. Standing Consultative Commission, which met biannually in Geneva. General Coolidge is a command pilot with more than 4,100 flying hours. He has expertise in military systems acquisition.

David E. Crow (NAE) graduated from the University of Missouri-Rolla with a Ph.D. in mechanical engineering. Dr. Crow joined the faculty of the University of Connecticut as a distinguished professor-in-residence in the mechanical engineering department after a distinguished career in industry. He joined Pratt & Whitney in 1966, rising to the position of senior vice president of Pratt & Whitney's engineering organization, where he was responsible for the design, development, validation, and certification of all Pratt & Whitney large commercial engines, military engines, and rocket products. He also led the research and development of advanced technologies systems to meet future aircraft requirements. Dr. Crow previously held the position of senior vice president for Pratt & Whitney's large commercial engines organization, which included the PW4000 and JT9D high-thrust family of products. Dr. Crow is a past secretary of the Society of Automotive Engineers (SAE), and a member of both ASME and AIAA. In addition to having served as president of Pi Tau Sigma, he has served on the Engineering Advisory Board at Clarkson University and is an elected member of the Academy of Mechanical Engineers at the University of Missouri-Rolla. His expertise is in propulsion engineering, thermodynamics, aerodynamics, systems engineering, and rocket propulsion engineering.

Thomas W. Eagar (NAE) earned his Sc.D. in metallurgy from the Massachusetts Institute of Technology in 1976. Dr. Eagar also completed the business administration program at Lehigh University and the program for senior executives. He has held numerous positions at the Massachusetts Institute of Technology, including professor of materials engineering and engineering systems. Currently, he is the Thomas Lord Professor of Materials Engineering and Engineering Systems. His professional interests include materials processing and manufacturing; special interests in welding and joining of metals, ceramics, and electronic materials; deformation processing; alternative manufacturing processes; manufacturing management; materials systems analysis; selection of materials; and failure analysis. He is the recipient of many honors and awards; the most recent include a Silver Quill Award and the William Irrgang Award from the American Welding Society; a General Electric Distinguished Lecture at Rensselaer Polytechnic Institute; and the Henry Marion Howe Medal from ASM International. His memberships include those in the NAE, the American Welding Society, the American Council of International Institutes of Welding, the Society of Automotive Engineers, the American Ceramic Society, the Society of Manufacturing Engineers, the ASME, the American Society for Testing and Materials, and the Materials Research Society.

Gerard W. Elverum Jr. (NAE) received a B.S. in physics from the University of Minnesota's Institute of Technology, after which he carried out pioneering research on the physical properties, performance, and combustion characteristics of various liquid propellant combinations for rockets at Caltech's Jet Propulsion Laboratory. He was also responsible for design and technology development programs on advanced rocket engines. In 1959, Mr. Elverum joined Space Technology Laboratories (STL) as section head of advanced propulsion. STL had systems engineering responsibility for the Air Force's ballistic missile programs, and he worked on propulsion systems for the Atlas, Titan I and Titan II intercontinental ballistic missiles (ICBMs). In 1962 he evolved a unique design concept for deep-throttling liquid

bipropellant rocket engines. His patented concept was ultimately selected for the Lunar Module Descent Engine (LMDE) of the Apollo program. Mr. Elverum was STL's program manager and chief engineer for LMDE from its inception through delivery of the first engine to Grumman in 1966. A fixed-thrust version of the LMDE was used to power the Delta stage of the Thor-Delta II launch vehicle. Over 12 years this engine accomplished 65 successful launches of many important national and international payloads. In 1972, Mr. Elverum initiated technology development of direct combustion-driven high-energy chemical lasers at TRW Space and Defense (formerly STL). During the next 18 years, three of the nation's most powerful high-energy chemical lasers (NACL, MIRACL, and ALPHA) were developed under his direction. During the 10 years prior to his retirement in 1990, he was vice president and general manager of the Applied Technology Division of TRW's S&D. Mr. Elverum received a special achievement award from the ASME in 1971 and the Outstanding Engineering Merit Award from the Institute for the Advancement of Engineering in 1972. In 1973 he won the James H. Wyld propulsion award from the AIAA. Mr. Elverum was made a fellow of the AIAA in 1983 and was elected to the National Academy of Engineering in 1987. He has expertise in propulsion engineering, systems engineering, rocket propulsion engineering, rocket missile propulsion, and satellite/spacecraft propulsion.

Carl E. Franklin is an independent consultant and president of International Falcon Associates, Inc. General Franklin retired from the U.S. Air Force in 1998 when he was commander of the 9th Air Force and U.S. Central Air Forces (USCENTAF)—a command of six wings with more than 350 aircraft and 36,000 personnel. As the air component commander for U.S. Central Command, he was responsible for developing contingency plans and conducting air operations in an area of responsibility stretching from Kenya across the Arabian Peninsula and Southwest Asia, including Iraq, to Pakistan. General Franklin was commissioned as a distinguished graduate of Texas Tech University's Air Force Reserve Officer Training Corps program. He commanded a fighter test and evaluation squadron, a tactical reconnaissance wing, an air warfare center under Air Combat Command, and the Joint Task Force Southwest Asia, where he directed coalition air operations over Iraq. His staff experience included two tours at Headquarters U.S. Air Force and an assignment at a major North Atlantic Treaty Organization (NATO) command headquarters, where he was the senior officer directing an international staff from eight nations. A command pilot with some 3,780 hours in fighter and trainer aircraft, he has expertise in military systems acquisition and aircraft propulsion.

Frank C. Gillette, Jr., received a B.S. in mechanical engineering from the University of Florida. Mr. Gillette retired from Pratt & Whitney in 1998, after 36 years of service, and now actively consults with Pratt & Whitney Large Military Engines, also performing reviews of Sikorsky helicopters and assessing damage tolerance of their aircraft. During his time at Pratt & Whitney, he played a major role in designing and developing almost every engine that powers the U.S. Air Force front-line fighter aircraft. As director of the F119 engine, he was responsible for the JAFE, YF-119, and F119 EMD programs. During these programs, he developed a thrust vectoring supercruise engine for the U.S. Air Force's new F-22 Raptor fighter. Mr. Gillette is currently a consultant for United Technologies and Belcan Corporation and participates in the final design reviews for the Belcan Corporation. He is active at the University of Florida and recently completed the search for dean of engineering and is on the Engineering Advisory Committee of the University of Florida Foundation board of directors. He is an active fellow in the ASME and an associate fellow of the AIAA. His expertise is in military systems acquisition, propulsion engineering, materials science and engineering, thermodynamics, aerodynamics, systems engineering, rocket propulsion engineering, and space science.

Edward M. Greitzer (NAE) graduated from Harvard University with a Ph.D. in mechanical engineering. Dr. Greitzer is currently the H.N. Slater Professor of Aeronautics and Astronautics at the Massachusetts Institute of Technology. His professional interests include aeropropulsion, internal flow, gas turbines, active control of aeromechanical systems, robust design of gas turbine engines, and fluid machinery. A

member of the NAE and the ASME, he is an expert in propulsion engineering, thermodynamics, and aerodynamics.

Jeffrey W. Hamstra graduated from the University of Michigan with an M.S. in aerospace engineering. Mr. Hamstra is currently a Lockheed Martin fellow in propulsion integration and is responsible for providing technical consultation and guidance, conducting program reviews, and ensuring technical integrity in the propulsion discipline across the entire Lockheed Martin aero enterprise. He has 20 years of experience in jet propulsion systems integration at Lockheed Martin Aeronautics Company and its Heritage organizations, including program experience from F-16, F-22, F-35 Joint Strike Fighter, and Skunk Works Advanced Development Programs. He has performed as an R&D principal investigator, aircraft project lead, and function department manager. He is familiar with U.S. aircraft engine industry, government propulsion organizations, and propulsion technology programs and has expertise in propulsion engineering, thermodynamics, aerodynamics, systems engineering, and aircraft propulsion. He was inducted as a Lockheed Martin fellow in 2003.

Bernard L. Koff (NAE) is an engineering pioneer whose leadership in the gas turbine industry produced a host of innovative breakthroughs in design and development. With GE and Pratt & Whitney, from which he retired as executive vice president of engineering and technology, his contributions impacted the design and development of over half of all jet engines flying. Mr. Koff also led the design and development of the oxygen and hydrogen high-pressure pumps to replace the Rocketdyne units on the space shuttle main engine. His patents and highly regarded technical papers cover the entire spectrum of jet engine design and manufacturing technology. Honors and awards include the ASME/AIAA/SAE Daniel Guggenheim Medal, the Air Force Association's Theodore von Karman Award, AIAA Reed Aeronautics Award (its highest), AIAA Air Breathing Propulsion Award, AIAA Engineer of the Year, AIAA & SAE Littlewood Lecture Award, ASME Tom Sawyer Award, SAE Franklin Kolk Award, the GE Perry Egbert Award, and the P&W George Mead Medal. He is a fellow of the ASME, AIAA, and SAE. Mr. Koff is a former member of the ASEB and served on three NRC committees. His expertise is in propulsion engineering, materials science and engineering, thermodynamics, aerodynamics, systems engineering, and rocket propulsion engineering.

Mitsuru Kurosaka received a B.S. and an M.S. from the University of Tokyo and a Ph.D. from the California Institute of Technology. After graduation from Caltech in 1968, he worked in the industry, first at AiResearch Mfg. Co. and then at General Electric R&D Center. Since 1987, he has been a professor of aeronautics and astronautics, University of Washington, Seattle. His interests are thermofluid problems related to air-breathing propulsion. He has expertise in propulsion engineering, thermodynamics, aerodynamics, and aircraft propulsion.

D. Brian Landrum graduated from North Carolina State University with a Ph.D. in aerospace. Dr. Landrum is currently an associate professor at the University of Alabama in Huntsville (UAH), in the department of mechanical and aerospace engineering. His professional activities and affiliations include the AIAA, the American Helicopter Society, Phi Kappa Phi, and Sigma Gamma Tau. Recent honors and awards include National Faculty Advisor of the Year (AIAA), associate fellow (AIAA), Outstanding Student Group Advisor (UAH), and the Alabama-Mississippi Section Professional of the Year (AIAA). He has expertise in aerodynamics, rocket propulsion engineering, rocket missile propulsion, and satellite/spacecraft propulsion.

Ivett Leyva graduated from the California Institute of Technology with a Ph.D. in aeronautics. Dr. Leyva is currently a senior aerodynamicist at Microcosm, Inc. She is responsible for coordinating and performing numerical and analytical studies for the design of the DARPA FALCON program launch vehicle and designs hardware for rocket engine subcomponents. Prior to her current position, Dr. Leyva was a thermal sciences engineer for Exponent, where she investigated the cause, origin, and future

prevention of aviation accidents as well as fires and explosions, from the residential to the industrial scales. Her expertise is in propulsion engineering, thermodynamics, aerodynamics, and rocket propulsion engineering.

Lourdes Q. Maurice received a Ph.D. in mechanical engineering from the University of London's Imperial College. Dr. Maurice is currently the chief scientific and technical advisor for the environment in the Federal Aviation Administration, Office of Environment and Energy. She serves as the agency technical expert for basic and exploratory research and advanced technology development focused on aircraft environmental impacts and the application of such technology to noise and emissions certification. She previously served as the Air Force deputy, basic research sciences and propulsion science and technology, in the Office of the Deputy Associate Secretary of the Air Force for Science and Technology. In this position she managed the \$220 million per year basic research sciences and \$240 million per year propulsion science and technology portfolios at the Air Force secretariat. Dr. Maurice also worked at the AFRL's Propulsion and Power Directorate from 1983 to 1999, planning and executing basic, exploratory, and advanced development propulsion science and technology programs focusing on state-of-the-art aviation fuels and propulsion systems. Dr. Maurice is serving a second term on the AIAA Propellants and Combustion Technical Committee. She has authored over 80 publications and is a fellow of the AIAA, as well as a member of the Tau Beta Pi Honorary Engineering Society, the American Association for the Advancement of Science (AAAS), and the American Chemical Society (ACS). She has expertise in aircraft propulsion, propulsion engineering, thermodynamics, aerodynamics, military systems acquisition, and systems engineering.

Neil E. Paton (NAE) graduated from the Massachusetts Institute of Technology with a Ph.D. in materials science. Currently, he is the chief technology advisor and chairman of the Technology Advisory Board at Liquidmetal Technologies, where he has worked since March 2002. Prior to joining Liquidmetal, he served for 12 years as vice president of technology for Howmet Corporation and as president of Howmet Research Corporation, which developed products, processes, and materials for gas turbines. He also worked in materials development and advanced engineering for 20 years at Rockwell International, where he was involved in numerous programs, including the space shuttle program and the National Aerospace Plane program. He has experience in propulsion engineering, materials science and engineering, rocket propulsion engineering, aircraft propulsion and rocket/missile propulsion.

Lawrence P. Quinn graduated from Michigan State University with a Ph.D. in inorganic chemistry. He was employed for 38 years at the AFRL at Edwards Air Force Base, where he was involved in developing advanced propellants; producing physics-based combustion; and rocket exhaust plume models; planning air-launched missile and research technology programs; developing carbon/carbon nozzle technology; and guiding engineering analysis. He also served as acting division chief of several divisions and ended his career as associate technical director of the Space and Missile Systems Division. Currently, Dr. Quinn is director of Southern California Operations at Aerojet. He is responsible for the development of business with the AFRL at Edwards and Kirtland Air Force Bases, the Naval Air Weapons Center, JPL, and other government organizations in southern California. His expertise is in rocket boost and satellite/spacecraft and missile propulsion.

Eli Reshotko (NAE) graduated from the California Institute of Technology with a Ph.D. in aeronautics and physics. Dr. Reshotko is currently the Kent H. Smith Professor Emeritus of Engineering at Case Western Reserve University. He was elected to the NAE in 1984 and is a fellow of the following societies: AIAA, ASME, the American Physical Society, and the American Academy of Mechanics, which he served as president. He is co-author of over 100 publications and is affiliated with many task forces, committees, and governing boards, several of which he served as chair. His area of expertise is viscous effects in external and internal aerodynamics; two- and three-dimensional compressible boundary layers and heat transfer; stability and transition of viscous flows, both incompressible and compressible;

and low-drag technology for aircraft and underwater vehicles. He has expertise in propulsion engineering, thermodynamics, aerodynamics, and aircraft propulsion.

Kenneth M. Rosen (NAE) graduated from Rensselaer Polytechnic Institute with a Ph.D. in mechanical engineering and is a graduate of the Advanced Management Program at the Harvard University Business School. Dr. Rosen has over 43 years of experience in the aerospace and turbo machinery community, much of it at the leadership level. Dr. Rosen is a founding partner of Aero-Science Technology Associates, LLC (ASTA). ASTA is an engineering and business development consulting firm established to service both government and industry customers. For the last 4 years, Dr. Rosen managed his own consulting firm, General Aero-Science Consultants LLC, and served as corporate president of ConceptsNREC, a turbomachinery research company, from 2000 to 2002. Prior to this he spent over 38 years with United Technologies Corporation. Beginning his career in propulsion and aerothermodynamics at Pratt & Whitney Aircraft, he quickly moved to Sikorsky Aircraft, where he held many important engineering and management positions, including vice president of research and engineering and advanced programs, directing such advanced technology projects as the Comanche, S-92 (2003 Collier trophy winner), Cypher (UAVs), and the Black Hawk and X-Wing helicopters. During this period he managed all of Sikorsky's research, development, design, ground/flight testing, and systems engineering efforts. Dr. Rosen was also responsible for all of the company's advanced products and low-observable activities. His professional expertise includes product/business development, program management, helicopter/V/STOL design, turbomachinery, systems integration, low observable technology, propulsion systems, transmission design, pneumodynamics, icing, aerothermodynamics, and systems engineering. Dr. Rosen is an elected member of the NAE and a fellow of the Royal Aeronautical Society, the SAE, AIAA, and the American Helicopter Society. He has been chairman of the board of the Rotorcraft Industry Technology Association, chairman of the UTC Engineering Coordination Steering Committee and the AIA Rotorcraft Advisory Group. Additionally, he is a longtime member of NASA's Aeronautics and Space Transportation Technology Advisory Committee, the SAE Aerospace Council, and the NRC panel that assessed air and ground vehicle technology at the ARL. Dr. Rosen holds five U.S. patents and has written numerous papers on helicopter design, product development, propulsion, aerothermodynamics, icing, and systems engineering. He has expertise in propulsion engineering, thermodynamics, aerodynamics, military systems acquisition, systems engineering, rocket propulsion engineering, aircraft propulsion, and aircraft propulsion.

Robert L. Sackheim (NAE) received a B.S. in chemical engineering from the University of Virginia and an M.S. in chemical engineering from Columbia University. He taught propulsion courses at UCLA, and is teaching a flight propulsion course at the UAH. He has published over 250 papers and currently holds 9 patents. Mr. Sackheim recently retired (mid-May 2006) as the assistant director and chief engineer for propulsion at NASA's MSFC, where he served about 7 years. Prior to his NASA service, he spent 35 years as a TRW (now Northrop-Grumman) employee in key engineering, technical leadership, and management positions. His last position at TRW was director of the Propulsion and Combustion Systems Center. His recent awards and honors include several MSFC Director's Commendations, the Presidential Rank Award for Meritorius Executive Service, the Martin Schilling Award for Management, the Hermann Oberth Award for Outstanding Achievement in Astronautics, the AIAA Holgar Toftoy for Outstanding Technical Leadership, the NASA Medal for Outstanding Technical Leadership, the AIAA Sustained Service Award for Outstanding Contributions to the Institute, the AIAA Wyld Propulsion Award, and he has also received three annual chairmen's awards for outstanding technical contributions from TRW. He has also received patent of the year award and recognition from the Association of Aeronautics and Astronautics of France in recognition of the high quality of his contributions to the propulsion community. His professional and honorary society affiliations include membership of Sigma Xi and a fellow of AIAA. He was chairman of the AIAA Liquid Propulsion Technical Committee, the Los Angeles section of the AIAA, and the Mississippi/Alabama section of the AIAA, and has served on numerous committees and advisory boards. He is a member of the NAE. He was selected for membership on this committee due to his expertise in space science, space astronautics, rocket/missile propulsion,

spacecraft/satellite propulsion, propulsion engineering, materials science, and engineering, and thermodynamics.

Ben T. Zinn (NAE) received a Ph.D. in aerospace and mechanical sciences from Princeton University. He is currently the holder of the David S. Lewis Jr. Chair and is a Regents' Professor at the School of Aerospace Engineering at Georgia Tech. His research areas include control of combustion processes, combustion instabilities, propulsion, acoustics, microscale combustion, and energy conversion systems. Dr. Zinn has published nearly 400 papers and reports and holds 9 patents in these fields. Additionally, he has edited two AIAA progress volumes on combustion diagnostics and has contributed chapters on pulse combustion to several books. Dr. Zinn is currently the director of NASA's URETI Center on Aeropropulsion and Power. He formerly served as director of the Army MURI on intelligent turbine engines. Dr. Zinn has also served on several Air Force boards dealing with propulsion issues. Dr. Zinn's honors include membership in the NAE; ASME's International Gas Turbine Institute Aircraft Engine Technology Award, 2005; honorary professor, Beijing University of Aeronautics and Astronautics; Fellow of the ASME and AIAA; the Alfred C. Egerton Gold Medal of the Combustion Institute, 2002; AIAA Air-Breathing Propulsion Award, 2003; AIAA Pendray Aerospace Literature Award, 2000; AIAA Propellants and Combustion Award, 1996; and Georgia Tech's Distinguished Professor Award, 1990. He has expertise in air-breathing and rocket propulsion systems, combustion, combustion instabilities, active control of combustion processes, and acoustics.

Appendix B

Meetings and Speakers

MEETING 1
WASHINGTON, D.C.
MARCH 1-2, 2005

Co-Sponsor Discussion on Study Background, Intent and Priorities

Jim Engle

Deputy Assistant Secretary of the Air Force for Research and Engineering

Robert Shaw

Office of the Director of Defense Research and Engineering

National Aerospace Initiative Update

Ronald M. Sega

Director of Defense Research and Engineering

Department of Defense Propulsion Science and Technology

Michael Richman, Associate Director, Aerospace Technology

Office of the Deputy Under Secretary of Defense, Science and Technology

MEETING 2
WASHINGTON, D.C.
APRIL 5-6, 2005

Air Force Future Propulsion Requirements and Concepts

John Pernot, Deputy Chief, Future Concepts and Transformation Division

Headquarters, U.S. Air Force/XPXC

Propulsion Directorate Overview

Mike Heil, Director, Propulsion Directorate

Air Force Research Laboratory

Defense Advanced Research Projects Agency

Arthur Morrish, Director, Tactical Technology Office

Defense Advanced Research Projects Agency

Space Requirements

Andrew Culbertson, Associate Director, Space Platforms
Office of the Director, Defense Research & Engineering

Air Force Research Laboratory, Science and Technology Overview

Mike Huggins, Chief, Space and Missile Propulsion Division
Air Force Research Laboratory

Air Force Space Propulsion Basic Research Activities

Mitat Birkan, Program Manager, Space Propulsion
Air Force Office of Scientific Research

Overview of NASA Marshall Space Flight Center

Robert Sackheim, Assistant Director and Chief Engineer for Propulsion
NASA Marshall Space Flight Center

Gas Turbine Engine Materials

Dallis Hardwick, Materials Technology Lead
Air Force Research Laboratory/MLLM

Compression Systems Technology

John Lueke, Compression Systems Technology Lead
Air Force Research Laboratory/PRTF

Aerospace Fuels/Thermal Management

Tim Edwards, Fuels Technology Lead
Air Force Research Laboratory/PRTC

Combustion Systems Science and Technology

Carlos Arana, Combustion Systems Technology Lead
Air Force Research Laboratory/PRTC

Turbine Systems

Charles Stevens, Turbine Systems Technology Lead
Air Force Research Laboratory/PRTT

Propulsion Integration Technologies

Alex Giese, Exhaust Systems Technology Lead
Air Force Research Laboratory/PRTA

Mechanical Systems Technology

Nelson Forster, Mechanical Systems Technology Lead
Air Force Research Laboratory/PRTM

Technology Readiness Level 6 Demonstrators

Richard McNally, Advanced Technology Demonstrator Engines Lead
Air Force Research Laboratory/P RTP

Turbine Engine Technology Transition

Mark Dale, Chief, Propulsion Branch, Turbine Engine Division
Air Force Research Laboratory/PRPT

High Cycle Fatigue

Daniel Thomson, High Cycle Fatigue Program Manager
Air Force Research Laboratory/PRT

Overview of Turbine Engine Technologies, Progress, and Future Opportunities

Jeffrey Stricker, Chief Engineer, Turbine Engine Division
Air Force Research Laboratory/PRT

Current/Future Turbine Engine Technology Investment Plans and VAATE

Larry Burns, VAATE Program Manager
Air Force Research Laboratory

NASA Glenn Research Center, In-Space Propulsion Activities

Robert Jankovsky, Chief, Electric Propulsion Branch, and
Mark Klem, Manager, Alternative Power Project

Air Force Research Laboratory, Hypersonic Propulsion

Robert Mercier, Deputy for Technology, and Thomas Jackson, Deputy for Science
Air Force Research Laboratory, Propulsion Directorate

**MEETING 3
WASHINGTON, D.C.
MAY 24-26, 2005**

Thermodynamic Cycle Analysis of Pulse Detonation Engines and the Pulse Detonation Engine

William Heiser, Professor Emeritus
U.S. Air Force Academy

Department of Defense, Propulsion Science and Technology Overview

Ronald M. Sega
Director, Defense Research and Engineering

HyFly Program Overview and Navy HyFly

Gil Graff, Weapons Science and Technology Manager
Office of Naval Research

Sea Power 21/Naval Capabilities Development Office Overview and Navy Turbine Engine Technology

Charles A. Gorton, Chief Technology Officer, AIR-4.4T
NAVAIR Propulsion and Power Engineering

Navy Revolutionary Approach to Time-Critical Long Range Strike (RATTLRS)

Bill Voorhees, Propulsion and Power Air Vehicles Technology Team Lead
NAVAIR

NAI High Speed Hypersonics—Army

Billy Walker, Senior Research Scientist
U.S. Army Research, Development, and Engineering Command

**MEETING 4
WASHINGTON, D.C.
AUGUST 16-17, 2005**

Strategy Options

Bob May, Deputy for Support
Aeronautical Systems Center

Defense S&T Reliance

Karen Ray, Defense S&T Reliance Executive Staff Chair
Office of Naval Research

Strategy Options

Jon Ogg, Director, Chief Information Officer and Communications, AFMC/A6, and
Ted Fecke, Technical Advisor Propulsion, ASC

Strategy Options

Bill Borger, Director, Propulsion, AFRL, and
William Koop, Chief, Turbine Engine Division, AFRL/PRT

Strategy Options

Tim Dues, Deputy for Logistics and Depot Maintenances
Air Force Materiel Command

Aerojet Overview—Hypersonic Propulsion

Adam Siebenhaar, Director, Hypersonic Propulsion
Aerojet

Positron Energy Conversion Status Review

Kenneth Edwards
Air Force Research Laboratory

DARPA Update

Dave Lucia, DARPA/TTO

Appendix C

Site Visits

Site Visit 1

March 24, 2005

Pratt & Whitney MMI, Seattle, Washington

Participant: Mitsuru Kurosaka

Site Visit 2

March 24, 2005

Microcosm, Inc., El Segundo, California

Participants: Gerard Elverum, Ivett Leyva, Neil Paton, Lawrence Quinn

Site Visit 3

March 25, 2005

Northrop Grumman Space Technology, Redondo Beach, California

Participants: Gerard Elverum, Ivett Leyva, Neil Paton, Lawrence Quinn

Site Visit 4

March 25, 2005

Space Exploration Technologies, El Segundo, California

Participants: Gerard Elverum, Neil Paton, Lawrence Quinn

Site Visit 5

April 13, 2005

Rocketdyne Propulsion and Power, Canoga Park, California

Participants: Gerard Elverum, Ivett Leyva, Neil Paton

Site Visit 6

April 14, 2005

Air Force Research Laboratory, Edwards Air Force Base, California

Participants: Gerard Elverum, Ivett Leyva, Neil Paton, Lawrence Quinn

Site Visit 7

April 15, 2005

AirLaunch, LLC, Mojave Airport, California

Participants: Gerard Elverum, Neil Paton, Lawrence Quinn

Site Visit 8

April 19, 2005

Northrop Grumman Space Technology, Redondo Beach, California

Participant: Gerard Elverum

Site Visit 9

April 19, 2005

Lockheed Martin Space Systems Company, Michoud Operations, New Orleans, Louisiana

Participants: Robert Sackheim, D. Brian Landrum

Site Visit 10

April 21, 2005

Aerojet, Sacramento, California

Participants: Gerard Elverum, Neil Paton, Lawrence Quinn

Site Visit 11

April 26-27, 2005

Wright-Patterson Air Force Base, Ohio

Participant: Frank Gillette, Jr.

Site Visit 12

May 4, 2005

GE Aircraft Engines, Lynn, Massachusetts

Participants: Kenneth Rosen, Paul Cizmas

Site Visit 13

May 5, 2005

GE Aircraft Engines, Cincinnati, Ohio

Participants: Donald Bahr, Dilip Ballal, Edward Greitzer, Jeffrey Hamstra, Bernard Koff, Ben Zinn

Site Visit 14

May 5, 2005

Okalahoma City Air Logistics Center

Participants: Kenneth Eickman, Frank Gillette, Jr.

Site Visit 15

May 9, 2005

Allison Advanced Development Company, Indianapolis, Indiana

Participant: Dilip Ballal

Site Visit 16

May 11, 2005

Air Force Research Laboratory, Wright-Patterson Air Force Base, Ohio

Participants: Lourdes Maurice, Dilip Ballal

Site Visit 17

May 17, 2005

United Technologies Corporation, Pratt & Whitney Division, East Hartford, Connecticut

Participants: David Crow, Paul Cizmas, Kenneth Rosen, Ben Zinn

Site Visit 18

May 18, 2005

Pratt & Whitney, West Palm Beach, Florida
Participants: Yvonne Brill, D. Brian Landrum

Site Visit 19
May 27, 2005
ATK Thiokol, Elkton, Maryland
Participants: Robert Sackheim, Yvonne Brill

Site Visit 20
June 21, 2005
Army Tactical Missile Propulsion Group, Hunstville, Alabama
Participants: David Crow, Ben Zinn, Robert Sackheim

Site Visit 21
June 27-30, 2005
Williams International, Detroit, Michigan
Participants: David Crow, Frank Gillette, Jr.

Site Visit 22
October 20, 2005
University of Dayton (representatives from the National Air and Space Intelligence Center and the
Air Force Research Laboratory)
Participants: Dilip Ballal, Dennis Bushnell, and Lourdes Maurice

Appendix D

Background Information on the Delta IV and Atlas V Families of Large Launch Vehicles

RS-68 BOOSTER ENGINE FOR DELTA IV

In the early 1990s, Rocketdyne initiated development of the first new indigenous booster-class engine in the United States in more than 25 years. The engine was designated the RS-68 and was ultimately selected to power the Delta family of evolved expendable launch vehicles (EELVs) that was developed for the Air Force by the Boeing Space Systems Company. The RS-68 is a conventional bell nozzle, LOx LH₂ booster engine that develops 650,000 lb of sea level thrust. During the design and development phases, this engine utilized a simplified design philosophy (compared with, for example, the Apollo rocket engines and the space shuttle main engine (SSME)), significantly reducing parts count (again, compared with current cryogenic engines worldwide). Rocketdyne also claims that this overall simplified design approach resulted in lower development and production costs. The engine is capable of being throttled to 60 percent of full power level.

The RS-68 is the largest LOx/H₂ engine in the world today. The engine uses a simple, open gas generator cycle with a regeneratively cooled main chamber. The turbine exhaust gases can be vectored on command to provide roll control capability for the Delta IV family of launch vehicles. The engine was designed, developed, and certified in a little over 5 years, and the first RS-68 flew on the first Delta IV launch in late 2002. At 656,000 lb of sea level thrust, the RS-68 develops the equivalent of 17 million hp (the equivalent of 11 Hoover Dams at full power generation).

The RS-68 has far fewer parts than the SSME, which greatly contributes to its lower production costs. It has only 11 major components, including the main combustion chamber (MCC), single oxygen and hydrogen turbopumps, gimbal bearing, injector, gas generator, heat exchangers, and fuel exhaust duct. This amounts to a reduction of parts from SSME of over 80 percent and a reduction in hand-touched labor by 92 percent. The development cycle time was also much reduced, and the nonrecurring costs were claimed to be reduced by a factor of five compared to those of previous cryogenic engines.

The engine stands 17 feet tall, is 8 feet in diameter, and has a quadrapod thrust frame that mates it to the Delta IV common booster core first stage. The engine performance and operating characteristics are summarized in Table D-1.

RL-10B-2 ENGINE FOR DELTA III AND IV UPPER STAGES

The RL-10 engine, developed by Pratt & Whitney in the late 1950s, was the world's first LOx/LH₂-fueled rocket engine operated in space. The RL-10 engine, used on stages (Nova A-3, Nova B-3, and Saturn IV) and on launch vehicles (Nova A, Nova B, Saturn B-1, Saturn C-2, Saturn C-3, and Saturn I), weighed 131 kg and developed an I_{sp} of 410 sec. The engine operated with a nominal chamber pressure of 348 psi and provided a T/W ratio of 44.63. Since the first successful launch of an Atlas/Centaur RL-10 in November of 1961, Pratt & Whitney has developed nine different models of the RL-10 engine family. The RL-10

has earned the reputation of being a highly reliable, safe, and high-performing cryogenic upper-stage engine for a wide variety of upper stages for a large number of U.S. EELVs.

TABLE D-1 RS-68 Engine Major Performance and Operating Characteristics

| Characteristic | Thrust Level | |
|-----------------------|--------------|-----|
| | 100% | 60% |
| Thrust (thousand lbf) | | |
| At vacuum | 745 | 440 |
| At sea level | 650 | 345 |
| Weight | 14,560 | |
| Engine mixture ratio | 6.0 | 6.0 |
| I_{sp} (sec) | | |
| At vacuum | 410 | 410 |
| At sea level | 365 | 365 |
| Chamber pressure | 1,410 | 836 |
| Expansion ratio E | 21.5 | |

During the past four decades, the RL-10 engine family has placed more than 150 government, military, and commercial payloads into space. The RL-10 has provided propulsion for a wide variety of rocket configurations, including those in the Saturn, Titan, Atlas, and Delta launch vehicle families. Payload size and mission configuration were used to determine the best engine model for each vehicle configuration.

The RL-10B-2 is a derivative of the successful RL-10 engine. It features the world's largest carbon-carbon extendible nozzle. This high expansion nozzle enables the RL-10B-2 to operate nominally with a chamber pressure of 633 psi and develops an I_{sp} of 465.5 sec. This engine can lift payloads up to 30,000 lb and currently powers the upper stage of the medium and heavy-lift configurations of Boeing's Delta IV launch vehicle in addition to the upper stage of the Delta III.

Current RL10 engine models and their supported vehicles are RL-10A-4-2 (Atlas V), RL-10-4 and RL-10-4-1 (Atlas II, IIA, IIAS, III and IIIB) and RL-10A-3-A (Titan IVB). The full family of flight-certified RL-10-XX engines is listed in Table D-2, along with their respective key design features.

TABLE D-2 Comparison of RL-10 Engine Models

| Characteristic | A-1 | A-3 | A-3-1 | A-3-3 | A-3-3a | A-4 | A-5 | A-4-1 | B-2 |
|---------------------------|-----------|-----------|------------|-----------|-----------|-----------|-----------|-----------|----------|
| Vacuum thrust (lb) | 15,000 | 15,000 | 15,000 | 15,000 | 16,500 | 20,800 | 14,560 | 22,300 | 24,750 |
| Chamber pressure (psia) | 300 | 300 | 300 | 395 | 475 | 578 | 485 | 610 | 644 |
| Thrust/weight | 50 | 50 | 50 | 50 | 54 | 67 | | 61 | |
| Expansion ratio | 40:1 | 40:1 | 40:1 | 57:1 | 61:1 | 84:1 | 43:1 | 84:1 | 285:1 |
| Specific impulse (sec) | 422 | 427 | 431 | 442 | 444 | 449 | 368 | 451 | 466.5 |
| Flight certification date | Nov. 1961 | June 1962 | Sept. 1964 | Oct. 1966 | Nov. 1981 | Dec. 1990 | Aug. 1992 | Feb. 1994 | May 1998 |

GRAPHITE EPOXY MOTOR FOR DELTA BOOSTERS

ATK Thiokol originally developed the graphite epoxy motor (GEM) for the Delta II launch vehicle for the Air Force and Boeing. GEM 40 boosters were used to increase the launch capability of the Delta II. The GEM 46 is a larger derivative of the highly reliable GEM 40 and will be used on the Delta III. This motor has increased length, diameter, and vectorable nozzles on three of the six ground-start motors.

The motor has also been used on the Delta II Heavy. More recently, GEM 60 motors were developed for the Delta IV EELV. These 70-ft motors provide auxiliary liftoff capability for the Delta IV M+ vehicles.

State-of-the-art automation, robotics, and process controls are used to produce GEMs. Cases are filament wound by computer-controlled winding machines using high-strength graphite fiber and durable epoxy resin. Critical processes (e.g., case bond application, propellant mixing, motor casting) are performed using an extensive network of computerized and robotic facilities to ensure accurate control of manufacturing. The delivered products are consistent, reliable, repeatable, and of high quality.

The current GEM family of motors now includes these:

- GEM 40, for Delta II boosters,
- GEM 46, for Delta III boosters, and
- GEM 60, for Delta IV boosters.

The 60-in.-diameter GEM motor is a strap-on booster system developed to increase the payload-to-orbit capability of the Delta IV M+ launch vehicles. Two and four strap-on motor configurations of the GEM 60 can be flown on the Delta IV M+ vehicles. The motor features a +5 degree canted, moveable nozzle assembly. This motor is a third-generation GEM with both fixed and vectorable nozzle configurations. The Delta IV launch vehicle family's inaugural flight occurred in November 2002 and was the first flight of the Air Force's EELV program.

Table D-3 summarizes operation and performance characteristics of the GEM 60 vectorable nozzle motor.

TABLE D-3 Performance and Operating Characteristics of the GEM 60 Vectorable Nozzle Motor

| Characteristic | Value | Characteristic | Value |
|---------------------------------|------------|------------------------|---------------------|
| Motor dimensions (in.) | | Weight (lbm) | |
| Diameter | 60 | Total loaded | 74,158 |
| Length | 518 | Propellant | 65,471 |
| Motor performance, 73°F nominal | | Case | 3,578 |
| Burn time (sec) | 90.8 | Nozzle | 2,187 |
| Average chamber pressure (psia) | 818 | Other | 2,922 |
| Total impulse (lbf-sec) | 17,950,000 | Burnout | 8,346 |
| Burn time average thrust (lbf) | 197, 539 | Temperature limits, | |
| Nozzle | | Operation (°F) | 30-100 |
| Housing material | 4340 Steel | Propellant designation | QEY 87% solids HTPB |
| Exit diameter (in.) | 43.12 | Production status | Production |
| Expansion ratio, average | 11.0 | | |

RD-180 BOOSTER ENGINE FOR THE ATLAS V FIRST STAGE

The engine that powers the first stage of the Atlas V EELV is the RD-180. The RD-180 is a two-thrust chamber version of the original Russian RD-170 (four chambers), which is used to power the first stage of the Yuzhnoye/Yuzhmash Ukrainian manufactured Zenit launch vehicle. This engine provides the required performance, operability, and reliability of the RD-170 in a size (933,400 lbf of vacuum thrust) that meets the booster needs of the Atlas V version of the EELV (first used in the United States to successfully power all the Atlas III launches).

The RD-180 is a total propulsion unit/engine system with hydraulics for control valve actuation and thrust vector gimbaling, pneumatics for valve actuation and system purging, and a thrust frame to distribute loads, all self contained as part of the engine. The engine, which employs a LOx lead start, a staged combustion cycle, and a LOx-rich turbine drive, delivers 10 percent better performance than kerosene (RP-1)-fueled operational U.S. booster engines and can provide relatively clean, reusable operation (beyond one mission duty cycle).

After a highly competitive procurement process, Lockheed Martin selected the RD-180 engine to provide the booster propulsion for its Atlas III launch vehicle and the Atlas V for the Air Force's EELV.

The RD-180 is a staged-combustion cycle engine. The two thrust chambers can gimbal ± 8 degrees. The engine has a health monitoring and life prediction system. The fewest possible interfaces are utilized between the launch pad and vehicle (pneumatic and hydraulic systems are self-contained, electrical panels consolidated, and a thrust frame simplifies the mechanical interface).

The engine offers relatively clean operations with a staged-combustion, oxidizer-rich preburner and oxidizer start and shutdown modes that eliminate the potential for coking and unburned kerosene pollution. Between 40 and 100 percent continuous throttling allows real-time trajectory matching and engine checkout on the pad before launch commit. The RD-180 was developed and qualified in 42 months at a much lower cost than past U.S. booster engine developments because of the strong flight-proven RD-170 heritage. A schematic of the RD-180 dual-nozzle engine is shown in Figure D-1.

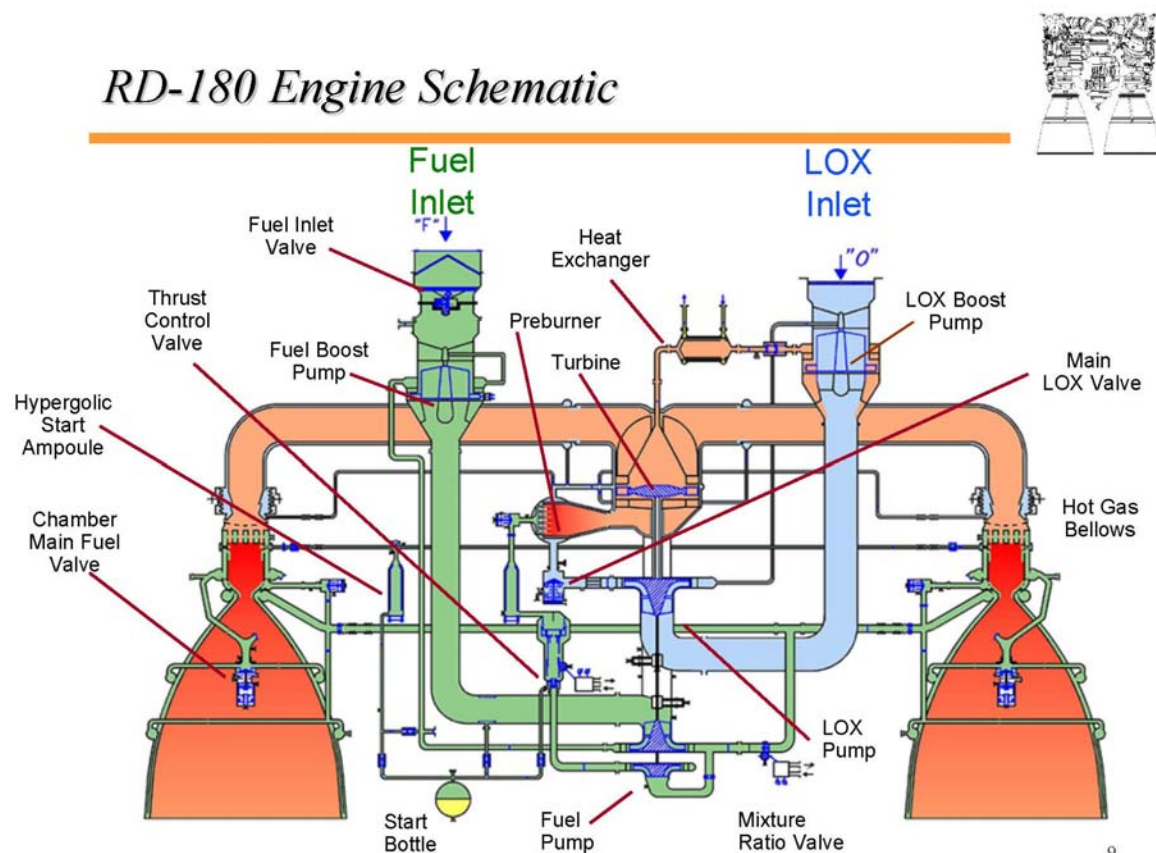

FIGURE D-1 RD-180. SOURCE: AIAA.

RL-10A-4-2 ENGINE FOR ATLAS V SECOND STAGE

The RL-10A-4-2 (used on the Centaur IIIB upper stage and the Atlas IIIB and Atlas V launch vehicle) is a LO_x/LH₂ closed expander. It is equipped with a single turbine and a gearbox that drive the two pumps. It also has dual direct spark ignition and can be flown with a fixed or extendable nozzle. The engine operates nominally with a chamber pressure of 610 psi and develops an I_{sp} of 451 sec. This engine's performance and operating characteristics are summarized in Table D-4.

TABLE D-4 Performance and Operating Characteristics of the RL10A-4-2

| Characteristic | Value |
|--------------------------------------|---------------------|
| Weight w/nozzle (lb) | 386 |
| Length, approx. (in.) | 91.5 |
| Nozzle extension (in.) | 20 |
| Nozzle area ratio | 84:1 |
| I_{sp} vacuum (sec) | 451 |
| Thrust (lb) | 22,300 |
| Propellants | LOx/LH ₂ |
| Nominal mixture ratio, oxidizer/fuel | 5.5:1 |

Appendix E

Background Information on FALCON Launch Vehicle Concepts

AIRLAUNCH

AirLaunch's fundamental design concept for its FALCON vehicle, QuickReach, is a two-stage vehicle. It uses liquid oxygen (LOx)/propane, ablative chambers, and a pressure-fed propulsion system for both stages.¹ The technology utilized for tank pressurization for both the LOx and the propane is termed vapor pressurization and is known as VaPak. This basic approach to tank pressurization was studied by Aerojet in the early 1960s. It was then used in a modified form (autogenous pressurization) to provide net positive suction head (NPSH) for the nitrogen tetroxide (N₂O₄) side of Titan II engines. It was also used in American Rocket Co. (AMROC) hybrid engines for LOx and nitrous oxide (N₂O) oxidizers, and recently it has been used in the hybrid rocket motor of Scaled Composites' Space Ship One. N₂O was also used as the oxidizer in the hybrid propulsion development program (HPDP) sounding rockets launched from Wallops Flight Facility in the mid 1990s. This program was sponsored by NASA and DARPA.

AirLaunch uses single engines for both the first and second stage, which poses no manifolding or plumbing issues (AirLaunch, 2005). It claims that the simplicity of the engines leads to higher reliability and lower operating costs (AirLaunch, 2005).

VaPak utilizes the internal energy of a liquid stored in a closed container to perform the work required to expel the liquid from the container. Before starting, the bulk liquid temperature is adjusted so that the vapor pressure equals the desired tank pressure. The liquid is in thermal equilibrium with the saturated vapors present in the tank ullage (other gases excluded). When the tank valve is opened, draining the liquid or vapor, the tank pressure drops, upsetting the vapor-liquid equilibrium. At this point, the liquid boils, creating additional vapor and tending to counteract the pressure reduction.

Because the heat of vaporization for the vapor being generated is obtained from the liquid, the liquid temperature decreases. Since the vapor pressure of the liquid is a function of its temperature, there is a progressive decrease in the tank pressure as material is expelled, which can be used as a natural throttle.

AirLaunch's QuickReach configuration, shown in Figure E-1, uses a common bulkhead between the propane tanks of the first and second stage, with a second stage engine buried in the first-stage propane tank.

Separation is effected by a single circumferential cut of the first-stage propane tank wall. Thrust vector control is via liquid injection into the nozzle expansion cone. The head end and injector are derived from TRW's LEMDE (Apollo) and TRW's Delta second-stage engine of the 1980s. AirLaunch is using flight-proven fairings and avionics.

As its name implies, AirLaunch's plan is to launch its vehicle out of a C-17 or a C-5. The entire preloaded vehicle is transported on a special truck mounted in a frame that is directly loaded into the bay of the aircraft. The vehicle is resting in the frame on two sets of wheels (about 30 on a side). At launch the vehicle is pulled rearward by a deployed parachute. It rolls along the wheels and tips out of the rear of the aircraft. As it drops and reaches a nearly vertical nose-up position, the first-stage engine is turned on. With a FALCON-size vehicle, the designated aircraft could support two vehicles side by side. A larger

¹Notes taken during the site visit to AirLaunch on April 15, 2005.

vehicle intended for response to a requirement for CXV/crew exploration vehicle is designed as a direct scale-up of the QuickReach vehicle and would launch from the same aircraft. This vehicle would have a gross liftoff weight of 285,000 lb and could put ~8,000 lb into LEO.



FIGURE E-1 QuickReach small launch vehicle. SOURCE: AirLaunch (2005).

The primary objective of an air launch is to be independent of fixed launch sites. Launch at altitude also reduces some of the drag losses associated with ground launch. Such a concept could favorably address the Air Force goal of responsiveness and would accommodate launch surge needs. It also provides alternatives to satisfy certain CONUS range constraints.

LOCKHEED MARTIN SPACE SYSTEMS COMPANY

Recent advances in hybrid propulsion—Hyperion, HYSR, and Space Ship One—have demonstrated a high TRL for suborbital applications. Lockheed Martin Space Systems Company (LMSSC), Michoud Operations, is working to advance hybrid propulsion technologies from suborbital to orbital applications.² Its FALCON concept is based on a two-stage hybrid propulsion system that is capable of delivering a 1,000-lb payload to LEO from Cape Canaveral Air Force Base.

Launch vehicles that use hybrid propellant combinations containing an inert fuel gain the operational benefits of being nonexplosive. LMSSC said that the top three critical issues on the FALCON SLV program are to demonstrate that hybrid propulsion can achieve performance comparable to liquid systems, to demonstrate that such propulsion can satisfy mass fraction allocations, and to flight demonstrate the hybrid propulsion system in an orbital application (achieve TRL 8 or higher).

LMSSC predicts its various stage engines can operate at vacuum I_{sp} values of 335-375 sec for area ratios from 17:1 to 140:1. Lessons learned from data on the precursors AMROC, HyTOP, JIRAD, and HPDP indicated that heat had to be added to the forward end of a hybrid motor to ensure stability and high efficiency. LMSSC developed and patented an active approach, the staged combustion system (U.S. Patent 5,794,435), to accomplish this task. To demonstrate the effectiveness of this concept, a series of tests was performed at chamber pressures around 500 psi and various thrust levels, from 1,500 lbf to 250,000 lbf. Comparison tests were also run on an unstable baseline test that was ignited using conventional triethylamine/triethylborane. The same motor was retrofitted with the staged-combustion system and performed significantly better, exhibiting stability within 2.5 percent of the average chamber pressure (typical solid propulsion stability is 5 percent of the average chamber pressure). As an

²Notes taken from meeting with representatives of LMSSC, Michoud Operations, at NASA MSFC on April 19, 2005.

incremental step on the way to scaling the system to the 250,000 lbf motor, a test was planned to demonstrate the effectiveness of the staged-combustion system on a 24-in. diameter motor that was approximately 324 in. (24 ft) long. It was planned to turn off the staged-combustion system during the test to evaluate the effectiveness of the system. Data from testing indicate that the hybrid system is sufficiently stable and efficient to compete with liquid- and solid-based propulsion systems. The largest hybrid motor tested to date using the staged-combustion system was the HPDP 250,000-lbf motor, which was approximately 6 ft in diameter and 30 ft long. The motor was tested three times for a total burn duration of 80 sec. These tests demonstrated that the system could be successfully scaled to high-thrust motors that could be used for booster or first-stage applications.

In addition to stability and performance, LMSSC is developing technologies to decrease the physical size of hybrid propulsion systems. These technologies include energetic additives in the fuel grain, fuel with higher energy density, and multiple port configurations for increasing diameter.

MICROCOSM, INC.

Microcosm's design concept for the FALCON SLV is the Eagle vehicle. Eagle is a three-stage vehicle. The main characteristics for all three stages are these: LOx/Jet-A propellants, pressure-fed system (using a tridyne-based high performance pressurization system), ablative chambers, triplet injector, composite tanks, and industrial-grade low-cost avionics. The first stage has six pods, each consisting of two 20,000-lbf thrust (vacuum) engines, for a total of 240,000 lbf thrust for the first stage. The second stage has one pod, two engines, and 40,000 lbf thrust. The 20,000-lbf engines used in Eagle are a derivative of the flight-proven 5,000-lbf engines. Microcosm has had two successful suborbital flights with the 5,000-lbf engines: one in 1999 with a single engine per pod and one in 2001 with two engines in a pod.

A first series of tests for the 20,000-lbf engine was successfully completed at AFRL at Edwards Air Force Base on May 22, 2005. The tridyne-based technology has been developed through IR&D and two contracts from the National Reconnaissance Office. Microcosm's comprehensive analytical studies and experimental testing demonstrate the viability of this pressurization technology for a wide range of launch vehicle applications. The technology reduces the weight of the pressurization system by about 50 percent, resulting in a substantial increase in payload capacity. Microcosm is also working on developing all composite LOx and Jet-A tanks to enable pressure-fed systems to deliver meaningful payloads into orbit while keeping costs low.³ The tanks consist of a graphite composite liner with an embedded cryogenic sealant. This sealant prevents LOx from permeating into the carbon fiber through microcracks in the matrix. The liner is then over wrapped using the filament winding process. Microcosm will produce the first unit, but its sister manufacturing company, Scorpius Space Launch Company, is responsible for the production of subsequent vehicles.

Eagle's technology could be used to deliver as much as 160,000 lb to LEO. This would be achieved by scaling up the vehicles and designing larger engines and tanks to carry greater payloads. The composite tanks can be scaled up to 12-18 ft in diameter, and the ablative engines can be increased in size to 640,000 lbf.

Microcosm has a simple operations plan that allows launch on demand from a simple flat pad virtually anywhere in the world. Some of Microcosm's operational characteristics are as follows: air- and road-transportable launch system, pad crew of fewer than 12 persons, simple launch pad with fly-off interfaces, designed for launch in all but the very worst (99 percent launch reliability) weather, self-aligning Global Positioning System (GPS)/Inertial Navigation System guidance and navigation, no hypergols or explosive devices, and thrust-termination-based flight termination system with GPS tracking. Eagle has vertical vehicle integration, and the complete vehicle and its platform are put into flight-ready storage for call-up when needed.

³Jet A tanks use the same tank technology that is used for all commercial and military jets—namely, aluminum alloy tanks that are low cost, easy to fabricate, and readily available.

SPACE X

SpaceX has its headquarters in El Segundo, California, and a 300-acre propulsion and structural testing facility in Texas. It is focused on improving both the cost and the reliability of access to space. The company has a flat hierarchy and small engineering teams, and the ratio of engineers to managers is high.

The development of Space X's SLV for the FALCON program, also called the Falcon. The vehicle development is nearly complete. The Falcon's maiden flight will be carrying a TacSat-1. It is expected to launch after the Titan IV lifts off from the Vandenberg Air Force Base (SpaceX, 2005). The SpaceX FALCON program is focused on a responsiveness demonstration scheduled for August 2005. The company's payload integration process takes about 6 months. SpaceX uses a mobile launch infrastructure. It has a new and austere launch site and has decreased operations time from 21 to 10 days (SpaceX, 2005). The company proposes to meet the responsiveness criteria with a low-cost vehicle that has high availability and high reliability.

The Falcon vehicle has a payload capacity of about 1,400 lb to LEO. It launches from Vandenberg, Cape Canaveral, or Kwajalein and can attain any inclination. The vehicle has two stages with common domes. It has an aluminum monocoque structure. The first stage, which is pump fed, is slated to be recovered and reused. The second stage is pressure fed. The propellants are LOx/RP-1 for both stages.

To achieve high reliability, FALCON has a simple design. SpaceX exceeds in many ways the EELV testing requirements. Its manufacturing and inspection are based on a three-dimensional model. Also, the Falcon vehicle holds for 3 sec prior to launch at full thrust and does an automatic health check (SpaceX, 2005).

REFERENCES

- AirLaunch. 2005. "2005 Responsive Space Conference," Presentation to the 2005 Responsive Space Conference, April 25-28.
- SpaceX. 2005. "The Falcon launch vehicle, achieving responsiveness requirements through high reliability and low cost," Presentation to the 2005 Responsive Space Conference, April 25-28.