



Practical Approaches to Hot-Mix Asphalt Mix Design and Production Quality Control Testing

DETAILS

0 pages | null | PAPERBACK

ISBN 978-0-309-43622-9 | DOI 10.17226/23136

AUTHORS

BUY THIS BOOK

FIND RELATED TITLES

Visit the National Academies Press at NAP.edu and login or register to get:

- Access to free PDF downloads of thousands of scientific reports
- 10% off the price of print titles
- Email or social media notifications of new titles related to your interests
- Special offers and discounts



Distribution, posting, or copying of this PDF is strictly prohibited without written permission of the National Academies Press. (Request Permission) Unless otherwise indicated, all materials in this PDF are copyrighted by the National Academy of Sciences.

TRANSPORTATION RESEARCH
CIRCULAR

Number E-C124

December 2007

**Practical Approaches
to Hot-Mix Asphalt Mix
Design and Production
Quality Control Testing**

TRANSPORTATION RESEARCH BOARD
OF THE NATIONAL ACADEMIES

**TRANSPORTATION RESEARCH BOARD
2007 EXECUTIVE COMMITTEE OFFICERS**

Chair: Linda S. Watson, Executive Director, LYNX–Central Florida Regional Transportation Authority, Orlando

Vice Chair: Debra L. Miller, Secretary, Kansas Department of Transportation, Topeka

Division Chair for NRC Oversight: C. Michael Walton, Ernest H. Cockrell Centennial Chair in Engineering,
University of Texas, Austin

Executive Director: Robert E. Skinner, Jr., Transportation Research Board

**TRANSPORTATION RESEARCH BOARD
2007 TECHNICAL ACTIVITIES COUNCIL**

Chair: Neil J. Pedersen, State Highway Administrator, Maryland State Highway Administration, Baltimore

Technical Activities Director: Mark R. Norman, Transportation Research Board

Paul H. Bingham, Principal, Global Insight, Inc., Washington, D.C., *Freight Systems Group Chair*

Shelly R. Brown, Principal, Shelly Brown Associates, Seattle, Washington, *Legal Resources Group Chair*

James M. Crites, Executive Vice President, Operations, Dallas–Fort Worth International Airport, Texas, *Aviation
Group Chair*

Leanna Depue, Director, Highway Safety Division, Missouri Department of Transportation, Jefferson City, *System
Users Group Chair*

Arlene L. Dietz, A&C Dietz, LLC, Salem, Oregon, *Marine Group Chair*

Robert M. Dorer, Deputy Director, Office of Surface Transportation Programs, Volpe National Transportation
Systems Center, Research and Innovative Technology Administration, Cambridge, Massachusetts, *Rail
Group Chair*

Robert C. Johns, Director, Center for Transportation Studies, University of Minnesota, Minneapolis, *Policy and
Organization Group Chair*

Karla H. Karash, Vice President, TranSystems Corporation, Medford, Massachusetts, *Public Transportation
Group Chair*

Marcy S. Schwartz, Senior Vice President, CH2M Hill, Portland, Oregon, *Planning and Environment Group Chair*

Leland D. Smithson, AASHTO SICOP Coordinator, Iowa Department of Transportation, Ames, *Operations and
Maintenance Group Chair*

L. David Suits, Executive Director, North American Geosynthetics Society, Albany, New York, *Design and
Construction Group Chair*

TRANSPORTATION RESEARCH CIRCULAR E-C124

Practical Approaches to Hot-Mix Asphalt Mix Design and Production Quality Control Testing

Sponsored by

General Issues in Asphalt Technology Committee
Characteristics of Bituminous Paving Mixtures to Meet Structural
Requirements Committee
Transportation Research Board

December 2007

Transportation Research Board
Washington, D.C.
www.TRB.org

TRANSPORTATION RESEARCH CIRCULAR E-C124

ISSN 0097-8515

The **Transportation Research Board** is a division of the National Research Council, which serves as an independent adviser to the federal government on scientific and technical questions of national importance. The National Research Council, jointly administered by the National Academy of Sciences, the National Academy of Engineering, and the Institute of Medicine, brings the resources of the entire scientific and technical communities to bear on national problems through its volunteer advisory committees.

The **Transportation Research Board** is distributing this Circular to make the information contained herein available for use by individual practitioners in state and local transportation agencies, researchers in academic institutions, and other members of the transportation research community. The information in this Circular was taken directly from the submission of the authors. This document is not a report of the National Research Council or of the National Academy of Sciences.

Design and Construction Group

L. David Suits, *Chair*

Bituminous Materials Section

James Moulthrop, *Chair*

General Issues in Asphalt Technology Committee

Rebecca S. McDaniel, *Chair*

Eileen C. Sheehy, *Secretary*

Timothy B. Aschenbrener
Joe W. Button
Ronald Collins
Frank Fee
Gary L. Fitts
Thomas P. Harman

Russell Gary Hicks
Gerald A. Huber
Gayle N. King
Julie E. Klierwer
David E. Newcomb

Harold R. Paul
James A. Scherocman
Scott Shuler
H. Barry Takallou
Donald E. Watson
John J. Weigel, Jr.

Characteristics of Bituminous Paving Mixtures to Meet Structural Requirements Committee

Ramon Bonaquist, *Chair*

Ala R. Abbas
Egbert Beuving
Bruce A. Chadbourn
Jo Sias Daniel
Hervé Di Benedetto
John P. Donahue
Ervin L. Dukatz, Jr.
Frank Fee
Jagan Mohan Gudimetlla
Kamil Kaloush

Julie E. Klierwer
Eyad A. Masad
Leslie Ann McCarthy
Walaa S. Mogawer
Louay N. Mohammad
James S. Moulthrop
Terhi Pellinen
Michael B. Robinson
Reynaldo Roque
A. Tom Scarpas

James A. Scherocman
Charles W. Schwartz
Haroon I. Shami
Richard K. Steger
Laith Tashman
Jacob Uzan
William R. Vavrik
Linbing Wang
Dean C. Weitzel
R. Christopher Williams

Frederick D. Hejl, *Senior Program Officer*
Michael DeCarmine, *Senior Program Associate*

Transportation Research Board

500 Fifth Street, NW
Washington, DC 20001

www.TRB.org

Jennifer Correro, Proofreader and Layout

Contents

Preface	1
<i>Frank Fee and Harold “Skip” Paul</i>	
Current Superpave Mix Design Practice: Survey of the User–Producer Regions	2
<i>Rebecca S. McDaniel</i>	
A Look at the Bailey Method and Locking Point Concept in Superpave Mixture Design	12
<i>Louay N. Mohammad and Khalid Al Shamsi</i>	
Analysis of Oklahoma Mix Designs for the National Center for Asphalt Technology Test Track Using the Bailey Method	33
<i>Danny Gierhart</i>	
Using the Superpave Gyrotory Compactor to Estimate Rutting Resistance of Hot-Mix Asphalt	45
<i>Hussain U. Bahia and Ahmed F. Faheem</i>	
Using the Indirect Tension Test to Evaluate Rut Resistance in Developing Hot-Mix Asphalt Mix Designs	62
<i>Don Christensen and Ray Bonaquist</i>	

Preface

Since the introduction of the Superpave mix design procedure, there has been considerable research to refine the design procedure so that laboratory tests and procedures used during the hot-mix asphalt (HMA) mix design process relate better to actual field performance. Also, a number of agencies have been concerned with the lack of a proof test for validating the volumetric properties. Many have expressed a desire for a truly simple mix test that could be employed at the HMA plant lab level.

These issues were explored in a workshop at the 85th Annual Meeting of the Transportation Research Board (TRB). The papers in this document were written following the workshop and are based on the presentations; the papers have not undergone a formal peer review.

The first paper offers a state-of-the-practice for Superpave mix design and specification, which is based on an in-depth survey of the regional User–Producer Groups. It includes a summary of changes made to the Superpave mix design procedure as a result of NCHRP research findings, Expert Task Group/American Association of State Highway and Transportation Officials (ETG/AASHTO) recommendations, and individual state experience.

The remaining papers deal with other tools for mix design and evaluating HMA during production that are relatively simple and implementable. This includes such things as the Bailey method of gradation evaluation, use of the Superpave gyratory compactor to assess performance, and use of the locking point to establish N_{Design} . In addition, other mix tests that show some potential as practical tools for use in the verification of mix designs and the quality control of HMA production are offered. These changes and new tools are intended to improve the field performance of HMA.

Appreciation is expressed to the authors for their contributions and to Rebecca McDaniel, who provided valuable editorial input to the text.

—Frank Fee
Citgo Asphalt

—Harold “Skip” Paul
Louisiana Department of Transportation and Development

Current Superpave Mix Design Practice *Survey of the User-Producer Regions*

REBECCA S. MCDANIEL

North Central Superpave Center, Purdue University

In 2004 and 2005, the National Asphalt Pavement Association and FHWA sponsored a series of workshops around the country to assess the current state of the practice in hot-mix asphalt (HMA), including Superpave implementation. What was working well with Superpave and what aspects were perceived by the users as needing refinement were also discussed. Ultimately, the goal of the workshop series is to develop a best practices guide to share practical experience to further improve the performance of Superpave and HMA. This paper summarizes the key findings of the workshops regarding aggregates, binders, plant production, field placement, mix design, quality control, and performance of Superpave HMA, particularly in terms of changes made to the specifications and practices.

In 2004 and 2005, the National Asphalt Pavement Association (NAPA) and FHWA sponsored a series of workshops around the country to assess the current state of the practice in hot-mix asphalt (HMA). One obvious focus of the workshops was on the status of Superpave implementation. Discussions at the workshops included what was working well with Superpave and what aspects were perceived by the users as needing refinement. Ultimately, the goal of the workshop series is to develop a best practices guide to share practical experience to further improve the performance of Superpave and HMA. This paper summarizes what changes have been made to the Superpave system and the rationale for those changes.

The four 1-day workshops were held in conjunction with meetings of the regional asphalt user producer groups. The meeting locations are shown in **Table 1**. In order to get the practical experience needed to assess the true state of the practice, invited guests represented each state highway agency and the asphalt paving industry in each state. Typically one state representative and two contractors or materials suppliers participated. Occasionally state pavement association executives also took part. The meetings were open, so additional people also attended. More than 40 states were represented by agencies or industry representatives, as shown in **Figure 1**.

TABLE 1 Locations and Dates of Regional HMA Workshops

Group	Location	Date
Northeast	Portsmouth, New Hampshire	October 21–22, 2004
Southeast	Baton Rouge, Louisiana	October 18, 2004
North Central	Lafayette, Indiana	January 26, 2005
Rocky Mountain	Denver, Colorado	April 7, 2005

BACKGROUND

The Superpave system, as developed under SHRP, consisted of three basic components: performance-based binder specifications, a mix design procedure, and mixture analysis techniques to predict performance. Although the three components were envisioned as a system that should be implemented together, typically the binder specifications were implemented first, followed later by the mix design procedure. The mix analysis techniques were only implemented on a limited basis for some experimental projects or other special applications, like warranty projects.

One of the main goals of Superpave implementation was to achieve uniformity in the specifications and tests used by the various states. Uniformity would facilitate the exchange of information and experience across state lines. It would also be conducive to reciprocity of training and certification, since states would be using the same test procedures. The benefit to industry working in multiple states would be substantial. Inconsistency in specifications creates difficulty for the contractor, thereby contributing to additional cost for the buyer.

Uniformity was deemed so important, in fact, the AASHTO Standing Committee on Highways passed a resolution in 1997 urging all AASHTO members to adopt Superpave without making modifications to the standards, requirements, and methods (1). For a variety of reasons, that resolution has not been unanimously heeded. In fact, the number of states using Superpave strictly by the book is quite small.

One of the goals of the workshops described here was to understand what changes have been made to the system, why they were made and how successful they have been. Besides documenting the state of the practice, it is hoped that sharing this information will help to identify areas needing further refinement on a national or at least regional level to help reinstitute the uniformity that was originally sought. In addition, sharing these experiences may help states and industry partners deal with issues others have faced.

STATE OF THE PRACTICE

A recent survey by the Association of Modified Asphalt Producers (AMAP) (2) showed that at least 34 states have made changes in the performance-graded (PG) binder specifications. This review of the state of the practice shows that numerous changes have also been made on the mixture side. The following summarizes the state of the practice in the areas of binders, aggregates, mix design and quality control, plant production, and field issues, focusing on changes that have been implemented and the reasons for those changes.

Binders

PG binders were developed as a key component of Superpave and are now the norm across the country. During the NAPA–FHWA workshops, relatively few issues with binders were noted. In general, most industry representatives were hot-mix producers and some aggregate producers, but few binder suppliers participated. While the binder suppliers certainly have concerns, at this point the binders do not appear to be causing difficulties for hot-mix producers.

As the AMAP survey showed, most states have implemented so-called PG+ specifications, adding tests to address perceived problems. Common pluses include elastic

recovery tests or requiring a modifier, sometimes a specific modifier, for certain grades. The rationale for these changes varies somewhat. Some state representatives stated that they were not comfortable yet with accepting binders blindly. They feel the need to add tests or requirements to assure themselves that they are getting the binders they want. Sometimes the changes were made to allow states to get binders that they had used successfully prior to implementing the PG specifications.

In some cases, changes were made to ensure states do not get certain products—prohibiting acid modification is one example. The North Central and Rocky Mountain groups seemed especially concerned about the effects of acid modification. The compatibility of acid modification with antistripping additives is a major question. One suggested solution to this issue is to require the binder supplier to add the antistripping additive so that the supplier can control the product. This solution does not work for states that add lime to the mix, however. Communication between the binder supplier and mix designer can help to avoid problems.

There was also little consistency in how mixing and compaction temperatures are determined. Some states accept the manufacturers' recommendations, while others use certain temperature ranges for various grades. For laboratory mixing and compaction temperatures, some states use a fixed temperature for everything or for specific grades, while others use the manufacturers' values.

Aggregates

In the aggregates area, specification changes have been made by a number of states. Many of these changes were implemented to encourage the use of finer gradations due to some perceived problems with early, typically coarse Superpave mixes. These changes include changing gradation requirements and limits, and added control sieves or master gradation bands.

The issue of fine versus coarse mixes was discussed extensively at each meeting. In general, most states used coarse mixes early in the implementation of Superpave. Many are now moving back towards somewhat finer mixes to control permeability, improve smoothness, and improve durability. Coarser mixes were frequently cited as being more sensitive to changes in aggregate properties or production variability. Some states have implemented changes in gradation to encourage the use of finer mixes. Others leave it up to the contractor to select a fine or coarse mix.

Other changes to the aggregate specifications include changing criteria for such properties as fine aggregate angularity (FAA), sand equivalent value, and flat and elongated content. These changes were typically made to allow greater use of local materials that might not meet the original criteria. How these criteria are used in mix design, QC, and with other aggregate requirements vary widely.

The fine aggregate angularity test was often questioned. Is this test getting us what we need? Many noted that the FAA test actually discriminates against some desirable, cubical aggregates in favor of flakier particles that bulk up the volume. Due to problems with the test or with meeting the FAA limits with locally available materials, many states have changed or dropped the requirement. Lowering the FAA for high volume mixes is fairly common. On the other hand, some states have actually raised the FAA for medium volume roadways.

Many states still limit the natural sand content. Of these states, some also check FAA and others do not. There are also some states that use FAA and N_{ini} to control the natural sand

content. In the West, Arizona and New Mexico commented that they have seen increases in the natural sand used to control excessive voids in mineral aggregate (VMA).

A number of the concerns and problems noted in the aggregates area are not new. Either due to increased scrutiny of mix properties or increased sensitivity of Superpave mixes to small changes however some of these problems are assuming greater importance. To deal with these issues, changes have been made by individual contractors in their practices and QC. Some states have also implemented programs, or changes to existing programs, to help control variability.

For example, variation in the specific gravity or absorption of an aggregate source from ledge to ledge, or even within a ledge, was frequently cited as a problem. Superpave mixes, especially coarser mixes, seem to be more sensitive to these changes. The increased reliance on volumetric properties also heightens the awareness of changing specific gravity and absorption since these property changes impact air voids, VMA, and eventually performance. Since many states are now using volumetric properties as pay factors, the contractors are justifiably concerned about changes that affect the volumetrics.

The material properties of aggregates in a specific area are based on the geological formation and are therefore relatively fixed. Therefore, controlling variability can become somewhat problematic. There are steps that can be taken, however, to account for this variability. Some contractors noted that they perform more frequent specific gravity tests to be able to adjust for changes. States need to be receptive to changes in the mixture to account for these variations.

With more states considering percent within limit specifications, controlling variability is growing in interest. Illinois mentioned that they have implemented an aggregate gradation control system with fairly tight limits on gradation. This has led to substantial improvements in gradation control at the hot-mix plant. Several contractors commented that incentives and disincentives have helped focus upper management attention on making changes to control the materials used and mixtures produced. One contractor said that by making him responsible for his end product, it necessitated that he work with the aggregate producer to resolve problems. The contractor has the incentive to do what needs to be done to ensure quality.

Other aggregate properties were observed to be variable. For example, in the Northeast, some sources vary in their flat and elongated content. For materials known to be variable, it was suggested to prepare mix designs over a range of properties before the project begins so that if changes are encountered, the mix can be changed quickly to account for the variation. This is, of course, an added burden for the contractor, but it may save time during production.

There were a number of other aggregate issues raised, but this summarizes the most common changes in specifications and practices. While there are certainly differences across and even within state lines, there were many consistent themes that came through clearly.

Mix Design and Quality Control

The topic of QC was an area where many differences between states could be expected, and they were indeed observed. The proliferation of PG+ specifications shows how little uniformity there is between the states on the binder side, but it appears there is even more variation on the mixture side.

Many states expressed concern that the mixes were low in binder content. Some indicated binder contents had decreased by 0.1 to 0.2 while others said the binder contents dropped by as much as 0.7% when the Superpave mix design system was implemented. Concern about long-

term durability of Superpave-designed mixes was especially prevalent in the Northeast and Southeast.

While many states shared this concern, however, the approaches they used to address the perceived problem varied widely. Some states decreased the design air void content; 3.5% air was frequently cited. Others changed the gyration levels or used a given gyration level for higher traffic than specified by AASHTO. Minimum binder contents and minimum film thicknesses are also sometimes specified to ensure adequate binder is in the mix.

Some states have adjusted gradations, as noted before, or changed VMA requirements to attempt to get more binder in the mixtures. One state changed its gyratory compaction protocol to utilize the locking point concept to help avoid dry, permeable mixes. (At least two different locking point definitions are in use; both involve determining where the specimen height does not change with successive gyrations.)

Achieving VMA during mix design and production remains an issue in some areas, though mix designers have learned some techniques for ensuring adequate VMA. Changing gradation, especially removing fines, is one common way to increase VMA. One contractor noted that if the VMA changes during production, he checks the aggregate specific gravity. Because aggregate specific gravity has such an impact on VMA, the need for a better, faster test for specific gravity was mentioned.

The use of reclaimed asphalt pavement (RAP) varies widely across the country. A few states do not allow RAP, while others recycle nearly everything they mill up. Some contractors noted that their crews prefer working with RAP mixes because the increased stiffness help avoid some of the problems they occasionally experienced with soft binders.

In the gyratory, there have been issues with comparison of contractors' and agencies' test results. The use of the internal angle to calibrate gyratories has helped many states resolve some of these differences. Other states are still using external angle and report no problems.

Experience with gyration levels in the gyratory is also varied. As noted earlier, several states have reduced gyration levels, especially for lower volume roadways. A few are still using the original gyration table with seven different compaction levels. As with binder grade, consultants need to understand that higher gyration level mixes are not suited to every application, especially for lower volume roadways.

There is a notable lack of consistency between the states with regard to mix design. A number of different factors have been changed by varied amounts. Most states have tweaked the system in isolation from surrounding states. Due to the interrelationship between the volumetric and compaction parameters and performance, the effects of these differing changes are not yet known. The changes were made in a good faith effort to improve performance, but their effectiveness is still unproven.

The need for a performance test, though, was one thing all the states could agree on. The availability of a reliable, timely test for performance would help resolve many of the other issues mix designers, contractors and agencies face. Lacking this test method, a number of states have implemented additional mixture tests to attempt to ensure good performance. Loaded wheel testers are typically used; those other tests or requirements are being considered in some states.

Plant Production

The common themes that resounded across the country regarding plant production were the need to strive for consistency and to pay attention to details. Consistency is critical to controlling dust

content, reducing segregation, managing stockpiles, processing or fractionating aggregates, etc. The need for consistency is typically accommodated by changes contractors and suppliers make in their own practices rather than changes made to specifications. The use of more cold feed bins was frequently cited as one way to get better control of aggregate gradations. Metering dust into the mix and calibrating the metering system was also recommended. Details such as plant maintenance and watching for changes in the materials feeding into the plant are essential.

Controlling moisture in the mix was cited as key to avoiding problems with the tender zone. Adequately drying aggregates impacts fuel costs and productivity. Keeping the aggregates dry before introducing them into the plant can help mitigate these impacts. Several hot-mix producers said that they had paved their stockpile areas to help control moisture in the aggregates; some have even covered their stockpiles.

The need for good QC people was emphasized. Adequate QC staffing and training is essential to guide production. In discussions of both plant production and field placement, the importance of the QC people was paramount. Several contractors noted that they let the QC person control the project, adjusting the mix or production to control the end product. In addition to being knowledgeable, QC people need to have the authority to make the changes that need to be made.

Field Issues

In some of the early field use of Superpave, compaction problems, especially the tender zone, were fairly common. These workshops confirmed that the contractors have largely learned how to handle these problems, though changes to state design practices have also contributed. Contractors have learned that there is not one solution that works in all cases, but they do have an array of possible solutions to try. They must be flexible and adjust on the fly to deal with changes in the mix. Changing rollers and roller patterns has helped in many cases. Adding a roller to the compaction train can also help achieve adequate density before the mat cools. Pneumatic rollers, high-frequency rollers, and oscillatory rollers were cited as helpful in some cases. Avoiding the tender zone by monitoring mix temperature was also suggested.

Changes in lift thicknesses in many states have also helped reduce the compaction problems. Especially with coarse mixes, thicker lifts are needed to ensure compaction. Many states have increased lift thicknesses to four times the nominal maximum size of aggregate (NMSA). Others are using three times the nominal; few attempt to use lesser thicknesses.

The need for adequate lift thickness will be critical as local agencies use Superpave mixes more frequently. Due to the severe budget restrictions most local agencies face, thicker lifts can have a serious impact on the number of miles paved. The use of smaller NMSA mixes and finer mixes can help.

Joint density is another area of concern for the states and contractors. Reducing segregation at the joint can help, as can joint sealant, proper “bumping” of the joint, proper rolling, echelon paving and more. States use a variety of tests and tolerances to control joint density.

Paver segregation has been observed in a number of states across the country. The paver manufacturers have been quite responsive and have developed retrofits to correct segregation sources within the paver. In some states, these retrofits are required. Shuttle buggies or material transfer devices also help to reduce segregation and have the added benefit of improving smoothness as well.

PERFORMANCE

Another important topic covered at the NAPA–FHWA regional workshops was the level of performance of HMA today. Some of the performance concerns included permeability, joint densities, and durability. Permeability problems were encountered in some areas several years ago. Changes to lift thickness, use of finer mixes and more care in compaction have largely resolved these problems.

Joint densities continue to be a problem in some states, but there are a number of alternatives to address them, including changes in rollers and roller patterns, proper raking of the joint material, use of wedge or notched joints, sealants, and more. Specifying a joint density requirement can help focus attention on the problem. Instituting a joint density specification should be done in a step-wise fashion so that both the contractor and the agency can develop a sense of confidence in the specification.

Durability is a concern in the Northeast and Southeast in particular, as well as a few other areas. Changes to the mix design practices, such as using finer gradations and requiring minimum binder contents, have been made in an attempt to ensure adequate durability. In other parts of the country, mixes are performing well with no durability problems to date.

In fact, most participants in these workshops indicated that HMA is performing better than ever. Rutting has been largely eliminated. The PG specifications have led to significant reductions in thermal cracking. In some states, pavement management data prove that roads are lasting longer and performing better. Over and over, participants commented that there has been a major decrease in distress.

Participants also commented on the continued need to pay attention to details. Quality in design and construction (production, placement, and compaction) is essential to getting good performance. Focused attention can resolve many of the issues we are now facing, such as joint density and segregation.

Another comment heard at every workshop—usually more than once—was that we know more about our mixtures and how to handle them now than ever before. The personnel are more knowledgeable and more diligent about getting things right. Continued communication and training is critical to the continued success of the industry. We need to reach out to consultants, aggregate suppliers, local agencies, and others involved in the industry to ensure they too benefit from this increase in knowledge.

While a number of issues and problems were raised at every workshop, the overall response was very positive. Implementation of the Superpave mix design system has definitely put the HMA industry on the right track to improved pavement performance, though we need to constantly strive for improvement.

SUMMARY AND CONCLUSIONS

This series of four regional workshops sponsored by NAPA and FHWA afforded the opportunity to gauge the state of the practice in HMA. Topics covered included aggregates, binders, plant production, field placement, mix design, and QC issues. Lastly, the performance of today's HMA pavements was reviewed.

- In the aggregates area, variation in aggregate properties was cited as an area of concern. Mixture volumetrics are sensitive to changes in specific gravity, absorption, shape, and gradation. Increased testing frequencies, adjusting the mix to account for changing properties, and tighter control of aggregate properties were among the solutions offered to help deal with these changes.
 - Improved aggregate tests are needed, especially for properties like shape and texture (to replace FAA) and specific gravity.
 - Most states have added tests or requirements to the PG binder specifications, resulting in a proliferation of varying binder requirements. Improved methods of quantifying the effects of modifiers are needed to help agencies become more comfortable with blind specifications.
 - State agencies and contractors are concerned about varying modification methods, especially acid modification and its compatibility with antistripping additives, which explains some of the additions to the PG binder specifications.
 - Early Superpave mixes were generally coarser than previously used mixes in most parts of the country. Many states are now moving back to somewhat finer mixes due to concerns about permeability, smoothness, and durability.
 - There is virtually no consistency in how states have changed the mix design procedures to address what they perceive to be problems with mix design. A wide range of changes have been implemented.
 - Some states are concerned about long-term mix durability, and they feel that mixes may be under-asphalted. To increase the binder content, they have changed the design air voids, gyratory levels (including the locking point), VMA, and gradation. They have also instituted or maintained previous minimum binder contents or film thickness requirements, in some cases.
 - RAP usage varies widely from no RAP in some states to reuse of essentially all milled material in others.
 - States use different gyration levels and use either internal or external angle calibration of the Superpave gyratory compactor.
 - States were in general agreement that a performance test is needed to help resolve some of the issues regarding materials and mix design.
 - Ensuring quality production at the plant requires attention to detail and consistency. Maintenance and calibration of equipment is critical. Good stockpile management techniques are essential. Controlling the moisture content of aggregates can have a big impact on production rates, compaction (tender zone), and fuel costs.
 - Adequate numbers of knowledgeable QC personnel are absolutely crucial to the success of the project. Furthermore, these people need to have the authority to make changes as they are needed.
 - Early problems with field compaction and the tender zone have largely been resolved by paying more attention to the mix, varying roller patterns, adding or changing roller types, controlling moisture in the mix, and increasing lift thicknesses.
 - Some field issues remain, such as joint density and paver segregation, but there are alternatives to help address these issues.
 - Despite these problems and concerns, however, there was an overall feeling that HMA today is better than ever. Rutting has been virtually eliminated and thermal cracking is substantially reduced. Pavement performance and life cycle have been largely improved.

- Last, at each and every workshop, the increased level of expertise in the industry was complimented. In various ways, participants commented that we know our materials, mixtures, and our business better than ever before. Communication and training are vital and are being emphasized to ensure continued improvement.

ACKNOWLEDGMENTS

This work was sponsored by NAPA and FHWA. The support, cooperation and insights of David Newcomb and Kent Hansen of NAPA; Dale Decker, Consultant; and John Bukowski and John D'Angelo of FHWA are greatly appreciated. All those who gave their time and energy to share their experiences in the regional workshops are also thanked for their contributions, which were critical to developing a full picture of the state of the practice.

REFERENCES

1. AASHTO Standing Committee on Highways. Resolution SCOH-97 AM-1, Uniform Implementation of SHRP Superpave. Available at <http://bridge.ecn.purdue.edu/~spave/Technical%20Info/Articles.AASHTO1.htm>. Accessed July 29, 2005.
2. Grzybowski, K. The Minuses of Plus Specifications. Association of Modified Asphalt Producers, February 2005. Available at www.modifiedasphalt.org/library.asp#past. Accessed July 29, 2005.

A Look at the Bailey Method and Locking Point Concept in Superpave Mixture Design

LOUAY N. MOHAMMAD

KHALID AL SHAMSI

Louisiana Transportation Research Center

This study analyzes the physical and performance characteristics of asphalt concrete mixtures with aggregate structures designed using the Bailey method of aggregate gradation evaluation. Three aggregate types—limestone, sandstone, and granite—were considered in this study. Three different aggregate structures of 12.5-mm nominal maximum particle size were designed for each aggregate type. Mixtures were designed for high traffic levels. The binder type selected was performance grade 76-22M. The compaction characteristics of the mixtures were analyzed using data from the Superpave gyratory compactor. Locking points and compaction indices were defined and determined for all the mixtures in the study. Simulative (Hamburg wheel tracking test) and fundamental (semicircular fracture and IT strength) tests were conducted to determine laboratory performance properties and evaluate the mixtures under different loading and environmental conditions. The design number of gyrations (N_{des}) recommended by Superpave was compared to the locking points obtained from this study. The data indicate that the current N_{des} level recommended by Superpave is much higher than the locking points of the mixtures and may subject the mixtures to high compaction energy for an extended period of time. Selected mixtures were designed using the locking point as the design number of gyrations instead of the recommended Superpave N_{des} . The data presented in this paper suggests that mixes with dense aggregate structures can be designed using their locking point instead of the recommended N_{des} . The designed mixtures maintained good resistance to permanent deformation and maintained an adequate level of durability.

The behavior of hot-mix asphalt (HMA) depends on the properties of the individual components and how they react with each other in the system. Several mixture design methods have been developed over time, in an effort to create a mixture that is capable of providing acceptable performance based on a certain predefined set of criteria. The most recently developed mixture design method is the Superpave method. It includes several processes and decision points. The Superpave system employs gyratory compaction to fabricate asphalt mixture specimens. The level of compaction in the Superpave gyratory compactor (SGC) is based upon the design traffic level. In summary, the design compaction levels are established, and then materials are selected and characterized. Afterwards, mixture specimens are prepared and laboratory test results are compared to criteria. Those criteria are purely volumetric and do not employ any mechanical properties, i.e., strength or stiffness, to evaluate mixture performance.

Although aggregate constitutes approximately 95% by weight of asphalt mixtures, the aggregate specifications in the Superpave system were developed based on experience from a number of experts in the field. The group did no research on aggregates but they did build on prior studies and recommendations of many researchers who came before them and the expertise of many practitioners. From this previous research, they developed rules and recommendations for the Superpave system.

As a result of the lack of research conducted to develop the aggregate specifications, those specifications and requirements can still be improved, especially in terms of designing the aggregate structure to improve mixture stability. For example, the current Superpave system lacks guidance for the selection of the design aggregate structure and understanding the

interaction of the aggregate structure with mixture design and performance. Furthermore, the trial and error nature of the conventional process of formulating the gradation curve, and the use of weight instead of volume when blending aggregates, make it imperative to implement a more rational approach to design the aggregate structure based on sound principles of aggregate packing.

The SGC is generally used to measure only volumetric properties such as density or air void content as a function of compaction gyrations. However, several attempts have been made to analyze the densification curve obtained from the SGC in order to evaluate an asphalt mixture's workability and resistance to permanent deformation. The value of N_{initial} and the slope of the initial portion of the SGC compaction curve have been hypothesized to reveal certain mixture properties such as tenderness of the mixtures and the strength of aggregate structure (1).

Bahia et al. (2) suggested that the current method of interpretation of the results from the SGC and the design criteria are biased toward performance under traffic and do not adequately consider the constructability of mixtures. He proposed the use of the SGC curve to evaluate the constructability of the mixtures as well as their resistance to traffic loading. He introduced the concept of compaction and traffic indices. The compaction energy index (CEI) and the traffic densification index (TDI) are used to relate to construction and in-service performance of HMA mixtures. Bahia suggested that controlling these indices is expected to allow optimization of HMA construction and traffic requirements.

Mallick (4) found that the gyratory ratio, the ratio of the number of gyrations required to achieve 2% voids and 5% voids, was suitable for characterizing HMA. He stated that a gyratory ratio of 4 can be used to differentiate between stable and unstable mixes and, further, that mixes with a gyratory ratio less than 4 may be unstable.

Vavrik et al (5) suggested the evaluation of mixture compaction characteristics based upon the locking point or the point during compaction at which the mixture exhibits a marked increase in resistance to further densification. Alabama Department of Transportation (DOT) (6) is adopting the locking point mix design concept. They define the locking point as the point where the sample being gyrated loses less than 0.1 mm in height between successive gyrations. Georgia DOT uses the concept of locking point in designing HMA mixtures. They define the locking point as the number of gyrations at which, in the first occurrence, the same height has been recorded for the third time (7). For Georgia, typical locking points are reported to be in the range of the low 60s to high 80s measured with Superpave gyratory compactor.

An important control parameter in asphalt mixture volumetric design is the percentage of voids in the mineral aggregate (VMA). However, several researchers and highway agencies have reported that difficulties exist in meeting the minimum VMA requirements (8, 9, 10). Under current specifications, many otherwise sound mixtures are subject to rejection solely on the basis of failing to meet the VMA requirement. Studies (11, 12) also show that a VMA requirement based on nominal maximum particle size (NMPS) does not take into account the gradation of the mixture, ignores the film thickness of the asphalt binder and, thus, is insufficient by itself to correctly differentiate between good-performing and poor-performing mixtures.

OBJECTIVE AND SCOPE

The objective of this study was to incorporate an analytical gradation design and evaluation method into the Superpave mixture design procedure and to analyze the compaction and performance characteristics of the resulting asphalt concrete (AC) mixtures. The Bailey method of aggregate gradation and evaluation was used to design and evaluate the aggregate structures for all the mixtures in the study. The compaction characteristics of the mixtures were analyzed using data from the SGC. Locking points and compaction indices were defined and determined for all the mixtures in the study. The performance of the designed mixtures was evaluated using both simulative and fundamental laboratory tests. Gradation parameters were used to analyze the effect of gradation on compaction and performance properties of asphalt mixtures.

Three aggregate types commonly used in Louisiana were studied. These are limestone, sandstone, and granite. For each type, three aggregate structures (coarse, medium, and fine) were designed using the Bailey method of aggregate gradation evaluation. All the asphalt mixtures were 12.5-mm (1/2-in.) NMPS mixtures and were designed for high-volume traffic [greater than 30 million equivalent single-axle loads (ESALs)]. A performance grade (PG) 76-22M binder was used for all the mixtures. Laboratory simulative and mechanistic tests were conducted, including the Hamburg wheel tracking test and semicircular notched fracture test, respectively.

MATERIALS

The asphalt binder used in this study was a styrene–butadiene (SB) polymer-modified asphalt binder meeting Louisiana PG specifications (13) for PG 76-22M. Table 1 presents the laboratory test results on the selected binder. Different aggregate stockpiles from each aggregate type were used. Natural coarse sand was used whenever necessary in the final design blends.

TABLE 1 Louisiana Department of Transportation and Development PG Asphalt Cement Specification and Test Results

Binder Grade	PG 76-22M	
	Specification	Test Results
Original Binder		
Rotational viscosity 135°C, Pa*s	3.0-	1.68
Dynamic shear, 10 rad/s $G^*/\sin \delta$, kPa	1.00+@76°C	1.29
Flash point °C	232+	305
Solubility %	99.0+	99.5
Force ductility ratio (f2/f1, 4°C, 5 cm/min, f2 @30-cm elongation	0.30+	0.49
Tests on Rolling Thin-Film Oven		
Mass loss %	1.00-	0.08
Dynamic shear, 10 rad/s, $G^*/\sin \delta$, kPa	2.20+@76°C	2.84
Elastic recovery, 25°C, 10-cm elongation %	60+	70
Tests on Pressure-Aging Vehicle Residue		
Dynamic shear, 10 rad/s, $G^*\sin \delta$, kPa, 25°C	5000-	2297
Bending beam creep stiffness, S_{max} , MPa, tested at -12°C	300-	195
Bending beam creep slope m value, min, tested at -12°C	0.300+	0.327

AGGREGATE STRUCTURE DESIGN

The main aim of this task was to design the aggregate structures using an analytical aggregate gradation method that will allow a rational blending of different sizes of aggregate to achieve an optimum aggregate structure for better mixture performance. The Bailey method for aggregate gradation evaluation was utilized for this purpose. The Bailey method is a comprehensive gradation evaluation procedure to provide aggregate interlock as the backbone for the aggregate skeleton (14, 15). In this method, the definition of coarse and fine aggregate is not based on the conventional No. 4 sieve. Coarse aggregates are defined as the large aggregate particles that, when placed in a unit volume, create voids. Fine aggregates are aggregate particles that can fill the voids created by the coarse aggregates. The sieve that separates the coarse and fine aggregates is called the primary control sieve (PCS) and is dependent on the NMPS of the aggregate blend. The PCS is mathematically defined as 0.22 of the NMPS based on two- and three-dimensional analysis of the packing of different-shaped particles. Furthermore, the aggregate blend below the PCS is divided into coarse and fine portions and each portion is evaluated.

The method provides a set of tools that allows the evaluation of aggregate blends. Aggregate ratios, which are based on particle packing principles, are used to analyze the particle packing of the overall aggregate structure. The coarse aggregate (CA) ratio is used to characterize the packing and size distribution of the coarse portion of the aggregate blend. The coarse portion of the fine aggregate is evaluated using the fine aggregate ratio of the coarse portion (FA_c), and the fine portion of the fine aggregate is evaluated using the fine aggregate ratio of the fine portion (FA_f). The details of the method are available in other publications (14, 15).

Three aggregate structures were designed for each aggregate type (coarse, medium, fine). The structures were designed to meet the recommended ranges of the Bailey method parameters. Table 2 shows the design gradations and their Bailey method evaluation parameters for each aggregate type. For granite aggregate, only two aggregate gradations (medium and fine) were designed. Reasonable separation was maintained between the aggregate gradations within each type of aggregate in order to capture the variation in performance (if any) within the same nominal maximum size of aggregate (NMSA) for each type of aggregate. This separation is quantified by the decrease in the volume of CA in the structure when moving from the coarse to fine gradations. A great effort was made to maintain the number of stockpiles used for each aggregate blend as practical as possible. A maximum of four different stockpiles of readily available, commonly used aggregates in Louisiana were used.

MIXTURE DESIGN

Mixture design was performed for all the aggregate structures using the Superpave mixture design method. All the mixtures were designed for high-volume traffic ($N_{des}=125$ gyrations at 1.25° angle of gyration). The optimum asphalt content was determined as the asphalt content required to achieve 4.0% at N_{des} . Table 2 presents the results of the mix designs conducted on all the mixtures considered in this study. Optimum asphalt contents ranged from a low of 3.5% to a high of 5.1%. The coarse mixtures had higher optimum asphalt contents for all the aggregate types considered. This is explained by the higher VMA values for the coarse mixtures compared to the others, which created more room for the asphalt binder to be added and hence increased the optimum asphalt content.

TABLE 2 Aggregate Structures and Mixture Design Data

Mixture Name	LS Coarse	LS Medium	LS Fine	SST Coarse	SST Medium	SST Fine	GR Medium	GR Fine
Mix Type	12.5 mm Bailey Designs							
Aggregate Blend	42.2% #78 LS 14.3% #8 LS 36.7 % #11 LS 6.8% Sand	44.3% #78 LS 44.5 % #11 LS 11.2% Sand	41.0% #78 LS 23.6% #10 LS 20.2 % #11 LS 15.2% Sand	59.4% #78 SST 21.4% #11 SST 19.2 % #11 LS	49.8% #78 SST 43.6% #10 LS 6.6% Sand	41.3% #78 SST 48.4% #10 LS 10.3% Sand	48.3% #78 GR 29.7% #11 GR 15.4 % #10 LS 6.6% Sand	36.5% #78 GR 30.2% #11 GR 22.4 % #10 LS 10.9% Sand
Metric (U.S.) sieve								
19 mm (¾ in.)	100.0	100.0	100.0	100.0	100.0	100.0	100.0	100.0
12.5 mm (½ in.)	97.1	97.0	97.2	96.0	96.6	97.2	97.7	98.3
9.5 mm (¾ in.)	80.3	80.2	81.7	80.7	83.8	86.5	82.5	86.8
4.75 mm (No. 4)	46.9	55.2	59.8	48.6	57.6	64.7	54.4	65.0
2.36 mm (No. 8)	31.5	39.6	46.1	32.8	41.6	48.4	39.5	49.0
1.18 mm (No. 16)	21.8	27.9	34.7	22.2	31.5	36.9	27.8	35.4
0.6 mm (No. 30)	15.3	19.7	25.6	16.2	23.7	27.8	19.7	25.5
0.3 mm (No. 50)	9.3	11.1	14.4	12.1	15.9	17.7	11.7	14.6
0.15 mm (No. 100)	6.6	7.4	9.3	6.7	11.2	12.1	7.4	9.0
0.075 mm (No. 200)	5.5	6.0	7.2	4.2	8.4	9.1	5.4	6.5
CA Volume	56.0	46.4	41.0	56.0	47.8	40.8	48.1	38.3
CA Ratio	0.612	0.706	0.797	0.627	0.765	0.792	0.694	0.728
FA _c Ratio	0.487	0.374	0.361	0.493	0.471	0.435	0.377	0.352
OAC, %	5.1	4.0	3.5	5.1	3.6	3.9	4.5	4.3
VTM	4.0	4.0	4.0	4.0	4.0	4.0	4.0	4.0
VMA	11.0	11.3	9.4	13.1	8.4	8.5	11.3	10.9
VFA	64.8	62.7	58.5	69	50.0	54.0	62.4	60.6
%G _{mm} at N _{ini}	85.1	86.2	88.0	86.6	86.4	88.0	87.3	87.1
%G _{mm} at N _{max}	97.2	97.4	97.3	97.0	97.1	97.4	97.2	97.0
Effective film thickness, microns	8.7	5.5	3.4	8.8	2.5	2.5	6.0	4.5
Dust/P _{beff}	1.3	2.0	3.1	1.1	4.7	4.7	1.7	2.3

LS: Siliceous limestone, SST: Sandstone, GR: Granite, VFA: voids filled with aggregate.

VMA values ranged from a high of 13.1 % to a low of 8.4%. The sandstone medium and fine mixtures had the lowest VMA values. The VMA values for all the mixtures were below the minimum requirement of the current Superpave system for 12.5-mm (1/2-in.) NMPS mixtures. It is noted that mixtures with similar NMPS have different VMA values. This observation supports the concern about the validity of the current VMA requirements based on the NMPS. It is evident that VMA is sensitive to aggregate gradation within the same NMPS. All the mixtures met the Superpave requirements for %G_{mm}@N_{ini} and %G_{mm}@N_{max}.

The average effective binder film thicknesses ranged from 8.8 microns for limestone and sandstone coarse mixtures to as low as 2.5 for medium and fine sandstone mixtures. For most

medium and fine mixtures, the calculated film thickness was below the generally reported range of 6.0 to 8.0 microns.

ASPHALT MIXTURE COMPACTIBILITY

The compactibility of the designed asphalt mixtures was evaluated using results from the SGC. The densification curves obtained from the SGC were used to evaluate mixture resistance to the compaction energy applied by the SGC.

In this study, the following terms will be used in the analysis of the results from the SGC:

- SGC locking point. The SGC locking point is the number of gyrations after which the rate of change in height is equal to or less than 0.05 mm for three consecutive gyrations (Figure 1a).
- SGC compaction densification index (CDI). The area under the SGC densification curve from $N = 1$ to the SGC locking point (Figure 1b). This index is hypothesized to be related to compactibility of asphalt mixtures. Higher values of this index are associated with mixtures that are difficult to compact.
- SGC traffic densification index (TDI). The area under the SGC densification curve from the SGC Locking Point to N at 98% G_{mm} or the end of compaction, whichever comes first (Figure 1b). This index is hypothesized to be related to the mixtures stability under traffic loading. Higher values are supposed to be indicative of better mixtures stability.

The locking point data from the SGC suggest that coarse mixtures take a higher number of gyrations to reach to the locking condition. This indicates that it takes more energy to densify coarse mixtures compared to the medium and fine mixtures. As the aggregate gradation becomes finer, the compactibility of the mixtures improves except for the fine granite mixture in which locking point was slightly higher than the medium gradation. It is worth noting that the locking points are much lower than the design number of gyrations recommended by the current Superpave system. The highest locking point is less than 70% of the recommended design number of gyrations for the heavy traffic category ($N_{des} = 125$). The fine limestone mixture had the lowest locking point (57 gyrations).

The concept of energy indices was first introduced by Bahia (2) in 1998. In his study, Bahia calculated the energy indices using the region from $N = 8$ to N at 92% G_{mm} of the densification curve for the CEI (later renamed CDI as used in this study) and from N at 96% G_{mm} to N at 98% G_{mm} for the TDI. He assumed that the first eight gyrations represent the constant compaction energy applied by the paver screed. In this study, however, the densification curve is divided into two main regions: the densification region from $N = 1$ to the locking point, which is used to calculate the CDI, and the post-densification region from the locking point to $N = 205$, which represents the terminal densification of the mixture at the end of service life and is used to calculate the TDI. Figure 1c shows the energy indices calculated for all the mixtures in the study.

The compaction densification index CDI from the SGC had notable variations across the different gradations within the same NMPS, indicating that it is sensitive to the size distribution of blends having the same NMPS. For example, for limestone mixtures, the fine mixture required about 48% lower energy to reach the locking condition than the coarse mixture. The sandstone had lower variation in CDI across the different gradations. The fine sandstone mixtures took

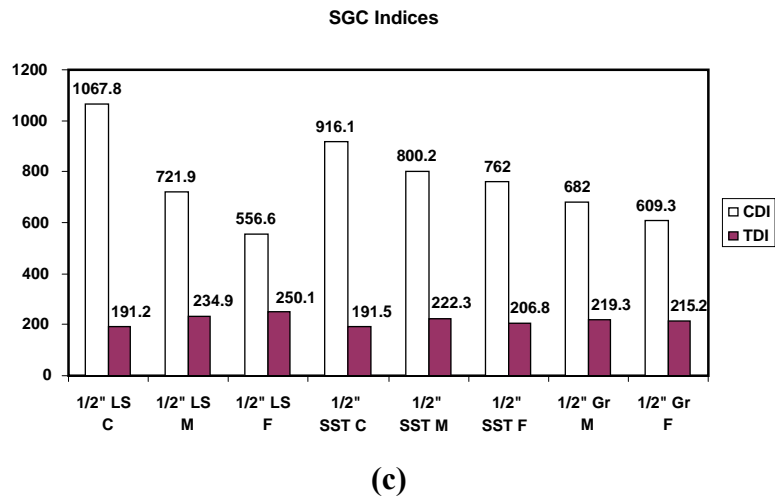
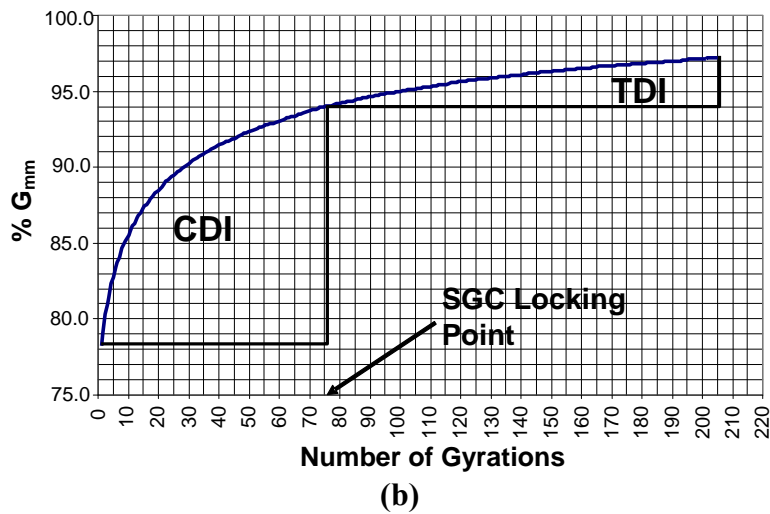
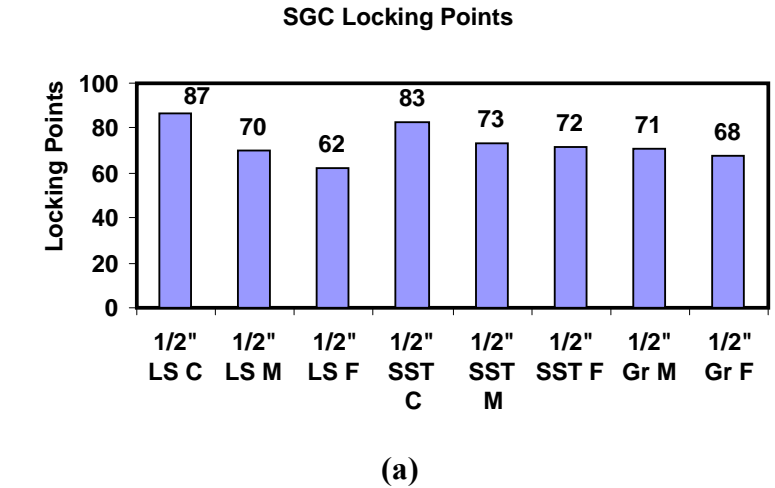

FIGURE 1 Compaction parameters of asphalt mixtures.

about 17% less compaction energy than the coarse one to reach to the locking condition. There was about an 11% difference in compaction energy between the medium and the fine granite gradations. The data, therefore, suggests that it will take more energy to compact coarse mixtures in the first region of the densification curve, indicating that those mixtures might be less desirable for construction and more likely to have compactibility problems.

The aggregate resistance to further densification from traffic loading was explored using the TDI from the SGC. The variation of this index, although still existent, is less than that observed with the CDI. This was expected since the behavior of the mixtures beyond their locking points was relatively similar with very small rates of change in mixture densification.

RESULTS AND DISCUSSION

Gradation Parameters and Mixtures Volumetrics

The effect of aggregate gradation on mixture volumetrics was investigated using the gradation parameters obtained from the Bailey method. Two parameters were used in this investigation. These are the CA ratio and the FA_c ratio. The third Bailey parameter, FA_f , is not calculated for fine mixtures having 12.5-mm NMPS or lower (15). Figure 2 illustrates the relationship of the Bailey parameters with mixture's volumetric and other physical properties. It should be noted that all the mixtures were subjected to the same type and amount of compaction energy (SGC Compaction, N_{des}).

CA ratio, which is predominantly a function of the coarse aggregate blend by volume, seems to have the strongest correlation with the mixture volumetrics. As the CA ratio increases, the smaller size particles in the coarse portion of the aggregate structure become more dominant, and that had an inverse effect on the main volumetric parameters such as VMA and VFA. A strong correlation was obtained between the CA ratio and the effective film thickness ($R^2 = 0.946$).

Mixture volumetrics seem to be less sensitive to the change in the FA_c ratio. A parabolic type of relationship was obtained between FA_c ratio and both VMA and VFA. The minimum value occurred around an FA_c value of 0.435. As the volume of fines exceeds the voids in the coarse part of the fine portion of the blend (that is, moving right from the dip), the VMA in the overall fraction increases. In contrast, as the volume of the coarse part of the overall fine fraction increases (that is, moving left from the dip), the VMA in the overall fraction increases. No relationship could be established between the FA_c ratio and effective film thickness or dust/ P_{beff} ratio.

Gradation Parameters and Mixture Compactibility

It was established earlier that compaction characteristics were different for mixtures with different aggregate gradations. In order to quantify the effect of aggregate gradation on the compactibility of the mixtures, the gradation parameters from the Bailey method were utilized. Figures 2*i* and 2*j* describe the relationship between mixture compactibility, as represented by the SGC compaction densification index CDI, and those parameters from the gradation analysis. CDI clearly does respond to a change in the gradation parameters, indicating that those parameters describe the actual gradation characteristics of the mixtures and that the

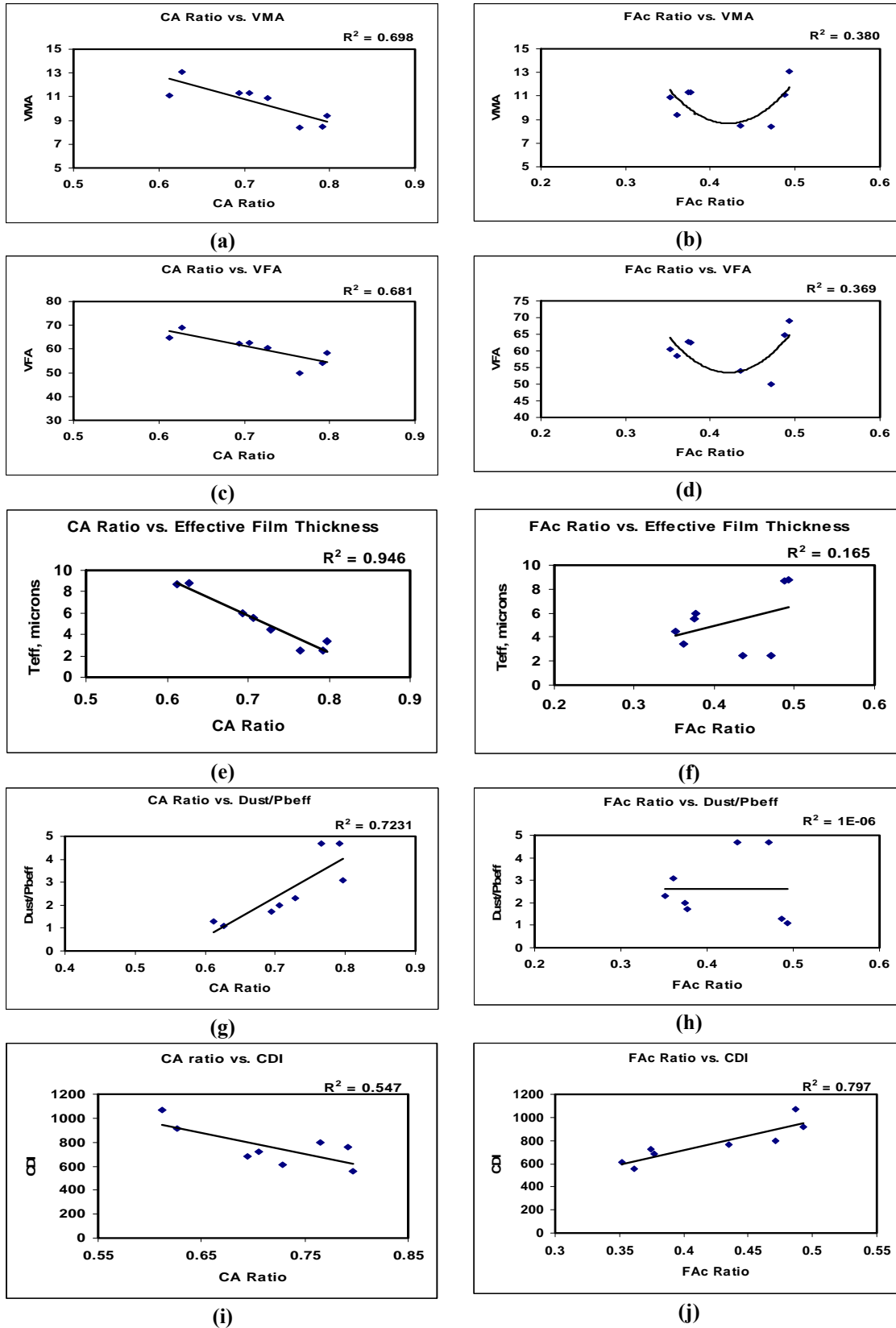

FIGURE 2 Bailey method gradation parameters and mixture physical properties.

compactibility of the mixtures is a function (among other factors) of the particle size distribution as measured by those parameters. FA_c ratio had the best correlation with the CDI. This parameter describes the coarse portion of the fine region in the aggregate gradation curve.

MIXTURE PERFORMANCE

Hamburg Wheel Tracking Test

The designed mixtures were evaluated for their performance under severe load and environmental conditions using the Hamburg wheel tracking (HWT) test. This is a torture test to determine a mixture's resistance to rutting and moisture damage. The HWT device measures the combined effects of rutting and moisture damage by rolling a steel wheel across the surface of an asphalt concrete slab 260.8 mm wide by 320.3 mm long and 40.0 mm thick (for surface course mixtures) that is immersed in hot water at a temperature of 50°C. Two slabs per mixture were tested simultaneously. The slabs were compacted to $7.0 \pm 0.5\%$ air voids. A fixed load of 685 N was applied at a rate of 56 wheel passes per minute. A load cycle in this test is equivalent to two passes. All the tests were run for 20,000 cycles.

Figure 3a presents the mean rut depths for all the mixtures in the study together with their statistical grouping. Mixtures with the same letter are not significantly different in their performance. All the mixtures had superior performance with a maximum rut depth of 3.7 mm after 20,000 cycles for the limestone coarse mixture. No signs of stripping were found at the end of the test period. The best performing mixture was the sandstone medium mixture with only 1.5-mm rut depth after 20,000 cycles.

The effect of aggregate gradation on HWT results was evaluated using the parameters obtained from the Bailey method as shown in Figures 3b and 3c. The gradation parameter describing the coarse portion of the gradation curve (CA ratio) had good correlation with the HWT data with an R^2 of 0.769. The trend indicates that there might be optimum values for this parameter for better rutting resistance under HWT test conditions of load and environment. The FA_c ratio had a weaker correlation with HWT results.

The results from the HWT test were also analyzed using the traffic densification index, TDI, obtained from the SGC. It was expected that the higher the TDI, the lower the rut depths obtained from the HWT test, if this index truly provides an indication of a mixture's stability. The data, however, showed an unexpected increase in the rut depth after a certain value of TDI as shown in Figure 3d. This raises a question of the suitability of this energy approach to highlight plastic instability of asphalt mixtures. The inability of this index to capture that can be attributed to the fact that the mixture is contained within the rigid walls of the compaction mold and the equally rigid top and bottom platens, which prevent any of the lateral flow that constitutes the basic mechanism of permanent deformation in asphalt pavements.

The effect of VMA on the rutting performance of asphalt mixtures, as measured by the HWT test, is shown in Figure 3e. A trend of increasing rut depth with higher VMA values is observed. The correlation however, is not statistically significant.

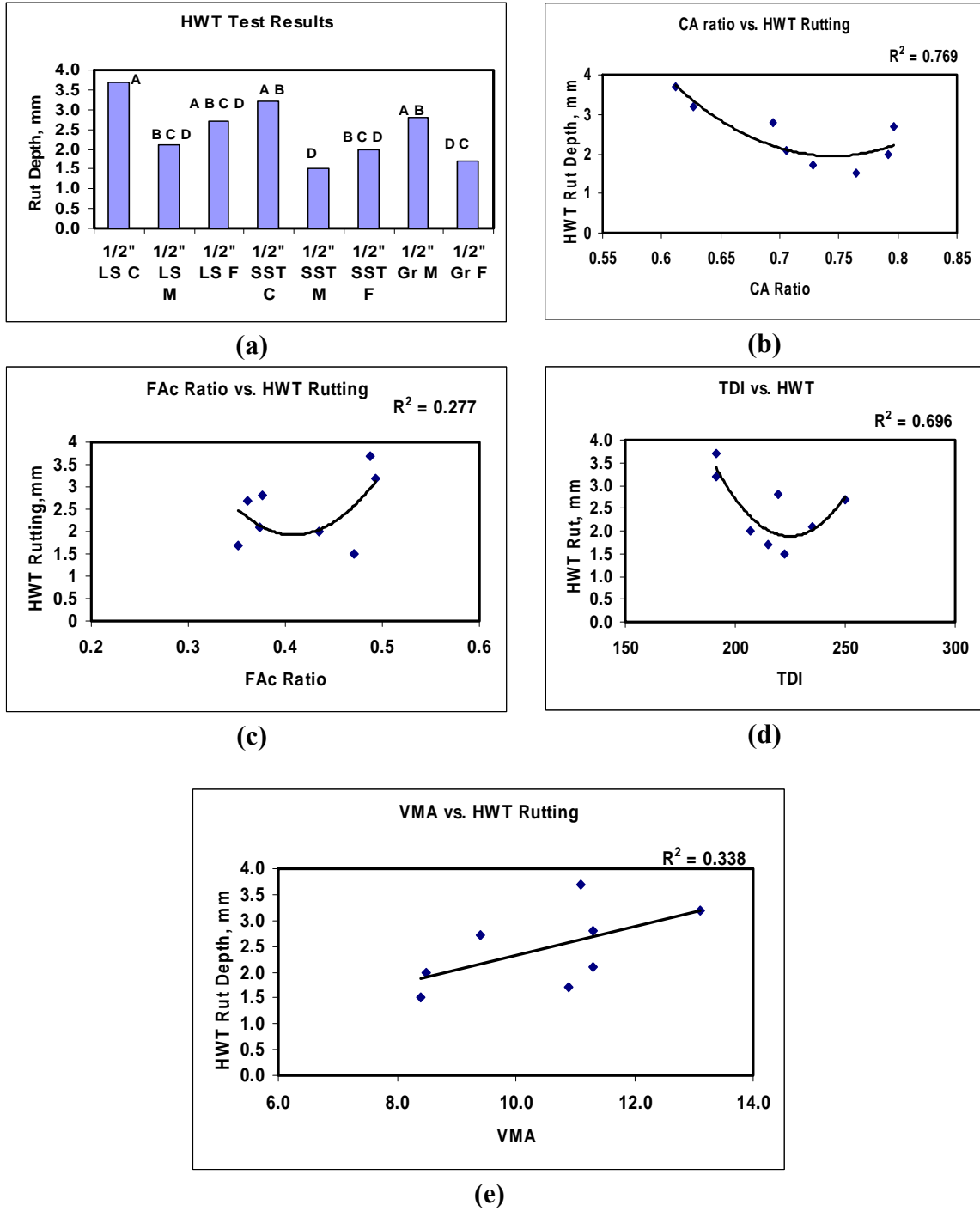

FIGURE 3 Analysis of the HWT test results.

Semicircular Fracture Energy Test

The fracture resistance of the mixtures designed in this study was investigated using the J-integral approach. This approach is gaining popularity for characterizing heterogeneous materials

such as asphalt mixtures. The method accounts for flaws represented by a notch, which in turn, reveals the material's resistance to crack propagation or what is called fracture resistance (16).

Three notch depths were used: 25.4 mm, 31.8 mm, and 38.0 mm. Two specimens per notch depth were tested. SGC specimens 150.0 mm in diameter by 57.0 mm thickness were compacted to $7.0 \pm 0.5\%$ air voids. The specimens were then sliced perpendicular to the central axis to obtain semicircular test specimens. Air void measurements were made again on the cut specimens to ensure that air void level was still within the targeted range. The test specimens were then loaded monotonically at a rate of 0.5 mm/min in a three-point bending load configuration as shown in [Figure 4a](#).

The load deflection curve was recorded and the fracture resistance was determined as follows:

$$J_c = -\left(\frac{1}{b}\right) \frac{dU}{da}$$

where b is the specimen thickness, a is the notch depth, and U is the total strain energy to failure, i.e., the area up to fracture under the load-deflection plot as presented in [Figure 4b](#). The test temperature was 25°C. [Figure 5](#) presents the results of the calculated fracture resistance from the semicircular notched fracture test for all the mixtures. Within each aggregate type, coarser mixtures had higher fracture resistance compared to the medium and fine ones. The highest fracture resistance was obtained for the sandstone coarse mixture, which was about 79% higher than that obtained for coarse limestone mixtures and 38% higher than the medium granite mixture. A good correlation was obtained between the fracture resistance and the mixtures' effective film thicknesses ($R^2 = 0.620$) in which the fracture resistance increased with thicker binder films around the aggregates, as clearly shown in [Figure 6a](#).

The sensitivity of the fracture energy to VMA is clearly demonstrated in [Figure 6b](#). Mixtures with higher VMA values tended to have better fracture resistance than those with relatively lower VMA values.

The relationship of the gradation parameters to the fracture resistance is shown in [Figures 6c](#) and [6d](#). A trend of decreasing J_c with higher CA ratio (finer gradation) is observed. No trend could be established between FA_c ratio and J_c .

The energy data were also analyzed using the traffic densification index defined earlier, as shown in [Figure 6e](#). No correlation could be established between this parameter and the fracture resistance of the mixtures. This index was mainly developed to assess a mixture's resistance to densification under traffic and hence it is not expected to describe the fracture resistance as measured by the J -integral test.

Mixture Design Based on Variable Compaction Level

It was clearly evident from the results discussed in the previous section of this paper that neither VMA nor the design number of gyrations is the same for mixes with different aggregate types and structures. Different mixes responded differently to the applied compaction energy, which makes the current approach of specifying the same design number of gyrations to all different

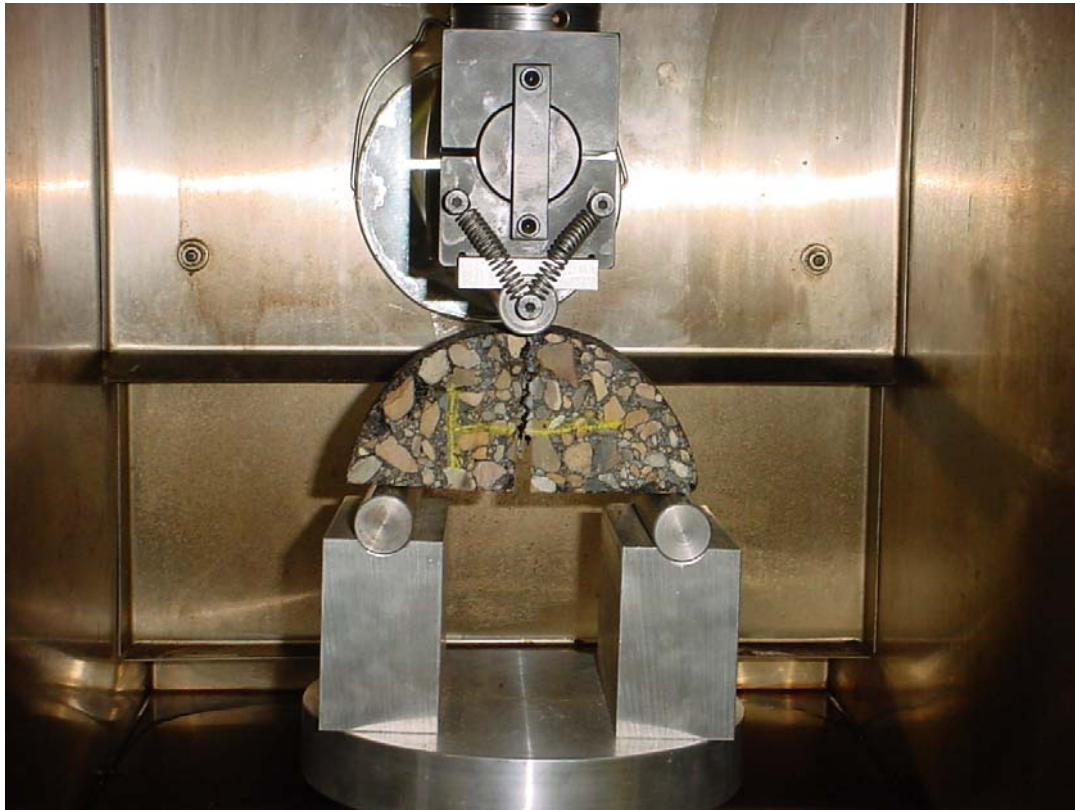

(a)

Typical load-deformation results from the semicircular fracture test

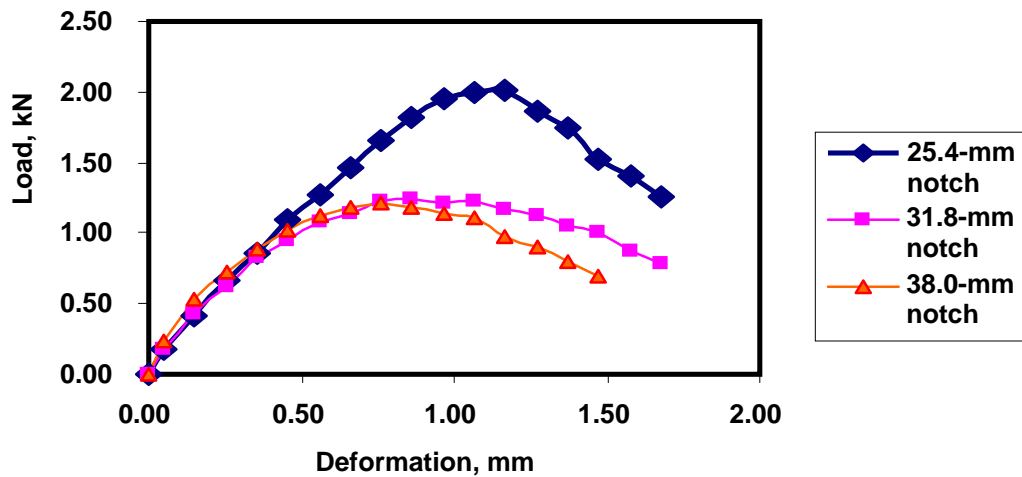

(b)

FIGURE 4 Semicircular test setup and typical output.

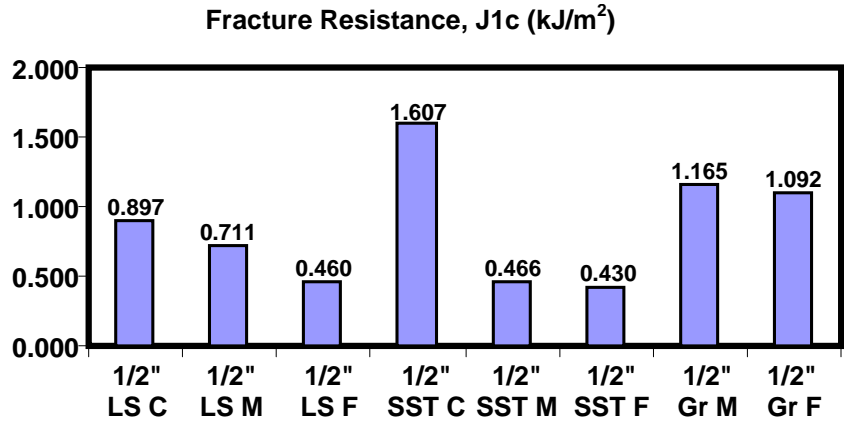

FIGURE 5 Semicircular fracture energy test results.

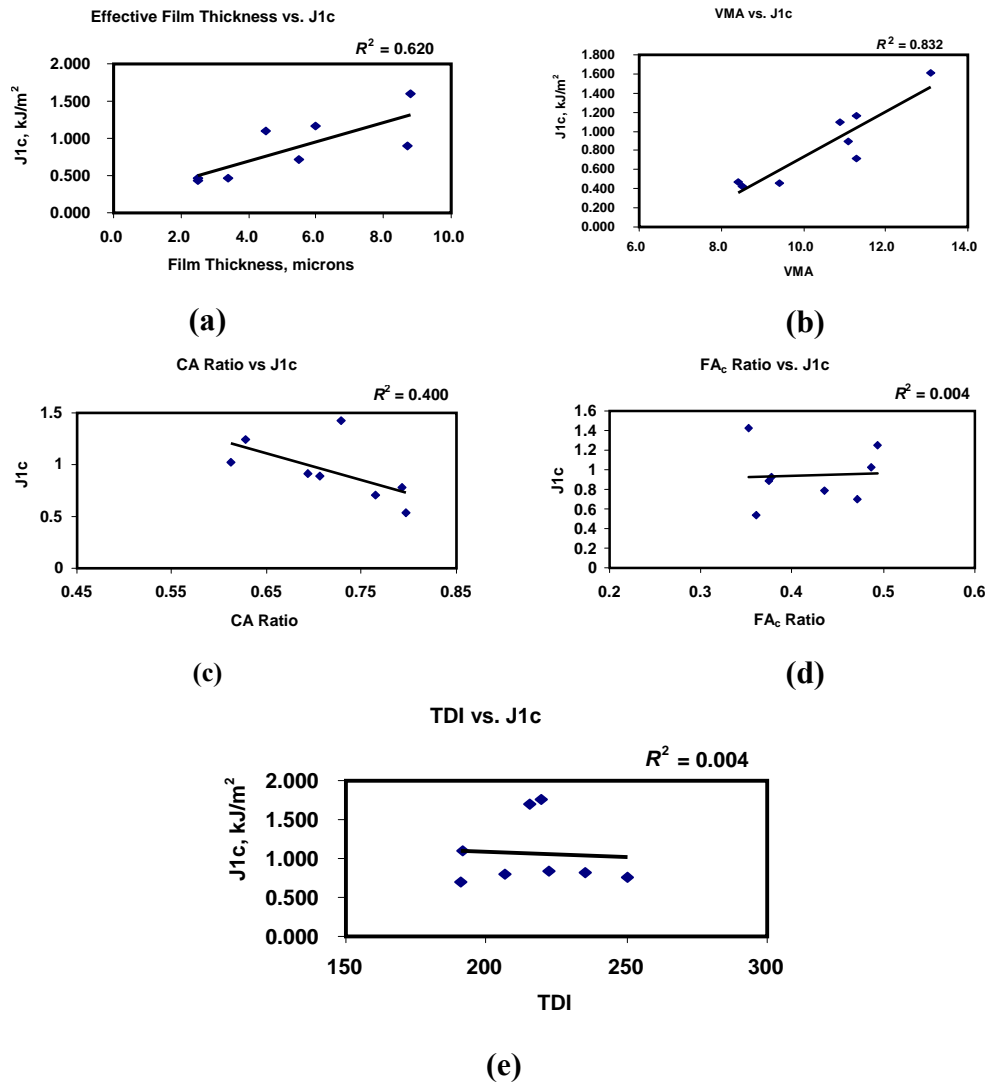

FIGURE 6 Mix physical properties and semicircular fracture energy test results.

mixes in the same traffic level questionable. Therefore, a test plan was developed to determine if it is appropriate to design asphalt mixtures by using a number of gyrations that is mix-specific and lower than that recommended by the current Superpave system. The premise was that using a lower number of gyrations will increase the design asphalt content and hence improve durability. The suggested approach was to utilize the concept of locking point in specifying the design number of gyrations. It was shown that the locking points of all the mixtures designed in this study were different and lower than the currently specified single N_{des} for all the mixes in the traffic level considered. A limited number of mixtures designed in this study were selected for mixture design using the locking point concept as opposed to the traditional Superpave N_{des} . The selected mixtures were as follows: fine granite, fine limestone, coarse limestone, and medium sandstone.

Graphical comparisons of the physical properties of mixtures designed using the locking point, together with their properties from N_{des} , are presented in [Figure 7](#). As anticipated, compacting mixtures to their locking point yielded higher design asphalt contents than those obtained when N_{des} was used. The design asphalt content ranged from 4.1% to 5.4% with the locking point, compared to 3.5% to 5.1% for the same mixtures compacted using N_{des} . It is worth noting that, except for the coarse limestone mixture, there was about a 0.6% increase in asphalt content for all other mixtures when the mixtures were designed using their locking points at the same 4.0% air void level.

The VMA values were about 1.1% to 1.2% higher with the locking point, except for the medium sandstone mixture in which there was a 0.8% increase. Again, this finding clearly indicates that VMA is compaction dependent and specifying it based on NMPS only as currently adopted by the Superpave design system is questionable.

Higher asphalt contents naturally resulted in higher VFA, lower Dust/ P_{beff} ratio, and hence higher effective film thicknesses for the mixtures considered.

For comparison and determination of relative performance, the selected mixtures were evaluated using a similar testing suite conducted in phase one, mainly HWT, indirect tensile (IT) strength test (ITS), and fracture resistance using the notched semicircular fracture energy test (Jc).

The performance of the mixtures in the HWT test is shown in [Figure 8](#). There was a slight increase in the amount of rutting for mixtures designed using the locking point partly due to higher asphalt contents used. The highest rut depth was 4.0 mm for 12.5 mm (1/2 in.) coarse limestone. The results however, are still within the range of good performing mixtures indicating that stability was not compromised by designing the mixes using lower compaction levels.

The cohesion characteristics of the mixtures were determined using the ITS and strain test to determine the tensile strength and strain of the mixtures. This test was conducted at 25°C in accordance with AASHTO T245. Each test specimen was loaded to failure at a 50.8 mm/min (2 in./min) deformation rate. The loads and deformations were continuously recorded. Aged samples were conditioned using long-term oven aging in a force draft oven at 85°C for 5 days following the protocol recommended in AASHTO PP2 (1994).

Three parameters from this test were used in the analysis: aged IT strength, aged IT strain, and toughness index (TI). Tensile strength values were slightly lower than those obtained for the mixtures compacted at N_{des} . The strength values ranged from 168.3 for the 12.5 mm (1/2 in.) coarse limestone mixture to 325.0 psi for the 12.5-mm (1/2-in.) medium sandstone mixture ([Figure 9](#)). The highest reduction in strength was observed for the 12.5-mm (1/2-in.) fine limestone mixture which had a strength value of 27.8% lower than that obtained for the same

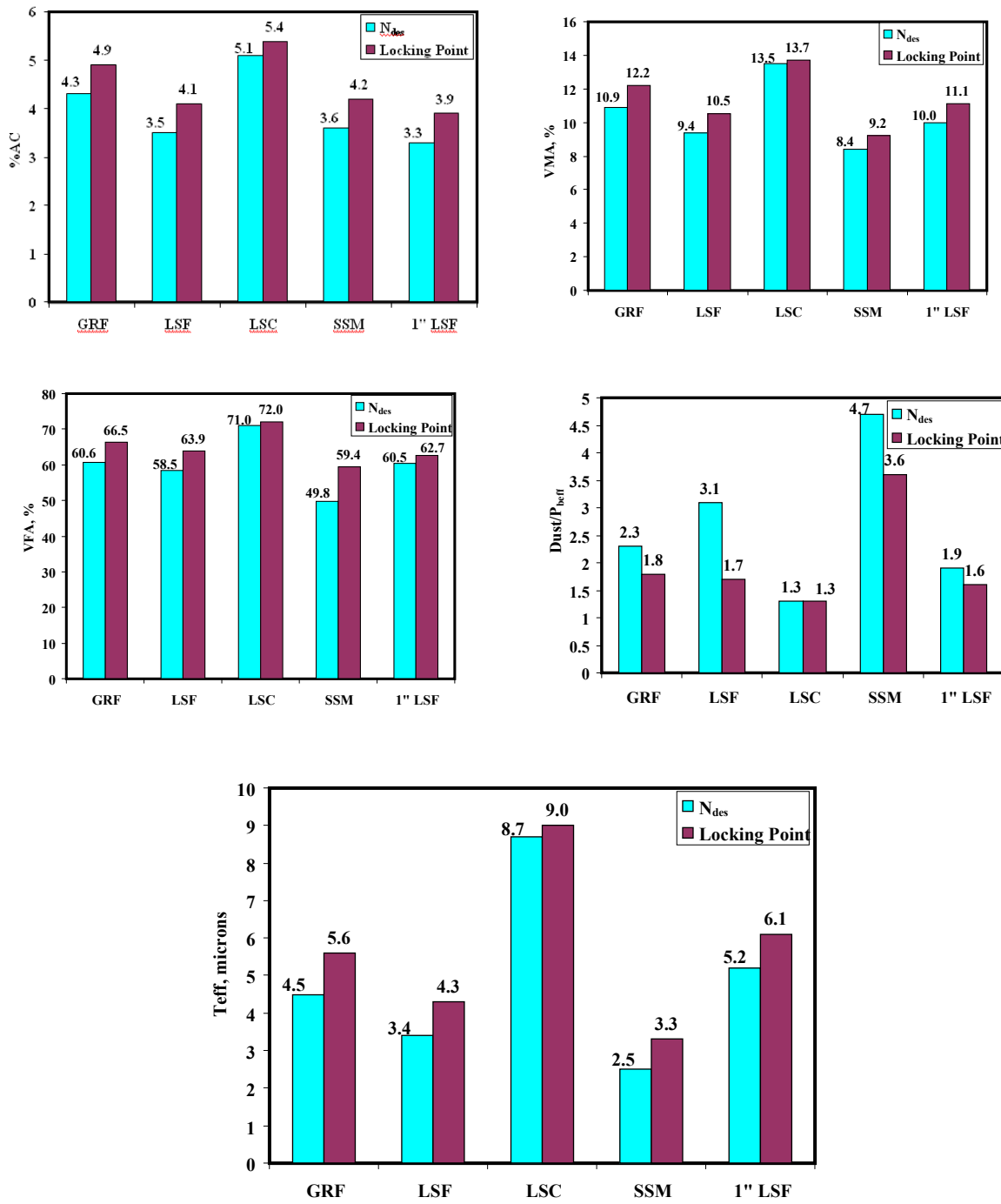

FIGURE 7 Comparison of mixtures' physical properties.

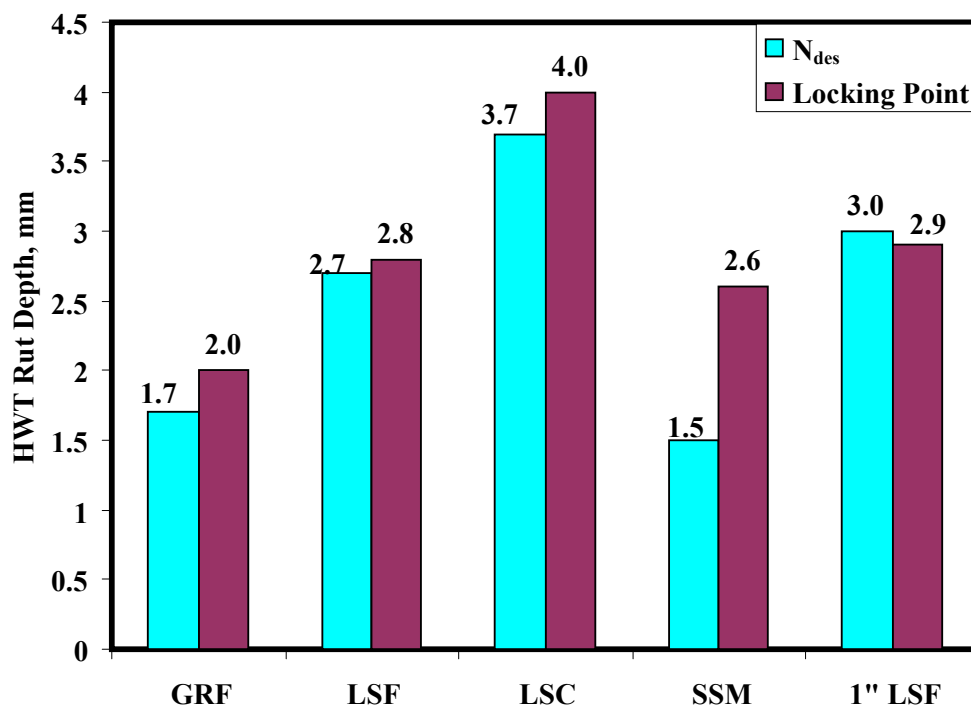

FIGURE 8 HWT results comparison.

mix designed using the Superpave recommended N_{des} . The lowest change in strength was observed for the one inch fine limestone with only 4.1% reduction in strength.

Analyzing the strain data presented in [Figure 9](#) clearly indicates that the mixtures now exhibit higher IT strain values at failure, which implies that they will retain more flexibility over time compared to the phase one mixtures and that makes them relatively less prone to pre-mature failure due to aging.

TI data are also presented in [Figure 9](#). The TI is a parameter describing the toughening characteristics in the post peak region. It compares the performance of a specimen with that of an elastic perfectly plastic reference material, for which the TI remains a constant at one. For an ideal brittle material with no post-peak load carrying capacity, the value of TI equals zero.

The lowest toughness index was obtained for the medium sandstone mixture, followed by the fine limestone. Those two mixtures had the lowest effective film thickness and the highest dust/ P_{beff} ratio. Their TI values, although still not considered low (>0.5), are exhibited than those of the other mixtures, which makes them less favorable in terms of their ability to resist aging over time. It should be noted that all the mixtures showed better toughness properties at their locking points than at Superpave N_{des} .

[Figure 10](#) presents the calculated J -integral from the semicircular notched fracture test. The test was conducted on mixtures that were aged for 5 days in a forced-draft oven at 85°C. All the mixtures exhibited an increase in their fracture resistance when designed using the locking point. The granite fine mixture showed the same fracture resistance under both N_{des} and locking point and was the highest among the mixtures tested. The biggest improvement in fracture resistance was observed for the coarse limestone mixture for which there was about 49%

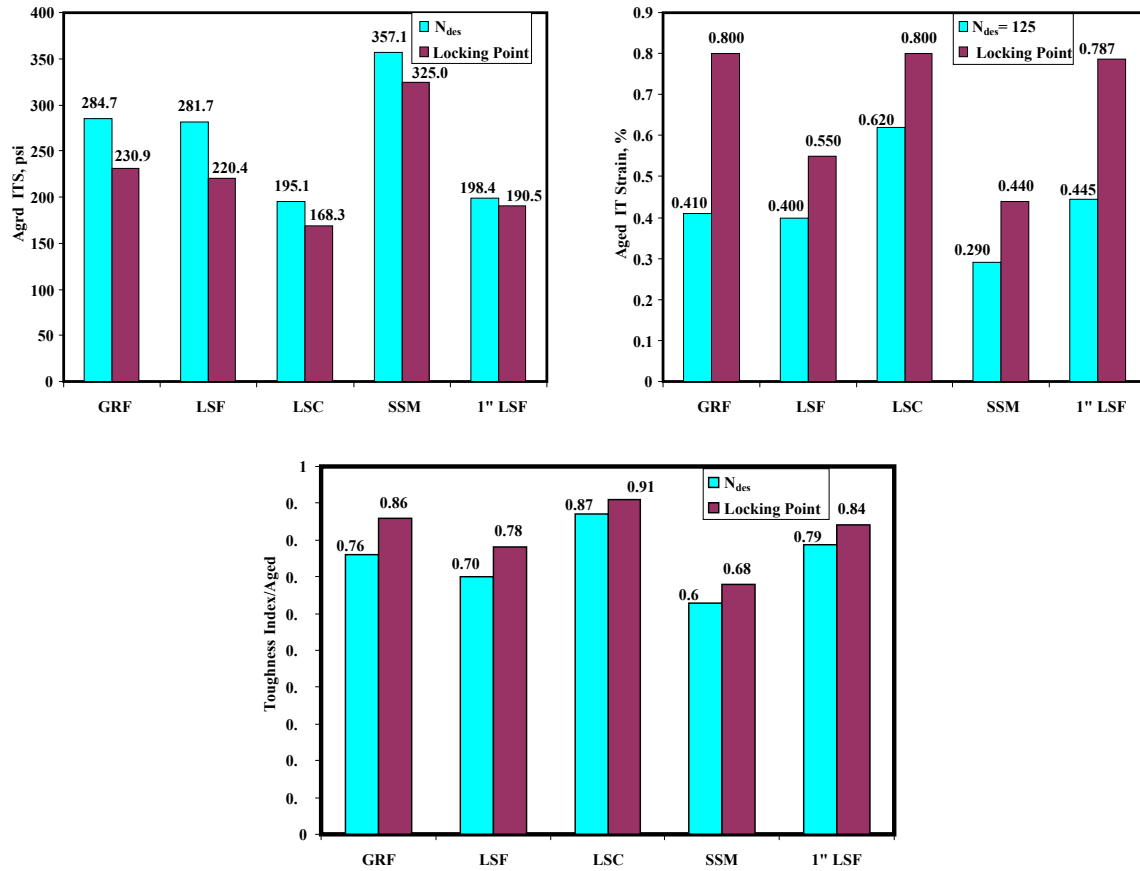

FIGURE 9 ITS results comparison.

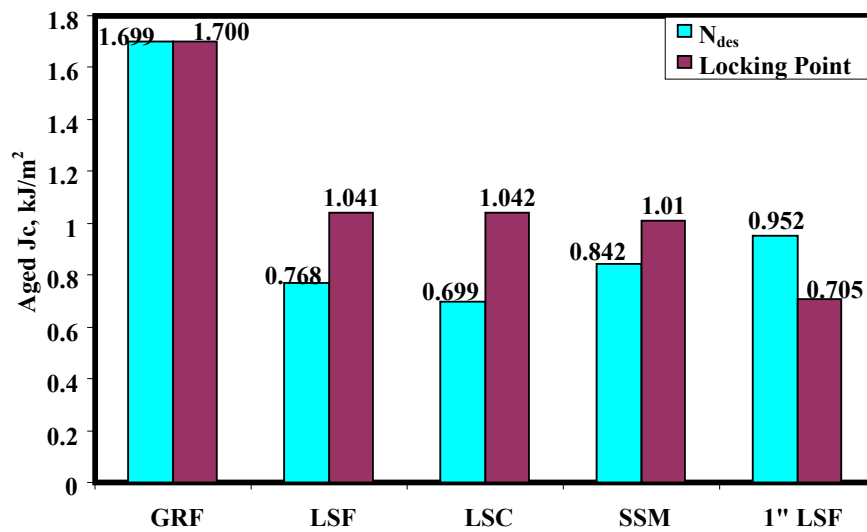

FIGURE 10 Semicircular fracture resistance test results comparison.

increase in J_c when designed using the locking point, followed by the fine limestone mixture which had about 35% increase in J_c . The 12.5-mm (1/2-in.) medium sandstone mixture gained about 20% in J_c .

SUMMARY AND CONCLUSIONS

The compaction and performance characteristics of asphalt mixtures with aggregate structures designed using an analytical gradation method were evaluated through a series of laboratory tests and aggregate gradation analyses. Eight mixtures were evaluated. Aggregate structures were designed using the Bailey method of aggregate gradation evaluation. The compactibility of the mixtures was evaluated using the data from the SGC. Laboratory tests performed on the designed mixtures included the HWT, semicircular fracture test and the indirect tensile strength test. Aggregate gradation analysis was conducted using the parameters from the Bailey method. This type of analysis provides a tool that correlates gradation parameters to mixture performance properties.

The findings of this study are summarized as follows:

- The Bailey method provides a rational approach to aggregate blending and evaluation.
- Adhering to the recommended Bailey ratios produced satisfactory results in terms of volumetrics for coarse mixtures. Fine and medium mixtures however, had lower VMA values than the current Superpave recommendations.
- The data from the SGC suggest that coarse mixtures are more difficult to compact compared to medium and fine ones.
- The compaction data also suggest that the current recommended Superpave design number of gyrations is too high and subjects the mixtures to unnecessarily high compaction loads for a long period of time, which might have an adverse effect on the final mixture volumetrics. The highest locking point in this study was under 70% of the recommended design number of gyrations for the heavy traffic category.
- The CA ratio, which is predominantly a function of the coarse aggregate blend by volume, seems to have the strongest correlation with mixture volumetrics. Mixture volumetrics seem to be less sensitive to changes in the FA_c ratio.
- A strong correlation was obtained between the effective film thickness and CA ratio ($R^2 = 0.946$).
- CDI does respond to changes in the gradation parameters, indicating that these parameters do describe the actual gradation characteristics of the mixtures and that the compactibility of the mixtures is a function of the particle size distribution as measured by the Bailey gradation parameters (among other factors). The FA_c ratio had the best correlation with the CDI.
- All the mixtures had good performance in the HWT test with a maximum rut depth of 3.7 mm after 20,000 cycles for the limestone coarse mixture. No signs of stripping were found at the end of the test period.
- The results showed that the performance of the mixtures in the HWT test was sensitive to the CA ratio used to analyze the coarse portion of the aggregate gradation in this study.

- The results from the HWT test were not sensitive to changes in the traffic densification index, TDI, from the SGC densification curve.
- Coarser mixtures tended to have higher fracture resistance compared to the medium and fine ones.
- A good correlation was obtained between the fracture resistance and the mixture effective film thickness ($R^2 = 0.620$) in which the fracture resistance of the mixtures increased with thicker binder films around the aggregates.
- High VMA seemed to improve the fracture resistance of the asphalt mixtures.
- The gradation parameter CA ratio had a statistically significant correlation with Jc. The higher this parameter (finer gradation), the lower the fracture energy obtained.
- No correlation could be established between the TDI and the fracture resistance of the mixtures.
- The data presented in this paper suggest that mixes with dense aggregate structures can be designed using their locking point instead of the recommended N_{des} . The designed mixtures maintained good resistance to permanent deformation and an adequate level of durability.

REFERENCES

1. McGennis, R. B., R. M. Anderson, T. W. Kennedy, and M. Solaimanian. *Background of Superpave Asphalt Mixture Design and Analysis*. Report No. FHWA-SA-95-003. FHWA, U.S Department of Transportation, 1995.
2. Bahia H. U., T. Friemel, P. Peterson, and J. Russell. Optimization of Constructibility and Resistance to Traffic: A New Design Approach for HMA Using the Superpave Gyratory Compactor. *Journal of the Association of Asphalt Paving Technologists*, Vol. 67, 1998, pp. 189–232.
3. Guler M., H. U. Bahia, P. J. Bosscher, and M. E. Plesha. Device for Measuring Shear Resistance of Hot-Mix Asphalt in Gyratory Compactor. In *Transportation Research Record: Journal of the Transportation Research Board*, No. 1723, TRB, National Research Council, Washington, DC, 2000, pp. 116–124.
4. Mallick R. B. Use of Superpave Gyratory Compactor to Characterize Hot-Mix Asphalt. In *Transportation Research Record: Journal of the Transportation Research Board*, No. 1681, TRB, National Research Council, Washington, DC, 1999, pp. 86–96.
5. Vavrik, W. R., and S. H. Carpenter. Calculating Air Voids at Specified Number of Gyration in Superpave Gyratory Compactor. In *Transportation Research Record: Journal of the Transportation Research Board*, No. 1630, TRB, National Research Council, Washington, DC, 1998, pp. 117–125.
6. Alabama Department of Transportation. Special Provision No. 02-0360(5)-2004—Amendment for Section 424. Alabama Standard Specifications, 2002 edition.
7. Georgia Department of Transportation. Special Provision-Section 828—Hot-Mix Asphaltic Concrete Mixtures, November 26, 2003.
8. Kandhal, P. S., K. Y. Foo, and R. B. Mallick. Critical Review of the Voids in Mineral Aggregate Requirements in Superpave. In *Transportation Research Record: Journal of the Transportation Research Board*, No. 1609, TRB, National Research Council, 1998, pp. 21–27.
9. Anderson, R. M., and R. A. Bentsen. Influence of Voids in the Mineral Aggregate on the Mechanical Properties of Coarse and Fine Asphalt Mixtures. *Journal of the Association of Asphalt Paving Technologists*, Vol. 70, 2001, pp. 1–37.
10. Coree, B. J., and W. Hislop. The Difficult Nature of Minimum VMA: Historical Perspective. In *Transportation Research Record: Journal of the Transportation Research Board*, No. 1681, TRB, National Research Council, 1999, pp. 148–156.

11. Musselman, J. A., G. C. Page, and G. A. Sholar. Field Conditioning of Superpave Asphalt Mixtures. In *Transportation Research Record: Journal of the Transportation Research Board, No. 1761*, TRB, National Research Council, 2001, pp. 61–69.
12. Coree, B. J., and W. Hislop. A Laboratory Investigation into the Effects of Aggregate-Related Factors on Critical VMA in Asphalt Paving Mixtures. *Journal of the Association of Asphalt Paving Technologists*, Vol. 70, 2001, pp. 70–131.
13. Louisiana Standard Specifications for Roads and Bridges. Louisiana Department of Transportation and Development, Baton Rouge, 2000 edition.
14. Vavrik, W. R., W. J. Pine, G. A. Huber, S. H. Carpenter, and R. Bailey. The Bailey Method of Gradation Evaluation: The Influence of Aggregate Gradation and Packing Characteristics on Voids in the Mineral Aggregate. *Journal of the Association of Asphalt Paving Technologists*, Vol. 70, 2001, pp. 132–175.
15. Vavrik, W. R., G. Huber, W. J. Pine, S. H. Carpenter, and R. Bailey. Bailey Method for Gradation Selection in HMA Mixture Design. *Transportation Research Circular E-C044. Bailey Method for Gradation Selection in Hot-Mix Asphalt Mixture Design*, TRB, National Research Council, Washington, D.C., 2002, p 1.
16. Mohammad, L. N., Z. Wu, and M. Aglan. Characterization of Fracture and Fatigue Resistance of Recycled Polymer-Modified Asphalt Pavements. *Proc., RILEM: 5th International Conference on Cracking in Pavements: Mitigation, Risk Assessment and Prevention*, Limoges, France, May 5–8, 2004, pp. 375–382.

Analysis of Oklahoma Mix Designs for the National Center for Asphalt Technology Test Track Using the Bailey Method

DANNY GIERHART

Oklahoma Department of Transportation

The Oklahoma Department of Transportation (ODOT) has designed hot-mix asphalt (HMA) mixtures to research perpetual pavement at the National Center for Asphalt Technology (NCAT) test track. The HMA types include a rich bottom layer mixture, a Superpave 19.0-mm mixture, and a 12.5-mm stone mastic asphalt mixture. Each mix design was analyzed using the Bailey method to gain familiarity with the method and examine the method's projection of performance.

This paper provides an explanation of the Bailey method analysis performed on mix designs created for ODOT's perpetual pavement research at the NCAT test track and considerations regarding the local application of the method. It also includes a summary of the method.

The Bailey method was developed by Robert Bailey of the Illinois DOT in the early 1980s. The method evaluates the way aggregate particles fit together by analyzing unit weight, aggregate bulk gravity, and aggregate gradation. This packing depends on gradation, type, and amount of compactive effort, particle shape, particle surface texture, and particle strength.

The basic suppositions of the Bailey method correspond well with traditional HMA design assumptions. The specific parameters used in the analysis may need to be re-evaluated on a regional basis. A key concern resulting from an analysis of Oklahoma mix designs is permeability associated with coarse-graded HMA mixtures.

As the concept of perpetual or long-lasting pavement is explored across the United States, there is a degree of uncertainty regarding the pavement thickness required to perform as a perpetual pavement. Some states have placed pavements in thicknesses up to 500 mm (20 in.). Many believe that long-lasting pavements do not necessarily need to be so thick. The question that needs to be answered for the Oklahoma Department of Transportation (ODOT) is "how thick does a pavement section built with our local materials need to be to perform as a perpetual pavement?" If this question can be answered from the 2006 round of testing at the National Center for Asphalt Technology's (NCAT's) test track, ODOT can more accurately design long-lasting pavements. This would eliminate excessively thick pavements overdesigned due to uncertainty and save construction dollars better spent on other projects.

ODOT agreed with NCAT to place two 61-m (200-ft) test sections in the 2006 test track. Each test section will begin and end with a 7.6-m (25-ft) transition from the previous section. As shown in [Figure 1](#), the asphalt mixes ODOT will use at the test track follow the typical perpetual pavement design concept of (a) a solid foundation, (b) a flexible, fatigue-resistant asphalt base, (c) a stiff, rut-resistant intermediate layer, and (d) a rut-resistant, skid-resistant surface. The first section will be 250 mm (10 in.) thick and consisting of a 50-mm (2-in.) base lift of RBL mix with performance grade (PG) 64-22, 75 mm (3 in.) of 19.0 mm Superpave with PG 64-22, 75 mm (3 in.) of 19.0 mm Superpave with PG 76-28, capped with 50 mm (2 in.) of stone mastic asphalt (SMA) with PG 76-28 [nominal maximum aggregate size (NMAS) of ½ in.]. The second section will be 356 mm (14 in.) thick and consist of a 75-mm (3-in.) lift of RBL mix with PG 64-22, two 75-mm (3-in.) lifts of 19.0-mm Superpave with PG 64-22, 75 mm (3 in.) of 19.0-mm

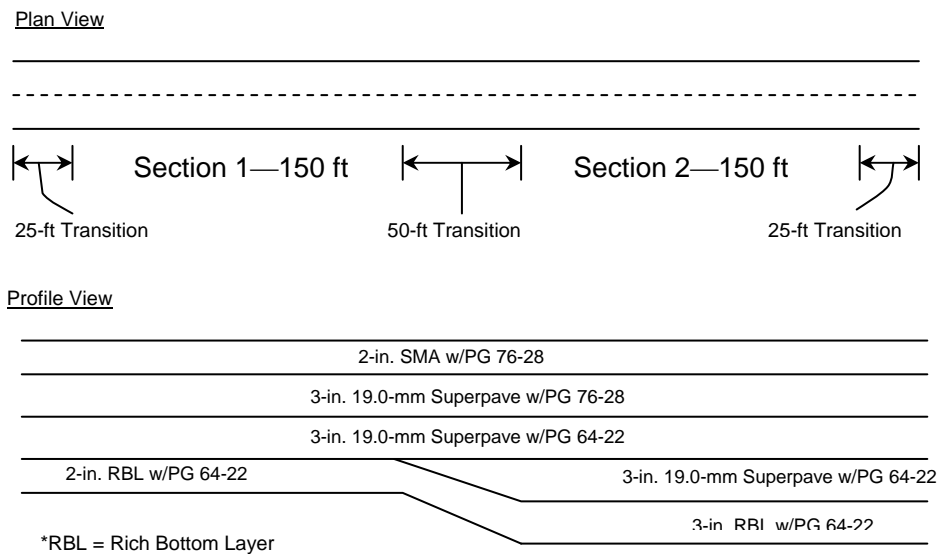

FIGURE 1 ODOT’s structural test sections at NCAT test track.

Superpave with PG 76-28, capped with 50 mm (2 in.) of SMA with PG 76-28. NCAT provides a subgrade with properties similar to those found in Oklahoma. Each test section is instrumented with strain gauges and pressure plates. ODOT intends to analyze the data for each section and interpolate to determine the thickness required to function as a perpetual pavement by comparing the recorded strains at the bottom of each section to the maximum strain allowable for indefinite fatigue life.

Designs for each mix type have been performed by ODOT Materials Division. Although a traditional mix design method was used, the mixes were also evaluated using the Bailey method. The Bailey method evaluates the way aggregate particles fit together and their effect on volumetrics, susceptibility to segregation, and compactability. This packing depends on gradation, type, and amount of compactive effort, particle shape, particle surface texture, and particle strength. The individual aggregates and the combined blend of aggregates are evaluated by volume as well as by weight.

MATERIALS

When analyzing mix designs by any method, including the Bailey method, an understanding of the constituent materials is critical. Because the Bailey method focuses on aggregate packing, the types of asphalt binder used will not be highlighted in this discussion.

Crushed aggregate from three different quarries and river sand were used in the mix designs. Out of the four aggregate sources, three have distinctly different properties. [Table 1](#) summarizes each material.

All of the chips and one of the screenings came from the Hanson Quarry at Davis, Oklahoma. They come from a rhyolite formation, and are very hard and very angular. Aggregates from this quarry tend to increase air voids and voids in mineral aggregate (VMA) when they are increased in a mix. The screenings are a by-product of the crushing operation.

TABLE 1 Summary of Aggregate Properties

	Hanson	Martin Marietta	Dolese	GMI Sand
Aggregate type	Rhyolite	Limestone	Limestone	River sand
Aggregate shape	Very angular	Angular	Angular	Rounded
L.A. abrasion (% loss)	16.3	26.3	25.2	n/a
Micro Deval (% loss)	7.4	23.8	14.7	n/a
P _{75 μm} (P ₂₀₀) (screenings)	6.8	1.1	12.9	2.0

They are fine-graded, with 100% passing the 9.5-mm sieve. The percent passing the 75 μm sieve normally ranges from 7% to 9%.

The other screenings came from the Dolese Quarry, also located at Davis, Oklahoma. Although this quarry is located within a few miles of the Hanson Quarry, its material comes from a limestone formation. These screenings also have 100% passing the 9.5-mm sieve.

The material called stone sand came from the Martin Marietta Quarry, also located at Davis, Oklahoma. This quarry is situated very close to the Dolese Quarry and is also in a limestone formation. The stone sand is basically a washed screenings material, with only 1% to 3% passing the 75 μm sieve. This fine aggregate also tends to increase voids and VMA with increased usage.

The river sand comes from the GMI pit in Oklahoma City, Oklahoma. This sand has rounded particles, 100% passing the 4.75-mm sieve with around 90% still passing the 600 μm sieve, and typically about 2% passing the 75 μm sieve. This material tends to decrease voids and VMA with increased usage.

The different asphalt mix designs obviously required different combinations of aggregates. Because of previous ODOT work regarding permeable mix designs, the three dense-graded mixes are all on the fine side, using only 35% chips in the RBL and 30% chips in the two 19.0-mm Superpave mixes. The final mix designs are shown in [Table 2](#).

BAILEY METHOD ANALYSIS

ODOT did not actually design the mixes using Bailey method principles. They were simply analyzed using the principles afterward. The first part of the analysis used the Microsoft Excel volume blending sheets provided by Bill Pine in the Asphalt Institute's Bailey method course. These spreadsheets are well written, comprehensive, and easy to use.

A Transportation Research Circular (*I*) has been written which explains the Bailey Method in great detail. Therefore, this report will provide the results of ODOT's Bailey method analysis, but will not go into great detail about how to calculate them. A brief summary of the method follows. Then the mixes used at the NCAT test track are analyzed using the principles of the Bailey method.

Overview of Bailey Method

The Bailey method evaluates the way aggregate particles fit together. This packing depends on gradation, type, and amount of compactive effort, particle shape, particle surface texture, and

TABLE 2 Summary of Mix Properties

		RBL w/PG 64-22	19.0-mm Superpave w/PG 64-22	19.0-mm Superpave w/PG 76-28	SMA w/PG 76-28
% Passing	25.0 mm	100	100	100	100
	19.0 mm	100	95	95	100
	12.5 mm	99	81	81	97
	9.5 mm	88	72	72	78
	4.75 mm	58	63	63	29
	2.36 mm	39	43	43	23
	1.18 mm	25	29	29	19
	600 μm	18	22	22	16
	300 μm	13	15	15	15
	150 μm	10	7	7	14
	75 μm	8.1	4.9	4.9	12.3
% Asphalt concrete		6.0	4.3	4.3	6.8
% Cellulose fibers		0	0	0	0.3
# Gyration		50	100	100	50
% Air voids		2.0	4.0	4.0	4.0
VMA		14.6	13.5	13.5	18.2
VFA		85.4	70.4	70.4	78.0
Dust proportion		1.5	1.3	1.3	2.0
Permeability ($\times 10^{-5}$ cm/s)		0.1	0.0	0.0	0.0
Asphalt pavement analyzer rut depth (mm)		5.5	4.9	2.4	1.9

particle strength. The individual-aggregates and the combined blend of aggregates are evaluated by volume as well as by weight. The loose unit weight (LUW) and the rodded unit weight (RUW) are necessary to evaluate the aggregate structure volumetrically. This method can be used to evaluate existing mixes and laboratory blends. The following four principles are applied in the evaluation of the aggregate structure:

Principle No. 1

Mixes are first categorized as either fine or coarse and evaluated accordingly. Some particles create voids, while other particles fill voids. The mix behaves differently depending on whether the fine or the coarse particles are in control, as summarized in [Table 3](#). The primary control sieve (PCS) determines the break between coarse and fine fractions of the combined blend.

Principle No. 2

This principle deals with the coarse fraction of the aggregate structure. Because of the inherent differences between fine and coarse mixes, the coarse fraction is defined differently for each mix type. The evaluation of this portion of the aggregate structure uses the idea of the half sieve. Particles retained on the half sieve are referred to as pluggers. Particles passing the half sieve but

TABLE 3 Bailey Principle No. 1

Fine in Control	Coarse in Control
Coarse fraction spread apart and floating in the fine fraction.	Fine aggregate mainly fills voids created by coarse aggregate.
Little to no particle-on-particle contact of the coarse aggregate.	There is some degree of particle-on-particle contact of the coarse aggregate.
Fine fraction carries most of the load.	Coarse fraction carries most of the load.
Fine aggregate must have sufficient gradation, shape, texture, and strength to support the load.	Coarse aggregate must have sufficient gradation, shape, texture, and strength to support the load. However, the fine aggregate does play a role in supporting the coarse aggregate.
6% change in PCS results in approximately 1% change in VMA or air voids.	4% change in PCS results in approximately 1% change in VMA or air voids.
Decreasing coarse aggregate volume increases VMA and voids (providing fine fraction characteristics remain similar).	Increasing coarse aggregate volume increases VMA and voids (providing fine fraction characteristics remain similar).
As the coarse aggregate volume increases above tolerances, the mix can go in and out of coarse aggregate interlock, resulting in problems.	As the coarse aggregate volume increases above tolerances, compactability decreases, and chance of segregation increases.

retained on the PCS are called interceptors. The interceptors are too large to fit into the voids created by the pluggers and therefore spread them apart. The ratio of the % interceptors to the % pluggers is defined as the coarse aggregate (CA) ratio. Principle No. 2 is summarized in [Table 4](#).

Principle No. 3

This principle deals with the coarse part of the fine fraction of the aggregate structure. Because of the inherent differences between fine and coarse mixes, the fine fraction is defined differently for each mix type. The evaluation of this portion of the aggregate structure uses the idea of the secondary control sieve (SCS). The ratio of the fine part of the fine fraction to the total fine fraction is defined as the fine aggregate (FA_c) ratio. Therefore, $1 - FA_c$ ratio is the decimal amount of the coarse part of the fine fraction. The FA_c ratio is the primary factor in the controlling the VMA and voids of the mixture. Key features of this principle are shown in [Table 5](#).

Principle No. 4

This principle deals with the fine part of the fine fraction of the aggregate structure. Because of the inherent differences between fine and coarse mixes, the fine fraction is defined differently for each mix type. The evaluation of this portion of the aggregate structure uses the idea of the tertiary control sieve (TCS). The ratio of the fine part of the fine part of the fine fraction to the total fine part of the fine fraction is defined as the FA_f ratio. Therefore, the small particles passing the TCS fit into the voids created by the coarser particles found between the SCS and the TCS. This principle is described in [Table 6](#).

The results of the analysis of each mix using the principles of the Bailey method follow.

TABLE 4 Bailey Principle No. 2

Fine in Control	Coarse in Control
Half sieve = 1/2 the original PCS. The PCS is now looked at as the new nominal maximum particle size (NMPS).	Half sieve = 1/2 the original NMPS.
New PCS = 0.22 times the original PCS.	PCS stays as originally defined.
The portion evaluated as the new coarse fraction is smaller than that of coarse mixes and therefore less sensitive to changes.	The portion evaluated as the coarse fraction is larger than that of fine mixes and therefore more sensitive to changes.
0.35 increase in CA ratio results in approximately 1% increase in VMA or air voids.	0.20 increase in CA ratio results in approximately 1% increase in VMA or air voids.
Too-low CA ratio means too few interceptors and therefore VMA and voids are lower.	Too-low CA ratio means too few interceptors and therefore VMA and voids are lower.
By definition of fine mixes, the coarse particles are floating in the fine particles. Therefore the CA ratio of fine mixes does not relate to segregation.	Too-low CA ratio means too many coarse particles and therefore the mix is prone to segregation.
Too-high CA ratio means too many interceptors and therefore the mix is tender and difficult to properly compact.	Too-high CA ratio means too many interceptors and therefore the mix is tender and difficult to properly compact.
CA ratio acceptable range is 0.6–1.0	CA ratio acceptable range changes depending on NMPS.

TABLE 5 Bailey Principle No. 3

Fine in Control	Coarse in Control
SCS = 0.22 times the new PCS.	SCS = 0.22 times the original PCS.
New PCS = 0.22 times the original PCS.	PCS stays as originally defined.
FA _c ratio acceptable range is 0.35–0.50	FA _c ratio acceptable range is 0.35–0.50
0.05 increase in FA _c ratio up to 0.50 results in approximately 1% decrease in VMA or air voids.	0.05 increase in FA _c ratio up to 0.55 results in approximately 1% decrease in VMA or Air voids.
Once FA _c ratio increases beyond 0.50 VMA begins to increase.	Once FA _c ratio increases beyond 0.55 VMA begins to increase.
As FA _c ratio increases toward 0.50, compactability of fine fraction increases.	As FA _c ratio increases toward 0.55, compactability of fine fraction increases.

TABLE 6 Bailey Principle No. 4

Fine in Control	Coarse in Control
TCS = 0.22 times the new SCS.	TCS = 0.22 times the original SCS.
New SCS = 0.22 times the new PCS.	SCS stays as originally defined.
FA _f ratio acceptable range is 0.35–0.50	FA _f ratio acceptable range is 0.35–0.50
As the FA _f ratio increases up to 0.50, VMA decreases.	As the FA _f ratio increases up to 0.55, VMA decreases.
Once FA _f ratio increases beyond 0.50 VMA begins to increase.	Once FA _f ratio increases beyond 0.55 VMA begins to increase.

RBL Mix

According to the Bailey method, fine-graded mixes should have a chosen unit weight (CUW) of less than 90% of the CA LUW. The spreadsheet was used to back calculate a CUW of 78.9% from the design aggregate percentages of the RBL, which classifies the design as a fine-graded mix. ODOT chose to design fine-graded mixes because in our experience, the mixes that would fall into the coarse-graded category are often too permeable. Using the FA spreadsheet for 12.5 nominal maximum size mixes, the aggregate gradations, LUWs, RUWs, and bulk gravities were input. The spreadsheet used those values to calculate the old CA ratio, new CA ratio, and new FA_c ratio. The resulting values are shown in Table 7.

Even though this is a fine-graded mix from the Bailey method point of view, 62% of the aggregate structure by weight and by volume for this mix is retained on the original PCS. Therefore, the old CA ratio, calculated at 0.875 for this mix, still gives an indication of susceptibility to segregation. The CA ratio is the ratio of the fine part (interceptors) to the coarse part (pluggers) of the overall coarse fraction. Therefore, a low ratio means that most of the overall coarse fraction is made up of the coarsest part of that fraction. When that happens, the mix is susceptible to segregation. When the CA ratio is high, as in this case, the opposite is true. Of the 62% of the aggregate structure retained on the original PCS, 87.5% are interceptors, while only 12.5% are pluggers. Based on this ratio, ODOT will be expecting a RBL lift with a low probability of segregation inherent in the mix.

Because the RBL mix is fine-graded from the Bailey method point of view, a new CA ratio was calculated. The NMPS is the same sieve as the old PCS (2.36 mm for this mix) and the new PCS (0.600 mm) is the nearest sieve size to 0.22 times the old PCS. In short, the new CA ratio deals with coarse part of the fine fraction. It should be noted that while 62% of the total aggregate fraction was analyzed using the old CA ratio, the new CA ratio deals with only 21% of the total aggregate fraction. Therefore, the effect on susceptibility to segregation is mitigated by quite a bit. The new CA ratio of 0.556 for this mix was slightly below the preferred range of 0.60 to 1.00, which indicates a slight propensity toward segregation.

A new FA_c ratio was also calculated for the RBL mix. The value of 0.558 is slightly higher than the preferred range of 0.35 to 0.50. High values indicate a high dust–binder ratio (1.4 for this design). Also, as this value gets higher, VMA tends to get lower. Because the ODOT mixes were designed by traditional methods first, then evaluated using the Bailey method, the

TABLE 7 Summary of Bailey Method Properties: RBL w/PG 64-22 Mix

	RBL w/PG 64-22 (Fine-Graded Mix)	
	Value	Suggested Range
CUW	78.9%	< 90%
Old CA ratio	0.875	No suggested range; as old CA ratio decreases, segregation susceptibility increases.
New CA ratio	0.556	0.60–1.00
New FA_c ratio	0.558	0.35–0.50
New FA_f ratio	Not applicable to 12.5-mm NMPS mixes.	Not applicable to 12.5-mm NMPS mixes.

design already had sufficient VMA. However, if a designer was evaluating the mix on paper before the lab work, this ratio could be a helpful tool in the decision-making process.

The new FA_f ratio cannot be calculated for 12.5-mm NMPS mixes. For 12.5-mm NMPS mixes, the new SCS is the 0.150-mm sieve. The TCS used to calculate the new FA_f ratio is defined as the sieve nearest to 0.22 times the new SCS, in this case the .032-mm sieve, which is not usually included in the nest of sieves for Superpave mixes.

The Bailey method is also used to predict air voids and VMA on subsequent samples from an initial mix analysis based on changes in the aggregate gradation. For fine-graded mixes, the following four main principles are used:

1. 6.0% change in the original PCS \cong 1% change in VMA or voids;
2. 0.35% change in the new CA ratio \cong 1% change in VMA or voids;
3. 0.05% change in the new FA_c ratio \cong 1% change in VMA or voids; and
4. 0.05% change in the new FA_f ratio \cong 1% change in VMA or voids.

Seven trials were mixed in the lab as ODOT was developing specifications for the RBL mix. **Figure 2** shows the estimated air void contents predicted from the initial trial plotted against the actual air void content for all seven trials of the RBL mix. In general, there was poor agreement between the actual and estimated air void contents. The largest difference was observed at Trial No. 5, where the void content estimations actually showed a value of about -1%, compared to the actual air void content of about 9%. This trial marked the point at which 100% of the natural sand was removed from the mix and replaced with more angular manufactured sand. However, the actual air void content on the final trial (No. 7) was exactly the same as the estimated air void content.

19.0-mm Superpave Mix

The spreadsheet was again used to back calculate a CUW from the design aggregate percentages of the Superpave mix. The CUW was 50.7%, which classifies the design as a fine-graded mix. Using the FA spreadsheet for 19.0 nominal maximum size mixes, the aggregate gradations, LUWs, RUWs, and bulk gravities were input. The spreadsheet used those values to calculate the old CA ratio, new CA ratio, new FA_c ratio, and new FA_f ratio. The resulting values are shown in **Table 8**.

For this mix, only 37% of the aggregate structure was retained on the original PCS. The old CA ratio, calculated at 0.358 for this mix, indicates that this mix may be susceptible to segregation. Of the 37% of the aggregate structure retained on the original PCS, only 10% are interceptors, while the remaining 27% are pluggers. So, even though this mix is classified as fine graded, the relative particle sizes in the coarse aggregate fraction may render it inherently susceptible to segregation.

The new CA ratio on the Superpave mix deals with a larger portion of the total aggregate fraction than did the RBL mix. For this mix, 37% of the total aggregate fraction was analyzed using the old CA ratio, while the new CA ratio dealt with only 34% of the total aggregate fraction. The new CA ratio of 0.681 for this mix was within the preferred range of 0.60 to 1.00. Although the portion between the 4.75-mm sieve and the 1.18-mm sieve does not indicate a susceptibility to segregation, the portion coarser than the 4.75-mm size does. ODOT will closely observe this mix during placement with these ratios in mind.

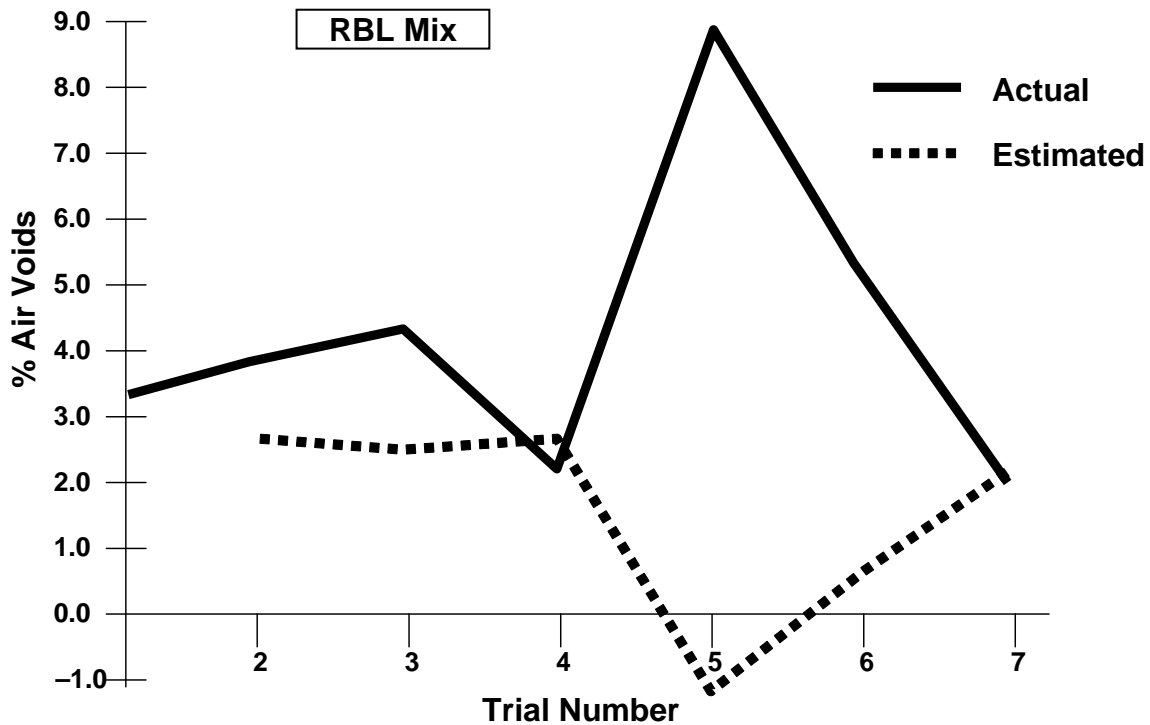

FIGURE 2 Comparison of actual versus estimated void content—RBL (air voids at 6.0% binder).

TABLE 8 Summary of Bailey Method Properties—19.0-mm Superpave Mixes

19.0-mm Superpave w/PG 64-22 and w/PG 76-28 (Fine-Graded Mix)		
	Value	Suggested Range
CUW	50.7%	< 90%
Old CA ratio	0.358	No suggested range; as old CA ratio decreases, segregation susceptibility increases
New CA ratio	0.681	0.60–1.00
New FA _c ratio	0.517	0.35–0.50
New FA _f ratio	0.332	0.35–0.50

A new FA_c ratio was also calculated for the Superpave mix. The ratio of 0.517 is slightly higher than the preferred range of 0.35 to 0.50. This slightly high value tracks well with a slightly high dust–binder ratio of 1.3 for this design. Again, higher ratios tend to inhibit VMA, this mix with its angular fine fraction already had sufficient VMA.

The new FA_f ratio of 0.332 is slightly lower than the preferred range of 0.35 to 0.50. Although the slightly high new FA_c ratio and the slightly low new FA_f ratio worked together to meet volumetric requirements, it probably would have been better for field compactability if both had been within the preferred ranges.

Because ODOT's Superpave specifications have already been developed, only two trials were mixed in the lab. **Figure 3** shows the estimated air void content on Trial No. 2 predicted from the initial trial plotted against the actual air void content for both trials of the Superpave mix. Again, there was poor agreement between the actual and estimated air void content on Trial No. 2, showing a difference of 3.3%. The spreadsheet estimated that the void content would decrease 1.3% from Trial No. 1, and it actually increased 2.0%. For Trial No. 2 the percentage of softer, less angular limestone screenings was decreased by 10% while the percentage of harder, more angular rhyolite screenings was increased by 10%. Furthermore, the washed limestone screenings (stone sand) was increased by 5% while the rounded natural sand was decreased by 5%. Intuitively, the air voids would definitely increase as a result of these changes. However, because the Bailey method only looks at particle size distribution in voids estimation, the factors of particle shape, particle texture, and particle strength are ignored. This analysis underscored the need to use the knowledge and experience we already have and not rely solely on one analysis tool.

SMA Mix

The spreadsheet was again used to backcalculate a CUW from the design aggregate percentages of the SMA mix. The CUW was 110.0%, which barely meets the preferred range of 110% to 125% for SMA mixes. Using the SMA spreadsheet for 12.5 nominal maximum size mixes, the aggregate gradations, LUWs, RUWs, and bulk gravities were input. The spreadsheet used those values to calculate the CA ratio, FA_c ratio, and FA_f ratio. The resulting values are shown in **Table 9**.

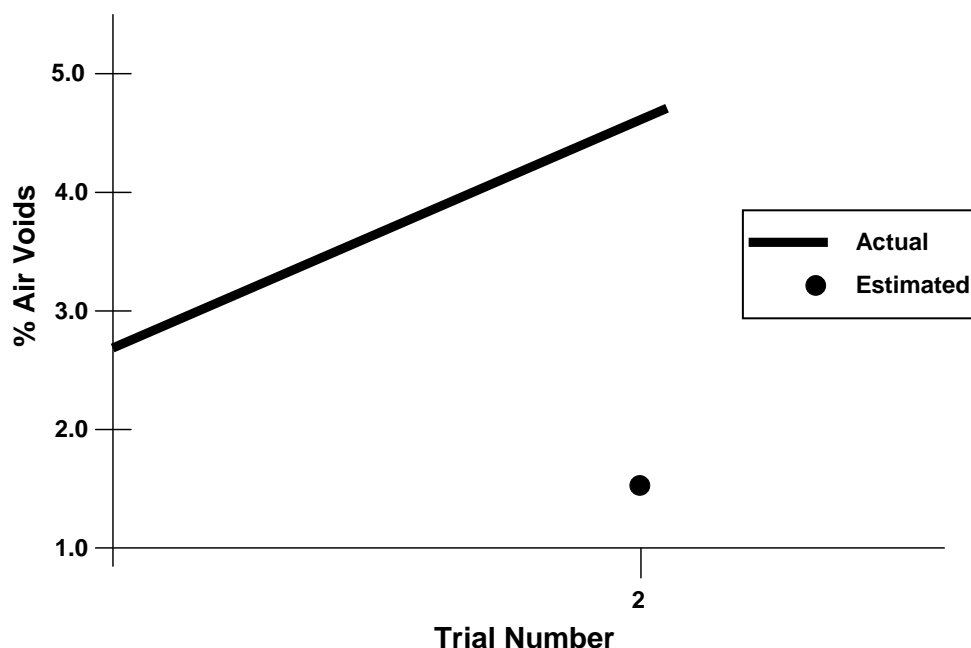

FIGURE 3 Comparison of actual versus estimated void content—
19.0-mm Superpave (air voids at 4.3% binder).

TABLE 9 Summary of Bailey Method Properties—SMA w/PG 76-28 Mix

	SMA w/PG 76-28	
	Value	Suggested Range
CUW	110.0%	110%–125%
CA ratio	0.398	0.25–0.40
FA _c ratio	0.720	0.60–0.85
FA _f ratio	0.843	0.65–0.90

As expected for SMA mixes, the CA ratio deals with a large percentage of the aggregate structure, as 77% was retained on the PCS. The CA ratio, calculated at 0.398 for this mix, falls within the preferred range of 0.25 to 0.40. However, it should be noted that unless a 6.3-mm sieve was inserted into the nest of sieves, the percent passing the half sieve is interpolated from the 9.5-mm sieve and the 4.75-mm sieve. The amount of material retained between these two sieves will be substantial for most SMA mixes (49% in this mix) and could lead to significant error by assuming a linear relationship between them.

A FA_c ratio was also calculated for the SMA mix. The ratio of 0.720 falls in the middle of the preferred range of 0.60 to 0.85, indicating a good balance between the relative fractions of the FA. While mixes with ratios falling outside of this or other ranges may still perform well, mixes with ratios within the ranges will almost always perform well.

The FA_f ratio of 0.843 also falls within the preferred range of 0.65 to 0.90. Typically, a higher ratio indicates a higher percentage passing the 75 μ m sieve. This SMA mix was intentionally designed at the upper limit to decrease the potential for permeability.

Because ODOT's SMA specifications have already been developed, only two trials were mixed in the lab. Figure 4 shows the estimated air void content on Trial No. 2 predicted from the initial trial plotted against the actual air void content for both trials of the SMA mix. This time, there was excellent agreement between the actual and estimated air void content on Trial No. 2, with both showing 3.3%. The spreadsheet estimated that the void content would decrease 4.4% from Trial No. 1, which it actually did. Most of the decrease in voids could be attributed to the increase in the PCS. A relatively small change of 2% in the PCS results in a 1% change in voids.

CONCLUSIONS

ODOT observations made from analysis so far are as follows:

1. The Bailey method principles make sense when reviewed in the context of previous mix design experience.
2. The method provides a way to quantify changes that we have only made educated guesses at before.
3. Based on previous experience, the method provides a reasonable indication of aggregate combinations which are susceptible to segregation and field compactability problems.
4. Based on previous experience, the mixes that fall into the coarse-graded category are often too permeable.
5. The voids estimation process looks at particle size distribution only, and is therefore blind to changes in aggregate strength, shape, and texture.

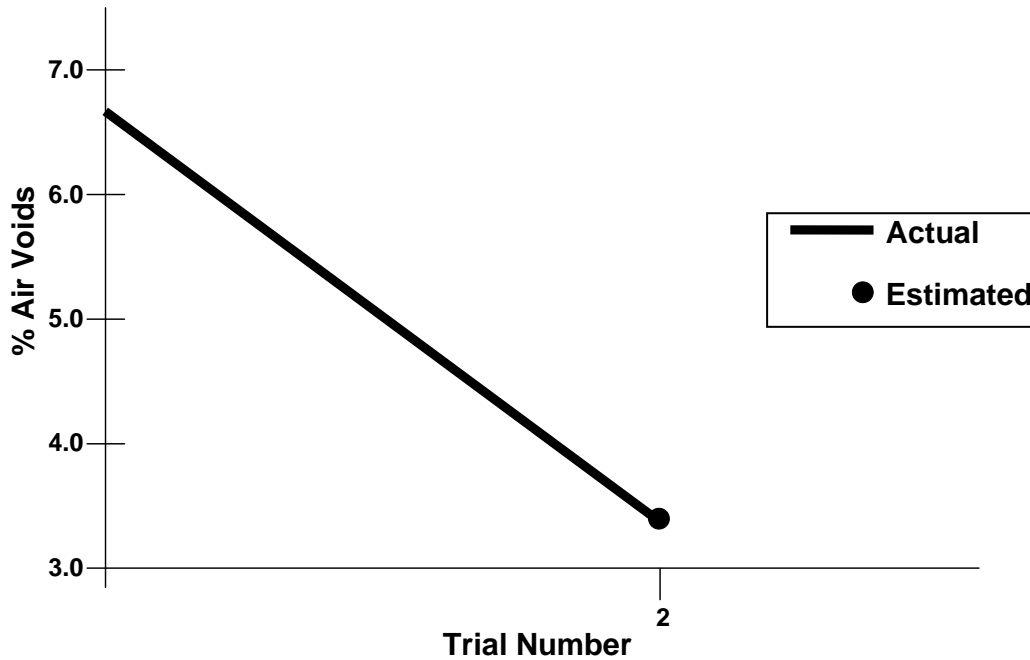

FIGURE 4 Mix comparison of actual versus estimated void content —12.5-mm SMA (air voids at 7.0% binder).

6. The voids estimation process performs better when working with aggregates of similar properties.

7. Although the Bailey method is a good tool, users must not forget the things they already know about the materials they are using.

8. The default values in the voids estimation process should vary depending on the types of aggregate used.

9. Each user should analyze historical data and interview field personnel to calibrate the method to their own materials.

REFERENCE

1. Vavrlick, W. R., G. H. Huber, W. J. Pine, S. H. Carpenter, and R. Bailey. Bailey Method for Gradation Selection in HMA Mixture Design. *Transportation Research Circular E-C044: Bailey Method for Gradation Selection in Hot-Mix Asphalt Mixture Design*, TRB, National Research Council, Washington, DC, 2002, p. 1.

Using the Superpave Gyrotory Compactor to Estimate Rutting Resistance of Hot-Mix Asphalt

HUSSAIN U. BAHIA

AHMED F. FAHEEM

*The Asphalt Pavement Research Group
The University of Wisconsin, Madison*

Several approaches have been introduced lately to characterize the performance-related properties of asphalt mixtures. The majority of these efforts are focused on developing special equipment to test mixtures at conditions similar to those acting on pavements due to moving traffic. Because the Superpave gyrotory compactor (SGC) is used routinely for compaction, and because it has components to measure load and densification, this study investigated its use for estimating the stability of asphalt mixtures as a surrogate or an estimate for results of the proposed method for the simple performance test. Several asphalt mixtures were produced using four different aggregate sources, different asphalt contents, and different gradations. Each mixture was compacted using the SGC. To evaluate if the results from the SGC can be related to rutting, mixtures were also tested using the new repeated compression test procedure recommended by the NCHRP Project 9-19 and used in the *Mechanistic-Empirical Pavement Design Guide*.

Densification curves produced by the SGC were used to determine volumetric properties of the mix and to calculate the traffic densification index (TDI), which is the value of the area under the densification curve from 92% density to 98% density and which represents the densification experienced due to traffic loading during the pavement service life. One more index, the traffic force index (TFI), is calculated. The TFI is the amount of work done to change the density of the mix from 92% to 98% measured using a special accessory added to the SGC called the pressure distribution analyzer (PDA). The results from the mixture rutting tests were used to estimate the rutting rate and the flow number (FN), which is the point at which the mixture starts to exhibit tertiary flow. The FN, which is considered an important mixture property, is shown to have a strong correlation to the TFI derived from the mixtures' resistance behavior measured in the SGC and the PDA. The TFI was found to be strongly correlated to the TDI, giving the opportunity to estimate the mixture resistance to compaction forces using its volumetric behavior.

The main finding of the study is that the SGC gives information that can be used to characterize the stability of asphalt mixtures. Such information could be used as an initial screening criterion to select mixtures for various traffic levels.

BACKGROUND

The Superpave gyrotory compactor (SGC) is the primary device used in Superpave mix design. The SGC was developed on the basis of a Texas gyrotory compactor with modifications using the principles of a French compactor (*I*). One limitation of the Superpave mix design is that it considers volumetric properties only, while it is known that it is a mixture's mechanical properties that relate to the performance of asphalt pavements. Although efforts are being made to develop separate tests for measuring mechanical properties of mixtures, the procedures are expected to require more equipment and significant time that could be reduced if an initial estimate of best potential mixtures could be identified. Since the SGC is a key component of the current design procedure and its use is now widely understood, it would be desirable to utilize it for the purpose of acquiring mechanical properties of the mixture. Proper interpretation of the results could lead to the establishment of a standard practice serving as a supplement to the

volumetric design. Many attempts have been made in this regard, some before Superpave, while the majority has come after the introduction of the SGC (2–8). These studies had a common theme of attempting to find if the SGC could be used to evaluate the stability of asphalt mixtures.

One of the unique methods of interpretation of the SGC results was proposed in 1998 to determine a mixture's performance under traffic and to show that the compaction process can be broken down into two stages (4, 8, 9). As shown in Figure 1, the first stage is a simulation of the field compaction behavior of the mixes. It is measured by the energy required to densify the mixtures between eight gyrations and 92% G_{mm} . This measurement is called the construction densification index (CDI).

The second stage reflects the performance of mixtures under traffic loading. It is a measurement of the energy required to compact mixes between 92% G_{mm} and 98% G_{mm} . This measurement is called the traffic densification index (TDI). The 98% G_{mm} value is considered the critical density, at which the mixture is approaching the plastic failure zone. Mixtures with higher TDI values are more desirable because they are expected to support more traffic without significant deformation.

It is therefore hypothesized that using the densification curves generated from the SGC, the mechanical stability of asphalt mixtures can be examined. The amount of densification required to achieve the target densities called for by the Superpave specification can capture the mechanical stability of the asphalt mixtures. As shown in Figure 1, it is clear that mixes that meet Superpave criteria (same density of 96% G_{mm} at 100 gyrations) can show different performance energy indices. The fine blend shows less resistance to construction as its CDI is

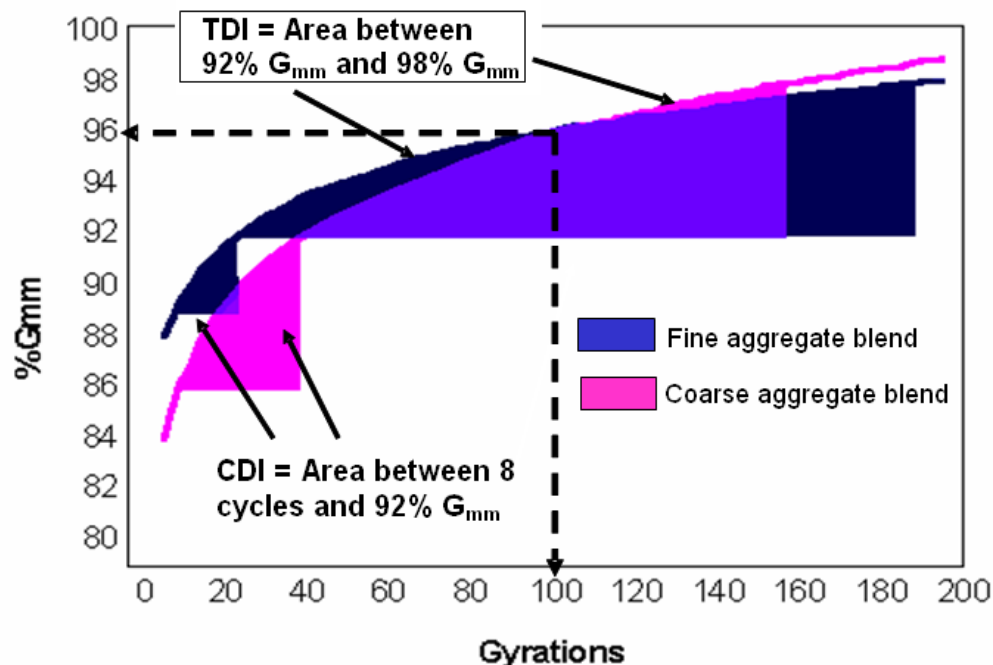

FIGURE 1 Definition of CDI and TDI and difference between densification of fine and coarse aggregate blends.

smaller. However, it is shown that it would resist the traffic more effectively as its TDI is much larger.

Although the concept of using CDI and TDI appeared to be logical and useful when introduced, there were still some doubts about using volumetric measurements without measuring the stress distribution in the sample to evaluate mixture behavior. In 2000, these doubts led to the development of a device that could be inserted on top of the mixture sample and could generate information about the stress distribution during compaction and the mixture's resistance to compaction. The device was called the Gyrotory Load Plate Assembly (GLPA). A report was prepared to describe the development of this device and the interpretation of results from SGC testing with the GLPA (7).

Figure 2a shows a sketch of the GLPA. The plate includes three load cells equally spaced on the perimeter of a double-plate assembly, which can be inserted on the mixture in the SGC mold, as shown in Figure 2b. The load cells allow measuring the variation of forces on top of the sample during gyration such that the position or eccentricity of the resultant force from the gyrotory compactor, shown in Figure 2c, can be determined in real time. The two-dimensional distributions of the eccentricity of the resultant force can be used to calculate the effective moment required to overcome the internal shear frictional resistance of mixtures while tilting the mold to conform to the 1.25° angle.

The GLPA was utilized to develop indices that are similar to the densification indices mentioned earlier. The resistive energy produced by the mixture from N_{ini} to 92% G_{mm} is calculated and termed the compaction force index (CFI), and the resistance to compaction from 92% and 98% G_{mm} is calculated and termed the traffic force index (TFI). In this way, the CDI and TDI relate to the densification, and the CFI and TFI relate to the resistive effort. Figure 3 illustrates the four indices used as response variables in the study.

In 2002, a study sponsored by the NCHRP was conducted to investigate the relationship between the SGC compaction properties and the permanent deformation of pavements in service. The main finding of this study was that compaction at maximum stress relates to field rutting (10).

SGC and Mechanical Stability of Asphalt Mixtures

At this stage it may be appropriate to identify what affects the mechanical stability of an asphalt mixture in the SGC and why the densification or the force curves could be good indicators of stability. The mechanical stability is widely regarded as the outcome of, first, the rock-to-rock contact within the mixture and, second, the binder rheology. How the SGC captures the effects of these two factors can be explained using the schematics shown in Figure 4, which depict what happens in the SGC as it compacts an asphalt mixture specimen.

Figure 4 shows the orientation of the asphalt mixture inside the compaction mold. The sample is inclined by an angle of 1.25°. This makes the resultant of the compaction pressure out of center, or in other words, it creates eccentricity of the resultant load [moment = load (R) multiplied by eccentricity (distance of R from center)]. The eccentricity depends on the strength of the mixture; for a strong mix (Mix A) the eccentricity is larger than for a weak mix (Mix B) that has less aggregate interlock. Therefore, the eccentricity can be a measure of the shear resistance (interlock) of the aggregates in the asphalt mixture.

A new generation of the GLPA was manufactured to measure the eccentricity during compaction. This newer generation was renamed the pressure distribution analyzer (PDA) and,

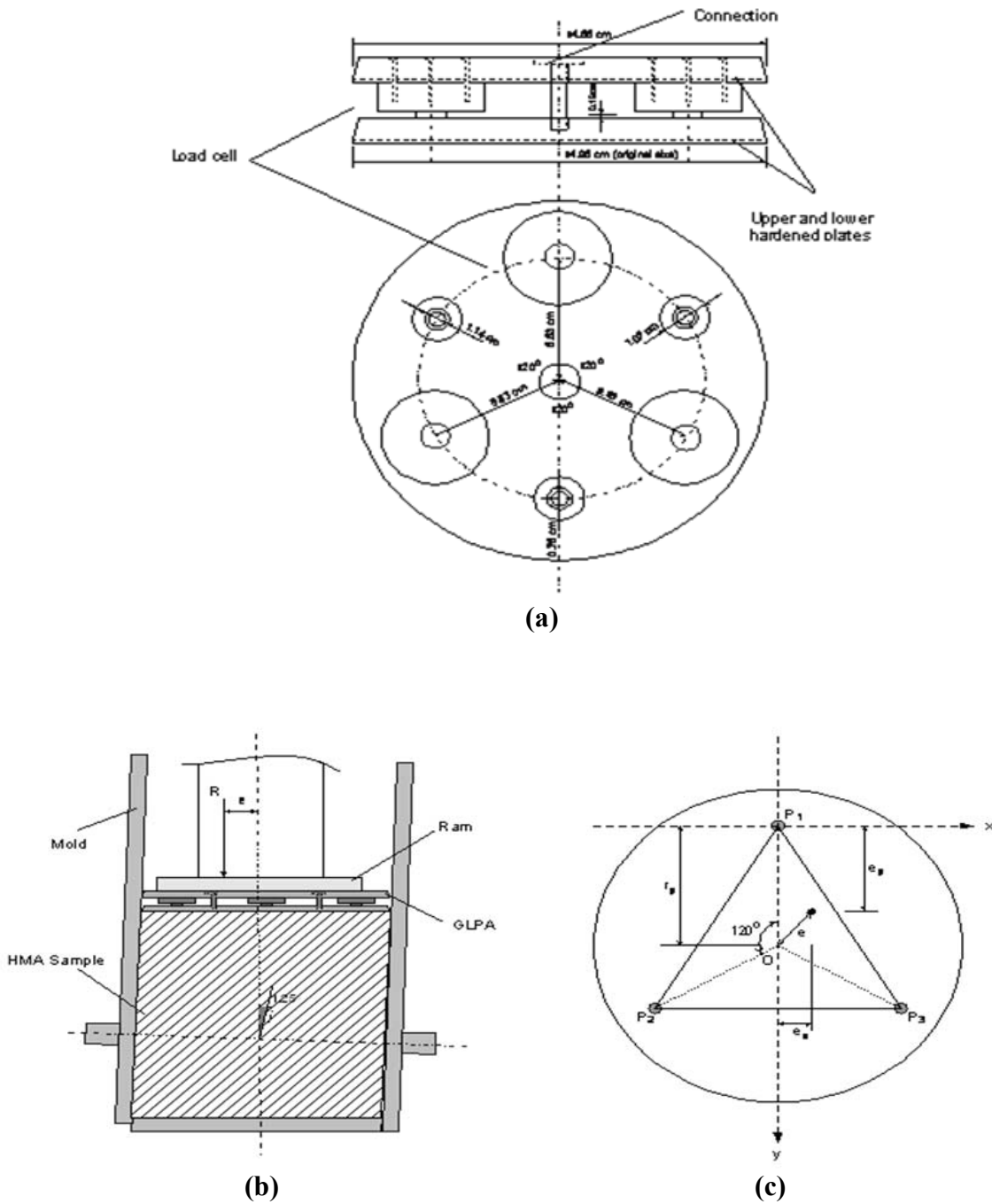

FIGURE 2 Illustration of the GLPA (7): (a) cross section of the plate including the load cells; (b) cross section of the mold with the plate inside; and (c) the components of eccentricity.

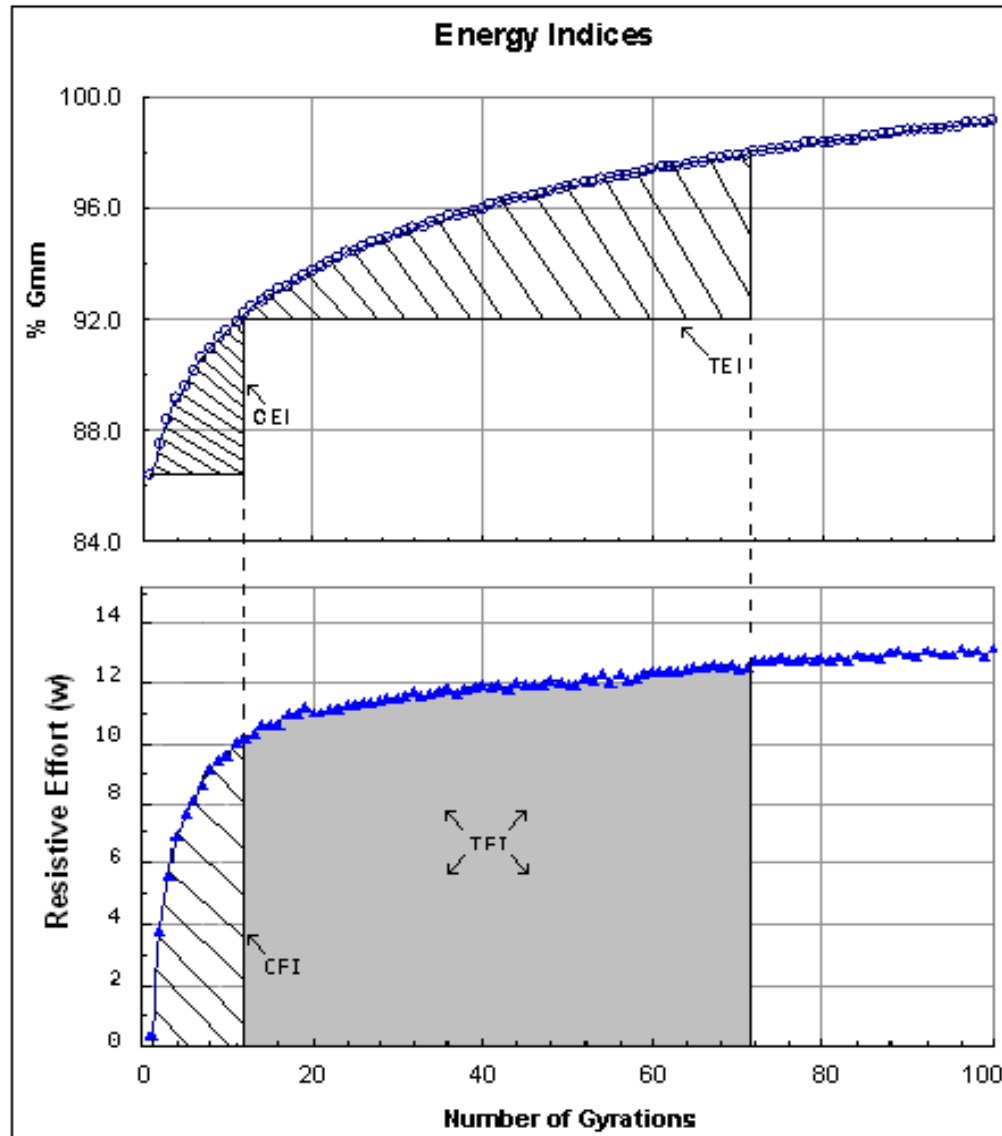

FIGURE 3 Determination of CDI, TDI, CFI, and TFI (9).

although it provides the same function, it does not require wire connections to a computer but rather uses a special integrated device that allows saving data during compaction. The PDA is much simpler to handle and can fit in any gyratory brand. With the use of the PDA, the eccentricity can be calculated from the signals measured by the load cells. Based on the calculated eccentricity (e) the resistive effort (ω) of the asphalt mixture can be calculated as a function of gyrations. The following equation shows the calculation of the resistive effort:

$$\omega = \frac{4eP\theta}{Ah} \quad (1)$$

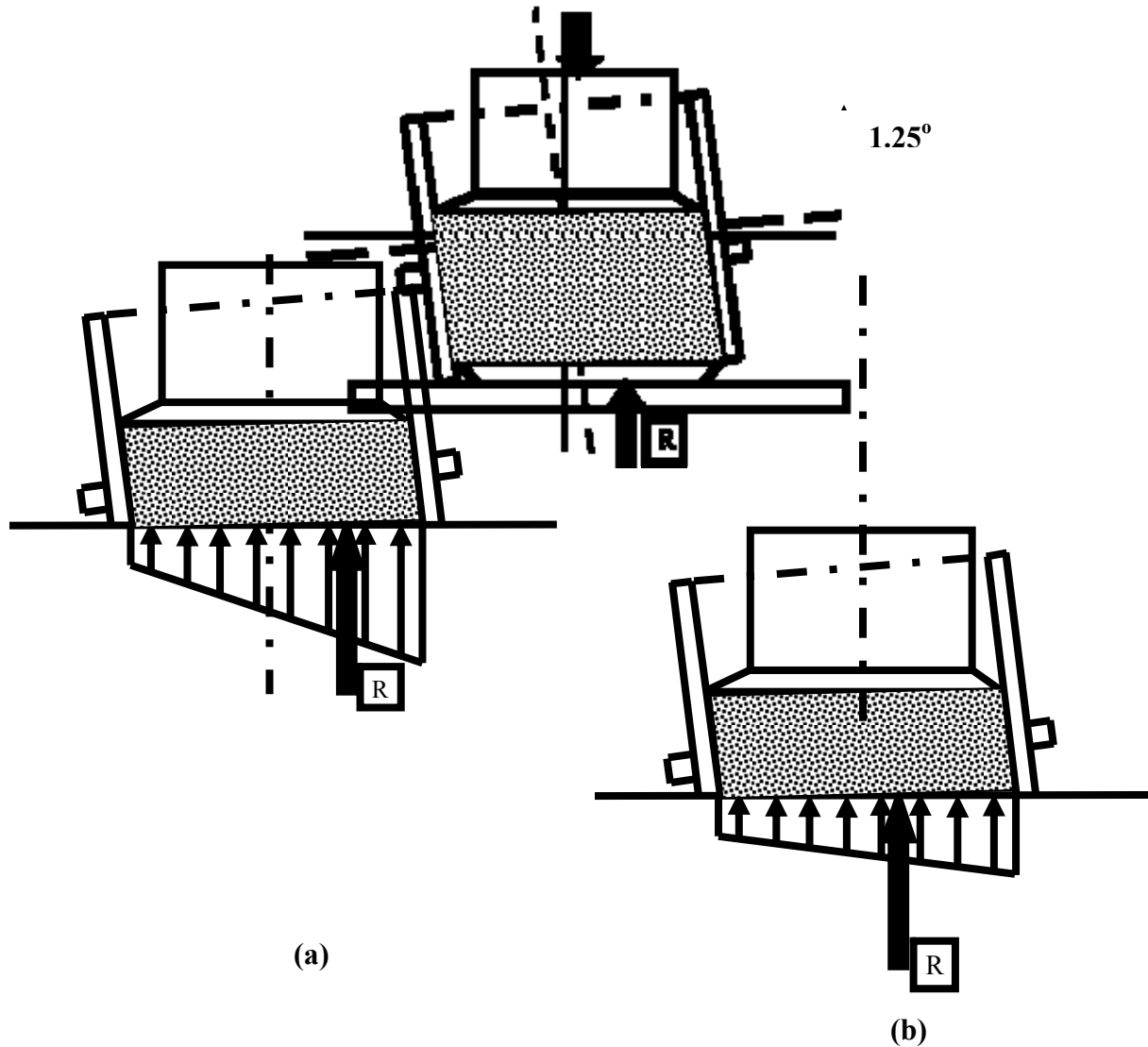

FIGURE 4 Reaction of different mixes to compaction: (a) Mix A, strong aggregate interlock, large moment and (b) Mix B, less aggregate interlock, small moment.

where

ω = is the resistive effort,

e = the eccentricity of resultant force,

P = the magnitude of resultant force,

θ = the angle of tilting (1.25°),

A = the area of specimen, and

h = the height of specimen at any given gyration.

Plotting the resistive effort versus the gyration number will yield a curve similar to that for densification. The resistive effort curve is divided at 92% G_{mm} into a construction side and a traffic side. To quantify the resistive efforts above and below 92% G_{mm} , the area under the resistive effort curve between N_{ini} and 92% G_{mm} is calculated and termed the CFI, and the area between 92% and 98% G_{mm} is calculated and termed the TFI.

Performance Testing to Evaluate Resistance for Rutting

Through a study conducted for the NCHRP (Project 9-19), Arizona State University has developed a laboratory test method for permanent deformation of asphalt mixes (9). A cylindrical sample approximately 100 mm in diameter and 150 mm in height, cut for a sample prepared in the SGC, is subjected to a haversine axial load. This load is applied for duration of 0.1 s, followed by a rest time of 0.9 s. A confining pressure can also be applied during the test, though none was used in this study. The cumulative axial and radial strains are measured using linear variable differential transformers (LVDTs) and recorded during the test (11).

Rutting is time dependent creep failure; therefore, the modulus $[E(t)]$ is equivalent to the deviator stress divided by the total time dependent strains. For viscoelastic materials, it is the convention to use compliance $[D(t)]$ rather than the modulus. Compliance is the reciprocal of the modulus, $D(t) = 1/E(t)$. Using the compliance allows for the separation of different strain components (ϵ_e , ϵ_p , ϵ_{ve} , ...) at constant stress levels, which is a better method for interpretation of results. The ϵ_p , which is the permanent strain component, has been found to follow a simple power model as a function of the number of cycles of load applications (12).

$$\epsilon = aN^b \quad (2)$$

Figure 5 shows the outcome of a rutting test. Three zones generally define the cumulative permanent strain curve: primary, secondary, and tertiary. Primary permanent deformation accumulates rapidly. In the secondary zone, the rate decreases reaching a constant rate of deformation throughout the zone. The rate of deformation increases again in the tertiary zone and permanent deformation accumulates rapidly. The point (cycle number) at which the tertiary flow starts has been referred to as the flow number (FN). The results obtained from the test are typically presented in a log-log chart showing the cumulative permanent strain versus the number of cycles and a normal chart showing the permanent strain rate versus the number of cycles. The analysis is done using the power law model (11, 12, 13). The parameter a represents the permanent strain at $N = 1$ and b represents the rate of change in the permanent strain as a function of change in loading cycles.

The FN and the rate of deformation are expected to reflect the mechanical stability of the mixture. However, the FN represents a fundamental property of the mixture that can be used in correlating the mechanical stability of the mixture to various volumetric properties. Furthermore, traffic indices that are calculated from the SGC, which are a good representation of the volumetric performance-related properties, can be related to the FN. Both then can provide a characterizing procedure for asphalt mixtures. The temperature and load level were selected after significant testing and evaluation of the performance of mixtures produced with Wisconsin aggregates. The details of testing conditions were selected, as described below, to determine if the SGC can provide a surrogate measure to the simple performance test.

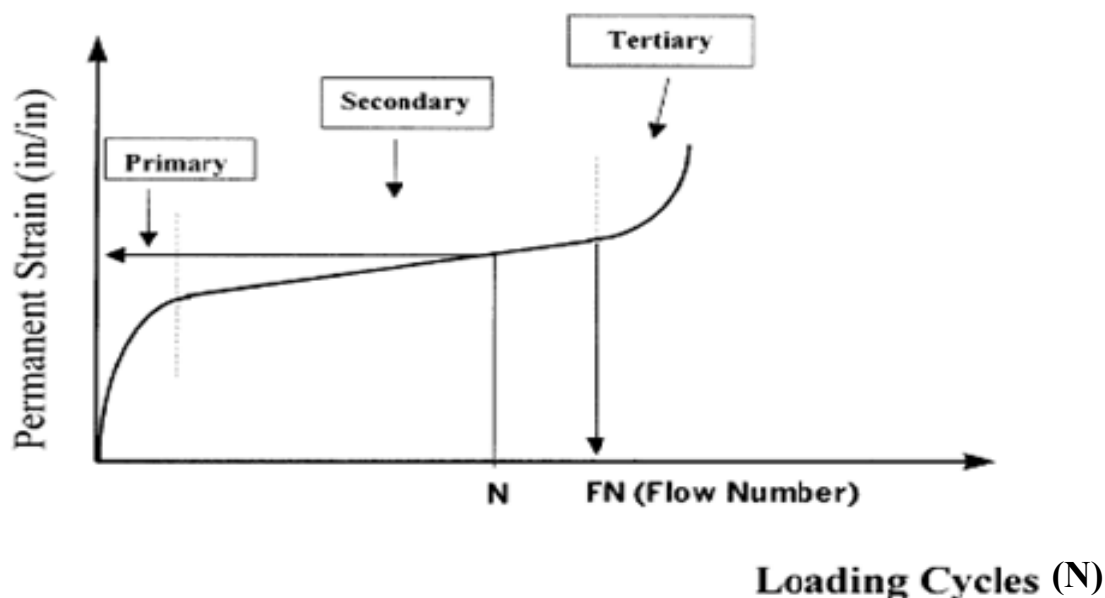

FIGURE 5 Permanent strain due to rutting (after 13).

HYPOTHESIS AND EXPERIMENTAL PLAN

The main hypothesis of this study was that the mechanical stability of an asphalt mixture (specifically resistance to rutting) can be predicted from compaction parameters measured using the SGC. To test this hypothesis, specific control variables were selected and some response variables were measured.

The controlled variables included:

- Four aggregate sources from four major asphalt contractors in Wisconsin. Referred to in this paper as sources A, B, C, and D.
- Two types of gradation blends called here S-shaped blend and fine blend.
- Three asphalt contents were planned for each blend. These levels include optimum, optimum +0.5%, and optimum -0.5%. The individual optimum asphalt contents varied between mixtures to simulate actual mixture properties used in the field.

Three types of response variables were measured. The SGC was used for measuring densification of the mixtures as well as shear resistance during the densification process. The densification was measured at relatively high temperatures resembling compaction temperatures, generally in the range of 125°C to 140°C. The newly developed simple performance test, which consists of a uniaxial compression test system under repeated creep, was used to estimate the rutting rate and the FN.

Due to limited aggregate availability, a partial factorial design was used as shown in [Table 1](#). For contractor A, a total of six blends were prepared for each mix as planned at three different asphalt contents: optimum, optimum +0.5% and optimum -0.5%. For the other three contractors (B, C, and D), two blends of each mix were prepared and compacted at the optimum

TABLE 1 Aggregate Blends for Mixes

Source	Type	Mix No.	PG Binder	S or F	Opt. AC	Blend Design	Quantity %
A	19.0-mm E30 Superpave (Gravel)	01	64-28	F	4.3±0.5	7/8" Chip	10
						5/8" Stone	15
						3/8" Chip	30
						1/4" Minus man sand	25
						Washed natural sand	20
	19.0-mm E10 Superpave (Gravel)	02	58-28	F	4.6±0.5	7/8" Chip	10
						5/8" Stone	15
						3/8" Chip	30
						1/4" Minus man sand	25
						Washed natural sand	20
	19.0-mm E10 Superpave (Gravel)	03	58-28	F	4.5±0.5	Cr. RAP	15
						7/8" × 5/8" H.F. stone	10
						5/8" × 1/2" H.F. stone	15
						3/8" × 1/4" H.F. stone	20
						1/4" Minus man sand	30
						Screened natural sand	10
	19.0-mm E3 Superpave (Gravel)	04	58-28	S	5.1±0.5	7/8" Chip	10
						5/8" Chip	15
						3/8" Chip	15
						Washed natural sand	20
Screened natural sand						40	
12.5-mm E3 Superpave (Gravel)						05	58-28
3/8" Chip	15						
Washed natural sand	5						
Screened natural sand	65						
B	12.5-mm E10 Superpave	01	64-28	S	6.2	3/8" Chip	30
						1/8" Man. Sand	25
						3/4" Conc. Stone	20
						1/2" Bit Stone	25
	12.5-mm E1 Superpave	02	58-28	F	5.8	3/4" Limestone	40
						3/8" Washed Chips	11
						Man. Sand	22
						Nat. Sand	27
C	12.5-mm E3 Superpave	01	58-28	F	5.5	3/4" Stone	13
						3/8" Stone	15
						Man. sand	42
						Natural sand	25
						Dust	5
	19.0-mm E3 Superpave	02	58-28	F	5.0	3/4" Stone	10
						1/2" Stone	9
						3/8" Stone	10
						Dust	10
						Natural sand	61
D	12.5-mm E3 Superpave (Gravel)	01	58-28	F	5.3	5/8" Rock	8
						5/8" Single aggregate	14
						5/16" Natural sand	13
						1/4" Man. sand	45
						5/8" Recycle	20
	19.0-mm E3 Superpave (Gravel)	02	58-28	F	5.3	1" Rock	11
						5/8" Rock	4
						5/8" Single Aggregate	10
						5/16" Natural sand	12
						1/4" Man. sand	43
						5/8" Recycle	20

asphalt content only. The aggregate proportions and gradations used in each mix design are also shown in [Table 1](#). The mixture designs were not hypothetical and were actually used or proposed to be used in pavements in Wisconsin by the contractors.

As shown in [Table 1](#) all the mixes used the same asphalt performance grade of PG 58-28 except for two mixes, A01 and B01, as they were made with PG 64-28. These are the most common grades used in the state of Wisconsin.

Calculating the response variables requires accurate determination of maximum specific gravity (G_{mm}) and bulk specific gravity (G_{mb}) test values. For this reason, two G_{mm} (Rice) samples were tested at each one of the asphalt contents used. Calculations based on G_{mb} values obtained from specimens compacted to N_{des} are considered very accurate because there is no back calculating using data from specimens compacted to N_{max} or higher gyrations.

The specific response variables measured with the use of the gyratory compactor included three sets of variables:

- a. Volumetric properties at selected gyrations. These include % G_{mm} @ N_{ini} , % G_{mm} @ N_{des} , % G_{mm} @ N_{max} , and voids in mineral aggregate.
- b. Energy indices calculated from densification curves. These include CDI (area under the densification curve from the 8th gyration to 92% G_{mm}), and TDI (area under the densification curve from 92% G_{mm} to 98% G_{mm}).
- c. Resistive force indices calculated from the eccentricity plots generated using the PDA. These include CFI (area under the resistive effort curve from the cycle number corresponding to 89% G_{mm} to cycle number corresponding to 92% G_{mm}) and TFI (area under the resistive effort curve from the cycle number corresponding to 92% G_{mm} to cycle number corresponding to 98% G_{mm}).

The CDI and CFI were calculated from specimens compacted to N_{des} (100 gyrations). Since the TDI and TFI require that the mixture reaches 98% G_{mm} , it was necessary to compact to a number of gyrations that would result in % G_{mm} above 98% to guarantee that TDI and TFI could be determined. For this reason, the decision was made to compact specimens to 600 gyrations.

Depending on the information gathered from volumetric testing of the mixtures the number of gyrations needed to achieve 7% air voids can be determined. This air void percentage is recommended by the NCHRP 9-19 as the void content for permanent deformation testing. The recommended dimensions for the rutting samples are height of 150 mm (6 in.) and diameter of 100 mm (4 in.) (11).

RESULTS AND ANALYSIS

As explained earlier, several mixtures were produced using different asphalt contents and different gradations. This is to insure that the study covers as wide a range of mixture properties as possible. The minimum asphalt content used was 3.8% and the maximum asphalt content used was 6.2%. A total of 11 mixture designs were used in this study from four different sources. Five of these mixes were compacted at three different asphalt contents: optimum, optimum +0.5%, and optimum -0.5%.

The FN and rate are used as indicators for the field performance of the mixtures. The traffic indices (TDI and TFI) were calculated using the data gathered from the SGC.

Figures 6, 7, and 8 summarize the outcome of this study. Figure 6 shows the average CDI for all the mixes. From the range shown on this plot, it is clear that the CDI can capture variability in the mixes. The wide range indicates that this method can help choose the appropriate mix that can be easily constructed in the field.

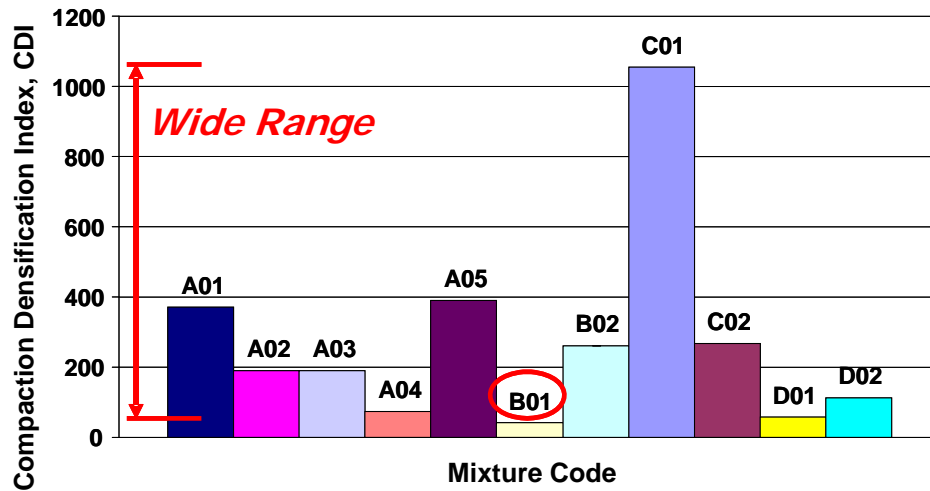

FIGURE 6 Average CDI values for all mixes.

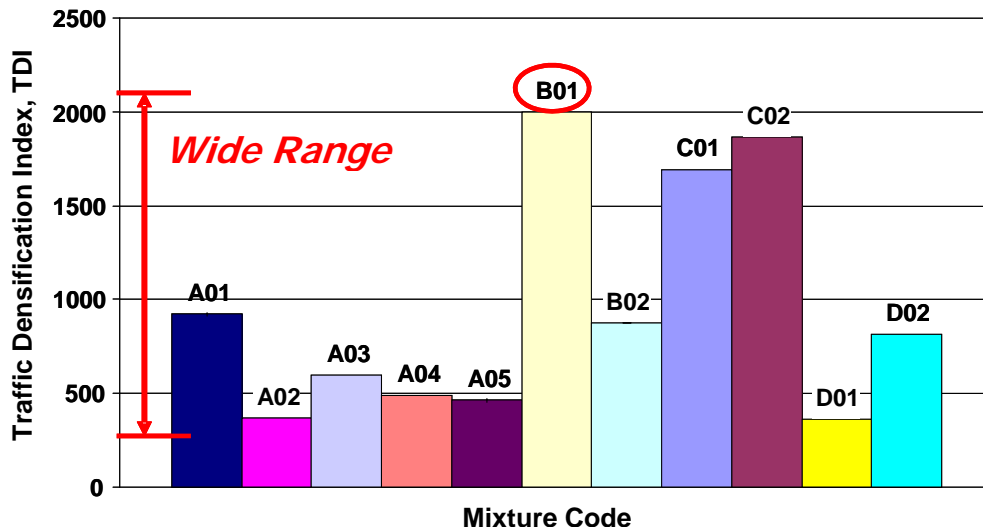

FIGURE 7 Average TDI values for all mixes.

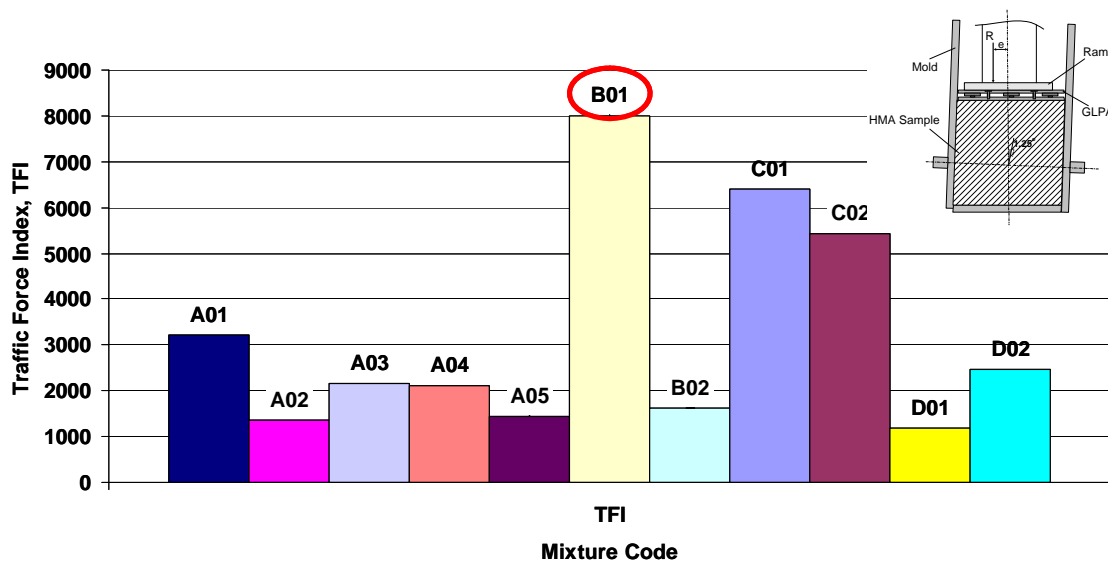

FIGURE 8 Average TFI values for all mixes.

Figure 7 shows the average TDI for all mixes. In this plot, the mix labeled B01 has the highest TDI indicating that it is the most resistant to traffic densification. However, from Figure 6, this mix was the easiest one to construct. This shows the great potential of this method for characterizing asphalt mixes. This mix in particular is the optimum performing mix desired in the field. This is because it requires very little effort to construct and once the construction is over, it would resist the traffic superbly.

Figure 8 shows the average TFI measured for all mixes using the PDA. Looking at mix B01, it can be seen that the TFI is showing the same behavior as the TDI. This indicates that the densification and shear resistance of the asphalt mixture are painting the same picture.

To test the hypothesis that the SGC results can be used to estimate the rutting performance, the analysis involved correlation between the traffic indices and the mixtures' rutting indicators. The rutting indicators included the FN and the rate of permanent deformation. Figure 9 shows the relationship between the TDI and the rate of accumulation of permanent deformation. Figure 10 shows the relationship of the TFI to the FN.

The traffic densification index (TDI) is assumed to represent the energy needed to reach the terminal permanent density condition at 98% G_{mm} . Based on Equation 2 relating the strain rate to the total accumulated strain, the rate of deformation should show a power relation with the energy required to reach the terminal permanent density. This type of trend is shown in Figure 9. Using a power law fit, the data in the figure shows a correlation between TDI and the strain rate. The correlations coefficient is approximately 79%, which signifies a strong correlation.

Since the TFI is related to the failure strain and the number of cycles, the relationship between the FN and the TFI should be a linear relationship. Such a linear relationship is confirmed in Figure 10, which shows that the correlation coefficient is at 81%, which is similar to the one obtained with the rate of deformation.

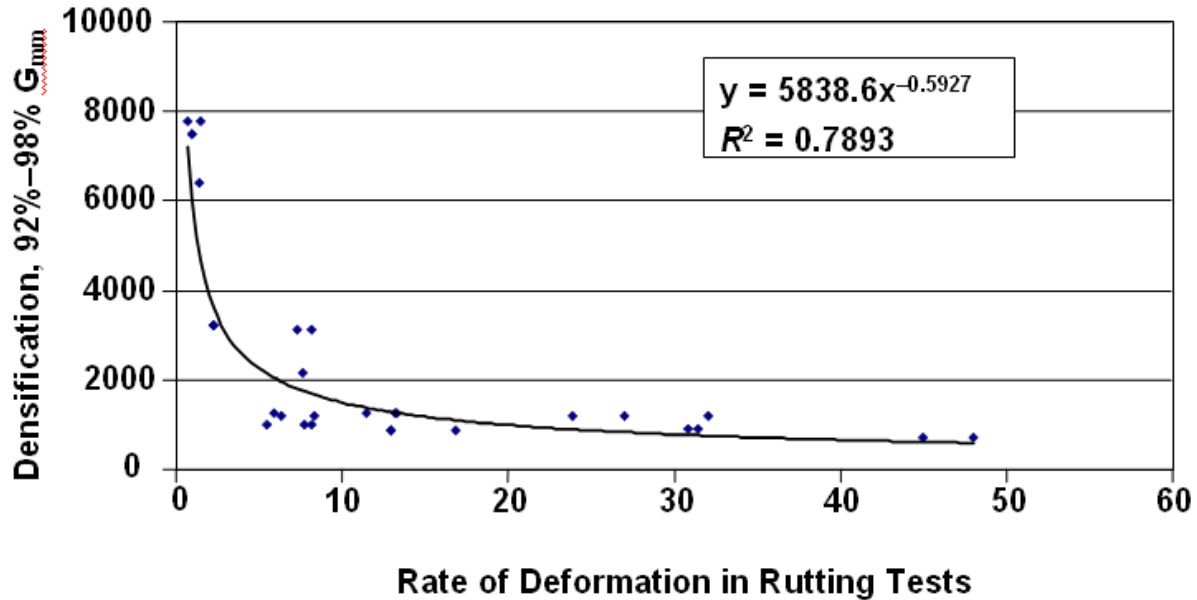

FIGURE 9 Correlation of TDI and rate of deformation.

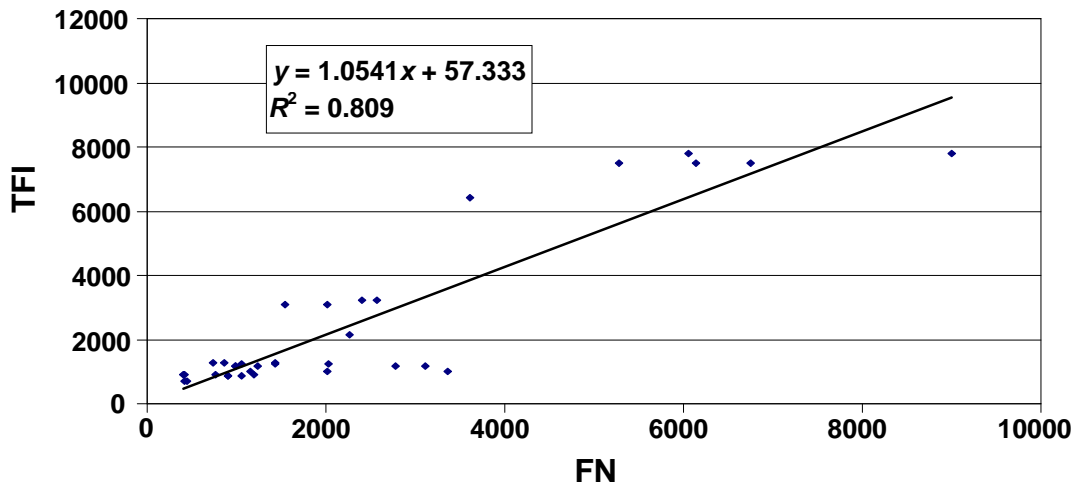

FIGURE 10 Correlation of TFI and FN.

Although the relation of TDI to the rate of deformation seems to be the more reliable, as it consists of a wider range of data points and it possesses a stronger correlation factor, the FN should be the main parameter in developing a criterion for mixture stability. This is because the FN is a material property that reflects mixture critical behavior in terms of proximity to instability under traffic loading. The rate of deformation is a local property of the material that depends on the secondary creep condition of the material and the testing conditions.

DEVELOPING A MIXTURE STABILITY CRITERION

Finding a strong relationship between TFI and mixture rutting for the set of mixture used is very promising and allows moving to the next step of deriving control limits for the mixture stability. These limits should take into account the traffic volume [equivalent single-axle loads (ESALs)], as it is the governing factor in selecting mixture parameters in a typical mixture design. Pavement temperature cannot be considered in this criterion since the compaction is conducted at higher temperatures. It is also suggested that effect of pavement temperature is already considered in the selecting the binder performance grade.

Since the mixtures included in this study covered a range of mixtures designed for different traffic levels, it is logical to use the design ESAL designations to try to derive an initial criterion. [Figure 11a](#), taken from a previous publication by the authors (14), shows the relationship between the mixture ESAL designation and the TFI values measured for the different mixes. As shown in the figure, for a given ESAL value there can be multiple TFI values. This is because current mixture design practice is based on the volumetric properties and no mechanical stability measure is used.

Although there is a large scatter, the data in the figure show a definite trend indicating that the higher the ESAL level of the mixture the higher the FN number is. To be on the safe side, it is suggested to use the average values of the TFI for each ESAL value as a guide for deriving the limits for the design criterion as shown in [Figure 11b](#).

Using the equation of the trend line, the proposed limits can be estimated for various levels of traffic. Also, based on the data collected for the CDI, a set of limits was introduced to account for the constructability of mixtures. These were estimated from averaging the values measured for the Wisconsin mixtures from various sources. [Table 2](#) includes the proposed concept of using the CDI to control resistance to constructability and TDI or TFI for resistance to traffic. Both TDI and TFI are included because the authors believe that the PDA, if available, will give a better direct indication of resistance to traffic effects. If, however, the PDA is not available, then TDI can be used.

SUMMARY OF FINDINGS

This study was focused on finding relationships between the results of the SGC and the simple performance test for rutting resistance. Two different gradation types for aggregates from four different sources in Wisconsin were used. The optimum asphalt contents used varied from 4.3% to 6.2%. In order to validate the chosen measure, it needed to be compared to a performance test, which was chosen to be the uniaxial repeated creep test based on recommendations by the NCHRP 9-19 project (11). The output of the performance test was the FN which indicates the cycles of loading at which a mixture transitions into tertiary creep failure. The measures that are obtained from the SGC are the TFI and the TDI. To measure the TFI, the PDA was used during compaction to determine the mixtures' resistance to compaction. The correlation between the TFI and the FN yielded a coefficient of determination of approximately 81%, which indicates a significant relationship between mixture resistance to permanent deformation and the TFI. Therefore, using TFI as an indication of mixture mechanical stability can help propose recommended minimum limits for mixture stability as a function of expected traffic levels.

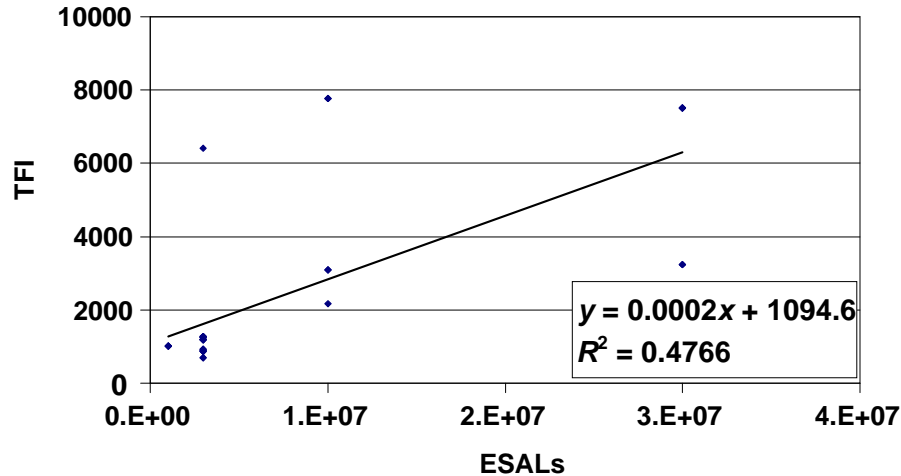

(a)

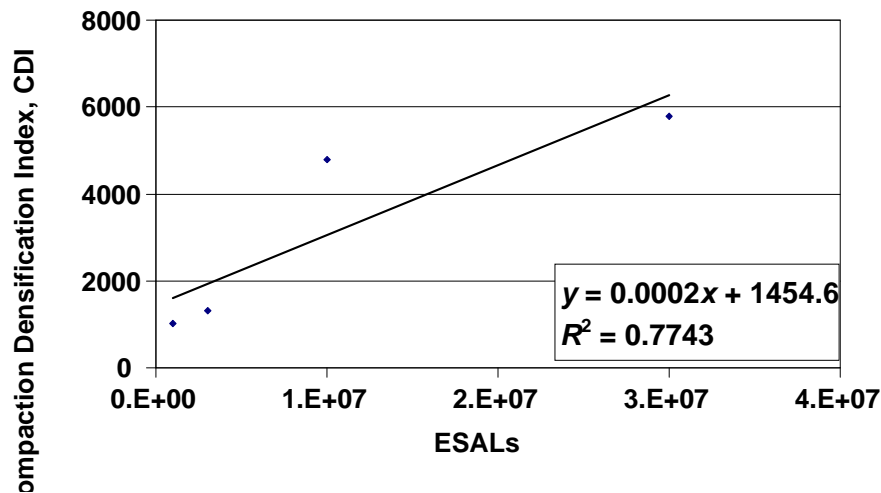

(b)

FIGURE 11 Setting TFI versus ESAL limits:
(a) TFI versus ESALs and (b) minimum TFI per ESAL versus ESAL.

In case the PDA is not available, a simplified method is introduced to use the densification curves produced by the SGC rather than the resistive effort curves measured by the PDA. This simplification required relating the TFI with the TDI, which was found to have a strong linear relationship with high R^2 value (about 93%). The relationship obtained showed that the TFI equals three times the TDI. Using the same idea of relating the TFI to traffic level, the TDI was used to set up similar limits. However the TDI is considered a surrogate for the TFI.

TABLE 2 Proposed Mixture Design Criteria

Constructibility		
Mixture Type*	CDI Maximum Value	
E3	100	
E10	200	
E30	300	
Traffic Resistance		
Mixture Type	TDI, min. value	Or TFI, min. value
E3	400	2000
E10	800	3000
E30	1200	4000

*E3, 10, 30: Mixtures designed for 3 million, 10 million, and 30 million ESALs respectively.

In addition to the resistance to traffic, the study shows that a measure of resistance to densification during construction (constructibility) can be derived from the SGC results. A criterion for constructibility is also proposed in this study that is based on the class of the mix as defined by the traffic volume.

The main conclusion of this study is that the SGC can be used not only to produce samples to measure volumetric properties, but also to estimate the constructibility and the mechanical stability of mixtures. The estimates can be used as an initial predictor of mixture resistance to compaction and to rutting under simulated traffic loading. An initial criterion was introduced. There is no doubt that these limits and conclusions need full field validation.

REFERENCES

1. Asphalt Institute. *Superpave Mix Design*. Superpave Series No. 2 (SP-2), 1996.
2. Sigurjonsson, S., and B. E. Ruth. Use of Gyratory Testing Machine to Evaluate Shear Resistance of Asphalt Paving Mixture. In *Transportation Research Record 1259*, TRB, National Research Council, Washington, D.C., 1990, pp. 63–78.
3. Ruth, B. E., X. Shen, and L. H. Wang. Gyratory Evaluation of Aggregate Blends to Determine their Effect on Shear Resistance and Sensitivity to Asphalt Concrete. In *Effects of Aggregate and Mineral Fillers on Asphalt Mixture Performance* (R. C. Meininger, ed), ASTM 1147, Ann Arbor, Michigan, 1992, p. 252.
4. Bahia, H. U., T. P. Friemel, P. A. Peterson, J. S. Russell, and B. Poehnel. Optimization of Constructibility and Resistance to Traffic: A New Design Approach for HMA Using the Superpave Compactor. *Asphalt Paving Technology: Journal of the Association of Asphalt Paving Technologists*, Vol. 67, 1998, pp. 189–232.
5. Mallick, R. B. Use of Superpave Gyratory Compactor to Characterize Hot-Mixture Asphalt. In *Transportation Research Record: Journal of the Transportation Research Board, No. 1681*, TRB, National Research Council, Washington, D.C., 1999, pp. 86–96.
6. Delage, K. P. *The Effect of Fine Aggregate Angularity on Hot-Mixture Asphalt Performance*. M.S. thesis. University of Wisconsin, Madison, November 2000.
7. Guler, M., H. U. Bahia, P. J. Bosscher, and M. E. Plesha. Development of a Device for Measuring Shear Resistance of HMA in the Gyratory Compactor. In *Transportation Research Record: Journal of the Transportation Research Board, No. 1723*, TRB, National Research Council, Washington, D.C., 2000, pp. 116–124.

8. Bahia, H. U., E. Masad, A. Stakston, S. Dessouky, and F. Bayomy. Simplistic Mixture Design Using the SGC and the DSR. *Asphalt Paving Technology: Journal of the Association of Asphalt Paving Technologists*, Vol. 72, 2003, pp. 196–225.
9. Stakston, A. D. The Effect of Fine Aggregate Angularity, Asphalt Content and Performance Graded Asphalts on Hot-Mix Asphalt Performance in a Laboratory Study. M.S. thesis. University of Wisconsin, Madison, 2002.
10. Anderson, R. M., P. A. Turner, and R. L. Peterson. *NCHRP Report 478: Relationship of Superpave Gyrotory Compactor Properties to HMA Rutting Behavior*, TRB, National Research Council, Washington, D.C., 2002.
11. Kaloush, K., and M. W. Witzak. Tertiary Flow Characteristics of Asphalt Mixtures. *Journal of the Association of Asphalt Paving Technologists*, Vol. 71, 2002, pp. 248–280.
12. Bahia, H. U., D. I. Hanson, M. Zeng, H. Zhai, M. A. Khatri, and R. M. Anderson. *NCHRP Report 459: Characterization of Modified Asphalt Binders in Superpave Mix Design*, TRB, National Research Council, Washington, D.C., 2001.
13. Witzak, M. W., K. Kaloush, T. Pellinen, M. El-Basyouny, and H. Von Quintus. *NCHRP Report 465: Simple Performance Test for Superpave Mix Design*, TRB, National Research Council, Washington, D.C., 2002.
14. Faheem, A., H. U. Bahia, and H. Ajideh. Estimating Results of a Proposed Simple Performance Test for Hot-Mix Asphalt from Superpave Gyrotory Compactor. In *Transportation Research Record: Journal of the Transportation Research Board*, No. 1929, Transportation Research Board of the National Academies, Washington, D.C., 2005, pp. 104–113.

Using the Indirect Tension Test to Evaluate Rut Resistance in Developing Hot-Mix Asphalt Mix Designs

DON CHRISTENSEN

RAY BONAQUIST

Advanced Asphalt Technologies

This paper describes how the indirect tension (IDT) strength test, when performed at high temperatures following the recommended protocol, can be used to evaluate the rut resistance of hot-mix asphalt (HMA) mixtures. The suggested procedure is simple, quick, and can be performed using a standard Marshall press without the need of a temperature control chamber. The paper includes a review of the initial development of the high-temperature IDT test, and also discusses how the new, rapid test procedure was developed. Improved guidelines for interpreting the results of the high-temperature IDT test are presented, which include a rule of thumb for accounting for differences in traffic speed. Two case studies are presented in which the IDT test was used to help ensure that HMA designs had sufficient rut resistance for their intended applications.

The purpose of this paper is to describe in some detail the use of high-temperature indirect tension (IDT) strength tests to evaluate the rut resistance of hot-mix asphalt (HMA) mixtures and to demonstrate how this test can be used in the mix design process. Since nearly the beginning of the implementation of the Superpave mix design system, engineers and technicians have expressed concern over the lack of a proof test to ensure that mixtures have adequate stability and rut resistance. The proposed IDT strength test is an excellent candidate for such a test—it is simple, quick, and, with a newly developed procedure, can be run using a standard Marshall press so that most construction materials laboratory can run this test without any additional expenditures on equipment or training. Furthermore, the test appears to correlate very well to HMA rut resistance for a wide range of mixtures.

This paper is divided into four sections, not including this introduction. A background section describes the initial development of the high-temperature IDT strength test. This is followed by a section describing the development of a rapid test protocol, allowing the test to be performed using a Marshall press and without a temperature control chamber. The next section of the paper is devoted to explaining how new, more effective guidelines for interpreting the results of the high-temperature IDT test were developed. The body of the paper concludes with two case studies in which the IDT test was used to help ensure adequate rut resistance for several HMA mix designs. The conclusions and recommendations include a description of the recommended procedure for the high-temperature IDT strength test.

BACKGROUND

In the late 1990s, researchers at Pennsylvania State University and Advanced Asphalt Technologies (AAT) performed research to evaluate the use of triaxial testing to evaluate the rut resistance of HMA mixtures and also to evaluate the role of aggregate internal friction in developing rut resistant mixtures (1, 2). As part of this research project, an abbreviated testing

protocol was developed and evaluated for determining the cohesion, c , and the angle of internal friction, ϕ (phi). This abbreviated protocol consisted of a compressive strength test and an IDT test. This procedure has been used in rock mechanics for some time and was adapted by the researchers for use in HMA characterization (1, 2). Both tests were performed at 20°C below the critical temperature for rutting—the annual, 7-day average maximum pavement temperature 20 mm below the pavement surface. The rate of deformation used in the IDT test was 3.75 mm/min. These test conditions were chosen to approximately replicate the rheological conditions existing in a pavement at the critical pavement temperature, while allowing a reasonably slow loading rate that could be performed easily in the laboratory. In evaluating the data from this project, it was discovered that the IDT strength data measured using this procedure correlated very well to both the results of the repeated shear at constant height (RSCH) test as performed on the Superpave shear tester (SST) and also to limited field rutting data (1, 2). Surprisingly, this indicated that the IDT strength test at high temperature was potentially a very simple, but accurate, means of characterizing the rut resistance of HMA mixtures in the laboratory (1, 2). **Figure 1** is a plot of maximum permanent shear strain from the RSCH test as a function of IDT strength.

Because these correlations were so surprising, a follow-up study was begun to confirm the relationship between IDT strength at high temperature and HMA rut resistance (3, 4). In this follow-up study, additional mixtures were tested using the IDT strength test and the RSCH procedure. Five mixtures from FHWA's accelerated load facility (ALF) rutting study (5) were included in the second study. The results confirmed the results of the first study.

IDT strengths determined in this study correlated very well with both the RSCH test results and to observed rutting rates in the FHWA–ALF rutting study (5).

If the IDT strength test is to be used with confidence in evaluating the rut resistance of HMA mixtures, some simple but effective theory is needed to explain why this test should relate to rut resistance in flexible pavements. Christensen and Bonaquist have pointed out a number of reasons why IDT strength at high temperatures should relate well to HMA rut resistance (6).

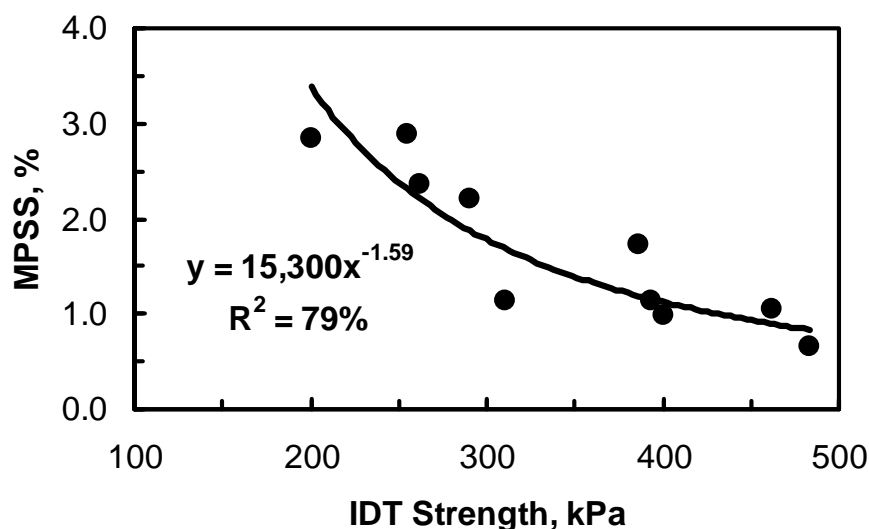

FIGURE 1 Maximum permanent shear strain as a function of IDT strength.

Perhaps the most important of these is that the critical stress state for rutting in an HMA pavement occurs not under the center of a tire, but under the edge of the tire, where distortional stresses are high and confinement is relatively low. In this location, the overall level of confining stress is similar to that which exists at failure in a typical IDT test at high temperatures. The confining stresses used in many triaxial strength tests are in fact much higher than what exists under the edge of a tire in a flexible pavement at high temperatures (6).

NEW RAPID TEST PROTOCOL

After several years of research, it was becoming increasingly clear that the IDT strength test was a very promising test for routine evaluation of HMA rut resistance. It was felt that the test could potentially be run at 50 mm/min but at a higher temperature (by about 10°C) and maintain the same rough rheological equivalency to traffic loading at high temperatures. This would simplify the procedure in two important ways: (a) the test could then be run using a standard Marshall press; and (b) failure would occur so quickly that the test could potentially be run at room temperature, after conditioning the specimen to the desired test temperature. This is essentially the same procedure used in determining Marshall flow and stability.

A small test program was developed to evaluate this hypothesis. A total of eight mixtures were tested using the original protocol—that is testing at 20°C below a typical critical pavement temperature or 50°C—using a loading rate of 3.75 mm/min. These mixtures were also tested using the new, simpler procedure, which involves testing at 10°C below the critical pavement temperature and at a loading rate of 50 mm/min. As shown in Figure 2, the results showed an excellent correlation between the two procedures, although the strengths found using the new protocol were slightly higher than those determined using the original protocol. Therefore, it is recommended that the IDT strength test be performed at 9°C below the critical pavement temperature for rutting, at a loading rate of 50 mm/min.

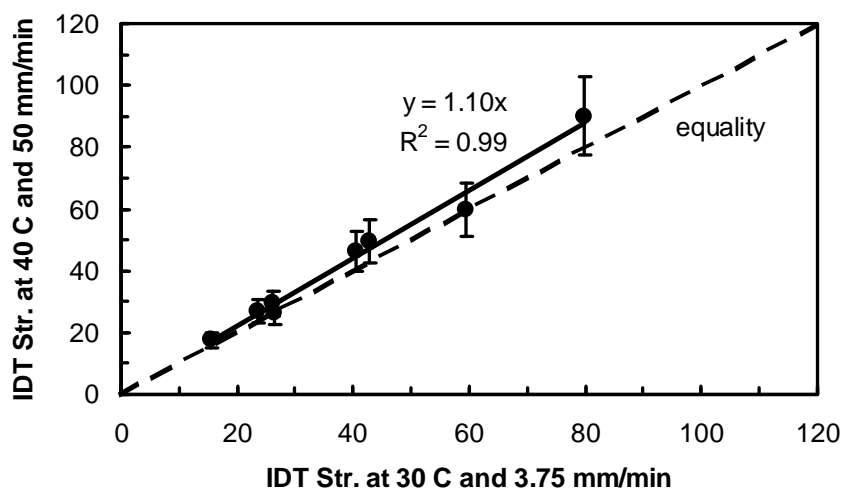

FIGURE 2 IDT strength at 40°C and 50 mm/min plotted against IDT strength at 30°C and 3.75 mm/min.

DEVELOPING IMPROVED GUIDELINES FOR THE IDT RUT TEST

Preliminary guidelines for interpreting the results of the IDT strength test at high temperature were included in the final report on the triaxial research project (1). However, if this procedure is to be used as a routine test by highway agencies and commercial testing labs, better guidelines are needed. Unfortunately, no significant database exists of IDT strength tests run under the proposed conditions, along with field rutting data. The recently developed rutting resistivity model does, however, provide an indirect means for developing improved guidelines for interpreting the results of the IDT strength test at high temperatures (7, 8).

As part of NCHRP Project 9-33, the resistivity–rutting model has been recalibrated. This recalibration was necessary for a number of reasons. The original model used the critical pavement temperature at 50 mm, whereas the Superpave binder selection protocol uses the critical temperature at 20 mm. Using the same depth in binder selection and IDT strength tests provides consistency in the mix design process. Furthermore, evaluation of this data set and several others suggested that the model was, in general, underestimating the rut resistance of modified binders. Using higher pavement temperatures (as occur closer to the pavement surface) would improve the performance prediction of modified binders compared to non-modified binders, since many types of polymer modification are more effective at high temperatures.

In the recalibrated model, the rutting rates on the different projects were adjusted approximately for differences in vehicle speeds. Recent research by Mohseni et al. strongly suggests that the critical pavement temperatures for rutting provided by Version 2.1 of LTPPBind are significantly lower than they should be—a conclusion consistent with analyses performed during initial calibration of the rutting–resistivity model (9). In the recalibrated model, 6°C was added to the critical temperatures as estimated from LTPPBind v. 2.1 to approximately account for this error. This also helped to improve the accuracy of the model as applied to modified binders.

The data set used in developing the rutting resistivity model is taken from three sources: WesTrack, the National Center for Asphalt Technology (NCAT) test track, and a number of test sections from the Minnesota Road Research project (MN/Road) (10, 11, 12). Most of these experiments do not provide rutting data as a function of time or traffic, so evaluating the best units for rutting is difficult. The initial calibration of the rutting/resistivity model assumed a rutting rate of mm/m/equivalent single-axle loads^{1/3} (ESALs) (7, 8). A large number of analyses were performed during the recalibration that suggested that rutting rate should be expressed in units of mm/m/ESAL^{0.75}. This rutting rate does not include the effects of binder age hardening; when binder age hardening is included in the calculation of rutting rate, the effective rate nears mm/m/ESAL^{0.5}, which is consistent with the rutting rate units suggested by Brown and Cross in the well-known National Rutting Study (13). The statistics for the final recalibrated model are summarized in Table 1. The recalibrated model can be given mathematically as:

$$RR = 0.60(N_{design} P)^{-0.9489} RD^{-23.35} \beta_{PASS} \beta_{MOD} \quad (1)$$

where

RR = rutting rate, mm/m/ESALs^{0.75},

N_{design} = design gyrations,

P = resistivity, calculated using quality control (QC) values for voids in mineral aggregate

- (VMA) and specific surface,
 RD = relative density,
 = $(1 - VTM_{field}) / (100 - VTM_{QC})$
 β_{PASS} = 1.55 for passing lane, 1.00 for driving lane, and
 β_{MOD} = 0.232 for modified binder, 1.00 otherwise.

The resistivity value used in Equation 1 is calculated using the following relationship:

$$P = \frac{(|\eta^*| / \sin \delta) S_a^2 G_b^2}{4.9 \text{VMA}^3} \quad (2)$$

where

- $|\eta^*|$ = binder dynamic viscosity, Pa-s,
 = $|E^*| / \omega$, where complex modulus $|E^*|$ is in Pa and frequency ω is in rad/s,
 δ = binder phase angle, degrees,
 S_a = aggregate surface area (specific surface), m^2/kg (estimated as the sum of the percents passing 300, 150, and 75 μm sieves divided by 5),
 G_b = aggregate bulk specific gravity, and
 VMA = VMA, volume %.

The R^2 value of 93% for the recalibrated rutting/resistivity model is quite good. Note that this analysis suggests that the passing lanes at MN/Road rutted about 55 % more than the driving lanes at equal traffic levels. The reason for this difference is not clear; it could be a result of slight differences in the way the lanes were constructed or because of differences in the traffic distribution for the two lanes. In this analysis, modified binders appear to provide four to five times lower rut rates than comparable unmodified binders. This is probably because of polymer networks that form within the mixture, providing additional stability to the aggregate structure during traffic loading above and beyond that predicted by the resistivity model. Figure 3 is a plot of measured rutting rates and those predicted using the recalibrated resistivity model. The recalibrated model is a useful tool for mixture design and analysis and also for the evaluation and initial calibration of laboratory tests of rutting resistance.

TABLE 1 Statistical Summary for Model for Log Rutting Rate

Predictor	Coefficient	Standard Deviation	t-value	p-value
Constant	-0.2208	0.2641	-0.84	0.407
$\log N_{design} \times P$	-0.9489	0.0858	-11.06	0.000
$\log RD$	-23.35	5.85	-3.99	0.000
β_{PASS}	0.1904	0.0641	2.97	0.004
β_{MOD}	-0.6345	0.0732	-8.66	0.000
S = 0.1860 $R^2 = 93.3$ 5 R^2 (Adj.) = 92.8 %				

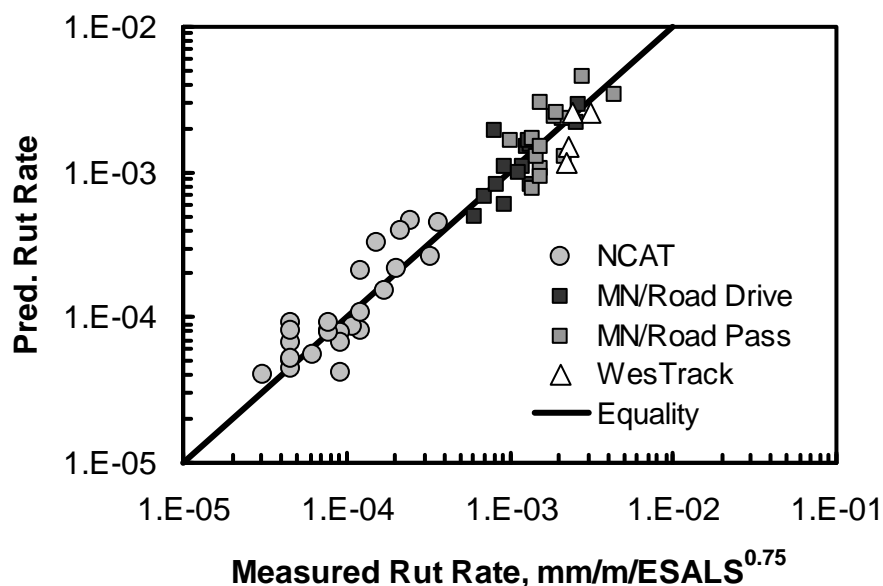

FIGURE 3 Plot of measured and predicted rut rates.

In Figure 4, rutting rates estimated using Equation 1 have been plotted against IDT strength, for an extensive set of data generated during NCHRP Projects 9-25 and 9-31. From these data, it is possible to estimate the rutting rate for a mixture based upon its IDT strength. However, to apply this rutting rate to estimate minimum IDT strengths for actual HMA mixtures, two corrections must be made—one for air voids and one for age hardening. IDT strength measurements are normally performed on specimens compacted to 4% air voids, while air voids in a newly constructed pavement are likely to be 6% to 8% or higher. Therefore, the rutting rate estimated from the correlation shown in Figure 4 must be adjusted to a higher air void level. In this analysis, 8% air voids was used, to reflect higher in-place air voids in HMA pavements.

The age-hardening correction is needed because HMA pavements harden substantially during the first few years of service, increasing their rut resistance significantly compared to unaged laboratory specimens. The correction applied in this case is based upon the binder viscosity estimated for a moderate climate using Witczak's global aging system (14). Table 2 shows the resulting guidelines, in terms of minimum IDT strength as a function of design traffic level. Allowable design traffic for a given mixture can also be estimated from a simple equation:

$$TR_{\max} = 1.97 \times 10^{-5} (\text{IDT})^{2.549} \quad (3)$$

where

TR_{\max} = maximum allowable traffic for a given mix, million ESALs and
 IDT = high-temperature IDT strength, kPa.

Equation 3 has the advantage of providing a more precise estimate of the rut resistance than the values given in Table 2.

The maximum allowable rut depth used in developing this table was 10 mm, with a safety factor of 2—that is, the actual rut depth used in estimating allowable rutting rate was 5 mm. The assumed standard traffic speed used in developing the guidelines in Table 2 was 70 km/h (44 mph); required strengths must be higher for slower traffic speeds. Based upon Equation 1 above, and typical relationships between binder modulus and frequency, a reasonable rule of thumb for accounting for traffic speed when interpreting the IDT test is that the estimated traffic level should be increased by a factor of $(70/v)$, where v is the average traffic speed in kilometers per hour [the correction factor would be $(44/v)$ when v is in miles per hour]. For example, in a project with an estimated design traffic level of 8 million ESALs, with an average speed of 35 km/h, the speed-adjusted design traffic level would be 16 million ESALs.

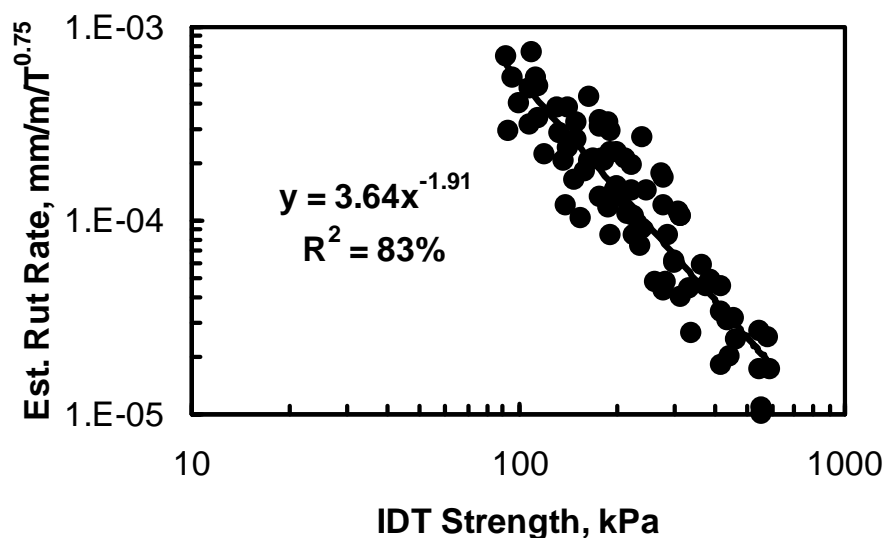

FIGURE 4 Relationship between rutting rate estimated using Equation 1 and measured IDT strength.

TABLE 2 Revised Guidelines for Interpreting IDT Strength Test at High Temperatures

Design Traffic Level* (ESALs)	Rut Resistance Category	IDT Strength Range (kPa)
—	Very poor	< 50
< 0.3	Poor	50 to < 110
0.3 to < 3	Minimal	110 to < 170
3 to < 10	Fair	170 to < 270
10 to < 30	Good	270 to < 430
30 to < 100	Very good	430 to < 660
100 to < 300	Excellent	≥ 660

*At 70 km/h (44 mph); to adjust estimated traffic level to 70 km/h, multiply by $(70/v)$, where v is the average traffic speed in kilometers per hour.

In the section below, two case studies are presented as an example of the use of the IDT strength test as an aid in ensuring proper levels of rut-resistant HMA mixtures. It should be emphasized that these case studies were done prior to the development of the guidelines given in [Table 2](#) and the associated test conditions. Therefore, the precise protocols selected and the desired strengths may differ slightly from the recommendations given in this paper. The case studies are however useful in demonstrating the use of the high-temperature IDT strength test in the mix design process.

CASE STUDIES

Coors Packaging Facility, Elkton, Virginia

This project was at the Coors Packaging Facility located near Interstate 81 in Elkton, Virginia. This facility serves as Coors' distribution facility for the Eastern United States. Product is shipped to this facility from Golden, Colorado, in insulated railroad tank cars. The product is bottled, packaged, and then trucked to various locations in the Eastern United States. About 150 trucks enter and leave the facility each day. The trucks drop trailers of empty bottles and then pick up a fully loaded trailer. The estimated traffic for the design was 300 ESALs per day. The traffic moves slowly, no more than 5 mph.

As part of an expansion of the facility in 2001, the truck parking area was expanded and new access roads were constructed. The pavement section consisted of a 50-mm thick, 19.0-mm coarse-graded surface course over a 75-mm thick, 25-mm fine-graded base course over a 150-mm thick layer of dense graded aggregate subbase. Within a year, the pavement began to experience rapid deterioration with areas of moderate to severe raveling, pumping, and shoving becoming apparent. A forensic evaluation of the pavement was performed. This investigation concluded that the surface course was the primary source of the distress. Specific deficiencies included:

1. High permeability,
2. High air void content,
3. Low asphalt content,
4. High variability of asphalt content and gradation, and
5. Local areas of insufficient lift thickness.

The base course was more uniform and better compacted and, except for a few small, localized distressed areas, was in good condition.

The recommended rehabilitation included removing the existing 19-mm surface course, making localized repairs to the base, and then replacing the surface with a properly designed 12.5-mm mixture to minimize the potential for surface water infiltration and to improve the durability of then pavement. The engineer of record and the Coors' facility staff, however, elected to use a fine-graded 19-mm surface course based on the excellent past performance of this mixture type in older pavements at the facility. The mixture was designed with performance grade (PG) 64-22 binder and included high-temperature IDT tests to ensure adequate rut resistance. The hot-mix supplier designed the mixture in accordance with AASHTO M323 using

a design compaction level of 75 gyrations. The mixture incorporated crushed gravel and 10% reclaimed asphalt pavement (RAP). [Table 3](#) presents pertinent properties of the mixture design.

High-temperature IDT tests and AASHTO T320 RSCH tests were conducted on laboratory prepared specimens at the optimum binder content and 0.5% higher than the optimum binder content. The specimens were prepared using a gyratory compactor meeting the requirements of AASHTO T312. The IDT tests were conducted using the original protocol, at a test temperature of 30°C using the slow loading rate of 3.75 mm/min. The RSCH tests were conducted at 50°C, which was the 7-day average maximum pavement temperature for the surface course at the project site estimated from LTPPBind 2.1. Replicate specimens were tested in each test. The results are summarized in [Table 4](#).

The average IDT strength for this mixture was 330 kPa. Based on this value and Equation 3, the mixture should provide adequate rut resistance up to a design traffic level of about 48 million ESALs. The estimated traffic level of 300 ESALs per day translates to 2.2 million ESALs over 20 years; multiplying by the speed correction factor of (44/5) gives a final adjusted design traffic level of 19 million ESALs, which is less than the estimated maximum traffic level.

The repair work was completed in May 2003. No performance problems have been reported in the first 2.5 years of operation.

APM Terminals, Port Elizabeth, New Jersey (Newark)

This project was at a container terminal at Port Elizabeth, New Jersey. The project included approximately 200,000 tons of asphalt pavement. The pavement at this facility is trafficked by top lifters similar to the one shown in [Figure 5](#). These machines are used to carry containers to and from ships, stack the containers for temporary storage, and to load and unload the containers from over the road trucks. Typical design loads for the top lifters used at this facility are given in [Table 5](#). As shown, the pavement is very heavily loaded. Because of the unusual nature of these vehicles and their tires, it is not possible to estimate an equivalent number of ESALs for the project. It is, however, clear that this application requires HMA mixtures exhibiting extreme levels of rut resistance.

Although there is considerable wander of the top lifters in container terminals, the traffic becomes channelized at the wharf and locations where the containers are stacked and loaded onto trucks. The traffic also stops at these locations. Rutting is a major design consideration for container terminal pavements.

[Table 6](#) presents the cross section for the pavement at this terminal. The pavement was designed using mechanistic–empirical methods considering fatigue cracking in the asphalt and rutting in the subgrade soil. Rutting in the asphalt layer was controlled through binder grade selection and specification of minimum high-temperature IDT strength. The project specifications required the high-temperature IDT strength to exceed 440 kPa when tested using a 3.75-mm loading rate at temperatures of 35°C for the surface course and 27°C for the base course. These temperatures were based on design pavement temperatures of 55 °C for the surface course and 47 °C for the base course. To account for slow speed loading, the design temperatures were 6 °C higher than the 7-day maximum pavement temperature estimated from LTPPBind 2.1 at a depth of 20 mm for the surface and 175 mm for the base.

TABLE 3 Coors Facility Volumetric Design Properties

Property	Design Value
Gradation	
Sieve Size, mm	% Passing
25.0	100
19.0	98
12.5	81
9.5	73
4.75	52
2.36	37
1.18	27
.600	20
.300	12
.150	8
.075	5.2
Aggregate bulk specific gravity	2.578
Fine aggregate angularity, %	48.1
Coarse aggregate angularity, %	99/96
Flat and elongated particles, %	0.7
Sand equivalent	88
Optimum asphalt content, weight %	5.0
Effective asphalt content, weight %	4.2
Air voids, Vol. %	3.8
VMA, Vol. %	13.3
Voids filled with asphalt, %	71
Dust to effective binder ratio	1.3
Binder grade	PG 64-22

TABLE 4 Summary of Coors Surface Mixture Permanent Deformation Testing

Specimen	Asphalt Content, %	Air Voids, %	IDT Strength, kPa	Maximum Permanent Shear Strain, %
1	5.0	4.7	358	
2	5.0	4.8	368	
3	5.0	4.3		1.45
4	5.0	4.7		1.83
5	5.5	4.4	312	
6	5.5	4.3	279	
7	5.5	4.3		2.32
8	5.5	4.0		1.43

The surface and base mixtures were designed by the hot-mix supplier in accordance with the Marshall mix design procedure specified in MS-2 using a compaction level of 75 blows. Both mixtures were produced with crushed trap rock. Table 7 summarizes pertinent properties of the surface and base mixtures.

High-temperature IDT tests and AASHTO T320 repeated shear constant height tests were conducted on laboratory prepared specimens at the optimum binder content during the mixture design review process. Additionally, high-temperature IDT tests were performed on laboratory



FIGURE 5 Top lifter used at APM Terminals, Port Elizabeth, New Jersey.

TABLE 5 Typical Design Load for Top Lifter

Condition	Front Dual Wheels	Real Single Wheel
Unloaded	222 kN	116 kN
Full container	444 kN	44.5 kN

TABLE 6 APM Terminal Pavement Cross Section

Specimen	Asphalt Content, %	Air Voids, %	IDT Strength, kPa	Maximum Permanent Shear Strain, %
1	5.0	4.7	358	
2	5.0	4.8	368	
3	5.0	4.3		1.45
4	5.0	4.7		1.83
5	5.5	4.4	312	
6	5.5	4.3	279	
7	5.5	4.3		2.32
8	5.5	4.0		1.43

compacted samples of loose mix and pavement cores taken from the test strip placed at the start of paving operations. All laboratory compacted specimens were prepared using a gyratory compactor meeting the requirements of AASHTO T312. The results of this testing are summarized in [Tables 8 and 9](#) for the base and surface mixtures, respectively. As shown, the IDT strength of the laboratory compacted mixtures exceeded the specified minimum strengths for the project.

An interesting observation obtained from the test strip data collected during this project is the high temperature IDT strength of field cores is much less than that of laboratory compacted specimens—only about 30% to 50% of the strength of these values. This is shown in [Figure 6](#), which is a plot of the high-temperature IDT strength data from [Tables 8 and 9](#) as a function of air voids. The lower strength of the field cores cannot be explained by differences in air voids or asphalt content. It appears that laboratory compaction creates a different structure in the core compared to field compaction. The criteria given in [Table 2](#) are based on gyratory-compacted specimens and should not be applied to data from field cores.

The APM terminals pavements were constructed in six stages between fall 2003 and spring 2005. The first two stages have been trafficked for two summers with no reported rutting.

CONCLUSIONS AND RECOMMENDATIONS

Conclusions

The high-temperature IDT test appears to be a simple and useful procedure for evaluating the rut resistance of HMA designs. A second generation of guidelines for interpreting the results of the IDT test has been developed, providing required IDT strength as a function of traffic level. The guidelines given in this paper are in both tabular form and an equation, which can be used to estimate allowable traffic for a given mixture based upon its IDT strength.

A useful rule of thumb for accounting for differences in average traffic speed when applying the high-temperature IDT strength to evaluate HMA rut resistance is to multiply the estimated design traffic level by $(70/v)$, where v is the average traffic speed in kilometers per hour.

AAT has used the high-temperature IDT strength test on several projects to help ensure that the HMA mix designs provided to clients have adequate levels of rut resistance for the intended application. Two case studies were described above demonstrating the use of the IDT test in developing HMA mix designs.

Testing of field cores on one of these projects indicates that the high-temperature IDT strength of field cores may be much lower than that of laboratory compacted specimens made using the same mixture. The guidelines for interpreting the high-temperature IDT strength test therefore do not apply to test results on field cores.

Recommended Procedure for IDT Strength Test at High Temperatures

The IDT strength test at high temperatures, as used to evaluate the rut resistance of HMA mixtures, should be performed using the following procedure. The testing machine used to load the specimens should have a minimum capacity of 20,000 N (5,000 lbf) and should be capable of

TABLE 7 APM Terminals Volumetric Design Properties

Property	Base	Surface
Gradation		
Sieve Size, mm	% Passing	
37.5	100	100
25.0	96	100
19.0	84	97
12.5	61	89
9.5	51	76
4.75	33	49
2.36	25	33
1.18	21	24
.600	14	18
.300	9	11
.150	5	6
.075	3.3	4.0
Aggregate bulk specific gravity	2.752	2.747
Fine aggregate angularity, %	NA	NA
Coarse aggregate angularity, %	100/100	100/100
Flat and elongated particles, %	NA	NA
Sand equivalent	NA	NA
Optimum asphalt content, weight %	4.0	5.0
Effective asphalt content, weight %	3.6	4.7
Air voids, volume %	4.8	4.3
VMA, volume %	13.5	15.4
Voids filled with asphalt, %	65	72
Dust to effective binder ratio	0.9	0.9
Binder grade	PG 70-22	PG 82-22

TABLE 8 Summary of APM Terminals Base Mixture Permanent Deformation Testing

Specimen	Specimen Type	Asphalt Content, %	Air Voids, %	IDT Strength, kPa	Maximum Permanent Shear Strain, %
25K-1	Lab mixed, lab compacted	4.0	4.4	684	
25K-3	Lab mixed, lab compacted	4.0	4.5	750	
25K-4	Lab mixed, lab compacted	4.0	3.9	730	
25K-2	Lab mixed, lab compacted	4.0	5.0		0.95
25K-5	Lab mixed, lab compacted	4.0	4.6		1.00
25K-6	Lab mixed, lab compacted	4.0	4.4		0.82
1-1	Field mixed, lab compacted	3.9	1.7	860	
1-2	Field mixed, lab compacted	3.9	2.3	818	
1-3	Field mixed, lab compacted	3.9	2.7	825	
C1	Pavement cores	3.9	4.9	232	
C2	Pavement cores	3.9	5.3	230	
C3	Pavement cores	3.9	4.8	317	

TABLE 9 Summary of APM Terminals Surface Mixture Permanent Deformation Testing

Specimen	Specimen Type	Asphalt Content, %	Air Voids, %	IDT Strength, kPa	Maximum Permanent Shear Strain, %
19K-1	Lab mixed, lab compacted	5.0	3.9	509	
19K-3	Lab mixed, lab compacted	5.0	3.8	541	
19K-4	Lab mixed, lab compacted	5.0	3.9	508	
19K-2	Lab mixed, lab compacted	5.0	3.5		1.14
19K-5	Lab mixed, lab compacted	5.0	3.7		0.84
19K-6	Lab mixed, lab compacted	5.0	3.8		1.10
1-1	Field mixed, lab compacted	5.2	1.6	481	
1-2	Field mixed, lab compacted	5.2	1.5	455	
1-3	Field mixed, lab compacted	5.2	1.3	454	
C1	Pavement cores	5.2	4.2	239	
C2	Pavement cores	5.2	4.8	228	
C3	Pavement cores	5.2	5.3	238	

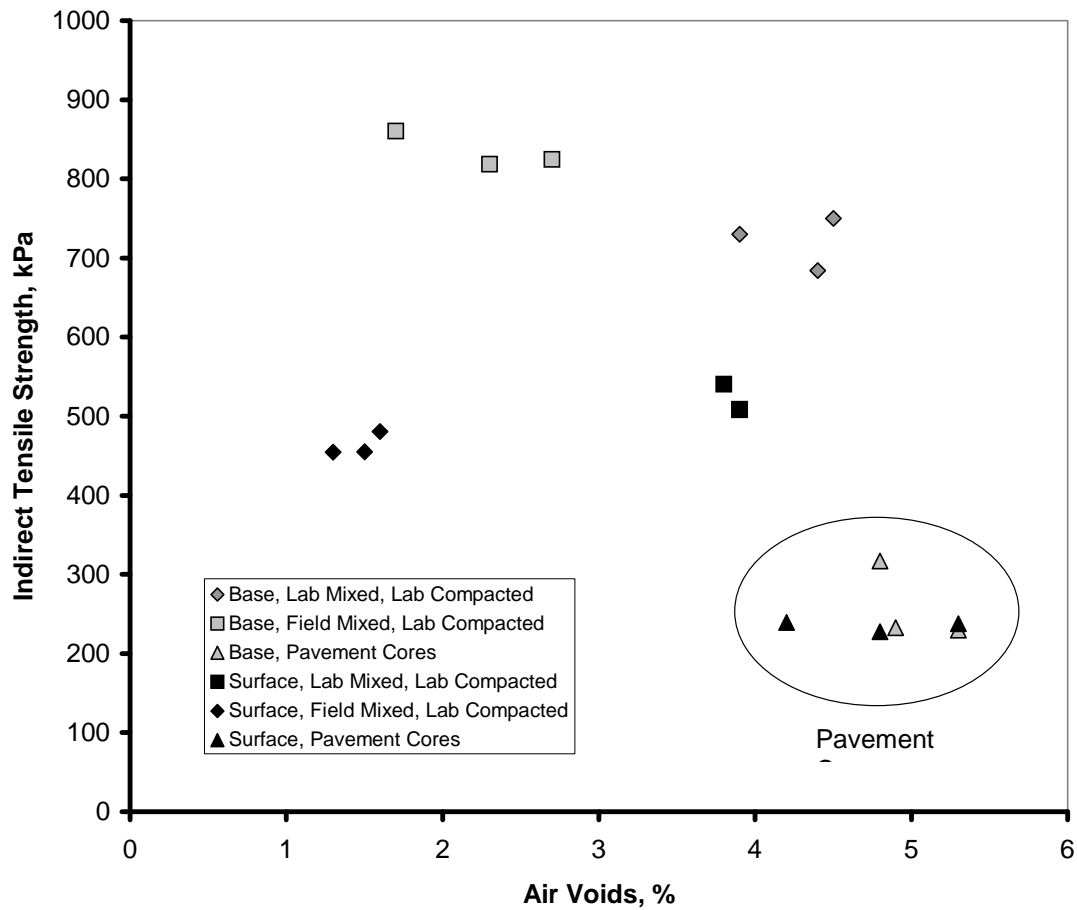

FIGURE 6 IDT strengths for APM base and surface mixtures.

applying the load at a rate of 50 mm/min. Most commercially available Marshall test frames should be suitable for applying the load to the IDT specimen. The testing system should include a means of measuring the failure load to an accuracy of ± 50 N (± 10 lbf). Specimens should be 150 mm in diameter, prepared using a Superpave gyratory compactor, to an air void content of $4.0 \pm 0.5\%$ and to a height of 115 ± 10 mm. The test temperature should be 9°C lower than the yearly, 7-day average, maximum pavement temperature 20 mm below the pavement surface, as determined using LTPPBind Version 2.1. Specimens should be conditioned prior to testing either for 1 to 2 h in a controlled temperature chamber or for 30 to 60 min in a controlled-temperature water bath. If a water bath is used to condition the specimens, they should be tightly sealed in a plastic bag prior to immersion. The specimen should be removed from the chamber or bath, removed from the plastic bag (if applicable), then placed in the testing apparatus and immediately loaded to failure at 50 mm/min. Failure should occur within 60 s of removal from the chamber or bath to ensure that the specimen temperature does not significantly change during testing.

The IDT strength is calculated using the following formula:

$$\sigma_{IDT} = \frac{2P}{\pi tD} \quad (4)$$

where

σ_{IDT}	=	IDT strength, in Pa;
P	=	maximum applied load, N;
π	\cong	3.1416;
t	=	thickness, m; and
D	=	diameter, m.

Two specimens should be tested, and the average of the two strengths reported as the IDT strength. To evaluate the rut resistance of the mixture based upon the results of the high-temperature IDT strength test, Table 2 and/or Equation 3 as given in this paper may be used. Because the use of the IDT strength test in this way is a relatively new technology, paving engineers should use experience and common sense in applying this procedure, particularly in initial applications with local materials and conditions.

ACKNOWLEDGMENTS

The information presented in this paper was developed during several different research projects with different sponsors, including FHWA, the Pennsylvania Department of Transportation, and NCHRP. The views expressed in this paper are those of the authors do not necessarily reflect the views or policies of any of these agencies.

REFERENCES

1. Christensen, D. W., R. Bonaquist, and D. P. Jack, *Evaluation of Triaxial Strength as a Simple Test for Asphalt Concrete Rut Resistance*, Final Report to the Pennsylvania Department of Transportation,

- Report No. FHWA-PA-2000-010+97-04 (19), PTI Report 2K26, Pennsylvania Transportation Institute, University Park, August 2000, 80 pp.
2. Christensen, D. W., R. F. Bonaquist, D. A. Anderson and S. Gokhale. Indirect Tension Strength as a Simple Performance Test. In *TRB Circular E-C068: New Simple Performance Test for Asphalt Mixes*, Transportation Research Board of the National Academies, Washington, D. C., 2004, pp. 44–57. Available at <http://gulliver.trb.org/publications/circulars/ec068.pdf>.
 3. Gokhale, S. V. *Simplified Protocol for Triaxial Testing of Hot-Mix Asphalt Concrete*. Thesis. Pennsylvania State University, University Park, December 2001.
 4. Gokhale, S. V., D. A. Anderson, and R. F. Bonaquist. Simplified Protocol for Triaxial Testing of Hot-Mix Asphalt Concrete. *The Electronic Journal of the Association of Asphalt Paving Technologists*, Vol. 74E, 2005.
 5. Stuart, K. D., and W. S. Mogawer. *Validation of Asphalt Binder and Mixture Tests That Measure Rutting Susceptibility Using the Accelerated Loading Facility*. Final Report, FHWA-RD-99-204.
 6. Christensen, D. W., and R. Bonaquist. Use of Strength Tests for Evaluating the Rut Resistance of Asphalt Concrete. *Journal of the Association of Asphalt Paving Technologists*, Vol. 71, 2002, pp. 692–711.
 7. Christensen, D. W., and R. F. Bonaquist. Rut Resistance and Volumetric Composition of Asphalt Concrete Mixtures. *Journal of the Association of Asphalt Paving Technologists*, Vol. 74, 2005.
 8. Christensen, D. W., and R. F. Bonaquist. *Revised Final Report for NCHRP Projects 9-25 and 9-33*. NCHRP, Washington, D.C., 2006.
 9. Mohseni, A., S. C. Carpenter, and J. D'Angelo. Development of Superpave High-Temperature Performance Grade Based on Rutting Damage. *Journal of the Association of Asphalt Paving Technologists*, March 2005.
 10. Brown, E. R., L. Michael, E. Dukatz, J. Scherocman, G. Huber, R. Sines, J. D'Angelo, and C. Williams. *Performance of Coarse-Graded Mixes at Westrack—Premature Rutting*. Final Report, FHWA-RD-99-134, June 1998.
 11. Brown, E. R., B. Prowell, A. Cooley, J. Zhang, and R. B. Powell. Evaluation of Rutting Performance on the 2000 NCAT Test Track. *Journal of the Association of Asphalt Paving Technologists*, Vol. 73, 2004, pp. 287–325.
 12. Mulvaney, R., and B. Worel. *MnROAD Mainline Rutting Forensic Investigation*, Minnesota Department of Transportation, St. Paul, October 2002.
 13. Brown, E. R., and S. A. Cross. A National Study of Rutting in Hot-Mix Asphalt (HMA) Pavements. *Journal of the Association of Asphalt Paving Technologists*, Vol. 61, 1992, pp. 535–573.
 14. Mirza, M. W., and M. W. Witczak. Development of a Global Aging System for Short- and Long-Term Aging of Asphalt Cements. *Journal of the Association of Asphalt Paving Technologists*, Vol. 64, 1995, pp. 393–424.

THE NATIONAL ACADEMIES

Advisers to the Nation on Science, Engineering, and Medicine

The **National Academy of Sciences** is a private, nonprofit, self-perpetuating society of distinguished scholars engaged in scientific and engineering research, dedicated to the furtherance of science and technology and to their use for the general welfare. On the authority of the charter granted to it by the Congress in 1863, the Academy has a mandate that requires it to advise the federal government on scientific and technical matters. Dr. Ralph J. Cicerone is president of the National Academy of Sciences.

The **National Academy of Engineering** was established in 1964, under the charter of the National Academy of Sciences, as a parallel organization of outstanding engineers. It is autonomous in its administration and in the selection of its members, sharing with the National Academy of Sciences the responsibility for advising the federal government. The National Academy of Engineering also sponsors engineering programs aimed at meeting national needs, encourages education and research, and recognizes the superior achievements of engineers. Dr. Charles M. Vest is president of the National Academy of Engineering.

The **Institute of Medicine** was established in 1970 by the National Academy of Sciences to secure the services of eminent members of appropriate professions in the examination of policy matters pertaining to the health of the public. The Institute acts under the responsibility given to the National Academy of Sciences by its congressional charter to be an adviser to the federal government and, on its own initiative, to identify issues of medical care, research, and education. Dr. Harvey V. Fineberg is president of the Institute of Medicine.

The **National Research Council** was organized by the National Academy of Sciences in 1916 to associate the broad community of science and technology with the Academy's purposes of furthering knowledge and advising the federal government. Functioning in accordance with general policies determined by the Academy, the Council has become the principal operating agency of both the National Academy of Sciences and the National Academy of Engineering in providing services to the government, the public, and the scientific and engineering communities. The Council is administered jointly by both the Academies and the Institute of Medicine. Dr. Ralph J. Cicerone and Dr. Charles M. Vest are chair and vice chair, respectively, of the National Research Council.

The **Transportation Research Board** is one of six major divisions of the National Research Council. The mission of the Transportation Research Board is to provide leadership in transportation innovation and progress through research and information exchange, conducted within a setting that is objective, interdisciplinary, and multimodal. The Board's varied activities annually engage about 7,000 engineers, scientists, and other transportation researchers and practitioners from the public and private sectors and academia, all of whom contribute their expertise in the public interest. The program is supported by state transportation departments, federal agencies including the component administrations of the U.S. Department of Transportation, and other organizations and individuals interested in the development of transportation. www.TRB.org

www.national-academies.org



TRANSPORTATION RESEARCH BOARD

500 Fifth Street, NW
Washington, DC 20001

THE NATIONAL ACADEMIES™

Advisers to the Nation on Science, Engineering, and Medicine

The nation turns to the National Academies—National Academy of Sciences, National Academy of Engineering, Institute of Medicine, and National Research Council—for independent, objective advice on issues that affect people's lives worldwide.

www.national-academies.org