



## Bus Rapid Transit Practitioner's Guide

### DETAILS

---

241 pages | | PAPERBACK

ISBN 978-0-309-42217-8 | DOI 10.17226/23172

### AUTHORS

---

BUY THIS BOOK

FIND RELATED TITLES

### Visit the National Academies Press at [NAP.edu](http://NAP.edu) and login or register to get:

---

- Access to free PDF downloads of thousands of scientific reports
- 10% off the price of print titles
- Email or social media notifications of new titles related to your interests
- Special offers and discounts



Distribution, posting, or copying of this PDF is strictly prohibited without written permission of the National Academies Press. (Request Permission) Unless otherwise indicated, all materials in this PDF are copyrighted by the National Academy of Sciences.

TRANSIT COOPERATIVE RESEARCH PROGRAM

---

---

**TCRP REPORT 118**

---

---

**Bus Rapid Transit  
Practitioner's Guide**

KITTELSON & ASSOCIATES, INC.  
Orlando, FL

IN ASSOCIATION WITH

HERBERT S. LEVINSON TRANSPORTATION CONSULTANTS  
New Haven, CT

DMJM+HARRIS  
Fairfax, VA

*Subject Areas*  
Public Transit

---

Research sponsored by the Federal Transit Administration in cooperation with the Transit Development Corporation

---

**TRANSPORTATION RESEARCH BOARD**

WASHINGTON, D.C.  
2007  
[www.TRB.org](http://www.TRB.org)

## TRANSIT COOPERATIVE RESEARCH PROGRAM

The nation's growth and the need to meet mobility, environmental, and energy objectives place demands on public transit systems. Current systems, some of which are old and in need of upgrading, must expand service area, increase service frequency, and improve efficiency to serve these demands. Research is necessary to solve operating problems, to adapt appropriate new technologies from other industries, and to introduce innovations into the transit industry. The Transit Cooperative Research Program (TCRP) serves as one of the principal means by which the transit industry can develop innovative near-term solutions to meet demands placed on it.

The need for TCRP was originally identified in *TRB Special Report 213—Research for Public Transit: New Directions*, published in 1987 and based on a study sponsored by the Urban Mass Transportation Administration—now the Federal Transit Administration (FTA). A report by the American Public Transportation Association (APTA), *Transportation 2000*, also recognized the need for local, problem-solving research. TCRP, modeled after the longstanding and successful National Cooperative Highway Research Program, undertakes research and other technical activities in response to the needs of transit service providers. The scope of TCRP includes a variety of transit research fields including planning, service configuration, equipment, facilities, operations, human resources, maintenance, policy, and administrative practices.

TCRP was established under FTA sponsorship in July 1992. Proposed by the U.S. Department of Transportation, TCRP was authorized as part of the Intermodal Surface Transportation Efficiency Act of 1991 (ISTEA). On May 13, 1992, a memorandum agreement outlining TCRP operating procedures was executed by the three cooperating organizations: FTA, the National Academies, acting through the Transportation Research Board (TRB); and the Transit Development Corporation, Inc. (TDC), a nonprofit educational and research organization established by APTA. TDC is responsible for forming the independent governing board, designated as the TCRP Oversight and Project Selection (TOPS) Committee.

Research problem statements for TCRP are solicited periodically but may be submitted to TRB by anyone at any time. It is the responsibility of the TOPS Committee to formulate the research program by identifying the highest priority projects. As part of the evaluation, the TOPS Committee defines funding levels and expected products.

Once selected, each project is assigned to an expert panel, appointed by the Transportation Research Board. The panels prepare project statements (requests for proposals), select contractors, and provide technical guidance and counsel throughout the life of the project. The process for developing research problem statements and selecting research agencies has been used by TRB in managing cooperative research programs since 1962. As in other TRB activities, TCRP project panels serve voluntarily without compensation.

Because research cannot have the desired impact if products fail to reach the intended audience, special emphasis is placed on disseminating TCRP results to the intended end users of the research: transit agencies, service providers, and suppliers. TRB provides a series of research reports, syntheses of transit practice, and other supporting material developed by TCRP research. APTA will arrange for workshops, training aids, field visits, and other activities to ensure that results are implemented by urban and rural transit industry practitioners.

The TCRP provides a forum where transit agencies can cooperatively address common operational problems. The TCRP results support and complement other ongoing transit research and training programs.

## TCRP REPORT 118

Project A-23A  
ISSN 1073-4872  
ISBN: 978-0-309-09884-7  
Library of Congress Control Number 2007927926

© 2007 Transportation Research Board

### COPYRIGHT PERMISSION

Authors herein are responsible for the authenticity of their materials and for obtaining written permissions from publishers or persons who own the copyright to any previously published or copyrighted material used herein.

Cooperative Research Programs (CRP) grants permission to reproduce material in this publication for classroom and not-for-profit purposes. Permission is given with the understanding that none of the material will be used to imply TRB, AASHTO, FAA, FHWA, FMCSA, FTA, or Transit Development Corporation endorsement of a particular product, method, or practice. It is expected that those reproducing the material in this document for educational and not-for-profit uses will give appropriate acknowledgment of the source of any reprinted or reproduced material. For other uses of the material, request permission from CRP.

### NOTICE

The project that is the subject of this report was a part of the Transit Cooperative Research Program conducted by the Transportation Research Board with the approval of the Governing Board of the National Research Council. Such approval reflects the Governing Board's judgment that the project concerned is appropriate with respect to both the purposes and resources of the National Research Council.

The members of the technical advisory panel selected to monitor this project and to review this report were chosen for recognized scholarly competence and with due consideration for the balance of disciplines appropriate to the project. The opinions and conclusions expressed or implied are those of the research agency that performed the research, and while they have been accepted as appropriate by the technical panel, they are not necessarily those of the Transportation Research Board, the National Research Council, the Transit Development Corporation, or the Federal Transit Administration of the U.S. Department of Transportation.

Each report is reviewed and accepted for publication by the technical panel according to procedures established and monitored by the Transportation Research Board Executive Committee and the Governing Board of the National Research Council.

The Transportation Research Board of the National Academies, the National Research Council, the Transit Development Corporation, and the Federal Transit Administration (sponsor of the Transit Cooperative Research Program) do not endorse products or manufacturers. Trade or manufacturers' names appear herein solely because they are considered essential to the clarity and completeness of the project reporting.

*Published reports of the*

### TRANSIT COOPERATIVE RESEARCH PROGRAM

*are available from:*

Transportation Research Board  
Business Office  
500 Fifth Street, NW  
Washington, DC 20001

*and can be ordered through the Internet at*

<http://www.national-academies.org/trb/bookstore>

Printed in the United States of America

# THE NATIONAL ACADEMIES

## *Advisers to the Nation on Science, Engineering, and Medicine*

The **National Academy of Sciences** is a private, nonprofit, self-perpetuating society of distinguished scholars engaged in scientific and engineering research, dedicated to the furtherance of science and technology and to their use for the general welfare. On the authority of the charter granted to it by the Congress in 1863, the Academy has a mandate that requires it to advise the federal government on scientific and technical matters. Dr. Ralph J. Cicerone is president of the National Academy of Sciences.

The **National Academy of Engineering** was established in 1964, under the charter of the National Academy of Sciences, as a parallel organization of outstanding engineers. It is autonomous in its administration and in the selection of its members, sharing with the National Academy of Sciences the responsibility for advising the federal government. The National Academy of Engineering also sponsors engineering programs aimed at meeting national needs, encourages education and research, and recognizes the superior achievements of engineers. Dr. William A. Wulf is president of the National Academy of Engineering.

The **Institute of Medicine** was established in 1970 by the National Academy of Sciences to secure the services of eminent members of appropriate professions in the examination of policy matters pertaining to the health of the public. The Institute acts under the responsibility given to the National Academy of Sciences by its congressional charter to be an adviser to the federal government and, on its own initiative, to identify issues of medical care, research, and education. Dr. Harvey V. Fineberg is president of the Institute of Medicine.

The **National Research Council** was organized by the National Academy of Sciences in 1916 to associate the broad community of science and technology with the Academy's purposes of furthering knowledge and advising the federal government. Functioning in accordance with general policies determined by the Academy, the Council has become the principal operating agency of both the National Academy of Sciences and the National Academy of Engineering in providing services to the government, the public, and the scientific and engineering communities. The Council is administered jointly by both the Academies and the Institute of Medicine. Dr. Ralph J. Cicerone and Dr. William A. Wulf are chair and vice chair, respectively, of the National Research Council.

The **Transportation Research Board** is a division of the National Research Council, which serves the National Academy of Sciences and the National Academy of Engineering. The Board's mission is to promote innovation and progress in transportation through research. In an objective and interdisciplinary setting, the Board facilitates the sharing of information on transportation practice and policy by researchers and practitioners; stimulates research and offers research management services that promote technical excellence; provides expert advice on transportation policy and programs; and disseminates research results broadly and encourages their implementation. The Board's varied activities annually engage more than 5,000 engineers, scientists, and other transportation researchers and practitioners from the public and private sectors and academia, all of whom contribute their expertise in the public interest. The program is supported by state transportation departments, federal agencies including the component administrations of the U.S. Department of Transportation, and other organizations and individuals interested in the development of transportation. [www.TRB.org](http://www.TRB.org)

[www.national-academies.org](http://www.national-academies.org)

# COOPERATIVE RESEARCH PROGRAMS

## CRP STAFF FOR TCRP REPORT 118

**Christopher W. Jenks**, *Director, Cooperative Research Programs*  
**Crawford F. Jencks**, *Deputy Director, Cooperative Research Programs*  
**Gwen Chisholm Smith**, *Senior Program Officer*  
**Eileen P. Delaney**, *Director of Publications*  
**Natalie Barnes**, *Editor*

## TCRP PROJECT A-23A PANEL

### Field of Operations

**Jack M. Reilly**, *Transportation Management and Design, Latham, NY (Chair)*  
**Graham Carey**, *Lane Transit District, Eugene, OR*  
**RoseMary Covington**, *Sacramento Regional Transit District, Sacramento, CA*  
**John Dockendorf**, *Pennsylvania DOT, Harrisburg, PA*  
**David R. Fialkoff**, *Miami-Dade Transit Agency, Miami, FL*  
**Leon Goodman**, *Searingtown, NY*  
**Dennis P. Hinebaugh**, *University of South Florida Center for Urban Transportation Research, Tampa, FL*  
**Garet Johnson**, *Charlotte-Mecklenburg Planning Commission, Charlotte, NC*  
**James R. Lightbody**, *San Jose, CA*  
**Michael H. Mulhern**, *Massachusetts Bay Transportation Authority Retirement Fund, Boston, MA*  
**John M. Muth**, *Charlotte Area Transit System, Charlotte, NC*  
**Michael Sanders**, *Connecticut DOT, Newington, CT*  
**Stan Teply**, *University of Alberta, Edmonton, AB*  
**Martha Welborne**, *California Community Foundation, Los Angeles, CA*  
**Walter Kulyk**, *FTA Liaison*  
**Peter Shaw**, *TRB Liaison*

## AUTHOR ACKNOWLEDGMENTS

The *Bus Rapid Transit Practitioner's Guide* was developed under TCRP Project A-23A. The TCRP Project A-23A team consisted of Kittelson & Associates, Inc. (prime contractor), Herbert S. Levinson Transportation Consultants, and DMJM+Harris.

Alan Danaher, P.E., PTOE, AICP, Kittelson & Associates, Inc., was the Principal Investigator. The Co-investigator was Herbert S. Levinson, P.E., Herbert S. Levinson Transportation Consultants. The other lead researcher was Samuel L. Zimmerman, DMJM+Harris.

The Executive Summary was written by Herb Levinson and edited by Alan Danaher.

Chapter 1, Introduction, was developed by Alan Danaher. Herb Levinson provided overall editing of the material.

Chapter 2, Planning Framework, was developed with contributions from several project team members. Sam Zimmerman provided the basic framework for discussion, with added insights provided by Alan Danaher and Herb Levinson.

Chapter 3, Estimating BRT Ridership, was developed with contributions from many project team members. The discussion on application of mode choice models was extracted from research conducted for TCRP A-23A by Sam Zimmerman, supported by Terri Morrell and Maureen Araujo of DMJM+Harris.

*(continued on page x)*

# FOREWORD

By **Gwen Chisholm Smith**

Staff Officer

Transportation Research Board

*TCRP Report 118: Bus Rapid Transit Practitioner's Guide* provides information on the costs, impacts, and effectiveness of implementing selected bus rapid transit (BRT) components. It includes practical information that can be readily used by transit professionals and policy makers in planning and decision making related to implementing different components of BRT systems. This report updates some of the information presented in *TCRP Report 90: Bus Rapid Transit* and presents the latest developments and research results related to the costs and impacts of implementing various BRT components and their effectiveness.

---

Information is available from bus rapid transit (BRT) projects on the costs and effectiveness of implementing various BRT components and their effectiveness. Obtaining and evaluating this information can help transit systems determine whether these selected BRT components are sufficiently cost-effective for application. Impacts of BRT components include, but are not limited to, the effects on the implementing transit systems, the community, and the political structure. This research reviews the BRT demonstration projects underway or planned in the United States, similar projects throughout the world, and bus systems that employ various components described below. Major BRT components addressed in this Practitioner's Guide include the following: (1) use of exclusive right-of-way, including busways, exclusive lanes, and bypass/queue jumping lanes for buses at congested intersections to reduce vehicle running time; (2) use of more limited-stop service including express service and skip-stopping; (3) application of intelligent transportation technology such as signal priority, automatic vehicle location systems, system security, and customer information; (4) use of advanced technology vehicles (e.g., articulated buses, modern propulsion systems, more accessible vehicles, and low-floor buses) and new specially designed vehicles with doors on each side; (5) design of stations; (6) use of off-board, fare-payment smart cards or proof-of-payment systems; (7) "branding" the system; (8) use of vehicle guidance systems (mechanical, electronic, or optical); and (9) other strategies that enhance customer satisfaction.

To assist in the development of the Practitioner's Guide, the research team reviewed pertinent literature, including *TCRP Report 90, Volume 1: Case Studies in Bus Rapid Transit* and *Volume 2: Implementation Guidelines*, relevant to the costs, impacts, and related effectiveness of implementing selected BRT components. Also, the research team surveyed selected transit agencies that had implemented or have planned BRT systems to obtain information on costs, impacts, and effectiveness of the selected BRT components. Information collected included ridership, capital and operating costs, community acceptance, associated land-use development, funding support, support for system expansion,

improved mobility, quality of service, travel time, comfort, dwell time, reliability, convenience, safety, security, improved frequency, and wait time. This information was used as input to the Practitioner's Guide. The Guide covers a wide range of BRT development scenarios in assessing different component packages. The Guide also provides guidelines for BRT ridership estimation and overall insights on land development impacts associated with BRT development.

# CONTENTS

## S-1 Summary

### 1-1 Chapter 1 Introduction

- 1-1 Overview
- 1-1 Nature of BRT
  - 1-1 Definition
  - 1-2 Components/Features
  - 1-3 Questions Commonly Asked
    - 1-3 How Well Does It Work?
    - 1-3 Is It a Viable Rapid Transit Option?
    - 1-4 What Are Its Costs and Benefits?
    - 1-4 Which Components Are Essential?
    - 1-4 How Can Community Support Be Achieved?
    - 1-4 How Can BRT Be Integrated with the Existing Bus System?
  - 1-4 What the Guide Covers
    - 1-4 Chapter 2—Planning Framework
    - 1-4 Chapter 3—Travel Demand Estimation
    - 1-5 Chapter 4—Component Costs and Impacts
    - 1-5 Chapter 5—System Packaging and Integration
    - 1-5 Chapter 6—Land Development Guidelines
  - 1-5 References

### 2-1 Chapter 2 Planning Framework

- 2-1 Introduction and Overview
- 2-1 Federal, State, and Local Context
- 2-3 Alternatives Analysis Steps
  - 2-4 Establish Goals and Evaluate Problems and Needs
  - 2-5 Identify Alternatives
  - 2-7 Evaluate Alternatives
  - 2-9 Select and Refine Mode and Alignment
- 2-11 System Planning Principles
- 2-12 References

### 3-1 Chapter 3 Estimating BRT Ridership

- 3-1 Introduction and Summary
- 3-2 Ridership Experience
  - 3-3 Ridership Growth
  - 3-3 Prior Modes
  - 3-4 Rider Characteristics
  - 3-5 Attitude and Preference Surveys
  - 3-8 Research Findings
  - 3-8 Conclusions from Aggregate Evidence
- 3-9 Ridership Estimation Overview



3-10	Application of Travel Demand Estimation Models
3-10	Key Steps
3-11	Mode Choice
3-14	Incremental Logit Model (Pivot-Point Procedure)
3-15	Application of Elasticity Factors
3-16	Elasticity Methods
3-17	Application
3-20	Estimating Additional Rapid Transit Ridership Impacts
3-22	Guidelines
3-24	Sketch Planning
3-24	Detailed Alternatives Analyses
3-25	References

#### **4-1 Chapter 4 Component Features, Costs, and Impacts**

4-1	Introduction
4-2	Running Way Components
4-8	Busways
4-16	Arterial Bus Lanes
4-24	Transit Signal Priority
4-37	Queue Jumps/Bypass Lanes
4-41	Curb Extensions
4-45	Station Components
4-60	Vehicle Components
4-61	Size of Vehicle
4-67	Modern Vehicle Styling
4-71	Low-Floor Boarding
4-75	Propulsion/Fuel Technologies
4-79	Automatic Vehicle Location
4-82	Driver Assist and Automation
4-85	Service and System Components
4-85	Service Plans
4-99	Fare Collection
4-102	Passenger Information
4-108	Enhanced Safety and Security Systems
4-112	Branding
4-117	References

#### **5-1 Chapter 5 System Packaging, Integration, and Assessment**

5-1	Introduction
5-1	Choosing the “Best” Package of Components
5-1	General Guidelines
5-2	Packaging and Staging Examples
5-5	Assessing System Performance
5-5	Analysis Parameters
5-9	Analysis Steps and Procedures
5-13	Example BRT Development Scenarios
5-13	Context and Assumptions
5-15	Scenario 1: Grade-Separated Busway Connecting CBD to Park-and-Ride Lot
5-18	Scenario 2: At-Grade Busway
5-21	Scenario 3: At-Grade Busway and Median Arterial Busway
5-25	Scenario 4: Bus Lanes and Transit Signal Priority

5-29	Scenario 5: Bus Lanes Only (No Transit Signal Priority)
5-33	Scenario 6: Transit Signal Priority Only
5-37	Summary and Comparison of BRT Development Scenarios
5-40	Assessment of BRT Development Scenarios
5-41	References

## **6-1 Chapter 6 Land Development Guidelines**

6-1	Introduction
6-1	Experience and Research
6-1	Overview of Transit-Oriented Development
6-2	TOD Measures
6-2	Quantifying TOD Impacts
6-5	Achieving TOD with BRT
6-6	TOD Programs
6-7	Boston
6-8	Pittsburgh
6-10	Ottawa
6-12	Developer Perceptions
6-12	Methodology
6-13	Boston
6-15	Ottawa
6-17	Caveats
6-17	Guidelines
6-17	Coordinating BRT with Land Development
6-18	Stakeholder Perspectives
6-20	Evaluating TOD Programs
6-20	Resource Materials
6-21	References

## **AUTHOR ACKNOWLEDGMENTS (continued)**

The section on elasticity factors was developed by Herb Levinson. Alan Danaher, Herb Levinson, and Frank Spielberg, Vanasse Hangen Brustlin, Inc., provided overall editing of the material.

Chapter 4, Component Features, Costs, and Impacts, was developed with contributions from many project team members. The busways, arterial bus lanes, station components, and service plans profiles were developed by Herb Levinson. The signal priority, queue jumps/bypass lanes, curb extensions, and branding profiles were developed by Alan Danaher. The nine vehicle components profiles, the fare collection profile, and the real-time passenger information profile were developed by Mario G. Candia-Martinez of Kittelson & Associates, Inc.

Chapter 5, System Packaging, Integration, and Assessment, was developed by Herb Levinson with Alan Danaher and Kelly L. Blume, P.E., of Kittelson & Associates, Inc., editing the material.

Chapter 6, Land Development Guidelines, was developed by Kelly Blume and Patrick J. McMahon, AICP, of Kittelson & Associates, Inc., and edited by Herb Levinson.

Special thanks goes to Lisa L. Bobersky, Kittelson & Associates, Inc., for her work in the overall assembly of the document; Paul J. Ryus, P.E., Kittelson & Associates, Inc., for sharing his photographs of BRT system components; and Paige Cameron for her work in compiling bibliographic information.

The project team thanks Ronald Fisher and Jim Ryan of the Federal Transit Administration for their input into the development of Chapter 3.

The project team thanks the agencies and staff who provided data on their existing or planned BRT systems. Their assistance and input were invaluable in helping to shape the *Bus Rapid Transit Practitioner's Guide*. Agencies and staff included:

- Adelaide Metro (Adelaide, Australia)—Tom Wilson
- Connecticut Department of Transportation (Hartford, CT)—Mike Sanders
- Regional Transportation District (Denver, CO)—Bill Hoople
- Greater Cleveland Regional Transit Authority (Cleveland, OH)—Mike Schipper and Danielle Willis
- King County Metro (Seattle, WA)—Ron Atherley
- Los Angeles Metropolitan Transportation Authority (Los Angeles, CA)—Susan Chapman and Rex Gephart
- Massachusetts Bay Transportation Authority (Boston, MA)—Mike Mulhern and David Carney
- Metro-Dade Transit Agency (Miami, FL)—David Fialkoff and Bob Pearsall
- Ottawa-Carleton Regional Transit Commission (Ottawa, ON)—Colin Leach
- Port Authority of Allegheny County (Pittsburgh, PA)—Richard Feder
- Queensland Transport (Brisbane, Australia)
- San Francisco Department of Parking and Traffic (San Francisco, CA)—Gerald Robbins
- TransLink (Vancouver, BC)—Ian Fisher and Brian Mills

The project team acknowledges LeAnn Waletzko, AICP, of DMJM+Harris for her assistance in collecting data about existing and planned BRT systems.

The project team thanks the following parties for their valuable contributions to Chapter 6:

- Massachusetts Bay Transportation Authority (Boston, MA)—Dennis DiZoglio, Mark Boyle, and John “Tad” Read
- City of Ottawa (Ottawa, ON)—Helen Gault, Vivi Chi, and Sandra Candow
- Peter J.V. Koonce, P.E., of Kittelson & Associates, Inc.
- The developers who participated in the surveys in Boston and Ottawa
- Center for Transit-Oriented Development—Mariia Zimmerman
- Urban Land Institute

All web site addresses provided in the *Bus Rapid Transit Practitioner's Guide* were current at the time this report was produced but are subject to change.

## SUMMARY

The *Bus Rapid Transit Practitioner's Guide* shows transportation professionals how to identify and assess the costs and impacts of the various features that make up a bus rapid transit (BRT) system. It covers running ways, stations, vehicles, service plans, intelligent transportation systems (ITS) applications, fare collection, and branding. It complements *TCRP Report 90: Bus Rapid Transit* and the FTA document *Characteristics of Bus Rapid Transit for Decision-Making*.

This Guide complements *TCRP Report 90* and FTA's *Characteristics of Bus Rapid Transit Decision-Making*.

### WHAT IS BRT?

BRT has been defined by the FTA as a "rapid mode of transportation that can provide the quality of rail transit and the flexibility of buses." *TCRP Report 90* expands this definition to "a rubber-tired form of rapid transit that combines stations, vehicles, services, running ways, and ITS elements into an integrated system with a strong image and identity." In brief, BRT is an integrated system of facilities, equipment, services, and amenities that improves the speed, reliability, and identity of bus transit. BRT is, in many respects, rubber-tired light rail transit (LRT) with greater operating flexibility and potentially lower costs.

BRT provides the quality of rail transit with the flexibility of buses.

### WHY CONSIDER BRT?

There are many reasons why communities consider BRT as a rapid transit option:

- BRT can be implemented quickly and incrementally.
- BRT can be the most flexible rapid transit mode for cost-effectively serving the broad variety of urban and suburban environments and markets in the United States and Canada.
- BRT can operate on arterial streets; in freeway medians, on freeway shoulders, and alongside freeways; in railroad and other separate rights-of-way; and in tunnels.
- BRT can accommodate express and local services on a single facility.
- BRT can provide sufficient transport capacity for most urban corridors in the United States and Canada.
- BRT can be less costly to implement than a rail transit line while providing similar benefits.
- BRT has little additional implementation costs over local bus service where it runs on streets and highways.
- BRT can be effectively integrated into the surrounding environment and can generate significant urban development benefits.

### WHERE SHOULD BRT BE CONSIDERED?

BRT is especially desirable in large urban areas where peak-period and all-day passenger flows are sufficient to warrant frequent service and there is a sufficient presence of buses to justify dedicated running ways. The following thresholds are suggested:

- There should be one or more strong anchors, such as the city center, and a large tributary area. Current experience suggests that, in the United States or Canada, urbanized area population generally should exceed 750,000

---

## Bus Rapid Transit Practitioner's Guide

BRT can operate in many different configurations.

and central business district (CBD) employment should be at least 50,000 (*TCRP Report 90*). However, a large university or other outlying major activity center may support a BRT route or system.

- Desired trunk line BRT headways should be 8 to 10 minutes or shorter during peak periods and not more than 12 to 15 minutes during off-peak periods.
- Ideally, there should be at least one BRT (and local) bus per traffic signal cycle where buses operate in a dedicated arterial street BRT lane.

Accordingly, BRT systems should focus on at least one major activity center, preferably with limited and/or expensive parking. Usually, lines radiate from the city center; sometimes they connect with radial rail rapid transit lines, and, in very large urban areas, cross-town BRT lines may be appropriate. BRT also can be introduced into some areas with large existing or developing suburban activity centers to attract automobile trips to transit. The systems would be developed in stages as BRT ridership grows over time. In all cases, ridership potential should be sufficient to support frequent all-day and peak-period service.

### PLANNING BRT

Communities contemplating BRT should have a clear vision of BRT needs and opportunities. BRT lines should be planned as an interconnected system of routes and incrementally developed, with the most promising links built first.

BRT should be planned and developed through a process that stresses solving demonstrated current and forecast future problems and needs. Planning requires a realistic assessment of demands, costs, benefits, and impacts for a range of alternatives that includes a “base case” and may include one or more rail rapid transit options. Continuous community and decision-maker support is essential.

### Objectives

BRT should provide attractive and reliably fast transit service that

- Serves demonstrated current and forecast future transit demand and needs,
- Provides reserve capacity for future growth,
- Attracts automobile drivers to transit,
- Relates to and reinforces transit and pedestrian-oriented development, and
- Has affordable initial implementation and ongoing operating and maintenance costs.

BRT plans should focus on major markets, take advantage of incremental development opportunities, and promote complementary “Transit First” policies. “Deconstruction” of a BRT system by removing elements critical to its success to cut costs should be avoided. The addition of unnecessary, capital cost-intensive features also should be avoided.

### Steps

An open, objective planning process should meet FTA Alternatives Analysis Requirements for “New Starts” (more than \$75 million in investment) and “Small Starts” (less than \$75 million in investment). Each option should be compared with a “base case” that includes low-cost transportation system management treatments.

The BRT planning process has five key steps:

Incremental development of BRT is possible.

1. Establishing goals and objectives for transportation and related quality-of-life concerns
2. Evaluating current problems and future needs
3. Identifying investment alternatives, including running ways and stations
4. Evaluating each alternative in terms of costs, benefits, and community impacts (including ridership, travel times, constructability, operating feasibility, land development benefits, environmental effects, and capital and operating costs)
5. Selecting, refining, and detailing a preferred option (for which realistic and reliable estimates of costs, ridership, and benefits are essential)

### Principles

The following principles should guide BRT planning, design, and development:

- BRT should be developed as a permanently integrated system of facilities, services, and amenities.
- The BRT system should provide the key attributes of rail transit to the maximum extent possible.
- BRT should be complemented by appropriate Transit First policies. Examples include transit-oriented development, complementary downtown parking policies, and adequate park-and-ride space at outlying stations.
- BRT should be rapid. It should operate on separate rights-of-way wherever possible and on wide, continuous, free-flowing streets where separate rights-of-way are unavailable or removed from markets. Wide station spacing (except in downtown areas) is desirable. Transit preferential treatments such as exclusive bus lanes, transit signal priority (TSP), queue jumps/bypass lanes, and curb extensions are desirable.
- BRT systems should be capable of staged development. Subsequent development could include extending a BRT line, upgrading the running way, or building new lines.
- BRT systems should be reasonable in their costs to the community, urban travelers (especially transit riders), and the transit agency. Investments should be balanced with present and likely future ridership. Systems should be designed to increase transportation capacity in heavily traveled corridors, reduce travel times for riders, and minimize total person delay in the corridors served. A basic goal should be to maximize person flow with the minimum net total person delay over the long run.
- Streets and corridors with existing long, heavily traveled bus routes are likely candidates for BRT. Often, BRT development will involve restructuring existing bus routes to provide sufficient service frequency along the BRT route.
- System design and operations should enhance the presence, permanence, and identity of BRT facilities and services. BRT must be more than just express service along a bus lane or busway.
- BRT should have a consistent, appealing image. BRT vehicles, stations, and marketing materials should convey the image of BRT as a rapid, easy-to-use service.

The Guide provides ten guiding principles for BRT planning, design, and development.

---

## Bus Rapid Transit Practitioner's Guide

- Each urban area has its own specific needs, opportunities, and constraints that must be recognized. Thus, BRT systems must be carefully customized in order to apply the various components, obtain public support, and translate plans into operating systems.

### RIDERSHIP

Realistic and reliable ridership forecasts are essential to size system design features, develop service plans, estimate capital and operating costs, perform alternatives analysis and cost-benefit comparisons, and make sound investment decisions. Ridership forecasts are needed for different time periods pending the complexity of the BRT project. Forecast horizons for FTA New Starts funding include the base year, the opening year, the year when ridership reaches maturity, and a design year usually 20 years into the future. Estimates should be provided for peak and off-peak conditions by line segment and by station boardings and alightings.

Travel time, service frequency, and fare elasticities can be used for smaller-scale projects, especially where BRT would operate along existing bus routes. An on-bus survey can identify desired travel patterns and demographic and socio-economic information. Allowance should be made for “new” trips—trips diverted from automobiles, trips not made previously, and trips made with greater frequency. Population and employment growth should be taken into account.

Ridership for larger BRT projects can be estimated by the traditional four-step process—trip generation, trip distribution, mode split, and trip assignment—where the BRT operates on a new right-of-way (such as a busway). Household travel surveys can provide the basic information needed for modeling and analysis. Elasticity methods can be used where the BRT line would operate along an existing bus route.

It is essential to recognize BRT's unique physical and operating features in the demand forecasting process. Salient research studies of customer response to new BRT systems (or upgraded express bus service) have identified two findings:

- The attractiveness of BRT systems, not unlike that of new rail systems, has been greater than might be expected on the basis of reductions in travel time, service frequency, and cost.
- All things being equal (e.g., newness, component quality, system configuration and completeness in terms of all the elements of rapid transit, origin-to-destination travel times, reliability, and costs), BRT systems are likely to attract levels of ridership similar to those of rail-based systems.

Studies of ridership based upon applying elasticities to arterial street BRT lines in Boston, Los Angeles, and Vancouver (BC) found that actual ridership was up by about 20% more than that resulting from improved travel times and service frequencies. Accordingly, a 25% increase in base ridership above the gains obtained by elasticity computations is a suggested upper limit for *full-featured BRT*.

Common practice applies up to a 12-minute in-vehicle travel time “bias constant” for rail rapid transit. That is, the travel times for mode-split modeling purposes would be 12 minutes shorter for rail in comparison to local bus service. Accordingly, a maximum 10-minute bias constant is suggested for *full-featured BRT*.

The amount of the bias constant that is applied will depend upon the quality and the extent of various BRT service features. The guidelines give suggested allocations of bias effects to each major BRT component (running ways, stations,

Elasticities can be used to estimate ridership for smaller-scale BRT projects.

The four-step model can be used to estimate ridership for BRT on separate rights-of-way.

vehicles, service patterns, ITS applications, and branding). The six individual major components add up to 85% of the bias constant. The remaining 15% of the bias constant represents component synergy that should be added when the subtotal is 60% or greater. *Where site-specific data from preference surveys suggest other percentages, the site-specific data should be used. Transit agencies are encouraged to collect local data and/or derive percentages from customer surveys and share their findings with other transit agencies.*

Within each component, values were estimated according to the presence of specific features. For example, a high-level BRT system using a grade-separated busway with uniquely designed vehicles would have a bias constant of 9.5 minutes of in-vehicle travel time, while a minimal system operating on city streets would have a bias constant of 4.3 minutes of in-vehicle travel time (or increases in base ridership of 24% and 11%, respectively, when elasticities are used).

## COMPONENT PROFILES

Chapter 4 of this *Bus Rapid Transit Practitioner's Guide* presents the characteristics, costs, and impacts of 17 BRT components and gives guidelines for developing and assessing the individual components. Each profile contains the following information:

- Scale of application
- Selected typical examples
- Estimated costs (capital, operating)
- Likely impacts (ridership, operating cost savings, land development, etc.)

Where applicable, the profiles also include the following information:

- Conditions of application
- Design and operating features
- Implementability (institutional factors)
- Analysis tools (analogy/synthesis, analytical modeling, simulation)

Profiles have been developed for the following components:

- Running way components
  - > Busways on separate rights-of-way
  - > Arterial bus lanes
  - > Transit signal priority
  - > Queue jumps/bypass lanes
  - > Curb extensions
- Stations
- Vehicles
  - > Size of vehicle
  - > Modern vehicle styling
  - > Low-floor boarding
  - > Fuel/propulsion technologies
  - > Automatic vehicle location

Site-specific data are preferred for identifying the added impacts of BRT attributes.

The components of full-featured BRT have synergy.

The Guide contains profiles for running ways, stations, vehicles, service plans, systems, and branding.



---

## Bus Rapid Transit Practitioner's Guide

- > Driver assist and automation
- Service and systems
  - > Service plan features
  - > Fare collection
  - > Passenger information
  - > Enhanced safety and security systems
- Branding

### INTEGRATION AND ASSESSMENT

BRT components should be packaged into an integrated system of services, facilities, and amenities that reflects specific needs, opportunities, and resources. All BRT systems have running ways, stations, vehicles, and service patterns. The types of these features and the types of various ITS components and branding depend upon specific local conditions.

#### General Guidelines

Developing BRT calls for identifying appropriate corridors, analyzing options, selecting desired BRT components, assessing these components, and preparing a preferred investment and operations plan. Key steps in developing and analyzing BRT service alternatives include the following:

1. *Establish the Need.* Considerations include (a) slow and unattractive local bus service; (b) peak-period congestion on major roadways; (c) continued (or anticipated) growth in CBD employment, urban population, and transit ridership; and (d) community desire to improve transit.
2. *Identify the Market.* Current and future land use and demographic characteristics should be clearly identified. Market segments include riders diverted from local bus and automobiles as well as new trips. Similarly, current and future transit ridership profiles—including origin-to-destination patterns, expected BRT ridership, and maximum load section (point) volumes—should be determined. Candidate markets include corridors with sufficient ridership potential to allow frequent all-day service (preferably at headways not greater than 10 to 12 minutes). A strong CBD (e.g., with more than 50,000 jobs) and high-density corridors are supportive of BRT.
3. *Select Type of Running Way.* Selecting the type of BRT running way depends upon (a) availability of off-street right-of-way within the proposed BRT corridors; (b) width, continuity, and operational characteristics of arterial streets; and (c) the ability to integrate BRT operation with existing transit service.
4. *Recognize Public Preferences.* Community and agency preferences regarding BRT routes should be taken into account. The public's preference for a special BRT vehicle should have the support of the transit agency responsible for operating the BRT service. Similarly, operational treatments such as bus lanes, TSP, and queue jump/bypass lanes should have the support of the street transportation agencies.
5. *Integrate BRT with Existing Bus Services.* Existing bus routes on streets in or serving a BRT corridor may need to be restructured. Local routes should

The Guide provides guidelines for integrating and assessing BRT components.

feed rather than duplicate the BRT service. Where BRT operates on busways, terminals or outlying stations can serve as focal points for connecting bus services.

6. *Consider Funding Availability.* Available resources for capital, operating, and maintenance requirements are essential. The funding available for BRT may influence the type and extent of BRT features and the staging of BRT service implementation. Where funding is limited, BRT may have to operate on city streets rather than on off-street busways (at least initially). Similarly, existing vehicles might have to be used initially (although distinctively colored).
7. *Explore Development Opportunities.* Opportunities for land development near BRT stations should be explored. They can have bearing on (a) the extent of the BRT system, (b) the location and design of stations, (c) the type of running way selected, and (d) ridership. Experience suggests that, under the right market conditions, BRT can influence development at major outlying busway stations (e.g., Ottawa) or along rebuilt urban streets with improved landscaping and sidewalks (e.g., Boston).

### Costs and Effects

The costs and effects of various BRT components were derived from the information contained in the project profiles. Exhibit S-1 gives representative unit costs for running ways, transit preferential treatments, stations, vehicles, fare collection, passenger information systems, branding, and ITS. Right-of-way costs were excluded because they depend upon running way options and local circumstances. Exhibit S-2 and Exhibit S-3 give cost and travel time savings for various running way options and preferential treatments, respectively.

The various costs and effects can be applied to any projected BRT route and the local bus routes in the same corridor. The key analysis steps for each alternative are shown in Exhibit S-4.

### Example BRT Development Scenarios

Chapter 5 uses example BRT development scenarios (case studies) for a 15-mile BRT route to show how the steps in Exhibit S-4 were actually applied. The following six scenarios were analyzed:

- Grade-separated busway (14 miles) and CBD bus lanes (1 mile)
- At-grade busway (14 miles) and CBD bus lanes (1 mile)
- Median arterial busway (5 miles), at-grade busway (5 miles), mixed traffic (4 miles), and CBD bus lanes (1 mile)
- Bus lanes with TSP (10 miles), mixed traffic (4 miles), and CBD bus lanes (1 mile)
- Bus lanes without TSP (10 miles), mixed traffic (4 miles), and CBD bus lanes (1 mile)
- TSP in mixed traffic (15 miles)

The Guide evaluates six example BRT scenarios (case studies).

*Bus Rapid Transit Practitioner's Guide*

**Exhibit S-1 Representative BRT Component Development Costs**

Component	Unit	Cost/Unit
<i>Running Way</i>		
Off-street busway		
At-grade	Per route-mile	\$5 million
Grade-separated	Per route-mile	\$13 million
Elevated	Per route-mile	\$50 million
Tunnel	Per route-mile	\$200 million
On-street		
Median arterial busway	Per route-mile	\$4 million
Bus lane - new construction	Per route-mile	\$25 million
Bus lane - striping lane	Per route-mile	\$100,000
<i>Transit Preferential Treatments</i>		
Queue bypass		
Parking removal	Per approach	Negligible
Use of right turn lane	Per approach	Negligible
Added lane	Per approach	\$300,000
Curb extension	Per extension	\$60,000
TSP	Per intersection	\$30,000
Special transit phase	Per intersection	\$10,000
<i>Stations</i>		
Typical		
Basic	Per station	\$21,000*
Enhanced	Per station	\$30,000*
Major		
At-grade	Per station	\$150,000
Grade-separated	Per station	\$2.5 million
Intermodal center	Per station	\$12.5 million
Passing lane	Per lane-mile	\$2.7 million
<i>Vehicles</i>		
Conventional standard	Per vehicle	\$325,000
Stylized standard	Per vehicle	\$350,000
Conventional articulated	Per vehicle	\$570,000
Stylized articulated	Per vehicle	\$780,000
Specialized BRT	Per vehicle	\$1.3 million
<i>Fare Collection</i>		
On-board		
Magnetic card media	Per vehicle	\$15,000
Smart media	Per vehicle	\$20,000
Off-board		
Magnetic card media	Per machine	\$60,000
Smart media	Per machine	\$65,000
<i>Passenger Information</i>		
At-station information	Per sign	\$6,000
On-board information	Per vehicle	\$4,000
<i>Branding</i>		
Branding	Per system	Negligible
<i>ITS Applications</i>		
On-board security	Per vehicle	\$10,000
On-board vehicle guidance		
Optical/magnetic sensors	Per mile	\$20,000
Hardware integration	Per vehicle	\$50,000
On-board precision docking		
Optical/magnetic sensors	Per station	\$4,000
Hardware integration	Per vehicle	\$50,000
On-board performance monitoring	Per vehicle	\$2,000
AVL	Per vehicle	\$8,000

\* One direction

NOTE: Values are in 2004 U.S. dollars. Costs include engineering and design.

SOURCE: *TCRP Report 90* (TRB, 2003), *Characteristics of Bus Rapid Transit for Decision-Making* (FTA, 2004), *TCRP Project A-23A Interim Report, A Compendium of Vehicles and Hybrid Drive Systems for Bus Rapid Transit Service* (WestStart-CALSTART, 2005), and *TCRP Synthesis 48*.

**Exhibit S-2 Cost and Travel Time Savings of Various Running Way Options**

Running Way Option	Cost per Mile (millions)	Time Savings per Mile (minutes)	Cost per Minute Saved (millions)
Partially grade-separated busway	\$13.00	4.30	\$3.00
At-grade busway	\$5.00	3.60	1.40
Median arterial busway	\$4.00	1.50	2.70
Bus lane (rebuilt)	\$2.50	1.10*	2.30
Bus lane (re-striped)	\$0.10	1.10*	0.09
Queue bypass (add lane)	\$0.30*	0.10	3.00
Curb extension	\$0.24	0.27	0.90
TSP	\$0.12	0.33	0.40

\* May be 0.5 to 0.7 minutes/mile for higher bus operating speeds

NOTE: The base condition is a running speed of 10 mph (6 minutes/mile and 6 stations/mile).

SOURCE: Exhibit 5-4 and Exhibit 5-5

**Exhibit S-3 Costs and Travel Time Savings of Preferential Treatments**

Treatment	Approaches per Mile	Cost/Unit (millions)	Cost/Mile (millions)	Time Savings/Unit (seconds)	Time Savings/Mile (seconds)
Queue bypass (with construction)	1	\$0.30	\$0.30	6	6
Curb extension	4	\$0.06	\$0.40	4	16
TSP	4	\$0.03	\$0.12	3	20

SOURCE: Exhibit 5-8 and project profiles

Comparisons of anticipated BRT travel times, ridership, and development costs for the six scenarios analyzed are shown in Exhibit S-5. Similar information can be developed for BRT proposals in any given corridor. While the numbers and relationships are specific to the six scenarios analyzed, several patterns emerge:

1. As BRT development costs increase, there is a consistent reduction in travel times and a growth in BRT ridership.
2. Faster travel times reduce operating costs for any given bus volume.
3. The busway scenarios, because of their exclusive right-of-way and wider station spacing, have the greatest gains in speeds and ridership, but also the greatest investment costs.
4. The lower-cost scenarios (i.e., bus lanes and TSP) have the smallest time savings and ridership gains.
5. Travel time savings appears to be the greatest contributor to BRT ridership gains, followed by the provision of special BRT features. While BRT may run at short intervals, the splitting of corridor service between BRT and local bus operations may limit computed BRT ridership gains because of the combined bus frequencies.

Any city-specific analysis should reflect local conditions in terms of land and construction costs, population and employment growth, and land development impacts. Current experience suggests that major investments such as busways and reconstructed arterial streets may encourage new investments.

*Bus Rapid Transit Practitioner's Guide*

Exhibit S-4 Key Analysis Steps	
Step	Items to Analyze
1. Estimate base conditions.	A. Existing bus services B. Existing travel times C. Existing ridership
2. Define future conditions.	A. Type of running way B. Station types and spacing C. Vehicle type and door configuration D. Method of fare collection E. Transit preferential treatments
3. Estimate travel time savings.	A. BRT B. Other bus services
4. Allocate base corridor riders to BRT and local services.	A. Rider survey to identify origin-to-destination patterns and preferences B. Relative travel times of various services
5. Estimate ridership gains from travel time savings (for BRT and other services).	A. Effects of running way type B. Effects of station spacing and dwell times C. Effects of priority treatments
6. Estimate ridership gains from improved frequency.	A. Greater frequency on BRT routes B. BRT riders who save time by taking first bus on combined BRT-local route
7. Subtotal ridership (from Steps 5 and 6).	
8. Estimate additional ridership from BRT components (features).	A. Features of BRT route
9. Estimate total base year riders (Step 7 + Step 8).	
10. Estimate BRT fleet requirements	A. Peak-hour peak direction riders in maximum load section B. Vehicle type, size, and passenger capacity C. Round-trip vehicle travel time (with recovery) D. Provision for spares
11. Estimate effects of growth	A. Population and employment growth in corridor
12. Estimate development costs of BRT components (features).	

Exhibit S-5 Illustrative BRT Travel Times, Ridership, and Costs						
	Scenario 1	Scenario 2	Scenario 3	Scenario 4	Scenario 5	Scenario 6
Item	Grade-Separated Busway	At-Grade Busway	At-Grade Busway & Median Arterial Busway	Bus Lanes (Rebuilt) & TSP	Bus Lanes Only	TSP Only
Existing (base) one-way travel time	94 min	94 min	94 min	94 min	94 min	94 min
BRT in-vehicle travel time	29 min	43 min	48 min	50 min	57 min	58 min
<i>% reduction</i>	69%	54%	49%	47%	39%	38%
Assumed BRT base ridership	10,000	10,000	20,000	8,000	8,000	8,000
Anticipated BRT ridership	17,660	15,700	33,020	11,600	10,885	10,815
<i>% increase</i>	77%	57%	65%	45%	36%	35%
Existing local bus ridership	20,000	20,000	20,000	16,000	16,000	16,000
Anticipated local bus ridership	10,000	10,000	-	8,490	8,490	8,000
Estimated development costs*	\$242.0 million	\$109.4 million	\$84.3 million	\$40.3 million	\$12.5 million	\$11.4 million

\* In 2004 dollars

NOTE: Numbers have been rounded.

SOURCE: Computed

**LAND DEVELOPMENT**

There is growing documentation of the positive land development effects associated with BRT, especially where the systems have operated for several decades. Land development effects were quantified for busway systems in Adelaide (Australia), Brisbane (Australia), Ottawa, and Pittsburgh and along reconstructed arterial streets in Bogotá (Colombia) and Boston. The data showed the following:

- For every 5 minutes of additional walking time to a BRT station in Bogotá, the rental price of a property decreased between 6.8% and 9.3% after controlling for structural characteristics and neighborhood attributes.
- Boston's Silver Line, operating on rebuilt Washington Street between downtown Boston and Dudley Square, has generated more than \$700 million in new investment within a few blocks of the BRT route.
- Brisbane's South East Busway has reported a 20% gain in property values near the Busway. There has been a greater increase in home values along the Busway as compared with other suburban areas.
- Ottawa's Transitway system has generated more than \$1 billion (Canadian) dollars in new investment since its opening in December 1983. The municipality's land use policy requires major activities to locate near the Transitway and also limits parking at or near stations. The St. Laurent Center—connected to the Transitway by weather-protected, grade-separated walks—is one of Canada's most productive shopping centers. About a third of the Center's customers arrive via the Transitway. Concurrent with the opening of the St. Laurent Transitway Station in 1987, the Center completed a major expansion that included 80 additional stores.
- Pittsburgh's East Busway, which shares a corridor with a railroad, has generated more than \$302 million in new development between 1983 and 2000. About 80% is clustered at stations. One-third of the new development represents an extension of the CBD.
- In contrast, where bus service is improved without any major changes in physical facilities, little transit-oriented development (TOD) has been realized, as along San Pablo Avenue in Oakland.

The following guidelines for helping communities, transit agencies, and developers plan and assess land development opportunities along BRT lines and at BRT stations emerged from a review of salient literature; an overview of TOD programs in Boston, Ottawa, and Pittsburgh; and developer surveys conducted in Boston and Ottawa:

- BRT, like rail transit, can improve accessibility and increase passenger capacity in the corridors that it serves. It can help increase CBD intensity and encourage development at major nodes and in outlying areas. Each of these locations offers promise for transit-related development. BRT junctions with major intersecting bus routes also offer promising locations for TOD.
- BRT systems should serve both existing and future markets. Where BRT serves existing markets in built-up areas, the customer base is well-established, but creating new TOD projects may be difficult. Where BRT serves underdeveloped areas, it has the opportunity to shape development around the route.

The Guide provides guidelines for assessing land development opportunities along BRT lines and at BRT stations.

---

*Bus Rapid Transit Practitioner's Guide*

- Successful TOD requires a strong, dynamic market, especially for retail development. Only where there is a latent demand for development near transit can significant increases in land value be achieved. Thus, not every BRT route or station can attract development.
- Land should be available at reasonable cost for the intended uses.
- The BRT route should provide a strong sense of permanence and a clear identity (in addition to faster service) to attract development. Improved (preferably separate) running ways and new urban design features can create a positive climate for investment; a good example of this is the positive development effects of Boston's Washington Street Silver Line.
- The location and design of BRT routes should consider land development opportunities. Vision is important. Urban redevelopment, for example, has been a major consideration underlying Cleveland's Euclid Avenue Transitway.
- Convenient transit passenger access should be provided for developments adjacent to, or integrated with, BRT stations. Attractively designed BRT stations with conflict-free, weather-protected pedestrianways connecting transit stations to adjacent activity centers can have a positive effect on land development. The St. Laurent station along Ottawa's Transitway is an example of such a treatment.
- Site designs should encourage density, diversity, and walkability. Transit-supportive uses (retail, office, and residential) should be encouraged. Mixed-use developments can add interest and variety; however, the various uses do not have to be mixed in the same location.
- Transit-supportive policies should be established. They can specify where various developments can locate (i.e., zoning), site design and access features, and parking requirements. Ottawa's Official Plan, for example, requires all major retail centers to be located along its Transitway or LRT system.
- Parking policies should support TOD. It is desirable to avoid both too much and too little parking. Parking should be limited, especially adjacent to BRT stations, and structured parking, while costly, may be desirable where land costs are high and space is at a premium. Ottawa's policies, for example, specify a maximum parking requirement of one parking space per 455 square feet of development within 1,300 feet of a BRT station and a maximum of two spaces per 1,000 square feet of office space elsewhere.
- Public-private partnerships should be encouraged. The public sector has the power to resolve land assembly problems, ensure that the site is ready for development, contribute land, and fund infrastructure improvements. Private developers can finance, build, and operate the developments. Working together, they can expedite TOD.
- Service planning should recognize that BRT, in contrast to rail transit, can potentially minimize transfers by providing both transfer-free neighborhood feeder bus service and trunk service.

**GUIDE CONTENTS**

The six chapters in the *Bus Rapid Transit Practitioner's Guide* contain detailed guidelines for planning BRT; estimating BRT ridership; describing component features, designs, costs, and impacts; packaging, integrating, and assessing systems; and achieving land development benefits.



---

*Bus Rapid Transit Practitioner's Guide*

This page is intentionally blank.

## CHAPTER 1. INTRODUCTION

### OVERVIEW

The *Bus Rapid Transit Practitioner's Guide* is intended to aid transportation practitioners in planning, assessing, and implementing bus rapid transit (BRT) systems. The Guide shows transportation professionals how to identify the costs and impacts of different features that make up a BRT system. It covers the main components of BRT: running ways, stations, vehicles, intelligent transportation systems (ITS) applications, service planning, fare structure, and operating practices. It also sets forth a process for the most efficient packaging of components into an integrated system given financial, environmental, and institutional constraints.

The Guide was developed through TCRP Project A-23A, "Cost and Effectiveness of Selected Bus Rapid Transit Components." It is a follow-on to the TCRP project that produced *TCRP Report 90: Bus Rapid Transit (1)*, which contains 26 case studies from cities around the world that have or are planning to implement BRT systems (in Volume 1) and planning and implementation guidelines for BRT systems (in Volume 2). The Guide also complements the FTA document *Characteristics of Bus Rapid Transit for Decision-Making (CBRT, 2)*.

In recent years, a growing body of information has become available on the costs and effectiveness of various BRT components. The synthesis and evaluation of this information can help transit agencies determine which components are most effective for application.

This Guide sets forth the component costs and impacts of BRT components and shows how they relate. Impacts include, but are not limited to, effects on ridership, system performance, and community development.

The Guide also establishes a process for estimating ridership impacts associated with different BRT components, the attractiveness of which can be further identified through preference surveys of users and non-users and the application of elasticity factors or more elaborate mode choice models. Thus, the Guide complements and goes beyond the information and guidelines contained in *TCRP Report 90 (1)* and *CBRT (2)* by showing how best to package different BRT components, given their costs and effects while recognizing local financial, environmental, and institutional constraints.

### NATURE OF BRT

#### Definition

BRT has been defined by the FTA as a "rapid mode of transportation that can provide the quality of rail transit and the flexibility of buses." In *TCRP Report 90 (1)*, the definition of BRT was expanded to "a flexible, rubber-tired form of rapid transit that combines stations, vehicles, services, running ways, and ITS elements into an integrated system with a strong image and identity." BRT is an integrated system of features, services, and amenities that improves the speed, reliability, and identity of bus transit.

The Guide addresses costs, impacts, and packaging of BRT components.

BRT is an integrated *system* of features, services, and amenities.

---

## Bus Rapid Transit Practitioner's Guide

### Components/Features

The main features of BRT systems include the following:

- Dedicated (bus-only) running ways (preferably, physically separated from other traffic)
- Accessible, safe, secure, and attractive stations
- Easy-to-board, attractive, and environmentally friendly vehicles
- Efficient (i.e., off-board) fare collection
- ITS applications to provide real-time passenger information, signal priority, and service command/control
- Frequent, all-day service
- Distinctive system identity

All BRT systems must have running ways, stations, and vehicles. Other major components include service design, the fare collection system, the application of ITS technology, and branding. Service design is the *key* to system design. The individual components must be compatible and must support the service design.

The type of each component varies among systems. Running ways include special physical facilities such as busways, and operational treatments such as bus lanes, queue jumps/bypass lanes, and transit signal priority (TSP). Stations can range from smaller passenger waiting areas with simple shelters to large-scale terminals with many passenger amenities. BRT vehicles typically are large-capacity, stylized vehicles with low-floor boarding and different degrees of ITS integration, such as automatic vehicle location (AVL), next-stop annunciators, and driver-assist systems. Fare collection systems can be located either on- or off-board vehicles and can integrate new electronic media such as smart cards. Service design can range from BRT serving as a new line-haul service with limited stops to BRT serving as a feeder service that extends the reach of rail transit. Finally, branding the system creates a unique logo, color scheme, and/or marketing strategy that distinguishes the BRT service from other transit services.

Major BRT components addressed and incorporated into the Guide include the following:

- Use of exclusive right-of-way, including busways, exclusive lanes, and bypass lanes for buses at congested intersections (“queue jumping”) to reduce vehicle running time
- Use of limited-stop service, including express service and skip-stopping;
- Application of ITS technology such as TSP, AVL systems, advanced security systems, and customer information systems
- Use of advanced technology vehicles (e.g., articulated buses, buses with modern propulsion systems, and low-floor buses) and new, specially designed vehicles that may have doors on each side
- Design of stations
- Use of off-board fare payment, including smart cards and proof-of-payment systems
- Branding the system
- Use of vehicle guidance systems (mechanical, electronic, or optical)
- Other strategies that enhance customer satisfaction

A BRT system must have running ways, stations, and vehicles.

Service design is the key to system design.

The Guide covers nine major BRT components, including running ways, stations, vehicles, operating strategies, ITS, and branding.

**QUESTIONS COMMONLY ASKED**

There are many reasons for communities to consider BRT as a rapid transit option:

- BRT can be implemented quickly and incrementally.
- BRT can be the most flexible rapid transit mode for cost-effectively serving the broad variety of urban and suburban environments and markets found in the United States and Canada.
- BRT can operate
  - > On arterial streets,
  - > In freeway medians and on freeway shoulders,
  - > Alongside freeways,
  - > In railroad and other separate rights-of-way,
  - > On aerial structures , and
  - > Underground (in tunnels).
- BRT can accommodate express and limited-stop services on a single facility.
- BRT can provide sufficient transport capacity for most urban corridors in the United States and Canada.
- BRT can be less costly to implement than a rail transit line while providing similar benefits.
- BRT can have very little additional implementation cost over local bus service.
- BRT can have modest operating costs for most urban corridors in the United States and Canada.
- BRT can be effectively integrated into the surrounding environment and generate significant urban development benefits.

There are many important questions that transit planners and policy-makers must ask as they evaluate whether BRT is the appropriate transit mode to apply in a particular corridor or region.

**How Well Does It Work?**

BRT may be considered an alternative to rail, particularly light rail transit (LRT), in an urban area. BRT can provide rail-like operating characteristics in terms of operating speed, capacity, and dependability. To what degree do running way, station, and vehicle characteristics play a role?

**Is It a Viable Rapid Transit Option?**

With suitable operating characteristics, will a BRT system attract sufficient ridership at a reasonable cost to make it a cost-effective alternative to rail? Will the passenger amenities associated with BRT be perceived as comparable to those associated with rail systems?

There are many reasons to consider BRT in the U.S. and Canada.

BRT has flexibility in operation and can be developed incrementally.

---

## Bus Rapid Transit Practitioner's Guide

### What Are Its Costs and Benefits?

What are the costs of different elements of a BRT system and their benefits? In particular, what is their impact on travel time and ridership?

### Which Components Are Essential?

Given the limited financial resources of many transit agencies and local jurisdictions, which BRT components will provide the greatest benefit at a reasonable cost? What is the best packaging of BRT components given physical and financial opportunities and constraints?

### How Can Community Support Be Achieved?

With the scale of a BRT system identified, how does this system fit into the community in terms of compatible stations and vehicles and the overall branding of the system? What land development impacts associated with BRT might be expected, and will they be compatible with local land development objectives?

### How Can BRT Be Integrated with the Existing Bus System?

What is the best service design for a new BRT line or system? How can BRT interface with local bus service in a corridor, and what type/degree of feeder bus service might be appropriate? What changes in local bus services are needed?

### WHAT THE GUIDE COVERS

The *Bus Rapid Transit Practitioner's Guide* is divided into five remaining chapters. The Guide has been developed in a format similar to *TCRP Report 100: Transit Capacity and Quality of Service Manual*, 2nd Edition (3), with sidebars provided to highlight or summarize certain points made in the document.

The guidelines can complement locally derived values on costs, ridership gains, travel time savings, improved reliability, and land development effects. They can also serve as a benchmark to which locally derived values may be compared.

### Chapter 2 - Planning Framework

This chapter presents a planning process for assessing the needs, demand, alternatives, components, and configuration of a new or enhanced BRT system. A critical focus is how the costs, impacts, and effectiveness of different BRT components should be addressed in relation to ridership demand, alignment, options and service design alternatives, and a final BRT system configuration. The relationship to the FTA New Starts and Small Starts programs associated with the new SAFETEA-LU federal transportation funding reauthorization is also discussed.

### Chapter 3 - Travel Demand Estimation

This chapter describes BRT ridership experience. It also discusses methods and assumptions for estimating ridership changes resulting from implementing a BRT service. Key topics include mode choice models, elasticities, and BRT component synergy. Some judgments were made for the potential ridership gains of various BRT features.

Six chapters give planning and evaluation guidelines.

The guidelines should be used in conjunction with locally derived values.

## Chapter 4 - Component Costs and Impacts

This chapter reviews a number of individual BRT components, including running ways, stations, vehicles, fare collection, passenger information, and service design. Guidelines are set forth for each component in terms of estimating (1) location and scale of application; (2) capital and operating costs; (3) likely impacts, including impacts on BRT ridership and travel time; and (4) analysis methods. Implementation issues including likely community acceptance are also addressed.

## Chapter 5 - System Packaging and Integration

This chapter gives guidance for packaging and integrating different BRT components and assessing their effects. It shows how BRT components can be packaged, and it gives parameters and procedures for estimating costs and effects. It also gives examples of estimating BRT impacts for various BRT development scenarios.

## Chapter 6 - Land Development Guidelines

This chapter reviews existing documentation of land development impacts associated with recent BRT projects, as well as public agency and developer perceptions of how BRT service and BRT components impact land development location, design, and decision-making. The perceptions were obtained from a BRT land development survey conducted for two existing BRT systems: the Transitway in Ottawa and the Silver Line in Boston. Transit-oriented development (TOD) policies were obtained from Ottawa and Pittsburgh. Guidelines are provided for assessing the likely land development impacts of new BRT systems (or system improvements) and determining what land development policy and design standards might be applied to encourage TOD around BRT facilities.

## REFERENCES

1. Levinson, H., S. Zimmerman, J. Clinger, S. Rutherford, R. Smith, J. Cracknell, and R. Soberman. *TCRP Report 90: Bus Rapid Transit: Vol. 1, Case Studies in Bus Rapid Transit, and Vol. 2, Implementation Guidelines*. Transportation Research Board of the National Academies, Washington, D.C., 2003.
2. Diaz, R.B., M. Chang, G. Darido, E. Kim, D. Schneck, M. Hardy, J. Bunch, M. Baltes, D. Hinebaugh, L. Wnuk, F. Silver, and S. Zimmerman. *Characteristics of Bus Rapid Transit for Decision-Making*. FTA, Washington, D.C., 2004.
3. Kittelson & Associates, Inc., KFH Group, Inc., Parsons Brinckerhoff Quade and Douglass, Inc., and K. Hunter-Zaworski. *TCRP Report 100: Transit Capacity and Quality of Service Manual*. Transportation Research Board of the National Academies, Washington, D.C., 2003.

---

*Bus Rapid Transit Practitioner's Guide*

This page is intentionally blank.

## CHAPTER 2. PLANNING FRAMEWORK

### INTRODUCTION AND OVERVIEW

BRT should be an outgrowth of a planning and development process that stresses solving demonstrated current and forecast future problems and related needs. Planning for BRT calls for a realistic assessment of demands, costs, benefits, and impacts for a range of alternatives that includes a "base case" and may include one or more rail-based rapid transit alternatives. The basic planning objective should be to provide attractive and reliably fast transit service that

- Serves demonstrated current and forecast future transit demand and needs,
- Provides reserve capacity for future demand growth,
- Attracts auto drivers to transit,
- Relates to and reinforces transit- and pedestrian-oriented development plans, and
- Has affordable initial implementation and ongoing operating and maintenance costs.

Plans for BRT should focus on major markets, take advantage of incremental development opportunities, and promote complementary Transit First policies. "Deconstruction" of a BRT system by removing elements critical to its success to cut costs should be avoided. At the same time, the addition of unnecessary, capital cost-intensive features should be avoided.

BRT can be especially desirable in large cities, where passenger flows warrant frequent service and there is a sufficient presence of buses to justify dedicated running ways. The following thresholds are suggested:

- There should be one or more strong anchors (such as the city center) and a large tributary area. Current experience suggests that, in the United States or Canada, urban population should generally exceed 750,000 and central business district (CBD) employment should generally be at least 50,000 (1). However, a large university or other outlying activity center may support a BRT route or system.
- Desired trunk line BRT headways should not be more than 8 to 10 minutes during peak periods and not more than 12 to 15 minutes during off-peak periods.
- Ideally, there should be at least one BRT (and local) bus per traffic signal cycle where buses operate in a dedicated arterial street BRT lane.

### FEDERAL, STATE, AND LOCAL CONTEXT

Good transportation planning practice requires that major infrastructure investment proposals derive from an objective analysis of a reasonable range of investment options, including a base case. These alternatives are developed from an understanding of the transportation and transportation-related challenges and problems faced in metropolitan areas in general and specific corridors in particular.

The planning process should be open and objective. It should reflect each area's needs, opportunities, and resources. Studies involving a major capital investment (such as a busway) should include an alternatives analysis performed in accordance with FTA guidelines. However, low-cost, short-term operational

Do not remove critical BRT system elements to cut costs.

BRT needs one or more strong anchors and a tributary area.



*Bus Rapid Transit Practitioner's Guide*

strategies may be implemented by the transit agencies in conjunction with highway and street traffic agencies.

The SAFETEA-LU legislation requires a less rigorous alternatives analysis and FTA evaluation process for projects where less than \$75 million of federal funds is requested. However, the new Small Starts transit capital assistance program follows the basic analysis process described above.

Exhibit 2-1 illustrates the different types of analyses that are part of the transportation planning continuum and relates them to different levels of FTA funding programs. Note that the information needs and ridership forecasting process for the various planning activities are different in both breadth and depth.

BRT project development activities are related to level of funding.

**EXHIBIT 2-1 Types of Analyses for Assessing Transit Project Development**

Planning/Project Development Phase	Bus Corridor Improvements, <\$25 Million	Small Starts, <\$75 Million*	New Starts, >\$75 Million*
Screening of Alternatives/Systems Planning	Process Function: Identification and Screening of Broadly Defined System Package Concepts for Refinement and Analysis		
	Criteria: Sketch Planning Level of Detailed Cost, Benefit, and Impact Estimates		
	Products: Alternatives for Further Refinement and/or Analysis		
Alternatives Analysis	N/A	Process Functions: Less Detailed Analysis, Fewer "Justification" Criteria Needed; Otherwise Same as for New Starts	Process Functions: Definition of Alternatives at Both BRT Element and System's Package Level, Check Reasonability of Analysis Results
		Criteria: More Accurate Estimates of Costs, Benefits, and Impacts for System Alternatives	Criteria: More Accurate Estimates of Costs, Benefits, and Impacts for System Alternatives
		Outcome: Single System's Package to Bring into Project Development/PE	Outcome: Single System's Package to Bring into Project Development/PE
Preliminary Engineering	Process Functions: Detailed Definition of Each Element in Selected System Package, Assessment of Reasonability of Specifications, and Cost Estimates, by Element		
	Criteria: Detailed Cost, Performance, and Impact Estimates to Take into Final Design and Implementation		
	Outcome: Detailed Definition of Project to Take into Final Design/Implementation		

\*Limit of federal funding

SOURCE: CBRT (2)

FTA's new Very Small Starts funding category within Small Starts has "no build" as the baseline alternative.

FTA requires that an alternative be developed to serve as a base case for developing and evaluating a complete range of "build" alternatives. For both New Starts and Small Starts projects, this base case alternative will be different from a traditional "do nothing" or "no project" alternative. FTA requires that the base case alternative achieve the most benefit from existing transit and highway infrastructure with only modest additional investment. Sometimes it is called a transportation system management (TSM) option.

FTA also requires that the range of alternatives includes options that are intermediate in cost between the baseline and more expensive fixed-guideway (usually rail transit) investments. In recent years, the need to consider a

“reasonable range of alternatives” has translated into the development and analysis of BRT options that usually cover a range of technological sophistication and costs.

This chapter gives general guidelines for applying the alternatives analysis procedures to BRT. The best place to find more detailed information and guidance on the federal New Starts and Small Starts planning and project development process is at the following FTA web site:

[http://www.fta.dot.gov/funding/grants\\_financing\\_263.html](http://www.fta.dot.gov/funding/grants_financing_263.html)

In most corridor applications, a BRT line will generally cost less than an LRT line. However, BRT can represent a substantial investment in both capital and operating and maintenance costs. Accordingly, the decision to invest in BRT should be taken seriously and follow the same basic project planning process used for any rapid transit investment, whether or not federal funding assistance is requested.

### ALTERNATIVES ANALYSIS STEPS

After policy endorsement of goals, objectives, and criteria, transportation planners should begin the rapid transit planning and project development process with an in-depth analysis of the characteristics and causes of current and potential future transportation and transportation-related problems and needs in a given corridor (or corridors). This corridor should have been identified by the ongoing systems planning process as needing a rapid transit investment. This analysis, known as an “alternatives analysis,” should focus on multi-modal (transit and highway) demand, supply, and performance in the corridor or corridors in question. It should also cover transportation-related environmental, social, economic development, and land use-related challenges and issues.

The key steps in the alternatives analysis process are shown in Exhibit 2-2. They include the following:

1. Establishing goals
2. Evaluating current problems and future needs
3. Identifying investment alternatives
4. Evaluating the alternatives
5. Selecting the general alignment for the recommended mode

The key questions to be addressed include the following:

- What are the problems and needs now and in the future?
- What are the modes, corridors, and service patterns?
- What is the ridership?
- What are the costs and benefits?

After a complete analysis of the current and projected future situations (i.e., analysis of a “no project” or “do nothing” option), alternative rapid transit and/or other multi-modal solutions should be identified (with the exception of Very Small Starts projects). The first alternative to be identified should be one or more modest-investment alternatives also referred to as TSM or base case alternatives. This option should include both additions of new capacity and services as well as operational improvements.

BRT investments should be studied to the same extent as rail-based transit investments.

There are five key steps in the alternatives analysis process.

An objective analysis of a full range of transit alternatives is necessary.

*Bus Rapid Transit Practitioner's Guide*

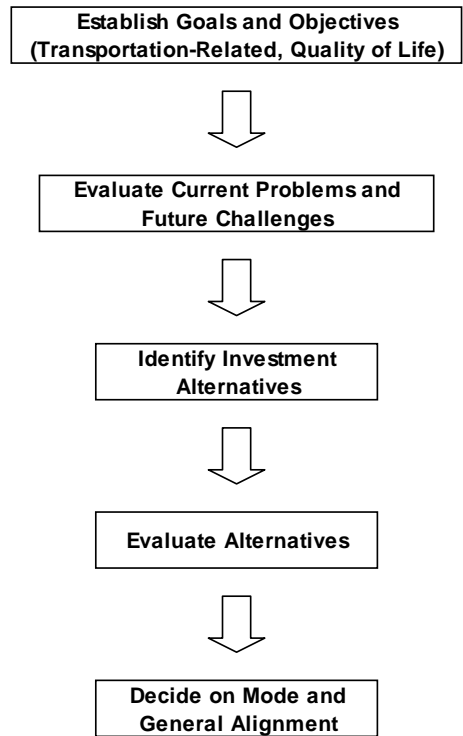

SOURCE: TCRP A-23A project team

**EXHIBIT 2-2 Alternatives Analysis Process**

Based on the analysis of the TSM alternatives, one or more rapid transit alternatives should be identified and analyzed. Where a modest BRT investment is contemplated, there may be only one rapid transit build alternative. However, where more expensive (e.g., in excess of \$75 million in federal funding) BRT and rail-based alternatives are examined, less expensive rapid transit alternatives should be examined, too.

Preliminary engineering follows the alternatives analysis process.

Following an open, objective analysis of the full range of alternatives in terms of the goals, objectives, and criteria enunciated at the beginning of the planning process, policy officials will select a single rapid transit alternative to take into more detailed planning, engineering, and design. This alternative will be defined in terms of basic mode and general alignment. The next step in the process, preliminary engineering, defines the selected alternative to a level of detail normally requiring completion of 30% of engineering and design activities.

Environmental review follows preliminary engineering.

At the conclusion of preliminary engineering, the environmental review process under the National Environmental Policy Act (NEPA) should have been completed, and the scope and cost of the project will be sufficiently defined to permit commitment to construction of the project by the various funding partners, including FTA. The federal commitment will reflect a rigorous cost-effectiveness analysis utilizing the results of the alternatives analysis and preliminary engineering processes. Realistic assessments of costs, ridership, benefits, and operating feasibility are essential.

**Establish Goals and Evaluate Problems and Needs**

At the outset, existing problems and needs of transit (and highway) services in a given corridor (or throughout the region) should be identified. Where for

example, is transit service slow, overcrowded, and unreliable? Where is recurrent congestion that might be reduced by new transit or highway investments? Where can existing problems be alleviated by transit (and/or highway) operational strategies? How will future growth affect the problem?

Where BRT is envisioned, an initial estimate of the demand for new BRT service should be undertaken. The following activities should be included:

- Identifying the market segments to be served
- Developing potential service configurations and frequencies for the new BRT service and local bus services in the corridor
- Estimating ridership for both the BRT and the local bus service

Existing bus ridership, land use patterns, and roadway characteristics may influence corridor selection and the viability of BRT service.

### *Identify Market Segments*

BRT can and should serve multiple market segments, targeted to serve both choice riders and transit-dependent populations. Market segments will include commuter trips to downtown areas and shorter, intermediate trips along a route. A market segmentation analysis should serve as an input into the potential travel demand assessment for BRT travel.

### *Initial Service Planning*

Associated with the initial market segment analysis, the desired configuration for new BRT service should be identified. This configuration could include a new limited-stop line-haul BRT service in a corridor or BRT running a portion in line-haul service with limited stops and then branching into local neighborhoods to serve as a circulator. Various options are shown in Exhibit 2-3. In any case, the impacts on local bus service in the corridor should be assessed. This assessment will include any changes in service frequency and/or span, as well as any restructuring of local bus service to complement the new BRT service. It could include allowing certain local buses to operate along all or part of the BRT facility.

### **Identify Alternatives**

Once a preliminary estimate of BRT ridership demand and an assessment of potential service concepts is completed, running way opportunities and alternatives should be identified, along with an appropriate station spacing plan and approximate station locations. This alternatives development process should be structured to follow FTA alternatives analysis guidelines where federal funding is involved, including an initial alternatives scoping process. Both running way and station alternatives should be narrowed down and refined as the alternatives analysis process proceeds, with build alternatives compared to a designated base case or no-build alternative.

BRT should be driven by both needs and opportunities.

Identify potential markets and ridership for BRT.

*Bus Rapid Transit Practitioner's Guide*

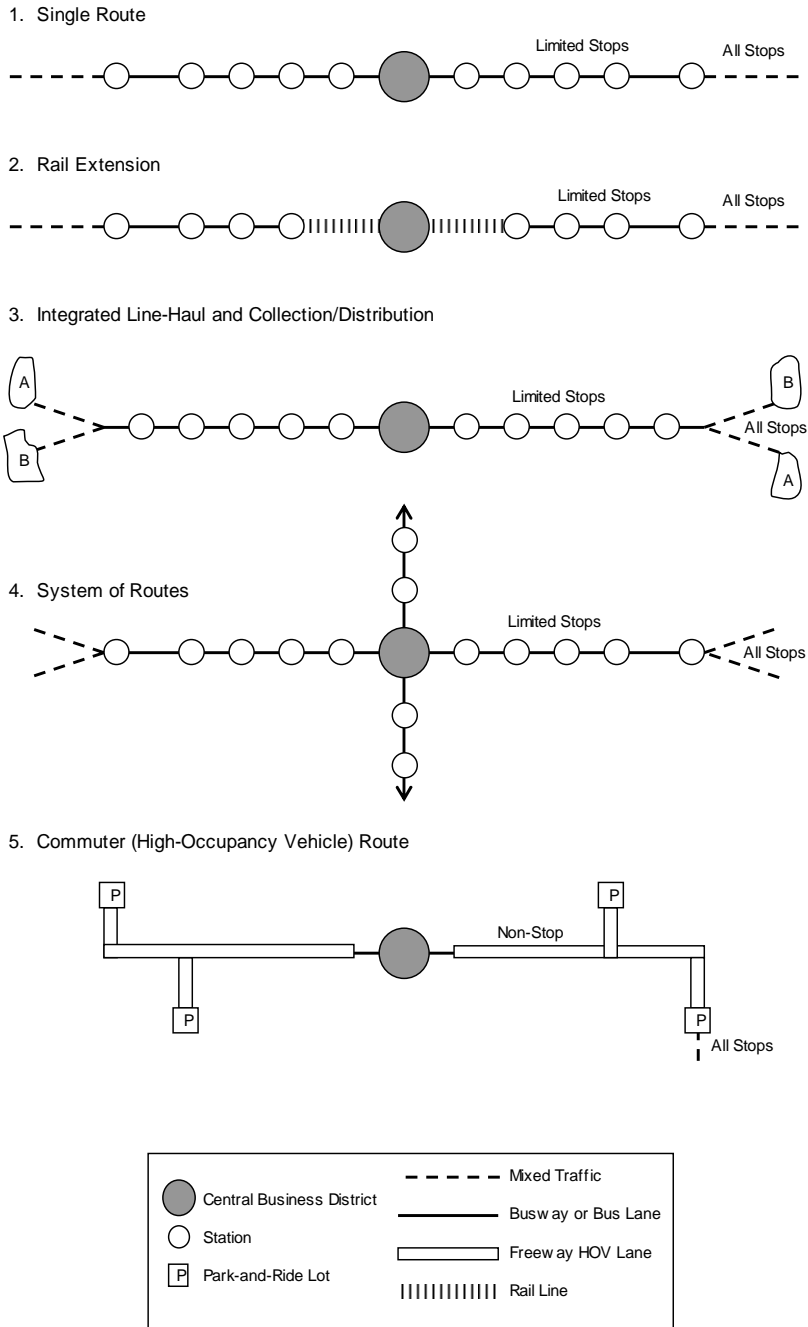

SOURCE: TCRP Report 90 (1)

EXHIBIT 2-3 BRT Route Configurations

*Identify Running Way Opportunities*

The corridor in which a new BRT route would operate typically would have a major roadway operating through a portion or all of its length, and/or a parallel rail route, and/or an open space corridor. Assessment of potential off-street running way opportunities, such as a busway, in the corridor will require obtaining data and insights on existing property ownership, environmental

features, existing/planned rail operations, and any other constraints to developing the corridor for BRT. Assessment of on-street running way opportunities should address the feasibility of developing bus lanes along the curb vs. in the median, including any potential for a median busway facility. The ability to modify parking regulations and other traffic controls should also be identified.

In addition to the corridor-level, physical BRT running way alternatives, intersection preferential treatment alternatives should be assessed. These alternatives include the potential implementation of TSP, queue jumps/bypass lanes, and/or curb extensions. A key decision is the trade-off between developing an exclusive busway or bus lanes vs. developing intersection preferential treatments in a BRT corridor. The need and opportunity to package new facilities and preferential treatments to maximize travel time savings for BRT should be indicated.

### *Identify Station Locations*

Once different running way alternatives are established for a BRT corridor, station locations and functions should be identified. Stations should be located in accordance with an overall BRT station spacing objective for the corridor; they should serve major activity centers along the route, as well as major crosstown transit routes.

### **Evaluate Alternatives**

An objective analysis of a reasonable range of alternatives is required for informed decision-making. Each option should be evaluated for its costs, effectiveness, and community impacts. Assessments should include ridership, travel times, constructability, operating feasibility, land development benefits, environmental effects, and capital and operating costs. Realistic and reliable estimates of costs and benefits are essential.

### *Estimate Ridership*

Ridership estimates are paramount among decision criteria. Ridership estimation is one of the most important activities that takes place during alternatives analysis for a number of reasons:

- Ridership reflects the ability of a given investment to attract new riders. Thus, ridership in itself is an important direct benefit. In quantitative terms, the benefits of new transit systems are related to the increase in ridership they generate multiplied by the change in the generalized "price" (linear combination of time and cost) of using them, both compared to a base case.
- Ridership is indirectly related to most other transit benefits, including congestion relief, air pollution emissions and fuel consumption, and the ability to induce positive land use and economic development effects.
- Ridership is an important input for detailed planning and design.

Transportation planners, therefore, should accurately estimate ridership for a complete range of options to satisfy good planning practice and FTA requirements. However, providing BRT estimates has historically been difficult for two reasons. First, full-featured BRT (i.e., BRT including off-board fare collection, ITS, dedicated running ways, etc.) is a relatively new mode, with little documented ridership experience. Second, there is a difference of opinion among many citizens and transportation professionals as to the relative attractiveness of BRT and rail rapid

There are trade-offs between running way improvements and intersection preferential treatments.

BRT ridership forecasting is addressed in more detail in Chapter 3.

Realistic and reliable ridership estimates are essential because ridership affects benefits and system design.

---

*Bus Rapid Transit Practitioner's Guide*

transit, particularly in relation to transit's competitiveness with driving. The public frequently associates "bus rapid transit" with conventional local bus service. Therefore, their response to abstract "stated preference" surveys could be significantly different from their actual response to something they see operating.

Making ridership forecasting for BRT even more challenging is the flexibility of BRT's relatively small vehicles and their ability to operate anywhere. This flexibility provides planners with a large variety of service plans and, hence, facility and equipment options. The traveler response to one BRT package with one level of completeness and quality may indeed be different from another, even if origin-to-destination travel times and costs are the same.

Current experience suggests that, where rail and BRT alternatives have the same station spacing, amenities, vehicle quality, span of service, level of running way dedication, and fare collection methods, their impedance (generalized cost) functions and modal bias constants should be basically the same. If one alternative (e.g., BRT) was better than the other in these respects, it would be the more favorable. Accordingly, whatever ridership forecasting approach is used for one rapid transit mode should be used for the other, subject to the caveat of system content comparability. The operable guidance for forecasting is, therefore, to *be conservative, consistent, and objective*.

Even where a detailed alternatives analysis is not mandated or warranted (e.g., because a major capital investment in BRT or any other mode is not being contemplated), ridership forecasting is important. Environmental impact assessment, evaluation of service plan options, estimation of vehicle and facility requirements, development of facility designs, and prudent financial planning all depend on good ridership information.

#### *Estimate Costs*

Capital and operating costs for each BRT option in a corridor are essential in comparing differences and obtaining funding. Capital cost estimates should include the costs of developing the new BRT running way, stations, vehicles, and system elements such as fare collection passenger information, security and safety systems, and branding. In the initial screening of different BRT corridor alternatives, generalized costs per station and per vehicle-hour can be applied based on costs derived from past BRT implementation efforts.

Operating cost estimates should include the basic costs of operating and maintaining the new BRT service. Operating cost estimates should address changes in operating costs associated with any changes in local transit service in the corridor. Standard cost models based upon bus-hours, bus-miles, and peak vehicles can be used; however, annual maintenance costs for stations and special running ways should be added.

Eventually transforming both capital and operating costs to a life-cycle cost assessment allows for a longer-term investment comparison of alternatives.

#### *Estimate Benefits*

The costs of different types and levels of BRT investment and the benefits of the new service for transit users, the agency providing the new BRT service, and the community as a whole should be indicated.

A basic input to estimating ridership and operating cost savings is the travel time savings associated with the new BRT operation, stemming from the use of exclusive facilities, preferential treatments, low-floor boarding on vehicles, and/or

Similar ridership forecasting approaches should be used for BRT and rail transit if BRT and rail transit have similar features.

Ridership forecasts should be conservative, consistent, and objective.

Life-cycle cost assessment should be a consideration.

Travel time savings and improved service reliability are key BRT benefits.

potential self-service fare collection, along with fewer stops. Travel time savings for transit users resulting from the new BRT service should be translated into cost savings by applying value of time assumptions. By attracting former automobile users, the new BRT service also can reduce automobile running times. By reducing travel time and improving reliability, the number of vehicles providing the service can be reduced.

Benefits to the community associated with a new BRT service include potential reductions in motor vehicle volumes and vehicle-miles traveled (VMT) in a corridor. Associated with this is potential air quality benefits resulting from fewer vehicles, less VMT, and the typically lower emissions of new BRT vehicles.

### *Constructability*

A key evaluation necessity even in the initial screening of BRT running way and station alternatives is determining whether the improvements can be constructed and operated without undue impact. "Undue impact" is defined as major right-of-way acquisition/relocation, extraordinarily high construction costs, or major harm to the community. Examples of poor constructability are developing a median arterial busway where maintaining frequent local cross-street access is required and constructing a busway in an active rail corridor where the required separation of the two facilities would result in major property acquisition and relocation.

### *Service Integration*

The type of BRT service to be provided in a corridor should be identified before alignment, station, and vehicle alternatives are developed and evaluated. As specific BRT running way and station alternatives are defined, the interface between the new BRT service and any existing local bus service in the corridor should be further addressed. One issue that should be addressed is determining whether BRT and local bus services will share the same stations or have separate stops. Having BRT and local buses at the same stations would require longer facilities (i.e., more berths) and potentially greater station costs; however, nearby local bus stops could be eliminated. Having a BRT station at a major crosstown bus route location may allow consolidation of BRT/crosstown stops, thereby facilitating passenger trips, which is critical for heavy bus passenger transfer movements.

Determine the degree to which BRT and local bus service should be integrated.

### *Community Development*

A key issue in any community is BRT's ability to attract developer investment to a BRT corridor, particularly to areas around BRT stations. Several cities have found that BRT can increase development intensity, property values, and housing prices. Recent surveys in Boston and Ottawa (as documented in Chapter 6) identify factors that attract developer interest to BRT corridors. Being able to target developer interest early in the planning process and working to create joint development incentives and opportunities at certain BRT stations should be a major objective in any BRT development effort.

## **Select and Refine Mode and Alignment**

After an initial evaluation of BRT service and routing options along a corridor, more refined planning and engineering analyses should be undertaken to define and detail a preferred option. This preferred option could represent a combination of previous options considered or a totally new option.



---

## *Bus Rapid Transit Practitioner's Guide*

### *Route/Alignment/Transit Preferential Treatments*

At the refined options stage, the specific route and alignment for the BRT service should be identified. This process will include identifying a specific on- or off-street alignment and a design treatment for the running way, as well as transit preferential treatment strategies (e.g., TSP, queue jumps/bypass lanes, curb extensions) to be applied at different locations along the route. The running way identification should be based on conceptual plans for the BRT facility, including typical sections, plans and profiles, grade-separated provisions for busways, and the location of stations and how they integrate with the BRT route alignment and the surrounding community.

Trade-offs between different types of transit preferential treatments at intersections should be understood at this stage. The final need for and feasibility of implementing TSP vs. queue jump/bypass lanes vs. curb extensions should be identified and related to the final location of BRT stations.

### *Refined Service Plan*

The refined BRT service plan should take the basic concept identified in the initial alternatives evaluation and identify a route structure, station locations, service span, and service frequency by time of day for the new BRT service. The service plan should also indicate modifications to any existing or new local bus service that would operate along all or a portion of the BRT corridor.

### *Station Features*

In conjunction with locating stations along the preferred alternative, a station functional classification scheme should be prepared. A station functional classification scheme identifies the function and scale of station development appropriate for different types of locations. The functional classification scheme would include identifying the relative size of station facilities, access mode provisions (e.g., walk-in, bicycle, bus transfer, kiss-and-ride, and/or park-and-ride), and the extent of passenger waiting area and shelter amenities to be provided at different stations. Typically, larger BRT stations with more passenger amenities are provided at terminal and major bus transfer locations. "Intermediate" stations typically have smaller stations with fewer amenities.

The size of passenger shelters based on anticipated ridership and other factors would be indicated in the station classification scheme. In addition to the size of the passenger waiting area and the extent of shelters, the need for other passenger amenities such as bicycle racks, a schedule information board, lighting, a telephone, a waste receptacle, landscaping, climate control, and real-time passenger information displays would be identified.

The station classification scheme can vary by the "look" and "feel" of station materials where tied to a particular theme associated with the adjacent neighborhood or a specific development. Some minimum level of branding that ties stations together, such as the provision of a consistent station identification sign and schedule board, is essential.

### *Vehicle Selection*

With the development of a refined BRT service plan and updated ridership projections, the size and type of BRT vehicle should be chosen. A basic decision is whether standard 40- to 45-foot buses, 60-foot articulated buses, and/or special BRT vehicles should be used for the new BRT service. The service plan may change once the vehicle size is established.

A station classification scheme is helpful in developing design features.

Choosing between standard-length and articulated buses is a basic decision.

In addition to the size of the BRT vehicle, its stylized look, fuel propulsion system, and interior layout should be identified. Input on the desired look and features of a new BRT vehicle can be obtained from preference surveys of both transit riders and non-riders.

### *ITS Elements*

The extent and type of ITS components to be incorporated into the vehicle need to be identified. Basic ITS components on BRT vehicles typically include next-stop annunciators, AVL, automatic passenger counters (APCs), and vehicle diagnostics. Advanced ITS technology that could be integrated into the BRT vehicles includes precision docking, automated guidance, and collision warning and avoidance systems. Real-time passenger information could be provided at stations and on-board vehicles.

### *Branding Strategy*

A branding strategy that creates a unique image for the new BRT service should complement running ways, vehicles, and stations and establish a BRT identity. Branding must be addressed in conjunction with further definition of the running way, station, and vehicle design to be applied. The branding strategy should include identifying a unique name, logo, and color scheme for the BRT service, identifying the different BRT system components to be branded, and developing marketing and other public information materials.

Branding of vehicles, stations, and marketing materials creates BRT's image.

### *Estimated Relationship of Ridership and Components*

As the new BRT service is further defined, the relative impact of different components on ridership can be estimated as an aid in prioritizing the extent of BRT component application given any financial constraints associated with the project. This process will include identifying the cost-effectiveness trade-off between the proposed running way treatment, the degree of station development, and the type/style of vehicle to be operated. Also, the relative merit of implementing certain passenger amenities at stations and certain ITS features on vehicles should be assessed. The use of preference surveys of both transit riders and non-riders can aid in identifying priorities in BRT component application.

## **SYSTEM PLANNING PRINCIPLES**

The following principles should guide BRT planning, design, and development:

- BRT should be developed as a permanently integrated system of facilities, services, and amenities.
- The BRT system should afford the key attributes of rail transit to the maximum extent possible.
- BRT should be complemented by appropriate Transit First policies. Examples include transit-oriented development, complementary downtown parking policies, and adequate park-and-ride space at outlying stations.
- BRT should be rapid. It should operate on separate rights-of-way wherever possible and on wide, continuous, free-flowing streets where separate right-of-way is unavailable or removed from markets. Wide station spacing (except in downtown areas) is desirable. TSP treatments and transit-sensitive traffic controls are desirable.

The Guide identifies 10 BRT system planning principles.

---

## Bus Rapid Transit Practitioner's Guide

BRT systems should focus on at least one major activity center, typically the CBD.

- BRT systems should be capable of staged development. Subsequent development could include extending a BRT line or upgrading the running way.
- BRT systems should be reasonable in their costs to the community, urban travelers (especially transit riders), and the transit agency. Investments should be balanced with present and likely future ridership. The system should be designed to increase transportation capacity in heavily traveled corridors, reduce travel times for riders, and minimize total person delay in the corridors served. A basic goal should be to maximize person flow with the minimum net total person delay over the long run.
- Streets and corridors with existing long, heavily traveled bus routes are likely candidates for BRT. Often, BRT development will involve restructuring existing bus routes to provide sufficient service frequency along at least one BRT route.
- System design and operations should enhance the presence, permanence, and identity of BRT facilities and services. BRT must be more than just express service along a bus lane or busway.
- BRT should have a consistent, appealing image. BRT vehicles, stations, and marketing materials should convey the image of BRT as a rapid, easy-to-use service.
- Each urban area has its own specific needs, opportunities, and constraints that must be recognized. Thus, BRT systems must be carefully customized in order to apply the various components, obtain public support, and translate plans into operating systems.

BRT systems should focus on at least one major activity center, typically the CBD. As a result, BRT lines are usually radial. Sometimes, however, they may connect with radial transit lines. In very large urban areas, crosstown lines may be appropriate.

BRT also can be introduced into areas with large existing suburban activity centers to attract single-occupant vehicle trips. Systems would be developed in stages, with BRT ridership planned to grow over time. In all cases, ridership should be sufficient to support frequent service.

Communities contemplating BRT should have a clear vision of BRT needs and opportunities. BRT should be planned as interconnected systems of routes that can be incrementally developed, with the most promising lines built first.

### REFERENCES

1. Levinson, H., S. Zimmerman, J. Clinger, S. Rutherford, R. Smith, J. Cracknell, and R. Soberman. *TCRP Report 90: Bus Rapid Transit: Vol. 1, Case Studies in Bus Rapid Transit, and Vol. 2, Implementation Guidelines*. Transportation Research Board of the National Academies, Washington, D.C., 2003.
2. Diaz, R.B., M. Chang, G. Darido, E. Kim, D. Schneck, M. Hardy, J. Bunch, M. Baltes, D. Hinebaugh, L. Wnuk, F. Silver, and S. Zimmerman. *Characteristics of Bus Rapid Transit for Decision-Making*. FTA, Washington, D.C., 2004.

## CHAPTER 3. ESTIMATING BRT RIDERSHIP

### INTRODUCTION AND SUMMARY

Estimating BRT ridership is an important task. Realistic and reliable ridership forecasts are essential in sizing system design features, developing service plans, estimating capital and operating costs, performing alternatives analysis and cost-benefit comparisons, and making investment decisions.

This chapter reviews current BRT ridership experience, summarizes salient ridership research efforts, describes travel demand models and elasticity methods for estimating BRT ridership, and gives guidelines for applying modal preference (bias) factors to BRT systems.

Key findings and guidelines are as follows:

- BRT ridership forecasts are needed for the base year, the opening year, the year when ridership reaches maturity, and a design year usually 20 years into the future. FTA's *Proposed Interim Guidance and Instructions, Small Starts Provision of the Section 5309 New Starts Program*, issued June 5, 2006, suggests that opening year forecasts will be required for projects defined as Small Starts (less than \$250 million total cost and \$75 million federal contribution). For larger projects, both 20-year and opening-year forecasts will be required.
- Ridership estimates should be provided for peak and off-peak conditions by line segment and by station boardings and alightings.
- On-board travel surveys should capture key traveler information (e.g., trip origins, destinations, purposes, and frequencies and socioeconomic characteristics). This information provides an important input to various demand estimation procedures. A CBD employee survey is desirable to provide origins and travel modes for downtown workers.
- Ridership can be estimated by the traditional four-step process (i.e., trip generation, trip distribution, mode choice, and trip assignment) where BRT operates on a new right-of-way (such as a busway). Household travel surveys can provide the basic information needed for modeling and analysis, but data from on-board surveys also should be gathered in order to have sufficient data representing transit users during model development.
  - > The "pivot point" application of the incremental logit mode choice model is well-suited for estimating BRT ridership, especially when analyzing a new alignment.
  - > Travel paths should use acceptable weights for in-vehicle and out-of-vehicle travel times. Network coding should treat BRT as a separate facility in terms of travel times and stop locations.
- Travel time, service frequency, and cost elasticities can be used for smaller-scale projects where BRT would operate along existing bus routes. An on-board survey can provide information about desired travel patterns as well as demographic and socioeconomic information. Allowance should be made for "new" trips (i.e., trips diverted from automobiles, trips not

Ridership forecasts are needed for BRT projects to obtain FTA New Starts and Small Starts funding.

Use of existing transit rider origin-destination surveys can help determine BRT trip patterns.

Elasticities can be used to estimate ridership for smaller BRT projects.

---

## Bus Rapid Transit Practitioner's Guide

With similar attributes, BRT systems can attract ridership comparable to rail transit ridership.

Ridership for most major transit projects, including BRT, is forecast using disaggregate choice models based on a logit function and a linear measure of (dis)utility. The utility function includes a constant, often referred to as a "bias" constant, which accounts for all of the "unmeasured attributes" that contribute to individual choice. These unmeasured attributes contribute to the perceived desirability of one mode compared to another. Thus, a quantity added to or subtracted from the bias constant may be said to reflect the unmeasured attributes of BRT.

made before, and trips made with greater frequency). Population and employment growth should be taken into account.

- BRT's unique physical and operating features must be recognized in the travel demand estimation process. Salient studies of aggregate and disaggregate customer response to new BRT systems (or upgraded express bus service) have found the following:
  - > The attractiveness of BRT systems, not unlike that of new rail systems, has been greater than might be expected on the basis of reductions in travel times and costs.
  - > All things being equal (i.e., newness, component quality, system configuration and completeness in terms of all the elements of rapid transit, origin-to-destination travel times, reliability, and costs), BRT systems are likely to attract levels of ridership similar to those of rail-based systems.

Studies of ridership elasticities for arterial street BRT in Boston, Los Angeles, and Vancouver (BC) indicate that actual ridership was up to about 20% more than that computed by travel time and service analysis frequencies. Accordingly, a 25% increase is a suggested upper limit for full-featured BRT above that obtained by elasticity computations.

Recent practice has applied mode-specific "bias constants" equivalent to up to 15 minutes of in-vehicle travel time for rail rapid transit (i.e., for modeling purposes, the impedance for a trip using rail would be up to 15 units less than that computed using the unadjusted impedance function). The BRT (and rail) bias constants used should depend upon the quality and extent of the features available for each transit alternative that is evaluated. In this chapter, judgments were made as to the likely impacts of various BRT features on ridership.

These preferences reflect the informational advantages of the unique identity of a system with simple route structure and schedules, the superior waiting and transferring environments of stations as opposed to bus stops, and the comfort/ride quality of better, more modern vehicles and exclusive transit running ways. The differences are far greater between local bus systems and generic rapid transit than they are between, for example, light rail and BRT running in the same environment with the same station and running way configurations, basic route pattern, and schedule.

Therefore, the ridership forecasting approach used for one rapid transit mode should be used for the other, subject to the caveat of system comparability. The operable guidance for forecasting is "be conservative and consistent." The sections in this chapter document the aspects of estimating ridership response to BRT features and provide guidelines for keying BRT features to ridership estimates.

Examples of ridership estimates are given in Chapter 5.

### RIDERSHIP EXPERIENCE

In the past 10 years, a large number of BRT systems have opened in the United States and Canada. Information has been assembled on ridership growth, the sources of this growth, the relevance of demand elasticities, and rider attitudes. Relevant findings follow.

**Ridership Growth**

Ridership experience with BRT in six major urban areas is summarized in Exhibit 3-1. In most cases, corridor ridership has grown faster than the reduction in transit travel time, suggesting demand/travel time elasticities over 1.0. In other words, although increases in service frequencies contribute to the ridership gains, other factors appear to be at work as well. The data also indicate that a large portion of BRT ridership consists of new transit trips, not trips diverted from other transit routes.

**EXHIBIT 3-1 Ridership Experience with BRT**

Location	% Corridor Ridership Gain	Time Period	Maximum % Reduction in Travel Time	% BRT Ridership that is New Transit Trips
Los Angeles	40	3 years	25	>30
Miami	85	5 years	30	>50
Brisbane (Australia)	60	2 years	NA	>45
Vancouver (BC)	30	2 years	16	>25
Boston	100	18 months	20-30	>30
Oakland	20*	1 year	17	>30*

\* Offset to secular decline

SOURCE: CBRT (1)

Expanded service and improved frequency also enhance ridership during weekends. Exhibit 3-2 shows that ridership along the South Miami-Dade busway corridor increased more than 70% on weekdays and 150% on weekends from 1996 to 2003. Most of this growth reflects improved coverage as well as the presence of the busway.

**EXHIBIT 3-2 Ridership Growth over Time: South Miami-Dade Busway Corridor**

Time Period	1st Quarter 1996	3rd Quarter 2003	% Change
Average weekday	7,600	13,000	+70
Average weekend (Saturday + Sunday)	6,000	15,000	150

SOURCE: South Miami-Dade Busway Corridor Case Study (2)

The same phenomenon was apparent along Boston's Washington Street Silver Line. As shown in Exhibit 3-3, combined Saturday and Sunday traffic grew more than 90% as compared to 80% growth in weekday travel.

**Prior Modes**

Previous travel modes of BRT riders in Adelaide (Australia), Boston, Los Angeles, Oakland, Pittsburgh, and Vancouver are shown in Exhibit 3-4. According to the exhibit, new transit trips (i.e., trips made by former automobile drivers and pedestrians and by riders who did not make the trips before) represented approximately 20% to 33% of the trips in Adelaide, Boston, and Los Angeles.

Former rail rapid transit riders represented 22% of the BRT riders in Boston and 13% of the BRT riders in Oakland. In Boston, the Silver Line BRT service provides more direct access to Dudley Square and downtown Boston than the Orange Line (rail).

BRT systems have been observed to attract 20% to 33% new riders.

*Bus Rapid Transit Practitioner's Guide*

**EXHIBIT 3-3 Boston: Washington Street Ridership Growth over Time**

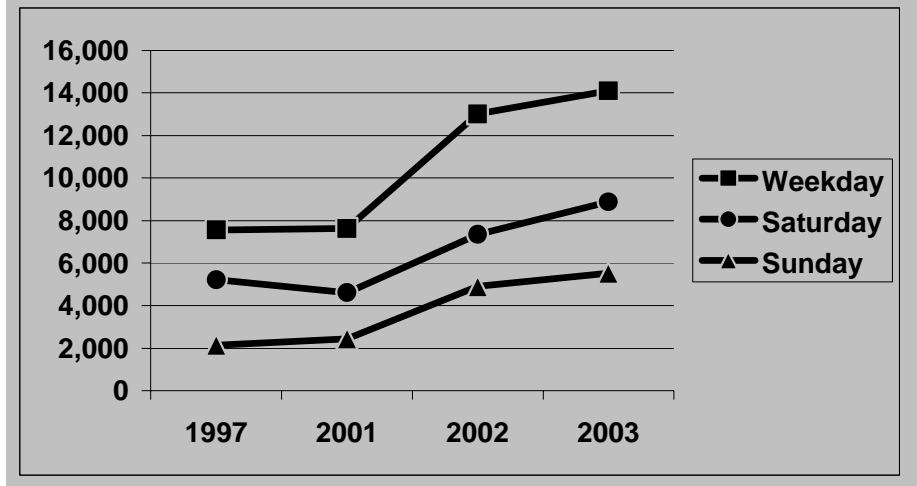

SOURCE: MBTA Silver Line (3)

**EXHIBIT 3-4 Prior Transportation Mode of BRT Riders**

BRT System	% Using Prior Mode					
	Bus	Subway	Drive Auto	Walk	Did Not Make Trip	Other
Adelaide (Australia)	70	—	—	—	24	6
Boston: Silver Line	45	22	3	—	17	13
Los Angeles: Wilshire-Whittier	67	—	—	—	33	—
Oakland: San Pablo	55	13	19	—	9	4
Pittsburgh: East Busway Extension	82	—	7	—	11	—
Pittsburgh: West Busway	56	—	34	4	—	6
Vancouver (BC): 98B	72	—	24	1	—	3

SOURCE: TCRP Project A-23A Interim Report (4), Massachusetts Bay Transportation Authority (MBTA), and Alameda-Contra Costa Transit District (AC Transit)

**Rider Characteristics**

Exhibit 3-5 and Exhibit 3-6, respectively, compare the demographic characteristics of riders on the Silver Line BRT system in Boston and the park-and-ride/transitway system in Houston with the characteristics of riders on the respective local bus systems. The characteristics of riders on the premium bus systems appear to have more in common with the general perception of the characteristics of rail transit users than with the general perception of the characteristics of local bus users.

**EXHIBIT 3-5 Characteristics of MBTA Silver Line Riders**

Customers	% 1995 (Route 49)	% 2003 (Silver Line)
Origin in South End	29	48
Ages 18-24	3	15
Household income > \$80,000 per year	8	15

SOURCE: MBTA

**EXHIBIT 3-6** Characteristics of Houston RTCR Riders

Houston METRO Service	% Riders with Annual Household Income > \$50,000	% Riders with Annual Household Income > \$75,000	% Riders with 2 or More Household Vehicles
RTCR park-and-ride services	70	50	61
Local bus	11	-	16

NOTE: RTCR = Rubber-Tired Commuter Rail (BRT)

SOURCE: 2002 Houston METRO on-board survey

In both areas, the improved bus service attracts more high-income riders than the corresponding local bus service. Houston's "rubber-tired commuter rail" service attracts half its riders from households with incomes of more than \$75,000; more than 60% come from households with two or more vehicles. The difference in the characteristics of those who ride the express bus compared to those who ride local buses mainly reflects the design of the service. The express bus gathers riders only in more affluent suburbs and operates in an express mode to the downtown area, with no intermediate stops in areas with lower-income populations. More than 35,000 riders use the system each weekday.

Boston's Silver Line covers the exact same area as the previous Massachusetts Bay Transportation Authority (MBTA) route 49 local service, but it does so faster and attracts riders from the Orange Line (rail rapid transit).

**Attitude and Preference Surveys**

Attitude and preferences surveys of both transit riders and non-riders regarding different BRT components can be an important input to estimating the impact of different BRT components on ridership attraction. Several transit agencies have conducted rider surveys for existing BRT services in order to design new and extended service. Other transit agencies are beginning to conduct such surveys before services are planned, designed, and implemented.

The purpose of preference surveys is to identify which BRT components are most important to potential users and which would contribute the most to a decision by riders and non-riders to use such a service. It is important to administer such surveys to both riders and non-riders, as the premium attributes associated with BRT are intended to attract potential choice riders to use the service.

*Types of Surveys*

Two types of surveys could be applied in BRT planning and design:

- Potential riders and non-riders could be queried on the relative importance of different BRT components *before* the new BRT service is implemented.
- Surveys could ask riders *after* they have taken a new BRT service which components of the service most influenced their decision to ride the new service and what potential enhancements could be made to the service.

These surveys typically use a numerical rating scale, with ratings extending from "not at all important" to "extremely important." Some surveys have been conducted where riders rate the overall importance of different components from "excellent" to "very poor," with the percentage rating for different attributes reported.

Attitude/preference surveys can help transit agencies estimate BRT components' impacts on ridership.

Surveys can be conducted before and after BRT service is implemented.



*Bus Rapid Transit Practitioner's Guide*

*Results from Past Surveys*

Several transit agencies have conducted attitude surveys to identify the relative importance of different BRT components. Surveys undertaken in Los Angeles, Oakland, and Washington, D.C., are highlighted in this section.

*Los Angeles*

In Los Angeles, a survey was undertaken after the initial Metro Rapid Wilshire-Whittier and Ventura BRT lines were opened to measure the importance that riders and bus operators place on various attributes of Metro Rapid service and potential enhancements to the service. Exhibit 3-7 summarizes the responses. The highlights are as follows:

- Operators' highest-rated current attributes were simple routes (9.2), traffic signal priority (8.9), and schedules (8.6).
- Customers' highest-rated current attributes were service intervals (9.8), simple routes (9.4), and time until next bus display (9.2).
- Operators' highest-rated potential enhancements were off-vehicle fare payment (9.0) and exclusive bus lanes (8.5).
- Customers' highest-rated potential enhancements were feeder network (8.7) and multiple-door entry and exit (8.5).

**EXHIBIT 3-7 Los Angeles: Metro Rapid Attribute Importance Ratings**

Attributes	Operators and Customers	Operators	Customers
<i>Current Attributes</i>			
Simple Routes	9.3	9.2	9.4
Schedules	8.8	8.6	8.9
Service Intervals	9.3	8.5	9.8
Less Frequent Stops	8.8	8.4	9.0
Level Bus Entry/Exit	8.6	8.0	9.0
Color-Coded Buses and Stations	8.3	7.5	8.8
Traffic Signal Priority	8.8	8.9	8.9
Time Until Next Bus Display	8.1	4.7	9.2
<i>Potential Enhancements</i>			
Exclusive Bus Lanes	7.9	8.5	7.7
High-Capacity Buses	7.9	7.6	8.0
Multiple-Door Entry and Exit	8.4	8.0	8.5
Off-Vehicle Fare Payment	8.4	9.0	8.3
Feeder Network	8.0	5.9	8.7

NOTE: Attribute Importance Ratings are based on a 0-10 scale with 10 = "extremely important" and 0 = "not at all important."

SOURCE: *A Qualitative Study of Metro Rapid and Associated Alternatives (5)*

*Oakland*

A rider survey was conducted after Oakland's San Pablo Rapid BRT service opened. Exhibit 3-8 summarizes the ratings obtained for a variety of performance measures. The exhibit shows the percentage of respondents who rated each measure as "excellent," "good," "fair," "poor," and "very poor." The highest rating was for the ease of identifying the right bus. Other measures that at least 75% of respondents rated as "excellent" or "good" were wheelchair securement, travel time, quality of new buses, location of bus signs, and service frequency.

EXHIBIT 3-8 Oakland: Performance Measures Survey

Performance Measure	Percentage of Respondents Rating the Performance Measure				
	Excellent	Good	Fair	Poor	Very Poor
Rapid Bus service overall	39.3	43.6	14.8	1.2	1.2
Easy to identify the right bus	45.8	36.5	14.5	1.7	1.5
Wheelchair securement	42.4	37.8	16.6	1.9	1.3
Travel time on the bus	37.2	40.3	19.2	1.9	1.4
Quality of new buses	39.9	37.2	17.4	3.0	2.5
Location of bus signs	35.5	41.6	18.3	2.8	1.9
Frequency of buses	34.1	40.9	19.3	3.8	1.8
Reliability	30.3	42.0	23.0	3.3	1.4
Routes go where I need to go	34.7	36.6	21.8	4.7	2.3
Quality of bus shelters	27.6	41.7	24.1	4.5	2.0
Cleanliness	26.7	42.1	23.2	5.5	2.5
Personal safety on buses	26.0	42.2	24.4	4.7	2.7
Driver courtesy	29.6	38.8	24.2	4.6	3.6
Information at bus stops	27.2	37.8	22.3	9.4	3.3
Availability of seats	21.2	39.4	28.3	8.3	2.9
Value for fare paid	23.1	33.5	27.7	9.7	6.0

SOURCE: AC Transit presentation

*Washington, D.C.*

Service improvements desired by bus riders and non-riders in the Washington, D.C., area are set forth in Exhibit 3-9 and Exhibit 3-10. The improvements most desired by riders were on-time performance, more frequent service, and a longer service span. The improvements most desired by non-riders were better information, better shelters, and more convenient stops. These desired service improvements are clearly the service features that are or can be supported by BRT.

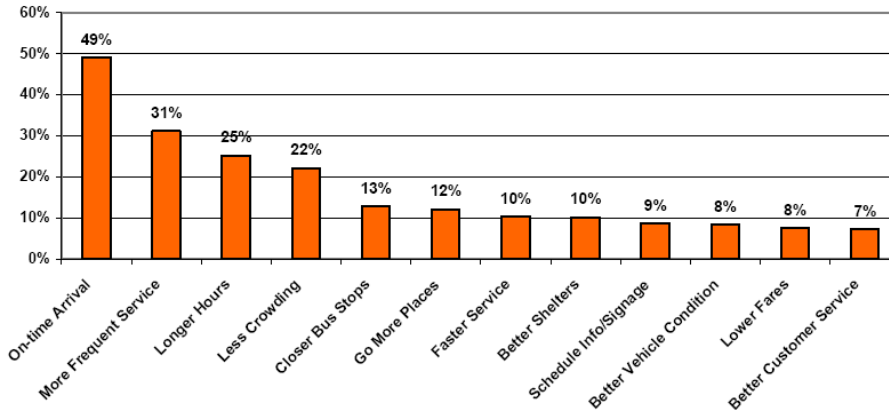

SOURCE: WMATA Regional Bus Study, 2003, as reproduced in *TCRP Web-Only Document 32 (6)*

EXHIBIT 3-9 Service Improvements Desired by Bus Riders in Washington, D.C.

*Bus Rapid Transit Practitioner's Guide*

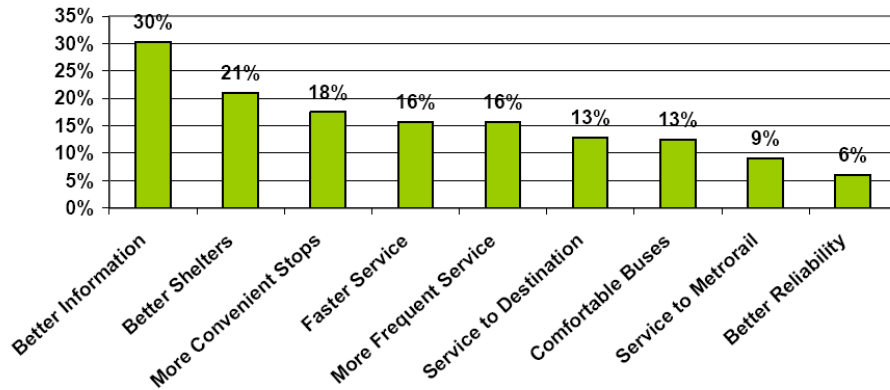

SOURCE: WMATA Regional Bus Study, 2003, as reproduced in *TCRP Web-Only Document 32 (6)*

**EXHIBIT 3-10** Service Improvements Desired by Infrequent Bus Riders and Non-Riders in Washington, D.C.

**Research Findings**

Several research investigations have analyzed the ability of express bus/BRT service to attract riders relative to the ability of rail transit to attract riders:

- A landmark study by McFadden et al. (7) found that, where travel times, costs, transfer requirements, and system quality are equal, rail- and bus-based rapid transit systems are likely to have the same passenger attraction.
- Pushkarev and Zupan (8) found that both new busways and new rail rapid transit lines experienced substantial increases in ridership:
  - > Shirley Busway - Washington, D.C. 104%
  - > Lindenwold Line (rail) - New Jersey 56%
  - > Skokie Swift (rail) - Chicago 54%
  - > BART (Transbay) (rail) - San Francisco 51%
- Ben-Akiva and Morikawa (9) indicated that, when quantifiable service characteristics (travel time, cost, transfers, etc.) are equal, riders show no preference for rail transit over quality bus alternatives for CBD-oriented work trips.
- Currie (10) stated that BRT systems should be able to generate ridership equal to rail when the total trip attributes of both alternatives (travel times, costs, ride quality, minimal transfers, and quality of stations and facilities) are the same.

**Conclusions from Aggregate Evidence**

The preceding examples suggest BRT ridership responses that are more similar to what happens when new rail systems are introduced rather than what happens with relatively simple changes in local bus service frequency, travel times, and service span. The examples suggest that the identity, information, and amenity advantages of BRT *in addition to* improvements in span of service, frequency, routing, and travel times are important in attracting riders.

Four past research investigations evaluated the relative ridership generation propensity of BRT and LRT.

The combined effects of improved travel times, service frequencies, and BRT features on BRT ridership are summarized for four BRT services in Exhibit 3-11. (The information in the exhibit was summarized for the BRT planning study Bus Rapid Transit Plans in New York's Capital District [11] and used in forecasting BRT ridership for the Route 5 corridor in Albany, NY.) Exhibit 3-11 shows that 10% to 21% of the ridership increases were in addition to those attributed to travel time and service frequency improvements. The greatest gains were in Boston, where extensive physical changes and urban design improvements were made along the streets used by BRT.

**EXHIBIT 3-11 Impact of Various Factors Beyond Level of Service on BRT Ridership**

Ridership Increase	Los Angeles Metro Rapid		Vancouver	Boston
	Ventura Blvd	Wilshire-Whittier Blvd	B-Line #98	Silver Line
Weekday	2,850 riders <sup>1</sup>	20,660 riders <sup>1</sup>	4,000 <sup>2</sup>	2,290 <sup>3</sup>
	26%	33%	29%	30%
Due to headway changes	6%	8%	9%	7%
Due to travel time changes	10%	12%	6%	2%
Due to other changes	10%	13%	14%	21%

<sup>1</sup> SOURCE: TCRP Report 90 (12)

<sup>2</sup> SOURCE: APTA Intermodal Operations Planning Workshop (13)

<sup>3</sup> SOURCE: MBTA counts

Based on these findings, it is likely that a full-featured BRT service operating on a fully segregated running way with specialized (or stylized) vehicles, attractive stations, and efficient fare collection practices would have a 25% gain in base ridership beyond gains from travel time and service frequency improvements.

A full-featured BRT service with separate running way could have a 25% gain in ridership beyond gains associated with travel time and frequency improvements.

**RIDERSHIP ESTIMATION OVERVIEW**

Ridership estimation procedures should recognize the unique aspects and needs of BRT. BRT operates in an assortment of running ways that range from mixed traffic to grade-separated busways. In many cases, BRT services are even laid out on existing bus routes.

The range of operating environments suggests that several ridership estimation approaches may be appropriate. Approaches include applying regional travel demand and mode choice models, using pivot-point procedures (incremental logit models), and applying service elasticities. The pivot-point approach is especially desirable where BRT will operate on a new alignment such as a busway.

The methods that are used should be reliable, produce reasonable results, and be easy to comprehend by transit planning and operations personnel. Data collection requirements and costs should be kept to a minimum.

Surveys are needed to provide a clear picture of existing travel patterns and provide inputs for model development and calibration. An on-board rider survey is essential to indicate where passengers board and alight; to identify passenger origins, destinations, and trip purposes; and to obtain passengers' socioeconomic characteristics. A CBD (or other major activity center) employee survey can provide useful information on employee travel modes and trip origins and destinations.

---

## Bus Rapid Transit Practitioner's Guide

Appropriate "path-building" for BRT is important in using regional modeling to develop BRT ridership projections.

While most planning agencies use the traditional four-step trip-based process, many agencies in larger metropolitan areas are considering use of tour-based or activity-based processes. Advanced models based on these processes may be used when available for BRT analysis.

Most modern mode choice models are based on a theory of user utility first applied by McFadden. This approach posits that an individual makes a choice among alternatives based on the utility of each alternative relative to the combined utility of all other alternatives considered. Utility is represented as a function that is a linear combination of the measured attributes of each alternative plus a constant that reflects the value associated with the unmeasured attributes.

Equitable treatment of all modes of travel in terms of travel times, costs, path-building, and network assumptions is essential. "Path-building" for use in models should give proper weights to each travel time component. Transit networks should clearly differentiate various BRT and local transit services that operate along the same street or in the same corridor.

### APPLICATION OF TRAVEL DEMAND ESTIMATION MODELS

BRT ridership should be estimated from the traditional four-step demand estimation process when major investments are anticipated (e.g., when BRT will operate on new right-of-way). Household travel surveys are needed to provide the basic information for modeling and analyzing.

The modeling process is appropriate on a system (or corridor) scale especially for long time horizons where future growth is anticipated. Providing realistic estimates of current and future employment is essential. Analysis should be conducted for both peak and off-peak conditions.

### Key Steps

The steps and data flow for the four-step demand estimation process are shown in Exhibit 3-12 and discussed below:

1. *Trip Generation.* This step estimates the number of trip ends produced by and attracted to a given travel analysis unit or zone. Inputs are generally the number of households and jobs, stratified by characteristics such as income, auto ownership, and type of job. This step models the trip frequency decision.
2. *Trip Distribution.* This step estimates travel flows by linking trips "produced" and "attracted" based on zone-to-zone "impedances" (i.e., generalized cost estimates derived from a transportation system network description).
3. *Mode Choice.* This step models the mode choice decision. It estimates the share of trips made between each origin-to-destination pair based on demographic characteristics (e.g., income) and the characteristics of the competing modes in terms of times and costs.
4. *Assignment.* This step models path choice. It estimates the flow of person or vehicle trips on/through each element of the transportation network (i.e., link, lines, stations, and termini). Inputs are origin-to-destination trip matrices or trip tables and a transportation system network description.

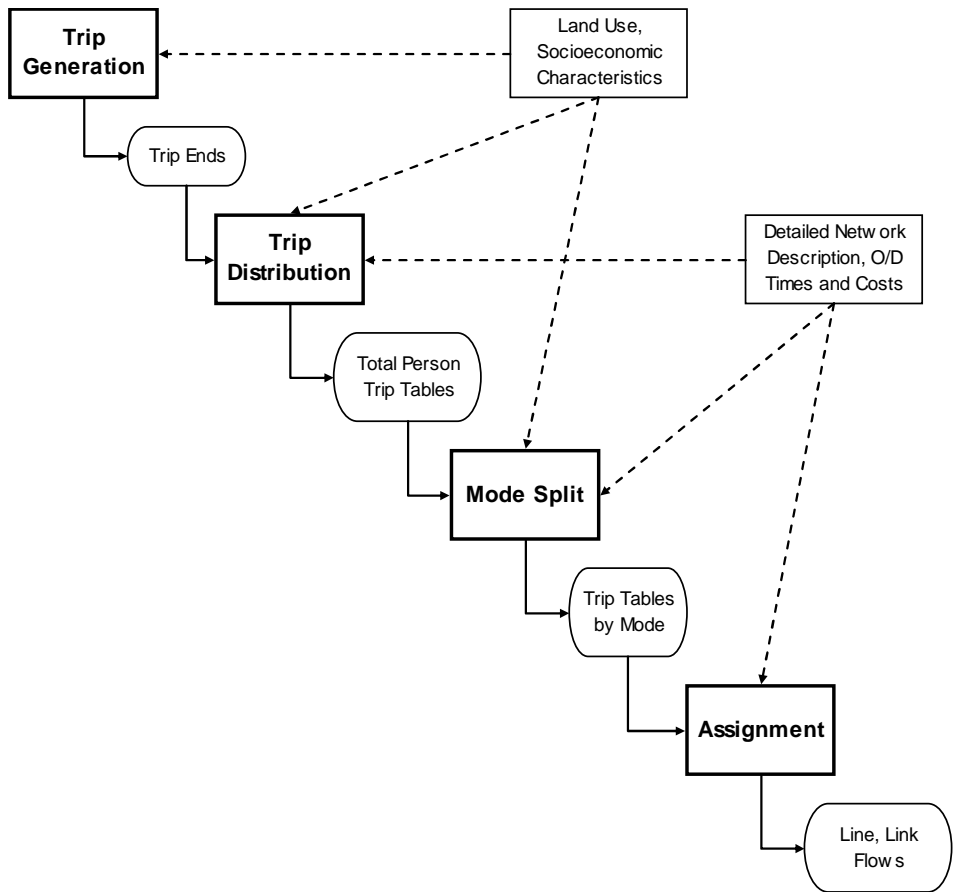

SOURCE: Sam Zimmerman

EXHIBIT 3-12 Four-Step Travel Demand Estimation Process

**Mode Choice**

The choice of travel mode can be forecast in several ways depending on the nature of the project and available data. The generally accepted method for projecting choice of mode in the four-step process is to apply a discrete choice model estimated using disaggregate data of revealed behavior. This model most often takes the form of a mode-split model based on a logistics (or “logit”) function. While developed with disaggregate data, these models are generally applied using aggregate data developed in the previous steps of the four-step process. This logit formulation estimates the probability of the choice of each of the various modes for any given trip depending on each mode’s relative desirability for that trip. Modes are relatively more desirable if they are faster, cheaper, or have other more favorable features than competing modes.

Stated another way, the share of trips between two points is a function of the utility of a given mode divided by the sum of the utilities of all modes (expressed in exponential terms). Thus, the more utility that a mode has for a potential traveler, the larger its share of all trips will be. The general form of the model is shown in the following equation:

A logit model can be used to estimate mode choice.

---

*Bus Rapid Transit Practitioner's Guide*

$$P(m) = \frac{e^{\text{utility of mode } m}}{\sum_{x=1}^n e^{\text{utility of mode } x}} \quad (3-1a)$$

where:  $P(m)$  = the probability of using mode  $m$  for a given trip  
 $n$  = number of modes available for a given trip

In application, the model is expressed in “disutilities” or impedances. The general equation becomes:

$$P(m_{ij}) = \frac{e^{a(\text{impedance for mode } m_{ij})}}{\sum_{x=1}^n e^{a(\text{impedance for mode } x_{ij})}} \quad (3-1b)$$

where:  $P(m_{ij})$  = the probability of using mode  $m$  for a given trip between  $i$  and  $j$   
 $a$  = calibration parameter  
 $n$  = number of modes available for a given trip

The exponential expansion is negative. Therefore, the higher the impedance of a specific mode is, the lower the probability that the mode will be chosen and the lower its resulting mode share.

The formulation shown in Equation 3-1b is referred to as “multinomial logit.” It is used when the data suggest that all modes are “independent,” so that a change in the probability of choice of any one mode ( $m$ ) will affect the choice probabilities for all other modes ( $1 \dots n$ ) proportionally. In practice, choices of mode are not fully independent. Instituting a significant new transit facility (e.g., BRT or light rail) is more likely to attract those who are already using some form of transit. The choice of transit, as opposed to the choice of an auto-based mode, reflects all the transit options available to a user.

The form of the model used to estimate these sets of choices (e.g., walk-to-transit vs. drive-to-transit and local service vs. premium service) is known as “nested logit.” The impedance of a higher-level choice (e.g., transit vs. auto) is expressed as a combination of the impedances of modes included in subordinate sets or “nests” (e.g., local service and premium service) and the relative choice probabilities.

In either formulation, the impedances are defined by a linear combination of factors that reflect the mode’s attractiveness, the characteristics of trip-makers and their households, and other factors that represent the environment in which the trip is made. The factors directly related to the attributes of the mode of interest include in-vehicle travel time, out-of-vehicle travel time (e.g., walking, waiting for the initial vehicle, and waiting while transferring), and out-of-pocket costs (such as fares, tolls, and parking). Factors related to trip-makers and their households can include income, auto ownership, number of workers, and so forth. Income often is reflected by converting out-of-pocket costs to equivalent minutes of in-vehicle time based on a proportion of the hourly wage. Environmental factors affecting choice of mode include such items as CBD destination, availability of sidewalks, and density of development.

Even when all the factors listed previously are included in the impedance function for a given mode, analysis typically reveals that a quantity needs to be included to reflect the unmeasured attributes. This term is often referred to as the modal bias constant. The attributes of transit services that these constants are thought to reflect include attributes such as reliability, comfort, passenger amenities, station features, and service branding. These factors are calibrated for each mode for each trip interchange.

Exhibit 3-13 illustrates a typical logit-based mode choice model that could be utilized. A possible formulation for impedance of each mode is as follows:

$$Impedance = [a_1x_1 + a_2x_2 + Wa_3x_3 + \dots + a_nx_n] + b \quad (3-2)$$

- where:
- W = income of traveler
  - x<sub>1</sub> = in-vehicle travel time
  - x<sub>2</sub> = out-of-vehicle travel time
  - x<sub>3</sub> = out-of-pocket costs
  - x<sub>n</sub> = other measures
  - a<sub>1</sub>...a<sub>n</sub> = coefficients
  - b = modal bias constant

Further information on disaggregate travel demand/mode choice modeling can be found in *Discrete Choice Analysis Theory and Application to Predict Travel Demand* (14), *Urban Travel Demand* (15), and *A Self-Instructing Course in Disaggregate Mode Choice Modeling* (16).

Use of a bias constant reflects unmeasured mode choice attributes.

$$P(m)_{ij} = \frac{e^{a(impedance)_{ij}^m}}{\sum_m e^{a(impedance)_{ij}^m}} \quad (3-3)$$

where:

- $P(m)_{ij}$  = the probability of a trip from origin  $i$  to destination  $j$  using mode  $m$
- $Impedance_{ij} = A^m \times TIV_{ij}^m + B^m \times TOV_{ij}^m + C^m \times \$_{ij}^m + D^m E^m$   
 = generalized cost or disutility (impedance)  
 = a measure of travel difficulty
- $A^m, B^m, C^m, D^m$  = model coefficients (differentiated by mode in some cases)
- $TIV_{ij}^m$  = in-vehicle time between zones  $i$  and  $j$  for mode  $m$
- $TOV_{ij}^m$  = out-of-vehicle time between zones  $i$  and  $j$  for mode  $m$
- $\$_{ij}^m$  = out-of-pocket cost between zones  $i$  and  $j$  for mode  $m$
- $E^m$  = modal bias constant for mode  $m$  (may be same for all transit modes)
- $a$  = calibration parameter
- $e$  = base of the natural logarithms

EXHIBIT 3-13 Example Logit Mode Choice Model Formulation



The incremental logit model is also known as the pivot-point procedure. The pivot-point procedure is useful for forecasting BRT ridership when accompanied by a transit rider survey.

### INCREMENTAL LOGIT MODEL (PIVOT-POINT PROCEDURE)

Pivot-point procedures that apply the incremental logit model are extremely useful in forecasting BRT ridership when they are accompanied by on-board surveys that capture key traveler information. They have been used in places as diverse as the United Kingdom; China; York, ON; Philadelphia; and Tucson. They have several important advantages:

- They are observed (measured) mode shares.
- They require describing only those system components that are anticipated to change.
- They require data only for the influence area of the route or corridor under study.

Thus, the analysis requires much less effort than developing a full-scale travel demand model, and it produces results that conform to the base case scenario.

The pivot-point procedure estimates changes in mode choice relative to a base year condition. The predicted relative changes are applied to a base matrix to determine future demand (ridership). More specifically, the future mode share is a function of the existing mode share and the changes in utilities for a specific mode as compared with the changes in utilities for all modes being analyzed. (Further discussion is contained in ten publications listed in the references [17-26]).

The formulation of the incremental logit model is as follows:

$$P_i' = \frac{P_i \times e^{\Delta u_i}}{\sum_{i=1}^k P_i \times e^{\Delta u_i}} \quad (3-4)$$

where:  $P_i$  = baseline probability of using mode  $i$

$P_i'$  = revised probability of using mode  $i$

$\Delta u_i$  = the change in utility for mode  $i$

$k$  = number of travel modes available

Manheim (23) has suggested the following simplifications:

1. Two modes  $i$  and  $j$

$$P_i' = \frac{1}{1 + \left(\frac{P_{0j}}{P_{0i}}\right) e^{\Delta u_j - \Delta u_i}} \quad (3-5)$$

where:  $P_{0i}$  and  $P_{0j}$  = initial mode share for modes  $i$  and  $j$

$\Delta u_i$  and  $\Delta u_j$  = the change in utility for mode  $i$  and  $j$

2. Only changes in some levels

$$P_{0t}' = \frac{1}{1 + e^{-\Delta u_t} \left(\frac{1}{P_{0t}} - 1\right)} \quad (3-6)$$

where:  $P_{0t}$  = initial transit mode share

$P_{0t}'$  = future transit mode share

$\Delta u_t$  = change in transit utility

The incremental logit model draws its coefficients for utilities from available models for the area under consideration. Where such models are not available,

coefficients may be “borrowed” from other sources. Alternatively, the illustrative coefficients shown in Exhibit 3-14 may be utilized. These coefficients represent the mid-range of U.S. experience with mode choice models.

**EXHIBIT 3-14 Illustrative Coefficients in the Mode Choice Model**

Variables		Coefficients		
Attribute	Units	HBW	HBO	NHB
In-vehicle time for (most) transit modes	Minutes	-0.020	-0.010	-0.020
In-vehicle time for commuter rail	Minutes	-0.016	-0.008	-0.016
All out-of-vehicle time	Minutes	-0.040	-0.020	-0.040
Drive-access time	Minutes	-0.040	-0.020	-0.040
Transfers	Number	-0.100	-0.050	-0.100
Fares (cents)	Cents	-0.003	-0.0015	-0.0015
Transit-access logsum	Utilities	0.6	0.6	0.6

SOURCE: *Discussion Piece #9 (27)*

The general steps in applying the model are as follows:

1. Define the influence area for the traffic analysis zones that would be directly affected by the new BRT service.
2. For each affected zone-to-zone pair, define the existing transit service level (in terms of in-vehicle time, wait time, walk time, travel time, etc.) and the likely changes as a result of the proposed BRT service.
3. Estimate the change in transit share by the pivot-point process.
4. Convert pivoted transit shares to a zone-to-zone trip table.
5. Assign trips to the proposed BRT line to derive ridership estimates.

This process can be completed for future years by applying growth factors or using available future-year trip matrices (19).

Transit path-building should find for each zone-to-zone interchange the best single path available for transit system walk access and for transit system drive access. Ideally, the best paths should reflect combined headways (where several transit lines on the same mode service common boarding and alighting locations) and should avoid multiple-path effects across different transit modes (27).

Illustrative impedance factors are given in Exhibit 3-15. The weights given to transfers depend upon the attractiveness and convenience of transfers.

**EXHIBIT 3-15 Illustrative Impedance Weights for Path Selection**

Impedance	Units	Weight
In-vehicle time for (most) transit modes	Minutes	1.0
In-vehicle time for commuter rail	Minutes	0.8
All out-of-vehicle time	Minutes	2.0
Drive-access time	Minutes	2.0
Transfers	Number	2.0-5.0
Fare (cents, peak/off-peak)	Cents	0.15/0.075

SOURCE: *Discussion Piece #9 (27)*

**APPLICATION OF ELASTICITY FACTORS**

As previously discussed, ridership changes resulting from BRT service can be estimated by introducing BRT travel times and service frequencies into mode-split models. Alternatively, it may be desirable to apply various travel time and service elasticities based on estimated changes in service span, frequencies (or bus miles),

There are five key steps in applying the incremental logit model.

Elasticity factors can be applied where BRT is overlaid on existing routes and for small-scale BRT investments.

and travel times. Application of elasticities is generally appropriate where BRT service is overlaid on existing bus routes and there are relatively small-scale investments.

**Elasticity Methods**

Ridership elasticity is defined as the change in ridership corresponding to a 1% change in fare, travel time, or service frequency. It is normally computed in three ways:

Elasticity computations can involve shrinkage factor, midpoint arc elasticity, or log arc elasticity methods.

1. *Shrinkage Factor.* The shrinkage factor has been used as a “rule of thumb” in estimating the ridership effects of fare changes. It is the simplest method to use and gives a reasonable approximation for small fare changes. The percentage increase in ridership is equal to the percentage change in an attribute (e.g., travel time) times the appropriate elasticity factor. The equations are as follows:

$$E = \frac{\frac{\Delta R}{R_1}}{\frac{\Delta X}{X_1}} = \frac{\frac{(R_2 - R_1)}{R_1}}{\frac{(X_2 - X_1)}{X_1}} \tag{3-7a}$$

or

$$R_2 = R_1 + \frac{ER_1(X_2 - X_1)}{X_1} \tag{3-7b}$$

where:  $E$  = elasticity  
 $R_1$  = base ridership  
 $R_2$  = estimated future ridership  
 $X_1$  = quantity of base attribute (such as travel time or frequency)  
 $X_2$  = quantity of future attribute

2. *Midpoint (Linear) Arc Elasticity.* This method is commonly used in estimating ridership changes and is used in Chapter 5. It is defined as follows:

$$R_2 = \frac{(E - 1)X_1R_1 - (E + 1)X_2R_1}{(E - 1)X_2 - (E + 1)X_1} = R_1F \tag{3-8}$$

where:  $E$  = elasticity  
 $R_1$  = base ridership  
 $R_2$  = estimated future ridership  
 $X_1$  = quantity of base attribute (such as travel time or frequency)  
 $X_2$  = quantity of future attribute  
 $F$  = multiplier

3. *Log Arc Elasticity.* The log arc elasticity most closely approximates the “point elasticity.” It is defined as follows:

$$R_2 = 10^{E(\log X_2 - \log X_1) + \log R_1} \tag{3-9a}$$

or

$$R_2 = e^{E(\ln X_2 - \ln X_1) + \ln R_1} \tag{3-9b}$$

where:  $E$  = elasticity

$R_1$  = base ridership

$R_2$  = estimated future ridership

$X_1$  = quantity of base attribute (such as travel time or frequency)

$X_2$  = quantity of future attribute

A comparison of these elasticity computation methods is shown in Exhibit 3-16. For small changes ( $\pm 10\%$ ), the three methods give similar results. However, for large changes, results from the shrinkage factor method diverge considerably.

**EXHIBIT 3-16 Elasticity Values for Different Methods of Computation**

Fare Change (%)	Log Arc Elasticity	Midpoint Arc Elasticity	Shrinkage Factor
-50%	-0.300	-0.311	-0.46
-30%	-0.300	-0.303	-0.38
-10%	-0.300	-0.300	-0.32
+10%	-0.300	-0.300	-0.28
+30%	-0.300	-0.302	-0.25
+50%	-0.300	-0.311	-0.23
+100%	-0.300	-0.311	-0.19

SOURCE: TCRP Web Document 12 (28)

**Application**

Application of elasticities requires estimating the likely base ridership along the BRT route. This base ridership reflects a portion of the total existing route or corridor ridership. An on-board survey of bus riders along the proposed BRT route or corridor can assist in allocating existing ridership between BRT and existing bus service. This survey should provide origin-to-destination and station-to-station travel patterns as well as rider characteristics. It can be adjusted to future years based on anticipated growth in the corridor.

Identify base ridership in order to apply elasticities.

*Base Ridership Estimates*

Ridership diversion from existing routes should reflect travel patterns, comparative travel times and service preferences, where BRT is located, and whether BRT replaces an existing bus route. General guidelines are given in Exhibit 3-17.

When BRT replaces a single local service, all existing ridership can be allocated to the BRT service (Option 1). The more common circumstance is where BRT and local service will operate on the same street (Option 2). The ridership allocation between BRT and local service can be based on judgment (including experience elsewhere); it can reflect division of ridership equally between the two services; or it can (preferably) be based upon origin-to-destination and boarding/alighting patterns, market research, and/or relative travel times. Exhibit 3-18 gives possible allocations based on various relationships between BRT and local bus running times.

To maintain reasonable headways between BRT and local bus service on the same street, it may be appropriate to initially allocate ridership about equally between the two services. This has been the experience of several existing BRT systems. Moreover, equal headways are desirable at major boarding points such as downtowns. Thus, a "default" allocation of 50% seems reasonable.

*Bus Rapid Transit Practitioner's Guide*

**EXHIBIT 3-17 Guidelines for Allocating Base Corridor Ridership to BRT and Local Services**

Service Before	Service After	Initial Allocation of Service/Ridership between BRT and Local Service	Travel Time Savings	Service Frequency Changes
1. Single local service	Single BRT service	All service on street allocated to BRT	All time savings allocated to BRT in applying elasticities	All frequency changes allocated to BRT; use BRT service frequencies in applying elasticities
2. Single local service	BRT plus local service on same street	1. Judgment 2. Equal allocation 3. Based on patterns of boarding and alighting, where available, and relative travel times	Time savings allocated to each type of service in applying elasticities	Use a portion of BRT trips

SOURCE: Estimated

**EXHIBIT 3-18 Examples of Mode Shares Based on Relative BRT and Local Service Running Time Ratios on Same Street**

Allocation Method	
Equation (a)	$\frac{\sqrt{t_2}}{\sqrt{t_1} + \sqrt{t_2}}$
Equation (b)	$\frac{t_2}{t_1 + t_2}$
Equation (c)	$\frac{e^{t_2}}{e^{t_1} + e^{t_2}}$
Equation (d)	$\frac{e^{-t_1}}{e^{-t_1} + e^{-t_2}}$

$t_1$  = BRT minutes and  $t_2$  = local service minutes

Relative Travel Times		Results			
$t_1$	$t_2$	Equation (a)	Equation (b)	Equation (c)	Equation (d)
1	1.0	0.50	0.50	0.50	0.50
1	1.5	0.55	0.60	0.62	0.62
1	2.0	0.59	0.67	0.73	0.73
1	2.5	0.61	0.71	0.82	0.82
1	3.0	0.63	0.75	0.88	0.88
1	4.0	0.67	0.80	0.95	0.95

SOURCE: Estimated

A more general BRT ridership allocation equation is as follows:

$$(pR_1)A + (pR_1)B = pR_1(A + B) \tag{3-10}$$

where:

$p$  = percentage of base ridership attracted to BRT

$A$  = ridership growth due to time savings (and possible frequencies computed by elasticities)

$B$  = increase in base ridership resulting from special features of BRT

$R_1$  = base bus ridership on street (or in corridor)

*Elasticity Computations*

Preferably elasticities should be applied on a station-to-station basis. An approximate value can be obtained by looking at aggregate time savings and ridership.

Exhibit 3-19 gives typical midpoint arc elasticity values that could be used in estimating ridership. It should be noted that there is a considerable range in reported elasticities. Therefore, these values should be modified as appropriate to reflect local experiences.

**EXHIBIT 3-19 Typical Midpoint Arc Elasticities**

Item	Travel Time	Bus Miles	Bus Frequencies
Application	New routes replace or complement existing routes	Service expansion	Greater frequency of existing routes
Range	-0.3 to -0.5	0.6 to 1.0	0.3 to 0.5
Typical	-0.4	0.7 to 0.8	0.4

SOURCE: *Patronage Impacts of Changes in Transit Fares and Services (29)* and *TCRP Report 99 (30)*

Elasticity data for in-vehicle travel times can be obtained from *The Demand for Public Transportation (31)*. This document and similar U.S. information suggest that the in-vehicle travel time elasticity for home-based work trips (as affected by dedicated exclusive bus lanes) should be in the range of -0.5 to -0.7. General elasticity values of -0.3 to -0.5 have been reported both in the United States and United Kingdom.

As an example, assuming that travel times decrease from 12 to 10 minutes as a result of BRT operation, the following changes in ridership are anticipated based on an elasticity of -0.35 and a base ridership of 1,000.

By the shrinkage factor method:

$$R_2 = 1,000 + \frac{(-0.35)(1,000)(10-12)}{12} = 1,058 = +5.8\%$$

By the midpoint arc elasticity method:

$$R_2 = \frac{(-0.35-1)(12)(1,000) - (-0.35+1)(10)(1,000)}{(-0.35-1)(10) - (-0.35+1)(12)} = 1,066 = +6.6\%$$

The equation for estimating BRT ridership from changes in both in-vehicle travel time and service frequency is as follows:

$$R_3 = R_1 F_1 [1 + a(F_2 - 1)](1 + x) \tag{3-11a}$$

- where:  $R_1$  = base ridership
- $F_1$  = multiplier for travel time elasticity
- $F_2$  = multiplier for service frequency elasticity
- $a$  = proportion of BRT ridership that would save time by boarding the first bus that arrives at a combined BRT/local stop

Examples of elasticity calculations are provided.

*Bus Rapid Transit Practitioner's Guide*

$x$  = increase in ridership resulting from special BRT features ( $0 < x < 0.25$ )

$R_3$  = estimated future ridership

If  $a = 1$ , the equation reduces to:

$$R_3 = R_1 F_1 F_2 (1 + x) \tag{3-11b}$$

The *relative* increase in ridership is:

$$\frac{R_3}{R_1} = F_1 [1 + a(F_2 - 1)](1 + x) \tag{3-11c}$$

Thus, the *relative* increase in ridership is independent of the initial ridership value.

When BRT is overlaid on local bus routes, there may be improved frequency at BRT stations as a result of the combined service, and some proportion of riders may save time by taking the first bus (BRT or local) that arrives. This proportion of riders is represented by  $a$  in Equation 3-11a. Estimates of the proportion of riders saving time for a combined BRT/local route are given in Exhibit 3-20. If the individual headways are 10 minutes and the time saved by taking the first bus that arrives is 20 minutes, then, from Exhibit 3-20,  $a = 0.25$ .

**EXHIBIT 3-20 Estimated Proportion of Riders Saving Time for Various BRT and Local Headways**

Total Time Savings	Individual BRT and Local Headway*		
	8 Minutes	10 Minutes	12 Minutes
5 minutes	0.80	1.00	1.00
10 minutes	0.40	0.50	0.60
20 minutes	0.20	0.25	0.30
30 minutes	0.13	0.17	0.20
40 minutes	0.10	0.12	0.15

\* These values are the values of  $a$  in Equation 3-11a, and  $a = \text{BRT headway} \div (2 \times \text{time savings on entire route})$ .

SOURCE: Computed

**ESTIMATING ADDITIONAL RAPID TRANSIT RIDERSHIP IMPACTS**

Transit riders want to reach their destinations safely, quickly, and reliably. This objective is best met by bus and rail rapid transit that operates as a premium mode and offers riders the following:

- A clearly identifiable running way, with a sense of permanence and minimum traffic interferences
- Safe, secure, and convenient access to attractive yet functional stations
- Clean, comfortable, climate-controlled vehicles that are easy to board and exit
- Passenger information systems at stations and on vehicles, which give "next station" announcements and vehicle arrival times
- A long service span, with frequent service throughout the day
- A simple, understandable service pattern
- A clear system image and identity

An open question is what features BRT must have in order to qualify as “premium.” Is branding sufficient? Can operations in mixed traffic afford a degree of reliability sufficient for riders to perceive the operations as premium, and, if not, what proportion of the service must be on a restricted guideway to achieve “premium” status? What features are required at BRT “stations” for riders to perceive the service in a manner similar to rail? Some suggested answers follow.

Current practice suggests that a modal bias constant in the range equivalent to 10 to 12 minutes of in-vehicle travel time is appropriate to account for the characteristics of rail transit service that are not represented in impedance functions that include only travel time, service frequency, and cost. A few studies based upon travel time elasticity computations have suggested that full-featured, “complete” BRT could attract up to 25% more riders than that obtained by applying elasticity factors. This additional ridership reflects “new” trips as a result of BRT.

Using these findings as a guide, a travel time bias constant equivalent up to 10 minutes of in-vehicle time may be considered in forecasting ridership for BRT systems, depending upon the extent and quality of the BRT system. A “complete” BRT system could also increase the base ridership up to 25% more than that obtained from elasticity computations. This increase is in addition to the ridership gains resulting from elasticity computations.

Each BRT component will account for a portion of the 25% increment. An estimated distribution of the additional ridership impacts, grouped by the estimated maximum percentages for each component, is shown in Exhibit 3-21. These estimates were developed by the research team. *Where site-specific data from preference surveys suggest other percentages, the site-specific data should be used. Transit agencies are encouraged to collect local data and/or derive percentages from customer surveys and share their findings with other transit agencies.*

**EXHIBIT 3-21 Estimated Additional Ridership Impacts of Selected BRT Components**

Component	Maximum %
Running ways	20%
Stations	15%
Vehicles	15%
Service patterns	15%
ITS applications	10%
Branding	10%
<i>Subtotal</i>	<i>85%</i>
BRT component synergy (when subtotal is 60 or more)	15%
<i>Total</i>	<i>100%</i>

SOURCE: Estimated by research team

Because a quality running way provides the basic underpinning of BRT, it is estimated to account for 20% of new ridership. Stations, vehicles, and service patterns are each estimated to account for 15%. ITS applications and branding are each estimated to account for 10%. Another 15% is suggested for the synergy of all components when the subtotal exceeds 60%.

Exhibit 3-22 gives a breakdown of the (estimated) percentages for various types of treatments for each component. Except for running ways, the percentages are additive, depending upon the number of features provided per component.

Added BRT features have an impact on ridership beyond those impacts associated with travel time savings and service frequency improvements. This impact could be as high as 25%.

Site-specific data from preference surveys can be used to identify incremental BRT ridership impacts.

Multiple BRT components may create synergy.



*Bus Rapid Transit Practitioner's Guide*

**EXHIBIT 3-22 Additional Ridership Impacts of Selected BRT Components**

Component		Percentage
1.	Running Ways (not additive)	20
	Grade-separated busways (special right-of-way)	(20)
	At-grade busways (special)	(15)
	Median arterial busways	(10)
	All-day bus lanes (specially delineated)	(5)
	Peak-hour bus lanes	—
	Mixed traffic	—
2.	Stations (additive)	15
	Conventional shelter	—
	Unique/attractively designed shelter	2
	Illumination	2
	Telephones/security phones	3
	Climate-controlled waiting area	3
	Passenger amenities	3
	Passenger services	2
3.	Vehicles (additive)	15
	Conventional vehicles	—
	Uniquely designed vehicles (external)	5
	Air conditioning	—
	Wide multi-door configuration	5
	Level boarding (low-floor or high platform)	5
4.	Service Patterns (additive)	15
	All-day service span	4
	High-frequency service (10 min or less)	4
	Clear, simple, service pattern	4
	Off-vehicle fare collection	3
5.	ITS Applications (selective additive)	10
	Passenger information at stops	7
	Passenger information on vehicles	3
6.	BRT Branding (additive)	10
	Vehicles & stations	7
	Brochures/schedules	3
<i>Subtotal (Maximum of 85)</i>		<i>85</i>
7.	Synergy (applies only to at least 60 points)	15
<i>Total</i>		<i>100</i>

NOTE 1: Applies to a maximum of 10-min travel time bias constant (e.g., percentage of 10 min)

NOTE 2: Applies to a 25% gain in ridership beyond that obtained by travel time and service frequency elasticities

SOURCE: Estimated by research team

Exhibit 3-23 gives an example of the estimated additional ridership for a high-level BRT system (with busways, off-vehicle fare collection, special vehicles, etc.) and for a minimal BRT system (without those components). In this example, the high-level BRT system would have a 9.5-minute bias constant as compared to a 4.3-minute bias constant for the minimal system. The increase in base ridership is in addition to that obtained from elasticity computations. The increases in base ridership for the high-level and minimal systems shown in Exhibit 3-23 are 24% and 11%, respectively.

**GUIDELINES**

The most complex ridership forecasting approaches are used for the detailed alternatives analyses and project design activities associated with large, costly applications. At the other end of the scale are simple “sketch planning”

approaches—often using elasticities, growth factors, and other simple techniques “borrowed” from other cities—appropriate for smaller, less complex, and less risky applications.

**EXHIBIT 3-23 Illustrative Examples of Additional Ridership Estimates**

Component	System 1 (High-Level)		System 2 (Minimal)	
Running Ways	Grade-separated busway	20%	All-day bus lanes	5%
Stations	Unique, attractively designed	2%	Unique, attractively designed	2%
	Illumination	2%	Illumination	2%
	Telephones/security phones	3%	Telephones/security phones	0%
	Passenger amenities	3%	Passenger amenities	0%
Vehicles	Uniquely designed vehicles	5%	Uniquely designed vehicles	5%
	Wide multi-door access	5%	Wide multi-door access	0%
	Low-floor vehicles	5%	Low-floor vehicles	0%
Service Pattern	All-day service span	4%	All-day service span	4%
	High-frequency service	4%	High-frequency service	4%
	Clean, simple service pattern	4%	Clean, simple service pattern	4%
	Off-vehicle fare collection	3%	Off-vehicle fare collection	0%
ITS Applications	Passenger information at stops	7%	Passenger information at stops	7%
	Passenger information on vehicles	3%	Passenger information on vehicles	0%
BRT Branding	Vehicles and stations	7%	Vehicles and stations	7%
	Brochures and schedules	3%	Brochures and schedules	3%
<i>Subtotal</i>		<i>80%</i>		<i>43%</i>
Synergy		15%		0%
<i>Total</i>		<i>95%</i>		<i>43%</i>
Bias (10 minutes x Total) (in minutes)		9.5		4.3
Elasticity increment (0.25 x Total)		0.24		0.11

SOURCE: Estimated by research team

Regardless of the type of BRT application being analyzed, the most conservative, reasonable ridership forecasting approach available should be used. In most cases, this conservative approach will involve ridership elasticity-based “growth” factors and/or mode choice models derived from statistical analyses of detailed demand survey data for the existing conventional local bus system. Pivot-point mode split estimates will be useful.

If, however, comparisons are to be made with rail-based rapid transit alternatives or if it is desired to estimate the upper bound of an envelope of ridership expectations, then a more aggressive approach can be used. The guidelines presented below for this situation differentiate between conventional local bus systems and full-featured BRT applications. For the purpose of the guidelines, full-featured BRT is defined as follows:

- The system has permanently integrated rapid transit elements as well as a unique identity and quality brand image.
- The system operates on dedicated transitways, either totally independent from the street system or physically separated in arterial or freeway rights-of-way, for the majority of its corridor.
- The system has all-day service levels that permit passengers to arrive randomly at stations and avoid experiencing waiting times perceived to be excessive (maximum headways of 15 minutes in the off-peak and 10 minutes in the peak).

---

## Bus Rapid Transit Practitioner's Guide

- The system has permanent stations with a high design quality, a high level of amenities, and a unique BRT identity.
- The system incorporates high-quality vehicles that are configured for the BRT services offered and markets served and have a unique BRT identity.

### Sketch Planning

For “sketch planning” purposes, the “upper end of the envelope” ridership forecasts for full-featured BRT systems should use existing local bus ridership in BRT corridors and the elasticities cited in the literature (e.g., *The Demand for Public Transportation* [31]) for rapid transit systems, most often rail-based, rather than elasticities cited for conventional local bus systems. In the case that the requisite rapid transit travel times and service frequency elasticities are available for a given city, these should be utilized.

If only local bus system elasticities are available for the given city, these can be “factored” using the procedures described earlier. The “BRT growth” factors can be applied above and beyond elasticity factors reflecting travel time and frequency changes to the local bus system. These factors should vary from 1.05 to 1.25 times the existing all-day corridor demand, depending on the nature of the BRT application and the extent of features provided. In the case of an integrated package of improvements where there is no dedicated running way but some type of BRT “brand identity,” then the special BRT factor should be 1.05 to 1.15. If the BRT application is similar to the full-featured system described above, the factor would be closer to 1.25.

For applications that are neither a full-featured, integrated system nor a simple package of bus service and facility improvements, the BRT “growth factor” would be proportional to the features included but lie between 1.05 and 1.25 as previously noted.

### Detailed Alternatives Analyses

Past practice has applied bias constants for rail rapid transit systems of no more than 12 minutes of equivalent in-vehicle travel time. Accordingly, a bias constant of up to an equivalent 10 minutes of in-vehicle travel time could be considered for full-featured BRT. Guidelines for applying bias constants to BRT systems follow:

1. Where the results of travel model calibration and validation efforts using real ridership data suggest that customer response to the travel times and out-of-pocket costs of new rail systems will be different from and more positive than those for conventional local bus systems, BRT alternatives of similar content and quality to the empirically observed rail systems should be treated the same as the rail alternatives.
  - > The same mode choice model structure and “calibration” coefficients and constants should be utilized for BRT. The suggested bias constant ranges up to 10 minutes for BRT (and up to 12 minutes for rail-based transit).
2. Where neither rail-based transit nor BRT exists in a given metropolitan area, proposed BRT alternatives of content and quality similar to proposed rail-based alternatives should be treated the same as the rail-based alternatives.
  - > The same mode choice model structure and “calibration” coefficients and constants should be utilized for BRT. The suggested bias constant

The precise value will depend on the extent of BRT features. Mixed-traffic BRT alternatives (e.g., streetcar and rapid bus) would be afforded proportionally less favorable treatment than full-featured, higher quality BRT operating on independent, grade-separated running ways.

ranges up to 10 minutes for BRT (and up to 12 minutes for rail-based transit).

3. Where the BRT alternative is different (lower) in content and overall quality than proposed rail-based alternatives for valid technical reasons, then modal bias constants and impedance (generalized cost) coefficients should be adjusted to be a reasonable and proportional average (depending on quality and content) of those for the conventional local bus system and those for the rail-based modes, again keeping in mind the maximum 10-minute BRT in-vehicle travel time advantage noted above.
  - > The mode choice model modal bias constant and impedance (generalized cost) coefficients used to estimate ridership for BRT should fall in between that obtained from a valid calibration for the existing local bus system and that obtained for a rail-based system. Where BRT falls in the continuum would depend on the nature of the respective systems.
4. Where the current rail system is old, in poor repair, and unreliable and has real safety and security issues, the coefficients and constants used for full-featured BRT alternatives and any proposed rail transit alternatives should be the same even if there is model calibration evidence that "all things being equal, customers prefer bus to rail."

Results should be checked for reasonableness, whatever method is used.

## REFERENCES

1. Diaz, R.B., M. Chang, G. Darido, E. Kim, D. Schneck, M. Hardy, J. Bunch, M. Baltés, D. Hinebaugh, L. Wnuk, F. Silver, and S. Zimmerman. *Characteristics of Bus Rapid Transit for Decision-Making*. FTA, Washington, D.C., 2004.
2. Miami-Dade South Busway Corridor Case Study, University of South Florida, Center for Transportation Research.
3. Herzenberg, A. *MBTA Silver Line*. Presented at Financial Future of Transit in the New York Region. New York University, Wagner School of Public Administration, Oct. 2004.
4. Kittelson & Associates, Inc., Herbert S. Levinson Transportation Consultants, DMJM+Harris, and OURCO, Inc. TCRP Project A-23A Interim Report. Unpublished. 2004.
5. MSI International. *A Qualitative Study of Metro Rapid and Associated Alternatives*. Jul. 2002.
6. TranSystems Corporation, Planners Collaborative, Inc., and Tom Crikelair Associates. *TCRP Web-Only Document 32: Elements Needed to Create High-Ridership Transit Systems: Interim Guidebook*. Transportation Research Board of the National Academies, Washington, D.C., 2005.
7. McFadden, D.L., A. Talvitie, S. Cosslet, I. Hasan, and F.A. Reid. Demand Model Estimation and Validation. *Urban Travel Demand Forecasting Project, Phase I Final Report, Vol. 5*. University of California, Berkeley, June 1977.
8. Pushkarev, B.S., and J.M. Zupan. *Public Transportation and Land Use Policy*. Indiana University Press, Bloomington, 1977.
9. Ben-Akiva, M., and T. Morikawa. Comparing Ridership Attraction of Rail and Bus. *Transport Policy, Vol. 9*. Elsevier Science, Ltd., Oxford, Apr. 2002.
10. Currie, G. *The Demand Performance of Bus Rapid Transit*. Institute of

FTA is continuing to evaluate the use of bias constants in BRT and rail New Starts proposals.

---

*Bus Rapid Transit Practitioner's Guide*

- Transportation Studies, Department of Civil Engineering, Monash University, Melbourne, Australia, 2004.
11. Falbel, S., H. Levinson, K. Younger, and S. Misiewicz. *Bus Rapid Transit Plans in New York's Capital District. Journal of Public Transportation, 2006 Bus Rapid Transit Special Edition*. National Center for Transit Research, University of South Florida, College of Engineering, Tampa, 2006.
  12. Levinson, H., S. Zimmerman, J. Clinger, S. Rutherford, R. Smith, J. Cracknell, and R. Soberman. *TCRP Report 90: Bus Rapid Transit: Vol. 1, Case Studies in Bus Rapid Transit, and Vol. 2, Implementation Guidelines*. Transportation Research Board of the National Academies, Washington, D.C., 2003.
  13. APTA Intermodal Operations Planning Workshop. *TransLink Welcoming Session*. Vancouver, BC, Aug. 9-11, 2004.
  14. Ben-Akiva, M., and S. Lerman. *Discrete Choice Analysis Theory and Application to Predict Travel Demand*. MIT Press, Cambridge, 1985.
  15. Domenich, T., and D. McFadden. *Urban Travel Demand: A Behavioral Analysis*. North-Holland, New York, 1975.
  16. Horowitz, J.L., F.S. Koppelman, and S.R. Lerman. *A Self-Instructing Course in Disaggregate Mode Choice Modeling. Final Report*. UMTA, Washington, D.C., 1986.
  17. *Semi-Independent Forecasts of Ridership and User Benefits for New Starts Projects*. FTA, Washington, D.C., June 2006.
  18. Kumar, A. Use of Incremental Form of Logit Models in Demand Analysis. *Transportation Research Record 775*. TRB, National Research Council, Washington, D.C., 1980, pp. 21-27.
  19. Ho, E. *DRRA Route 55 Corridor Ridership Estimates - Summary*. Gallup Corporation.
  20. Daly, A., J. Fox, and J.G. Tuinenga. *Pivot-Point Procedures in Practical Travel Demand Forecasting*. 45th Congress of the European Regional Science Association. European Regional Science Association, Amsterdam, August 2005.
  21. *City of Tucson Alternatives Analysis: Incremental Logit Methodology*. Hexagon Transportation Consultants, Inc., San Jose, Apr. 2005.
  22. Integrated Transport Economics and Appraisal Division. *Transport Analysis Guidance: Variable Demand Modelling - Key Processes*. Department for Transport, London, June 2006.
  23. Manheim, M.L. *Fundamentals of Transportation Systems Analysis. Vol. 1: Basic Concepts*. MIT Press, Cambridge, 1979.
  24. *Tucson Major Transit Investment Study: Model Methodology and Forecasting Results. Draft*. Hexagon Transportation Consultants, Inc., San Jose, Oct. 2005.
  25. *Analysis and Augmentation of MWCOC's Transit Models: Executive Summary and Three Technical Work Papers*. Barton-Aschman Associates, Washington, D.C., March 1983.
  26. Martin, W.A., and N.A. McGuckin. *NCHRP Report 365: Travel Estimation Techniques for Urban Planning*. TRB, National Research Council, Washington, D.C., 1995.
  27. *Discussion Piece #9: Semi-Independent Forecasts of Ridership and User Benefits for New Starts Projects*. FTA, Washington, D.C., June 2006.

28. Pratt, R.H., Texas Transportation Institute, Cambridge Systematics, Inc., Parsons Brinckerhoff Quade & Douglas, Inc., SG Associates, Inc., and McCollom Management Consulting, Inc. *TCRP Web Document 12: Traveler Response to Transportation System Changes: Interim Handbook*. TRB, National Research Council, Washington, D.C., 2000.
29. Mayworm P.A., A.M. Lago, and J.M. McEnroe. *Patronage Impacts of Changes in Transit Fares and Services*. Report USDOT/UMTA UPM 33. Ecosometrics, Sept. 1980.
30. KFH Group, Inc. *TCRP Report 99: Embracing Change in a Changing World: Case Studies Applying New Paradigms for Rural and Small Urban Transit Service Delivery*. Transportation Research Board of the National Academies, Washington, D.C., 2004.
31. Balcombe, R., R. Mackett, N. Paulley, J. Preston, J. Shires, H. Titheridge, M. Wardman, and P. White. *The Demand for Public Transportation, A Practical Guide*, Report 593. Transportation Research Laboratory, London, 2004.

---

*Bus Rapid Transit Practitioner's Guide*

This page is intentionally blank.

## CHAPTER 4. COMPONENT FEATURES, COSTS, AND IMPACTS

### INTRODUCTION

This chapter presents the characteristics, costs, and impacts of different BRT components and contains guidelines for developing and assessing individual components. Profiles have been developed for the following:

- Running way components
  - > Busways on separate rights-of-way (ROWs)
  - > Arterial bus lanes
  - > Transit signal priority
  - > Queue jumps/bypass lanes
  - > Curb extensions
- Station components
- Vehicle components
  - > Size of vehicle
  - > Modern vehicle styling
  - > Low-floor boarding
  - > Propulsion technologies
  - > Automatic vehicle location
  - > Driver assist and automation
- Service and system components
  - > Service plan features
  - > Fare collection
  - > Passenger information
  - > Enhanced safety and security systems
- Branding

Each of the component profiles includes the following information:

- Scale of application
- Selected typical examples
- Estimated costs (capital, operating)
- Likely impacts (ridership, operating cost savings, land development, etc.)

Where applicable, component profiles also include the following information:

- Conditions of application
- Design and operating features

The component profiles provide basic information and guidelines that will help practitioners.

There are five categories of BRT component profiles in the Guide.



*Bus Rapid Transit Practitioner's Guide*

- Implementability (institutional factors)
- Analysis tools (analogy/synthesis, analytical modeling, simulation)

The general component analysis framework is shown in Exhibit 4-1. Components such as busways and bus lanes enhance ridership by saving time in conjunction with expanded service. Other components such as improved urban design or passenger amenities may enhance ridership (or even enhance development directly).

Implementability is an essential consideration in assessing components. BRT components should be “implemented” by achieving a reasonable balance between costs and benefits and without introducing any major adverse impacts.

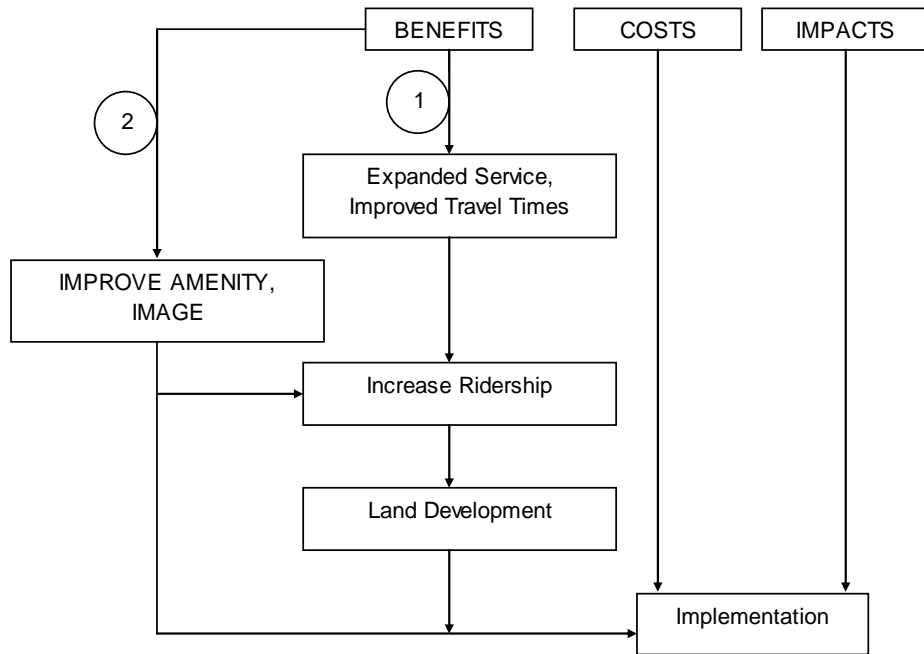

NOTE 1: Physical/operational factors (e.g., bus lanes)  
 NOTE 2: Branding and passenger information (for example)  
 SOURCE: TCRP A-23A project team

**EXHIBIT 4-1** General BRT Component Analysis Framework

**RUNNING WAY COMPONENTS**

Running ways, along with stations and vehicles, are essential parts of any BRT system. How well they perform has an important bearing on BRT speed, reliability, identity, and passenger attraction. Running way types vary in degree of separation, type of marking, and extent of lateral guidance. Each feature has an important bearing on BRT system performance and costs. Examples of running way performance are set forth in Exhibit 4-2. Photos of various types of running ways are in Exhibit 4-3 through Exhibit 4-9.

**EXHIBIT 4-2 Generalized Effects of BRT Running Way Elements**

Element	System Performance					System Benefits
	Travel Time Savings	Reliability	Identity and Image	Safety and Security	Capacity	
Running Way Segregation Types: <ul style="list-style-type: none"> <li>▪ Mixed-flow lanes with queue jumps</li> <li>▪ Designated (reversed) arterial lanes</li> <li>▪ At-grade exclusive lane (transitway)</li> <li>▪ Grade-separated exclusive lane (transitway)</li> </ul>	Congestion delays decrease with increased running way segregation.	Running way segregation reduces the risk of delay due to non-recurring congestion and accidents.	Running way segregation highlights a permanent investment and the special treatment for BRT.	Separation of BRT vehicles from other traffic streams reduces hazards.	Multiple lanes increase capacity. Segregation reduces congestion delay, increasing throughput.	Running way segregation highlights a permanent investment that attracts development. Speed benefits associated with the running way enhance ridership gain and environmental benefit.
Running Way Marking: <ul style="list-style-type: none"> <li>▪ Signage</li> <li>▪ Lane delineators</li> <li>▪ Alternative pavement color/texture</li> </ul>			Markings highlight that BRT running ways are a special, reserved treatment.			
Running Way Guidance Types: <ul style="list-style-type: none"> <li>▪ Optical guidance</li> <li>▪ Electromagnetic guidance</li> <li>▪ Mechanical guidance</li> </ul>	Guidance allows operators to operate vehicles safely at maximum speeds.		Guidance provides a smoother ride, enhancing image.	Guidance allows for safer operation at higher speeds.		

SOURCE: CBRT (7)



SOURCE: <http://www.allaboutsilverline.com>

**EXHIBIT 4-3 Bus Tunnel (Boston)**

---

*Bus Rapid Transit Practitioner's Guide*



SOURCE: [www.gobrt.org](http://www.gobrt.org)

**EXHIBIT 4-4** Grade-Separated Busway (Pittsburgh)



SOURCE: Kittelson & Associates, Inc.

**EXHIBIT 4-5** At-Grade Busway (Orlando)



SOURCE: [www.gobrt.org](http://www.gobrt.org)

**EXHIBIT 4-6** Median Busway (Vancouver)



SOURCE: Kittelson & Associates, Inc.  
**EXHIBIT 4-7** Curb Bus Lane (Los Angeles)



SOURCE: Kittelson & Associates, Inc.  
**EXHIBIT 4-8** Dual Curb Bus Lanes (New York City)

A more detailed classification of running ways by degree of access control (segregation) is given in Exhibit 4-10. At one end of the spectrum is operation in mixed traffic; at the other is grade-separated busways. Grade-separated BRT operations are generally considered "full BRT." BRT operations in bus-only lanes or in mixed traffic are generally considered "light BRT."

*Bus Rapid Transit Practitioner's Guide*



SOURCE: Kittelson & Associates, Inc.

**EXHIBIT 4-9 Bus-Only Street (Portland, OR)**

**EXHIBIT 4-10 BRT Running Ways Classified by Extent of Access Control (Degree of Segregation)**

Class	Access Control	Facility Type
I	Uninterrupted flow - full control of access	Bus tunnel Grade-separated busway Reserved freeway lanes
II	Partial control of access	At-grade busway
III	Physically separated lanes within street right-of-way	Arterial median busway Bus streets
IV	Exclusive/semi-exclusive lanes	Concurrent and contraflow bus lanes
V	Mixed traffic operations	

SOURCE: *TCRP Report 90 (2)*

Exhibit 4-11 gives examples of the various types of running ways in each access classification. Exhibit 4-12 gives order of magnitude costs as set forth in *TCRP Report 90 (2)*. (Costs exclude the right-of-way costs that would be required for off-street BRT operation.) These costs provide an initial planning guide and should be modified to reflect specific local circumstances.

Options that have a high degree of right-of-way segregation cost more than those where BRT operates in mixed traffic or in reserved bus lanes. However, the former provide the fastest and most reliable BRT service, offer a high degree of system permanence, and may stimulate BRT-related land development.

The choice of running way type for any given corridor will depend on market potential and route-specific opportunities and constraints. Key questions to be addressed are as follows:

- What are the markets to be served, and how well are these markets served by proposed alignments?
- Will there be a sufficient “presence” of buses in any corridor to make running way improvements worthwhile—especially busways and bus lanes?

The choice of running way depends on market potential and route-specific opportunities and constraints.

There are four key questions to ask in identifying the type of BRT running way needed.



- Are suitable rights-of-way available for busway development, and can these rights-of-way effectively connect with the city center and other major activity centers?
- Are arterial streets and roadways wide enough to provide segregated median BRT running ways?

**EXHIBIT 4-11 Examples of Various Types of BRT Running Ways**

Facility Type	Access Class	Examples
<b>Busways</b>		
Bus tunnel	I	Boston, Seattle
Grade-separated busway	I	Ottawa, Pittsburgh
At-grade busway	II	Miami, Hartford, Los Angeles (Orange Line)
<b>Freeway lanes</b>		
Concurrent flow lanes	I	Ottawa, Phoenix
Contraflow lanes	I	New Jersey approach to Lincoln Tunnel
Bus-only or bus priority ramps	I	Los Angeles
<b>Arterial streets</b>		
Arterial median busway	III	Curitiba (Brazil), Vancouver (BC), Cleveland
Curb bus lane	IV	Rouen (France), Vancouver, Las Vegas
Dual curb lanes	IV	New York City (Madison Ave)*
Interior bus lanes	IV	Boston
Median bus lane	IV	Cleveland
Contraflow bus lane	IV	Los Angeles, Pittsburgh
Bus-only street	IV	Portland (OR)*
Mixed traffic flow	V	Los Angeles
Queue jump/bypass lane	V	Leeds (UK), Vancouver
TSP	V	Los Angeles, Oakland

\* Regular bus operations

SOURCE: Updated from *TCRP Report 90 (2)*

**EXHIBIT 4-12 Typical BRT Running Way Costs as of 2004 (Excluding Right-of-way)**

Component	Cost (Millions)
<i>Running Way Type</i>	
Grade-separated busway	
Below grade (tunnel)	\$60 to \$105 per lane-mile
Aerial	\$12 to \$30 per lane-mile
At-grade busway	
Separate ROW or median	\$0.5 to \$10.2 per lane-mile
Arterial lanes (reconstructed)	\$2.5 to \$2.9 per lane-mile
Mixed flow lanes - queue jump	\$0.1 to \$0.29 per lane-mile
<i>Guidance Type</i>	
Optical	\$11,000 to \$134,000 per vehicle
Electromagnetic sensors	\$20,000 per mile
Hardware and integration	\$50,000 to \$95,000 per vehicle

SOURCE: CBRT (7)

Busways on separate rights-of-way provide the highest type of BRT service in terms of travel speeds, service reliability, BRT identity, and passenger attraction. However, they can be costly, are sometimes difficult to build, and are not always located in the major transit corridors; therefore, on-street BRT operations in median busways, bus lanes, or even mixed traffic often become necessary.

*Bus Rapid Transit Practitioner's Guide*

Traffic engineering treatments must be integrated into the BRT running way.

BRT on city streets should use the “fastest” streets available wherever possible, because bus speeds correlate closely with automobile speeds for any given stop frequency and dwell times.

Transit-sensitive traffic engineering treatments are essential. These treatments include the following:

- Peak-period or all-day curb parking and left/right-turn restrictions. Curb parking should be prohibited wherever curb bus lanes are provided.
- One-way traffic movements (but only where they do not adversely affect passenger access to bus stops)
- Traffic signal timing strategies that use shorter rather than longer cycles
- Traffic signal coordination for general traffic and, in some cases, for BRT
- Special lanes for left and right turns
- Special treatments for buses (bus lanes, traffic signal priorities, and queue bypasses)
  - > Bus lanes are desirable wherever there is a sufficient “presence” of buses, the lanes improve BRT running times and reliability, curb parking can be prohibited when curb bus lanes operate, and the service requirements of adjacent establishments can be accommodated.
  - > Bus TSP and queue bypass lanes are desirable, especially where it is not practical to provide bus lanes.
- Effective enforcement of traffic controls and bus lanes

Exhibit 4-13 identifies the impacts of different running way components on travel time savings in cities with existing BRT systems.

**EXHIBIT 4-13 Sources of BRT Travel Time Savings**

BRT System	Exclusive Running Way	Increased Stop Spacing	Exclusive Lanes/Queue Bypass	TSP
Adelaide (Australia)	55%	40%	3%	2%
Los Angeles: Wilshire-Whittier	—	67%	—	33%
Los Angeles: Ventura	—	67%	—	33%
South Miami-Dade Busway	50%	25%	—	25%

SOURCE: TCRP Project A-23A Interim Report (3)

The profiles that follow give guidelines for busways, bus lanes, TSP, queue jumps/bypass lanes, and curb extensions. These guidelines cover planning, design, costs, and effects.

**Busways**

Busways are separated roadway facilities for the exclusive use of buses, either within an overall roadway right-of-way or in a separate right-of-way. Busways — especially when off-street and grade-separated — are the most effective BRT running way option in terms of operating speed, service reliability, and BRT identity. They mirror rail transit facilities in both operating features and permanence. When placed in major travel corridors, they can attract many riders. This profile gives guidelines for busway planning and design and for assessing costs and effectiveness.

Busways offer high operating speeds and reliable BRT service. Busways also establish a clear BRT identity and a sense of permanence.

### Scale of Application

Busways may connect the city center with outlying parts of the urban area (radial busways) or with the terminus of a rail transit line. They also may take the form of a bus subway (tunnel) within the central area. They may be fully or partially grade-separated, or they may operate fully at grade. They may be placed in separate right-of-way, alongside or within a freeway, or within the center of a wide arterial street. They generally extend for at least 5 miles (usually more).

There are various degrees of grade separation for busways.

### Selected Typical Examples

Examples of each type of busway follow:

- *Radial Busways from City Center*—Brisbane, Australia; Ottawa; and Pittsburgh
- *CBD Bus Tunnels*—Boston and Seattle
- *Extensions of Rail Transit Line*—Los Angeles (Orange Line), Miami (South Dade), and Philadelphia (Ardmore Line)
- *Grade-Separated Busways*—Brisbane, Ottawa, and Pittsburgh
- *At-Grade Busways, Separate Right-of-Way*—Los Angeles (Orange Line) and Miami (South Dade)
- *Median Arterial Busways in City Streets*—Bogotá, Colombia; Curitiba, Brazil; Cleveland; and Vancouver (Richmond), BC

### Conditions of Application

Busways typically involve substantial development costs. Experience suggests that they are mainly a large-city treatment (i.e., used with urban populations exceeding one million people). However, where suitable rights-of-way are readily available, they also may be appropriate in smaller urban areas.

Busways are usually applied in larger cities.

Desired conditions of application (or “applicability”) are as follows:

1. *Radial Busways from CBD (or other major anchors)*. These busways usually require at least 75,000 jobs in the city center.
2. *Extensions of Rail Transit Line*. Busways should be keyed to heavily used rail transit terminals (or outlying stations). Available right-of-way, such as an abandoned railroad line or a utility corridor, can afford a cost-effective extension.
3. *Median Arterial Busways*. Wide arterial streets are essential. A minimum 80- to 90-foot curb-to-curb width is desirable to allow far-side BRT stops and near-side left turns to share a common envelope. The absolute minimum width is 70 feet. The minimum width requires providing left turns and stations at different locations as well as transitioning of the busway alignment when station platforms or turn lanes are provided to save space.

Busways in the center of arterial roadways normally require a curb-to-curb width of at least 70 feet.

Busways may be located in separate right-of-way (Ottawa and Pittsburgh), alongside or within a freeway envelope (Brisbane), in a downtown bus tunnel (Boston and Seattle), or in the center of a wide street (Cleveland).

### Location and Alignment

Ideally, busways should penetrate high-density residential and commercial areas, traverse the city center, and provide convenient access to major downtown activities. They should be located on their own right-of-way wherever possible.



---

## Bus Rapid Transit Practitioner's Guide

Busways should save at least 5 minutes in travel time.

Locations in order of desirability are (1) separate right-of-way, (2) one side of a freeway, and (3) within freeway or city street medians.

Railroad and freeway rights-of-way offer opportunities for relatively easy land acquisition and low development costs. However, the right-of-way availability should be balanced with its proximity and access to key transit markets. Such right-of-way may generate little walk-on traffic, limit opportunities for land development, and require complex negotiations.

Busways should be long enough to save at least 5 minutes of travel time over bus operations along arterial streets. Generally, radial busways should be at least 5 miles long; 10 miles or more usually will be desirable. Alignment should be direct, with a minimum number of sharp bus turns. Stops should be widely spaced in outlying areas. It is generally desirable to provide at least three stops in the CBD, spaced at 1/4- to 1/2-mile intervals.

Busways on separate right-of-way should enable express BRT services to pass around stopped buses at stations. This characteristic increases service flexibility, reliability, and capacity, but it requires cross sections of about 80 feet at stations.

Busways could be designed to allow for possible future conversion to rail or other fixed guideway transit. A 60-foot, mid-station, right-of-way width and an 80-foot width at stations can allow BRT service during the conversion period. Structures should be able to sustain train loadings, and clearances should be adequate for train operations.

Busway stations typically have a higher level of access facilities.

Busway stations should be accessible by foot, automobile, bicycle, and/or bus. They should be placed at major traffic generators and at intersecting bus lines. Park-and-ride facilities should be provided in outlying areas where most access is by car.

Busways can be integrated with the design of new communities and provide a framework for transit-oriented developments.

Suitable connections to the urban street network (at-grade or grade-separated) are desirable where BRT vehicles enter and leave busways and intermediate points.

### *Design and Operation*

Busways should operate in normal flow.

Busway design should permit safe and efficient operations. Designs should be keyed to the characteristics of vehicles and the capabilities of bus drivers. Busways should operate in normal flow, with outside shoulders wherever possible. Center-island busway stations should be limited to BRT vehicles with doors on both sides.

Roadway geometry should be governed by the performance and clearance requirements of standard 40- to 45-passenger buses and 60- to 70-foot articulated buses. Joint-use guideways should be able to accommodate light rail vehicles.

Design speeds of 60 to 70 miles per hour are desirable for grade-separated buses and 50 to 60 miles per hour for other busways.

Busway lanes should be 11.5 to 12 feet wide on separate right-of-way and at least 11 feet wide where buses operate within street medians. Grades should be less than 6% wherever possible with 9% the absolute maximum. Vertical clearances should be at least 13 to 14.5 feet for urban transit buses.

The BRT service plan associated with busways should depend upon land use and BRT market characteristics. Typically, one (or two) basic all-stop high-frequency bus services should be provided with "overlay" peak-period express routes. An excessive number of service varieties should be avoided to minimize passenger confusion.

*Estimated Costs*

Busway development costs include land acquisition, construction, and engineering. These costs vary by running way location, type, design features, and the type of terrain traversed. Costs, therefore, should be carefully estimated for each busway facility.

Experience can serve as a guide in (1) making initial estimates or (2) checking actual estimates. See Exhibit 4-14 through Exhibit 4-17.

Exhibit 4-14 gives total busway development costs for bus tunnels, grade-separated busways, and at-grade busways. The (rounded) reported cost ranges (in millions of dollars per mile by facility type) are as follows:

- Bus tunnels \$214-329 million per mile
- Grade-separated busways \$6-50 million per mile
- At-grade busways on dedicated right-of-way \$1-15 million per mile
- Median arterial busways \$6-16 million per mile

Exhibit 4-15 gives land costs set forth in the TCRP Project A-23A Interim Report (3). Land costs ranged from \$0.5 to \$6 million per mile (rounded). Typical costs (rounded) follow:

- Cleveland: Euclid Busway \$1 million per mile
- Pittsburgh (two busways) \$4 to 6 million per mile

Busway development costs depend on running way type, location, features, and type of terrain traversed.

**EXHIBIT 4-14 Reported Busway System Development Costs (U.S. Dollars)**

Busway Type and System	Year Opened	Miles	Cost (millions)	Cost (millions)/Mile
<b>Bus Tunnels</b>				
Boston - Silver Line <sup>1</sup>	2005	4.1	\$ 1,350.0	\$ 329.3
Seattle <sup>1</sup>	1989	2.1	\$ 450.0	\$ 214.3
<b>Grade-Separated Busways</b>				
Adelaide, Australia (guided bus) <sup>1</sup>	1989	7.5	\$ 67.9	\$ 9.1
Brisbane, Australia <sup>2</sup>	2001	10.3	\$ 330.1	\$ 32.0
Ottawa <sup>2,3</sup>	1983	16.0	\$ 297.1	\$ 18.6
Pittsburgh: South Busway <sup>1</sup>	1977	4.3	\$ 27.0	\$ 6.3
Pittsburgh: East Busway <sup>1</sup>	1983	6.8	\$ 130.0	\$ 19.1
Pittsburgh: East Busway Extension <sup>2</sup>	2003	2.3	\$ 68.8	\$ 29.9
Pittsburgh: West Busway <sup>2,4</sup>	2000	5.0	\$ 249.9	\$ 50.0
<b>At-Grade Busways (Off-Street)</b>				
Hartford: New Britain (proposed) <sup>1</sup>	2007	9.6	\$ 145.0	\$ 15.1
South Miami-Dade <sup>1</sup>	1996	8.2	\$ 59.0	\$ 7.2
South Miami-Dade Extension <sup>2</sup>	2007	11.5	\$ 13.5 <sup>5</sup>	\$ 1.2
<b>At-Grade Busways (On-Street)</b>				
Bogotá, Colombia: TransMilenio <sup>1</sup>	2000	23.6	\$ 184.0	\$ 7.8
Cleveland: Euclid Avenue <sup>2,6</sup>	2008	10.7	\$ 168.4	\$ 15.7
Quito, Ecuador: Trole Bus <sup>1</sup>	1996	10.0	\$ 57.6	\$ 5.8

<sup>1</sup> From *TCRP Report 90 (2)*

<sup>2</sup> From TCRP Project A-23A Interim Report (3)

<sup>3</sup> Miles and Cost reflect only the grade-separated busway portion of the BRT route.

<sup>4</sup> Does not include Wabash HOV facility. From Port Authority of Allegheny County data.

<sup>5</sup> Does not include land acquisition costs

<sup>6</sup> Under construction. Miles and Cost include only the transitway portion of the BRT route.

SOURCE: Adapted from *TCRP Report 90 (2)*

BRT busway system development costs vary widely.

---

*Bus Rapid Transit Practitioner's Guide*
**EXHIBIT 4-15 Reported Busway Land Acquisition Costs (U.S. Dollars)**

Busway Type and System	Miles	Cost (millions)	Cost (millions)/Mile
<b>Grade-Separated Busways</b>			
Adelaide, Australia (guided bus)	7.5	\$ 4.0	\$ 0.5
Pittsburgh: West Busway <sup>1</sup>	5.0	\$ 26.3	\$ 5.3
Pittsburgh: West Busway <sup>2</sup>	5.0	\$ 31.5	\$ 6.3
Pittsburgh: East Busway Extension	2.3	\$ 10.0	\$ 4.3
<b>Other Busways</b>			
Cleveland: Euclid Avenue	10.7	\$ 13.7	\$ 1.3
Hartford: New Britain (proposed)	9.6	\$ 12.0	\$ 1.3

<sup>1</sup> Cost obtained from FTA<sup>2</sup> Cost obtained from Port Authority of Allegheny County

SOURCE: TCRP Project A-23A Interim Report (3)

Exhibit 4-16 gives busway construction costs set forth in TCRP Project A-23A Interim Report (3). Running way costs for grade-separated busways ranged from \$5 million (rounded) per mile in Adelaide to \$44 million (rounded) for Pittsburgh's West Busway (which traverses hilly terrain and includes a rehabilitated rail tunnel). Costs for Ottawa's Transitway and Pittsburgh's East Busway (mainly built in the 1980s and 1990s) were \$13 million (rounded) per mile and \$17 million (rounded) per mile, respectively. The at-grade busways in Cleveland (under construction) and Hartford (proposed) were estimated to cost approximately \$4 million per mile and \$6 million per mile, respectively.

Exhibit 4-17 gives the busway construction cost ranges set forth in CBRT (1). The ranges are expressed in terms of costs per lane-mile and should be doubled to obtain costs per route-mile. The below-grade busway costs appear to be less than those previously cited for Boston and Seattle.

Busway operating costs have been estimated at \$10,000 per year per lane-mile.

**EXHIBIT 4-16 Reported Busway Construction Costs (U.S. Dollars)**

Busway Type and System	Year Opened	Miles	Cost (millions)	Cost (millions)/Mile
<b>Bus Tunnels</b>				
Boston: Silver Line <sup>1</sup>	2005	4.1	\$ 1,350.0	\$ 329.3
Seattle <sup>1</sup>	1989	2.1	\$ 450.0	\$ 214.3
<b>Grade-Separated Busways</b>				
Adelaide, Australia (guided bus) <sup>2</sup>	1989	7.5	\$ 37.0	\$ 4.9
Brisbane, Australia: South East Busway <sup>2</sup>	2001	10.3	\$ 262.8	\$ 25.5
Ottawa: Transitway <sup>2,3</sup>	1983	16.0	\$ 212.6	\$ 13.3
Pittsburgh: South Busway <sup>1</sup>	1977	4.3	\$ 27.0	\$ 6.3
Pittsburgh: East Busway <sup>1</sup>	1983	6.8	\$ 113.0	\$ 16.6
Pittsburgh: East Busway Extension <sup>1</sup>	2003	2.3	\$ 30.1	\$ 13.1
Pittsburgh: West Busway <sup>2,4</sup>	2000	5.0	\$ 220.9	\$ 44.2
<b>At-Grade Busways (Off-Street)</b>				
Hartford: New Britain (proposed) <sup>1</sup>	2007	9.6	\$ 53.8	\$ 5.6
South Miami-Dade <sup>1</sup>	1996	8.2	\$ 57.0	\$ 7.0
South Miami-Dade Extension <sup>2</sup>	2007	11.5	\$ 9.5	\$ 0.8
<b>At-Grade Busways (On-Street)</b>				
Bogotá, Colombia: TransMilenio <sup>1</sup>	2000	23.6	\$ 184.0	\$ 7.8
Cleveland: Euclid Avenue <sup>2,5</sup>	2008	10.7	\$ 44.3	\$ 4.2

<sup>1</sup> From *TCRP Report 90 (2)* (development costs)<sup>2</sup> From TCRP Project A-23A Interim Report (3) (running way costs)<sup>3</sup> Miles and Cost reflect only the grade-separated busway portion of the BRT route.<sup>4</sup> Does not include Wabash HOV facility. From Port Authority of Allegheny County data.<sup>5</sup> Under construction. Miles and Cost columns include only transitway portion of BRT route.

**EXHIBIT 4-17 Busway Construction Costs by Type (U.S. Dollars)**

Busway Type	Cost/Lane-Mile (millions)
At Grade	\$6.5 to \$10.2
Aerial	\$12 to \$30
Below Grade	\$60 to \$105
Additional Lanes	\$2.5 to \$3.0 (within existing roadway profile) \$6.5 to \$10.2 (outside existing roadway profile)

SOURCE: CBRT (7)

*Likely Impacts*

BRT busways (especially when grade-separated) reduce travel times and improve reliability. They enhance ridership by both their travel time savings and sense of permanence. They also can encourage new land development near stations.

*Travel Time Savings*

Busway travel time savings can be estimated (1) by analogy with existing BRT systems and (2) by analyzing the relationships among busway design speed, station spacing, and dwell times at stops. Speeds are improved by service patterns that provide express (non-stop) operations.

Typical urban transit buses operate at speeds of about 10 to 12 miles per hour. Speeds up to 20 miles per hour can be anticipated with arterial median busways. Speeds of 25 to 40 miles per hour can be anticipated with grade-separated busways.

Exhibit 4-18 gives estimated average bus speeds on busways, assuming a maximum 50 miles per hour busway running speed. For a maximum 55 miles per hour running speed, these speeds would be increased about 4 miles per hour. Thus, assuming a 15-second dwell time per stop, average bus speeds would range from 26 miles per hour with half-mile station spacing to more than 40 miles per hour when station spacing exceeds 1.5 miles.

Grade-separated busways permit schedule speeds of 25 to 40 mph depending on frequency of stations.

**EXHIBIT 4-18 Estimated Average Busway Speeds**

Average Stop Spacing (miles)	Average Dwell Time per Stop (seconds)				
	0	15	30	45	60
0.5	36 mph	26 mph	21 mph	18 mph	16 mph
1.0	42 mph	34 mph	30 mph	27 mph	24 mph
1.5	44 mph	38 mph	35 mph	32 mph	29 mph
2.0	46 mph	41 mph	37 mph	35 mph	32 mph
2.5	46 mph	42 mph	39 mph	37 mph	35 mph

NOTE: Applies to busways or exclusive freeway HOV lanes with assumed 50-mph top bus running speed

SOURCE: CBRT (7)

Exhibit 4-19 gives actual reported busway speeds. Express buses typically operate at 40 to 60 miles per hour on busways, while all-stop service ranges from 24 to about 30 miles per hour. The exceptions are Miami, where speeds are constrained by "Stop" signs along the busway at non-signalized intersections, and the downtown Seattle Bus Tunnel, which has closely spaced stations.

*Bus Rapid Transit Practitioner's Guide*

**EXHIBIT 4-19 Reported and Anticipated Busway Speeds**

Facility	Express Service Speed (miles/hour)	All-Stop Service Speed (miles/hour)
Hartford: New Britain (proposed)	38	32
South Miami-Dade	18	14
Ottawa Transitway	60	24
Pittsburgh: South Busway	40	30
Pittsburgh: East Busway	40	30
Pittsburgh: West Busway	40	30
Seattle Bus Tunnel	—	13

SOURCE: *TCRP Report 90 (2)*

Reported (and anticipated) travel time savings as a result of busway operation are given in Exhibit 4-20. According to Exhibit 4-20, travel times are typically reduced about 20% to 40% depending upon initial bus speeds. Travel time savings are generally about 2 to 3 minutes per mile for grade-separated busways and about 1.5 to 2.0 minutes per mile for at-grade busways. Where busways serve as queue bypasses, as in the case of Pittsburgh's West Busway, time savings can exceed 4 to 5 minutes per mile.

Grade-separated busways typically save passengers several minutes per mile.

**EXHIBIT 4-20 Reported Travel Time Savings of Busways**

Busway Type and System	Travel Time (minutes)			Travel Time Savings (Minutes)	
	Before	After	% Reduction	Total	Per Mile
<b>Grade-Separated Busways</b>					
Adelaide, Australia	40	25	38	15	2
Brisbane, Australia	—	—	—	—	2 <sup>2</sup>
Pittsburgh: South Busway	—	—	—	6-11	1.4-2.6
Pittsburgh: East Busway	51-54	30	41-94	21-24	3.1-3.5 <sup>3</sup>
Pittsburgh: West Busway	—	—	—	25-26	5.0-5.2 <sup>4</sup>
Seattle	15	10	31	5	2.4
<b>At-Grade Busways</b>					
Bogotá, Colombia	—	—	32	—	—
Cleveland <sup>1</sup>	41	33	20	8	1.2
Hartford: New Britain <sup>1</sup>	35	20	43	15	1.6
Porto Alegre, Brazil	24	17	29	7	2.1

<sup>1</sup> Anticipated

<sup>2</sup> Estimated

<sup>3</sup> East Busway all-stop service

<sup>4</sup> Morning peak-hour inbound only

SOURCE: *TCRP Report 90 (2)*

*Ridership*

The improved busway travel times should be introduced into the travel demand and mode-split models to assess future ridership. In addition, based on a maximum in-vehicle travel time bias constant of 10 minutes, the following busway travel time factors should be used in the modeling process:

- Grade-separated busway (special right-of-way) 20% (2 minutes)
- At-grade busways on separate right-of-way 15% (1.5 minutes)
- Median arterial busways 10% (1.0 minute)

*Cost-Ridership Considerations*

The number of passengers using BRT services on a busway should bear a reasonable relationship to the development costs incurred. Ideally, the travel time benefits, measured by the value of time saved for bus passengers, should exceed the annualized development and operating/maintenance costs. Typical values are shown in Exhibit 4-21. These values assume that the value of travel time increase in future years would offset the effects of the time value of money.

Travel time benefits should exceed annualized BRT costs.

**EXHIBIT 4-21 Busway Riders Needed to Produce a Net Benefit**

Busway Cost (millions/mile)	Time Savings (minutes/mile)			
	1	2.5	5	7.5
\$10	11,000*	4,000*	2,200	1,500
\$25	27,500*	11,000*	5,500	3,700
\$50	55,000*	22,000*	11,000	7,300
\$200 (bus tunnel)	220,000	88,000	44,000*	29,300*
\$300 (bus tunnel)	330,000	132,000	66,000*	44,000*

\* Typical value

NOTE: Capital recovery parameters are 50 years at 5% interest with 300 days per year and a value of time of \$10 per hour.

SOURCE: *TCRP Report 90 (2)*

*Operating Benefits*

Operating benefits of busways include (1) greater driver productivity, (2) lower fuel consumption, and (3) greater safety. Examples of these benefits are given in Exhibit 4-22. Values for any BRT system will require careful assessment of bus miles and bus hours, both with and without busways. Operating costs per passenger trip for Pittsburgh's East Busway were substantially lower than costs for the city's local bus routes because of a combination of high ridership and high busway speeds (4).

**EXHIBIT 4-22 Reported Busway Operating Benefits**

System	Benefits
Ottawa Transitway	150 fewer buses, with \$58 million (Canadian) savings in vehicle costs and \$28 million (Canadian) in operating costs
Seattle Bus Tunnel	20% reduction in surface street bus volumes and 40% fewer crashes on tunnel bus routes
Bogotá, Colombia, TransMilenio Median Busway	93% fewer fatalities and 40% drop in pollutants
Curitiba, Brazil, Median Busway	30% less fuel consumption per capita

SOURCE: *TCRP Report 90 (2)*

*Land Development Benefits*

Land development impacts depend upon the busway features provided (e.g., attractive stations), the travel time savings, the land development potentials in their environs, and supportive land development policies. The reported land development benefits along busways given in Exhibit 4-23 illustrate what might be achieved elsewhere. (See also Chapter 6.)

*Bus Rapid Transit Practitioner's Guide*

**EXHIBIT 4-23** Reported Land Development Benefits along Busways

System	Benefits
Pittsburgh East Busway	59 new developments within a 1,500-ft radius of station; \$302 million in land development benefits of which \$275 million was new construction and 80% is clustered at stations
Ottawa Transitway	\$1 billion (Canadian) in new construction at Transitway stations
Adelaide, Australia, Guided Busway	Tea Tree Gully area is becoming an urban village.
Brisbane, Australia, South East Busway	Up to 20% gain in property values near Busway; property values in areas within 6 miles of station grew 2 to 3 times faster than those at greater distances

SOURCE: *TCRP Report 90 (2)*

*Implementability*

Busways require off-street corridors or wide city streets—conditions that may be difficult to take advantage of in many cities. Because of potential land and environmental impacts, community concerns, and costs, busways may sometimes be challenging to implement, especially in the short run. Costs may sometimes require substantial funding support from state and federal agencies.

Getting community acceptance may be time-consuming and may require adding design features to ameliorate community concerns. Such features may add to project costs. (An example is the sound barriers along Los Angeles' Orange Line Busway).

However, while busway development costs are high relative to BRT operations in bus lanes or mixed traffic, so are the benefits. As stated earlier, speeds up to 20 miles per hour can be anticipated with arterial median busways, and speeds of 25 to 40 miles per hour can be anticipated with grade-separated busways. Thus, busways perform equivalent to (and sometimes better than) light rail transit, and they should be viewed as a viable, cost-effective alternative.

*Evaluation*

Busways are an attractive BRT option in terms of speed, reliability, passenger attractiveness, and permanence. Operating speeds and passenger attraction can equal those for many rail transit lines. Designs should provide adequate downtown distribution as well as line-haul service. Maximum community benefits accrue when land development policies encourage transit-oriented development in busway corridors and around stations.

**Arterial Bus Lanes**

Bus lanes are a means of improving the speed and reliability of BRT on city streets. The basic goals of bus lanes are to give BRT vehicles an operating environment that is free from delays caused by other vehicles and to improve bus service reliability. Bus lanes also increase the visibility and identity of the BRT system. Bus lanes may operate in the same direction of general traffic (concurrent flow) or in the opposite direction (contraflow) along one-way streets.

*Scale of Application*

Bus lanes may operate along short sections of street or they may operate over a large part of the BRT route. Dedicated bus lanes should be provided over as much of a given BRT route as financially, physically, and operationally practical.

Busways can perform equivalent to or better than LRT from a travel time perspective.

Either concurrent or contraflow operation is possible for arterial bus lanes.

### *Conditions of Application*

Bus lanes require (1) a sufficient frequency of buses, (2) traffic congestion along the roadway, (3) suitable street geometry, and (4) community willingness to enforce the regulations. From a BRT perspective, bus lanes are useful in establishing a clear identity for the BRT service's running way.

Guidelines for the operation of arterial bus lanes include the following:

- Concurrent flow lanes may operate along the outside curb, in the lane adjacent to a parking lane (interior lane), or in a paved median area.
- Concurrent flow lanes can operate at all times, for extended hours (e.g., from 7 a.m. to 7 p.m.), or just during peak hours.
- Contraflow lanes should operate at all times.
- Under conditions of heavy bus volumes, dual concurrent-flow or contraflow lanes may be desirable.
- Where the bus lanes operate at all times, special colored pavement may be desirable to improve the identity of the BRT operations.
- Bus lanes should be at least 11 feet wide to accommodate an 8.5-foot bus width.
- The bus lanes should carry as many people as in the adjacent general traffic lane. Generally, at least 25 buses should use the lanes during the peak hour. (Ideally, there should be at least one bus per signal cycle to give buses a steady presence in the bus lane.) There should be at least two lanes available for general traffic in the same direction, wherever possible.
- Parking should be prohibited where bus lanes are along the curb, but it may remain where interior bus lanes are provided. (Interior bus lanes are located in the lanes adjacent to the curb lanes.)
- There should be suitable provisions for goods delivery and service vehicle access, either during off-hours or off-street.

The primary basis for determining whether lane dedication is applicable should be a comparison of costs and benefits. The "operating without a dedicated running way" scenario should be compared to the "operating a dedicated running way" scenario. Effectiveness should be analyzed in terms of changes in total person travel time for all travelers in the given corridor irrespective of mode. The analysis should take into account potential shifts by motorists to parallel arterials if capacity is taken away from general traffic on the arterial in question.

The most critical parameters influencing the outcome of any evaluation of dedicated lanes are the number of buses in the peak hour and peak direction and the number of people on the buses. Travel time savings for current transit users and the potential attraction of new riders, along with potential operating and maintenance cost savings, is traded off against changes in travel times for current automobile users, access, and parking impacts at adjacent land uses.

### *Selected Typical Examples*

There are several examples of arterial bus lanes integrated into existing and planned BRT systems in North America. Exhibit 4-24 gives the relative magnitude of different placements of the bus lanes along selected arterial BRT corridors.

Bus lanes require a sufficient presence of buses, auto traffic congestion, suitable street geometry, and community willingness to enforce regulations.

Costs and benefits should be compared to assess the feasibility of dedicating a travel lane to BRT.



*Bus Rapid Transit Practitioner's Guide*

**EXHIBIT 4-24 Integrated BRT Systems with Arterial Bus Lanes**

City	BRT System	Street	Percentage of Running Way					
			Curb Lanes		Interior Lanes		Median Lanes or Transitway	
			<50%	>50%	<50%	>50%	<50%	>50%
Boston	Silver Line Phase 1	Washington St	X			X		
Las Vegas	MAX	N Las Vegas Blvd		X				
Los Angeles	Rapid Bus	Wilshire Blvd		X				
Orlando	Lymmo	Magnolia St/Livingston St		X <sup>1</sup>				
Vancouver, BC	98B	Granville St/Road B	X				X	
York, ON		VIVA	X <sup>2</sup>					
Ottawa	Transitway	Albert St/Slater St	CBD			CBD		
Cleveland <sup>3</sup>		Euclid Ave	X					X
Eugene <sup>3</sup>	EMX	Various						X

<sup>1</sup> Both directions on one side of respective streets

<sup>2</sup> Queue jumpers using right-turn bays

<sup>3</sup> Under construction

SOURCE: TCRP A-23A project team

*Estimated Costs*

Initial capital and ongoing operating and maintenance costs depend on the “before” situation for the particular corridor in question and the precise nature of what is to be implemented. If the proposed bus lane is to be taken from an existing general traffic or parking lane, initial and ongoing costs should be minimal; however, if the addition of a bus lane involves procurement of new right-of-way and new construction, initial costs could be substantial while the operating/maintenance costs for the new dedicated transit facility will be modest.

*Capital Cost*

The cost of implementing dedicated bus lanes depends on the current situation and the nature of the planned changes. Unit costs for both initial construction and subsequent lane operation/maintenance can be obtained from city and state departments of transportation in the respective community.

Capital costs are affected by right-of-way needs and costs, the design details of the existing arterial street (e.g., Are utilities to be moved? Is a median to be cleared and paved? Will sidewalks be rebuilt?), and the design details of the new lanes themselves. If existing lanes are utilized with no new construction, the initial capital costs will be limited mainly to modest re-striping and signage costs.

According to CBRT (1), the range of costs for adding new bus lanes is as identified in Exhibit 4-25.

Capital costs for bus lanes depend on the extent of new construction.

**EXHIBIT 4-25 Range of Capital Costs for Adding New Bus Lanes**

Type of New Arterial Transit Lanes	Cost Range (Exclusive of Right-of-way and with Uncolored Pavement)
Curb or off-set lanes	\$2 to \$3 million per lane mile
Median transitway	\$5 to \$10 million per lane mile

SOURCE: CBRT (7)

Where existing lanes are converted to bus lanes, capital costs may range from \$50,000 to \$100,000 per mile for re-striping and signing. Where street reconstruction is required to provide new bus lanes, as noted in Exhibit 4-25, the costs are substantially higher. The reconstruction of 2.2 miles of Washington Street in Boston for the Silver Line Phase 1 cost \$10.5 million per mile, of which about 20% was for brick-paved sidewalks and crosswalks, architectural street lighting, and landscaping.

*Operations and Maintenance Cost*

The operations and maintenance (O&M) cost for dedicated bus lanes includes the costs for street lighting and routine maintenance (e.g., pothole and crack filling, cleaning, and snow plowing). The incremental O&M costs for a dedicated bus lane depend on the nature of the situation before and after the dedication. If the dedicated bus lanes were formerly devoted to either parking or general traffic, there would be no incremental operating and maintenance costs other than those associated with more frequent maintenance.

The O&M costs of the new dedicated bus lanes themselves are not the only O&M cost impact. If a bus lane saves enough time that a decrease in the number of buses necessary to provide a given level of service is possible, transit O&M costs are likely to decrease as well.

If the proposed dedicated lanes result from a widening, the incremental O&M costs should be modest: certainly less than \$10,000 per lane-mile per year (based on national average O&M costs for arterial streets).

Most transit agencies have fully allocated or marginal O&M cost models that have vehicle hours and peak vehicle requirements as primary input. Analysis of revenue travel speeds and times is necessary to ascertain the degree to which both of these would be decreased as the result of the addition of dedicated bus lanes.

*Likely Impacts*

*Travel Time and Reliability*

The primary reason to add dedicated transit lanes to a BRT package is to improve travel times and reliability over mixed-traffic operation. The benefits of reduced travel times for transit users and improvements in reliability are traded off against increased travel times for other highway system users if the new dedicated arterial transit lanes are taken away from the general traffic stream.

Reliability is as important to BRT users and service providers as travel time savings. Improved travel time consistency means that regular transit users enjoy the ability to begin their trips at the same time every day, and transit operators can reduce the amount of recovery time built into their schedules, which potentially saves O&M costs.

The likely benefits of bus lane operation depend upon the length of the lane and the amount of time saved. Some observations on likely benefits follow:

Incremental O&M costs for bus lanes vary based on before and after conditions.

*Bus Rapid Transit Practitioner's Guide*

The extent of benefits of a bus lane depends on the amount of in-vehicle travel time saved.

- A small amount of time savings mainly results in passenger benefits.
- As the travel time savings increase, the bus lane may reduce fleet requirements and operating costs.
- Time savings of more than 5 minutes (on a typical trip) can affect mode choice, further increase ridership, and possibly encourage land development.

Exhibit 4-26 illustrates these relationships.

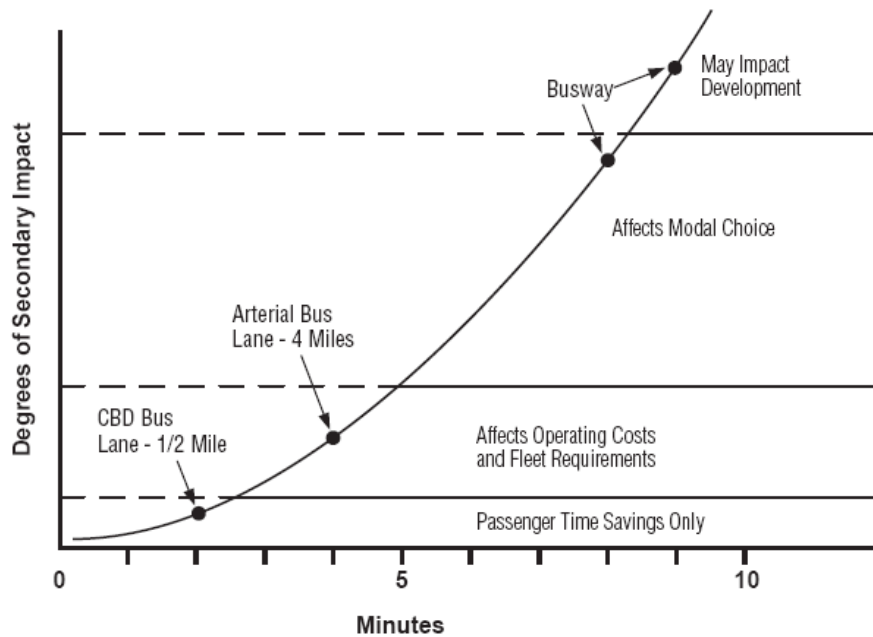

SOURCE: *TCRP Report 90 (2)*

**EXHIBIT 4-26** Degree of Bus Lane Impacts

*Examples of Travel Time and Reliability Improvements*

Examples of travel time savings observed with certain arterial street bus lane treatments are shown in Exhibit 4-27. Examples of improvements in bus lane reliability are shown in Exhibit 4-28. The improved reliability is measured by the percentage change in the coefficient of variation (standard deviation divided by the mean).

*Operating Cost Savings*

Operating cost savings may result from reduction in journey time, especially where buses run at close headways. For example, when buses operate on a 10-minute headway, a 5-minute time savings each way would require one less vehicle.

**EXHIBIT 4-27 Observed Travel Time Savings with Arterial Bus Lanes**

City	Street	Savings (Minutes per Mile)
Los Angeles	Wilshire Blvd	0.1 to 0.2 (a.m.) 0.5 to 0.8 (p.m.)
Dallas	Harry Times Blvd	1
Dallas	Ft. Worth Blvd	1.5
New York City	Madison Ave (dual bus lanes)	43%* express bus 34%* local bus
San Francisco	1st Street	39%* local bus

\* Percentage reduction in travel time

SOURCE: *TCRP Report 90 (2)*, *TCRP Report 26 (5)*, TCRP Project A-23A research

**EXHIBIT 4-28 Observed Reliability Improvements with Arterial Bus Lanes**

City	Street	% Improvement*
Los Angeles	Wilshire Blvd	12 to 27
New York City	Madison Ave	57

\*Coefficient of variation multiplied by 100

SOURCE: *TCRP Report 90 (2)* and *TCRP Report 26 (5)*

*Parking and Access to Adjacent Properties*

Negative consequences of dedicating a curb lane to transit are (1) the impact on access to adjacent properties and (2) the loss of parking if parking is currently allowed during the period of operation. Both impacts can be mitigated by the use of either interior or median lanes, among other techniques. Also, deliveries can occur in alleys, to the rear of establishments, from the opposite side of the street, or, in some cases, from cross streets. Evaluating the impact on parking requires an analysis of current and future parking conditions.

Evaluation of bus lane impacts on parking and access is critical.

*Land Development Effects*

Bus lanes on city streets generally have minimum land development effects. However, when the bus lanes are part of major street reconstruction and beautification, the overall project could have a positive effect when the market conditions are right. (An example is the Boston Silver Line interior bus lanes on Washington Street, where the street reconstruction resulted in \$700 million of new development). However, such impacts are site-specific and should be evaluated on a case-by-case basis.

Bus lanes could have land development impacts when there is major street reconstruction.

*Implementability*

Bus lanes generally can be easily and quickly implemented. Their installation costs are low; they typically require no property acquisition; and they have minimum environmental impacts. There are, however, concerns that should be addressed in planning and development:

- Where bus lanes operate on streets lined with many businesses, curb access for deliveries and services is essential. This need for access may require (1) providing bus lanes adjacent to the curb lane (interior lanes)

---

## Bus Rapid Transit Practitioner's Guide

when space permits, (2) limiting the hours of curb bus lane operation (e.g., to the CBD during the morning peak and from the CBD during the afternoon peak), or (3) initially relying on turn restrictions and/or parking controls to improve traffic flow. Obviously, where alleys or off-street access to businesses are available, the need for curb access is less crucial.

- Where streets are heavily traveled, bus flows are light, and there is a limited presence of buses, installing bus lanes may be counterproductive and met most with resistance from street traffic and transportation agencies. In these cases, queue bypasses or TSP at intersections may be a more appropriate solution to improve bus flow.

### Analysis Tools

#### Travel Time Changes

Analysis of the travel time implications of new dedicated bus lanes should cover all persons traveling in the respective corridor, including automobile drivers and passengers, not just existing and future transit passengers. Historic information on changes in transit travel times from implementation of bus lanes can be obtained from a variety of sources, including CBRT (1) and TCRP Report 90 (2).

The *Highway Capacity Manual* (6) can be used to calculate the impact of removing a general traffic lane from an arterial and dedicating it to the exclusive use of transit. It should be noted that when the effect of removing a lane from general traffic use is analyzed, path changes for existing highway users must be accounted for. For example, if the corridor is part of a continuous grid of major arterials, some general traffic may divert to parallel streets after a lane is removed.

The likely changes in travel times resulting from installing a bus lane can be estimated in three basic ways:

- Analogy (an estimate based on a synthesis and analysis of actual operating experience; see subsequent discussion)
- Application of *Highway Capacity Manual* Signalized Intersection Delay Analysis
- Computer simulation

Estimated travel time rate reductions based on analogy (analysis/synthesis of experience) are shown in Exhibit 4-29. These values can provide an initial order of magnitude estimate of time savings. More refined estimates of travel time savings and speed increases can be obtained from the values shown in Exhibit 4-30, Exhibit 4-31, and Exhibit 4-32.

The top half of Exhibit 4-30 shows the estimated speed changes resulting from installing a curb bus lane for various initial speeds. Exhibit 4-31 graphs the speed before and after bus lane installation. Given the initial bus speed, the chart may be used to estimate the benefits of a curb bus lane. The gain in speed ranges from less than 1.5 miles per hour for initial bus speeds lower than 6 miles per hour to more than 2 miles per hour for greater initial bus speeds. These benefits are generally consistent with the 1.5- to 2.0-miles-per-hour gain in speed reported in a 1961 Progress Report on transit capacity (7).

General traffic diversion impacts should be assessed if a bus lane is created from a general traffic lane.

Travel time savings from bus lanes can be estimated based on existing operating experience, application of *Highway Capacity Manual* procedures, and computer simulation.

Bus lanes typically increase bus speeds by 1.5 to 2.0 mph.

**EXHIBIT 4-29** Estimated Travel Time Rate Reduction with Arterial Bus Lanes—Generalized Based on Analogy

Location	Minutes per Mile Reduction
Highly congested CBD	3 to 5
Typical CBD	1 to 2
Typical Arterial	0.5 to 1

SOURCE: *Bus Rapid Transit Options for Densely Developed Areas (8)*

**EXHIBIT 4-30** Estimated Travel Time Rate Reduction with Arterial Bus Lanes - For Specific Cases Based on Analogy

Item	Case A	Case B	Case C	Case D	Case E
Initial Speed (mph)	3.0	4.0	6.0	8.0	10.0
Speed with Curb Bus Lane (mph)	4.4	5.7	8.0	10.2	12.2
mph Gain	1.4	1.7	2.0	2.2	2.2
% Gain	47.0	42.0	33.3	27.5	22.0
Initial Minutes/Mile	20.0	15.0	10.0	7.5	6.0
Minutes/Mile with Bus Lane	13.5	10.5	7.5	5.9	4.0
Minutes/Mile Gain	6.5	4.5	2.5	1.6	1.1
% Gain	32.5	30.0	25.0	21.3	18.3

SOURCE: *TCRP Report 90 (2)*

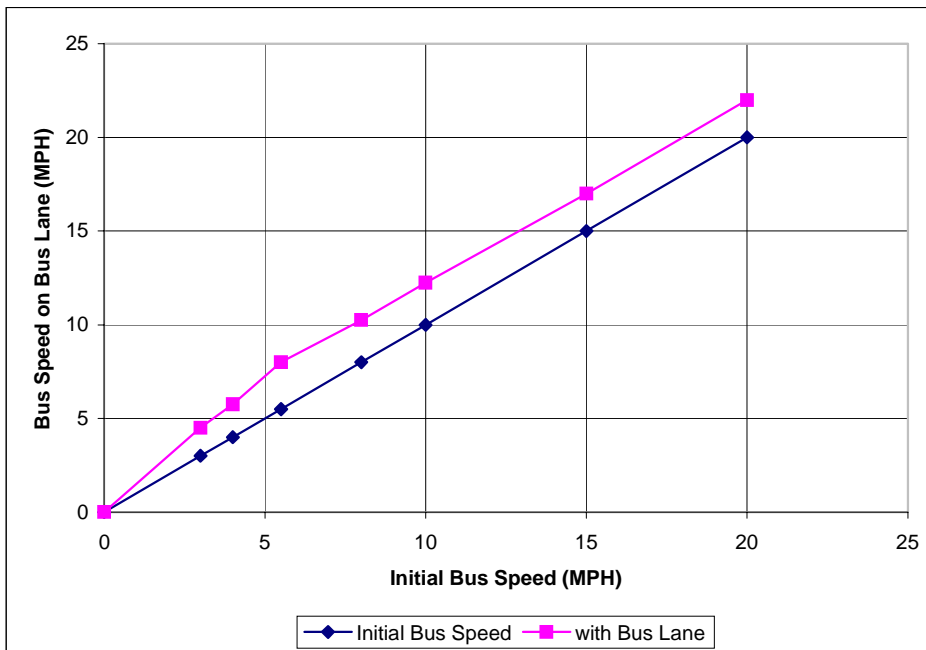

SOURCE: TCRP A-23A research

**EXHIBIT 4-31** Arterial Speeds with and without Curb Bus Lane

---

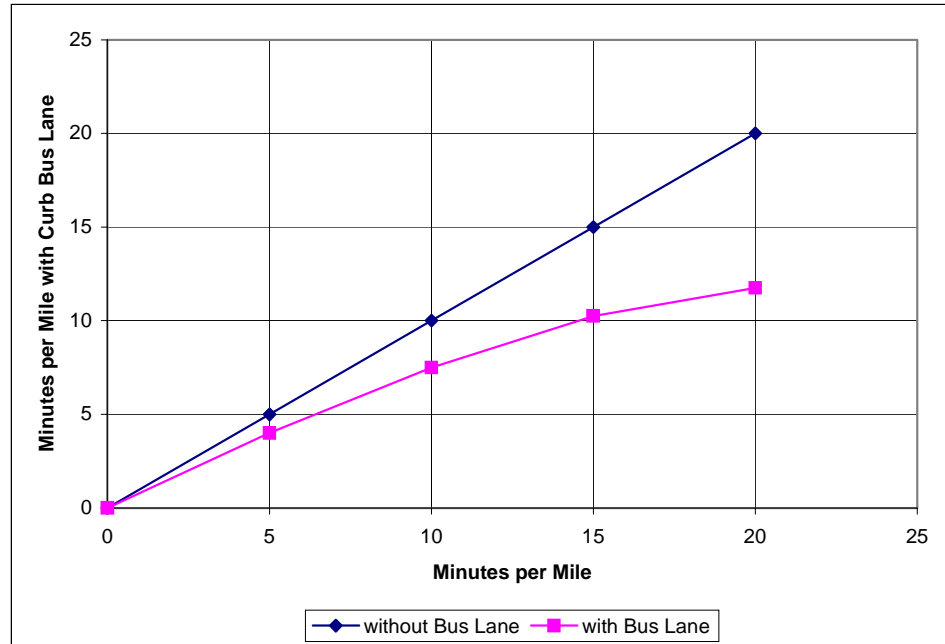
*Bus Rapid Transit Practitioner's Guide*

SOURCE: TCRP A-23A research

**EXHIBIT 4-32 Time Savings with Curb Bus Lane**

The bottom half of Exhibit 4-30 and Exhibit 4-32 show the time savings in minutes per mile resulting from installing a bus lane. The percentage of time saved declines from about 33% at the lowest initial speeds to about 20% at speeds that are typical for an arterial bus (or BRT route).

The actual time saved depends upon the length of the bus lane. For example, based on Exhibit 4-31, a bus traveling at about 10 miles per hour (6 minutes per mile) before bus lane installation may expect a savings of about 1 minute per mile after bus lane installation. If the bus lane is 5 miles long, the total savings would be 5 minutes.

#### *Overall Arterial Bus Lane Evaluation*

Exhibit 4-33 gives a framework for assessing the current and proposed situation along a BRT corridor for potential bus lane application. Key factors include travel time, ridership, parking effects, and O&M costs for new dedicated bus lanes.

The flowchart in Exhibit 4-34 illustrates how the situation would be analyzed.

#### **Transit Signal Priority**

TSP along the through lanes (or “mainline”) of a roadway is the process of altering the signal timing to give a priority or advantage to transit operations. TSP modifies the normal signal operation process to better accommodate transit vehicles within the coordinated operation of the signal system along a corridor. TSP is different from signal preemption, which interrupts normal signal operation to accommodate special events (e.g., a train approaching a railroad grade crossing adjacent to a signal or an emergency vehicle responding to an emergency call).

EXHIBIT 4-33 Dimensions of Overall Bus Lane Evaluation

Proposed / Current	Bus Service Levels and Types	# of General Traffic Lanes	# of Parking Lanes and Controls	Level of General Traffic Congestion	Inter-section Controls	Critical Inter-section Turning Movements
Level and type of bus service (e.g., local v. express)						
Number of general traffic lanes						
Number of parking lanes and parking controls						
ROW width						
Level of general traffic congestion						
Intersection controls						
Turning movements at critical intersections						
Adjacent land uses						

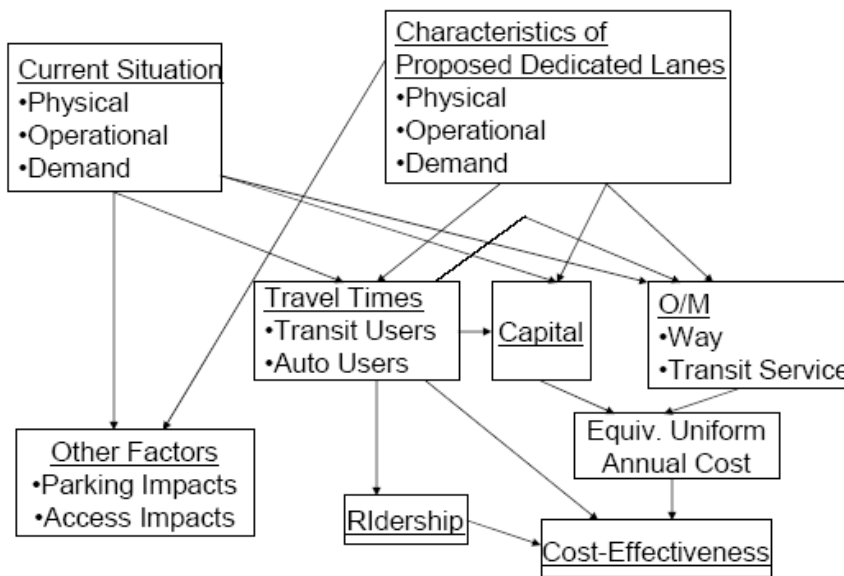

SOURCE: TCRP A-23A research

EXHIBIT 4-34 Evaluation of BRT Arterial Bus Lanes

The usual TSP treatment is a relatively minor adjustment of phase split times at a traffic signal. The green phase serving the approaching bus may start sooner or stay green a little longer, so that the bus delay approaching the intersection will be reduced or eliminated. The lengthened transit phase split time is recovered on the following signal cycle so that the corridor signal coordination timing plan can be maintained.

Transit signal *priority* is not the same as *preemption*.



*Bus Rapid Transit Practitioner's Guide*

TSP keeps a signal system in coordination.

Two characteristics differentiate TSP from emergency vehicle preemption. First, the phase is served in its "normal" position in the signal cycle (as opposed to preemption, where the signal controller immediately brings up the preempt phase). Second, the background arterial coordination timing is maintained through the entire priority event (as opposed to preemption, where the controller immediately drops the coordination timing). Exhibit 4-35 illustrates the green extension/red truncation concept.

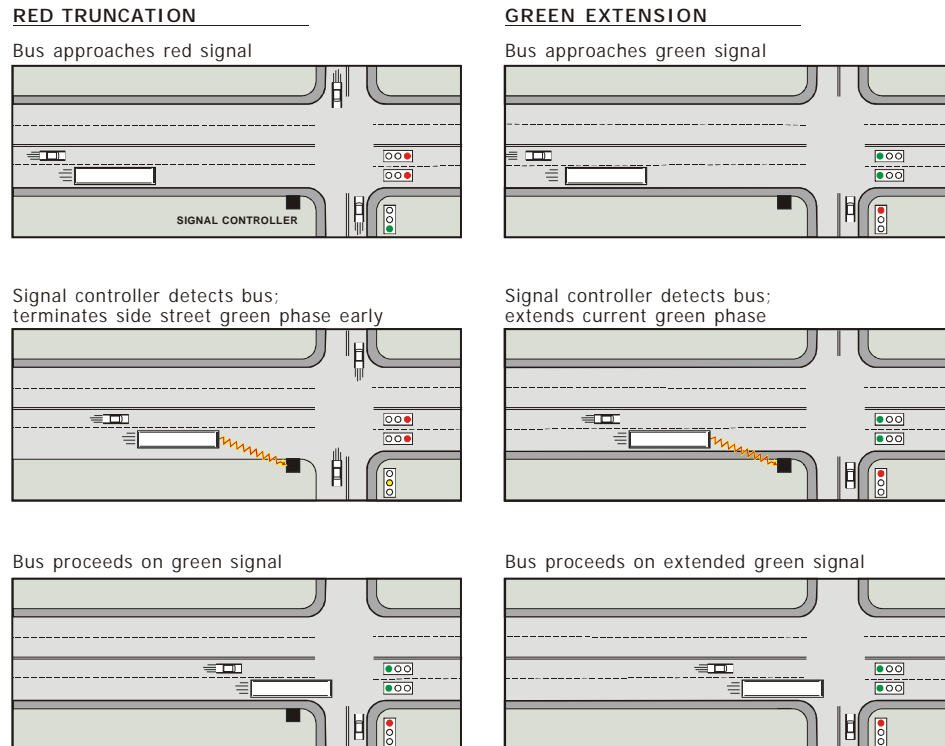

SOURCE: *Transit Capacity and Quality of Service Manual (9)*  
**EXHIBIT 4-35 TSP Green Extension/Red Truncation Concept**

TSP systems can be manually implemented by the bus operator or automatically implemented using on-board technology. The latter is the preferred method because it eliminates the human factor requiring the operator to remember to activate the emitter. In many cases, the automated TSP will be tied to an AVL system that can provide priority only if the corresponding bus is behind schedule. The priority is based on the TSP logic programmed into the traffic signal controller.

There are different ways of providing TSP detection.

TSP detection can be provided by several different means. In many cases in the United States and Canada, agencies use optical detection to transmit requests from buses to the traffic signal controller. Inductive loop-based systems use an inductive loop embedded in the pavement and a transponder mounted on the underside of the transit vehicle to distinguish transit vehicles from other traffic. Detection systems based on global positioning system (GPS) technologies are emerging, and radio frequency (RF) systems have been used in several cases. The predominance of optical detection is generally attributed to its existing, widely deployed use for emergency vehicle preemption.

TSP strategies include passive, active, and real-time priority. Passive strategies attempt to accommodate buses through the use of pre-timed modifications to the

signal system that occur whether or not a bus is present. Strategies can range from simple changes in intersection signal timing to systemwide retiming to facilitate bus operations. Passive strategies can utilize bus operations data, such as bus travel times along street segments, to derive enhanced signal timing coordination plans.

Active strategies adjust the signal timing after a bus is detected approaching the intersection. Depending on the capabilities of the signal control equipment and the presence of bus location or passenger loading detection equipment on board the bus, TSP may be either unconditional or conditional. Unconditional strategies provide priority whenever a bus arrives. To decide whether to provide priority for a given bus, conditional strategies incorporate information from on-board AVL equipment (which can identify if and by how much the bus is behind schedule) and/or automatic passenger counting equipment (which can identify how many people are on board), along with signal controller data on how recently priority was given to another bus at the intersection. Real-time or adaptive strategies consider both bus and general traffic arrivals at an intersection or network of intersections. Such strategies require specialized equipment that is capable of optimizing signal timings in the field to respond to current traffic conditions and bus locations. The green time can be advanced or extended within any signal cycle.

Exhibit 4-36 identifies common TSP treatments related to the different priority strategies. TSP can be activated either at a distributed or centralized level. At the distributed level, decisions on TSP activation at an intersection are dependent on local interaction between the bus and signal controller. In a centralized system, the bus and signal controller operation to activate TSP are controlled by a centralized traffic management system. Passive priority systems must be activated at the distributed level, while active and real-time priority systems can be activated at either the distributed or centralized level.

More detail on TSP can be found in the ITS America publications *An Overview of Transit Signal Priority* (10) and *Transit Signal Priority: A Planning and Implementation Handbook* (11).

TSP can be active or passive.

TSP can be conditional or unconditional.

TSP can be activated at the intersection level or at a centralized level.

**EXHIBIT 4-36 Common TSP and Preemption Treatments**

Treatment	Description
<i>Passive Priority</i>	
Adjust cycle length	Reduce cycle lengths at isolated intersections to benefit buses
Split phases	Introduce special phases at intersection for bus movement
Areawide timing plans	Preferential progression for buses through signal offsets
Bypass metered signals	Buses use special reserved lanes, special signal phases, or are rerouted to non-metered signals
Adjust phase length	Increased green time for approaches with buses
<i>Active Priority</i>	
Green extension	Increase phase time for current bus phase
Early start (red truncation)	Reduce other phase times to return to green for buses earlier
Special phase	Addition of a bus phase
Phase suppression	Skipped non-priority phases
<i>Real-Time Priority</i>	
Delay-optimizing control	Signal timing changes to reduce overall person delay
Network control	Signal timing changes considering the overall system performance
<i>Preemption</i>	
Preemption	Current phase terminated and signal returns to bus phase

SOURCE: *Transit Capacity and Quality of Service Manual* (9)

---

## Bus Rapid Transit Practitioner's Guide

### *Scale of Application*

TSP can be applied at a single intersection experiencing extensive bus delay or at a number of intersections along a corridor, whether or not a coordinated signal system is in effect.

TSP is an integral part of arterial BRT operations and is applied in most of the cities either operating or developing BRT systems. It is also now being applied in corridors with just local bus operation—a good example being Portland, OR, where TSP has been implemented at more than 250 intersections.

### *Conditions of Application*

TSP is typically applied when there is significant traffic congestion and, hence, bus delays along a roadway. Estimated bus travel time and delay can be identified through field surveys of existing conditions or through simulation modeling of future conditions. Studies have found that TSP is most effective at signalized intersections operating under level of service (LOS) D and E conditions with a volume-to-capacity ratio ( $v/c$ ) between 0.80 and 1.00. There is limited benefit in implementing priority under LOS A through C conditions as the roadway is relatively uncongested and neither major bus travel time nor reliability increases can be achieved. Under oversaturated traffic conditions ( $v/c$  greater than 1.00), long vehicle queues prevent buses from getting to the intersection soon enough to take advantage of TSP without disrupting general traffic operations.

A basic guideline is to apply TSP when there is an estimated reduction in bus delay with negligible change in general traffic delay. Given this condition, the net total person delay (on both buses and general traffic) should decrease with application of TSP at a particular intersection or along an extended corridor.

Given the frequency of bus service in a given corridor, TSP may be given only to certain buses such that the disruption to general traffic operations is minimized. Conditional priority is most commonly accepted as an initial TSP application in a corridor, assuming that buses would be issued priority only if they are behind schedule or have a certain number of persons on board the bus. Los Angeles Metro Rapid, for example, limits TSP to every other signal cycle.

For TSP to be most effective, bus stops should be located on the far side of signalized intersections so that a bus activates the priority call and travels through the intersection and then makes a stop. Past studies and actual applications have shown that greater reduction in bus travel time and variability in travel times can be achieved with a far-side vs. near-side stop configuration.

### *Selected Typical Examples*

As of 2005, almost 40 urban areas provided some form of TSP (for bus and/or rail) in North America. Exhibit 4-37 gives a representative set of agencies with the specific TSP strategy employed.

TSP is most effective at intersections operating under LOS D and E conditions.

Conditional priority is typically the initial TSP application.

Far-side bus stops facilitate TSP.

EXHIBIT 4-37 TSP and Preemption Strategy by Agency

Agency	City	Early Green (Red Truncation)	Green Extension	Phase Insertion	Preemption	Other
AC Transit	Oakland, CA	X	X			
Ben Franklin Transit	Richland, WA	X	X			
Calgary Transit	Calgary, AL	X	X			
LYNX	Orlando, FL				X	
City of Glendale	Glendale, CA	X	X			
Charlotte Area Transit	Charlotte, NC				X	
Houston METRO	Houston, TX	X	X			X
Illinois DOT (RTA)	Chicago, IL	X	X			X
Jefferson Transit Authority	Port Townsend, WA			X		
King County Metro	Seattle, WA	X	X			
LA County MTA	Los Angeles, CA	X	X	X		
Metropolitan Transit	Minneapolis, MN				X	
City of Ottawa	Ottawa, ON			X		X
Pace Suburban Bus Service	Arlington Heights, IL	X	X			
Pierce Transit	Tacoma, WA	X	X			
Port Authority of Allegheny County	Pittsburgh, PA			X		
Sacramento RTD	Sacramento, CA	X	X			
SCVTA	Santa Clara Co., CA	X	X	X		X
Skagit Transit	Burlington, WA	X	X			
SEPTA	Philadelphia, PA	X				X
St. Cloud MTC	St. Cloud, MN	X	X			
TriMet	Portland, OR	X	X			X
Utah Transit Authority	Salt Lake City, UT	X	X			
WMATA	Washington, D.C.	X	X			

SOURCE: *Transit Signal Priority (1)*

*Estimated Costs*

Costs for implementing TSP along a BRT corridor will depend on the configuration of the existing signal control system (with higher costs associated with signal upgrades), equipment/software for the intersection, vehicles, and the central management system.

Costs specifically associated with TSP are highly dependent on whether the TSP system will be localized to a corridor or centralized and integrated into a transit or regional traffic management center. To implement a conditional priority system, the central signal system needs to be integrated into the transit management center. A key assessment in determining cost is whether or not existing traffic control software and controllers are compatible with TSP. Estimates for traffic signal controller replacement range between \$3,500 and \$5,000, depending on the vendor and the functionality prescribed for TSP. Costs for communication links needed to integrate these traffic signals into the existing signal system and costs for future signal system upgrades would be extra and would vary depending on the specific signal system configuration and extent of TSP application. In general, if existing software and controller equipment can be

Costs depend on whether TSP is localized to a route or integrated with a transit management center.

*Bus Rapid Transit Practitioner's Guide*

used, costs can be less than \$5,000 per intersection, but costs can increase to \$20,000 to \$30,000 per intersection if equipment needs to be replaced.

Costs for transit detection vary significantly based on the ultimate technology chosen. Exhibit 4-38 provides capital and operating costs for different TSP detection systems.

**EXHIBIT 4-38 Characteristics of Different TSP Detection Systems**

System	Technology	Cost/Intersection	Cost/Bus	O&M Costs
Optical	Optical emitters	Moderate (\$15,000)	Moderate (\$2,000)	Emitter replacement (\$1,500)
Wayside Reader	Radio frequency (RF) technology. Uses bus-mounted tags and wayside antenna, which must be located within 35 feet of bus. Radio transmits and decoder reads rebound message.	High (\$20,000)	Low (\$250)	Tag replacement (\$50)
"Smart" Loops	Loop amplifier detects transmitter powered by vehicle's electrical system.	Low (\$2,500 per amplifier; use existing loop detector)	Low (\$500)	Same as loop detector

SOURCE: TCRP A-23A project team

*Likely Impacts*

TSP benefits vary based on type and degree of application.

Exhibit 4-39 and Exhibit 4-40 present the measured/estimated impacts of TSP in selected cities on travel time, reliability (schedule adherence), and operating costs, as well as the impacts of TSP on general traffic. Expected benefits of TSP vary depending on the application. A summary of these impacts follows.

**EXHIBIT 4-39 Reported Initial Estimates of Benefits to Buses from Traffic Signal Priority**

Location	% Running Time Saved	% Increase in Speeds	% Reduced Intersection Delay	Source
Anne Arundel County, MD	13-18	—	—	9, 12
Bremerton, WA	10	—	—	2, 9, 12
Chicago: Cermak Road	15-18	—	—	12
Hamburg, Germany	—	25-40	—	2
Los Angeles: Wilshire-Whittier Metro Rapid	8-10	—	—	2, 12
Pierce County, WA	6	—	—	2
Portland, OR	5-12	—	—	9
Seattle: Rainier Avenue	8	—	13	2, 12
Toronto	2-4	—	—	2

SOURCE: *Transit Capacity and Quality of Service Manual* (9), "Evaluation of Service Reliability Impacts of Traffic Signal Priority Strategies for Bus Transit" (12), and *TCRP Report 90* (2)

**EXHIBIT 4-40 ITS America's Summary of TSP Benefits and Impacts**

Location	Transit Type	Number of Intersections	TSP Strategy	Benefit/Impact
Portland, OR: Tualatin Valley Hwy	Bus	10	Early green, green extension	Bus travel time savings = 1.4-6.4%. Average bus signal delay reduction = 20%.
Portland, OR: Powell Blvd	Bus	4	Early green, green extension, queue jump	5-8% bus travel time reduction. Bus person delay generally decreased. Inconclusive impacts of TSP on traffic.
Seattle: Rainier Ave at Genesee	Bus	1	Early green, green extension	For prioritized buses: <ul style="list-style-type: none"> <li>▪ 50% reduction of signal-related stops</li> <li>▪ 57% reduction in average signal delay</li> </ul> 13.5% decrease in intersection average person delay. Average intersection delay did not change for traffic. 35% reduction in bus travel time variability. Side-street effects insignificant.
Seattle: Rainier Ave (Midday)	Bus	3	Early green, green extension	For TSP-eligible buses: <ul style="list-style-type: none"> <li>▪ 24% average reduction in stops for eligible buses</li> <li>▪ 34% reduction in average intersection delay</li> </ul> 8% reduction in travel times. Side-street drivers do not miss green signal when TSP is granted to bus.
Europe	Bus	5 study sites	Various	10 seconds/intersection average signal delay reduction. 40-80% potential reduction in transit signal delay. Transit travel times in England and France reduced 6-42%. 0.3-2.5% increase in automobile travel times. 1- to 2-year payback period for installation of TSP.
Sapporo City, Japan: Rt 36	Bus	Unknown	Unknown	6.1% reduction in bus travel time. 9.9% increase in ridership.
Toronto	Street-car	36	Early green, green extension	15-49% reduction in transit signal delay. One streetcar removed from service.
Chicago: Cermak Rd	Bus	15	Early green, green extension	7-20% reduction in transit travel time. Transit schedule reliability improved. Reduced number of buses needed to operate the service. Passenger satisfaction level increased. 1.5 seconds/vehicle average decrease in vehicle delay. 8.2 seconds/vehicle average increase in cross-street delay.
San Francisco	LRT & Trolley	16	Early green, green extension	6-25% reduction in transit signal delay.
Minneapolis: Louisiana Ave	Bus	3	Early green, green extension, actuated transit phase	0-38% reduction in bus travel times depending on TSP strategy. 23% (4.4 seconds/vehicle) increase in traffic delay. Skipping signal phases caused some driver frustration.
Los Angeles: Wilshire and Ventura Blvds	Bus	211	Early green, green extension, actuated transit phase	7.5% reduction in average running time. 35% decrease in bus delay at signalized intersections.

SOURCE: *An Overview of Transit Signal Priority (10)*

---

## *Bus Rapid Transit Practitioner's Guide*

TSP typically reduces transit travel times by 8% to 12%.

TSP saved buses 0.3 to 0.5 minute per mile on average in Los Angeles.

Travel time savings from TSP can translate into reduced operating costs.

TSP typically results in negligible increases in general traffic delay.

### *Bus Travel Time*

Travel time savings associated with TSP in North America and Europe have ranged from 2% to 18%, depending on the length of corridor, particular traffic conditions, bus operations, and the TSP strategy deployed. A reduction of 8% to 12% has been typical. The reduction in bus delay at signals has ranged from 6% to 80%.

In Los Angeles, in the initial Wilshire-Whittier and Ventura BRT corridors, average running time along both corridors decreased by 7.5%; the decrease was attributed directly to TSP. This decrease corresponds to 0.5 minute per mile on Wilshire-Whittier Boulevard and 0.3 minute per mile on Ventura Boulevard. The reduction in bus signal delay at intersections with TSP was 33% to 36%. In Chicago, buses realized an average 15% to 18% reduction in running time along Cermak Road, with the reductions varying from 7% to 20% depending on the time of day. Along San Pablo Avenue in Oakland, each bus saved an average of 5 seconds per intersection with TSP. BRT vehicles along Vancouver's 98B line saved up to 1.5 minutes per trip.

### *Service Reliability*

Schedule adherence as measured by variability in bus travel times and arrival times at stops improves significantly with TSP application. In Seattle, along the Rainier Avenue corridor, bus travel time variability was reduced by 35%. In Portland, OR, TriMet avoided adding one more bus to a corridor by using TSP and experienced up to a 19% reduction in travel time variability. In Vancouver, the travel time variability decreased about 40%.

### *Bus Operating Costs*

By reducing bus travel time and delay and the variability in travel time and delay, transit agencies have realized both capital cost savings (by saving one or more buses during the length of the day to provide service on a route) and operating costs savings (due to more efficient bus operation). In Los Angeles, the MTA indicated that, before the Wilshire-Whittier and Ventura BRT implementation, the average cost of operating a bus was \$98 per hour. A traffic signal delay reduction of 4.5 minutes per hour translates into a cost savings of approximately \$7.35 per hour per bus for the initial two BRT corridors. For a bus operating along these corridors for 15 hours a day, the cost savings would be approximately \$110.25 per day. Assuming 100 buses per day for an average of 300 days per calendar year in the two corridors, this translates into an approximately \$3.3 million annual operating cost savings for the MTA. This savings does not include the added benefit of travel time savings for the Rapid Bus passengers. With an anticipated project life cycle of 10 years, the relative benefits-cost ratio for TSP associated with the Wilshire-Whittier and Ventura BRT corridors was estimated to be more than 11:1.

### *General Traffic*

Increases in general traffic delay associated with TSP have been shown to be negligible, ranging in most cases from 0.3% to 2.5%. In Los Angeles, the effects of TSP on side-street traffic in the Wilshire-Whittier and Ventura corridors were found to be minimal, where the average increase in delay was 1 second per vehicle at the 12 test locations measured.

### Analysis Tools

Field surveys and both analytical and simulation modeling can be used to estimate the reduction in bus delay and, hence, reductions in overall travel time associated with the application of TSP. A description of the potential application of surveys and simulation follows.

#### Field Surveys

The most accurate yet perhaps most time-consuming and expensive way to identify the impact of TSP is to conduct a "before" and "after" evaluation of changes in bus travel time and schedule adherence through field data collection. An on-board bus travel time and delay survey is the most appropriate tool to be applied. Measuring changes in general traffic delay associated with TSP is much more cumbersome as extensive staff are required to manually record vehicle delays in the field, videotape general traffic conditions, and then decipher changes in delay through video observations.

#### Analytical Model

As mentioned previously, TSP advances or extends the green time whenever buses arrive within the designated windows at the beginning or end of the cycle. Therefore, the red time that buses incur is reduced. Delays to buses with and without TSP can be approximated by using delay curves for signalized intersections that relate intersection approach green time available per cycle ( $g/C$ ) to the volume-to-capacity ratio ( $v/c$ ) of the approach. Such signalized intersection delay curves are presented in Exhibit 4-41 through Exhibit 4-44 for different signal cycle lengths. Thus, assuming 10% of the cycle time for a TSP window, the delay savings for any given  $v/c$  for the particular intersection approach can be estimated by comparing the delays for the initial  $g/C$  value with those for an appropriate curve with a higher value (e.g., comparing the curves in the figures that follow).

Exhibit 4-45 gives an example of how priority for buses can reduce delay. A 90-second cycle with a  $g/C$  of 0.4 is assumed as a base with a  $v/c$  ratio of 0.8. The base delay is 33 seconds. An increase in  $g/C$  to 50% would result from TSP. The longer green period would result in a 26-second delay, which is a savings of 7 seconds or 21% per signalized intersection. This savings compares to an average 5 to 6 seconds saved per bus found along Wilshire-Whittier and Ventura Boulevards in Los Angeles and along San Pablo Avenue in Oakland.

Before-and-after travel time and delay assessments can quantify the impacts of TSP.

Highway Capacity Manual delay curves for signalized intersections can be used to estimate travel time savings from TSP.



*Bus Rapid Transit Practitioner's Guide*

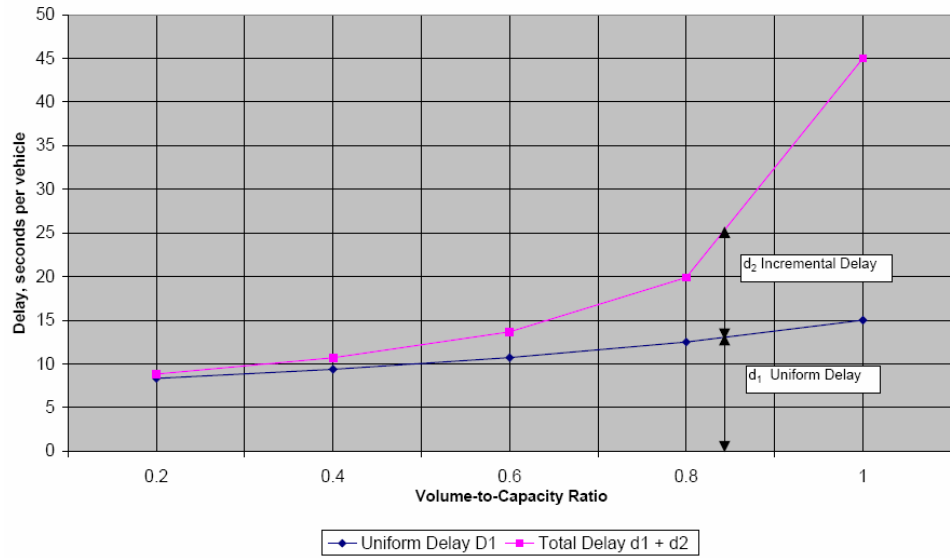

SOURCE: TCRP A-23A project team

**EXHIBIT 4-41** Signalized Intersection Delay (60-Second Cycle and 50% Effective Green)

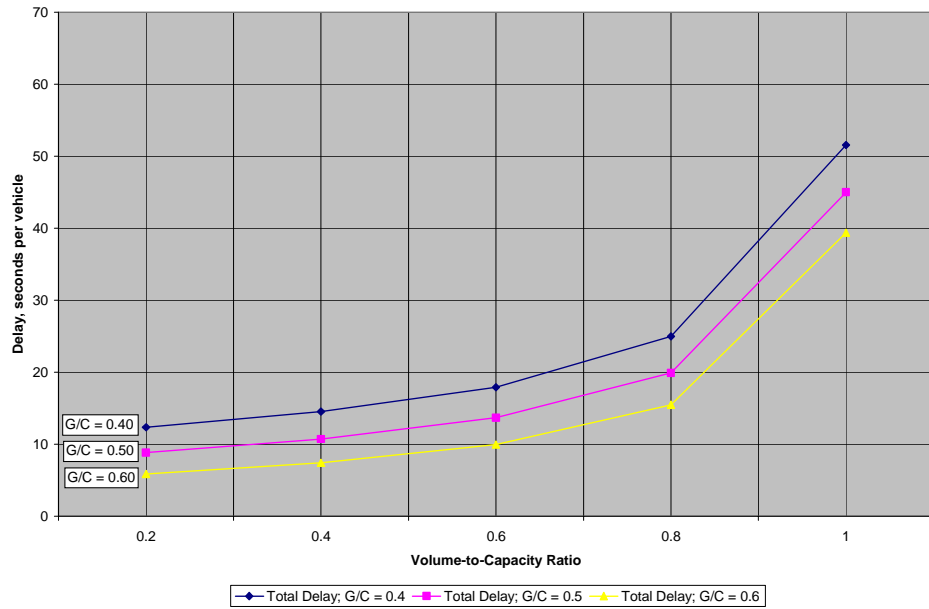

SOURCE: TCRP A-23A project team

**EXHIBIT 4-42** Signalized Intersection Delay (60-Second Cycle and Range of Effective Green)

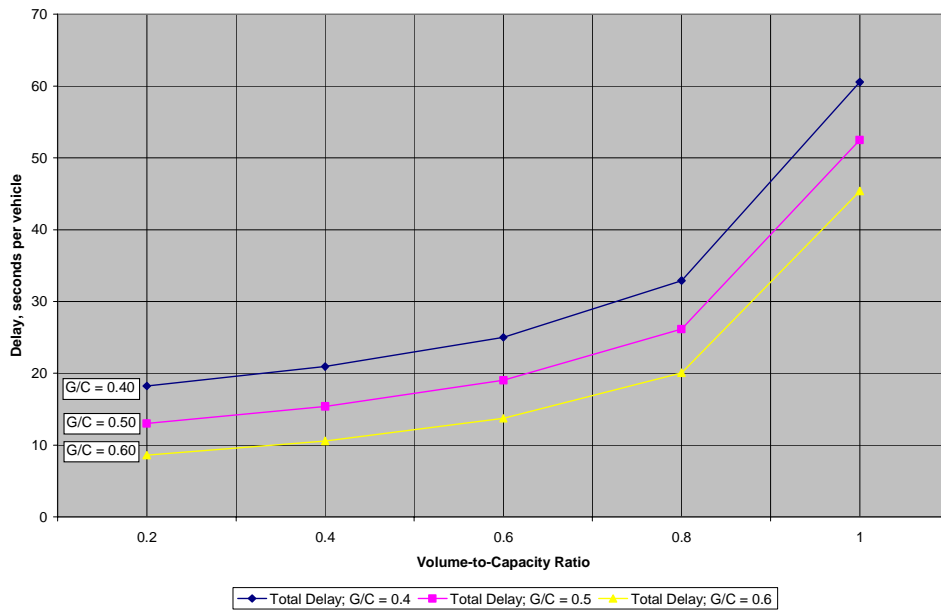

SOURCE: TCRP A-23A project team

**EXHIBIT 4-43** Signalized Intersection Delay (90-Second Cycle and Range of Effective Green)

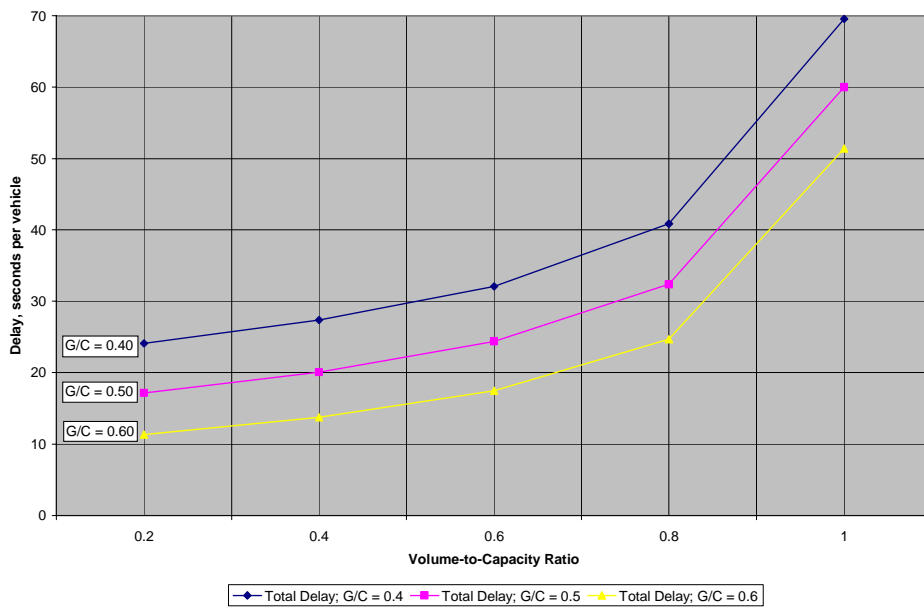

SOURCE: TCRP A-23A project team

**EXHIBIT 4-44** Signalized Intersection Delay (120-Second Cycle and Range of Effective Green)

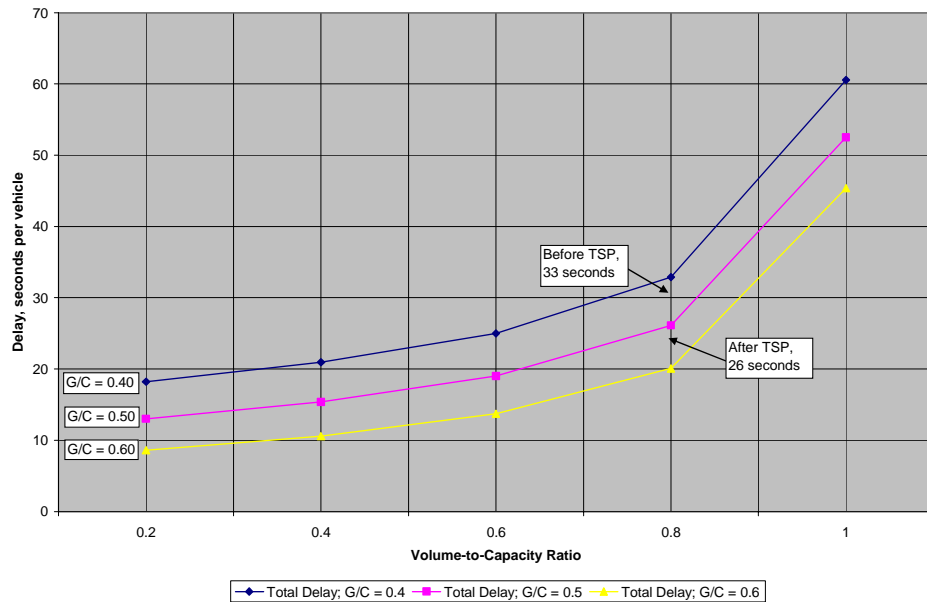

SOURCE: TCRP A-23A project team

**EXHIBIT 4-45** Effect of TSP on Signalized Intersection Delay (90-Second Cycle)

*Simulation Modeling*

Another method to identify TSP impacts is to develop a simulation model of “before” and “after” conditions at an intersection or along a corridor and measure the change in bus travel time and delay and general traffic delay. The model should be calibrated to field conditions through some level of field data collection of bus travel times and bus and general traffic delays. Given the time to develop a simulation model plus added field data collection for calibration, this analysis approach can be very expensive.

*Decision Framework*

In deciding if and to what extent TSP should be integrated along a BRT corridor, the following questions should be addressed:

- Are traffic conditions and bus volumes along the corridor currently within or projected to be within the “operationally feasible” range to successfully implement TSP?
- Can TSP be implemented without creating undue congestion on heavily traveled cross streets?
- Is it possible to implement an extended preferential treatment along the corridor, such as arterial bus lanes or a busway, and if so, would TSP provide added benefits to warrant the added cost?
- Can bus stops be located on the far side of the intersection (or mid-block) so that effective TSP can be provided?
- Is the existing traffic signal control system capable of providing TSP? If not, can it be easily modified?
- Will AVL be integrated with the BRT vehicles (which will dictate whether conditional or unconditional TSP can be applied)?

Simulation modeling is a tool that can be used to assess TSP impacts.

The flowchart shown in Exhibit 4-46 illustrates different factors (and their relationships) to be considered in deciding on the application and configuration of TSP for a BRT project.

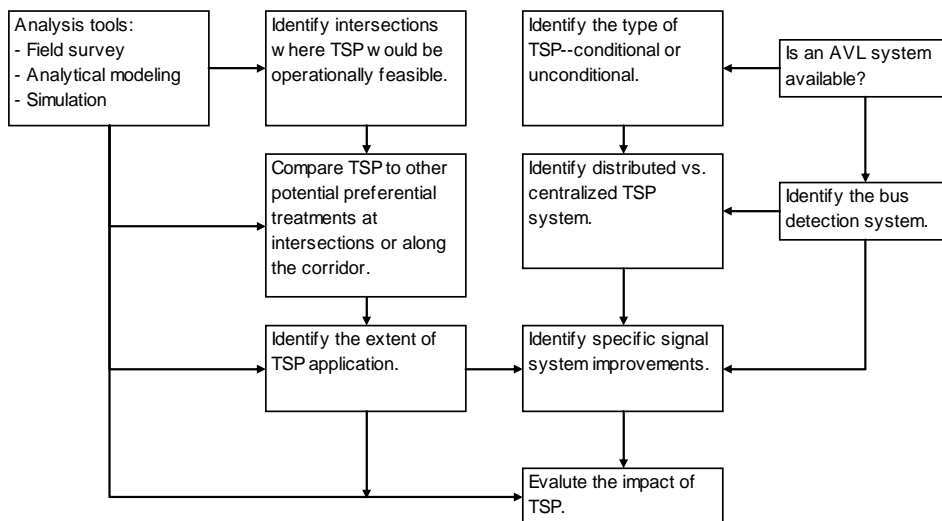

SOURCE: TCRP A-23A project team  
**EXHIBIT 4-46 TSP Decision Framework**

**Queue Jumps/Bypass Lanes**

BRT vehicles can bypass traffic queues at intersections through either the application of a “queue jump” or “bypass lane.” With a queue jump, the bus would enter either a right-turn lane (as shown in Exhibit 4-47) or a separate lane developed for buses only between the through and right-turn lane and then stop on the near side of the intersection. A separate, short bus signal phase would then be provided to allow the bus an early green to move into the through lane ahead of general traffic. Typically, green time from the parallel general traffic movement is reduced to accommodate the special bus signal phase, which typically is only 3 to 4 seconds. With a bypass lane (illustrated in Exhibit 4-47 and Exhibit 4-48), the bus would not have a separate signal phase but would continue through the intersection into a far-side stop before pulling back into general traffic. Queue jumps or bypass lanes are applied as an alternative to mainline TSP.

With either a queue jump or bypass lane treatment, a right-turn lane or separate lane for buses must be provided. A separate lane is essential where there are heavy right turns that move on special phases. This lane should be of sufficient length to allow the buses to bypass the general traffic queue at the intersection most of the time. On a roadway with existing shoulders, a queue jump or bypass lane treatment can be developed assuming the shoulder is of sufficient width (10 feet minimum) and pavement design to accommodate bus traffic.

Queue jumps are a near-side intersection treatment with an added signal phase.

Bypass lanes are similar but do not have a separate signal phase.

Queue jumps and bypass lanes can be an alternative to TSP.

A right-turn lane or separate lane is required to implement a queue jump lane or bypass lane.

*Bus Rapid Transit Practitioner's Guide*

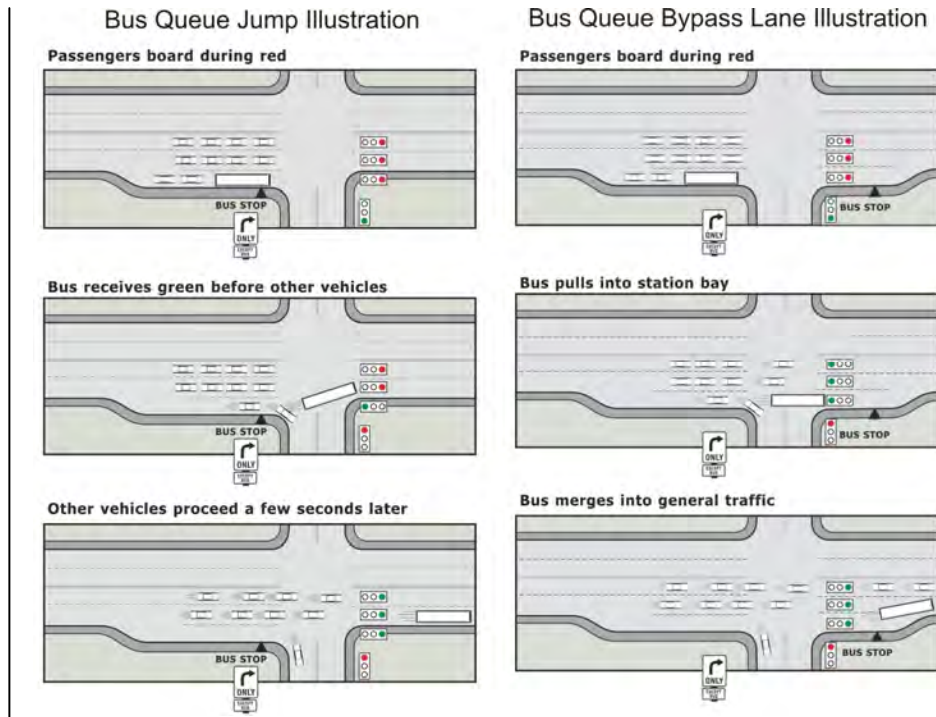

SOURCE: Kittelson & Associates, Inc.

**EXHIBIT 4-47** Queue Jump and Bypass Lane Operation



SOURCE: Kittelson & Associates, Inc.

**EXHIBIT 4-48** Bypass Lane Signs (Portland, OR, and Las Vegas)

With a queue jump, the bus stop (if there is one at a particular intersection) needs to be on the near side, as the bus would trigger a separate signal phase after it serves a stop. With a bypass lane, the stop should be on the far side, which will reduce the conflict with right-turn traffic. For either treatment, right-turn channelization must not interfere with bus movements either back into general traffic or straight through the intersection.

With a queue jump, the typical type of bus detection is either a loop located in the pavement of a right-turn lane or separate bus lane on the near side of the intersection (just short of the stop bar or crosswalk) or video detection.

### *Scale of Application*

Queue jumps and bypass lanes are applied at a single intersection or a series of intersections along an arterial roadway. Bus volumes are typically fairly low because high bus volumes may warrant bus-only lanes.

### *Selected Typical Examples*

Queue jumps and bypass lanes have been developed in several U.S. cities, including Portland, Denver, San Francisco, Las Vegas, and Seattle.

### *Estimated Costs*

The cost of a queue jump or bypass lane will vary widely based on whether an existing right-turn lane or shoulder is present to develop a bus queue bypass. If existing roadway lanes or shoulders are available to develop an adequate queue jump or bypass lane treatment, then the costs of the installation will focus on roadway signing and striping modifications and the provision of a separate signal for the queue jump treatment. The signing and striping costs have ranged from \$500 to \$2,000 for applications in the United States. The cost of a bus queue jump signal is estimated to range from \$5,000 to \$15,000, based on the type of detection deployed (loop vs. video). A queue jump signal with loop detection typically has a lower cost than one with video detection.

The development of a new separate lane for buses for a bypass or the development of a new or lengthened right-turn lane will be dependent on the availability of right-of-way, existing utilities present, and other roadside features. Costs for new lane construction will vary widely based on the extent of roadway reconstruction, utility modification, and right-of-way acquisition required. If a far-side bus pullout is provided, added costs would be incurred.

### *Likely Impacts*

#### *Travel Time and Reliability*

By allowing a bus to bypass general traffic queuing at a signalized intersection, bus travel time is reduced with improved service reliability. The extent of bus travel time savings will depend on the extent of general traffic queuing at a signalized intersection, the extent to which a bypass treatment can be developed to bypass the general traffic queue, and the magnitude of right-turn traffic if the queue bypass uses such a lane (and also whether or not free right turns are allowed from the right-turn lane). With either a queue jump or bypass lane, some increase in delay to right-turn traffic could occur if a separate lane for buses is not provided. Bus travel time savings are reduced if the right-turn lane traffic volume is heavy and there is limited opportunity for free rights or right turns on red.

Application of bus queue jumps has been shown to produce 5% to 15% reductions in travel time for buses through intersections. Service reliability is improved because of reduced bus delay at signals.

Costs for queue jumps and bypass lanes depend on the availability of existing roadway lanes and/or shoulders.

Queue jumps and bypass lanes have been shown to reduce transit travel times by 5% to 15%.

---

## Bus Rapid Transit Practitioner's Guide

Reported travel time savings associated with queue jumps/bypass lanes are as follows:

- 7- to 10-second bus intersection delay savings on Lincoln Street at 13th Avenue in Denver
- 27-second reduction in bus travel time along NE 45th Street route in Seattle during morning peak period
- 12-second reduction in bus travel time along NE 45th Street route in Seattle during afternoon peak period in Seattle
- 6-second reduction in bus travel time along NE 45th Street route in Seattle across an entire day

### *Operating Cost Savings*

By reducing bus travel time, some operating cost savings can be achieved with queue jumps and/or bypass lanes if implemented in a systematic manner.

### *Safety*

With either a bus queue jump or bypass lane treatment at a signalized intersection, extra signing and pavement marking are important given the potential perception by motorists of unexpected bus maneuvers (e.g., a bus pulling ahead of general traffic from a right-turn or separate lane or buses going through the intersection in a right-turn lane).

### *Ridership*

If queue jumps and/or bypass lanes are applied in a systematic manner along a corridor, a potentially sizable reduction in bus travel time could occur, which could attract increased ridership. Similar to arterial bus lanes, elasticity factors can be applied to translate identified bus travel time savings to the potential for increased ridership.

### *Implementability*

A bus queue jump or bypass lane is an alternative to TSP in the through lanes at a signalized intersection, and it becomes more attractive if (1) existing right-turn lanes and far-side bus pull-off areas are available and (2) TSP would have an unacceptable impact on bus travel times and/or general traffic delay. Queue jump and bypass lane treatments are also more effective where the bypass lane is sufficiently long to bypass the general traffic queue and the right-turn volume in the bypass lane is relatively low.

### *Analysis Tools*

The reduction in bus delay and, hence, travel time associated with the provision of queue jumps or bypass lanes can be estimated by using procedures in the *Highway Capacity Manual* (6). Intersection approach delay for general traffic can be identified for a condition where buses would be in the general traffic stream with no queue jump/bypass treatment being provided. The delay to buses with the queue jump/bypass treatment can then be estimated in the separate lane where buses would operate, accounting for any delays associated with right-turn traffic. With a queue jump signal, some increased general traffic delay would occur due to the reduction of green time for cross-street through traffic to create a separate bus signal phase.

Queue jumps and bypass lanes become more attractive if TSP has unacceptable impacts.

*Highway Capacity Manual* procedures can be used to estimate the delay reduction from queue jumps and bypass lanes.

Exhibit 4-49 presents a graph that identifies the travel time savings associated with a queue jump treatment assuming (1) the queue jump lane is long enough to function effectively and (2) an advance green of about 10% of the cycle length is provided. The example assumes an initial  $g/C$  (effective green time per cycle) of 50% and  $v/c$  of 0.8. After the queue jump is installed, the  $g/C$  is assumed as 0.6 and the  $v/c$  at 0.2. In this example, a bus travel time savings of 17 seconds would result. Comparative benefits for other values of  $g/C$  and  $v/c$  can be obtained either by interpolation or by application of the delay equations.

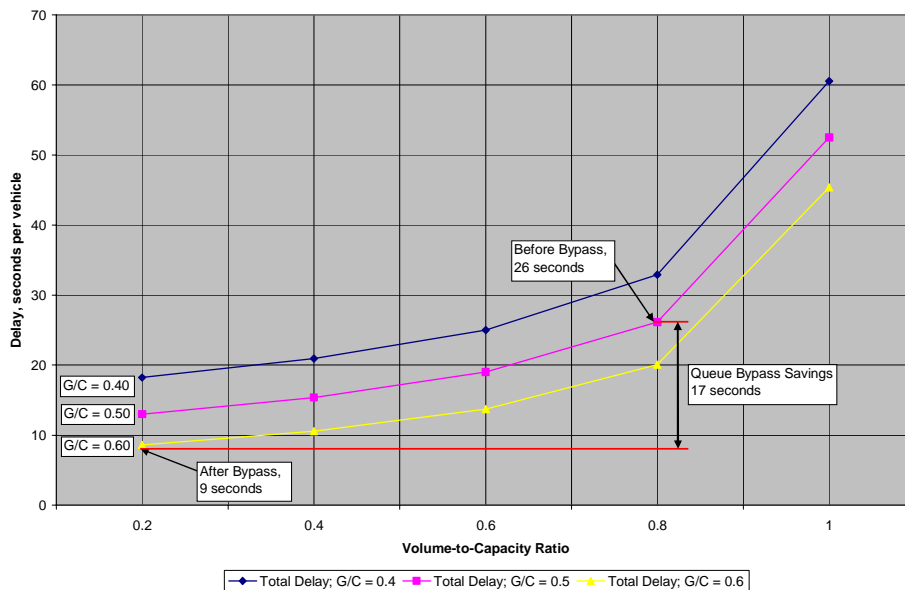

SOURCE: TCRP A-23A project team

**EXHIBIT 4-49** Effect of Queue Jump with Advanced Green on Signalized Intersection Delay (90-Second Cycle)

Simulation modeling can also be applied to identify impacts to both bus travel time and general traffic delay associated with queue jump or bypass lane application.

**Curb Extensions**

Curb extensions can serve as bus preferential treatments along arterial street BRT operations. The concept involves extending the sidewalk area into the street so that buses do not have to pull out of a travel lane to serve passengers at a stop. Thus, a curb extension can also serve as a BRT stop. Curb extensions can be far-side, near-side, or mid-block. Curb extension operation is illustrated in Exhibit 4-50. A far-side curb extension is depicted in Exhibit 4-51.

To develop a curb extension, either a parking lane or loading zone must be available to develop the expanded passenger waiting area. This treatment requires the elimination of two or more parking spaces or a loading zone to provide a sufficient length to develop the curb extension. Another term for these treatments is "bus bulbs."

On-street parking or a loading zone is necessary to create a curb extension.



*Bus Rapid Transit Practitioner's Guide*

**Before**

Bus pulls to curb at bus stop: must wait for gap in traffic to proceed.

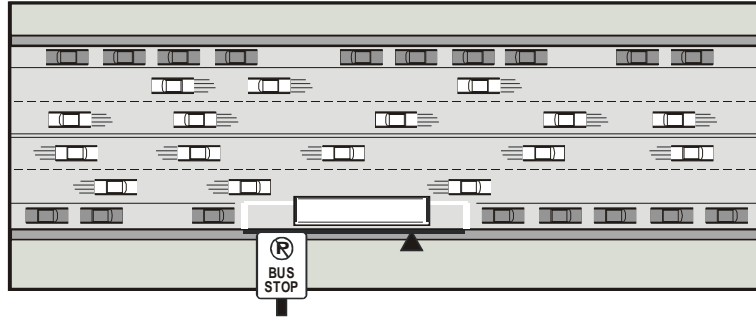

**After**

Curb extended into parking lane, bus stops in travel lane; more curbside parking available.

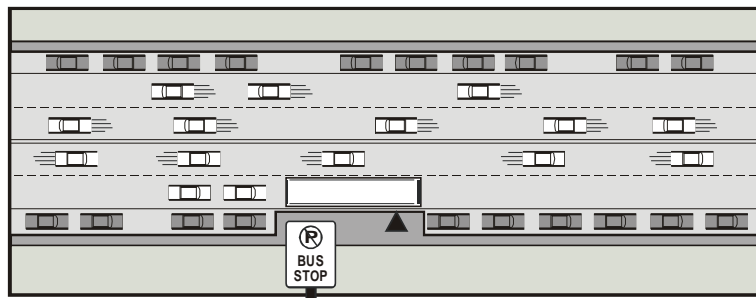

SOURCE: *Transit Capacity and Quality of Service Manual (9)*

**EXHIBIT 4-50 Curb Extension Operation**



SOURCE: *Transit Capacity and Quality of Service Manual (9)*

**EXHIBIT 4-51 Curb Extension (Portland, OR)**

In addition to serving as a bus preferential treatment, curb extensions provide an opportunity to beautify the streetscape by providing added space for landscaping and passenger amenities such as benches, telephones, and pedestrian-scale lighting. Curb extensions also reduce the pedestrian crossing distance across the street on which the bus is operating. The placement of street furniture and landscaping must not impede intersection sight distance.

### *Scale of Application*

Curb extensions can be provided at single stops or along a section of a bus route. A typical width for a curb extension is the width of the parking lane or loading zone removed (8 to 10 feet). Lengths of curb extensions can range from 30 to 40 feet for a standard bus to 50+ feet if multiple standard buses and/or articulated buses are accommodated. Outside of the curb extension, there is typically a curb return to the side street on one side (if the extension is at an intersection) and a transition taper to a parking lane or loading zone on the other.

### *Conditions of Application*

Curb extensions are feasible where arterial traffic volumes are low, bus service is frequent, pedestrian volumes are substantial, development densities are high, and curb parking is permitted at all times along the roadway. Curb extensions can only be applied where it is possible to widen the sidewalk either at an intersection or mid-block. For use as bus stops, curb extensions are typically associated with near-side bus stops. If far-side stops are developed as curb extensions, blockage to general traffic caused by the bus stopping should not result in unacceptable queuing and potential traffic conflicts at the intersection. Given the limited benefit associated with providing TSP in general traffic lanes where near-side bus stops exist, curb extensions are typically applied at near-side stops without TSP.

### *Selected Typical Examples*

Curb extensions are provided along bus routes in several U.S. cities, including San Francisco, Charlotte, Orlando, Grand Rapids, Lansing, Portland (OR), Seattle, West Palm Beach, and St. Petersburg (13).

### *Estimated Costs*

The cost of a curb extension varies based on the length and width of the treatment, site constraints, and the specific design of the curb extension. In San Francisco, costs of existing curb extensions have ranged from \$40,000 to \$80,000 each. Much of the cost stems from the need to provide adequate drainage, which often necessitates re-grading the street and sidewalk and moving drains, manholes, street lights, signal poles, street furniture, fire hydrants, and other features.

### *Likely Impacts*

#### *Travel Time and Reliability*

By allowing a bus to stop in the general traffic lane and not have to pull over to a curb at a bus stop, travel time is reduced by eliminating "clearance time," which is the time a bus waits to find an acceptable gap in the traffic stream so that the bus can pull back into the general traffic lane. The clearance time depends on the adjacent lane traffic volume, and various studies have shown that clearance times can range from 9 to 20 seconds.

There are opportunities for added streetscaping with curb extensions.

Curb extensions work well on streets where bus service is frequent, travel volumes are low, there are higher pedestrian volumes, and curbside parking is permitted at all times.

Curb extensions eliminate bus "clearance time."

*Bus Rapid Transit Practitioner's Guide*

Curb extensions work best when traffic in the adjacent curb lane does not exceed 400 to 500 vehicles per hour.

Exhibit 4-52 identifies clearance times associated with different adjacent-lane mixed-traffic volumes under particular bus operating conditions. A volume of 300 to 500 vehicles per lane (typical for a city street and the upper volume limit for constructing curb extensions) results in a savings of up to 5 seconds per stop. By eliminating clearance time, the variability of clearance time at stops along an arterial corridor can be improved, and, thus, bus service reliability also can be improved. At the same time, provision of a near-side curb extension precludes the ability to provide a dedicated right-turn lane at an intersection.

**EXHIBIT 4-52 Average Bus Clearance Time (Random Vehicle Arrivals)**

Adjacent Lane Mixed-Traffic Volume (vehicles/hour)	Average Re-Entry Delay (seconds)
100	1
200	2
300	3
400	4
500	5
600	6
700	8
800	10
900	12
1,000	15

SOURCE: Computed using 2000 *Highway Capacity Manual* (6) unsignalized intersection methodology (minor street right turn at a bus stop) assuming a critical gap of 7 seconds and random vehicle arrivals. Delay based on 12 buses stopping per hour.

*Operating Cost Savings*

By reducing bus travel time, some operating cost savings can be achieved with curb extensions if implemented in a systematic manner.

*Safety*

A curb extension for a BRT stop can improve pedestrian safety because the crossing distance is reduced. At the same time, given that curb extensions have a relatively tight curb return on the intersection end of the treatment, vehicles turning right must be able to make the turn safely. Curb extensions are typically not provided where there are high right-turn volumes (particularly truck traffic) and where a larger curb return would cut back on the space available to develop a curb extension at an intersection.

*Ridership*

If curb extensions are applied in a systematic manner along a corridor, a potentially sizable reduction in bus travel time could occur, which could attract increased ridership. Similar to arterial bus lanes, elasticity factors could be applied to translate identified bus travel time savings into the potential for increased ridership.

Curb extensions reduce the length of crosswalks.

Systematic application of curb extensions can result in a sizable reduction in bus travel times.

*Implementability*

The ability to develop curb extensions depends on the ability to remove parking or a loading zone at an intersection or mid-block. Curb extensions for bus preferential treatments are most appropriate when TSP is not feasible and when bus queue jump or bypass lane treatments are either not possible or would have unacceptable operational or safety impacts.

The feasibility of curb extensions depends upon the ability to remove on-street parking and/or loading zones.

*Analysis Tools*

The reduction in clearance time at bus stops with the provision of curb extensions can be estimated using the procedures in the *Transit Capacity and Quality of Service Manual* (9).

The difference in intersection approach delay if a bus stops at a near-side curb extension as opposed to traveling through the intersection can be estimated by using procedures in the *Highway Capacity Manual* (6). If the curb extension is at an unsignalized intersection or a mid-block location, the added intersection approach delay is associated with the time the bus is stopped serving passengers and whether there is an adjacent traffic lane that other vehicles can use to get around the bus. At a signalized intersection, there is the added factor of whether a bus stops at a near-side stop during the green or red signal phase. If a bus stops during a green phase, then the delay to general traffic would be similar to an unsignalized intersection or mid-block stop condition.

Simulation modeling can be applied to identify the impacts to bus travel time and general traffic delay associated with curb extension application.

**STATION COMPONENTS**

Stations provide the key link between passengers and the BRT system. Along with vehicles and running ways, they are essential components. They are also important in providing a clear system identity and reinforcing development in their environs. They can range from simple stops with well-lit shelters to complex facilities with extensive amenities and features (such as those found at many rail stations).

Stations are the link between passengers and vehicles.

This profile provides guidelines for key station features. Automated passenger information and off-vehicle fare collection (which are both associated with stations) and station spacing are discussed in separate profiles.

*Scale of Application*

BRT stations (in contrast to bus lanes and busways) are provided along the entire BRT route or system. They are widely spaced (except in central areas and other densely developed areas) to allow high operating speeds; the wide spacing also reduces station investment costs.

Stations should be placed at transit-supportive major activity centers (which may include the city center, outlying office and retail complexes, large schools, and hospitals), at major intersecting transit lines, and at interchanging arterial streets. Good pedestrian, bicycle, transit, and park-and-ride access is essential.

---

*Bus Rapid Transit Practitioner's Guide*

*Selected Typical Examples*

Examples of BRT stations are shown in Exhibit 4-53 through Exhibit 4-61. These examples illustrate the wide range of station types that have been keyed to specific local conditions. All give BRT stations a clear, specific identity.



SOURCE: Kittelson & Associates, Inc.

**EXHIBIT 4-53 BRT Station Examples (Los Angeles)**



SOURCE: Kittelson & Associates, Inc.  
**EXHIBIT 4-54 BRT Station Example (Pittsburgh)**



SOURCE: Kittelson & Associates, Inc.  
**EXHIBIT 4-55 BRT Station Example (Orlando)**



SOURCE: Kittelson & Associates, Inc.  
**EXHIBIT 4-56 BRT Station Example (York, ON)**



---

*Bus Rapid Transit Practitioner's Guide*



SOURCE: Kittelson & Associates, Inc.

**EXHIBIT 4-57 BRT Station Example (Miami)**



SOURCE: Regional Transportation Commission of Southern Nevada

**EXHIBIT 4-58 BRT Station Example (Las Vegas)**



SOURCE: Kittelson & Associates, Inc.

**EXHIBIT 4-59 BRT Station Examples (Boston)**



SOURCE: <http://en.wikipedia.org>

**EXHIBIT 4-60 BRT Station Example (Brisbane, Australia)**



SOURCE: [www.i70mtncorridor.com](http://www.i70mtncorridor.com)

**EXHIBIT 4-61 BRT Station Example (Ottawa)**

*Types and Features*

A wide range of station types and features influences both costs and performance. These types and features include the following:

- Type of running way (busway, median arterial busway, or city street operations)
- Type of construction (at-grade, elevated, or subway)
- Platform length and height
- Auxiliary features (such as telephones, temperature control, automated passenger information, and security provisions)
- Passenger amenities (such as benches, restrooms, and drinking fountains)
- Need for stairs, escalators, and pedestrian bridges

There is a wide range of BRT station types and features.



*Bus Rapid Transit Practitioner's Guide*

- Station building type and design
- Need for passing lanes

Exhibit 4-62 gives examples of station features and amenities for selected BRT systems (circa 2002). Exhibit 4-63 gives features of BRT stations as reported in CBRT (1).

Exhibit 4-64 lists features that may be provided for various running way alignments. The exhibit can serve as a guide in designing and costing stations.

**EXHIBIT 4-62 Examples of BRT Station Features and Amenities**

City	Service	Features
Boston	Silver Line	Mezzanines in four tunnel stations with fare collection provisions. Six curbside stations on Washington Street have seating, information panels, telephones, trash receptacles, and communications panel.
Cleveland	Euclid Avenue	Shelters, amenities, and possibly fare vending machines.
Hartford	New Britain-Hartford Busway	Passenger drop-off areas, some park-and-ride. Full range of amenities, climate-controlled buildings, restrooms, and telephones at major stations.
Houston	Transit centers	Have extensive park-and-ride lots at stations.
Los Angeles	San Bernardino HOV/Busway; Wilshire-Whittier; Ventura Metro Bus	Circular island at El Monte Station; large park-and-ride there. Major stations: double canopy shelter and "Next Bus" display signs. Other stations: single canopy shelter and bollards.
Miami	South Miami-Dade	Translucent, waterproof fiber canopies, pay telephones, and benches.
New York City	I-495 bus lane	New Jersey buses use 200-berth Midtown Bus Terminal.
Ottawa	Transitway system	Passenger shelters, radiant heat, benches, telephones, and television monitors announcing bus arrivals.
Pittsburgh	Busways	Simple shelters, some with telephones.
Seattle	Bus tunnel	Architectural features such as murals/clocks.
Vancouver, BC	B-Lines	Well-lit, distinctive shelters; real-time electronic bus information displays; and customer information signage.
Adelaide, Australia	On guided busway	Protected shelters, bicycle access/storage, and short-/long-term parking.
Brisbane, Australia	South East Busway	Architecturally distinctive designs, passenger protection, elevators and stations, covered pedestrian bridges over busway, real-time passenger information displays, ticketing machines, public telephones, passenger seats, drinking fountains, retail kiosks, public restrooms, and security systems.
Sydney, Australia	Liverpool-Parramatta Busway; bus lanes	Real-time passenger information, lighting, and security cameras.
Rouen, France	Optically guided bus lanes	Most stations are simple bus shelters; some have ticketing provisions.
Bogotá, Colombia	TransMilenio	Similar to rapid transit station in design, with fare payment provisions and high platform.
Quito, Ecuador	Trolebus	Tube-like shelter at stations, off-vehicle fare collection, and high platform.

SOURCE: *TCRP Report 90 (2)*

**EXHIBIT 4-63 Features of Selected Existing BRT Stations**

Feature	Boston (Silver Line Phase 1)	Honolulu (City Express)	Las Vegas (North MAX)	Los Angeles (Metro Royal)	Miami (South Dade Busway)	Oakland (San Pablo Rapid)	Orlando (Lymmo)	Pittsburgh (Busways)	Phoenix (Rapid)
<i>Station Geometry</i>									
Platform Height	A	A	C	A	A	A	A	B	A
Maximum Vehicles Accommodated	1	1	1	1	2	1	2	3	1
Passing Capability	D	D	E	D	F	D	G	F	E
<i>Passenger Amenities and Services</i>									
Telephone					X				
Restroom									
Vending			X						
Seating	X		X		X	X	X	X	X
Trash Container	X		X	X	X	X	X	X	
Temperature Control								X	
Public Art							X		
Public Address							X	X	
Emergency Telephone	X				X			X	
Security Monitoring/Police							X		

NOTE: A = standard curb, B = raised curb, C = level platform, D = adjacent mixed-flow lane, E = bus pullouts for station, F = passing lane, and G = no passing.

SOURCE: CBRT (7)

**EXHIBIT 4-64 BRT Station Types and Features**

Feature	Curbside Bus Stop		Median Arterial Busway		Busway		
	Typical	Major	Typical	Major	Typical	Major	Inter-modal Center
Conventional shelter <sup>1</sup>	X						
Unique BRT shelter	X	X	X	X	X	X	X
Illumination	X	X	X	X	X	X	X
Telephones/security phone		X	X	X	X	X	X
Temperature control			X	X <sup>2</sup>	X <sup>2</sup>	X	X
<i>Passenger Amenities</i>							
Seating		X	X	X	X	X	X
Trash containers		X	X	X	X	X	X
Restrooms							X
Public address/automated passenger information systems		X	X	X	X	X	X
<i>Passenger Services</i>							
Vending machines, newsstands		X	X	X	X	X	X
Shops						X	X
Special services (e.g., dry cleaners)						X	X

<sup>1</sup> Conventional shelter is a minimum treatment that generally should not be used for a BRT service.

<sup>2</sup> In some environments

NOTE: Major stations should be provided at interchanging transit lines, large park-and-ride lots, and important passenger generators.

SOURCE: TCRP A-23A research

*Bus Rapid Transit Practitioner's Guide*

*Estimated Costs*

Reported station costs for various BRT station features are shown in Exhibit 4-65 through Exhibit 4-67. The following observations apply:

- Costs for busway stations range from about \$150,000 (Miami) to more than \$3 million (Ottawa). A major cost item is the provision of a station building.
- Costs for stations on arterial streets range from about \$60,000 to \$100,000 (Los Angeles and Vancouver) to \$250,000 (Las Vegas). The stations in Las Vegas have adjusted the curb heights to permit level boarding of Civis Iris buses.
- Costs for bus shelters are modest. They are increased only slightly by providing benches, telephones, trash receptacles, special painting, and bicycle racks. Station costs are substantially increased when ticket vending machines are added. Costs are also increased substantially when roadway widening at stations is included.
- Station buildings (such as provided in Brisbane and Ottawa) are the major cost item. They can cost several million dollars—even more when grade-separated pedestrian-ways are provided.
- Passing lanes at stations can also account for sizeable costs.

Major cost items for stations include provision of station buildings and passing lanes for buses.

Ticket vending machines can substantially increase station costs.

**EXHIBIT 4-65** Reported BRT Station Costs by Type of Running Way

Type of Running Way	System	Cost/Station (millions)
Busway	Adelaide, Australia	\$1.50
	Brisbane, Australia	\$1.90
	Hartford (proposed)	\$2.40
	Miami (extension)	\$0.15
	Pittsburgh: West Busway	\$0.45
	Pittsburgh: East Busway (extension)	\$0.50
	Ottawa	\$3.30
Freeway shoulder lanes	Ottawa	\$4.40
Median arterial bus lanes	Cleveland	\$0.30
Mixed traffic or bus lanes	Boston	\$0.23
	Las Vegas	\$0.25
	Los Angeles	\$0.06 to \$0.10
	Ottawa	\$0.10
	Vancouver, BC	\$0.07

SOURCE: TCRP Project A-23A Interim Report (3)

**EXHIBIT 4-66** Reported BRT Station Costs by Type of Station and Roadway Features

Item	Cost
<i>Type of Stop/Station</i>	
Simple stop	\$16,000 to \$26,000 per shelter
Enhanced stop	\$25,000 to \$35,000 per shelter
Designated station	\$150,000 to \$2.5 million
Intermodal transit center	\$5 to \$20 million
<i>Roadway Feature</i>	
Bus pullout	\$0.05 to \$0.06 million per station platform
Passing lanes at station	\$2.5 to \$2.9 million per mile per lane

SOURCE: CBRT (7)

**EXHIBIT 4-67 Reported BRT Station Costs by Station Component**

Component	Cost
<i>Cleveland</i>	
Bench	\$2,000
Standard shelter	\$15,000
Upgraded shelter	\$150,000
Posted bus information	\$10,000
Real-time bus information	\$15,000
Ticket machine	\$10,000
Artwork/landscaping	\$1,000,000 overall
Trash receptacle	\$1,000
Telephone	\$500
<i>Miami</i>	
Bench	\$60
Ticket vending machine	\$27,700
Telephone	\$850
Trash receptacle	\$6
Special painting/logo	\$350
Bicycle racks	\$1,000
<i>Ottawa</i>	
5' x 10' shelter	\$4,500
Oversized shelter	\$11,000 to \$15,000
Large station building	Several million dollars
<i>Vancouver, BC</i>	
Cost per shelter	\$44,600
Services per platform	\$26,160

SOURCE: TCRP Project A-23A Interim Report (3)

*Likely Impacts*

The generalized effects of various station features on BRT system performance and benefits are set forth in Exhibit 4-68. The benefits may include more riders and more potential development. More specifically, BRT stations afford three major benefits:

- They can reduce travel times by expediting passenger boarding and alighting and by being widely spaced (where the spacing is appropriate for the surrounding land uses). See the "Fare Collection" and "Service Plans" sections of this chapter for discussion of these impacts.
- They can attract riders by providing a range of services for boarding and alighting patrons, by being located convenient to transit-supportive destinations and attractions, and by being pedestrian-friendly and safe. Automated passenger information systems can also prove beneficial. See the discussion in the "Passenger Information" section of this chapter.
- They can serve adjacent developments and encourage additional development in their environs. (See Chapter 6.)

There are three major benefits of BRT stations.

*Bus Rapid Transit Practitioner's Guide*

**EXHIBIT 4-68 Generalized Effects of BRT Station Elements**

Element	System Performance					System Benefits
	Travel Time Savings	Reliability	Identity and Image	Safety and Security	Capacity	
Station Types: <ul style="list-style-type: none"> <li>▪ Basic shelter</li> <li>▪ Enhanced shelter</li> <li>▪ Designated station</li> <li>▪ Intermodal transit center</li> </ul>	Integrated stations serving multiple modes minimize transfer time penalties.		More distinct station types enhance the brand identity of the system. Additional amenities appeal to customers.	More defined stations build in design treatments to link to surrounding communities.	Larger stations increase loading capacity at stations.	More defined stations attract potential development.
Platform Height: <ul style="list-style-type: none"> <li>▪ Standard curb</li> <li>▪ Raised curb</li> <li>▪ Level platform</li> </ul>	Reduced vertical clearance facilitates boarding and reduces dwell time.	Reduced vertical clearance facilitates boarding and reduces dwell time variability.	Level platforms present an image of advanced technology, similar to some rail systems.	Reduced vertical clearance may reduce tripping during boarding and alighting.	Reduced dwell times for platform heights increase station throughput.	
Platform Layout: <ul style="list-style-type: none"> <li>▪ Single vehicle-length platform</li> <li>▪ Extended platform with unassigned berths</li> <li>▪ Extended platform with assigned berths</li> </ul>	Allowing multiple vehicles to load and unload facilitates lower station clearance times.	Allowing multiple vehicles to load and unload reduces delay.			Longer platforms limit queuing delays for vehicles waiting to load.	
Passing Capability: <ul style="list-style-type: none"> <li>▪ Bus pullouts</li> <li>▪ Passing lanes at stations</li> </ul>	Passing at stations allows for express routes and minimizes delays at stations.	Passing at stations allows for schedule maintenance and recovery.			Passing limits queuing delays at stations.	
Station Access: <ul style="list-style-type: none"> <li>▪ Pedestrian linkages</li> <li>▪ Park-and-ride facility</li> </ul>			Treatments to highlight station access attract riders.	Better pedestrian linkages to communities facilitate integration with communities.		Better access attracts customers.

SOURCE: CBRT (7)

*Ridership Effects of Station Features*

There is some evidence that BRT systems attract riders as a result of their running way permanence, attractive vehicles and stations, clear and frequent service, and good connections to adjacent development. Station components have been estimated to account for up to 15% of a maximum 10-minute travel time bias constant or 25% added ridership beyond that obtained by travel time and service frequency improvements alone. The likely additional ridership associated with various station components is as shown in Exhibit 4-69. The increments are additive up to a total of 15%.

**EXHIBIT 4-69 BRT Station Component Contribution to Ridership Increases**

Component	Contribution to Ridership Increase
Unique, attractively designed shelters	2%
Illumination	2%
Telephones/security phones	3%
Climate-controlled waiting area	3%
Passenger amenities	3%
Passenger services	2%
Total	15%

SOURCE: Estimated by TCRP A-23A project team

*Land Development Effects*

Attractively designed BRT stations with conflict-free, weather-protected pedestrian access to adjacent activity centers can have a positive effect on land development. Examples of development adjacent to busway stations in Ottawa and Brisbane are shown in Exhibit 4-70 through Exhibit 4-72.

Exhibit 4-70 shows the entrance to Bayshore Shopping Centre in Ottawa, which was constructed to provide direct access to and from the Bayshore Transitway station. In Exhibit 4-71, two existing office towers have direct access to a Transitway station. A third tower is under construction. The developer advertises ready Transitway access as an advantage of the property.



SOURCE: Steve Brandon, www.flickr.com

**EXHIBIT 4-70 Bayshore Transitway Station (Ottawa)**



SOURCE: <http://www.oxfordproperties.com>

**EXHIBIT 4-71 Office Development at Kent Transitway Station (Ottawa)**

More than \$1 billion (Canadian) in new residential and commercial construction has occurred along Ottawa's Transitway system. The St. Laurent shopping center, which is directly connected to the Transitway, is one of Canada's busiest and most productive shopping centers. A substantial proportion of its patrons use the Transitway.

#### *Design Guidelines*

BRT stations should be permanent, weather-protected facilities that are convenient, comfortable, safe, and fully accessible. They should be fully integrated with their surroundings and should be an urban design asset. They should provide a full range of passenger amenities, including shelters, passenger information, telephones, lighting, and security provisions. They should provide a unified design theme; there should be a consistent pattern of station location, configuration, and design. A BRT "icon" designating each station is essential. Convenient, weather-protected, and conflict-free connections to nearby destinations are essential.

Station designs should integrate BRT, traffic, and pedestrian movements and separate them as appropriate.

Stations should provide a full range of passenger amenities and a unified design theme.

Stations should be permanent and provide protection from the weather.



NOTE: These photos show the Queensland Art Gallery (adjacent to the Cultural Centre station's pedestrian bridge), the Queen Street Mall (above the Queen Street station), and a connection to the South East Busway inside Queen Street Mall.

SOURCE: <http://en.wikipedia.org>

EXHIBIT 4-72 Commercial Development around South East Busway (Brisbane)



*Bus Rapid Transit Practitioner's Guide*

*Berth Design*

Linear parallel berths are desirable for most BRT stations. However, shallow saw-tooth berths are desirable in terminal areas where independent entry and exit is essential. Each berth should be at least 45 to 50 feet long for a 40-foot bus and at least 65 to 70 feet long for a 60-foot articulated bus. Berths should be at least 11 feet wide. Additional distance is needed for independent entry and exit.

The number of berths should be sufficient to accommodate anticipated peak-hour bus flows without frequent spillback. For busways and median arterial busways, a minimum of two berths should be provided in each direction of travel.

Exhibit 4-73 gives the approximate number of berths that should be provided for various bus flow rates and dwell times assuming a 5% failure rate (i.e., a 5% probability that one bus will arrive at a berth to find another bus already occupying it). More detailed procedures for different failure rates that take into account the decreasing efficiency of multiple berths are set forth in the *Transit Capacity and Quality of Service Manual* (9). In general, linear, online stations without bus passing capabilities have a maximum of three to four effective berths.

More detailed procedures for estimating the required number of berths are contained in the *Transit Capacity and Quality of Service Manual*.

**EXHIBIT 4-73 Approximate Number of Bus Berths Required for a 5% Failure**

Bus Flow Rate (Buses per Hour)	Dwell Time (Seconds per Stop)					
	10	20	30	40	50	60
<i>Unsignalized</i>						
15	1	1	1	1	1	1
30	1	1	1	1	1	2
45	1	1	1	1	2	2
60	1	1	2	2	2	3
75	1	2	2	2	3	3
90	1	2	2	2	3	4
105	1	2	3	3	4	4
120	2	2	3	3	4	5
<i>Signalized (50% Green per Cycle and Near-Side Stop)</i>						
15	1	1	1	1	1	1
30	1	1	1	1	2	2
45	1	1	2	2	3	3
60	1	2	2	2	3	4
75	1	2	3	3	4	5
90	2	3	3	4	5	5
105	2	3	4	5	5	6
120	2	3	4	5	6	7

NOTE: Assumes 10-15 seconds of clearance time between buses and a 60% coefficient of dwell time variation.

SOURCES: *TCRP Report 26 (5)* and *Transit Capacity and Quality of Service Manual (9)*

*Platform Design*

There are two basic options for BRT platform configuration: side platforms and center platforms.

Side platform configurations are common along streets and busways. They adapt to the right-hand (curb) side of door arrangements in the United States and Canada. Far-side stations and near-side left-turn lanes can share the same envelope along median arterial busways.

BRT can use side platforms or center platforms.

Center platform configurations are used along several busways in South America (e.g., Bogotá and Curitiba). They are used by trolley buses operating in the Harvard Square Tunnel in Cambridge, MA, and will be used in downtown Cleveland along the Euclid Avenue Busway. They allow more efficient and economical station design where buses have doors on both sides. However, they require left-hand doors and may limit operations in mixed traffic if there are no doors on the right-hand side of the bus as well.

Side platforms should be about 10 to 12 feet wide. A 20- to 25-foot width is desirable for center platforms.

Platform heights should be coordinated with vehicle design and fare collection methods. High-level platforms similar to rail rapid transit are used in Bogotá and Curitiba, where BRT service is limited to locations with these platforms. In the United States, the trend is toward low-floor buses coordinated with low-floor platforms.

Low-floor platforms are typically 6 inches above street level, leaving about 8 inches to the base of the vehicle. "Raised curbs" are typically 9 to 10 inches above the street level, leaving about 5 inches to the base of the vehicle. "Level" platforms are typically 14 inches high. "High" platforms as in Bogotá are several feet above street level.

Platform designs should accommodate space for fare collection and passenger queuing.

#### *Passenger Area Design*

Passenger waiting area design should include shelters, wind screens, radiant heaters in cold climate, signage and graphics, ITS displays, telephones, possibly bicycle racks, and possibly newspaper vending. Larger, enclosed stations and terminal facilities may also provide drinking fountains, restrooms, and expanded retail services.

Adequate vandal-resistant and easily maintained lighting should be provided. Lighting levels on open platforms should be about five footcandles, and lighting levels should be increased to 10 to 15 footcandles beneath canopies.

Both actual security and perceived security are essential. Both require good visibility. Passengers should be able to see and be seen from locations within the station and from outside space. Abrupt or blind corners should be avoided. Security equipment such as emergency call boxes and closed circuit television may be warranted.

Stations should be barrier-free and comply with ADA guidelines (14). Where a vehicle-mounted lift or ramp is employed for wheelchair access, a clear area 96 inches long (measured perpendicular to the vehicle) and 60 inches wide (measured parallel to the vehicle) is required for lift deployment and wheelchair maneuvering. The cross slope of this area should not exceed 2% (measured parallel to the vehicle).

#### *Operational Considerations*

Station configurations and design should support the BRT service plan and operating philosophy. There should be convenient transfers between the BRT service and intersecting transit routes. Independent bus arrivals and departures should be provided at major transit centers and terminal stations.

Low-floor platforms range from typical curb height to "level" platforms.

BRT stations must comply with ADA guidelines.

---

## *Bus Rapid Transit Practitioner's Guide*

### *Evaluation*

Stations are an essential BRT component. For maximum cost-effectiveness they should be coordinated with adjacent development, widely spaced (insofar as it is appropriate for the surrounding land uses), and economically designed while still providing the necessary passenger services and amenities. The wide spacing will provide BRT travel time benefits, while the station design itself enhances ridership and may stimulate land development.

### **VEHICLE COMPONENTS**

BRT vehicles have important bearing on ridership attraction, system performance, and environmental compatibility. Propulsion systems impact revenue, service times, emissions, and operating and maintenance costs. Seating arrangements, floor height, and door configuration impact dwell time at stations, BRT travel time, and passenger comfort. Physical vehicle size; aisle width; and number, width, and arrangement of doors influence BRT system capacity.

The number of bus sizes, types, and propulsion systems on the market has increased as more transit systems are using specialized vehicles for their BRT services. Experience has suggested the following general guidelines for vehicle selection, design, and operation (2,15):

- Vehicles should be selected, and designed, for the type of services offered (e.g., local and express) and the nature of markets served.
- Vehicles should provide sufficient capacity for anticipated ridership levels, on-board rider comfort, wheelchair securement, bicycle storage (if bicycles are allowed on board), and planned service frequencies. Lengths ranging from 40 to 45 feet for single-unit vehicles and from 60 to 82 feet for articulated and double-articulated vehicles can be considered.
- Vehicles should have strong passenger appeal and should be environmentally friendly, easy to access, and comfortable. Desirable features include air conditioning, bright lighting, panoramic windows, and real-time passenger information.
- Vehicles should be easy to board and alight. Low floor heights of 15 inches or less above the pavement are desirable unless technologies and station designs permit reliable level boarding.
- A sufficient number of door channels should be provided, especially where fares are collected off-vehicle. Generally, one door channel should be provided for each 10 feet of vehicle length.
- Wide aisles and sufficient passenger circulation space on buses can lower dwell times and allow better distribution of passengers within the bus.
- The allocation of space between standing and seated passengers depends upon the markets served. Total passenger capacity increases when the number of seats is reduced. Accordingly, on heavily traveled BRT routes, it may be desirable to provide 2-and-1 transverse seats or longitudinal seats on both sides of the bus.
- Emissions of particulate matter, hydrocarbons, carbon monoxide, and nitrous oxide can be reduced by using ultra low sulfur diesel (ULSD) fuel with digital filters or by operating compressed natural gas (CNG) or hybrid electric buses. Hybrid propulsion is quiet, improves fuel economy,

allows buses to accelerate faster, eliminates abrupt shifting, and improves ride quality.

- Use of electronic, mechanical, and optional guidance systems enables rail-like passenger boarding and alighting convenience and rail-like service times at stations. Guidance systems may also reduce right-of-way requirements.
- Standard, stylized, and specialized vehicles can be used in BRT service. Each should have distinct livery, graphics, and icons to create a unique BRT identity and image. Each should have suitable door arrangements and internal layouts.
- Vehicles should be well-proven in revenue service before being introduced into BRT operation, especially where frequent service is anticipated.
- Costs should be evaluated on a life-cycle basis that considers both the initial investment and the recurring operating and maintenance costs.

**Size of Vehicle**

Bus size should be based on BRT passenger capacity and operations requirements. Bus dimensions have become fairly standard with small variations, and most buses can be classified into one of three categories: small buses (around 30 to 35 feet in length) typically used in small communities or as feeders or shuttles; standard buses (40 to 45 feet), which are the most commonly used buses for transit service; and articulated buses (60 feet and longer), which are used for heavy patronage routes and for BRT service. Double-articulated buses with a length of 80 feet are used in some places (such as Curitiba). Exhibit 4-74 shows typical sizes and capacities for buses in the United States and Canada. Exhibit 4-75 shows a standard length bus and an articulated bus used in the same BRT service.

Buses used for BRT range in size. Standard-length (40 to 45 feet) buses and articulated buses are the most common.

**EXHIBIT 4-74 Typical Bus Sizes and Capacity**

Length	Width	Floor Height	Number of Door Channels	Number of Seats (including seats in wheelchair tie-down areas)	Maximum Passenger Capacity (seated plus standing)
40 ft (12.2 m)	96-102 in	13-36 in	2-5	35-44	50-60
45 ft (13.8 m)	96-102 in	13-36 in	2-5	35-52	60-70
60 ft (18 m)	96-102 in	13-36 in	4-7	31-65	80-90
80 ft (24 m)	96-102 in	13-36 in	7-9	40-70	110-130

SOURCE: Vehicle Catalog 2005 Update (16)

The size of BRT vehicles has an impact on the ability to transport bicycles. Some agencies that provide BRT service using standard-length vehicles have front-mounted bicycle racks on the vehicles; others do not allow bicycles on BRT. Agencies that provide BRT service using articulated vehicles may or may not allow bicycles on board. The decision to allow bicycles on board should be sensitive to anticipated ridership levels (seated passengers, standing passengers, and bicyclists), headways, dwell times, and interior space available to accommodate bicycles as well as wheelchairs.

---

*Bus Rapid Transit Practitioner's Guide*

SOURCE: Kittelson & Associates, Inc.

**EXHIBIT 4-75 Standard-Length and Articulated Buses (Van Hool BRT)**

Seating arrangements should facilitate passenger flow through vehicles. A 2-1 seating configuration may be desirable for heavily used BRT routes.

*Scale of Application*

Based on a biannual BRT *Vehicle Demand and Supply Analysis Update (17)* conducted by the FTA, the average annual demand for BRT vehicles based on size is 325 articulated, 115 40- to 45-foot buses, and 80 30- to 35-foot buses. This demand analysis was based on 48 cities with plans for BRT system implementation. Exhibit 4-76 identifies select agencies' tentative vehicle demand by size for a 10-year period ranging from 2004 to 2013.

*Conditions of Application*

The size of buses for a BRT operation should depend on the overall estimated ridership for the new service, the planned frequency of service, and a maximum tolerable passenger loading condition on the vehicle. The *Transit Capacity and Quality of Service Manual (9)* identifies the level of service associated with certain passenger loading conditions on a transit vehicle.

*Selected Typical Examples*

Exhibit 4-77 contains an inventory of buses currently available specifically for BRT service along with a brief description of their seating and standee capacity, and dimensions. Exhibit 4-78 through Exhibit 4-81 show available BRT vehicles.

**EXHIBIT 4-76 Tentative Vehicle Demand for Select Cities for 2004-2013**

City/ Community	Transit Authority/Agency	Articulated Vehicle	40- to 45-ft Vehicle	30- to 35-ft Vehicle
Alameda-Contra Costa Counties, CA	AC Transit	60	3	
Albany	Capital District Transportation Authority (CDTA)		20	
Atlanta	Metropolitan Atlanta Rapid Transit Authority (MARTA)	32	12	165
Austin	Capital Metropolitan Transportation Authority	25		
Boston	Massachusetts Bay Transportation Authority (MBTA)	146	100	
Charlotte	Charlotte Area Transit System (CATS)	16		
Chicago	Chicago Transit Authority (CTA) and Chicago Dept of Transportation (CDT)	80	355	
Cleveland	Greater Cleveland Regional Transportation Authority (GCRTA)	81		
Denver	Denver Regional Transit District (RTD), U.S. 36 Transportation Management Org.		25	
Detroit	Metropolitan Affairs Coalition	27		
El Paso	Sun Metro	10		
Eugene, OR	Lane Transit District (LTD)	15		
Fort Collins, CO	Transfort Dial-a-Ride, City of Fort Collins	22		
Hartford	Connecticut Department of Transportation	44	10	10
Honolulu	Department of Transportation Service, City and County of Honolulu	25		
Indianapolis	Indianapolis Public Transportation Corporation	40		
Kansas City, MO	Kansas City Area Transit Authority (KCATA)		12	
Las Vegas	Regional Transportation Commission of Southern Nevada (RTC)	40		
Los Angeles	Los Angeles County Metropolitan Transportation Authority (LACMTA)	901	243	
Louisville	Louisville Transit Authority River City (TARC)	44		
Miami	Miami-Dade County Transit Agency	15	10	600
Milwaukee	Milwaukee County Transit System	30		
Minneapolis	Minneapolis Metro Transit	14	12	
Montgomery County, MD	Public Works and Transportation, Division Transit Services, "Ride On"	197	310	33
New York	MTA Long Island Bus	650		
Newark	New Jersey Transit	18		
Northern Virginia	Virginia Department of Rail and Public Transportation	7		
Orange County, CA	Orange County Transportation Authority (OCTA)		38	
Orlando-FlexBRT	Florida Department of Transportation			36
Phoenix	City of Phoenix	15		
Pittsburgh	Port Authority of Allegheny County Planning Department	25		
Reno	Reno Regional Transportation Commission	15	7	
Salt Lake City	Utah Transit Authority	40		
San Diego	San Diego Metropolitan Transit Development Board (MTDB)	60		
San Francisco	San Francisco Municipal Railway (Muni)	66	17	
Santa Clara, CA	Santa Clara Valley Transportation	120		
Seattle	King County Metro Transit and Seattle County Sound Regional Transit	357		
Snohomish City	Washington Public Transportation Benefit Area Corporation (Community Transit)	20		
<b>Total</b>		<b>3,257</b>	<b>1,174</b>	<b>844</b>

SOURCE: *Vehicle Demand and Supply Analysis Update (17)*

*Bus Rapid Transit Practitioner's Guide*

**EXHIBIT 4-77 Inventory of BRT Vehicles**

<b>Standard-Length Buses</b>				
<b>Make/Model</b>	<b>Description</b>	<b>Length</b>	<b>Width</b>	<b>Height</b>
NABI 40 - LFW	<ul style="list-style-type: none"> <li>▪ Seats - 40</li> <li>▪ Standees - 30</li> <li>▪ Front- or rear-door wheelchair ramp</li> <li>▪ Two wheelchair positions</li> <li>▪ Low-floor entry/exit at all doors</li> </ul>	40 ft	102 in.	116 in.
Orion VII	<ul style="list-style-type: none"> <li>▪ Seats - 43 (37 seated passengers with 2 wheelchair positions filled)</li> <li>▪ Standees - 34</li> <li>▪ Front- or rear-door wheelchair ramp</li> <li>▪ Low-floor entry/exit at all doors</li> </ul>	41 ft	101.8 in.	132 in., 135 in. Hybrid, CNG
<b>Stylized Standard-Length Buses</b>				
<b>Make/Model</b>	<b>Description</b>	<b>Length</b>	<b>Width</b>	<b>Height</b>
New Flyer - Model Invero D40i	<ul style="list-style-type: none"> <li>▪ Seats - 44 (90% forward facing with perimeter seating available)</li> <li>▪ Standees - 46</li> <li>▪ Patented two-stage wheelchair ramp</li> <li>▪ Low floor at all doors, step rear</li> <li>▪ Plug slide front and rear doors</li> </ul>	41 ft	102 in.	126 in. with rear-mount HVAC
New Flyer - Model D40LF	<ul style="list-style-type: none"> <li>▪ Seats - 39 (70% forward facing with perimeter seating available)</li> <li>▪ Standees - 43</li> <li>▪ Flip-out wheelchair ramp</li> <li>▪ Low floor at all doors, step rear</li> <li>▪ Slide glide front and rear doors</li> </ul>	40 ft	102 in.	111 in. with rear-mount HVAC
Van Hool - Model A330	<ul style="list-style-type: none"> <li>▪ Seats - 33 forward-facing</li> <li>▪ Standees - 49</li> <li>▪ Flip-out wheelchair ramp</li> <li>▪ Low floor at all doors</li> <li>▪ Three doors (first and third pivot in, center wide door opens out)</li> </ul>	40 ft, 6.6 in.	102 in.	122 in.
NOVA LFS	<ul style="list-style-type: none"> <li>▪ Seats - 47 various configurations</li> <li>▪ Standees - 32</li> <li>▪ Two ultra-wide doors</li> <li>▪ Wheelchair ramps</li> <li>▪ Low-floor entry/exit at all doors</li> <li>▪ Full low-floor, ADA compliant</li> </ul>	40 ft	102 in.	123 in.
NABI CompoBus 45C - LFW	<ul style="list-style-type: none"> <li>▪ Seats - 46 transit and suburban configurations available</li> <li>▪ Standees - 23</li> <li>▪ Front- or rear-door wheelchair ramp</li> <li>▪ Two wheelchair positions</li> <li>▪ Low-floor entry/exit at all doors</li> </ul>	45 ft	102 in.	126 in.
<b>Conventional Articulated Buses</b>				
<b>Make/Model</b>	<b>Description</b>	<b>Length</b>	<b>Width</b>	<b>Height</b>
NABI 60 - LFW	<ul style="list-style-type: none"> <li>▪ Seats - 62</li> <li>▪ Standees - 31</li> <li>▪ Two doors, third door optional</li> <li>▪ Choice of door width and type</li> <li>▪ Front- or rear-door wheelchair ramp</li> <li>▪ Two wheelchair positions</li> <li>▪ Low-floor entry/exit at all doors</li> </ul>	60 ft	102 in.	116 in.

(continued on next page)

Neoplan AN 460LF	<ul style="list-style-type: none"> <li>▪ Seats - 68, customer selectable</li> <li>▪ Standees - 29</li> <li>▪ Front- or rear-door wheelchair ramp</li> <li>▪ Two wheelchair positions</li> <li>▪ Full low-floor for easy entry/exit</li> <li>▪ Two or three doors, extra-wide plug</li> </ul>	60 ft	102 in.	135 in.
New Flyer - Model DE60LF	<ul style="list-style-type: none"> <li>▪ Seats - 62 forward-facing, perimeter seating available</li> <li>▪ Standees - 53</li> <li>▪ Flip-out wheelchair ramp</li> <li>▪ Low floor at all doors, rear riser</li> <li>▪ Up to three slide and glide doors</li> </ul>	61 ft	102 in.	131 in. with roof-mount battery pack

**Stylized Articulated Buses**

Make/Model	Description	Length	Width	Height
NABI 60 - BRT	<ul style="list-style-type: none"> <li>▪ Seats - 60, transit and suburban configurations available</li> <li>▪ Standees - 30</li> <li>▪ Front- or rear-door wheelchair ramp</li> <li>▪ Two wheelchair positions</li> <li>▪ Low-floor entry/exit at all doors (15")</li> <li>▪ Two doors, third door optional</li> <li>▪ Up to two left-side doors</li> </ul>	60 ft	102 in.	135 in.
New Flyer - Model DE60-BRT	<ul style="list-style-type: none"> <li>▪ Seats - 47 to 53 (75% forward facing with perimeter seating available)</li> <li>▪ Standees - 53</li> <li>▪ Flip-out wheelchair ramp</li> <li>▪ Low floor at all doors, rear riser</li> <li>▪ Three to five slide and glide doors</li> </ul>	61 ft	102 in.	131 in. with roof-mount battery pack
Van Hool - Model A300	<ul style="list-style-type: none"> <li>▪ Seats - 43 forward-facing</li> <li>▪ Standees - 57</li> <li>▪ Flip-out wheelchair ramp</li> <li>▪ Full low floor and at all doors</li> <li>▪ Four doors - first, third, and fourth pivot in, second (center wide door) opens out</li> </ul>	60 ft, 6.6 in.	102 in.	134 in.

**Specialized BRT Vehicles**

Make/Model	Description	Length	Width	Height
APTS - Phileas 60	<ul style="list-style-type: none"> <li>▪ Seats - 37 forward-facing</li> <li>▪ Standees - 67 (1 passenger/2.7 ft<sup>2</sup>)</li> <li>▪ Full low-floor (100%)</li> <li>▪ Three doors, on one or on both sides</li> </ul>	60.5 ft	100 in.	123 in.
Irisbus CIVIS	<ul style="list-style-type: none"> <li>▪ Seats - 27 forward and perimeter</li> <li>▪ Standees - 90 (1 passenger/2.7 ft<sup>2</sup>)</li> <li>▪ Flip-out wheelchair ramp</li> <li>▪ Full low-floor</li> <li>▪ Four wide doors, on one side</li> </ul>	60 ft	100 in.	134 in.

SOURCE: Vehicle Catalog 2005 Update (16)



SOURCE: KCATA

**EXHIBIT 4-78 Stylized Standard-Length Bus (Gillig BRT)**



*Bus Rapid Transit Practitioner's Guide*



NOTE: This bus is no longer being manufactured.

SOURCE: Vehicle Catalog 2005 Update (16)

**EXHIBIT 4-79 Conventional Articulated Bus (Neoplan AN 460LF)**



SOURCE: Vehicle Catalog 2005 Update (16)

**EXHIBIT 4-80 Stylized Articulated Bus (NABI BRT)**



SOURCE: Regional Transportation Commission of Southern Nevada

**EXHIBIT 4-81 Specialized Articulated Bus (CIVIS)**

*Estimated Costs*

BRT vehicle costs range widely based on length, style, and features.

Exhibit 4-82 shows approximate prices (in 2005 dollars) for BRT vehicles based on size and styling options. Hybrids will cost about \$150,000 more per vehicle.

**EXHIBIT 4-82 Costs of BRT Vehicles by Size**

Bus Type	Bus Length	Typical Price Range
Conventional Standard	40-45 ft	\$300,000 to \$350,000
Stylized Standard	40-45 ft	\$300,000 to \$400,000
Conventional Articulated	60 ft	\$500,000 to \$600,000
Stylized Articulated	60 ft	\$600,000 to \$950,000
Specialized BRT	60-80 ft	\$950,000 to \$1,600,000

SOURCE: Vehicle Catalog 2005 Update (16) and NCHRP Project A-23A research team

*Likely Impacts*

Certain economic considerations should be taken into account when selecting a bus size. Larger buses provide added capacity and, hence, can accommodate a particular ridership demand with fewer vehicles or longer headways. This results in operating cost savings and potential capital cost savings. Larger buses also have greater potential for absorbing added ridership under less-crowded conditions. Passenger waiting time at stations can also be reduced with larger buses when transit routes are operating under peak load conditions. However, larger buses may also require new garage and storage facilities, and, where BRT penetrates neighborhoods, smaller buses may be more appropriate.

*Implementability*

The implementability of a specific bus size should be based on a capacity analysis that takes into account peak-hour passenger volumes. Buses should be large enough to reasonably accommodate peak-hour loadings while maintaining a balance with station capacity and adequate frequency. Labor costs are similar for both small and large buses because drivers for either size of bus may be paid the same; this factor introduces an initial disadvantage to running a fleet with small buses.

*Analysis Tools*

The vehicle size is required for capacity calculations. Based on *Transit Capacity and Quality of Service Manual (9)*, the total capacity of a bus is normally equal to 125% to 150% of seating capacity at maximum schedule load  $P_{max}$ . Passengers per hour can be calculated using the following equation:

$$P = \min(P_{max} \times f \times PHF, P_{max} \times B \times PHF) \tag{4-1}$$

- where:  $P$  = person capacity (persons/hour)
- $f$  = scheduled bus frequency (bus/hour)
- $B$  = station capacity (see *Transit Capacity and Quality of Service Manual [9]*)
- $PHF$  = peak-hour factor

**Modern Vehicle Styling**

Modern vehicle styling refers to the physical “modern” or “futuristic” internal and external appearance of buses used in BRT systems. This characteristic can influence riders’ perception of the BRT system (e.g., by providing an added feeling of safety). Additionally, modern-looking, attractive, and comfortable vehicles have been shown to increase ridership. Good interior styling is desirable.

*Scale of Application*

The extent of external modern styling application ranges from retrofitting standard buses to include front cone treatments to create a modern, sleek appearance to purchasing new buses with a modern, rail-like appearance. For BRT systems, all vehicles providing the particular service should be stylized vehicles.

Enhanced interior styling and design is also offered on most BRT vehicles available in the market. Some enhanced interior design features include larger, frameless windows; tinted sun guard on windows; pleasant color schemes; high-quality interior materials and finishes; enhanced, more comfortable seat designs

Bus capacity is typically 125% to 150% of seating capacity at maximum scheduled load.

Stylized vehicles should be used for BRT service. Vehicle styling is an element of branding.

---

*Bus Rapid Transit Practitioner's Guide*

with high backs; small worktables at some seats; wider aisles; added leg room; and a continuous, brightly lit interior.

*Conditions of Application*

Modern vehicle styling may be applied as part of BRT branding to provide customers with an improved perception of the transit system in its entirety. Various levels of vehicle styling exist in the market, with the more futuristic-looking vehicles involving greater initial costs. Additionally, unlike 60-foot BRT vehicles, the market offers few options in terms of highly futuristic styling for 40- to 45-foot vehicles.

Another important consideration, particularly for 40- to 45-foot BRT vehicles, is the accommodation of bicycles on board. Front-mounted bike racks may adversely impact the futuristic external appearance of the vehicle; nevertheless, some agencies have gone ahead with this bike rack placement option without receiving any negative feedback from the public.

The interior styling and design of the vehicle should have the objective of being functional, pleasant, and comfortable. In addition to aesthetics, the interior styling and design should be planned in conjunction with elements such as seating and standing capacity, wheelchair accommodations, and additional passenger amenities that may be implemented (such as closed-circuit television or worktables).

*Selected Typical Examples*

Exhibit 4-79 through Exhibit 4-81 illustrated various levels of styling for 60-foot buses. Some agencies that use stylized vehicles for BRT service are identified in Exhibit 4-83. Exhibit 4-84 shows an example of a NABI stylized 42-foot BRT vehicle. The modern, rail-like appearance of the NABI stylized vehicle is intended to improve users' perception of BRT service. Exhibit 4-85 illustrates a 40-foot stylized bus manufactured by Gillig. This vehicle has a more subtle futuristic design without wheel covers and a less-pronounced front cone. Exhibit 4-86 shows a non-stylized bus for comparative purposes.

**EXHIBIT 4-83 Agencies Operating Stylized Vehicles**

<b>Agency</b>	<b>Buses in Operation</b>	<b>Manufacturer</b>
Los Angeles County MTA - Metro Rapid, Orange Line	Stylized 40-ft and stylized 60-ft articulated	NABI
Phoenix - Rapid Express	Stylized 40-ft	NABI
AC Transit	Stylized 41-ft and stylized 61-ft articulated	Van Hool
Las Vegas	Specialized 60-ft articulated	Irisbus

SOURCE: Vehicle Catalog 2005 Update (16)

Some internal design options may provide additional comfort and convenience to users. Exhibit 4-87 shows two BRT vehicle interiors. Exhibit 4-88 illustrates contoured seats with high backs and small worktables. Exhibit 4-89 shows a support for standees in the articulation joint of a 60-foot BRT vehicle.



SOURCE: NABI  
**EXHIBIT 4-84** Example of a Stylized BRT Vehicle



SOURCE: Gillig  
**EXHIBIT 4-85** Example of a Stylized BRT Vehicle



SOURCE: Gillig  
**EXHIBIT 4-86** Example of a Non-Stylized Vehicle



SOURCE: DMJM+Harris  
**EXHIBIT 4-87** Examples of BRT Vehicle Interiors

---

*Bus Rapid Transit Practitioner's Guide*



SOURCE: York Region Transit

**EXHIBIT 4-88** Example of Seats with High Backs and On-Board Worktables



SOURCE: Kittelson & Associates, Inc.

**EXHIBIT 4-89** Example of Support for Standees in the Articulation Joint of a Bus

*Estimated Costs*

Stylized vehicles are more expensive than conventional non-stylized vehicles. However, although initial costs may be higher, these vehicles may have a positive impact on ridership that offsets the initial cost difference relative to a regular, non-stylized vehicle. Exhibit 4-82 shows some examples of typical prices for conventional and stylized buses. These prices may increase considerably with hybrid power systems.

### *Likely Impacts*

The implementation of modern-looking vehicles with improved interior aesthetics has been proven to have a positive impact on ridership. Additionally, larger windows and higher roofs give clients a feeling of added security and space (1). These factors combined can have a positive effect on the image of the BRT system.

A characteristic closely tied to modern vehicle styling is branding, which has been shown to increase ridership by 35% to 100% and time savings by 17% to 43%.

### *Implementability*

Application of complete modern vehicle styling may require the purchase of new vehicles. A cost analysis should determine if the added stylized features of new vehicles will improve ridership, improve the image of the BRT system, and provide any additional benefits expected by the transit agency. Vehicle storage requirements should also be considered if an agency plans to upgrade from conventional 40- to 45-foot vehicles to articulated or specialized vehicles. The interior design of the vehicle may be designed to accommodate agency-specific requirements and amenities. This process will require direct communication with the manufacturer before and during the procurement process.

### *Analysis Tools*

Three basic methods may be used to analyze the impact of modern vehicle styling and enhanced interior design: (1) surveys that reflect public opinion of BRT systems with and without these components, (2) a study that reflects ridership variations with the application of these components, and (3) cost analysis of the increased revenues from ridership and a comparison to the additional cost of vehicle purchase and maintenance.

## **Low-Floor Boarding**

Ease of vehicle access is determined by two factors: bus floor height and bus door characteristics.

Low-floor buses have a floor height that allows easier access into the vehicle as well as faster loading times for abled and disabled passengers alike. A low-floor bus (like that shown in Exhibit 4-90) typically has a floor height of around 15 inches and enables one-step passenger boarding. These buses use ramps for disabled passenger loading as opposed to the lifts used on high-floor buses. (In some BRT systems, level loading on high-floor buses may be available through the use of platforms.) An added characteristic of these buses is relocation of vehicle components that would typically be found under the bus to other, unconventional areas.

Door characteristics such as size, number of doors, and location of doors also impact the ease of access to a bus. Door characteristics also impact dwell time. Exhibit 4-91 shows Lane Transit District's custom BRT vehicle, which has three doors on the right side and two doors on the left side.

Vehicle access depends on floor height and number and width of doors.



*Bus Rapid Transit Practitioner's Guide*



SOURCE: Kittelson & Associates, Inc.

**EXHIBIT 4-90 Low-Floor Bus (Las Vegas)**



SOURCE: Lane Transit District

**EXHIBIT 4-91 BRT Door Configuration (Eugene, OR)**

There is a trend toward purchase of continuous low-floor buses.

Continuous floors on low-floor buses improve passenger circulation.

*Scale of Application*

In 2003, less than 20% of the U.S. bus fleet consisted of low-floor buses. (See Exhibit 2-12 in *Transit Capacity and Quality of Service Manual* [9].) Based on a research study conducted by APTA and reported in the 2005 *Public Transportation Factbook* (18), the proportion of buses using low-floor boarding in 2005 was found to be approximately 39%. Additionally in 2004, 82.7% of buses built were low-floor buses, and a similar number had been placed on order as of January 2005. The study covered approximately 70% of all U.S. transit agencies.

The vast majority of agencies planning bus deliveries between 2002 and 2012 selected continuous low-floor buses as their first choice instead of low-floor buses with a step or high-floor buses (17). The continuous floor improves passenger circulation inside the vehicle.

*Conditions of Application*

Since the Americans with Disabilities Act (ADA) of 1990, low-floor vehicles are quickly becoming the predominant choice of transit agencies around the country. ADA Title II states that public transportation agencies must comply with

accessibility requirements in newly purchased vehicles. Additionally, agencies must make efforts, within their economic capabilities, to modify existing buses or purchase or lease used buses that meet the accessibility requirements. However, there is no impending time limit or fixed requirement that obligates transit agencies to use low-floor vehicles.

### *Selected Typical Examples*

Low-floor buses are found in many of the BRT systems that operate across the United States. Examples of these agencies include AC Transit (CA), Los Angeles MTA, the Port Authority of Allegheny County (PA), the Regional Transportation Commission of Southern Nevada, and the Charlotte Area Transit System.

### *Estimated Costs*

The cost difference between low-floor buses and regular high-floor buses has greatly diminished from a 20% higher cost for low-floor buses in 1997 to a virtually equal cost in 2005. This cost reduction is because low-floor buses have become an industry standard in the past few years and proportionally more low-floor buses are built today than high-floor buses.

The conventional 40- to 45-foot partial low-floor bus ranges in price from \$300,000 to \$350,000. A 40-foot bus of this type has a boarding floor height of 14 inches above the pavement and can accommodate between 35 and 44 seated passengers and between 50 and 60 seated-plus-standing passengers. Passenger capacity increases to between 35 and 52 seated and between 60 and 70 seated-plus-standing for a 45-foot bus.

Maintenance costs for low-floor buses remain slightly higher than for high-floor buses because of the accessibility difficulties encountered with components typically placed under the bus, which have to be relocated to unconventional areas. The higher bus maintenance cost is somewhat offset by the lower cost of ramp maintenance for low-floor buses as opposed to lift maintenance for high-floor buses. The maintenance cost of a bus ramp used to aid loading of passengers in wheelchairs into a low-floor bus ranges from \$50 to \$300 per bus per year while the maintenance cost of a lift for a conventional bus ranges from \$1,500 to \$2,400 per bus per year.

### *Likely Impacts*

The number and size of doors influence passenger flow rates and dwell times. Double-channel doors process passengers faster than single-channel doors. However, the size of doors in BRT systems has a limited effect on passenger flow rate within certain size limits. For example, there is little, if any, difference between 3.75-foot and 4.5-foot double-channel doors because, in either case, only two streams of flow will typically be used, with occasional one- and three-stream flows.

The number of door channels available will affect dwell time because a greater number of door channels can lessen dwell time and a malfunctioning door may cause delays for passengers. It is desirable to provide one door channel for every 10 feet of vehicle length on heavily traveled BRT routes. However, additional doors may take away area for seating capacity in the vehicle and may lower passenger quality of service from that perspective.

In passenger service time calculations, the *Transit Capacity and Quality of Service Manual* (9) reduces boarding times by 20% with the application of low-floor buses. This reduction varies in real value according to the number of doors available, as

Low-floor buses have slightly higher maintenance costs, but this is compensated for by the lower cost of wheelchair ramp maintenance.

The number and size of doors influences passenger flow rates and dwell times.

Low-floor buses allow faster passenger boarding than high-floor buses.



*Bus Rapid Transit Practitioner's Guide*

illustrated in Exhibit 4-92. Faster boarding times may also have a positive effect on bus frequency in high passenger density areas.

**EXHIBIT 4-92 Passenger Service Times**

Door Channels	Passenger Service Time (seconds/passenger)
1	2.5
2	1.5
3	1.1
4	0.9
6	0.6

NOTE: Reduce times by 20% for low-floor buses.  
 SOURCE: *Transit Capacity and Quality of Service Manual (9)*

Low-floor buses also enhance passenger comfort when boarding. However, the seating capacity of these vehicles is less than for high-floor buses, which adversely affects another aspect of quality of service: There is greater probability of passengers having to stand. Exhibit 4-93 shows the capacity differences between low-floor and high-floor buses.

**EXHIBIT 4-93 Capacity of Low-Floor vs. High-Floor Buses**

Bus Type and Length	Capacity		
	Seated	Standing	Total
Low-floor, 35 feet	30-35	20-35	55-70
Low-floor, 40 feet	35-40	25-40	55-70
High-floor, 35 feet	35-40	20-30	50-60
High-floor, 40 feet	40-45	20-35	65-75

SOURCE: *Transit Capacity and Quality of Service Manual (9)*

For disabled users, wheelchair loading times for high-floor buses using lifts range from 60 to 200 seconds, depending on the experience and severity of the disability of the user. Low-floor buses reduce loading times to between 30 and 60 seconds.

*Implementability*

Low-floor buses have become the industry standard and are currently ordered in higher numbers than high-floor buses. Although these buses are becoming the norm, there are still transit agencies in cities such as New Orleans that prefer high-floor buses due to the possibility of street flooding. Capacity requirements are another consideration: Low-floor buses have a slightly lower seating capacity because space is taken up by wheel wells and relocated vehicle components, and this may pose additional costs for agencies with high passenger volumes where additional buses would be required to meet peak passenger demands.

*Analysis Tools*

Vehicle accessibility has a considerable effect on passenger service times. Low-floor boarding and number of doors available are important determinants of passenger service times, as shown in Exhibit 4-92.

### Propulsion/Fuel Technologies

#### Description

Propulsion technologies are constantly changing to meet stricter emissions standards as well as provide propulsion systems with higher efficiency. Diesel buses currently dominate most BRT operations; however, other propulsion technologies are also available and becoming increasingly popular, such as natural gas and diesel-electric hybrids. Electric trolley buses (including dual-mode vehicles such as those operating in Boston and Seattle) are less popular, and their application is expected to be limited in the coming years.

#### Scale of Application

The most commonly available propulsion systems today are diesel, natural gas, and hybrid electric engines. The use of ULSD and CNG engines is expected to increase dramatically as new emissions caps are implemented by the U.S. EPA. Exhibit 4-94 illustrates the number of vehicles powered by ULSD and CNG engines projected for purchase through 2013. After 2009, more vehicles are expected to be powered by CNG than ULSD based on the preferences of transit agencies across the country.

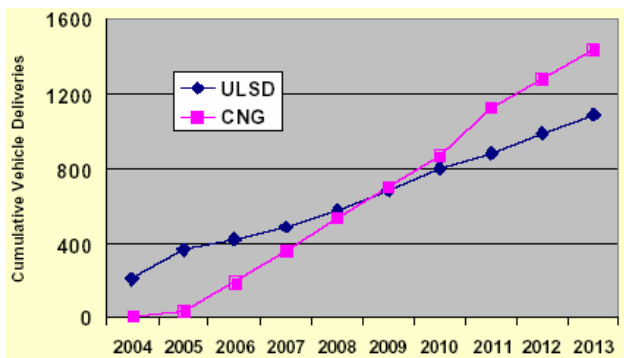

SOURCE: *Vehicle Demand and Supply Analysis Update (17)*

EXHIBIT 4-94 Projected BRT Vehicle Deliveries with ULSD and CNG Propulsion Systems

Exhibit 4-95 and Exhibit 4-96 illustrate the fuel preferences expressed by U.S. transit agencies for future vehicle purchases. Exhibit 4-95 identifies ULSD and CNG as the preferred fuel alternatives for articulated vehicles with very little preference expressed for other fuel types. Exhibit 4-96 also identifies ULSD and CNG as the preferred fuel alternative for 40- to 45-foot BRT vehicles.

#### Conditions of Application

New U.S. EPA caps limiting the amount of nitrogen oxide (NOx), hydrocarbon (HC), and particulate matter emissions will be phased in between 2007 and 2010. These caps will contribute to the increased application of ULSD engines, which will become conventional on newly built diesel transit vehicles.

New U.S. EPA standards for bus emissions are being phased in.

Bus Rapid Transit Practitioner's Guide

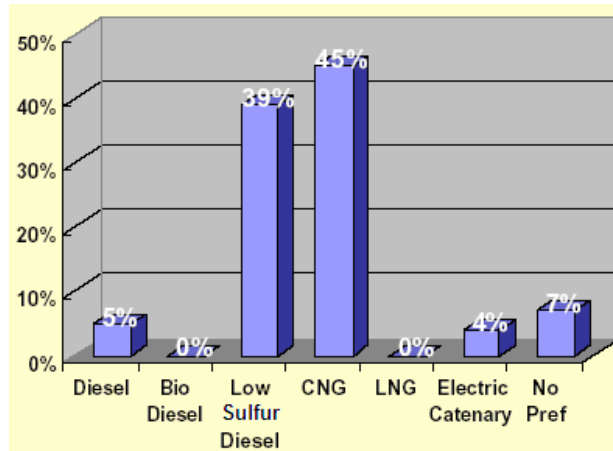

SOURCE: *Analysis of Fuels and Propulsion System Options for BRT Vehicles (19)*

EXHIBIT 4-95 Fuel Preferences for Articulated Vehicles

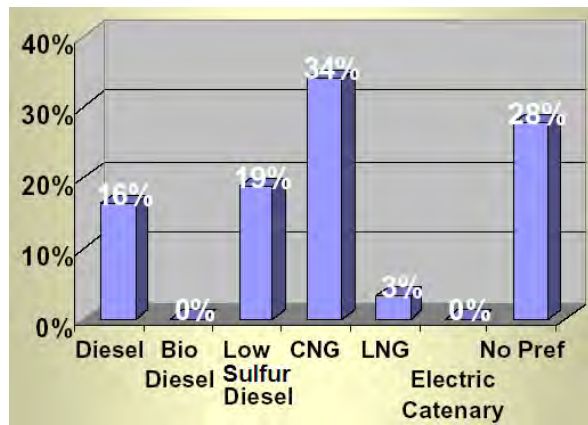

SOURCE: *Vehicle Demand and Supply Analysis Update (17)*

EXHIBIT 4-96 Fuel Preferences for 40- to 45-Foot Vehicles

Exhibit 4-97 identifies the percentage of manufactured heavy vehicle that must meet the emissions caps starting in 2007. Particulate matter emissions must be dropped to 0.01 grams per brake horsepower hour (g/bhp-hr) beginning in 2007. NO<sub>x</sub> and HC emissions will go through a phasing process in which 25% of vehicles manufactured in 2007 must have NO<sub>x</sub> emissions at a maximum of 0.20 g/bhp-hr and HC emissions of 0.14 g/bhp-hr. These percentage requirements for NO<sub>x</sub> and HC emissions will increase to 50% by 2008, 75% by 2009, and 100% by 2010.

EXHIBIT 4-97 Heavy Duty Truck and Bus Emission Standards for 2004-2010

Type of Emission	2004	2005	2006	2007	2008	2009	2010
PM (g/bhp-hr)	0.10 (0.05 for urban buses)			0.01			
NO <sub>x</sub> (g/bhp-hr)				25% of vehicles at 0.20	50% of vehicles at 0.20	75% of vehicles at 0.20	100% of vehicles at 0.20
HC (g/bhp-hr)	1.3			25% of vehicles at 0.14	50% of vehicles at 0.14	75% of vehicles at 0.14	100% of vehicles at 0.14

SOURCE: *Analysis of Fuels and Propulsion System Options for BRT Vehicles (19)*

*Selected Typical Examples*

Most vehicle manufacturers today offer a variety of propulsion system options. The application of a given type of propulsion system typically depends on performance requirements by the transit agency, budget, and experiences with different propulsion systems. For example, a hybrid vehicle may be purchased by an agency for noise reduction purposes rather than improved gas mileage.

Exhibit 4-98 identifies the different propulsion system options that BRT vehicle manufacturers currently provide. These systems are available for both articulated and 40- to 45-foot vehicles.

Manufacturer	Propulsion System Options
NABI	ULSD, CNG, LNG, Diesel-Electric Hybrid
New Flyer	ULSD, Diesel-Electric Hybrid, Gasoline-Electric Hybrid, Natural Gas, Electric Trolley
Van Hool	ULSD, CNG
NOVA	ULSD
Neoplan	ULSD, CNG/LNG

SOURCE: Vehicle Catalog 2005 Update (16)

*Estimated Costs*

The California Natural Gas Vehicle Coalition gives an average capital cost of \$25,000 per bus for fueling stations for fleets with more than 100 buses. This value may vary considerably based on factors such as distance to gas lines, land acquisition issues, and labor costs, among others.

Operating costs for CNG buses may vary from 20% higher than diesel-powered buses to equal or lower prices than diesel buses. This difference changes significantly with newer, modern CNG buses as compared to newer, modern diesel buses because the newer CNG buses are cheaper to operate. Additionally, the cost of CNG is about 30% cheaper than diesel. One example of this is Pierce Transit in Tacoma, WA, where CNG buses are reported to have fuel costs nearly 7¢ less per mile than diesel buses.

Liquefied natural gas (LNG) has some of the same characteristics of CNG, such as low emissions and similar costs for a fueling station. The primary advantage of LNG is that LNG is a higher-density fuel that provides about 2.5 times the range of CNG. The disadvantage of LNG in comparison to diesel is that fuel tanks must be twice as big and 800 pounds heavier to provide a similar range. Additionally, the high capital costs associated with the implementation of LNG infrastructure may offset the cheaper LNG fuel cost in comparison to diesel.

Hybrid-powered vehicles use a small auxiliary engine powered by either diesel or natural gas and an electric motor as the main power source. These power units can produce up to 90% fewer emissions, quieter performance, less brake and transmission wear, and better fuel economy (19). Another advantage reported is the lower maintenance costs for brakes associated with hybrid vehicles. This phenomenon is particularly noticeable when vehicles operate with frequent stops.

Although *Analysis of Fuels and Propulsion System Options for BRT Vehicles* (19) mentions 25% to 50% better fuel economy, these values are high in comparison to improvements in fuel economy experienced by some transit agencies. Aspen RFTA, for example, reported fuel economy improvements for their hybrid buses ranging from 4% to 22% depending on route characteristics and vehicle age, among

Application of a certain propulsion system for BRT vehicles depends on transit agency performance requirements, budget, and past experience with propulsion systems.

Hybrid engines are more expensive than diesel engines but are expected to become more popular as maintenance expertise improves and diesel engine costs increase to comply with new EPA standards.

*Bus Rapid Transit Practitioner's Guide*

other factors. This range is considerably lower than values reported in *Analysis of Fuels and Propulsion System Options for BRT Vehicles* (19).

A disadvantage of hybrid power systems is the higher capital cost in comparison to diesel engines. Hybrid engines on transit vehicles usually cost \$100,000 to \$250,000 more than diesel engines. Also, maintenance may be higher because of vehicle battery pack costs. Hybrid engines, however, are expected to become increasingly economically attractive as maintenance expertise increases and diesel engine costs increase to comply with 2007 and 2010 EPA standards.

*Likely Impacts*

The implementation of the new emissions caps by the EPA will require manufacturers to produce cleaner and more efficient propulsion systems. These requirements will lead to considerably lower particulate matter and NOx emissions.

Exhibit 4-99 and Exhibit 4-100 illustrate the expected improvements in particulate matter and NOx emissions with the new standards. In the year 2030, approximately 155,000 short tons per year of particulate matter would have been produced without the implementation of the new standards, in comparison to the expected 30,000 short tons per year with the new standards. Similarly, NOx emissions would have remained at around 3,000,000 short tons per year by 2030 without the new standards; in comparison, only 400,000 short tons per year are expected to be produced by 2030 with the new standards.

Besides the inherent benefits of lower emissions with more technologically advanced propulsion systems, other impacts of advanced propulsion systems can also be observed. Two examples are noise reduction and lower brake maintenance costs associated with hybrid vehicles.

Hybrid vehicles produce considerably lower noise levels than diesel engine vehicles. Lower noise levels can be an important factor that drives agencies to purchase hybrid vehicles. For example the Aspen RFTA purchased hybrid buses at a cost nearly \$200,000 higher than diesel buses for noise reduction purposes.

Reduced noise and less brake maintenance are associated with hybrid vehicles.

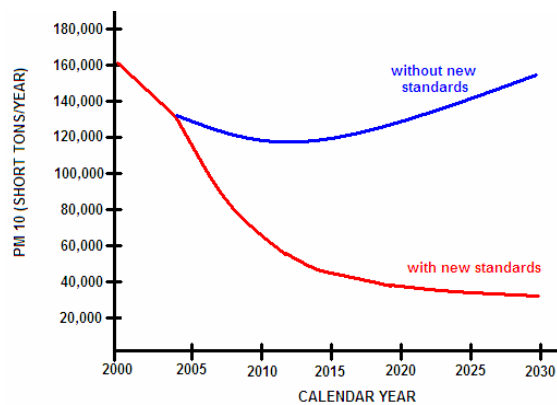

SOURCE: *Analysis of Fuels and Propulsion System Options for BRT Vehicles* (19)

**EXHIBIT 4-99** Projected Vehicle Particulate Matter Emissions

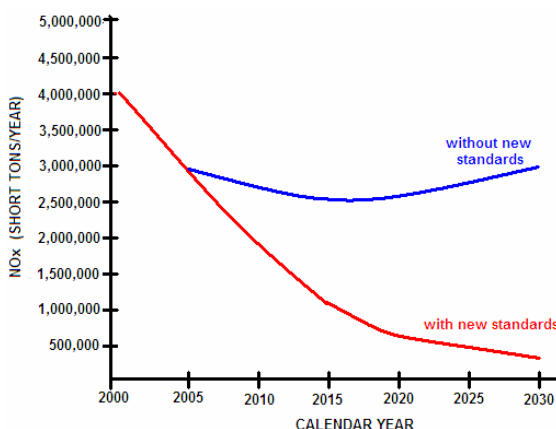

SOURCE: *Analysis of Fuels and Propulsion System Options for BRT Vehicles (19)*

EXHIBIT 4-100 Projected Vehicle Nitrogen Oxides Emissions

*Implementability*

The implementation of different types of propulsion systems must be carefully analyzed during the preliminary engineering stage of a BRT project. Agency requirements and needs, budget, fuel availability, maintenance facility requirements, and experience should play an important role in helping agencies identify the ideal propulsion system. Most manufacturers currently produce vehicles that meet or exceed EPA requirements; nevertheless, agencies should ensure compliance during the procurement process through a specific clause in the procurement contract.

**Automatic Vehicle Location**

AVL technology is used to track the location of vehicles in real time through the use of GPS devices or other location relay methods. Information about the vehicle location is transmitted to a centralized control center in either raw data format or as processed data. Exhibit 4-101 identifies methods used for identifying vehicle positioning. Exhibit 4-102 shows a central monitoring system and AVL display.

AVL can be used in conjunction with other vehicle ITS systems, including automatic passenger counters (APCs). Using AVL with APCs can provide transit agencies with passenger origin-to-destination data. The left side of Exhibit 4-103 shows two overhead APC sensors mounted on York Region Transit's BRT vehicles. The right side of the exhibit shows one of the sensors in detail. CBRT (1) reports that APCs cost \$1,000 to \$10,000 per bus.

AVL tracks the location of BRT vehicles, thus facilitating TSP and automated passenger information.

*Bus Rapid Transit Practitioner's Guide*

**EXHIBIT 4-101 Methods Used To Determine Vehicle Position**

System	Technology Description	Advantages/Disadvantages
Global Positioning Systems (GPS)	The location of the GPS device is determined through an interpolation of satellite signals.	Until 2000 it had an accuracy of only 100 meters due to the intentional degradation applied to the system by the U.S. military. Once this degradation was removed the accuracy improved to between 10 and 20 meters; however, agencies had already adopted DGPS and the increased accuracy has not yet been proven to be sufficient for an AVL system.
Differential GPS (DGPS)	A permanent GPS receiver is placed at a location with known coordinates. The difference between the known coordinates and the GPS measured coordinates is applied as a correction factor to GPS-determined vehicle locations on the system.	This system provides accuracy around 1 meter. The U.S.DOT is deploying a National DGPS (NDGPS), which will eliminate the need to have unique differential stations as was done before this initiative.
Signpost System	Radio beacons are placed on signposts along a bus route; when a bus passes the signpost, the short-range radio reads the location of the bus.	This system was used before GPS although it is still in use by the King County Transit Authority (Seattle). This system cannot read the location of a bus when it strays off its route and would require modification to the radio beacon placements if routes are modified.
Odometer and Compass	This method calculates the location of a vehicle based on odometer and direction readings; it is usually used as an additional aid to any of the methods above to more accurately estimate the vehicle location.	This method is economic but accuracy is limited and therefore is generally used as a supplement to more accurate methods.

SOURCE: *Automatic Vehicle Location: Successful Transit Applications (20)*



SOURCE: Kittelson & Associates, Inc.

**EXHIBIT 4-102 BRT Monitoring System and AVL Display (York, ON)**

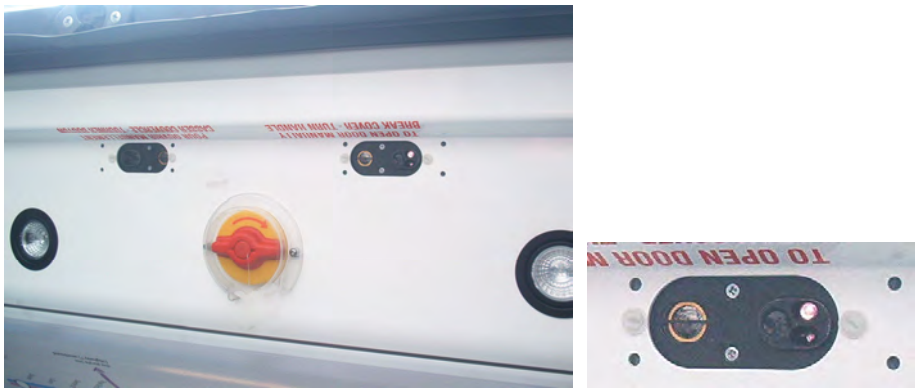

SOURCE: Kittelson & Associates, Inc.

EXHIBIT 4-103 APC Sensors (York, ON, Region)

*Scale of Application*

Based on data provided by FHWA, currently 69% of fixed-route transit vehicles in the 78 largest metropolitan areas use AVL systems. This percentage includes both BRT and non-BRT vehicles. Exhibit 4-104 shows a continuously increasing trend in the application of AVL systems in the United States.

The proportion of transit agencies using AVL systems continues to grow.

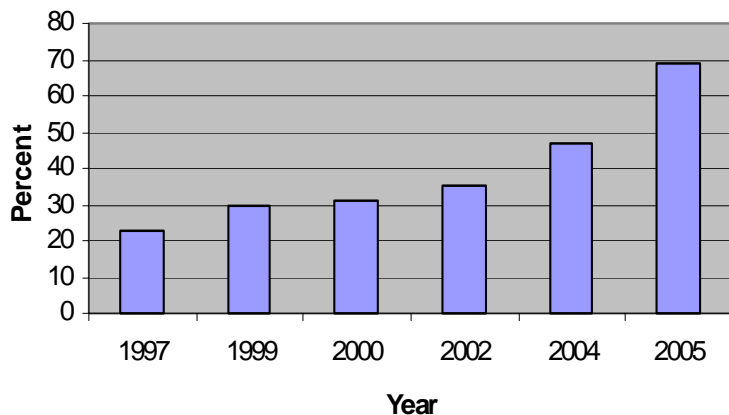

SOURCE: *Tracking the Deployment of the Integrated Metropolitan Intelligent Transportation Systems Infrastructure in the USA (21)*

EXHIBIT 4-104 Percentage of Transit Vehicles Using AVL Systems

*Conditions of Application*

AVL systems are primarily applied to track the location of transit vehicles in a route network, with certain vehicle diagnostic systems and security features incorporated to provide enhanced vehicle monitoring. The result is a quicker response to breakdowns and emergencies on the vehicles. AVL also can be integrated with TSP and real-time passenger information systems.

*Selected Typical Examples*

Agencies that operate BRT or premium bus services and use AVL devices include TriMet (Portland); King County Metro (Seattle); Massachusetts Bay Transportation Authority (Boston); Greater Hartford Transit District (BRT under development); Los Angeles County Metropolitan Transportation Authority; BC



---

## Bus Rapid Transit Practitioner's Guide

Transit (Vancouver); Glendale Beeline (Glendale, CA); Queensland Transport (Brisbane); State Transit Authority of New South Wales (Sydney); and TransMilenio S.A. (Bogotá). TriMet and Glendale Beeline both use GPS for AVL. King County Metro uses the signpost system.

### Estimated Costs

Capital costs of AVL systems, with reported costs per vehicle, are shown in Exhibit 4-105. These values were obtained from *TCRP Synthesis 48 (22)*, which included agencies in the United States, Finland, Italy, the United Kingdom, Ireland, and Taiwan.

### Likely Impacts

Some likely impacts of the application of an AVL system are as follows:

- *Improved system control.* The system in general can be calibrated with greater ease to distribute service times and coverage adequately through the application of TSP.
- *Improved bus safety.* In an emergency, the control center can relay vehicle location immediately to authorities.
- *Improved quality of service.* Passengers can be notified in real time of the location of the next bus and its expected arrival time.
- *Improved system integration.* Vehicle connections can be better scheduled and controlled by knowing the location of each vehicle.
- *Reduced need for voice communication.* This can simplify vehicle operation for the driver.

Some agencies reported specific economic benefits from reductions in bus fleet size, increased ridership, and lower operating costs associated with the AVL system. Cost reductions associated with person-hours saved due to improved schedule adherence through the application of TSP were also reported. Exhibit 4-106 summarizes economic benefits reported by selected agencies.

### Driver Assist and Automation

Automation and driver assist systems include components such as vehicle collision warning systems, precision docking assistance, and vehicle guidance systems. Guidance systems can be used either throughout a bus route or only when the bus approaches a station.

The guidance systems can be physical, optical, or electronic. Physical systems use a guideway that may connect to the bus through guide-wheels or guide-rail, in which case the driver only needs to control acceleration and braking. Optical systems use painted stripes on the road to control lateral distances and guide the bus forward. Electronic control systems can fully automate the control of the bus through differential GPS (DGPS), magnetic markers, or other accurate positioning technology.

Other driver assist systems include TSP, side collision warning systems (SCWS), and frontal/rear collision warning systems. SCWS allows detection of objects during turning or merge movements, providing a warning for the driver to avoid possible collisions.

AVL improves system control, bus safety, quality of service, and system integration.

AVL reduces voice communication.

Driver assist and automation systems include collision warning systems, precision docking assistance, and vehicle guidance systems.

Guidance systems can be physical, optical, or electronic.

**EXHIBIT 4-105 Capital Costs and Reported per Vehicle Costs of AVL Systems**

Agency	Number of Vehicles with AVL	Type of AVL	Total Capital Cost of AVL System	Reported AVL Cost per Vehicle
RTD	1,111	GPS	\$15,000,000	N/A
City Bus	25	GPS	\$150,000	\$3,000
DTC	189	GPS	\$12,000,000	N/A
Fairfax CUE	12	GPS	\$60,000	\$5,000
Glendale Beeline	20	GPS	\$171,000 (includes the capital cost of 2 signs)	\$8,100
LADOT/LACMT A - Metro Rapid	150	Loop inductors	\$2,100,000 (includes cost of TSP system - signal equipment, roadway sensors, etc.)	\$100
San Francisco Muni	827	GPS	\$9,600,000	N/A
TriMet	689	GPS	\$7,000,000	\$4,500
ATC Bologna	450	GPS	\$4,891,400	\$4,891
Taipei	135	GPS	\$270,000	\$2,000
London Buses (U.K.)	5,700	Signpost	\$23,251,500-\$27,901,800	\$3,100-\$4,650
YTV	340	DGPS and signpost	\$1,400,000	\$3,000
Centro	6	GPS	\$705,300	N/A
King County Metro	1,300	Signpost	\$15,000,000	\$7,000
Dublin Bus (Ireland)	156	GPS	\$660,300	\$2,919
Kent County Council	141	DGPS	\$2,000,000	\$5,000

SOURCE: *TCRP Synthesis 48 (22)*

**EXHIBIT 4-106 Economic Benefits of AVL Systems**

Agency	Location	Reported Benefits
MARTA	Atlanta, GA	\$1.5 million annual savings in operating costs
London Transit	London, ON	\$40,000 to \$50,000 savings on each schedule adherence survey
KCATA	Kansas City, MO	\$189,000 maintenance and \$215,000 labor savings by reducing fleet size
MTA	Baltimore, MD	\$2 to \$3 million per year savings on reduced fleet size
PRTC	Prince William County, VA	\$870,000 annual savings
TriMet	Portland, OR	\$1.9 million annual savings in operating costs. Increase of 450 in ridership on a specific route (Fall 1999 to Fall 2000).
RTD	Denver, CO	5.1% increase in ridership (1995 to 1996) and 33% reduction in passenger assaults (AVL in combination with silent alarms)
MCTS	Milwaukee, WI	4.8% increase in revenue ridership (1993 to 1997)
TTC	Toronto, ON	Estimated 0.5% to 1.0% increase in ridership

SOURCE: *TCRP Report 90 (2)*

*Scale of Application*

Driver assist and automation systems can be applied individually or collectively on a new BRT vehicle, and the extent of systems incorporated can substantially increase the cost of a new vehicle. Collision warning systems are still somewhat in the experimental stage and have had only limited application to date.

---

## Bus Rapid Transit Practitioner's Guide

### Conditions of Application

The ADA encourages the construction of new facilities with improved access to vehicles and reasonable retrofits of existing facilities. Automated docking systems provide this access because, generally, these are constructed to offer passengers level boarding with a very small gap between the curb and the vehicle.

Automated guidance and collision warning systems are particularly attractive where BRT operates along a lane of restricted width and/or in congested traffic conditions.

### Selected Typical Examples

Some current examples of driver assist and automation include the North Las Vegas MAX service's original use of precision docking for its vehicles and the use of collision warning in Phoenix and Pittsburgh. Los Angeles Metro Rapid also implemented loop detectors that specifically identify buses approaching the intersection in order to apply TSP.

The North Las Vegas MAX service has CIVIS buses equipped with optical guidance technology. This technology consists of a vertical camera mounted on the front top part of the bus that points directly down to stripes painted on the pavement (as shown in Exhibit 4-107). A computer analyzes the image, and information is sent to electronic lateral controls in real time to correct the direction of the vehicle. According to FTA, the lateral guidance system can keep the bus within 1.9 inches of the desired path at 50 mph.

The guidance system for the BRT line in Las Vegas has been discontinued because the high-temperature climate prevents the guide stripes from reliably adhering to the pavement.



SOURCE: Kittelson & Associates, Inc.

**EXHIBIT 4-107** Precision Docking (Las Vegas)

The Pennsylvania Department of Transportation deployed SCWS in 100 transit buses operated by the Port Authority of Allegheny County (PAT), and feedback was obtained from drivers to determine the efficiency of the SCWS in helping drivers identify vehicles in blind spots and avoid collisions. Based on the feedback from drivers, a redevelopment of the SCWS was planned.

### Estimated Costs

Exhibit 4-108 presents illustrative costs for driver assist systems.

**EXHIBIT 4-108 Driver Assist System Costs**

Driver Assist and Automation System	Cost
Loop detectors	\$13,500/intersection
Magnetic tape (3M)	\$5,000-\$1,000/vehicle
Curb-guided, rail-guided, grid-based	\$3 to \$15.5 million per lane-mile
Vision and magnetic plug/tape-based	\$20,000 per lane-mile
DGPS	\$250 per lane-mile (cost for building digital map)

SOURCE: CBRT (1) and *Bus Rapid Transit Lane Assist Technology Systems* (23)

*Likely Impacts*

Precision docking can have a considerable impact on dwell time since vehicles stop at the same location every time, allowing passengers to board in a more organized manner through a well-marked path to the vehicle. Automated guidance and collision warning systems, if working properly, will provide for safer bus operations.

**SERVICE AND SYSTEM COMPONENTS**

**Service Plans**

BRT service plans (in terms of route structure, service span and frequency, and station spacing) complement BRT physical features in developing the overall BRT system. The underlying goals are to provide rapid and reliable service, ensure passenger safety and security, and provide a pleasant, comfortable, and convenient ride. This profile gives guidelines for developing and assessing service features. Fare collection practices—which are also associated with service plans, stations, and vehicles—are discussed in a later profile.

*Scale of Application*

The BRT service plan may cover a single route, a series of routes, or the entire BRT system. It may be provided in stages that are compatible with related infrastructure development.

BRT service plans may cover a single route or several routes, or an entire BRT system may be coordinated with local bus service.

*Types, Features, and Examples*

Service types (spans and frequencies) for various running ways and examples of each are shown in Exhibit 4-109, Exhibit 4-110, and Exhibit 4-111. Observations based on these tables are as follows:

- Along arterial streets, a single BRT route can be provided (e.g., the Silver Line in Boston). Usually, this service is “overlaid” on the existing local service (as in the case of Ventura Boulevard Metro Rapid in Los Angeles).
- Along busways (and freeways), a single service can be operated (e.g., along the Orange Line busway in Los Angeles). More common is the provision of a basic “all-stop” BRT that is complemented by daytime or peak-hour service (as in Miami, Ottawa, and Pittsburgh).
- A commuter-type service can operate in freeway bus and high-occupancy vehicle (HOV) lanes during peak hours (as in Houston). Strictly speaking, however, this is more of an express bus operation than a BRT service.
- BRT routes usually run all day (i.e., about 6 a.m. to midnight). Where BRT service complements local service, a 12-hour span may be appropriate.

## Bus Rapid Transit Practitioner's Guide

BRT typically runs at 10-minute headways or better during peak hours, with all-day service.

- Service frequency is tailored to market demands. Most existing systems have headways of 10 minutes or less during peak hours.
- Station spacing along arterial streets ranges from about 0.25 mile to 1.2 miles, with most systems exceeding 0.5 mile for spacing. (See Exhibit 4-111.) Station spacing along busways ranges from 0.6 mile in Miami to about 1.1 miles in Pittsburgh. The average station spacing is about 1.0 mile along Brisbane's South East Busway, 1.3 miles along Ottawa's Transitway system, and 0.8 mile along Vancouver's Granville Street 98B Line.

EXHIBIT 4-109 BRT Service Types

Principal Running Way Type	Service Pattern	Service Span			Example
		Weekdays	Saturday	Sunday	
<i>Arterial Streets</i>					
Mixed traffic	All-stop	All day	All day	All day	Los Angeles, Oakland
Bus lanes	Connecting bus routes	All day	All day	All day	
Median busways (no passing)					Richmond, BC (B Line); Curitiba
<i>Freeways</i>					
Mixed traffic	Non-stop with local distribution	All day	All day	—	Phoenix
Bus/HOV lanes	Commuter express	Rush hours	—	—	
<i>Busways</i>					
N/A	All-stop	All day	All day	All day	Los Angeles (Orange Line), Pittsburgh, Ottawa, Miami
N/A	Express	Daytime or rush hours	—	—	
N/A	Feeder service	Daytime, all day, or rush hours	Daytime	Daytime	Ottawa
N/A	Connecting bus routes	All day	All day	All day	Ottawa

NOTE: All day is typically 18 to 24 hours. Daytime is typically 7 a.m. to 7 p.m. Rush hours are typically 6:30 a.m. to 9 a.m. and 4 p.m. to 6 p.m.

SOURCE: TCRP Report 90 (2)

**EXHIBIT 4-110 Examples of BRT Service Patterns**

BRT Service	Service Pattern
Arterial Streets Boston - Silver Line Cleveland - Euclid Ave (under construction) Curitiba - various routes Los Angeles - Wilshire and Ventura Blvds New York City - proposed BRT routes Vancouver, BC - 98-B and 99-B Lines	BRT only BRT only BRT only BRT overlaid on local service BRT overlaid on local service BRT overlaid on local service
Busways Boston - Silver Line Los Angeles - Orange Line Miami - South Miami Dade Busway Ottawa - Transitway system  Pittsburgh - Busway system	3 basic BRT routes All-stop BRT route All-stop BRT route + peak-period express routes 2 basic all-stop BRT routes + many peak-period express routes Basic all-stop routes + peak-period express routes

SOURCE: TCRP A-23A research

**EXHIBIT 4-111 Experience with BRT Service Plans**

Service Plan Characteristic	Miami	Oakland	Orlando	Pittsburgh	Phoenix
	South Dade Busway	San Pablo Rapid	Lymmo	Busways	Rapid
Route Structure	Integrated network of routes	BRT route overlay onto local route	BRT route replaced local downtown circulator	Integrated network of routes	Express routes
Number of Routes Operating in Network	6	1	1	3	4
Number of All-Stop Routes	2	1	1	3	—
Number of Express Routes	4	—	—	—	4
Span of Service	All day	All day	All day	All day	Weekday peak hour only
Frequency of Service (headway during peak hour)	10 minutes	12 minutes	5 minutes	1 minute	10 minutes
Station Spacing (average)	0.57 mile	0.56 mile	900 feet	0.57 to 1.14 miles	0.25 mile

SOURCE: CBRT (7)

*Conditions of Application*

General guidelines for developing BRT service plans should reflect city structure, types of running ways, potential markets, and available resources. General guidelines include the following:

- BRT routes should serve corridors and areas with high employment and passenger concentrations.
- Routes generally should be radial, with the CBD, a major activity center, or a rail transit terminal serving as the anchor. However, in very large cities such as Chicago, Los Angeles, and New York, BRT may be appropriate in heavily traveled cross-town corridors.

---

*Bus Rapid Transit Practitioner's Guide*

- Routes should be direct, and the number of bus turns should be kept to a minimum.
- BRT routes should operate on partially or fully dedicated right-of-way wherever possible. When buses run in mixed traffic, they should use roadways that are relatively free-flowing.
- BRT service should be clear, easy to understand, direct, and operationally efficient. Clarity of service is essential in reinforcing BRT identity.
- Generally, a few high-frequency BRT routes is better than many routes operating on a long headway.
- A single, non-branching BRT route can enhance BRT identity and permit short headways. However, in some cases, branches may be desirable at the outer ends of the route. In general, there should not be more than two basic BRT services per route.
- BRT routes should provide convenient transfers to intersecting bus routes and rail transit lines.
- BRT routes on city streets should have a single stopping pattern. BRT routes on busways should include a basic all-day "all-stop" service that may be complemented by peak-period express (or limited-stop) service.
- The basic BRT service should operate at 5- to 10-minute intervals (or less) during peak hours, at maximum intervals of 8 to 12 minutes midday, and 12 to 15 minutes at other times. Express and feeder services can run at somewhat longer intervals. (See Exhibit 4-112.)
- BRT routes should operate at less than 80% of their facilities' capacities to avoid bus-bus congestion. (See Exhibit 4-113.)
- BRT stations should be placed as far apart as possible to improve operating speeds. The actual spacing will depend upon the type of running way, the type of surrounding development, development density and form, passenger modes of arrival, and arterial street spacing.
- Stations in the CBD and other places where passengers mainly arrive as pedestrians should be spaced 0.25 to 0.33 mile apart.
- Stations where passengers mainly arrive by bus should be spaced about 0.5 to 1 mile apart.
- Stations where passengers mainly arrive by automobile should be spaced 1 to 2 miles apart.
- Bus lanes and busways may be used by all transit operators in a region where vehicles meet established safety requirements.
- Emergency vehicles such as police cars, fire trucks, and ambulances should be allowed to use busways and bus lanes.
- BRT may share reserved freeway lanes with HOVs when joint use does not reduce BRT travel times, service reliability, or identity.

EXHIBIT 4-112 Typical BRT Service Frequencies

Service Type <sup>1</sup>	Frequency (minutes) <sup>1</sup>			
	Peak Hours	Midday	Evening	Saturday-Sunday
All-stop (base service)	5-10	8-12	12-15	12-15
Express	8-12	10-15 <sup>2</sup>	—	—
Feeder	5-15 <sup>2</sup>	10-20	10-30	10-30
Commuter express	10-20	—	—	—
Connecting bus routes	5-15	5-20	10-30	10-30

<sup>1</sup> Per route

<sup>2</sup> When operated

SOURCE: Adapted from *TCRP Report 90 (2)*

EXHIBIT 4-113 Estimated Speed Reduction Factors Resulting from Bus-Bus Interference

Bus Berth Volume to Capacity Ratio	Index (Speed Reduction Factor)
<0.5	1.00
0.5	0.97
0.6	0.94
0.7	0.89
0.8	0.81
0.9	0.69
1.0	0.53
1.1	0.35

SOURCE: *TCRP Report 26 (5)*

*Estimated Costs*

Costs of BRT service plans include both capital and operating costs.

*Capital Costs*

BRT service plans have important impacts on fleet requirements that, in turn, influence vehicle acquisition costs. The buses needed for a given BRT route can be estimated by dividing the round trip travel plus layover times by the peak headway (in minutes). The relationships are as follows:

$$N = \frac{(2L) \times 60}{Vh} + T_L \tag{4-2}$$

- where:
- N = number of buses required
  - L = one-way route length (miles)
  - V = operating speed (mph)
  - T<sub>L</sub> = layover time (minutes)
  - h = headway (minutes)

The number of BRT vehicles needed in a fleet depends on round-trip BRT travel time, layover time, peak BRT headway, and number of spare vehicles required.



*Bus Rapid Transit Practitioner's Guide*

Assuming that the layover/schedule recovery time equals 10% of the total round-trip running time, the previous relationship becomes the following:

$$N = \frac{(2.2L) \times 60}{Vh} = \frac{132L}{Vh} \tag{4-3}$$

The results of this computation are given in Exhibit 4-114 for a 20-mile round-trip route length with headways of 5, 10, and 15 minutes. It is desirable to add several spare vehicles to the numbers obtained.

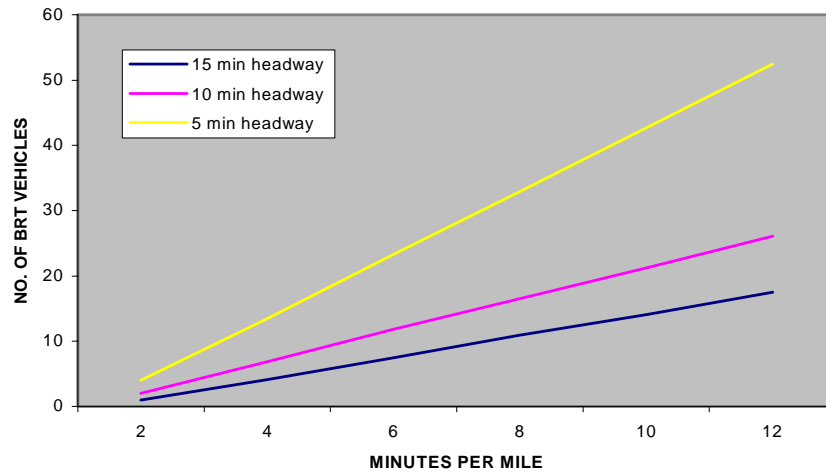

NOTE 1: 20-mile round-trip length

NOTE 2: Assumes round-trip times are increased 10% to account for bus layover

**EXHIBIT 4-114 Effect of Bus Travel Times on Vehicle Requirements**

This relationship is useful in assessing the effects of (1) improving bus speeds along an existing route and simultaneously reducing the headway of an existing route and (2) developing a new route. Exhibit 4-115 gives illustrative computations for each.

*Operating and Maintenance Costs*

Estimates of O&M costs are needed for (1) a new BRT route or system and (2) changes in existing system costs resulting from BRT operations. For example, if a BRT route replaces an existing limited-stop bus route, both the BRT route costs and the cost savings resulting from eliminating the limited-stop service should be computed. Another example is where local bus routes are restructured to feed a BRT station rather than operate parallel to it.

O&M costs depend upon the extent and type of BRT service provided. Cost estimates should recognize the unique service aspects of BRT. The unique service aspects include the following:

- BRT typically has a lower peak-to-base ratio than local bus service. This lower ration results in greater driver productivity and less “dead” mileage to and from bus garages.
- BRT service is faster than local service. Fewer stops and starts can save fuel and reduce maintenance costs per mile of travel.
- BRT systems may have increased O&M costs for running ways (e.g., busways), stations, off-vehicle fare collection, and ITS.

BRT O&M costs depend on the extent and type of service provided.

The faster scheduled speed offered by BRT reduces operating costs.

- BRT operating costs are sensitive to “driver” wage rates and benefits and operating speeds. Therefore, they must reflect local conditions and must be developed specifically for each BRT system.
- Annual O&M costs are generally computed from a three-factor cost model that is based on local transit operating experience. This model is as follows:

$$\text{Annual Costs} = A (\text{Bus Miles}) + B (\text{Bus Hours}) + C (\text{Peak Vehicles}) \quad (4-4)$$

**EXHIBIT 4-115 Examples of BRT Fleet Requirements**

**Example 1 - Improving Speed of Existing Route**

10-mile route length each way  
10% added to round-trip running time for layover/recovery times each way

Measure	Before BRT	After BRT
Speed (mph)	12.0	15.0
Speed (minutes/mile)	5.0	4.0
Headway (minutes)	10.0	10.0
Buses required	$N = \frac{(2.2)(10)(60)}{(12)(10)} = 11$	$N = \frac{(2.2)(10)(60)}{(15)(10)} = 9$
<i>Buses saved = 2</i>		

**Example 2 - Improving Speed and Reducing Headways**

10-mile route length each way  
10% added to round-trip running time for layover/recovery times each way

Measure	Before BRT	After BRT
Speed (mph)	12.0	15.0
Speed (minutes/mile)	5.0	4.0
Headway (minutes)	10.0	8.0
Buses required	$N = \frac{(2.2)(10)(60)}{(12)(10)} = 11$	$N = \frac{(2.2)(10)(60)}{(15)(8)} = 11$
<i>Buses saved = 0</i>		

**Example 3 - New BRT Route Added to Existing System**

10-mile route length each way  
10% added to round-trip running time for layover/recovery times each way

Measure	Before BRT	After BRT
Speed (mph)	—	16.0
Speed (minutes/mile)	—	3.75
Headway (minutes)	—	6.0
Buses required	—	$N = \frac{(2.2)(10)(60)}{(16)(6)} = 14$
<i>Buses saved = N/A</i>		

NOTE: About 10-15% spares would be required in both cases.

SOURCE: TCRP A-23A project team

---

*Bus Rapid Transit Practitioner's Guide*

BRT O&M costs should also include (1) costs per station for station maintenance including passenger information systems, (2) costs per lane-mile for busway maintenance, and (3) costs for maintaining ITS systems (e.g., TSP). Including these cost items leads to the following (approximate) cost allocation model for BRT service:

$$\text{O\&M Cost} = A (\text{Bus Miles}) + B (\text{Bus Hours}) + C (\text{ITS Peak Vehicles}) + D (\text{Number of Stations}) + E (\text{Miles of Running Way to be Maintained}) + F (\text{ITS Operating Costs}) \quad (4-5)$$

Exhibit 4-116 gives the resulting cost allocation framework for establishing the appropriate unit cost coefficients (factors). The non-vehicle maintenance costs associated with running ways and stations are listed separately and are related to the specific number of units involved. O&M costs for ITS facilities are estimated separately for each facility.

The preferred approach (also required for FTA Alternatives Analysis) involves detailed "resource build up" computations for each operating cost component. The actual pay-hours (as well as revenue bus hours) would be estimated for a given BRT route based upon service frequencies, running times, layover requirements, and prevailing wage rates and benefits. Bus maintenance, fuel consumption, supplies, and insurance costs would be keyed to bus miles—taking bus stopping cycles into account in estimating fuel costs.

Station maintenance costs would be estimated on a per-station basis. Running way maintenance costs would be estimated as needed, on a per-mile basis. ITS costs would be estimated separately. Other non-vehicle maintenance costs and general administrative costs would be based on the actual time and materials involved.

In both approaches, when dealing with operating costs, it may be possible to eliminate general administration costs, which are about 15% to 20% of the total. (See Exhibit 4-117 and Exhibit 4-118). Precise allocation of non-vehicle maintenance costs in the build-up approach may not be necessary since these costs typically account for less than 5% of the total.

Operating cost comparisons conducted for the Port Authority of Allegheny County in Pittsburgh indicate that BRT can cost less per passenger trip to operate than LRT for the demand and operating conditions found in most U.S. cities. Operating costs for Pittsburgh's East and South Busways (from 1989) averaged \$0.52 per passenger trip. According to *TCRP Report 90 (2)*, costs per trip for light rail lines in Buffalo, Pittsburgh, Portland, Sacramento, and San Diego averaged \$1.31; the range was from \$0.97 (San Diego) to \$1.68 (Sacramento).

**EXHIBIT 4-116 Example of Fully Allocated Approach for BRT Expense Items**

Function and Expense Object Class <sup>1</sup>	Vehicle Hours	Vehicle Kilo-meters	Peak Vehicles	Lane-Miles of Special Running Ways	Number of Stations	ITS <sup>2</sup>
<i>501 Labor</i>						
010 Vehicle operations	X					
041 Vehicle maintenance		X				
042 Non-vehicle maintenance			X			
Running ways				X		
Stations					X	
ITS						X
160 General administration			X			
<i>502 Fringe benefits</i>						
010 Vehicle operations	X					
041 Vehicle maintenance		X				
042 Non-vehicle maintenance			X			
Running ways				X		
Stations					X	
ITS						X
160 General administration			X			
<i>503 Services</i>			X			
<i>504 Materials and supplies</i>						
010 Vehicle operations		X				
041 Vehicle maintenance		X				
042 Non-vehicle maintenance		X				
Running ways				X		
Stations					X	
ITS						X
160 General administration			X			
<i>505 Utilities</i>			X			
<i>506 Casualty and liability costs</i>		X				
<i>507 Taxes</i>						
010 Vehicle operations	X					
041 Vehicle maintenance		X				
042 Non-vehicle maintenance			X			
Running ways				X		
Stations					X	
ITS						X
160 General administration			X			
<i>508 Purchased transportation</i>		X				
<i>509 Miscellaneous expenses</i>			X			
<i>510 Expense transfers</i>			X			
<i>511-516 Total reconciling items</i>			X			

<sup>1</sup> Adapted from FTA Section 15 Reporting System, Level R

<sup>2</sup> Specifically computed

*Bus Rapid Transit Practitioner's Guide*

**EXHIBIT 4-117 Operating Expenses for Bus Transit (2001)**

Item	Percentage
Vehicle Operations	50.5
Purchased Transportation	10
Vehicle Maintenance	19.6
Non-Vehicle Maintenance	4.1
General Administration	15.7
Total	100%

NOTE: The total is \$13,335,332,000.

SOURCE: *Public Transportation Handbook* (24)

**EXHIBIT 4-118 Example Allocation Of Direct And Indirect Costs - Bronx New York (1975)**

Item	Percentage Distribution		
	Pay Hours	Bus Miles	Total
Direct Operating Costs	43.2	13.8	57.0
Direct Overhead	10.7	8.4	19.1
Subtotal	53.9	22.2	76.1
Indirect Overhead	8.5	15.4	23.9
Total	62.4	37.6	100.0

SOURCE: *How to Allocate Bus Route Costs* (25)

*Likely Impacts*

The generalized effects of BRT route length, route structure, service span and frequency, station spacing, and method of headway control are set forth in Exhibit 4-119. More detailed discussion and guidelines for assessing travel time savings and ridership increases follow.

*Travel Time Savings*

BRT travel times depend upon (1) the type of running way, (2) the number of stops made, and (3) the dwell time at each stop. Along arterial streets, delays at traffic signals also affect running times.

BRT operation on arterial streets has been shown to save up to 2 minutes per mile as a result of wider station spacing. For example, New York City's limited-stop buses with stations placed at approximate 0.5-mile intervals save 0.9 minutes per mile overall. Savings are greatest in Manhattan (almost 2 minutes per mile) and least in Staten Island (0.5 minute per mile).

The combined effects of stop spacing (stops *made* per mile) and dwell times for BRT service on freeways and off-street busways are shown in Exhibit 4-120 for a 50-mph top operating speed. This table can be used as a guide in estimating BRT performance. A top speed of 55 mph would result in an approximate 4-mph increase in the speeds shown. For additional information, see *Transit Capacity and Quality of Service Manual* (9).

BRT travel times depend on type of running way, number of stops, and dwell times.

**EXHIBIT 4-119 Summary of Effects of BRT Service Plan Elements on System Performance and Benefits**

Service Plan Element	System Performance					System Benefits
	Travel Time Savings	Reliability	Identity and Image	Safety and Security	Capacity	
<i>Route length</i>		Shorter route lengths may promote greater control of reliability.				Service plans are customer-responsive, attract ridership, and maximize system benefits.
<i>Route structure:</i> <ul style="list-style-type: none"> <li>▪ <i>Single route</i></li> <li>▪ <i>Overlapping route with skip-stop or express variations</i></li> <li>▪ <i>Integrated or network system</i></li> </ul>	Integrated route structures reduce the need for transfers.		Distinctions between BRT and other service may better define brand identity. Integrated route structures may widen exposure to the brand.			
<i>Span of service:</i> <ul style="list-style-type: none"> <li>▪ <i>Peak hour only</i></li> <li>▪ <i>All day</i></li> </ul>		Wide spans of service suggest the service is dependable.				
<i>Frequency of service</i>	More frequent service reduces waiting time.	High frequencies limit the impact of service interruptions.		High frequencies increase potential conflicts with other vehicles and pedestrians. High frequencies reduce security vulnerability at stations.	Operating capacity increases with frequency.	
<i>Station spacing:</i> <ul style="list-style-type: none"> <li>▪ <i>Narrow station spacing</i></li> <li>▪ <i>Wide station spacing</i></li> </ul>	Less frequent station spacing reduces travel time.	Less frequent station spacing limits variation in dwell times.				
<i>Method of schedule control:</i> <ul style="list-style-type: none"> <li>▪ <i>Schedule-based control</i></li> <li>▪ <i>Headway-based control</i></li> </ul>	Headway-based control for high frequency operations maximizes speeds.					

SOURCE: CBRT (7)

*Bus Rapid Transit Practitioner's Guide*

Exhibit 4-120, Part A, shows how bus travel times relate to arterial street bus speeds and station dwell times. Exhibit 4-120, Part B, gives generalized values for estimating the effects of street-traffic delays for various operating environments.

**EXHIBIT 4-120 Peak-Hour Bus Travel Time Rates for Various Stop Spacings, Dwell Times, and Operating Environments**

<b>A. Base Travel Time Rates (minutes per mile)</b>									
<i>Average Dwell Time Per Stop (sec)</i>	<i>Stops Made Per Mile</i>								
	<i>2</i>	<i>4</i>	<i>5</i>	<i>6</i>	<i>7</i>	<i>8</i>	<i>9</i>	<i>10</i>	<i>12</i>
10	2.40	3.27	3.77	4.3	4.88	5.53	6.23	7.00	8.75
20	2.73	3.93	4.60	5.3	6.04	6.87	7.73	8.67	10.75
30	3.07	4.60	5.43	6.3	7.20	6.20	9.21	10.33	12.75
40	3.40	5.27	6.26	7.3	8.35	9.53	10.71	12.00	14.75
50	3.74	5.92	7.08	8.3	9.52	10.88	12.21	13.67	16.75
60	4.07	6.58	7.90	9.3	10.67	12.21	13.70	15.33	18.75

<b>B. Additional Travel Time Losses (minutes per mile)</b>				
<i>CENTRAL BUSINESS DISTRICT</i>				
<i>Signal Operation</i>	<i>Bus Lane with No Right Turns</i>	<i>Bus Lane with Right Turn Delay</i>	<i>Bus Lanes Blocked by Traffic</i>	<i>Mixed Traffic Flow</i>
Typical	1.2	2	2.5-3.0	3
Signal Set for Buses	0.6	1.4	N/A	N/A
Signals More Frequent Than Bus Stops	1.7-2.2	2.5-3.0	3.0-4.0	3.5-4.0

<i>ARTERIAL ROADS OUTSIDE OF CBD</i>		
<i>Signal Operation</i>	<i>Bus Lane</i>	<i>Mixed Traffic</i>
Typical	0.7	1.2
Range	0.5-1.0	0.8-1.6

NOTE: Add values from Part A and Part B to obtain suggested estimate of total bus travel time. Convert total travel time rate to estimated average speed by dividing into 60 to obtain miles per hour. Interpolation between shown values of dwell time is achieved on a straight-line basis.

SOURCE: *TCRP Report 90 (2)* and *TCRP Report 26 (5)*

Exhibit 4-121 gives an illustrative example of how bus speeds vary as a function of stop spacing and various levels of traffic delays; it assumes 20- and 30-second dwell times.

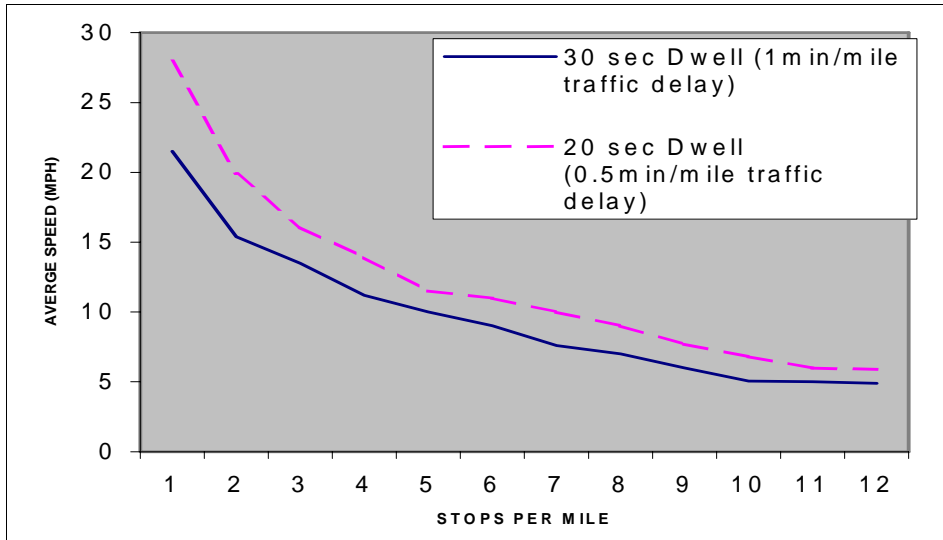

SOURCE: TCRP Research Results Digest 38 (26)  
**EXHIBIT 4-121 Relationship Between Arterial Street Bus Speeds, Stop Frequency, and Dwell Times**

Travel time savings can be estimated in three ways:

1. *Comparing BRT speeds on busways with local service.* Obtain anticipated BRT speeds from Exhibit 4-120 and compare them with existing bus speeds in the corridor during rush and non-rush periods. (Speeds are essentially the inverse of delay rates).
2. *Comparing BRT speeds on arterial streets with existing local bus speeds, when existing speeds are known.*
  - a. Obtain existing delay rates (speed) for each time period to be analyzed.
  - b. Use Part A of Exhibit 4-120 to estimate the minutes per mile (delay rates) for both existing local services and proposed BRT services.
  - c. Adjust results as follows:

$$D_A = \frac{D_B \times A}{B} \tag{4-6}$$

where:  $B$  = minutes/mile from Exhibit 4-120, Part A, before BRT  
 $A$  = minutes/mile from Exhibit 4-120, Part A, after BRT  
 $D_B$  = observed delay rate (inverse of bus speeds) before BRT  
 $D_A$  = adjusted delay rate after BRT  
 Savings =  $D_B - D_A$

See Example 1 in Exhibit 4-122.

3. *Comparing BRT speeds on arterial streets when existing bus speeds are not known.*
  - a. Estimate delay rates for both existing and future conditions from Exhibit 4-120, Part A.
  - b. Add about 1.0 to 1.2 minutes per mile for arterial traffic congestion for existing and proposed conditions (Exhibit 4-120, Part B). If the after-

There are multiple ways to estimate BRT travel time savings.



*Bus Rapid Transit Practitioner's Guide*

BRT condition includes a bus lane, add 0.5 to 1.0 minute per mile. (See Example 2 in Exhibit 4-122.)

Illustrative calculations are given in Exhibit 4-122.

<b>EXHIBIT 4-122 Examples - Estimating Arterial Speed Changes</b>		
<b>Example 1 - Observed Bus Speeds 7.5 mph (8 min/mile)</b>		
	Existing Conditions	BRT Conditions
Stops/Mile	8	2
Dwell/Stop	20 seconds	30 seconds
Min/Mile	6.87 (8.7 mph)	3.07 (19.5 mph)
Adjustment to Reflect Observed Travel Times	$3.07 \times \frac{8.00}{6.87} = 3.57 \text{ min/mi} = 16.8 \text{ mph}$	
<b>Example 2 - BRT On City Streets, Existing Bus Speeds Not Known</b>		
<i>Exhibit 4-120, Part A</i>		
	Existing Conditions	BRT Conditions
Stops/Mile	8	2
Dwell/Stop	20 seconds	30 seconds
Min/Mile	6.87	3.07
<i>Exhibit 4-120, Part B</i>		
Additional Time Loss	1.00 min/mile	1.00 min/mile
Total Time (Min/Mile)	7.87	4.07
Speed	7.6 mph	14.7 mph

SOURCE: Computed

*Ridership Impacts*

The presence of all-day, short-headway BRT service with a simple route pattern can further enhance ridership. Collectively, these features would compose about 12% of a 10-minute travel time bias constant (1.2 minutes) and about 12% of a 25% ridership surcharge beyond that computed by travel time and service elasticities alone (about 3%). Estimated percentage contributions of various service features are as follows:

- All-day service: 4%
- High-frequency service: 4%
- Clear, simple route structure: 4%

*Land Development Effects*

BRT facilities in Boston, Brisbane, Ottawa, and Pittsburgh have produced important land development benefits. These are discussed in detail under "Busways" and in Chapter 6.

*Implementability*

BRT service plans are straightforward and easy to implement once needed rights-of-way are obtained. The service can be readily expanded as ridership demands grow and/or running ways are extended. The main constraint to overcome is possible community reluctance to provide wide station spacing. As

BRT service plans impact ridership.

Communities may be reluctant to implement wider station spacing for BRT.

with other transit service improvements, resources should be available to provide the improved service.

When a BRT route runs on a new right-of-way, changes in existing bus routes may be needed. These changes should take place when the BRT service commences or shortly thereafter.

When the BRT operates on a rebuilt street or roadway, the existing bus service should be maintained throughout the construction period.

### *Implications*

The BRT service plan brings together the many diverse yet related BRT elements. It should be viewed as an integral part of an overall BRT system—not just another route. From an operations management perspective, it should be treated similar to rail transit lines. BRT vehicles should endeavor to maintain uniform headways, the service should be rapid and simple, and the complexities inherent in many local bus services should be avoided.

### **Fare Collection**

Fare payment has a large influence on dwell time and speed of service. Fares may be collected in a number of ways, either on or off the vehicle at each transit station. Some commonly used on-board methods for fare collection include exact change payments, use of proof-of-purchase tickets, and pass scanners. Off-board payment methods include payment booths located at each station, ticket vending machines (as shown in Exhibit 4-123), and prepayment boarding areas. The use of more advanced payment methods such as electronic smart cards increases boarding speed and can contribute to a considerable decrease in dwell time.

Fare payment may be divided into three design attributes: fare collection process, fare media, and fare structure (1). The fare collection process refers to the use of different devices to validate payment; these can be on-board or off-board the vehicle depending on the BRT design. Fare media are the type of payments that are accepted, such as passes, cash, prepaid tickets, or smart cards. Types of fare media are shown in Exhibit 4-124. Fare structure refers to the systemwide structure for fare collection, such as using one payment valid for the entire trip, charging by distance traveled, or providing free transfers.

### *Scale of Application*

Fare collection equipment is provided on vehicles and/or at stations depending upon agency policy, station passenger boardings, and station design.

The most common BRT fare payment methods in the United States are (1) pay on boarding, (2) proof of payment, and (3) barrier system. Most U.S. systems have implemented some electronic fare payment method, usually on board buses, to allow easier payment and faster boarding.

Smart cards are being implemented in Chicago and Washington, D.C. With contactless smart cards, each rider needs only to wave the card in front of the reader, which can result in considerable time savings. In the Los Angeles BRT system, payment is through a combination of proof of payment and smart cards.

BRT systems can utilize on- or off-board fare collection.

*Bus Rapid Transit Practitioner's Guide*



SOURCE: Regional Transportation Commission of Southern Nevada

**EXHIBIT 4-123 BRT Ticket Vending Machine (Las Vegas)**



SOURCE: Chicago Transit Authority

**EXHIBIT 4-124 Smart Card and Single-Ride Fare Card**

The fare media and fare structure selected for a BRT system depend on BRT service structure and agency policies.

*Conditions of Application*

Fare payment methods for planned BRT systems should be analyzed based on the three design attributes: fare collection process, fare media, and fare structure. Each has implications that are specific to each BRT system and community. In areas of low passenger boarding, buses using electronic validation machines can collect fares. With high passenger volumes, additional investment in automated fare collection may be justified. The second and third design attributes should be selected through an evaluation of the BRT system structure and agency policies (e.g., if fares will be flat, variable by distance, or variable by zone, or if employee or frequent rider benefits will be implemented). The transit agency should also consider whether media would be multiuse (e.g., for toll payments) or be usable by other agencies for the purpose of integrating a regional transit system.

*Selected Typical Examples*

Fare collection practices for U.S. BRT systems are shown in Exhibit 4-125. Most systems use a pay-on-board system. Las Vegas MAX uses a proof-of-payment system. Boston's Silver Line bus tunnel uses barrier stations, as shown in Exhibit 4-126. (Barrier stations, which can include turnstiles or fare gates, are also used in Curitiba's BRT and Bogotá's TransMilenio systems.) AC Transit, which uses a pay-on-board system on its San Pablo Avenue BRT, is planning on an ultimate BRT system that will use automated passenger counting technology; cash, card, and pass fare media; and a flat fare system.

Most BRT systems in the U.S. currently use a pay-on-board system.

**EXHIBIT 4-125 Fare Collection Examples for BRT Systems**

System \ Item	Boston Silver Line	Chicago Express	Honolulu City Express	North Las Vegas MAX	L.A. Metro Rapid	South Miami-Dade Busway	Oakland San Pablo Rapid	Pittsburgh West Busway	Phoenix Rapid
Fare Collection Process	POB	POB	POB	POP	POB	POB	POB	POB	POB
Fare Transaction Media	C, P, MS	C, P, MS	C, P	MS	C, P, SC <sup>1</sup>	C, P	C, P, SC	C, P	C, P
Fare Structure	F	F	F	F	F	F	F	DB <sup>2</sup>	F
Equipment at Stations				TVM					
Equipment for On-Board Validation	EF	EF	EF	HV	EF	EF	EF	EF	EF

NOTE: POB = pay on board, POP = proof of payment, C = cash, P = paper, MS = magnetic stripe, SC = smart card, F = flat, DB = distance-based, TVM = ticket vending machine, EF = electronic farebox, HV = handheld validator

<sup>1</sup> Future

<sup>2</sup> For express service

SOURCE: CBRT (7)



SOURCE: MBTA

**EXHIBIT 4-126 Fare Payment in Barrier BRT System (Boston)**

---

## Bus Rapid Transit Practitioner's Guide

### *Estimated Costs*

Exhibit 4-127 gives cost ranges for capital, installation, operation, and maintenance costs for various elements of bus fare collection systems. This table provides general fare collection equipment costs for all transit modes in general (i.e., it does not address BRT systems in particular).

### *Likely Impacts*

#### *Dwell Time*

The application of prepaid fare collection methods increases boarding speeds because it allows all doors of the transit vehicle to be used for boarding. This increase may not always occur for on-board fare payment because usually only one payment verification station is available on a bus (usually near the driver). However, double-channel front doors, with one channel used by riders with passes or swipe cards, could expedite passenger boarding.

*Transit Capacity and Quality of Service Manual* (9) provides ranges for passenger service times. These values have been reproduced in Exhibit 4-128.

#### *Convenience for Users*

The use of electronic payment methods increases the flexibility and convenience of payment for customers. Fare reductions may be implemented for a specific number of trips, or rolling activate-on-first-use passes may provide customers with the ability to store their payment cards as long as necessary. Another convenience to customers is the use of smart cards that can be simply scanned without removing them from a wallet.

#### *Convenience for Agencies*

Agencies can easily track BRT system usage by having an electronic record of ticket sales. This system allows easy determination of demand by zones.

An inherent convenience of electronic payment is that exact change is not necessary and agencies may charge uneven amounts for transit service as required.

### **Passenger Information**

Information can be relayed to passengers through various methods, including visual displays at stations or on vehicles, audible announcements, brochures, the Internet, the telephone, and mobile communications devices. Brochures and posters can inform passengers of BRT route and station locations. Displays and audible announcements at stations or on board vehicles can inform passengers of the next vehicle's arrival time, the next station name, or possible delays, with accuracy and at programmed intervals. (Most passenger information systems of this type work in connection with AVL systems.) A single-line dynamic message sign in a BRT station is shown in Exhibit 4-129. A station-area kiosk is shown in Exhibit 4-130. On-board information displays are shown in Exhibit 4-131 ("transit TV") and Exhibit 4-132 (dynamic message sign).

Electronic fare payment increases convenience for BRT users and transit agencies.

Transit information can be provided to BRT users through various methods.

**EXHIBIT 4-127 Fare Collection Equipment Capital and Maintenance Costs\***

<b>Capital Cost Elements (Bus-Related Fixed Costs per Unit)</b>	<b>Low</b>	<b>High</b>
Mechanical farebox	\$2,000	\$3,000
Electronic registering farebox	\$4,000	\$5,000
Electronic registering farebox (with smart card reader)	\$5,000	\$8,000
Validating farebox (with magnetic card processing unit)	\$10,000	\$12,000
Validating farebox (with smart card reader)	\$12,000	\$14,000
Validating farebox (with magnetic & smart card reader)	\$13,000	\$17,500
Stand-alone smart card processing unit	\$1,000	\$7,000
Magnetic fare card processing unit (upgrade)	\$4,000	\$6,000
On-board probe equipment**	\$500	\$1,500
Garage probe equipment**	\$2,500	\$3,500
Application software (smart card units)	\$0	\$100,000
Garage hardware/software	\$10,000	\$20,000
Central hardware/software	\$25,000	\$75,000
<b>Payment Media Costs</b>		
	<b>Low</b>	<b>High</b>
Magnetic or capacitive cards	\$0.01	\$0.30
Contactless cards (plastic)	\$2.00	\$5.00
Contactless cards (paper)	\$0.30	\$1.00
Contact cards	\$1.50	\$4.00
<b>Operation and Maintenance Costs</b>		
	<b>Low</b>	<b>High</b>
Spare parts (% of equipment cost)	10%	15%
Support services include training, documentation, revenue testing, and warranties (% of equipment cost)	10%	15%
Installation (% of equipment cost)	3%	10%
Nonrecurring engineering & software costs (% of equipment cost)	0%	30%
Contingency (% of equipment/operating cost)	10%	15%
Equipment maintenance costs (% of equipment cost)	5%	7%
Software licenses/system support (% of systems/software cost)	15%	20%
Revenue handling costs (% of annual cash revenue)	5%	10%
Clearinghouse (e.g., card distribution, revenue allocation) *** (% of annual automatic fare collection revenue)	3%	6%

\* Actual cost depends on functionality/specifications, quantity purchased, and specific manufacturer.

\*\* In an integrated regional system, there is no additional cost for probe equipment.

\*\*\* This cost depends on the nature of the regional fare program, if any.

SOURCE: *TCRP Report 94 (27)*

**EXHIBIT 4-128 Passenger Service Times Associated with Different Payment Methods**

<b>Payment Method</b>	<b>Service Time (seconds/passenger)</b>
Pre-payment	2.25 to 2.75
Single Ticket or Token	3.4 to 3.6
Exact Change	3.6 to 4.3
Swipe or Dip Card	4.2
Smart Card	3.0 to 3.7

SOURCE: *Transit Capacity and Quality of Service Manual (9)*

*Bus Rapid Transit Practitioner's Guide*



SOURCE: Kittelson & Associates, Inc.

**EXHIBIT 4-129** Real-Time Passenger Information Sign in Station (Los Angeles)



SOURCE: Kittelson & Associates, Inc.

**EXHIBIT 4-130** Kiosk (Orlando)



SOURCE: Kittelson & Associates, Inc.



**EXHIBIT 4-131** On-Board Passenger Information Display - Mounting and Screen Detail (Orlando)





SOURCE: Kittelson & Associates, Inc.

EXHIBIT 4-132 On-Board Passenger Information Display (Los Angeles)

Vehicle coloring and design also can serve as a way to communicate BRT routes served and service type (if a BRT system has more than one service). For example, red buses may represent express service while green buses may stop more frequently. Branding and logos on vehicles increases the effectiveness of this type of communication. Exhibit 4-133 shows how the silver color theme of Boston's Silver Line BRT service is developed in various components of the service.

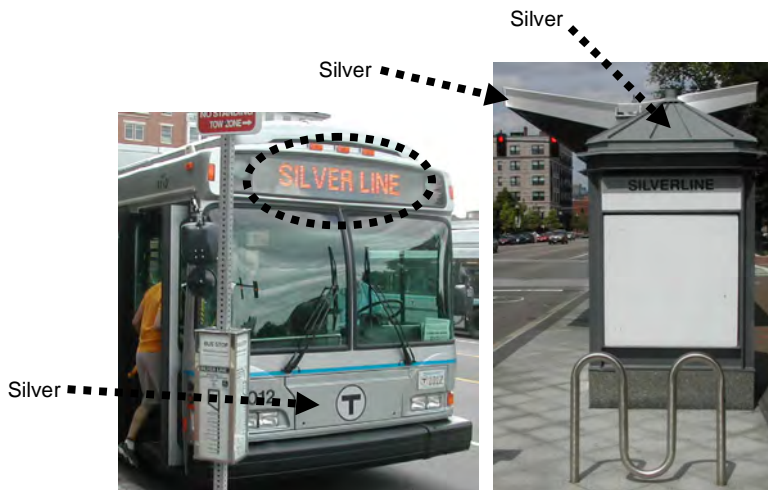

SOURCE: Kittelson & Associates, Inc.

EXHIBIT 4-133 Use of Color to Identify BRT Components (Boston)



---

## *Bus Rapid Transit Practitioner's Guide*

### *Scale of Application*

Passenger information systems used in some transit systems include telephone information stations, which require passengers to place a free call and request desired information; automated station announcements on vehicles, which announce the name of the next stop; and real-time information at stations, which uses AVL systems to track the arrival time of the next vehicle and communicate it through monitors or audible announcements to customers. Based on the 2005 U.S. DOT vehicle catalog, all buses being manufactured have some kind of passenger information system, such as audible announcements or visual liquid crystal display (LCD) screens.

Some transit agencies also make real-time information about bus locations and bus arrivals available over the Internet, the telephone, and/or mobile communications devices (such as cell phones) for pre-trip planning purposes. Exhibit 4-134 shows a real-time vehicle location map available via the Internet to users of the TriMet transit system. Interactive Voice Response (IVR) systems allow users to request real-time information by voice input or touch-tone keypad input (28).

### *Conditions of Application*

Adequate passenger information is essential both on vehicles and at stations. Real-time information systems can provide important information to passengers. They can relay regular schedule information, service delays or disruptions, temporary service changes, route and schedule changes, and emergency messages. They are essential at places of heavy boarding, alighting, and interchange, such as bus terminals or downtown transit stops. Both visual and audible messages can be provided. Information should be accessible by disabled riders.

A study conducted by WestStart-CALSTART for the FTA on community preferences in BRT systems (17) found that most riders preferred both audible and visual next-stop information displays on buses and countdown timers, vehicle arrival signals, and interactive information systems at transit stations.

### *Selected Typical Examples*

Exhibit 4-135 gives examples of passenger information systems that have been implemented for BRT systems in various cities, along with the type of information available to customers. Several cities in the United States have implemented or are planning to implement real-time passenger information systems. Among these are Boston, Las Vegas, Los Angeles, Phoenix, and Pittsburgh. Cities outside the United States that have implemented these systems include Ottawa, Brisbane, Vancouver, and Curitiba.

### *Estimated Costs*

Passenger information systems are part of ITS because vehicle location information provided to passengers is obtained with the use of AVL systems. Exhibit 4-136 shows cost ranges for passenger information components as well as some reported costs obtained from agencies across the United States.

A survey conducted for FTA showed rider preferences for real-time passenger information on BRT vehicles and at BRT stations.

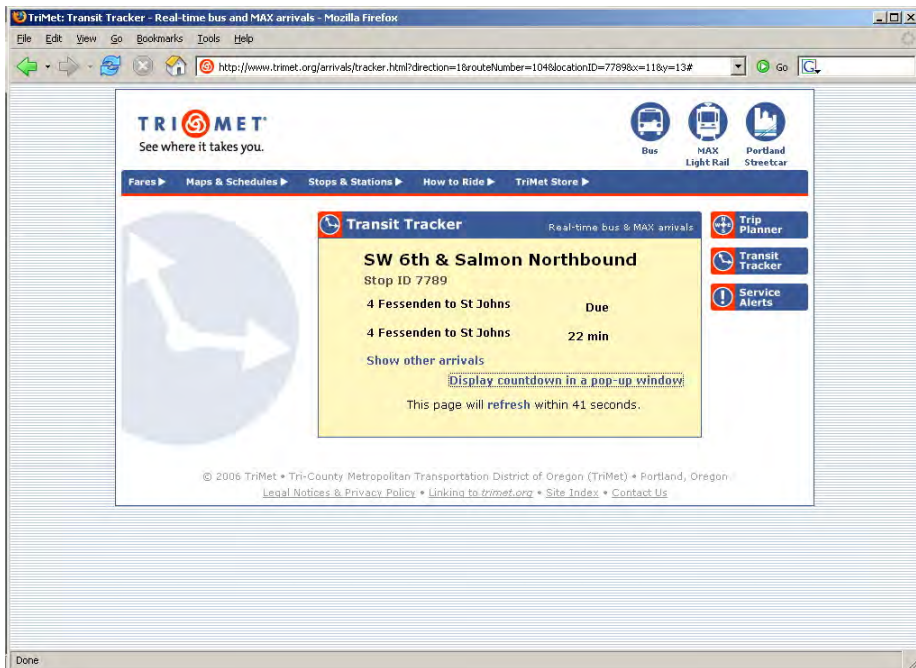

SOURCE: www.trimet.org

EXHIBIT 4-134 Real-Time Transit Information on the Internet (Portland, OR)

EXHIBIT 4-135 BRT Passenger Information System Application Examples

City	Transit System	Telephone Information Stations	Passenger Information Automated Station Announcements On Vehicle	Real Time Information at Stations
<i>US/Canada</i>				
Boston	Silver Line	Yes	Yes	Yes
Eugene, OR	Arterial Median Transitway		Yes	
Hartford	New Britain Busway (proposed)	Yes	Yes	
Los Angeles	Metro Rapid	Yes	Yes	Yes
Miami	South Miami-Dade Busway	Yes		
Pittsburgh	South-East-West Busway	Yes	Some buses	
Vancouver, BC	Broadway and Richmond "B" Lines		Yes	Yes
Ottawa	Transitway	Yes	Yes	Some locations
<i>Australia</i>				
Brisbane	South East Busway		Yes	Yes
Sydney	Liverpool-Parramatta BRT			Yes
<i>Europe</i>				
Rouen, France	Optically Guided Bus		Yes	
<i>South America</i>				
Curitiba, Colombia	Median Busway System		Yes	

SOURCE: TCRP Report 90 (2)

---

*Bus Rapid Transit Practitioner's Guide*
**EXHIBIT 4-136 Passenger Information System Component Costs**

Component	Cost
Status sign (at stations)	\$4,000-\$8,000 each
Los Angeles Metro Rapid	\$5,000
TriMet	\$4,000
On-board passenger information	\$2,000-\$7,000 per bus
Los Angeles Metro Rapid	\$4,000
Voice and video monitoring	\$4,000-\$5,000 capital, \$25,000 O&M
Electronic information kiosk	\$1.3 million (New York City, 20 kiosks)

SOURCE: CBRT (1), TCRP Report 90 (2), and TCRP Synthesis 48 (22)

### *Likely Impacts*

The availability of information to customers has numerous benefits for the BRT system in general: a greater distribution of posted, audible, visual, and Internet information increases the probability that more people will be willing to use the transit system. People who do not generally use the transit system but observe transit signs or well-branded stops near the places they commute may be more willing to try transit.

Passenger information systems at transit stations may help avoid the crowding of people into the first vehicle they observe going to their destination if they are informed that a second vehicle on that route will arrive just 2 or 3 minutes later. Telephone communication can improve security.

### *Implementability*

When considering the implementation of passenger information systems, an agency should take into account compatibility issues between various systems to make certain that software or hardware problems do not prevent the system from functioning adequately. Many agencies take a step-by-step approach to implementing these systems, which may lead to compatibility problems between systems acquired and implemented at different stages of BRT project development.

### *Analysis Tools*

Passenger information availability is used along with spatial, temporal, and capacity availability to determine whether transit is an alternative for commuters in a particular geographic area. If commuters do not have information on the routes, departure times, or types of service, they are less likely to use the service in the first place. This analysis is a required early step in a quality of service evaluation. Availability of transit information to a population must be determined first, and quality of information provided to the population must be determined once transit is available.

### **Enhanced Safety and Security Systems**

Safety and security of BRT services and facilities is essential. Transit agencies generally are responsible for the safety and security of BRT passengers and operators. The types of concerns that agencies should address range from criminal activity at stations and on buses (which are security concerns) to crash prevention and passenger well-being (which are safety concerns).

Safety and security systems may be implemented using ITS and non-ITS solutions. Security systems typically focus on crime prevention and communication for quick response from emergency personnel. Safety systems

focus on maintaining the uninterrupted operation of the BRT system by preventing injuries to users and damage to system vehicles and infrastructure. Manual surveillance and the provision of defensible space are also essential.

System designs and operating practices should also take into account protection against terrorism in a post-9/11 world. Good communication systems (e.g., GPS and real-time passenger information), multiple doors on buses, and two points of access to stations are desirable. In addition, alternative routes and services should be available. Useful references include *Designing and Operating Safe and Secure Transit Systems* (29) and *Volume 10 of NCHRP Report 525* (30).

Additional information on crime trends in transit systems can be obtained from the National Transit Database (NTD).

### *Scale of Application*

Safety and security systems are being implemented in most new BRT systems through the application of both ITS technology and non-ITS solutions. All manufacturers of buses made for BRT operations offer standard and optional ITS safety and security technology. They should be applied on a systemwide basis.

The typical technologies used for transit safety and security include alarms, closed-circuit television (CCTV) systems, call boxes, vehicle monitoring systems, pager systems, and driver assist technologies such as rear- or side-view cameras. An on-board CCTV camera, a station camera, and a station emergency phone are shown in Exhibit 4-137 through Exhibit 4-139. Non-ITS safety and security solutions also may be implemented and should be considered based on the specific characteristics of the BRT system. Non-ITS components for safety and security include adequate lighting and visibility at stations, security personnel at transfer stations, running way guidance and segregation, boarding platforms for level boarding, personnel training for emergency situations, and station designs providing good sight lines.

Silent alarms have been implemented by transit agencies across the United States. Silent alarm systems immediately notify authorities of disruptive or threatening behavior on board a bus, and the perpetrator has no way of knowing that police have been notified.

Remote monitoring of bus locations helps identify emergency situations through immediate communication if a vehicle strays off course or stops unexpectedly, assuring the safety of passengers on board. Monitoring cameras are commonly used security features on buses and transit stations; they can help in investigations of occurrences on board transit vehicles as well as deter criminal activity. Cameras may be monitored in real time to increase safety to users and increase response time in case of emergency.

Security at transit stations can be increased by providing a well-lit environment with security personnel (where feasible). Other solutions such as the application of transparent walls at transit stops can help eliminate hidden areas that pose a security concern.

A variety of safety and security systems (ITS and non-ITS) are available for use on BRT vehicles and at BRT stations.

Security personnel could be placed at larger BRT stations.

---

*Bus Rapid Transit Practitioner's Guide*



SOURCE: Kittelson & Associates, Inc.

**EXHIBIT 4-137 On-Board CCTV Camera (Las Vegas)**



SOURCE: DMJM+Harris

**EXHIBIT 4-138 BRT Station Camera (Brisbane, Australia)**



SOURCE: DMJM+Harris and Kittelson & Associates, Inc.

**EXHIBIT 4-139 BRT Station Emergency Phones**

Driver assist technology can aid in the safer operation of a transit vehicle. This technology includes components such as cameras for collision warning and prevention and voice and data communication with a central control center. Vehicle diagnostics systems help identify vehicle malfunctions as well as maintenance requirements, thereby increasing vehicle safety. Lane assist technology allows vehicles to operate at higher speeds in narrower lanes, and increases safety for passengers, improves functionality, and decreases the space required for buses.

### *Conditions of Application*

An agency should obtain a Certificate of Compliance from the FTA for each safety certifiable element in the system. These elements include any part of the transit project that can pose a safety or security concern to transit agency passengers, employees, contractors, emergency personnel, or the general public.

A Certificate of Compliance for BRT system safety and security features should be obtained from FTA.

### *Selected Typical Examples*

One example of a transit agency with an aggressive safety and security program is the Washington Metropolitan Area Transit Authority (WMATA). This agency has earned the nation's top safety award based on the safety and security programs implemented in its transit system.

WMATA buses are equipped with silent alarms that automatically change destination signs to an emergency message upon activation; the silent alarms also cause vehicle running lights to flash repeatedly for police to easily identify the bus.

An important component of safety is personnel training. WMATA, for example, has instituted biannual refresher courses in the Heimlich maneuver, CPR, and other first aid procedures for its personnel.

### *Estimated Costs*

Costs for implementing ITS technology for safety and security may vary widely depending on the procurement strategy. Smaller agencies may see increased costs associated with ITS systems simply due to the smaller quantity of ITS components purchased. Examples of costs can be obtained from previous purchases by other agencies. (One example is the Intercity Transit Agency in Thurston County, WA, which operates 34 fixed-route buses. This agency allocated \$500,000 for real-time on-board security monitoring systems.)

Example costs for safety and security components described in this Guide are listed in Exhibit 4-67, Exhibit 4-108, and Exhibit 4-136.

### *Likely Impacts*

Many agencies have experienced a considerable reduction in safety and security incidents through the implementation of ITS security systems. *British Columbia's Provincial Intelligent Transportation Systems Vision and Strategic Plan (31)* documents a 33% reduction in passenger assaults with the implementation of security-focused Advanced Public Transportation Systems (APTS). Additionally, crime prevention systems can have a very positive effect on overall agency operations because these systems lower the risk of damage to facilities and because users acquire an added sense of security, which positively affects ridership.

---

## Bus Rapid Transit Practitioner's Guide

### Implementability

The implementation of safety and security systems should follow the recommendations presented in FTA's *Handbook for Transit Safety and Security Certification* (32). The Handbook provides a series of steps that should be followed to obtain a Safety and Security Certification. FTA's web site provides an abundant amount of information related to security measures that should be considered in implementing a safety and security system; a "Top 20 Security Program Action Items for Transit Agencies" list is available, which directly addresses safety and security concerns related to risk of terrorist attacks on transit systems.

From an ITS point of view, the agency should ensure compatibility between safety and security systems. Ensuring compatibility is particularly important when systems have been obtained through separate procurements or when software has been upgraded. Systems should be tested, and response times to possible emergencies should be assessed. Some transit agencies conduct mock emergencies to determine how well emergency systems function and the readiness of transit employees and emergency personnel.

### Analysis Tools

The primary tool for analyzing safety and security system standards is FTA's *Handbook for Transit Safety and Security Certification* (32). The safety and security certification (SSC) program presented in the Handbook encompasses the equipment, maintenance and operation procedures, and facilities for the three categories listed in Exhibit 4-140. All systems should be analyzed to verify that they meet FTA safety and security requirements before a safety and security certification is issued to the agency.

The following steps compose the certification process:

1. Identify certifiable elements
2. Develop safety and security design criteria
3. Develop and complete design criteria conformance checklist
4. Perform construction specification conformance
5. Identify additional safety and security test requirements
6. Perform testing and validation in support of the SSC program
7. Manage integrated tests for the SSC program
8. Manage "open items" in the SSC program
9. Verify operational readiness
10. Conduct final determination of project readiness and issue safety and security certification

### Branding

"Branding" of BRT system facilities is designed to provide a unique identity. It includes a distinctive system name and logo that is applied to vehicles, stations, schedules, and various passenger amenities.

The certification process in FTA's *Handbook for Transit Safety and Security Certification* includes 10 steps.

Branding should give each BRT system a unique identity.

Branding is typically applied to BRT vehicles, stations, running ways, and schedule/marketing materials.

**EXHIBIT 4-140 Safety and Security Certification Program Categories**

Category	Description
Systemwide Elements	Includes passenger vehicles, voice and data communications, CCTV, grade crossing and traffic control system, intrusion detection system, running ways, fare collection, supervisory control, fire protection and suppression systems, and auxiliary vehicles and equipment.
Fixed Facilities	Includes stations and shelter stops, pedestrian bridges, yard and shop structures, and the control center. Equipment installed in stations or sheltered stops such as HVAC, escalators, and elevators is also considered part of the facility.
Plans, Procedures, and Training	Includes emergency preparedness plans, security plans and procedures, training programs, rule books, and standard operating procedures.

SOURCE: *Handbook for Transit Safety and Security Certification (32)*

*Scale of Application*

Branding should be applied systemwide and should include the following:

- Branding stations and terminal features such as bus/BRT stop signs, passenger information boards, fare collection equipment, and media
- Giving vehicles a special styling, unique livery, added passenger amenities, and marketing panels
- Branding running ways by using special paving materials, colors, and markings
- Branding marketing materials such as route maps, route schedules, web sites, and media information

Bus operators in York Region Transit's Viva BRT system wear a distinctive uniform, as shown in Exhibit 4-141. The uniform displays the name of the BRT service and is color-coordinated with the vehicles.



SOURCE: Kittelson & Associates, Inc.

**EXHIBIT 4-141 Branding Example - Operator Uniform (York, ON)**





SOURCE: Kittelson & Associates, Inc.

**EXHIBIT 4-144 BRT Branding Example - Logo (Orlando)**



SOURCE: Kittelson & Associates, Inc.

**EXHIBIT 4-145 BRT Branding Example - Station (Los Angeles)**

*Estimated Costs*

Capital and operating cost information for branding is not readily available. The distinctive CIVIS bus used in Las Vegas costs about \$1 million, which is approximately double the cost of other buses in BRT service.

*Bus Rapid Transit Practitioner's Guide*

*Conditions of Application*

Branding should be an integral part of the overall BRT system design. There are no specific "warrants" as such.

*Selected Typical Examples*

Examples of current branding applications for existing BRT systems are presented in Exhibit 4-142 through Exhibit 4-145.

**EXHIBIT 4-142 Branding of Features of Existing BRT Systems**

City	Service	Logo	Enhanced Stations	Real-time Passenger Information	Modernistic Vehicle	Vehicle Aesthetic Enhancements
Boston	Silver Line	X	X	X		X
Honolulu	CityExpress	X				
Las Vegas	MAX	X	X	X	X	X
Los Angeles	Metro Rapid	X	X	X		X
Oakland	Rapid Bus	X	X	X		X
Orlando	Lymmo	X	X			
Phoenix	Rapid	X	X	X		

SOURCE: TCRP A-23A research

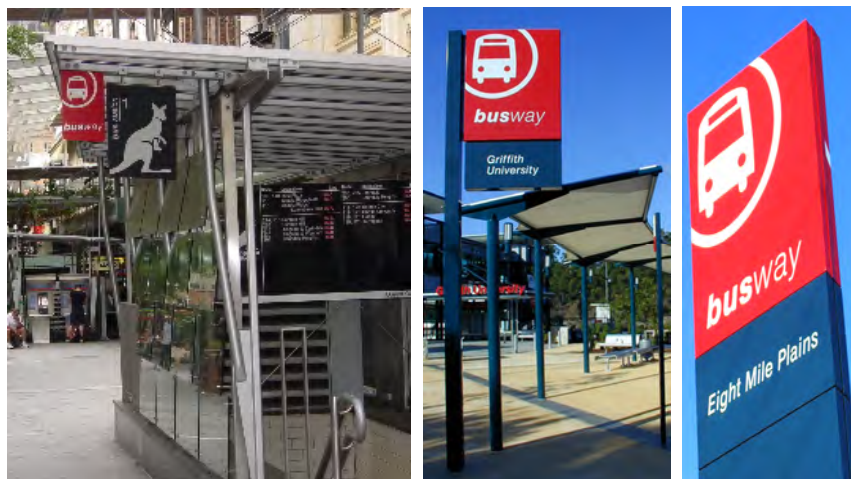

SOURCE: DMJM+Harris

**EXHIBIT 4-143 BRT Branding Example - Signs (Brisbane)**

*Bus Rapid Transit Practitioner's Guide*

*Likely Impacts*

Branding conveys a system identity/image to existing and potential passengers. This image may translate into increased ridership over the long run.

*Ridership Impacts*

No information was found on the likely ridership effect of improved branding. However, the effects may be inferred through analysis of the modal bias values used for rail transit. Guidelines for transferring rail transit bias constants to BRT are given in Chapter 3.

*Land Development Effects*

No information is available on the effects of branding on land development.

*Implementability*

Branding can be easily and quickly implemented. The installation costs are low, and there are no land acquisition or environmental impacts.

*Analysis Methods*

Two basic impact methods for analyzing branding impacts may be used: (1) similar experiments elsewhere and (2) stated preference surveys. The stated preference surveys should assess passenger response to specific branding features and identify the ridership effects of improved BRT branding.

Exhibit 4-146 documents how the costs and effectiveness of a branding program can be analyzed. It is difficult to make generalizations about the analysis outcome in view of differences among potential BRT markets in different metropolitan areas and differences in attitudes toward the existing local bus system.

Preference surveys can assess passenger response to specific branding features.

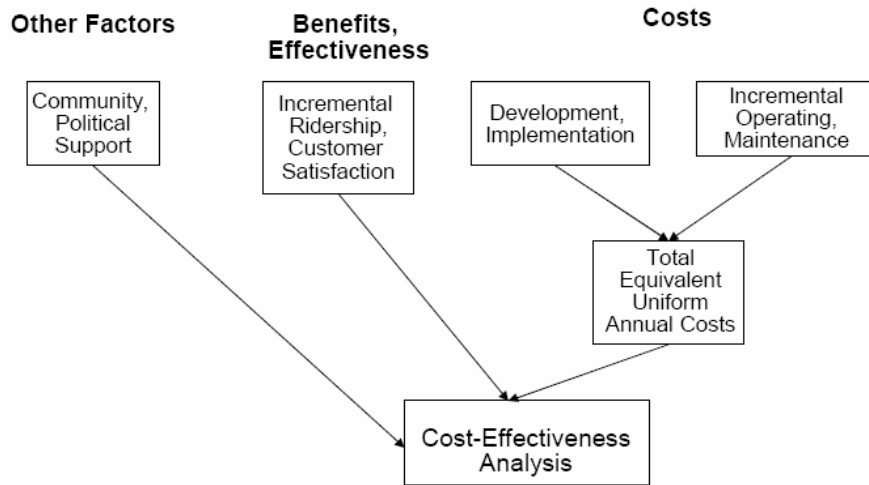

SOURCE: TCRP A-23A research

**EXHIBIT 4-146** Impact Analysis: BRT Branding

## REFERENCES

1. Diaz, R.B., M. Chang, G. Darido, E. Kim, D. Schneck, M. Hardy, J. Bunch, M. Baltes, D. Hinebaugh, L. Wnuk, F. Silver, and S. Zimmerman. *Characteristics of Bus Rapid Transit for Decision-Making*. FTA, Washington, D.C., 2004.
2. Levinson, H., S. Zimmerman, J. Clinger, S. Rutherford, R. Smith, J. Cracknell, and R. Soberman. *TCRP Report 90: Bus Rapid Transit: Vol. 1, Case Studies in Bus Rapid Transit, and Vol. 2, Implementation Guidelines*. Transportation Research Board of the National Academies, Washington, D.C., 2003.
3. Kittelson & Associates, Inc., Herbert S. Levinson Transportation Consultants, DMJM+Harris, and OURCO, Inc. *TCRP Project A-23A Interim Report*. Unpublished. 2004.
4. Biehler, A.D. Exclusive Busways versus Light Rail Transit: A Comparison of New Fixed Guideway Systems. *Special Report 221: Light Rail Transit: New System Successes at Affordable Prices*. Transportation Research Board, National Research Council, Washington, D.C., 1989, pp. 89-97.
5. St. Jacques, K., and H. Levinson. *TCRP Report 26: Operational Analysis of Bus Lanes on Arterials*. Transportation Research Board, National Research Council, Washington, D.C., 1997.
6. *Highway Capacity Manual*. Transportation Research Board, National Research Council, Washington, D.C., 2000.
7. Rainville, Jr., W.S., W.S. Homburger, D.C. Hyde, and R. Strickland. *Preliminary Progress Report of Transit Subcommittee*. Committee on Highway Capacity. Proceedings, Vol. 40. Highway Research Board, Washington, D.C., 1961.
8. Wilbur Smith & Associates. *Bus Rapid Transit Options for Densely Developed Areas*. UMTA, Washington, D.C., 1975.
9. Kittelson & Associates, Inc., KFH Group, Inc., Parsons Brinckerhoff Quade and Douglass, Inc., and K. Hunter-Zaworski. *TCRP Report 100: Transit Capacity and Quality of Service Manual*. Transportation Research Board of the National Academies, Washington, D.C., 2003.
10. Chang, J. (ed.). *An Overview of Transit Signal Priority*. Intelligent Transportation Society of America, Washington, D.C., July 2002.
11. Smith, H.R., B. Hemily, and M. Ivanovic. *Transit Signal Priority: A Planning and Implementation Handbook*. Intelligent Transportation Society of America, Washington, D.C., 2005.
12. Chang, J., J. Collura, F. Dion, and H. Rakha. Evaluation of Service Reliability Impacts of Traffic Signal Priority Strategies for Bus Transit. *Transportation Research Record 1841*. Transportation Research Board of the National Academies, Washington, D.C., 2003, pp. 23-31.
13. Fitzpatrick, K., K.M. Hall, S. Farnsworth, and M.D. Finley. *TCRP Report 65: Evaluation of Bus Bulbs*. Transportation Research Board, National Research Council, Washington, D.C., 2001.
14. *Americans with Disabilities Act Accessibility Guidelines*. The Access Board, Washington D.C., Sept. 2002.
15. Zimmerman, S.L., and H.S. Levinson. Vehicle Selection for BRT: Issues and Options. *Journal of Public Transportation*. Vol. 7, No. 1. Center for Urban Transportation Research, Tampa, FL, 2004.
16. Vehicle Catalog 2005 Update. A Compendium of Vehicles and Hybrid Drive

---

*Bus Rapid Transit Practitioner's Guide*

- Systems for Bus Rapid Transit Service. WestStart-CALSTART, 2005.
17. WestStart-CALSTART. *Vehicle Demand and Supply Analysis Update*. FTA, Washington, D.C., 2004.
  18. *Public Transportation Factbook*. APTA, Washington, D.C., 2005.
  19. FTA. *Analysis of Fuels and Propulsion System Options for BRT Vehicles*. Washington, D.C., 2004.
  20. *Automatic Vehicle Location: Successful Transit Applications: A Cross-Cutting Study: Improving Service and Safety*. Joint Program Office for Intelligent Transportation Systems, FTA, Washington, D.C., Aug. 2000.
  21. *Tracking the Deployment of the Integrated Metropolitan Intelligent Transportation Systems Infrastructure in the USA: FY2004 Results*. Intelligent Transportation Systems Joint Program Office, FHWA, Washington, D. C., July 2005.
  22. Schweiger, C.L. *TCRP Synthesis 48: Real-Time Bus Arrival Information Systems*. Transportation Research Board of the National Academies, Washington, D.C., 2003.
  23. Metro Transit. *Bus Rapid Transit Lane Assist Technology Systems*. University of Minnesota, Minneapolis, 2003.
  24. *Public Transportation Handbook*. APTA, Washington, D.C., 2003.
  25. Levinson, H., and P. Conrad. How to Allocate Bus Route Costs. *Transit Journal*. Vol. 5, No. 4, pp. 39-48. Washington, D.C., 1979.
  26. St. Jacques, K., and H. Levinson. *TCRP Research Results Digest 38: Operational Analysis of Bus Lanes on Arterials: Applications and Refinement*. Transportation Research Board, National Research Council, Washington, D.C., Sept. 2000.
  27. Multisystems, Inc., Mundle & Associates, Inc., and Simon & Simon Research and Associates, Inc. *TCRP Report 94: Fare Policies, Structures, and Technologies: Update*. Transportation Research Board of the National Academies, Washington, D.C., 2003.
  28. Raman, M., C. Schweiger, K. Shammout, and D. Williams. *Guidance for Developing and Deploying Real-Time Traveler Information Systems for Transit*. FTA, Washington, D.C., 2003.
  29. Taylor, B., A. Loukaitou-Sideris, R. Liggett, C. Fink, M. Wachs, E. Cavanagh, C. Cherry, and P.J. Haas. *Designing and Operating Safe and Secure Transit Systems: Assessing Current Practices in the United States and Abroad*. Mineta Transportation Institute, San Jose, CA, Nov. 2005.
  30. Friedman, D., D. Bratvold, S. Mirsky, G. Kaiser, P. Schaudies, E. Bolz, R. Castor, and F. Latham. *NCHRP Report 525: Surface Transportation Security*, Vol. 10, *Guide to Transportation's Role in Public Health Disasters*. Transportation Research Board of the National Academies, Washington, D.C., 2006.
  31. *British Columbia's Provincial Intelligent Transportation Systems Vision and Strategic Plan*. British Columbia Ministry of Transportation, Canada, Nov. 2001.
  32. Adduci, R.J., A. Boyd, and J. Caton. *Handbook for Transit Safety and Security Certification*. Volpe National Transportation Systems Center. FTA, Washington, D.C., Nov. 2002.

## CHAPTER 5. SYSTEM PACKAGING, INTEGRATION, AND ASSESSMENT

### INTRODUCTION

BRT is an integrated *system* of services, facilities, and amenities that is designed to improve speed, reliability, and identity. It calls for packaging various components in a coherent and supportive manner that reflects specific needs, resources, and opportunities.

This chapter gives guidelines for system packaging and integration that summarize and apply findings from other chapters of the *Bus Rapid Transit Practitioner's Guide*. It shows how BRT components can be packaged, it gives parameters and procedures for estimating costs and effects, and it gives examples of estimating BRT performance and impacts for various BRT scenarios. Details of the alternatives analysis process are contained in Chapter 2.

### CHOOSING THE "BEST" PACKAGE OF COMPONENTS

All BRT systems will have running ways, stations, and vehicles. The types of these features, as well as the types of various ITS-related components, will depend upon local needs, conditions, attitudes, and resources. Some guidelines follow.

#### General Guidelines

Developing BRT for any community requires the following activities:

- Identifying the appropriate corridors
- Comparing alternative alignments
- Selecting the desired BRT alignments and components

Key considerations include the following:

1. *Establish the Need.* Considerations include (a) slow and unattractive local bus service; (b) peak-period congestion on major roadways; and (c) continued (or anticipated) growth in CBD employment, urban population, and transit ridership.
2. *Identify the Market.* The nature of the current and future land use and demographic characteristics should be clearly identified. Market segments include riders diverted from local bus and auto and riders making new trips. Similarly, current and future transit—including origin-to-destination patterns, expected BRT ridership, and maximum load section (point) volumes—should be determined. Candidate markets include corridors with sufficient ridership potential to allow frequent all-day service (preferably at intervals not greater than 10 to 12 minutes between buses). A strong CBD (e.g., more than 50,000 jobs) and high-density corridors are supportive of BRT.
3. *Select Type of Running Way.* Selecting the types of BRT running ways will depend upon (a) availability of right-of-way within the proposed BRT corridors; (b) width, continuity, and operational characteristics of arterial streets; (c) the ability to integrate BRT operation with existing transit service; and (d) proximity to markets.
4. *Recognize Public Preferences.* Community and agency preferences regarding BRT routes should be taken into account. Selecting special BRT vehicles,

All BRT systems have running ways, stations, and vehicles.

Developing BRT calls for identifying corridors, selecting components, and assessing options.

The Guide provides seven guidelines for packaging BRT components.

---

## Bus Rapid Transit Practitioner's Guide

for example, should have the support of the transit agency responsible for operating the BRT service. Similarly, operational treatments such as bus lanes, TSP, and queue bypass lanes should have the support of the street transportation agencies.

5. *Integrate BRT with Existing Bus Services.* It may be desirable to restructure existing bus routes on streets in or serving a BRT corridor. Local routes should feed rather than duplicate the BRT service. Where BRT operates on busways, terminals, or outlying stations, it can serve as a focal point for connecting bus services.
6. *Consider Funding Availability.* Available resources for capital, operating, and maintenance requirements are essential. The funding available for BRT may influence the type, extent, and staging of BRT features. Where funding is limited, BRT may have to operate on city streets rather than on off-street busways. Similarly, existing vehicles might have to be used initially (although distinctively colored). Resource constraints may also limit the extent of the BRT system, making staging essential.
7. *Explore Development Opportunities.* Opportunities for land development near BRT stations should be explored. They can have bearing on the (a) extent of the BRT system, (b) location and design of stations, and (c) type of running way selected. Experience suggests that, under the right market conditions, BRT can influence development at major outlying busway stations (e.g., Ottawa) or along rebuilt urban streets with improved landscaping and walks (e.g., Boston).

### Packaging and Staging Examples

BRT can be developed incrementally, with each stage keyed to demand characteristics and the availability of resources. The stages can include the following:

- *Adding elements or features.*
- *Upgrading key elements such as vehicles, stations, and fare collection systems.*
- *Relocating operations to off-street running ways.*
- *Extending the system.* For example, Pittsburgh started out with 4.3 miles of busway in 1977; today there are almost 20 miles of busway. Boston opened a 2.2-mile surface route in 2002 and added a 1.1-mile bus tunnel in 2005. Any modifications of a BRT system should be planned and designed such that the existing bus lanes or busway are not adversely affected by construction.

Examples of packaging BRT elements for modest- and high-demand BRT systems are shown in Exhibit 5-1 and Exhibit 5-2, respectively.

Exhibit 5-1 illustrates how BRT features could be packaged for a modest-demand and modest-cost system. This system would likely include local and BRT service, standard vehicles in a special livery, and a combination of dedicated bus lanes and mixed-traffic operations, radios, and on-board fare collection.

Exhibit 5-2 gives illustrative packaging features for a high-demand, high-cost, and high-performance application. This application includes specially dedicated vehicles, fully dedicated bus lanes (including possible bus-only roadways), and an extensive array of BRT features.

BRT can be developed in stages that add or upgrade features, relocate service to off-street alignments, and/or extend the system. Stages are keyed to ridership demand and resource availability.

**EXHIBIT 5-1 Packaging BRT Elements - Modest-Demand and Modest-Cost BRT System**

Services	Stations	Vehicles	Running Way	Systems
Primarily local	Simple stops	No special treatment	<b>Mixed traffic</b>	<b>Radios, on-board fare collection</b>
<b>Mixed limited-stop, local</b>	<b>Super stops</b>	Special signage	<b>Dedicated arterial curb lanes, competing turns allowed</b>	<b>AVL for schedule adherence</b>
All-stop (local), mixed local/express	On-line and off-line stations, significant parking for transit patrons	<b>Dedicated vehicles, special livery</b>	<b>Dedicated freeway median lanes, merge/weave access/egress</b>	ITS passenger information, fare collection
Point-to-point express	Transfer/transit centers	Dedicated vehicles, uniquely specified (e.g., double-articulated buses, hybrid propulsion)	Fully dedicated lanes, exclusive freeway access/egress	ITS vehicle priority
	Intermodal transfer/transit center	Mechanical or electronic guidance	Partial grade separation	ITS vehicle lateral guidance
		Fully electric propulsion system	Full grade separation, curbed/striped/cabled for guidance	ITS automation, electric power system
			Overhead power contact system	

NOTE: Boldface text denotes elements of a modest-demand, modest-cost BRT system.

SOURCE: *BRT (1)*, as reproduced in *TCRP Report 90 (2)*

**EXHIBIT 5-2 Packaging BRT Elements - High-Demand and High-Cost BRT System**

Services	Stations	Vehicles	Running Way	Systems
Primarily local	Simple stops	No special treatment	Mixed traffic	Radios, on-board fare collection
Mixed limited-stop, local	Super stops	Special signage	Dedicated arterial curb lanes, competing turns allowed	<b>AVL for schedule adherence</b>
<b>All-stop (local), mixed local/express</b>	<b>On-line and off-line stations, significant parking for transit patrons</b>	Dedicated vehicles, special livery	Dedicated freeway median lanes, merge/weave access/egress	<b>ITS passenger information, fare collection</b>
Point-to-point express	Transfer/transit centers	<b>Dedicated vehicles, uniquely specified (e.g., double-articulated buses, hybrid propulsion)</b>	<b>Fully dedicated lanes, exclusive freeway access/egress</b>	ITS vehicle priority
	Intermodal transfer/transit center	Mechanical or electronic guidance	Partial grade separation	ITS vehicle lateral guidance
		Fully electric propulsion system	Full grade separation, curbed/striped/cabled for guidance	ITS automation, electric power system
			Overhead power contact system	

NOTE: Boldface text denotes elements of a high-demand, high-cost BRT system.

SOURCE: *BRT (1)*, as reproduced in *TCRP Report 90 (2)*



*Bus Rapid Transit Practitioner's Guide*

Major BRT cost components include running ways, stations, design, and (in some cases) vehicles.

Exhibit 5-3 identifies the allocation of capital costs by BRT component for several existing and under construction BRT systems, illustrating different packaging of components.

**EXHIBIT 5-3 Allocation of Capital Costs by BRT Component**

BRT System	Total Development Costs (millions)	Land Acquisition	Running Way	Stations	Buses	ITS/TSP	Design/Administration/Supervision	Other
Adelaide, Australia	\$67.9	5.9%	54.5%	6.5%	22.5%	—	1.5% design; 9.0% admin.	—
Boston	\$37.8	—	60.8%	9.6%	27.6%	2.0% CAD/AVL	<sup>2</sup>	—
Brisbane, Australia	\$330.1	—	79.6%	2.5%	—	2.0% ITS	<sup>2</sup>	15.9% tunnel
Cleveland	\$168.4	8.1%	26.3%	10.8%	12.8%	5.1% TSP	26.1%	10.8% <sup>3</sup>
Hartford	\$145.0	8.3%	37.1%	19.7%	7.7%	0.7% ITS	22.6%	3.9% <sup>4</sup>
Las Vegas	\$19.2	0%	—	23.4%	63.0%	1.5% AVL; 1.3% TSP	<sup>2</sup>	10.5% <sup>5</sup>
Los Angeles: Wilshire-Whittier	\$5.0	0%	0%	48.7%	0%	51.3% TSP	<sup>2</sup>	—
Los Angeles: Ventura	\$3.2	0%	0%	48.8%	0%	51.2% TSP	<sup>2</sup>	—
Los Angeles: Phase 2	\$101.9	0%	0%	42.9%	0.3%	55.0% TSP	<sup>2</sup>	1.8% operations support
Ottawa	\$324.0	—	69.0%	27.6%	—	—	<sup>2</sup>	3.4% park-and-ride
Pittsburgh: East Busway Extension	\$68.8	14.5%	44.2%	2.9%	0%	—	24.4%	13.4% <sup>6</sup>
Pittsburgh: West Busway (PAT)	\$299.1	8.8%	73.9%	0.9%	0%	—	<sup>2</sup>	16.4% <sup>7</sup>
Vancouver, BC: 98B (from IBI Group)	\$41.3	8.9%	22.8% <sup>1</sup>	6.3%	33.4%	1.0% ITS; 3.9% TSP; 6.3% AVL	6.5%	10.9% garage

<sup>1</sup> Includes 3.9% for landscaping

<sup>2</sup> Design/administration/supervision costs not itemized in source data

<sup>3</sup> 1.0% for a maintenance facility, 0.6% for art, and 9.2% for contingencies

<sup>4</sup> 0.6% for traffic signals, 1.0% for railroad crossings, and 2.3% for a multi-use trail

<sup>5</sup> 0.6% for dynamic message signs and 9.9% for ticket vending machines

<sup>6</sup> 7.3% for a linear park and 6.1% for a park-and-ride lot

<sup>7</sup> Wabash HOV facility

NOTE: CAD = computer-assisted dispatch

SOURCE: TCRP Project A-23A Interim Report (3)

## ASSESSING SYSTEM PERFORMANCE

Assessing BRT system performance requires estimating travel times, service frequencies, ridership benefits, and development costs. This section brings together key performance and cost parameters and shows how they may be used to assess the effect of a given BRT system.

### Analysis Parameters

BRT costs and travel times were obtained from *TCRP Report 90 (2)*, *TCRP Project A-23A Interim Report (3)*, *CBRT (4)*, and project profiles are set forth in Exhibit 5-4 through Exhibit 5-9. This information can be used as a guide in estimating the costs and effects of various BRT features. Local experience and local information should be used where available.

Exhibit 5-4 gives representative unit costs for running ways, including transit priority treatments, stations, vehicles, fare collection, passenger information systems, and ITS. Right-of-way costs have been excluded since they vary widely depending on the running way option and local circumstances. These costs are based on information contained in the BRT component profiles in Chapter 4, the *TCRP Project A-23A Interim Report (3)*, and *CBRT (4)*.

Exhibit 5-5 gives typical effects of BRT running way treatments that are keyed to an initial base running time of 6 minutes per mile (10 miles per hour). The off-street travel times and speeds assume wide station spacing, while the on-street treatments are keyed to the initial station spacing.

Exhibit 5-6 gives typical effects of station spacing and dwell times on bus travel time rates (in minutes per mile). If the station spacing remains constant and the dwell times change, the changes in the one-way running time represent the changes in dwell time at each station times the number of stations.

Exhibit 5-7 shows how the number of door channels and type of fare collection influence passenger service times. For example, pre-payment has a service time of 2.5 seconds per passenger. When two doors are available, the dwell time per passenger per door is  $2.5 \times 0.6$ , or 1.5 seconds per passenger.

Exhibit 5-8 presents typical cost and travel time effects for various running way options. A partially grade-separated busway would cost \$3.0 million per minute of travel time saved. In contrast, TSP would cost \$0.4 million per minute of travel time saved. Costs per person-minute saved depend upon the number of buses and the number of passengers per bus along the BRT route.

Exhibit 5-9 gives estimated costs and estimated travel time savings for queue bypasses, curb extensions, and TSP. Time savings in seconds per mile ranges from 6 seconds (one queue bypass per mile) to 20 seconds (four TSP treatments per mile).

Assessing system performance involves estimating changes in travel times, service frequencies, and ridership as compared with development costs.

This guide provides unit costs for BRT components.

*Bus Rapid Transit Practitioner's Guide*

**EXHIBIT 5-4 Representative BRT Component Development Costs**

Component	Unit	Cost/Unit
<i>Running Way</i>		
Off-street busway		
At-grade	Per route-mile	\$5 million
Grade-separated	Per route-mile	\$13 million
Elevated	Per route-mile	\$50 million
Tunnel	Per route-mile	\$200 million
On-street		
Median arterial busway	Per route-mile	\$4 million
Bus lane - new construction	Per route-mile	\$25 million
Bus lane - striping lane	Per route-mile	\$100,000
<i>Transit Preferential Treatments</i>		
Queue bypass		
Parking removal	Per approach	Negligible
Use of right-turn lane	Per approach	Negligible
Added lane	Per approach	\$300,000
Curb extension	Per extension	\$60,000
TSP	Per intersection	\$30,000
Special transit phase	Per intersection	\$10,000
<i>Stations</i>		
Typical		
Basic	Per station	\$21,000*
Enhanced	Per station	\$30,000*
Major		
At-grade	Per station	\$150,000
Grade-separated	Per station	\$2.5 million
Intermodal center	Per station	\$12.5 million
Passing lane	Per lane-mile	\$2.7 million
<i>Vehicles</i>		
Conventional standard	Per vehicle	\$325,000
Stylized standard	Per vehicle	\$350,000
Conventional articulated	Per vehicle	\$570,000
Stylized articulated	Per vehicle	\$780,000
Specialized BRT	Per vehicle	\$1.3 million
<i>Fare Collection</i>		
On-board		
Magnetic card media	Per vehicle	\$15,000
Smart media	Per vehicle	\$20,000
Off-board		
Magnetic card media	Per machine	\$60,000
Smart media	Per machine	\$65,000
<i>Passenger Information</i>		
At-station information	Per sign	\$6,000
On-board information	Per vehicle	\$4,000
<i>Branding</i>		
Branding	Per system	Negligible
<i>ITS Applications</i>		
On-board security	Per vehicle	\$10,000
On-board vehicle guidance		
Optical/magnetic sensors	Per mile	\$20,000
Hardware integration	Per vehicle	\$50,000
On-board precision docking		
Optical/magnetic sensors	Per station	\$4,000
Hardware integration	Per vehicle	\$50,000
On-board performance monitoring	Per vehicle	\$2,000
AVL	Per vehicle	\$8,000

\* One direction

NOTE: Values are in 2004 U.S. dollars.

SOURCE: *TCRP Report 90 (2)*, *TCRP Project A-23A Interim Report (3)*, *CBRT (4)*, *Vehicle Catalog 2005 Update (5)*, and *TCRP Synthesis 40 (6)*

**EXHIBIT 5-5 Typical Effects of BRT Running Way Components**

Component		Estimated Effects	Savings Compared to Base*	Comments
Off-street	Elevated	40 mph, 1.5 min/mi	4.5 min/mi	Assumed speed
	Some grade separation	35 mph, 1.7 min/mi	4.3 min/mi	Reflects wide station spacing
	At-grade	25 mph, 2.4 min/mi	3.6 min/mi	
On-street	Median arterial busway	13.3 mph, 4.5 min/mi	1.5 min/mi	Assumes no change in station spacing
	Bus lane (new construction or striping)	12.2 mph, 4.9 min/mi	1.1 min/mi	From TCRP A-23A April-June 2005 Quarterly Progress Report (7)
Traffic treatments	Queue bypass	—	6 sec/int	Estimated
	Curb extension	—	4 sec/int	From TC&QSM (8), Exhibit 4-5, 400 vehicles per hour
	TSP	—	5 sec/int	From Los Angeles, Oakland
	Special signal phase	—	—	Has important safety benefits

\* Benefits are keyed to a base running speed of 10 mph (6 minutes/mile and 6 stations/mile).

NOTE: int = intersection

SOURCE: Derived from project profiles

**EXHIBIT 5-6 Typical Effects of BRT Station Spacing and Dwell Times**

Condition		Before (6 stops per mile)	After (2 stops per mile)	Change
Same boarding times	Dwell/stop	15 seconds	15 seconds	0 seconds
	Minutes/mile	4.8	2.6	+2.2
Slower boarding times	Dwell/stop	15 seconds	20 seconds	-5 seconds
	Minutes/mile	4.8	2.7	+2.1
Faster boarding times	Dwell/stop	15 seconds	10 seconds	5 seconds
	Minutes/mile	4.8	2.4	+2.4

NOTE: Excludes traffic delays

SOURCE: *Transit Capacity and Quality of Service Manual (8)*, Exhibit 4-6

Reducing the number of stops and reducing dwell times improves BRT speeds.

*Bus Rapid Transit Practitioner's Guide*

**EXHIBIT 5-7 Typical Effects of Door Channels and Fare Collection Methods on Passenger Service Times**

Situation	Single-Door Boarding Time (seconds/passenger) <sup>1</sup>
Swipe or dip card	4.5
Exact change	4.0
Smart card	3.5
Single ticket or token	3.5
Pre-payment <sup>2</sup>	2.5

Situation	Single-Door Alighting Time (seconds/passenger) <sup>1</sup>
Front door	3.3
Rear door	2.1

Situation	Proportion of Basic Dwell Time <sup>3</sup>
1 door channel	1.00
2 door channels	0.60
3 door channels	0.44
4 door channels	0.36
5 door channels	0.24

<sup>1</sup> Add 0.5 second/passenger for standees. Subtract 0.5 second/passenger for low-floor buses.

<sup>2</sup> Pre-payment includes no fare, bus pass, free transfer, and pay-on-exit.

<sup>3</sup> The dwell times in the upper two-thirds of the table are reduced to these percentages as door channels are added. For example, adding a single-channel rear door to a bus that currently has one boarding channel can reduce dwell time to 60% of the current dwell time. These percentages assume fares are prepaid and can be applied to boarding or alighting.

SOURCE: *Transit Capacity and Quality of Service Manual (8)*, Exhibits 4-2 and 4-3

**EXHIBIT 5-8 Cost and Travel Time Savings of Various BRT Running Way Options**

Running Way Option	Cost per Mile (millions)	Time Savings per Mile (minutes)	Cost per Minute Saved (millions)
Partially grade-separated busway	\$13.00	4.30	\$3.00
At-grade busway	\$5.00	3.60	1.40
Median arterial busway	\$4.00	1.50	2.70
Bus lane (rebuilt)	\$2.50	1.10*	2.30
Bus lane (re-striped)	\$0.10	1.10*	0.09
Queue bypass (add lane)	\$0.30*	0.10	3.00
Curb extension	\$0.24	0.27	0.90
TSP	\$0.12	0.33	0.40

\* May be 0.5 to 0.7 minutes/mile for higher bus operating speeds

NOTE: The base condition is a running speed of 10 mph (6 minutes/mile and 6 stations/mile).

SOURCE: Exhibit 5-4 and Exhibit 5-5

**EXHIBIT 5-9 Costs and Travel Time Savings of Preferential Treatments**

Treatment	Approaches per Mile	Cost/Installation (millions)	Cost/Mile (millions)	Time Savings/Unit (seconds)	Time Savings/Mile (seconds)
Queue bypass (with construction)	1	\$0.30	\$0.30	6	6
Curb extension	4	\$0.06	\$0.40	4	16
TSP	4	\$0.03	\$0.12	3	20

SOURCE: Exhibit 5-8 and project profiles

## Analysis Steps and Procedures

Key analysis steps in estimating the costs and effects of various BRT options are shown in Exhibit 5-10 and Exhibit 5-11. These steps should be applied, as appropriate, to BRT and local bus services in the same corridor. The steps are the following:

1. Define base conditions.
2. Define future conditions with BRT.
3. Estimate travel time savings.
4. Allocate base corridor ridership to BRT and other services (this reflects diverted riders from other base transit routes).
5. Estimate ridership gains from travel time savings.
6. Estimate ridership effects of improved service frequencies (where applicable).
7. Obtain the total BRT riders by adding the results of Steps 5 and 6.
8. Estimate the additional BRT riders from BRT features (this reflects new BRT riders).
9. Estimate the total base year BRT riders by adding the results of Steps 7 and 8.
10. Develop an initial estimate of BRT fleet requirements.
11. Estimate the effects of growth (including added fleet requirements).
12. Estimate the development costs of various BRT features.

The "ridership" shown in Exhibit 5-11 reflects BRT riders diverted from existing bus routes in the BRT corridor. The "enhanced ridership" includes BRT trips diverted from automobiles and new trips.

Where comprehensive surveys are not available (or where the BRT route is to be overlaid on local bus service), route ridership data can be used in conjunction with relative BRT and local bus travel times to divert riders to BRT. An on-board rider survey is desirable to provide detailed information on passenger origins and destinations and boarding/alighting patterns. The "new" riders are estimated by increasing ridership estimates based on elasticities to account for special BRT features.

The application of these steps in analyzing and comparing BRT options is straightforward. Some general guidelines are as follows.

### *Define Base Conditions*

The existing conditions in the proposed BRT corridor should be clearly defined. These include route structure, service frequencies, stop spacing and dwell times, travel times, and ridership. Travel times should be developed for each section or segment where operating characteristics differ (e.g., CBD and other). Average daily conditions are a point of departure; where possible, conditions should be defined for peak and off-peak conditions.

There are 12 key steps in analyzing the cost and effects of BRT options.

On-board rider surveys are valuable for identifying BRT rider travel patterns.

*Bus Rapid Transit Practitioner's Guide*

**EXHIBIT 5-10 Key BRT Assessment Steps**

Step	Items to Analyze
1. Define base conditions.	A. Existing bus services B. Existing travel times C. Existing ridership
2. Define future conditions.	A. Type of running ways B. Station types and spacing C. Vehicle type and door configuration D. Method of fare collection E. Transit priority treatments
3. Estimate travel time savings.	A. BRT B. Other bus services
4. Allocate base corridor riders to BRT and local services.	A. Rider survey to identify origin-to-destination patterns and preferences B. Relative travel times of various services
5. Estimate ridership gains from travel time savings (for BRT and other services).	A. Effects of running way type B. Effects of station spacing and dwell times C. Effects of priority treatments
6. Estimate ridership gains from improved frequency.	A. Greater frequency on BRT routes B. BRT riders who save time by taking first bus on combined BRT-local route
7. Subtotal ridership from Steps 5 and 6.	
8. Estimate additional ridership from BRT features.	A. Features on BRT route
9. Estimate total base year riders (Step 7 + Step 8).	
10. Estimate BRT fleet requirements.	A. Peak-hour peak direction riders in maximum load section B. Vehicle type, size, and passenger capacity C. Round-trip vehicle travel time (including schedule recovery) D. Provision for spares
11. Estimate effects of growth.	A. Population and employment growth in BRT corridor
12. Estimate development costs of BRT components (features).	

*Define Future Conditions*

The proposed BRT alignment and types of running ways should be established. The station types, station locations, frequencies, vehicle types and door configurations, methods of fare collection, and (in turn) station dwell times should be identified. Transit priority treatments that may improve BRT, and, in some cases, local bus performance, should be indicated. Initial BRT service frequencies should be established (generally not more than 10- to 12-minute headways). Changes in route structure in the corridor should be identified.

*Estimate Travel Time Savings*

The travel times for BRT service should be estimated taking into account the anticipated service pattern, future station spacing and dwell times, running way types, and transit preferential treatments. Travel time savings for local buses using priority lanes and other treatments also should be estimated. The travel time savings should be estimated based on the following order:

- Type of running way
- Station spacing/dwell times
- Transit priority treatments

BRT travel times are based on station spacing, dwell time, type of running way, and transit preferential treatments.

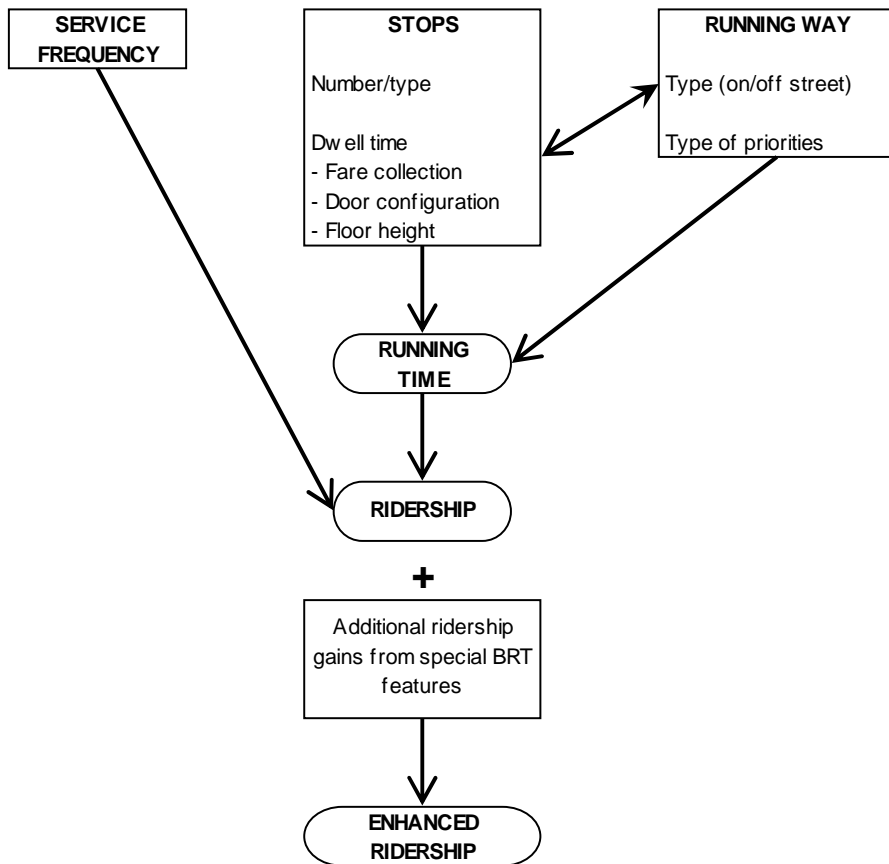

NOTE: Additional ridership from population and economic growth

EXHIBIT 5-11 BRT Ridership Analysis Concept

*Allocate Base Ridership to BRT and Local Bus Service*

The method of allocating existing bus riders to BRT and local bus service in the BRT corridor will depend on (1) where BRT will operate and (2) whether it replaces an existing service.

When BRT replaces a single local service, all base ridership can be allocated to the BRT service. Where BRT will operate in the same corridor as local service, the existing ridership can be allocated based on boarding and alighting patterns. An approximately equal division between the two services provides a reasonable default value. Alternatively, the ridership allocation can be based on judgment, based on the division of ridership equally between both services, or (preferably) based upon origin-to-destination surveys, boarding and alighting patterns, market research, and/or relative travel times. (See Chapter 3 and Exhibit 3-18 for further discussion.) Where BRT will operate on a new alignment, the allocation should be based on a conventional demand modeling process wherever data are available.

Existing experience with BRT and limited-stop bus service on city streets indicates that both services often operate at about the same frequencies. Thus, equal headways are desirable at major boarding points such as downtown areas.

An *initial* allocation of riders between BRT and other services is necessary.



*Estimate BRT Ridership*

BRT ridership for the base (and future) years should be estimated through the traditional trip generation, trip distribution, mode split, and trip assignment process wherever BRT will run on a new alignment such as a busway. The alternative is to apply elasticity methods or use an incremental logit model (pivot-point procedure).

For situations where BRT operates on the same street with local bus service, elasticity methods may be appropriate. Typical travel time elasticity values of -0.3 to -0.5 can be used. (A value of -0.4 is used in subsequent examples. Similarly, a service frequency elasticity value of +0.4 was used.)

Ridership based upon travel time elasticities should be calculated first, followed by application of service frequency elasticities as appropriate. Calculations should use the midpoint arc elasticity equation (Equation 3-8) shown in Chapter 3. (See Chapter 3 for more details.)

Additional BRT ridership may result from providing various BRT features such as busways, specially delineated bus lanes, attractive stations, modern stylized vehicles, and passenger information systems. Accordingly, the base ridership should be increased up to 25% depending upon the extent of these features. Where a conventional modeling process is used, a travel time bias constant up to 10 minutes of in-vehicle travel time can be used. These adjustments account for the new, previously non-transit, trips that would be attracted to BRT.

*Estimate Fleet Requirements*

Peak BRT vehicle requirements (an input to cost estimates) can be obtained by converting the daily line ridership to peak-hour peak-direction riders at the maximum load section. These computations will depend upon the nature of the route, the likely turnover of passengers, the round-trip running times, vehicle size, and established loading standards. The basic relationships are as follows:

$$P = \frac{\text{Daily Riders}}{\text{Turnover}} \times \% \text{ in Peak Hour} \times \% \text{ in Peak Direction} \quad (5-1)$$

In Equation 5-1, *P* = peak-hour peak-direction passengers in the maximum load section. Turnover ranges from about 1.2 to 2.0 passengers per bus depending on the route structure and areas served. (Turnover is essentially the inverse of the ratio between the riders at the maximum load section and the daily ridership on a bus route.)

The peak-hour peak-direction factor is about 0.05 to 0.07 (with 0.06 assumed for the purposes of this chapter). The number of buses in the maximum load section needs to carry the maximum volume of peak-hour passengers, *n*, which is equivalent to:

$$n = \frac{P}{\text{Passenger Spaces per Bus}} \quad (5-2)$$

In Equation 5-2, 50 passenger spaces per bus is assumed for regular buses and 60 passenger spaces per bus is assumed for articulated buses.

The peak headway is 60 divided by the number of buses per hour (*n*). The fleet requirement equals:

$$\frac{\text{Round Trip Running Time} + \text{Layover Recovery Time}}{\text{Peak Headway}} + \text{Spares} \quad (5-3)$$

Daily ridership should be translated into peak-hour peak-direction ridership in the maximum load section. From this number, the necessary headway and fleet requirements can be computed.

There usually should be at least two to three spare vehicles, or 10 to 20 percent of the fleet, whichever is greater.

#### *Estimate Effects of Growth*

BRT ridership can be expected to grow in future years as a result of population and employment growth and greater acceptance of the BRT service. Ridership estimates, therefore, are desirable for (1) several years after BRT ridership has stabilized and (2) future years, especially where major capital investments are involved. Fleet requirements should be adjusted accordingly. These estimates should be based on each community's experience and projections.

#### *Estimate System Development Costs*

BRT development costs should be estimated based upon (1) local experience and (2) the values shown in Exhibit 5-4. They will, of course, vary depending upon the type and extent of BRT features. They should be estimated for each BRT feature and then aggregated. Example applications of these features are set forth in the following section.

### **EXAMPLE BRT DEVELOPMENT SCENARIOS**

This section analyses the effects and costs of six different BRT scenarios. It describes each scenario, analyzes its travel time and ridership changes, and estimates its costs. Finally, the results of the six scenarios are compared and assessed.

In many respects, the six scenarios represent an alternatives analysis of the candidate corridor. Costs and effects are based on the values contained in earlier sections of the chapter. Agencies should use locally observed values wherever available.

#### **Context and Assumptions**

The following assumptions underlie the analysis of each scenario.

1. The BRT route is 15 miles long—1 mile in the CBD and 14 miles in outlying areas. Buses operate in mixed traffic unless otherwise specified.
2. The existing bus speeds are 6 mph in the CBD (1 mile) and 10 mph elsewhere (14 miles). This translates into a 94-minute one-way travel time.
3. Existing daily ridership in the corridor for the six scenarios were assumed to range from 16,000 to 20,000.
4. Where the BRT and local service would run on the same street, the initial base ridership was allocated equally between BRT and local services. Initial allocations between BRT and local bus only include diverted riders.
5. The BRT headway does not exceed 10 minutes.
6. The BRT layover is 10 minutes.
7. The daily riders in the maximum load section were estimated by dividing the daily ridership by the "turnover." The turnover ranged from 1.2 to 1.8. (Thus, a daily ridership of 12,000 would have 6,700 to 10,000 passengers at the maximum load section.) The lower values were used for busways with the CBD at one end of the route; the higher values were used for the CBD centrally located along an arterial street.
8. The peak-hour peak-direction ridership was assumed to be 6% of the daily riders in the maximum load section.

This guide presents six BRT development scenarios to show how costs and effects of BRT can be estimated.

Agencies should use locally observed values in assessing their BRT services.

Several assumptions are inherent in the six scenarios.

---

*Bus Rapid Transit Practitioner's Guide*

9. Sixty spaces per bus were assumed for each scenario (articulated buses).
10. Anticipated BRT ridership and fleet requirements for each scenario were developed for the base year. They should be adjusted, as appropriate, to reflect likely future growth.
11. Cost estimates were based on the values set forth in Exhibit 5-4.

The scenarios are straightforward and enable comparison of costs and effects of various BRT features. They use several simplifying assumptions to facilitate computations:

- The scenarios assume a single daily value of travel time and ridership. In practice, it is desirable to look at peak- and off-peak travel times and ridership in assessing BRT. The effects of traffic signal timing on bus speeds could be used to refine the travel time savings and their relation to ridership. Both BRT and local bus ridership would be built from the ground up on a segment-by-segment basis.
- The scenarios use service elasticities. Incremental logit models can be used where detailed travel patterns and network information is available.
- Assumptions were made regarding the allocation of base ridership between local service and BRT. The assumptions differed by scenario. The effects of other allocations can be assessed by iterating the procedure.
- It was assumed that BRT stations would be placed at the locations of major passenger attraction, thus accounting for a large portion of existing ridership. Experience indicates that relatively few stations can account for most of a line's ridership.

Daily BRT riders reflect diverted and new trips. Rider surveys in conjunction with street, bus route, and land use patterns will influence the assignment of diverted riders to the BRT system. Stated preference surveys could provide further insight into desirable BRT features and their ridership impacts. In most cases, local bus service parallels BRT to serve short trips and trips where the origin or destination is beyond a convenient walking distance from a BRT station.

For each scenario, the following exhibits were prepared:

- A diagram that describes the scenario
- A table that provides the assumptions for the scenario
- A table that describes each step in the analysis procedure
- A table that gives estimated development costs for each BRT feature

The following six scenarios were analyzed:

- Grade-separated busway (Exhibit 5-12)
- At-grade busway (Exhibit 5-16)
- At-grade busway and median arterial busway (Exhibit 5-20)
- Bus lanes and TSP (Exhibit 5-24)
- Bus lanes only (Exhibit 5-28)
- TSP only (Exhibit 5-32)

The six BRT development scenarios show the effects of various running way types and station spacings.

**Scenario 1: Grade-Separated Busway Connecting CBD to Park-and-Ride Lot**

The description and assumptions for this scenario are shown in Exhibit 5-12 and Exhibit 5-13. Exhibit 5-14 describes the detailed analysis and Exhibit 5-15 gives the estimated costs by BRT feature.

A 14-mile grade-separated busway with 10 stations connects with a 1-mile curbside bus lane in the CBD with three stations. Specialized, articulated BRT vehicles would be used. Fare collection would be off the vehicle. The local bus route would remain on city streets.

The BRT route would have the following effects:

- Reduce the number of stops from 90 to 13
- Reduce the one-way running time from 94 to 29 minutes
- Increase the daily BRT ridership from 10,000 to almost 18,000

Development costs for Scenario 1 were estimated at \$242.0 million.

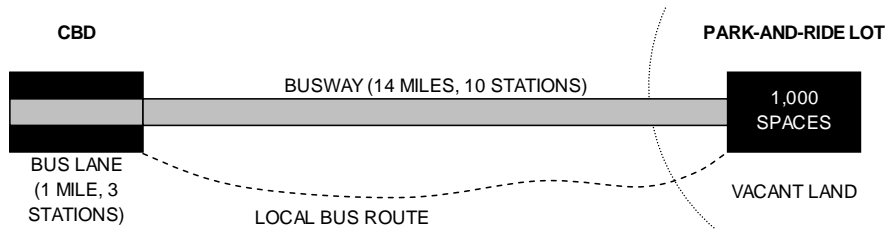

**EXHIBIT 5-12 BRT Development Scenario 1: Grade-Separated Busway**

**EXHIBIT 5-13 Key Assumptions of BRT Development Scenario 1**

Feature	Existing Service (Base)	Computed Results	
		Local	BRT
Daily Ridership	20,000	10,000	17,661
Stops	90	90	13
Dwell/Stop	15 sec	15 sec	20 sec <sup>1</sup> 10-15 sec <sup>2</sup>
Frequency	8 min	10-min minimum	4 min
Speed	6 mph CBD; 10 mph elsewhere	9.8 mph	31 mph <sup>2</sup>
One-Way Travel Time	94 min	92 min	29 min
Fare Collection	On board	On board	On board
Vehicle	Conventional	Conventional	Specialized
Passenger Information			
Stations	No	No	Yes
Vehicles	No	No	Yes
Branding	No	No	Yes
Development Potential	N/A	At outer end	At outer end
Development Costs	N/A	N/A	\$242.0 million

<sup>1</sup> The 20-second dwell time for BRT assumes no change in fare collection or door channels available, in comparison to the existing service. The 20-second dwell time for BRT is higher than the dwell time for local bus because BRT has fewer stops and higher passenger boardings.

<sup>2</sup> With off-vehicle fare collection and multi-door boarding

*Bus Rapid Transit Practitioner's Guide*

**EXHIBIT 5-14 Analysis - Scenario 1**

Item	Analysis
Travel times	<p>Existing Condition:</p> <ul style="list-style-type: none"> <li>▪ 1 mi at 6 mph (10 min/mi) = 10 min (CBD mixed traffic)</li> <li>▪ 14 mi at 10 mph (6 min/mi) = 84 min (mixed traffic)</li> <li>▪ Total travel time = 94 min</li> </ul> <hr/> <p>Proposed Condition 1 - Local:</p> <ul style="list-style-type: none"> <li>▪ 1 mi (CBD) at 8 min/mi = 8 min                             <ul style="list-style-type: none"> <li>▫ Start with 6-mph speed</li> <li>▫ 1.5-mph gain due to bus lane speeds</li> <li>▫ Net speed = 7.5 mph = 8 min/mi</li> </ul> </li> <li>▪ 14 mi at 10 mph (6 min/mi) = 84 min (on local streets)</li> <li>▪ Total travel time = 92 min</li> </ul> <hr/> <p>Proposed Condition 2 - BRT:</p> <ul style="list-style-type: none"> <li>▪ 1 mi (CBD) at 7 min/mi = 7 min                             <ul style="list-style-type: none"> <li>▫ Start with 6-mph speed</li> <li>▫ 1.5-mph (2 min/mi) gain from CBD bus lane</li> <li>▫ 1.1-mph (1 min/mi) gain from fewer stops (only 3 in CBD)</li> <li>▫ Net speed = 8.6 mph = 7 min/mi</li> </ul> </li> <li>▪ 14 mi at 38 mph (1.58 min/mi) = 22 min (busway)                             <ul style="list-style-type: none"> <li>▫ 50-mph busway running speed</li> <li>▫ 10 stops at 1.4 mi/stop</li> <li>▫ For 1.5 mi between stops, 15-sec dwell = 38 mph*</li> <li>▫ Net speed = 38 mph = 1.58 min/mi</li> </ul> </li> <li>▪ Total travel time = 29 min (overall average speed 31 mph)</li> </ul> <hr/> <p>If the BRT scenario uses on-vehicle fare collection, assume a dwell of 20 sec/stop, or 37 mph. This translates to 30 min for the total trip. The average speed for the total trip is then 35 mph.</p>
Ridership estimates	<p>Assumed initial allocation of base riders:</p> <ul style="list-style-type: none"> <li>▪ BRT: 10,000 riders and 10-min maximum headway</li> <li>▪ Local: 10,000 riders and 10-min minimum headway</li> </ul> <p>The preferred method of estimating BRT and local bus ridership is using the four-step model (trip generation, trip distribution, mode split, and trip assignment) and applying incremental logit models. An alternative method using elasticities is described below.</p> <hr/> <p>1. Apply travel time elasticity factors to BRT:</p> $R_2 = \frac{(E - 1)T_1R_1 - (E + 1)T_2R_1}{(E - 1)T_2 - (E + 1)T_1}$ <p>where <math>R_1</math> = initial ridership, <math>R_2</math> = anticipated ridership, <math>T_1</math> = initial travel times, <math>T_2</math> = travel times with BRT, and <math>E</math> = travel time elasticity factor = -0.4.</p> $R_2 = \frac{(-1.4 \times 94 \times 10,000) - (0.6 \times 29 \times 10,000)}{(-1.4 \times 29) - (0.6 \times 94)} = 15,361$

	<p>2. Estimate additional ridership generated by BRT features.</p> <p>Weights applied to up to 25% increase in base ridership are obtained from elasticity computations. (See Exhibit 3-22 for details.)</p> <table border="1"> <thead> <tr> <th><u>Component</u></th> <th><u>Percentage</u></th> </tr> </thead> <tbody> <tr> <td>Running Way</td> <td>20%</td> </tr> <tr> <td>Stations</td> <td>12%</td> </tr> <tr> <td>Vehicles (normal floor boarding)</td> <td>10%</td> </tr> <tr> <td>Service pattern</td> <td>15%</td> </tr> <tr> <td>ITS (assumed)</td> <td>10%</td> </tr> <tr> <td>Branding</td> <td>10%</td> </tr> <tr> <td><i>Subtotal</i></td> <td><i>77%</i></td> </tr> <tr> <td>BRT component synergy</td> <td>15%</td> </tr> <tr> <td><i>Total</i></td> <td><i>92%</i></td> </tr> </tbody> </table> <p>The 92% applies to an increase in base ridership of 25% beyond that obtained by elasticities. <math>0.92 \times 25\% = 23\%</math>.</p> <p>Anticipated additional BRT ridership = <math>10,000 \times 23\% = 2,300</math>.</p> <p>Total anticipated BRT ridership in the base year = <math>15,361 + 2,300 = 17,661</math>.</p>	<u>Component</u>	<u>Percentage</u>	Running Way	20%	Stations	12%	Vehicles (normal floor boarding)	10%	Service pattern	15%	ITS (assumed)	10%	Branding	10%	<i>Subtotal</i>	<i>77%</i>	BRT component synergy	15%	<i>Total</i>	<i>92%</i>
<u>Component</u>	<u>Percentage</u>																				
Running Way	20%																				
Stations	12%																				
Vehicles (normal floor boarding)	10%																				
Service pattern	15%																				
ITS (assumed)	10%																				
Branding	10%																				
<i>Subtotal</i>	<i>77%</i>																				
BRT component synergy	15%																				
<i>Total</i>	<i>92%</i>																				
Fleet requirements	<p>Peak-hour peak-direction riders in the maximum load section (<math>P</math>):</p> $P = \frac{\text{Daily Riders}}{\text{Turnover}} \times \% \text{ in Peak Hour} \times \% \text{ in Peak Direction}$ <p>Turnover is assumed to be 1.20. (The BRT line extends on only one side of the CBD.)</p> $P = \frac{17,661}{1.20} (10\%) (60\%) = 883$ <p>At 60 passengers per bus, 15 buses are needed in the maximum load section (with 4-minute headways).</p> <p>BRT vehicles needed:</p> $\frac{\text{Round Trip Running Time} + \text{Layover Time}}{\text{Headway}} = \frac{58 + 10}{4} = 17$ <p>Add 4 spares to get 21 buses.</p>																				
Estimated costs	See Exhibit 5-15.																				

\* From *Transit Capacity and Quality of Service Manual (8)*, Exhibit 4-47

*Bus Rapid Transit Practitioner's Guide*

**EXHIBIT 5-15 Estimated Development Costs - Scenario 1**

Item	Units	Unit Cost	Total Cost
Busway	14 miles	\$13 million/mile	\$182 million
Bus lane	1 mile	\$100,000/mile	\$100,000
Stations - busway	10 stations	\$2.5 million/station	\$25 million
Stations - CBD	3 stations	\$60,000/station	\$180,000
Passing lane	2 lane-miles <sup>1</sup>	\$2.7 million/lane-mile	\$5.4 million
Specialized, articulated BRT vehicles	21 vehicles	\$1.3 million/vehicle	\$27.3 million
Off-board fare collection	28 ticket vending machines <sup>2</sup>	\$65,000/machine	\$1.8 million
Station information	26 locations <sup>3</sup>	\$6,000/location	\$156,000
Vehicle information	21 vehicles	\$4,000/vehicle	\$84,000
Total (2004 dollars)			\$242.0 million

<sup>1</sup> (10 stations x 2 directions) at 0.1 mile each

<sup>2</sup> Two per station plus two additional machines

<sup>3</sup> 13 stations x 2 locations/station

NOTE: Excludes park-and-ride lot costs

**Scenario 2: At-Grade Busway**

The description and assumptions for this scenario are shown in Exhibit 5-16 and Exhibit 5-17. Exhibit 5-18 describes the detailed analysis, and Exhibit 5-19 gives the estimated costs by BRT feature.

An at-grade busway extends for 7 miles on each side of the city center. The two busways are connected by bus lanes on one mile of downtown streets. Specialized, articulated BRT vehicles would be used. Fare collection would occur off of the vehicle. The local bus route would remain on city streets.

The BRT service would have the following effects:

- Reduce the number of stops from 90 to 17
- Reduce the one-way running time from 94 to 43 minutes
- Increase the daily BRT ridership from 10,000 to 15,699

Development costs for Scenario 2 were estimated at \$109.4 million.

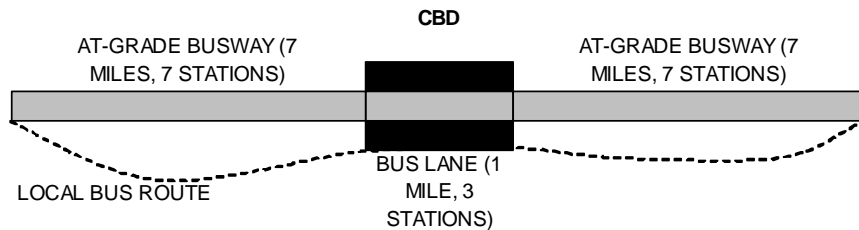

**EXHIBIT 5-16 BRT Development Scenario 2**

**EXHIBIT 5-17 Key Assumptions of BRT Development Scenario 2**

Feature	Existing Service (Base)	Computed Results	
		Local	BRT
Daily Ridership	20,000	10,000	15,699
Stops	90	90	17
Dwell/Stop	15 sec	15 sec	20 sec <sup>1</sup> 10-15 sec <sup>2</sup>
Frequency	8 min	10-min minimum	6 min
Speed	6 mph CBD; 10 mph elsewhere	9.8 mph	20.9 mph <sup>2</sup>
One-Way Travel Time	94 min	92 min	43 min
Fare Collection	On board	On board	On board
Vehicle	Conventional	Conventional	Specialized
TSP	No	No	Along busway
Passenger Information			
Stations	No	No	Yes
Vehicles	No	No	Yes
Branding	No	No	Yes
Development Costs	N/A	N/A	\$109.4 million

<sup>1</sup> The 20-second dwell time for BRT assumes no change in fare collection or door channels available, in comparison to the existing service. The 20-second dwell time for BRT is higher than the dwell time for local bus because BRT has fewer stops and higher passenger boardings.

<sup>2</sup> With off-vehicle fare collection and multi-door boarding

**EXHIBIT 5-18 Analysis - Scenario 2**

Item	Analysis
Travel times	<p>Existing Condition:</p> <ul style="list-style-type: none"> <li>▪ 1 mi at 6 mph (10 min/mi) = 10 min (CBD mixed traffic)</li> <li>▪ 14 mi at 10 mph (6 min/mi) = 84 min (mixed traffic)</li> <li>▪ Total travel time = 94 min</li> </ul> <hr/> <p>Proposed Condition 1 - Local:</p> <ul style="list-style-type: none"> <li>▪ 1 mi (CBD) at 8 min/mi = 8 min                             <ul style="list-style-type: none"> <li>▫ Start with 6-mph speed</li> <li>▫ 1.5-mph gain due to bus lane speeds</li> <li>▫ Net speed = 7.5 mph = 8 min/mi</li> </ul> </li> <li>▪ 14 mi at 10 mph (6 min/mi) = 84 min (on local streets)</li> <li>▪ Total travel time = 92 min</li> </ul> <hr/> <p>Proposed Condition 2 - BRT:</p> <ul style="list-style-type: none"> <li>▪ 1 mi (CBD) at 7 min/mi = 7 min                             <ul style="list-style-type: none"> <li>▫ Start with 6-mph speed</li> <li>▫ 1.5-mph (2 min/mi) gain from CBD bus lane</li> <li>▫ 1.1-mph (1 min/mi) gain from fewer stops (only 3 in CBD)</li> <li>▫ Net speed = 8.6 mph = 7 min/mi</li> </ul> </li> <li>▪ 14 mi at 22 mph (2.7 min/mi) = 38 min (busway)                             <ul style="list-style-type: none"> <li>▫ 2.7 min/mi is the initial speed for L.A.'s Orange Line busway</li> <li>▫ TSP time saving, 28 locations at 5 sec/intersection = 140 sec, or 2 min (rounded)</li> </ul> </li> <li>▪ Total travel time = 43 min (overall average speed 20.9 mph)</li> </ul>
Ridership estimates	<p>Assumed initial allocation of base riders:</p> <ul style="list-style-type: none"> <li>▪ BRT: 10,000 riders and 10-min maximum headway</li> <li>▪ Local: 10,000 riders and 10-min minimum headway</li> </ul> <p>The preferred method of estimating BRT and local bus ridership is using the four-step model and applying incremental logit models. An alternative method using elasticities is described below.</p>



*Bus Rapid Transit Practitioner's Guide*

	<p>1. Apply travel time elasticity factors to BRT:</p> $R_2 = \frac{(E-1)T_1R_1 - (E+1)T_2R_1}{(E-1)T_2 - (E+1)T_1}$ <p>where <math>R_1</math> = initial ridership, <math>R_2</math> = anticipated ridership, <math>T_1</math> = initial travel times, <math>T_2</math> = travel times with BRT, and <math>E</math> = travel time elasticity factor = -0.4.</p> $R_2 = \frac{(-1.4 \times 94 \times 10,000) - (0.6 \times 43 \times 10,000)}{(-1.4 \times 43) - (0.6 \times 94)} = 13,499$ <p>Since the BRT service is on a new alignment, there would be no increase in frequency that would allow application of service frequency elasticities.</p> <p>2. Estimate additional ridership generated by BRT features.</p> <p>Weights applied to up to 25% increase in base ridership are obtained from elasticity computations. (See Exhibit 3-22 for details.)</p> <table border="1" data-bbox="657 609 1385 871"> <thead> <tr> <th>Component</th> <th>Percentage</th> </tr> </thead> <tbody> <tr> <td>Running Way</td> <td>15%</td> </tr> <tr> <td>Stations</td> <td>12%</td> </tr> <tr> <td>Vehicles (normal floor boarding)</td> <td>10%</td> </tr> <tr> <td>Service pattern</td> <td>15%</td> </tr> <tr> <td>ITS (assumed)</td> <td>10%</td> </tr> <tr> <td>Branding</td> <td>10%</td> </tr> <tr> <td><i>Subtotal</i></td> <td><i>72%</i></td> </tr> <tr> <td>BRT component synergy</td> <td>15%</td> </tr> <tr> <td><i>Total</i></td> <td><i>87%</i></td> </tr> </tbody> </table> <p>The 87% applies to an increase in base ridership of 25% beyond that obtained by elasticities. <math>0.87 \times 25\% = 22\%</math>.</p> <p>Anticipated additional BRT ridership = <math>10,000 \times 22\% = 2,200</math>.</p> <p>Total anticipated BRT ridership in the base year = <math>13,499 + 2,200 = 15,699</math>.</p>	Component	Percentage	Running Way	15%	Stations	12%	Vehicles (normal floor boarding)	10%	Service pattern	15%	ITS (assumed)	10%	Branding	10%	<i>Subtotal</i>	<i>72%</i>	BRT component synergy	15%	<i>Total</i>	<i>87%</i>
Component	Percentage																				
Running Way	15%																				
Stations	12%																				
Vehicles (normal floor boarding)	10%																				
Service pattern	15%																				
ITS (assumed)	10%																				
Branding	10%																				
<i>Subtotal</i>	<i>72%</i>																				
BRT component synergy	15%																				
<i>Total</i>	<i>87%</i>																				
Fleet requirements	<p>Peak-hour peak-direction riders in the maximum load section (<math>P</math>):</p> $P = \frac{\text{Daily Riders}}{\text{Turnover}} \times \% \text{ in Peak Hour} \times \% \text{ in Peak Direction}$ <p>Turnover is assumed to be 1.80. (The BRT line extends on both sides of the CBD.)</p> $P = \frac{15,699}{1.80} (10\%) (60\%) = 523$ <p>At 60 passengers per bus, 9 to 10 buses are needed in the maximum load section (with approximate 6-minute headways).</p> <p>BRT vehicles needed:</p> $\frac{\text{Round Trip Running Time} + \text{Layover Time}}{\text{Headway}} = \frac{86 + 10}{6} = 16$ <p>Add 4 spares to get 20 buses.</p>																				
Estimated costs	See Exhibit 5-19.																				

**EXHIBIT 5-19 Estimated Development Costs - Scenario 2**

Item	Units	Unit Cost	Total Cost
Busway	14 miles	\$5 million/mile	\$70.0 million
Bus lane	1 mile	\$100,000/mile	\$100,000
Stations - busway	14 stations	\$150,000/station	\$2.1 million
Stations - CBD	3 stations	\$60,000/station	\$180,000
Passing lanes	2.8 lane-miles <sup>1</sup>	\$2.7 million/lane-mile	\$7.6 million
Specialized, articulated BRT vehicles	20 vehicles	\$1.3 million/vehicle	\$26.0 million
Off-board fare collection	36 ticket vending machines <sup>2</sup>	\$65,000/machine	\$2.3 million
Station information	34 locations <sup>3</sup>	\$6,000/location	\$204,000
Vehicle information	20 vehicles	\$4,000/vehicle	\$80,000
TSP	28 intersections	\$30,000/intersection	\$840,000
Total (2004 dollars)			\$109.4 million

<sup>1</sup> (14 stations x 2 directions) at 0.1 mile each

<sup>2</sup> Two per station plus two additional machines

<sup>3</sup> 17 stations x 2 locations/station

**Scenario 3: At-Grade Busway and Median Arterial Busway**

The description and assumptions for this scenario are shown in Exhibit 5-20 and Exhibit 5-21. Exhibit 5-22 describes the detailed analysis, and Exhibit 5-23 gives the estimated development costs for various BRT features.

A one-mile pair of downtown bus lanes connects with a 5-mile median arterial busway, a 5-mile at-grade busway, and 4 miles of mixed-traffic operations. Stylized, articulated buses would be operated, and fare collection would be off the vehicle. TSP would be provided at signalized intersections outside the CBD. The BRT service would replace the local bus service, which has a base daily ridership of 20,000.

The BRT service would have the following effects:

- Reduce the number of stops from 90 to 22
- Reduce the one-way running time from 94 to 47.9 minutes
- Increase the daily ridership from 20,000 to 33,022

If the base ridership were 10,000, the BRT ridership would be 16,511. Development costs for Scenario 3 were estimated at \$84.3 million.

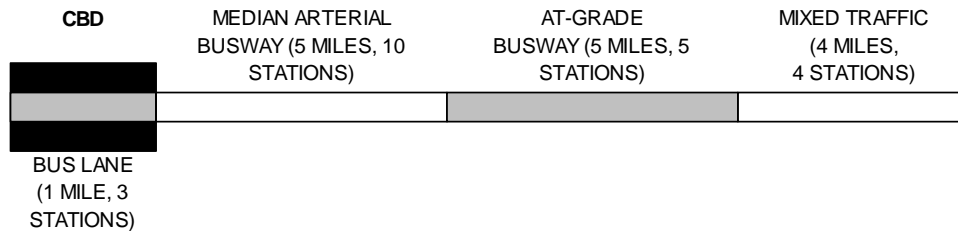

**EXHIBIT 5-20 BRT Development Scenario 3**

*Bus Rapid Transit Practitioner's Guide*

**EXHIBIT 5-21 Key Assumptions of BRT Development Scenario 3**

Feature	Existing Service (Base)	Computed Results (BRT)
Daily Ridership	20,000	33,022
Stops	90	22
Dwell/Stop	15 sec	20 sec <sup>1</sup> 10-15 sec <sup>2</sup>
Frequency	8 min	3 min
Speed	6 mph CBD; 10 mph elsewhere	18.8 mph
One-Way Travel Time	94 min	47.9 min
Fare Collection	On board	Off board
Vehicle	Conventional	Stylized, articulated
TSP	No	Yes
Passenger Information Stations	No	Yes
Vehicles	No	Yes
Branding	No	Yes
Development Costs	N/A	\$84.3 million

<sup>1</sup> The 20-second dwell time for BRT assumes no change in fare collection or door channels available, in comparison to the existing service. The 20-second dwell time for BRT is higher than the dwell time for local bus because BRT has fewer stops and higher passenger boardings.

<sup>2</sup> With off-vehicle fare collection and multi-door boarding

**EXHIBIT 5-22 Analysis - Scenario 3**

Item	Analysis
Travel times	Existing Condition: <ul style="list-style-type: none"> <li>▪ 1 mi at 6 mph (10 min/mi) = 10 min (CBD mixed traffic)</li> <li>▪ 14 mi at 10 mph (6 min/mi) = 84 min (mixed traffic)</li> <li>▪ Total travel time = 94 min</li> </ul>

	<p>Proposed Condition:</p> <ul style="list-style-type: none"> <li>▪ 1 mi (CBD) at 7 min/mi = 7 min             <ul style="list-style-type: none"> <li>▫ Start with 6-mph speed</li> <li>▫ 1.5-mph (2 min/mi) gain from CBD bus lane</li> <li>▫ 1.1-mph (1 min/mi) gain from fewer stops (only 3 in CBD)</li> <li>▫ Net speed = 8.6 mph = 7 min/mi</li> </ul> </li> <li>▪ 5 mi at 19 mph (3.13 min/mi) = 15.6 min (median arterial busway)             <ul style="list-style-type: none"> <li>▫ For 2 stations/mi and 20-sec dwell, using Exhibit 4-56 of TC&amp;QSM (<math>\theta</math>) results in a base speed of 2.73 min/mi</li> <li>▫ Add 0.7 min/mi for traffic delay from Exhibit 4-57 of TC&amp;QSM (<math>\theta</math>)</li> <li>▫ Subtract 0.3 min/mi for TSP (5 sec/signal for 4 signals/mi)</li> <li>▫ Net speed = 19 mph = 3.13 min/mi</li> </ul> </li> <li>▪ 5 mi at 22.6 mph (2.66 min/mi) = 13.3 min (at-grade busway)             <ul style="list-style-type: none"> <li>▫ For 2 stations/mi and 20-sec dwell, using Exhibit 4-56 and Exhibit 4-57 of TC&amp;QSM (<math>\theta</math>) results in a base speed of 2.73 min/mi</li> <li>▫ Busway has 1 station/mi, so subtract 0.6 min/mi for one less stop, acceleration, and deceleration based on Exhibit 5-6 of this Guide</li> <li>▫ Add 0.7 min/mi for traffic delay from Exhibit 4-57 of TC&amp;QSM (<math>\theta</math>)</li> <li>▫ Subtract 0.17 min/mi (5 sec/signal for 2 signals/mi) for TSP</li> <li>▫ Net speed = 2.66 min/mi = 22.6 mph</li> </ul> </li> <li>▪ 4 mi at 20 mph (3.0 min/mi) = 12 min (mixed traffic)             <ul style="list-style-type: none"> <li>▫ With 2 stations/mi and 20-sec dwell, using Exhibit 4-56 of TC&amp;QSM (<math>\theta</math>) results in a base speed of 2.73 min/mi</li> <li>▫ Busway has 1 station/mi, so subtract 0.6 min/mi for one less stop, acceleration, and deceleration based on Exhibit 5-6 of this Guide</li> <li>▫ Add 1.2 min/mi for traffic delay from Exhibit 4-57 of TC&amp;QSM (<math>\theta</math>)</li> <li>▫ Subtract 0.33 min/mi (5 sec/signal for 4 signals/mi) for TSP</li> <li>▫ Net speed = 3.0 min/mi = 20 mph</li> </ul> </li> <li>▪ Total travel time = 47.9 min</li> <li>▪ Total speed = 18.8 mph</li> </ul>
--	--

The headway using existing (non-articulated) buses is 8 minutes. The BRT headway using articulated buses is 6 minutes.

Ridership estimates

It is assumed that all bus service will be BRT service.

The preferred method of estimating BRT ridership is using the four-step model and applying incremental logit models. An alternative method using elasticities is described below.

1. Apply travel time elasticity factors to BRT:

$$R_2 = \frac{(E - 1)T_1R_1 - (E + 1)T_2R_1}{(E - 1)T_2 - (E + 1)T_1}$$

where  $R_1$  = initial ridership,  $R_2$  = anticipated ridership,  $T_1$  = initial travel times,  $T_2$  = travel times with BRT, and  $E$  = travel time elasticity factor = -0.4.

$$R_2 = \frac{(-1.4 \times 94 \times 20,000) - (0.6 \times 47.9 \times 20,000)}{(-1.4 \times 47.9) - (0.6 \times 94)} = 25,974$$

2. Estimate increased ridership due to increase in service frequency ( $R_3$ ).

Elasticity (frequency) = +0.4  
 Existing 8-min headway = 7.5 buses/hour  
 Proposed 6-min headway = 10 buses/hour

$$R_3 = \frac{(-0.6 \times 7.5 \times 25,974) - (1.4 \times 10 \times 25,974)}{(-0.6 \times 10) - (1.4 \times 7.5)} = 29,122$$

*Bus Rapid Transit Practitioner's Guide*

	<p>3. Estimate additional ridership generated by BRT features.</p> <p>Weights applied to up to 25% increase in base ridership are obtained from elasticity computations. (See Exhibit 3-22 for details.)</p> <table border="1"> <thead> <tr> <th><u>Component</u></th> <th><u>Percentage</u></th> </tr> </thead> <tbody> <tr> <td>Running Way</td> <td></td> </tr> <tr> <td>    Median arterial busway (5 mi)</td> <td>(5 mi/15 mi) x 10% = 3.3%</td> </tr> <tr> <td>    At-grade busway (5 mi)</td> <td>(5 mi/15 mi) x 15% = 5%</td> </tr> <tr> <td>    Mixed traffic (4 mi)</td> <td>(4 mi/15 mi) x 0% = 0%</td> </tr> <tr> <td>    CBD bus lane (1 mi)</td> <td>(1 mi/15 mi) x 0% = 0%</td> </tr> <tr> <td>    Total</td> <td>8% (weighted average)</td> </tr> <tr> <td>Stations</td> <td>10%</td> </tr> <tr> <td>Vehicles (normal floor boarding)</td> <td>10%</td> </tr> <tr> <td>Service pattern</td> <td>15%</td> </tr> <tr> <td>ITS (assumed)</td> <td>10%</td> </tr> <tr> <td>Branding</td> <td><u>10%</u></td> </tr> <tr> <td>    <i>Subtotal</i></td> <td><u>63%</u></td> </tr> <tr> <td>BRT component synergy</td> <td><u>15%</u></td> </tr> <tr> <td>    <i>Total</i></td> <td><u>78%</u></td> </tr> </tbody> </table> <p>The 78% applies to an increase in base ridership of 25% beyond that obtained by elasticities. <math>0.78 \times 25\% = 19.5\%</math>.</p> <p>Anticipated additional BRT ridership = <math>20,000 \times 19.5\% = 3,900</math>.</p> <p>Total anticipated BRT ridership in the base year = <math>29,122 + 3,900 = 33,022</math>.</p>	<u>Component</u>	<u>Percentage</u>	Running Way		Median arterial busway (5 mi)	(5 mi/15 mi) x 10% = 3.3%	At-grade busway (5 mi)	(5 mi/15 mi) x 15% = 5%	Mixed traffic (4 mi)	(4 mi/15 mi) x 0% = 0%	CBD bus lane (1 mi)	(1 mi/15 mi) x 0% = 0%	Total	8% (weighted average)	Stations	10%	Vehicles (normal floor boarding)	10%	Service pattern	15%	ITS (assumed)	10%	Branding	<u>10%</u>	<i>Subtotal</i>	<u>63%</u>	BRT component synergy	<u>15%</u>	<i>Total</i>	<u>78%</u>
<u>Component</u>	<u>Percentage</u>																														
Running Way																															
Median arterial busway (5 mi)	(5 mi/15 mi) x 10% = 3.3%																														
At-grade busway (5 mi)	(5 mi/15 mi) x 15% = 5%																														
Mixed traffic (4 mi)	(4 mi/15 mi) x 0% = 0%																														
CBD bus lane (1 mi)	(1 mi/15 mi) x 0% = 0%																														
Total	8% (weighted average)																														
Stations	10%																														
Vehicles (normal floor boarding)	10%																														
Service pattern	15%																														
ITS (assumed)	10%																														
Branding	<u>10%</u>																														
<i>Subtotal</i>	<u>63%</u>																														
BRT component synergy	<u>15%</u>																														
<i>Total</i>	<u>78%</u>																														
<p>Vehicle requirements</p>	<p>Peak-hour peak-direction riders in the maximum load section (<i>P</i>):</p> $P = \frac{\text{Daily Riders}}{\text{Turnover}} \times \% \text{ in Peak Hour} \times \% \text{ in Peak Direction}$ <p>Turnover is assumed to be 1.50.</p> $P = \frac{33,022}{1.8} \times 10\% \times 60\% = 1,101$ <p>At 60 passengers per bus, approximately 20 buses are needed in the maximum load section (with 3-minute headways).</p> <p>BRT vehicles needed:</p> $\frac{\text{Round Trip Running Time} + \text{Layover Time}}{\text{Headway}} = \frac{95.8 + 10}{3} = 36$ <p>Add 4 spares to get 40 buses.</p>																														
<p>Estimated costs</p>	<p>See Exhibit 5-23.</p>																														

EXHIBIT 5-23 Estimated Development Costs - Scenario 3

Item	Units	Unit Cost	Total Cost
Bus lane	1 mile	\$0.5 million/mile	\$500,000
Median arterial busway	5 miles	\$4 million/mile	\$20 million
At-grade busway	5 miles	\$5 million/mile	\$25 million
Stations - CBD	3 stations	\$60,000/station	\$180,000
Stations - median arterial busway	10 stations	\$150,000/station	\$1.5 million
Stations - at-grade busway	5 stations	\$150,000/station	\$750,000
Stations - mixed traffic	4 stations	\$60,000/station	\$240,000
Passing lanes (busway)	1.0 lane-mile <sup>1</sup>	\$2.7 million/lane-mile	\$2.7 million
Stylized articulated BRT vehicles	40 vehicles	\$780,000/vehicle	\$31.2 million
Off-board fare collection	6 ticket vending machines <sup>2</sup>	\$65,000/machine	\$390,000
Station information	44 locations <sup>3</sup>	\$6,000/location	\$264,000
Vehicle information	40 vehicles	\$4,000/vehicle	\$160,000
TSP	46 intersections	\$30,000/intersection	\$1.4 million
Total (2004 dollars)			\$84.3 million

<sup>1</sup> (Five stations x two directions) at 0.1 mile each

<sup>2</sup> Two per station at three CBD locations

<sup>3</sup> 22 stations x 2 locations/station

#### Scenario 4: Bus Lanes and Transit Signal Priority

The description and assumptions for this scenario are shown in Exhibit 5-24 and Exhibit 5-25. Exhibit 5-26 describes the detailed analysis, and Exhibit 5-27 gives the estimated development costs for various BRT features.

This scenario includes 11 miles of bus lane, of which 10 miles would have specially delineated pavement. The outlying two miles on each side of the route that extends through the CBD includes operation in mixed traffic. TSP would be provided at 12 non-CBD locations. The BRT service would use stylized articulated buses with on-vehicle fare collection.

This scenario would have the following effects:

- Reduce the number of stops from 90 to 31
- Reduce one-way travel times for the BRT service from 94 to 49.7 minutes
- Daily BRT ridership would increase from 8,000 to 11,600

Local buses using the bus lanes and TSP would have their one-way running time reduced from 94 to 81 minutes. Development costs for Scenario 4 were estimated at \$40.3 million.

*Bus Rapid Transit Practitioner's Guide*

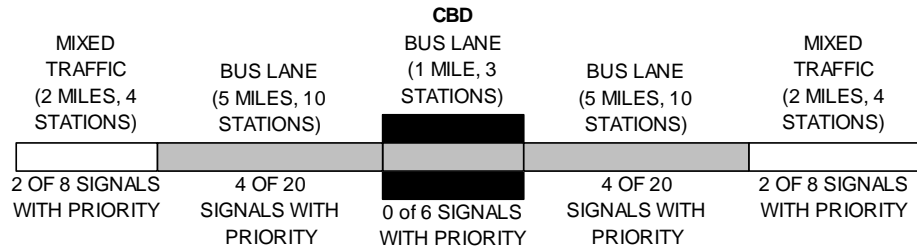

**EXHIBIT 5-24 BRT Development Scenario 4**

**EXHIBIT 5-25 Key Assumptions of BRT Development Scenario 4**

Feature	Existing Service (Base)	Computed Results	
		Local	BRT
Daily Ridership	16,000	8,490	11,600
Stops	90	90	31
Dwell/Stop	15 sec	15 sec	20 sec <sup>1</sup>
Frequency	8 min	10 min	10 min
Speed	6 mph CBD; 10 mph elsewhere	11.2 mph	18.1 mph
One-Way Travel Time	94 min	81 min	49.7 min
Fare Collection	On board	On board	On board
Vehicle	Conventional	Conventional	Stylized, articulated
Passenger Information			
Stations	No	No	Yes
Vehicles	No	No	Yes
TSP	No	No	12 signals
Development Costs	N/A	N/A	\$40.3 million

<sup>1</sup> The 20-second dwell time for BRT assumes no change in fare collection or door channels available, in comparison to the existing service. The 20-second dwell time for BRT is higher than the dwell time for local bus because BRT has fewer stops and higher passenger boardings.

**EXHIBIT 5-26 Analysis - Scenario 4**

Item	Analysis
Travel times	<p>Existing Condition:</p> <ul style="list-style-type: none"> <li>▪ 1 mi at 6 mph (10 min/mi) = 10 min (CBD mixed traffic)</li> <li>▪ 14 mi at 10 mph (6 min/mi) = 84 min (mixed traffic)</li> <li>▪ Total travel time = 94 min</li> </ul> <hr/> <p>Proposed Condition - Local:</p> <ul style="list-style-type: none"> <li>▪ Local buses would also benefit from a bus-only lane.</li> <li>▪ 1 mi (CBD) at 7 min/mi = 7 min                             <ul style="list-style-type: none"> <li>▫ Start with 6-mph speed</li> <li>▫ 1.5-mph (2 min/mi) gain from CBD bus lane</li> <li>▫ 1.1-mph (1 min/mi) gain from fewer stops (only 3 in CBD)</li> <li>▫ Net speed = 8.6 mph = 7 min/mi</li> </ul> </li> <li>▪ 10 mi at 12 mph (5 min/mi, non-CBD bus lanes) = 50 min                             <ul style="list-style-type: none"> <li>▫ Start with 10 mph = 6 min/mi</li> <li>▫ Subtract 1 min/mi (see Exhibit 5-8 of this Guide)</li> <li>▫ No TSP</li> <li>▫ Net speed = 5 min/mi</li> </ul> </li> <li>▪ 4 mi at 10 mph (6 min/mi, mixed traffic) = 24 min</li> <li>▪ Total travel time = 81 min</li> </ul>

	<p>Proposed Condition - BRT:</p> <ul style="list-style-type: none"> <li>▪ 1 mi (CBD) at 7 min/mi = 7 min             <ul style="list-style-type: none"> <li>▫ Start with 6-mph speed</li> <li>▫ 1.5-mph (2 min/mi) gain from CBD bus lane</li> <li>▫ 1.1-mph (1 min/mi) gain from fewer stops (only 3 in CBD)</li> <li>▫ Net speed = 8.6 mph = 7 min/mi</li> </ul> </li> <li>▪ 10 mi at 22 mph (2.73 min/mi) = 27.3 min (non-CBD bus lanes)             <ul style="list-style-type: none"> <li>▫ With 2 stations/mi and 20-sec dwell, using Exhibit 4-56 of TC&amp;QSM (<math>\theta</math>) results in a base speed of 2.73 min/mi</li> <li>▫ Add 0.7 min/mi for traffic delay from Exhibit 4-57 of TC&amp;QSM (<math>\theta</math>)</li> <li>▫ Subtract 0.7 min/mi (5 sec/signal for 8 signals) for TSP</li> <li>▫ Net speed = 2.73 min/mi = 22 mph</li> </ul> </li> <li>▪ 4 mi at 15.6 mph (3.85 min/mi) = 15.4 min (mixed traffic)             <ul style="list-style-type: none"> <li>▫ With 2 stations/mi and 20-sec dwell, using Exhibit 4-56 of TC&amp;QSM (<math>\theta</math>) results in a base speed of 2.73 min/mi</li> <li>▫ Add 1.2 min/mi for traffic delay from Exhibit 4-57 of TC&amp;QSM (<math>\theta</math>)</li> <li>▫ Subtract 0.08 min/mi (5 sec/signal for 4 signals) for TSP</li> <li>▫ Net speed = 3.85 min/mi = 15.6 mph</li> </ul> </li> <li>▪ Total travel time = 49.7 min</li> <li>▪ Total speed = 18.1 mph</li> </ul>
<p>Ridership estimates</p>	<p>Assumed initial allocation of base riders:</p> <ul style="list-style-type: none"> <li>▪ BRT: 8,000 riders and 10-min maximum headway</li> <li>▪ Local: 8,000 riders and 10-min minimum headway</li> </ul> <p>The method of estimating BRT and local bus ridership using the four-step model and applying incremental logit models may be applicable for bus lanes on city streets. A method using elasticities is described below.</p> <hr/> <p>1a. Apply travel time elasticity factors to BRT for improved travel time:</p> $R_2 = \frac{(E-1)T_1R_1 - (E+1)T_2R_1}{(E-1)T_2 - (E+1)T_1}$ <p>where <math>R_1</math> = initial ridership, <math>R_2</math> = anticipated ridership, <math>T_1</math> = initial travel times, <math>T_2</math> = travel times with BRT, and <math>E</math> = travel time elasticity factor = -0.4.</p> $R_2 = \frac{(-1.4 \times 94 \times 8,000) - (0.6 \times 49.7 \times 8,000)}{(-1.4 \times 49.7) - (0.6 \times 94)} = 10,251$ <p>1b. Apply travel time elasticity factors to local bus service for improved travel time:</p> $R_2 = \frac{(E-1)T_1R_1 - (E+1)T_2R_1}{(E-1)T_2 - (E+1)T_1}$ <p>where <math>R_1</math> = initial ridership, <math>R_2</math> = anticipated ridership, <math>T_1</math> = initial travel times, <math>T_2</math> = travel times with BRT, and <math>E</math> = travel time elasticity factor = -0.4.</p> $R_2 = \frac{(-1.4 \times 94 \times 8,000) - (0.6 \times 81 \times 8,000)}{(-1.4 \times 81) - (0.6 \times 94)} = 8,490$



*Bus Rapid Transit Practitioner's Guide*

	<p>2a. Estimate the proportion of BRT riders who would save time by taking the first bus (BRT or local) that arrives.</p> <p>An <i>approximate</i> estimate can be obtained based upon the following relationship:</p> $a = \frac{h}{2} \times \frac{1}{t_2}$ <p>where <math>a</math> = approximate length of route where riders would take first bus (assumed equal to % of riders), <math>h</math> = BRT headway (min), and <math>t_2</math> = time saved over local bus (total length of route). For Scenario 4, <math>h</math> = 10 min and maximum time savings is <math>94 - 49.7 = 44.3</math> min.</p> $a = \frac{10}{2} \times \frac{1}{44.3} = 11\%$ <p>The proportion of BRT riders who would save time by taking the first bus that arrives is <math>11\% \times 10,251 = 1,128</math>.</p> <p>2b. Estimate increased ridership due to increase in service frequency (<math>R_3</math>).</p> <p>Elasticity (frequency) = +0.4          Initial 8-min headway = 7.5 buses/hour          Proposed 5-min headway (combined routes) = 12 buses/hour</p> $R_3 = \frac{(-0.6 \times 7.5 \times 1,128) - (1.4 \times 12 \times 1,128)}{(-0.6 \times 12) - (1.4 \times 7.5)} = 1,357$ <p>Since 1,128 BRT riders were already included in the ridership estimate, the <i>net</i> increase is <math>1,357 - 1,128 = 229</math> BRT riders.</p> <p>3. Estimate additional ridership generated by BRT features.</p> <p>Weights applied to up to 25% increase in base ridership are obtained from elasticity computations. (See Exhibit 3-22 for details).</p> <table border="1" data-bbox="657 1029 1385 1396"> <thead> <tr> <th><u>Component</u></th> <th><u>Percentage</u></th> </tr> </thead> <tbody> <tr> <td>Running Way</td> <td></td> </tr> <tr> <td>  Bus lanes, special pavement (10 mi)</td> <td>(10 mi/15 mi) x 5% = 3.3%</td> </tr> <tr> <td>  Mixed traffic (4 mi)</td> <td>(4 mi/15 mi) x 0% = 0%</td> </tr> <tr> <td>  CBD bus lane (1 mi)</td> <td>(1 mi/15 mi) x 0% = 0%</td> </tr> <tr> <td>  Total</td> <td>3% (weighted average)</td> </tr> <tr> <td>Stations (enhanced)</td> <td>10%</td> </tr> <tr> <td>Vehicles (stylized, articulated)</td> <td>10%</td> </tr> <tr> <td>Service pattern</td> <td>12%</td> </tr> <tr> <td>ITS</td> <td>10%</td> </tr> <tr> <td>Branding</td> <td>10%</td> </tr> <tr> <td>  <i>Subtotal</i></td> <td><i>55%</i></td> </tr> <tr> <td>BRT component synergy</td> <td>0%</td> </tr> <tr> <td>  <i>Total</i></td> <td><i>55%</i></td> </tr> </tbody> </table> <p>The 55% applies to an increase in base ridership of 25% beyond that obtained by elasticities. <math>0.55 \times 25\% = 14\%</math>.</p> <p>Anticipated additional BRT ridership = <math>8,000 \times 14\% = 1,120</math>.</p> <p>Total anticipated BRT ridership in the base year considering <i>only</i> travel time savings = <math>10,251 + 1,120 = 11,371</math>. Total anticipated BRT ridership in the base year considering <i>both</i> travel time and service frequency changes = <math>10,251 + 229 + 1,120 = 11,600</math>.</p> <p>If 10,000 riders were initially allocated to BRT, the preceding ridership values would be increased 10/8 or 25% to 14,214 and 14,500, respectively.</p>	<u>Component</u>	<u>Percentage</u>	Running Way		Bus lanes, special pavement (10 mi)	(10 mi/15 mi) x 5% = 3.3%	Mixed traffic (4 mi)	(4 mi/15 mi) x 0% = 0%	CBD bus lane (1 mi)	(1 mi/15 mi) x 0% = 0%	Total	3% (weighted average)	Stations (enhanced)	10%	Vehicles (stylized, articulated)	10%	Service pattern	12%	ITS	10%	Branding	10%	<i>Subtotal</i>	<i>55%</i>	BRT component synergy	0%	<i>Total</i>	<i>55%</i>
<u>Component</u>	<u>Percentage</u>																												
Running Way																													
Bus lanes, special pavement (10 mi)	(10 mi/15 mi) x 5% = 3.3%																												
Mixed traffic (4 mi)	(4 mi/15 mi) x 0% = 0%																												
CBD bus lane (1 mi)	(1 mi/15 mi) x 0% = 0%																												
Total	3% (weighted average)																												
Stations (enhanced)	10%																												
Vehicles (stylized, articulated)	10%																												
Service pattern	12%																												
ITS	10%																												
Branding	10%																												
<i>Subtotal</i>	<i>55%</i>																												
BRT component synergy	0%																												
<i>Total</i>	<i>55%</i>																												
Fleet requirements	<p>Peak-hour peak-direction riders in the maximum load section (<math>P</math>):</p> $P = \frac{\text{Daily Riders}}{\text{Turnover}} \times \% \text{ in Peak Hour} \times \% \text{ in Peak Direction}$																												

	<p>Turnover is assumed to be 1.80.</p> $P = \frac{11,371}{1.80} (10\%) (60\%) = 379$ <p style="text-align: center;">to</p> $P = \frac{11,600}{1.80} (10\%) (60\%) = 387$
	<p>At 60 passengers per bus, seven buses are needed in the maximum load section (with approximate 10-minute headways).</p>
	<p>BRT vehicles needed:</p> $\frac{\text{Round Trip Running Time} + \text{Layover Time}}{\text{Headway}} = \frac{112 + 10}{10} = 12.2$ <p>Round up to 13. Add 3 spares to get 16 buses.</p>
Estimated costs	See Exhibit 5-27.

**EXHIBIT 5-27 Estimated Development Costs - Scenario 4**

Item	Units	Unit Cost	Total Cost
Bus lane - CBD	1 mile	\$100,000/mile	\$100,000
Bus lane - outlying (special pavement)	10 miles	\$2.5 million/mile	\$25 million
Mixed traffic	4 miles	—	—
Stations - CBD (enhanced)	3 stations	\$60,000/station	\$180,000
Stations - bus lanes (enhanced)	20 stations	\$60,000/station	\$1.2 million
Stations - mixed traffic (enhanced)	8 stations	\$60,000/station	\$480,000
Stylized, articulated BRT vehicles	16 vehicles	\$780,000/vehicle	\$12.5 million
Station information	62 locations*	\$6,000/location	\$372,000
Vehicle information	16 vehicles	\$4,000/vehicle	\$64,000
TSP	12 intersections	\$30,000/intersection	\$360,000
Total (2004 dollars)			\$40.3 million

\* Two per station (for 31 stations)

**Scenario 5: Bus Lanes Only (No Transit Signal Priority)**

The description and assumptions for this scenario are shown in Exhibit 5-28 and Exhibit 5-29. Exhibit 5-30 describes the detailed analysis, and Exhibit 5-31 gives the estimated development costs for various BRT features.

This scenario includes 11 miles of bus lanes and 4 miles of mixed-traffic operation (on each side of the CBD). Conventional articulated buses with on-vehicle fare collection would be used. The bus lanes would be delineated by pavement markings and signage.

This scenario would have the following effects:

- Reduce the number of stops from 90 to 31
- Reduce BRT one-way running times from 94 to 57 minutes
- Daily BRT ridership would likely increase from 8,000 to 10,886

The one-way running time for local buses using the bus lanes would be reduced from 94 to 81 minutes. Development costs for Scenario 5 were estimated

*Bus Rapid Transit Practitioner's Guide*

at \$12.5 million. The cost savings over Scenario 4 results from not rebuilding the bus lane.

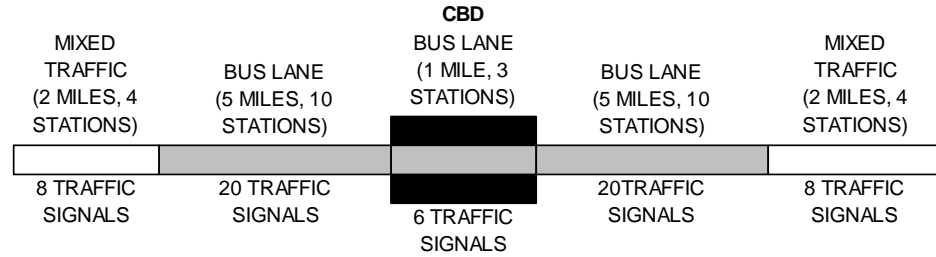

**EXHIBIT 5-28 BRT Development Scenario 5**

**EXHIBIT 5-29 Key Assumptions of BRT Development Scenario 5**

Feature	Existing Service (Base)	Computed Results	
		Local	BRT
Daily Ridership	16,000	8,490	10,886
Stops	90	90	31
Dwell/Stop	15 sec	15 sec	20 sec <sup>1</sup>
Frequency	8 min	10-min minimum	10-min maximum
Speed	6 mph CBD; 10 mph elsewhere	11.2 mph	15.8 mph
One-Way Travel Time	94 min	81 min	57 min
Fare Collection	On board	On board	On-board smart card
Vehicle	Conventional	Conventional	Conventional, articulated
Passenger Information Stations	No	No	Yes
Vehicles	No	No	Yes
Development Costs	N/A	N/A	\$12.5 million

<sup>1</sup> The 20-second dwell time for BRT assumes no change in fare collection or door channels available, in comparison to the existing service. The 20-second dwell time for BRT is higher than the dwell time for local bus because BRT has fewer stops and higher passenger boardings.

**EXHIBIT 5-30 Analysis - Scenario 5**

Item	Analysis
Travel times	Existing Condition: <ul style="list-style-type: none"> <li>▪ 6 mph over 1 mi = 10 min (CBD mixed traffic)</li> <li>▪ 10 mph over 14 mi = 84 min (mixed traffic)</li> <li>▪ Total = 94 min</li> </ul>

	<p>Proposed Condition - Local:</p> <ul style="list-style-type: none"> <li>▪ Local buses would also benefit from a bus-only lane.</li> <li>▪ 1 mi (CBD) at 7 min/mi = 7 min             <ul style="list-style-type: none"> <li>▫ Start with 6-mph speed</li> <li>▫ 1.5-mph (2 min/mi) gain from CBD bus lane</li> <li>▫ 1.1-mph (1 min/mi) gain from fewer stops (only 3 in CBD)</li> <li>▫ Net speed = 8.6 mph = 7 min/mi</li> </ul> </li> <li>▪ 10 mi at 12 mph (5 min/mi, non-CBD bus lanes) = 50 min             <ul style="list-style-type: none"> <li>▫ Start with 10 mph = 6 min/mi</li> <li>▫ Subtract 1 min/mi (see Exhibit 5-8 in this Guide)</li> <li>▫ No TSP</li> <li>▫ Net speed = 5 min/mi</li> </ul> </li> <li>▪ 4 mi at 10 mph (6 min/mi, mixed traffic) = 24 min</li> <li>▪ Total travel time = 81 min</li> </ul> <hr/> <p>Proposed Condition - BRT:</p> <ul style="list-style-type: none"> <li>▪ 1 mi (CBD) at 7 min/mi = 7 min             <ul style="list-style-type: none"> <li>▫ Start with 6-mph speed</li> <li>▫ 1.5-mph (2 min/mi) gain from CBD bus lane</li> <li>▫ 1.1-mph (1 min/mi) gain from fewer stops (only 3 in CBD)</li> <li>▫ Net speed = 8.6 mph = 7 min/mi</li> </ul> </li> <li>▪ 10 mi at 17.5 mph (3.43 min/mi) = 34.3 min (non-CBD bus lanes)             <ul style="list-style-type: none"> <li>▫ With 2 stations/mi and 20-sec dwell, using Exhibit 4-56 of TC&amp;QSM (<math>\delta</math>) results in a base speed of 2.73 min/mi</li> <li>▫ Add 0.7 min/mi for traffic delay from Exhibit 4-57 of TC&amp;QSM (<math>\delta</math>)</li> <li>▫ Net speed = 3.43 min/mi = 17.5 mph</li> </ul> </li> <li>▪ 4 mi at 15.3 mph (3.93 min/mi) = 15.7 min (mixed traffic)             <ul style="list-style-type: none"> <li>▫ With 2 stations/mi and 20-sec dwell, using Exhibit 4-56 of TC&amp;QSM (<math>\delta</math>) results in a base speed of 2.73 min/mi</li> <li>▫ Add 1.2 min/mi for traffic delay from Exhibit 4-57 of TC&amp;QSM (<math>\delta</math>)</li> <li>▫ Net speed = 3.93 min/mi = 15.3 mph</li> </ul> </li> <li>▪ Total travel time = 57 min</li> <li>▪ Average Speed = 15.8 mph</li> </ul> <hr/> <p>The 3.43-min/mi speed in the bus lanes reflects the initial speed for Los Angeles's Orange Line busway adjusted +0.7 min/mi for traffic delay.</p> <hr/> <p>The 3.93-min/mi speed is the initial speed for Los Angeles's Orange Line busway adjusted +1.20 min/mi for traffic delay.</p>
<p>Ridership estimates</p>	<p>Assumed initial allocation of base riders:</p> <ul style="list-style-type: none"> <li>▪ BRT: 8,000 riders and 10-min maximum headway</li> <li>▪ Local: 8,000 riders and 10-min minimum headway</li> </ul> <p>The method of estimating BRT and local bus ridership using the four-step model and applying incremental logit models may be applicable. A method using elasticities is described below.</p> <hr/> <p>1a. Apply travel time elasticity factors to BRT:</p> $R_2 = \frac{(E - 1)T_1R_1 - (E + 1)T_2R_1}{(E - 1)T_2 - (E + 1)T_1}$ <p>where <math>R_1</math> = initial ridership, <math>R_2</math> = anticipated ridership, <math>T_1</math> = initial travel times, <math>T_2</math> = travel times with BRT, and <math>E</math> = travel time elasticity factor = -0.4.</p> $R_2 = \frac{(-1.4 \times 94 \times 8,000) - (0.6 \times 57 \times 8,000)}{(-1.4 \times 57) - (0.6 \times 94)} = 9,739$ <p>1b. Apply travel time elasticity factors to local bus service for improved travel time:</p> $R_2 = \frac{(E - 1)T_1R_1 - (E + 1)T_2R_1}{(E - 1)T_2 - (E + 1)T_1}$ <p>where <math>R_1</math> = initial ridership, <math>R_2</math> = anticipated ridership, <math>T_1</math> = initial travel times, <math>T_2</math> = travel times with BRT, and <math>E</math> = travel time elasticity factor = -0.4.</p> $R_2 = \frac{(-1.4 \times 94 \times 8,000) - (0.6 \times 81 \times 8,000)}{(-1.4 \times 81) - (0.6 \times 94)} = 8,490$

*Bus Rapid Transit Practitioner's Guide*

	<p>2a. Estimate the proportion of BRT riders who would save time by taking the first bus (BRT or local) that arrives.</p> <p>An <i>approximate</i> estimate can be obtained based upon the following relationship:</p> $a = \frac{h}{2} \times \frac{1}{t_2}$ <p>where <math>a</math> = approximate length of route where riders would take first bus (assumed equal to % of riders), <math>h</math> = BRT headway (min), and <math>t_2</math> = time saved over local bus (total length of route). For Scenario 5, <math>h</math> = 10 min and maximum time savings is <math>94 - 57 = 37</math> min.</p> $a = \frac{10}{2} \times \frac{1}{37} = 13.5\%$ <p>The proportion of BRT riders who would save time by taking the first bus that arrives is <math>13.5\% \times 9,739 = 1,315</math>.</p> <p>2b. Estimate increased ridership due to increase in service frequency (<math>R_3</math>).</p> <p>Elasticity (frequency) = +0.4          Initial 8-min headway = 7.5 buses/hour          Proposed 5-min headway (combined routes) = 12 buses/hour</p> $R_3 = \frac{(-0.6 \times 7.5 \times 1,315) - (1.4 \times 12 \times 1,315)}{(-0.6 \times 12) - (1.4 \times 7.5)} = 1,582$ <p>Since 1,315 riders were already included in the ridership estimate, the <i>net</i> increase is <math>1,582 - 1,315 = 267</math> riders.</p> <hr/> <p>3. Estimate additional ridership generated by BRT features.</p> <p>Weights applied to up to 25% increase in base ridership are obtained from elasticity computations. (See Exhibit 3-22 for details).</p> <table border="1" data-bbox="657 1060 1391 1323"> <thead> <tr> <th><u>Component</u></th> <th><u>Percentage</u></th> </tr> </thead> <tbody> <tr> <td>Running Way</td> <td>0%</td> </tr> <tr> <td>Stations (enhanced)</td> <td>7%</td> </tr> <tr> <td>Vehicles (articulated)</td> <td>5%</td> </tr> <tr> <td>Service pattern (regular)</td> <td>12%</td> </tr> <tr> <td>ITS</td> <td>10%</td> </tr> <tr> <td>Branding</td> <td>10%</td> </tr> <tr> <td><i>Subtotal</i></td> <td><i>44%</i></td> </tr> <tr> <td>BRT component synergy</td> <td>0%</td> </tr> <tr> <td><i>Total</i></td> <td><i>44%</i></td> </tr> </tbody> </table> <p>The 44% applies to an increase in base ridership of 25% beyond that obtained by elasticities. <math>0.44 \times 25\% = 11\%</math>.</p> <p>Anticipated additional BRT ridership = <math>8,000 \times 11\% = 880</math>.</p> <p>Total anticipated BRT ridership in the base year considering <i>only</i> travel time savings = <math>9,739 + 880 = 10,619</math>. Total anticipated BRT ridership in the base year considering <i>both</i> travel time and service frequency changes = <math>9,739 + 267 + 880 = 10,886</math>.</p> <hr/> <p>If 10,000 riders were initially allocated to BRT, the preceding ridership values would be increased 10/8 or 25% to 13,274 and 13,608, respectively.</p>	<u>Component</u>	<u>Percentage</u>	Running Way	0%	Stations (enhanced)	7%	Vehicles (articulated)	5%	Service pattern (regular)	12%	ITS	10%	Branding	10%	<i>Subtotal</i>	<i>44%</i>	BRT component synergy	0%	<i>Total</i>	<i>44%</i>
<u>Component</u>	<u>Percentage</u>																				
Running Way	0%																				
Stations (enhanced)	7%																				
Vehicles (articulated)	5%																				
Service pattern (regular)	12%																				
ITS	10%																				
Branding	10%																				
<i>Subtotal</i>	<i>44%</i>																				
BRT component synergy	0%																				
<i>Total</i>	<i>44%</i>																				
Fleet requirements	<p>Peak-hour peak-direction riders in the maximum load section (<math>P</math>):</p> $P = \frac{\text{Daily Riders}}{\text{Turnover}} \times \% \text{ in Peak Hour} \times \% \text{ in Peak Direction}$																				

	<p>Turnover is assumed to be 1.80.</p> $P = \frac{10,619}{1.80} \times 10\% \times 60\% = 354$ <p style="text-align: center;">to</p> $P = \frac{10,886}{1.80} \times 10\% \times 60\% = 363$
	At 60 passengers per bus, six are needed in the maximum load section (with 10-minute headways).
	<p>BRT vehicles needed:</p> $\frac{\text{Round Trip Running Time} + \text{Layover Time}}{\text{Headway}} = \frac{114 + 10}{10} = 12.4 = 13$ <p>Add 3 spares to get 16 buses.</p>
Estimated costs	See Exhibit 5-31.

**EXHIBIT 5-31 Estimated Development Costs - Scenario 5**

Item	Units	Unit Cost	Total Cost
Bus lane - CBD	1 mile	\$100,000/mile	\$100,000
Bus lane - outlying	10 miles	\$100,000/mile	\$1 million
Mixed traffic	4 miles	—	—
Stations - CBD (enhanced)	3 stations	\$60,000/station	\$180,000
Stations - bus lanes (enhanced)	20 stations	\$60,000/station	\$1.2 million
Stations - mixed traffic (enhanced)	8 stations	\$60,000/station	\$480,000
Conventional articulated BRT vehicles	16 vehicles	\$570,000/vehicle	\$9.1 million
Station information	62 locations*	\$6,000/location	\$372,000
Vehicle information	16 vehicles	\$4,000/vehicle	\$64,000
Total (2004 dollars)			\$12.5 million

\* Two per station (for 31 stations)

**Scenario 6: Transit Signal Priority Only**

The description and assumptions for this scenario are shown in Exhibit 5-32 and Exhibit 5-33. Exhibit 5-34 describes the detailed analysis, and Exhibit 5-35 gives the estimated development costs for various BRT features.

This scenario includes TSP for BRT at all non-CBD signalized intersections. Bus-only lanes would operate within the CBD. Conventional articulated buses would operate with on-board fare collection.

This scenario would have the following effects:

- Reduce the number of BRT stops from 90 to 31
- Reduce BRT one-way running times from 94 to 58.2 minutes
- Increase daily BRT ridership from 8,000 to 10,817

Development costs for Scenario 6 were estimated at \$11.4 million.

*Bus Rapid Transit Practitioner's Guide*

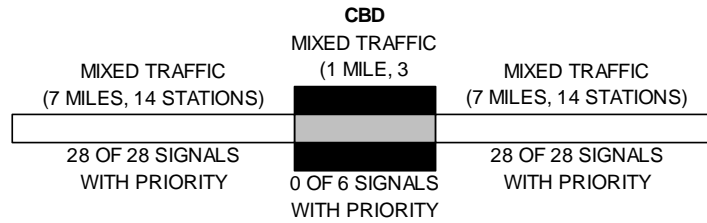

**EXHIBIT 5-32 BRT Development Scenario 6**

**EXHIBIT 5-33 Key Assumptions of BRT Development Scenario 6**

Feature	Existing Service (Base)	Computed Results	
		Local	BRT
Daily Ridership	16,000	8,000	10,817
Stops	90	90	31
Dwell/Stop	15 sec	15 sec	20 sec <sup>1</sup>
Frequency	8 min	10 min	10 min
Speed	6 mph CBD; 10 mph elsewhere	9.8 mph	15.5 mph
One-Way Travel Time	94 min	92 min	58.2 min
Fare Collection	On board	On board	On-board smart card
Vehicle	Conventional	Conventional	Conventional, articulated
Passenger Information Stations	No	No	Yes
Passenger Information Vehicles	No	No	Yes
Development Costs	N/A	N/A	\$11.4 million

<sup>1</sup> The 20-second dwell time for BRT assumes no change in fare collection or door channels available, in comparison to the existing service. The 20-second dwell time for BRT is higher than the dwell time for local bus because BRT has fewer stops and higher passenger boardings.

**EXHIBIT 5-34 Analysis - Scenario 6**

Item	Analysis
Travel times	<p>Existing Condition:</p> <ul style="list-style-type: none"> <li>▪ 6 mph over 1 mi = 10 min (CBD mixed traffic)</li> <li>▪ 10 mph over 14 mi = 84 min (mixed traffic)</li> <li>▪ Total = 94 min</li> </ul> <hr/> <p>Proposed Condition 1 - Local:</p> <ul style="list-style-type: none"> <li>▪ 1 mi (CBD) at 8 min/mi = 8 min                             <ul style="list-style-type: none"> <li>▫ Start with 6-mph speed</li> <li>▫ 1.5-mph gain due to bus lane speeds</li> <li>▫ Net speed = 7.5 mph = 8 min/mi</li> </ul> </li> <li>▪ 14 mi at 10 mph (6 min/mi) = 84 min (on local streets)</li> </ul> <p>Total travel time = 92 min</p>

	<p>Proposed Condition 2 - BRT:</p> <ul style="list-style-type: none"> <li>▪ 1 mi at 7.8 min/mi = 7.8 min (CBD) <ul style="list-style-type: none"> <li>▫ The 7.8-min/mi speed reflects a base travel time of 3.3 min/mi and +4.5 min/mi for traffic delays (because traffic signals are more frequent than bus stops).</li> </ul> </li> <li>▪ 14 mi at 3.6 min/mi = 50.4 min (non-CBD) <ul style="list-style-type: none"> <li>▫ The 3.6-min/mi speed is the initial speed for Los Angeles's Orange Line busway adjusted +1.20-min/mi for traffic delay and -5 sec/signal for TSP.</li> </ul> </li> <li>▪ Total = 58.2 min</li> </ul>
<p>Ridership estimates</p>	<p>Assumed initial allocation of base riders:</p> <ul style="list-style-type: none"> <li>▪ BRT: 8,000 riders and 10-min maximum headway</li> <li>▪ Local: 8,000 riders and 10-min minimum headway</li> </ul> <p>The method of estimating BRT and local bus ridership using the four-step model and applying incremental models may be applicable. A method applying elasticities is described below.</p> <hr/> <p>1. Apply travel time elasticity factors to BRT:</p> $R_2 = \frac{(E-1)T_1R_1 - (E+1)T_2R_1}{(E-1)T_2 - (E+1)T_1}$ <p>where <math>R_1</math> = initial ridership, <math>R_2</math> = anticipated ridership, <math>T_1</math> = initial travel times, <math>T_2</math> = travel times with BRT, and <math>E</math> = travel time elasticity factor = -0.4.</p> $R_2 = \frac{(-1.4 \times 94 \times 8,000) - (0.6 \times 58.2 \times 8,000)}{(-1.4 \times 58.2) - (0.6 \times 94)} = 9,662$ <hr/> <p>2a. Estimate the proportion of BRT riders who would save time by taking the first bus (BRT or local) that arrives.</p> <p>An <i>approximate</i> estimate can be obtained based upon the following relationship:</p> $a = \frac{h}{2} \times \frac{1}{t_2}$ <p>where <math>a</math> = approximate length of route where riders would take first bus (assumed equal to % of riders), <math>h</math> = BRT headway (min), and <math>t_2</math> = time saved over local bus (total length of route). For Scenario 5, <math>h = 10</math> min and maximum time savings is <math>94 - 58 = 36</math> min.</p> $a = \frac{10}{2} \times \frac{1}{36} = 14\%$ <p>The proportion of BRT riders who would save time by taking the first bus that arrives is <math>14\% \times 9,662 = 1,353</math>.</p> <p>2b. Estimate increased ridership due to increase in service frequency (<math>R_3</math>).</p> <p>Elasticity (frequency) = +0.4  Initial 8-min headway = 7.5 buses/hour  Proposed 5-min headway (combined routes) = 12 buses/hour</p> $R_3 = \frac{(-0.6 \times 7.5 \times 1,353) - (1.4 \times 12 \times 1,353)}{(-0.6 \times 12) - (1.4 \times 7.5)} = 1,628$ <p>Since 1,353 riders were already included in the ridership estimate, the <i>net</i> increase is <math>1,628 - 1,353 = 275</math> riders.</p>



*Bus Rapid Transit Practitioner's Guide*

	<p>3. Estimate additional ridership generated by BRT features.</p> <p>Weights applied to up to 25% increase in base ridership are obtained from elasticity computations. (See Exhibit 3-22 for details).</p> <table border="1" data-bbox="662 323 1149 579"> <thead> <tr> <th><u>Component</u></th> <th><u>Percentage</u></th> </tr> </thead> <tbody> <tr> <td>Running Way</td> <td>0%</td> </tr> <tr> <td>Stations (enhanced)</td> <td>7%</td> </tr> <tr> <td>Vehicles (conventional, articulated)</td> <td>5%</td> </tr> <tr> <td>Service pattern</td> <td>12%</td> </tr> <tr> <td>ITS</td> <td>10%</td> </tr> <tr> <td>Branding</td> <td>10%</td> </tr> <tr> <td><i>Subtotal</i></td> <td><i>44%</i></td> </tr> <tr> <td>BRT component synergy</td> <td>0%</td> </tr> <tr> <td><i>Total</i></td> <td><i>44%</i></td> </tr> </tbody> </table> <p>The 44% applies to an increase in base ridership of 25% beyond that obtained by elasticities. <math>0.44 \times 25\% = 11\%</math>.</p> <p>Anticipated additional BRT ridership = <math>8,000 \times 11\% = 880</math>.</p> <p>Total anticipated BRT ridership in the base year considering <i>only</i> travel time savings = <math>9,662 + 880 = 10,542</math>. Total anticipated BRT ridership in the base year considering <i>both</i> travel time and service frequency changes = <math>9,662 + 275 + 880 = 10,817</math>.</p>	<u>Component</u>	<u>Percentage</u>	Running Way	0%	Stations (enhanced)	7%	Vehicles (conventional, articulated)	5%	Service pattern	12%	ITS	10%	Branding	10%	<i>Subtotal</i>	<i>44%</i>	BRT component synergy	0%	<i>Total</i>	<i>44%</i>
<u>Component</u>	<u>Percentage</u>																				
Running Way	0%																				
Stations (enhanced)	7%																				
Vehicles (conventional, articulated)	5%																				
Service pattern	12%																				
ITS	10%																				
Branding	10%																				
<i>Subtotal</i>	<i>44%</i>																				
BRT component synergy	0%																				
<i>Total</i>	<i>44%</i>																				
<p>Vehicle requirements</p>	<p>Peak-hour peak-direction riders in the maximum load section (<math>P</math>):</p> $P = \frac{\text{Daily Riders}}{\text{Turnover}} \times \% \text{ in Peak Hour} \times \% \text{ in Peak Direction}$ <p>Turnover is assumed to be 1.80.</p> $P = \frac{10,542}{1.80} \times 10\% \times 60\% = 351$ <p style="text-align: center;">to</p> $P = \frac{10,817}{1.80} \times 10\% \times 60\% = 361$ <p>At 60 passengers per bus, six buses are needed in the maximum load section (with 10-minute headways).</p> <p>BRT vehicles needed:</p> $\frac{\text{Round Trip Running Time} + \text{Layover Time}}{\text{Headway}} = \frac{116 + 10}{10} = 12.6 = 13$ <p>Add 3 spares to get 16 buses.</p>																				
<p>Estimated costs</p>	<p>See Exhibit 5-35.</p>																				

**EXHIBIT 5-35 Estimated Development Costs - Scenario 6**

Item	Units	Unit Cost	Total Cost
Stations - CBD (enhanced)	3 stations	\$60,000/station	\$180,000
Stations - other (enhanced)	28 stations	\$60,000/station	\$1.7 million
Conventional articulated BRT vehicles	16 vehicles	\$570,000/vehicle	\$9.1 million
Station information	62 locations*	\$6,000/location	\$372,000
Vehicle information	16 vehicles	\$4,000/vehicle	\$64,000
Total (2004 dollars)			\$11.4 million

\* Two per station

**Summary and Comparison of BRT Development Scenarios**

Exhibit 5-36 compares the following for the six scenarios analyzed:

- Existing and anticipated BRT travel and the likely percentage reduction
- Existing and anticipated BRT ridership and the likely percentage increase
- Anticipated development costs

The six BRT scenarios studied in this chapter reduce transit running times 38% to 69%.

**EXHIBIT 5-36 Summary of Anticipated BRT Travel Times, Ridership, and Costs**

Item	Scenario 1	Scenario 2	Scenario 3	Scenario 4	Scenario 5	Scenario 6
	Grade-Separated Busway	At-Grade Busway	At-Grade Busway & Median Arterial Busway	Bus Lanes (Rebuilt) & TSP	Bus Lanes Only	TSP Only
Existing (base) one-way travel time	94 min	94 min	94 min	94 min	94 min	94 min
BRT in-vehicle travel time	29 min	43 min	48 min	50 min	57 min	58 min
% reduction	69%	54%	49%	47%	39%	38%
Assumed BRT base ridership	10,000	10,000	20,000	8,000	8,000	8,000
Anticipated BRT ridership	17,660	15,700	33,020	11,600	10,885	10,815
% increase	77%	57%	65%	45%	36%	35%
Existing local bus ridership	20,000	20,000	20,000	16,000	16,000	16,000
Anticipated local bus ridership	10,000	10,000	-	8,490	8,490	8,000
Estimated development costs*	\$242.0 million	\$109.4 million	\$84.3 million	\$40.3 million	\$12.5 million	\$11.4 million

\* In 2004 dollars

NOTE: Numbers have been rounded.

SOURCE: Computed

*Bus Rapid Transit Practitioner's Guide*

Daily ridership increases consistently with the savings in one-way travel times.

Exhibit 5-37 shows the likely sources of the anticipated increases in BRT ridership for each of the six BRT scenarios. The anticipated future BRT ridership is also "normalized" to a "base ridership" of 10,000 daily riders. The BRT features accounted for about 8% to 10% of the bus lane/TSP riders and 12% to 14% of the busway ridership.

**EXHIBIT 5-37 Source of Anticipated BRT Ridership**

Item	Scenario 1	Scenario 2	Scenario 3	Scenario 4	Scenario 5	Scenario 6
	Grade-Separated Busway	At-Grade Busway	At-Grade Busway & Median Arterial Busway	Bus Lanes (Rebuilt) & TSP	Bus Lanes Only	TSP Only
Base condition	10,000	10,000	20,000	8,000	8,000	8,000
Reduced travel time	5,360	3,500	5,974	2,250	1,740	1,660
Increased Frequency	—	—	3,148	230	265	275
Subtotal	15,360	13,500	29,120	10,480	10,005	9,935
BRT features*	2,300	2,200	3,900	1,120	880	880
Total	17,660	15,700	33,020	11,600	10,885	10,815
Normalized to 10,000 base riders	17,760	15,700	16,510	14,500	13,605	13,520

\* Percentage applied to subtotal depending on extent of BRT features. Maximum is 25%.

NOTE: Numbers have been rounded.

SOURCE: Ridership estimates for each scenario

The effect of travel time savings for the 15-mile BRT route on daily BRT ridership (assuming a base BRT ridership of 10,000) is shown in Exhibit 5-38. There is a consistent linear trend, showing steady ridership growth as the time savings (in absolute time or minutes per mile) increases.

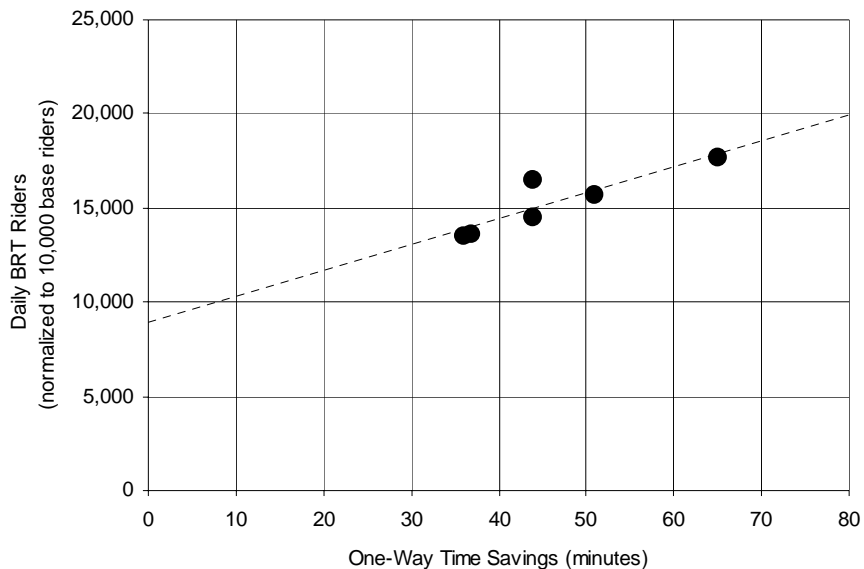

**EXHIBIT 5-38 Daily BRT Ridership v. Travel Time Savings**

The anticipated time savings are related to estimated development costs in Exhibit 5-39. As development costs increase, there is a corresponding gain in the travel time saved. Exhibit 5-40 shows how BRT ridership would grow as development costs increase. Again, there is a consistent linear trend.

Investment in busways translates into greater time savings and higher ridership.

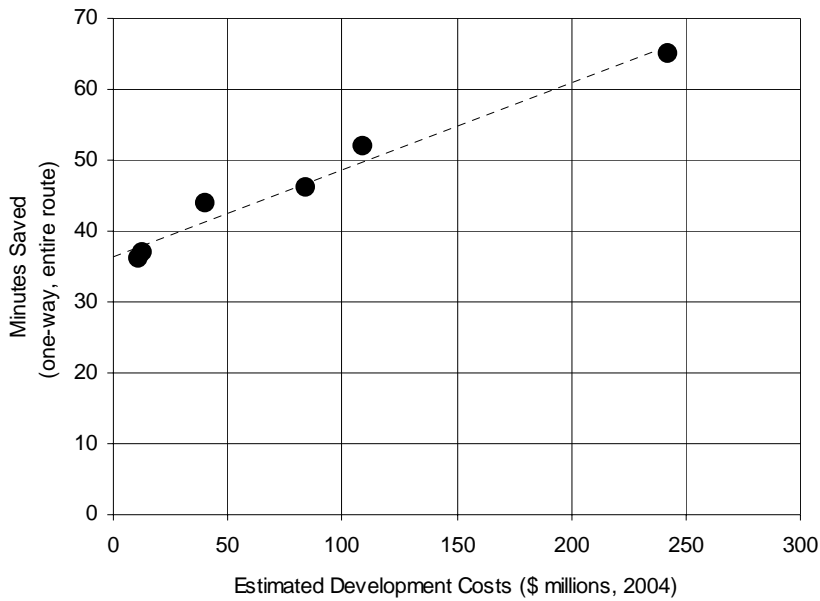

**EXHIBIT 5-39** Time Savings v. Estimated Development Costs

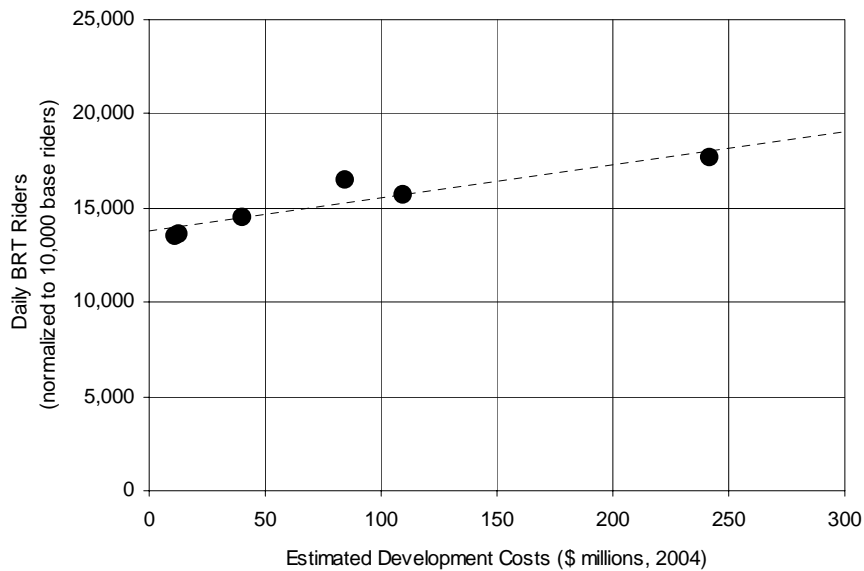

**EXHIBIT 5-40** Daily BRT Ridership vs. Estimated Development Costs

---

## Bus Rapid Transit Practitioner's Guide

The information contained in these exhibits can be developed for any series of BRT proposals for a given corridor. While the numbers and relationships shown are specific to the six scenarios analyzed, several patterns emerge:

- As development costs increase, there is a consistent reduction in travel times and a growth in BRT ridership.
- Faster travel times reduce operating costs for any given bus volume.
- The busway scenarios, because of their exclusive right-of-way and wider station spacing, have the greatest gains in speeds and ridership.
- The low-cost scenarios (i.e., bus lanes and TSP) have the smallest time savings and ridership gains.
- Travel time savings appear to be the greatest contributor to BRT ridership gains, followed in turn by the provision of special BRT features. While BRT may run at short intervals, the splitting of corridor service between BRT and local bus operations may limit the computed ridership gains from combined bus frequencies.

Any city-specific analyses should reflect local conditions in terms of land and construction costs, population and employment growth, and land development impacts. Current experience suggests that major investments such as busways or reconstructed arterial streets may encourage new investments. These effects are discussed in Chapter 6.

### Assessment of BRT Development Scenarios

The preceding ridership estimates are largely influenced by the initial allocation of street (or corridor) ridership between BRT and local transit service. The proportions of riders that would use BRT in the six scenarios are as follows:

- Scenario 1 - 64%
- Scenario 2 - 61%
- Scenario 3 - 100%
- Scenario 4 - 58%
- Scenario 5 - 56%
- Scenario 6 - 57%

A review of ridership along busways in Miami, Pittsburgh, and Ottawa shows a wide range in usage depending on geography, street system, and assigned routes. In Miami, all parallel local service now operates on the busway. In Ottawa, about two-thirds of all transit riders use the busway for at least a portion of their trip.

The mix between local and limited (or BRT) service on city streets ranges from about 35% to 65%. (In Vancouver, however, all local services in the corridor were replaced by the 98-B BRT service.) Specific values reported were as shown in Exhibit 5-41.

These comparisons suggest that the 56% to 58% allocations anticipated for Scenarios 4, 5, and 6 may be optimistic. More conservative BRT ridership estimates, based on allocating 40% of the initial base ridership to BRT, results in BRT accounting for about 47% of total riders. (See Exhibit 5-42.) This percentage is close to current experience. In any real-world situation, review of detailed ridership patterns and station usage, along with possible changes in routes and services, will permit more refined estimates.

**EXHIBIT 5-41 Allocation of Ridership between Local Bus and BRT (or Limited-Stop) Service**

Street	% of Riders Using BRT
Wilshire Boulevard (Los Angeles)	34%
Grand Concourse (New York City)*	35%
1st and 2nd Avenues (New York City)*	46%
Flatbush Avenue Southbound (New York City)*	54%
Fordham Road (New York City)	54%
Ventura Boulevard (Los Angeles)	66%
Average	48%

\*Average of 6:00 a.m. to 10:00 a.m.

SOURCE: New York City Transit Authority

**EXHIBIT 5-42 Anticipated Route Ridership with 40% of Base Ridership Allocated to BRT - Selected BRT Development Scenarios**

Service	Scenario 4	Scenario 5	Scenario 6
BRT	9,280	8,710	8,650
Local	10,190	10,190	9,600
Total	19,470	18,900	18,250
% BRT	48%	46%	47%

**REFERENCES**

1. Zimmerman, S. *BRT: A Primer Paper*. Prepared for the 2001 ITE Annual Meeting. Chicago, IL, 2001.
2. Levinson, H., S. Zimmerman, J. Clinger, S. Rutherford, R. Smith, J. Cracknell, and R. Soberman. *TCRP Report 90: Bus Rapid Transit: Vol. 1, Case Studies in Bus Rapid Transit, and Vol. 2, Implementation Guidelines*. Transportation Research Board of the National Academies, Washington, D.C., 2003.
3. Kittelson & Associates, Inc., Herbert S. Levinson Transportation Consultants, DMJM+Harris, and OURCO, Inc. *TCRP Project A-23A Interim Report*. Unpublished. 2004.
4. Diaz, R.B., M. Chang, G. Darido, E. Kim, D. Schneck, M. Hardy, J. Bunch, M. Baltes, D. Hinebaugh, L. Wnuk, F. Silver, and S. Zimmerman. *Characteristics of Bus Rapid Transit for Decision-Making*. FTA, Washington, D.C., 2004.
5. *Vehicle Catalog 2005 Update. A Compendium of Vehicles and Hybrid Drive Systems for Bus Rapid Transit Service*. WestStart-CALSTART, 2005.
6. Moffat, G.K., A.H. Ashton, and D.R. Blackburn. *TCRP Synthesis 40: A Challenged Employment System: Hiring, Training, Performance Evaluation, and Retention of Bus Operators*. Transportation Research Board, National Research Council, Washington D.C., 2001.
7. Kittelson & Associates, Inc., H.S. Levinson, and DMJM+Harris. *TCRP A-23A April-June 2005 Quarterly Progress Report*. Unpublished. Jul. 2005.
8. Kittelson & Associates, Inc., KFH Group, Inc., Parsons Brinckerhoff Quade and Douglass, Inc., and K. Hunter-Zaworski. *TCRP Report 100: Transit Capacity and Quality of Service Manual*. Transportation Research Board of the National Academies, Washington, D.C., 2003.

---

*Bus Rapid Transit Practitioner's Guide*

This page is intentionally blank.

## CHAPTER 6. LAND DEVELOPMENT GUIDELINES

### INTRODUCTION

The growth and development of urban areas reflects the impacts of transportation technology. Suburban railroads, city and interurban electric railways, rapid transit, and roadways have continually influenced where people and businesses locate. These impacts have been well documented in the past.

BRT has emerged in recent years as a relatively new rapid transit mode. Similar to LRT in many aspects, it also has begun to impact the areas it serves. There is growing documentation of its positive development effects; however, given the newness of most BRT systems, more information is needed regarding when, where, and why these effects occur over time and how communities can work with transit agencies and developers to achieve BRT transit-oriented development (TOD).

The “Experience and Research” section documents available cost, impact, and effectiveness data for BRT land development.

The “TOD Programs” section contains overviews of selected agencies’ TOD incentives and programs and information from case studies of Boston and Ottawa. The case studies address the land development impacts of BRT from the perspective of community efforts to link land development with proximate transit service.

The “Developer Perceptions” section presents findings from surveys of developers in Boston and Ottawa. The surveys focused on the characteristics of BRT that are likely to impact development decisions. It is believed that such formal surveys have not been conducted elsewhere.

The “Guidelines” section synthesizes and interprets information from the previous sections and from other research on the land development impacts of transit investments related to BRT. The guidelines are intended to help public agencies (i.e., transit agencies, local government agencies, and metropolitan planning organizations) assess the potential land development benefits of BRT system development by identifying data sources, identifying analysis tools, and providing guidance on conducting future surveys of the various stakeholders in the development process.

### EXPERIENCE AND RESEARCH

#### Overview of Transit-Oriented Development

TOD is defined by Caltrans as follows:

“TOD is a strategy that has broad potential in both large urban and small communities using bus or rail transit systems. It focuses compact growth around transit stops, thereby capitalizing on transit investments by bringing potential riders closer to transit facilities and increasing ridership. TOD can also produce a variety of other local and regional benefits by encouraging walkable compact and infill development. Transit agencies often play an important role in TOD. Local governments can play a significant role in promoting TOD through plans, policies, zoning provisions, and incentives for supportive densities [and] designs, along with a mix of land uses.

There is limited—but growing—documentation of BRT’s land development impacts.

Developers’ perceptions of BRT have not been formally surveyed before.

The guidelines in this chapter address circumstances under which can BRT foster transit-oriented development.



---

## Bus Rapid Transit Practitioner's Guide

“For development to be transit-oriented, it needs to be more than just adjacent to transit. Development generally needs to be shaped by transit in terms of parking, density, and/or building orientation in comparison to conventional development for it to be considered transit-oriented. A successful TOD will reinforce both the community and the transit system.”  
(1)

*TCRP Report 102* (2) contains other definitions. For the purposes of this chapter, the key characteristic of TOD is that it is the formal linking of land development opportunities and activities with the station sites of premium transit services to encourage a desirable form of development.

### TOD Measures

*NCHRP Research Results Digest 294* (3) summarizes surveys of public agencies and transportation professionals across the United States to identify indicators that can and/or should be used to quantify the land development impacts of TOD. The research evaluated 56 categorized measures in terms of each measure's usefulness, the level of effort required to obtain its data, and how frequently it should be monitored. The indicators recommended as “the foundation for [a TOD] evaluation program” are the following:

- Transit ridership
- Density (population/housing)
- Quality of streetscape design
- Quantity of mixed-use structures
- Pedestrian activity/pedestrian safety
- Increase in property value/tax revenue
- Public perception (resident and merchant surveys)
- Mode connections at the transit station
- Parking configuration (for commuters, for residents, and shared)

*NCHRP Research Results Digest 294* notes that, “while data collection is relatively easy for some of these indicators, it is more difficult for some of the others; a strategy suggested in the [research] is setting aside government funds to monitor TOD progress. For virtually every indicator, with a few exceptions, data collection needs to occur only yearly or less frequently.” (3)

### Quantifying TOD Impacts

In describing the measured benefits of TOD, *TCRP Report 102* (2) says “...relatively few serious studies have been carried out that assign benefits to TOD in any quantitative sense,” the exceptions being studies of ridership increases and property gains. The report also notes that “...quite a few of the benefits of TOD are associated with any form of compact, mixed-use development.”

Examples of recent studies quantifying the land value benefits of rail transit investments are set forth in Exhibit 6-1. Proximity to rail and LRT stations generally increases land values. However, comparable studies of BRT are limited – largely because of the relative newness of the concept.

Several key indicators can be used to quantify and monitor land development activity along transit routes.

**EXHIBIT 6-1 Land Value Results of Selected Price Model Studies**

Author(s)	Data Source	Selected Results
<i>Heavy Rail Rapid Transit</i>		
Cervero and Duncan, 2002b	3,802 sales of properties in multi-family housing in Los Angeles in 2000	No evidence of appreciable effects
Lewis-Workman and Brod, 1997	All recorded single family property sales (263) within 1.61 km of BART's Pleasant Hill station from the 1984-1996 period	Premium of \$1,578 for every 0.03 km closer to BART station
Benjamin and Sirmans, 1996	250 residential apartment rental prices in Washington during 1992	Premium of 2.4% to 2.6% for every 0.16 km closer to Metro station
Landis et al., 1995	2,359 sales of single-family homes in Alameda and Contra Costa Counties during 1990	Premium of \$100-\$200 per 0.1 km closer to the station
McDonald and Osuji, 1995	79 blocks in Chicago during 1980 and 1990	Premium of 17% for location within 0.5 mile of a station
Smith, 1978	300 new home sales in Chicago for 1971	Premium of \$450 for every 0.8 km closer to rail transit station
Damm et al., 1980	286 single-family and 771 multi-family housing sales from 1969 to 1976 in Washington, D.C.	Dummy variables indicating location within 0.16 km of a station: elasticities of -0.19 for multi-family housing and between -0.06 to -0.13 for single-family housing sales
<i>Light Rail Transit/Trolley Service</i>		
Dueker and Bianco, 1999	Population Census' median house value in Portland between 1980 and 1990	Premium of \$2,300 for properties within 0.06 km of a MAX station
Lewis-Workman and Brod, 1997	Cadastral information for nearly all properties (4,170) within 1.6 km of three MAX stations in Portland	Premium of \$75 per 0.03 km closer to the station
Forrest et al., 1995	795 house sales in Manchester (UK) during 1990	Premium ranging from 2.1% to 8.1% depending on distance to station
Cervero and Duncan, 2002c	1,495 sales of properties in multi-family housing in San Diego in 2000	Premium for multi-family units ranging from 2% to 6%
Landis et al., 1995	134 single-family sales in San Diego during 1990	Premium of \$272 for every 0.1 km closer to station
Dabinett, 1998	Sheffield (UK) Supertram	No evidence of appreciable effects
Al-Mosaind et al., 1993	235 single-family home sales in Portland during 1988	Premium of \$663 per 0.03 km closer to station

NOTE: Results apply to area and properties studied only. Refer to each source study for details.  
 SOURCE: The Value of Accessibility to Bogotá's Bus Rapid Transit System (4)

Examples of land development benefits of existing BRT systems are given in Exhibit 6-2.

BRT systems—especially busways—have created land development benefits.

*Bus Rapid Transit Practitioner's Guide*

**EXHIBIT 6-2 Reported Land Development Benefits of BRT**

BRT System	Land Development Benefits
Adelaide Guided Busway	Tea Tree Gully area is becoming urban village.
Bogotá TransMilenio	For every 5 minutes of additional walking time to a BRT station, the rental price of a property decreases between 6.8% and 9.3% after controlling for structural characteristics and neighborhood attributes
Boston Silver Line (rebuilt Washington Street)	\$700+ million in new investment within two to three blocks of BRT line
Brisbane South East Busway	Up to 20% gain in property values near busway. Property values in areas within 6 miles of station grew two to three times faster than those at greater distances. Higher increase in median home values around busway than other suburban areas.
Ottawa Transitway System	\$1 billion (Canadian) in new construction at Transitway Stations.
Pittsburgh East Busway	59 new developments within 1,500 feet of stations. \$302 million in land development benefits of which \$275 million was new construction. 80% clustered at stations.
Pittsburgh West Busway	Land development focused on six park-and-ride lots.

SOURCE: The Value of Accessibility to Bogotá's Bus Rapid Transit System (4) and *TCRP Report 90* (5)

Findings of other studies are as follows:

- The Value of Accessibility to Bogotá's Bus Rapid Transit System (4) reports that, for every 5 minutes of additional walking time to a BRT station in Bogotá, the rental price of a property decreases between 6.8% and 9.3% after controlling for structural characteristics and neighborhood attributes.
- Boston's Silver Line operating on rebuilt Washington Street between downtown Boston and Dudley Square has generated more than \$700 million in new investment within a few blocks.
- Brisbane's South East Busway has reported a 20% gain in property values near the busway. There has been a greater increase in home values along the busway as compared with other suburban areas.
- Ottawa's Transitway system has generated more than \$1 billion (Canadian) dollars in new investment along the Transitway. The municipality's land use policy requires major activity centers to locate near the Transitway and has been supportive of TOD. The St. Laurent Centre, which is connected to the Transitway by weather-protected, grade-separated walks, is one of Canada's most productive shopping centers. About one-third of customers arrive via the Transitway. Concurrent with opening the St. Laurent Transitway station in 1987, the Centre completed a major expansion that included 80 additional stores.
- Pittsburgh's East Busway, which shares a corridor with a railroad, generated more than \$302 million in new development between 1983 and 2000. By 2007, more than \$500 million of new investment has been reported. About 80% is clustered at stations. One-third of the new development represents an extension of the CBD. The extent to which this development would have occurred without the busway was not reported by PAT.

**Achieving TOD with BRT**

Achieving TOD at BRT stations requires (1) providing the right mix, design, and density of activities; (2) recognizing the development potential associated with BRT; and (3) acknowledging that land development impacts may not be realized in the near term.

An important insight can be found in studying the factors that researchers have identified as being characteristics of a successful TOD project. *NCHRP Research Results Digest 294* (3) cites a 2001 study by Nelson, Niles, and Hibshoosh (6) that identifies 16 factors in successful TOD projects. These factors are listed in Exhibit 6-3. Of the 16 factors, transit technology and resident reactions are the only factors where mode-specific differences might be significant, and the latter is highly likely to reflect the perceived "rail bias."

**EXHIBIT 6-3 Factors Determining the Success of TOD**

Number and Siting of TODs	Station Area Parking	Regional Marketing Structure	Resident Reactions
Transit Quality	Employment and Housing Density	Consumer Activity Patterns	Housing Type Preference/Life Stage
Transit Technology	Commercial Mix	Travel Behavior/Trip Chaining	Self-Selection in Residential Choice
Street Pattern	Retail Siting Criteria	Zoning Flexibility/Land Assembly	Government Policies

SOURCE: *A New Planning Template for Transit-Oriented Development* (6) as reproduced in *NCHRP Research Results Digest* (3)

Factors for TOD success added by other researchers include the following:

- The Victoria Transportation Policy Institute (VTPI) lists employment density and clustering, demographic mix (captive riders), transit pricing and rider subsidies, parking pricing, tolls, the quality of transit service, the effectiveness of transit marketing, walkability, and street design. VTPI cites previous research in concluding that "TOD generally requires at least six residential units per acre in residential areas and 25 employees per acre in commercial centers, and about twice that for premium quality transit, such as rail service.... These densities create adequate transit ridership to justify frequent service..." (7)
- The Urban Land Institute identifies 10 principles for TOD success (8):
  - > Make It Better with a Vision
  - > Apply the Power of Partnerships
  - > Think Development When Thinking about Transit
  - > Get the Parking Right
  - > Build a Place, Not a Project
  - > Make Retail Development Market-Driven, Not Transit-Driven
  - > Mix Uses, but Not Necessarily in the Same Place
  - > Make Buses a Great Idea
  - > Encourage Every Price Point to Live around Transit
  - > Engage Corporate Attention

The Urban Land Institute has published 10 principles for successful TOD.

The various factors do not explicitly depend on the mode of the premium service. They depend instead on service design decisions and external factors (such as market conditions, the specifics of land development regulations, and site design).

Citizens, transportation professionals, and decision-makers traditionally have perceived rail service as more attractive than bus service. The rail bias underlying ridership estimates reflects the sense of permanence associated with rail infrastructure, the technology, and the level of investment. It also may be perceived when comparing the land development effects of BRT and rail service.

However, ridership experience with BRT indicates that similar bias considerations apply to BRT in terms of passenger attraction. (See Chapter 3 for more information.) Similarly, reported development effects indicate that BRT can influence land development.

In Chapter 2 of CBRT (9), the authors state that "...rapid bus technologies are so new that there is little evidence about their attractiveness for development." Research organizations such as the Urban Land Institute and the Center for Transit-Oriented Development have not conducted BRT-specific studies to date. These organizations have assembled much data on TOD in general, however. The question is whether general TOD data and/or TOD data for rail and regular bus service can be applied to BRT.

None of the previous research reviewed distinguishes the land development impacts of BRT from the impacts of high-quality transit service in general or from the impacts of rail service. For example: As stated in Chapter 2 of *The New Transit Town* (10), "The more that BRT can approach [the] features of rail in its design ... the more it will succeed in providing an attractive development climate." In many cases, the type of transit linked to TOD is described in the research with a generic phrase such as "premium service" or "rapid service," which conveys that a high-quality transit service is offered but is non-specific as to the mode. In cases where a modal distinction is present, it typically takes the form of an assumption that a rail station is being assessed, without reference to explicit service characteristics. Thus, research to date does not provide evidence that BRT and rail services with similar service characteristics have different land development impacts.

In conclusion, BRT is a "premium transit" or "rapid transit" service. BRT can physically operate in any corridor that rail transit can; BRT service can be provided at levels comparable to rail service (e.g., headways and vehicle features); development around BRT stations can achieve the "success" characteristics noted above; and BRT service can be attractive to riders. It is therefore reasonable to expect that BRT could achieve land development effects similar to rail-based TOD where the service structure is similar, and that it is not necessary to distinguish BRT from LRT or other rail modes for the purposes of assessing land development impacts.

### TOD PROGRAMS

This section overviews the TOD program requirements and incentives of Boston, Pittsburgh, and Ottawa. The overview illustrates how BRT is being incorporated into selected TOD programs. Program information was obtained through surveys (Boston and Ottawa) and review of planning documents and codes.

Full-featured BRT can be similar to rail transit in terms of its impacts on land development.

## Boston

### *Overview of TOD Program*

The Massachusetts Bay Transit Authority (MBTA) and State of Massachusetts define TOD as mixed-use, higher-density, pedestrian-oriented development located within 0.5 mile of a transit station and designed to encourage transit use, walking, and other alternative modes of transportation. While densities, intensities, and types of uses will vary depending upon the location and type of transit service, TOD shall generally have the following characteristics:

- A mix of uses
- Moderate to high density
- Pedestrian orientation
- Connectivity between uses and transit station
- Reduced parking
- Attractive streetscapes and urban design

The City of Boston does not have a specific definition for TOD or an explicit program to promote TOD beyond efforts on surplus City property. However, it recognizes that Boston's long transit history and dense development pattern have made TOD the norm.

MBTA's TOD program encourages development of the type described above. However, the program is targeted toward the development of surplus property owned by MBTA in coordination with local jurisdictions. MBTA does not have surplus property in the Silver Line BRT corridor and, therefore, has not been active as a developer of TOD projects in the corridor.

The City and MBTA work together on TOD projects when they occur within the city limits, but they both acknowledge that TOD has become the common practice in the City of Boston and several of the surrounding communities. *TCRP Report 102 (2)* has a chapter that looks extensively at the history of TOD in Boston and addresses some of these issues in greater detail than is possible for this report.

### *Requirements and Incentives*

Because TOD is the traditional form of development in Boston and does not take place within narrowly defined programs, MBTA and the City place few, if any, requirements upon TOD projects. Given the few restrictions placed on TOD projects by MBTA and the City, there are currently few, if any incentives offered directly by either MBTA or the City for TOD per se.

The Boston Redevelopment Authority (BRA) is the City's planning and development arm and provides a variety of development incentives to projects in the City. The assistance offered includes site acquisition, neighborhood visioning, grants, low-interest loans, joint development opportunities, multi-agency coordination, and streetscape improvements. While the BRA encourages developers to make their projects pedestrian-friendly, mixed-use in character, and with minimized parking, there is no qualifying process for this assistance that depends upon meeting specific design standards. BRA staff mentioned that developers are very receptive to this encouragement because they have seen that it is the traditional pattern of development and they have seen it work throughout the City.

MBTA's TOD program is focused on City/MBTA surplus property.

---

## Bus Rapid Transit Practitioner's Guide

Boston has realized \$700 million in development along its Washington Street Silver Line alignment.

### *Impacts*

BRA noted that \$700 million of development occurred in a 1.5-mile stretch of the Washington Street corridor in the same time period as the Silver Line was being implemented. Public investment in the corridor was clearly an impetus for development, but it is difficult to determine how influential the Silver Line operation has been relative to other investments such as roadway resurfacing and streetscaping. While the corridor was previously served by the #49 bus line, it is difficult to discern the impact of the new development on ridership as opposed to the Silver Line's service changes.

Planning and implementation of the Silver Line in the South Boston Waterfront has also occurred in tandem with a boom in development, beginning the transformation of acres of parking lots to what will become a very dense mix of offices, housing, and retail. Even more than on Washington Street, this boom has followed a wide array of public investment, including the construction of a new Federal courthouse and a convention center. Creating an improved transportation link from this area to the downtown has clearly been a key factor and one reason for Silver Line Phase 2 development. There had been no previous service along this portion of the line, so any ridership developed is a result of new development.

Throughout the system, MBTA has seen a demand for increased housing opportunities adjacent to transit stations, and much of the development in the Washington Street corridor has been residential with ground floor commercial.

### **Pittsburgh**

#### *Overview of TOD Program*

The City of Pittsburgh defines TOD projects as "developments that focus on areas in which stations are located, through the adoption of public programs and regulations by local governments that permit an intensively built mix of land uses and activities around the station." Pittsburgh's busway stations are considered Major Transit Facilities. A Major Transit Facility is defined as "a platform or waiting area adjacent to a public mass transit system which utilizes an exclusive right-of-way."

#### *Requirements and Incentives*

In certain zoning districts, proximity to a Major Transit Facility allows developers to take advantage of increased development densities. These zoning districts are defined by the City as follows:

- The Urban Neighborhood Commercial (UNC) District is intended to serve a broader market than the immediate neighborhood; allow a range of development while controlling impacts on the neighborhood adjacent to them; ensure that new developments fit within existing development patterns; and reinforce qualities of the built environment, such as the continuity of storefronts and pedestrian-oriented streetscapes.
- The Highway Commercial (HC) District is intended to accommodate auto-oriented commercial activities and uses for which automobile travel is generally required (such as automobile dealerships, fast food restaurants, and appliance stores); improve the design quality of auto-oriented development (making such areas more attractive components of the city); provide space for large-scale regional retail stores that require large lots, broadly defined market areas, and high sales volumes and that tend to be incompatible with locations adjoining smaller neighborhoods; provide

space for commercial uses that would create conflicts with residential uses or other less intensive types of land uses; and maintain the efficiency of the City's existing and planned traffic network.

- The Urban Industrial (UI) District is intended to allow mid-sized to large industries with lower external impacts on surrounding properties and districts; provide a flexible district that addresses the growing need for easily adaptable and flexible spaces (including office parks, incubator spaces, high technology, and service sector industries); allow multi-use buildings that permit assembly, inventory, sales, and business functions within the same space; and encourage adaptive reuse of manufacturing buildings and allow the development of high density multi-unit residential buildings.

Exhibit 6-4, Exhibit 6-5, and Exhibit 6-6 show how proximity to a Major Transit Facility is accommodated in the City's zoning code. As the exhibits show, proximity allows increases in floor area ratio and maximum building height.

Pittsburgh's transit-supportive land development code allows increased densities near "major transit facilities."

Site Development Standard	UNC District
Minimum Lot Size	0
Maximum Floor Area Ratio	
when not located within 1500 ft. of a Major transit facility	3:1
when located within 1500 ft. of a Major Transit Facility	4:1
Maximum Lot Coverage	
Minimum Front Setback	none required
Minimum Rear Setback	
when not adjacent to a way	20 ft.
when adjacent to a way	none required
Minimum Exterior Sideyard Setback	none required
Minimum Interior Sideyard Setback	none required
Maximum Height	
when not located within 1500 ft. of a Major transit facility	45 ft. (not to exceed 3 stories)
when located within 1500 ft. of a Major Transit Facility	60 ft. (not to exceed 4 stories)

SOURCE: City of Pittsburgh Zoning Code

EXHIBIT 6-4 Site Development Standards for Pittsburgh's UNC District



*Bus Rapid Transit Practitioner's Guide*

Site Development Standard	HC District
Minimum Lot Size	0
Maximum Floor Area Ratio	
when not located within 1500 ft. of a Major transit facility	2:1
when located within 1500 ft. of a Major Transit Facility	3:1
Maximum Lot Coverage	
Minimum Front Setback	none required
Minimum Rear Setback	
when not adjacent to a way	20 ft.
when adjacent to a way	none required
Minimum Exterior Sideyard Setback	none required
Minimum Interior Sideyard Setback	none required
Maximum Height	75 feet (not to exceed 5 stories)

SOURCE: City of Pittsburgh Zoning Code

EXHIBIT 6-5 Site Development Standards for Pittsburgh's HC District

Site Development Standard	UI District
Minimum Lot Size	0
Maximum Floor Area Ratio	
when not located within 1500 ft. of a Major Transit Facility	3:1
when located within 1500 ft. of a Major Transit Facility	4:1
Maximum Lot Coverage	
Minimum Front Setback	none required
Minimum Rear Setback	
when not adjacent to a way	20 ft.
when adjacent to a way	none required
Minimum Exterior Sideyard Setback	10 ft.
Minimum Interior Sideyard Setback	10 ft.
Maximum Height	60 ft. (not to exceed 4 stories)

SOURCE: City of Pittsburgh Zoning Code

EXHIBIT 6-6 Site Development Standards for Pittsburgh's UI District

**Ottawa**

*Overview of TOD Program*

In Ottawa, TOD is development that is focused on Mixed-Use Centers. Mixed-Use Centers are “lands that have been identified as strategic locations on the rapid transit network. These nodes can be defined as ... compact, transit-oriented, [and] pedestrian-friendly areas where the highest concentrations of residential, employment, retail, and other uses in the urban area are located.” The Transitway and the LRT line are not differentiated with respect to the requirements conditioned on the development of Mixed-Use Centers.

Several Mixed-Use Centers are identified in the City's Official Plan. The Official Plan and the Transportation Master Plan include policies that regulate transit-supportive land uses, such as locating Mixed-Use Centers at rapid transit stations, so the City is able to impose requirements on TOD by imposing requirements on Mixed-Use Centers. The requirements are intended to achieve employment targets (e.g., 5,000 jobs) and population targets.

Mixed-Use Centers in Ottawa are allowed only along the rapid transit network.

### Requirements and Incentives

To construct a Mixed-Use Center, developers must complete a Community Design Plan for Council approval. Community Design Plans delineate the boundaries of the Mixed-Use Center and guide development in Mixed-Use Centers by regulating how buildings are oriented to the rapid transit network, parking supply (regulated within 1,300 feet), provision of (informal) park-and-ride lots and passenger drop-off zones, compactness of development (regulated through setbacks and building heights), mix of land uses, pedestrian and bicycle accessibility (including direct pedestrian connections), and proximity of employment uses (within 1,300 feet). New regional shopping centers *must* be located on the rapid transit network. Additional requirements may include the following:

- High-density residential uses should occur close to a BRT station, and medium-density residential uses should occur in locations where it can act as a transition to nearby low-density residential neighborhoods.
- Parking requirements may be reduced for developments located within 2,000 feet of a rapid transit (bus or rail) station, after considering factors such as walking distance from the development to the station, the presence and frequency of transit service between the development and the station, and physical barriers in the pedestrian network.
- A maximum parking requirement may be implemented for development located within 1,300 feet of a rapid transit station.
- “Big box” retail uses are permitted only when located within multi-story buildings oriented to the street, with multiple pedestrian entrances, with storefront display windows, and where at least 80% of parking is located underground or within structures.
- Wayfinding signage may be required for the guidance of transit users.

The Community Design Plan requirements apply to existing rapid transit lines as well as rapid transit lines and connections that will be constructed over the next 20 years.

Although there is no formal TOD incentive program, the City of Ottawa offers the following services and opportunities:

- The City provides pre-consultation design assistance where possible. The City encourages all developers to have pre-consultation meetings with City staff.
- The Community Design Plan process provides a basis for consistent community visioning.
- The City is willing to explore joint development opportunities on City-owned lands.
- While Provincial Statutes prohibit waiving municipal charges, permit fees, and inspections fees, there is some provision for Development Charge discounts for projects near transit stations. All residential applicants and developers near transit stations are eligible for these Development Charge discounts.

Before 2001, some of the independent municipalities that are now part of the City of Ottawa offered discounted development charges and reduced parking requirements. The City of Ottawa is developing new zoning that, when

Ottawa requires Community Design Plans for development around rapid transit stations.

---

## Bus Rapid Transit Practitioner's Guide

The City of Ottawa is planning to modify parking space requirements near Transitway stations.

implemented in 2006, may include a TOD incentive program. City staff provided the following examples of what the new zoning may allow:

- The maximum parking requirement within 1,300 feet of a transit station is 1 parking space per 455 square feet of development.
- Office uses of more than 25,000 square feet may have a minimum of 1.8 parking spaces for every 1,075 square feet of gross floor area and a maximum of 2.0 spaces per 1,000 square feet.
- Uses in core areas (i.e., within 100 feet of a transit station) may be required to share parking spaces.

City staff indicated that developer response to the TOD requirements varies. Development of properties owned by the federal government was characterized by a "very positive" response, while some private developers were "less positive." This variation was borne out in the surveys of developers, as described later in this chapter.

### DEVELOPER PERCEPTIONS

The developer perspective on specific transit service characteristics and components (particularly BRT service characteristics and components) has been addressed to a limited extent in previous research. The research performed for *NCHRP Research Results Digest 294 (3)* did not survey developers. The survey of developers and lenders performed for *TCRP Report 102 (2)* focused on the financial aspects of TOD projects. Caltrans reports that, "whether real or perceived, many developers believe there are significant barriers to overcome in trying to secure funding for TODs; these barriers include the belief that mixed-use developments are risky, difficulty in appraising TODs using traditional appraisal methods, and a perceived unwillingness of investors to fund developments in central cities."

A 2005 study conducted by Mejias and Deakin (11) looked at development activity along San Pablo Avenue in Oakland, where the new San Pablo Rapid BRT service runs. This study surveyed 11 developers involved in recent or ongoing residential and mixed-use projects on San Pablo Avenue. A key finding was that developers "...view transit availability as a bonus but not necessarily a major development incentive." A second finding was that a BRT service distinguished from regular local bus service primarily by increased stop spacing and bus preferential treatments is *not* adequate to attract developer interest. A third finding was that factors such as unattractive streetscaping, high crime rates, and confusing and inflexible development regulations can deter developers regardless of the quality of the transit service. Not cited was the proximity of BART stations within a mile of San Pablo Avenue and joint development at some of the other train stations.

### Methodology

Special surveys were conducted in Boston and Ottawa to assess the impact of BRT components on land development decisions and perceived differences in BRT and rail transit. Boston was chosen to assess the impact of an arterial street BRT operation (the Silver Line), while Ottawa was chosen to assess the impact of an off-street busway (the Transitway). Transit agency real estate and city/county planning and economic development staff in each city were contacted to review the factors that resulted in added development along the new BRT lines.

Selected developers (including a non-profit agency) in Boston and Ottawa who have made development decisions along the BRT lines were interviewed to obtain

A survey of developers along San Pablo Avenue in Oakland reported that increased stop spacing and transit preferential treatments were not enough to attract developer interest.

their insights. Developer contacts were identified from the initial local jurisdiction contacts and, in the case of Ottawa, from station area walking maps such as the one in Exhibit 6-7. For developers, the focus was on the hard or design elements of BRT, including stations, running ways, and vehicles. The questions revolved around the factors that influence why developers might be inclined to locate different types of development (i.e., residential, commercial, or mixed-use) within walking distance of BRT stations in different types of environments (i.e., CBD, central city, or suburban) and different features.

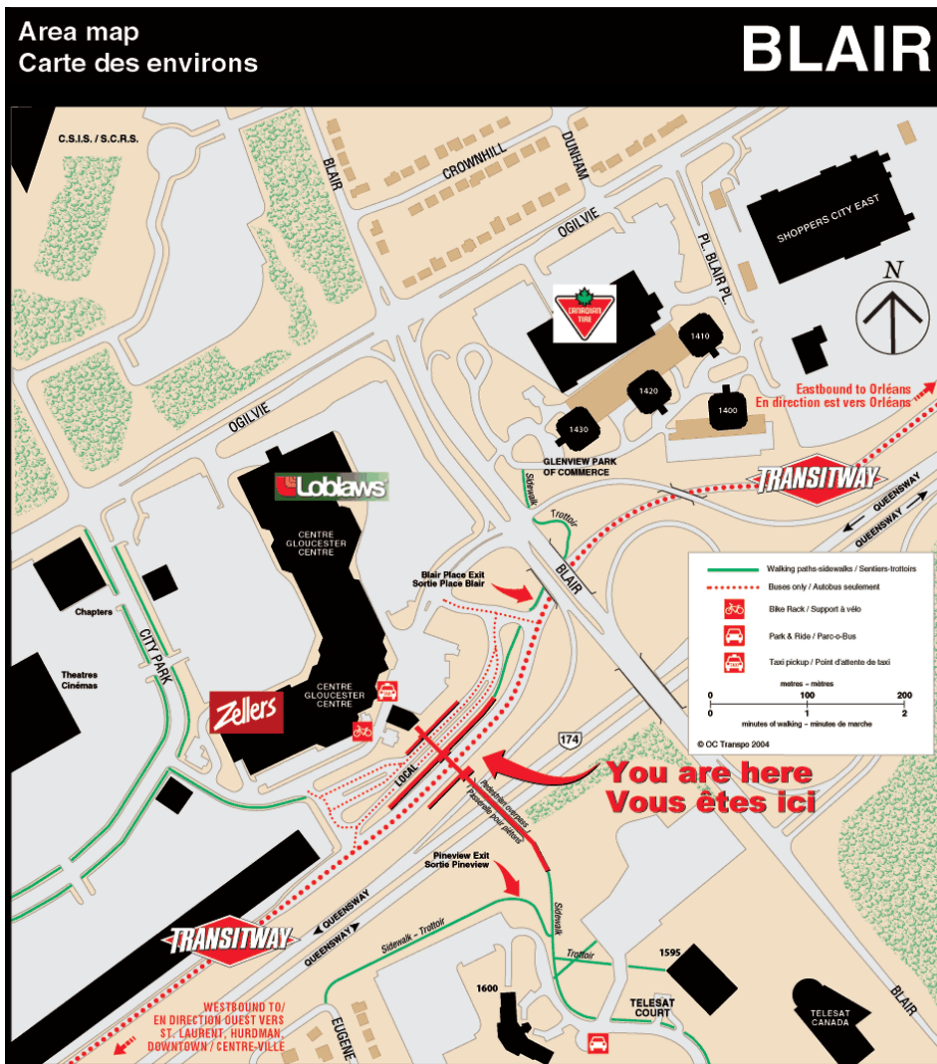

SOURCE: OC Transpo

EXHIBIT 6-7 Transitway Station Area Map - Blair Station

## Boston

### TOD Overview

The first phase of Boston's first BRT project, the Silver Line, opened in July 2002 on Washington Street between the Dudley Square/Roxbury neighborhoods, traveling through the South End and ending at the Downtown Crossing station.

*Bus Rapid Transit Practitioner's Guide*

The Washington Street corridor was served by the Orange Line—an elevated heavy rail line—until 1987, when the Orange Line was shifted to right-of-way that had been purchased for a highway. Exhibit 6-8 is a map of the MBTA subway system, which includes the Silver Line.

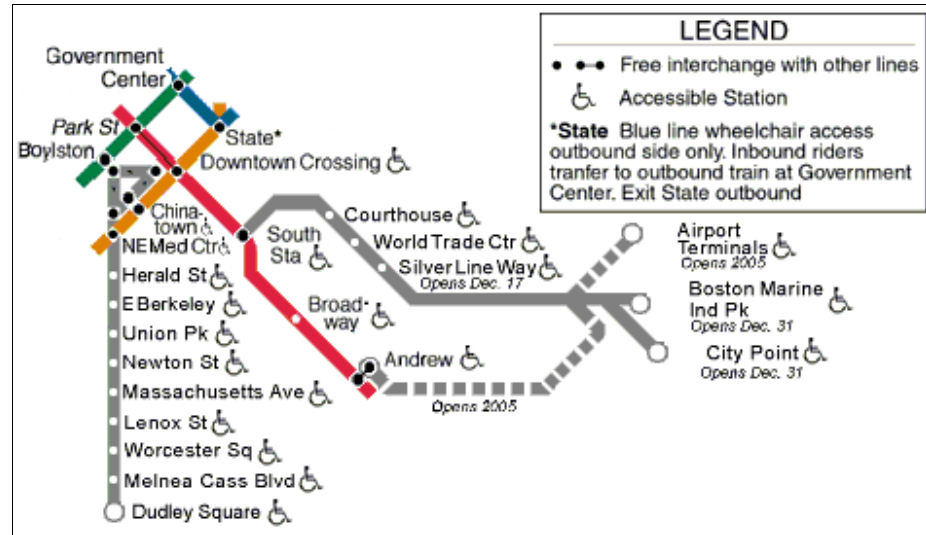

SOURCE: MBTA

EXHIBIT 6-8 Subway and BRT Map with Silver Line

Most of the second phase, from South Station to Logan Airport, opened in December 2004, and the connection to the airport began operation in 2005. A considerable portion of this segment is located underground, and the press release for the opening read, “New Subway Opens in Boston for First Time Since 1918.” (Silver Line schedules are also found under “Subway” on MBTA’s web site.) This phase of the Silver Line was built at the same time as a new federal courthouse and new convention center spurred significant construction in the South Boston Waterfront, which was formerly filled with surface parking lots and port access. Massport, a state-created entity charged with management of the airports, bridges, and port facilities, owns much of the property in this area and has been actively involved in encouraging TOD.

A third phase, a bus tunnel, is planned to connect the two initial segments but has encountered challenges from stakeholders along the proposed alignment and the FTA. This connection is important not so much because of the need for trips along the entire length of the corridor but to connect each of the initial phases to all of the existing rail lines to allow for single-transfer trips throughout the entire MBTA system.

The parties that provided input to this research included staff from MBTA, the BRA (a division of the City of Boston), Massport, and the Washington Gateway Main Street program, as well as five developers. One of the developers is a non-profit development corporation.

*Summary of Boston Developer Surveys*

The Silver Line has clearly played a role in encouraging development along its first two phases, although in each instance the other public investments may have had as much, if not more, influence on the development prospects. All of the

surveyed developers have seen a benefit in the connections to downtown provided by the Silver Line, and some of their projects have less parking because of the adjacent transit. However, most projects still contain on-site structured parking to meet the needs of tenants. Finally, some developers expressed a preference for rail and had concerns about MBTA's long-term commitment to the Washington Street portion of the line and its ability to link the two sections to each other and the entire system.

Important factors underlying development decisions were proximity to the Silver Line, supportive zoning, land availability and cost, and provisions of real-time passenger information. The reconstruction of Washington Street, including widening sidewalks and installing amenities, was perceived (by some) to be as important in making investment decisions as the transit improvement itself.

It is interesting to compare developer interest along the Silver Line with the findings of Mejias and Deakin's San Pablo Avenue study (11). In Boston, some developers stated that reconstruction of Washington Street as part of Silver Line development was an attractive component of the BRT project. In Oakland, developers thought that the attractiveness of some sections of San Pablo Avenue was "a bonus" while other sections needed to be improved to enhance "development prospects."

Both Boston and Oakland developers shared concerns about the "permanence" of BRT investments. Some Boston developers expressed this concern directly by contrasting BRT with heavy rail (a more costly alternative). Some Oakland developers did not know that the San Pablo Rapid service existed, presumably because it runs in mixed traffic and required relatively little reconstruction of San Pablo Avenue.

## Ottawa

### *TOD Overview*

The City of Ottawa is a regional government that, since 2001, includes 11 urban and rural communities and 800,000 residents. The City forecasts that the region's population will exceed 1 million within the next 20 years. To accommodate this level of growth, City policies include TOD and the Transitway; TOD projects are located at Mixed-Use Centers according to the relevant policy documents and reports. Such a center was depicted in Exhibit 6-7. When supported by an extensive rapid transit network and deployment of transit preferential treatments, the requirements for Mixed-Use Centers further the City's aim of realizing the highest level of future transit usage that can reasonably be achieved (i.e., a target mode share of 30%).

OC Transpo (the Ottawa transit agency) is a part of the City of Ottawa government, so the transit agency and the city government were not surveyed separately. Surveyed staff included current and former staff. City staff answered the survey questions about development activity near the Transitway and provided copies of several documents that describe elements of the TOD program. These documents include the following:

- City of Ottawa's Official Plan (May 2003)
- City of Ottawa's Transportation Master Plan (September 2003)
- "Land Use Strategies to Support Increased Transit Ridership - A Guidebook" (prepared for the City by Entra Consultants, March 2003)

Factors influencing development along Boston's Silver Line include supportive zoning, land availability and cost, and a reconstructed streetscape.

Developers in Boston and Oakland expressed concerns about the "permanence" of BRT.

---

## *Bus Rapid Transit Practitioner's Guide*

### *Developer Involvement in Transitway Development*

The City indicated that developers had the opportunity to be involved in the development of the rapid transit network because the City used a very extensive public involvement process during the Rapid Transit Expansion Study, development of the City's Transportation Master Plan, and development of the City's 2020 Growth Management Strategy. The City also regularly has dialogues with the local Homebuilders Association, the local chapter of the Building Owners and Managers Association, and the federal government (which is the largest employer in Ottawa). The level of developer involvement is based primarily on whether a given developer owns property affected by rapid transit network development. Developer involvement is less linked to whether the rapid transit line is a BRT line or an LRT line.

City staff indicated that they could not quantify developers' interest in specific components of BRT (e.g., proximity of station, ridership, quality of pedestrian environment, quality of streetscape/transitway, transit service frequency, and station amenities), but they related the following qualitative observations:

- Developer interest in BRT components is site-specific.
- The federal government (a major landowner and employer in Ottawa) has always had a high level of interest in the BRT components listed above. Public Works and Government Services Canada, a federal agency, is currently preparing a long-term master plan to develop Tunney's Pasture (one of the Transitway stations) in accordance with Official Plan objectives to intensify development and increase ridership.
- Private developers are less interested if there are significant additional costs associated with the BRT components listed above. Private developers generally contribute their share to the Transitway as a result of legislative requirements.
- Developers feel that BRT contributes to the station-area development market. The City does not have trend data to verify this.
- Developers endorse proximity to rapid transit when promoting sales and rentals. The City does not know what effect this has on sales and rentals.

### *Summary of Ottawa Developer Surveys*

The City and developer surveys resulted in the following findings and insights:

- The range of responses from developers was wide in terms of positive and negative viewpoints on TOD and rapid transit systems such as BRT. Much concern seemed to spring from frustration with the timetable of transit line construction and the amount of right-of-way that developers are required to dedicate to transit routes (which are not necessarily separate issues.)
- LRT and BRT are not significantly different from the perspective of virtually all of the surveyed developers in terms of the modes' impact on TOD project success. If this is the case generally, then research completed to understand the developer perspective on land development impacts of LRT could be applied to BRT. One developer indicated a preference for BRT, which was surprising given common assumptions about the relative attractiveness of bus and rail modes.

LRT and BRT are not significantly different in Ottawa from the perspective of surveyed developers.

- The City's perspective on developer interest in BRT components is generally supported by the developer surveys. The City's perspective on developers' views of LRT vs. BRT also is generally supported by the developer surveys. Nevertheless, a disconnect may exist between the perceptions of the development community, transportation professionals, and several classes of the general public regarding which TOD factors (and BRT components) are important, which are not, and how the factors might be ranked. For example, walking distance to transit is important for public agencies and for people who intend to use transit, but not for developers who believe that their target customers do not intend to use transit and/or believe that walking distance is a very insignificant issue in comparison to other development concerns. These ideas of relative value may originate in inconsistent understanding of what rapid transit hopes to achieve and what it is capable of achieving in a given environment.

### Caveats

The results of the developer survey described in this chapter were based on a small sample size. In addition to the obvious differences between the two cities (e.g., climate and development character) and expected differences between each developer's business philosophies, Boston and Ottawa have very different transit histories: A new BRT line in Boston complements a mature subway system, while a new LRT line complements an established BRT line in Ottawa. The findings and implications related to TOD influences are likely to reflect these factors.

### GUIDELINES

TOD at BRT stations has the benefits of improving mobility choices, reducing reliance on driving and achieving greater sustainability, and enhancing BRT ridership. Suggested guidelines for planning and assessing land development related to BRT follow.

### Coordinating BRT with Land Development

The following guidelines will help communities, transit agencies, and developers plan and assess the land development opportunities and impacts along BRT lines:

- BRT, like rail transit, can improve accessibility and increase passenger capacity in the corridors that it serves. It can help increase CBD intensity and encourage development at major development nodes and in outlying areas. Each of these locations offers promise for transit-related development. BRT junctions with major intersecting bus routes also offer promising locations for TOD.
- BRT systems should serve both existing and future markets. Where BRT serves existing markets in built-up areas, the customer base is well-established, but creating new TOD projects may be difficult. Where BRT serves undeveloped areas, it has the opportunity to shape development around it.
- For TOD to be successful, there must be a market for TOD. Only where there is a latent demand for development near transit can significant increases in land value be achieved. Thus, not every BRT route or station can attract development.
- Land should be available at reasonable cost for the intended uses.

The Guide provides several guidelines for planning and assessing the land development impacts of BRT.



---

## *Bus Rapid Transit Practitioner's Guide*

- TOD works best in dynamic markets. Strong markets are particularly important for retail developments.
- The BRT route should provide a strong sense of permanence and a clear identity (in addition to faster service) to attract development. Improved (preferably separate) running ways and new urban design features can create a positive climate for investment; a good example of this is the positive development effects of Boston's Washington Street Silver Line.
- The location and design of BRT routes should consider land development opportunities. Vision is important. Urban redevelopment, for example, has been a major consideration underlying Cleveland's Euclid Avenue Transitway.
- Convenient transit passenger access should be provided for developments adjacent to, or integrated with, BRT stations. Attractively designed BRT stations with conflict-free, weather-protected pedestrianways connecting transit stations to adjacent activity centers can have a positive effect on land development. The St. Laurent station along Ottawa's Transitway is an example of such a treatment.
- Site designs for TODs should encourage density, diversity, and walkability. Transit-supportive uses (such as retail, office, and residential) should be encouraged. Mixed-use developments can add interest and variety; however, the various uses do not have to be mixed in the same location.
- Parking policies should support TOD. It is desirable to avoid either too much or too little parking. Parking should be limited, especially adjacent to BRT stations, and structured parking, while costly, may be desirable where land costs are high and space is at a premium. Ottawa's policies, for example, specify a maximum parking requirement of one parking space per 455 square feet of development within 1,300 feet of a BRT station and a maximum of two spaces per 1,000 square feet of office space elsewhere.
- Transit-supportive policies should be established. They can specify where various developments can locate (i.e., zoning), site design and access features, and parking requirements. Ottawa's Official Plan, for example, requires all major centers to be located along its Transitway or LRT system.
- Public-private partnerships should be encouraged. The public sector has the power to resolve land assembly problems, ensure that the site is ready for development, contribute land, and fund infrastructure improvements. Private developers can finance, build, and operate the developments. Working together, they can expedite TOD.
- Service planning should consider that BRT, in contrast to rail transit, can potentially minimize transfers by providing transfer-free neighborhood feeder bus service as well as trunk service.

### **Stakeholder Perspectives**

The parties involved in BRT and land development (i.e., transit users, tenants, residents, customers, transit agencies, planners, developers, lenders, and local governments) have different perspectives on the value of TOD and specific TOD design requirements. The following guidelines are directed to these differences:

The various parties involved in TOD may have different perspectives on the value of TOD and TOD design requirements.

- The surveys conducted for this *Bus Rapid Transit Practitioner's Guide* suggest that, for developers, financial concerns related to TOD requirements, TOD incentives, and demonstrated agency commitment to the BRT (or rail) service are important. These considerations may outweigh the value of the BRT (or rail) service's operating characteristics (e.g., headways and service span).
- The differing perspectives indicate that there is an opportunity to educate the parties involved in the development of TOD projects and BRT lines. For example, developers may benefit by learning more about how their tenants view premium transit services.
- Achieving TOD along BRT lines calls for achieving stakeholder consensus and resolving conflicts by establishing a clear vision and set of goals for a TOD project. *The New Transit Town (10)* points out that there can be conflicts between local and regional jurisdictions. These conflicts should be minimized.
- The Executive Summary of the *Statewide Transit-Oriented Development Study (1)* identifies three elements required to overcome the unwillingness of investors to finance TOD projects: well-planned phasing, a solid track record for implementing projects and conducting accurate market studies, and availability of multiple sources of capital with varying investment timelines.
- Surveys conducted for the *Bus Rapid Transit Practitioner's Guide* identified the following developer concerns that should be addressed:
  - > Availability of land at a reasonable cost
  - > Land development regulations affecting properties in the vicinity of transit stations (especially those that require dedication of right-of-way to transit facilities)
  - > Agency commitment to the transit corridor
  - > Good connections to regional destinations
  - > Existence of a strong development market
- According to surveys described in *Redevelopment and Revitalization Along Urban Arterials (11)*, developers may be discouraged by high development costs, difficulties in obtaining financing because comparable projects do not exist, limited development incentives, incompatible surrounding land uses, small parcel sizes, confusing codes, inflexible development regulations, slow review processes, high vehicle speeds, excessive parking requirements, high crime rates, environmental conditions, and certain state laws. Developers may be encouraged by density bonuses, low land costs in redevelopment zones, exemptions from state environmental review laws, coordinated streetscaping projects, pooled open space requirements, city efforts to reduce crime, city assistance with neighborhood communication, shortened review periods, and clearer zoning codes.

The following guidelines concern specific BRT components:

- Attractively designed BRT stations with conflict-free, weather-protected pedestrian-ways connecting transit stations to adjacent activity centers can have a positive effect on land development.

Attractively designed stations can have a positive effect on land development.

## Bus Rapid Transit Practitioner's Guide

- “More defined stations attract potential development,” according to CBRT (9).
- BRT services that do not operate in a fixed guideway may not attract developer interest according to Redevelopment and Revitalization Along Urban Arterials (11).

### Evaluating TOD Programs

TODs often evolve over a long time frame (as in Ottawa and Pittsburgh). They should be periodically evaluated for effectiveness and possible changes in public policy or public-private arrangements. The components of a recommended TOD evaluation program are shown in Exhibit 6-9. The exhibit describes the usefulness of each indicator, the ease of collecting the data necessary to evaluate each indicator, and frequency of monitoring for each indicator. Once the initial evaluation program is established, subsequent updates should be less costly. *NCHRP Research Results Digest 294* (3) suggests that, because construction of a BRT line is typically less expensive than construction of a rail line, surveys of land development impacts could be funded with the cost savings.

**EXHIBIT 6-9 Indicators Recommended as the Foundation of a TOD Evaluation Program**

Indicator	Usefulness Score <sup>1</sup>	Ease of Data Collection Score <sup>2</sup>	Frequency of Monitoring <sup>3</sup>
Transit Ridership	70	61	More than once a year
Density (Population/Housing)	67	—	Once a year
Quality of Streetscape Design	77	—	Once a year
Quantity of Mixed-Use Structures	60	54	Once a year
Pedestrian Activity/Pedestrian Safety	60	59	Once a year
Increase in Property Value/Tax Revenue	63	57	Once a year
Public Perception	63	—	Once a year
Mode Connections at the Transit Station	63	79	Once a year
Parking Configuration	53	62	Once a year

<sup>1</sup> Percentage of survey respondents rating indicator as “Very Useful”

<sup>2</sup> Percentage of survey respondents rating indicator as “Very Easy” to collect data

<sup>3</sup> *NCHRP Research Results Digest 294* (3) reports that the majority of indicators studied should be collected once a year or less often according to survey respondents. A key exception is Transit Ridership, which most respondents stated should be collected more often than once a year.

SOURCE: *NCHRP Research Results Digest 294* (3)

*In general, BRT systems are likely to attract levels of ridership (comprising customers, residents, and employees) like those of rail systems with similar service characteristics. Property values can increase near a BRT station beyond that observed in more distant locations.*

### Resource Materials

Some potential resources for BRT-related TOD program evaluation include the following:

- *NCHRP Research Results Digest 294: Transit-Oriented Development: Developing a Strategy to Measure Success* (3), available through TRB, gives indicators for monitoring TOD programs. It suggests that “...transit agencies/state DOTs/MPOs set aside special funds for TODs to support pedestrian activity surveys, resident and merchant surveys, analyses of property values and taxes, design assessment, and density tracking.”

General TOD information is available from many other sources.

- The Center for Transit-Oriented Development maintains the National TOD Database, which is a “GIS [geographical information system] database that combines a current demographic snapshot of who presently lives near transit with information on travel behavior in each transit region of the country.” A promising potential application of this database is the ability to derive historical trends and before-and-after comparisons of station area development.
- The Center for Transit-Oriented Development and the Urban Land Institute have published several reports and case studies about the impacts of TOD in general and factors in successful TOD projects.
- The BRT Institute at the Center for Urban Transportation Research is a clearinghouse of information about existing and planned BRT services.
- VTI's Online TDM [Transportation Demand Management] Encyclopedia (<http://www.vtpi.org/tdm/>) summarizes many sources of TOD and TOD-related information.
- The U.S. Census provides relevant demographic data (e.g., population densities) in a variety of formats.
- Building permit data, vacancy rates, rental prices, and home value data can be obtained from local governments to track development activity and demand for development near BRT stations.
- Local government staff (from planning, economic development, and real estate departments) can provide information about new projects, developer response to TOD program requirements and incentives, and TOD trends.
- Transit agency staff can provide information about new projects, developer response to TOD program requirements and incentives, and TOD trends
- Other comprehensive TOD research reports and studies include the following:
  - > *TCRP Report 102: Transit-Oriented Development in the United States: Experiences, Challenges, and Prospects (2)*, available through TRB
  - > *Developing Around Transit: Strategies and Solutions that Work (8)*, available from the Urban Land Institute
  - > *The New Transit Town (10)*, edited by Dittmar and Ohland and available from Island Press

## REFERENCES

1. Parker, T., and G. B. Arrington. *Statewide Transit-Oriented Development Study: Factors for Success in California, Executive Summary*. California Department of Transportation, May 2002.
2. Cervero, R., S. Murphy, C. Ferrell, N. Goguts, Y. Tsai, G. Arrington, J. Boroski, J. Smith-Heimer, R. Golem, P. Peninger, E. Nakajima, E. Chui, R. Dunphy, M. Myers, S. McKay, and N. Witenstein. *TCRP Report 102: Transit-Oriented Development in the United States: Experiences, Challenges, and Prospects*. Transportation Research Board of the National Academies, Washington, D.C., 2004.
3. Renne, J., and J. Wells. *NCHRP Research Results Digest 294: Transit-Oriented*

---

*Bus Rapid Transit Practitioner's Guide*

- Development: Developing a Strategy to Measure Success.* Transportation Research Board of the National Academies, Washington, D.C., 2005.
4. Rodriguez, D., and F. Targa. The Value of Accessibility to Bogotá's Bus Rapid Transit System. Department of Civil and Environmental Engineering, University of North Carolina, Chapel Hill, 2003.
  5. Levinson, H., S. Zimmerman, J. Clinger, S. Rutherford, R. Smith, J. Cracknell, and R. Soberman. *TCRP Report 90: Bus Rapid Transit: Vol. 1, Case Studies in Bus Rapid Transit, and Vol. 2, Implementation Guidelines.* Transportation Research Board of the National Academies, Washington, D.C., 2003.
  6. Nelson, D., J. Niles, and A. Hibshoosh. *A New Planning Template for Transit-Oriented Development.* MTI Report 01-12. San Jose: Mineta Transportation Institute, College of Business, San Jose State University, 2001.
  7. Victoria Transport Policy Institute. TDM Encyclopedia: Transit-Oriented Development. <http://www.vtpi.org/tdm/tdm45.htm>. Updated Apr. 4, 2006.
  8. Dunphy, R., R. Cervero, F. Dock, M. McAvey, D. Porter, and C. Swenson. *Developing Around Transit: Strategies and Solutions that Work.* Urban Land Institute, Washington, D.C., 2004.
  9. Diaz, R.B., M. Chang, G. Darido, E. Kim, D. Schneck, M. Hardy, J. Bunch, M. Baltes, D. Hinebaugh, L. Wnuk, F. Silver, and S. Zimmerman. *Characteristics of Bus Rapid Transit for Decision-Making.* FTA, Washington, D.C., 2004.
  10. Dittmar, H., and G. Ohland (Eds.). *The New Transit Town: Best Practices in Transit-Oriented Development.* Island Press, Washington, D.C., 2004.
  11. Mejias, L. and E. Deakin. Redevelopment and Revitalization Along Urban Arterials: Case Study of San Pablo Avenue, California, from the Developers' Perspective. *Transportation Research Record: Journal of the Transportation Research Board No. 1902.* Transportation Research Board of the National Academies, Washington D.C., 2005, pp. 26-34.

*Abbreviations and acronyms used without definitions in TRB publications:*

AAAE	American Association of Airport Executives
AASHO	American Association of State Highway Officials
AASHTO	American Association of State Highway and Transportation Officials
ACI-NA	Airports Council International-North America
ACRP	Airport Cooperative Research Program
ADA	Americans with Disabilities Act
APTA	American Public Transportation Association
ASCE	American Society of Civil Engineers
ASME	American Society of Mechanical Engineers
ASTM	American Society for Testing and Materials
ATA	Air Transport Association
ATA	American Trucking Associations
CTAA	Community Transportation Association of America
CTBSSP	Commercial Truck and Bus Safety Synthesis Program
DHS	Department of Homeland Security
DOE	Department of Energy
EPA	Environmental Protection Agency
FAA	Federal Aviation Administration
FHWA	Federal Highway Administration
FMCSA	Federal Motor Carrier Safety Administration
FRA	Federal Railroad Administration
FTA	Federal Transit Administration
IEEE	Institute of Electrical and Electronics Engineers
ISTEA	Intermodal Surface Transportation Efficiency Act of 1991
ITE	Institute of Transportation Engineers
NASA	National Aeronautics and Space Administration
NASAO	National Association of State Aviation Officials
NCFRP	National Cooperative Freight Research Program
NCHRP	National Cooperative Highway Research Program
NHTSA	National Highway Traffic Safety Administration
NTSB	National Transportation Safety Board
SAE	Society of Automotive Engineers
SAFETEA-LU	Safe, Accountable, Flexible, Efficient Transportation Equity Act: A Legacy for Users (2005)
TCRP	Transit Cooperative Research Program
TEA-21	Transportation Equity Act for the 21st Century (1998)
TRB	Transportation Research Board
TSA	Transportation Security Administration
U.S.DOT	United States Department of Transportation