

Risk-Based Management Guidelines for Scour at Bridges with Unknown Foundations

DETAILS

0 pages | null | PAPERBACK

ISBN 978-0-309-43677-9 | DOI 10.17226/23243

BUY THIS BOOK

FIND RELATED TITLES

AUTHORS

Visit the National Academies Press at NAP.edu and login or register to get:

- Access to free PDF downloads of thousands of scientific reports
- 10% off the price of print titles
- Email or social media notifications of new titles related to your interests
- Special offers and discounts



Distribution, posting, or copying of this PDF is strictly prohibited without written permission of the National Academies Press. (Request Permission) Unless otherwise indicated, all materials in this PDF are copyrighted by the National Academy of Sciences.

ACKNOWLEDGMENT

This work was sponsored by the American Association of State Highway and Transportation Officials (AASHTO), in cooperation with the Federal Highway Administration, and was conducted in the National Cooperative Highway Research Program (NCHRP), which is administered by the Transportation Research Board (TRB) of the National Academies.

COPYRIGHT PERMISSION

Authors herein are responsible for the authenticity of their materials and for obtaining written permissions from publishers or persons who own the copyright to any previously published or copyrighted material used herein.

Cooperative Research Programs (CRP) grants permission to reproduce material in this publication for classroom and not-for-profit purposes. Permission is given with the understanding that none of the material will be used to imply TRB, AASHTO, FAA, FHWA, FMCSA, FTA, Transit Development Corporation, or AOC endorsement of a particular product, method, or practice. It is expected that those reproducing the material in this document for educational and not-for-profit uses will give appropriate acknowledgment of the source of any reprinted or reproduced material. For other uses of the material, request permission from CRP.

DISCLAIMER

The opinion and conclusions expressed or implied in the report are those of the research agency. They are not necessarily those of the TRB, the National Research Council, AASHTO, or the U.S. Government.

This report has not been edited by TRB.

THE NATIONAL ACADEMIES

Advisers to the Nation on Science, Engineering, and Medicine

The **National Academy of Sciences** is a private, nonprofit, self-perpetuating society of distinguished scholars engaged in scientific and engineering research, dedicated to the furtherance of science and technology and to their use for the general welfare. On the authority of the charter granted to it by the Congress in 1863, the Academy has a mandate that requires it to advise the federal government on scientific and technical matters. Dr. Ralph J. Cicerone is president of the National Academy of Sciences.

The **National Academy of Engineering** was established in 1964, under the charter of the National Academy of Sciences, as a parallel organization of outstanding engineers. It is autonomous in its administration and in the selection of its members, sharing with the National Academy of Sciences the responsibility for advising the federal government. The National Academy of Engineering also sponsors engineering programs aimed at meeting national needs, encourages education and research, and recognizes the superior achievements of engineers. Dr. William A. Wulf is president of the National Academy of Engineering.

The **Institute of Medicine** was established in 1970 by the National Academy of Sciences to secure the services of eminent members of appropriate professions in the examination of policy matters pertaining to the health of the public. The Institute acts under the responsibility given to the National Academy of Sciences by its congressional charter to be an adviser to the federal government and, on its own initiative, to identify issues of medical care, research, and education. Dr. Harvey V. Fineberg is president of the Institute of Medicine.

The **National Research Council** was organized by the National Academy of Sciences in 1916 to associate the broad community of science and technology with the Academy's purposes of furthering knowledge and advising the federal government. Functioning in accordance with general policies determined by the Academy, the Council has become the principal operating agency of both the National Academy of Sciences and the National Academy of Engineering in providing services to the government, the public, and the scientific and engineering communities. The Council is administered jointly by both the Academies and the Institute of Medicine. Dr. Ralph J. Cicerone and Dr. William A. Wulf are chair and vice chair, respectively, of the National Research Council.

The **Transportation Research Board** is a division of the National Research Council, which serves the National Academy of Sciences and the National Academy of Engineering. The Board's mission is to promote innovation and progress in transportation through research. In an objective and interdisciplinary setting, the Board facilitates the sharing of information on transportation practice and policy by researchers and practitioners; stimulates research and offers research management services that promote technical excellence; provides expert advice on transportation policy and programs; and disseminates research results broadly and encourages their implementation. The Board's varied activities annually engage more than 5,000 engineers, scientists, and other transportation researchers and practitioners from the public and private sectors and academia, all of whom contribute their expertise in the public interest. The program is supported by state transportation departments, federal agencies including the component administrations of the U.S. Department of Transportation, and other organizations and individuals interested in the development of transportation. www.TRB.org

www.national-academies.org

CONTENTS

LIST OF FIGURES	ii
LIST OF TABLES	ii
ACKNOWLEDGEMENTS	iii
ABSTRACT	iii
EXECUTIVE SUMMARY	1
1. Introduction	5
1.1. Bridges with Unknown Foundations	5
1.2. Performance-Based versus Traditional Design Practice	10
1.3. Report Overview	12
2. General Approach to Risk Management	13
2.1. Probability of Failure	13
2.1.1. Hazardous Potential	13
2.1.2. Vulnerability to Failure	14
2.1.3. Correlations with Observed Failures	16
2.1.4. Multiple Failure Modes	16
2.2. Cost of Failure	18
2.2.1. Expenses per Mile for the Motor Carrier Industry	18
2.2.2. Bridge Costs	21
2.2.3. Price Elasticity of Demand	22
2.2.4. Loss of Life	23
2.2.5. HYRISK Cost of Failure Equation	24
2.3. Risk of Failure	25
2.4. Mitigating Activities	26
2.5. General Guidelines for Risk Management	27
3. Quantifying Risk of Scour Failure	34
3.1. HYRISK Background	34
3.2. Annual Probability of Scour Failure	34
3.3. The Scour Risk Equation	40
3.4. Lifetime Risk of Scour Failure	42
4. Mitigating Actions for Scour	43
4.1. Pertinent Findings from Experience	43
4.2. Foundation Reconnaissance	44
4.3. Scour Monitoring	49
4.4. Scour Countermeasures	53
5. Scour Risk Management Guidelines	56
5.1. Can the Foundation Be Inferred?	58
5.2. Is the Bridge a High Priority Structure?	59
5.3. Screening Bridges According to Risk	60
5.3.1. Does the Bridge Meet Minimum Performance Level?	61
5.3.2. Is Automated Scour Monitoring Warranted?	62
5.3.3. Are Scour Countermeasure Warranted?	63
5.3.4. Is Foundation Reconnaissance and Scour Analysis Warranted?	63
5.4. Install Countermeasures without Field Reconnaissance and Scour Analysis	65
5.5. Develop a Bridge Closure Plan	66
5.6. Is Significant Scour Occurring?	68
6. Scour Management Case Studies	69

6.1.	Information Search and Preliminary Screens.....	69
6.2.	The Minimum Performance Level Criterion	70
6.3.	Scour Risk Assessment.....	72
6.4.	Management Alternatives.....	74
7.	Conclusions and Recommendations	81
8.	References.....	83

LIST OF FIGURES

Figure 1	General risk management guidelines flow chart.....	32
Figure 2	HYRISK scour vulnerability versus NBI item 113.....	39
Figure 3	Average HYRISK scour vulnerability versus NBI item 113.....	40
Figure 4	Scour risk management guidelines flow chart.....	57

LIST OF TABLES

Table 1	Numbers of Bridges with Unknown Foundations by State	7
Table 2	Numbers of Bridges with Unknown Foundations by Age.....	9
Table 3	Detour Duration versus ADT	18
Table 4	Occupancy per Vehicle Mile by Daily Trip Purpose	19
Table 5	Comparison of Total and Variable Costs per Mile	19
Table 6	Values of Time Used in the Derivation of Road User Costs	19
Table 7	Estimates of the Values of Travel Time.....	20
Table 8	Values of Time.....	21
Table 9	Cost of Bridge Construction.....	22
Table 10	Cost Multiplier for Early Replacement.....	22
Table 11	Assumed Number of Lives Lost in Bridge Failure.....	24
Table 12	Annual Probability of Scour Failure	36
Table 13	Bridge Overtopping Frequency versus NBI Items 26 and 71.....	36
Table 14	Scour Vulnerability versus NBI Items 60 and 61	37
Table 15	Effectiveness of NDT Methods	47
Table 16	Fixed Scour Monitoring Methods	49
Table 17	Comparison of Instrument Types.....	51
Table 18	Comparison of Fixed Instrumentation.....	51
Table 19	Comparison of Portable Instrumentation	52
Table 20	Estimated Instrument Cost.....	52
Table 21	Stone Riprap weights.....	54
Table 22	Bedding stone sizes	54
Table 23	Material costs (Florida).....	54
Table 24	Material costs (New York State)	54
Table 25	Material costs (Colorado)	54
Table 26	Average Total Armor Costs per Pier (Florida).....	55
Table 27	Minimum Performance Levels for Bridges	61
Table 28	Summary of Required Data	70
Table 29	Annual Probability of Failure, Example 1.....	71
Table 30	Annual Probability of Failure, Example 2.....	72
Table 31	Case Study Management Decisions by Functional Classification	77
Table 32	Summary of Bridge Case Studies.....	79

ACKNOWLEDGEMENTS

The research reported herein was performed under NCHRP Project 24–25 by GKY & Associates, Inc (GKY&A). Mr. Stuart M. Stein, President of GKY&A, was the Principal Investigator. The other contributors to this report include Mr. Karsten A. Sedmera, Water Resources Engineer at GKY&A, and Mr. David R. Pearson, Vice President of GKY&A. Larry Olsen, President of Olson Engineering, Inc. helped evaluate non-destructive testing methods; Martin W. McCann, Jr. of Jack R. Benjamin and Associates, Inc. researched existing risk methodologies and helped formulate the risk-based guidelines; Dr. Max Shepherd, President of OEA, Inc., helped evaluate methods for scour monitoring and scour countermeasures; Libby Ogard, a sub-contractor for Tioga Group, helped evaluate the economic assumptions; Jorge Pagan, Principal Bridge Engineer (Hydraulics) of the Federal Highway Administration, provided invaluable input at the start of the project, including contacts for data collection and the Federal perspective on unknown foundations; and J. Sterling Jones, formerly of the Federal Highway Administration, provided National Bridge Inventory data and analysis as well as contact information for State Transportation Agency personnel who currently make management decisions for bridges with unknown foundations. All work was performed under the general supervision of Mr. Stein at GKY&A.

ABSTRACT

The US currently has over 60,000 bridges over water with unknown foundations. This report presents a risk-based approach to managing these bridges in the absence of foundation information. The general framework in this report, which is primarily applied to scour failure, can easily be applied to other hazards such as earthquakes and tsunamis. The guidelines illustrate how to collect appropriate data, estimate risk of failure from an estimated failure probability and associated economic losses, and use risk in a structured approach to select an appropriate management plan. Risk analysis is specifically used to select appropriate performance standards for various bridge classifications and justify the costs of nondestructive testing of foundations, monitoring activities, and countermeasures. The scour guidelines were then applied to sixty case studies in the US to validate the management plan that it selected for bridges with known foundations, and to illustrate its specific application in a variety of settings.

EXECUTIVE SUMMARY

Bridges are skillfully designed to withstand the most common natural hazards (e.g. floods, erosion/scour, earthquakes), but the inherent uncertainty associated with natural phenomena requires bridge owners to regularly inspect bridges for signs of a problem (i.e. vulnerability to failure). While some aspects of a bridge's vulnerability to failure are easy to inspect (e.g. visible cracks or corrosion), the condition of a bridge's foundation is comparatively difficult and expensive to inspect and evaluate using standard methods. Analysis of National Bridge Inventory (NBI) data, as published in 2005, shows that almost half of the States in the US had more than a thousand bridges with unknown foundations. This is disturbing since the percentage of bridges with unknown foundations supporting principal arterials (high traffic roads) in a given State ranges from 0 to 25%. It is equally troubling that more than 1,500 bridges with unknown foundations nation-wide have been built since the year 2000.

The first phase of this study surveyed the expert opinion of various specialists including various engineers, economists, and State transportation officials. This analysis generally showed that risk-based methods provide the most inexpensive and flexible way to select a management plan. These methods generally use available data to estimate the monetary risk associated with a particular failure, and then weigh this against the cost of various mitigating actions (e.g. increased monitoring, foundation reconnaissance, countermeasures or retrofits). Estimating risk of failure involves correlating historic rates of failure with the potential for a given hazard at a given site and with uncertain indicators of the bridge's vulnerability to failure. The risk equation used in this study is the product of the estimated probability of failure and the total cost of failure. The total cost of failure is

the sum of the cost of replacing the bridge, the costs of lost time and additional mileage on detours, and the cost of loss of life (in the event of failure).

Given the uncertainty in such risk estimates, the general approach to risk management outlined in this report suggests a series of three consecutive screening analyses to select the most appropriate management plan. The first screen states that high priority bridges – bridges that provide access to emergency services, evacuation routes, or support principal arterials – should automatically qualify for the most aggressive management plan (i.e. foundation reconnaissance required to perform standard failure analyses). The second screen involves setting minimum performance levels (MPL) for various functional classifications (NBI item 26). Any remaining bridges with unknown foundations with an estimated probability of failure greater than its pertinent MPL should also receive the most aggressive management plan. The third screen involves comparing the estimated risk of failure for any remaining bridges to the cost of installing automated monitoring, then to the cost of installing countermeasures, to see if any of these special activities are warranted. If countermeasures are warranted, then automated monitoring is probably not warranted. Similarly, if countermeasures are warranted but the cost of foundation reconnaissance and standard failure analyses is more than 50% of the cost of the countermeasures (or retrofits), then foundation reconnaissance and standard failure analyses may not be warranted before installing the countermeasures. If countermeasures are installed without standard failure analysis, then the engineer should install countermeasures that are appropriate for similar site and bridge types.

This general approach was then applied specifically to scour failure by using the scour vulnerability assumptions proposed in the HYRISK methodology. Analysis shows that there is a strong correlation between HYRISK's estimated scour vulnerability and the known scour vulnerability of 297,796 bridges with known foundations. The probability of

scour failure was estimated by contacting transportation officials about historical scour failures nation-wide. Twenty-five States provided data via phone interviews and emails, and this data suggests that the annual average probability of failure is $33/161,000 = 0.000205$, or about 1 in 5,000 per year. Scaling this to all bridges over water (i.e. 379,788) yields almost 80 scour failures per year. Applying the original HYRISK method to all of the bridges over water in the NBI database yields about 60,511 failures per year (i.e. the sum of the individual probabilities of failure). Since these assumptions clearly do not correspond with experience and result in exaggerated risk factors, all of the original HYRISK failure probabilities were scaled down to a level corresponding to the approximate number of failures (nation-wide) obtained from the State interviews (i.e. about 100 scour failures nation-wide per year). Statistical rules are used to estimate a lifetime probability of failure from the annual probability of failure and the tentative remaining life of a bridge. The report then summarizes the cost and suitability of various state-of-the-art scour mitigation methods including foundation reconnaissance via non-destructive testing, scour monitoring equipment, and scour countermeasure designs.

The general guidelines for risk management of bridges with unknown foundations were then customized for scour failure. Minimum performance levels were selected for different functional classifications (i.e. NBI item 26) such that all arterials perform at least as good as the national average annual probability of failure (0.0002). The scour management guidelines show the engineer how to estimate probability of scour failure and the cost of appropriate scour monitoring methods, scour countermeasures, non-destructive testing, and scour analyses. The guidelines also show the engineer how to perform the cost-benefit analyses already described.

The scour guidelines were then applied to data from sixty case studies from six States in order to validate the overall approach. Twenty-nine of the case studies involved

bridges with known foundations and scour evaluations, and two of the case studies involved bridges that actually failed due to scour. The results show that most of the twenty-nine case studies (including the scour failures) for which there are known scour evaluations validate the management plan that the scour guidelines suggested. There were only three case studies – collector-classed bridges – with known foundations for which the scour guidelines may not have recommended a sufficiently aggressive management plan. This possibility for error is the primary reason why the minimum requirement in the scour guidelines is to develop a bridge closure plan, and to keep a detailed record of the stream bed's elevation during biennial inspections. Monitoring the stream bed elevation every two years and reviewing/updating the bridge closure plan each time should help officials identify problems that may not have been apparent before this risk analysis.

The sixty case studies regarding scour failure in this report show that risk of failure (i.e. probability*cost) can be successfully used to identify bridges that warrant special activities (e.g. automated monitoring, countermeasures or retrofits, replacement, or closure). Future studies of scour vulnerability should focus on relating scour vulnerability to better indicators, which may not be currently monitored but cost less than performing foundation reconnaissance on thousands of less-important bridges with unknown foundations that may be low-risk. Once the general approach has been developed for other hazards (earthquakes, tsunamis, etc.), the joint probability of failure due to multiple hazards may be estimated collectively.

1. INTRODUCTION

Bridges are skillfully designed to withstand the most common natural hazards (e.g. floods, erosion/scour, earthquakes), but the inherent uncertainty associated with natural phenomena requires bridge owners to regularly inspect bridges for signs of a problem (i.e. vulnerability to failure). While some aspects of a bridge's vulnerability to failure are easy to inspect (e.g. visible cracks or corrosion), the condition of a bridge's foundation is comparatively difficult and expensive to inspect. This difficulty is compounded if the buried portion of the bridge's foundation is unknown. In other words, if the pertinent aspects of vulnerability – dimension, composition, or geologic context of the foundation, etc. – are unknown, it will be difficult to estimate the bridge's vulnerability of failure during a hazard, even if the nature and severity of the stress is understood. Thus, the primary goal of this research is to develop guidelines that will help bridge owners manage bridges with unknown foundations with respect to their vulnerability to hazard-induced failure. While the general approach to risk management developed herein should be applicable to a variety to natural hazards, scour is the primary hazard used to evaluate the guidelines in this report.

1.1. Bridges with Unknown Foundations

For context, the following two tables show the number of bridges with unknown foundations that were recorded in the National Bridge Inventory (NBI) at the end of 2005. The NBI coding guide published by FHWA (1) explains the various NBI items.

Table 1 yields interesting information concerning the State and functional classification distribution of bridges with unknown foundations:

- Many States have less than a couple of dozen bridges with unknown foundations and seven States have no bridges with unknown foundations in the NBI

database. This indicates that bridges with unknown foundations are not a significant issue for all States.

- Almost half the States report over 1,000 bridges with unknown foundations, indicating a potentially significant management issue.
- Along with the total number of bridges with unknown foundations, the functional classification of those bridges indicates the severity of the management issue. While Texas has the largest population of bridges with unknown foundations (9,113), only 33 of these are principal arterials (less than one half of one percent). Alaska on the other hand has only 151 bridges with unknown foundations, but a far higher percentage of these are principal arterials (37, or 25 percent). In other words, while Alaska has relatively few bridges with unknown foundations, it has more principal arterials with unknown foundations than Texas.

Table 2 presents the temporal distribution of bridges with unknown foundations by functional classification. This table indicates the following temporal characteristics:

- Bridges built between 1950 and 1980 constitute a large proportion of the population of bridges with unknown foundations. This era also coincides with the construction of the interstate system.
- Sixty-nine principal arterials have been built between 2000 and 2005 that are identified as having unknown foundations. This is surprising given their functional importance and their very recent construction.

This brief review of the NBI database shows that the scale of the problems that States face in managing bridges with unknown foundations vary significantly. Both the number and functional classification of these bridges contribute to the scale of the problem. It is equally troubling that this problem is still growing.

Table 1 Numbers of Bridges with Unknown Foundations by State

State	Rural Functional Classifications						Urban Functional Classifications						Totals
	01	02	06	07	08	09	11	12	14	16	17	19	
	Principal Arterial - Interstate	Principal Arterial-Other	Minor Arterial	Major Collector	Minor Collector	Local	Principal Arterial - Interstate	Principal Arterial-Other Freeways or Expressways	Other Principal Arterial	Minor Arterial	Collector	Local	
Alabama	4	70	79	503	843	1,662	4	5	25	39	55	164	3,453
Alaska	7	29	4	19	23	46	1	0	1	7	1	13	151
Arizona	0	0	0	1	0	33	0	0	1	3	5	25	68
Arkansas	0	1	11	48	4	10	0	0	1	2	0	2	79
California	4	23	112	318	305	993	3	9	71	84	60	126	2,108
Colorado	1	2	9	4	3	8	0	0	0	1	1	0	29
Connecticut	0	0	0	0	0	0	0	0	0	0	0	0	0
Delaware	0	0	0	0	0	0	0	0	0	0	0	0	0
DC	0	0	0	0	0	0	0	0	0	0	0	8	8
Florida	3	110	111	224	188	837	13	27	74	136	280	444	2,447
Georgia	3	346	434	1,227	565	1,780	0	32	178	288	188	406	5,447
Hawaii	0	0	0	0	0	0	0	0	0	2	0	8	10
Idaho	0	1	1	71	74	318	0	0	3	6	9	14	497
Illinois	0	0	0	1	0	1	0	0	0	0	0	0	2
Indiana	0	1	0	140	263	828	0	0	42	101	75	156	1,606
Iowa	0	1	3	92	256	1,371	0	0	0	11	6	30	1,770
Kansas	0	0	0	0	1	5	0	0	0	0	0	0	6
Kentucky	0	0	0	0	0	1	0	0	0	0	0	1	2
Louisiana	17	13	180	527	488	2,963	12	1	30	84	58	401	4,774
Maine	6	2	1	4	3	76	2	0	0	2	5	4	105
Maryland	0	0	0	0	0	4	0	0	0	0	0	1	5
Massachusetts	2	0	10	25	16	70	0	1	42	95	45	52	358
Michigan	3	36	43	157	13	360	2	2	9	10	11	11	657
Minnesota	0	0	2	16	24	161	0	0	0	4	2	7	216
Mississippi	0	16	11	1,205	187	4,790	0	0	32	54	101	137	6,533
Missouri	0	0	1	6	1	0	0	0	0	0	0	0	8
Montana	2	1	5	1	429	1,244	0	0	0	1	0	2	1,685
Nebraska	0	0	0	0	0	0	0	0	0	0	0	0	0
Nevada	0	0	2	1	3	24	0	0	1	10	1	3	45
New Hampshire	0	0	0	3	6	22	0	0	2	5	4	1	43
New Jersey	0	6	7	11	7	53	0	4	20	23	20	14	165
New Mexico	0	7	7	46	41	254	1	0	13	27	39	33	468
New York	0	0	0	1	1	13	0	2	7	9	4	12	49
North Carolina	0	29	95	464	700	3,949	0	2	30	81	77	379	5,806

State	Rural Functional Classifications						Urban Functional Classifications						Totals
	01	02	06	07	08	09	11	12	14	16	17	19	
	Principal Arterial - Interstate	Principal Arterial-Other	Minor Arterial	Major Collector	Minor Collector	Local	Principal Arterial - Interstate	Principal Arterial-Other Freeways or Expressways	Other Principal Arterial	Minor Arterial	Collector	Local	
North Dakota	0	0	3	210	0	1,780	0	0	0	5	3	7	2,008
Ohio	0	2	1	13	23	222	0	0	2	1	5	12	281
Oklahoma	0	0	9	1	1	9	1	2	5	0	0	0	28
Oregon	5	58	90	425	235	801	4	2	18	50	51	56	1,795
Pennsylvania	0	0	0	0	1	7	0	0	0	0	0	0	8
Rhode Island	0	0	0	0	0	0	0	0	0	0	0	0	0
South Carolina	21	49	125	592	443	1,904	6	0	20	49	96	144	3,449
South Dakota	0	0	0	1	0	0	0	0	0	0	0	0	1
Tennessee	6	8	32	74	252	654	0	0	8	27	24	73	1,158
Texas	9	18	40	199	190	6,524	2	4	205	463	319	1,140	9,113
Utah	0	0	0	1	0	4	0	0	1	0	0	2	8
Vermont	0	2	5	29	26	155	0	0	2	4	9	6	238
Virginia	0	0	0	0	2	16	0	0	0	0	0	0	18
Washington	0	0	1	47	39	102	0	0	5	4	3	5	206
West Virginia	0	0	0	0	0	0	0	0	0	0	0	0	0
Wisconsin	0	0	0	0	0	0	0	0	0	0	0	0	0
Wyoming	0	0	1	0	43	347	1	0	0	3	7	13	415
Puerto Rico	0	0	21	70	40	77	0	0	9	23	36	36	312
Totals	93	831	1,456	6,777	5,739	34,478	52	93	857	1,714	1,600	3,948	57,638

Table 2 Numbers of Bridges with Unknown Foundations by Age

Year Built	Rural Functional Classifications						Urban Functional Classifications						Totals
	01	02	06	07	08	09	11	12	14	16	17	19	
	Principal Arterial - Interstate	Principal Arterial-Other	Minor Arterial	Major Collector	Minor Collector	Local	Principal Arterial - Interstate	Principal Arterial-Other Freeways or Expressways	Other Principal Arterial	Minor Arterial	Collector	Local	
1900-1904	0	0	1	20	65	534	0	0	14	14	10	32	690
1905-1909	0	0	5	8	15	96	0	0	3	10	5	18	160
1910-1914	0	0	3	17	42	240	0	0	9	21	20	30	382
1915-1919	1	1	7	36	40	324	0	1	14	24	9	39	496
1920-1924	0	31	59	148	92	679	0	0	42	42	32	67	1,192
1925-1929	1	36	91	154	112	532	0	3	47	55	46	82	1,159
1930-1934	0	51	103	256	180	1,131	0	6	42	72	50	109	2,000
1935-1939	0	50	106	290	209	1,347	1	1	62	85	69	105	2,325
1940-1944	1	41	98	256	268	1,270	0	0	31	31	49	103	2,148
1945-1949	5	44	96	275	207	898	1	3	31	50	42	66	1,718
1950-1954	2	95	125	591	623	2,470	0	4	67	104	95	219	4,395
1955-1959	8	97	186	946	630	2,534	5	4	49	149	132	260	5,000
1960-1964	23	51	102	797	707	3,824	4	10	56	150	192	499	6,415
1965-1969	24	44	86	736	650	3,357	14	12	73	125	155	400	5,676
1970-1974	11	74	60	606	535	3,159	5	12	60	167	159	453	5,301
1975-1979	7	27	53	532	432	3,038	4	10	31	145	115	420	4,814
1980-1984	1	35	45	365	359	2,596	7	2	51	109	108	273	3,951
1985-1989	1	36	41	258	236	2,473	7	4	67	161	123	306	3,713
1990-1994	0	51	77	268	244	2,353	2	14	52	74	76	210	3,421
1995-1999	4	26	70	181	169	1,701	0	2	21	55	57	146	2,432
2000-2004	4	35	28	81	90	1,101	2	4	20	21	31	89	1,506
Totals	93	831	1,456	6,777	5,739	34,478	52	93	857	1,714	1,600	3,948	57,638

1.2. Performance-Based versus Traditional Design Practice

This report focuses on estimating the vulnerability of bridges with unknown foundations to hazards that might cause these bridges to fail unexpectedly, which is obviously an important aspect of performance. The main problem in estimating a bridge's vulnerability to failure, however, is the inherent uncertainty about its performance concerning infrequent or unobserved hazards – hence the notion of probability and risk. The literature review phase of this study highlighted several risk-based methodologies (see *Appendix A*), some of which were useful in developing guidelines for managing bridges with unknown foundations. The literature review for this report also catalogued a number of concerns about establishing performance standards (see *Appendix B*) that might affect bridge management.

Since bridge performance obviously relates to the design of bridges, it is interesting to note that design professionals are increasingly implementing performance-based design approaches to design. These applications include structural and seismic engineering, fire protection, etc. The purpose of performance-based design is to provide methods for siting, designing, constructing and maintaining facilities, such that they are capable of predictable performance levels with a specified (minimum) reliability. Performance may be measured in terms of the amount of damage (e.g., displacement), which if realized compromises stated functional or life-safety goals. A fundamental foundation of performance-based design is the notion that engineering tools can be used to analytically evaluate the performance of a structural system and consider the uncertainties in loading and response (e.g., performance) such that a performance goal can be achieved.

As part of a performance-based design process, performance goals are established in conjunction with the facility owner. A performance goal is a statement about a performance level (i.e., a functional objective) the owner of a facility wants to achieve and the likelihood

that unsatisfactory performance (e.g., the functional objective is not met) will occur. Typically, multiple performance levels are defined that represent alternative levels of response/damage. For instance, a functional objective might be stated as; only minor damage occurs (under the load conditions of interest), with the facility retaining its strength and configuration and is available for normal use. The risk of extended closure should be negligible, following post-event inspection.

The ability to achieve a performance goal requires a number of steps. Initially, a performance goal must be translated into terms of physical response/performance for the structural system (e.g., displacement or offset) that can be assessed by engineering methods. In addition, evaluation methods (engineering tools and design methods) must account for the uncertainties associated with the occurrence of load events and estimating facility performance, such that desired levels of reliability can be achieved. From an engineering design perspective, procedures are required to systematically and explicitly incorporate the desired levels of reliability dictated by different performance goals.

In contrast, traditional methods of engineering design have been based on an assessment of building performance at code allowable limits (e.g., stress levels), and not the response/performance that would be expected. Whereas factors of safety (or safety margins) are incorporated in traditional design methods, they have not been established on the basis of actual material properties or on the expected performance. As a result, traditional design procedures do not provide the designer or the facility owner with insight to the performance (physical or functional) that would occur (under a given load condition), or a sense of the risk that is being implicitly accepted. Further, traditional methods of design tend to be more prescriptive and thus do not readily accommodate facility-specific factors that influence performance and reliability. Alternatively, performance-based methods offer

increased flexibility in the design process and contribute to cost-efficiencies in a design that meet facility specific requirements and desired performance goals.

1.3. Report Overview

This introduction primarily underscores the extent of the problem regarding bridges with unknown foundations and how it relates to bridge design. Section 2 describes how this uncertainty limits the ability to predict hazard-induced bridge failures, and outlines a general approach for using risk to select a pertinent, cost-effective management plan for bridges with unknown foundations. The remaining sections (3 through 6) describe how this approach applies to a common water-related bridge hazard known as scour. Note also that section 2 also serves as a summary of the research approach used to develop the “*Scour Risk Management Guidelines*.” For the sake of conciseness all of the original literature reviews and stakeholder interviews that are mentioned in this report appear in the auxiliary appendices.

2. GENERAL APPROACH TO RISK MANAGEMENT

This section describes a general approach for using risk to manage bridges with unknown foundations with respect to hazard-induced failure. The following discussion will introduce the steps required to quantify the risk of failure associated with a specific hazard, and then outline the steps needed to use risk to select an appropriate management plan.

2.1. Probability of Failure

One of the first requirements for assessing the risk of bridge failure associated with a specific hazard is to quantify the probability of failure. The main idea of studying the occurrence of failure is to study both the occurrence of hazardous events and a bridge's vulnerability to these occurrences. However, it should be apparent at this stage that the vulnerability of a bridge with an unknown foundation will be difficult to predict – hence the notion of probability. Probability of failure in this context refers to the likelihood of hazard-induced bridge failure within a specific range of time. For example, an annual probability of failure is the likelihood that a hazard-induced bridge failure will occur in any given year.

The basic approach for quantifying a probability of failure involves the following steps:

1. Describe the uncertainty in the frequency and severity of a hazard.
2. Describe the uncertainty in a bridge's vulnerability to this hazard.
3. Correlate these uncertainties with observed failures.
4. Calculate the probability of failure for multiple failure modes.

2.1.1. Hazardous Potential

Natural hazards (e.g. scour, earthquakes, violent storms, etc.) are often difficult to forecast, but there are at least two factors used to describe the potential for hazards. The first factor is the relative severity of a possible hazardous event, or the magnitude of a hazardous event (e.g. an eight meter tsunami wave height). The second factor is the local frequency of occurrence, which describes how often an event of a specific magnitude occurs

at a particular bridge location. These two factors are usually lumped in any given measure of the likelihood of a hazardous event. Thus, it is common to see geographic maps that show spatial contours of the likelihood of a hazard of a specific magnitude.

For example, flood magnitudes are usually specified in reference to their expected return period (e.g. a 100-yr flood). Note that the magnitude of such a flood is site-specific. In other words, the 100-yr flood somewhere along a creek might entail a five meter rise in channel stage, whereas a 100-yr flood somewhere along a river downstream might entail a two meter rise in channel stage. Note also that the expected return period (e.g. 100-yr) is the inverse of the probability (i.e. $P_{100} = 1 / [100 \text{ yr}] = 0.01$) that an event of this magnitude will occur in any given year. In other words, the probability of a 100-yr flood is actually an annual probability of occurrence that is site-specific and magnitude-specific. Thus, flood maps usually show contours representing different expected frequencies (e.g. 10-yr, 100-yr, etc.) overlaid on contours of elevation in the floodplain.

2.1.2. Vulnerability to Failure

As noted earlier, bridges are generally designed to withstand the most common and frequent natural hazards, but budget and technology issues ultimately limit a bridge's ability to withstand more severe (and usually infrequent) events. In other cases, vulnerability to failure may relate to an unforeseen change in wear or stress that was used to estimate the design life of the bridge. In either case, a bridge's vulnerability to failure is divisible into two basic factors: the degree of stress or degradation that a bridge can safely withstand, and the corresponding severity of the hazardous event required to induce this degree of stress or degradation. In other words, the first factor is a description of a bridge's specific mode of failure, while the second is a description of the type and degree of hazard required to induce this failure mode. Thus, it should be evident that any uncertainty about the foundation of a bridge also makes the bridge's failure mode uncertain.

For example, scour refers to sediment erosion that occurs in a stream or river that flows under a bridge. Scour may cause a bridge to fail when enough sediment erodes to undermine and collapse a pier, footing, or abutment. The amount of scour that will occur around a pier, footing, or abutment during a flow of a given magnitude is usually predicted using the methods described in the FHWA HEC-18 manual (2). This manual describes how to predict the depth of scour that may occur at a bridge site. There are three basic types of scour – long-term aggradation or degradation, contraction scour, and local scour – which may be induced by floods, droughts, or other phenomena that alter the fluvial sediment load. It is also worth noting that some scour holes are eventually refilled by natural sediment transport processes, which illustrates that some forms of degradation – and thus vulnerability – are temporary.

Characterizing a bridge's vulnerability to failure in this context implies that the mode of failure can be predicted – with reasonable certainty – using measured or inferred data. The FHWA HEC-18 manual for scour is perhaps the best example of using measured data to predict (and ultimately prevent) a site-specific mode of failure. Bridges with unknown foundations, however, lack information about the construction (i.e. form, depth, or geotechnical setting) of piers, footings, or abutments, which makes predicting their vulnerability to hazard-induced bridge failure more difficult. Furthermore, determining the substructure of an unknown foundation may be expensive; thus, it may be useful to relate what is known about the bridge and its setting to similar bridges in order to model and thereby predict the substructure. This predicted substructure could then be used to estimate the bridge's vulnerability to failure and ultimately the bridge's probability of failure. For example, if in any given year there are on average 2 scour failures out of 1,000 bridges with the same hazardous potential and vulnerability to failure, then the annual probability of failure for these bridges is $2/1000$ or 0.002.

2.1.3. Correlations with Observed Failures

If models already exist for predicting the hazardous potential of a site and the corresponding vulnerability of a bridge to fail, then these two quantities can be correlated with the number of observed hazard-induced bridge failures to generate a model of the probability of failure. The main reason for this correlation is to account for inherent uncertainties regarding the likelihood of a hazard and the corresponding vulnerability of failure for any bridge considered, which are often only qualitatively measured. The first step in this correlation is to collect the following information about each bridge that has failed:

- The nature and likelihood of hazard, and each site's vulnerability to failure.
- The timing and magnitude of the event that ultimately caused bridge failure.

Each known bridge failure then contributes to the estimate of the probability of failure for a given hazardous potential (HP) and vulnerability to failure (VF). Thus, for a given length of record the annual probability of failure for a given HP and VF is computed as the total number of failures for a given HP and VF divided by the total number of bridges that could have failed, divided by the number of years in the record. If this is done correctly, the sum of the annual probabilities of failure for all of the bridges that could have failed during the period of record should equal the total number of observed failures during the period of record divided by the number of years in the record. Note that it may also be prudent to scale these probabilities of failure up slightly to account for any uncertainties in the record.

2.1.4. Multiple Failure Modes

The discussion thus far has focused on quantifying the probability of hazard-induced failure for a single mode or mechanism of inducing failure, which is the simplest case. Engineering experience, however, has demonstrated that multiple failure modes are often

possible. If multiple failure modes are to be considered, the method for calculating the total probability of hazard-induced failure will depend on whether the individual failure modes are correlated or independent. The information in the following subsections is adapted from the National Institute of Standards and Technology's Engineering Statistics Handbook (3).

Independent or Competing Failure Modes The competing failure mode approach applies if the following three conditions apply.

1. Each failure mechanism leading to a particular type of failure (i.e. failure mode) proceeds independently of every other one, at least until a failure occurs.
2. The component fails when the first of all the competing failure mechanisms reaches a failure state.
3. Each of the k failure modes has a known life distribution model $F_i(t)$.

If these three conditions apply to the multiple failure modes, then the total probability of failure (P_t) can be calculated from each individual probability of failure (P_i) can be obtained from the following equation.

$$P_t = 1 - \prod_{i=1}^k (1 - P_i) \quad (1)$$

An example of competing failure modes might be failure due to scour versus failure during an earthquake.

Correlated Failure Modes There are several types of correlations between failure modes that are possible. The Engineering Statistics Handbook (3) offers three different ways to conceptualize correlated failure modes: modes acting in series, modes acting in parallel, or a combination of both. In the context of bridges with unknown foundations, an example of correlated failure modes might be an earthquake-induced collapse versus an earthquake-induced mass wasting event (i.e. a mud slide, avalanche, or dam failure).

2.2. Cost of Failure

Regardless of methodology, certain general economic assumptions are necessary for computation of risk. These include commercial and non-commercial vehicle operating costs, passenger vehicle occupancy rates, the value of lost productivity and life, and bridge replacement costs. Thus, the total cost of a bridge failure is more than just the cost of constructing a new bridge.

2.2.1. Expenses per Mile for the Motor Carrier Industry

The modified HYRISK methodology by Pearson et al. (4) contains an estimate of the average time that an average motorist might spend on a detour. Table 3 shows that the detour time varies according to ADT of the roadway.

Table 3 Detour Duration versus ADT

Average Daily Traffic (ADT)	Detour Duration (days)
ADT < 100	1095
100 ≤ ADT < 500	730
500 ≤ ADT < 1000	548
1000 ≤ ADT < 5000	365
ADT ≥ 5000	183

The cost of wear on the detour must be carefully weighed against the reduced wear on the closed roadway and bridge. If the wear on the detour will be significantly more than the comparative wear on the original road, then this may also be added to the cost of failure. Average expenses per mile for all types of for-hire truck transportation embracing truckload, less-than-truckload (LTL), and a wide range of specialized carriage were \$1.78 in 2000 according to the Federal Highway Administration (5). Tables 4 through 6 provide addition metrics.

Table 4 Occupancy per Vehicle Mile by Daily Trip Purpose

Trip Purpose	Mean	Standard Error
All personal vehicle trips	1.63	0.012
Work	1.14	0.007
Work-related	1.22	0.020
Family/personal	1.81	0.016
Church/school	1.76	0.084
Social/recreational	2.05	0.028
Other	2.02	0.130

1990 through 2000 and forecasts through 2005

Source: *The 2001 National Household Travel Survey, daily trip file, U.S. Department of Transportation* (www.bts.gov/publications/national_household_travel_survey, accessed May 26, 2005)**Table 5 Comparison of Total and Variable Costs per Mile**

Cost Category	Automobiles	Trucks
Total per mile	\$0.45	\$1.80
Driver costs	--	\$0.50
Total vehicle cost per mile	\$0.45	\$1.30
Variable cost per mile	\$0.15	\$0.43
Variable as % of total	33%	33%

Source: *Minnesota Department of Transportation* (<http://www.lrrb.org/pdf/200319.pdf>, accessed May 26, 2005)**Table 6 Values of Time Used in the Derivation of Road User Costs**

Vehicle Type	Value of Time from MBC <i>(1990 Dollars)</i>	Value of Time Adjusted <i>(1998 Dollars using CPI)</i>
Small passenger car	\$9.75	\$12.16
Medium/large passenger car	\$9.75	\$12.16
Pickup/van	\$9.75	\$12.16
Bus	\$10.64	\$13.27
2-axle single unit truck	\$13.64	\$17.01
3-axle single unit truck	\$16.28	\$20.30
2-S2 semi truck	\$20.30	\$25.32
3-S2 semi truck	\$22.53	\$28.10
2-S1-2 semi truck	\$22.53	\$28.10
3-S2-2 semi truck	\$22.53	\$28.10
3-S2-4 semi truck	\$22.53	\$28.10

Source: <http://tti.tamu.edu/documents/407730.pdf>, accessed on May 26, 2005, accessed May 26, 2005.

The Highway Economic Requirements System (HERS) procedure for calculating travel time costs recognizes that the value of travel time differs between trips drivers take as part of their work (on-the-clock trips) and other trips. Time savings during on-the-clock trips are valued on the basis of savings to the employer. The savings include wages, fringe benefits, and for some types of trucks, vehicle cost and the inventory carrying costs of the cargo.

Alternatively, off-the-clock time savings reflect the results of research examining choice situations (e.g., toll versus free route, speed, or housing location) that require choosing to save time versus money or safety. Table 7 shows estimated values of travel time.

Table 7 Estimates of the Values of Travel Time

Travel Purpose	Automobiles		Trucks	
	Small	Medium	4-Tire	6-Tire
<i>Business Travel</i>				
Value per person*	\$21.20	\$21.20	\$21.20	\$18.10
Average vehicle occupancy	1.43	1.43	1.43	1.05
Total business	\$31.55	\$31.96	\$32.47	\$22.01
<i>Personal Travel</i>				
Value per person*	\$10.60	\$10.60	\$10.60	
Average vehicle occupancy	1.67	1.67	1.67	
Total personal	\$17.70	\$17.70	\$17.70	

* 2000 Dollars

Source: FHWA web site (<http://isddc.dot.gov/olpfiles/fhwa/010617.pdf>, accessed May 26, 2005)

Statistics for Mean Hourly Wage Rate for each state are obtained from U.S. Department of Labor. It is also possible to obtain statistics for counties in each state from the same source. Value of time per individual for passenger car can also be calculated by multiplying mean hourly wage rate by 0.41. Table 8 shows a complete listing by State.

Table 8 Values of Time

State	Mean Wage* (\$/hour)	Value of time† (\$/hour)	State	Mean Wage* (\$/hour)	Value of time† (\$/hour)
Alabama	15.35	6.29	Montana	14.37	5.89
Alaska	20.27	8.31	Nebraska	15.89	6.51
Arizona	16.77	6.88	Nevada	16.49	6.76
Arkansas	14.21	5.83	New Hampshire	18.01	7.38
California	20.18	8.27	New Jersey	20.69	8.48
Colorado	19.14	7.85	New Mexico	15.87	6.51
Connecticut	21.35	8.75	New York	20.96	8.59
Delaware	18.77	7.70	North Carolina	16.40	6.72
District of Columbia	27.87	11.43	North Dakota	14.72	6.04
Florida	16.23	6.65	Ohio	17.26	7.08
Georgia	17.23	7.06	Oklahoma	14.97	6.14
Guam	13.20	5.41	Oregon	17.78	7.29
Hawaii	17.67	7.24	Pennsylvania	17.29	7.09
Idaho	15.76	6.46	Puerto Rico	10.61	4.35
Illinois	18.55	7.61	Rhode Island	18.38	7.54
Indiana	16.26	6.67	South Carolina	15.35	6.29
Iowa	15.38	6.31	South Dakota	13.98	5.73
Kansas	16.24	6.66	Tennessee	15.74	6.45
Kentucky	15.47	6.34	Texas	16.98	6.96
Louisiana	15.02	6.16	Utah	16.40	6.72
Maine	16.09	6.60	Vermont	16.66	6.83
Maryland	19.89	8.15	Virgin Islands	13.62	5.58
Massachusetts	21.78	8.93	Virginia	18.81	7.71
Michigan	19.03	7.80	Washington	19.65	8.06
Minnesota	19.15	7.85	West Virginia	14.65	6.01
Mississippi	13.77	5.65	Wisconsin	16.94	6.95
Missouri	16.57	6.79	Wyoming	15.63	6.41

* Source: <http://www.bls.gov/oes/current/oesrcst.htm>, accessed January 12, 2006.

† Source: The value of time is assumed to be 41% of the mean wage as suggested by José A. Gómez-Ibáñez, William B. Tye, Clifford Winston, "Essays in Transportation Economics and Policy: A Handbook in Honor of John R. Meyer", 1999.

2.2.2. Bridge Costs

Table 9 provides estimates for bridge construction. These costs should be increased by about twenty percent for phased construction.

Table 9 Cost of Bridge Construction

Bridge Superstructure Type, Demolition	Total Cost (\$/ft²)
Reinforced concrete flat slab; simple span	50-65*
Reinforced concrete flat slab; continuous span	60-80*
Steel deck/girder; simple span	62-75*
Steel deck/girder; continuous span	70-90*
Pre-stressed concrete deck/girder; simple span	50-70*
Pre-stressed concrete deck/girder; continuous span	65-110*
Post-tensioned, cast-in-place, concrete box girder cast on scaffolding; span length ≤ 240 ft	75-110
<i>Steel Box Deck/Girders:</i>	
Span range from 150 ft to 280 ft	76-120
For curvature add a 15 percent premium segmental concrete box girders; span range from 150 ft to 280 ft	80-110
Movable bridges; bascule spans & piers	900-1500
<i>Demolition of Existing Bridges:</i>	
Typical	9-15
Bascule spans & piers	63

* Increase the cost by twenty percent for phased construction.

Source: <http://www.dot.state.fl.us/structures/Manuals/LRFDS DG2002AugChap11.pdf>, accessed May 26, 2005.

The modified HYRISK methodology (4) suggests that the ADT influences how quickly a bridge will be replaced, which increases the total construction cost. Table 10 shows the suggested cost multipliers for different ADT levels.

Table 10 Cost Multiplier for Early Replacement

Average Daily Traffic (ADT)	Cost Multiplier for Early Replacement
ADT < 100	1.0
100 ≤ ADT < 500	1.1
500 ≤ ADT < 1000	1.25
1000 ≤ ADT < 5000	1.5
ADT ≥ 5000	2.0

2.2.3. Price Elasticity of Demand

Elasticity is defined as the percentage change in consumption of a good caused by a one-percent change in its price or other characteristics such as travel time, or road capacity. If prices decline, generally travel increases as lower-value trips become more affordable, conversely if price increases traveler may choose to forego trips, chain trips together or shift to different mode, route or destination.

A detailed summary of demand elasticity is given *Appendix B*. However, demand elasticity was not incorporated in this study because research indicates that demand elasticity is very low (on the order of 3%), which is comparable to the uncertainty in the other elements of total cost of failure. Elasticity also does not account for loss of consumer surplus. While demand for use of a roadway (as measured in ADT) may go down as travel costs increase with a detour, the reduction in demand would not represent the net savings in travel costs due to the reduced ADT. Those who hypothetically choose not to travel because of the increased travel costs associated with a detour would experience a loss of consumer surplus (a cost to them) since they would now choose an alternative (travel route, place of business, domicile, etc.) that is not preferable to the original route. If the alternative were preferable, the user would have implemented it before the bridge failed and the ADT would already be reduced.

2.2.4. *Loss of Life*

In the “Plan of Action for Scour Critical Bridges” published by Idaho DOT in 2004 (see *Appendix B*) the assumed cost per fatality is \$500,000. This value assignment is obviously subjective and could vary considerably based on both economic and sociological factors. The number of lives lost is assumed to vary depending on the ADT and functional classification (see Table 11). High-ADT crossings, interstates and principal arterials are assumed to have more potential fatalities.

Table 11 Assumed Number of Lives Lost in Bridge Failure

Average Daily Traffic (ADT)	Number of Lives Lost
ADT < 100	0
100 ≤ ADT < 500	1
500 ≤ ADT < 1000	2
1000 ≤ ADT < 5000	2
ADT ≥ 5000 (Not an interstate or arterial)	5
ADT ≥ 5000 (interstate or arterial)	10

2.2.5. HYRISK Cost of Failure Equation

The extension to the HYRISK equation developed by GKY & Associates, Inc. (see *Appendix A*) provides a simple equation for calculating the total cost of bridge failure. The only addition to the equation considered here is the cost of fatalities (see Section 2.4.4, entitled “*Loss of Life*”). Price elasticity of demand was not added due to the reasons already stated. Thus, when the previous considerations are implemented, the equation for calculating the cost of failure is given in Equation 2.

$$Cost = C_1 e W L + \left[C_2 \left(1 - \frac{T}{100} \right) + C_3 \frac{T}{100} \right] D A d + \left[C_4 O \left(1 - \frac{T}{100} \right) + C_5 \frac{T}{100} \right] \frac{D A d}{S} + C_6 X \quad (2)$$

The terms in this equation are defined as follows.

- $Cost$ = total cost of bridge failure (\$),
- C_1 = unit rebuilding cost from Table 9 or use local data (\$/ft²),
- e = cost multiplier for early replacement based on average daily traffic from Table 10,
- W = bridge width from NBI item 52 (ft),
- L = bridge length from NBI item 49 (ft),
- C_2 = cost of running automobile from Table 5 (i.e. \$0.45/mi), or use local data
- C_3 = cost of running truck from Table 5 or use local data (\$1.30 /mi),
- D = detour length from NBI item 19 (mi),

- A = average daily traffic (ADT) from NBI item 29,
- d = duration of detour based on ADT from Table 3 (days),
- C_4 = value of time per adult in passenger car from Table 8 or use local data (\$/hr),
- O = average occupancy rate from Table 4 or use local data (typically 1.63 adults),
- T = average daily truck traffic (ADTT) from NBI item 109 (% of ADT),
- C_5 = value of time for truck from Table 6 or Table 7 or use local data (\$22.01/hr),
- S = average detour speed (typically 40 mph),
- C_6 = cost for each life lost (typically \$500,000 or use local data), and
- X = number of deaths resulting from failure from Table 11 or use local data.

Note that this equation is the sum of three basic concerns: the cost of reconstruction (i.e. the C_1 term), two detour-related consumer costs (i.e. the C_2 , C_3 , C_4 , and C_5 terms), and the potential cost of fatalities (the C_6 term). Thus, this equation provides a template that is easily adjusted for local data and other concerns.

2.3. Risk of Failure

Once the probability of failure and the cost of failure associated with a specific hazard are known (or estimated), the risk of failure is computed as the product of these two quantities. For example, if the *annual* probability of hazard-induced bridge failure is multiplied by the cost of bridge failure, then the risk of hazard-induced bridge failure will have the units: dollars per year. Thus, the annual risk of failure is only a fraction of the total cost of bridge failure because the occurrence of failure in any given year is uncertain.

Estimating the risk of failure over longer periods of time (e.g. \$ per decade) requires the use of probability theory. The proper way to adjust an annual risk to another length of time is to adjust the annual probability of failure and then multiply the adjusted probability of failure by the cost of failure. The following equation can be used to calculate the probability of failure over a specific period of time (P_T , where T is the new period) from the annual probability of failure (P_A).

$$P_T = 1 - (1 - P_A)^T \quad (3)$$

Note that P_T is the probability that *at least one* failure will occur in T years, which is greater than the annual probability of failure. Thus, the risk of at least one hazard-induced bridge failure in T years is computed as the product of P_T and the total cost of bridge failure. This equation is useful for assessing the risk of failure over the remaining life of a bridge that has already been tentatively scheduled for replacement or retrofits (i.e. due to other operational concerns).

2.4. Mitigating Activities

The former subsections dealt with quantifying the risk of a hazard-induced bridge failure. The main goal for developing these guidelines, however, is to reduce this risk in the most cost-effective manner. This necessarily entails listing the cost of any pertinent methods for mitigating a hazard-induced failure. Mitigating activities might include performing various forms of field reconnaissance to measure or infer any pertinent unknown foundation characteristics, increasing or changing the level or frequency of monitoring, or installing protective countermeasures or retrofits.

Since field reconnaissance ultimately reduces the uncertainty in a bridge's vulnerability to hazard-induced failure, the modeler should consider the cost of any geophysical method that can be used to determine the unknown foundation as well as the

cost of any other attending analyses that are used to assess the bridge's vulnerability. The cost of different monitoring or protective countermeasures, likewise, should include both installation cost and maintenance cost. The provisional schedule for replacing or closing the bridge should also be considered.

2.5. General Guidelines for Risk Management

Once the risk of failure has been quantified and the various mitigating actions are known, the main task is to use the estimated risk, which is an uncertain measure, to select an appropriate course of action. Figure 1 presents a structured decision tree that uses pertinent aspects of the risk of failure to justify one or more of the mitigating actions already identified for managing risk associated with unknown foundations. The initial decisions in this figure primarily involve identifying bridges with foundations that might be determined easily – and thus analyzed like all other bridges with known foundations – or identifying bridges that are too important or potentially too vulnerable to delay action. Thus, the first step (“Can the foundation be inferred?”) is to search harder for foundation records that could be used to adequately determine the foundation, and effectively remove these from the population of unknown foundations. The following summarizes the pertinent findings from a careful literature review and interviews (see *Appendices B–C*) regarding common assumptions for unknown foundations.

- Older structures (built before 1960) were usually built on timber piling.
- Depth of piles can be assumed as at least 10 feet for bridges with unknown foundations.
- If rock is near the surface, spread foundations can be assumed to support bridges with unknown foundations.
- The top of a typical spread footing can be assumed to be 3 feet below the top of the soil and the bottom 7 feet below the top of the soil.

If the foundation cannot be inferred, then any bridges that are deemed critical for emergency services or national security (i.e. “*Is it a high priority structure?*” in Figure 1) should benefit from the most aggressive mitigating activities. High priority structures are bridges that are so important that every possible effort should be made to determine the foundation and protect it as necessary. In other words, the ramifications of failure are so devastating that investment is warranted even if a cost-benefit analysis doesn’t justify such action. Each State Transportation Agency can set its own definition for these high priority structures, with the following suggestion provided herein:

- Principal arterials
- Evacuation routes
- Bridges that provide access to local emergency services such as hospitals
- Bridges that are defined as critical by a local emergency plan (e.g., bridges that enable immediate emergency response to disasters)

Principal arterials have importance beyond the simple measure of ADT. Oftentimes these are critical economic links that have national economic importance. On a regional level, principal arterials are the major (and in some rural cases, only) link between towns, cities, and other developed areas. Failure of a principal arterial will affect far more than just the traffic that normally travels across the bridge. As traffic is rerouted, the traffic that normally travels the minor arterials and collector roads may be caught in severe delays resulting from extreme overcapacity. Evacuation routes are also suggested in this category since these routes are oftentimes the only practical means of evading natural disasters (e.g., hurricanes). The risk of injury and death – not from the bridge failure, but from the natural disaster - may be too great to bear if such a route is not available due to failure.

Any bridges that are not high priority may still be an unacceptable hazard if it is in poor condition. Thus, the next step should be to estimate the risk of failure (i.e. “Calculate

the risk of failure” in Figure 1), and establish minimum performance levels (MPL; i.e. maximum probabilities of failure) for different functional classifications (i.e. NBI item 26). Any of the remaining bridges with unknown foundations with an estimated probability of failure greater than its pertinent MPL (i.e. “Does the bridge meet the minimum performance level?” in the figure) should also receive the most aggressive management plan.

The most aggressive management plan for high priority bridges or bridges that don’t meet their MPL arguably involves, at a minimum, the following steps:

- Perform foundation reconnaissance and any standard failure analyses to determine the risk of failure and consider any pertinent mitigating actions (e.g. countermeasures, or bridge replacement or closure).
- Use sound engineering judgment to select a mitigating plan of action, which may include replacing or closing the bridge.

Any bridges that are not removed from the population of unknown foundations via the first two decisions outlined in Figure 1 should then be subjected to a structured benefit-cost analysis similar to the one outlined in the figure to select a risk management plan. The estimated risk can be used as a potential benefit that may justify the cost of implementing certain mitigating actions. It should be evident that the safest management plan for a bridge with an unknown foundation is to use foundation reconnaissance to determine the foundation before considering other mitigating actions, and that increased monitoring or the installation of countermeasures or retrofits without sufficient analysis are less safe but potentially helpful alternatives. It should also be evident that increased monitoring may reduce the risk of death if the bridge’s imminent failure is detected early enough to stop traffic prior to structural failure. Furthermore, installing a countermeasure or retrofit using sound engineering judgment and monitoring its effectiveness during significant

events – but using methods short of using standard failure analyses to guide the installation – may be safer than relying on automated monitoring to predict imminent failure.

Thus, Figure 1 first suggests that the cost of automated monitoring be compared to the risk of death (i.e. the product of the lifetime probability of failure and the estimated cost of death) to determine if automated monitoring is warranted (i.e. “*Is automated monitoring warranted?*” in the figure). If automated monitoring is warranted (e.g. risk > monitoring cost), then the risk of death can be neglected in the risk of failure that is used to determine if countermeasures or retrofits are warranted (i.e. “*Are countermeasures/retrofits warranted?*” in the figure). Countermeasures or retrofits are probably warranted if the risk of failure is greater than the estimated cost of a countermeasure or retrofit, in which case automated scour monitoring is probably not warranted.

If countermeasures or retrofits are warranted, then the cost of foundation reconnaissance and standard failure analysis should be compared to the cost of the proposed countermeasure or retrofit to see if analyses are warranted (i.e. “*Are foundation reconnaissance and standard analyses warranted?*” in Figure 1). Foundation reconnaissance and standard failure analysis are probably warranted if the cost of foundation reconnaissance and standard failure analysis is less than half the cost of the countermeasure or retrofit (i.e. above “*Are foundation reconnaissance and standard analyses warranted?*” in the figure). Otherwise, it is probably most cost-effective to install countermeasures without the standard analysis and develop a bridge closure plan that includes monitoring the bridge’s vulnerability during several significant events (i.e. to the right of “*Are foundation reconnaissance and standard analyses warranted?*” in the figure).

If monitoring is warranted instead of countermeasures or retrofits, then a bridge closure plan should be developed that involves monitoring the bridge for any signs of degradation or increased vulnerability (i.e. below and beside “*Are countermeasures/retrofits warranted?*” in Figure 1). If automated monitoring was warranted, then the vulnerability to failure should be monitored continuously. Otherwise, at a minimum, this monitoring (i.e. “*Monitor failure mode(s).*” in the figure) should be more intensive and perhaps more frequent than the standard biennial inspections. If this monitoring reveals a problem (i.e. “*Is the vulnerability significantly increasing?*” in the figure), then further mitigating activities are warranted.

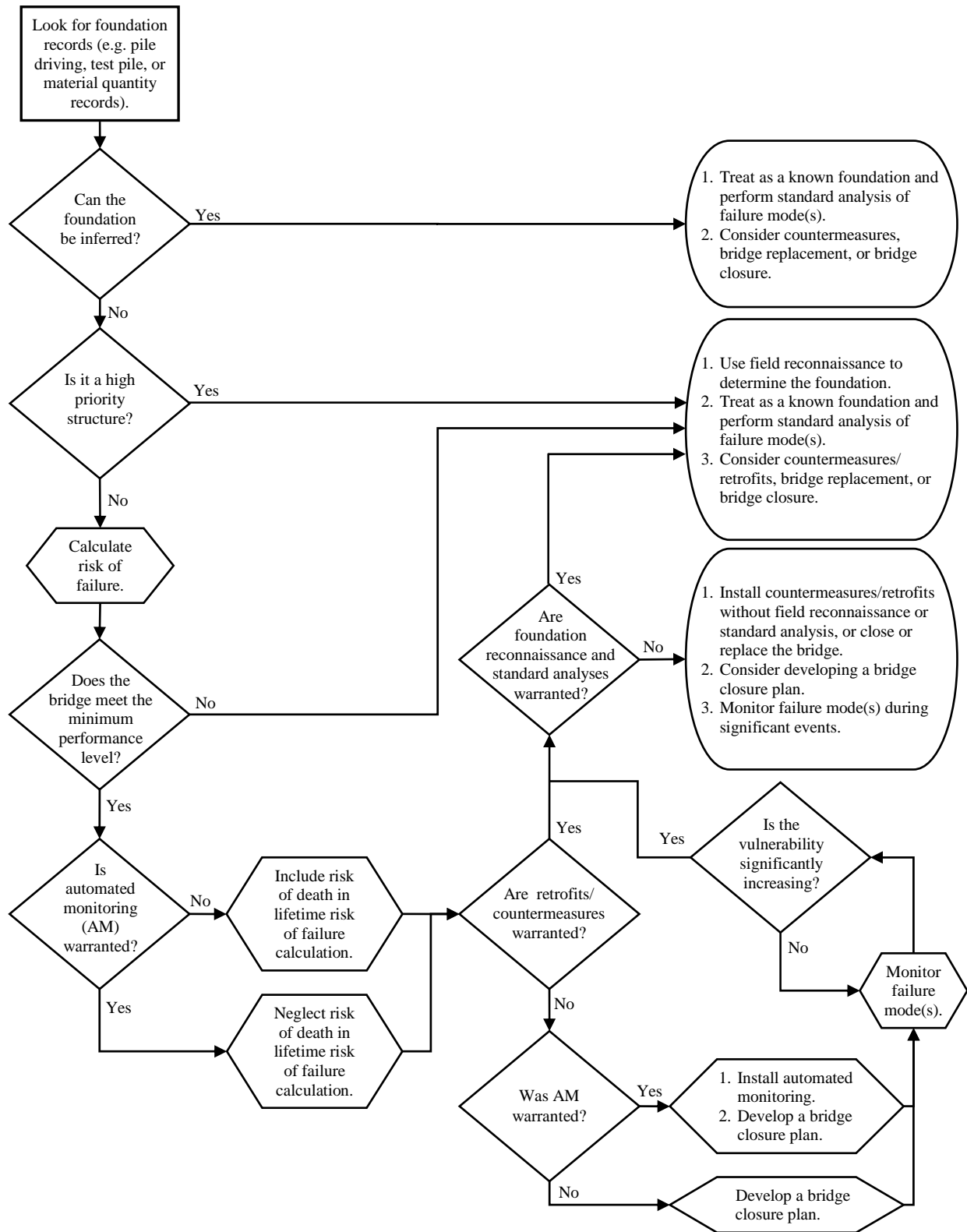

Figure 1 General risk management guidelines flow chart

A detailed application of these guidelines is presented in Section 5, entitled “*Scour Risk Management Guidelines*”. The next two sections, however, present the supporting analysis for the scour guidelines in a similar manner to the general approach to risk management.

3. QUANTIFYING RISK OF SCOUR FAILURE

This section gives an overview of the HYRISK methodology and then moves on to discuss the annual probability of scour failure assumptions, the scour risk equation, and the lifetime risk of scour failure that are used in the *Scour Risk Management Guidelines* section.

3.1. HYRISK Background

The available literature contains several methods for quantifying the risk of scour-related bridge failure (see *Appendix A*), but none of them were deemed complete. HYRISK is a well known model that has simple data requirements, and ranks bridges according to their expected annual loss due to scour (i.e. scour that induces failure or heavy damage). This was deemed the most complete method available. The risk rankings produced by the model, however, were not intended to place exact monetary values on scour losses. In other words, the probabilities of failure in HYRISK were assigned qualitative values based on expert opinions for ranking purposes. Thus, the original HYRISK model was not intended to estimate how much money should be spent on scour countermeasures to protect a bridge that is approaching the end of its design life (i.e. its provisional schedule for replacement). A later extension of the model improved the cost of failure assumptions and permitted the modeler to adjust the cost of failure and the probability of failure in the risk equation, and calculate a cost-benefit ratio for scour countermeasures. Thus, the extended HYRISK model was selected as the base for the risk equation used in the proposed guidelines.

3.2. Annual Probability of Scour Failure

One modification to the HYRISK method relates to the probability of failure assumptions. Interviews (see *Appendix C*) with State transportation officials lead to an estimate of approximately 33 failures per year for the 25 States interviewed (i.e. 33 out of about 161,000 bridges). This suggests that the annual average probability of failure is

$33/161,000 = 0.000205$, or about 1 in 5,000 per year. Scaling this to all bridges over water (i.e. 379,788) yields almost 80 scour failures per year.

Applying the original HYRISK method to all of the bridges over water in the NBI database (i.e. 356,378 bridges, as of the end of 2005; see also *Appendices A, D*) yields about 60,511 failures per year (i.e. the sum of the individual probabilities of failure). This corresponds to an annual average probability of failure of 0.17, which implies that about 1 in 6 bridges fail per year due to scour. These assumptions clearly do not correspond with experience and result in exaggerated risk factors. Again, this was not a problem within the context of the original HYRISK methodology because HYRISK was primarily used to prioritize bridges. However, when using risk to select a course of action (guidelines), it is important that risk be as accurate as possible in order to properly account for the costs and benefits of various management activities. For this reason, all of the original HYRISK failure probabilities have been scaled down to a level corresponding to the approximate number of failures (nation-wide) obtained from the State interviews (see *Appendix D*).

The new probability assumptions are given in Table 12, many of which are orders of magnitude lower than the original HYRISK assumptions (see *Appendix A*). This table lists the annual probability of failure (P_A) for different scour vulnerability and overtopping frequency ratings. These scour vulnerability and overtopping frequency ratings are obtained from Tables 13 and 14 using common NBI data items.

Table 12 Annual Probability of Scour Failure

Scour Vulnerability (from Table 14)	Overtopping Frequency (from Table 13)			
	Remote (R)	Slight (S)	Occasional (O)	Frequent (F)
(0) Failed	1	1	1	1
(1) Imminent failure	0.01	0.01	0.01	0.01
(2) Critical scour	0.005	0.006	0.008	0.009
(3) Serious scour	0.0011	0.0013	0.0016	0.002
(4) Advanced scour	0.0004	0.0005	0.0006	0.0007
(5) Minor scour	0.000007	0.000008	0.00004	0.00007
(6) Minor deterioration	0.00018	0.00025	0.0004	0.0005
(7) Good condition	0.00018	0.00025	0.0004	0.0005
(8) Very good condition	0.000004	0.000005	0.00002	0.00004
(9) Excellent condition	0.0000025	0.000003	0.000004	0.000007

Note that scour vulnerability is a surrogate for NBI item 113, and that overtopping frequency indicates how often this vulnerability is tested. The scour vulnerability is a function of substructure condition (NBI item 60) and channel protection (NBI item 61) ratings, while the overtopping frequency is an implied attribute of the waterway adequacy rating (NBI item 71). In other words, the overtopping frequency is a measure of a site's likelihood of a scour event, and the HYRISK scour vulnerability is a measure of a bridge's vulnerability to scour failure. Note also that small values for scour vulnerability (or NBI item 113) correspond to a high risk of scour-induced failure.

Table 13 Bridge Overtopping Frequency versus NBI Items 26 and 71

Functional Class: (NBI Item 26 Code)	Waterway Adequacy (NBI Item 71 Code)										
	(0)	(1)	(2)	(3)	(4)	(5)	(6)	(7)	(8)	(9)	(N)
Principal Arterials, Interstates (01, 11)											
Freeways, Expressways (12)											
Other Principal Arterials (02, 14)											
Minor Arterials (06, 16)											
Major Collectors (07, 17)											
Minor Collectors (08)											
Locals (09, 19)											

Key: N = Never; R = Remote ($T > 100$ yr); S = Slight ($T = 11-100$ yr);

O = Occasional ($T = 3-10$ yr); F = Frequent ($T < 3$ yr)

Table 14 Scour Vulnerability versus NBI Items 60 and 61

Channel Protection (NBI Item 61 Code)	Substructure Condition (NBI Item 60 Code)										
	(0) Failed	(1) Imminent Failure	(2) Critical Condition	(3) Serious Condition	(4) Poor Condition	(5) Fair Condition	(6) Satisfactory condition	(7) Good Condition	(8) Very Good Condition	(9) Excellent Condition	(N) Not Applicable
(0) Failure	0	0	0	0	0	0	0	0	0	0	0
(1) Failure	0	1	1	1	1	1	1	1	1	1	N
(2) Near Collapse	0	1	2	2	2	2	2	2	2	2	N
(3) Channel Migration	0	1	2	2	3	4	4	4	4	4	N
(4) Undermined Bank	0	1	2	3	4	4	5	5	6	6	N
(5) Eroded Bank	0	1	2	3	4	5	5	6	7	7	N
(6) Bed Movement	0	1	2	3	4	5	6	6	7	7	N
(7) Minor Drift	0	1	2	3	4	6	6	7	7	8	N
(8) Stable Condition	0	1	2	3	4	6	7	7	8	8	N
(9) No Deficiencies	0	1	2	3	4	7	7	8	8	9	N
(N) Not Over Water	0	1	N	N	N	N	N	N	N	N	N

The substructure condition code (NBI item 60) rates the general condition of a bridge's foundation, which should include a qualitative evaluation of how much scour – if any – has been observed at the bridge. Likewise, the channel and channel protection condition code (NBI item 61) is a qualitative measure of the observed stability of the stream (related to long-term aggradation or degradation). In the HYRISK methodology these two codes were deemed the closest potential measures of a bridge's vulnerability to scour failure.

The NBI database at the end of 2005 has data for 297,796 bridges with known foundations. This selection excludes culverts and only includes bridges with known foundations that are over water (i.e. NBI item 113 ≠ “U” or “N” or “6”) and with no missing values for NBI items 26, 60, 61, 71, and 113. These bridges were selected for analysis

because they have enough information to evaluate the relationship between the HYRISK scour vulnerability and NBI item 113.

Figure 2 plots the relationship between the HYRISK scour vulnerability and the NBI item 113 in such a way that the size of the dot is directly proportional to the number of bridges that correspond to these integer values. This figure clearly shows that the relationship between the HYRISK scour vulnerability rating and the NBI scour evaluation is uncertain. This uncertainty results, in part, from using prediction variables (i.e. NBI items 60 and 61) that do not account for all the characteristics that influence a bridge site's scour potential, and that do not explicitly predict the scour depth required to undermine the bridge's foundation.

A closer look at the selected NBI data, however, shows that there is a strong relationship between NBI item 113 and HYRISK's scour vulnerability. Figure 3 shows the relationship between NBI item 113 and the *average* scour vulnerability value (i.e. the average scour vulnerability for each NBI item 113 rating) for bridges with known foundations. This figure shows that the HYRISK scour vulnerability for bridges with known foundations is consistent with NBI item 113, and thus is a useful predictor of a bridge's annual probability of failure.

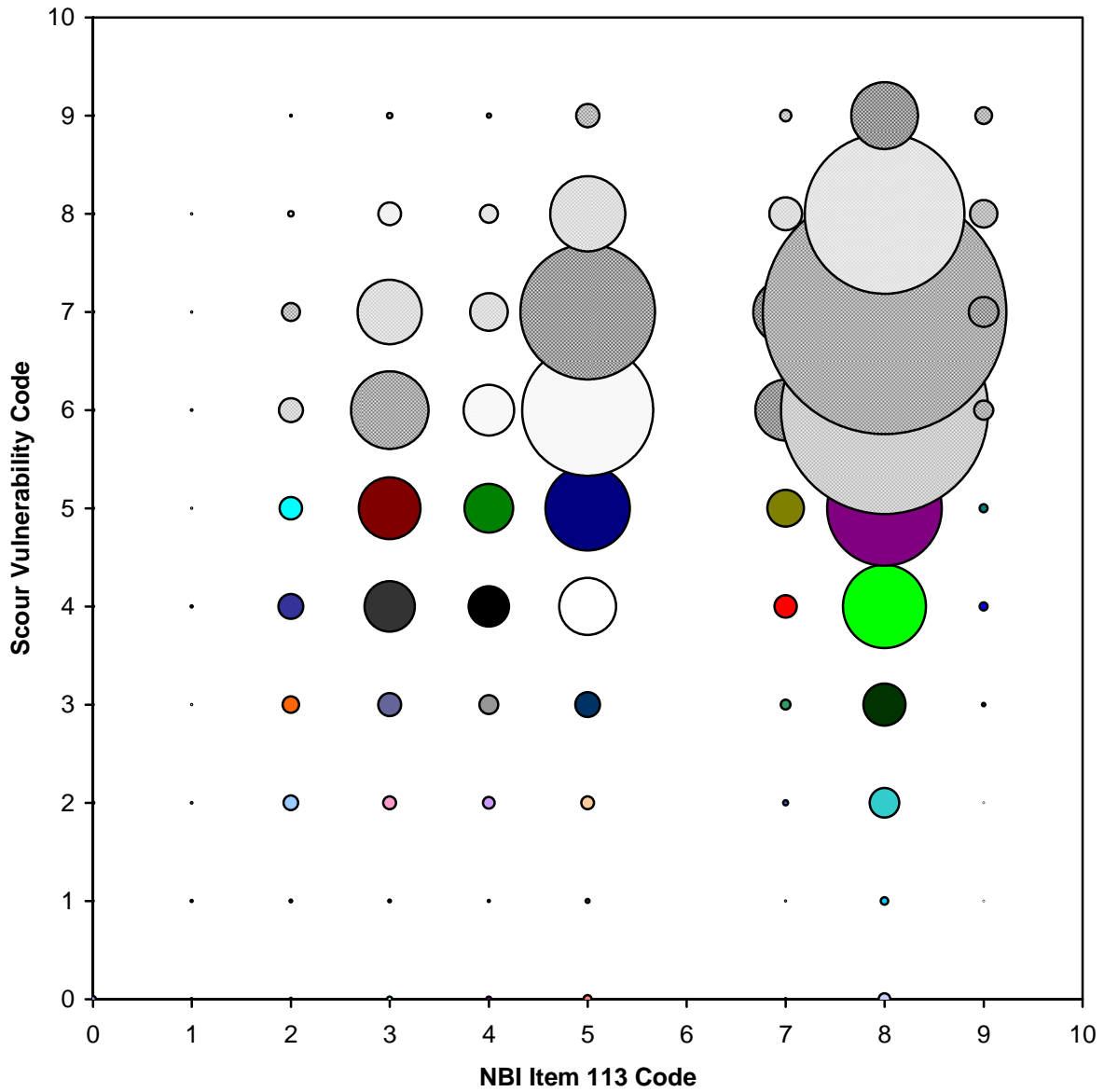

Figure 2 HYRISK scour vulnerability versus NBI item 113

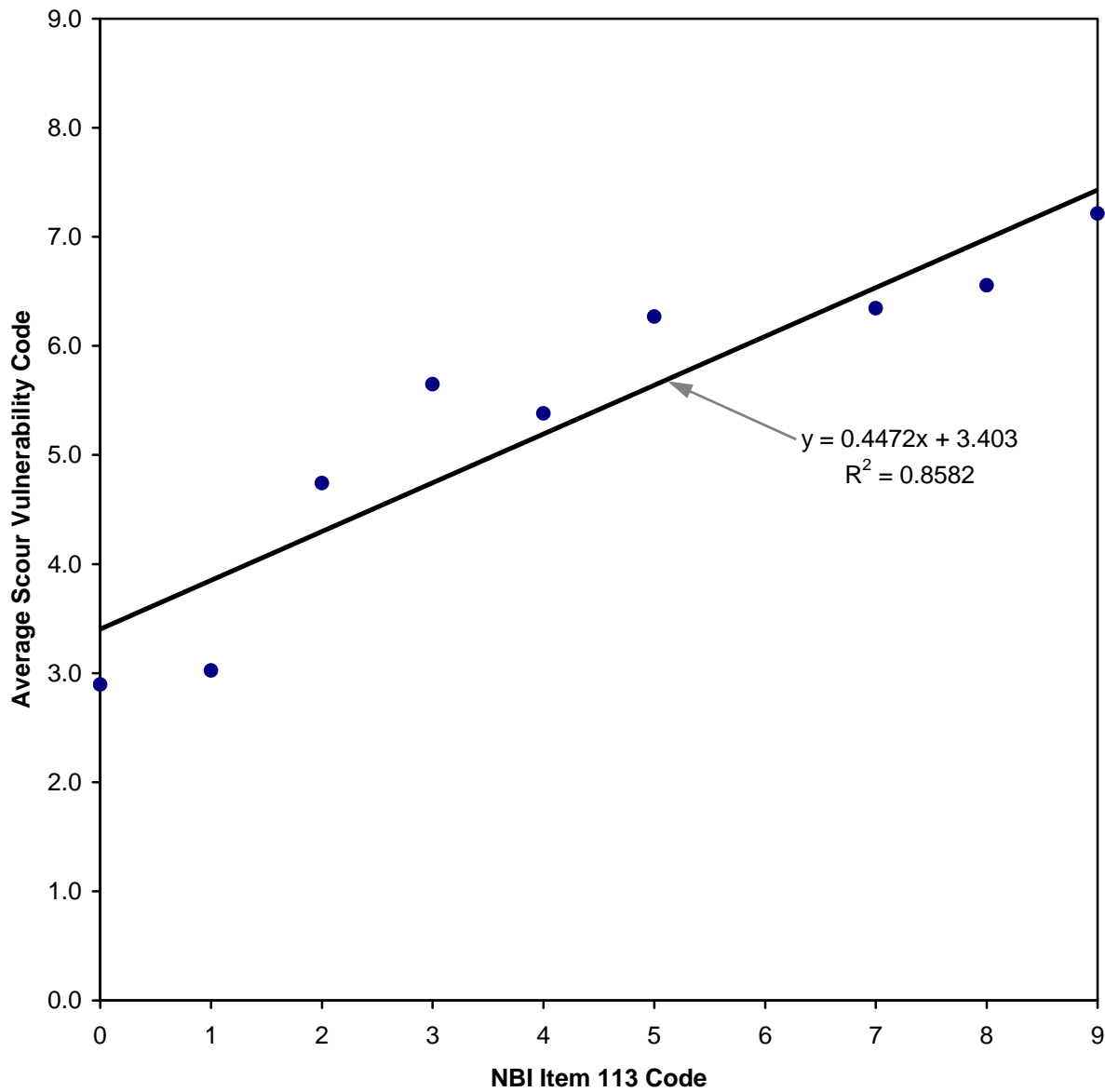

Figure 3 Average HYRISK scour vulnerability versus NBI item 113

3.3. The Scour Risk Equation

The HYRISK equation developed by GKY & Associates, Inc. (see *Appendix A*) for the annual risk of scour failure in these guidelines is given below.

$$Risk_A = K \cdot P_A \cdot Cost \tag{4}$$

The terms in this equation are defined as follows.

$Risk_A$ = annual risk of scour failure (\$/year),

K = risk adjustment factor based on foundation type and type of span based on NBI items and where available from more developed databases, foundation information,

P_A = annual probability of failure based on NBI items 26, 60, 61, 71, and 113 (see Table 12),

$Cost$ = total cost of failure (\$, see Equation 2),

The first thing to note about this equation is that it is the product of three main factors: the annual probability of failure (P_A), the cost of failure (everything between the braces), and a risk adjustment factor (K). The risk adjustment factor permits downward risk adjustments based upon knowledge of the structural and/or foundation design. The equation for K is given below.

$$K = K_1 K_2 \quad (5)$$

In this equation K_1 is a bridge type factor based on NBI data, and K_2 is a foundation type factor based on information, which may be obtained from State inventories but is not in the NBI database.

The values presently recommended for K_1 are 1.0 for spans less than 100 feet long and 0.67 for rigid continuous spans with lengths in excess of 100 feet. This factor adjusts to reflect the benefit of structural continuity which can compensate for loss of intermediate supports. The factors are subjective, based on a limited delpic survey and data developed in FHWA RD-85-107, Tolerable Movement Criteria for Highway Bridges (6). The influence of rigidity, type of structure, etc., has significant effects on the tolerable movement criteria, which may be defined as an increase in maximum stress to a point below yield, therefore precluding collapse.

The values recommended for K_2 , given below, should be developed for both abutment and pier condition, selecting the largest value for the analysis.

- 1.0: unknown foundations or spread footings on erodible soil above scour depth with pier footing top visible or 1- to 2 ft below stream bed
- 0.8: pile foundations when length is unknown, are less than 19 ft, or are all-wood pile foundations
- 0.2: foundations on massive rock

These factors are again subjective and should be revised or adjusted using local experience or further forensic studies. It should be noted that even structures supported by massive rock foundations may still incur damage due to inadequate waterway openings or other causes. Therefore, the risk adjustment factor cannot by definition be zero in a dollar-based risk analysis.

3.4. Lifetime Risk of Scour Failure

The HYRISK extension (see *Appendix A*) demonstrates that the lifetime probability of failure (P_L) can be related to the annual probability of failure (P_A) and to the provisional remaining life of a bridge (L) as follows.

$$P_L = 1 - (1 - P_A)^L \quad (6)$$

Once the lifetime probability of failure is known, the lifetime risk of scour failure ($Risk_L$) can then be calculated by substituting P_L for P_A in the risk equation (Equation 4), as shown below. The lifetime risk of scour failure is an estimate of the monetary risk of failure during the provisional remaining life of the bridge.

$$Risk_L = K \cdot P_L \cdot Cost \quad (7)$$

4. MITIGATING ACTIONS FOR SCOUR

This section summarizes recent findings from States that have experience in mitigating scour for bridges with unknown foundations, and the three basic types of mitigating actions for scour:

1. Perform foundation reconnaissance.
2. Install automated scour monitoring.
3. Install scour countermeasures.

4.1. Pertinent Findings from Experience

There are several options for mitigating the vulnerability of bridges with unknown foundations against sediment scour. One option is to monitor the scour and to close the bridge when the scour reaches some critical value. Since the penetration depth of the foundation is unknown it is, however, difficult to determine the “critical scour depth”. If the bridge has been in existence for a number of years and has experienced high velocity flows during its life, Webb et al. (7) show that it may be possible to measure the maximum scour depth experienced by the piers with the use of high frequency sonar or ground penetrating radar. Both of these techniques yield pictures of the sub-bottom with shaded lines at layers where there is a change in soil density. Relic scour holes can often be detected using these techniques and the depths quantified. If the structure did not experience any damage during the event that created the scour then it is safe to use this depth as a critical value for closing the bridge.

Another way of dealing with the unknown foundation problem is to armor the bed where erosion and scour are anticipated. The FHWA HEC-23 manual (8) describes current countermeasures available for scour critical bridges and bridges with unknown foundations. In the FHWA HEC-23 manual scour countermeasures are divided into hydraulic,

structural, and monitoring. The latest scour monitoring techniques and associated costs are described as well as the cost of armoring of the bed with riprap and a manmade product.

The following summarizes the pertinent findings from a careful literature review and interviews (see *Appendices B–C*) regarding mitigating actions for scour.

- Significant investments are usually not made on bridges which need to be replaced within 5 years.
- Routine/Regular monitoring of bridges takes place once every two years.
- The most common countermeasures adopted for scour problems at bridges with unknown foundations include installing riprap or grout bags.

4.2. Foundation Reconnaissance

Foundation reconnaissance will hereafter refer to using non-destructive methods to estimate unknown properties or dimensions of a bridge's foundation. It is important to note that the methods summarized in this report provide a brief overview of the current state-of-the-art technology. Since some or all of this information will ultimately become obsolete, it is worth mentioning that the Central Federal Lands Highway Division web site (9) currently has a report on geophysical methods for determining bridge substructure, which they are likely to keep up-to-date.

Foundation reconnaissance focuses on investigating buried man-made structures, but this is only a subset of the broader field of non-destructive testing (or evaluation) and geophysical methods. One important consideration in selecting an appropriate method for investigating a bridge's foundation is to catalogue what is already known, and what can be inferred from design plans, material lists, and pertinent historical practice. Interviews with officials (see *Appendix C*) show that some States, like New Jersey, have inferred the pier or footing depth for most of their bridges with unknown foundations using inexpensive probing and soil cores. Soil cores and probing may yield a conservative estimate for the

minimum depth of a pier or footing. For example, it may be known that historic practice entailed installing piers down to a specified depth below a certain bedrock (or fill) layer.

Other bridge foundations are harder to infer because of uncertainties regarding the geologic setting of the bridge or the construction practice. Reducing the uncertainty, in this case, will entail using other geophysical methods, or what is generally termed non-destructive testing (or evaluation).

The National Cooperative Highway Research Program (NCHRP) 21-5 project “Determination of Unknown Subsurface Bridge Foundations” (10) and the NCHRP 21-5(2) project “Unknown Subsurface Bridge Foundation Testing” (11) were performed to evaluate and develop existing and new technologies that can determine unknown subsurface bridge foundation depths. The NCHRP 21-5 Phase I research focused on the identification of potential NDE methods for determining depths of unknown bridge foundations at 7 bridges in Colorado, Texas and Alabama. The NCHRP 21-5 (2) Phase II research focused on evaluating the validity and accuracy of the identified NDE methods for determining depths of unknown bridge foundations. In this phase, 21 bridge sites were studied in North Carolina, Minnesota, New Jersey, Michigan, Oregon, Massachusetts and Colorado. Phase II research also involved the development of hardware and software needed to perform the NDE testing.

A more detailed summary of the methods described in these NCHRP reports is given in *Appendix E*. This research generally showed that the borehole-based Parallel Seismic method was both the most accurate and most applicable NDE method for the determination of the depth of unknown bridge foundations that was considered. This suggests that it would be valuable to initially perform at least one Parallel Seismic test for each bridge to check the accuracy of depth predictions from any other less costly surface methods that may also be applicable for a given foundation type of the bridge being tested. Ultraseismic or

other surface methods that are subsequently proven to be accurate based on a comparison with the Parallel Seismic results may then be used with greater confidence to evaluate unknown foundation depths of other abutments and/or piers on a bridge.

It should be noted that as local experience is gained with the use of any of the borehole or surface NDE methods for typical local bridge substructure types and subsurface conditions, the accuracy and applicability of the methods will become much better known to DOT engineers. This local knowledge can then be used to further optimize the selection of NDE methods from technical and cost perspectives. Knowledge of unknown foundation bridge substructure will range from knowing only what is visible to having design drawings and subsurface geology information without as-built plans.

Table 15 shows the ranges of effectiveness of the various methods available for nondestructive evaluation of bridge foundations in the NCHRP study.

Table 15 Effectiveness of NDT Methods

Ability to Identify Foundation Parameters	Sonic Echo (SE)/Impulse Response (IR) Test (Compressional Echo)	Bending Wave (BW) Test (Flexural Echo)	Ultraseismic (US) Test (Compressional and Flexural Echo)	Spectral Analysis of Surface Wave (SASW) Test	Surface Ground Penetrating Radar (GPR) Test	Parallel Seismic (PS) Test	Borehole Radar (BHR) Test	Induction Field (IF) Test
Foundation Parameters								
Depth of Exposed Piles	Fair to Good	Poor to Good	Fair to Excellent			Good to Excellent	Poor to Excellent	None to Excellent
Depth of Footing/Cap	Poor to Good	Poor to Fair	Fair to Excellent	Fair to Good	Poor	Good	Poor to Good	
Piles Exist Under Cap?					Fair to Poor	Good	Fair to Good	None to Excellent
Depth of Pile below Cap?					Poor	Good to Excellent	Fair to Good	
Geometry of Substructure			Fair	Poor to Good	Poor to Good	Fair	Fair to Excellent	Poor to Fair
Material Identification				Good	Poor to Fair	Poor to Fair	Poor to Fair	
Access Requirements								
Bridge Substructure	Yes	Yes	Yes	Yes	Yes	Yes	No	Yes
Borehole	No	No	No	No	No	Yes	Yes	Yes
Subsurface Complications	Low to High	Medium to High	Low to High	Low	High	Medium	High	Medium to High
Operational Cost	\$2,000 to \$2,500	\$2,000 to \$2,500	\$2,000 to \$2,500	\$2,000 to \$2,500	\$2,000 to \$2,500	\$2,000 to \$2,500	\$2,000 to \$2,500	\$2,000 to \$2,500
Equipment Cost	\$10,000 to \$20,000	\$15,000 to \$20,000	\$20,000	\$20,000	>\$30,000	\$15,000 to \$25,000	>\$35,000	\$20,000
Required Expertise								
Field Acquisition	Technician	Technician	Technician	Technician-Engineer	Technician-Engineer	Technician-Engineer	Engineer	Engineer
Data Analysis	Engineer	Engineer	Engineer	Engineer	Engineer	Engineer	Engineer	Engineer

Ability to Identify Foundation Parameters	Sonic Echo (SE) / Impulse Response (IR) Test (Compressional Echo)	Bending Wave (BW) Test (Flexural Echo)	Ultraseismic (US) Test (Compression al and Flexural Echo)	Spectral Analysis of Surface Wave (SASW) Test	Surface Ground Penetrating Radar (GPR) Test	Parallel Seismic (PS) Test	Borehole Radar (BHR) Test	Induction Field (IF) Test
Limitations	Most useful for columnar or tabular structures. Response complicated by bridge superstructure elements. Stiff soils and rock limit penetration.	Only useful for purely columnar substructure, softer soils, and shorter piles. Response complicated by various bridge superstructure elements, and stiff soils may show only depth to stiff soil layer.	Cannot image piles below cap. Difficult to obtain foundation bottom reflections in stiff soils.	Cannot image piles below cap. Use restricted to bridges with flat, longer access for testing.	Signal quality is highly controlled by environmental factors. Adjacent substructure reflections complicate data analysis. Higher cost equipment.	Difficult to transmit large amount of seismic energy from pile caps to smaller (area) piles.	Radar response is highly site dependent (very limited response in conductive, clayey, salt-water saturated soils).	It requires the reinforcement in the columns to be electrically connected to the piles underneath the footing. Only applicable to steel or reinforced substructure.
Advantages	Lower cost equipment and inexpensive testing. Data interpretation for pile foundations may be able to be automated using neural network. Theoretical modeling should be used to plan field tests.	Lower cost equipment and inexpensive testing. Theoretical modeling should be used to plan field tests. The horizontal impacts are easy to apply.	Lower equipment and testing costs. Can identify the bottom depth of foundation inexpensively for a large class of bridges. Combines compressional and flexural wave reflection tests for complex substructures.	Lower equipment and testing costs. Also shows variation of bridge material and subsurface velocities (stiffnesses) vs. depth and thicknesses of accessible elements.	Fast testing times. Can indicate geometry of accessible elements and bedrock depths. Lower testing costs.	Lower equipment and testing costs. Can detect foundation depths for largest class of bridges and subsurface conditions.	Commercial testing equipment is now becoming available for this purpose. Relatively easy to identify reflections from the foundation; however, imaging requires careful processing.	Low equipment costs and easy to test. Could work well to complement PS tests and help determine pile type.

4.3. Scour Monitoring

Scour monitoring provides early identification of potential scour problems to reduce the potential for bridge failure. The FHWA HEC-23 manual (8) identifies three types of scour monitoring: fixed instrumentation, portable instrumentation, visual monitoring, and geophysical instrumentation.

Fixed instrumentation continuously monitors scour from a secured location on the bridge structure. As such, multiple sensors are required to monitor multiple piers. These instruments connect to a data logger which can be configured to communicate remotely through telemetry. Table 16 lists the currently employed fixed instrumentation with their capabilities and limitations.

Table 16 Fixed Scour Monitoring Methods

Method	Suitable River Environments			Estimated Allocation of Maintenance Resources‡	Installation Experience by State
	Velocity*	Bed Material†	Ice/Debris Load‡		
<i>Fixed Instrumentation</i>					
Sonar	All	All	L	M	CO, FL, IN, NY, VA TX
Magnetic Sliding Collar	All	S, F	All	M	CO, FL, IN, MI, MN, NM, NY, TX
Float Out Device	All	S, F	All	L	AZ, CA, NV
Sounding Rods	M, S	C	M, L	H	AR, IA, NY
<i>Portable Instrumentation</i>					
Physical Probes	M, S	All	M, L	L	Widely Used
Sonar Probes	M, S	All	L	L	Widely Used
<i>Geophysical Instrumentation</i>					
Reflection Seismic Profiles	All	All	M	H	Special Circumstances
Ground Penetrating Radar	All	S,F	M, L	H	Special Circumstances

* F=Fast; M = Moderate; S = Slow. † C = Coarse; S = Sand; F= Fine. ‡ H = High; M = Moderate; L = Low.

Of the devices listed in the table, sonar and magnetic sliding collars have shown the most promise during deployments, according to many studies (8, 12–14). Prices for these two instruments are similar — the sonar cost approximately \$4,000 and the magnetic sliding collar is also approximately \$4,000, according to the FHWA HEC-23 manual. These

costs include the basic instrument mounting hardware, power supply data logger, and instrument shelter/enclosure. Adding a cell-phone based telemetry link to the system adds approximately \$3,000 to the cost. Installation costs for these instruments are dependent on the complexity of the situation. These complexities include bridge deck height, foundation geometry, and the bridge deck overhang distance. The FHWA HEC-23 manual reports the level of effort required for installation of an instrument system typically exceeds 5 person days.

Fixed instrumentation is not feasible for all bridges. For example, the number of piers may deem placing fixed instruments at each bridge cost prohibitive. Under such conditions, portable instrumentation — capable of monitoring multiple piers and bridges — presents a cost-effective solution. Portable instruments provide flexibility to quickly respond to flood conditions at multiple bridges. The previous table lists the currently employed portable instrumentation with their capabilities and limitations based on the FHWA HEC-23 manual. The physical and sonar probes are widely used with methods that range from a simple lead lines for physical probes to 75,000 sonar probes deployed from a truck mounted articulated crane, according to Schall and Price (15). Geophysical instrumentation is a portable instrument that provides a forensic tool to evaluate scour conditions experienced during previous floods, according to Webb et al. (7). The two commonly used instruments are the reflection seismic profilers and ground penetrating radar. Both instruments provide detailed images of sub-bottom profiles for identifying/mapping in-filled scour holes. This equipment is expensive and requires specialized training to operate and interpret the data.

Table 17 summarizes the advantages and limitations of the instrumentation presented above, according to the FHWA HEC-23 manual. In general, fixed instrumentation is used when continuous monitoring is required, portable instruments are

used when a greater area coverage is required (multiple bridges and multiple piers), and geophysical instruments are used as a forensic tool.

Table 17 Comparison of Instrument Types

Instrument Category	Advantage	Limitation
Fixed	Continuous monitoring, low operational cost, ease of use	May miss maximum scour, maintenance of equipment
Portable	Complete mapping, use at multiple bridges	Labor intensive
Geophysical	Forensic investigations	Labor intensive, specialized training

Tables 18 through 20 provide a summary of the fixed and portable instrumentation, and an estimate of the cost of the instruments.

Table 18 Comparison of Fixed Instrumentation

Instrument	Best Application	Advantages	Disadvantages
Sonar	Coastal regions	Time history, built with off the shelf components	Debris, high sediment or air entrainment
Sounding Rod	Coarse -bed channels	Simple, mechanical device	Unsupported length, binding, auguring
Magnetic Sliding Collar	Fine-bed channels	Simple, mechanical device	Unsupported length, binding, debris
Float Out	Ephemeral channels	Lower cost, ease of installation	Battery life

Table 19 Comparison of Portable Instrumentation

Instrument	Best Application	Advantages	Disadvantages
Physical Probes	Small bridges and channels	Simple technology	Accuracy, high flow application
Sonar	Larger bridges and channels	Point data or complete mapping, accurate	High flow application
Reflection Seismic Profilers	Larger bridges and channels and coastal environments	Accurate map of the bottom and sub-bottom in water depths on the order of hundreds of feet	Expensive, must be submerged, data contamination by bridge piers etc.
Ground Penetrating Radar	Small to medium bridges and in freshwater channels	Accurate map of the bottom and sub-bottom on sand bars and to water depths on the order of 30 feet, samples under good conditions	Expensive, post processing, water depth exceed 30 ft, saline waters, clay

Table 20 Estimated Instrument Cost

Instrument	Instrument Cost	Cost for Installation or Use	Operation Cost
Physical Probes	<\$2,000	Varies by use	Varies, minimum 2-person crew for safety
Portable Sonar	\$500 (fish finder) - \$75,000 (sonar on truck mounted articulated crane)	Varies by use	Varies, minimum 2-person crew for safety
Fixed Sonar	\$5,000 - \$15,000	Minimum 5-person days	Typically <\$1/hr per site visit
Sounding Rod	\$7,500 - \$10,000	Minimum 5-person days	Typically <\$1/hr per site visit
Magnetic Sliding Collar	\$5,000 - \$10,000	Minimum 5-person days	Typically <\$1/hr per site visit
Float Out	\$3,000 + \$500/float out	Varies with number installed	Typically <\$1/hr per site visit
Ground Penetrating Radar	\$15,000 - \$50,000	Varies by site conditions	Contractors costs range from \$1,000 to \$2,000 per day
Reflection Seismic Profilers	>\$20,000	Dependent on required survey vessel	Dependent on vessel costs

4.4. Scour Countermeasures

Guidelines developed for management of bridges with unknown foundations will undoubtedly include some protocol to implement countermeasures against scour. There are a number of ways to armor a bed to minimize or prevent scour. Of the various materials that can be used, broken stone or riprap is the most common. In recent years, however, several manmade systems have been developed that are cost effective for many situations. The cost associated with any system is very site/location-specific. Some parts of the country have an abundant supply of dense stone while others have little or no stone. Transportation costs are expensive and it is in locations with little or no natural stone that locally manufactured products are most practical. For cost comparison purposes a particular riprap gradation and median diameter specifications have been selected. These specifications, which are used by the State of Florida for erosion mitigation, are presented in Tables 21 and 22. Also, since there is a significant difference in costs for different locations around the United States, average costs are given for three locations, Florida (Table 23), New York State (Table 24), and Colorado (Table 25). The costs are divided into:

1. Material cost at the source,
2. Cost per unit surface area (including filter material and bedding stone),
3. Transportation cost per mile from the source to the site, and
4. Installation cost.

It should be noted that installation costs can vary significantly from one situation to the next (distance of barges and cranes from site, water depths, bridge heights, presence of environmentally sensitive flora and fauna, etc.).

For local pier scour protection the FHWA HEC-23 recommends that the armor coverage extend horizontally at least two times the pier width, measured from the pier face.

Table 21 Stone Riprap weights

Weight Maximum ^a	Weight 50% ^c	Weight Minimum ^d	Minimum Blanket Thickness
<i>kg</i> ^b [<i>lbs</i>]	<i>kg</i> [<i>lbs</i>]	<i>kg</i> [<i>lbs</i>]	<i>m</i> [<i>ft</i>]
320 [700]	135 [300]	25 [60]	0.75 [2.5]

^a Ensure that at least 97% of the material by weight is smaller than weight maximum. ^b Bulk specific gravity not less than 2.3. ^c Ensure that at least 50% of the material by weight is greater than weight 50%. ^d Ensure that at least 85% of the material by weight is greater than weight minimum.

Table 22 Bedding stone sizes

Standard Sieve Sizes		
<i>(inches)</i>	<i>(mm)</i>	Individual Percentage by Weight Passing
12	305	100
10	254	70 to 100
6	152	60 to 80
3	75	30 to 50
1	25	0 to 15

Note: Minimum blanket thickness of 1 ft and bulk specific gravity of not less than 2.3

Table 23 Material costs (Florida)

Item	Material ^a	Material ^b	Transportation ^c	Installation
	<i>(\$/ton)</i>	<i>(\$/m²)</i>	<i>(\$/m²)</i>	<i>(\$/m²)</i>
<i>Rip-Rap</i> ^d	16.50	34	26	91
<i>Cabled Block</i> ^e	140.30 - 180.40	48 - 57	2.70 - 8.00	21.50 - 43.00

^a Metric ton = 1.102 short tons = 2204.6 lbs. ^b Costs include filter material and bedding stone. ^c Based on 440 miles haul (distance from Atlanta, Ga. To Orlando, FL). ^d Rip-rap specifications shown in Tables 21 and 22. ^e Cost information based on one manufacturer's estimates.

Table 24 Material costs (New York State)

Item	Material ^a	Material ^b	Transportation ^c	Installation
	<i>(\$/ton)</i>	<i>(\$/m²)</i>	<i>(\$/m²)</i>	<i>(\$/m²)</i>
<i>Rip-Rap</i> ^d	9.90	22	10	59
<i>Cabled Block</i> ^e	140.30 - 180.40	48 - 57	2.70 - 8.00	21.50 - 43.00

^a Metric ton = 1.102 short tons = 2204.6 lbs. ^b Costs include filter material and bedding stone. ^c Based on 40 mile haul distance, as documented by Kuennen (16). ^d Rip-rap specifications shown in Tables 21 and 22. ^e Cost information based on one manufacturer's estimates.

Table 25 Material costs (Colorado)

Item	Material ^a	Material ^b	Transportation ^c	Installation
	<i>(\$/ton)</i>	<i>(\$/m²)</i>	<i>(\$/m²)</i>	<i>(\$/m²)</i>
<i>Rip-Rap</i> ^d	9.90	21	10	70
<i>Cabled Block</i> ^e	140.30 - 180.40	48 - 57	2.70 - 8.00	21.50 - 43.00

^a Metric ton = 1.102 short tons = 2204.6 lbs. ^b Costs include filter material and bedding stone. ^c Based on 40 mile haul distance, as documented by Kuennen (16). ^d Rip-rap specifications shown in Tables 21 and 22. ^e Cost information based on one manufacturer's estimates.

The spatial extent of armoring for a given pier depends on the size of the pier. The FHWA HEC-18 manual (2) recommends that pier scour protection extend two pier widths

out from the pier in all directions. Based on the costs presented in Table 23, the costs of rip-rap and cabled block for various pier widths and lengths are presented in Table 26.

Table 26 Average Total Armor Costs per Pier (Florida)

Material	Pier width/length ratio (m)			
	<i>(2/6)</i>	<i>(3/8)</i>	<i>(4/10)</i>	<i>(5/15)</i>
<i>Rip-Rap</i>	19,328	41,676	72,480	120,800
<i>Cabled Block</i>	9,242 - 13,830	19,927 - 29,822	34,656 - 51,864	57,760 - 86,440

The local scour protections outlined in this document are based on the assumption that the effective bed shear stress near a pier is twice that on a flat bed upstream of the pier. The cost estimates presented here represent averages as indicated and are only valid for this point in time. Local conditions and circumstances can and will alter these values.

5. SCOUR RISK MANAGEMENT GUIDELINES

If we consider the fact that there are approximately 400,000 bridges over water, that over 60,000 of these have unknown foundations, and that research shows that – on average – approximately 80 fail due to scour every year, these facts strongly indicate that the strategies employed by bridge owners to prevent scour failure are working, even for bridges with unknown foundations. Several States have guidelines for managing bridges with unknown foundations. These guidelines are often not formally documented, but exist nonetheless as informal operating procedures. These guidelines benefit from information collected through literature searches, formal and informal surveys, and various interviews with experts across the country. Thus, States are encouraged to assess the effectiveness of their current guidelines to determine whether or not the guidelines included herein offer any benefits over their own. Given the infrequency of scour failure, many States might reasonably choose to stay the course with existing procedures. For those who do not have guidelines (formal or informal) in place, these guidelines should be selected or used to develop a pertinent management plan. A single bridge failure can have significant economic and political consequences, and these potential consequences should drive the implementation of reasonable management guidelines.

The general flow of the guidelines to be presented in this section is illustrated in Figure 4. While the decisions in this figure apply to individual bridges, the schedule of work orders should correlate with the functional priority and/or estimated risk of failure of the pertinent bridges.

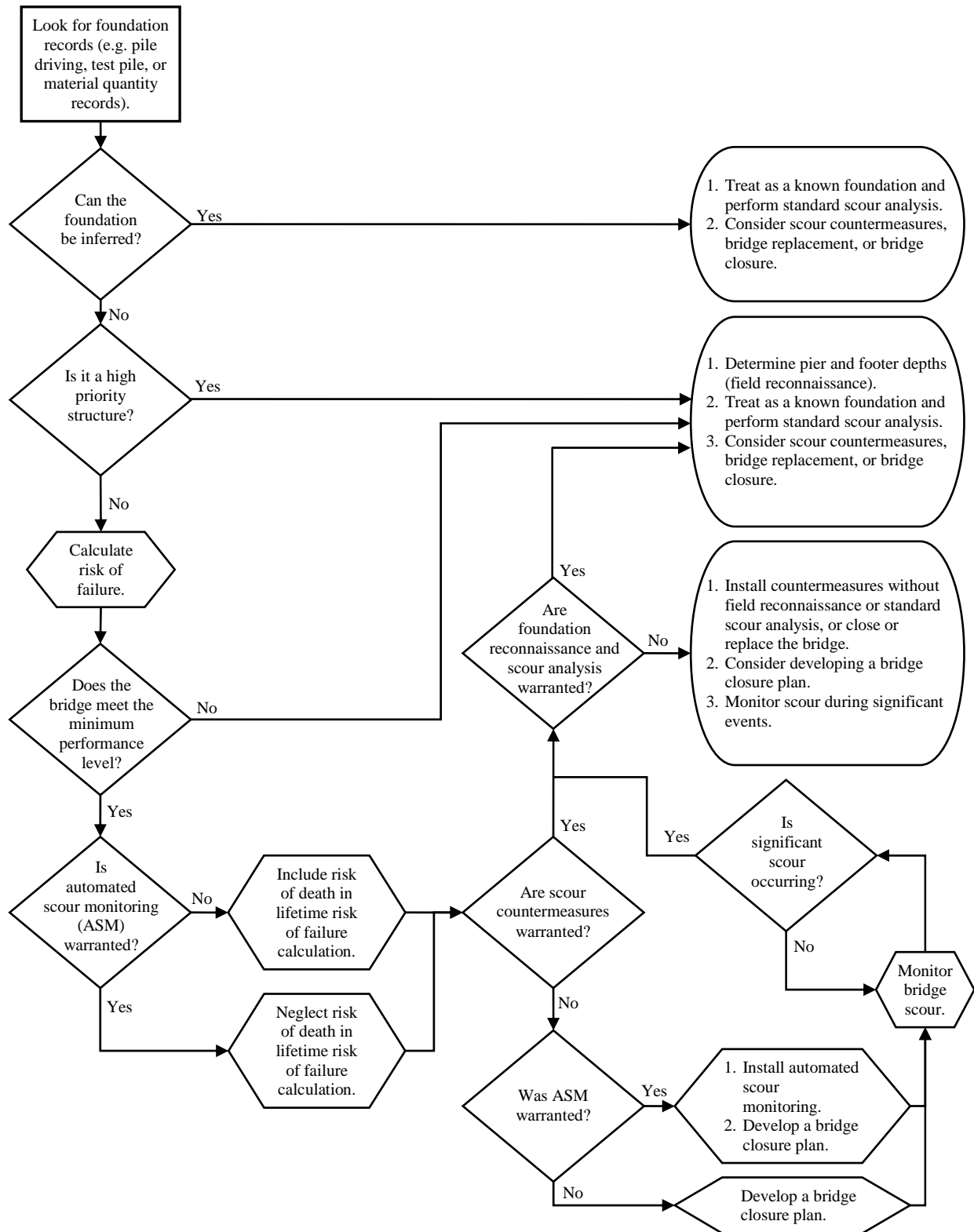

Figure 4 Scour risk management guidelines flow chart

5.1. Can the Foundation Be Inferred?

The introduction shows that there are over 3,700 bridges built in the past 10 years (i.e. 1995 – 2005) for which foundation information is not available. In fact, 69 principal arterials have been built between 2000 and 2005 for which foundation information is not available. Perhaps transportation agencies are not devoting enough effort toward finding these plan sets, especially those developed over the past decade. Every effort should be made to find construction records before going any further with these guidelines. These guidelines suffer from gross assumptions and significant uncertainties. Efforts expended to locate foundation information will be repaid with greater confidence in future management activities. Foundation information to be collected would include as-built plans that might include pile driving records, material-use records, and other pertinent footing or abutment records. The following summarizes the pertinent findings from a careful literature review and interviews (see *Appendices B–C*) regarding common assumptions for unknown foundations.

- Older structures (built before 1960) were usually built on timber piling.
- Depth of piles can be assumed as at least 10 feet for bridges with unknown foundations.
- If rock is near the surface, spread foundations can be assumed to support bridges with unknown foundations.
- The top of a typical spread footing can be assumed to be 3 feet below the top of the soil and the bottom 7 feet below the top of the soil.

If foundation records are located, take the following steps:

1. Assume that the foundation information from any identified plan set is accurate and use this information to determine/estimate the necessary parameters for a scour evaluation. In other words, continue as if the foundation is known.

2. Evaluate scour using FHWA HEC-18 (2).
3. If scour analysis indicates that countermeasures are warranted, countermeasures should be designed using FHWA HEC-23 (8) – or consider replacing or closing the bridge.

5.2. Is the Bridge a High Priority Structure?

High priority structures are bridges that are so important that every possible effort should be made to determine the foundation and protect it as necessary. In other words, the ramifications of failure are so devastating that investment is warranted even if a cost-benefit analysis doesn't justify such action. Each State Transportation Agency can set its own definition for these high priority structures, with the following suggestion provided herein:

- Principal arterials
- Evacuation routes
- Bridges that provide access to local emergency services such as hospitals
- Bridges that are defined as critical by a local emergency plan (e.g., bridges that enable immediate emergency response to disasters)

Principal arterials have importance beyond the simple measure of ADT. Oftentimes these are critical economic links that have national economic importance. On a regional level, principal arterials are the major (and in some rural cases, only) link between towns, cities, and other developed areas. Failure of a principal arterial will affect far more than just the traffic that normally travels across the bridge. As traffic is rerouted, the traffic that normally travels the minor arterials and collector roads may be caught in severe delays resulting from extreme overcapacity.

Evacuation routes are suggested in this category since these routes are oftentimes the only practical means of evading natural disasters (e.g., hurricanes). The risk of injury

and death – not from the bridge failure, but from the natural disaster - may be too great to bear if such a route is not available due to failure.

For high priority structures, the following steps should be taken.

1. Perform field reconnaissance to determine foundation type and depth. If the foundation is a spread footing, drill through the footing to determine elevation of the footing bottom. If the foundation is piles, use foundation reconnaissance to determine depth of piles. The parallel seismic test is generally the most effective reconnaissance method. Assume that the foundation information from the field evaluation is accurate. If field reconnaissance is unsuccessful (no access for testing, poor signal from NDT, etc.), assume a foundation depth. For piles, assume a 10 foot depth or use local knowledge. This should be a conservative assumption. Spread footing depths are easily discovered and an assumption should not be necessary for this type of foundation. In other words, continue as if the foundation is known.
2. Evaluate scour using FHWA HEC-18 (2).
3. If scour analysis indicates that countermeasures are warranted, countermeasures should be designed using FHWA HEC-23 (8) – or consider replacing or closing the bridge.

5.3. Screening Bridges According to Risk

For those bridges foundations not discovered through research or field evaluations (the previous steps), a screening analysis should be performed. The screening tool utilizes the annual probability of failure, which can be estimated from NBI items 26, 60, 61, and 71 using Tables 12–14.

5.3.1. Does the Bridge Meet Minimum Performance Level?

The minimum performance level (MPL), as shown below in Table 27, is the probability of failure that a bridge with a certain functional classification (NBI item 26) must outperform. For example, an urban minor arterial must have an annual probability of failure less than 0.0002 to meet the MPL. This is based on the finding that bridges have an average annual probability of failure due to scour of approximately 0.0002 and this results in a total number of scour failures that is low (probably on the order of 100 bridges per year). Given this average target, the performance level is adjusted higher or lower depending upon roadway functional classification (see *Appendix D*). As clearly stated earlier in the report, the performance level does NOT correspond to a design standard. Design standards have many conservative assumptions and factors of safety that result in performance that is perhaps an order of magnitude (or more) more conservative than the design return period would indicate.

Table 27 Minimum Performance Levels for Bridges

NBI Item 26	Description	Minimum Performance Level <i>(Threshold Probability of Failure)</i>
<i>Rural</i>		
01, 02	Principal Arterial – All	0.0001
06, 07	Minor Arterial or Major Collector	0.0005
08	Minor Collector	0.001
09	Local	0.002
<i>Urban</i>		
11, 12, 14	Principal Arterial – All	0.0001
16	Minor Arterial	0.0002
17	Collector	0.0005
19	Local	0.002

First, compare the annual probability of failure (from Table 12) to the pertinent MPL in Table 27. If the annual probability of failure is greater than or equal to the MPL, the following steps should be taken.

1. Perform field reconnaissance to determine foundation type and depth. If the foundation is a spread footing, drill through the footing to determine elevation of

the footing bottom. If the foundation is piles, use foundation reconnaissance to determine depth of piles. The parallel seismic test is generally the most effective reconnaissance method. Assume that the foundation information from the field evaluation is accurate. If field reconnaissance is unsuccessful (no access for testing, poor signal from NDT, etc.), assume a foundation depth. For piles, assume a 10 foot depth or use local knowledge. This should be a conservative assumption. Spread footing depths are easily discovered and an assumption should not be necessary for this type of foundation. In other words, continue as if the foundation is known.

2. Evaluate scour using FHWA HEC-18 (2).
3. If scour analysis indicates that countermeasures are warranted, countermeasures should be designed using FHWA HEC-23 (8) – or consider replacing or closing the bridge.

If the MPL is met, compute K and the lifetime probability of failure (P_L) using Equations 5 through 7, and continue.

5.3.2. *Is Automated Scour Monitoring Warranted?*

The lifetime risk of death is the product of the adjusted lifetime probability of scour failure, the number of deaths, and the cost of each death (i.e. $R_{\text{death}} = K * P_L * X * C_6$). This cost should be compared to the cost of installing automated scour monitoring (ASM) since ASM will reduce the likelihood of death if failure occurs to a negligible level. With ASM, a bridge is constantly monitored for scour and can be closed if scour levels are deemed threatening to structural stability. The cost of installing ASM can be estimated from information reported in and references cited in Section 4.3, entitled “*Scour Monitoring*”.

If the lifetime risk of death is greater than the cost of installing ASM, then ASM is provisionally recommended. However, if the next step in these guidelines recommends

installing countermeasures, then ASM is probably not warranted. If ASM is warranted, then the lifetime risk of failure (P_L) in the next step should be revised by subtracting from it the risk of death. If, on the other hand, the lifetime risk of death is less than the cost of automated scour monitoring, then biennial scour monitoring or countermeasures might be warranted instead of ASM.

5.3.3. *Are Scour Countermeasure Warranted?*

Countermeasure costs can be estimated based on local experience (preferable) or information provided in the “*Scour Countermeasures*” subsection. Every effort should be made to use local information for estimating countermeasure cost and environmental permitting requirements should be considered since these requirements may dictate countermeasure selection and design. Use the “*Lifetime Risk of Scour Failure*” subsection to compute the lifetime risk of failure in accordance with the “*Is Automated Scour Monitoring Warranted?*” section. If the lifetime risk of failure is greater than the estimated cost of countermeasures, countermeasures are warranted (proceed to “*Is Foundation Reconnaissance and Scour Analysis Warranted?*”). If the lifetime risk of failure is less than the estimated cost of countermeasures, countermeasures are not warranted (proceed to “*Has Bed Elevation Significantly Lowered?*”).

5.3.4. *Is Foundation Reconnaissance and Scour Analysis Warranted?*

Typically, engineering costs represent approximately 10 to 20% of total project costs. If engineering costs are high relative to construction costs, a reasonable course of action might be to construct without detailed engineering. This is the course selected by Maryland State Highway Administration (MSHA) for small bridges (see *Appendix C*). They have found that scour analysis (and all the data collection associated with it) typically costs on the order of \$50,000, while installing countermeasures might cost \$10,000 for a small bridge. The MSHA decision to forego analysis in such a case is reasonable. Given the

criticality of bridge structures and the potential for loss of life, analysis to illuminate proper countermeasure design is probably worth more than 20% of total cost.

If the cost of foundation reconnaissance and scour analysis is less than 50% of the estimated cost of countermeasures, the following steps should be taken.

1. Perform field reconnaissance to determine foundation type and depth. If the foundation is a spread footing, drill through the footing to determine elevation of the footing bottom. If the foundation is piles, use foundation reconnaissance to determine depth of piles. The parallel seismic test is generally the most effective reconnaissance method. Assume that the foundation information from the field evaluation is accurate. If field reconnaissance is unsuccessful (no access for testing, poor signal from NDT, etc.), assume a foundation depth. For piles, assume a 10 foot depth or use local knowledge. This should be a conservative assumption. Spread footing depths are easily discovered and an assumption should not be necessary for this type of foundation. In other words, continue as if the foundation is known.
2. Evaluate scour using FHWA HEC-18 (2).
3. If scour analysis indicates that countermeasures are warranted, countermeasures should be designed using FHWA HEC-23 (8) – or consider replacing or closing the bridge.

This test assumes that it is reasonable to spend up to 50% of countermeasure costs on field reconnaissance and scour analysis. This can be adjusted based on local willingness to accept the uncertainty involved with installing countermeasures without field reconnaissance and scour analysis.

If the cost of foundation reconnaissance and scour analysis is greater than the estimated cost of countermeasures, then proceed to Section 5.4, entitled “*Install Countermeasures without Field Reconnaissance and Scour Analysis*”.

5.4. Install Countermeasures without Field Reconnaissance and Scour Analysis

Use local experience to install grout bags, rip rap, or other countermeasures without detailed field reconnaissance of the foundation and scour analysis. Maryland State Highway Administration (MSHA; see *Appendix C*) often uses grout bags or riprap without detailed scour analysis. The grout bags used are usually class 3 grout bags that are 3 feet by 4 feet by one foot. A grout bag installation for a small two lane bridge might cost \$10,000. This is inexpensive relative to surveying and modeling required to analyze scour, estimated at approximately \$50,000 by MSHA.

If countermeasures are installed without analysis, the uncertainty involved with the adequacy of the countermeasure warrants more rigorous monitoring than the standard 2-yr frequency. These bridges should be monitored during the first significant event (perhaps a rainfall of a few inches) to check on the stability of the installation during high flow conditions. Thereafter, it should be monitored during events that are more intense than those it has already withstood. For example, if the countermeasure has withstood a 5 year event and a 10-year event is predicted, then monitoring during the event is suggested. If the countermeasure has already withstood a 25 year event, then monitoring may not be warranted if a 10-year event is predicted. The bridge closure plan (see Section 5.5, entitled “*Develop a Bridge Closure Plan*”) should be followed to guide actions to be taken depending upon monitoring findings.

If the bridge owner is not confident that a countermeasure can be designed for the site without doing field analysis, then the bridge owner should consider foundation

reconnaissance and scour analysis warranted and follow the recommendations in the “*Is Foundation Reconnaissance and Scour Analysis Warranted?*” subsection.

5.5. Develop a Bridge Closure Plan

If countermeasures are not installed or if countermeasures are installed without detailed surveys and analysis, then it is strongly recommended that the bridge owner develop a detailed closure plan to mitigate the risk of loss of life during and after scour-critical events. The Plans of Action for Scour Critical Bridges Office Manual published by the Idaho Transportation Department in 1994 (see *Appendix B*) has several examples of such plans, part of which are included in these guidelines. This document should be consulted for detailed guidance on developing and implementing a bridge closure plan.

Each bridge closure plan should have two basic components:

- Closure Criteria: critical water surface elevation markers, critical scour depths, damage assessments, etc.
- Traffic Control Plans: detour routes, sign placement, public announcements, personnel lists, emergency contacts, etc.

Due to the uncertainty regarding bridges with scour around an unknown foundation, it is acknowledged that it will be difficult to select critical water surface elevations for these bridges with any certainty. In these cases, the local bridge engineer should examine the inspection data and use their best judgment to set closure markers (e.g. easy-to-see lines on a pier or abutment) to indicate the maximum water level that they feel the bridge can safely endure. Note that California DOT officials recommend installing a remote stage sensor in lieu of just paint on the substructure. These sensors are fairly simple and reliable instruments, which can monitor numerous trigger elevations and do not require the physical presence of personnel until conditions warrant. If the closure water level is uncertain, then the local engineer should establish another marker to indicate when

frequent scour measurements should be initiated. These markers or triggers should be reviewed and/or updated after each scour inspection.

A bridge should be closed if the water surface elevation (WSEL) exceeds the designated closure marker or if scour measurements exceed a predetermined depth. A bridge should also be closed if any other evidence of bridge distress is noted. Evidence of bridge distress includes, but is not limited to:

- Bridge movement under load
- Joint deflection
- Bridge deck sagging
- Pressure flow conditions
- Excessive debris buildup
- Bridge or approach embankment overtopping
- High-velocity flow impinging directly on abutments or unarmored embankments
- Abutment armor failure

Furthermore, if, at any time, monitoring personnel do not feel the bridge is safe or if they are uncomfortable working on the bridge due to flood conditions at the bridge, they should close the bridge to traffic and stay off of the structure until it has been inspected for stability.

The bridge monitoring team should be given sufficient information, training, and equipment to perform scour monitoring, observe the WSEL marks, take measure-down readings to the WSEL with a weighted tape measure, use any other monitoring equipment, and perform an emergency closure of the bridge – if necessary. Each closure monitoring team should have an information card with necessary bridge data, detour route(s), emergency contact information for traffic enforcement and the district engineer, and closure instructions for each bridge.

Closure instructions might include load restrictions, lane closures and total closure criteria. The method of closure should also be described (e.g. barricades, law enforcement officers detour routes, etc.). The method of closure should also consider the scour vulnerability of any bridges along the detour route(s). Instructions for re-opening the bridge or lanes should also be provided.

The closure plan should clearly state the notification protocol when a bridge closure may be required. Bridge inspectors who detect a problem at a bridge need to know who to contact in order to initiate the decision to close or limit a bridge, and how to implement the closure plan. A different notification protocol may be needed for situations where emergency remediation is required but closure is not.

5.6. Is Significant Scour Occurring?

If both automated scour monitoring (ASM) and scour countermeasures are not warranted, then scour monitoring should be performed with every 2-yr routine bridge inspection for all bridges with unknown foundations. However, if ASM was warranted then ASM should be used to monitor scour continuously. See Section 4.3, entitled “*Scour Monitoring*”, for detail on monitoring options. If the scour depth increases significantly from baseline conditions (as-built drawings or initial scour survey), action should be taken. The first action is to follow the bridge closure plan (see Section 5.5, entitled “*Develop a Bridge Closure Plan*”) to take any necessary immediate action. Countermeasures should then be considered for this site (return to Section 5.3.4, entitled “*Is Foundation Reconnaissance and Scour Analysis Warranted?*”). The scour depth trigger elevation can be adjusted based on local geotechnical and engineering considerations and should represent the depth of scour that the bridge engineer thinks the individual bridge can withstand (i.e. based on experience and relevant event histories).

6. SCOUR MANAGEMENT CASE STUDIES

This section offers a few examples of how the scour guidelines in the previous section may be used to evaluate bridges with unknown foundations and select a management plan. The examples given here are based on 60 case studies obtained from a recent survey of bridges in six States (see *Appendix F*).

6.1. Information Search and Preliminary Screens

The first step in applying the scour guidelines to bridges with unknown foundations is to collect the pertinent data for each bridge. The first step in this data collection should be to search harder for any records that might be used to determine or infer the foundation. If foundation records are located and the bridge engineer is confident that these records are sufficient for inferring the foundation, then they should follow the advice given in the “*Are there any Foundation Records?*” subsection of the scour management guidelines.

If foundation records can not be found, the next step is to see if the bridge is considered a high priority structure. The “*Is the Bridge a High Priority Structure?*” subsection of the scour risk management guidelines gives the definition of a high priority structure, and outlines the course of action for any high priority structures. Once the foundation has been satisfactorily determined or inferred, the bridge can be evaluated as a known foundation using FHWA HEC-18 (2).

All remaining bridges with unknown foundations should be evaluated using data that is easy to collect or obtain. The bridge survey form (see *Appendix F*) can be used to collect the pertinent data for evaluating these bridges using the scour risk management guidelines. Table 28 summarizes all of the data that the screening analysis may require. The first step in the “*Perform Screening Analysis*” subsection of the guidelines, however, only requires four of the NBI items in this table – namely, items 26, 60, 61, and 71.

Table 28 Summary of Required Data

Required Data Value	Source	Required Data Value	Source
Detour length (miles)	NBI item 19	Truck running cost (\$/mi)	Planning, C ₃ *
Functional classification	NBI item 26	Duration of detour (days)	Planning, d*
Average daily traffic	NBI item 29	Value of time, cars (\$/mi)	Planning, C ₄ *
Structure length (feet)	NBI item 49	Avg car occupancy	Planning, O*
Deck Width (feet)	NBI item 52	Value of time, trucks (\$/mi)	Planning, C ₅ *
Substructure condition	NBI item 60	Avg detour speed (mph)	Planning, S*
Channel protection	NBI item 61	No. deaths from failure	Planning, X*
Waterway adequacy	NBI item 71	Cost for each lost life (\$)	Planning, C ₆ *
Avg daily truck traffic (%)	NBI item 109	Cost of automated scour monitoring (\$)	Hydraulics†
Span length (> 100 ft?)	Inspections	Cost of scour countermeasures (\$)	Hydraulics†
Remaining life (years)	Design/Planning	Cost of foundation reconnaissance (\$)	Geotechnical†
Car running cost (\$/mi)	Planning, C ₂ *	Cost of scour evaluation (\$)	Hydraulics†

*Estimate using local data or the default values as defined in Equation 2.

†Estimate from past experience based on similar structures and streams.

6.2. The Minimum Performance Level Criterion

The first step in the screening analysis involves comparing the estimated annual probability of failure for a bridge to its minimum performance level. Consider two examples from the case studies. The first example is bridge number 57-0072 in San Diego County, CA, which was built in 1938 and supports state route 76 – a rural minor arterial road – over Pala Creek. This bridge has five spans supported by concrete piles of known length, and has an NBI item 113 rating of “3” (scour critical and unstable). This known foundation was used to test the guidelines. The minimum performance level for a rural minor arterial class bridge according to Table 27 is 0.0005 – the threshold probability of failure that this bridge must outperform. The first step in evaluating this bridge is to estimate the overtopping frequency and scour vulnerability of this bridge, as in the Table 29 below, and then the annual probability of failure.

Table 29 Annual Probability of Failure, Example 1

Data/Parameter (source)	Value	Interpretation
NBI item 26 (bridge survey)	6	Rural minor collector
NBI item 71 (bridge survey)	7	Waterway exceeds the minimum criteria
∴ Overtopping Frequency (Table 13)	S	Slight (once in 11-100 years)
NBI item 60 (bridge survey)	5	Foundation is in fair condition
NBI item 61 (bridge survey)	3	Banks are failing and threaten the bridge
∴ Scour Vulnerability (Table 14)	4	Analysis: stable; Survey: foundation is exposed
∴ Annual probability of failure (Table 12)	0.0005	A 1 in 2,000 chance of failure in any given year

This bridge has a known foundation that probably requires action. Furthermore, this bridge does not meet the minimum performance level for bridges with unknown foundations because the estimated annual probability of failure is not less than 0.0005. Thus, if this bridge had an unknown foundation the guidelines would have recommended the following three step strategy to ensure the safety of this bridge.

1. Perform field reconnaissance to determine foundation type and depth. If the foundation is a spread footing, drill through the footing to determine elevation of the footing bottom. If the foundation is piles, use foundation reconnaissance to determine depth of piles. The parallel seismic test is generally the most effective reconnaissance method. Assume that the foundation information from the field evaluation is accurate. If field reconnaissance is unsuccessful (no access for testing, poor signal from NDT, etc.), assume a foundation depth. For piles, assume a 10 foot depth or use local knowledge. This should be a conservative assumption. Spread footing depths are easily discovered and an assumption should not be necessary for this type of foundation. In other words, continue as if the foundation is known.
2. Evaluate scour using FHWA HEC-18 (2).

3. If scour analysis indicates that countermeasures are warranted, countermeasures should be designed using FHWA HEC-23 (8) – or consider replacing or closing the bridge.

The second example is bridge number 091470064302038 in Limestone County, TX, which was built in 1977 and supports FM-39 – a rural major collector road – over Sanders Creek. This bridge has pre-stressed concrete box girders on multiple concrete drilled shafts, and has an NBI item 113 rating of “3” (scour-critical and unstable). This known foundation was also used to test the guidelines. The minimum performance level for an urban-local class bridge according to Table 27 is 0.0005 – the threshold probability of failure that this bridge must outperform. The first step in evaluating this bridge is to estimate the overtopping frequency and scour vulnerability of this bridge, as in the Table 30 below, and then the annual probability of failure.

Table 30 Annual Probability of Failure, Example 2

Data/Parameter (source)	Value	Interpretation
NBI item 26 (bridge survey)	7	Rural major collector
NBI item 71 (bridge survey)	6	Waterway meets the minimum criteria
∴ Overtopping Frequency (Table 13)	S	Slight (once in 11-100 years)
NBI item 60 (bridge survey)	7	Foundation is in good condition
NBI item 61 (bridge survey)	7	Channel has some minor drift and damage
∴ Scour Vulnerability (Table 14)	7	Countermeasures now make it stable
∴ Annual probability of failure (Table 12)	0.00025	A 1 in 4,000 chance of failure in any given year

This bridge meets the minimum performance level because the estimated annual probability of failure is less than 0.0005. However, because the foundation is assumed to be unknown, this probability of failure should be used to calculate the lifetime risk of failure in order to select a management plan.

6.3. Scour Risk Assessment

The bridge in the second example has a safe 29-year track record so far, and the Texas Department of Transportation (TXDOT) originally designed this bridge to last 47

more years. This example will be evaluated as an unknown foundation even though the foundation is known to be scour-critical and therefore unstable. The “*Lifetime Risk of Scour Failure*” section provides a way to estimate the risk of failure that can be used to select a reasonable management plan.

The first step in calculating the risk of failure for this bridge is to calculate the lifetime probability of failure using Equations 6 and 7. The lifetime probability of failure for this bridge can be computed from the annual probability of failure and its tentative remaining life as follows: $1-(1-0.00025)^{47}$, or about 0.012. In other words, this annual probability of failure (0.00025) suggests that there is approximately a 1 in 83 (0.012) chance that this bridge will fail in the next 47 years.

The next step in computing the risk of failure is to calculate the approximate cost of failure using Equation 2. Given that this bridge has an average daily traffic load of 2,700 motorists per day, if this bridge were to fail Table 11 estimates that two lives might be lost in the event of bridge failure. If each lost life is valued at \$500,000, the lifetime cost of death is calculated as follows:

$$\begin{aligned} C_{death} &= C_6 \cdot X \\ &= (\$500,000 / person) \cdot (2 people) = \$1,000,000 \end{aligned}$$

TXDOT estimates that a new bridge in this location will cost about \$1,092,987, that the detour would be approximately 11 miles long, and that the daily truck traffic is approximately 10 percent of the average daily traffic. Furthermore, if the running cost is \$0.45/mi/car and \$1.30/mi/truck, the duration of the detour is about 365 days (see Table 3), then the car and truck running cost associated with the detour for this bridge is computed as follows:

$$\begin{aligned}
 C_{\text{running}} &= \left[C_2 \cdot \left(1 - \frac{T}{100} \right) + C_3 \cdot \frac{T}{100} \right] \cdot D \cdot A \cdot d \\
 &= \left[\$0.45 / \text{mi} \cdot \left(1 - \frac{10}{100} \right) + \$1.30 / \text{mi} \cdot \frac{10}{100} \right] \cdot (11 \text{ mi}) \cdot (2,700 / \text{day}) \cdot (365 \text{ days}) \\
 &= \$5,799,668
 \end{aligned}$$

If the average wage of each car occupant is \$6.96 (see Table 8), the average occupancy per car is 1.63 people, and the average cost of truck time is about \$22.01, then the cost of lost time is computed as follows:

$$\begin{aligned}
 C_{\text{wages}} &= \left[C_4 \cdot O \cdot \left(1 - \frac{T}{100} \right) + C_5 \cdot \frac{T}{100} \right] \cdot \frac{D \cdot A \cdot d}{S} \\
 &= \left[(\$6.96) \cdot (1.63) \cdot \left(1 - \frac{10}{100} \right) + (\$22.01 / \text{truck}) \cdot \frac{10}{100} \right] \cdot \frac{(11 \text{ mi}) \cdot (2,700 / \text{day}) \cdot (365 \text{ days})}{40 \text{ mi} / \text{hr}} \\
 &= \$3,363,623
 \end{aligned}$$

Thus, the total cost of bridge failure is approximately \$11,256,277. The risk adjustment factor (i.e. K in “*Lifetime Risk of Scour Failure*”) for this bridge is equal to one (i.e. no adjustment) because this bridge has spans that are less than 100 feet long. The risk of a scour-induced failure over the remaining life of the bridge is just the product of the lifetime probability of failure, the total cost of failure, and the risk adjustment factor; in other words about \$131,504 (i.e. 1.2% of the total cost of failure).

6.4. Management Alternatives

At this point the “*Scour Risk Management Guidelines*” stipulate that the lifetime risk of failure (above) should be compared to the cost of three different mitigating actions for the bridge in Limestone County, TX. The first alternative (see Figure 4) is to consider automated scour monitoring. Since the cost of automated scour monitoring was estimated to be \$20,000 and the risk of death is approximately \$11,069 (i.e. $P_L \cdot C_{\text{death}} \cdot K = 0.012 \cdot \$1,000,000 \cdot 1.0$), automated scour monitoring is probably not warranted.

Next, scour countermeasures are considered warranted if the lifetime risk of failure is greater than the estimated cost of scour countermeasures, which TXDOT estimates to be about \$50,000. In this case, scour countermeasures are probably warranted because the lifetime risk of failure (\$131,500) is more than twice the estimated cost of countermeasures (\$50,000). Thus, even though this bridge (i.e. example 2 in Table 30) passed the minimum performance level, the estimated risk associated with this bridge is greater than the cost of installing protective countermeasures.

At this point, the bridge owner must now decide if a full scour analysis using foundation reconnaissance and FHWA HEC-18 (2) is warranted before installing countermeasures. In this case, TXDOT estimated that a scour evaluation would cost \$5,000. The cost of foundation reconnaissance was unknown, but it is probably less than \$10,000. In other words, the total cost of field analysis (\$15,000) is only 30% of the estimated cost of installing countermeasures. Thus, field reconnaissance (i.e. foundation reconnaissance followed by scour analysis) is probably warranted because the total cost of field analysis is less than half the estimated cost of countermeasures. Thus, if this bridge had an unknown foundation, the guidelines would have recommended the following steps to ensure the safety of this bridge:

1. Perform field reconnaissance to determine foundation type and depth. If the foundation is a spread footing, drill through the footing to determine elevation of the footing bottom. If the foundation is piles, use foundation reconnaissance to determine depth of piles. The parallel seismic test is generally the most effective reconnaissance method. Assume that the foundation information from the field evaluation is accurate. If field reconnaissance is unsuccessful (no access for testing, poor signal from NDT, etc.), assume a foundation depth. For piles, assume a 10 foot depth or use local knowledge. This should be a conservative

assumption. Spread footing depths are easily discovered and an assumption should not be necessary for this type of foundation. In other words, continue as if the foundation is known.

2. Evaluate scour using FHWA HEC-18 (2).
3. If scour analysis indicates that countermeasures are warranted, countermeasures should be designed using FHWA HEC-23 (8) – or consider replacing or closing the bridge.

Since this bridge has a known foundation that was found to be scour-critical, this management plan – for an unknown foundation – would probably reveal that this bridge in fact needs corrective action.

Table 31 shows a tally of the scour management decisions for 59 of the 60 case studies (see *Appendix F* for the survey data) versus functional classification and priority. This table shows that 30 case studies are considered high priority, which means that their economic value is difficult to quantify but is probably more than sufficient to justify foundation reconnaissance and standard scour analysis using FHWA HEC-18. Of the remaining 29 case studies that are not high priority structures, the scour guidelines found that 9 of these warrant foundation reconnaissance and standard scour analysis. It should be recognized that while performing a scour analysis may not ultimately change the management plan of any of these bridges, the benefit of an informed management decision is assumed to be greater than the risk associated with the existing management decision. Finally, risk analysis suggests that the remaining 20 bridges only warrant developing a bridge closure plan that includes monitoring the bed elevation during biennial inspections. Thus, this table shows that the scour guidelines are conservative in that they recommended foundation reconnaissance for 39 of the 59 case studies evaluated. However, this is partly due to the fact that 36% (21 bridges) of the case studies involved a principal arterial (i.e.

70% of the high priority case studies), whereas about 4 percent of the bridges nationwide with unknown foundations support principal arterials.

Table 31 Case Study Management Decisions by Functional Classification

Functional Classification (NBI item 26)	Scour Management Decision		
	Countermeasures without analysis*	Countermeasures with analysis*	Closure plan and stream bed monitoring
<i>High Priority</i>			
Principal arterials (all)		21	
All others		9	
<i>Non-High Priority</i>			
Urban minor arterials		1	
Urban collectors			1
Urban locals		1	1
Rural minor arterials		3	7
Rural major collectors		4	3
Rural minor collectors			4
Rural locals			4
<i>Totals</i>	0	39	20

*Analysis implies foundation reconnaissance followed by standard scour analysis, which may change the decision to install countermeasures (or close or replace the bridge).

Table 32 provides a more detailed summary of the sixty case studies results. Note that 26 of these bridges have known foundations (NBI item 113 ≠ “U”), and that one did not have enough information to be properly evaluated (i.e. 480A0430001 in Tennessee). Of the 29 case studies that were not high priority structures, five of them did not meet the minimum performance level (MPL). Of the five case studies that did not meet the MPL, three of them had known foundations that were rated scour critical, and one (#45-0063 in California) had an unknown foundation that recently failed due to scour. Risk analysis ultimately found that four of the case studies that passed the MPL warranted foundation reconnaissance and standard scour analysis before considering scour countermeasures.

This table shows that most of the twenty-nine case studies for which there are scour evaluations validate the management plan that the “*Scour Risk Management Guidelines*” suggested. There are only four case studies with known foundations in which the scour guidelines may not have selected an appropriate management plan. For example, the scour

guidelines may not have recommended a sufficiently aggressive management plan for three of the case studies – specifically: #89S42900017 in Tennessee, #0670091 in North Carolina, and #091100041802028 in Texas – when the NBI item 113 code was scour critical and therefore unstable. Alternatively, there was one bridge – #160062 in Florida – for which the scour guidelines recommended foundation reconnaissance when the NBI item 113 code indicated that the foundation is stable with respect to scour. However, given the uncertainties associated with using the available data to predict scour vulnerability, a few mistakes are inevitable. This possibility for error is the primary reason why the minimum requirement in the scour guidelines is to develop a bridge closure plan, and to keep a detailed record of the stream bed’s elevation during biennial inspections. Monitoring the stream bed elevation every two years and reviewing/updating the bridge closure plan each time should help officials identify problems that may not have been apparent before this risk analysis.

Table 32 Summary of Bridge Case Studies

State	Structure No. (NBI item 8)	Functional Classification (NBI item 26)*	NBI item 113	Overtopping Frequency	Scour Vulnerability	High Priority	Meet MPL	Mitigating Action Decisions		
								Automated Scour Monitoring	Scour Counter-measures	Field, Scour Analysis
CA	55-0621M	14 (U PA)	U	Slight	7	Yes	No			Yes
CA	57-0043Z	6 (R MnA)	U	Slight	6		Yes	No	No	No
CA	57-0096	6 (R MnA)	U	Slight	7		Yes	No	No	No
CA	45-0019R	2 (R PA)	U	Slight	5	Yes	Yes			Yes
CA	45-0063	6 (R MnA)	U	Slight	6		Yes	No†	Yes	Yes
CA	55-0228	11 (U I)	3	Slight	5	Yes	Yes			Yes
CA	57-0072	6 (R MnA)	3	Slight	4		No			Yes
CA	41-0025	14 (U PA)	3	Slight	6	Yes	No			Yes
CA	20-0038	6 (R MnA)	U	Slight	4	Failed	No			Yes
CA	12-0073	2 (R PA)	2	Slight	6	Yes	No			Yes
FL	030145	2 (R PA)	U	Slight	7	Yes	No			Yes
FL	050018	6 (R MnA)	U	Slight	7	Yes	Yes			Yes
FL	120160	14 (U PA)	U	Slight	7	Yes	No			Yes
FL	120165	2 (R PA)	8	Slight	8	Yes	Yes			Yes
FL	160063	16 (U MnA)	8	Slight	6		No			Yes
FL	100352	1 (R I)	7	Remote	7	Yes	No			Yes
FL	100434	2 (RPA)	7	Slight	7	Yes	No			Yes
FL	150107	11 (U I)	U	Slight	6	Yes	No			Yes
FL	100039	2 (RPA)	U	Slight	7	Yes	No			Yes
FL	100100	14 (U PA)	U	Slight	7	Yes	No			Yes
NY	3330270	7 (R MjC)	3	Slight	4		No			Yes
NY	2268710	9 (R L)	U	Occasional	6	Yes	Yes			Yes
NY	2268950	9 (R L)	U	Occasional	6	Yes	Yes			Yes
NY	5017820	14 (U PA)	U	Slight	7	Yes	No			Yes
NY	3300120	14 (U PA)	U	Occasional	7	Yes	No			Yes
NY	3330150	17 (U C)	U	Occasional	5		Yes	No	No	No
NY	1092839	11 (U I)	8	Slight	7	Yes	No			Yes
NY	5516290	12 (U F/E)	6	Slight	7	Yes	No			Yes
NY	1024960	14 (U PA)	8	Occasional	4	Yes	No			Yes
NY	3312460	9 (R L)	8	Occasional	4		Yes	No	No	No
NC	0550011	7 (R MjC)	3	Slight	3	Yes	No			Yes
NC	1470038	14 (U PA)	7	Slight	2	Yes	No			Yes
NC	0670091	8 (R MnC)	3	Slight	7		Yes	No	No	No

State	Structure No. (NBI item 8)	Functional Classification (NBI item 26)*	NBI item 113	Overtopping Frequency	Scour Vulnerability	High Priority	Meet MPL	Mitigating Action Decisions		
								Automated Scour Monitoring	Scour Counter-measures	Field, Scour Analysis
NC	0450113	9 (R L)	U	Occasional	6		Yes	No	No	No
NC	0130115	9 (R L)	8	Slight	7	Yes	Yes			Yes
NC	0120101	9 (R L)	U	Occasional	7	Yes	Yes			Yes
NC	0510042	8 (R MnC)	U	Slight	6	Yes	Yes			Yes
NC	0890008	9 (R L)	U	Slight	6		Yes	No	No	No
NC	0710032	6 (R MnA)	8	Slight	7		Yes	No	No	No
NC	1250013	8 (R MnC)	U	Slight	7	Yes	Yes			Yes
TN	480A0430001	9 (R L)	0	Closed	0	Failed	‡			‡
TN	040A1360001	9 (R L)	U	Occasional	6		Yes	No	No	No
TN	09SR0770025	7 (R MjC)	U	Slight	6		Yes	No	Yes	Yes
TN	12SR2250005	7 (R MjC)	U	Slight	6		Yes	No	No	No
TN	19019430001	19 (U L)	U	Slight	7		Yes	No	Yes	Yes
TN	31021320001	8 (R MnC)	U	Occasional	5		Yes	No	No	No
TN	58SR0270007	8 (R MnC)	5	Slight	6		Yes	No	No	No
TN	81S61140007	7 (R MjC)	5	Slight	6		Yes	No	No	No
TN	89S42900017	8 (R MnC)	3	Occasional	5		Yes	No	No	No
TN	780B0720001	19 (U L)	U	Slight	5		Yes	No	No	No
TX	090180039801026	7 (R MjC)	3	Slight	4		No			Yes
TX	090740004904052	2 (R PA)	3	Slight	7	Yes	No			Yes
TX	091100001423285	1 (R I)	3	Slight	7	Yes	No			Yes
TX	091100041802028	7 (R MjC)	3	Slight	5		Yes	No	No	No
TX	091470064302038	7 (R MjC)	3	Slight	7		Yes	No	Yes	Yes
TX	090140AA0268002	6 (R MnA)	U	Occasional	6		Yes	No	No	No
TX	090740AA0128001	6 (R MnA)	U	Occasional	6		Yes	No	No	No
TX	091100AA0878002	6 (R MnA)	U	Occasional	6		Yes	No	No	No
TX	091470AA0173001	6 (R MnA)	U	Occasional	5	Yes	Yes			Yes
TX	091470AA0327001	6 (R MnA)	U	Occasional	5		Yes	No	No	No

*Abbreviations: R = rural; U = urban; I = interstate; F/E = freeway or expressway; PA = principal arterial; A = arterial; Mn = minor; Mj = major; C = collector; L = local.

‡Automated scour monitoring would have been warranted if scour countermeasures were not warranted.

‡Tennessee did not have enough information about this bridge – before it failed – to evaluate it.

7. CONCLUSIONS AND RECOMMENDATIONS

This research reveals a number of important facts concerning bridges with unknown foundations and managing their potential vulnerability to unexpected failure.

- Bridges with unknown foundations are prevalent in many states. Many of them are old structures, but 1,506 have been constructed between 2000 and 2004.
- A bridge's foundation may differ considerably from its design plan. Thus, if as-built construction records are lost, then the bridge's vulnerability to hazards that degrade or stress the foundation can not be properly evaluated without expending funds to determine the foundation.
- Experts can correlate pertinent bridge failures (or estimates of potential failures) with relevant data that is easily obtained for bridges with unknown foundations in order to estimate probability of failure.
- The sixty case studies regarding scour failure in this report show that risk of failure (i.e. probability*cost) can be successfully used to identify bridges that warrant special activities (e.g. automated monitoring, countermeasures or retrofits, replacement, or closure).
- Given the uncertainty with these estimates, this study also shows that it is prudent to establish performance standards (maximum probability of failure) that are a function a bridge's importance (i.e. functional classification).
- While most of the analysis in this report focuses on estimating a bridge's vulnerability to scour failure, the general approach outlined here should be applicable to many other hazards (e.g. earthquakes, debris flows, tsunamis, etc.).

The "*Scour Risk Management Guidelines*" in this report admittedly benefit from the collective research and experience of many private, state, and federal institutions. The analysis presented in the "*Annual Probability of Scour Failure*" section focuses on using

existing data to estimate scour vulnerability and probability of failure, which is clearly useful but subject to significant uncertainty. Thus, future studies of scour vulnerability should focus on relating scour vulnerability to better indicators, which may not be currently monitored but cost less than performing foundation reconnaissance on thousands of less-important bridges with unknown foundations that may be low-risk. It is important that this research focus on improving predictions of both a site's potential for scour (i.e. hazardous potential) as well as the bridge's vulnerability to failure (i.e. structural "weakness").

Other hazards – like earthquakes, debris flows, tsunamis, etc. – are less common and thus harder to study and counteract. The "*General Approach to Risk Management*" section of this report provides a useful outline for how future research projects can begin the work of correlating pertinent bridge failures (or estimates of potential failures) to relevant indicators of hazardous potential and vulnerability to failure. The scour research presented in this report is a valuable example of the general approach. Once this has been developed for other hazards, the joint probability of failure due to multiple hazards may be estimated collectively.

8. REFERENCES

1. *Recording and Coding Guide for the Structure Inventory and Appraisal of the Nation's Bridges*, FHWA-PD-96-001 and Errata Sheet, Federal Highway Administration, 1995.
2. Richardson, E. V., and S. R. Davis. *Evaluating Scour at Bridges*, 4th ed. Hydraulic Engineering Circular No. 18, FHWA NHI 01-001. Federal Highway Administration, U.S. Department of Transportation, Washington, D.C., May, 2001.
3. National Institute of Science and Technology, and NEMATECH, Inc. How can you evaluate reliability from the "bottom-up" (component failure mode to system failure rate)? National Institute of Science and Technology, Gaithersburg MD.
www.itl.nist.gov/div898/handbook/apr/section1/apr18.htm. Accessed March 3, 2006.
4. Pearson, D., S. Stein, and J. S. Jones. *HYRISK Methodology and Users Guide*. Report FHWA-RD-02-XXX. Federal Highway Administration, Washington, D.C., 2002.
5. Office of Operations, Federal Highway Administration, U.S. Department of Transportation. ops.fhwa.dot.gov/freight/documents/bts.pdf. Accessed May 26, 2005.
6. Moulton, L. K., H. V. S. GangaRao, and G. T. Halvorsen. *Tolerable Movement Criteria for Highway Bridges*. Report FHWA-RD-85-107. Federal Highway Administration, Washington, D. C., 1985.
7. Webb, D. J., N. L. Anderson, T. Newton, S. Cardimona, and A. Ismail. Ground penetrating radar (GPR): a tool for monitoring bridge scour. In *Application of innovative non-destructive methods to geotechnical and environmental investigation*, (C. Anderson, and Newton, ed.). Report RDT-03-008. Missouri Department of Transportation, Rolla MO, April, 2003, pp. C1-C22.
8. Lagasse, P. F., L. W. Zevenbergen, J. D. Schall, and P. E. Clopper. *Bridge Scour and Stream Instability Countermeasures*, 2nd ed. Hydraulic Engineering Circular No. 23,

- FHWA NHI 01-003. U.S. Department of Transportation, Washington D.C., March 01, 2001.
9. Central Federal Lands Highway Division. *Application of Geophysical Methods to Highway Related Problems*. Federal Highway Administration, Washington, D.C., September 2003. www.cflhd.gov/geotechnical/. Accessed January 30, 2006.
 10. Olson, L. D., F. Jalinoos, and M. F. Aouad. *NCHRP Final Report 21-5: Determination of Unknown Subsurface Bridge Foundations*. Federal Highway Administration, Washington D.C., August, 1995.
 11. Olson, L. D., and M. F. Aouad. *NCHRP Final Report 21-5 (2): Unknown Subsurface Bridge Foundation Testing*. Federal Highway Administration, Washington, D.C., June, 2001.
 12. Mason, R. R. Jr. and D. M Sheppard. Field Performance of an Acoustic Scour-Depth Monitoring System. *Fundamentals and Advancements in Hydraulic Measurements and Experimentation Conference*, Buffalo NY, August 1-5, 1994, pp. 366-375.
 13. Hunt, B. E. and G. R. Price. Scour Monitoring – Lessons Learned. Keynote Paper in *Second International Conference on SCOUR and EROSION ICSE-2*. Singapore, November 14-17, 2004.
 14. Haas, C., J. Weissmann, and T. Groll. Remote Bridge Scour Monitoring: A Prioritization and Implementation Guideline. Research Report 3970-1. University of Texas, San Antonio TX, 1999.
 15. Schall, J. D., and G. R. Price. *NCHRP Report 515: Portable Scour Monitoring Equipment*. TRB, Washington, D.C., 2004.

16. Kuennen, T. America's Quest for Premium Aggregates. Better Roads. James Information Media Inc., Des Plaines IA, 2004.
www.betterroads.com/articles/aug04a.htm. Accessed March 5, 2006.

APPENDICES

TABLE OF CONTENTS

Appendix A. Risk-Based Methodologies.....	1
HYRISK.....	1
HYRISK Countermeasures Economic Calculator.....	6
Probabilistic Assessment/Geotechnical/Geologic Materials.....	12
Risk-Based Cost-Benefit Assessment/Prioritizing Methods.....	13
Risk-based Design Methods.....	14
Evaluation of Epistemic Uncertainty.....	16
References.....	17
Appendix B. Specific Documents of Special Interest.....	19
Plan of Action for Scour Critical Bridges.....	19
Scour Critical Bridges: High-Flow Monitoring and Emergency Procedures.....	23
Scour and Flood Risk at Railway Structures.....	24
Scour Susceptible Bridge Screening Program.....	33
Price Elasticity of Demand.....	33
References.....	37
Appendix C. Survey Results.....	39
Level 1 Survey.....	39
Level 2a Survey.....	51
Level 2b Survey.....	54
Meeting with MD State Highway Administration (MSHA), February 09, 2005.....	60
Meeting with VDOT on March 09, 2005.....	62
Additional Telephone Conversations with State DOT Officials.....	64
Specific Survey: Traffic Characteristics versus Rebuilding Time.....	67
Scour-Related Bridge Failure Databases.....	80
Other Scour-Related Information.....	91
Management-Related Information.....	99
References.....	102
Appendix D. Annual Probability of Scour Failure and Minimum Performance Levels.....	103
HYRISK Probability Adjustments.....	103
Minimum Performance Levels.....	108
Appendix E. Non-Destructive Evaluation.....	112
Introduction.....	112
Surface NDE Methods.....	113
Borehole NDE Methods.....	117
Selection of NDE Methods for Unknown Bridge Foundation Depths.....	122
Effectiveness of NDE Methods.....	122
NDE Conclusions.....	125
References.....	125
Appendix F. Scour Management Case Studies.....	126
The Initial Bridge Survey.....	126
Case Study Evaluations and Responses.....	131
California Bridges.....	132
Florida Bridges.....	169
New York Bridges.....	205
North Carolina Bridges.....	242
Tennessee Bridges.....	277
Texas Bridges.....	319

Appendix G. Scour Evaluation Forms and Tables.....	359
Data Collection.....	359
Scour Risk Probability Tables	363
Minimum Performance Levels	364

LIST OF FIGURES

Figure 1 Flowchart for HYRISK methodology.....	1
Figure 2 Probability of failure versus expected life.....	7
Figure 3 Economic benefit of protection versus countermeasure protection levels.....	8
Figure 4 Minimum reasonable expenditure for countermeasure	11
Figure 5 Maximum benefit from expenditure on countermeasure.....	11
Figure 6 Maximum benefit/cost from expenditure on countermeasure	12
Figure 7 Scaling and adjustment of the HYRISK annual probability of failure table	106
Figure 8 Final annual probability of failure estimates	107
Figure 9 Minimum performance levels for each functional classification.....	110
Figure 10 Annual probability of failure and minimum performance levels	111
Figure 11 Surface echo tests	114
Figure 12 Bending waves method	115
Figure 13 Ultraseismic testing method.....	116
Figure 14 Spectral analysis of surface waves test.....	117
Figure 15 Parallel seismic method	118
Figure 16 Induction field method	119
Figure 17 Borehole radar method.....	120
Figure 18 Crosshole tomography method	121

LIST OF TABLES

Table 1 Probability of Scour Failure Using NBI Data	4
Table 2 Scour Vulnerability versus NBI Items 60 and 61	5
Table 3 Bridge Overtopping Frequency versus NBI Items 26 and 61.....	5
Table 4 Example Benefit/Cost Analysis of Scour Countermeasures	9
Table 5 Sample Input Table for Countermeasures Costs	10
Table 6 Assumed Number of Lives Lost in Bridge Failure.....	21
Table 7 Categories and Priorities Based on Priority Rating.....	26
Table 8 Elasticity of Various Measures of Travel Demand.....	35
Table 9 Elasticities Used To Determine Travel Demand for Bridge Detours.....	37
Table 10 Level 1 Survey Respondents.....	39
Table 11 Tabulation of Responses to Importance of Rebuild Time Factors	69
Table 12 Tabulation of Responses to Weights of Rebuild Time Factors	70
Table 13 Summary of state records regarding scour failures at bridges.....	81
Table 14 Minimum Performance Levels for Bridges	108
Table 15 Effectiveness of NDT Methods	123
Table 16 Case Study Respondents.....	126
Table 17 Bridge Case Study Comparison.....	239
Table 18 Overtopping Frequency	363
Table 19 Scour Vulnerability.....	363
Table 20 Annual Probability of Scour Failure	364
Table 21 Minimum Performance Levels	364

APPENDIX A. RISK-BASED METHODOLOGIES

During the review of available literature, several risk-based methodologies were encountered, some of which may be useful in development of guidelines for managing bridges with unknown foundations. The following subsections discuss a variety of methods that have been proposed or used to assess risk.

HYRISK

The HYRISK methodology estimates the risk of scour failure using pertinent items from the National Bridge Inventory (NBI) database, namely as the product of the probability of scour failure and the economic consequence associated with scour failure. A general flow chart for the methodology is presented in Figure 1.

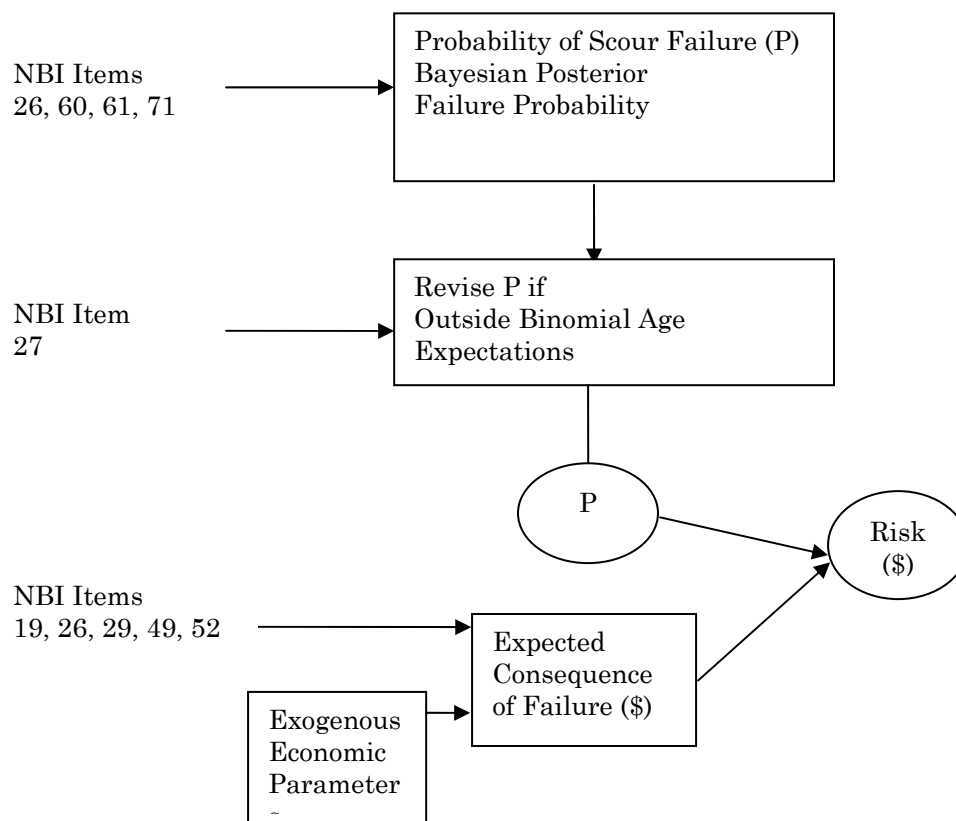

Figure 1 Flowchart for HYRISK methodology

The original HYRISK equation is presented below.

$$Risk = KP \left\{ C_1 WL + C_2 DAd + \left[C_3 O \left(1 - \frac{T}{100} \right) + C_4 \frac{T}{100} \right] \frac{DAd}{S} \right\}$$

where:

Risk = risk of scour failure (\$/year),

K = risk adjustment factor based on foundation type and type of span based on NBI items and where available from more developed databases, foundation information,

P = probability of failure based on NBI items 26, 60, 61, 71, and 113

*C*₁ = unit rebuilding cost (\$/ft²),

W = bridge width from NBI item 52 (ft),

L = bridge length from NBI item 49 (ft),

*C*₂ = cost of running vehicle (\$0.25/mi),

D = detour length from NBI item 19 (mi),

A = average daily traffic (ADT) from NBI item 29,

d = duration of detour based on ADT from NBI item 29 (days),

*C*₃ = value of time per adult in passenger car, (\$7.05/h in 1991),

O = average occupancy rate (1.56 adults),

T = average daily truck traffic (ADTT) from NBI item 109 (% of ADT),

*C*₄ = value of time for truck (\$20.56/h in 1991), and

S = average detour speed (40 mi/h).

The risk adjustment factor, *K*, permits downward risk adjustments based upon knowledge of the structural and/or foundation design. The equation is given below.

$$K = K_1 K_2$$

In this equation K_1 is a bridge type factor based on NBI data, and K_2 is a foundation type factor based on information, which may be obtained from State inventories but not in the NBI.

The values presently recommended for K_1 are 1.0 for simple spans and 0.67 for rigid continuous spans with lengths in excess of 100 ft. This factor adjusts to reflect the benefit of structural continuity which can compensate for loss of intermediate supports. The factors are subjective, based on a limited delpic survey and data developed in FHWA RD-85-107, *Tolerable Movement Criteria for Highway Bridges (1)*. The influence of actual rigidity, type of structure, etc., has significant effects on the tolerable movement criteria, which may be defined as an increase in maximum stress to a point below yield, therefore precluding the collapse case.

The values recommended for K_2 , given below, should be developed for both abutment and pier condition, selecting the largest value for the analysis.

- 1.0 for unknown foundations or spread footings on erodible soil above scour depth with pier footing top visible or 1- to 2 ft below stream bed
- 0.8 for pile foundations when length is unknown, are less than 19 ft, or are all-wood pile foundations
- 0.2 for foundations on massive rock

These factors are again subjective and should be revised or adjusted using local experience or further forensic studies. It should be noted that even structures supported by massive rock foundations may still incur damage due to inadequate waterway openings or other causes. Therefore, the risk adjustment factor cannot by definition be zero in a dollar-based risk analysis.

The probability of scour failure is estimated using Table 1 in one of two ways, depending on the code recorded for the bridge in NBI field 113. If the NBI field 113 ranges

from 0–9, then this code is used for the scour vulnerability in Table 1. However, if NBI field 113 is coded as “U” (unknown foundation), “T” (tidal), or even “6” (no scour evaluation), a scour vulnerability may be estimated using Table 2 using NBI items 60 (substructure condition) and 61 (channel and channel protection). Similarly, the overtopping frequency in Table 1 is obtained from Table 3 using NBI items 26 (functional class) and 71 (waterway adequacy).

Table 1 was originally developed by three experts in bridge scour and occurrence, namely Jorge Pagan, Philip Thompson, and J. Sterling Jones of the Federal Highway Administration’s Turner-Fairbank Highway Research Center in McLean, VA. The Idaho Department of Transportation reviewed this methodology and concluded that the annual probabilities of failure in this table are too large, but that the relative patterns are useful for ranking the vulnerability of bridges with unknown foundations.

Table 1 Probability of Scour Failure Using NBI Data

Scour Vulnerability <i>(Use NBI Item 113 code or Table 2)</i>	Overtopping Frequency <i>(Use Table 3)</i>			
	<i>Remote</i>	<i>Slight</i>	<i>Occasional</i>	<i>Frequent</i>
<i>(0) Failed</i>	1	1	1	1
<i>(1) Imminent failure</i>	1	1	1	1
<i>(2) Critical scour</i>	0.4567	0.4831	0.628	0.7255
<i>(3) Serious scour</i>	0.2483	0.2673	0.3983	0.4951
<i>(4) Advanced scour</i>	0.1266	0.1373	0.2277	0.2977
<i>(5) Minor scour</i>	0.00522	0.00648	0.0314	0.05744
<i>(6) Minor deterioration</i>	0.18745	0.2023	0.313	0.3964
<i>(7) Good condition</i>	0.18745	0.2023	0.313	0.3964
<i>(8) Very good condition</i>	0.00312	0.00368	0.0144	0.02784
<i>(9) Excellent condition</i>	0.00208	0.00216	0.0036	0.006

Table 2 Scour Vulnerability versus NBI Items 60 and 61

	Substructure Condition (NBI Item 60)										
	(0) Failed	(1) Imminent Failure	(2) Critical Scour	(3) Serious Scour	(4) Advanced Scour	(5) Minor Scour	(6) Minor Deterioration	(7) Good Condition	(8) Very Good Condition	(9) Excellent Condition	(N) Not Applicable
Channel Protection (NBI Item 61)	0	0	0	0	0	0	0	0	0	0	0
Failure (1)	0	1	1	1	1	1	1	1	1	1	N
Near Collapse (2)	0	1	2	2	2	2	2	2	2	2	N
Channel Migration (3)	0	1	2	2	3	4	4	4	4	4	N
Undermined Bank (4)	0	1	2	3	4	4	5	5	6	6	N
Eroded Bank (5)	0	1	2	3	4	5	5	6	7	7	N
Bed Movement (6)	0	1	2	3	4	5	6	6	7	7	N
Minor Drift (7)	0	1	2	3	4	6	6	7	7	8	N
Stable Condition (8)	0	1	2	3	4	6	7	7	8	8	N
No Deficiencies (9)	0	1	2	3	4	7	7	8	8	9	N
Not Over Water (N)	0	1	N	N	N	N	N	N	N	N	N

Table 3 Bridge Overtopping Frequency versus NBI Items 26 and 61

Functional Class (NBI Item 26)	Waterway Adequacy (NBI Item 71 code)											
	(0)	(1)	(2)	(3)	(4)	(5)	(6)	(7)	(8)	(9)	(N)	
<i>Principal arterials, interstates (01, 11)</i>			O	O	O	O	S	S	S	R	N	
<i>Freeways, expressways (12)</i>	Bridge closed	Unused										
<i>Other principal arterials (02, 14)</i>			F	O	O	O	S	S	S	R	N	
<i>Minor arterials (06, 16)</i>												
<i>Major collectors (07, 17)</i>												
<i>Minor collectors (08)</i>												
<i>Locals (09, 19)</i>			F	F	O	O	O	S	S	R	N	
Overtopping Frequency	Annual Probability			Return Period (years)								
Never (N)	0			never								
Remote (R)	0.01			>100								
Slight (S)	0.02			11 to 100								
Occasional (O)	0.2			3 to 10								
Frequent (F)	0.5			<3								

The HYRISK methodology was originally used to prioritize bridges with unknown foundations for foundation investigation through the ranking of relative risk. These risks are based on the following:

- Data readily available in the National Bridge Inventory (NBI)
- Basic economic assumptions
- The assumption that unknown foundations are generally poor (shallow or susceptible to scour)

HYRISK Countermeasures Economic Calculator

The HYRISK model proves useful in answering the question it was originally concerned with: Without extensive additional and bridge-specific data gathering, which bridges represent the greatest annual expected loss due to failure or heavy damage due to scour? Risk rankings produced by the model, however, are not intended to be used to place hard actual monetary values on losses; nor were they intended to be used as direct guidance to bridge owners to answer the current question: How much is reasonable to spend on scour countermeasures to protect a bridge with a known, finite life before scheduled replacement?

To begin answering this question, the probability of failure during the life expectancy of the bridge must be calculable. The lifetime probability of failure (P_L) is related to the annual probability of failure (P_A) in the following way:

$$P_L = 1 - (1 - P_A)^L.$$

Rearranging this equation yields the expected life of the bridge (L) as follows:

$$L = \frac{\log(1 - P_L)}{\log(1 - P_A)}.$$

The modeler should use the first equation above if the probability of failure at a specific point in time (such as with a scheduled bridge replacement) is desired. However, the second equation should be used if the modeler wishes to determine the bridge's expected life given an acceptable probability of failure while the bridge remains in service. Modelers

are encouraged to adjust P_A based on what may be known about the specific bridge being investigated.

As an example, if scour analysis indicates that a bridge will fail during a 20-year return period flood, P_A should be set to 0.05. For such a bridge, the graph shown in Figure 2 gives the probability of failure in any year between the present and 100 years hence.

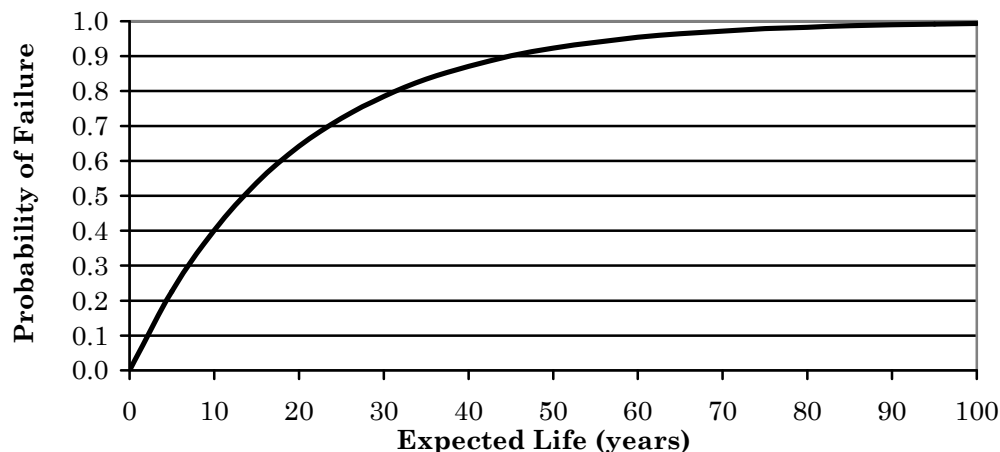

Figure 2 Probability of failure versus expected life

Lacking specific data about the costs associated with bridge failure, the modeler may use the values calculated by HYRISK. However, if better numbers are available, they should be used to obtain a tailored risk value. The extension of HYRISK allows for an additional cost lacking in the original HYRISK calculations – that associated with injury or loss of life. Using these, the cost of bridge failure may be calculated as follows.

$$R = C_F P_L$$

In this equation R is the risk (value of expected loss) due to failure and C_F is the cost of failure, including injury and loss of life.

A reasonable measure of resources appropriate for protection of a particular bridge is the present benefit value of any countermeasure contemplated. This value may be calculated using the following equation.

$$B = C_F (P_L - P_L')$$

In this equation B is the present value benefit and P_L' is the probability of failure over the expected life of the protected bridge.

This relationship may be used to explore the range of economic benefits offered by providing various levels of protection at the bridge site. Consider a bridge with a cost of failure of \$1,000,000 and, without countermeasures, the bridge has an annual probability of failure of 0.05 and a lifetime probability of failure of 0.51 over an expected life of 14 years. For this bridge, the benefit of countermeasures calculated using the previous equation for protection up to 100 years is shown in Figure 3.

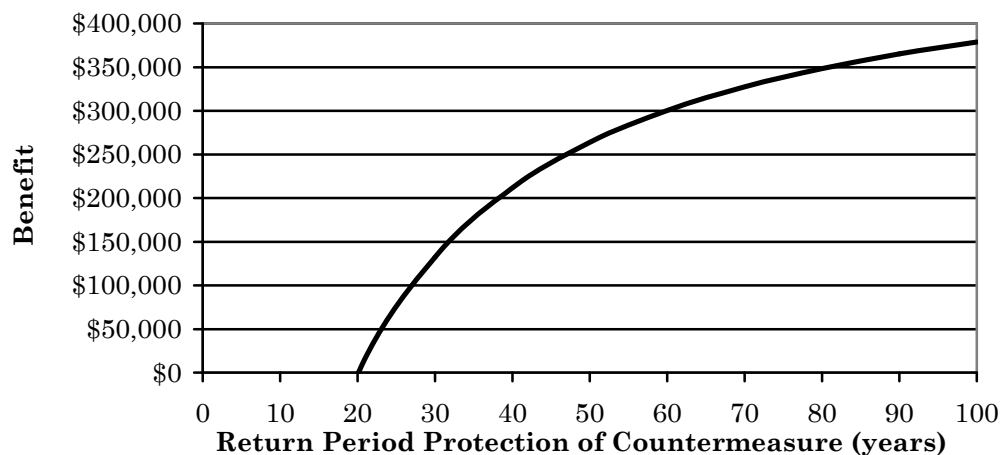

Figure 3 Economic benefit of protection versus countermeasure protection levels

The benefits calculated above, however, ignore the costs of implementing the countermeasures. To decide on a particular countermeasure appropriate for the bridge, these costs must be included. This can be done using a simple benefit-to-cost ratio or net benefit analysis for candidate countermeasures. Consider three countermeasures which might be feasibly employed at the bridge site shown in Table 4.

Table 4 Example Benefit/Cost Analysis of Scour Countermeasures

Countermeasure	Cost	Return Period Protection (yrs)	P_L'	Net Benefit	Benefit/Cost Ratio
Small Riprap	\$125,000	25	0.435	-\$50,327	0.60
Large Riprap	\$175,000	50	0.246	\$88,642	1.51
Grout Mats	\$275,000	100	0.131	\$103,746	1.38

Bridge owners may use this information to make a better-informed decision about which form of protection provides economic value while accounting for the expected (or desired) service life of the structure.

The basic question can now be addressed: how much money should be spent on a bridge with a limited remaining service life to reduce the risks associated with major damage or failure. Three determinations may be made, as follows.

1. The minimum design return interval to balance costs of countermeasures with risks
2. The countermeasure design return interval that will yield the greatest net cost benefit
3. The return interval that will yield the maximum benefit/cost ratio

It is envisioned that scour countermeasures would not be a consideration unless at least some elements of the bridge are scour critical. It is further envisioned that one would have access to a scour evaluation in order to determine the return interval that would cause failure or major expected damage if no countermeasures are provided. Further it is required that countermeasure costs can be assigned for protection to various levels of flooding above that return interval. A single bridge risk analysis is dependent on cost data associated with various probabilities of failure or major damage levels and it is reasonable that these costs should be provided by the designer as input to the model. Countermeasure costs are unique for each bridge.

A designer may have several countermeasure alternatives available. It is also reasonable to assume that one alternative will be either preferable for some non-economic cause or be the most cost effective for a given flood level. This alternative may then be selected, and its cost used. For example, the designer may choose small riprap for lower level flooding with lower velocities, choose a larger class riprap for intermediate flood levels, and choose cable-tied block or another alternative for high flood levels because the next size riprap may be unavailable or prohibitively expensive. A sample input table for countermeasure costs is illustrated in Table 5.

Table 5 Sample Input Table for Countermeasures Costs

Return Interval (yrs)	Design Velocity (m/s)	Type of Countermeasure	Cost	Comment
20	2.5	none	\$0	Failure R.I. with no protection
25	2.75	Class I riprap	\$50,000	
50	3.0	Class II riprap	\$75,000	
75	3.2	Class II riprap	\$75,000	
100	3.4	Class III riprap	\$100,000	
200	3.7	Cable-tied blocks	\$175,000	

The lower level of protection that should be considered can be visualized by plotting the annual risk costs and the annual cost of providing protection against return interval as illustrated in Figure 4. The lines may be quite irregular but they cross where the risks balance the costs of providing protection. If budget conditions allow for a higher level of protection the designer could either maximize the net benefit or the cost-benefit ratio. The net benefit, as illustrated in Figure 5, is the decrease in risk costs (over providing no protection) less the cost of the countermeasure. The cost-benefit ratio, as illustrated in Figure 6, is the net benefit divided by the cost of the countermeasure.

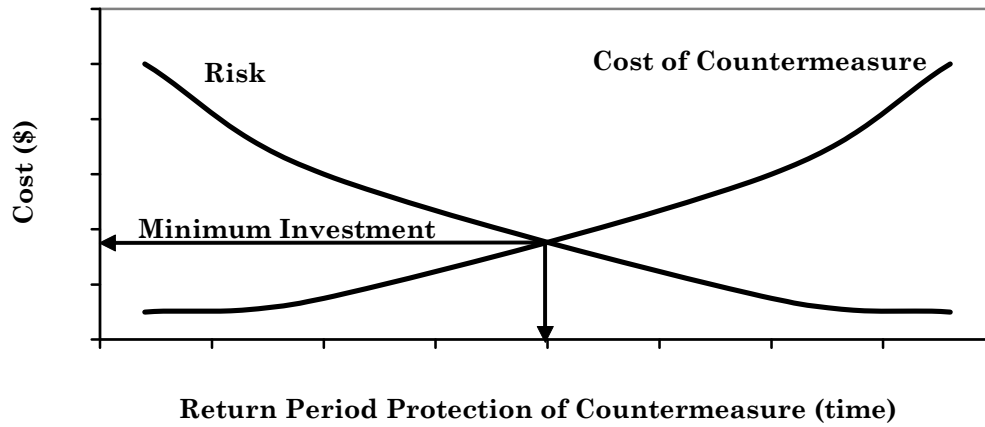

Figure 4 Minimum reasonable expenditure for countermeasure

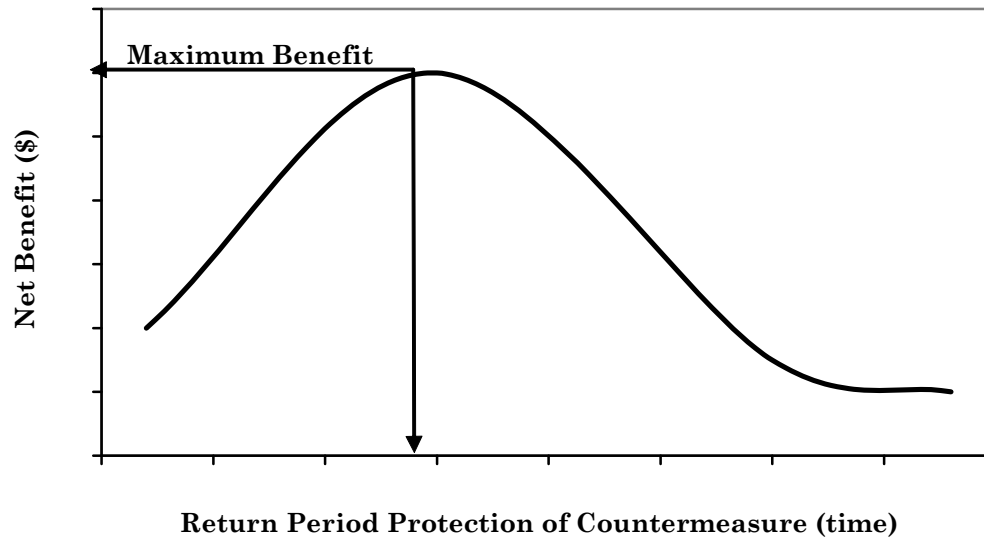

Figure 5 Maximum benefit from expenditure on countermeasure

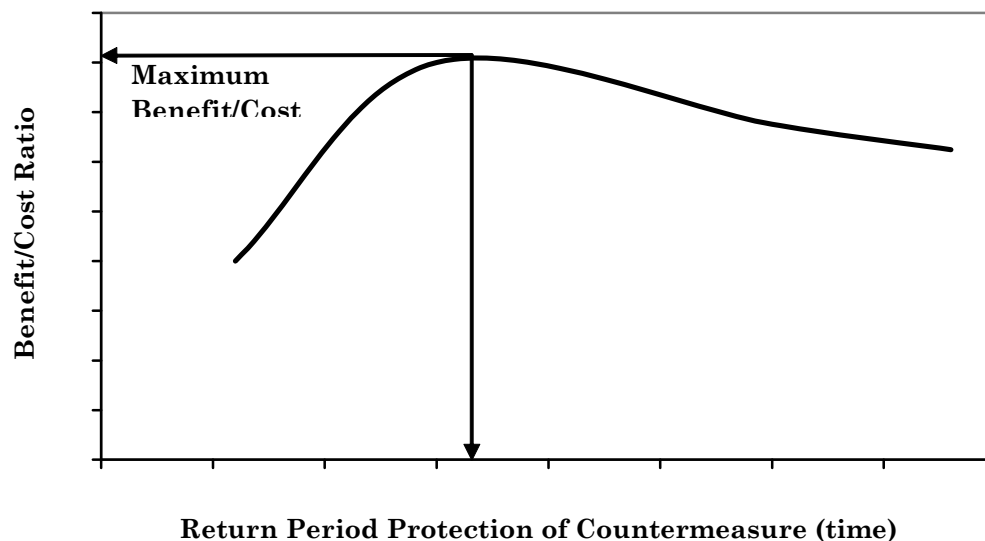

Figure 6 Maximum benefit/cost from expenditure on countermeasure

Probabilistic Assessment/Geotechnical/Geologic Materials

One focus of the literature search was to identify work that has used probabilistic methods to estimate the probability distribution of a particular parameter (e.g. material property) or the likelihood of performance of geologic or geotechnical materials. The objective was to identify applications in which probabilistic methods have been used where there has been a strong reliance on qualitative information, where engineering or scientific inferences may be necessary. The nature of problems of this type necessarily involves the use of professionals to evaluate and interpret available information (i.e. make subjective assessments or elicit expert opinion).

The literature search identified a number of papers in which probabilistic methods have been used to evaluate geotechnical and geologic problems. None these methods or applications were applicable to our problem, but a summary of them is presented as follows.

A number of cases were identified in which subjective assessments were used to evaluate geotechnical structures. McCann et al. (2) applied a Bayesian approach to update the frequency of failure of dams based on observed conditions obtained during periodic

(visual) dam safety inspections. This approach uses updated likelihood estimates based on professional interpretation of the severity of observed conditions at a dam and the degree to which these conditions are a precursor to failure. The Bayesian approach they proposed allows them to consider the relative likelihood that observed/known conditions are consistent with projects that have failed in the past, as opposed to cases in which those same conditions have been observed at projects that have performed well.

Anderson et al. (3) applied a condition indexing method to develop a risk index or prioritization scheme for embankment dams. The input for the risk index is obtained from visual inspections of dams. This method is based on subjective observations: a dam's hazard potential, the relative importance of potentially deficient elements of a dam, and the severity of the element's deficiency. The U.S. Army Corps of Engineers has developed and applied condition index systems for a number of different structure types, including gates and concrete structures.

Johnson and Niezgodna (4) applied a failure modes and effects analysis method and subjective evaluation scales (a so-called risk-based approach) to determine risk priority numbers for bridge countermeasures. This method determines a risk priority number based on subjective assessments of consequence, likelihood of occurrence, and detection. The methodology relies on rating scales developed by the authors.

Risk-Based Cost-Benefit Assessment/Prioritizing Methods

Methods that involve subjective evaluations of dams, as previously described, have also been used to prioritize bridges – for example Anderson et al. (3). This section summarizes some of the literature with respect to more quantitative evaluations in which risk-based cost-benefit approaches have been used to prioritize projects or actions.

There are many examples of risk-based cost-benefit analyses and prioritization methods in available literature. The following is a brief summary of the work that was reviewed. Examples of application range from water resources and seismic engineering – as documented by Baecher et al. (5), Bowles (6), Kunreuther et al. (7), and McCann et al. (2) – to chemical and nuclear power industries – as documented by Postle (8). This range of application varies in a number of respects. The following gives a few examples of the different contexts in which risk-based cost-benefit assessments have been used.

- Prioritization schemes that rank or order projects in a jurisdiction (i.e., a single owner or regulatory agency) as documented by McCann et al. (2) and Bohnenblust and Vanmarke (9)
- Risk reduction benefits and project costs, as documented by Baecher et al. (5), McCann et al. (2), and Bowles (6)
- Evaluation of facilities that fail to satisfy required performance goals and must be upgraded (a preferred project remediation alternative must be selected)

There appears to be a growing recognition in the literature of the importance of epistemic uncertainties (i.e. knowledge-based uncertainties) associated with conducting risk-based cost-benefit assessments. Postle (8) indicates it is important that these uncertainties be considered in the context of these evaluations. As we have discussed in our proposal, it is important to identify and carry these uncertainties through our analysis.

Risk-based Design Methods

A search was performed to identify applications in which risk-based criteria have been used to establish design requirements for civil systems. These examples include:

- Department of Energy (DOE; 10) design criteria for natural phenomena hazards

- U.S. Nuclear Regulatory Commission (11) criteria for establishing the seismic design requirements for new commercial nuclear power plants

The DOE has developed design requirements for seismic, wind and flood phenomena in which explicit performance goals and acceptable probabilities for unsatisfactory performance have been established. Simply stated, the design requirements are divided into the following parts.

- Specified Performance Level – The physical capability or functional performance that should be maintained by a structure, system or component (e.g., maintain confinement of hazardous materials)
- Acceptable Probability of Unsatisfactory Performance – This is the acceptable probability that a structure, system or component will fail to perform its specified performance level
- Risk Reduction – Based on the design of structures, systems and components (e.g., safety factors, design margins) there is a risk reduction that is achieved, such that the probability of failure at the design basis load is low and the overall probability of unacceptable performance is less than the Hazard Design Probability of Exceedance (see below).
- Hazard Design Probability of Exceedance – This is the annual probability that the design force/load will be exceeded. The hazard design probability of exceedance is established such that, when combined with the risk reduction, the acceptable probability of unsatisfactory of performance is achieved

Due to the variety of facilities that DOE owns, a series of facility categories are defined. These categories are defined in terms of the hazard a facility poses in the event of failure. Categories range from warehouse and administration buildings to nuclear reactors.

For each category a performance level (i.e., life safety, confinement of hazard materials, etc.), risk reduction and acceptable probability of unsatisfactory performance are defined.

The U.S. Nuclear Regulatory Commission recently changed the way in which the seismic design basis for commercial nuclear power plants is determined. While the commission has not set a risk-based standard like the DOE did, it has the same basic approach. The commission stated that the current population of nuclear power plants is safe (i.e. their risk of failure in general, and with respect to seismic events in particular, is acceptable). With this starting point and the benefit of probabilistic seismic hazard assessments for existing plants, they determined the hazard probability for several seismic motions that are considered in design. With well-defined seismic design standards for structures and equipment that require adequate seismic margins, there is a significant risk reduction in nuclear power plant designs. This risk reduction coupled with the hazard design probability level results in a low probability of plant failure due to seismic events.

Evaluation of Epistemic Uncertainty

This part of the literature review focuses on epistemic uncertainties that are evaluated in the context of subjective assessments. There are a number of papers, books and reports that discuss the evaluation of epistemic uncertainties that must be evaluated on the basis of professional assessments (also referred to as expert elicitations or subjective evaluations). Examples include Budnitz et al. (12), Baecher and Christian (13), EPRI (14), and Vick (15).

The evaluation of epistemic uncertainties involves a number of subjects. These include the selection of experts, the elicitation process (e.g. interaction with experts, how information is elicited, and feedback), epistemic uncertainty model building (identification and representation of uncertainties), and quantification.

The report by Budnitz et al. (12) discusses alternative levels of expert elicitation in the seismic hazard area (i.e. geology and seismology). This report describes an approach for conducting expert elicitations when engineering and scientific interpretations/inferences are necessary to assess model parameters and different interpretations of available information.

References

1. Moulton, L. K., H. V. S. GangaRao, and G. T. Halvorsen. Tolerable Movement Criteria for Highway Bridges. Report FHWA-RD-85-107. Federal Highway Administration, Washington, D. C., 1985.
2. McCann, M. W. Jr., J. B. Franzini, E. Kavazanjian, and H. C. Shah. Preliminary Safety Evaluation of Existing Dams. Report No. 69. John A. Blume Earthquake Engineering Center, Stanford University, Vol 1-2, 1985.
3. Andersen, G. R., C. W. Cox, L. E. Chouinard, and W. H. Hover. Prioritization of Ten Embankment Dams According to Physical Deficiencies. American Society of Civil Engineers, *Journal of Geotechnical & Geoenvironmental Engineering*, 2001, pp. 335-345.
4. Johnson, P. A. and S. L. Niezgoda. Risk-Based Method for Selecting Bridge Scour Countermeasures. American Society of Civil Engineers, *Journal of Hydraulic Engineering*, Vol. 130, No. 2, February 2004, pp. 121-128.
5. Baecher, G. B., E. M. Pate and R. de Neufville. Risk of Dam Failure in Benefit/Cost Analysis. *Water Resources Research*, Vol. 16, No. 3, 1979, pp. 449-456.
6. Bowles, D. S. Advances in the Practice and Use of Portfolio Risk Assessment. In *Proceedings of the Australian Committee on Large Dams Annual Meeting*, Cairns, Queensland, Australia, 2000.

7. Kunreuther, K., C. Cyr, P. Grossi, and W. Tao. Using Cost-Benefit Analysis to Evaluate Mitigation for Lifeline Systems. University of Pennsylvania, Pittsburg PA, 2004.
8. Postle M. Cost-Benefit Analysis and Chemical Risk Management. ICME, Ottawa Canada, 1997.
9. Bohnenblust, H., and E. H. Vanmarcke. *Research Report R82-12: Decision Analysis for Prioritizing Dams for Remedial Measures: A Case Study*. Department of Civil Engineering, Massachusetts Institute of Technology, Cambridge MA, 1982.
10. *DOE Standard 1020: Natural Phenomena Hazards Design and Evaluation Criteria for Department of Energy Facilities*. U.S. Department of Energy, Washington, D.C., 2002.
11. *Regulatory Guide 1.165: Identification and Characterization of Seismic Sources and Determination of Safe Shutdown Earthquake Ground Motion*. U.S. Nuclear Regulatory Commission, Washington, D.C., 1997.
12. Budnitz, R. J., G. Apostolakis, D. M. Boore, L.S. Cluff, K. J. Coppersmith, C. A. Cornell, P. A. Morris. Recommendations for probabilistic seismic hazard analysis: Guidance on uncertainty and use of experts. NUREG/CR 6372 Vol. 1, UCRL ID 122160. Senior Seismic Hazard Analysis Committee, U.S. Department of Energy, Washington, D.C., 1997.
13. Baecher, G. B., and J. T. Christian. Reliability and Statistics in Geotechnical Engineering, John Wiley & Sons, Ltd, 2003.
14. *Report NP-4726: Seismic Hazard Methodology for the Central and Eastern United States*. EPRI , Palo Alto CA, 1986.
15. Vick, S. G. Degrees of Belief: Subjective Probability and Engineering Judgment. American Society of Civil Engineers, Reston VA, 2002.

APPENDIX B. SPECIFIC DOCUMENTS OF SPECIAL INTEREST

The literature review for this report also yielded several documents of particular interest to the current research. The following summarizes the pertinent information from each document.

Plan of Action for Scour Critical Bridges

In this Idaho DOT report (*I*) scour critical bridges are subdivided into four categories based on lifetime risk and annual probability of failure. The risk and probability of failure are calculated using HYRISK. Each category corresponds to a recommended minimum response level as described below.

- **Category A (Vital Scour Critical Bridges)** Lifetime risk of failure for these bridges exceeds \$5,000,000. This lifetime risk cutoff value was set in consultation with the ITD Scour Committee. Plan of action for Category A includes:
 - A full Plan of Action including both monitoring and countermeasures should be developed and implemented in a timely manner.
 - Before scour countermeasures are installed, each Category A bridge should be treated as a Category B, C, or D bridge, depending on the annual probability of failure and the structural features of the bridge.
 - An extensive bridge closure plan has to be developed.
- **Category B (Extreme Scour Critical Bridges)** The lifetime risk is less than \$5,000,000, but the calculated annual probability of failure equals or exceeds 10 percent. Plan of action for Category B includes:
 - Bridges should be closed under high-flow conditions.

- A closure plan should be developed and implemented detailing closure trigger events, closure methods, a recommended detour route, and contact information for the District Engineer and traffic enforcement personnel.
 - Once a bridge is closed due to high flow, it should be inspected for stability prior to reopening the bridge to traffic.
 - Hydraulic and structural countermeasures should be incorporated in the case of frequent bridge closures.
- **Category C (Severe Scour Critical Bridges)** The lifetime risk is less than \$5,000,000. The annual probability of failure is between 1 and 10 percent, or less than 1 percent, but the bridge is founded on spread footings. Plan of action for Category C includes:
- Develop bridge monitoring (detailed in the report) and closure plan
 - Structural, monitoring, and hydraulic countermeasures may be developed for each bridge as funding allows.
 - Category C bridges should be treated as Category B bridges until a monitoring plan has been developed and implemented.
- **Category D (Moderate Scour Critical Bridges)** The annual probability of failure is less than 1 percent and driven pile foundation. Plan of action for Category D includes:
- Develop bridge monitoring and closure plan.
 - Bridges should be closed if distress is observed under high flow conditions.

The assumed cost per fatality is \$500,000. This value assignment is obviously subjective and could vary more considerably based on both economic and sociological factors. The number of lives lost is assumed to vary depending on the ADT and functional

classification (see Table 6). High-ADT crossings, interstates and principal arterials are assumed to have more potential fatalities.

Table 6 Assumed Number of Lives Lost in Bridge Failure

Number of Lives Lost	Average Daily Traffic (ADT)
0	ADT < 100
1	100 < ADT < 500
2	500 < ADT < 1000
2	1000 < ADT < 5000
5	ADT > 5000 (Not an interstate or arterial)
10	ADT > 5000 (interstate or arterial)

Unknown foundation bridges should be prioritized for further action based on lifetime risk. The bridge owner should make every attempt to determine the foundation type and depth. Once the foundation has been determined, a scour evaluation should be performed to determine whether the bridge is scour critical. Until the foundation is determined and scour depths are known, a monitoring plan with closure protocols should be implemented.

Routine biennial inspections and post-flood inspections should include stream cross sections along the bridge faces and local scour depth measurements at the ends of the piers, and at the four corners of each abutment (two wingwall ends plus the two inside corners). These measurements will be taken using portable monitoring instruments such as probes, portable sonar, etc.

Monitoring during high flows is a critical activity for bridges that could be destroyed or substantially damaged by a single flood. The crew performing high-flow monitoring should be focused on looking for indicators that the bridge is at imminent risk of failure.

All scour-critical bridges should be evaluated for signs of bridge distress. Such signs would include the following.

- Overtopping of the bridge deck or approach roadway
- Pressure flow at the bridge (the low chord mostly or fully submerged)

- Vertical or lateral displacement of the superstructure
- Visible damage to the bridge deck, low chord, or substructure
- Sinkholes in the roadway behind the abutments
- Massive debris buildup, especially if near the low chord

If any of these or other qualitative signs of structural distress are apparent at any time, the crew should implement an emergency bridge closure, call for formal or full bridge closure, and should avoid getting on the bridge if at all possible.

Scour Critical Bridges: High-Flow Monitoring and Emergency Procedures

In this Idaho DOT report (2) the following information was considered noteworthy.

- Maximum expected pier scour depth ranges from 2.4 to 3 times the pier width for circular or round-nosed piers aligned with the flow
- Square-nose piers will have a about 20 percent larger maximum scour depth than a sharp-nose pier, or 10 percent larger than a cylindrical or round-nose pier
- Abutment scour will be most severe where the roadway embankment leading up to an abutment obstructs a significant amount of the over-bank flow
- Abutment scour is greater if the abutment (embankment) is skewed in an upstream direction (into the flow)

Scour and Flood Risk at Railway Structures

In this report JBA Consulting (3) conducted a study that examined an existing priority system for evaluating scour potential at railway bridges. The system has been in use in the UK for some time and was reviewed for its effectiveness at assigning high priorities to bridges. The results in the report appear to show that the priority system is effective. After reviewing the system and railway bridge data the study recommended the threshold for assigning a high priority be changed, and showed that a calibrated threshold level would give more bridges a high priority.

The report also addresses a number of topics that go beyond foundation scour at railway bridges. For instance, based on a review of historic incidents, they noted there are several significant modes of failure that contribute to the overall risk of bridge failure, thus putting into context the relative fraction of the time foundation scour occurs. They also discuss issues regarding flood design for railway bridges and acceptable risk. There appears to be no direct link between their priority rating system and acceptable risk. The study looks at priority ratings and flood frequency, which is related but not the same. For example, it is not clear whether a structure that is assigned a high priority (and thus, would require some form of immediate attention) was assessed to determine the prevailing risk or whether it is acceptable or not. This would appear to be an important step with respect to maintaining a balanced safety approach and efficient allocation of resources.

The main focus of the research was on scour failure of railway structures that cross a water course. An old prioritization scheme was modified by factoring in more bridge data. The current British system uses a conservative “Priority Score” to prioritize risk associated with scour. Action will be taken once the score crosses a certain threshold value.

The key issues considered include the following.

- What is a failure?
- How should failure(s) be categorized?
- What indicators can be used to readily identify structures prone to scour damage/failure?
- What are the uncertainties in scour and flood risk identification?
- What is an acceptable ratio of estimated scour depth to estimated foundation depth?

Toward this end, the study did the following:

- Created a database of all points where an existing rail network crossed a water course (8,438 structures including bridges and culverts)
- Evaluated “Priority Rating” (PR), which indicates the degree of risk associated with bridges failure due to scour
- Found that complete data is available for 2,924 out of 8,438 structures
- Verified the accuracy of the data using GIS

This research concentrates on 2,924 structures for which complete information is available. Among 2,924 structures a total of 9,305 bridge supports or elements (an element is an abutment or a pier) have been rated. Classification of 9,305 elements is as follows:

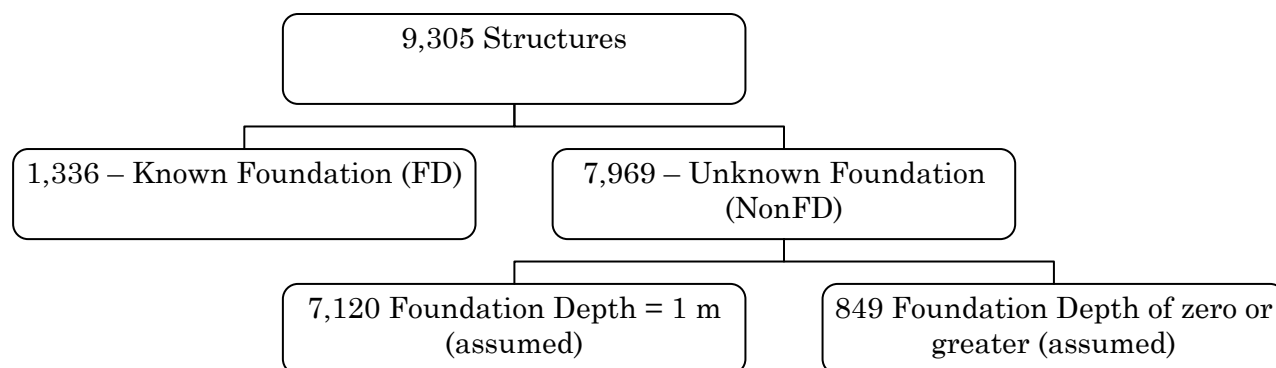

The change of bed depth (total scour) at a bridge structure is assumed to be composed of three components. The first component is Regime or Natural scour (due to

river) (TR); the second component is contraction scour, scour due to watercourse dimensions by the structure; and the third component is local scour, caused by flow discontinuities at the structure. The summation of contraction scour and local scour is termed total scour (TS).

$$\text{Preliminary Priority (PP)} = 15 + \ln (\text{TS}/\text{FD})$$

PP for most bridges is between 10 and 20.

$$\text{Final Priority Rating (PR)} = 15 + \ln (\text{TS}/\text{FD}) + \text{TR} + \text{FM}$$

FM = Foundation material

Table 7 gives categories and priorities based on the final priority rating calculated.

Table 7 Categories and Priorities Based on Priority Rating

Priority Rating	Category	Priority
>17	1	High
16 - <17	2	High
15 - <16	3	Medium
14 - <15	4	Medium
13 - <14	5	Low
<13	6	Low

The distribution of foundation depths measured for 1,336 elements were studied both on linear scale and on logarithmic scales. It is estimated that the mean value for foundation depth is 1.2 m and upper and lower SD values are 2.4 and 0.4 respectively. Hence the default value of 1 m foundation depth is very close to known foundation statistics.

If the foundation depth is not available (from drawings) then usually foundation depth is estimated using coring. This establishes the depth of pile cap or strip/pad foundation and will therefore provide a conservative estimate if the structure is founded on piles or is protected by timber coffer dam.

If the foundation depth is unknown then FM=0

$$\text{Hence PR} = 15 + \ln (\text{TS}/\text{FD}) + \text{TR} \quad (\text{TR ranges from } -1 \text{ to } 0)$$

And $PP = 15 + \ln(TS/FD)$

For fixed TS and $FD = 1m$ study established high priorities for 50.5% of elements using preliminary priorities and high priorities for 26.6% of elements using final priorities.

Some of the event(s) causing the failure:

- Highly localized flashfloods
- Severe storms of moderate spatial extent

The study established a relation between the average return period* of flood and Priority Rating. For example, a rating of 16.5 will fail for a 10-year flood; where as a rating of 14.4 will fail for a 1,000-year flood. The study also considered structural failure of bridges with unknown foundation but did not establish an overall priority number.

The author, Jeremy Benn of JBA Consulting was contacted in order to gather additional information. The paragraphs summarize the questions put to him and his responses.

Question: We are concentrating our research on highway bridges in United States. Do you think your methodology is applicable to this situation (as your methodology primarily concentrates on railway bridges)? For example, the methodology calculates a priority number and this number might be appropriate for US highway bridges where foundation information is available. In the absence of such data, your assumption of a foundation depth of 1 meter may not be appropriate for our study. In other words, the general methodology might be appropriate, but assumptions used to fill in missing data might not be appropriate. Do you have an opinion on this?

Response: There is no fundamental technical reason why the method cannot be used for highways. The UK Department of Transport indeed looked at the method over 10 years ago with a view to adopting it, but for some reason decided to develop its own (an unpublished procedure known as Advice Note D - which has never actually been adopted).

The causes of undermining scour are the same whatever the use of the bridge, namely flood conditions, an erodible material and the presence of bridge supports in a river. The use of the bridge really only has an influence on the consequences of failure and the mitigation options available (for instance it is slightly easier on a railway to close the bridge to traffic if need be).

The assumption of a minimum of 1m foundation depth if no information is available is very much the buck stop. While it may sound arbitrary, the depth was close to the mean of the available coring records (which it should be noted would not have included any pile depth). If there is evidence that piles exist, this minimum depth could be safely increased.

In our research we did ask the question, are there some additional factors unique to railways that may make them more vulnerable to scour? In the UK most of our railway bridges are over 140 years old and were built before methods of steel/deep piling were available. A common construction method was to use timber piles with a timber pile cap on top. However road bridges of the same age were also built this way - so this is an age rather than use issue. However, railways do have two features that do not always occur with road bridges - they cross rivers and floodplains on embankment (and hence there is less potential for overtopping, which increases backwater and hence flow depths during flood) and they are more often skewed relative to the river due to the limited curves allowable on rail track. It is interesting that in the two floods on the Eye Water (1846 and 1948), when all the railway structures collapsed, the 17th century masonry arch road bridge over the same river survived. The only reason we can surmise for this (other than luck!) is that the road approaches were not on embankment and so flood 'relief' was available to the structure by means of flow by-passing the bridge by overtopping the approach road.

In direct answer to your question, I think the method has potential for use in the US - particularly for bridges with piers and where the risk is undermining scour. The current

work we are undertaking for the RSSB is looking at additional 'tweaks' to the method to allow it to represent abutment scour, scour at inverts and also failure due to water pressure/ loading.

Question: Does "Foundation depth" in the document refers to the depth of the piles driven below the river bed if the foundation sits on piles?

Response: Correct - foundation depth included the depth of pile if known. If the existence of piles cannot be confirmed then the foundation depth was taken as the proven depth (usually the bottom of the pile cap/raft which can be established by core drilling through the bridge support).

Question: What does the term "Foundation Material" mean? Is this the material on which the foundation sits or the material used to build the foundation?

Response: Foundation material is the material on which the foundation lies. As this is often unknown, it is considered to use as a substitute the material in the river bed adjacent to the support which can be established by site investigation.

Question: Your research concentrates on 2,924 structures for which complete information is available. Are these structures strictly limited to railway bridges or did you consider any highway bridges?

Response: They were all railway bridges. The reason for this is the work was commissioned by the railway industry. Also in the UK it is the railway industry which has been at the forefront of research and pro-active management of scour risk following a bridge collapse in 1987 and so records and data are much more readily available. My impression is that in the US the opposite is true - most of the work has been on highways.

On other work we have undertaken, we do have much more limited data for road bridges, and there appears to be good correlation between the foundation depths and scour risk if you compare bridges of a similar age and construction.

Question: Among 2,924 structures a total of 9,305 bridge supports or elements (an element is an abutment or a pier) have been rated. When you established the priority (Preliminary Priority (PP) or Final Priority Rating (PR)), my understanding is that you established priority for an individual element. If a bridge has multiple piers then how do you come up with one priority score for the structure?

Response: We simply took the highest score of any support. We looked at other options such as weighting the scour or taking an average, but we found the additional effort/complexity did not really add any value. The reasons why we assess the supports individually are (a) it is then clear where the main risk to the structure lies and (b) it reduces the over conservatism of assessing the structure as a whole where you may well assess the risk based on the maximum scour depth and minimum foundation depth even if they were not at the same support.

Question: In section 2.4 "Summary of the Analysis" you have indicated that probability of uncertainty associated with a range of (+, -) 1 is 67%. How did you obtain this?

Response: Hopefully the attached Word document explains how the figures were derived.

Question: Once the bridge engineer establishes a priority (Low, Medium or High), are there any recommendations regarding a course of action based on the priority?

Response: Yes there are lists of standard recommendations for each category. In summary these are:

- Low - reassess at a suitable interval (normally 6 years but may be longer or shorter depending on circumstances)
- Medium - monitor and reassess at a suitable interval (normally 3 years but may be longer or shorter depending on circumstances)

- High - study in more detail to quantify the risk more accurately and to assess mitigation options that may be required (e.g. scour protection, flood warning). In the meantime however, interim measures are required immediately to monitor the structure during flood and to receive flood warnings.

Question: From the chart I can see if foundation depth = 0.01 m and Total scour depth = 10 m then a bridge element has a medium priority where as if foundation depth = 0.01 m and Total scour depth = 50 m then it has a high priority. From a scour stand point does it really matter whether total scour depth is 10 m or 50 m for a foundation depth of 0.01 m. Does it structurally matter whether foundation depth is 10m or 50m (as far as failure is concerned)? On a broader sense if the scour depth is more than foundation depth, I think there can be only one probability of failure. Please let me know what you think about this.

Response: From a structural viewpoint it doesn't really matter what the scour depth is once it is below the foundation depth as the result/consequence is probably the same. For local scour at piers, there could be an argument that the deeper the scour depth, the larger the spatial extent of the scour hole and hence it does present a greater threat to the stability of the structure.

However the main reason for allowing the priority score to increase as scour depth increases beyond foundation depth is that the uncertainty in the scour depth estimate being greater than a critical threshold (i.e. is it in practice going to be deeper than the foundation) reduces with scour depth.

The Railway Scour Assessment Procedure (referred to as EX2502 in the UK), calculates a Priority Score based on the ratio of estimated scour depth to foundation depth. The scour can then be further modified for other factors such as risk of blockage and the presence of scour counter measures. If a 1:1 ratio of scour depth to proven foundation

depth is used as a critical threshold the majority of structures on the railway network would be assessed as high priority – a result that is clearly overly conservative and out of sorts with the known historical incidence of scour and flood failure.

For this reason, EX2502 sets the critical threshold at 16.0. This requires the estimated scour depth to be at least 2.7 times the proven foundation depth. This appears at first a less than conservative threshold, but in practice is not. It is actually a result of the inherent conservatism of the available equations for estimating scour depth, and also the difficulty in establishing foundation depth and condition for structures. It is also probably a reflection that other risk factors (other than undermining due to scour) are being lumped in to the priority score.

Scour Susceptible Bridge Screening Program

In this report Renna (4) of the Florida DOT describes a general overview of the bridges crossing various canals in district four. Based on experience and bridge inspection reports it is concluded that most of the bridges crossing manmade channels are not susceptible to scour. This report also describes quantitative scour evaluation program but does not address the issue of “how to maintain bridges with unknown foundation” specifically.

Price Elasticity of Demand

Price elasticity was investigated as a possible cost of failure, but was not included in the final cost equation. This reviews the pertinent findings of this research. Travel demand models were originally developed in the late 60's and early 70's to analyze the need for new or modified highway facilities. First models were used to generate information about demand in six broad categories:

- Number of trips
- Destination of trips
- Route selection
- Travel time
- Mode of transportation
- Volume of current traffic within the network

Over time models have become more sophisticated and look at freight demand separately from passenger vehicle demand. Price is the direct, internal, variable, perceived cost involved in consuming a good. Price is not limited to monetary costs but can include non-monetary costs such as time, inconvenience and risk. Price changes often impact consumption decisions and can drive trade off decisions or demand shifts.

Average daily trip demand is impacted when transportation costs increase. Small price changes can create demand shift if there are competitive options. Many businesses make site selection decisions based on proximity to raw materials and end users and tend to optimize site location depending on transportation, labor and tax implications. Distribution functions are also significantly influenced by monetary transportation costs and service time to market variables.

Elasticity is defined as the percentage change in consumption of a good caused by a one-percent change in its price or other characteristics such as travel time, or road capacity. If prices decline, generally travel increases as lower-value trips become more affordable, conversely if price increases traveler may choose to forego trips, chain trips together or shift to different mode, route or destination.

Travel demand is often considered inelastic. Even with increases in fuel prices and taxes, motorists have historically not given up their vehicles. Some columnists contend that compared to Europe and Asia our price of fuel has not reached a high enough level to cause a shift in consumer travel demand. Fuel prices maybe considered to be a poor indicator of elasticity because of the new choices now available for hybrid vehicles and improved fuel efficiency in new vehicles. Fuel is considered to be only about one quarter of the total cost of driving, or a -0.3 elasticity of vehicle travel with respect to fuel price. Fuel is estimated at about 15% of total vehicle expense for the traveling public. Fuel is the second highest expense for a truck driver or about 28% of their total operating cost.

Table 8 Elasticity of Various Measures of Travel Demand

Dependent Variable	Short Term	Long Term
<i>Total Fuel Consumption</i>		
Mean elasticity	-0.25	-0.64
Range	-0.01 to -0.57	0 to -1.81
<i>Fuel Consumption Per Vehicle</i>		
Mean elasticity	-0.08	-1.1
Range	-0.08 to -0.08	-1.1 to -1.1
<i>Total Vehicle Kilometers</i>		
Mean elasticity	-0.10	-0.29
Range	-0.17 to -0.05	-0.63 to -0.10
<i>Vehicle Kilometers Per Vehicle</i>		
Mean elasticity	-0.10	-0.30
Range	-0.14 to -0.06	-0.55 to -0.11

Freight transportation companies have mechanisms in place today to recognize the variable cost of fuel. Fuel surcharges are often included in rate contracts and can be indexed to national or regional fuel price indices. Mileage or route choice is often a factor included in rate contracts. The Household Goods Carriers Guide is a widely accepted resource for determining trip mileage.

Many factors impact price sensitivity and can influence travel behavior. Some of these variables include:

- Vehicle purchase price
- Registration fees
- Fuel price
- Emission standards
- Tolls
- Parking fees
- Transit time
- Trip purpose
- Freight value

- Day of week
- Income level

In general high value freight and business/commuter travel is less elastic than recreational or shopping trips. Weekday travel demand is less elastic than weekend travel. Commuter peak travel windows show less elasticity than off peak travel demand. A number of port facilities and freight carriers have experimented with off peak delivery windows only to find a reduced number of facilities with the ability to load and unload freight during evening and late night hours.

Price elasticity increases if good quality alternatives exist. A good quality alternative is often viewed with respect to time and effort required to make the switch. If transit time is increased substantially or if information about route, schedule or fare information is not easily accessible, mode preference is often unchanged.

The price elasticity for freight transportation is complex and is mostly influenced by the value of the commodity. Full truckload volumes may be converted to intermodal (rail) freight containers, if a freight terminal is in route and access to the railroad is readily available. Less than truckload shipments are often time sensitive and the commodities are more valuable. Low value commodities often move via the lowest total cost mode and are the least sensitive to price changes.

In the last five years several research projects have been undertaken to estimate and model user costs in highway work zones. Generally traffic flow rate, vehicle speed and work zone length are the significant variables. Components of these variables include:

- Deceleration delay cost
- Reduced speed delay cost
- Acceleration delay cost
- Vehicle queue delay cost

- Excess cost of speed change cycles
- Excess running costs of vehicles at reduced speed through work zones
- Total hourly excess user cost

In general it was found that operating costs in reduced speed work zones are less but do not offset the reduced speed delay costs. The time delay variable is more important than the cost of operations.

Rising fuel costs, while significant have little impact on ADT. As a percentage of total operating cost, fuel amounts to less than 20%. Time, while controversial in how it is valued, is the single largest cost of delay. Time cost varies between rural and urban area, and varies by state and region of the country. In comparison to Europe and Asia, our travel costs are far less than our global neighbor's. Changes in fuel prices, vehicle costs and personal income to date have had little impact on travel demand or growth in ADT. Considering operating costs and national travel time estimates the following elasticities may be reasonable to determine travel demand with respect to bridge detours.

Table 9 shows elasticities which may be used to determine travel demand for bridge detours.

Table 9 Elasticities Used To Determine Travel Demand for Bridge Detours

Travel Demand Elasticity	Short Term	Long Term
Passenger vehicle	-0.16	-0.33
Truck	-0.39	-0.80

References

1. Idaho Transportation Department. Plans of action for scour critical bridges. Ayers Associates project no. 32-0629.00, Boise, ID, June 2004.
2. Idaho Transportation Department. Scour critical bridges: high-flow monitoring and emergency procedures. Ayers Associates project no. 32-0629.00, Boise, ID, July 2004.

3. JBA Consulting. Scour and Flood Risk at Railway Structures. Final Report prepared for Railway Safety & Standards Board, Project No. T112, Skipton, North Yorkshire, U.K., 2004.
4. Renna, R. Scour Susceptible Bridge Screening Program. Florida Department of Transportation, District 4, Fort Lauderdale FL, 1993.

APPENDIX C. SURVEY RESULTS

During the literature search, a survey was prepared and distributed to State DOTs using an AASHTO e-mail distribution list. The following sections summarize the survey and individual responses.

Level 1 Survey

Table 10 lists the names and organizations of respondents.

Table 10 Level 1 Survey Respondents

Name	Organization
Phil Brand	Arkansas Highway and Transportation Department
David Kilpatrick	Connecticut Department of Transportation
Thomas Scruggs	Georgia Department of Transportation
Brian Summers	Georgia Department of Transportation
Paul V. Liles, Jr.	Georgia Department of Transportation
Paul Santo	Hawaii Department of Transportation
Tri Buu	Idaho Department of Transportation
Ben Garde	Illinois Department of Transportation
Gary Peterson	Minnesota Department of Transportation
Marc Grunert	Nevada Department of Transportation
Harry Capers	New Jersey Department of Transportation
Scott Christie	Pennsylvania Department of Transportation
Wayne Seger	Tennessee Department of Transportation
Todd Jensen	Utah Department of Transportation
Frederick J. Townsend, Jr.	Virginia Department of Transportation
James E. Sothen	West Virginia Department of Transportation
Finn Hubbard	Wisconsin Department of Transportation

The following is a facsimile of the questionnaire and a summary of the responses received.

Bridge Management

1. Would you consider implementing risk-based guidelines for managing bridges with unknown foundations?	12 Yes 2 No
2. Do you believe there is a need to develop a plan of action for bridges with unknown foundations that could be implemented during and after flood events (e.g., temporarily bridge closure)?	13 Yes 1 No
3. Does your agency take a particular approach or use a particular methodology in its bridge management program to assess bridges with unknown foundations? If yes, provide a short description here. Provide copies of any documents more fully describing your approach or tell us how we may obtain them.	6 Yes 8 No

Frederick J. Townsend, Jr., VDOT

A scour risk assessment was performed on national bridge inspection standards (NBIS) structures with unknown foundations and on those deemed to be at risk. Consulting engineering firms were tasked with evaluating the risk and recommending actions required on a bridge site-specific basis.

Ben Garde, ILDOT

We keep a database and construction plans as well as microfilmed files which generally avoids the problem of having unknown foundations. Those, which do not have documentation on the foundations used, are given an increase in priority for replacement.

Gary Peterson, MnDOT

Our Bridge Management System tracks pier and abutment foundation types including unknown foundations. See <http://www.dot.state.mn.us/bridge/> for copies of our bridge inventory reports. Look under the Structural Data section.

David Kilpatrick, ConnDOT

We have included bridges with unknown foundations in our group of bridges that we would monitor during a critical river flow event.

Wayne Seger, TDOT

For West TN Timber pile bent bridges, we have assumed a pile length of 25' when looking at scour calculations. This was a common size timber pile used in those days of timber pile bent construction in that part of the State.

James E. Sothen, WV DOT

Bridges with ADT greater than 1000 having unknown foundations have been core drilled. Those with non-conclusive results remain unknown. Low ADT routes with no known scour problems may be assigned low risk, often with increased inspection.

4. Do you use the results of an assessment of bridges with unknown foundations to prioritize them for foundation investigations, maintenance or repairs and modifications? If yes, briefly describe your approach here. Provide copies of any documents more fully describing your approach or tell us how we may obtain them.	7 Yes 7 No
--	---------------

Frederick J. Townsend, Jr., VDOT

Virginia is divided into nine maintenance/construction districts. The recommendations from the scour study were given over to the districts for their action. The districts put together a plan of action for each bridge to address these recommendations. These actions ranged from monitoring, to installing countermeasures, to replacement.

Ben Garde, ILDOT

All structures at stream crossings are analyzed to see if scour can impact the foundation and if no foundation type information is known, they are given an even higher increase in priority for replacement. Same holds true for structures in seismic areas.

Harry Capers, NJDOT

For 'unknown foundation' bridges that were assessed as potentially scour critical during our Screening & Prioritization program, in-depth scour evaluations were performed. During that process, we attempted to obtain foundation data by using probing, NDT or borings. In some cases, the information obtained allowed us to draw conclusions about the foundation that removed the bridge from the 'unknown foundation' category. In other cases, some inferences could be drawn about the foundation that allowed us to make judgments about the bridge during the evaluation. In other cases, no information could be obtained and the scour critical judgment was made in a very conservative manner resulting in many being identified as scour critical. Once a bridge is identified as scour critical, it is treated the same regardless of whether or not the bridge has unknown foundations. New Jersey's policy is to retrofit scour critical bridges with countermeasures and to monitor them during and after significant storm events until the countermeasures are installed.

Gary Peterson, MnDOT

If bridges with unknown foundations have experienced a scour event or have a history of scour which threatened to undermine a footing, work to protect or replace the foundation or bridge would be considered as projects are identified and prioritized. Without a history of problems, its unlikely foundation type would influence repair or replacement decisions. Bridges with unknown foundations are required to be screened. Screening may involve foundation investigations, or may be subjective based on engineering judgment derived from observation of stream flow or performance during past high water events. Until a screening is performed, a plan to monitor the foundation during flood events is required to be filed. The process is documented in our NBIS Quality Assurance Review of Bridge Owners. See <http://www.dot.state.mn.us/bridge/DocumentsFormsLinks/>

Paul V. Liles, Jr., GDOT

If we suspect the bridge is scour susceptible, we will have the site drilled to tell us the probable location (depth) of the piles. In one case, we then used pulse-echo to determine if the piles were founded where we believed. When pulse-echo verified the depth, we replaced the bridge bents that were scour susceptible.

Wayne Seger, TDOT

If unknown foundation bridges are located in WTN, we look more closely at stream characteristics and histories, if known, and type of bridge design, simple or continuous spans.

James E. Sothen, WV DOT

Bridges are prioritized at our district level and repaired based on priority and availability of funds.

5. Does your agency use any risk-based guidelines for making transportation decisions? If yes, briefly describe them here. Provide copies of any document more fully describing your approach or tell us how we may obtain them. 5 Yes 9 No

Frederick J. Townsend, Jr., VDOT

The VDOT utilizes a business decision-making methodology whereby decisions are evaluated based on impact and risk.

Gary Peterson, MnDOT

MnDOT's bridge scour program considers risk when assigning bridge scour ratings. An initial screening process was done to determine which bridges are "low risk" for failure due to scour. A secondary screening process considers risk and allows ratings such as K – limited risk to public, monitor in lieu of evaluation and close if necessary. (see Bridge Scour Evaluation Procedure for MN Bridges at <http://www.dot.state.mn.us/bridge/DocumentsFormsLinks/>)

Paul V. Liles, Jr., GDOT

Flood recurrence intervals, earthquake return periods and wind design loads are based on recurrence intervals which are risk based decisions.

Wayne Seger, TDOT

Question is too broad. All decisions regarding transportation issues are risk-based

Tri Buu, Idaho DOT

Develop Plans of Action for scour critical bridges based on quantitative prioritization using risk analysis. Contact Lotwick Reese, 208 334 8491 for more info.

6. Does your agency consider "off-budget" costs (i.e., those paid for with road users' funds like lost productivity and the added cost of using a detour) as well as "off-budget" costs (i.e., those paid for with public funds like repairs or replacement) when making bridge maintenance decisions? If yes, briefly describe here how are they calculated and balanced? Provide any documents that more fully describe your approach or tell us how we may obtain them. 5 Yes 9 No

Frederick J. Townsend, Jr., VDOT

I can't say that I completely understand the question but yes, VDOT does take user costs into account when choosing a maintenance methodology. A higher dollar, but innovative approach may well have less impact on the traveling public, thus making the net cost of the project less. User costs are calculated using traffic counts times hours delay times average cost per hour times project duration.

Scott Christie, PENNDOT

Lane rental

Ben Garde, ILDOT

Decisions regarding user costs are routinely made for most projects. Traffic volumes and detour lengths play an important role in those decisions. Stage construction vs. closure are routine decisions for maintenance projects. No, we do not calculate these costs directly but use their relative influence in those decisions.

Gary Peterson, MnDOT

ADT is considered when determining how to handle traffic during construction (i.e. to close, detour, construct half at a time, bypass, etc). No calculation of user costs is usually made but ADT has a strong correlation to user costs.

Paul V. Liles, Jr., GDOT

High ADT routes will be rated higher.

David Kilpatrick, ConnDOT

Additional Info – For bridge maintenance decisions, it is the Department’s policy to perform whatever repairs are necessary to ensure the structure is safe for the traveling public. The Department will routinely schedule repair activities to be performed on off – peak hours for the limited access highways to reduce the impact on the traveling public. No calculations involving roadway user or detour costs are computed in deciding the best alternative to handle traffic.

Wayne Seger, TDOT

We look at repair costs and replacement costs when making bridge maintenance decisions. 90% of repair work by contract is stage construction. We will recommend accelerated construction schedules to reduce “off-budget” costs.

7. Does your agency use any discrete factors to determine how quickly it will replace or repair failing bridges (e.g., ADT, route classification, etc.)? If yes, please elaborate here. Provide any documents that more fully describe your approach or tell us how we may obtain them.

8 Yes
6 No

Frederick J. Townsend, Jr., VDOT

See Question 6. Criticality of the structure certainly plays a role in prioritizing both preventative and restorative maintenance.

Brian Summers, GDOT We primarily use route classification and ADT as well as safety and extreme inconvenience issues. High volume ADT Interstate bridges are generally given priority for repair. Interstate or State Route bridges that are closed are given the highest priority for immediate repair.

Ben Garde, ILDOT

No, we do not have one “top to bottom” priority ranking system. With limited budgets, we utilize a system that categorizes structures based on their condition (deck, super, sub, etc.), ADT, load carrying capacity, as well as functional deficiencies. Roadway conditions often influence priorities too. We try to avoid load posting situations where possible. Structures within categories then compete for limited funding.

Harry Capers, NJDOT

Scour critical bridges that show signs of scour along their foundations are repaired as a priority regardless of their having an 'unknown foundation' or not. Should a bridge show signs of a foundation failure, the repairs are made on an emergency basis. Failed bridges are likewise either repaired or replaced on an emergency basis.

Gary Peterson, MnDOT

Factors are weighed informally in the program planning process. Bridge Condition, Maintenance costs, ADT, age, functional adequacy, and road system among other items all weigh into decisions of when to repair or replace bridges.

Our Bridge Preservation, Improvement and Replacement Guidelines

(<http://www.dot.state.mn.us/bridge/DocumentsFormsLinks/>) formally but somewhat loosely document our repair and replacement decision process.

Phil Brand, AHTD

Sufficiency ratings are considered, but are not the sole prioritizing factor for replacing state-owned bridges.

David Kilpatrick, ConnDOT

When prioritizing, high ADT bridges are often given higher importance. FHWA has also indicated their concurrence of this.

Wayne Seger, TDOT

The only factors that would accelerate a repair/replacement of a failing/failed bridge is detour. In some cases, there is no detour. Political intervention will also come into play here. Traffic demands, i.e., ADT, will also factor into the timeliness.

Typical Bridge Foundation Design

1. Typically, what information does your agency have (or can easily obtain) on bridge foundation conditions (e.g., geology, geotechnical data, etc.

Frederick J. Townsend, Jr., VDOT

Most structures on the Primary and Interstate systems have soil boring information archived as part of the as-built plans. Bridges on the Secondary system would also have this information if the date of construction is within the last thirty or so years. Boring information is easily obtained as VDOT has in-house as well as on-call contractor drill crews.

Marc Grunert, NDOT

Older structures may have "Test Pit" information, while newer structures may have "Boring Logs". This information may or may not be readily accessible.

Brian Summers, GDOT

Georgia maintains both an electronic data base of foundation information and old bridge foundation report files that contain foundation recommendations, pile driving data and occasionally as-built foundation data. Information from around 1970 to the present is fairly good and available, but information prior to this is not as reliable and sometimes not

available.

Ben Garde, ILDOT

Our state retains the soil/rock exploration boring logs and existing structure foundation construction plans for future analysis. Most of our structures are founded on driven piling and we retain the “as built” pile driving records to further confirm the foundation in place.

Paul Santo, Hawaii DOT

Geological maps. Possible borings from a project in the vicinity.

Harry Capers, NJDOT

Boring logs and as-built plans are generally available. Foundation reports may or may not be available depending on the year the structure was built.

Gary Peterson, MnDOT

We have a foundation study typically including borings. Boring information is included in the bridge plan sheets. We also have pile driving reports and bridge construction documentation for most bridges.

Paul V. Liles, Jr., GDOT

Original plans, Bridge Foundation Report, As-built data, scour history – Some, All, or none of the above will be available for a given bridge.

David Kilpatrick, ConnDOT

Soil boring data, which is typically included in the design contact plans. If it's an unknown foundation, we won't have this data. We may have surficial and bedrock geology mapping for the area.

Wayne Seger, TDOT

Only on newer bridges that TDOT has design plans can one obtain geotech data. Some old design plans show foundation data at which rock was encountered. In those cases, rock may be cobble, solid, fractured, etc.; not necessarily always solid and didn't tell what type.

James E. Sothen, WV DOT

Many bridges have existing plans. Bridges without plans may be core drilled.

Tri Buu, Idaho DOT

Subsurface conditions, including soil or rock types, their engineering properties, ground water condition.

Foundation type, shallow foundation size and depth, pile driving data (not always available).

2. Does your State characterize unknown foundations in any systematic way, even if it is subjective? If so, please provide a short description here. Provide any documents describing that system or tell us how we may obtain them. 1 Yes 13 No

Gary Peterson, MnDOT

Bridges with unknown foundations are required to be screened. Screening may involve

foundation investigations, or may be subjective based on engineering judgment derived from observation of stream flow or performance during past high water events. Until a screening is performed, a plan to monitor the foundation during flood events is required to be filed. The process is documented in our NBIS Quality Assurance Review of Bridge Owners. See <http://www.dot.state.mn.us/bridge/DocumentsFormsLinks/>

Wayne Seger, TDOT

In Tennessee, geology in the Western third of the State is typically sand and silt with no rock. In the middle third, the ground has more rock both cobble and solid limestone. There is some chert and sandstone along the perimeters of the Middle section of the State. The Eastern third is mountainous with a mix of solid rock and large angular cobble. In general Middle and East TN are the most “stream stable” areas of the State.

3. Describe any relationship you believe may exist between a bridge’s size parameters (e.g., span length, width, number of lanes, total length, etc.) and foundation design.

Frederick J. Townsend, Jr., VDOT

Dead and live loads increase with the expansion of bridge deck area, ergo loads to the foundations increase making them larger or more complex.

Brian Summers, GDOT

Bridges with relatively short spans (<50 feet) and relatively short unsupported pier lengths (<20 feet) generally will have pile bents (top of pile directly supports the cap). Bridges with longer spans and long unsupported pier lengths will generally have pile footings (piles support a footing on which a column is poured that supports the cap), spread footings or drilled shafts. Some large bridge widenings that had scour-critical pile foundations that maintained the existing superstructure during construction used drilled shafts.

Ben Garde, ILDOT

We do not have any established relationship. Obviously, as the structure becomes larger and the loads become higher, it is more likely that the foundation is on piling. However, as the foundation soils become stronger and more difficult to drive piles (rock), it becomes more likely that the foundation is a spread footing.

Harry Capers, NJDOT

There is no direct relationship between the size of the bridge and foundation. The size and type of foundation depends on the subsurface conditions.

Gary Peterson, MnDOT

No historically reliable relationships.

Typically larger spanned bridges carry heavier loads and require stronger foundations which would include pile footings. Bridges over rivers and navigable waters typically will have stronger foundations to resist ice loads and ship impacts which would include pile footings.

Paul V. Liles, Jr., GDOT

The bigger the bridge, the bigger the foundation.

Phil Brand, AHTD

Of bridges with unknown foundations: In parts of the state without rock or rock-like soil at or near the surface, short span bridges (< $\approx 40'$) have driven piles; longer spans are often supported by wall-type piers with foundations below channel bottoms. In parts of the state where rock is near the surface, spread footings are common.

Wayne Seger, TDOT

We have never really looked at this type of relationship. On bridges we have design plans for, the foundation details only show the footing size and if piles were designed for footing support (material of piles are identified) but not pile length.

James E. Sothen, WV DOT

Bridges on major routes typically have foundations on rock. Foundations may be spread footings, piles or caissons.

4. Describe any relationship you believe may exist between a bridge's age and its foundation design. (Distinct foundation designs may dominate among bridges built in distinct time periods?)

Frederick J. Townsend, Jr., VDOT

Many of our older structures were built on timber piling. Also these older structures were built on spread foundations with less concern regarding scour.

Brian Summers, GDOT

Some older bridges (built in the 40's and 50's) used timber pile foundations, but there is generally not good correlation between the time periods and foundations used. Foundations were designed based on bridge layout and site-specific conditions.

Ben Garde, ILDOT

The older the bridge, the less likely it is supported by drilled shafts. The older the bridge, the more likely it is supported by timber piles (unless rock is close or the load demanded end bearing h-piles).

Paul Santo, Hawaii DOT

For older bridges, there doesn't seem to be a relationship. These days almost all bridges over streams are on piles or drilled shafts.

Gary Peterson, MnDOT

No historically reliable relationships.

Older bridges (pre 1950), if they have pile foundations, often used untreated timber piling with little restriction on source.

Paul V. Liles, Jr., GDOT

Designs change over time – use of timber piles, bigger spread footings, use of caissons – these can often be dated to the bridge era in which a structure was built.

Phil Brand, AHTD

Older bridges (>25 years) tend to be supported by timber piling and more massive wall-type

piers.

Wayne Seger, TDOT

Many older bridges (prior to 1960s) used timber piles to support concrete footings and substr. Also West TN used timber pile bents as the substructure elements for bridges. Concrete piles came along in 60's and are still used today. Steel piles have always been used, especially in Middle & East TN. Until recent years, when steel piles are used, one would assume they are point bearing on rock. In recent years, steel piles and steel pipe piles are being used due to the fact that the length can be extended by welding another section.

James E. Sothen, WV DOT

Major bridges that are old generally found on rock using timber or steel piling, concrete spread footings. All bridges built since late 50's and early 60's have foundations supported on rock. Very few if any erodible foundations built since 1960.

Tri Buu, Idaho DOT

Deep foundations of very old bridges are typically timber piles with vertical design loads in the range of 10 to 20 ton/pile.

5. What site-specific parameters may be used to infer foundation design?

Frederick J. Townsend, Jr., VDOT

Site-specific soil boring information will give the foundation designer a depth to, and the bearing capacity of competent rock or firm material. This information will also characterize the soil types as to whether, and to what depth, scour is likely. This information will determine if a deep (bearing or fiction piles) or a shallow spread foundation is most appropriate.

Marc Grunert, NDOT

None exists to my knowledge. Two, virtually-identical structures may exist in close proximity. Yet one will be built on spread-footings and the other on piling.

Brian Summers, GDOT Depth to rock or hard soil strata, presence of voids or limerock layers, depth to theoretical scour line, expected ease or difficulty of certain pile type installation, type work (widening vs. new construction), bridge layout.

Ben Garde, ILDOT

Looking at existing boring data or obtaining new boring data can give some suggestions on what type of foundation should have or could have been used. If the footing size is known or if by probing we can determine the size, it can indicate what must have been used (since the footing is too small to be a spread footing) or conversely, if the footing is very large, it can be assumed that it is likely a spread footing.

Paul Santo, Hawaii DOT

In Hawaii, piers and abutments within streams are likely to have pile foundations (either timber or concrete).

Harry Capers, NJDOT

H-Piles or steel pipe piles are used in North Jersey where soft soils sit above bedrock and concrete or pre-stressed concrete piles are used along the coastline, which is in a marine environment.

Gary Peterson, MnDOT

Exposed bottom of footing or piling.

Settlement may indicate a spread footing is in place. Often for bridges with pile footings, the approaches will continue to settle over time in relation to the pile supported bridge.

Borings that show weak soils probably have pile foundations. Borings showing shallow rock with granular overburden are likely on spread footings.

It may not be necessary to know the foundation type if the bridge very low ADT or has a long history of successfully weathering scour events.

Paul V. Liles, Jr., GDOT

Geologic formation in which the bridge was built

David Kilpatrick, ConnDOT

Areas of known deep compressible/soft soils will likely be on deep foundations.

Wayne Seger, TDOT

If timber piling was used, a common length timber was 25'-30', especially if it is a pile bent. Shorter timber piles were common used if the substructure was a timber pile supported concrete footing. Typically, if there are steel H-piles involved in either a pile bent or pile supported footing, we have assumed it point bearing on rock.

James E. Sothen, WV DOT

Dept to competent rock and quality of rock. Depth of scour.

7. What factors do you recognize to cause bridge foundation structures to deteriorate over time (e.g., materials, salt water, etc.)? Provide (or tell us how we may obtain) any data, documentation, or reference to quantify the relationship between such factors and deterioration over time.

Frederick J. Townsend, Jr., VDOT

Piles used as bents will deteriorate over time especially in the tidal zone of salt or brackish water. Ground water pollutants can also damage foundation piling. Marine borers will damage unprotected timber piling. Scour can diminish the effectiveness of spread foundations and if severe enough can diminish the effectiveness of a pile foundation.

Marc Grunert, NDOT

While adverse environmental factors, as well as materials used, may impact foundation deterioration, we have no data, documentation, or reference to quantify to relationship(s).

Brian Summers, GDOT

Corrosion of exposed steel piles in certain environments. However, exposed steel is protected with concrete encasing and bituminous or paint coatings, thus reducing or eliminating this problem. Some timber piles used as bridge fender systems in coastal environments degrade and are replaced as needed. We do not keep any data to quantify any deterioration.

Scott Christie, PENNDOT

Scour – and salt contamination

Ben Garde, ILDOT

Years of wet and dry cycles have been damaging to our timber piles. In soils with high chlorides and sulfides, we have seen aggressive corrosion of sheet, h-piles, and metal shells. Have no documentation to provide.

Paul Santo , Hawaii DOT

Salt water on steel and reinforced concrete foundation structures mainly at the tidal and splash zones.

Rocks and debris hitting foundation structures within relatively fast moving streams.

Sulfate attack on concrete foundations (although I have no knowledge of an occurrence at any of our bridges in Hawaii).

Harry Capers, NJDOT

Foundations typically deteriorate in the splash zone but there is no data substantiating the rate at which this occurs.

Gary Peterson, MnDOT

Downstream of a Paper plant an anaerobic bacteria that eats steel piling is present in the water. The rate of deterioration is a concern and consideration is being given to encasing the piling.

Timber piling tend to deteriorate more rapidly at the air/earth or air/water interface. They may be solid above and below this area.

Paul V. Liles, Jr., GDOT

Exposure to the elements, salt water, scour, corrosion, freeze-thaw are all factors that cause bridge deterioration.

Phil Brand, AHTD

Rust of exposed steel piling, rot and insect attack of wooden piling. Occasionally, stream bed-load has eroded concrete surfaces of piling and columns, but has not generally gotten to the foundation itself.

David Kilpatrick, ConnDOT

Factors that cause bridge foundations to deteriorate may include scour, material quality, poor construction techniques, salt, ASR, and poor or incorrect designs. No documentation exists quantifying the relationship of these factors and the rate of deterioration overtime experience in the state.

Wayne Seger, TDOT

Debris build up on bridge piers will damage pile bents and/or increase scour potential. Timber piling weathers quickly, especially if in a wet/dry zone. Steel piling rusts quickly in the wet/dry zones.

James E. Sothen, WV DOT

Deicing chemicals. We have timber piling on the river that has been in use for 80 to 100 years and are performing very well. Very few problems associated with foundations due to deterioration.

Level 2a Survey

Following the Level 1 survey, some respondents were contacted with follow-up questions by telephone. The following is a summary of the correspondence.

Harry Capers, NJ DOT

How do you determine whether the bridges with unknown foundation are scour critical or not? Do you adopt any particular methodology?

Bridges on spread footings can usually be reliably estimated by probing or coring to determine the depth of the footing which essentially eliminates the bridge from the 'unknown foundation' category. Bridges on pilings are assessed using engineering judgment based on conservative assumptions of pile lengths and calculated scour depths. The following is from our scope of work for scour evaluations of bridges on pilings of unknown length:

For bridges known to be founded on piles, the length of pile exposed due to scour should be determined as part of the first phase. If the length of exposure is five feet or less, the bridge will be classified as stable and SI&A Item 113 will be given a rating of "4" or "5". An exception to this would be a case where pile lengths can be estimated and are known to be twenty feet or less. In this case, the consultant should evaluate whether the bridge requires additional evaluation or should be classified as scour critical and SI&A Item 113 given a rating of "3". If the exposed length is greater than twenty feet, the bridge should be classified as scour critical and SI&A Item 113 should be given a rating of "3".

For bridges with an exposed pile length of between five and twenty feet, the consultant should evaluate the extent and cost of the additional analysis or non-destructive testing that will be required to determine the scour critical classification of the bridge. For these bridges, the estimated cost of scour countermeasures should also be determined for any potentially scour critical substructure element. The consultant should compare the two estimates and make a recommendation on a course of action which should be included in the scour evaluation report. If the Department decides to undertake the additional study, it will be performed as extra work in a second phase of the analysis.

<i>What kind of counter measures do you adopt for scour critical bridges with unknown foundation? Do you prioritize them in any particular manner?</i>	Scour countermeasures for bridges with ‘unknown foundations’ are typically designed the same as bridges with ‘known foundations’ once they are determined to be scour critical. We would typically use gabions or rip-rap. Once the bridge is determined to be scour critical, it would be prioritized based on the same parameters as any other bridge (Functional Classification, ADT, collapse vulnerability, bridge height, etc.).
<i>What kind of counter measures do you take for scour critical bridges with unknown foundations? Please provide us with any documentation.</i>	The repair of scour holes completed as a Priority Repair is not intended to provide a permanent scour countermeasure, it is intended only to repair the existing damage and usually consists of rip-rap or cement filled bags. Scour countermeasure installations are much more extensive and require environmental permits prior to construction.
<hr/> Frederick J. Townsend, Jr. P.E., VDOT <hr/>	
<i>Can you provide us with any documentation on the methodology and the recommendations provided by the consulting firms in "scour risk assessment"?</i>	The study was performed in accordance with the National Bridge Scour Evaluation Program – available on-line.
<i>How do the districts prioritize bridges with unknown foundations? Can you provide any documentation for this?</i>	The districts, through the appropriate District Bridge Engineer, have full autonomy in selecting candidates for inclusion in their maintenance/reconstruction program. Nine districts equal nine different ways of evaluating the regional bridge asset inventory. This is the long way around telling you that there is no cast-in-stone decision matrix for the prioritization process.
<i>Can you provide us with any documentation on the "business - decision making" methodology?</i>	Do a search for “business decision making” and “VDOT”. You should find an article in the July/August issue of the VDOT Bulletin in which there is a description of the BDM process.
<i>What kind of a duration and delay costs do you use in obtaining "user costs"?</i>	This is project specific. Given the ADT of affected roadways in the project area, we

estimate what the delays will likely be in person-hours. Regionally we estimate what the average cost per person-hour is and that's how the user cost is developed.

Is there any particular methodology you adapt to replace or repair failing bridges? Please provide us with any documentation you have.

Rule of thumb has the break point between rehabilitation and replacement at 60% of replacement value. Of course this percentage is not hard and fast and final resolution lies with the district. Many issues are involved in the decision making process (see BDM).

Level 2b Survey

Some respondents to the Level 1 survey were contacted with follow-up questions by e-mail. The following is a summary of the correspondence.

Does your organization have any database containing information on bridge foundation depth and information on soil characteristics on which foundation sits (or piles are driven)? If not a database, do you have a central location where you store as-built design drawings that would include this information?

Scott Christie PennDOT
We do have as built – usually kept at District offices

Paul Santo, HawaiiDOT
We do not have a database. We have a central location where we store as-built drawings. These drawings usually contain foundation and soil information.

Tri Buu, IdahoDOT
Information on bridge foundation types, subsurface conditions, etc. are in the bridge plans kept at the ITD's Bridge Design section. The information is also available on microfilms. We are currently creating a digital file for information of the existing bridges.

William M Kramer, ILDOT
No we do not have a data base. Yes we do have a central location where contract plans and as driven pile information is retained.

Andrea C. H. Hendrickson, MnDOT
No we do not have a database with bridge foundation depth and soil information. We do have average pile information in our hydraulics files in the Bridge Office, and plan sheets (not as-built) filed in the Bridge Office often include soil boring results. We also have the historical bridge construction file (separate file for each bridge located in a separate storage facility) for most of our bridges built since the 1930's that contain pile driving records and pile lengths for specific bridges.

Brian Summers, GDOT
We have a database system known as the Bridge Information Management System (BIMS) that maintains historical documents of all of our structures when the documents are available. It is an electronic historical archive and includes construction plans, foundation investigations and some as-built drawings. The records are stored in .tif files so they are not easy to query, but

they are available.

Wayne J. Seger, TNDOT

We do not have a database that contains foundation information or soils types for each bridge in the state. On bridges that only "as built" drawings exist; we do not know what is below ground level. On some design bridge plans, we may have some information regarding soils information, foundation type and size, and in limited cases pile lengths. On bridge plans designed in the last 5 to 10 years, actual pile lengths driven are listed on the sheets. If there are design plans, they are typically kept at headquarters Structures Division and a half size is kept in the inspection report.

Jack Mansfield, NJDOT

NJDOT does not have a database containing the bridge foundation system and associated geological characteristics upon which foundations sit. However, there is a document control office that stores all the as-built plans constructed by NJDOT. Also, a Bridge Evaluation Report is maintained and updated by the Structural Evaluation Unit. The Geotechnical Engineering Unit maintains the Geotechnical Foundation Report, as-drilled boring plans, and boring logs.

2. Do you have design standards for minimum foundation depth? For example, minimum foundation depth can be a minimum depth a pile should be driven or a minimum depth a spread footing be placed under the soil in your area.

Scott Christie PennDOT

To generalize – we use both shallow and deep foundations. Spread footings are generally a minimum of 6 ft in the ground. Pile foundations are always over 10 ft. Friction piles are normally 30 to 60 ft. And point bearing piles vary over a large range.

Paul Santo, HawaiiDOT

We do not have minimum foundation standards. Top of spread footings for bridges are usually placed between 2 to 4 feet below finish grade. Other structures may have soil cover of 12 inches.

Tri Buu, IdahoDOT

For piling foundation, our standard specifications require a minimum pile penetration of 10 feet (this specification has been revised recently requiring 20 feet minimum penetration for piles embedded in soft or loose soils). In the past, we normally placed the spread footings a minimum of 3 feet below the streambed.

William M Kramer, ILDOT

Yes, piles must be 10' long and spread footing must have at least 4' of embedment.

Andrea C. H. Hendrickson, MnDOT

Typically we try not to use piling when the length of the piling in the ground will be less than 10 feet.

Brian Summers, GDOT

No. Each structure is handled individually by the geotechnical engineer responsible. Minimum tip elevations for piles are determined by soil strata and scour evaluation.

Wayne J. Seger, TNDOT

I'm not sure if you would call this a standard, but we do not drive less than a 10 foot pile. In the last twenty to thirty years, we do not place a spread footing on soil. All footings are either on solid rock or pile supported. I have found some older bridge design drawings that show the footing to be founded on rock. However the rock shown on plans turns out to be round cobble rock which can be undermined due to scour or streambed migration. Bottom line is to be somewhat skeptical when using old design plans.

Jack Mansfield, NJDOT

No. Guidelines for the foundation depth are established based on AASHTO and HEC 18, Evaluating Scour At Bridges. The depth of the deep foundation system is determined by the design requirements.

3. *When foundation information is unavailable are there any foundation generalizations you can make? For example, piles driven into sandy soil are typically at least x feet deep, piles driven into clay soils are typically at least y feet deep, foundations over rock are typically spread footings on the rock surface. This doesn't have to be statistically developed, we would just like your opinion based on your experience/knowledge.*

Scott Christie PennDOT
We rarely use drilled shafts.

Paul Santo, HawaiiDOT
None for piles. However, we do have "default" soil design parameters provided to us from our Testing Lab. If the soil type is unknown, we assume the worst case.

Tri Buu, IdahoDOT
In areas where we generally know the types and conditions of subsurface materials, we may be able to guess the foundation type of an existing structure when there is no information available for that structure. For example, if the structure was built in the 1950's or earlier and the subsurface materials are loose or soft soils, we would assume that the structure were supported by timber piles with penetrations no less than 10 feet. If we know bedrock exists at a shallow depth, then we would assume that the structure was supported by spread footings placed on bedrock.

Until recently, most of the bridges in Idaho were supported either by shallow footings or pile foundations. Drilled shaft foundations have been used more often in the last five years or so. There are mainly only two types of piles used in Idaho. Timber piles in the past and steel piles, either H beams or pipe piles, in the last few decades. One bridge with micro-piles is currently under construction. We don't use pre-stressed concrete piling in Idaho.

William M Kramer, ILDOT
No we can not say pile in clay are "x" or pile in sand are "y". However, if boring data is available, the subsurface conditions and structure loadings can in some cases rule out spread footing (or suggest a spread footing if piles cant be driven) or verify that piles must have been used and they must be at least "x" ft. if they are to carry the loadings in that soil profile.

Andrea C. H. Hendrickson, MnDOT
No.

Brian Summers, GDOT

We do not make any generalizations at this point. We are considering different methods for making some assumptions since we have a large percentage of bridges with unknown foundation elevations. We have had many different practices over the past 50 years concerning foundations so it is difficult to make an assumption for all bridges that is safe.

Wayne J. Seger, TNDOT

If no foundation information is known but we see steel piles called out on plans or steel piles used in a pile bent, we assume those piles are driven to rock (solid), point bearing. In west Tennessee, there is a lot of timber pile bents. These are typically driven into sandy type soils. Whenever an old pile is extracted from the ground or undermined, measurements are taken to try to assess the "typical" pile length used in that area. We have found that 30 feet is a common length for timber in that part of the state. We also have old state standards for pre-stressed concrete piling. The 14" square piles are typically no longer than about 35 feet long. The 16" square piles can stretch as long as 60 feet.

Jack Mansfield, NJDOT

Soil borings taken at the site are generally used to estimate the existing foundation system. Regarding pile length, the typical timber pile design capacity of 24 tons for a nominal 12-in diameter pile and a maximum length of 40 to 50 feet is used to estimate existing foundation conditions.

Meeting with MD State Highway Administration (MSHA), February 09, 2005**Attendees:**

- Andy Kosicki, Ralph Manna (Structures, Bridges)
- Dan Sajedi (Materials, Geotechnical)
- Jeff Robert
- Len Podell
- Glenn Vaughan (Chief Design Division)
- Rod Thornton (small structures)

Currently there are around fifteen structures under the jurisdiction of MSHA with unknown foundations. Efforts have been taken to reduce the number from 50 to 15 in recent years. A majority of these structures were built prior to 1940. Once bridges with unknown foundation were identified, MSHA categorizes them into one of the following.

- (3a) No evidence of scour
- (3b) Scour susceptible
- (3c) Scour critical

The decision making process for bridges identified as scour susceptible or scour critical (3b and 3c) depends on the age of the structure. If a bridge needs to be replaced within next 5 to 10 years, they may not adopt any measure involving significant amount of money. If a bridge has more than 20 years of life (from their experience), they adopt certain measures to counter the scour problem. The following procedure describes various steps MSHA adopts in their scour inspection program.

- Scour monitoring: One of the main measures they adopt is regular scour monitoring, approximately once in every two years. The field crew establishes scour depth using sounding data and compares with past records. The crew

estimates change in scour depth between present and past records. If there is one foot increase in scour depth in five years, they take borings. If MSHA knows that a pier is on a spread footing, usually a 4 inch diameter hole is drilled through the footing to get soil and foundation depth information. For each pier it costs approximately \$1000/boring (2 holes). The typical thickness of a spread footing is around 4 feet to 6 feet. Cost of scour monitoring depends on the size of the channel. Installing 60 grout bags per day costs approximately \$10,000 to \$25,000. For a small bridge (2 lanes) it costs about \$10,000 to install grout bags. Streams in Maryland tend to be small but for Woodrow Wilson Bridge on Potomac River, expected cost of monitoring is around \$250,000 in 1.5 years.

- Counter measures: If a crew observes more increase in scour depth (two to three feet) or if the bottom of the footing is exposed, MSHA adopts counter measures along with rigorous monitoring. Counter measures usually include placing sized grout bags or riprap. Class three grout bag has dimensions of 3' long, 4' wide and 1' deep. Grout bags usually extend to 6 feet; beyond that MSHA has permitting issues.
- Scour analysis: After adopting counter measures MSHA regularly monitors bridges. If they find more scour depth or if grout bags fail, they suspect greater vulnerability in the stream. Bridges of that nature are identified as scour critical and advanced techniques like scour analysis are used. Performing a scour analysis tends to be expensive (approximately \$50,000 for survey and H&H analysis), hence they normally do not adopt this procedure unless there is a real need (e.g., large bridge with high ADT). During the course of an event MSHA monitors bridges more closely. If flow overtops a bridge with unknown foundations, they close the bridge and wait for inspection.

Meeting with VDOT on March 09, 2005**Attendee:**

The attendee at the meeting was Frederick J. Townsend (Structure and Bridge).

Virginia is divided into nine districts and each has a bridge engineer to maintain bridges under his jurisdiction. Each district is further classified into residency and each residency into headquarters. Richmond district has six residencies and each residency has up to ten area headquarters. A consultant was hired to study all bridges in the early 1990s for scour vulnerability. VDOT found that among 2,500 bridges approximately 25 bridges are scour critical and neither construction drawings nor foundation information is available for those bridges. VDOT has many other bridges with unknown foundation but those bridges are not classified as scour vulnerable. VDOT considers that if design plans for the bridges are available then the foundation is known. VDOT inspects their bridges once every two years as a part of routine bridge maintenance program. If they find no visible problem they keep monitoring the bridges. Field crew establishes scour depth using sounding data and compares with past records. Crew estimates change in scour depth between present and past records. If there is one to two foot increase in scour depth they increase monitoring and provide counter measures. Ninety percent of the counter measures are provided because of erosion due to the meandering of the stream. If they find problem in piers then they protect piers using grout bags. In order to determine the size of the riprap (as a counter measure) they may perform an approximate H&H analysis. They use USGS quadrangle map, FIS, USGS regression equations, etc to determine discharge, elevation and other hydrological parameters in determining the scour criticality of the bridge. Detailed H&H is performed only for new structures, which are scour critical. They adopt a "Class 1 Bridge Survey" method to perform detailed H&H. Permitting is a big concern when installing counter measures in water. After installing counter measures they monitor the performance of the

countermeasures for one significant storm. If the counter measures performance is satisfactory, they monitor the bridge on a regular cycle. Most of the bridges with unknown foundations are located on rural roads in Virginia. From an economic prospective, sometimes they may build a new structure instead of repairing the old one. Bridges having timber piling may have critical scour problems if they are exposed to both dry and wet conditions. Usually timber piles are more than 10 feet deep. Spread footings are not usually found on erodable soils unless it is an older structure. Spread footings are usually two feet under the top of the soil and three feet in thickness. VDOT is unlikely to have soil information if the foundation information is unavailable. In that case they may do borings to get soil information, which gives them more confidence on their assumption regarding foundation information. Obtaining boring information is not very expensive. To get boring information by drilling approximately 50 feet deep it costs approximately \$2,000 for two people for a bridge located on a small back road. Mr. Townsend also agreed to a methodology involving a minimum acceptable level of performance for each road under the classification of National Highway Institute.

Additional Telephone Conversations with State DOT Officials

Garland Land, Heavy Bridge Maintenance Engineer, Arkansas DOT:

Arkansas DOT officials routinely inspect bridges once every two years. They also plot the profile of the channel once every five years to see the changes due to erosion. If the inspector sees a change of approximately 2 feet during a routine inspection then they increase the frequency of scour monitoring to once a year. If the bridge inspector finds a significant change or if the footing is exposed, they place the bridge in scour critical category, perform scour analysis, adopt a rigorous monitoring approach, and place riprap countermeasures as needed. Typical size of the riprap is approximately 1.5 feet in diameter. If a bridge with an unknown foundation is located in the northeast part of the state then there is a high chance that it is supported on timber piling. They normally provide a concrete cap for the piles or drive new concrete piles to support the bridge in case of scour vulnerability. Bridges located in the northwest side of the state tend to be founded on bedrock and hence are not very susceptible to scour.

Wayne Seger, Bridge Inspection and Repair Office, Tennessee DOT:

Tennessee DOT officials routinely inspect bridges once every two years. They measure cross sections upstream and down stream of bridges using sounding data to estimate scour depth. In 1990's they did extensive H&H modeling (using WSPRO) to determine the scour depth and identified bridges that were scour susceptible or scour critical. Once identified, they monitor these bridges more frequently and adopt countermeasures accordingly. Their experience suggests that many bridges with unknown foundation are old and most of them are supported on timber piling. If the scour depth is more than the pile depth the bridge is classified scour critical. If the depth of the footing is unknown then they place riprap

countermeasures if the bridge is scour susceptible. The riprap used for scour protection falls into one of the following categories.

- Type b: 3 inch to 2.25 feet in diameter placed in 2.5 feet thick blanket with at least 20% by weight is more than 6 inch
- Type c: 5 inch to 3 feet in diameter placed in 3.5 feet thick blanket with at least 20% by weight is more than 9 inch

In the future they will adopt more advanced countermeasures such as gabions and filter fabric.

Tri Buu, Geotechnical Engineer, Idaho DOT: There are approximately 3,200 bridges over streams in Idaho, and approximately 580 of these have unknown foundations. Most of these bridges are maintained by local agencies. They routinely inspect bridges every two years. In 1990 they implemented a scour evaluation program for all bridges in the state. This program involved hiring three companies to do scour analysis for all of their bridges. Several years of data were collected and the results were entered into the HYRISK program, which they used to categorize bridges as “not vulnerable to scour”, “scour susceptible”, or “scour critical”. They rated bridges using NBIS.

Scott Christie, Chief Bridge Engineer, Pennsylvania DOT: Pennsylvania DOT officials worked with the USGS to develop a program to maintain bridges for scour vulnerability, which also addressed unknown foundation bridges. We obtained a report (1) from Ms. Julie at USGS that generally describes the field survey requirements. This report focuses mainly on characterizing the soil and identifying any evidence of scour and stream bank or bed erosion.

William Kramer, Foundation and Soils Unit Chief, Illinois DOT: They have approximately 300 bridges with unknown foundations, which is approximately 10% of the total number of bridges in Illinois. They studied all of the bridges in their state in the early

1990s, and ranked bridges with unknown foundations into one of five categories regarding scour vulnerability. A systematic maintenance program does not exist but they do monitor their scour critical bridges closely, especially during significant events. They sometimes adopt countermeasures (e.g. riprap) in the field. He said most of the scour critical bridges identified in that study have been replaced.

Andrea C. H. Hendrickson, Foundation and Soils Unit Chief, Minnesota

DOT: They only have approximately five bridges with unknown foundations. Thus, this is not a major issue for Minnesota.

Rick Renna, Florida DOT: FDOT is contemplating developing guidelines for managing their bridges with unknown foundations, and wanted to find out what we are doing for NCHRP. FDOT suggested that soil borings could be used to "back calculate" an unknown foundation. A major concern for FDOT is protection of evacuation routes - they recommend putting a very high priority on evaluating evacuation routes. Mr. Renna also noted that the cost of fixing a bridge is sometimes greater than the cost of replacing the bridge.

David Fry, Environmental Management, Virginia DOT: VDOT faces many permitting challenges when installing countermeasures for bridges. They have to obtain a permit from either the Army Corps of Engineers, or the Virginia Marine Resources Commission (VMRC), or both in complex cases. Countermeasures usually involve riprap and occasionally grout bags. If they place riprap, then they usually don't need a permit from the Corps; but if they want to place grout bags, they usually report it to DEQ and get a permit from Corps. However, if the drainage area is more than five square miles, they have to get a permit from VMRC regardless of the counter measure.

Lotwick Reese, Hydraulic Engineer, Idaho DOT: Bridges having no plans are considered bridges with unknown foundations. If a plan is available regarding a spread

footing and they have information on bottom of the footing, then this is used in their scour analysis. If a foundation is pile-supported and if no information is available to estimate the bottom of the pile, they assume a depth of 10 feet and perform scour analysis. If a conceptual plan is available and as-built information is unavailable, they assume that the structure is built according to the concept plan. Once scour analysis is performed they rate bridges using NBIS. They have not addressed the issue of bridges that have no plans yet.

Specific Survey: Traffic Characteristics versus Rebuilding Time

One hundred and eleven surveys were e-mailed twice to the AASHTO Subcommittee on Bridges and Structures. Twenty-six responses were collected and tabulated. The responses represent states with diverse geographies, populations, and rural versus urban settings. One response was from a Federal Agency.

When asked to estimate the traffic characteristics that were most important in predicting rebuild time, ADT and political pressure were deemed the leading predictors of rebuild time. ADT was ranked first or second in importance by 54% of the respondents.

Other leading factors for predicting rebuild time included structure type, length, and bypass length. “Other” refers to variables receiving only rare mention or low rank – for example: permit time, loss of toll revenue, right of way access, and weather.

The second question asked each respondent to rate the importance of the top ten variables that impact bridge rebuild time in such a way that the sum of the ratings is less than or equal to 100%. This question included other social and economic considerations that were suggested by the preliminary interviews of bridge experts.

The availability of funds for bridge construction was the single leading predictor of bridge rebuilding time. Cluster analysis suggests that the second most important factors include ADT, political interest, cost of reroute, and environmental permitting. If ADT, cost

of reroute, and political interest are considered dimensions of an average level of service concern, then this question arguably confirms the ratings from the first question.

The third question asked the experts if they were aware of any relationships between traffic characteristics and the rebuild time within their jurisdiction. Of the 25 written responses, ten of them said that no formal rules or guidelines are being used to predict rebuild time. Detours were mentioned several times. If reasonable detours exist, rebuilding time is likely to increase. One expert explicitly said that rebuilding time increases if short detours are available.

The fourth question focused on accelerated construction. It is assumed that if accelerated construction practices are used, the same variables may be a predictor of bridge rebuilding time. The response to this question confirmed that ADT and user costs are the single most important determinate of rebuilding time.

The final question gave participants the opportunity to comment on other factors which influence bridge reconstruction time. Responses included a variety of social, contracting, and procurement issues. One insightful comment mentioned that while higher ADT draws higher staff priority, federal and environmental issues supersede ADT.

The following lists the questions asked and a tabulation of the responses.

Question: When estimating the time it will take to rebuild bridge lost unexpectedly, please rank the most important variables which impact rebuilding time. (#1 = Most important). If the variable has no impact on rebuild time, please note as “n/a”. Please rate each variable.

Response Tabulation

Table 11 lists the response.

Table 11 Tabulation of Responses to Importance of Rebuild Time Factors

Factor	Average Rating	Median Rating	Rated First or Second
ADT	2.35	2	14
Structure type	5.12	5	9
Bypass length	4.04	4	7
Political pressure	4.00	3	6
Functional classification	4.19	3	6
Structure length	4.46	5	5
ADTT	3.85	4	5
Highway system	4.00	2.5	4
STRAHNET highway designation	3.19	1.5	3
Total project cost	5.15	4	2
NBIS bridge length	4.42	1	2
Bridge improvement cost	5.08	4	1
Maintenance responsibility	5.58	4	1
Designated level of service	5.00	5	0
Designated national truck network	3.31	n/a	0
Future ADT	3.77	n/a	0
Route signing	4.31	n/a	0

Question: Please estimate a weight (in the form of a percentage) that each variable has on the total time it will take to rebuild a bridge? (Please make sure the total adds up to 100%). There are 10 variables.

Response Tabulation

Table 12 lists the response.

Table 12 Tabulation of Responses to Weights of Rebuild Time Factors

Factor	Average Rating	Median Rating
Availability of funds to perform the work	12.77	10
ADT	11.96	10
Political interest	11.62	10
Cost of reroute (lost time and operating costs)	11.58	10
Environmental permits or conditions	11.42	10
Emergency route designation	9.81	10
Social Factors (e.g. only school access)	9.54	8.5
Availability of workforce, materials or equipment	9.50	5
ADTT	4.96	4
Other	--	--

Question: In your state, what is the relationship between traffic characteristics and rebuild time? Are there any decision rules or criteria used to guide or predict rebuild time. Please feel free to attach examples.

Response 1

- All items in 1 and 2 impact rebuild time
- Size and cost have a significant impact
- If a major/high cost bridge fails it will be a high priority to replace
- Securing rebuilding funds takes time
- Actual rebuilding times are based on past experience with other structures

Response 2

- Traffic characteristics dictate the construction.
- Political pressure is a factor in low vol. bridge construction

Response 3

- No hard and fast rules
- When a bridge fails it is an emergency
- The greater the ADT the greater the intensity of effort to restore service

Response 4

- Not having many short detour options makes rebuilding time very important

- Traffic characteristics would rarely play a role in rebuild time.

Response 5

- Rebuild time increases if detours are short 3 miles or less
- Rebuild time is inversely proportional to ADT
- Human and \$\$ resources are available to solve the traffic and structure wrt to ADT and classification
- \$\$\$ is directly related to ADT

Response 6

- Case by case decision

Response 7

- No established rules. Strive to provide bypass within a month for routes with long bypass. Traffic characteristics come into play when rebuild is considered.

Response 8

- There are no rules. In recent experience bridges lost unexpectedly were replaced on fast track

Response 9

- The heavier the traffic the sooner the rebuild

Response 10

- No rules to predict rebuild time, to my knowledge

Response 11

- If traffic is detoured, rebuild time goes down.

Response 12

- Traffic characteristics not much impact on rebuild time. It is primarily based on size and type of structure.

Response 13

- Don't know

Response 14

- No rules in NM for rebuild time

Response 15

- Traffic volumes linked to revenue for toll roads. Rev loss will push for faster rebuild time.
- Need to consider LOS impact on reroutes
- Rebuild based on complexity of structure

Response 16

- None – replace as fast as Fed and environmental permits allow. Design is small amount of time, getting permits, environmental clearance and rights of way are the problem.

Response 17

- No rules or criteria

Response 18

- No rules in place. Criticality to mobility is more important than cost.

Response 19

- If traffic count was high, accelerated construction activity would be encouraged to get the bridge open as soon as possible.

Response 20

- No formal guidelines, generally ADT indicates higher importance of the bridge. We would therefore consider it urgent to restore service to a high ADT bridge.

Response 21

- (Army) as a federal agency we are not involved in a lot of bridge rebuilding and have not established these relationships. We will usually defer to the local states.

Response 22

- To date we have not developed any relationships between traffic characteristics and rebuilding time.

Response 23

- The more traffic the more political pressure you get to build quickly

Response 24

- Traffic characteristics are not significant criteria in predicting rebuild time. TX Dot does not have formal criteria in predicting rebuild time.

Response 25

- We (OH) are working toward a plan development policy concerning maintenance of traffic, accelerated contracts and construction techniques. This tool can be applied to unexpected repair or replacement of bridges. Maintenance of traffic is the engine that drives the process.

Question: What determines when accelerated construction techniques would be used? Please list the factors that must be present in order to justify accelerated construction.

Response 1

- Based on major or high volume structures

Response 2

- Significant economic impact to regional/local commerce
- Adverse impacts on emergency services – hospital access
- Length of detour
- Total construction time needed

Response 2

- Three – High ADT, ADTT; long detour; political pressure

Response 3

- Primarily it is the level of impact the loss has on ADT
- User costs and disruption of emergency services are key factors

Response 4

- Used almost always in AZ due to long detours on most highways

Response 5

- ADT and functional classification
- Capacity and LOS of alt. routes
- Funds
- Capacity of contractors
- Environmental permit delays
- Traffic flow delays and LOS, public reaction

Response 6

- ADT and loss of revenue

Response 7

- Political pressure and traffic characteristics determine if accelerated construction is warranted.

Response 8

- Based on Traffic volume and economic impact on surrounding communities and business.

Response 9

- If the state declares an emergency this leads to Fed funds

Response 10

- Each project is a case by case. High ADT and political pressure, length and inconvenience of detour, environmental limitations, and public input can drive accelerated construction.

Response 11

- User costs

Response 12

- High traffic, emergency access, strategic route

Response 13

- Whenever public is impacted – acceleration should be considered

Response 14

- Accelerated construction has been used in NM when recovery time is short, detours are preferred and result in faster rebuild.

Response 15

- Higher volume with significant revenue losses associated with long rebuild.
- Effects on surrounding highway network and local economic considerations.

Response 16

- Will accelerated construction lead to a quality product, and if time gained is worth anything, road user costs.

Response 17

- ADT, reroute type, political interests and participation.

Response 18

- Criticality to mobility, local impact and emergency response, detour availability, feasibility with regard to weather, fabrication time, traffic disruption.

Response 19

- If bridge was totally out of service, that in itself would encourage accelerated construction.

Response 20

- High ADT, no available detour to accommodate the traffic, interstate route

Response 21

- Applicability of bridge design for rapid construction techniques
- No reasonable location for temporary bridge
- Temporary bridge too expensive
- Environmental permits will take too long to secure relative to temp. bridge

Response 22

- When there is no convenient detour
- Emergency vehicle access is delayed
- Cost of delay is unacceptable politically or economically

Response 23

- Factors include user costs, criticality or importance of structure, detour length or availability and cost.

Response 24

- Maintenance of traffic is the main concern. Balancing the cost of acceleration against the public user cost is still a case by case determination.
- Emergencies are typically processed in the following fashion:
 - Use of type “A” emergency contracts – no bid, start the same day with time and materials
 - Lesser “B” emergencies may be bid on a shortened schedule with a few invited contractors.

- Combining type “A” and “B” Example demolition and site prep while preparing design and bidding for the bridge construction.
- Partnership with designers, suppliers, contractors and the department to cut through most formality.
- Drop everything to process project documentation, submittals, and reviews
- Use standard construction techniques that everyone knows how to do
- Contractor my staff the job to work 24/7 unless this is not effective based upon preordering project materials
- Replace the bridge using existing plans to minimize design time.

Question: Please list any additional comments about factors which influence the time needed to rebuild bridge lost unexpectedly.

Response 1

- Maintenance of traffic-longer const times are needed if staged building process

Response 2

- national security, hurricane evacuation routes and military routes impact time

Response 3

- Traffic disruption, access to advance construction tech, skilled personnel availability. Construction industry is not oriented to develop Joint Venture solutions and risk mgt tech for this type of project – in PR

Response 4

- The # of lost bridges in state and in adjacent states determines availability of resources (designers and materials)

Response 5

- Traffic volume and availability of a detour route

Response 6

- FHWA Fed Emergency funds are usually 100% above obligation but rebuild must be done within 6 months of event

Response 7

- Procurement laws/rules can impact design and construction selection

Response 8

- Political demands fast rebuild time unless there is a reasonable detour nearby.

Response 9

- Higher ADT draws higher staff priority but Fed Regs and Environmental considerations make no such distinction with respect to ADT/use.

Response 10

- If route can be closed to traffic, rebuild time can be cut drastically.

Response 11

- Environmental agency response not as responsive as they need to be.

Response 12

- Time required is directly related to the length and width of bridge. Also bridges over major rivers will take longer to replace.

Response 13

- Availability of new or replacement bridge components
- Purchase required ROW

Response 14

- Evaluation/analysis of the reason for losing the bridge
- Time required for bridge removal

- Whether a temporary bridge is viable (if so a pressure for a replacement bridge may be substantially reduced)

Response 15

- Funds for contractor incentives, physical location (site difficulties and access)

Response 16

- Time to design the repair or replacement
- Availability of existing plans, hydraulic or foundation data
- Availability of mill materials for steel beams or girders
- Lead time on fabricated elements: beams, bearings, railings etc
- Site access problems: cofferdams, sheeting, placement of cranes etc
- Working around the MOT or detour
- Time of year
- Contractor ability to schedule and devote full capacity to the project

Scour-Related Bridge Failure Databases

State DOT officials were contacted by telephone during June – July 2005 to ascertain the status and availability of a historical record of scour failures at bridges. These conversations focused on quantifying the historical performance and the designed performance of bridges with regard to scour failure. Table 13 summarizes the results from these conversations. This phone survey discovered that many states had not formally compiled a record that summarized bridge failures (and their cause) on a state-wide scale. Thus, many provided estimates based on their collective memories of bridge failures, which are denoted as “anecdotal” record types in the table. Some states only record the cause of failure on state-owned bridges, which are denoted as “state” bridge owners in the table. Two of the state participants and Sterling Jones of the Federal Highway Administration preferred to estimate an average number of scour failures per year over their tenure, while most preferred to estimate a total number of scour failures over their tenure or their summary record. Furthermore most states have been submitting bridge failure information each year since the late- 1980’s to New York’s Safety and Assurance Program.

It is easy to calculate, from this information, the average number of scour failures per year, the annual probability of failure (i.e. average failures per year divided by the number of bridges over water), and the implied return period of scour failure (i.e. the inverse of the annual probability of failure). This analysis shows that – for the 25 states that responded – about 33 (i.e. 32.69 in Table 13) bridges per year fail due to scour. This result yields an annual probability of scour failure of about 0.0002, and an implied return period of failure of about 4,900 years. If this number of scour failures for the 25-state record is scaled by the ratio of 379,788 (the total number of bridges over water in the US) over

160,831 (the number of bridges over water from the 25-state record), this reveals that about 77 bridges per year fail due to scour in the US.

Table 13 Summary of state records regarding scour failures at bridges

State	Record Type	Estimated Failures Per Year	No. Recorded Failures	Record Length (years)	No. Bridges Over Water‡	Bridge Owners Included	Average No. of Failures Per Year	Annual Probability of Failure	Implied Return Period (years)
AL	anecdotal	6	--	15	14,000	all	6	4.3E-04	2,333
AR	anecdotal	--	16*	25	11,463	all	0.64	5.6E-05	17,911
CO	anecdotal	--	25	40	5,443	all	0.625	1.1E-04	8,709
GA	record	--	60	30	6,847	state	2	2.9E-04	3,424
HI	anecdotal	--	5	5	774	all	1	1.3E-03	774
IA	anecdotal	--	3	12	2,100	state	0.25	1.2E-04	8,400
ID	anecdotal	--	4	10	3,508	all	0.4	1.1E-04	8,770
IL	anecdotal	--	3	30	12,000	all	0.1	8.3E-06	120,000
MD	record	--	0	20	2,507	all	0	0	--
MN	anecdotal	--	1	30	360	all	0.0333	9.3E-05	10,800
MO	anecdotal	--	3	10	7,893	state	0.3	3.8E-05	26,310
MS	record	--	8*	16	12,299	all	0.5	4.1E-05	24,598
ND	anecdotal	--	1	35	300	state	0.0286	9.5E-05	10,500
NH	record	--	86	78	1,796	all	1.10	6.1E-04	1,629
NJ	record	--	3	26	3,256	all	0.115	3.5E-05	28,219
NM	anecdotal	0.25	--	14	1,591	all	0.25	1.6E-04	6,364
NV	record	--	6	20	294	all	0.3	1.0E-03	980
NY	record	--	32	85	12,643	all	0.376	3.0E-05	33,583
OH	anecdotal	--	2	10	14,000	state	0.2	1.4E-05	70,000
PA	anecdotal	--	150	9	15,650	all	16.67	1.1E-03	939
TN	record	--	10	38	16,867	all	0.263	1.6E-05	64,095
UT	anecdotal	--	3	5	1,749	all	0.6	3.4E-04	2,915
WA	record	--	43	82	5,823	all	0.524	9.0E-05	11,104
WV	anecdotal	--	4*	15	5,741	all	0.267	4.6E-05	21,529
WY	record	--	2	14	1,927	all	0.143	7.4E-05	13,489
US	(all above)	--	563.5	27.0	160,831	--	32.69	2.0E-04	4,921
US	record†	--	--	--	305,756	--	27.40	9.0E-05	11,157
US	anecdotal‡	25	--	32	379,788	--	25	6.6E-05	15,192

*Instance where the state official estimated no scour failures, but the NY record recorded this number of scour failures.

†Source: The quasi-national bridge failure database, which is updated and maintained by New York's Safety and Assurance Program and has failure records for 39 States and Puerto Rico.

‡Source: Sterling Jones of the Federal Highway Administration; a table acquired on June 9, 2005.

The following summarizes the questions that were asked of each transportation official:

1. Do you have a database recording scour-related bridge failures (i.e. requiring structural repair or replacement)?
 - Does it contain: structure ID, year built or age, function classification (NBI 26), and ADT (NBI 29, 30)?
 - Do you record the cause of failure both state and county bridges?
 - May we request a copy?
 - How many bridges (over water) do you monitor for scour-related failures (i.e. state-owned vs. county-owned)?
2. If you do not have a database:
 - What is your conservative estimate for the average number of scour-related bridge failures per year?
 - What is your conservative estimate for the largest number of scour-related bridge failures per year?
 - Do you record the cause of failure both state and county bridges?
 - Can you give any of the following info for any of the structures: structure ID, year built or age, function classification (NBI 26), and ADT (NBI 29, 30)?
3. How many bridges (over water) do you monitor/record for scour-related failures (i.e. state-owned vs. county-owned)?

The following responses were obtained:

Paul Liles, State Bridge Engineer, Georgia DOT: No database is available.

Paul has been monitoring bridges for 30 years, and he only knew about 2 failures that were not associated with the 500-yr flood in 1994. He also recalled 4 scour-related bridge

improvements (riprap and dikes) on local road bridges. The 1994/1995 flood event caused them to replace 47 state and local bridges, and he estimates that FEMA may have replaced 10-20 more county bridges during this event. Thus, the total number of failed bridges for this event is between 57 and 67. He stated that most state bridges are designed to last 50-100 years, whereas county roads are typically designed to last 25 years. Paul later stated that there are 14,500 state and county bridges in their monitoring program. However, they are only responsible for maintaining 6,600 of those bridges (state bridges). They do not monitor why any of the remaining 7,900 county bridges may have been replaced.

Scott Christie, State Bridge Chief, Pennsylvania DOT: No database is available. He suggested that we could submit a request to compile the records, but he doubted that many records are available or accessible. He estimated that ~80% of their bridge closures are due to scour problems, but he did not know how many bridges that percentage represents or how many closures were due to failure versus maintenance.

Jim Lane, State Bridge Engineer, New Jersey DOT: They have a database extending to at least 1979 of all state/county bridge failures in a MS Word document, which Jim sent us via e-mail. This database lists a bridge ID, bridge name, year built/failed, bridge material type, and cause of failure. This database lists three failures that were due to flood events. Jim later e-mailed NBI items 26, 29, and 30 for these three bridges.

Terry Leatherwood, State Bridge Inspector, Tennessee DOT: They have a database. Terry sent a spreadsheet of failures.

Frank Liss, State Hydraulics Engineer, West Virginia DOT: Someone in James Sothen's office transferred the call to Jim Shook, who transferred it to Frank Liss. No database is available. Jim Shook was not aware of any failures since the early 1990's, but he suspected that some maintenance work may have occurred. Frank Liss referred us

by e-mail to Bill Wolford who handles “scour evaluations” and might have better estimates.

Mr. Wolford did not respond.

Collin Boone, State Hydraulics Engineer, Arkansas DOT: Phil Brand recommended calling Collin Boone. No database is available. Collin couldn't recall any failures, but agreed to contact some bridge inspectors to verify this. He later estimated that no state bridges have failed due to scour within the last ten years. However, they do not monitor local or county roads and he would not guess how many of these roads might be failing due to scour. Collin later said that they monitor 11,463 bridges over water every two years. However, they are only responsible for maintaining 5,500 of those bridges (state bridges). They do not monitor why any of the 5,963 county or local roads may have been replaced.

Gary Peterson, State Bridge Engineer, Minnesota DOT: No database is available. He is asking their personnel for better records. He said that some counties say that they fill in 2-3 abutments per year that have partially washed out partly due to debris jams. He doesn't think they have had any structural failures, though. He later reported that one state-owned bridge on a principal arterial failed in the last 30 years. They have 162 bridges with unknown foundations, and have 360 bridges over water totally. Of these, 191 are state owned and 169 are locally owned.

Lotwick Reese, State Hydraulic Engineer, Idaho DOT: Tri Buu could recall at least two scour related bridge failures in 10 years. Tri then transferred the call to Lotwick Reese, who could recall 4 bridges that failed due to scour in the past 10 years. One was a US-95 overpass, two more were county-owned roads (1996, 1997), and the last one was an I-15 overpass.

Mike Fazio, State Hydraulic Engineer, Utah DOT: Mike recalled that 3 county-owned bridges failed in Jan 2005, which they estimate was due to a 125-yr flood event. He then e-mailed a more detailed list of these failures.

Mark Grunert, State Bridge Chief, Nevada DOT: No database is available. Mark recalls 6 bridges that have failed due to scour over the last 22 years. They monitor and record cause of failure for all state and county bridges. Four “major” (500-yr) floods and 2 localized floods (1982/3 and 1983/4) account for the six bridge losses. Two of these failures were US-95 arterial roads, and the rest were collector or local roads. NV currently has 294 bridges over water, and 164 of them are state-owned bridges.

Matt O’Conner, State Hydraulic Engineer, Illinois DOT: No database is available. Matt is not aware of any state bridge failures, and only a “few” county bridges (which are “off-line”) failing due to scour in the last 30 years. He estimates that they have about 4,000 state-owned bridges and about 12,000 total bridges over water.

Paul Santo’s retired coworker, State Bridge Design Engineer, Hawaii DOT: Does not know if a database is available. The anonymous (retired) coworker only recalls 3 bridges that were replaced after a flood that occurred about five years ago. He stated that their bridges have naturally strong foundations, and that the 3 bridge failures were wooden structures. This coworker placed a note on Curtis Metuda’s desk, but no one responded.

Sterling Jones, Federal Hydraulics Laboratory Manager, Federal Highway Administration: Sterling estimates that on average about 25 bridges fail per year nation-wide, and that there are roughly 500,000 bridges over water nationally.

Peggy Johnson, Professor, Pennsylvania State University, Water Resources Engineering: Dr. Johnson estimates that about 150 bridges have failed in PA in the past 9 years due to scour, primarily due to three regional flood events.

David Chang, State Hydraulic Engineer, North Carolina DOT: David thinks a database is available. He asked David Beard to call us about the data, but no one responded.

Bill Krouse, State Hydraulic Engineer, Ohio DOT: No database is available. They define a bridge as a 10 foot span or more (versus 20 ft or more according to Federal definition). Bill only recalls 2 state-owned bridges that have failed due to scour in the last 10 years, and both failing bridges were 10 foot metal arch bridges. They only monitor state owned bridges (~9,618 over water), and there are an additional 27,834 county and local bridges over water.

Mike Sullivan, State Safety and Assurance Representative, New York DOT: They have a database. Mike obtained authorization, and later sent their records for NY.

Steven White, State Bridge Records, Colorado DOT: Mr. White agreed to attempt compiling a database, but he was unable to meet our deadline. Steven recalls only 5 canal bridges failing since 1970. They monitor and record the cause of failure of state and county bridges. He also recalled that in the 1965 flood that around 15-20 bridges failed. He said the following in a subsequent e-mail, which also contained some photos.

Attached is some of the information I have gotten so far.

The photos were of a 5 year scour event (June 3-5, 2005) during a replacement of a check dam that had failed.

Other "scour" like problems CDOT is worrying about are sinkholes caused by small (less than 20') culvert failures. We had to close I-70 near Vail in both directions for around 18 hours due to a sinkhole from a failed culvert (loss of section mid-way under I-70 and washing out of fill) about 2 years ago. We have found about 50 minor culverts requiring repair out of around 1200 on I-70 and I-25 in Colorado. We are

working on the rest of Colorado Interstates and NHS highways to locate any more over probably the next 3-4 years. Attached are photos of some of these problems.

Please go to www.denverpost.com for a report on the 1965 flooding in the 6/16/2005 front-page story.

Overall, Colorado has not had major loss of highway bridges with the exception of the 1965-66 floods. Occasionally, we have lost a few small county bridges during flooding, but Colorado in general is a semi-arid state with most of our bridges built later than 1950 with adequate foundations for most flooding events. (knock on wood) Colorado had a 10,000 year flood in 1976 in the Thompson Canyon east of Estes Park. There were several bridges in the canyon, but because of the twisting canyon and location of the bridges and being set into granite bedrock, only one bridge had permanent damage of 1 foot settlement which was repaired by raising the pier cap. That bridge was only recently replaced about 6 months ago. All the other bridges were overtopped, but the flow was turned just upstream into the canyon walls. In fact, we lost roadway sitting on granite 15-20 feet above the normal stream due to the crashing of the water as it was forced to make 90+ degree turns.

Over 200 people living and camping in the canyon were lost in the flood that was caused by a midnight rainstorm on the night of July 31 – August 1, 1976. This was right around the centennial day and year of Colorado statehood.

George Conner, State Maintenance Engineer, Alabama DOT: No database is available. George says that they always close bridges before they fail due to scour. They have several cases per year where they have to close a local road to add additional braces or supports to keep the bridge functional. In many cases, they choose to post weight-limiting signs to keep the road operational. They have 5,600 state bridges, and ~80% of them are over water. All together, they have 14,000 bridges over water that they monitor.

Jim Camp, State Maintenance Engineer, Arizona DOT: No database is available. Jim recalls over the last 15 years that a few bridges each year need some work because they wash out. Most of them just need new rip-rap or fill. He wasn't sure, but he thinks approximately one structure every other year may need to be braced while they fill part of the foundation or abutment. They monitor all NBI listed bridges, and he estimates that they have around 600-800 state bridges over water. He did not know the total number of state and local bridges in his State.

David Claman, State Hydraulics Engineer, Iowa DOT: No database is available. David said that they only monitor/record 2,100 state bridges (over water). There are an additional 20,000 bridges over water managed by each county/local government. David remembered three principal arterial bridges that failed since 1993. Two of them occurred in 1998, and another occurred in 1996. He sent two examples of their management plan for bridges with unknown foundations by e-mail (PDF).

Warren Bailey, State Bridge Management Engineer, Mississippi DOT: A database is available, but it is large and needs to be queried for scour-related failures to limit the results. Warren agreed to look into how to query the database (for state structures), but did not follow up. A voice message for Fred Hollis to query his database for county/local bridge failures was never answered.

Jerry Ellerman, State Bridge Management, Wyoming DOT: No database is available, but they do report their recollections of all bridge failures to NY. Jerry said they monitor both state and local bridges, but he does not know how many. He recalled two scour-related failures, one partial collapse leading to repair in 1997, and one requiring replacement in 1991. Both were county-owned roads. From his copy of the NY-maintained list of all the bridge failures in WY, he determined that they have records of bridge failures in WY dating back to 1980.

Prakash Dave, State Bridge Engineer, Maryland DOT: A database is available, but it is large and needs to be queried for scour-related failures to limit the results. He later said that they could not find any recorded failure that was attributed to scour.

Dave Powelson, State Bridge Engineer, New Hampshire DOT: Dave had a copy of the national bridge failure record, which is managed by Shawn McAdoo in NY. He also saw historical accounts of flooding in 1927 that resulted in 76 bridge replacements, and of floods in 1936 and 1938 that resulted in “a few” replacements. His copy of the NY-maintained record showed that floods caused one bridge in 1984, five bridges in 1987, and one bridge in 1995 to fail. NH has 3,055 bridges over water by state definitions. He said that this record, however, only notes that “floods” caused the bridge replacements. The report does not mention scour specifically.

Shawn McAdoo, State Safety and Assurance, New York DOT: Shawn e-mailed their national database of bridge failures (a MS Access database). This database is updated yearly as each state reports all of their bridge failures for that year. At the start of the database (1987), each state was asked to send historical accounts of any past bridge failures that they could recall. This database should not be considered a complete record, and it does not report how many bridges each state has been monitoring. The accuracy of the records in this database depends on the participating States.

Cliff Scott, State Bridge Engineer, Wyoming DOT: Cliff recalled only one bridge that failed due to scour since 1970. They only monitor state-owned bridges, and he estimated that there are 2-300 state bridges over water in WY.

Ken Foster, State Bridge Inspection Engineer, Missouri DOT: No database is available. Ken estimates that there have been 2-3 state bridge failures due to scour over the last 10 years. He is only aware of 3-4 off-line bridges that have failed due to scour, but

he is not confident that this reflects a state-wide off-line number of failures. He stated that Missouri experienced two 500-yr flood events in his tenure, and he does not know off-hand how many state bridges over water that they currently monitor.

Other Scour-Related Information

State officials were also asked to respond to the following questions:

1. How has the number of bridges (over water) changed over your tenure (i.e. about how many bridges over water did you have at the beginning of your tenure)?
2. When (approximate year) did your state begin designing new bridges for scour?
3. What magnitude flood is used in the scour equation for those bridges? Is it different for different functional classifications (NBI item 26)?
4. When any existing bridge needs scour countermeasures (e.g. rip-rap), what magnitude flood is used in the scour equation to design the countermeasures? Is it different for different functional classifications (NBI item 26)?

The following responses were obtained:

Paul Liles, State Bridge Engineer, Georgia DOT: Paul said that the number of bridges over water has been relatively constant over the last 30 years. They began designing for scour sometime in the late 1980's. They design new bridges to withstand the scour from a Q_{500} flood, but he said that their Q_{500} is really just the Q_{100} multiplied by a safety factor. They also design their scour countermeasures based on a Q_{500} . Paul stated that he was not confident that the scour equations really give them 500-yr flood protection.

George Conner, State Bridge Maintenance Engineer, Alabama DOT:

George estimated that the number of bridges over water has not changed much in 30 years. He said that they started designing for scour after 1991. Eric Christie said that new state bridges are designed for the Q_{500} and Q_{100} scour events, but that counties usually do not design for scour. For scour countermeasures, they look at the Q_{100} scour predictions, which they don't trust, and use engineering judgment (experience) to decide how much is needed. They have about 3000 bridges with unknown foundations, and most of them are county-

owned bridges. Eric does not think their counties will heed any scour guidelines in the foreseeable future.

Collin Boone, State Hydraulics Engineer, Arkansas DOT: Collin said that the number of bridges over water has increased about 15% since 1992. They have been designing for scour since at least 1989. For scour at new bridges, they look at the Q_{100} and Q_{500} and the Q_{overtop} , and choose whichever yields the maximum scour. This is also what they use to design scour countermeasures.

Steven White, State Bridge Records, Colorado DOT: Steve estimated that the number of bridges over water has probably increased at a rate of about 40 bridges per year (most of them local bridges). He said that CO started designing scour countermeasures in 1975 to prevent the damage caused by the flood of 1965. CO started using federal guidelines for scour design in 1995, when the coding guide first came out. He said they always look at the scour predicted for the Q_{100} and the Q_{500} , but in the end they almost always “go all the way to bedrock”. For scour countermeasures, they always look at the scour predicted from the Q_{100} and Q_{500} , but they seldom heed this alone. The decision to use scour countermeasures at all is always weighed in a careful cost-benefit analysis, where they look at the sufficiency rating of the bridge, its life-expectancy, and its functional class and ADT. The cost-benefit analysis usually leads them to replace any older bridges that need countermeasures with better designs.

Jerry Ellerman, State Bridge Operations, Wyoming DOT: Jerry estimated that the number of bridges over water has stayed roughly constant over the past 14 years. Bill Bailey said they started designing for scour around 1979, and later adopted federal guidelines. They look at Q_{100} and Q_{500} for predicting scour for new bridges. For scour countermeasures, they usually just look at Q_{100} .

Jim Camp, State Bridge Maintenance, New Mexico DOT: Jim estimated that there has been a 5% increase in the number of bridges over water in last 14 years. They have been designing for scour since 1991 or 1992. New state bridges are designed according to federal guidelines (using Q_{100} and Q_{500}). For scour countermeasures, they look at the Q_{100} , but they often deviate from the calculated design numbers based on the history of each bridge's performance.

Andy Thomas, State Bridge Engineer, Pennsylvania DOT: Andy said they don't keep any records of how many bridges they've had historically. He said that they have been designing for scour since at least 1993. For new bridges they look at Q_{100} with full safety factors and at historically destructive flows. He said that Q_{500} is almost never conservative enough, and is often ignored. Thus, whichever flow gives them the most predicted scour is what they use in their new bridge designs. The same procedure applies to how they design scour countermeasures.

Andrea Hendrickson, State Hydraulics Engineer, Minnesota DOT: Gary Peterson set up a conference call with Andrea. Gary looked at some total bridge statistics and estimated that the number of bridges over water has remained relatively constant over the past 16 years (and may have actually declined slightly). Andrea said that they've been designing for scour since at least 1989 (her earliest record on-hand). For new bridges they look at Q_{100} , Q_{500} , and Q_{overtop} to see which of them predicts the most scour. For scour countermeasures, they usually just design them for Q_{100} (with safety factors).

Mike Sullivan, State Hydraulics Engineer, New York DOT: Mr. Sullivan wrote the following in an e-mail.

Of the 19,734 bridges in New York State, 12,643 of them are over water (4,023 state-owned (NYSDOT), 8083 local-owned (town, county, etc.), and 537 have the owner

listed as "other" as in other bridge authorities (NYS Thruway etc.) or non-DOT state agencies (NYS Dept. of Environmental Conservation, etc.).

Of the 12,643 bridges over water, 12,081 are highway bridges over water (3,972-State, 7,775-Local, and 334-Other).

Of the 12,081 highway bridges over water, only 766 bridges are currently coded as Scour-Critical for FHWA Item 113 (Item 113 = 0,1,2,or 3).

Of the 766 Scour-Critical bridges, only 1 bridge (local-owned) is coded '0' for Item 113, which indicates it has failed and is closed to traffic. The remaining 765 scour-critical bridges are all coded '2' or '3' (37='2', 728='3').

I can't really estimate the growth rate of our bridges. I would guess that the number of bridges over water has remained fairly constant since the early 1970s (after the interstate boom of the 60s). The oldest data I have indicates that there were 12,599 bridges (highway, railroad, and pedestrian) over water in 1994 and 12,616 over water in 1997 - Not much of a growth rate when compared to 12,643 bridges over water in 2005.

Responses to other questions are listed below:

1. NYSDOT created its Bridge Safety Assurance Unit shortly after the NYS Thruway bridge collapse in 1987. The first edition of our Hydraulic Vulnerability Manual was issued in 1991. The first edition of HEC-18 was also released in 1991. Therefore, I assume we started formally designing for scour in 1991. I passed these three questions on to our Hydraulic Design Unit but I haven't received a response yet. They may be out in the field.
2. 500-year event for Interstate bridges. 100-year event for all others.
3. 500-year event for Interstate bridges. 100-year event for all others.

Terry Leatherwood, State Maintenance Engineer, Tennessee DOT: Mr.

Leatherwood wrote the following in an e-mail.

We only have records going back to 1982. However, I can give you 2 or 3 data points.

In December of 1982, Tennessee had 17,554 bridges. This total broke down to 5,360 system (state maintained) and 12,194 off-system (local) bridges.

In March of 1990, Tennessee had 18,711 bridges. This total broke down to 7,023 system (state maintained) and 11,688 off-system (local) bridges.

In May of 2000, Tennessee had 18,994 bridges. This total broke down to 7,898 system (state maintained) and 11,096 off-system (local) bridges.

The Statewide Summary report, that I e-mailed to you the other day, contains totals on the current number of public highway bridges in Tennessee.

The above figures are for the TOTAL number of bridges. Our records (from years ago) do not break out bridges over waterways versus other types. So, I can't give you exact figures for that. However, if you look at our current numbers you see that:

Percentage of system bridges over waterways = $(6,446 / 8,071) \times 100 = 79.866 \%$

Percentage of off-system bridges over waterways = $(10,421 / 11,361) \times 100 = 91.726\%$

You could assume that these percentages have remained constant (which I think is mostly true) and multiple the above bridge count figures by these percentage numbers to estimate the number of bridges over waterways for each data point.

While we had some procedures for the hydraulic design of bridges dating all the way back to the 1920's and 1930's, we did not really get serious about scour design until the Hatchie River Bridge failure in the Spring of 1989. This failure resulted in 8 deaths and was investigated by the National Transportation Safety Board (NTSB).

It really showed us that our bridge scour design process could and should be improved. We took steps to improve our design process starting in 1989.

Our current hydraulic design procedures are available on-line at the following URL:
http://www.tdot.state.tn.us/Chief_Engineer/assistant_engineer_design/structures/thmall.pdf

You may want to especially read Memorandum 08 starting on page 49.

All System bridges are checked for the 100 yr. flood and at the 500-yr level as well.

This is because the maximum 500-yr event may not necessarily generate the maximum scour.

For off-system (local) bridges, it varies depending upon the program under which the bridge is built. Basically, a local bridge is usually built in one of 3 ways in Tennessee.

1) The local owner can decide to build the bridge using local funding only (i.e. no State or Federal funding is used). In this case, the scour design of the bridge is totally in hands of the designer (it could be a consulting engineering firm or a county/city engineer) selected by the local owner. As we say in Tennessee, TDOT "has no dog in this hunt". However, most consulting engineering firms would follow TDOT Guidelines as a "good practice".

2) The Tennessee Dept. of Transportation (TDOT) has a program to use Federal Highway funds to help local owners replace bridges. If the local owner chooses to use this program, he pays 20% of the cost with 80% being Federal funding. The bridge is designed by TDOT engineers. TDOT also lets the construction contract and provides construction inspection. Basically, in this case, the bridge is treated exactly as if it was a System bridge. The only difference is that the local owner assumes maintenance responsibility for the new bridge once it is built.

3) TDOT also has a second program that uses State Aid funding (A.K.A. Grant Program Funding) to help local owners replace bridges. These are typically small

bridges and culverts on local, low ADT routes. Under this program, the local owner hires an engineering firm to design the bridge and provide construction inspection. The design plans are submitted to TDOT for review and approval before the local owner lets the contract. These "Grant" bridges are not usually designed, hydraulically, for the full 100 yr. event. Our general requirement is that the hydraulic design must be an improvement over the existing bridge that is being replaced. However, the bridge is still checked for scour at the upper 100 yr. and 500 yr. levels.

As above, this depends upon if the bridge is a System bridge or an Off-System bridge. For a System bridge, the TDOT Hydraulic Office designs the scour countermeasures in accordance with our established design procedures as outlined above.

However, TDOT is not responsible for maintenance for local (Off-System) bridges.

This is by Tennessee Law as listed below:

Tennessee Code Annotated Section 54-1-126: Responsibility for maintenance of public roads, streets, highways or bridges.

(a) The department of transportation is responsible for the maintenance of only those public roads, streets, highways or bridges and similar structures which are designated by the department as being on the state system of highways or the state system of interstate highways.

(b) The department shall enter into a written contract with each city, county, or metropolitan government before undertaking any work or providing any funds for work with respect to public roads, streets, highways or bridges and similar structures, within their boundaries, other than those designated by the department as being on the state system of highways or the state interstate system of highways.

These contracts shall include a provision that such city, county or metropolitan government is solely responsible for all maintenance of the completed work. No such contract shall be valid in the absence of such maintenance provision.

So, while TDOT can recommend that a local bridge owner install scour countermeasures, it is the TOTAL responsibility of the local owner to follow through on our recommendations. The type of countermeasure installed is solely the decision of the local owner and whatever engineer he chooses to use or hire for the job.

Lotwick Reese, State Hydraulics Engineer, Idaho DOT: Lotwick estimated that the number of bridges over water has stayed roughly constant over the past 10 years. He said they started designing for scour around the early 1980's, and later adopted federal guidelines. They look at Q_{500} and Q_{overtop} for predicting scour for new bridges. The same applies to how they design scour countermeasures.

Bill Krouse, State Hydraulics Engineer, Ohio DOT: They started designing for scour after the Schoharie collapse, presumably like all the States. Before that they used a more common sense approach. They have not used spread footings on scour-prone soils for probably 25 years or more.

James Lane, State Bridge Engineer, New Jersey DOT: There were 825 bridges over waterways in 1983. Specific criteria for scour design were instituted in 1998. The criteria used prior to that date were less specific. They use Q_{100} in new bridge scour design and in scour countermeasure design.

Management-Related Information

State officials were asked the following questions:

1. What criteria do you use to identify a bridge over water with an unknown foundation as scour-critical or at-risk, and what methods did you use to evaluate these criteria?
2. Once a bridge with an unknown foundation is identified as scour-critical or at-risk, what monitoring and/or action plan do you use?

The following responses were obtained:

Sharon Slagle, State Bridge Design, Texas DOT: Ms. Slagle wrote the following in an e-mail.

Thank you for your interest in our bridge scour program. You can read TxDOT policy on scour in our online manuals, particularly the following:

- * Hydraulic Design Manual
- * Bridge Inspection Manual
- * Geotechnical Manual

Mark McClelland can answer specific questions you have about Texas bridge foundations, and you can reach him most effectively by e-mail at [omitted].

David Claman, State Bridge Maintenance, Iowa DOT: David said that Iowa goes to all of their bridges with unknown foundations and measure any scour holes present at these bridges (during their routine inspection every 2 years). They are reasonably confident that all of their piles are 20 feet or longer. If they discover a scour hole that is five feet or less, they assume that the bridge is scour safe. If they discover a scour hole exceeding 5 feet in depth, they label it scour critical (currently applies to 180-190 bridges). Once a bridge is labeled such, the bridge is inspected during and after any flood peak that

exceeds the “critical water mark” assigned to that bridge. To select the critical water mark, they perform an H&H study of the underlying waterway, which usually entails monitoring after any event greater than the 25-yr flood. During a “critical” flood they close the bridge, and use sonar to monitor the berms and bed before opening the bridge again. Iowa will soon begin using an online “Scour Watch” system to monitor – in real-time – all of their scour critical bridges. David said that Tennessee, New York, Connecticut, and Iowa are also planning to use this system.

Terry Leatherwood, State Bridge Inspector, Tennessee DOT: Mr.

Leatherwood wrote the following in an e-mail.

As for the Scour Watch program, yes, we are in the process of implementing it. We plan to use the scour watch program to monitor all scour critical bridges (as defined by NBI Item 113 being coded as 3 or less) irrespective of whether the bridge has unknown foundations or not. We have already completed a process where we screened all of our bridges into "low risk" or "at risk" categories. Most culvert type structures and bridges with foundations solidly set in bedrock were classified as "low risk". We then took the "at risk" bridges and ran an analysis to determine a coding value for NBI Item 113. Our procedure for these "at risk" bridges was as follows:

PROCEDURE:

The drainage area of the stream at the bridge site was calculated. Usually this was done using U.S.G.S. quadrangle sheets. Then the TDOT QCALC software program was used to compute theoretical discharges for the 100 year flood event. Depending upon the functional class of the route, we sometimes looked at other return frequencies as well. For example, on local county roads, we often looked at lower frequencies down to a 2 year return period. On higher functional class routes, we would sometimes check the 500 year return in addition to the 100 year return

period. However, the main coding decision for Item 113 was based upon the 100 year return frequency.

Using these discharges, field surveys of the site, and hydraulic parameters from published sources and field observation; a hydraulic analysis of the steam crossing was done using the WSPRO software program. The output from this analysis provided theoretical water surface elevations and velocities which were then incorporated into software using methodology contained in the HEC-18 manual to predict theoretical scour lines for the structure. The theoretical scour conditions were then evaluated using available data on the structure and certain engineering assumptions to provide an assessment as to the site's vulnerability to scour and to make a recommendation for the coding of NBI Item 113.

Most of our "at risk" bridges with unknown foundations consist of timber pile supported structures. For these bridges, the lengths of the timber piles are unknown. In this case, we simply assumed that the length of the piles would not exceed 30 feet and based our scour assessment upon this assumption. This assumption may, or may not, be conservative but it seemed reasonable to us at the time.

Our main "Plan of Action" for these scour critical bridges is to just monitor them with the Scour Watch system until they can be replaced with new bridges designed to modern standards. For System bridges, we may also install various types of scour countermeasures (such as rip-rap or gabion beds, etc.) if we feel they are needed. We are forbidden, by Tennessee law, to do any maintenance work on local (County or City owned) bridges. We will, however, issue recommendations to local bridge owners to install scour countermeasures if we believe they are needed. However, it is entirely the responsibility of the local owners to follow through on our

recommendations. We have no legal authority to "make" the local bridge owner comply with our recommendations. The only thing we can do is order the bridge weight posted or closed if we judge it to be unsafe for legal loads. If the local owner fails to comply with a Weight Posting or Closure order, we shut off all Federal Highway funding to that owner until he does.

References

1. Cinotto, P. J. and K. E. White. Procedures for Scour Assessments at Bridges in Pennsylvania. Open-file report 00-64, Pennsylvania Department of Transportation, Lemoyne, PA, 2000.

APPENDIX D. ANNUAL PROBABILITY OF SCOUR FAILURE AND MINIMUM PERFORMANCE LEVELS

There are two changes that are designed to make the original HYRISK method more applicable to managing bridges with unknown foundations. The first basic change involves scaling the annual probabilities down to a level that corresponds better to the recorded number of bridges that have failed due to scour. The first change primarily improves prediction of the risk factor in HYRISK, but it also improves our understanding of bridge performance. Thus, the second change involves introducing minimum performance levels that hold bridges with higher importance to a higher performance standard than less-important bridges.

HYRISK Probability Adjustments

The scour-related bridge failure interviews (see *Appendix C*) with State transportation agencies lead to an estimate of approximately 33 failures per year for the 25 States interviewed (i.e. 33 out of about 161,000 bridges). This suggests that the annual average probability of failure is $33/161,000 = 0.000206$, or about 1 in 5,000 per year. Scaling this to all bridges over water (i.e. 379,788) yields almost 80 scour failures per year. Many of the NCHRP panel members believe that the number of scour failures is probably under-reported, particularly for non-State-owned bridges. This belief is partly substantiated by the fact that the quasi-national bridge failure database maintained by NY recorded a few more scour failures in Arkansas, Mississippi, and West Virginia than the interviewed state officials could find in their records or collective memory. Thus, given the nature of the uncertainty in any of these “records” a more conservative estimate of the number of scour failures might be about 100 per year.

If the original HYRISK method (see tables in *Appendix A*) is applied to all of the bridges over water in the NBI database (i.e. 356,378 bridges, as of the end of 2005), this

analysis yields about 60,511 failures per year (i.e. the sum of the probabilities of failure for all 356,373 bridges). This corresponds to an annual average probability of failure of 0.17, and implies that about 1 in 6 bridges fail per year due to scour. These assumptions clearly do not correspond with the experience cited earlier, and result in exaggerated risk factors. Note that this was not a problem within the context of the original HYRISK methodology because HYRISK was primarily used to prioritize bridges. However, when using risk to set a course of action (guidelines), it is important that risk be as accurate as possible in order to properly account for costs and benefits of various management activities. For this reason, all of the original HYRISK failure probabilities have been scaled down to a level corresponding to the approximate number of failures (nation-wide) obtained from the State interviews.

Figure 7 shows how the probabilities of failure in the original HYRISK method were adjusted in three basic steps. Each step is represented by a new row of tables in this figure. Each table shows information versus scour vulnerability and overtopping frequency. The first table in each row shows the probabilities of failure, which is adjusted in each successive row of the figure. The second table in each row shows how many bridges in the 2005 NBI database correspond to each level of scour vulnerability and overtopping frequency – in other words, this table results from applying Tables 2 and 3 (*Appendix A*) to each bridge in the 2005 NBI database. The third table in each row is the product of the corresponding entries in the first and second tables in each row – in other words, this table shows the number of scour failures per year implied by the probabilities of failure.

The first row in this figure shows the result of applying the original HYRISK probabilities to the bridge population – in other words, the original HYRISK probabilities imply that about 60,511 bridges fail each year due to scour. The second row in the figure shows the result of multiplying the original HYRISK probabilities by 0.00121

(0.000206/0.1698), which effectively reduces the total number of scour failures per year to about 73 per year. The third row in the figure shows the effect of adjusting the probabilities of failure for scour vulnerabilities equal to 1 through 4. To understand this adjustment, recall that any bridge with a low scour vulnerability rating is more vulnerable to scour than a bridge with a high scour vulnerability rating. Thus, this adjustment basically assumes that bridges with a scour vulnerability of 4 or less are probably more likely to fail than the result of the first adjustment – in other words, this adjustment raises the total number of scour failures to about 117 per year. The fourth and final row in the figure shows the effect of rounding off most of the probabilities to two significant digits and recognizing that any bridge with a scour vulnerability rating equal to 0 means that it has already failed.

The final adjustment in (the fourth row) in Figure 7 shows that the adjusted probabilities of failure imply that about 109 bridges fail per year due to scour, which is a little more conservative than the interviews regarding bridge failure indicated. However, these probabilities are much more consistent with experience than the original HYRISK method, and thus should yield much more reasonable risk factors. Thus, these are the probabilities used in the “*Scour Risk Management Guidelines*” section of the report. Figure 8 plots these probabilities of failure versus scour vulnerability and overtopping frequency in a way that should help the reader understand the next section better. Note that scour vulnerability is displayed along the x-axis, while overtopping frequency is displayed with different symbols, which are explained in the legend.

It should be noted again that the inverse of annual probability of failure has the same units as a return period, but this should not be confused with the expected design life of a bridge (see “*Performance-Based versus Traditional Design Practice*” in the *Introduction*). In other words, the probability of failure is a measure of the expected performance of a bridge; but its inverse is not an explicit measure of its expected design life.

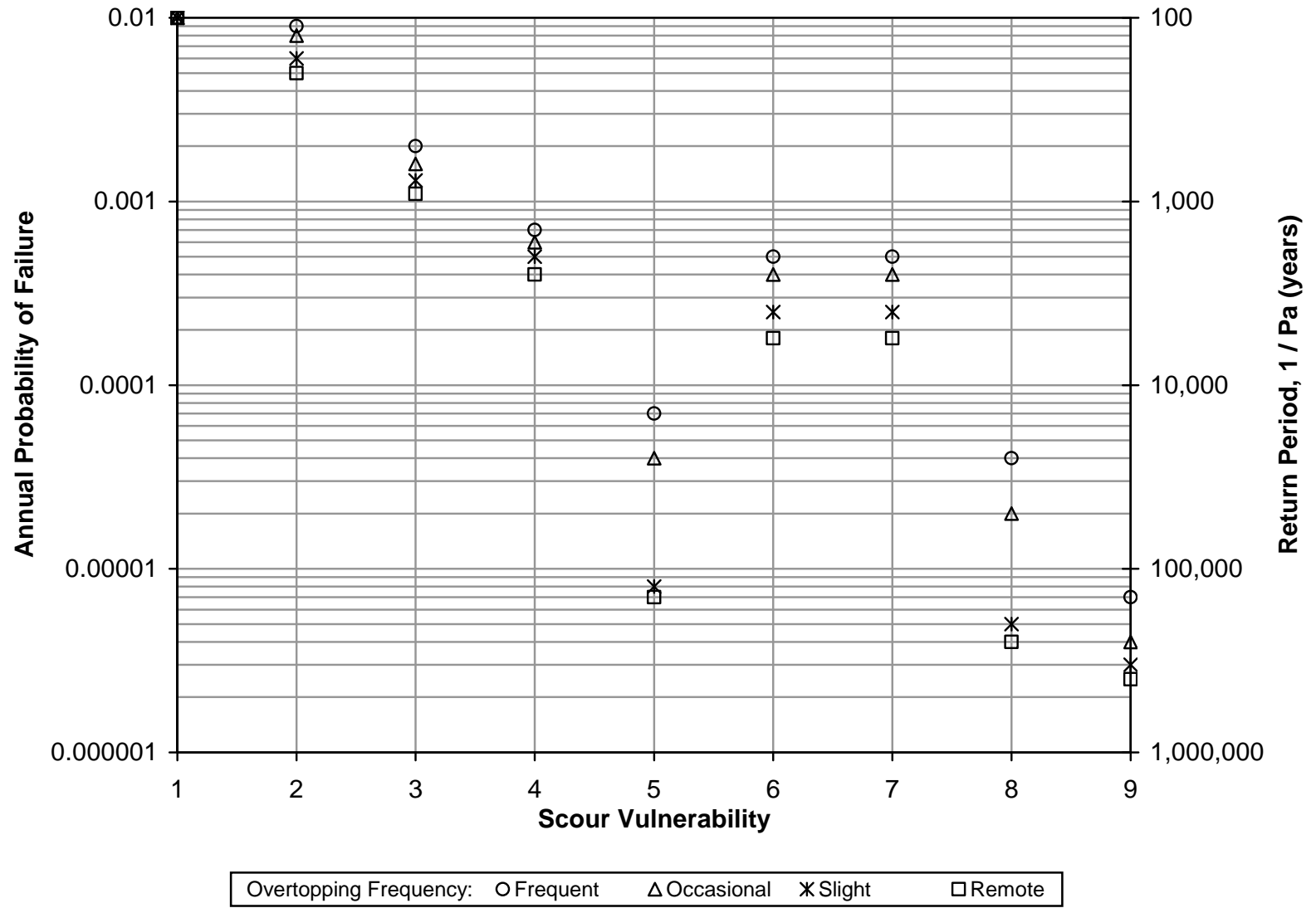

Figure 8 Final annual probability of failure estimates

Minimum Performance Levels

The scour guidelines also include minimum performance levels (MPL) for bridges with unknown foundations. MPLs are designed to ensure that any bridge with an unknown foundation and a high (estimated) annual probability of scour failure is automatically selected for foundation reconnaissance to determine the foundation and obtain a scour assessment. Given the uncertainty associated with predicting the scour vulnerability of a bridge with an unknown foundation, the MPL for such bridges should be a function of bridge importance – i.e. functional classification (NBI item 26). One important consideration regarding the selection of MPLs is that the bridge failure interviews indicated that the average annual probability of scour failure nation-wide is approximately 0.0002. Thus, important bridges (e.g. principal arterials) might be held to a minimum performance greater than 0.0002, while less important bridges (e.g. locals) might suffice with a minimum performance less than 0.0002. This is the basic premise behind the MPLs given in Table 14, which are used in the scour guidelines.

Table 14 Minimum Performance Levels for Bridges

NBI Code	Description	Minimum Performance Level <i>(Threshold Probability of Failure)</i>
<i>Rural</i>		
01, 02	Principal Arterial – All	0.0001
06, 07	Minor Arterial or Major Collector	0.0005
08	Minor Collector	0.001
09	Local	0.002
<i>Urban</i>		
11, 12, 14	Principal Arterial – All	0.0001
16	Minor Arterial	0.0002
17	Collector	0.0005
19	Local	0.002

Any bridge with an unknown foundation and an annual probability of failure greater than or equal to the corresponding MPL in this table should be enrolled in the safest management plan, starting with foundation reconnaissance to determine the foundation.

Figure 9 shows these MPLs within the context of Figure 8 according to NBI item 26 – functional classification. In other words, any bridge that has a probability of failure below the corresponding MPL line in Figure 9 meets the MPL. Note that meeting the standard set by a MPL in this context simply means that a bridge meets the minimum standard for its classification or importance. Such bridges may still have a risk of failure that prompts the scour guidelines to recommend additional action.

Finally, Figure 10 shows the MPLs in Figure 9 superimposed on Figure 8. This figure shows how the MPLs relate to the annual probabilities of failure. For example, this figure shows that a rural minor arterial – NBI item 26 = “06” – must have an annual probability of failure less than 0.0005 in order to meet the MPL. The figure also shows that this means that a rural minor arterial will only pass the minimum standard if any of the following conditions are true:

- Scour vulnerability = 5, 8, or 9
- Scour vulnerability = 6 or 7, and overtopping frequency ≠ frequent
- Scour vulnerability = 4, and overtopping frequency = remote

Similarly, a rural minor collector – NBI item 26 = “08” – only passes the MPL if its scour vulnerability is greater than 3, while any principal arterial only passes the MPL if its scour vulnerability is equal to 5, 8 or 9.

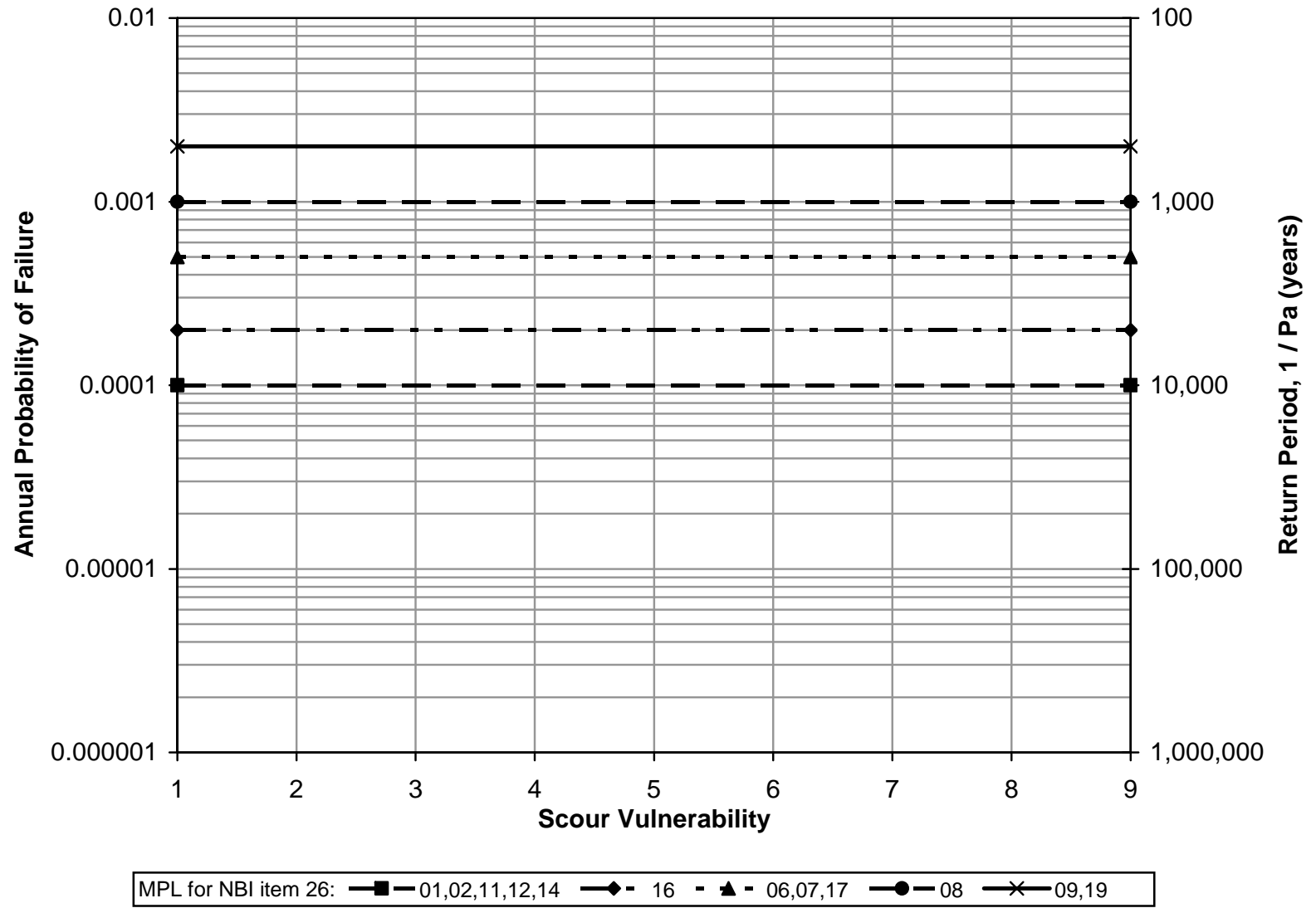

Figure 9 Minimum performance levels for each functional classification

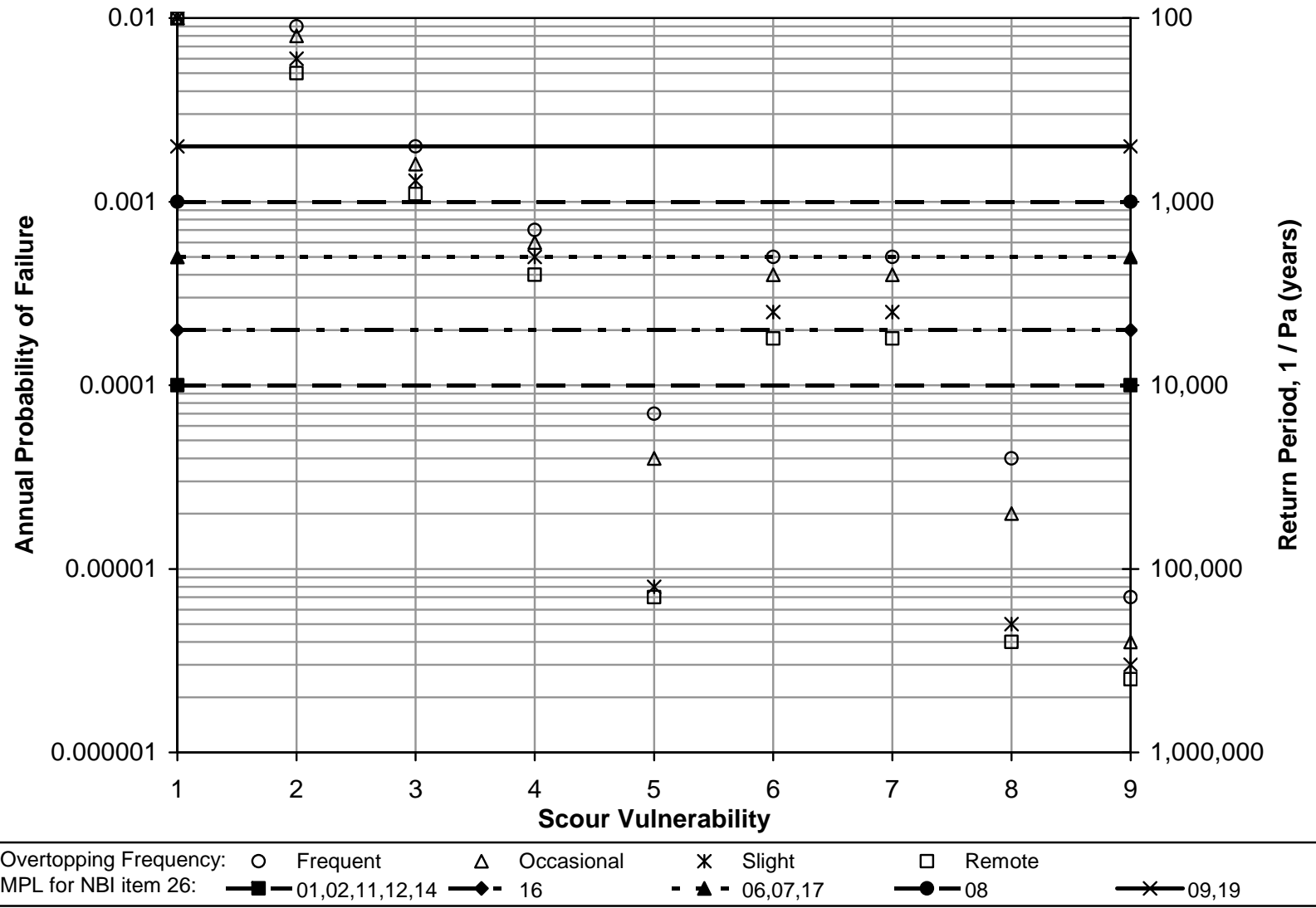

Figure 10 Annual probability of failure and minimum performance levels

APPENDIX E. NON-DESTRUCTIVE EVALUATION

Introduction

It is anticipated that guidelines for managing bridges with unknown foundations will likely include some investigation of the foundation to eliminate as much uncertainty as possible. Therefore, the literature search included information on non-destructive evaluation techniques that could be employed to provide at least some additional information on the type and depth of unknown bridge foundations.

The National Cooperative Highway Research Program (NCHRP) 21-5 project “Determination of Unknown Subsurface Bridge Foundations” (1) and the NCHRP 21-5(2) project “Unknown Subsurface Bridge Foundation Testing” (2) were performed to evaluate and develop existing and new technologies that can determine unknown subsurface bridge foundation depths. The NCHRP 21-5 Phase I research focused on the identification of potential NDE methods for determining depths of unknown bridge foundations at 7 bridges in Colorado, Texas and Alabama. The NCHRP 21-5 (2) Phase II research focused on evaluating the validity and accuracy of the identified NDE methods for determining depths of unknown bridge foundations. In this phase, 21 bridge sites were studied in North Carolina, Minnesota, New Jersey, Michigan, Oregon, Massachusetts and Colorado. Phase II research also involved the development of hardware and software needed to perform the NDE testing. Please note that this section is intended to provide a simple, quick summary of the most important findings of the NCHRP 21-5 and 21-5(2) research. Full details of the findings, including additional data and full discussions of methods, test locations, etc., can be found in the final reports for each of these stages of the research.

The research found that the borehole Parallel Seismic (PS) and surface Ultraseismic (US) methods were the most applicable methods for determining unknown foundation depths. A number of other NDE methods were also investigated in the research and found

to have more limited applications. These more limited NDE methods are also discussed herein and include the Sonic Echo/Impulse Response (SE/IR), Bending Waves (BW), Spectral Analysis of Surface Waves (SASW) surface methods and the Induction Field (IF) and Ground Penetrating Radar (GPR) borehole methods. Although the Crosshole Tomography method used for imaging of drilled shaft foundation defects was discussed during the NCHRP research, due to budget limitations and the requirement for two or more borings this method was not researched at that time. It is discussed herein for completeness as it has since been applied to the unknown foundation problem.

Surface NDE Methods

Brief discussions of the surface-based Sonic Echo/Impulse Response, Bending Wave, Ultraseismic, and Spectral Analysis of Surface Waves NDE methods for determination of unknown bridge foundation depths are presented below.

Sonic Echo/Impulse Response (SE/IR) Test In the Sonic Echo/Impulse Response test (see Figure 11), the source and receiver are placed on the top and/or sides of the exposed pile or column as the following figure. The depth of the reflector, e.g., a pile bottom, is calculated using the identified sound (compression) wave echo time(s) for SE tests, or resonant peaks for IR tests due to the applied source impact.

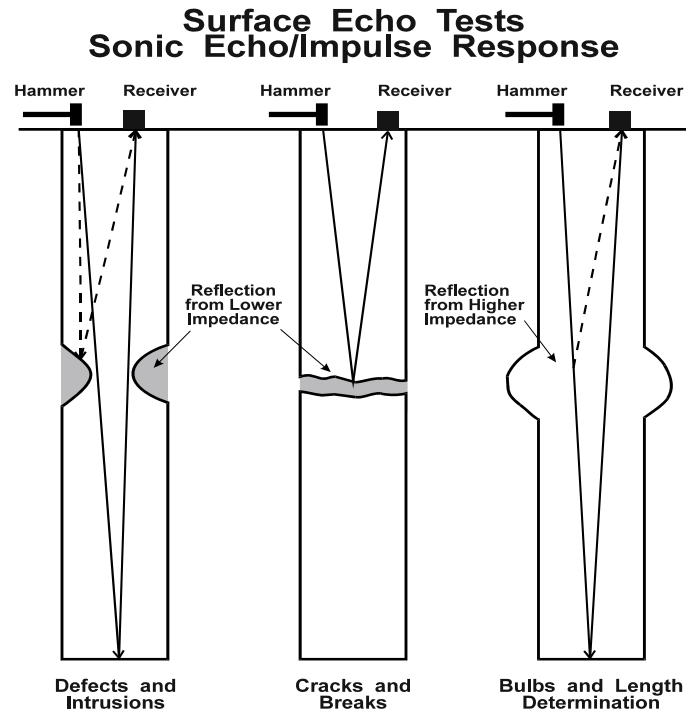
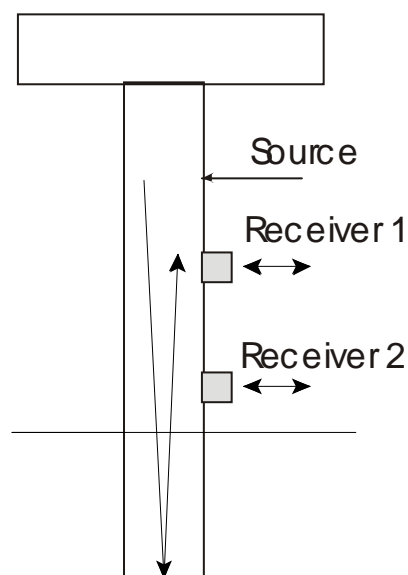

Figure 11 Surface echo tests

Bending Wave (BW) Test The Bending Wave (BW) test (see Figure 12) is based on the dispersion characteristics and echoes of bending waves traveling along very slender members like piles. The method was first developed for timber piles. The method involves mounting two horizontal receivers a few feet apart on one side of an exposed pile, and then impacting the pile horizontally on the opposite side of the pile a few feet above the topmost receiver in an attempt to identify an echo of bending wave energy from the pile tip as shown in the following figure. Analyses may be performed on BW data by the Short Kernel Method in the time domain (similar to filtering in an SE test), or from modal analysis in the frequency response domain (like the Impulse Response method). The BW method was found in the research to be limited to comparatively short pile foundations in soft soil conditions.



Timber Pile

Figure 12 Bending waves method

Ultraseismic (US) Test The Ultraseismic test (see Figure 13) involves impacting exposed substructure to generate and record the travel of compression or flexural waves down and up substructure at multiple receiver locations on the substructure as shown in the following figure. This test combines the capabilities of the SE/IR and BW measurements with geophysical processing to separate reflections of wave energy coming from foundation elements versus reflections from the top of exposed substructure. The US method was found to be more accurate and applicable than the SE/IR or BW tests.

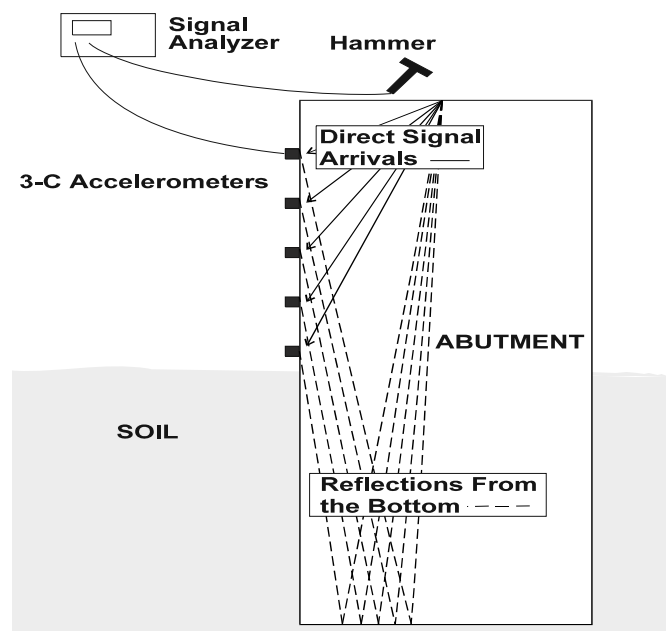

Figure 13 Ultraseismic testing method

Spectral Analysis of Surface Waves (SASW) Test The Spectral Analysis of Surface Waves (SASW) test (see Figure 14) involves determining the variation of surface wave velocity vs. depth in layered systems as shown in the following figure. The bottom depths of wall shaped pier and abutment substructures or footings can be determined if they have suitable flat, horizontal and exposed surfaces for testing. The foundation element bottoms are indicated by the slower velocity of surface wave travel in underlying soils. This test was found to be very applicable for these types of foundations where the foundation depths were less than or equal to $2/3$ the width of the accessible flat test surface.

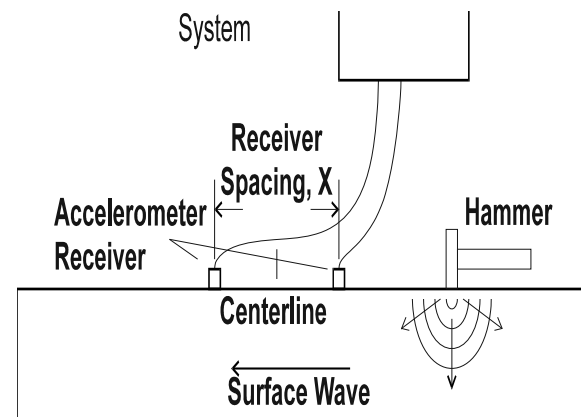

Figure 14 Spectral analysis of surface waves test

Borehole NDE Methods

Brief discussions are presented below of the borehole-based Parallel Seismic, Induction Field and Borehole Radar NDE methods for determination of unknown bridge foundation depths.

Parallel Seismic (PS) Test The Parallel Seismic (PS) test (see Figure 15) consists of impacting exposed foundation substructure either vertically or horizontally with an impulse hammer to generate compression or flexural waves which travel down the foundation and are transmitted into the surrounding soil as shown in the following figure. The refracted compression (or shear) wave arrival is tracked at regular intervals by a hydrophone receiver suspended in a water-filled cased borehole (original PS procedure) or by a clamped three-component geophone receiver (new procedure-better for shear wave arrivals) in a cased or uncased borehole (if it stands open without caving). The depth of a foundation is typically indicated by a weaker and slower signal arrival below the tip of the foundation. Diffraction of wave energy from the foundation bottom was also found to be indicative of its depth in PS tests as well. The PS test was found to be the most accurate and widely applicable NDE method for determination of unknown bridge foundation depths of all tested NDE methods.

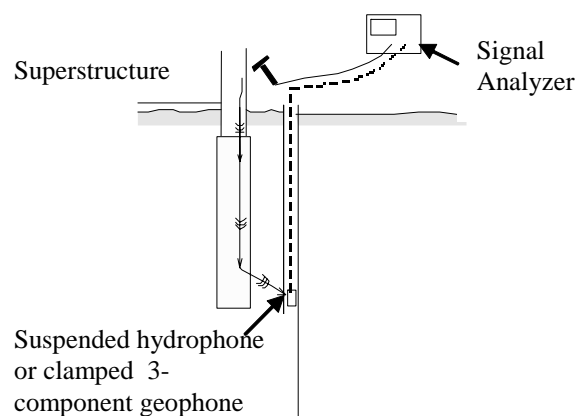

Figure 15 Parallel seismic method

Induction Field (IF) Test The Induction Field (IF) method (see Figure 16) is similar in its application to the Parallel Seismic method, but employs the use of electromagnetic waves instead of stress (sound) waves as shown in the following figure. An electromagnetic field is set up in the ground between a steel pile (or electrically continuous reinforced concrete foundation) and a steel electrode (or other electrically isolated steel containing foundation). A triaxial magnetic field search coil is used to measure the field strength in a PVC cased boring drilled within 1 m (3 ft) or less of the foundation that extends about 3 m (10 ft) below the foundation bottom. When the coil goes below the foundation the field amplitude decreases to a minimum thereby indicating the depth of a steel pile or reinforced foundation. Interpretation of the data from the Induction Field method is complicated by the existence of ferrous or other conductive materials in the bridge structure, and the presence of conductors (such as cables or pipes) in the ground around the pile. The IF test is only applicable to reinforced concrete foundations or steel piles that have accessible, electrically connected rebar/steel.

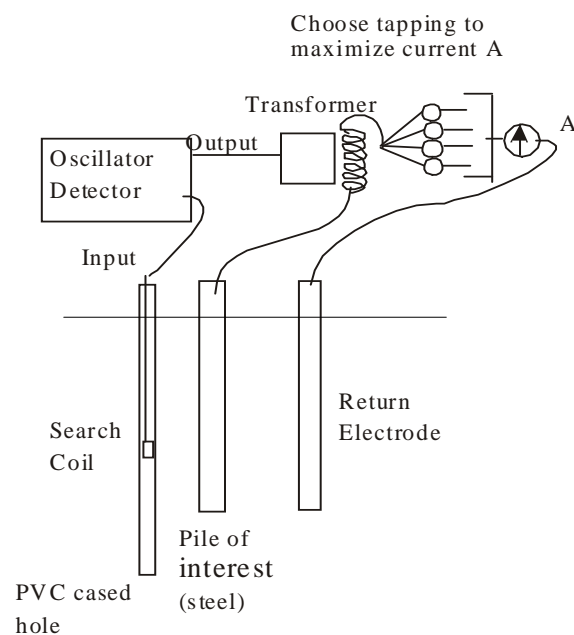

Figure 16 Induction field method

Borehole Radar (BHR) The Ground Penetrating Radar (GPR) method (see Figure 17) as applied in a borehole uses a transmitter/receiver radar antenna to measure the reflection of radar echoes from the side of the bridge substructure foundation as shown in the following figure. The BHR test is most sensitive to foundations of steel or with steel, as the electromagnetic wave energy reflects strongly from steel. The BHR method is limited in its application by wet, conductive clays and salt water as the wave energy is severely attenuated by these subsurface conditions with high dielectric constants.

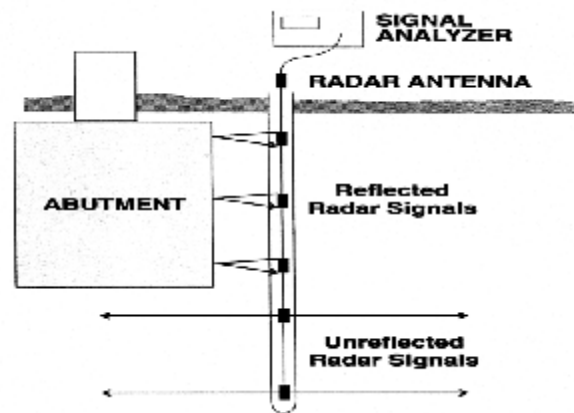

Figure 17 Borehole radar method

Crosshole Tomography The Crosshole Tomography (CT) method (see Figure 18) is commonly used to image defects in drilled shafts found by Crosshole Sonic Logging as shown in the following figure. However, where the tubes are inside the concrete shaft tied to the foundation cage for drilled shaft, CT of a bridge substructure involves drilling and typically casing two or more boreholes on opposite sides of an unknown bridge substructure foundation system which are outside of any foundation element. A sonic source is put in at least a borehole and either hydrophone (typically) or geophone (requires grouted casings) receivers are use to sense the arrival times of compressional wave energy for multiple angled ray paths. Straight- to curved-ray analyses are used to produce velocity tomograms and wave amplitude analyses can also be used to attempt to image the unknown foundation elements of a bridge substructure. NSA Engineering of Golden, Colorado has applied the subsurface CT imaging method to identify unknown foundation depths and geometries for piles below pile caps (www.nsaengineering.com). The accuracy and limitation of the CT method are largely unknown at this time and research is needed to further investigate the method.

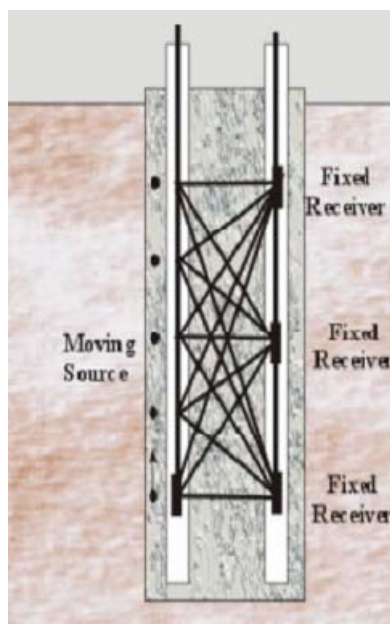

Figure 18 Crosshole tomography method

Selection of NDE Methods for Unknown Bridge Foundation Depths

The research showed that the borehole-based Parallel Seismic method was both the most accurate and most applicable NDE method for the determination of the depth of unknown bridge foundations for bridge scour safety evaluation purposes. This suggests that it would be valuable to initially perform at least one Parallel Seismic test for each bridge to check the accuracy of depth predictions from any other less costly surface methods that may also be applicable for a given foundation type of the bridge being tested. Ultraseismic or other surface methods that are subsequently proven to be accurate based on a comparison with the Parallel Seismic results may then be used with greater confidence to evaluate unknown foundation depths of other abutments and/or piers on a bridge.

It should be noted that as local experience is gained with the use of any of the borehole or surface NDE methods for typical local bridge substructure types and subsurface conditions, the accuracy and applicability of the methods will become much better known to DOT engineers. This local knowledge can then be used to further optimize the selection of NDE methods from technical and cost perspectives. Knowledge of unknown foundation bridge substructure will range from knowing only what is visible to having design drawings and subsurface geology information without as-built plans.

Effectiveness of NDE Methods

Table 15 shows the ranges of effectiveness of the various methods available for nondestructive evaluation of bridge foundations.

Table 15 Effectiveness of NDT Methods

Ability to Identify Foundation Parameters	Sonic Echo (SE)/Impulse Response (IR) Test (Compressional Echo)	Bending Wave (BW) Test (Flexural Echo)	Ultraseismic (US) Test (Compressional and Flexural Echo)	Spectral Analysis of Surface Wave (SASW) Test	Surface Ground Penetrating Radar (GPR) Test	Parallel Seismic (PS) Test	Borehole Radar (BHR) Test	Induction Field (IF) Test
<i>Foundation Parameters</i>								
Depth of Exposed Piles	Fair to Good	Poor to Good	Fair to Excellent			Good to Excellent	Poor to Excellent	None to Excellent
Depth of Footing/Cap Piles Exist Under Cap?	Poor to Good	Poor to Fair	Fair to Excellent	Fair to Good	Poor	Good	Poor to Good	
Depth of Pile below Cap?					Fair to Poor	Good	Fair to Good	None to Excellent
Geometry of Substructure			Fair	Poor to Good	Poor	Good to Excellent	Fair to Good	
Material Identification				Good	Poor to Fair	Poor to Fair	Poor to Fair	
<i>Access Requirements</i>								
Bridge Substructure	Yes	Yes	Yes	Yes	Yes	Yes	No	Yes
Borehole	No	No	No	No	No	Yes	Yes	Yes
Subsurface Complications	Low to High	Medium to High	Low to High	Low	High	Medium	High	Medium to High
Operational Cost	\$2,000 to \$2,500	\$2,000 to \$2,500	\$2,000 to \$2,500	\$2,000 to \$2,500	\$2,000 to \$2,500	\$2,000 to \$2,500	\$2,000 to \$2,500	\$2,000 to \$2,500
Equipment Cost	\$10,000 to \$20,000	\$15,000 to \$20,000	\$20,000	\$20,000	>\$30,000	\$15,000 to \$25,000	>\$35,000	\$20,000
<i>Required Expertise</i>								
Field Acquisition	Technician	Technician	Technician	Technician-Engineer	Technician-Engineer	Technician-Engineer	Engineer	Engineer
Data Analysis	Engineer	Engineer	Engineer	Engineer	Engineer	Engineer	Engineer	Engineer

Ability to Identify Foundation Parameters	Sonic Echo (SE)/Impulse Response (IR) Test (Compressional Echo)	Bending Wave (BW) Test (Flexural Echo)	Ultraseismic (US) Test (Compressional and Flexural Echo)	Spectral Analysis of Surface Wave (SASW) Test	Surface Ground Penetrating Radar (GPR) Test	Parallel Seismic (PS) Test	Borehole Radar (BHR) Test	Induction Field (IF) Test
Limitations	Most useful for columnar or tabular structures. Response complicated by bridge superstructure elements. Stiff soils and rock limit penetration.	Only useful for purely columnar substructure, softer soils, and shorter piles. Response complicated by various bridge superstructure elements, and stiff soils may show only depth to stiff soil layer.	Cannot image piles below cap. Difficult to obtain foundation bottom reflections in stiff soils.	Cannot image piles below cap. Use restricted to bridges with flat, longer access for testing.	Signal quality is highly controlled by environmental factors. Adjacent substructure reflections complicate data analysis. Higher cost equipment.	Difficult to transmit large amount of seismic energy from pile caps to smaller (area) piles.	Radar response is highly site dependent (very limited response in conductive, clayey, salt-water saturated soils).	It requires the reinforcement in the columns to be electrically connected to the piles underneath the footing. Only applicable to steel or reinforced substructure.
Advantages	Lower cost equipment and inexpensive testing. Data interpretation for pile foundations may be able to be automated using neural network. Theoretical modeling should be used to plan field tests.	Lower cost equipment and inexpensive testing. Theoretical modeling should be used to plan field tests. The horizontal impacts are easy to apply.	Lower equipment and testing costs. Can identify the bottom depth of foundation inexpensively for a large class of bridges. Combines compressional and flexural wave reflection tests for substructures.	Lower equipment and testing costs. Also shows variation of bridge material and subsurface velocities (stiffnesses) vs. depth and thicknesses of accessible elements.	Fast testing times. Can indicate geometry of accessible elements and bedrock depths. Lower testing costs.	Lower equipment and testing costs. Can detect foundation depths for largest class of bridges and subsurface conditions.	Commercial testing equipment is now becoming available for this purpose. Relatively easy to identify reflections from the foundation; however, imaging requires careful processing.	Low equipment costs and easy to test. Could work well to complement PS tests and help determine pile type.

NDE Conclusions

The NCHRP 21-5 and 21-5(2) research resulted in greatly improved understanding of the applicability and accuracy of such NDE methods using sonic, ultrasonic, seismic, magnetic and electromagnetic techniques. Of all of the methods researched, the borehole Parallel Seismic Method was found to be the most accurate and versatile method for determining unknown foundation depths for the broadest range of foundation types. The surface Ultraseismic Method was found to be the most accurate method for determining single substructure element depths such as piles, piers, abutments, etc. However, the Ultraseismic and other surface methods do not provide data on the elements below the first major change in cross-section, such as a pier with a pilecap on piles, where the piles will not be detected.

References

1. Olson, L.D., F. Jalinoos, and M.F. Aouad. *NCHRP Final Report 21-5: Determination of Unknown Subsurface Bridge Foundations*. Federal Highway Administration, Washington D.C., August, 1995.
2. Olson, L.D., and M.F. Aouad. *NCHRP Final Report 21-5 (2): Unknown Subsurface Bridge Foundation Testing*. Federal Highway Administration, Washington, D.C., June, 2001.

APPENDIX F. SCOUR MANAGEMENT CASE STUDIES

Table 16 lists the Department of Transportation officials in six States who were invited to participate in a case study of the proposed scour guidelines. These six states were selected for their interest in guidelines for managing bridges with unknown foundations, and for their willingness to complete the survey.

Table 16 Case Study Respondents

State	Name	Job Title	Survey Completion Time
California	Steve Ng	Chief of structure hydraulics and hydrology	1 month
Florida (1/2)	Richard Semple	Structures management coordinator	2 weeks
Florida (1/2)	Manuel Luna	Assistant structure coordinator	3 weeks
New York	Robert Burnett	Director of geotechnical engineering bureau	2 weeks
North Carolina	Mohammed Mulla	Assistant state geotechnical engineer	1 month
Tennessee	Wayne Seger	Civil engineering manager II	2 weeks
Texas	Alan Kowalik	Bridge inspection branch manager	2 weeks

The Initial Bridge Survey

The following three pages is a sample of the survey that each official was asked to complete for each one of the ten bridges (over water) they select in their state. In selecting bridges, they were asked to keep the following criteria in mind:

- All the bridges selected should be “over water” (i.e. NBI item 113 ≠ “N”).
- At least half of the bridges selected should have unknown foundations (i.e. NBI item 113 = “U”).
- Include one bridge that has already failed due to scour if the supporting data for such a case study is available.

They were also asked to indicate whether each bridge provides critical access to emergency services (e.g. for a hospital or an evacuation route). Tennessee and Texas responded that they have little or no practical experience with using any field

reconnaissance methods, and Tennessee requested the NDE literature review from this report in order to estimate this cost.

Bridge #__**Example Page 1**

Respondent Information

Name	E-mail Address
Job Title	Phone
Job Description (In what way does your job involve bridge maintenance?)	Mailing Address

Bridge Description

Please provide a general description of the bridge including its name, location, route, and water body.

National Bridge Inventory (NBI) Data

Please provide the following information for the bridge. This information should be available in the NBI database. Please provide the NBI Database Values consistent with those required in the 2002 NBI Coding Guide, and specify the units (where appropriate).		
NBI Item No.	NBI Item Description	NBI Database Value
1	State Code	
5	Inventory Route	
8	Structure Number	
19	Bypass, Detour Length (e.g. in miles)	
26	Functional Classification of Inventory Route	
27	Year Built	
29	Average Daily Traffic	
49	Structure Length (e.g. in feet)	
52	Deck Width, Out-to-Out (e.g. in feet)	
60	Substructure	
61	Channel and Channel Protection	
71	Waterway Adequacy	
109	Average Daily Truck Traffic	
113	Scour Critical Bridges (2002 NBI Guidelines)	

Example Page 2**Undocumented Assumptions**

Please provide the following information for the bridge which is not documented in the NBI database.	
Description	User Input
Bridge Type (check only one)	<input type="checkbox"/> Simple Span(s) <input type="checkbox"/> Continuous Span(s) over 100 ft.
Remaining life of bridge in years. If this bridge has already failed, report the actual lifetime of the bridge before it failed	_____ years
Total Bridge Rebuilding Cost, if known. If unknown, estimate the cost by multiplying the bridge area by the cost per unit area as shown in Table 1 and the ADT cost multiplier as shown in Table 2. If estimated, provide the assumptions used in the spaces below:	\$ _____
Bridge Area: _____ ft ² ; Cost per unit area: _____ \$/ft ² ; Cost Multiplier: _____	

Economic Loss Data

Please provide the following economic factors to be associated with the failure of this bridge. Either check the box confirming that the default factor is to be used or provide a different value.		
Description	Default Value	User-Provided Value
Car running cost	\$0.45 per mile <input type="checkbox"/>	
Truck running cost	\$1.30 per mile <input type="checkbox"/>	
Duration of detour *	Use Table 2 (days) <input type="checkbox"/>	
Value of time per adult *	Use Table 3 (\$/hr) <input type="checkbox"/>	
Average car occupancy rate	1.63 people <input type="checkbox"/>	
Value of time for trucks	\$22.01 per hour <input type="checkbox"/>	
Average detour speed	40 miles per hour <input type="checkbox"/>	
Number of deaths from failure *	Use Table 2 (Number of people) <input type="checkbox"/>	
Cost for each life lost	\$500,000 <input type="checkbox"/>	

* Please select an appropriate value from the reference table listed.

Cost of Analysis or Corrective Actions

Provide estimates for the following costs. Keep in mind that these costs may depend on a number of factors, e.g., the number of piers, abutments, etc. Also keep in mind that the guidelines include many significant broad assumptions, so significant effort is not warranted in estimating this data.	
Description	User Input
Estimated cost of installing automated scour monitoring	\$ _____
Estimated cost of installing scour countermeasures	\$ _____
Estimated cost of field reconnaissance to determine foundation type and depth (nondestructive testing, borings, etc.)	\$ _____
Estimated cost to evaluate scour (survey, hydrology, and hydraulics analysis, if unavailable)	\$ _____

Table 1 Cost of Bridge Construction**Example Page 3**

Bridge Superstructure Type	Total Cost (\$/ft ²)
Reinforced concrete flat slab; simple span	\$50-65*
Reinforced concrete flat slab; continuous span	\$60-80*
Steel deck/girder; simple span	\$62-75*
Steel deck/girder; continuous span	\$70-90*
Pre-stressed concrete deck/girder; simple span	\$50-70*
Pre-stressed concrete deck/girder; continuous span	\$65-110*
Post-tensioned, cast-in-place, concrete box girder cast on scaffolding; span length <=240 ft	\$75-110
<i>Steel Box Deck/Girder:</i>	
Span range from 150 ft to 280 ft	\$76-120
For curvature add a 15 percent premium segmental concrete box girders; span range from 150 ft to 280 ft	\$80-110
Movable bridges; bascule spans & piers	\$900-1500
<i>Demolition of existing bridges:</i>	
Typical	\$9-15
Bascule spans & piers	\$63

* Increase the cost by twenty percent for phased construction.

Source: <http://www.dot.state.fl.us/structures/Manuals/LRFDSDG2002AugChap11.pdf> visited on January 12, 2005.**Table 2 Bridge Failure Statistics versus Average Daily Traffic**

Average Daily Traffic (ADT)	Cost Multiplier for Early Replacement	Detour Duration (days)	Number of Lives Lost
ADT < 100	1.0	1,095	0
100 < ADT < 500	1.1	730	1
500 < ADT < 1000	1.25	548	2
1000 < ADT < 5000	1.5	365	2
ADT > 5000	2.0	183	5* - 10†

* Not an interstate or arterial. † Interstate or arterial.

Table 3 Values of Time by State

State	Value of time (\$/hour)	State	Value of time (\$/hour)
Alabama	\$6.29	Montana	\$5.89
Alaska	\$8.31	Nebraska	\$6.51
Arizona	\$6.88	Nevada	\$6.76
Arkansas	\$5.83	New Hampshire	\$7.38
California	\$8.27	New Jersey	\$8.48
Colorado	\$7.85	New Mexico	\$6.51
Connecticut	\$8.75	New York	\$8.59
Delaware	\$7.70	North Carolina	\$6.72
District of Columbia	\$11.43	North Dakota	\$6.04
Florida	\$6.65	Ohio	\$7.08
Georgia	\$7.06	Oklahoma	\$6.14
Guam	\$5.41	Oregon	\$7.29
Hawaii	\$7.24	Pennsylvania	\$7.09
Idaho	\$6.46	Puerto Rico	\$4.35
Illinois	\$7.61	Rhode Island	\$7.54
Indiana	\$6.67	South Carolina	\$6.29
Iowa	\$6.31	South Dakota	\$5.73
Kansas	\$6.66	Tennessee	\$6.45
Kentucky	\$6.34	Texas	\$6.96
Louisiana	\$6.16	Utah	\$6.72
Maine	\$6.60	Vermont	\$6.83
Maryland	\$8.15	Virgin Islands	\$5.58
Massachusetts	\$8.93	Virginia	\$7.71
Michigan	\$7.80	Washington	\$8.06
Minnesota	\$7.85	West Virginia	\$6.01
Mississippi	\$5.65	Wisconsin	\$6.95
Missouri	\$6.79	Wyoming	\$6.41

State wage data is from <http://www.bls.gov/oes/current/oesrcst.htm>, visited on January 12, 2006. This table assumes that the value of time is equal to 41% of the mean hourly wage, as proposed by José A. Gómez-Ibáñez, William B. Tye, Clifford Winston, "Essays in Transportation Economics and Policy: A Handbook in Honor of John R. Meyer", 1999.

Case Study Evaluations and Responses

After each state completed and returned the surveys, the “*Scour Risk Management Guidelines*” were applied to each case study. Then a one to two-page summary was written to explain how the guidelines selected a pertinent management plan. Note that each state also received a copy of three tables for calculating probability of failure and directions for creating a bridge closure plan (i.e. Tables 14–16 and “*Develop a Bridge Closure Plan*” from the main report). These summaries were returned to the survey respondents, who were then asked to comment on the recommendations. Each survey respondent was specifically asked to use the following questions to guide their comments:

- Do you agree with the final recommendation for each of the bridges with unknown foundations? Please explain with specific examples.
- Given the analysis that we have presented, do you have suggestions for improving the predicted vulnerability ratings? Please explain with specific examples.
- Do you have any concerns about using risk to select a management plan when a bridge foundation is truly unknown?
- Are there any other factors that might influence your risk management decisions?

All of the survey correspondence is presented in the next five subsections, which are organized by state, and then by case study. Each case study heading has the completed survey form and the management plan obtained from the “*Scour Risk Management Guidelines*”. All of the comments about the management summaries are presented after each State’s set of case studies because many of the comments apply to the general approach or to a comparison of case studies.

California Bridges*Bridge #1***The Initial Survey**

Respondent Information

Name Luis Avila	E-mail Address Luis_Avila@dot.ca.gov
Job Title Transportation Engineer	Phone (916) 227-8030
Job Description (In what way does your job involve bridge maintenance?) Substructure inspection for Bridges over water.	Mailing Address 1801 30 th St. Sacramento, CA 95816

Bridge Description

Please provide a general description of the bridge including its name, location, route, and water body.
North Arm Newport Bay, Bridge Number 55-0621M, District 12, Route 00001, Post Mile 18.38
A continuous two spans RC slab bridge on a single column RC bent and open-end RC diaphragm abutments, all are on driven RC piles.

National Bridge Inventory (NBI) Data

Please provide the following information for the bridge. This information should be available in the NBI database. Please provide the NBI Database Values consistent with those required in the 2002 NBI Coding Guide, and specify the units (where appropriate).		
NBI Item No.	NBI Item Description	NBI Database Value
1	State Code	069
5	Inventory Route	00001
8	Structure Number	55 0621M
19	Bypass, Detour Length (e.g. in miles)	No entry (1.9 mi)*
26	Functional Classification of Inventory Route	No entry (14)*
27	Year Built	1982
29	Average Daily Traffic	No entry (59,000)*
49	Structure Length (e.g. in feet)	113.84 ft
52	Deck Width, Out-to-Out (e.g. in feet)	No entry (11.6 ft)*
60	Substructure	7 - Good
61	Channel and Channel Protection	8 - Protected
71	Waterway Adequacy	8 - Equal Desirable
109	Average Daily Truck Traffic	No entry (0)*
113	Scour Critical Bridges (2002 NBI Guidelines)	U - Undefined Code

****This bridge has missing NBI data which was estimated using structure number "55 0614" since this bridge supports the same route over the same water body.***

Undocumented Assumptions

Please provide the following information for the bridge which is not documented in the NBI database.	
Description	User Input
Bridge Type (check only one)	<input checked="" type="checkbox"/> Simple Span(s) <input type="checkbox"/> Continuous Span(s) over 100 ft.
Remaining life of bridge in years. If this bridge has already failed, report the actual lifetime of the bridge before it failed	51 years
Total Bridge Rebuilding Cost, if known. If unknown, estimate the cost by multiplying the bridge area by the cost per unit area as shown in Table 1 and the ADT cost multiplier as shown in Table 2. If estimated, provide the assumptions used in the spaces below: Bridge Area: _____ ft ² ; Cost per unit area: _____ \$/ft ² ; Cost Multiplier: _____	\$200,000

Economic Loss Data

Please provide the following economic factors to be associated with the failure of this bridge. Either check the box confirming that the default factor is to be used or provide a different value.			
Description	Default Value		User-Provided Value
Car running cost	\$0.45 per mile	<input checked="" type="checkbox"/>	
Truck running cost	\$1.30 per mile	<input checked="" type="checkbox"/>	
Duration of detour *	Use Table 2 (days)	<input checked="" type="checkbox"/>	183
Value of time per adult *	Use Table 3 (\$/hr)	<input checked="" type="checkbox"/>	\$8.27
Average car occupancy rate	1.63 people	<input checked="" type="checkbox"/>	
Value of time for trucks	\$22.01 per hour	<input checked="" type="checkbox"/>	
Average detour speed	40 miles per hour	<input checked="" type="checkbox"/>	
Number of deaths from failure *	Use Table 2 (Number of people)	<input checked="" type="checkbox"/>	10
Cost for each life lost	\$500,000	<input checked="" type="checkbox"/>	

* Please select an appropriate value from the reference table listed.

Cost of Analysis or Corrective Actions

Provide estimates for the following costs. Keep in mind that these costs may depend on a number of factors, e.g., the number of piers, abutments, etc. Also keep in mind that the guidelines include many significant broad assumptions, so significant effort is not warranted in estimating this data.	
Description	User Input
Estimated cost of installing automated scour monitoring	\$25,000
Estimated cost of installing scour countermeasures	\$30,000
Estimated cost of field reconnaissance to determine foundation type and depth (nondestructive testing, borings, etc.)	\$20,000
Estimated cost to evaluate scour (survey, hydrology, and hydraulics analysis, if unavailable)	\$5,000

Scour Management Evaluation

1. Route 1 over the North Arm of Newport Bay

Bridge 55-0614 in Newport Beach, CA was constructed in 1982 and supports an urban principal arterial class road. This bridge has an unknown foundation depth and is not recorded in the NBI. It is further assumed that foundation records can not be found.

Is it a high-priority bridge?

This bridge supports an urban principal arterial, which provides access to emergency services and has significant economic value. *Thus, in this context this bridge is considered a high priority bridge* and should be given special attention.

Recommended management strategy

This bridge probably provides critical access to local services and has significant economic value. Thus, because this bridge has an unknown foundation the guidelines recommend the following three-step strategy to ensure the safety of this bridge.

1. Perform field reconnaissance to determine foundation type and depth. If the foundation is a spread footing, drill through the footing to determine elevation of the footing bottom. If the foundation is piles, use foundation reconnaissance to determine depth of piles. The parallel seismic test is generally the most effective reconnaissance method. Assume that the foundation information from the field evaluation is accurate. If field reconnaissance is unsuccessful (no access for testing, poor signal from NDT, etc.), assume a foundation depth. For piles, assume a 10 foot depth or use local knowledge. This should be a conservative assumption. Spread footing depths are easily discovered and an assumption should not be necessary for this type of foundation. In other words, continue as if the foundation is known.
2. Evaluate scour using FHWA HEC-18 manual.
3. If scour analysis indicates that countermeasures are warranted, countermeasures should be designed using FHWA HEC-23 manual – or consider replacing or closing the bridge.

Bridge #2

The Initial Survey

Respondent Information

Name Luis Avila	E-mail Address Luis_Avila@dot.ca.gov
Job Title Transportation Engineer	Phone (916) 227-8030
Job Description (In what way does your job involve bridge maintenance?) Substructure inspection for Bridges over water.	Mailing Address 1801 30 th St. Sacramento, CA 95816

Bridge Description

Please provide a general description of the bridge including its name, location, route, and water body.
San Luis Rey River, Bridge Number 57-0043Z, District 11, Route 00076, Post Mile 9.58
Parabolic RC girders (2) at end spans and RC arch spans with RC diaphragm abutments and RC piers (2 legs) all founded on spread footings except pier 5 and 6 are on timber piles

National Bridge Inventory (NBI) Data

Please provide the following information for the bridge. This information should be available in the NBI database. Please provide the NBI Database Values consistent with those required in the 2002 NBI Coding Guide, and specify the units (where appropriate).		
NBI Item No.	NBI Item Description	NBI Database Value
1	State Code	069
5	Inventory Route	00076
8	Structure Number	57 0043Z
19	Bypass, Detour Length (e.g. in miles)	No entry (50 mi)*
26	Functional Classification of Inventory Route	No entry (06)*
27	Year Built	1925
29	Average Daily Traffic	No entry (3,600)*
49	Structure Length (e.g. in feet)	671.91 ft
52	Deck Width, Out-to-Out (e.g. in feet)	23.95 ft
60	Substructure	No entry (6)*
61	Channel and Channel Protection	7 – Minor Damage
71	Waterway Adequacy	7 – Above Minimum
109	Average Daily Truck Traffic	No entry (1%)*
113	Scour Critical Bridges (2002 NBI Guidelines)	U – Undefined Code

****This bridge has missing NBI data which was estimated using structure number "57 0171" since this bridge supports the same route over the same water body.***

Undocumented Assumptions

Please provide the following information for the bridge, which is not documented in the NBI database.	
Description	User Input
Bridge Type (check only one)	<input checked="" type="checkbox"/> Simple Span(s) <input checked="" type="checkbox"/> Continuous Span(s) over 100 ft.
Remaining life of bridge in years. If this bridge has already failed, report the actual lifetime of the bridge before it failed	10 Years
Total Bridge Rebuilding Cost, if known. If unknown, estimate the cost by multiplying the bridge area by the cost per unit area as shown in Table 1 and the ADT cost multiplier as shown in Table 2. If estimated, provide the assumptions used in the spaces below: Bridge Area: _____ ft ² ; Cost per unit area: _____ \$/ft ² ; Cost Multiplier: _____	\$2,800,000

Economic Loss Data

Please provide the following economic factors to be associated with the failure of this bridge. Either check the box confirming that the default factor is to be used or provide a different value.			
Description	Default Value		User-Provided Value
Car running cost	\$0.45 per mile	<input checked="" type="checkbox"/>	
Truck running cost	\$1.30 per mile	<input checked="" type="checkbox"/>	
Duration of detour *	Use Table 2 (days)	<input checked="" type="checkbox"/>	365
Value of time per adult *	Use Table 3 (\$/hr)	<input checked="" type="checkbox"/>	\$8.27
Average car occupancy rate	1.63 people	<input checked="" type="checkbox"/>	
Value of time for trucks	\$22.01 per hour	<input checked="" type="checkbox"/>	
Average detour speed	40 miles per hour	<input checked="" type="checkbox"/>	
Number of deaths from failure *	Use Table 2 (Number of people)	<input checked="" type="checkbox"/>	2
Cost for each life lost	\$500,000	<input checked="" type="checkbox"/>	

* Please select an appropriate value from the reference table listed.

Cost of Analysis or Corrective Actions

Provide estimates for the following costs. Keep in mind that these costs may depend on a number of factors, e.g., the number of piers, abutments, etc. Also keep in mind that the guidelines include many significant broad assumptions, so significant effort is not warranted in estimating this data.	
Description	User Input
Estimated cost of installing automated scour monitoring	\$45,000
Estimated cost of installing scour countermeasures	\$2,800,000
Estimated cost of field reconnaissance to determine foundation type and depth (nondestructive testing, borings, etc.)	\$20,000
Estimated cost to evaluate scour (survey, hydrology, and hydraulics analysis, if unavailable)	\$5,000

Scour Management Evaluation

2. State Route 76 over San Luis Rey River

Bridge 57-0043Z in San Diego County, CA was constructed in 1925 and supports a rural minor arterial class road. This bridge has an unknown foundation depth and is not recorded in the NBI. It is further assumed that foundation records can not be found.

Is it a high-priority bridge?

This bridge supports a rural road, which is not a principal arterial, emergency evacuation route, and does not provide direct access to other emergency services (e.g. hospital, fire stations, etc.). *Thus, in this context this bridge is not considered a high priority bridge.*

Does the bridge meet the minimum performance level?

The minimum performance level for a rural minor arterial class bridge, according to the Guidelines, is 0.0005 – the threshold probability of failure that this bridge must outperform. To estimate this bridge’s annual probability of failure, it is first necessary to estimate the overtopping frequency and scour vulnerability of this bridge, as in the table below.

Data/Parameter (source)	Value	Interpretation
NBI item 26 (12/2005 NBI database)	6*	Rural minor arterial classification
NBI item 71 (bridge survey)	7	Waterway exceeds the minimum criteria
∴ Overtopping Frequency (guidelines)	S	Slight (once in 11-100 years)
NBI item 60 (12/2005 NBI database)	6*	Foundation is in satisfactory condition
NBI item 61 (bridge survey)	7	Channel has some minor drift and damage
∴ Scour Vulnerability (guidelines)	6	Not yet evaluated, but probably stable
∴ Annual probability of failure (guidelines)	0.00025	A 1 in 4,000 chance of failure in any given year

*Missing NBI values were selected based on a parallel bridge (NBI item 8 = “57-0171”).

This bridge meets the minimum performance level because the annual probability of failure is less than 0.0005. However, because the foundation is unknown, we need to determine the most cost effective way to manage this uncertainty.

Is automated scour monitoring warranted?

Automated scour monitoring is considered warranted if the risk of death is greater than the cost of automated scour monitoring. The lifetime probability of failure for this bridge can be computed from the annual probability of failure and its tentative remaining life (10 years, according to the survey respondent) as follows: $1 - (1 - 0.00025)^{10}$, or about 0.0025 (a 1 in 400 chance of failure in the next 10 years). This and other survey data are now used to calculate the risk of death as follows:

$$R_{death} = K \cdot P_L \cdot C_6 \cdot X$$

$$= (0.67) \cdot (0.0025 / yr) \cdot (\$500,000 / person) \cdot (2 people) = \$2,497$$

Since the cost of automated scour monitoring was estimated to be \$45,000 and the risk of death is \$2,497, *automated scour monitoring is probably not warranted.*

Are scour countermeasures warranted?

Scour countermeasures are considered warranted if the lifetime risk of failure is greater than the estimated cost of scour countermeasures, which the survey respondent estimated to be about \$2,800,000. The first step in estimating the risk of failure is to estimate the potential cost of failure, assuming that it would need to be replaced. The survey respondent estimated that a new bridge would cost about \$2,800,000. The car and truck running cost associated with the detour for this bridge is computed from the survey data (partly from bridge #57-0171) as follows:

$$\begin{aligned} C_{\text{running}} &= \left[C_2 \cdot \left(1 - \frac{T}{100} \right) + C_3 \cdot \frac{T}{100} \right] \cdot D \cdot A \cdot d \\ &= \left[\$0.45 / \text{mi} \cdot \left(1 - \frac{1}{100} \right) + \$1.30 / \text{mi} \cdot \frac{1}{100} \right] \cdot (50 \text{ mi}) \cdot (3600 / \text{day}) \cdot (365 \text{ days}) \\ &= \$30,123,450 \end{aligned}$$

The cost of lost wages is computed from the survey data as follows:

$$\begin{aligned} C_{\text{wages}} &= \left[C_4 \cdot O \cdot \left(1 - \frac{T}{100} \right) + C_5 \cdot \frac{T}{100} \right] \cdot \frac{D \cdot A \cdot d}{S} \\ &= \left[(\$8.27 / \text{per}) \cdot (1.63 \text{ per}) \cdot \left(1 - \frac{1}{100} \right) + (\$22.01 / \text{truck}) \cdot \frac{1}{100} \right] \cdot \frac{(50 \text{ mi}) \cdot (3600 / \text{day}) \cdot (365 \text{ days})}{40 \text{ mi} / \text{hr}} \\ &= \$22,281,168 \end{aligned}$$

When we include the cost of death, the total cost of bridge failure totals \$56,204,618. Computing the risk of a scour-induced failure over the remaining life of the bridge is just the product of 0.67, the lifetime probability of failure, and the total cost of failure – about \$94,037. *Thus, scour countermeasures are probably not warranted* because the lifetime risk of failure is less than the estimated cost of scour countermeasures.

Recommended management strategy

This bridge meets the performance standards for these guidelines and does not appear to warrant automated scour monitoring or countermeasures (assuming that scour countermeasures really costs the same as a new bridge). However, because this bridge has an unknown foundation the guidelines strongly recommend that you follow the recommendations in the “Bridge Closure Plan” section of this report.

Furthermore, scour monitoring should be performed with every 2-yr routine bridge inspection for all bridges with unknown foundations. If the scour depth increases more than two feet from baseline conditions (as-built drawings or initial scour survey), action should be taken. The first action is to follow the “Bridge Closure Plan” to take any necessary immediate action. Countermeasures should then be considered for this site; or close or replace the bridge. This two foot trigger can be adjusted based on local geotechnical and engineering considerations and should represent the depth of scour that the bridge engineer feels comfortable with for the individual bridge.

Bridge #3

The Initial Survey

Respondent Information

Name Luis Avila	E-mail Address Luis_Avila@dot.ca.gov
Job Title Transportation Engineer	Phone (916) 227-8030
Job Description (In what way does your job involve bridge maintenance?) Substructure inspection for Bridges over water.	Mailing Address 1801 30 th St. Sacramento, CA 95816

Bridge Description

Please provide a general description of the bridge including its name, location, route, and water body.
San Felipe Creek, Bridge Number 57-0096, District 11, Route 00078, Post Mile 72.92
Continuous 5 span RC haunched T-girders (3) with cantilever end spans on 2 column bents on spread footings.

National Bridge Inventory (NBI) Data

Please provide the following information for the bridge. This information should be available in the NBI database. Please provide the NBI Database Values consistent with those required in the 2002 NBI Coding Guide, and specify the units (where appropriate).		
NBI Item No.	NBI Item Description	NBI Database Value
1	State Code	069
5	Inventory Route	00078
8	Structure Number	57 0096
19	Bypass, Detour Length (e.g. in miles)	19.88 mile
26	Functional Classification of Inventory Route	06-Rural Minor Arterial
27	Year Built	1948
29	Average Daily Traffic	1150
49	Structure Length (e.g. in feet)	165.03 ft
52	Deck Width, Out-to-Out (e.g. in feet)	28.54 ft
60	Substructure	7 - Good
61	Channel and Channel Protection	8 - Protected
71	Waterway Adequacy	8 – Equal Desirable
109	Average Daily Truck Traffic	1
113	Scour Critical Bridges (2002 NBI Guidelines)	U – Undefined Code

Undocumented Assumptions

Please provide the following information for the bridge which is not documented in the NBI database.	
Description	User Input
Bridge Type (check only one)	<input checked="" type="checkbox"/> Simple Span(s) <input type="checkbox"/> Continuous Span(s) over 100 ft.
Remaining life of bridge in years. If this bridge has already failed, report the actual lifetime of the bridge before it failed	18 years
Total Bridge Rebuilding Cost, if known. If unknown, estimate the cost by multiplying the bridge area by the cost per unit area as shown in Table 1 and the ADT cost multiplier as shown in Table 2. If estimated, provide the assumptions used in the spaces below: Bridge Area: _____ ft ² ; Cost per unit area: _____ \$/ft ² ; Cost Multiplier: _____	\$900,000

Economic Loss Data

Please provide the following economic factors to be associated with the failure of this bridge. Either check the box confirming that the default factor is to be used or provide a different value.			
Description	Default Value		User-Provided Value
Car running cost	\$0.45 per mile	<input checked="" type="checkbox"/>	
Truck running cost	\$1.30 per mile	<input checked="" type="checkbox"/>	
Duration of detour *	Use Table 2 (days)	<input checked="" type="checkbox"/>	365
Value of time per adult *	Use Table 3 (\$/hr)	<input checked="" type="checkbox"/>	\$8.27
Average car occupancy rate	1.63 people	<input checked="" type="checkbox"/>	
Value of time for trucks	\$22.01 per hour	<input checked="" type="checkbox"/>	
Average detour speed	40 miles per hour	<input checked="" type="checkbox"/>	
Number of deaths from failure *	Use Table 2 (Number of people)	<input checked="" type="checkbox"/>	2
Cost for each life lost	\$500,000	<input checked="" type="checkbox"/>	

* Please select an appropriate value from the reference table listed.

Cost of Analysis or Corrective Actions

Provide estimates for the following costs. Keep in mind that these costs may depend on a number of factors, e.g., the number of piers, abutments, etc. Also keep in mind that the guidelines include many significant broad assumptions, so significant effort is not warranted in estimating this data.	
Description	User Input
Estimated cost of installing automated scour monitoring	\$25,000
Estimated cost of installing scour countermeasures	\$100,000
Estimated cost of field reconnaissance to determine foundation type and depth (nondestructive testing, borings, etc.)	\$20,000
Estimated cost to evaluate scour (survey, hydrology, and hydraulics analysis, if unavailable)	\$5,000

Scour Management Evaluation

3. State Route 78 over San Felipe Creek

Bridge 57-0096 in San Diego County, CA was constructed in 1948 and supports a rural minor arterial class road. This bridge has an unknown foundation depth and it is further assumed that foundation records can not be found.

Is it a high-priority bridge?

This bridge supports a rural road, which is not a principal arterial, emergency evacuation route, and does not provide direct access to other emergency services (e.g. hospital, fire stations, etc.). *Thus, in this context this bridge is not considered a high priority bridge.*

Does the bridge meet the minimum performance level?

The minimum performance level for a rural minor arterial class bridge, according to the guidelines, is 0.0005 – the threshold probability of failure that this bridge must outperform. To estimate this bridge’s annual probability of failure, it is first necessary to estimate the overtopping frequency and scour vulnerability of this bridge, as in the table below.

Data/Parameter (source)	Value	Interpretation
NBI item 26 (bridge survey)	6	Rural minor arterial classification
NBI item 71 (bridge survey)	8	Waterway meets the desirable criteria
∴ Overtopping Frequency (guidelines)	S	Slight (once in 11-100 years)
NBI item 60 (bridge survey)	7	Foundation is in good condition
NBI item 61 (bridge survey)	8	Channel is stable and protected by vegetation
∴ Scour Vulnerability (guidelines)	7	Countermeasures were installed and is now stable
∴ Annual probability of failure (guidelines)	0.00025	A 1 in 4,000 chance of failure in any given year

This bridge meets the minimum performance level because the annual probability of failure is less than 0.0005. However, because the foundation is unknown, we need to determine the most cost effective way to manage this uncertainty.

Is automated scour monitoring warranted?

Automated scour monitoring is considered warranted if the risk of death is greater than the cost of automated scour monitoring. The lifetime probability of failure for this bridge can be computed from the annual probability of failure and its tentative remaining life (18 years, according to the survey respondent) as follows: $1 - (1 - 0.00025)^{18}$, or about 0.0045 (a 1 in 222 chance of failure in the next 18 years). This and other survey data are now used to calculate the risk of death as follows:

$$R_{death} = K \cdot P_L \cdot C_6 \cdot X$$

$$= (1.0) \cdot (0.0025 / yr) \cdot (\$500,000 / person) \cdot (2 people) = \$4,490$$

Since the cost of automated scour monitoring was estimated to be \$25,000 and the risk of death is \$4,490, *automated scour monitoring is probably not warranted.*

Are scour countermeasures warranted?

Scour countermeasures are considered warranted if the lifetime risk of failure is greater than the estimated cost of scour countermeasures, which the survey respondent estimated to be about \$100,000. The first step in estimating the risk of failure is to estimate the potential cost of failure, assuming that it would need to be replaced. The survey respondent estimated that a new bridge would cost about \$900,000. The car and truck running cost associated with the detour for this bridge is computed from the survey data as follows:

$$\begin{aligned} C_{\text{running}} &= \left[C_2 \cdot \left(1 - \frac{T}{100} \right) + C_3 \cdot \frac{T}{100} \right] \cdot D \cdot A \cdot d \\ &= \left[\$0.45 / \text{mi} \cdot \left(1 - \frac{1}{100} \right) + \$1.30 / \text{mi} \cdot \frac{1}{100} \right] \cdot (20 \text{ mi}) \cdot (1,150 / \text{day}) \cdot (365 \text{ days}) \\ &= \$3,829,862 \end{aligned}$$

The cost of lost wages is computed from the survey data as follows:

$$\begin{aligned} C_{\text{wages}} &= \left[C_4 \cdot O \cdot \left(1 - \frac{T}{100} \right) + C_5 \cdot \frac{T}{100} \right] \cdot \frac{D \cdot A \cdot d}{S} \\ &= \left[(\$8.27 / \text{per}) \cdot (1.63 \text{ per}) \cdot \left(1 - \frac{1}{100} \right) + (\$22.01 / \text{truck}) \cdot \frac{1}{100} \right] \cdot \frac{(20 \text{ mi}) \cdot (1,150 / \text{day}) \cdot (365 \text{ days})}{40 \text{ mi} / \text{hr}} \\ &= \$2,832,803 \end{aligned}$$

When we include the cost of death, the total cost of bridge failure totals \$8,562,665. Computing the risk of a scour-induced failure over the remaining life of the bridge is just the product of the lifetime probability of failure and the total cost of failure – about \$38,450. *Thus, scour countermeasures are probably not warranted* because the lifetime risk of failure is less than the estimated cost of scour countermeasures.

Recommended management strategy

This bridge meets the performance standards for these guidelines and does not appear to warrant automated scour monitoring or countermeasures. However, because this bridge has an unknown foundation the guidelines strongly recommend that you follow the recommendations in the “Bridge Closure Plan” section of this report.

Furthermore, scour monitoring should be performed with every 2-yr routine bridge inspection for all bridges with unknown foundations. If the scour depth increases more than two feet from baseline conditions (as-built drawings or initial scour survey), action should be taken. The first action is to follow the “Bridge Closure Plan” to take any necessary immediate action. Countermeasures should then be considered for this site; or close or replace the bridge. This two foot trigger can be adjusted based on local geotechnical and engineering considerations and should represent the depth of scour that the bridge engineer feels comfortable with for the individual bridge.

Bridge #4

The Initial Survey

Respondent Information

Name Luis Avila	E-mail Address Luis_Avila@dot.ca.gov
Job Title Transportation Engineer	Phone (916) 227-8030
Job Description (In what way does your job involve bridge maintenance?) Substructure inspection for Bridges over water.	Mailing Address 1801 30 th St. Sacramento, CA 95816

Bridge Description

Please provide a general description of the bridge including its name, location, route, and water body.
North Fork Kings River, Bridge Number 45-0019R, District 06, Route 00041, Post Mile R47.16 Original: 7 span, continuous RC girder. Widening: 9 span, continuous RC slab. Present bridge on RC pile (8) bents and closed end cantilever abutments. All founded on concrete piles.

National Bridge Inventory (NBI) Data

Please provide the following information for the bridge. This information should be available in the NBI database. Please provide the NBI Database Values consistent with those required in the 2002 NBI Coding Guide, and specify the units (where appropriate).		
NBI Item No.	NBI Item Description	NBI Database Value
1	State Code	069
5	Inventory Route	00041
8	Structure Number	45 0019R
19	Bypass, Detour Length (e.g. in miles)	1.24 mile
26	Functional Classification of Inventory Route	02-Rural Other Princ
27	Year Built	1959-reconstructed, built ?
29	Average Daily Traffic	7800
49	Structure Length (e.g. in feet)	24.21 ft
52	Deck Width, Out-to-Out (e.g. in feet)	42.65 ft
60	Substructure	6-Satisfactory
61	Channel and Channel Protection	5-Bank Protection Eroded
71	Waterway Adequacy	8 – Equal Minimum
109	Average Daily Truck Traffic	14
113	Scour Critical Bridges (2002 NBI Guidelines)	U – Undefined Code

Undocumented Assumptions

Please provide the following information for the bridge which is not documented in the NBI database.	
Description	User Input
Bridge Type (check only one)	<input checked="" type="checkbox"/> Simple Span(s) <input type="checkbox"/> Continuous Span(s) over 100 ft.
Remaining life of bridge in years. If this bridge has already failed, report the actual lifetime of the bridge before it failed	10 years
Total Bridge Rebuilding Cost, if known. If unknown, estimate the cost by multiplying the bridge area by the cost per unit area as shown in Table 1 and the ADT cost multiplier as shown in Table 2. If estimated, provide the assumptions used in the spaces below: Bridge Area: _____ ft ² ; Cost per unit area: _____ \$/ft ² ; Cost Multiplier: _____	\$1,800,000

Economic Loss Data

Please provide the following economic factors to be associated with the failure of this bridge. Either check the box confirming that the default factor is to be used or provide a different value.			
Description	Default Value		User-Provided Value
Car running cost	\$0.45 per mile	<input checked="" type="checkbox"/>	
Truck running cost	\$1.30 per mile	<input checked="" type="checkbox"/>	
Duration of detour *	Use Table 2 (days)	<input checked="" type="checkbox"/>	183
Value of time per adult *	Use Table 3 (\$/hr)	<input checked="" type="checkbox"/>	\$8.27
Average car occupancy rate	1.63 people	<input checked="" type="checkbox"/>	
Value of time for trucks	\$22.01 per hour	<input checked="" type="checkbox"/>	
Average detour speed	40 miles per hour	<input checked="" type="checkbox"/>	
Number of deaths from failure *	Use Table 2 (Number of people)	<input checked="" type="checkbox"/>	10
Cost for each life lost	\$500,000	<input checked="" type="checkbox"/>	

* Please select an appropriate value from the reference table listed.

Cost of Analysis or Corrective Actions

Provide estimates for the following costs. Keep in mind that these costs may depend on a number of factors, e.g., the number of piers, abutments, etc. Also keep in mind that the guidelines include many significant broad assumptions, so significant effort is not warranted in estimating this data.	
Description	User Input
Estimated cost of installing automated scour monitoring	\$30,000
Estimated cost of installing scour countermeasures	\$1,800,000
Estimated cost of field reconnaissance to determine foundation type and depth (nondestructive testing, borings, etc.)	\$20,000
Estimated cost to evaluate scour (survey, hydrology, and hydraulics analysis, if unavailable)	\$5,000

Scour Management Evaluation

4. State Route 41 NB over the North Fork of Kings River

Bridge 45-0019R in Kings County, CA was constructed in 1959 and reconstructed in 2000 and supports a rural principal arterial class road. This bridge has an unknown foundation depth, and it is further assumed that foundation records can not be found.

Is it a high-priority bridge?

This bridge supports a rural principal arterial, which has significant economic value and may provide access to critical local services. *Thus, in this context this bridge is considered a high priority bridge* and should be given special attention.

Recommended management strategy

This bridge has significant economic value and may provide critical access to local services. Thus, the guidelines recommend the following three-step strategy to ensure the safety of this bridge.

1. Perform field reconnaissance to determine foundation type and depth. If the foundation is a spread footing, drill through the footing to determine elevation of the footing bottom. If the foundation is piles, use foundation reconnaissance to determine depth of piles. The parallel seismic test is generally the most effective reconnaissance method. Assume that the foundation information from the field evaluation is accurate. If field reconnaissance is unsuccessful (no access for testing, poor signal from NDT, etc.), assume a foundation depth. For piles, assume a 10 foot depth or use local knowledge. This should be a conservative assumption. Spread footing depths are easily discovered and an assumption should not be necessary for this type of foundation. In other words, continue as if the foundation is known.
2. Evaluate scour using FHWA HEC-18 manual.
3. If scour analysis indicates that countermeasures are warranted, countermeasures should be designed using FHWA HEC-23 manual – or consider replacing or closing the bridge.

Bridge #5

The Initial Survey

Respondent Information

Name Luis Avila	E-mail Address Luis_Avila@dot.ca.gov
Job Title Transportation Engineer	Phone (916) 227-8030
Job Description (In what way does your job involve bridge maintenance?) Substructure inspection for Bridges over water.	Mailing Address 1801 30 th St. Sacramento, CA 95816

Bridge Description

Please provide a general description of the bridge including its name, location, route, and water body.
Kings River, Bridge Number 45-0063, District 06, Route 00043, Post Mile 26.4 Continuous RC slab on pile (6) bents and open-end pile cap abutments. All founded on concrete piles.

National Bridge Inventory (NBI) Data

Please provide the following information for the bridge. This information should be available in the NBI database. Please provide the NBI Database Values consistent with those required in the 2002 NBI Coding Guide, and specify the units (where appropriate).		
NBI Item No.	NBI Item Description	NBI Database Value
1	State Code	069
5	Inventory Route	00043
8	Structure Number	45 0063
19	Bypass, Detour Length (e.g. in miles)	13.05 mile
26	Functional Classification of Inventory Route	06-Rural Minor Arterial
27	Year Built	1954
29	Average Daily Traffic	8410
49	Structure Length (e.g. in feet)	23.49 ft
52	Deck Width, Out-to-Out (e.g. in feet)	8.26 ft
60	Substructure	7 - Good
61	Channel and Channel Protection	6-Bank Slumping
71	Waterway Adequacy	8 – Equal Desirable
109	Average Daily Truck Traffic	15
113	Scour Critical Bridges (2002 NBI Guidelines)	U – Undefined Code

Undocumented Assumptions

Please provide the following information for the bridge which is not documented in the NBI database.	
Description	User Input
Bridge Type (check only one)	<input checked="" type="checkbox"/> Simple Span(s) <input type="checkbox"/> Continuous Span(s) over 100 ft.
Remaining life of bridge in years. If this bridge has already failed, report the actual lifetime of the bridge before it failed	23 years
Total Bridge Rebuilding Cost, if known. If unknown, estimate the cost by multiplying the bridge area by the cost per unit area as shown in Table 1 and the ADT cost multiplier as shown in Table 2. If estimated, provide the assumptions used in the spaces below: Bridge Area: _____ ft ² ; Cost per unit area: _____ \$/ft ² ; Cost Multiplier: _____	\$1,000,000

Economic Loss Data

Please provide the following economic factors to be associated with the failure of this bridge. Either check the box confirming that the default factor is to be used or provide a different value.			
Description	Default Value		User-Provided Value
Car running cost	\$0.45 per mile	<input checked="" type="checkbox"/>	
Truck running cost	\$1.30 per mile	<input checked="" type="checkbox"/>	
Duration of detour *	Use Table 2 (days)	<input checked="" type="checkbox"/>	183
Value of time per adult *	Use Table 3 (\$/hr)	<input checked="" type="checkbox"/>	\$8.27
Average car occupancy rate	1.63 people	<input checked="" type="checkbox"/>	
Value of time for trucks	\$22.01 per hour	<input checked="" type="checkbox"/>	
Average detour speed	40 miles per hour	<input checked="" type="checkbox"/>	
Number of deaths from failure *	Use Table 2 (Number of people)	<input checked="" type="checkbox"/>	10
Cost for each life lost	\$500,000	<input checked="" type="checkbox"/>	

* Please select an appropriate value from the reference table listed.

Cost of Analysis or Corrective Actions

Provide estimates for the following costs. Keep in mind that these costs may depend on a number of factors, e.g., the number of piers, abutments, etc. Also keep in mind that the guidelines include many significant broad assumptions, so significant effort is not warranted in estimating this data.	
Description	User Input
Estimated cost of installing automated scour monitoring	\$25,000
Estimated cost of installing scour countermeasures	\$100,000
Estimated cost of field reconnaissance to determine foundation type and depth (nondestructive testing, borings, etc.)	\$20,000
Estimated cost to evaluate scour (survey, hydrology, and hydraulics analysis, if unavailable)	\$5,000

Scour Management Evaluation

5. State Route 43 over Kings River

Bridge 45-0063 in Kings County, CA was constructed in 1954 and reconstructed in 1985 and supports a rural minor arterial class road. This bridge has an unknown foundation depth, and it is further assumed that foundation records can not be found.

Is it a high-priority bridge?

This bridge supports a rural road, which is not a principal arterial, emergency route or provide direct access to other emergency services (e.g. hospital, fire stations, etc.). *Thus, in this context this bridge is not considered a high priority bridge.*

Does the bridge meet the minimum performance level?

The minimum performance level for a rural minor arterial class bridge, according to the guidelines, is 0.0005 – the threshold probability of failure that this bridge must outperform. To estimate this bridge’s annual probability of failure, it is first necessary to estimate the overtopping frequency and scour vulnerability of this bridge, as in the table below.

Data/Parameter (source)	Value	Interpretation
NBI item 26 (bridge survey)	6	Rural minor arterial classification
NBI item 71 (bridge survey)	8	Waterway meets the desirable criteria
∴ Overtopping Frequency (guidelines)	S	Slight (once in 11-100 years)
NBI item 60 (bridge survey)	7	Foundation is in good condition
NBI item 61 (bridge survey)	6	Channel has widespread minor damage
∴ Scour Vulnerability (guidelines)	6	Not yet evaluated, but probably stable
∴ Annual probability of failure (guidelines)	0.00025	A 1 in 4,000 chance of failure in any given year

This bridge meets the minimum performance level because the annual probability of failure is less than 0.0005. However, because the foundation is unknown, we need to determine the most cost effective way to manage this uncertainty.

Is automated scour monitoring warranted?

Automated scour monitoring is considered warranted if the lifetime risk of death is greater than the cost of automated scour monitoring. The lifetime probability of failure for this bridge can be computed from the annual probability of failure and its tentative remaining life (23 years, according to the survey respondent) as follows: $1 - (1 - 0.00025)^{23}$, or about 0.0057 (a 1 in 175 chance of failure in the next 23 years). This and other survey data are now used to calculate the risk of death as follows:

$$R_{death} = K \cdot P_L \cdot C_6 \cdot X$$

$$= (1.0) \cdot (0.0057) \cdot (\$500,000 / person) \cdot (10 people) = \$28,671$$

Since the cost of automated scour monitoring was estimated to be \$25,000 and the risk of death is \$28,671, *automated scour monitoring may be warranted*. However, before installing automated scour monitoring, we should determine if scour countermeasures are also warranted.

Are scour countermeasures warranted?

Scour countermeasures are considered warranted if the lifetime risk of failure is greater than the estimated cost of scour countermeasures, which the survey respondent estimated to be about \$100,000. The first step in estimating the risk of failure is to estimate the potential cost of failure, assuming that it would need to be replaced. The survey respondent estimated that a new bridge would cost about \$1,000,000. The car and truck running cost associated with the detour for this bridge is computed from the survey data as follows:

$$\begin{aligned} C_{\text{running}} &= \left[C_2 \cdot \left(1 - \frac{T}{100} \right) + C_3 \cdot \frac{T}{100} \right] \cdot D \cdot A \cdot d \\ &= \left[\$0.45 / \text{mi} \cdot \left(1 - \frac{15}{100} \right) + \$1.30 / \text{mi} \cdot \frac{15}{100} \right] \cdot (13 \text{ mi}) \cdot (8,410 / \text{day}) \cdot (183 \text{ days}) \\ &= \$11,554,268 \end{aligned}$$

The cost of lost wages is computed from the survey data as follows:

$$\begin{aligned} C_{\text{wages}} &= \left[C_4 \cdot O \cdot \left(1 - \frac{T}{100} \right) + C_5 \cdot \frac{T}{100} \right] \cdot \frac{D \cdot A \cdot d}{S} \\ &= \left[(\$8.27 / \text{per}) \cdot (1.63 \text{ per}) \cdot \left(1 - \frac{15}{100} \right) + (\$22.01 / \text{truck}) \cdot \frac{15}{100} \right] \cdot \frac{(13 \text{ mi}) \cdot (8,410 / \text{day}) \cdot (183 \text{ days})}{40 \text{ mi} / \text{hr}} \\ &= \$7,382,519 \end{aligned}$$

When we include the cost of death, the total cost of bridge failure totals \$23,936,771. Computing the risk of a scour-induced failure over the remaining life of the bridge is just the product of the lifetime probability of failure and the total cost of failure – about \$114,332. *Thus, scour countermeasures are probably warranted* because the lifetime risk of failure is greater than the estimated cost of scour countermeasures. The guidelines further recommend that you install countermeasures rather than automated scour monitoring.

Is foundation reconnaissance and scour analysis warranted?

The survey respondent estimated the foundation reconnaissance and scour analysis costs to be about \$20,000 and \$5,000, respectively. Since this is only about 25% of the estimated cost of installing countermeasures, *foundation reconnaissance and scour analysis are probably warranted before installing the countermeasures.*

Recommended management strategy

Given the results explained above, the guidelines recommend the following steps to ensure the safety of the bridge:

1. Perform field reconnaissance to determine foundation type and depth. If the foundation is a spread footing, you could drill through the footing to determine elevation of the footing bottom. The parallel seismic test is generally the most effective NDT method. Assume that the foundation information from the field evaluation is accurate. If field reconnaissance is unsuccessful (no access for testing, poor signal from NDT, etc.), assume a foundation depth using local knowledge. This should be a conservative assumption. Spread footing depths are

easily discovered and an assumption should not be necessary for this type of foundation. In other words, continue as if the foundation is known.

2. Evaluate scour using FHWA HEC-18 manual.
3. If scour analysis indicates that countermeasures are warranted, countermeasures should be designed using FHWA HEC-23 manual – or consider replacing or closing the bridge.

Bridge #6

The Initial Survey

Respondent Information

Name	Luis Avila	E-mail Address	Luis_Avila@dot.ca.gov
Job Title	Transportation Engineer	Phone	(916) 227-8030
Job Description (In what way does your job involve bridge maintenance?)	Substructure inspection for Bridges over water.		
	Mailing Address		
	1801 30 th St. Sacramento, CA 95816		

Bridge Description

Please provide a general description of the bridge including its name, location, route, and water body.
San Juan Creek, Bridge Number 55-0228, District 12, Route 00005, Post Mile 8.87
A simply supported 4 span composite welded steel girder (15 each) with RC open end cantilever abutments and solid pier walls, all supported on concrete driven piles. High Priority structure.

National Bridge Inventory (NBI) Data

Please provide the following information for the bridge. This information should be available in the NBI database. Please provide the NBI Database Values consistent with those required in the 2002 NBI Coding Guide, and specify the units (where appropriate).		
NBI Item No.	NBI Item Description	NBI Database Value
1	State Code	069
5	Inventory Route	00005
8	Structure Number	55 0228
19	Bypass, Detour Length (e.g. in miles)	1.24 mile
26	Functional Classification of Inventory Route	11-Urban Interstate
27	Year Built	1958
29	Average Daily Traffic	212000
49	Structure Length (e.g. in feet)	609.91 ft
52	Deck Width, Out-to-Out (e.g. in feet)	160.10 ft
60	Substructure	5-Fair
61	Channel and Channel Protection	5-Bank Protection Eroded
71	Waterway Adequacy	8 – Equal Desirable
109	Average Daily Truck Traffic	0
113	Scour Critical Bridges (2002 NBI Guidelines)	3-3 SC - Unstable

Undocumented Assumptions

Please provide the following information for the bridge which is not documented in the NBI database.	
Description	User Input
Bridge Type (check only one)	<input checked="" type="checkbox"/> Simple Span(s) <input type="checkbox"/> Continuous Span(s) over 100 ft.
Remaining life of bridge in years. If this bridge has already failed, report the actual lifetime of the bridge before it failed	27 years
Total Bridge Rebuilding Cost, if known. If unknown, estimate the cost by multiplying the bridge area by the cost per unit area as shown in Table 1 and the ADT cost multiplier as shown in Table 2. If estimated, provide the assumptions used in the spaces below: Bridge Area: _____ ft ² ; Cost per unit area: _____ \$/ft ² ; Cost Multiplier: _____	\$17,000,000

Economic Loss Data

Please provide the following economic factors to be associated with the failure of this bridge. Either check the box confirming that the default factor is to be used or provide a different value.			
Description	Default Value		User-Provided Value
Car running cost	\$0.45 per mile	<input checked="" type="checkbox"/>	
Truck running cost	\$1.30 per mile	<input checked="" type="checkbox"/>	
Duration of detour *	Use Table 2 (days)	<input checked="" type="checkbox"/>	183
Value of time per adult *	Use Table 3 (\$/hr)	<input checked="" type="checkbox"/>	\$8.27
Average car occupancy rate	1.63 people	<input checked="" type="checkbox"/>	
Value of time for trucks	\$22.01 per hour	<input checked="" type="checkbox"/>	
Average detour speed	40 miles per hour	<input checked="" type="checkbox"/>	
Number of deaths from failure *	Use Table 2 (Number of people)	<input checked="" type="checkbox"/>	10
Cost for each life lost	\$500,000	<input checked="" type="checkbox"/>	

* Please select an appropriate value from the reference table listed.

Cost of Analysis or Corrective Actions

Provide estimates for the following costs. Keep in mind that these costs may depend on a number of factors, e.g., the number of piers, abutments, etc. Also keep in mind that the guidelines include many significant broad assumptions, so significant effort is not warranted in estimating this data.	
Description	User Input
Estimated cost of installing automated scour monitoring	\$45,000
Estimated cost of installing scour countermeasures	\$200,000
Estimated cost of field reconnaissance to determine foundation type and depth (nondestructive testing, borings, etc.)	\$20,000
Estimated cost to evaluate scour (survey, hydrology, and hydraulics analysis, if unavailable)	\$5,000

Scour Management Evaluation

6. Interstate 5 over San Juan Creek

Bridge 55-0228 in San Clemente, CA was constructed in 1958 and reconstructed in 1996 and supports an urban interstate. This bridge's foundation is known with an NBI item 113 rating of "3" (scour critical and unstable). However, this bridge will be evaluated as if it had an unknown foundation to test the guidelines.

Is it a high-priority bridge?

This bridge supports an urban interstate, which is emergency evacuation route, and provides direct access to other emergency services (e.g. hospital, fire stations, etc.). *Thus, in this context this bridge is considered a high priority bridge and should be given special attention.*

Recommended management strategy

This bridge has a known foundation, and requires action. This bridge furthermore provides critical access to local services and has significant economic value. Thus, if this bridge had an unknown foundation the guidelines would have recommended the following three-step strategy to ensure the safety of this bridge.

1. Perform field reconnaissance to determine foundation type and depth. If the foundation is a spread footing, drill through the footing to determine elevation of the footing bottom. If the foundation is piles, use foundation reconnaissance to determine depth of piles. The parallel seismic test is generally the most effective reconnaissance method. Assume that the foundation information from the field evaluation is accurate. If field reconnaissance is unsuccessful (no access for testing, poor signal from NDT, etc.), assume a foundation depth. For piles, assume a 10 foot depth or use local knowledge. This should be a conservative assumption. Spread footing depths are easily discovered and an assumption should not be necessary for this type of foundation. In other words, continue as if the foundation is known.
2. Evaluate scour using FHWA HEC-18 manual.
3. If scour analysis indicates that countermeasures are warranted, countermeasures should be designed using FHWA HEC-23 manual – or consider replacing or closing the bridge.

Bridge #7

The Initial Survey

Respondent Information

Name Luis Avila	E-mail Address Luis_Avila@dot.ca.gov
Job Title Transportation Engineer	Phone (916) 227-8030
Job Description (In what way does your job involve bridge maintenance?) Substructure inspection for Bridges over water.	Mailing Address 1801 30 th St. Sacramento, CA 95816

Bridge Description

Please provide a general description of the bridge including its name, location, route, and water body.
Pala Creek, Bridge Number 57-0072, District 11, Route 00076, Post Mile 23.23
Continuous seven span with cantilever ends RC haunched slab with RC open-end diaphragm abutments and five column bents, all founded on concrete piles.

National Bridge Inventory (NBI) Data

Please provide the following information for the bridge. This information should be available in the NBI database. Please provide the NBI Database Values consistent with those required in the 2002 NBI Coding Guide, and specify the units (where appropriate).		
NBI Item No.	NBI Item Description	NBI Database Value
1	State Code	069
5	Inventory Route	00076
8	Structure Number	57 0072
19	Bypass, Detour Length (e.g. in miles)	1.24 mile
26	Functional Classification of Inventory Route	06-Rural Minor Arterial
27	Year Built	1938
29	Average Daily Traffic	123000
49	Structure Length (e.g. in feet)	122.05 ft
52	Deck Width, Out-to-Out (e.g. in feet)	33.14 ft
60	Substructure	5-Fair
61	Channel and Channel Protection	3-Bank Protection Eroded
71	Waterway Adequacy	8 – Equal Desirable
109	Average Daily Truck Traffic	16
113	Scour Critical Bridges (2002 NBI Guidelines)	3-3 SC - Unstable

Undocumented Assumptions

Please provide the following information for the bridge which is not documented in the NBI database.	
Description	User Input
Bridge Type (check only one)	<input checked="" type="checkbox"/> Simple Span(s) <input type="checkbox"/> Continuous Span(s) over 100 ft.
Remaining life of bridge in years. If this bridge has already failed, report the actual lifetime of the bridge before it failed	10 years
Total Bridge Rebuilding Cost, if known. If unknown, estimate the cost by multiplying the bridge area by the cost per unit area as shown in Table 1 and the ADT cost multiplier as shown in Table 2. If estimated, provide the assumptions used in the spaces below: Bridge Area: _____ ft ² ; Cost per unit area: _____ \$/ft ² ; Cost Multiplier: _____	\$700,000

Economic Loss Data

Please provide the following economic factors to be associated with the failure of this bridge. Either check the box confirming that the default factor is to be used or provide a different value.			
Description	Default Value		User-Provided Value
Car running cost	\$0.45 per mile	<input checked="" type="checkbox"/>	
Truck running cost	\$1.30 per mile	<input checked="" type="checkbox"/>	
Duration of detour *	Use Table 2 (days)	<input checked="" type="checkbox"/>	183
Value of time per adult *	Use Table 3 (\$/hr)	<input checked="" type="checkbox"/>	\$8.27
Average car occupancy rate	1.63 people	<input checked="" type="checkbox"/>	
Value of time for trucks	\$22.01 per hour	<input checked="" type="checkbox"/>	
Average detour speed	40 miles per hour	<input checked="" type="checkbox"/>	
Number of deaths from failure *	Use Table 2 (Number of people)	<input checked="" type="checkbox"/>	10
Cost for each life lost	\$500,000	<input checked="" type="checkbox"/>	

* Please select an appropriate value from the reference table listed.

Cost of Analysis or Corrective Actions

Provide estimates for the following costs. Keep in mind that these costs may depend on a number of factors, e.g., the number of piers, abutments, etc. Also keep in mind that the guidelines include many significant broad assumptions, so significant effort is not warranted in estimating this data.	
Description	User Input
Estimated cost of installing automated scour monitoring	\$25,000
Estimated cost of installing scour countermeasures	\$700,000
Estimated cost of field reconnaissance to determine foundation type and depth (nondestructive testing, borings, etc.)	\$20,000
Estimated cost to evaluate scour (survey, hydrology, and hydraulics analysis, if unavailable)	\$5,000

Scour Management Evaluation

7. State Route 76 over Pala Creek

Bridge 57-0072 in San Diego County, CA was constructed in 1938 and supports a rural minor arterial class road. This bridge's foundation is known with an NBI item 113 rating of "3" (scour critical and unstable). However, this bridge will be evaluated as if it had an unknown foundation to test the guidelines.

Is it a high-priority bridge?

This bridge supports a rural road, which is not a principal arterial, emergency route or provide direct access to other emergency services (e.g. hospital, fire stations, etc.). *Thus, in this context this bridge is not considered a high priority bridge.*

Does the bridge meet the minimum performance level?

The minimum performance level for a rural minor arterial class bridge, according to the guidelines, is 0.0005 – the threshold probability of failure that this bridge must outperform. To estimate this bridge's annual probability of failure, it is first necessary to estimate the overtopping frequency and scour vulnerability of this bridge, as in the table below.

Data/Parameter (source)	Value	Interpretation
NBI item 26 (bridge survey)	6	Rural minor arterial classification
NBI item 71 (bridge survey)	8	Waterway meets the desirable criteria
∴ Overtopping Frequency (guidelines)	S	Slight (once in 11-100 years)
NBI item 60 (bridge survey)	5	Foundation is in fair condition
NBI item 61 (bridge survey)	3	Bank protection has failed and threatens the bridge
∴ Scour Vulnerability (guidelines)	4	Analysis: stable; Survey: foundation is exposed
∴ Annual probability of failure (guidelines)	0.0005	A 1 in 2,000 chance of failure in any given year

This bridge does not meet the minimum performance level because the annual probability of failure is not less than 0.0005.

Recommended management strategy

This bridge has a known foundation, and requires action. Furthermore, this bridge does not meet the minimum performance level for bridges with unknown foundations. Thus, if this bridge had an unknown foundation the guidelines would have recommended the following three-step strategy to ensure the safety of this bridge.

1. Perform field reconnaissance to determine foundation type and depth. If the foundation is a spread footing, drill through the footing to determine elevation of the footing bottom. If the foundation is piles, use foundation reconnaissance to determine depth of piles. The parallel seismic test is generally the most effective reconnaissance method. Assume that the foundation information from the field evaluation is accurate. If field reconnaissance is unsuccessful (no access for testing, poor signal from NDT, etc.), assume a foundation depth. For piles, assume a 10 foot depth or use local knowledge. This should be a conservative assumption. Spread footing depths are easily discovered and an assumption should not be necessary for this type of foundation. In other words, continue as if the foundation is known.

2. Evaluate scour using FHWA HEC-18 manual.
3. If scour analysis indicates that countermeasures are warranted, countermeasures should be designed using FHWA HEC-23 manual – or consider replacing or closing the bridge.

Bridge #8

The Initial Survey

Respondent Information

Name Luis Avila	E-mail Address Luis_Avila@dot.ca.gov
Job Title Transportation Engineer	Phone (916) 227-8030
Job Description (In what way does your job involve bridge maintenance?) Substructure inspection for Bridges over water.	Mailing Address 1801 30 th St. Sacramento, CA 95816

Bridge Description

Please provide a general description of the bridge including its name, location, route, and water body.
Cottonwood Creek, Bridge Number 41-0025, District 06, Route 00145, Post Mile 5.39 Continuous RC slab pile (3) bents and wall abutments. All founded on concrete piles.

National Bridge Inventory (NBI) Data

Please provide the following information for the bridge. This information should be available in the NBI database. Please provide the NBI Database Values consistent with those required in the 2002 NBI Coding Guide, and specify the units (where appropriate).		
NBI Item No.	NBI Item Description	NBI Database Value
1	State Code	069
5	Inventory Route	00145
8	Structure Number	41 0025
19	Bypass, Detour Length (e.g. in miles)	21.75 mile
26	Functional Classification of Inventory Route	14-Urban Other Princ
27	Year Built	1953
29	Average Daily Traffic	21600
49	Structure Length (e.g. in feet)	131.89 m
52	Deck Width, Out-to-Out (e.g. in feet)	32.15 m
60	Substructure	No entry (7)*
61	Channel and Channel Protection	5-Bank Protection Eroded
71	Waterway Adequacy	7-Above Minimum
109	Average Daily Truck Traffic	7
113	Scour Critical Bridges (2002 NBI Guidelines)	3-3 SC - Unstable

**This missing data was filled in based on NBI item 67 = "7".*

Undocumented Assumptions

Please provide the following information for the bridge which is not documented in the NBI database.	
Description	User Input
Bridge Type (check only one)	<input checked="" type="checkbox"/> Simple Span(s) <input type="checkbox"/> Continuous Span(s) over 100 ft.
Remaining life of bridge in years. If this bridge has already failed, report the actual lifetime of the bridge before it failed	22 years
Total Bridge Rebuilding Cost, if known. If unknown, estimate the cost by multiplying the bridge area by the cost per unit area as shown in Table 1 and the ADT cost multiplier as shown in Table 2. If estimated, provide the assumptions used in the spaces below: Bridge Area: _____ ft ² ; Cost per unit area: _____ \$/ft ² ; Cost Multiplier: _____	\$800,000

Economic Loss Data

Please provide the following economic factors to be associated with the failure of this bridge. Either check the box confirming that the default factor is to be used or provide a different value.			
Description	Default Value		User-Provided Value
Car running cost	\$0.45 per mile	<input checked="" type="checkbox"/>	
Truck running cost	\$1.30 per mile	<input checked="" type="checkbox"/>	
Duration of detour *	Use Table 2 (days)	<input checked="" type="checkbox"/>	183
Value of time per adult *	Use Table 3 (\$/hr)	<input checked="" type="checkbox"/>	\$8.27
Average car occupancy rate	1.63 people	<input checked="" type="checkbox"/>	
Value of time for trucks	\$22.01 per hour	<input checked="" type="checkbox"/>	
Average detour speed	40 miles per hour	<input checked="" type="checkbox"/>	
Number of deaths from failure *	Use Table 2 (Number of people)	<input checked="" type="checkbox"/>	10
Cost for each life lost	\$500,000	<input checked="" type="checkbox"/>	

* Please select an appropriate value from the reference table listed.

Cost of Analysis or Corrective Actions

Provide estimates for the following costs. Keep in mind that these costs may depend on a number of factors, e.g., the number of piers, abutments, etc. Also keep in mind that the guidelines include many significant broad assumptions, so significant effort is not warranted in estimating this data.	
Description	User Input
Estimated cost of installing automated scour monitoring	\$25,000
Estimated cost of installing scour countermeasures	\$200,000
Estimated cost of field reconnaissance to determine foundation type and depth (nondestructive testing, borings, etc.)	\$20,000
Estimated cost to evaluate scour (survey, hydrology, and hydraulics analysis, if unavailable)	\$5,000

Scour Management Evaluation

8. State Route 145 over Cottonwood Creek

Bridge 41-0025 in Medera County, CA was constructed in 1953 and supports an urban principal arterial class road. This bridge's foundation is known with an NBI item 113 rating of "3" (scour critical and unstable). However, this bridge will be evaluated as if it had an unknown foundation to test the guidelines.

Is it a high-priority bridge?

This bridge supports an urban principal arterial, which has significant economical value and may provide critical access to local services. *Thus, in this context this bridge is considered a high priority bridge* and should be given special attention.

Recommended management strategy

This bridge has a known foundation, and requires action. Furthermore, this bridge has significant economic value and may provide critical access to local services. Thus, if this bridge had an unknown foundation the guidelines would have recommended the following three-step strategy to ensure the safety of this bridge.

1. Perform field reconnaissance to determine foundation type and depth. If the foundation is a spread footing, drill through the footing to determine elevation of the footing bottom. If the foundation is piles, use foundation reconnaissance to determine depth of piles. The parallel seismic test is generally the most effective reconnaissance method. Assume that the foundation information from the field evaluation is accurate. If field reconnaissance is unsuccessful (no access for testing, poor signal from NDT, etc.), assume a foundation depth. For piles, assume a 10 foot depth or use local knowledge. This should be a conservative assumption. Spread footing depths are easily discovered and an assumption should not be necessary for this type of foundation. In other words, continue as if the foundation is known.
2. Evaluate scour using FHWA HEC-18 manual.
3. If scour analysis indicates that countermeasures are warranted, countermeasures should be designed using FHWA HEC-23 manual – or consider replacing or closing the bridge.

Bridge #9

The Initial Survey

Respondent Information

Name	Luis Avila	E-mail Address	Luis_Avila@dot.ca.gov
Job Title	Transportation Engineer	Phone	(916) 227-8030
Job Description (In what way does your job involve bridge maintenance?)	Substructure inspection for Bridges over water.		
	Mailing Address		
	1801 30 th St. Sacramento, CA 95816		

Bridge Description

Please provide a general description of the bridge including its name, location, route, and water body.
Russian River, Bridge Number 20-0038, District 04, Route 00128, Post Mile 5.44
21 spans with 6 riveted steel pony truss spans on RC columns with curtain wall piers with 4 western approach T beam spans on RC column bents and 11 eastern approach T beam spans on RC column bents and angle wing abutments. All founded on timber piles of unknown depth and soil type. (Bridge failed 12/24/2005, presumably due to scour.)

National Bridge Inventory (NBI) Data

Please provide the following information for the bridge. This information should be available in the NBI database. Please provide the NBI Database Values consistent with those required in the 2002 NBI Coding Guide, and specify the units (where appropriate).		
NBI Item No.	NBI Item Description	NBI Database Value
1	State Code	069
5	Inventory Route	00128
8	Structure Number	20 0038
19	Bypass, Detour Length (e.g. in miles)	13.05 mile
26	Functional Classification of Inventory Route	06-Rural Minor Arterial
27	Year Built	1932
29	Average Daily Traffic	2400
49	Structure Length (e.g. in feet)	975.06 ft
52	Deck Width, Out-to-Out (e.g. in feet)	32.15 ft
60	Substructure	4-Poor
61	Channel and Channel Protection	1-Br Closed-Correct (7)*
71	Waterway Adequacy	8 – Equal Desirable (8)*
109	Average Daily Truck Traffic	12
113	Scour Critical Bridges (2002 NBI Guidelines)	0-0 SC – Bridge Failed (U)*

****This bridge failed on 12/24/2005, and the codes in parentheses were recorded a month before a new survey revealed that failure was imminent.***

Undocumented Assumptions

Please provide the following information for the bridge which is not documented in the NBI database.	
Description	User Input
Bridge Type (check only one)	<input checked="" type="checkbox"/> Simple Span(s) <input checked="" type="checkbox"/> Continuous Span(s) over 100 ft.
Remaining life of bridge in years. If this bridge has already failed, report the actual lifetime of the bridge before it failed	Failed at 74 years
Total Bridge Rebuilding Cost, if known. If unknown, estimate the cost by multiplying the bridge area by the cost per unit area as shown in Table 1 and the ADT cost multiplier as shown in Table 2. If estimated, provide the assumptions used in the spaces below: Bridge Area: _____ ft ² ; Cost per unit area: _____ \$/ft ² ; Cost Multiplier: _____	\$30,000,000 (Emergency Replacement)

Economic Loss Data

Please provide the following economic factors to be associated with the failure of this bridge. Either check the box confirming that the default factor is to be used or provide a different value.			
Description	Default Value		User-Provided Value
Car running cost	\$0.45 per mile	<input checked="" type="checkbox"/>	
Truck running cost	\$1.30 per mile	<input checked="" type="checkbox"/>	
Duration of detour *	Use Table 2 (days)	<input checked="" type="checkbox"/>	365
Value of time per adult *	Use Table 3 (\$/hr)	<input checked="" type="checkbox"/>	\$8.27
Average car occupancy rate	1.63 people	<input checked="" type="checkbox"/>	
Value of time for trucks	\$22.01 per hour	<input checked="" type="checkbox"/>	
Average detour speed	40 miles per hour	<input checked="" type="checkbox"/>	
Number of deaths from failure *	Use Table 2 (Number of people)	<input checked="" type="checkbox"/>	2
Cost for each life lost	\$500,000	<input checked="" type="checkbox"/>	

* Please select an appropriate value from the reference table listed.

Cost of Analysis or Corrective Actions

Provide estimates for the following costs. Keep in mind that these costs may depend on a number of factors, e.g., the number of piers, abutments, etc. Also keep in mind that the guidelines include many significant broad assumptions, so significant effort is not warranted in estimating this data.	
Description	User Input
Estimated cost of installing automated scour monitoring	\$45,000
Estimated cost of installing scour countermeasures	\$30,000,000
Estimated cost of field reconnaissance to determine foundation type and depth (nondestructive testing, borings, etc.)	\$20,000
Estimated cost to evaluate scour (survey, hydrology, and hydraulics analysis, if unavailable)	\$5,000

Scour Management Evaluation

9. State Route 128 over Russian River

Bridge 20-0038 in Sonoma County, CA was constructed in 1932 and reconstructed in 1972 and supports a rural minor arterial road. This bridge failed on December 24, 2005, but it had an unknown foundation depth before it failed. The NBI codes before it failed were recovered from the 2005 NBI database, and this data will be used to test the scour guidelines.

Is it a high-priority bridge?

This bridge supports a rural road, which is not a principal arterial, emergency route or provide direct access to other emergency services (e.g. hospital, fire stations, etc.). *Thus, in this context this bridge is not considered a high priority bridge.*

Does the bridge meet the minimum performance level?

The minimum performance level for a rural minor arterial class bridge, according to the guidelines, is 0.0005 – the threshold probability of failure that this bridge must outperform. To estimate this bridge's annual probability of failure, it is first necessary to estimate the overtopping frequency and scour vulnerability of this bridge, as in the table below.

Data/Parameter (source)	Value	Interpretation
NBI item 26 (bridge survey)	6	Rural minor arterial classification
NBI item 71 (bridge survey)	8	Waterway meets the desirable criteria
∴ Overtopping Frequency (guidelines)	S	Slight (once in 11-100 years)
NBI item 60 (bridge survey)	4	Foundation is in poor condition
NBI item 61 (12/2005 NBI database)	8	Channel is stable and protected by vegetation
∴ Scour Vulnerability (guidelines)	4	Analysis: stable; Survey: foundation is exposed
∴ Annual probability of failure (guidelines)	0.0005	A 1 in 2,000 chance of failure in any given year

This bridge does not meet the minimum performance level because the annual probability of failure is not less than 0.0005.

Recommended management strategy

This bridge does not meet the minimum performance level. Thus, the guidelines recommend the following three-step strategy to ensure the safety of this bridge.

1. Perform field reconnaissance to determine foundation type and depth. If the foundation is a spread footing, drill through the footing to determine elevation of the footing bottom. If the foundation is piles, use foundation reconnaissance to determine depth of piles. The parallel seismic test is generally the most effective reconnaissance method. Assume that the foundation information from the field evaluation is accurate. If field reconnaissance is unsuccessful (no access for testing, poor signal from NDT, etc.), assume a foundation depth. For piles, assume a 10 foot depth or use local knowledge. This should be a conservative assumption. Spread footing depths are easily discovered and an assumption should not be necessary for this type of foundation. In other words, continue as if the foundation is known.
2. Evaluate scour using FHWA HEC-18 manual.

3. If scour analysis indicates that countermeasures are warranted, countermeasures should be designed using FHWA HEC-23 manual – or consider replacing or closing the bridge.

Bridge #10

The Initial Survey

Respondent Information

Name Luis Avila	E-mail Address Luis_Avila@dot.ca.gov
Job Title Transportation Engineer	Phone (916) 227-8030
Job Description (In what way does your job involve bridge maintenance?) Substructure inspection for Bridges over water.	Mailing Address 1801 30 th St. Sacramento, CA 95816

Bridge Description

Please provide a general description of the bridge including its name, location, route, and water body.
Clear Creek, Bridge Number 12-0073, District 03, Route 00149, Post Mile 3.72
Continuous RC slab with RC 5-column bents and RC closed end backfilled strutted abutments all on spread footings.

National Bridge Inventory (NBI) Data

Please provide the following information for the bridge. This information should be available in the NBI database. Please provide the NBI Database Values consistent with those required in the 2002 NBI Coding Guide, and specify the units (where appropriate).		
NBI Item No.	NBI Item Description	NBI Database Value
1	State Code	069
5	Inventory Route	00149
8	Structure Number	12 0073
19	Bypass, Detour Length (e.g. in miles)	8.7 mile
26	Functional Classification of Inventory Route	02-Rural Other Princ
27	Year Built	1951
29	Average Daily Traffic	12900
49	Structure Length (e.g. in feet)	73.16 ft
52	Deck Width, Out-to-Out (e.g. in feet)	43.64 ft
60	Substructure	6-Satisfactory
61	Channel and Channel Protection	7-Minor Damage
71	Waterway Adequacy	8 – Equal Desirable
109	Average Daily Truck Traffic	7
113	Scour Critical Bridges (2002 NBI Guidelines)	2-2 SC – Extensive Scour

Undocumented Assumptions

Please provide the following information for the bridge which is not documented in the NBI database.	
Description	User Input
Bridge Type (check only one)	<input checked="" type="checkbox"/> Simple Span(s) <input type="checkbox"/> Continuous Span(s) over 100 ft.
Remaining life of bridge in years. If this bridge has already failed, report the actual lifetime of the bridge before it failed	20 years
Total Bridge Rebuilding Cost, if known. If unknown, estimate the cost by multiplying the bridge area by the cost per unit area as shown in Table 1 and the ADT cost multiplier as shown in Table 2. If estimated, provide the assumptions used in the spaces below: Bridge Area: _____ ft ² ; Cost per unit area: _____ \$/ft ² ; Cost Multiplier: _____	\$600,000

Economic Loss Data

Please provide the following economic factors to be associated with the failure of this bridge. Either check the box confirming that the default factor is to be used or provide a different value.			
Description	Default Value		User-Provided Value
Car running cost	\$0.45 per mile	<input checked="" type="checkbox"/>	
Truck running cost	\$1.30 per mile	<input checked="" type="checkbox"/>	
Duration of detour *	Use Table 2 (days)	<input checked="" type="checkbox"/>	183
Value of time per adult *	Use Table 3 (\$/hr)	<input checked="" type="checkbox"/>	\$8.27
Average car occupancy rate	1.63 people	<input checked="" type="checkbox"/>	
Value of time for trucks	\$22.01 per hour	<input checked="" type="checkbox"/>	
Average detour speed	40 miles per hour	<input checked="" type="checkbox"/>	
Number of deaths from failure *	Use Table 2 (Number of people)	<input checked="" type="checkbox"/>	10
Cost for each life lost	\$500,000	<input checked="" type="checkbox"/>	

* Please select an appropriate value from the reference table listed.

Cost of Analysis or Corrective Actions

Provide estimates for the following costs. Keep in mind that these costs may depend on a number of factors, e.g., the number of piers, abutments, etc. Also keep in mind that the guidelines include many significant broad assumptions, so significant effort is not warranted in estimating this data.	
Description	User Input
Estimated cost of installing automated scour monitoring	\$25,000
Estimated cost of installing scour countermeasures	\$100,000
Estimated cost of field reconnaissance to determine foundation type and depth (nondestructive testing, borings, etc.)	\$20,000
Estimated cost to evaluate scour (survey, hydrology, and hydraulics analysis, if unavailable)	\$5,000

Scour Management Evaluation

10. State Route 149 over Clear Creek

Bridge 12-0073 in Butte County, CA was constructed in 1951 and reconstructed in 1975 and supports a rural principal arterial class road. This bridge's foundation is known with an NBI item 113 rating of "2" (Analysis: scour critical; Survey: immediate action recommended). However, this bridge will be evaluated as if it had an unknown foundation to test the guidelines.

Is it a high-priority bridge?

This bridge supports a rural principal arterial, which has significant economical value and may provide critical access to local services. *Thus, in this context this bridge is considered a high priority bridge* and should be given special attention.

Recommended management strategy

This bridge has a known foundation, and requires action. Furthermore, this bridge has significant economic value and may provide critical access to local services. Thus, if this bridge had an unknown foundation the guidelines would have recommended the following three-step strategy to ensure the safety of this bridge.

1. Perform field reconnaissance to determine foundation type and depth. If the foundation is a spread footing, drill through the footing to determine elevation of the footing bottom. If the foundation is piles, use foundation reconnaissance to determine depth of piles. The parallel seismic test is generally the most effective reconnaissance method. Assume that the foundation information from the field evaluation is accurate. If field reconnaissance is unsuccessful (no access for testing, poor signal from NDT, etc.), assume a foundation depth. For piles, assume a 10 foot depth or use local knowledge. This should be a conservative assumption. Spread footing depths are easily discovered and an assumption should not be necessary for this type of foundation. In other words, continue as if the foundation is known.
2. Evaluate scour using FHWA HEC-18 manual.
3. If scour analysis indicates that countermeasures are warranted, countermeasures should be designed using FHWA HEC-23 manual – or consider replacing or closing the bridge.

Response to Evaluations

Steve Ng inserted comments into the management summary document, for convenience. His first comment appears in the second paragraph of the “Develop a Bridge Closure Plan” section of the summary. He said, “Consider installing a remote stage sensor in lieu of just paint on the substructure. These sensors are fairly simple, reliable instruments. They can be set for numerous trigger elevations to tailor to the site needs and would not require the physical presence of personnel until conditions warrant”. At the end of the management summaries Mr. Ng added the following comments.

General Comments: I noticed that if information is missing regarding detour miles and duration or ADT, default information was assumed. I would consider setting the defaults higher with notation regarding the conservative value (or do you have defaults tied to Route importance?) This will increase costs and put more pressure to obtain real or at least more representative information. Making recommendations for additional borings is fine, but there are costs, time, permits and environmental concerns. [What about] NDT costs and reliability? Do you have any guidance?

Unknown pile lengths: you assume they are 10 feet and move on. Sometimes the predicted scour will be below that 10 foot [assumption]. Geology will play a role. Also what happens if you do say that the scour is okay under this condition and the soils are not scour [prone]. Don't lead the evaluation to a “no work recommended” condition if there is no other consideration for seismic events. I was hoping to see some guidance regarding when it is appropriate to just rock and monitor without additional investigations or in lieu of a big effort to fine line evaluate all factors.

Florida Bridges*Bridge #1***The Initial Survey****Respondent Information**

Name Richard C. Semple	E-mail Address Richard.semple@dot.state.fl.us
Job Title Structures Management Coordinator	Phone 813-744-6050
Job Description (In what way does your job involve bridge maintenance?) Bridge Inspection Repair Plans Production Scour Evaluation Oversight	Mailing Address District Structures & Facilities District 1 & 7 2916 Leslie Road Tampa, FL 35619

Bridge Description

Please provide a general description of the bridge including its name, location, route, and water body.
BR #030145 US 41 NE over Fahka Union Canal Location: 13.7 miles SE of ST 951 MP: 39.214 Emergency Route

National Bridge Inventory (NBI) Data

Please provide the following information for the bridge. This information should be available in the NBI database. Please provide the NBI Database Values consistent with those required in the 2002 NBI Coding Guide, and specify the units (where appropriate).		
NBI Item No.	NBI Item Description	NBI Database Value
1	State Code	12
5	Inventory Route	1
8	Structure Number	030145
19	Bypass, Detour Length (e.g. in miles)	0.6 mi
26	Functional Classification of Inventory Route	02
27	Year Built	1969
29	Average Daily Traffic	2100
49	Structure Length (e.g. in feet)	219.2 ft
52	Deck Width, Out-to-Out (e.g. in feet)	420 ft
60	Substructure	7
61	Channel and Channel Protection	8
71	Waterway Adequacy	8
109	Average Daily Truck Traffic	11%
113	Scour Critical Bridges (2002 NBI Guidelines)	U

Undocumented Assumptions

Please provide the following information for the bridge which is not documented in the NBI database.	
Description	User Input
Bridge Type (check only one)	<input checked="" type="checkbox"/> Simple Span(s) <input type="checkbox"/> Continuous Span(s) over 100 ft.
Remaining life of bridge in years. If this bridge has already failed, report the actual lifetime of the bridge before it failed	13years
Total Bridge Rebuilding Cost, if known. If unknown, estimate the cost by multiplying the bridge area by the cost per unit area as shown in Table 1 and the ADT cost multiplier as shown in Table 2. If estimated, provide the assumptions used in the spaces below: Bridge Area: 9206 ft ² ; Cost per unit area: 70 \$/ft ² ; Cost Multiplier: 1.5	\$96,630.00

Economic Loss Data

Please provide the following economic factors to be associated with the failure of this bridge. Either check the box confirming that the default factor is to be used or provide a different value.		
Description	Default Value	User-Provided Value
Car running cost	\$0.45 per mile <input checked="" type="checkbox"/>	
Truck running cost	\$1.30 per mile <input checked="" type="checkbox"/>	
Duration of detour *	Use Table 2 (days) <input checked="" type="checkbox"/>	365
Value of time per adult *	Use Table 3 (\$/hr) <input checked="" type="checkbox"/>	\$6.65
Average car occupancy rate	1.63 people <input checked="" type="checkbox"/>	
Value of time for trucks	\$22.01 per hour <input checked="" type="checkbox"/>	
Average detour speed	40 miles per hour <input checked="" type="checkbox"/>	
Number of deaths from failure *	Use Table 2 (Number of people) <input checked="" type="checkbox"/>	2
Cost for each life lost	\$500,000 <input checked="" type="checkbox"/>	

* Please select an appropriate value from the reference table listed.

Cost of Analysis or Corrective Actions

Provide estimates for the following costs. Keep in mind that these costs may depend on a number of factors, e.g., the number of piers, abutments, etc. Also keep in mind that the guidelines include many significant broad assumptions, so significant effort is not warranted in estimating this data.	
Description	User Input
Estimated cost of installing automated scour monitoring	\$7,000.00/unit
Estimated cost of installing scour countermeasures	\$35,000.00
Estimated cost of field reconnaissance to determine foundation type and depth (nondestructive testing, borings, etc.)	\$6,015.00
Estimated cost to evaluate scour (survey, hydrology, and hydraulics analysis, if unavailable)	\$10,808.00

Scour Management Evaluation

1. US Highway 41 over Fahka Union Canal

Bridge 030146 in Collier County, FL was constructed in 1969. It supports a rural principal arterial. This bridge has an unknown foundation depth, and it is further assumed that foundation records can not be found.

Is it a high-priority bridge?

This bridge supports a rural principal arterial road, which is also an emergency evacuation route. *Thus, in this context this bridge is considered a high priority bridge* and should be given special attention.

Recommended management strategy

This bridge provides a critical emergency route for local residents and has significant economic value. Thus, the guidelines recommend the following three-step strategy to ensure the safety of this bridge.

1. Perform field reconnaissance to determine foundation type and depth. If the foundation is a spread footing, drill through the footing to determine elevation of the footing bottom. If the foundation is piles, use foundation reconnaissance to determine depth of piles. The parallel seismic test is generally the most effective reconnaissance method. Assume that the foundation information from the field evaluation is accurate. If field reconnaissance is unsuccessful (no access for testing, poor signal from NDT, etc.), assume a foundation depth. For piles, assume a 10 foot depth or use local knowledge. This should be a conservative assumption. Spread footing depths are easily discovered and an assumption should not be necessary for this type of foundation. In other words, continue as if the foundation is known.
2. Evaluate scour using FHWA HEC-18 manual.
3. If scour analysis indicates that countermeasures are warranted, countermeasures should be designed using FHWA HEC-23 manual – or consider replacing or closing the bridge.

Bridge #2

The Initial Survey

Respondent Information

Name Richard C. Semple	E-mail Address Richard.semple@dot.state.fl.us
Job Title Structures Management Coordinator	Phone 813-744-6050
Job Description (In what way does your job involve bridge maintenance?) Bridge Inspection Repair Plans Production Scour Evaluation Oversight	Mailing Address District Structures & Facilities District 1 & 7 2916 Leslie Road Tampa, FL 35619

Bridge Description

Please provide a general description of the bridge including its name, location, route, and water body.
BR# 050018. ST 78 over Indian Prairie Canal Location: 7.4 miles E of CR 721 MP: 20.665 Emergency Route

National Bridge Inventory (NBI) Data

Please provide the following information for the bridge. This information should be available in the NBI database. Please provide the NBI Database Values consistent with those required in the 2002 NBI Coding Guide, and specify the units (where appropriate).		
NBI Item No.	NBI Item Description	NBI Database Value
1	State Code	12
5	Inventory Route	1
8	Structure Number	050018
19	Bypass, Detour Length (e.g. in miles)	34.8 mi
26	Functional Classification of Inventory Route	06
27	Year Built	1960
29	Average Daily Traffic	3,200
49	Structure Length (e.g. in feet)	225 ft
52	Deck Width, Out-to-Out (e.g. in feet)	33.8 ft
60	Substructure	7
61	Channel and Channel Protection	9
71	Waterway Adequacy	8
109	Average Daily Truck Traffic	18%
113	Scour Critical Bridges (2002 NBI Guidelines)	U

Undocumented Assumptions

Please provide the following information for the bridge which is not documented in the NBI database.	
Description	User Input
Bridge Type (check only one)	<input checked="" type="checkbox"/> Simple Span(s) <input type="checkbox"/> Continuous Span(s) over 100 ft.
Remaining life of bridge in years. If this bridge has already failed, report the actual lifetime of the bridge before it failed	4 years
Total Bridge Rebuilding Cost, if known. If unknown, estimate the cost by multiplying the bridge area by the cost per unit area as shown in Table 1 and the ADT cost multiplier as shown in Table 2. If estimated, provide the assumptions used in the spaces below: Bridge Area: 7605 ft ² ; Cost per unit area: 70 \$/ft ² ; Cost Multiplier: 1.5	\$798,525.00

Economic Loss Data

Please provide the following economic factors to be associated with the failure of this bridge. Either check the box confirming that the default factor is to be used or provide a different value.		
Description	Default Value	User-Provided Value
Car running cost	\$0.45 per mile <input checked="" type="checkbox"/>	
Truck running cost	\$1.30 per mile <input checked="" type="checkbox"/>	
Duration of detour *	Use Table 2 (days) <input checked="" type="checkbox"/>	365
Value of time per adult *	Use Table 3 (\$/hr) <input checked="" type="checkbox"/>	\$6.65
Average car occupancy rate	1.63 people <input checked="" type="checkbox"/>	
Value of time for trucks	\$22.01 per hour <input checked="" type="checkbox"/>	
Average detour speed	40 miles per hour <input checked="" type="checkbox"/>	
Number of deaths from failure *	Use Table 2 (Number of people) <input checked="" type="checkbox"/>	2
Cost for each life lost	\$500,000 <input checked="" type="checkbox"/>	

* Please select an appropriate value from the reference table listed.

Cost of Analysis or Corrective Actions

Provide estimates for the following costs. Keep in mind that these costs may depend on a number of factors, e.g., the number of piers, abutments, etc. Also keep in mind that the guidelines include many significant broad assumptions, so significant effort is not warranted in estimating this data.	
Description	User Input
Estimated cost of installing automated scour monitoring	\$7,000.00/unity
Estimated cost of installing scour countermeasures	\$35,000.00
Estimated cost of field reconnaissance to determine foundation type and depth (nondestructive testing, borings, etc.)	\$6,015.00
Estimated cost to evaluate scour (survey, hydrology, and hydraulics analysis, if unavailable)	\$10,808.00

Scour Management Evaluation

2. State Route 78 over Indian Prairie Canal

Bridge 050018 in Glades County, FL was constructed in 1960 and supports a rural minor arterial class road. This bridge has an unknown foundation depth, and it is further assumed that foundation records can not be found.

Is it a high-priority bridge?

This bridge supports a rural road, which is an emergency evacuation route. *Thus, in this context this bridge is considered a high priority bridge* and should be given special attention.

Recommended management strategy

This bridge provides a critical emergency route for local residents and has significant economic value. Thus, the guidelines recommend the following three-step strategy to ensure the safety of this bridge.

1. Perform field reconnaissance to determine foundation type and depth. If the foundation is a spread footing, drill through the footing to determine elevation of the footing bottom. If the foundation is piles, use foundation reconnaissance to determine depth of piles. The parallel seismic test is generally the most effective reconnaissance method. Assume that the foundation information from the field evaluation is accurate. If field reconnaissance is unsuccessful (no access for testing, poor signal from NDT, etc.), assume a foundation depth. For piles, assume a 10 foot depth or use local knowledge. This should be a conservative assumption. Spread footing depths are easily discovered and an assumption should not be necessary for this type of foundation. In other words, continue as if the foundation is known.
2. Evaluate scour using FHWA HEC-18 manual.
3. If scour analysis indicates that countermeasures are warranted, countermeasures should be designed using FHWA HEC-23 manual – or consider replacing or closing the bridge.

Bridge #3

The Initial Survey

Respondent Information

Name Richard C. Semple	E-mail Address Richard.semple@dot.state.fl.us
Job Title Structures Management Coordinator	Phone 813-744-6050
Job Description (In what way does your job involve bridge maintenance?) Bridge Inspection Repair Plans Production Scour Evaluation Oversight	Mailing Address District Structures & Facilities District 1 & 7 2916 Leslie Road Tampa, FL 35619

Bridge Description

Please provide a general description of the bridge including its name, location, route, and water body.
BR# 120160. SR 80 over Orange River Location: 0.4 miles E of I-75 M.P.: 0.026 Emergency Route

National Bridge Inventory (NBI) Data

Please provide the following information for the bridge. This information should be available in the NBI database. Please provide the NBI Database Values consistent with those required in the 2002 NBI Coding Guide, and specify the units (where appropriate).		
NBI Item No.	NBI Item Description	NBI Database Value
1	State Code	12
5	Inventory Route	1
8	Structure Number	120160
19	Bypass, Detour Length (e.g. in miles)	6.2
26	Functional Classification of Inventory Route	14
27	Year Built	1990
29	Average Daily Traffic	27,500
49	Structure Length (e.g. in feet)	800 ft
52	Deck Width, Out-to-Out (e.g. in feet)	123 ft
60	Substructure	7
61	Channel and Channel Protection	8
71	Waterway Adequacy	8
109	Average Daily Truck Traffic	13%
113	Scour Critical Bridges (2002 NBI Guidelines)	U

Undocumented Assumptions

Please provide the following information for the bridge which is not documented in the NBI database.	
Description	User Input
Bridge Type (check only one)	<input checked="" type="checkbox"/> Simple Span(s) <input type="checkbox"/> Continuous Span(s) over 100 ft.
Remaining life of bridge in years. If this bridge has already failed, report the actual lifetime of the bridge before it failed	34 years
Total Bridge Rebuilding Cost, if known. If unknown, estimate the cost by multiplying the bridge area by the cost per unit area as shown in Table 1 and the ADT cost multiplier as shown in Table 2. If estimated, provide the assumptions used in the spaces below: Bridge Area: 98,468 ft ² ; Cost per unit area: 70 \$/ft ² ; Cost Multiplier: 2.0	\$13,777,120.00

Economic Loss Data

Please provide the following economic factors to be associated with the failure of this bridge. Either check the box confirming that the default factor is to be used or provide a different value.		
Description	Default Value	User-Provided Value
Car running cost	\$0.45 per mile <input checked="" type="checkbox"/>	
Truck running cost	\$1.30 per mile <input checked="" type="checkbox"/>	
Duration of detour *	Use Table 2 (days) <input checked="" type="checkbox"/>	183
Value of time per adult *	Use Table 3 (\$/hr) <input checked="" type="checkbox"/>	\$6.65
Average car occupancy rate	1.63 people <input checked="" type="checkbox"/>	
Value of time for trucks	\$22.01 per hour <input checked="" type="checkbox"/>	
Average detour speed	40 miles per hour <input checked="" type="checkbox"/>	
Number of deaths from failure *	Use Table 2 (Number of people) <input checked="" type="checkbox"/>	10
Cost for each life lost	\$500,000 <input checked="" type="checkbox"/>	

* Please select an appropriate value from the reference table listed.

Cost of Analysis or Corrective Actions

Provide estimates for the following costs. Keep in mind that these costs may depend on a number of factors, e.g., the number of piers, abutments, etc. Also keep in mind that the guidelines include many significant broad assumptions, so significant effort is not warranted in estimating this data.	
Description	User Input
Estimated cost of installing automated scour monitoring	\$7,000/unit
Estimated cost of installing scour countermeasures	\$35,000.00
Estimated cost of field reconnaissance to determine foundation type and depth (nondestructive testing, borings, etc.)	\$6,015.00
Estimated cost to evaluate scour (survey, hydrology, and hydraulics analysis, if unavailable)	\$10,808.00

Scour Management Evaluation

3. State Route 80 over Orange River

Bridge 120160 in Fort Myers, FL was constructed in 1990 and supports an urban principal arterial road. This bridge has an unknown foundation depth, and it is further assumed that foundation records can not be found.

Is it a high-priority bridge?

This bridge supports an urban principal arterial road, which is also an emergency evacuation route. *Thus, in this context this bridge is considered a high priority bridge* and should be given special attention.

Recommended management strategy

This bridge provides a critical emergency route for local residents and has significant economic value. Thus, the guidelines recommend the following three-step strategy to ensure the safety of this bridge.

1. Perform field reconnaissance to determine foundation type and depth. If the foundation is a spread footing, drill through the footing to determine elevation of the footing bottom. If the foundation is piles, use foundation reconnaissance to determine depth of piles. The parallel seismic test is generally the most effective reconnaissance method. Assume that the foundation information from the field evaluation is accurate. If field reconnaissance is unsuccessful (no access for testing, poor signal from NDT, etc.), assume a foundation depth. For piles, assume a 10 foot depth or use local knowledge. This should be a conservative assumption. Spread footing depths are easily discovered and an assumption should not be necessary for this type of foundation. In other words, continue as if the foundation is known.
2. Evaluate scour using FHWA HEC-18 manual.
3. If scour analysis indicates that countermeasures are warranted, countermeasures should be designed using FHWA HEC-23 manual – or consider replacing or closing the bridge.

Bridge #4

The Initial Survey

Respondent Information

Name Richard C. Semple	E-mail Address Richard.semple@dot.state.fl.us
Job Title Structures Management Coordinator	Phone 813-744-6050
Job Description (In what way does your job involve bridge maintenance?) Bridge Inspection Repair Plans Production Scour Evaluation Oversight	Mailing Address District Structures & Facilities District 1 & 7 2916 Leslie Road Tampa, FL 35619

Bridge Description

Please provide a general description of the bridge including its name, location, route, and water body.
BR# 120165 ST 80 EB over Bediman Creek Location: 0.1 miles E of CR 884 MP: 18.333 Emergency route

National Bridge Inventory (NBI) Data

Please provide the following information for the bridge. This information should be available in the NBI database. Please provide the NBI Database Values consistent with those required in the 2002 NBI Coding Guide, and specify the units (where appropriate).		
NBI Item No.	NBI Item Description	NBI Database Value
1	State Code	12
5	Inventory Route	1
8	Structure Number	120165
19	Bypass, Detour Length (e.g. in miles)	0.6 mi
26	Functional Classification of Inventory Route	02
27	Year Built	2006
29	Average Daily Traffic	5841
49	Structure Length (e.g. in feet)	120.1 ft
52	Deck Width, Out-to-Out (e.g. in feet)	45.1 ft
60	Substructure	8
61	Channel and Channel Protection	8
71	Waterway Adequacy	8
109	Average Daily Truck Traffic	13%
113	Scour Critical Bridges (2002 NBI Guidelines)	8

Undocumented Assumptions

Please provide the following information for the bridge which is not documented in the NBI database.	
Description	User Input
Bridge Type (check only one)	<input type="checkbox"/> Simple Span(s) <input checked="" type="checkbox"/> Continuous Span(s) over 100 ft.
Remaining life of bridge in years. If this bridge has already failed, report the actual lifetime of the bridge before it failed	50 years
Total Bridge Rebuilding Cost, if known. If unknown, estimate the cost by multiplying the bridge area by the cost per unit area as shown in Table 1 and the ADT cost multiplier as shown in Table 2. If estimated, provide the assumptions used in the spaces below: Bridge Area: 5172 ft ² ; Cost per unit area 80 \$/ft ² ; Cost Multiplier: 2.0	\$827,520.00

Economic Loss Data

Please provide the following economic factors to be associated with the failure of this bridge. Either check the box confirming that the default factor is to be used or provide a different value.		
Description	Default Value	User-Provided Value
Car running cost	\$0.45 per mile <input checked="" type="checkbox"/>	
Truck running cost	\$1.30 per mile <input checked="" type="checkbox"/>	
Duration of detour *	Use Table 2 (days) <input checked="" type="checkbox"/>	183
Value of time per adult *	Use Table 3 (\$/hr) <input checked="" type="checkbox"/>	\$6.65
Average car occupancy rate	1.63 people <input checked="" type="checkbox"/>	
Value of time for trucks	\$22.01 per hour <input checked="" type="checkbox"/>	
Average detour speed	40 miles per hour <input checked="" type="checkbox"/>	
Number of deaths from failure *	Use Table 2 (Number of people) <input checked="" type="checkbox"/>	10
Cost for each life lost	\$500,000 <input checked="" type="checkbox"/>	

* Please select an appropriate value from the reference table listed.

Cost of Analysis or Corrective Actions

Provide estimates for the following costs. Keep in mind that these costs may depend on a number of factors, e.g., the number of piers, abutments, etc. Also keep in mind that the guidelines include many significant broad assumptions, so significant effort is not warranted in estimating this data.	
Description	User Input
Estimated cost of installing automated scour monitoring	\$7,000/unit
Estimated cost of installing scour countermeasures	\$35,000
Estimated cost of field reconnaissance to determine foundation type and depth (nondestructive testing, borings, etc.)	\$6,015.00
Estimated cost to evaluate scour (survey, hydrology, and hydraulics analysis, if unavailable)	\$10,808.00

Scour Management Evaluation

4. State Route 80 EB over Bedman Creek

Bridge 120165 in Lee County, FL was constructed in 2006 and supports a rural principal arterial class road. This bridge's foundation is known with an NBI item 113 rating of "8" (Analysis: stable; Survey: stable). However, this bridge will be evaluated as if it had an unknown foundation to test the guidelines.

Is it a high-priority bridge?

This bridge supports a rural principal arterial, which is also an emergency evacuation route. *Thus, in this context this bridge is considered a high priority bridge and should be given special attention.*

Recommended management strategy

This bridge has a known foundation, and thus does not require any additional action. This bridge is an evacuation route and has significant economic value. Thus, if this bridge had an unknown foundation the guidelines would have recommended the following three-step strategy to ensure the safety of this bridge.

1. Perform field reconnaissance to determine foundation type and depth. If the foundation is a spread footing, drill through the footing to determine elevation of the footing bottom. If the foundation is piles, use foundation reconnaissance to determine depth of piles. The parallel seismic test is generally the most effective reconnaissance method. Assume that the foundation information from the field evaluation is accurate. If field reconnaissance is unsuccessful (no access for testing, poor signal from NDT, etc.), assume a foundation depth. For piles, assume a 10 foot depth or use local knowledge. This should be a conservative assumption. Spread footing depths are easily discovered and an assumption should not be necessary for this type of foundation. In other words, continue as if the foundation is known.
2. Evaluate scour using FHWA HEC-18 manual.
3. If scour analysis indicates that countermeasures are warranted, countermeasures should be designed using FHWA HEC-23 manual – or consider replacing or closing the bridge.

Bridge #5

The Initial Survey

Respondent Information

Name Richard C. Semple	E-mail Address Richard.semple@dot.state.fl.us
Job Title Structures Management Coordinator	Phone 813-744-6050
Job Description (In what way does your job involve bridge maintenance?) Bridge Inspection Repair Plans Production Scour Evaluation Oversight	Mailing Address District Structures & Facilities District 1 & 7 2916 Leslie Road Tampa, FL 35619

Bridge Description

Please provide a general description of the bridge including its name, location, route, and water body.
BR#160063. SR 37 over N. Fork Alafia River Location: 0.4 miles S of ST 60 MP: 17.787 Not Emergency

National Bridge Inventory (NBI) Data

Please provide the following information for the bridge. This information should be available in the NBI database. Please provide the NBI Database Values consistent with those required in the 2002 NBI Coding Guide, and specify the units (where appropriate).		
NBI Item No.	NBI Item Description	NBI Database Value
1	State Code	12
5	Inventory Route	1
8	Structure Number	16006.3
19	Bypass, Detour Length (e.g. in miles)	6.2 mi
26	Functional Classification of Inventory Route	1.6
27	Year Built	1957
29	Average Daily Traffic	11,500
49	Structure Length (e.g. in feet)	285.1 ft
52	Deck Width, Out-to-Out (e.g. in feet)	37.4 ft
60	Substructure	5
61	Channel and Channel Protection	7
71	Waterway Adequacy	8
109	Average Daily Truck Traffic	17%
113	Scour Critical Bridges (2002 NBI Guidelines)	8

Undocumented Assumptions

Please provide the following information for the bridge which is not documented in the NBI database.	
Description	User Input
Bridge Type (check only one)	<input checked="" type="checkbox"/> Simple Span(s) <input type="checkbox"/> Continuous Span(s) over 100 ft.
Remaining life of bridge in years. If this bridge has already failed, report the actual lifetime of the bridge before it failed	1 years
Total Bridge Rebuilding Cost, if known. If unknown, estimate the cost by multiplying the bridge area by the cost per unit area as shown in Table 1 and the ADT cost multiplier as shown in Table 2. If estimated, provide the assumptions used in the spaces below: Bridge Area: 10,663 ft ² ; Cost per unit area: 65 \$/ft ² ; Cost Multiplier: 2.0	\$1,386,190.00

Economic Loss Data

Please provide the following economic factors to be associated with the failure of this bridge. Either check the box confirming that the default factor is to be used or provide a different value.		
Description	Default Value	User-Provided Value
Car running cost	\$0.45 per mile <input checked="" type="checkbox"/>	
Truck running cost	\$1.30 per mile <input checked="" type="checkbox"/>	
Duration of detour *	Use Table 2 (days) <input checked="" type="checkbox"/>	183
Value of time per adult *	Use Table 3 (\$/hr) <input checked="" type="checkbox"/>	\$6.65
Average car occupancy rate	1.63 people <input checked="" type="checkbox"/>	
Value of time for trucks	\$22.01 per hour <input checked="" type="checkbox"/>	
Average detour speed	40 miles per hour <input checked="" type="checkbox"/>	
Number of deaths from failure *	Use Table 2 (Number of people) <input checked="" type="checkbox"/>	10
Cost for each life lost	\$500,000 <input checked="" type="checkbox"/>	

* Please select an appropriate value from the reference table listed.

Cost of Analysis or Corrective Actions

Provide estimates for the following costs. Keep in mind that these costs may depend on a number of factors, e.g., the number of piers, abutments, etc. Also keep in mind that the guidelines include many significant broad assumptions, so significant effort is not warranted in estimating this data.	
Description	User Input
Estimated cost of installing automated scour monitoring	\$7,000/unit
Estimated cost of installing scour countermeasures	\$88,000
Estimated cost of field reconnaissance to determine foundation type and depth (nondestructive testing, borings, etc.)	\$6,015.00
Estimated cost to evaluate scour (survey, hydrology, and hydraulics analysis, if unavailable)	\$10,808.00

Scour Management Evaluation

5. State Road 37 over N Fork Alafia River

Bridge 160063 in Mulberry, FL was constructed in 1951 and supports an urban minor arterial class road. This bridge's foundation is known with an NBI item 113 rating of "8" (Analysis: stable; Survey: stable). However, this bridge will be evaluated as if it had an unknown foundation to test the guidelines.

Is it a high-priority bridge?

This bridge supports an urban minor arterial, but it is not an emergency evacuation route and does not provide direct access to emergency services (e.g. hospital, fire stations, etc.). *Thus, in this context this bridge is not considered a high priority bridge.*

Does the bridge meet the minimum performance level?

The minimum performance level for an urban minor arterial class bridge, according to the guidelines, is 0.0002 – the maximum annual probability of failure allowed for this bridge. To estimate this bridge's annual probability of failure, it is first necessary to estimate the overtopping frequency and scour vulnerability of this bridge, as in the table below.

Data/Parameter (source)	Value	Interpretation
NBI item 26 (bridge survey)	16	Urban minor arterial classification
NBI item 71 (bridge survey)	8	Waterway is equal to the desirable criteria
∴ Overtopping Frequency (guidelines)	S	Slight (once in 11-100 years)
NBI item 60 (bridge survey)	5	Foundation is in fair condition
NBI item 61 (bridge survey)	7	Channel has some minor drift and damage
∴ Scour Vulnerability (guidelines)	6	Not yet evaluated, but probably stable
∴ Annual probability of failure (guidelines)	0.00025	A 1 in 4,000 chance of failure in any given year

This bridge does not meet the minimum performance level because the annual probability of failure is greater than 0.0002.

Recommended management strategy

This bridge has a known foundation, and thus does not require any additional action. But if the foundation was unknown it would not meet the minimum performance level. Thus, if it had an unknown foundation the guidelines would have recommended the following three-step strategy to ensure the safety of this bridge.

1. Perform field reconnaissance to determine foundation type and depth. If the foundation is a spread footing, drill through the footing to determine elevation of the footing bottom. If the foundation is piles, use foundation reconnaissance to determine depth of piles. The parallel seismic test is generally the most effective reconnaissance method. Assume that the foundation information from the field evaluation is accurate. If field reconnaissance is unsuccessful (no access for testing, poor signal from NDT, etc.), assume a foundation depth. For piles, assume a 10 foot depth or use local knowledge. This should be a conservative assumption. Spread footing depths are easily discovered and an assumption should not be necessary for this type of foundation. In other words, continue as if the foundation is known.

2. Evaluate scour using FHWA HEC-18 manual.
3. If scour analysis indicates that countermeasures are warranted, countermeasures should be designed using FHWA HEC-23 manual – or consider replacing or closing the bridge.

Bridge #6

The Initial Survey

Respondent Information

Name Manuel H. Luna, EIT	E-mail Address manuel.luna@dot.state.fl.us
Job Title: Project Coordinator	Phone (813) 744-6050 Cell (813) 323-1150
Job Description (In what way does your job involve bridge maintenance?) Project Coordinator for Scour Project, Paint Project and Bridge Management. Review Scour Reports, Conduct Quarterly Interdisciplinary Scour Meetings, prepared Biannual Federal Scour Reports. Certified Bridge Inspector, perform bridge inspection, review inspection reports, construction plan. Prepare bridge deficiencies list and assist project manager by conducting edit check of bridge data base. Write my own computer programs to accomplish this task.	Mailing Address FDOT Department Of Transportation 2916 Leslie Road Tampa, FL 33619

Bridge Description

Please provide a general description of the bridge including its name, location, route, and water body.
Bridge No. 100352 (Parallel to Bridge No. 100353) I-75 NB over Little Manatee River In Hillsborough County

National Bridge Inventory (NBI) Data

Please provide the following information for the bridge. This information should be available in the NBI database. Please provide the NBI Database Values consistent with those required in the 2002 NBI Coding Guide, and specify the units (where appropriate).

NBI Item No.	NBI Item Description	NBI Database Value
1	State Code	12
5	Inventory Route	00075
8	Structure Number	100352
19	Bypass, Detour Length (e.g. in miles)	0.6214
26	Functional Classification of Inventory Route	01
27	Year Built	1981
29	Average Daily Traffic	31000
49	Structure Length (e.g. in feet)	1391.083
52	Deck Width, Out-to-Out (e.g. in feet)	58.80
60	Substructure	8
61	Channel and Channel Protection	7
71	Waterway Adequacy	9
109	Average Daily Truck Traffic	20%
113	Scour Critical Bridges (2002 NBI Guidelines)	7

Undocumented Assumptions

Please provide the following information for the bridge which is not documented in the NBI database.	
Description	User Input
Bridge Type (check only one)	<input checked="" type="checkbox"/> Simple Span(s) <input type="checkbox"/> Continuous Span(s) over 100 ft.
Remaining life of bridge in years. If this bridge has already failed, report the actual lifetime of the bridge before it failed	54 years
Total Bridge Rebuilding Cost, if known. If unknown, estimate the cost by multiplying the bridge area by the cost per unit area as shown in Table 1 and the ADT cost multiplier as shown in Table 2. If estimated, provide the assumptions used in the spaces below: Bridge Area: 81804.95 _____ ft ² ; Cost per unit area: \$110 _____ \$/ft ² ; Cost Multiplier: 2 _____	\$ 17,997,089.00

Economic Loss Data

Please provide the following economic factors to be associated with the failure of this bridge. Either check the box confirming that the default factor is to be used or provide a different value.			
Description	Default Value		User-Provided Value
Car running cost	\$0.45 per mile	<input checked="" type="checkbox"/>	
Truck running cost	\$1.30 per mile	<input checked="" type="checkbox"/>	
Duration of detour *	Use Table 2 (days)	<input checked="" type="checkbox"/>	183
Value of time per adult *	Use Table 3 (\$/hr)	<input checked="" type="checkbox"/>	\$6.65
Average car occupancy rate	1.63 people	<input checked="" type="checkbox"/>	
Value of time for trucks	\$22.01 per hour	<input checked="" type="checkbox"/>	
Average detour speed	40 miles per hour	<input checked="" type="checkbox"/>	
Number of deaths from failure *	Use Table 2 (Number of people)	<input checked="" type="checkbox"/>	5
Cost for each life lost	\$500,000	<input checked="" type="checkbox"/>	2,500,000.00

* Please select an appropriate value from the reference table listed.

Cost of Analysis or Corrective Actions

Provide estimates for the following costs. Keep in mind that these costs may depend on a number of factors, e.g., the number of piers, abutments, etc. Also keep in mind that the guidelines include many significant broad assumptions, so significant effort is not warranted in estimating this data.	
Description	User Input
Estimated cost of installing automated scour monitoring	\$64,000.00 per unit
Estimated cost of installing scour countermeasures	\$ 187,784
Estimated cost of field reconnaissance to determine foundation type and depth (nondestructive testing, borings, etc.)	\$4,500.00
Estimated cost to evaluate scour (survey, hydrology, and hydraulics analysis, if unavailable)	\$8,000.00

Scour Management Evaluation

6. I-75 NB over Little Manatee River

Bridge 100352 in Hillsborough County, FL was constructed in 1981 and supports a rural interstate. This bridge's foundation is known with an NBI item 113 rating of "7" (scour countermeasures installed make it stable). However, this bridge will be evaluated as if it had an unknown foundation to test the guidelines.

Is it a high-priority bridge?

This bridge supports a rural road, which is not a principal arterial, emergency route or provide direct access to other emergency services (e.g. hospital, fire stations, etc.). *Thus, in this context this bridge is not considered a high priority bridge.*

Does the bridge meet the minimum performance level?

The minimum performance level for a rural minor arterial class bridge, according to the guidelines, is 0.0001 – the threshold probability of failure that this bridge must outperform. To estimate this bridge's annual probability of failure, it is first necessary to estimate the overtopping frequency and scour vulnerability of this bridge, as in the table below.

Data/Parameter (source)	Value	Interpretation
NBI item 26 (bridge survey)	1	Rural interstate classification
NBI item 71 (bridge survey)	9	Waterway is better than the desirable criteria
∴ Overtopping Frequency (guidelines)	R	Remote (once in more than 100 years)
NBI item 60 (bridge survey)	8	Foundation is in very good condition
NBI item 61 (bridge survey)	7	Channel has some minor drift and damage
∴ Scour Vulnerability (guidelines)	7	Countermeasures were installed and is now stable
∴ Annual probability of failure (guidelines)	0.00025	A 1 in 4,000 chance of failure in any given year

This bridge does not meet the minimum performance level because the annual probability of failure is greater than 0.0001.

Recommended management strategy

This bridge has a known foundation, and thus does not require any additional action. But if the foundation was unknown it would not meet the minimum performance level. Thus, if it had an unknown foundation the guidelines would have recommended the following three-step strategy to ensure the safety of this bridge.

1. Perform field reconnaissance to determine foundation type and depth. If the foundation is a spread footing, drill through the footing to determine elevation of the footing bottom. If the foundation is piles, use foundation reconnaissance to determine depth of piles. The parallel seismic test is generally the most effective reconnaissance method. Assume that the foundation information from the field evaluation is accurate. If field reconnaissance is unsuccessful (no access for testing, poor signal from NDT, etc.), assume a foundation depth. For piles, assume a 10 foot depth or use local knowledge. This should be a conservative assumption. Spread footing depths are easily discovered and an assumption should not be necessary for this type of foundation. In other words, continue as if the foundation is known.

2. Evaluate scour using FHWA HEC-18 manual.
3. If scour analysis indicates that countermeasures are warranted, countermeasures should be designed using FHWA HEC-23 manual – or consider replacing or closing the bridge.

Bridge #7

The Initial Survey

Respondent Information

Name Manuel H. Luna, EIT	E-mail Address manuel.luna@dot.state.fl.us
Job Title : Project Coordinator	Phone (813) 744-6050 Cell (813) 323-1150
Job Description (In what way does your job involve bridge maintenance?) Project Coordinator for Scour Project, Paint Project and Bridge Management. Review Scour Reports, Conduct Quarterly Interdisciplinary Scour Meetings, prepared Biannual Federal Scour Reports. Certified Bridge Inspector, perform bridge inspection, review inspection reports, construction plan. Prepare bridge deficiencies list and assist project manager by conducting edit check of bridge data base. Write my own computer programs to accomplish this task.	Mailing Address FDOT Department Of Transportation 2916 Leslie Road Tampa, FL 33619

Bridge Description

Please provide a general description of the bridge including its name, location, route, and water body.
US-301 over Hillsborough River

National Bridge Inventory (NBI) Data

Please provide the following information for the bridge. This information should be available in the NBI database. Please provide the NBI Database Values consistent with those required in the 2002 NBI Coding Guide, and specify the units (where appropriate).		
NBI Item No.	NBI Item Description	NBI Database Value
1	State Code	12
5	Inventory Route	00301
8	Structure Number	100434
19	Bypass, Detour Length (e.g. in miles)	19.88
26	Functional Classification of Inventory Route	02
27	Year Built	1985
29	Average Daily Traffic	10900
49	Structure Length (e.g. in feet)	451.43
52	Deck Width, Out-to-Out (e.g. in feet)	47.50
60	Substructure	8
61	Channel and Channel Protection	7
71	Waterway Adequacy	8
109	Average Daily Truck Traffic	10%
113	Scour Critical Bridges (2002 NBI Guidelines)	7

Undocumented Assumptions

Please provide the following information for the bridge which is not documented in the NBI database.	
Description	User Input
Bridge Type (check only one)	<input checked="" type="checkbox"/> Simple Span(s) <input type="checkbox"/> Continuous Span(s) over 100 ft.
Remaining life of bridge in years. If this bridge has already failed, report the actual lifetime of the bridge before it failed	54 years
Total Bridge Rebuilding Cost, if known. If unknown, estimate the cost by multiplying the bridge area by the cost per unit area as shown in Table 1 and the ADT cost multiplier as shown in Table 2. If estimated, provide the assumptions used in the spaces below: Bridge Area: <u>21444</u> ft ² ; Cost per unit area: <u>110.00</u> \$/ft ² ; Cost Multiplier: <u>2</u>	\$ 4,717,680.00

Economic Loss Data

Please provide the following economic factors to be associated with the failure of this bridge. Either check the box confirming that the default factor is to be used or provide a different value.			
Description	Default Value		User-Provided Value
Car running cost	\$0.45 per mile	x	
Truck running cost	\$1.30 per mile	x	
Duration of detour *	Use Table 2 (days)	x	183
Value of time per adult *	Use Table 3 (\$/hr)	x	\$6.65
Average car occupancy rate	1.63 people	x	
Value of time for trucks	\$22.01 per hour	x	
Average detour speed	40 miles per hour	x	
Number of deaths from failure *	Use Table 2 (Number of people)	x	5
Cost for each life lost	\$500,000	x	2,500,000.00

* Please select an appropriate value from the reference table listed.

Cost of Analysis or Corrective Actions

Provide estimates for the following costs. Keep in mind that these costs may depend on a number of factors, e.g., the number of piers, abutments, etc. Also keep in mind that the guidelines include many significant broad assumptions, so significant effort is not warranted in estimating this data.	
Description	User Input
Estimated cost of installing automated scour monitoring	\$ 50,000.00
Estimated cost of installing scour countermeasures	\$ 120,823.00
Estimated cost of field reconnaissance to determine foundation type and depth (nondestructive testing, borings, etc.)	\$ 4,500.00
Estimated cost to evaluate scour (survey, hydrology, and hydraulics analysis, if unavailable)	\$ 8,000.00

Scour Management Evaluation

7. US 301 over Hillsborough River

Bridge 100434 in Hillsborough County, FL was constructed in 1985 and supports an rural principal arterial class road. This bridge's foundation is known with an NBI item 113 rating of "7" (scour countermeasures installed make it stable). However, this bridge will be evaluated as if it had an unknown foundation to test the guidelines.

Is it a high-priority bridge?

This bridge supports an urban principal arterial road, which has significant economic value and may provide access to critical local services. *Thus, in this context this bridge is considered a high priority bridge* and should be given special attention.

Recommended management strategy

This bridge has a known foundation, and thus does not require any additional action. However, this bridge has significant economic value and may provide critical access to local services. Thus, if this bridge had an unknown foundation the guidelines recommend the following three-step strategy to ensure the safety of this bridge.

1. Perform field reconnaissance to determine foundation type and depth. If the foundation is a spread footing, drill through the footing to determine elevation of the footing bottom. If the foundation is piles, use foundation reconnaissance to determine depth of piles. The parallel seismic test is generally the most effective reconnaissance method. Assume that the foundation information from the field evaluation is accurate. If field reconnaissance is unsuccessful (no access for testing, poor signal from NDT, etc.), assume a foundation depth. For piles, assume a 10 foot depth or use local knowledge. This should be a conservative assumption. Spread footing depths are easily discovered and an assumption should not be necessary for this type of foundation. In other words, continue as if the foundation is known.
2. Evaluate scour using FHWA HEC-18 manual.
3. If scour analysis indicates that countermeasures are warranted, countermeasures should be designed using FHWA HEC-23 manual – or consider replacing or closing the bridge.

Bridge #8

The Initial Survey

Respondent Information

Name Manuel H. Luna, EIT	E-mail Address manuel.luna@dot.state.fl.us
Job Title Structure Project Coordinator	Phone (813) 744-6050 Cell (813) 323-1150
Job Description (In what way does your job involve bridge maintenance?) Project Coordinator for Scour Project, Paint Project and Bridge Management. Review Scour Reports, Conduct Quarterly Interdisciplinary Scour Meetings, prepared Biannual Federal Scour Reports. Certified Bridge Inspector, perform bridge inspection, review inspection reports, construction plan. Prepare bridge deficiencies list and assist project manager by conducting edit check of bridge data base. Write my own computer programs to accomplish this task.	Mailing Address FDOT Department Of Transportation 2916 Leslie Road Tampa, FL 33619

Bridge Description

Please provide a general description of the bridge including its name, location, route, and water body.
<p>Bridge Number 150107, the Howard Frankland is a tidal bridge constructed in 1959 and widened in 1992, 316 spans. This structure serves as the Northbound crossing of SR-93/I-275 over Old Tampa Bay. The maximum computed 100 and 500 year scour depths for this bridge are 27.5 feet and 29.5 feet respectively, which make the structure low risk, high priority.</p> <p>An accurate determination of the pile tip elevation is recommended, thus it may eliminate the need for a Phase 4 scour assessment or countermeasure according to our scour consultant, Pitman Hartenstein & associates, (PH&A)</p>

National Bridge Inventory (NBI) Data

Please provide the following information for the bridge. This information should be available in the NBI Database. Please provide the NBI Database Values consistent with those required in the 2002 NBI Coding Guide, and specify the units (where appropriate).

NBI Item No.	NBI Item Description	NBI Database Value
1	State Code	12
5	Inventory Route	00275
8	Structure Number	150107
19	Bypass, Detour Length (e.g. in miles)	0.6
26	Functional Classification of Inventory Route	11
27	Year Built	1959
29	Average Daily Traffic	67250
49	Structure Length (e.g. in feet)	15872
52	Deck Width, Out-to-Out (e.g. in feet)	62.3
60	Substructure	5
61	Channel and Channel Protection	7
71	Waterway Adequacy	8
109	Average Daily Truck Traffic	8%
113	Scour Critical Bridges (2002 NBI Guidelines)	U

Undocumented Assumptions

Please provide the following information for the bridge which is not documented in the NBI database.	
Description	User Input
Bridge Type (check only one)	<input checked="" type="checkbox"/> Simple Span(s) <input type="checkbox"/> Continuous Span(s) over 100 ft.
Remaining life of bridge in years. If this bridge has already failed, report the actual lifetime of the bridge before it failed	Estimated 25 years
Total Bridge Rebuilding Cost, if known. If unknown, estimate the cost by multiplying the bridge area by the cost per unit area as shown in Table 1 and the ADT cost multiplier as shown in Table 2. If estimated, provide the assumptions used in the spaces below: Bridge Area: <u>988,922.13</u> ft ² ; Cost per unit area: <u>110.00</u> \$/ft ² ; Cost Multiplier: <u>2.0</u>	\$ 219,762,868.60

Economic Loss Data

Please provide the following economic factors to be associated with the failure of this bridge. Either check the box confirming that the default factor is to be used or provide a different value.			
Description	Default Value		User-Provided Value
Car running cost	\$0.45 per mile	<input checked="" type="checkbox"/>	
Truck running cost	\$1.30 per mile	<input checked="" type="checkbox"/>	
Duration of detour *	Use Table 2 (days)	<input checked="" type="checkbox"/>	183
Value of time per adult *	Use Table 3 (\$/hr)	<input checked="" type="checkbox"/>	\$6.65
Average car occupancy rate	1.63 people	<input checked="" type="checkbox"/>	
Value of time for trucks	\$22.01 per hour	<input checked="" type="checkbox"/>	
Average detour speed	40 miles per hour	<input checked="" type="checkbox"/>	
Number of deaths from failure *	Use Table 2 (Number of people)	<input checked="" type="checkbox"/>	10
Cost for each life lost	\$500,000	<input checked="" type="checkbox"/>	\$2,500,000

* Please select an appropriate value from the reference table listed.

Cost of Analysis or Corrective Actions

Provide estimates for the following costs. Keep in mind that these costs may depend on a number of factors, e.g., the number of piers, abutments, etc. Also keep in mind that the guidelines include many significant broad assumptions, so significant effort is not warranted in estimating this data.	
Description	User Input
Estimated cost of installing automated scour monitoring	\$ 50,000.00 per Unit
Estimated cost of installing scour countermeasures	\$ 156,300/first bent Articulating block
Estimated cost of field reconnaissance to determine foundation type and depth (nondestructive testing, borings, etc.)	Dispersive Wave \$1000 per bent . For the first boring the cost is app.\$11,000.
Estimated cost to evaluate scour (survey, hydrology, and hydraulics analysis, if unavailable)	\$ 8,000.00 to 10,000.00

Scour Management Evaluation

8. I-275 NB over Tampa Bay

Bridge 150107 in Pinellas County, FL was constructed in 1959 and supports an urban interstate. This bridge has an unknown foundation depth, and it is further assumed that foundation records can not be found.

Is it a high-priority bridge?

This bridge supports an urban interstate, but it is not an emergency evacuation route and does not provide direct access to emergency services (e.g. hospital, fire stations, etc.). *Thus, in this context this bridge is not considered a high priority bridge.*

Does the bridge meet the minimum performance level?

The minimum performance level for an urban minor arterial class bridge, according to the guidelines, is 0.0001 – the maximum annual probability of failure allowed for this bridge. To estimate this bridge's annual probability of failure, it is first necessary to estimate the overtopping frequency and scour vulnerability of this bridge, as in the table below.

Data/Parameter (source)	Value	Interpretation
NBI item 26 (bridge survey)	11	Urban interstate classification
NBI item 71 (bridge survey)	8	Waterway is equal to the desirable criteria
∴ Overtopping Frequency (guidelines)	S	Slight (once in 11-100 years)
NBI item 60 (bridge survey)	5	Foundation is in fair condition
NBI item 61 (bridge survey)	7	Channel has some minor drift and damage
∴ Scour Vulnerability (guidelines)	6	Not yet evaluated, but probably stable
∴ Annual probability of failure (guidelines)	0.00025	A 1 in 4,000 chance of failure in any given year

This bridge does not meet the minimum performance level because the annual probability of failure is greater than 0.0001.

Recommended management strategy

This bridge does not meet the minimum performance level. Thus, the guidelines recommend the following three-step strategy to ensure the safety of this bridge.

1. Perform field reconnaissance to determine foundation type and depth. If the foundation is a spread footing, drill through the footing to determine elevation of the footing bottom. If the foundation is piles, use foundation reconnaissance to determine depth of piles. The parallel seismic test is generally the most effective reconnaissance method. Assume that the foundation information from the field evaluation is accurate. If field reconnaissance is unsuccessful (no access for testing, poor signal from NDT, etc.), assume a foundation depth. For piles, assume a 10 foot depth or use local knowledge. This should be a conservative assumption. Spread footing depths are easily discovered and an assumption should not be necessary for this type of foundation. In other words, continue as if the foundation is known.
2. Evaluate scour using FHWA HEC-18 manual.
3. If scour analysis indicates that countermeasures are warranted, countermeasures should be designed using FHWA HEC-23 manual – or consider replacing or closing the bridge.

Bridge #9

The Initial Survey

Respondent Information

Name Manuel H. Luna, EIT	E-mail Address manuel.luna@dot.state.fl.us
Job Title Structure Project Coordinator	Phone : (813) 744-6050
Job Description (In what way does your job involve bridge maintenance?) Project Coordinator for Scour Project, Paint Project and Bridge Management. Review Scour Reports, Conduct Quarterly Interdisciplinary Scour Meetings, prepared Biannual Federal Scour Reports. Certified Bridge Inspector, perform bridge inspection, review inspection reports, construction plan. Prepare bridge deficiencies list and assist project manager by conducting edit check of bridge data base. Write my own computer programs to accomplish this task.	Mailing Address FDOT Department Of Transportation 2916 Leslie Road Tampa, FL 33619

Bridge Description

Please provide a general description of the bridge including its name, location, route, and water body.
Bridge 100039 the US-41 SB over Little Manatee River is a 759 feet long bridge with 15 spans. It was built in 1971. The little manatee river is a tidally influence river. The calculated maximum water velocity is 10.42 fps. A geotechnical assessment is required given the unknown pile tip elevation.

National Bridge Inventory (NBI) Data

Please provide the following information for the bridge. This information should be available in the NBI database. Please provide the NBI Database Values consistent with those required in the 2002 NBI Coding Guide, and specify the units (where appropriate).		
NBI Item No.	NBI Item Description	NBI Database Value
1	State Code	12
5	Inventory Route	00041
8	Structure Number	100039
19	Bypass, Detour Length (e.g. in miles)	0.6214
26	Functional Classification of Inventory Route	02
27	Year Built	1971
29	Average Daily Traffic	8250
49	Structure Length (e.g. in feet)	758.85
52	Deck Width, Out-to-Out (e.g. in feet)	43.90
60	Substructure	7
61	Channel and Channel Protection	8
71	Waterway Adequacy	8
109	Average Daily Truck Traffic	12%
113	Scour Critical Bridges (2002 NBI Guidelines)	U

Undocumented Assumptions

Please provide the following information for the bridge which is not documented in the NBI database.	
Description	User Input
Bridge Type (check only one)	<input checked="" type="checkbox"/> Simple Span(s) <input type="checkbox"/> Continuous Span(s) over 100 ft.
Remaining life of bridge in years. If this bridge has already failed, report the actual lifetime of the bridge before it failed	App. 40 years
Total Bridge Rebuilding Cost, if known. If unknown, estimate the cost by multiplying the bridge area by the cost per unit area as shown in Table 1 and the ADT cost multiplier as shown in Table 2. If estimated, provide the assumptions used in the spaces below: Bridge Area: <u>33319.24</u> <u> </u> ft ² ; Cost per unit area: <u>60</u> \$/ft ² ; Cost Multiplier: 2.0 <u> </u>	\$ 39,983,308.80

Economic Loss Data

Please provide the following economic factors to be associated with the failure of this bridge. Either check the box confirming that the default factor is to be used or provide a different value.			
Description	Default Value	User-Provided Value	
Car running cost	\$0.45 per mile	<input checked="" type="checkbox"/>	
Truck running cost	\$1.30 per mile	<input checked="" type="checkbox"/>	
Duration of detour *	Use Table 2 (days)	<input checked="" type="checkbox"/>	183
Value of time per adult *	Use Table 3 (\$/hr)	<input checked="" type="checkbox"/>	\$6.65
Average car occupancy rate	1.63 people	<input checked="" type="checkbox"/>	
Value of time for trucks	\$22.01 per hour	<input checked="" type="checkbox"/>	
Average detour speed	40 miles per hour	<input checked="" type="checkbox"/>	
Number of deaths from failure *	Use Table 2 (Number of people)	<input checked="" type="checkbox"/>	5
Cost for each life lost	\$500,000	<input checked="" type="checkbox"/>	2,500,000

* Please select an appropriate value from the reference table listed.

Cost of Analysis or Corrective Actions

Provide estimates for the following costs. Keep in mind that these costs may depend on a number of factors, e.g., the number of piers, abutments, etc. Also keep in mind that the guidelines include many significant broad assumptions, so significant effort is not warranted in estimating this data.	
Description	User Input
Estimated cost of installing automated scour monitoring	\$ 50,000.00 per Unit
Estimated cost of installing scour countermeasures	\$172.00 per Square Yard
Estimated cost of field reconnaissance to determine foundation type and depth (nondestructive testing, borings, etc.)	\$4,500.00 Initial borings
Estimated cost to evaluate scour (survey, hydrology, and hydraulics analysis, if unavailable)	\$8,000.00

Scour Management Evaluation

9. US 41 SB over Little Manatee River

Bridge 100039 in Ruskin, FL was constructed in 1971 and supports a rural principal arterial class road. This bridge has an unknown foundation depth, and it is further assumed that foundation records can not be found.

Is it a high-priority bridge?

This bridge supports a rural principal arterial road, which has significant economic value and may provide access to critical local services. *Thus, in this context this bridge is considered a high priority bridge* and should be given special attention.

Recommended management strategy

This bridge has significant economic value and may provide critical access to local services. Thus, the guidelines recommend the following three-step strategy to ensure the safety of this bridge.

1. Perform field reconnaissance to determine foundation type and depth. If the foundation is a spread footing, drill through the footing to determine elevation of the footing bottom. If the foundation is piles, use foundation reconnaissance to determine depth of piles. The parallel seismic test is generally the most effective reconnaissance method. Assume that the foundation information from the field evaluation is accurate. If field reconnaissance is unsuccessful (no access for testing, poor signal from NDT, etc.), assume a foundation depth. For piles, assume a 10 foot depth or use local knowledge. This should be a conservative assumption. Spread footing depths are easily discovered and an assumption should not be necessary for this type of foundation. In other words, continue as if the foundation is known.
2. Evaluate scour using FHWA HEC-18 manual.
3. If scour analysis indicates that countermeasures are warranted, countermeasures should be designed using FHWA HEC-23 manual – or consider replacing or closing the bridge.

Bridge #10

The Initial Survey

Respondent Information

Name Manuel H. Luna, EIT	E-mail Address manuel.luna@dot.state.fl.us
Job Title: Project Coordinator	Phone (813) 744-6050 Cell (813) 323-1150
Job Description (In what way does your job involve bridge maintenance?) Project Coordinator for Scour Project, Paint Project and Bridge Management. Review Scour Reports, Conduct Quarterly Interdisciplinary Scour Meetings, prepared Biannual Federal Scour Reports. Certified Bridge Inspector, perform bridge inspection, review inspection reports, construction plan. Prepare bridge deficiencies list and assist project manager by conducting edit check of bridge data base. Write my own computer programs to accomplish this task.	Mailing Address FDOT Department Of Transportation 2916 Leslie Road Tampa, FL 33619

Bridge Description

Please provide a general description of the bridge including its name, location, route, and water body.
Bridge No. 100100 is a three spans, 321 feet long bridge, skew 20 degree , that was constructed in 1913 and reconstructed in 1994, as East/West crossing of SR-60 over the Hillsborough River.

National Bridge Inventory (NBI) Data

Please provide the following information for the bridge. This information should be available in the NBI database. Please provide the NBI Database Values consistent with those required in the 2002 NBI Coding Guide, and specify the units (where appropriate).		
NBI Item No.	NBI Item Description	NBI Database Value
1	State Code	12
5	Inventory Route	00060
8	Structure Number	100100
19	Bypass, Detour Length (e.g. in miles)	1.8642
26	Functional Classification of Inventory Route	14
27	Year Built	1913
29	Average Daily Traffic	36500
49	Structure Length (e.g. in feet)	322.89
52	Deck Width, Out-to-Out (e.g. in feet)	77.99
60	Substructure	6
61	Channel and Channel Protection	8
71	Waterway Adequacy	7
109	Average Daily Truck Traffic	5%
113	Scour Critical Bridges (2002 NBI Guidelines)	U

Undocumented Assumptions

Please provide the following information for the bridge which is not documented in the NBI database.	
Description	User Input
Bridge Type (check only one) Movable Bascule Bridge	<input checked="" type="checkbox"/> Simple Span(s) <input type="checkbox"/> Continuous Span(s) over 100 ft.
Remaining life of bridge in years. If this bridge has already failed, report the actual lifetime of the bridge before it failed	63 years
Total Bridge Rebuilding Cost, if known. If unknown, estimate the cost by multiplying the bridge area by the cost per unit area as shown in Table 1 and the ADT cost multiplier as shown in Table 2. If estimated, provide the assumptions used in the spaces below: Bridge Area: <u>25189.45</u> ft ² ; Cost per unit area: <u>\$1500</u> \$/ft ² ; Cost Multiplier: <u>2.0</u>	\$ 78,568,380.00

Economic Loss Data

Please provide the following economic factors to be associated with the failure of this bridge. Either check the box confirming that the default factor is to be used or provide a different value.			
Description	Default Value		User-Provided Value
Car running cost	\$0.45 per mile	X	
Truck running cost	\$1.30 per mile	X	
Duration of detour *	Use Table 2 (days)	X	183
Value of time per adult *	Use Table 3 (\$/hr)	X	\$6.65
Average car occupancy rate	1.63 people	X	
Value of time for trucks	\$22.01 per hour	X	
Average detour speed	40 miles per hour	X	
Number of deaths from failure *	Use Table 2 (Number of people)	X	5
Cost for each life lost	\$500,000	X	2,500,000

* Please select an appropriate value from the reference table listed.

Cost of Analysis or Corrective Actions

Provide estimates for the following costs. Keep in mind that these costs may depend on a number of factors, e.g., the number of piers, abutments, etc. Also keep in mind that the guidelines include many significant broad assumptions, so significant effort is not warranted in estimating this data.	
Description	User Input
Estimated cost of installing automated scour monitoring	\$64,000.00
Estimated cost of installing scour countermeasures	\$172.00 per SY
Estimated cost of field reconnaissance to determine foundation type and depth (nondestructive testing, borings, etc.)	\$4,500.00
Estimated cost to evaluate scour (survey, hydrology, and hydraulics analysis, if unavailable)	\$ 8,000.00

Scour Management Evaluation

10. State Route 60 over Hillsborough River

Bridge 100100 in Tampa, FL was constructed in 1913 and supports an urban principal arterial class road. This bridge has an unknown foundation depth, and it is further assumed that foundation records can not be found.

Is it a high-priority bridge?

This bridge supports an urban principal arterial road, which has significant economic value and may provide access to critical local services. *Thus, in this context this bridge is considered a high priority bridge* and should be given special attention.

Recommended management strategy

This bridge has significant economic value and may provide critical access to local services. Thus, the guidelines recommend the following three-step strategy to ensure the safety of this bridge.

1. Perform field reconnaissance to determine foundation type and depth. If the foundation is a spread footing, drill through the footing to determine elevation of the footing bottom. If the foundation is piles, use foundation reconnaissance to determine depth of piles. The parallel seismic test is generally the most effective reconnaissance method. Assume that the foundation information from the field evaluation is accurate. If field reconnaissance is unsuccessful (no access for testing, poor signal from NDT, etc.), assume a foundation depth. For piles, assume a 10 foot depth or use local knowledge. This should be a conservative assumption. Spread footing depths are easily discovered and an assumption should not be necessary for this type of foundation. In other words, continue as if the foundation is known.
2. Evaluate scour using FHWA HEC-18 manual.
3. If scour analysis indicates that countermeasures are warranted, countermeasures should be designed using FHWA HEC-23 manual – or consider replacing or closing the bridge.

Response to Evaluations

Richard Semple commented on the first five management summaries, which we submitted. He said:

I've reviewed the first five case studies, since those are the ones I submitted. The comments are inclusive to all five, in as much as the "Recommended Management Strateg[ies]" are all the same. The approach presented seems logical and is along the lines of our approach for determining the stability of "unknown foundation" bridges, with the goal to eliminate them from this criteria based on field reconnaissance and foundation investigation. At the present time, we're doing some select SPT borings, to determine soil resistance and using a similar bridge with known foundation and location, make a determination if the bridge can be reclassified from "unknown to "known" foundation. The concern in using "risk based management" is the fact that you're going "out on a limb" based on faith in your calculations. The one good thing that we have going for our situation is the relative slow flow of water and historical inspection data for our unknown foundation structures.

Manuel Luna commented on the last five management summaries, which he submitted. He and others correctly note that bridge numbers 150107 and 100352 should have been classified as high priority structures. Fortunately this mistake did not change the management summary in either case, and illustrates the conservatism of the scour guidelines regarding high ADT bridges. His full comments and questions are as follows:

1. I have some questions as far as the Howard Frankland Bridge (Br. No. 150107), which is classified as not a high priority bridge. I would like you to explain what is a high priority bridge? Since, this bridge is on the National Highway System and it is on the STRAHNET Highway designation with a pretty high ADT, and yet is not considered high priority bridge. Why?

2. According to our scour consultant, Hisham Sunna, he said the following:
"Although the Parallel Seismic method is very reliable for determining pile embedments, it is a costly method and one of the most field labor-intensive." Do you recommend any other method besides Parallel Seismic method to make an unknown foundation bridge known?
3. Hisham Sunna also questions the priority on the following bridge as follows: "I-75 NB over Little Manatee River. The statement is that it is not a high priority bridge because it is a rural route; we believe since I-75 is an evacuation route, as are most major N-S arterials in Florida, that it is a high priority bridge." Please explain.
4. Another question that I have is, why all the recommended Management Strategies are the same? Are there any other methods that can be used to make an unknown foundation bridge known? I do agree with Richard when he said: "The approach presented seems logical and it is along the lines of our approach for determining the stability of unknown foundation bridges in District 1 and 7."
5. As you can see we have some reservation in your prioritization method for some of our bridges, such as the Howard Frankland and The Little Manatee River, also you do not mention any historical data for ground elevation comparison, and how it can be used to assign level of risk for the unknown foundation bridges. As for the revering bridges in both Districts 1 and 7 the one good thing that we have in Florida is the relative slow flow of water and our historical data for ground elevation comparison for our unknown foundation structures over several years.

New York Bridges*Bridge #1***The Initial Survey**

Respondent Information

Name Bob Burnett	E-mail Address bburnett@dot.state.ny.us
Job Title Director, Geotech. Eng.	Phone 518-457-4712
Job Description (In what way does your job involve bridge maintenance?) We do foundations. Mike Sullivan, in our Structures Division Inventory Unit, completed the survey.	Mailing Address 50 Wolf Road, MP 31 Albany, NY 12232

Bridge Description

Please provide a general description of the bridge including its name, location, route, and water body.
County Road 1 over South Branch of Van Campen Creek. Town of Friendship, NY, NYSDOT Region 6 (Hornell), County 1 (Allegany). Not critical structure. Failed 8/2003.

National Bridge Inventory (NBI) Data

Please provide the following information for the bridge. This information should be available in the NBI database. Please provide the NBI Database Values consistent with those required in the 2002 NBI Coding Guide, and specify the units (where appropriate).		
NBI Item No.	NBI Item Description	NBI Database Value
1	State Code	62
5	Inventory Route	140000000
8	Structure Number	000000003330270
19	Bypass, Detour Length (e.g. in miles)	4 (km)
26	Functional Classification of Inventory Route	07
27	Year Built	1957
29	Average Daily Traffic	689
49	Structure Length (e.g. in feet)	32.92 (m)
52	Deck Width, Out-to-Out (e.g. in feet)	9.14 (m)
60	Substructure	4
61	Channel and Channel Protection	6
71	Waterway Adequacy	6
109	Average Daily Truck Traffic	8%
113	Scour Critical Bridges (2002 NBI Guidelines)	*3

* Bridge was coded "3". Scour Critical for Item 113 before it failed due to scour at pier in 8/2003. Bridge was replaced with a new single span prestressed concrete structure in 2004.

Undocumented Assumptions

Please provide the following information for the bridge which is not documented in the NBI database.	
Description	User Input
Bridge Type (check only one)	<input checked="" type="checkbox"/> Simple Span(s) <input type="checkbox"/> Continuous Span(s) over 100 ft.
Remaining life of bridge in years. If this bridge has already failed, report the actual lifetime of the bridge before it failed	46 years
Total Bridge Rebuilding Cost, if known. If unknown, estimate the cost by multiplying the bridge area by the cost per unit area as shown in Table 1 and the ADT cost multiplier as shown in Table 2. If estimated, provide the assumptions used in the spaces below: Bridge Area: _____ ft ² ; Cost per unit area: _____ \$/ft ² ; Cost Multiplier: _____	\$571,300

Economic Loss Data

Please provide the following economic factors to be associated with the failure of this bridge. Either check the box confirming that the default factor is to be used or provide a different value.		
Description	Default Value	User-Provided Value
Car running cost	\$0.45 per mile <input checked="" type="checkbox"/>	
Truck running cost	\$1.30 per mile <input checked="" type="checkbox"/>	
Duration of detour *	Use Table 2 (days) <input checked="" type="checkbox"/>	548
Value of time per adult *	Use Table 3 (\$/hr) <input checked="" type="checkbox"/>	\$8.59
Average car occupancy rate	1.63 people <input checked="" type="checkbox"/>	
Value of time for trucks	\$22.01 per hour <input checked="" type="checkbox"/>	
Average detour speed	40 miles per hour <input checked="" type="checkbox"/>	
Number of deaths from failure *	Use Table 2 (Number of people) <input checked="" type="checkbox"/>	2
Cost for each life lost	\$500,000 <input checked="" type="checkbox"/>	

* Please select an appropriate value from the reference table listed.

Cost of Analysis or Corrective Actions

Provide estimates for the following costs. Keep in mind that these costs may depend on a number of factors, e.g., the number of piers, abutments, etc. Also keep in mind that the guidelines include many significant broad assumptions, so significant effort is not warranted in estimating this data.	
Description	User Input
Estimated cost of installing automated scour monitoring	\$30,000
Estimated cost of installing scour countermeasures	\$25,000
Estimated cost of field reconnaissance to determine foundation type and depth (nondestructive testing, borings, etc.)	\$0
Estimated cost to evaluate scour (survey, hydrology, and hydraulics analysis, if unavailable)	\$25,000

Scour Management Evaluation

1. County Road 1 over South Branch of Van Campen Creek

Bridge 3330270 in Friendship, NY (Allegany County) was constructed in 1930. It supported a rural major collector class road before it failed due to scour in 2003. All of the data reported for this bridge was collected prior to failure and NBI item 113 was coded “3” (Scour critical and unstable). To test the guidelines, this bridge will be evaluated as if it had an unknown foundation.

Is it a high-priority bridge?

This bridge supported a rural road, which was not a principal arterial, emergency route, and does not provide direct access to other emergency services (e.g. hospital, fire stations, etc.). *Thus, in this context this bridge is not considered a high priority bridge.*

Does the bridge meet the minimum performance level?

The minimum performance level for a rural major collector class bridge, according to the guidelines, is 0.0005 – the threshold probability of failure that this bridge must outperform. To estimate this bridge’s annual probability of failure, it is first necessary to estimate the overtopping frequency and scour vulnerability of this bridge, as in the table below.

Data/Parameter (source)	Value	Interpretation
NBI item 26 (bridge survey)	7	Rural major collector classification
NBI item 71 (bridge survey)	6	Waterway exceeds than the minimum criteria
∴ Overtopping Frequency (guidelines)	0	Occasional (once in 3-10 years)
NBI item 60 (bridge survey)	4	Foundation is in poor condition
NBI item 61 (bridge survey)	6	Channel has widespread minor damage
∴ Scour Vulnerability (guidelines)	4	Analysis: stable; Survey: exposed foundation
∴ Annual probability of failure (guidelines)	0.0005	A 1 in 3,030 chance of failure in any given year

This bridge does not meet the minimum performance level because the annual probability of failure is not less than 0.0005.

Recommended management strategy

This bridge does not meet the minimum performance level. Thus, if it had an unknown foundation and had been evaluated before it failed the guidelines would have recommended the following three-step strategy to ensure the safety of this bridge.

1. Perform field reconnaissance to determine foundation type and depth. If the foundation is a spread footing, drill through the footing to determine elevation of the footing bottom. If the foundation is piles, use foundation reconnaissance to determine depth of piles. The parallel seismic test is generally the most effective reconnaissance method. Assume that the foundation information from the field evaluation is accurate. If field reconnaissance is unsuccessful (no access for testing, poor signal from NDT, etc.), assume a foundation depth. For piles, assume a 10 foot depth or use local knowledge. This should be a conservative assumption. Spread footing depths are easily discovered and an assumption should not be necessary for this type of foundation. In other words, continue as if the foundation is known.

2. Evaluate scour using FHWA HEC-18 manual.
3. If scour analysis indicates that countermeasures are warranted, countermeasures should be designed using FHWA HEC-23 manual – or consider replacing or closing the bridge.

Bridge #2

The Initial Survey

Respondent Information

Name Bob Burnett	E-mail Address bburnett@dot.state.ny.us
Job Title Director, Geotech. Eng.	Phone 518-457-4712
Job Description (In what way does your job involve bridge maintenance?)	Mailing Address 50 Wolf Road, MP 31 Albany, NY 12232

Bridge Description

Please provide a general description of the bridge including its name, location, route, and water body.
Warren Farm Road over Wiccopee Creek. Town of East Fishkill, NY. NYSDOT Region 8 (Poughkeepsie), County 2 (Dutchess). Dead end road to homes.

National Bridge Inventory (NBI) Data

Please provide the following information for the bridge. This information should be available in the NBI database. Please provide the NBI Database Values consistent with those required in the 2002 NBI Coding Guide, and specify the units (where appropriate).		
NBI Item No.	NBI Item Description	NBI Database Value
1	State Code	62
5	Inventory Route	180000000
8	Structure Number	000000002268710
19	Bypass, Detour Length (e.g. in miles)	199 (km)
26	Functional Classification of Inventory Route	09
27	Year Built	1980
29	Average Daily Traffic	200
49	Structure Length (e.g. in feet)	8.8 (m)
52	Deck Width, Out-to-Out (e.g. in feet)	7.8 (m)
60	Substructure	6
61	Channel and Channel Protection	6
71	Waterway Adequacy	5
109	Average Daily Truck Traffic	4%
113	Scour Critical Bridges (2002 NBI Guidelines)	U

Undocumented Assumptions

Please provide the following information for the bridge which is not documented in the NBI database.	
Description	User Input
Bridge Type (check only one)	<input checked="" type="checkbox"/> Simple Span(s) <input type="checkbox"/> Continuous Span(s) over 100 ft.
Remaining life of bridge in years. If this bridge has already failed, report the actual lifetime of the bridge before it failed	24 years
Total Bridge Rebuilding Cost, if known. If unknown, estimate the cost by multiplying the bridge area by the cost per unit area as shown in Table 1 and the ADT cost multiplier as shown in Table 2. If estimated, provide the assumptions used in the spaces below: Bridge Area: _____ ft ² ; Cost per unit area: _____ \$/ft ² ; Cost Multiplier: _____	\$1,513,850

70 (prestressed concrete) + 15 (demo)

Economic Loss Data

Please provide the following economic factors to be associated with the failure of this bridge. Either check the box confirming that the default factor is to be used or provide a different value.		
Description	Default Value	User-Provided Value
Car running cost	\$0.45 per mile <input checked="" type="checkbox"/>	
Truck running cost	\$1.30 per mile <input checked="" type="checkbox"/>	
Duration of detour *	Use Table 2 (days) <input checked="" type="checkbox"/>	730
Value of time per adult *	Use Table 3 (\$/hr) <input checked="" type="checkbox"/>	\$8.54
Average car occupancy rate	1.63 people <input checked="" type="checkbox"/>	
Value of time for trucks	\$22.01 per hour <input checked="" type="checkbox"/>	
Average detour speed	40 miles per hour <input checked="" type="checkbox"/>	
Number of deaths from failure *	Use Table 2 (Number of people) <input checked="" type="checkbox"/>	1
Cost for each life lost	\$500,000 <input checked="" type="checkbox"/>	

* Please select an appropriate value from the reference table listed.

Cost of Analysis or Corrective Actions

Provide estimates for the following costs. Keep in mind that these costs may depend on a number of factors, e.g., the number of piers, abutments, etc. Also keep in mind that the guidelines include many significant broad assumptions, so significant effort is not warranted in estimating this data.	
Description	User Input
Estimated cost of installing automated scour monitoring	\$20,000
Estimated cost of installing scour countermeasures	\$15,000
Estimated cost of field reconnaissance to determine foundation type and depth (nondestructive testing, borings, etc.)	\$5,000
Estimated cost to evaluate scour (survey, hydrology, and hydraulics analysis, if unavailable)	\$15,000

Scour Management Evaluation

2. Warren Farm Road over Wiccopee Creek

Bridge 2268710 in East Fishkill, NY (Dutchess County) was constructed in 1980 and supports a rural-local class road. This bridge has an unknown foundation depth, and it is further assumed that foundation records can not be found.

Is it a high-priority bridge?

This bridge supports a rural road, but it is the only evacuation route for a local community. *Thus, in this context this bridge is considered a high priority bridge.*

Recommended management strategy

This bridge is a critical evacuation route and has significant economic value. Thus, the guidelines recommend the following three-step strategy to ensure the safety of this bridge.

1. Perform field reconnaissance to determine foundation type and depth. If the foundation is a spread footing, drill through the footing to determine elevation of the footing bottom. If the foundation is piles, use foundation reconnaissance to determine depth of piles. The parallel seismic test is generally the most effective reconnaissance method. Assume that the foundation information from the field evaluation is accurate. If field reconnaissance is unsuccessful (no access for testing, poor signal from NDT, etc.), assume a foundation depth. For piles, assume a 10 foot depth or use local knowledge. This should be a conservative assumption. Spread footing depths are easily discovered and an assumption should not be necessary for this type of foundation. In other words, continue as if the foundation is known.
2. Evaluate scour using FHWA HEC-18 manual.
3. If scour analysis indicates that countermeasures are warranted, countermeasures should be designed using FHWA HEC-23 manual – or consider replacing or closing the bridge.

Bridge #3

The Initial Survey

Respondent Information

Name Bob Burnett	E-mail Address bburnett@dot.state.ny.us
Job Title Director, Geotech. Eng.	Phone 518-457-4712
Job Description (In what way does your job involve bridge maintenance?)	Mailing Address 50 Wolf Road, MP 31 Albany, NY 12232

Bridge Description

Please provide a general description of the bridge including its name, location, route, and water body.
Arbutus Road over Fishing Brook. Town of Newcomb, NY. NYSDOT Region 1 (Albany), County 2 (Essex). Dead-end road to homes

National Bridge Inventory (NBI) Data

Please provide the following information for the bridge. This information should be available in the NBI database. Please provide the NBI Database Values consistent with those required in the 2002 NBI Coding Guide, and specify the units (where appropriate).		
NBI Item No.	NBI Item Description	NBI Database Value
1	State Code	62
5	Inventory Route	118000000
8	Structure Number	000000002268950
19	Bypass, Detour Length (e.g. in miles)	199 (km)
26	Functional Classification of Inventory Route	09
27	Year Built	1950
29	Average Daily Traffic	100
49	Structure Length (e.g. in feet)	16.1 (m)
52	Deck Width, Out-to-Out (e.g. in feet)	4.5 (m)
60	Substructure	6
61	Channel and Channel Protection	7
71	Waterway Adequacy	5
109	Average Daily Truck Traffic	6%
113	Scour Critical Bridges (2002 NBI Guidelines)	U

Undocumented Assumptions

Please provide the following information for the bridge which is not documented in the NBI database.	
Description	User Input
Bridge Type (check only one)	<input checked="" type="checkbox"/> Simple Span(s) <input type="checkbox"/> Continuous Span(s) over 100 ft.
Remaining life of bridge in years. If this bridge has already failed, report the actual lifetime of the bridge before it failed	10years
Total Bridge Rebuilding Cost, if known. If unknown, estimate the cost by multiplying the bridge area by the cost per unit area as shown in Table 1 and the ADT cost multiplier as shown in Table 2. If estimated, provide the assumptions used in the spaces below: Bridge Area: _____ ft ² ; Cost per unit area: _____ \$/ft ² ; Cost Multiplier: _____	\$340,808

70 (prestressed concrete) + 15 (demo)

Economic Loss Data

Please provide the following economic factors to be associated with the failure of this bridge. Either check the box confirming that the default factor is to be used or provide a different value.		
Description	Default Value	User-Provided Value
Car running cost	\$0.45 per mile <input checked="" type="checkbox"/>	
Truck running cost	\$1.30 per mile <input checked="" type="checkbox"/>	
Duration of detour *	Use Table 2 (days) <input checked="" type="checkbox"/>	730
Value of time per adult *	Use Table 3 (\$/hr) <input checked="" type="checkbox"/>	\$8.54
Average car occupancy rate	1.63 people <input checked="" type="checkbox"/>	
Value of time for trucks	\$22.01 per hour <input checked="" type="checkbox"/>	
Average detour speed	40 miles per hour <input checked="" type="checkbox"/>	
Number of deaths from failure *	Use Table 2 (Number of people) <input checked="" type="checkbox"/>	1
Cost for each life lost	\$500,000 <input checked="" type="checkbox"/>	

* Please select an appropriate value from the reference table listed.

Cost of Analysis or Corrective Actions

Provide estimates for the following costs. Keep in mind that these costs may depend on a number of factors, e.g., the number of piers, abutments, etc. Also keep in mind that the guidelines include many significant broad assumptions, so significant effort is not warranted in estimating this data.	
Description	User Input
Estimated cost of installing automated scour monitoring	\$20,000
Estimated cost of installing scour countermeasures	\$15,000
Estimated cost of field reconnaissance to determine foundation type and depth (nondestructive testing, borings, etc.)	\$5,000
Estimated cost to evaluate scour (survey, hydrology, and hydraulics analysis, if unavailable)	\$15,000

Scour Management Evaluation

3. *Arbutus Road over Fishing Brook*

Bridge 2268950 in Newcomb, NY (Essex County) was constructed in 1950 and supports a rural local class road. This bridge has an unknown foundation depth, and it is further assumed that foundation records can not be found.

Is it a high-priority bridge?

This bridge supports a rural road, but it is the only evacuation route for a local community. *Thus, in this context this bridge is considered a high priority bridge.*

Recommended management strategy

This bridge is a critical evacuation route and has significant economic value. Thus, the guidelines recommend the following three-step strategy to ensure the safety of this bridge.

1. Perform field reconnaissance to determine foundation type and depth. If the foundation is a spread footing, drill through the footing to determine elevation of the footing bottom. If the foundation is piles, use foundation reconnaissance to determine depth of piles. The parallel seismic test is generally the most effective reconnaissance method. Assume that the foundation information from the field evaluation is accurate. If field reconnaissance is unsuccessful (no access for testing, poor signal from NDT, etc.), assume a foundation depth. For piles, assume a 10 foot depth or use local knowledge. This should be a conservative assumption. Spread footing depths are easily discovered and an assumption should not be necessary for this type of foundation. In other words, continue as if the foundation is known.
2. Evaluate scour using FHWA HEC-18 manual.
3. If scour analysis indicates that countermeasures are warranted, countermeasures should be designed using FHWA HEC-23 manual – or consider replacing or closing the bridge.

Bridge #4

The Initial Survey

Respondent Information

Name Bob Burnett	E-mail Address bburnett@dot.state.ny.us
Job Title Director, Geotech. Eng.	Phone 518-457-4712
Job Description (In what way does your job involve bridge maintenance?)	Mailing Address 50 Wolf Road, MP 31 Albany, NY 12232

Bridge Description

Please provide a general description of the bridge including its name, location, route, and water body.
Route 23 over CSX/Amtrak/Hudson River "Rip Van Winkle Bridge". Village of Catskill, NY, NYSDOT Region 1 (Albany), County 3 (Greene). Critical

National Bridge Inventory (NBI) Data

Please provide the following information for the bridge. This information should be available in the NBI database. Please provide the NBI Database Values consistent with those required in the 2002 NBI Coding Guide, and specify the units (where appropriate).		
NBI Item No.	NBI Item Description	NBI Database Value
1	State Code	62
5	Inventory Route	131000230
8	Structure Number	000000005017820
19	Bypass, Detour Length (e.g. in miles)	64 (km)
26	Functional Classification of Inventory Route	14
27	Year Built	1935
29	Average Daily Traffic	13609
49	Structure Length (e.g. in feet)	1536.1 (m)
52	Deck Width, Out-to-Out (e.g. in feet)	11.2 (m)
60	Substructure	6
61	Channel and Channel Protection	8
71	Waterway Adequacy	6
109	Average Daily Truck Traffic	5%
113	Scour Critical Bridges (2002 NBI Guidelines)	U

Undocumented Assumptions

Please provide the following information for the bridge which is not documented in the NBI database.	
Description	User Input
Bridge Type (check only one)	<input type="checkbox"/> Simple Span(s) <input checked="" type="checkbox"/> Continuous Span(s) over 100 ft.
Remaining life of bridge in years. If this bridge has already failed, report the actual lifetime of the bridge before it failed	29 years
Total Bridge Rebuilding Cost, if known. If unknown, estimate the cost by multiplying the bridge area by the cost per unit area as shown in Table 1 and the ADT cost multiplier as shown in Table 2. If estimated, provide the assumptions used in the spaces below: Bridge Area: _____ ft ² ; Cost per unit area: _____ \$/ft ² ; Cost Multiplier: _____	\$31,956,192

120 + 15 (demo)

Economic Loss Data

Please provide the following economic factors to be associated with the failure of this bridge. Either check the box confirming that the default factor is to be used or provide a different value.		
Description	Default Value	User-Provided Value
Car running cost	\$0.45 per mile <input checked="" type="checkbox"/>	
Truck running cost	\$1.30 per mile <input checked="" type="checkbox"/>	
Duration of detour *	Use Table 2 (days) <input checked="" type="checkbox"/>	183
Value of time per adult *	Use Table 3 (\$/hr) <input checked="" type="checkbox"/>	\$8.59
Average car occupancy rate	1.63 people <input checked="" type="checkbox"/>	
Value of time for trucks	\$22.01 per hour <input checked="" type="checkbox"/>	
Average detour speed	40 miles per hour <input checked="" type="checkbox"/>	
Number of deaths from failure *	Use Table 2 (Number of people) <input checked="" type="checkbox"/>	10
Cost for each life lost	\$500,000 <input checked="" type="checkbox"/>	

* Please select an appropriate value from the reference table listed.

Cost of Analysis or Corrective Actions

Provide estimates for the following costs. Keep in mind that these costs may depend on a number of factors, e.g., the number of piers, abutments, etc. Also keep in mind that the guidelines include many significant broad assumptions, so significant effort is not warranted in estimating this data.	
Description	User Input
Estimated cost of installing automated scour monitoring	\$150,000
Estimated cost of installing scour countermeasures	\$150,000
Estimated cost of field reconnaissance to determine foundation type and depth (nondestructive testing, borings, etc.)	\$50,000
Estimated cost to evaluate scour (survey, hydrology, and hydraulics analysis, if unavailable)	\$50,000

Scour Management Evaluation

4. Route 23 over Hudson River (“Rip Van Winkle Bridge”)

Bridge 5017820 in Catskill, NY (Albany County) was constructed in 1935 and supports an urban principal arterial class road. This bridge has an unknown foundation depth, and it is further assumed that foundation records can not be found.

Is it a high-priority bridge?

This bridge supports a rural road, which is a principal arterial and provides direct access to emergency services (e.g. hospital, fire stations, etc.). *Thus, in this context this bridge is considered a high priority bridge* and should be given special attention.

Recommended management strategy

This bridge provides critical access to local services and has significant economic value. Thus, the guidelines recommend the following three-step strategy to ensure the safety of this bridge.

1. Perform field reconnaissance to determine foundation type and depth. If the foundation is a spread footing, drill through the footing to determine elevation of the footing bottom. If the foundation is piles, use foundation reconnaissance to determine depth of piles. The parallel seismic test is generally the most effective reconnaissance method. Assume that the foundation information from the field evaluation is accurate. If field reconnaissance is unsuccessful (no access for testing, poor signal from NDT, etc.), assume a foundation depth. For piles, assume a 10 foot depth or use local knowledge. This should be a conservative assumption. Spread footing depths are easily discovered and an assumption should not be necessary for this type of foundation. In other words, continue as if the foundation is known.
2. Evaluate scour using FHWA HEC-18 manual.
3. If scour analysis indicates that countermeasures are warranted, countermeasures should be designed using FHWA HEC-23 manual – or consider replacing or closing the bridge.

Bridge #5

The Initial Survey

Respondent Information

Name Bob Burnett	E-mail Address bburnett@dot.state.ny.us
Job Title Director, Geotech. Eng.	Phone 518-457-4712
Job Description (In what way does your job involve bridge maintenance?) Rockway Turnpike over Mott Creek. Town of Hempstead (Long Island). NYSDOT Region 10 (Hauppauge), County 1 (Nassau). Not critical	Mailing Address 50 Wolf Road, MP 31 Albany, NY 12232

Bridge Description

Please provide a general description of the bridge including its name, location, route, and water body.

National Bridge Inventory (NBI) Data

Please provide the following information for the bridge. This information should be available in the NBI database. Please provide the NBI Database Values consistent with those required in the 2002 NBI Coding Guide, and specify the units (where appropriate).		
NBI Item No.	NBI Item Description	NBI Database Value
1	State Code	62
5	Inventory Route	140000000
8	Structure Number	000000003300120
19	Bypass, Detour Length (e.g. in miles)	16 (km)
26	Functional Classification of Inventory Route	14
27	Year Built	1993
29	Average Daily Traffic	33,850
49	Structure Length (e.g. in feet)	39.9 (m)
52	Deck Width, Out-to-Out (e.g. in feet)	34.0 (m)
60	Substructure	8
61	Channel and Channel Protection	6
71	Waterway Adequacy	5
109	Average Daily Truck Traffic	3%
113	Scour Critical Bridges (2002 NBI Guidelines)	U

Undocumented Assumptions

Please provide the following information for the bridge which is not documented in the NBI database.	
Description	User Input
Bridge Type (check only one)	<input checked="" type="checkbox"/> Simple Span(s) <input type="checkbox"/> Continuous Span(s) over 100 ft.
Remaining life of bridge in years. If this bridge has already failed, report the actual lifetime of the bridge before it failed	37years
Total Bridge Rebuilding Cost, if known. If unknown, estimate the cost by multiplying the bridge area by the cost per unit area as shown in Table 1 and the ADT cost multiplier as shown in Table 2. If estimated, provide the assumptions used in the spaces below: Bridge Area: _____ ft ² ; Cost per unit area: _____ \$/ft ² ; Cost Multiplier: _____	\$2,446,688

70 (prestressed concrete) + 15 (demo)

Economic Loss Data

Please provide the following economic factors to be associated with the failure of this bridge. Either check the box confirming that the default factor is to be used or provide a different value.		
Description	Default Value	User-Provided Value
Car running cost	\$0.45 per mile <input checked="" type="checkbox"/>	
Truck running cost	\$1.30 per mile <input checked="" type="checkbox"/>	
Duration of detour *	Use Table 2 (days) <input checked="" type="checkbox"/>	183
Value of time per adult *	Use Table 3 (\$/hr) <input checked="" type="checkbox"/>	\$8.59
Average car occupancy rate	1.63 people <input checked="" type="checkbox"/>	
Value of time for trucks	\$22.01 per hour <input checked="" type="checkbox"/>	
Average detour speed	40 miles per hour <input checked="" type="checkbox"/>	
Number of deaths from failure *	Use Table 2 (Number of people) <input checked="" type="checkbox"/>	10
Cost for each life lost	\$500,000 <input checked="" type="checkbox"/>	

* Please select an appropriate value from the reference table listed.

Cost of Analysis or Corrective Actions

Provide estimates for the following costs. Keep in mind that these costs may depend on a number of factors, e.g., the number of piers, abutments, etc. Also keep in mind that the guidelines include many significant broad assumptions, so significant effort is not warranted in estimating this data.	
Description	User Input
Estimated cost of installing automated scour monitoring	\$80,000
Estimated cost of installing scour countermeasures	\$30,000
Estimated cost of field reconnaissance to determine foundation type and depth (nondestructive testing, borings, etc.)	\$25,000
Estimated cost to evaluate scour (survey, hydrology, and hydraulics analysis, if unavailable)	\$25,000

Scour Management Evaluation

5. Rockway Turnpike over Mott Creek

Bridge 3300120 in Hempstead, NY (Nassau County) was constructed in 1993 and supports an urban principal arterial class road. This bridge has an unknown foundation depth, and it is further assumed that foundation records can not be found.

Is it a high-priority bridge?

This bridge supports an urban principal arterial, which has significant economic value and may provide access to critical local services. *Thus, in this context this bridge is considered a high priority bridge* and should be given special attention.

Recommended management strategy

This bridge has significant economic value and may provide critical access to local services. Thus, the guidelines recommend the following three-step strategy to ensure the safety of this bridge.

1. Perform field reconnaissance to determine foundation type and depth. If the foundation is a spread footing, drill through the footing to determine elevation of the footing bottom. If the foundation is piles, use foundation reconnaissance to determine depth of piles. The parallel seismic test is generally the most effective reconnaissance method. Assume that the foundation information from the field evaluation is accurate. If field reconnaissance is unsuccessful (no access for testing, poor signal from NDT, etc.), assume a foundation depth. For piles, assume a 10 foot depth or use local knowledge. This should be a conservative assumption. Spread footing depths are easily discovered and an assumption should not be necessary for this type of foundation. In other words, continue as if the foundation is known.
2. Evaluate scour using FHWA HEC-18 manual.
3. If scour analysis indicates that countermeasures are warranted, countermeasures should be designed using FHWA HEC-23 manual – or consider replacing or closing the bridge.

Bridge #6

The Initial Survey

Respondent Information

Name Bob Burnett	E-mail Address bburnett@dot.state.ny.us
Job Title Director, Geotech. Eng.	Phone 518-457-4712
Job Description (In what way does your job involve bridge maintenance?)	Mailing Address 50 Wolf Road, MP 31 Albany, NY 12232

Bridge Description

Please provide a general description of the bridge including its name, location, route, and water body.
Pearl Street over Mill River. Town of Hempstead (Long Island). NYSDOT Region 10 (Hauppauge), County 1 (Nassau). Not critical. 4 piers + abutments

National Bridge Inventory (NBI) Data

Please provide the following information for the bridge. This information should be available in the NBI database. Please provide the NBI Database Values consistent with those required in the 2002 NBI Coding Guide, and specify the units (where appropriate).		
NBI Item No.	NBI Item Description	NBI Database Value
1	State Code	62
5	Inventory Route	140000000
8	Structure Number	00000003330150
19	Bypass, Detour Length (e.g. in miles)	1 (km)
26	Functional Classification of Inventory Route	17
27	Year Built	*1932
29	Average Daily Traffic	10050
49	Structure Length (e.g. in feet)	49.6 m)
52	Deck Width, Out-to-Out (e.g. in feet)	18.2 (m)
60	Substructure	5
61	Channel and Channel Protection	6
71	Waterway Adequacy	4
109	Average Daily Truck Traffic	2%
113	Scour Critical Bridges (2002 NBI Guidelines)	U

*superstructure replaced 1986.

Undocumented Assumptions

Please provide the following information for the bridge which is not documented in the NBI database.	
Description	User Input
Bridge Type (check only one)	<input checked="" type="checkbox"/> Simple Span(s) <input type="checkbox"/> Continuous Span(s) over 100 ft.
Remaining life of bridge in years. If this bridge has already failed, report the actual lifetime of the bridge before it failed	30 years
Total Bridge Rebuilding Cost, if known. If unknown, estimate the cost by multiplying the bridge area by the cost per unit area as shown in Table 1 and the ADT cost multiplier as shown in Table 2. If estimated, provide the assumptions used in the spaces below: Bridge Area: _____ ft ² ; Cost per unit area: _____ \$/ft ² ; Cost Multiplier: _____	\$1,603,836

70 (prestressed concrete) + 15 (demo)

Economic Loss Data

Please provide the following economic factors to be associated with the failure of this bridge. Either check the box confirming that the default factor is to be used or provide a different value.		
Description	Default Value	User-Provided Value
Car running cost	\$0.45 per mile <input checked="" type="checkbox"/>	
Truck running cost	\$1.30 per mile <input checked="" type="checkbox"/>	
Duration of detour *	Use Table 2 (days) <input checked="" type="checkbox"/>	183
Value of time per adult *	Use Table 3 (\$/hr) <input checked="" type="checkbox"/>	\$8.59
Average car occupancy rate	1.63 people <input checked="" type="checkbox"/>	
Value of time for trucks	\$22.01 per hour <input checked="" type="checkbox"/>	
Average detour speed	40 miles per hour <input checked="" type="checkbox"/>	
Number of deaths from failure *	Use Table 2 (Number of people) <input checked="" type="checkbox"/>	5
Cost for each life lost	\$500,000 <input checked="" type="checkbox"/>	

* Please select an appropriate value from the reference table listed.

Cost of Analysis or Corrective Actions

Provide estimates for the following costs. Keep in mind that these costs may depend on a number of factors, e.g., the number of piers, abutments, etc. Also keep in mind that the guidelines include many significant broad assumptions, so significant effort is not warranted in estimating this data.	
Description	User Input
Estimated cost of installing automated scour monitoring	\$120,000
Estimated cost of installing scour countermeasures	\$45,000
Estimated cost of field reconnaissance to determine foundation type and depth (nondestructive testing, borings, etc.)	\$40,000
Estimated cost to evaluate scour (survey, hydrology, and hydraulics analysis, if unavailable)	\$25,000

Scour Management Evaluation

6. Pearl Street over Mill River

Bridge 3330150 in Hempstead, NY was constructed in 1930 and supports an urban collector class road. This bridge has an unknown foundation depth, and it is further assumed that foundation records can not be found.

Is it a high-priority bridge?

This bridge supports an urban road, which is not a principal arterial or emergency evacuation route, and does not provide direct access to other emergency services (e.g. hospital, fire stations, etc.). *Thus, in this context this bridge is not considered a high priority bridge.*

Does the bridge meet the minimum performance level?

The minimum performance level for an urban collector class bridge, according to the guidelines, is 0.0002 – the threshold probability of failure that this bridge must outperform. To estimate this bridge's annual probability of failure, it is first necessary to estimate the overtopping frequency and scour vulnerability of this bridge, as in the table below.

Data/Parameter (source)	Value	Interpretation
NBI item 26 (bridge survey)	17	Urban collector classification
NBI item 71 (bridge survey)	4	Waterway meets the minimum limits for no action
∴ Overtopping Frequency (guidelines)	0	Occasional (once in 3-10 years)
NBI item 60 (bridge survey)	5	Foundation is in fair condition
NBI item 61 (bridge survey)	6	Channel has widespread minor damage
∴ Scour Vulnerability (guidelines)	5	Analysis: stable; Survey: scour is within limits
∴ Annual probability of failure (guidelines)	0.00004	A 1 in 25,000 chance of failure in any given year

This bridge meets the minimum performance level because the annual probability of failure is less than 0.0005. However, because the foundation is unknown, we need to determine the most cost effective way to manage this uncertainty.

Is automated scour monitoring warranted?

Automated scour monitoring is considered warranted if the lifetime risk of death is greater than the cost of automated scour monitoring. The lifetime probability of failure for this bridge can be computed from the annual probability of failure and its tentative remaining life (30 years, according to the survey respondent) as follows: $1 - (1 - 0.00004)^{30}$, or about 0.0012 (a 1 in 833 chance of failure in the next 30 years). This and other survey data are now used to calculate the risk of death as follows:

$$R_{death} = K \cdot P_L \cdot C_6 \cdot X$$

$$= (1.0) \cdot (0.0012 / yr) \cdot (\$500,000 / person) \cdot (5 people) = \$2,998$$

Since the cost of automated scour monitoring was estimated to be \$120,000 and the risk of death is \$2,998, *automated scour monitoring is probably not warranted.*

Are scour countermeasures warranted?

Scour countermeasures are considered warranted if the lifetime risk of failure is greater than the estimated cost of scour countermeasures, which the survey respondent estimated to be about \$45,000. The first step in estimating the risk of failure is to estimate the potential cost of failure, assuming that it would need to be replaced. The survey respondent estimated that a new bridge would cost about \$1,603,836. The car and truck running cost associated with the detour for this bridge is computed from the survey data as follows:

$$\begin{aligned} C_{\text{running}} &= \left[C_2 \cdot \left(1 - \frac{T}{100} \right) + C_3 \cdot \frac{T}{100} \right] \cdot D \cdot A \cdot d \\ &= \left[\$0.45 / \text{mi} \cdot \left(1 - \frac{2}{100} \right) + \$1.30 / \text{mi} \cdot \frac{2}{100} \right] \cdot (0.6 \text{ mi}) \cdot (10,050 / \text{day}) \cdot (183 \text{ days}) \\ &= \$515,330 \end{aligned}$$

The cost of lost wages is computed from the survey data as follows:

$$\begin{aligned} C_{\text{wages}} &= \left[C_4 \cdot O \cdot \left(1 - \frac{T}{100} \right) + C_5 \cdot \frac{T}{100} \right] \cdot \frac{D \cdot A \cdot d}{S} \\ &= \left[(\$8.59 / \text{per}) \cdot (1.63 \text{ per}) \cdot \left(1 - \frac{2}{100} \right) + (\$22.01 / \text{truck}) \cdot \frac{2}{100} \right] \cdot \frac{(0.6 \text{ mi}) \cdot (10,050 / \text{day}) \cdot (183 \text{ days})}{40 \text{ mi} / \text{hr}} \\ &= \$390,687 \end{aligned}$$

When we include the cost of death, the total cost of bridge failure totals \$5,009,853. Computing the risk of a scour-induced failure over the remaining life of the bridge is just the product of the lifetime probability of failure and the total cost of failure – about \$6,008. *Thus, scour countermeasures are probably not warranted* because the lifetime risk of failure is less than the estimated cost of scour countermeasures.

Recommended management strategy

This bridge meets the performance standards for these guidelines and does not appear to warrant automated scour monitoring or countermeasures. However, because this bridge has an unknown foundation the guidelines strongly recommend that you follow the recommendations in the “Bridge Closure Plan” section of this report.

Furthermore, scour monitoring should be performed with every 2-yr routine bridge inspection for all bridges with unknown foundations. If the scour depth increases more than two feet from baseline conditions (as-built drawings or initial scour survey), action should be taken. The first action is to follow the “Bridge Closure Plan” to take any necessary immediate action. Countermeasures should then be considered for this site; or close or replace the bridge. This two foot trigger can be adjusted based on local geotechnical and engineering considerations and should represent the depth of scour that the bridge engineer feels comfortable with for the individual bridge.

Bridge #7

The Initial Survey

Respondent Information

Name Bob Burnett	E-mail Address bburnett@dot.state.ny.us
Job Title Director, Geotech. Eng.	Phone 518-457-4712
Job Description (In what way does your job involve bridge maintenance?)	Mailing Address 50 Wolf Road, MP 31 Albany, NY 12232

Bridge Description

Please provide a general description of the bridge including its name, location, route, and water body.
Interstate 90 over CSX/Hudson River "Patroon Island Bridge". City of Albany, NY. NYSDOT Region 1 (Albany), County 1 (Albany). Critical

National Bridge Inventory (NBI) Data

Please provide the following information for the bridge. This information should be available in the NBI database. Please provide the NBI Database Values consistent with those required in the 2002 NBI Coding Guide, and specify the units (where appropriate).		
NBI Item No.	NBI Item Description	NBI Database Value
1	State Code	62
5	Inventory Route	111000900
8	Structure Number	000000001092839
19	Bypass, Detour Length (e.g. in miles)	7 (km)
26	Functional Classification of Inventory Route	11
27	Year Built	1968
29	Average Daily Traffic	75196
49	Structure Length (e.g. in feet)	547.1 (m)
52	Deck Width, Out-to-Out (e.g. in feet)	27.1 (m)
60	Substructure	6
61	Channel and Channel Protection	8
71	Waterway Adequacy	6
109	Average Daily Truck Traffic	9%
113	Scour Critical Bridges (2002 NBI Guidelines)	8

Undocumented Assumptions

Please provide the following information for the bridge which is not documented in the NBI database.	
Description	User Input
Bridge Type (check only one)	<input type="checkbox"/> Simple Span(s) <input checked="" type="checkbox"/> Continuous Span(s) over 100 ft.
Remaining life of bridge in years. If this bridge has already failed, report the actual lifetime of the bridge before it failed	27years
Total Bridge Rebuilding Cost, if known. If unknown, estimate the cost by multiplying the bridge area by the cost per unit area as shown in Table 1 and the ADT cost multiplier as shown in Table 2. If estimated, provide the assumptions used in the spaces below: Bridge Area: _____ ft ² ; Cost per unit area: _____ \$/ft ² ; Cost Multiplier: _____	\$12,752,112

120 + 15 (Demo)

Economic Loss Data

Please provide the following economic factors to be associated with the failure of this bridge. Either check the box confirming that the default factor is to be used or provide a different value.		
Description	Default Value	User-Provided Value
Car running cost	\$0.45 per mile <input checked="" type="checkbox"/>	
Truck running cost	\$1.30 per mile <input checked="" type="checkbox"/>	
Duration of detour *	Use Table 2 (days) <input checked="" type="checkbox"/>	183
Value of time per adult *	Use Table 3 (\$/hr) <input checked="" type="checkbox"/>	\$8.59
Average car occupancy rate	1.63 people <input checked="" type="checkbox"/>	
Value of time for trucks	\$22.01 per hour <input checked="" type="checkbox"/>	
Average detour speed	40 miles per hour <input checked="" type="checkbox"/>	
Number of deaths from failure *	Use Table 2 (Number of people) <input checked="" type="checkbox"/>	10
Cost for each life lost	\$500,000 <input checked="" type="checkbox"/>	

* Please select an appropriate value from the reference table listed.

Cost of Analysis or Corrective Actions

Provide estimates for the following costs. Keep in mind that these costs may depend on a number of factors, e.g., the number of piers, abutments, etc. Also keep in mind that the guidelines include many significant broad assumptions, so significant effort is not warranted in estimating this data.	
Description	User Input
Estimated cost of installing automated scour monitoring	\$180,000
Estimated cost of installing scour countermeasures	\$150,000
Estimated cost of field reconnaissance to determine foundation type and depth (nondestructive testing, borings, etc.)	\$20,000*
Estimated cost to evaluate scour (survey, hydrology, and hydraulics analysis, if unavailable)	\$50,000

*We know that the channel piers have spread footings on rock. We do not know how resilient the rock layer is to scour. You could enter "0" here as we do not know all footing elevations for this structure.

Scour Management Evaluation

7. Interstate 90 over Hudson River (“Patroon Island Bridge”)

Bridge 1092839 in Albany, NY (Albany County) was constructed in 1968 and supports an urban interstate. This bridge’s foundation is known with an NBI item 113 rating of “8” (Analysis: stable; Survey: stable). However, this bridge will be evaluated as if it had an unknown foundation to test the guidelines.

Is it a high-priority bridge?

This bridge supports an urban interstate, which is emergency evacuation route, and provides direct access to other emergency services (e.g. hospital, fire stations, etc.). *Thus, in this context this bridge is considered a high priority bridge and should be given special attention.*

Recommended management strategy

This bridge has a known foundation, and thus does not require any additional action. This bridge provides critical access to local services and has significant economic value. Thus, if this bridge had an unknown foundation the guidelines would have recommended the following three-step strategy to ensure the safety of this bridge.

1. Perform field reconnaissance to determine foundation type and depth. If the foundation is a spread footing, drill through the footing to determine elevation of the footing bottom. If the foundation is piles, use foundation reconnaissance to determine depth of piles. The parallel seismic test is generally the most effective reconnaissance method. Assume that the foundation information from the field evaluation is accurate. If field reconnaissance is unsuccessful (no access for testing, poor signal from NDT, etc.), assume a foundation depth. For piles, assume a 10 foot depth or use local knowledge. This should be a conservative assumption. Spread footing depths are easily discovered and an assumption should not be necessary for this type of foundation. In other words, continue as if the foundation is known.
2. Evaluate scour using FHWA HEC-18 manual.
3. If scour analysis indicates that countermeasures are warranted, countermeasures should be designed using FHWA HEC-23 manual – or consider replacing or closing the bridge.

Bridge #8

The Initial Survey

Respondent Information

Name Bob Burnett	E-mail Address bburnett@dot.state.ny.us
Job Title Director, Geotech. Eng.	Phone 518-457-4712
Job Description (In what way does your job involve bridge maintenance?)	Mailing Address 50 Wolf Road, MP 31 Albany, NY 12232

Bridge Description

Please provide a general description of the bridge including its name, location, route, and water body.
Peace Bridge over I-190/Niagara River, City of Buffalo, NY. NYSDOT Region 5 (Buffalo), County 3 (Erie). Critical. Reconstructed in 1989.

National Bridge Inventory (NBI) Data

Please provide the following information for the bridge. This information should be available in the NBI database. Please provide the NBI Database Values consistent with those required in the 2002 NBI Coding Guide, and specify the units (where appropriate).		
NBI Item No.	NBI Item Description	NBI Database Value
1	State Code	62
5	Inventory Route	181000000
8	Structure Number	000000005516290
19	Bypass, Detour Length (e.g. in miles)	64 (km)
26	Functional Classification of Inventory Route	12
27	Year Built	1927
29	Average Daily Traffic	17,000
49	Structure Length (e.g. in feet)	1218.5 (m)
52	Deck Width, Out-to-Out (e.g. in feet)	11.9 (m)
60	Substructure	6
61	Channel and Channel Protection	9
71	Waterway Adequacy	8
109	Average Daily Truck Traffic	9%
113	Scour Critical Bridges (2002 NBI Guidelines)	6

Undocumented Assumptions

Please provide the following information for the bridge which is not documented in the NBI database.	
Description	User Input
Bridge Type (check only one)	<input checked="" type="checkbox"/> Simple Span(s) <input type="checkbox"/> Continuous Span(s) over 100 ft.
Remaining life of bridge in years. If this bridge has already failed, report the actual lifetime of the bridge before it failed	13years
Total Bridge Rebuilding Cost, if known. If unknown, estimate the cost by multiplying the bridge area by the cost per unit area as shown in Table 1 and the ADT cost multiplier as shown in Table 2. If estimated, provide the assumptions used in the spaces below: Bridge Area: _____ ft ² ; Cost per unit area: _____ \$/ft ² ; Cost Multiplier: _____	\$52,277,160

120 + 15 (demo)

Economic Loss Data

Please provide the following economic factors to be associated with the failure of this bridge. Either check the box confirming that the default factor is to be used or provide a different value.		
Description	Default Value	User-Provided Value
Car running cost	\$0.45 per mile <input checked="" type="checkbox"/>	
Truck running cost	\$1.30 per mile <input checked="" type="checkbox"/>	
Duration of detour *	Use Table 2 (days) <input checked="" type="checkbox"/>	183
Value of time per adult *	Use Table 3 (\$/hr) <input checked="" type="checkbox"/>	\$8.59
Average car occupancy rate	1.63 people <input checked="" type="checkbox"/>	
Value of time for trucks	\$22.01 per hour <input checked="" type="checkbox"/>	
Average detour speed	40 miles per hour <input checked="" type="checkbox"/>	
Number of deaths from failure *	Use Table 2 (Number of people) <input checked="" type="checkbox"/>	5
Cost for each life lost	\$500,000 <input checked="" type="checkbox"/>	

* Please select an appropriate value from the reference table listed.

Cost of Analysis or Corrective Actions

Provide estimates for the following costs. Keep in mind that these costs may depend on a number of factors, e.g., the number of piers, abutments, etc. Also keep in mind that the guidelines include many significant broad assumptions, so significant effort is not warranted in estimating this data.	
Description	User Input
Estimated cost of installing automated scour monitoring	\$100,000
Estimated cost of installing scour countermeasures	\$100,000
Estimated cost of field reconnaissance to determine foundation type and depth (nondestructive testing, borings, etc.)	\$0 (known)
Estimated cost to evaluate scour (survey, hydrology, and hydraulics analysis, if unavailable)	\$50,000

Scour Management Evaluation

8. Peace Bridge over Niagara River

Bridge 5516290 in Buffalo, NY (Erie County) was constructed in 1927 and supports an urban freeway. This bridge's foundation is known with an NBI item 113 rating of "6" (not yet evaluated, but probably stable). However, this bridge will be evaluated as if it had an unknown foundation to test the guidelines.

Is it a high-priority bridge?

This bridge supports an urban freeway, which provides direct access to emergency services (e.g. hospital, fire stations, etc.). *Thus, in this context this bridge is considered a high priority bridge* and should be given special attention.

Recommended management strategy

This bridge has a known foundation, and thus does not require any additional action. This bridge provides critical access to local services and has significant economic value. Thus, if this bridge had an unknown foundation the guidelines would have recommended the following three-step strategy to ensure the safety of this bridge.

1. Perform field reconnaissance to determine foundation type and depth. If the foundation is a spread footing, drill through the footing to determine elevation of the footing bottom. If the foundation is piles, use foundation reconnaissance to determine depth of piles. The parallel seismic test is generally the most effective reconnaissance method. Assume that the foundation information from the field evaluation is accurate. If field reconnaissance is unsuccessful (no access for testing, poor signal from NDT, etc.), assume a foundation depth. For piles, assume a 10 foot depth or use local knowledge. This should be a conservative assumption. Spread footing depths are easily discovered and an assumption should not be necessary for this type of foundation. In other words, continue as if the foundation is known.
2. Evaluate scour using FHWA HEC-18 manual.
3. If scour analysis indicates that countermeasures are warranted, countermeasures should be designed using FHWA HEC-23 manual – or consider replacing or closing the bridge.

Bridge #9

The Initial Survey

Respondent Information

Name Bob Burnett	E-mail Address bburnett@dot.state.ny.us
Job Title Director, Geotech. Eng.	Phone 518-457-4712
Job Description (In what way does your job involve bridge maintenance?)	Mailing Address 50 Wolf Road, MP 31 Albany, NY 12232

Bridge Description

Please provide a general description of the bridge including its name, location, route, and water body.
Route 42 over Shingle Kill. Town of Deer Park, NY. NYSDOT Region 8 (Poughkeepsie), County 3 (Orange). Not critical

National Bridge Inventory (NBI) Data

Please provide the following information for the bridge. This information should be available in the NBI database. Please provide the NBI Database Values consistent with those required in the 2002 NBI Coding Guide, and specify the units (where appropriate).		
NBI Item No.	NBI Item Description	NBI Database Value
1	State Code	62
5	Inventory Route	131000420
8	Structure Number	000000001024960
19	Bypass, Detour Length (e.g. in miles)	48 (km)
26	Functional Classification of Inventory Route	14
27	Year Built	1956
29	Average Daily Traffic	7895
49	Structure Length (e.g. in feet)	16.7 (m)
52	Deck Width, Out-to-Out (e.g. in feet)	12.6 (m)
60	Substructure	4
61	Channel and Channel Protection	5
71	Waterway Adequacy	4
109	Average Daily Truck Traffic	5%
113	Scour Critical Bridges (2002 NBI Guidelines)	8

Undocumented Assumptions

Please provide the following information for the bridge which is not documented in the NBI database.	
Description	User Input
Bridge Type (check only one)	<input checked="" type="checkbox"/> Simple Span(s) <input type="checkbox"/> Continuous Span(s) over 100 ft.
Remaining life of bridge in years. If this bridge has already failed, report the actual lifetime of the bridge before it failed	23years
Total Bridge Rebuilding Cost, if known. If unknown, estimate the cost by multiplying the bridge area by the cost per unit area as shown in Table 1 and the ADT cost multiplier as shown in Table 2. If estimated, provide the assumptions used in the spaces below: Bridge Area: _____ ft ² ; Cost per unit area: _____ \$/ft ² ; Cost Multiplier: _____	\$444,049

75 (steel-simple span) + 15 (demo)

Economic Loss Data

Please provide the following economic factors to be associated with the failure of this bridge. Either check the box confirming that the default factor is to be used or provide a different value.		
Description	Default Value	User-Provided Value
Car running cost	\$0.45 per mile <input checked="" type="checkbox"/>	
Truck running cost	\$1.30 per mile <input checked="" type="checkbox"/>	
Duration of detour *	Use Table 2 (days) <input checked="" type="checkbox"/>	183
Value of time per adult *	Use Table 3 (\$/hr) <input checked="" type="checkbox"/>	\$8.59
Average car occupancy rate	1.63 people <input checked="" type="checkbox"/>	
Value of time for trucks	\$22.01 per hour <input checked="" type="checkbox"/>	
Average detour speed	40 miles per hour <input checked="" type="checkbox"/>	
Number of deaths from failure *	Use Table 2 (Number of people) <input checked="" type="checkbox"/>	10
Cost for each life lost	\$500,000 <input checked="" type="checkbox"/>	

* Please select an appropriate value from the reference table listed.

Cost of Analysis or Corrective Actions

Provide estimates for the following costs. Keep in mind that these costs may depend on a number of factors, e.g., the number of piers, abutments, etc. Also keep in mind that the guidelines include many significant broad assumptions, so significant effort is not warranted in estimating this data.	
Description	User Input
Estimated cost of installing automated scour monitoring	\$20,000
Estimated cost of installing scour countermeasures	\$15,000
Estimated cost of field reconnaissance to determine foundation type and depth (nondestructive testing, borings, etc.)	\$0 (known)
Estimated cost to evaluate scour (survey, hydrology, and hydraulics analysis, if unavailable)	\$25,000

Scour Management Evaluation

9. Route 42 over Shingle Kill

Bridge 1024960 in Deer Park, NY (Orange County) was constructed in 1956 and supports an urban principal arterial roadway. This bridge has a known foundation with an NBI item 113 rating of “8” (Analysis: stable; Survey: stable). However, this bridge will be evaluated as if it had an unknown foundation to test the guidelines.

Is it a high-priority bridge?

This bridge supports an urban principal arterial, which has significant economic significance. *Thus, in this context this bridge is considered a high priority bridge* and should be given special attention.

Recommended management strategy

This bridge has a known foundation, and thus does not require any additional action. This bridge provides critical access to local services and has significant economic value. Thus, if this bridge had an unknown foundation the guidelines would have recommended the following three-step strategy to ensure the safety of this bridge.

1. Perform field reconnaissance to determine foundation type and depth. If the foundation is a spread footing, drill through the footing to determine elevation of the footing bottom. If the foundation is piles, use foundation reconnaissance to determine depth of piles. The parallel seismic test is generally the most effective reconnaissance method. Assume that the foundation information from the field evaluation is accurate. If field reconnaissance is unsuccessful (no access for testing, poor signal from NDT, etc.), assume a foundation depth. For piles, assume a 10 foot depth or use local knowledge. This should be a conservative assumption. Spread footing depths are easily discovered and an assumption should not be necessary for this type of foundation. In other words, continue as if the foundation is known.
2. Evaluate scour using FHWA HEC-18 manual.
3. If scour analysis indicates that countermeasures are warranted, countermeasures should be designed using FHWA HEC-23 manual – or consider replacing or closing the bridge.

Bridge #10

The Initial Survey

Respondent Information

Name Bob Burnett	E-mail Address bburnett@dot.state.ny.us
Job Title Director, Geotech. Eng.	Phone 518-457-4712
Job Description (In what way does your job involve bridge maintenance?)	Mailing Address 50 Wolf Road, MP 31 Albany, NY 12232

Bridge Description

Please provide a general description of the bridge including its name, location, route, and water body.
County Road 155 over East Branch Chenango Creek. Town of Cuyler, NY. NYSDOT Region 3 (Syracuse), County 2 (Cortland). Not critical

National Bridge Inventory (NBI) Data

Please provide the following information for the bridge. This information should be available in the NBI database. Please provide the NBI Database Values consistent with those required in the 2002 NBI Coding Guide, and specify the units (where appropriate).		
NBI Item No.	NBI Item Description	NBI Database Value
1	State Code	62
5	Inventory Route	140000000
8	Structure Number	000000003312460
19	Bypass, Detour Length (e.g. in miles)	14 (km)
26	Functional Classification of Inventory Route	09
27	Year Built	1983
29	Average Daily Traffic	79
49	Structure Length (e.g. in feet)	15.8 (m)
52	Deck Width, Out-to-Out (e.g. in feet)	7.9 (m)
60	Substructure	4
61	Channel and Channel Protection	6
71	Waterway Adequacy	4
109	Average Daily Truck Traffic	5%
113	Scour Critical Bridges (2002 NBI Guidelines)	8

Undocumented Assumptions

Please provide the following information for the bridge which is not documented in the NBI database.	
Description	User Input
Bridge Type (check only one)	<input checked="" type="checkbox"/> Simple Span(s) <input type="checkbox"/> Continuous Span(s) over 100 ft.
Remaining life of bridge in years. If this bridge has already failed, report the actual lifetime of the bridge before it failed	17years
Total Bridge Rebuilding Cost, if known. If unknown, estimate the cost by multiplying the bridge area by the cost per unit area as shown in Table 1 and the ADT cost multiplier as shown in Table 2. If estimated, provide the assumptions used in the spaces below: Bridge Area: _____ ft ² ; Cost per unit area: _____ \$/ft ² ; Cost Multiplier: _____	\$\$229,216

70 + 15 (demo)

Economic Loss Data

Please provide the following economic factors to be associated with the failure of this bridge. Either check the box confirming that the default factor is to be used or provide a different value.		
Description	Default Value	User-Provided Value
Car running cost	\$0.45 per mile <input checked="" type="checkbox"/>	
Truck running cost	\$1.30 per mile <input checked="" type="checkbox"/>	
Duration of detour *	Use Table 2 (days) <input checked="" type="checkbox"/>	\$1095
Value of time per adult *	Use Table 3 (\$/hr) <input checked="" type="checkbox"/>	\$8.59
Average car occupancy rate	1.63 people <input checked="" type="checkbox"/>	
Value of time for trucks	\$22.01 per hour <input checked="" type="checkbox"/>	
Average detour speed	40 miles per hour <input checked="" type="checkbox"/>	
Number of deaths from failure *	Use Table 2 (Number of people) <input checked="" type="checkbox"/>	0
Cost for each life lost	\$500,000 <input checked="" type="checkbox"/>	

* Please select an appropriate value from the reference table listed.

Cost of Analysis or Corrective Actions

Provide estimates for the following costs. Keep in mind that these costs may depend on a number of factors, e.g., the number of piers, abutments, etc. Also keep in mind that the guidelines include many significant broad assumptions, so significant effort is not warranted in estimating this data.	
Description	User Input
Estimated cost of installing automated scour monitoring	\$30,000
Estimated cost of installing scour countermeasures	\$20,000
Estimated cost of field reconnaissance to determine foundation type and depth (nondestructive testing, borings, etc.)	\$0 (known)
Estimated cost to evaluate scour (survey, hydrology, and hydraulics analysis, if unavailable)	\$15,000

Scour Management Evaluation

10. County Road 155 over East Branch Cheningo Creek

Bridge 3312460 in Cuyler, NY was constructed in 1983 and supports a rural local class road. This bridge has a known foundation with an NBI item 113 rating of “8” (Analysis: stable; Survey: stable). However, this bridge will be evaluated as if it had an unknown foundation to test the guidelines.

Is it a high-priority bridge?

This bridge supports a rural road, which is not a principal arterial, emergency evacuation route, and does not provide direct access to other emergency services (e.g. hospital, fire stations, etc.). *Thus, in this context this bridge is not considered a high priority bridge.*

Does the bridge meet the minimum performance level?

The minimum performance level for a rural local class bridge, according to the guidelines, is 0.002 – the threshold probability of failure that this bridge must outperform. To estimate this bridge’s annual probability of failure, it is first necessary to estimate the overtopping frequency and scour vulnerability of this bridge, as in the table below.

Data/Parameter (source)	Value	Interpretation
NBI item 26 (bridge survey)	9	Rural local classification
NBI item 71 (bridge survey)	4	Waterway meets the minimum limits for no action
∴ Overtopping Frequency (guidelines)	0	Occasional (once in 3-10 years)
NBI item 60 (bridge survey)	4	Foundation is in poor condition
NBI item 61 (bridge survey)	6	Channel has widespread minor damage
∴ Scour Vulnerability (guidelines)	4	Analysis: stable; Survey: foundation is exposed
∴ Annual probability of failure (guidelines)	0.0006	A 1 in 1,667 chance of failure in any given year

This bridge meets the minimum performance level because the annual probability of failure is less than 0.002. However, because the foundation is unknown, we need to determine the most cost effective way to manage this uncertainty.

Is automated scour monitoring warranted?

Automated scour monitoring is considered warranted if the risk of death is greater than the cost of automated scour monitoring. The lifetime probability of failure for this bridge can be computed from the annual probability of failure and its tentative remaining life (17 years, according to the survey respondent) as follows: $1 - (1 - 0.0006)^{17}$, or about 0.01 (a 1 in 100 chance of failure in the next 17 years). This and other survey data are now used to calculate the risk of death as follows:

$$R_{death} = K \cdot P_L \cdot C_6 \cdot X$$

$$= (1.0) \cdot (0.01 / yr) \cdot (\$500,000 / person) \cdot (0 people) = \$0$$

Since the cost of automated scour monitoring was estimated to be \$30,000 and the risk of death is \$0, *automated scour monitoring is probably not warranted.*

Are scour countermeasures warranted?

Scour countermeasures are considered warranted if the lifetime risk of failure is greater than the estimated cost of scour countermeasures, which the survey respondent estimated to be about \$20,000. The first step in estimating the risk of failure is to estimate the potential cost of failure, assuming that it would need to be replaced. The survey respondent estimated that a new bridge would cost about \$229,216. The car and truck running cost associated with the detour for this bridge is computed from the survey data as follows:

$$\begin{aligned} C_{\text{running}} &= \left[C_2 \cdot \left(1 - \frac{T}{100} \right) + C_3 \cdot \frac{T}{100} \right] \cdot D \cdot A \cdot d \\ &= \left[\$0.45 / \text{mi} \cdot \left(1 - \frac{5}{100} \right) + \$1.30 / \text{mi} \cdot \frac{5}{100} \right] \cdot (8.7 \text{ mi}) \cdot (79 / \text{day}) \cdot (1095 \text{ days}) \\ &= \$370,652 \end{aligned}$$

The cost of lost wages is computed from the survey data as follows:

$$\begin{aligned} C_{\text{wages}} &= \left[C_4 \cdot O \cdot \left(1 - \frac{T}{100} \right) + C_5 \cdot \frac{T}{100} \right] \cdot \frac{D \cdot A \cdot d}{S} \\ &= \left[(\$8.59 / \text{per}) \cdot (1.63 \text{ per}) \cdot \left(1 - \frac{5}{100} \right) + (\$22.01 / \text{truck}) \cdot \frac{5}{100} \right] \cdot \frac{(8.7 \text{ mi}) \cdot (79 / \text{day}) \cdot (1095 \text{ days})}{40 \text{ mi} / \text{hr}} \\ &= \$270,973 \end{aligned}$$

Since the cost of death is probably negligible, the total cost of bridge failure totals \$870,842. Computing the risk of a scour-induced failure over the remaining life of the bridge is just the product of the lifetime probability of failure and the total cost of failure – about \$8,840. *Thus, scour countermeasures are probably not warranted* because the lifetime risk of failure is less than the estimated cost of scour countermeasures.

Recommended management strategy

This bridge has a known foundation, and thus does not require any additional action. However, if this bridge had an unknown foundation the guidelines would have strongly recommended that you follow the recommendations in the “Bridge Closure Plan” section of this report.

Furthermore, scour monitoring should be performed with every 2-yr routine bridge inspection for all bridges with unknown foundations. If the scour depth increases more than two feet from baseline conditions (as-built drawings or initial scour survey), action should be taken. The first action is to follow the “Bridge Closure Plan” to take any necessary immediate action. Countermeasures should then be considered for this site; or close or replace the bridge. This two foot trigger can be adjusted based on local geotechnical and engineering considerations and should represent the depth of scour that the bridge engineer feels comfortable with for the individual bridge.

Response to Evaluations

Robert Burnett, the acting director of the NY geotechnical engineering bureau, was the first to comment on the management summaries. He said:

The recommendation to investigate the foundation, preferably using parallel seismic, followed by a scour analysis and possibly countermeasures came out far too frequently for the very diverse group of examples that we sent. The "value" of the structure to the transportation system does not seem to be properly accounted for, given that three absolutely crucial structures (Interstate 90 over the Hudson River, Peace Bridge over the Niagara River to Canada, The Rip Van Winkle Bridge over the Hudson) over two major rivers received the same advice as County Route 1 over Van Campen Creek. CR1 could be closed with hardly a ripple to the system and should not warrant even a minor effort to save it. The Peace Bridge to Canada is a major economic link and would certainly deserve an all-out investigation and mitigation project. The age of the structure and therefore its remaining life should also be a factor in economic decisions. Some of these bridges are less than 25 years old and some are more than fifty, some even 70, so our investment in them should take that into account. Yet, similar recommendations are made for many of them, as well. Is the structure condition and likely remaining life considered before the cost of the fix is proposed? One specific comment: I didn't understand how the risk of death from failure could be zero for County Route 155 over East Branch Chenango Creek. No one uses this bridge?

Mr. Burnett's comments regarding the correlation between a bridge's suggested risk management plan and its priority (i.e. functional importance) highlight an important aspect of the scour risk guidelines. The implication of his comments is that County Route 1, which has a lower priority than the Peace or Rip Van Winkle bridges, should have a different

management plan than these two high-priority bridges. He then suggests that the remaining life and the associated economics of the bridge should have changed these assessments. However, for the sake of clarity, Table 17 shows a comparison of these bridges with some pertinent parameters.

Table 17 Bridge Case Study Comparison

Scour Risk Parameter	County Road 1	Rip Van Winkle	Peace Bridge
Is it High Priority?	No	Yes	Yes
NBI Item 27 (Year Built)	1957	1935	1927
Remaining Life	46*	29	13
NBI Item 113 Code	3†	U	6
Overtopping Frequency	Occasional	Slight	Slight
Scour Vulnerability	4	7	7
Annual Probability of Failure	0.0005	0.00025	0.00025
Lifetime Probability of Failure	0.023	0.0072	0.0032
Total Cost of Failure	\$2,399,114	\$121,461,054	\$165,539,757
Does it Pass the MPL?	No	No	No

* This was the age of the bridge when it failed in August 2003.

† This was the NBI code before the bridge failed.

The first thing to note is that none of these three bridges passed their respective MPL's, and the last two did not pass the high-priority test, which effectively supersedes the MPL test in the guidelines. The next thing to note is that County Road 1 had a known foundation that was rated scour critical (i.e. NBI item 113 = 3) before it ultimately failed, and the scour vulnerability parameter (an estimated NBI Item 113 code) identified its poor condition. The last thing to note is that the Peace and Rip Van Winkle bridges both lack a proper scour evaluation, and that the latter has an unknown foundation. Thus, the latter two bridges would qualify for mitigation or replacement or closure because they are high priority, while County Road 1 would qualify for the same treatment due to its poor performance. In other words, both rationales are clearly worthy of concern. This underscores the fact that these guidelines have two criteria that add special conservatism to the value of these mitigation options: priority and poor performance. It also underscores the fact that the recommended risk management plans are not intended to prioritize the

work schedule of at-risk bridges. The States are ultimately free to rank the work orders for at-risk bridges with unknown foundations as they see fit.

Furthermore, County Road 155 had a risk of death equal to zero because its low ADT makes it very unlikely that anyone will be on the bridge if it were to fail unexpectedly. A more rigorous probabilistic model for whether someone will be on the bridge if and when it failed unexpectedly was deemed unnecessary given the uncertainty assigning a value of lost life. If a state has a better estimate for either of these aspects of casualties due to bridge failure, the guidelines allow this to be used.

Mike Sullivan, a NY hydraulics engineer, also submitted comments. Two of his comments relate to a mistake in the Annual Probability of Failure table that was attached to the management summaries. This mistake was subsequently acknowledged and discussed in a later phone conversation. His comments also underscore the fact that none of the case studies ultimately had a final recommendation that advocated installing automated scour monitoring (ASM). Ten of the case studies, however, would have warranted ASM if scour countermeasures were not also warranted. Mr. Sullivan's comments are as follows:

- 1) I came up with a different result for Bridge #1 (BIN 3330270 - County Road 1 over South Branch of Van Campen Creek, failed due to pier scour in 2003). When I plug the values for NBI Items 26 & 71 into Table 2, I get an Overtopping frequency = 'S' (Slight). The Annual Probability of Failure is then reduced to 0.00033 in Table 4. This would then indicate that the bridge does meet the minimum performance level because the annual probability of failure is less than 0.0005 (from Table 1).
- 2) Bridges 2,3,4,5,7,8, and 9 are all considered high-priority bridges and receive a Recommended Management Strategy Plan. These suggested guidelines are logical and similar to what we currently do. NYSDOT performs a Hydraulic Vulnerability

Assessment for every bridge over water and the FHWA now requires an individual Plan of Action for each bridge which is coded 0, 1, 2, 3, 7, or U for Item 113. 3) I came up with a different result for Bridge #6 (Annual Probability of Failure = 0.000075 instead of 0.00004 in Table 4). This increases the "risk of death" from \$2,998 to \$5,619. However, this revised "risk of death" value is still much lower than the estimated cost of scour monitoring (\$120,000). I spoke with [Mr.] Sedmera about this and he suggested increasing \$ value/person from the default value of \$500,000. I would like to see an example where the risk of death controls as compared to the cost of scour monitoring or scour countermeasures. I think it would have to be an Interstate Bridge (10 people) with an estimated remaining life of 30 years or more.

North Carolina Bridges*Bridge #1***The Initial Survey****Respondent Information**

Name Mohammed Mulla	E-mail Address mmulla@dot.state.nc.us
Job Title Transportation Engineer Manager	Phone 919-250-4088
Job Description (In what way does your job involve bridge maintenance?) Assistant State Geotechnical Engineer	Mailing Address 1589 Mail Service Center Raleigh, NC 27699

Bridge Description

Please provide a general description of the bridge including its name, location, route, and water body.
270011 Care County. Hubert C. Bonner Bridge. NC 12 Across Oregon Inlet. 8 miles south of Junction US 158. Critical Evacuation Route (only structure to southern Outer Banks)

National Bridge Inventory (NBI) Data

Please provide the following information for the bridge. This information should be available in the NBI database. Please provide the NBI Database Values consistent with those required in the 2002 NBI Coding Guide, and specify the units (where appropriate).		
NBI Item No.	NBI Item Description	NBI Database Value
1	State Code	374
5	Inventory Route	131000120
8	Structure Number	000000000550011
19	Bypass, Detour Length (e.g. in miles)	99
26	Functional Classification of Inventory Route	07
27	Year Built	1962
29	Average Daily Traffic	5100
49	Structure Length (e.g. in feet)	12865
52	Deck Width, Out-to-Out (e.g. in feet)	033.3
60	Substructure	3
61	Channel and Channel Protection	4
71	Waterway Adequacy	8
109	Average Daily Truck Traffic	7%
113	Scour Critical Bridges (2002 NBI Guidelines)	3

Undocumented Assumptions

Please provide the following information for the bridge which is not documented in the NBI database.	
Description	User Input
Bridge Type (check only one)	<input checked="" type="checkbox"/> Simple Span(s) <input type="checkbox"/> Continuous Span(s) over 100 ft.
Remaining life of bridge in years. If this bridge has already failed, report the actual lifetime of the bridge before it failed	2 years
Total Bridge Rebuilding Cost, if known. If unknown, estimate the cost by multiplying the bridge area by the cost per unit area as shown in Table 1 and the ADT cost multiplier as shown in Table 2. If estimated, provide the assumptions used in the spaces below: Bridge Area: <u>463,140</u> ft ² ; Cost per unit area: <u>110.00</u> \$/ft ² ; Cost Multiplier: <u>2.0</u>	\$101.9 million

Estimated cost to replace \$250 million to \$500 million depending on replacement alternative chosen.

Economic Loss Data

Please provide the following economic factors to be associated with the failure of this bridge. Either check the box confirming that the default factor is to be used or provide a different value.		
Description	Default Value	User-Provided Value
Car running cost	\$0.45 per mile <input checked="" type="checkbox"/>	
Truck running cost	\$1.30 per mile <input checked="" type="checkbox"/>	
Duration of detour *	Use Table 2 (days) <input checked="" type="checkbox"/>	183
Value of time per adult *	Use Table 3 (\$/hr) <input checked="" type="checkbox"/>	\$6.72
Average car occupancy rate	1.63 people <input checked="" type="checkbox"/>	
Value of time for trucks	\$22.01 per hour <input checked="" type="checkbox"/>	
Average detour speed	40 miles per hour <input checked="" type="checkbox"/>	
Number of deaths from failure *	Use Table 2 (Number of people) <input checked="" type="checkbox"/>	5
Cost for each life lost	\$500,000 <input checked="" type="checkbox"/>	

* Please select an appropriate value from the reference table listed.

Cost of Analysis or Corrective Actions

Provide estimates for the following costs. Keep in mind that these costs may depend on a number of factors, e.g., the number of piers, abutments, etc. Also keep in mind that the guidelines include many significant broad assumptions, so significant effort is not warranted in estimating this data.	
Description	User Input
Estimated cost of installing automated scour monitoring	\$10 to 20 million
Estimated cost of installing scour countermeasures	\$100 to 200 million
Estimated cost of field reconnaissance to determine foundation type and depth (nondestructive testing, borings, etc.)	\$1 million
Estimated cost to evaluate scour (survey, hydrology, and hydraulics analysis, if unavailable)	\$200,000 to 300,000

Scour Management Evaluation

1. State Road 12 over Oregon Inlet (“Hubert C. Bonner Bridge”)

Bridge 550011 in Dare County, NC was constructed in 1962. It supports a rural major collector class road. This bridge’s foundation is known with an NBI item 113 rating of “3” (scour critical and unstable). However, this bridge will be evaluated as if it had an unknown foundation to test the guidelines.

Is it a high-priority bridge?

This bridge supports a rural road, which is an emergency evacuation route. *Thus, in this context this bridge is considered a high priority bridge* and should be given special attention.

Recommended management strategy

This bridge has a known foundation, and is scheduled to be replaced very soon due to its poor condition. This bridge provides a critical emergency evacuation route for local residents and has significant economic value. Thus, if this bridge had an unknown foundation the guidelines recommend the following three-step strategy to ensure the safety of this bridge.

1. Perform field reconnaissance to determine foundation type and depth. If the foundation is a spread footing, drill through the footing to determine elevation of the footing bottom. If the foundation is piles, use foundation reconnaissance to determine depth of piles. The parallel seismic test is generally the most effective reconnaissance method. Assume that the foundation information from the field evaluation is accurate. If field reconnaissance is unsuccessful (no access for testing, poor signal from NDT, etc.), assume a foundation depth. For piles, assume a 10 foot depth or use local knowledge. This should be a conservative assumption. Spread footing depths are easily discovered and an assumption should not be necessary for this type of foundation. In other words, continue as if the foundation is known.
2. Evaluate scour using FHWA HEC-18 manual.
3. If scour analysis indicates that countermeasures are warranted, countermeasures should be designed using FHWA HEC-23 manual – or consider replacing or closing the bridge.

Bridge #2

The Initial Survey

Respondent Information

Name Mohammed Mulla	E-mail Address mmulla@dot.state.nc.us
Job Title Transportation Engineer Manager	Phone 919-250-4088
Job Description (In what way does your job involve bridge maintenance?) Assistant State Geotechnical Engineer	Mailing Address 1589 Mail Service Center Raleigh, NC 27699

Bridge Description

Please provide a general description of the bridge including its name, location, route, and water body.
730038 Pitt County. US 13 across Tar River. 0.4 miles northeast of junction NC 43

National Bridge Inventory (NBI) Data

Please provide the following information for the bridge. This information should be available in the NBI database. Please provide the NBI Database Values consistent with those required in the 2002 NBI Coding Guide, and specify the units (where appropriate).		
NBI Item No.	NBI Item Description	NBI Database Value
1	State Code	374
5	Inventory Route	121000130
8	Structure Number	000000001470038
19	Bypass, Detour Length (e.g. in miles)	01
26	Functional Classification of Inventory Route	14
27	Year Built	1955
29	Average Daily Traffic	012000
49	Structure Length (e.g. in feet)	541
52	Deck Width, Out-to-Out (e.g. in feet)	029.2
60	Substructure	6
61	Channel and Channel Protection	2
71	Waterway Adequacy	8
109	Average Daily Truck Traffic	12%
113	Scour Critical Bridges (2002 NBI Guidelines)	7

Undocumented Assumptions

Please provide the following information for the bridge which is not documented in the NBI database.	
Description	User Input
Bridge Type (check only one)	<input checked="" type="checkbox"/> Simple Span(s) <input type="checkbox"/> Continuous Span(s) over 100 ft.
Remaining life of bridge in years. If this bridge has already failed, report the actual lifetime of the bridge before it failed	6 years
Total Bridge Rebuilding Cost, if known. If unknown, estimate the cost by multiplying the bridge area by the cost per unit area as shown in Table 1 and the ADT cost multiplier as shown in Table 2. If estimated, provide the assumptions used in the spaces below: Bridge Area: 15,797 ft ² ; Cost per unit area: 100.80 \$/ft ² ; Cost Multiplier: 2.0	\$3.16 million

Economic Loss Data

Please provide the following economic factors to be associated with the failure of this bridge. Either check the box confirming that the default factor is to be used or provide a different value.		
Description	Default Value	User-Provided Value
Car running cost	\$0.45 per mile <input checked="" type="checkbox"/>	
Truck running cost	\$1.30 per mile <input checked="" type="checkbox"/>	
Duration of detour *	Use Table 2 (days) <input checked="" type="checkbox"/>	183
Value of time per adult *	Use Table 3 (\$/hr) <input checked="" type="checkbox"/>	\$6.72
Average car occupancy rate	1.63 people <input checked="" type="checkbox"/>	
Value of time for trucks	\$22.01 per hour <input checked="" type="checkbox"/>	
Average detour speed	40 miles per hour <input checked="" type="checkbox"/>	
Number of deaths from failure *	Use Table 2 (Number of people) <input checked="" type="checkbox"/>	10
Cost for each life lost	\$500,000 <input checked="" type="checkbox"/>	

* Please select an appropriate value from the reference table listed.

Cost of Analysis or Corrective Actions

Provide estimates for the following costs. Keep in mind that these costs may depend on a number of factors, e.g., the number of piers, abutments, etc. Also keep in mind that the guidelines include many significant broad assumptions, so significant effort is not warranted in estimating this data.	
Description	User Input
Estimated cost of installing automated scour monitoring	\$50,000
Estimated cost of installing scour countermeasures	\$61,000
Estimated cost of field reconnaissance to determine foundation type and depth (nondestructive testing, borings, etc.)	\$60,000
Estimated cost to evaluate scour (survey, hydrology, and hydraulics analysis, if unavailable)	\$20,000*

*have a scour report.

Scour Management Evaluation

2. US Highway 13 over Tar River

Bridge 1470038 in Greenville, NC was constructed in 1955 and supports an urban principal arterial class road. This bridge's foundation is known with an NBI item 113 rating of "7" (scour countermeasures installed make it stable). However, this bridge will be evaluated as if it had an unknown foundation to test the guidelines.

Is it a high-priority bridge?

This bridge supports an urban principal arterial road, and would incur significant financial damage if it were to fail. *Thus, in this context this bridge is considered a high priority bridge* and should be given special attention.

Recommended management strategy

This bridge has a known foundation, and thus does not require any additional action. However, this bridge has significant economic value and may provide critical access to local services. Thus, if this bridge had an unknown foundation the guidelines recommend the following three-step strategy to ensure the safety of this bridge.

1. Perform field reconnaissance to determine foundation type and depth. If the foundation is a spread footing, drill through the footing to determine elevation of the footing bottom. If the foundation is piles, use foundation reconnaissance to determine depth of piles. The parallel seismic test is generally the most effective reconnaissance method. Assume that the foundation information from the field evaluation is accurate. If field reconnaissance is unsuccessful (no access for testing, poor signal from NDT, etc.), assume a foundation depth. For piles, assume a 10 foot depth or use local knowledge. This should be a conservative assumption. Spread footing depths are easily discovered and an assumption should not be necessary for this type of foundation. In other words, continue as if the foundation is known.
2. Evaluate scour using FHWA HEC-18 manual.
3. If scour analysis indicates that countermeasures are warranted, countermeasures should be designed using FHWA HEC-23 manual – or consider replacing or closing the bridge.

Bridge #3

The Initial Survey

Respondent Information

Name Mohammed Mulla	E-mail Address mmulla@dot.state.nc.us
Job Title Transportation Engineer Manager	Phone 919-250-4088
Job Description (In what way does your job involve bridge maintenance?) Assistant State Geotechnical Engineer	Mailing Address 1589 Mail Service Center Raleigh, NC 27699

Bridge Description

Please provide a general description of the bridge including its name, location, route, and water body.
330091 Forsyth County. ST 1001 across Yadkin River. 0.8 miles west of junction ST 1173. Not critical or evac (US 421 is parallel nearby)

National Bridge Inventory (NBI) Data

Please provide the following information for the bridge. This information should be available in the NBI database. Please provide the NBI Database Values consistent with those required in the 2002 NBI Coding Guide, and specify the units (where appropriate).		
NBI Item No.	NBI Item Description	NBI Database Value
1	State Code	374
5	Inventory Route	131010010
8	Structure Number	00000000670091
19	Bypass, Detour Length (e.g. in miles)	01
26	Functional Classification of Inventory Route	08
27	Year Built	1979
29	Average Daily Traffic	001100
49	Structure Length (e.g. in feet)	000871
52	Deck Width, Out-to-Out (e.g. in feet)	031.0
60	Substructure	7
61	Channel and Channel Protection	7
71	Waterway Adequacy	8
109	Average Daily Truck Traffic	6%
113	Scour Critical Bridges (2002 NBI Guidelines)	3

Undocumented Assumptions

Please provide the following information for the bridge which is not documented in the NBI database.	
Description	User Input
Bridge Type (check only one)	<input checked="" type="checkbox"/> Simple Span(s) <input type="checkbox"/> Continuous Span(s) over 100 ft.
Remaining life of bridge in years. If this bridge has already failed, report the actual lifetime of the bridge before it failed	6 years
Total Bridge Rebuilding Cost, if known. If unknown, estimate the cost by multiplying the bridge area by the cost per unit area as shown in Table 1 and the ADT cost multiplier as shown in Table 2. If estimated, provide the assumptions used in the spaces below: Bridge Area: 15,797 ft ² ; Cost per unit area: 100.80\$/ft ² ; Cost Multiplier: 2.0	\$3.16 million

Economic Loss Data

Please provide the following economic factors to be associated with the failure of this bridge. Either check the box confirming that the default factor is to be used or provide a different value.		
Description	Default Value	User-Provided Value
Car running cost	\$0.45 per mile <input checked="" type="checkbox"/>	
Truck running cost	\$1.30 per mile <input checked="" type="checkbox"/>	
Duration of detour *	Use Table 2 (days) <input checked="" type="checkbox"/>	365
Value of time per adult *	Use Table 3 (\$/hr) <input checked="" type="checkbox"/>	\$6.72
Average car occupancy rate	1.63 people <input checked="" type="checkbox"/>	
Value of time for trucks	\$22.01 per hour <input checked="" type="checkbox"/>	
Average detour speed	40 miles per hour <input checked="" type="checkbox"/>	
Number of deaths from failure *	Use Table 2 (Number of people) <input checked="" type="checkbox"/>	2
Cost for each life lost	\$500,000 <input checked="" type="checkbox"/>	

* Please select an appropriate value from the reference table listed.

Cost of Analysis or Corrective Actions

Provide estimates for the following costs. Keep in mind that these costs may depend on a number of factors, e.g., the number of piers, abutments, etc. Also keep in mind that the guidelines include many significant broad assumptions, so significant effort is not warranted in estimating this data.	
Description	User Input
Estimated cost of installing automated scour monitoring	\$50,000
Estimated cost of installing scour countermeasures	\$61,000
Estimated cost of field reconnaissance to determine foundation type and depth (nondestructive testing, borings, etc.)	\$60,000
Estimated cost to evaluate scour (survey, hydrology, and hydraulics analysis, if unavailable)	\$20,000*

*have a scour report.

Scour Management Evaluation

3. State Road 1001 over Yadkin River

Bridge 670091 in Forsyth County, NC was constructed in 1979 and supports a rural minor collector class road. This bridge's foundation is known with an NBI item 113 rating of "3" (scour critical and unstable). However, this bridge will be evaluated as if it had an unknown foundation to test the guidelines.

Is it a high-priority bridge?

This bridge supports a rural road, which is not a principal arterial, emergency route, and does not provide direct access to other emergency services (e.g. hospital, fire stations, etc.). *Thus, in this context this bridge is not considered a high priority bridge.*

Does the bridge meet the minimum performance level?

The minimum performance level for a rural minor collector class bridge, according to the guidelines, is 0.001 – the threshold probability of failure that this bridge must outperform. To estimate this bridge's annual probability of failure, it is first necessary to estimate the overtopping frequency and scour vulnerability of this bridge, as in the table below.

Data/Parameter (source)	Value	Interpretation
NBI item 26 (bridge survey)	8	Rural minor collector classification
NBI item 71 (bridge survey)	8	Waterway is equal to the desirable criteria
∴ Overtopping Frequency (guidelines)	S	Slight (once in 11-100 years)
NBI item 60 (bridge survey)	7	Foundation is in good condition
NBI item 61 (bridge survey)	7	Channel has some minor drift and damage
∴ Scour Vulnerability (guidelines)	7	Countermeasures installed make it stable
∴ Annual probability of failure (guidelines)	0.00025	A 1 in 4,000 chance of failure in any given year

This bridge meets the minimum performance level because the annual probability of failure is less than 0.001. However, because the foundation is unknown, we need to determine the most cost effective way to manage this uncertainty.

Is automated scour monitoring warranted?

Automated scour monitoring is considered warranted if the lifetime risk of death is greater than the cost of automated scour monitoring. The lifetime probability of failure for this bridge can be computed from the annual probability of failure and its tentative remaining life (36 years, according to the survey respondent) as follows: $1 - (1 - 0.00025)^{36}$, or about 0.009 (a 1 in 111 chance of failure in the next 36 years). This and other survey data are now used to calculate the risk of death as follows:

$$R_{death} = K \cdot P_L \cdot C_6 \cdot X$$

$$= (1.0) \cdot (0.009 / yr) \cdot (\$500,000 / person) \cdot (2 people) = \$8,961$$

Since the cost of automated scour monitoring was estimated to be \$50,000 and the risk of death is \$8,961, *automated scour monitoring is probably not warranted.*

Are scour countermeasures warranted?

Scour countermeasures are considered warranted if the lifetime risk of failure is greater than the estimated cost of scour countermeasures, which the survey respondent estimated to be about \$800,000. The first step in estimating the risk of failure is to estimate the potential cost of failure, assuming that it would need to be replaced. The survey respondent estimated that a new bridge would cost about \$2,840,000. The car and truck running cost associated with the detour for this bridge is computed from the survey data as follows:

$$\begin{aligned} C_{\text{running}} &= \left[C_2 \cdot \left(1 - \frac{T}{100} \right) + C_3 \cdot \frac{T}{100} \right] \cdot D \cdot A \cdot d \\ &= \left[\$0.45 / \text{mi} \cdot \left(1 - \frac{6}{100} \right) + \$1.30 / \text{mi} \cdot \frac{6}{100} \right] \cdot (1 \text{ mi}) \cdot (1,100 / \text{day}) \cdot (365 \text{ days}) \\ &= \$201,152 \end{aligned}$$

The cost of lost wages is computed from the survey data as follows:

$$\begin{aligned} C_{\text{wages}} &= \left[C_4 \cdot O \cdot \left(1 - \frac{T}{100} \right) + C_5 \cdot \frac{T}{100} \right] \cdot \frac{D \cdot A \cdot d}{S} \\ &= \left[(\$6.72 / \text{per}) \cdot (1.63 \text{ per}) \cdot \left(1 - \frac{6}{100} \right) + (\$22.01 / \text{truck}) \cdot \frac{6}{100} \right] \cdot \frac{(1 \text{ mi}) \cdot (1,100 / \text{day}) \cdot (365 \text{ days})}{40 \text{ mi} / \text{hr}} \\ &= \$116,605 \end{aligned}$$

When we include the cost of death, the total cost of bridge failure totals \$4,157,757. Computing the risk of a scour-induced failure over the remaining life of the bridge is just the product of the lifetime probability of failure and the total cost of failure – about \$37,257. *Thus, scour countermeasures are probably not warranted* because the lifetime risk of failure is less than the estimated cost of scour countermeasures.

Recommended management strategy

This bridge has a known foundation, and thus does not require any additional action. However, if this bridge had an unknown foundation the guidelines would have strongly recommended that you follow the recommendations in the “Bridge Closure Plan” section of this report.

Furthermore, scour monitoring should be performed with every 2-yr routine bridge inspection for all bridges with unknown foundations. If the scour depth increases more than two feet from baseline conditions (as-built drawings or initial scour survey), action should be taken. The first action is to follow the “Bridge Closure Plan” to take any necessary immediate action. Countermeasures should then be considered for this site; or close or replace the bridge. This two foot trigger can be adjusted based on local geotechnical and engineering considerations and should represent the depth of scour that the bridge engineer feels comfortable with for the individual bridge.

Bridge #4

The Initial Survey

Respondent Information

Name Mohammed Mulla	E-mail Address mmulla@dot.state.nc.us
Job Title Transportation Engineer Manager	Phone 919-250-4088
Job Description (In what way does your job involve bridge maintenance?) Assistant State Geotechnical Engineer	Mailing Address 1589 Mail Service Center Raleigh, NC 27699

Bridge Description

Please provide a general description of the bridge including its name, location, route, and water body.
330091 Forsyth County. ST 1001 across Yadkin River Not critical or evac. (appears to have parallel routes)

National Bridge Inventory (NBI) Data

Please provide the following information for the bridge. This information should be available in the NBI database. Please provide the NBI Database Values consistent with those required in the 2002 NBI Coding Guide, and specify the units (where appropriate).		
NBI Item No.	NBI Item Description	NBI Database Value
1	State Code	374
5	Inventory Route	131011470
8	Structure Number	00000000450113
19	Bypass, Detour Length (e.g. in miles)	01
26	Functional Classification of Inventory Route	09
27	Year Built	1959
29	Average Daily Traffic	1000
49	Structure Length (e.g. in feet)	109
52	Deck Width, Out-to-Out (e.g. in feet)	20.3
60	Substructure	6
61	Channel and Channel Protection	6
71	Waterway Adequacy	6
109	Average Daily Truck Traffic	06
113	Scour Critical Bridges (2002 NBI Guidelines)	U

Undocumented Assumptions

Please provide the following information for the bridge which is not documented in the NBI database.	
Description	User Input
Bridge Type (check only one)	<input checked="" type="checkbox"/> Simple Span(s) <input type="checkbox"/> Continuous Span(s) over 100 ft.
Remaining life of bridge in years. If this bridge has already failed, report the actual lifetime of the bridge before it failed	46 years
Total Bridge Rebuilding Cost, if known. If unknown, estimate the cost by multiplying the bridge area by the cost per unit area as shown in Table 1 and the ADT cost multiplier as shown in Table 2. If estimated, provide the assumptions used in the spaces below: Bridge Area <u>2213</u> ft ² ; Cost per unit area <u>70</u> \$/ft ² ; Cost Multiplier: <u>1.25</u>	\$200,000

Economic Loss Data

Please provide the following economic factors to be associated with the failure of this bridge. Either check the box confirming that the default factor is to be used or provide a different value.		
Description	Default Value	User-Provided Value
Car running cost	\$0.45 per mile <input checked="" type="checkbox"/>	
Truck running cost	\$1.30 per mile <input checked="" type="checkbox"/>	
Duration of detour *	Use Table 2 (days) <input checked="" type="checkbox"/>	365
Value of time per adult *	Use Table 3 (\$/hr) <input checked="" type="checkbox"/>	\$6.72
Average car occupancy rate	1.63 people <input checked="" type="checkbox"/>	
Value of time for trucks	\$22.01 per hour <input checked="" type="checkbox"/>	
Average detour speed	40 miles per hour <input checked="" type="checkbox"/>	
Number of deaths from failure *	Use Table 2 (Number of people) <input checked="" type="checkbox"/>	2
Cost for each life lost	\$500,000 <input checked="" type="checkbox"/>	

* Please select an appropriate value from the reference table listed.

Cost of Analysis or Corrective Actions

Provide estimates for the following costs. Keep in mind that these costs may depend on a number of factors, e.g., the number of piers, abutments, etc. Also keep in mind that the guidelines include many significant broad assumptions, so significant effort is not warranted in estimating this data.	
Description	User Input
Estimated cost of installing automated scour monitoring	\$50,000
Estimated cost of installing scour countermeasures	\$50,000
Estimated cost of field reconnaissance to determine foundation type and depth (nondestructive testing, borings, etc.)	\$20,000
Estimated cost to evaluate scour (survey, hydrology, and hydraulics analysis, if unavailable)	\$20,000

Scour Management Evaluation

4. Pearl Street over Mill River

Bridge 450113 in Cleveland County, NC was constructed in 1959 and supports a rural local class road. This bridge has an unknown foundation depth, and it is further assumed that foundation records can not be found.

Is it a high-priority bridge?

This bridge supports an urban road, which is not a principal arterial or emergency route, and does not provide direct access to other emergency services (e.g. hospital, fire stations, etc.). *Thus, in this context this bridge is not considered a high priority bridge.*

Does the bridge meet the minimum performance level?

The minimum performance level for a rural local class bridge, according to the guidelines, is 0.002 – the threshold probability of failure that this bridge must outperform. To estimate this bridge’s annual probability of failure, it is first necessary to estimate the overtopping frequency and scour vulnerability of this bridge, as in the table below.

Data/Parameter (source)	Value	Interpretation
NBI item 26 (bridge survey)	9	Rural local classification
NBI item 71 (bridge survey)	6	Waterway meets the minimum limits for no action
∴ Overtopping Frequency (guidelines)	0	Occasional (once in 3-10 years)
NBI item 60 (bridge survey)	6	Foundation is in satisfactory condition
NBI item 61 (bridge survey)	6	Channel has widespread minor damage
∴ Scour Vulnerability (guidelines)	6	Not yet evaluated, but probably stable
∴ Annual probability of failure (guidelines)	0.0004	A 1 in 2,500 chance of failure in any given year

This bridge meets the minimum performance level because the annual probability of failure is less than 0.002. However, because the foundation is unknown, we need to determine the most cost effective way to manage this uncertainty.

Is automated scour monitoring warranted?

Automated scour monitoring is considered warranted if the lifetime risk of death is greater than the cost of automated scour monitoring. The lifetime probability of failure for this bridge can be computed from the annual probability of failure and its tentative remaining life (46 years, according to the survey respondent) as follows: $1 - (1 - 0.0004)^{46}$, or about 0.018 (a 1 in 56 chance of failure in the next 46 years). This and other survey data are now used to calculate the risk of death as follows:

$$R_{death} = K \cdot P_L \cdot C_6 \cdot X$$

$$= (1.0) \cdot (0.018 / yr) \cdot (\$500,000 / person) \cdot (2 people) = \$18,235$$

Since the cost of automated scour monitoring was estimated to be \$50,000 and the risk of death is \$18,235, *automated scour monitoring may not be warranted.*

Are scour countermeasures warranted?

Scour countermeasures are considered warranted if the lifetime risk of failure is greater than the estimated cost of scour countermeasures, which the survey respondent estimated to be about \$50,000. The first step in estimating the risk of failure is to estimate the potential cost of failure, assuming that it would need to be replaced. The survey respondent estimated that a new bridge would cost about \$200,000. The car and truck running cost associated with the detour for this bridge is computed from the survey data as follows:

$$\begin{aligned} C_{\text{running}} &= \left[C_2 \cdot \left(1 - \frac{T}{100} \right) + C_3 \cdot \frac{T}{100} \right] \cdot D \cdot A \cdot d \\ &= \left[\$0.45 / \text{mi} \cdot \left(1 - \frac{6}{100} \right) + \$1.30 / \text{mi} \cdot \frac{6}{100} \right] \cdot (1 \text{ mi}) \cdot (1,000 / \text{day}) \cdot (365 \text{ days}) \\ &= \$182,865 \end{aligned}$$

The cost of lost wages is computed from the survey data as follows:

$$\begin{aligned} C_{\text{wages}} &= \left[C_4 \cdot O \cdot \left(1 - \frac{T}{100} \right) + C_5 \cdot \frac{T}{100} \right] \cdot \frac{D \cdot A \cdot d}{S} \\ &= \left[(\$6.72 / \text{per}) \cdot (1.63 \text{ per}) \cdot \left(1 - \frac{6}{100} \right) + (\$22.01 / \text{truck}) \cdot \frac{6}{100} \right] \cdot \frac{(1 \text{ mi}) \cdot (1,000 / \text{day}) \cdot (365 \text{ days})}{40 \text{ mi} / \text{hr}} \\ &= \$106,005 \end{aligned}$$

When we include the cost of death, the total cost of bridge failure totals \$1,488,870. Computing the risk of a scour-induced failure over the remaining life of the bridge is just the product of the lifetime probability of failure and the total cost of failure – about \$27,150. *Thus, scour countermeasures are probably not warranted* because the lifetime risk of failure is less than the estimated cost of scour countermeasures.

Recommended management strategy

This bridge meets the performance standards for these guidelines and does not appear to warrant automated scour monitoring or countermeasures. However, because this bridge has an unknown foundation the guidelines strongly recommend that you follow the recommendations in the “Bridge Closure Plan” section of this report.

Furthermore, scour monitoring should be performed with every 2-yr routine bridge inspection for all bridges with unknown foundations. If the scour depth increases more than two feet from baseline conditions (as-built drawings or initial scour survey), action should be taken. The first action is to follow the “Bridge Closure Plan” to take any necessary immediate action. Countermeasures should then be considered for this site; or close or replace the bridge. This two foot trigger can be adjusted based on local geotechnical and engineering considerations and should represent the depth of scour that the bridge engineer feels comfortable with for the individual bridge.

Bridge #5

The Initial Survey

Respondent Information

Name Scott Webb	E-mail Address swebb@dot.state.nc.us
Job Title Transportation Engineer III	Phone 919-250-4088
Job Description (In what way does your job involve bridge maintenance?) Foundation Recommendations	Mailing Address 1589 Mail Service Center Raleigh, NC 27699

Bridge Description

Please provide a general description of the bridge including its name, location, route, and water body.
060115 Beaufort County, SR 13134 over Upper Goose Creek 1.4 miles from SR 1333 No parallel structure. Critical route

National Bridge Inventory (NBI) Data

Please provide the following information for the bridge. This information should be available in the NBI database. Please provide the NBI Database Values consistent with those required in the 2002 NBI Coding Guide, and specify the units (where appropriate).		
NBI Item No.	NBI Item Description	NBI Database Value
1	State Code	374
5	Inventory Route	131018340
8	Structure Number	000000000130115
19	Bypass, Detour Length (e.g. in miles)	11
26	Functional Classification of Inventory Route	9
27	Year Built	1976
29	Average Daily Traffic	320
49	Structure Length (e.g. in feet)	53
52	Deck Width, Out-to-Out (e.g. in feet)	29.4
60	Substructure	7
61	Channel and Channel Protection	7
71	Waterway Adequacy	8
109	Average Daily Truck Traffic	6
113	Scour Critical Bridges (2002 NBI Guidelines)	8

Undocumented Assumptions

Please provide the following information for the bridge which is not documented in the NBI database.	
Description	User Input
Bridge Type (check only one)	<input checked="" type="checkbox"/> Simple Span(s) <input type="checkbox"/> Continuous Span(s) over 100 ft.
Remaining life of bridge in years. If this bridge has already failed, report the actual lifetime of the bridge before it failed	25 years
Total Bridge Rebuilding Cost, if known. If unknown, estimate the cost by multiplying the bridge area by the cost per unit area as shown in Table 1 and the ADT cost multiplier as shown in Table 2. If estimated, provide the assumptions used in the spaces below: Bridge Area: 1550 ft ² ; Cost per unit area: 50 \$/ft ² ; Cost Multiplier: 1.1	\$85,000

Economic Loss Data

Please provide the following economic factors to be associated with the failure of this bridge. Either check the box confirming that the default factor is to be used or provide a different value.		
Description	Default Value	User-Provided Value
Car running cost	\$0.45 per mile <input checked="" type="checkbox"/>	
Truck running cost	\$1.30 per mile <input checked="" type="checkbox"/>	
Duration of detour *	Use Table 2 (days) <input checked="" type="checkbox"/>	730
Value of time per adult *	Use Table 3 (\$/hr) <input checked="" type="checkbox"/>	\$6.72
Average car occupancy rate	1.63 people <input checked="" type="checkbox"/>	
Value of time for trucks	\$22.01 per hour <input checked="" type="checkbox"/>	
Average detour speed	40 miles per hour <input checked="" type="checkbox"/>	
Number of deaths from failure *	Use Table 2 (Number of people) <input checked="" type="checkbox"/>	1
Cost for each life lost	\$500,000 <input checked="" type="checkbox"/>	

* Please select an appropriate value from the reference table listed.

Cost of Analysis or Corrective Actions

Provide estimates for the following costs. Keep in mind that these costs may depend on a number of factors, e.g., the number of piers, abutments, etc. Also keep in mind that the guidelines include many significant broad assumptions, so significant effort is not warranted in estimating this data.	
Description	User Input
Estimated cost of installing automated scour monitoring	\$50,000
Estimated cost of installing scour countermeasures	\$50,000
Estimated cost of field reconnaissance to determine foundation type and depth (nondestructive testing, borings, etc.)	\$20,000
Estimated cost to evaluate scour (survey, hydrology, and hydraulics analysis, if unavailable)	\$20,000*

*have a scour report

Scour Management Evaluation

5. State Road 1334 over Upper Goose Creek

Bridge 130115 in Beaufort County, NC was constructed in 1976. It supports a rural local class road. This bridge's foundation is known with an NBI item 113 rating of "8" (analysis: stable; survey: stable). However, this bridge will be evaluated as if it had an unknown foundation to test the guidelines.

Is it a high-priority bridge?

This bridge supports a rural road, which is an emergency evacuation route. *Thus, in this context this bridge is considered a high priority bridge* and should be given special attention.

Recommended management strategy

This bridge has a known foundation, and thus does not require any additional action. However, this bridge has significant economic value and may provide critical access to local services. Thus, if this bridge had an unknown foundation the guidelines would have recommended the following three-step strategy to ensure the safety of this bridge.

1. Perform field reconnaissance to determine foundation type and depth. If the foundation is a spread footing, drill through the footing to determine elevation of the footing bottom. If the foundation is piles, use foundation reconnaissance to determine depth of piles. The parallel seismic test is generally the most effective reconnaissance method. Assume that the foundation information from the field evaluation is accurate. If field reconnaissance is unsuccessful (no access for testing, poor signal from NDT, etc.), assume a foundation depth. For piles, assume a 10 foot depth or use local knowledge. This should be a conservative assumption. Spread footing depths are easily discovered and an assumption should not be necessary for this type of foundation. In other words, continue as if the foundation is known.
2. Evaluate scour using FHWA HEC-18 manual.
3. If scour analysis indicates that countermeasures are warranted, countermeasures should be designed using FHWA HEC-23 manual – or consider replacing or closing the bridge.

Bridge #6

The Initial Survey

Respondent Information

Name Scott Webb	E-mail Address swebb@dot.state.nc.us
Job Title Transportation Engineer III	Phone 919-250-4088
Job Description (In what way does your job involve bridge maintenance?) Foundation Recommendations	Mailing Address 1589 Mail Service Center Raleigh, NC 27699

Bridge Description

Please provide a general description of the bridge including its name, location, route, and water body.
060101 Beaufort County SR 1518 over Runyon Creek No parallel structure Critical route

National Bridge Inventory (NBI) Data

Please provide the following information for the bridge. This information should be available in the NBI database. Please provide the NBI Database Values consistent with those required in the 2002 NBI Coding Guide, and specify the units (where appropriate).		
NBI Item No.	NBI Item Description	NBI Database Value
1	State Code	374
5	Inventory Route	1310115180
8	Structure Number	00000000120101
19	Bypass, Detour Length (e.g. in miles)	5
26	Functional Classification of Inventory Route	9
27	Year Built	1964
29	Average Daily Traffic	530
49	Structure Length (e.g. in feet)	52
52	Deck Width, Out-to-Out (e.g. in feet)	25
60	Substructure	7
61	Channel and Channel Protection	8
71	Waterway Adequacy	5
109	Average Daily Truck Traffic	6
113	Scour Critical Bridges (2002 NBI Guidelines)	U

Undocumented Assumptions

Please provide the following information for the bridge which is not documented in the NBI database.	
Description	User Input
Bridge Type (check only one)	<input checked="" type="checkbox"/> Simple Span(s) <input type="checkbox"/> Continuous Span(s) over 100 ft.
Remaining life of bridge in years. If this bridge has already failed, report the actual lifetime of the bridge before it failed	15 years
Total Bridge Rebuilding Cost, if known. If unknown, estimate the cost by multiplying the bridge area by the cost per unit area as shown in Table 1 and the ADT cost multiplier as shown in Table 2. If estimated, provide the assumptions used in the spaces below: Bridge Area: 1300 ft ² ; Cost per unit area: 50 \$/ft ² ; Cost Multiplier: 1.25	\$81,250

Economic Loss Data

Please provide the following economic factors to be associated with the failure of this bridge. Either check the box confirming that the default factor is to be used or provide a different value.		
Description	Default Value	User-Provided Value
Car running cost	\$0.45 per mile <input checked="" type="checkbox"/>	
Truck running cost	\$1.30 per mile <input checked="" type="checkbox"/>	
Duration of detour *	Use Table 2 (days) <input checked="" type="checkbox"/>	548
Value of time per adult *	Use Table 3 (\$/hr) <input checked="" type="checkbox"/>	\$6.72
Average car occupancy rate	1.63 people <input checked="" type="checkbox"/>	
Value of time for trucks	\$22.01 per hour <input checked="" type="checkbox"/>	
Average detour speed	40 miles per hour <input checked="" type="checkbox"/>	
Number of deaths from failure *	Use Table 2 (Number of people) <input checked="" type="checkbox"/>	2
Cost for each life lost	\$500,000 <input checked="" type="checkbox"/>	

* Please select an appropriate value from the reference table listed.

Cost of Analysis or Corrective Actions

Provide estimates for the following costs. Keep in mind that these costs may depend on a number of factors, e.g., the number of piers, abutments, etc. Also keep in mind that the guidelines include many significant broad assumptions, so significant effort is not warranted in estimating this data.	
Description	User Input
Estimated cost of installing automated scour monitoring	\$50,000
Estimated cost of installing scour countermeasures	\$50,000
Estimated cost of field reconnaissance to determine foundation type and depth (nondestructive testing, borings, etc.)	\$20,000
Estimated cost to evaluate scour (survey, hydrology, and hydraulics analysis, if unavailable)	\$20,000

Scour Management Evaluation

6. State Road 1518 over Runyon Creek

Bridge 120101 in Beaufort County, NC was constructed in 1964. It supports a rural local class road. This bridge has an unknown foundation depth, and it is further assumed that foundation records can not be found.

Is it a high-priority bridge?

This bridge supports a rural road, which is an emergency evacuation route. *Thus, in this context this bridge is considered a high priority bridge* and should be given special attention.

Recommended management strategy

This bridge provides a critical emergency evacuation route for local residents and has significant economic value. Thus, the guidelines recommend the following three-step strategy to ensure the safety of this bridge.

1. Perform field reconnaissance to determine foundation type and depth. If the foundation is a spread footing, drill through the footing to determine elevation of the footing bottom. If the foundation is piles, use foundation reconnaissance to determine depth of piles. The parallel seismic test is generally the most effective reconnaissance method. Assume that the foundation information from the field evaluation is accurate. If field reconnaissance is unsuccessful (no access for testing, poor signal from NDT, etc.), assume a foundation depth. For piles, assume a 10 foot depth or use local knowledge. This should be a conservative assumption. Spread footing depths are easily discovered and an assumption should not be necessary for this type of foundation. In other words, continue as if the foundation is known.
2. Evaluate scour using FHWA HEC-18 manual.
3. If scour analysis indicates that countermeasures are warranted, countermeasures should be designed using FHWA HEC-23 manual – or consider replacing or closing the bridge.

Bridge #7

The Initial Survey

Respondent Information

Name Scott Webb	E-mail Address swebb@dot.state.nc.us
Job Title Transportation Engineer III	Phone 919-250-4088
Job Description (In what way does your job involve bridge maintenance?) Foundation Recommendations	Mailing Address 1589 Mail Service Center Raleigh, NC 27699

Bridge Description

Please provide a general description of the bridge including its name, location, route, and water body.
250042 Cumberland County SR 2030 over unnamed creek No parallel structure Critical route

National Bridge Inventory (NBI) Data

Please provide the following information for the bridge. This information should be available in the NBI database. Please provide the NBI Database Values consistent with those required in the 2002 NBI Coding Guide, and specify the units (where appropriate).		
NBI Item No.	NBI Item Description	NBI Database Value
1	State Code	374
5	Inventory Route	131020300
8	Structure Number	00000000510042
19	Bypass, Detour Length (e.g. in miles)	5
26	Functional Classification of Inventory Route	8
27	Year Built	1969
29	Average Daily Traffic	620
49	Structure Length (e.g. in feet)	91
52	Deck Width, Out-to-Out (e.g. in feet)	31
60	Substructure	6
61	Channel and Channel Protection	6
71	Waterway Adequacy	7
109	Average Daily Truck Traffic	6
113	Scour Critical Bridges (2002 NBI Guidelines)	U

Undocumented Assumptions

Please provide the following information for the bridge which is not documented in the NBI database.	
Description	User Input
Bridge Type (check only one)	<input checked="" type="checkbox"/> Simple Span(s) <input type="checkbox"/> Continuous Span(s) over 100 ft.
Remaining life of bridge in years. If this bridge has already failed, report the actual lifetime of the bridge before it failed	17 years
Total Bridge Rebuilding Cost, if known. If unknown, estimate the cost by multiplying the bridge area by the cost per unit area as shown in Table 1 and the ADT cost multiplier as shown in Table 2. If estimated, provide the assumptions used in the spaces below: Bridge Area: 2821 ft ² ; Cost per unit area: 70 \$/ft ² ; Cost Multiplier: 1.25	\$246,837

Economic Loss Data

Please provide the following economic factors to be associated with the failure of this bridge. Either check the box confirming that the default factor is to be used or provide a different value.		
Description	Default Value	User-Provided Value
Car running cost	\$0.45 per mile <input checked="" type="checkbox"/>	
Truck running cost	\$1.30 per mile <input checked="" type="checkbox"/>	
Duration of detour *	Use Table 2 (days) <input checked="" type="checkbox"/>	548
Value of time per adult *	Use Table 3 (\$/hr) <input checked="" type="checkbox"/>	\$6.72
Average car occupancy rate	1.63 people <input checked="" type="checkbox"/>	
Value of time for trucks	\$22.01 per hour <input checked="" type="checkbox"/>	
Average detour speed	40 miles per hour <input checked="" type="checkbox"/>	
Number of deaths from failure *	Use Table 2 (Number of people) <input checked="" type="checkbox"/>	2
Cost for each life lost	\$500,000 <input checked="" type="checkbox"/>	

* Please select an appropriate value from the reference table listed.

Cost of Analysis or Corrective Actions

Provide estimates for the following costs. Keep in mind that these costs may depend on a number of factors, e.g., the number of piers, abutments, etc. Also keep in mind that the guidelines include many significant broad assumptions, so significant effort is not warranted in estimating this data.	
Description	User Input
Estimated cost of installing automated scour monitoring	\$100,000
Estimated cost of installing scour countermeasures	\$100,000
Estimated cost of field reconnaissance to determine foundation type and depth (nondestructive testing, borings, etc.)	\$50,000
Estimated cost to evaluate scour (survey, hydrology, and hydraulics analysis, if unavailable)	\$50,000

Scour Management Evaluation

7. State Road 2030 over an Unnamed Creek

Bridge 510042 in Cumberland County, NC was constructed in 1969. It supports a rural minor collector class road. This bridge has an unknown foundation depth, and it is further assumed that foundation records can not be found.

Is it a high-priority bridge?

This bridge supports a rural road, which is an emergency evacuation route. *Thus, in this context this bridge is considered a high priority bridge* and should be given special attention.

Recommended management strategy

This bridge provides a critical emergency evacuation route for local residents and has significant economic value. Thus, the guidelines recommend the following three-step strategy to ensure the safety of this bridge.

1. Perform field reconnaissance to determine foundation type and depth. If the foundation is a spread footing, drill through the footing to determine elevation of the footing bottom. If the foundation is piles, use foundation reconnaissance to determine depth of piles. The parallel seismic test is generally the most effective reconnaissance method. Assume that the foundation information from the field evaluation is accurate. If field reconnaissance is unsuccessful (no access for testing, poor signal from NDT, etc.), assume a foundation depth. For piles, assume a 10 foot depth or use local knowledge. This should be a conservative assumption. Spread footing depths are easily discovered and an assumption should not be necessary for this type of foundation. In other words, continue as if the foundation is known.
2. Evaluate scour using FHWA HEC-18 manual.
3. If scour analysis indicates that countermeasures are warranted, countermeasures should be designed using FHWA HEC-23 manual – or consider replacing or closing the bridge.

Bridge #8

The Initial Survey

Respondent Information

Name Scott Webb	E-mail Address swebb@dot.state.nc.us
Job Title Transportation Engineer III	Phone 919-250-4088
Job Description (In what way does your job involve bridge maintenance?) Foundation Recommendations	Mailing Address 1589 Mail Service Center Raleigh, NC 27699

Bridge Description

Please provide a general description of the bridge including its name, location, route, and water body.
440008 Henderson County ST 1314 over Boylston Creek 1 mile south of ST 1426. Not critical

National Bridge Inventory (NBI) Data

Please provide the following information for the bridge. This information should be available in the NBI database. Please provide the NBI Database Values consistent with those required in the 2002 NBI Coding Guide, and specify the units (where appropriate).		
NBI Item No.	NBI Item Description	NBI Database Value
1	State Code	374
5	Inventory Route	131013140
8	Structure Number	000000000890008
19	Bypass, Detour Length (e.g. in miles)	3
26	Functional Classification of Inventory Route	9
27	Year Built	1986
29	Average Daily Traffic	1300
49	Structure Length (e.g. in feet)	42
52	Deck Width, Out-to-Out (e.g. in feet)	21
60	Substructure	6
61	Channel and Channel Protection	6
71	Waterway Adequacy	8
109	Average Daily Truck Traffic	6
113	Scour Critical Bridges (2002 NBI Guidelines)	U

Undocumented Assumptions

Please provide the following information for the bridge which is not documented in the NBI database.	
Description	User Input
Bridge Type (check only one)	<input checked="" type="checkbox"/> Simple Span(s) <input type="checkbox"/> Continuous Span(s) over 100 ft.
Remaining life of bridge in years. If this bridge has already failed, report the actual lifetime of the bridge before it failed	2 years
Total Bridge Rebuilding Cost, if known. If unknown, estimate the cost by multiplying the bridge area by the cost per unit area as shown in Table 1 and the ADT cost multiplier as shown in Table 2. If estimated, provide the assumptions used in the spaces below: Bridge Area: 882 ft ² ; Cost per unit area: 75 \$/ft ² ; Cost Multiplier: 1.5	\$99,200

Economic Loss Data

Please provide the following economic factors to be associated with the failure of this bridge. Either check the box confirming that the default factor is to be used or provide a different value.		
Description	Default Value	User-Provided Value
Car running cost	\$0.45 per mile <input checked="" type="checkbox"/>	
Truck running cost	\$1.30 per mile <input checked="" type="checkbox"/>	
Duration of detour *	Use Table 2 (days) <input checked="" type="checkbox"/>	365
Value of time per adult *	Use Table 3 (\$/hr) <input checked="" type="checkbox"/>	\$6.72
Average car occupancy rate	1.63 people <input checked="" type="checkbox"/>	
Value of time for trucks	\$22.01 per hour <input checked="" type="checkbox"/>	
Average detour speed	40 miles per hour <input checked="" type="checkbox"/>	
Number of deaths from failure *	Use Table 2 (Number of people) <input checked="" type="checkbox"/>	2
Cost for each life lost	\$500,000 <input checked="" type="checkbox"/>	

* Please select an appropriate value from the reference table listed.

Cost of Analysis or Corrective Actions

Provide estimates for the following costs. Keep in mind that these costs may depend on a number of factors, e.g., the number of piers, abutments, etc. Also keep in mind that the guidelines include many significant broad assumptions, so significant effort is not warranted in estimating this data.	
Description	User Input
Estimated cost of installing automated scour monitoring	\$50,000
Estimated cost of installing scour countermeasures	\$50,000
Estimated cost of field reconnaissance to determine foundation type and depth (nondestructive testing, borings, etc.)	\$20,000
Estimated cost to evaluate scour (survey, hydrology, and hydraulics analysis, if unavailable)	\$20,000

Scour Management Evaluation

8. State Road 1314 over Boyleston Creek

Bridge 890008 in Henderson County, NC was constructed in 1986 and supports a rural local class road. This bridge has an unknown foundation depth, and it is further assumed that foundation records can not be found.

Is it a high-priority bridge?

This bridge supports a rural road, which is not a principal arterial, emergency route, and does not provide direct access to other emergency services (e.g. hospital, fire stations, etc.). *Thus, in this context this bridge is not considered a high priority bridge.*

Does the bridge meet the minimum performance level?

The minimum performance level for a rural local class bridge, according to the guidelines, is 0.002 – the threshold probability of failure that this bridge must outperform. To estimate this bridge's annual probability of failure, it is first necessary to estimate the overtopping frequency and scour vulnerability of this bridge, as in the table below.

Data/Parameter (source)	Value	Interpretation
NBI item 26 (bridge survey)	9	Rural local classification
NBI item 71 (bridge survey)	8	Waterway is equal to the desirable criteria
∴ Overtopping Frequency (guidelines)	S	Slight (once in 11-100 years)
NBI item 60 (bridge survey)	6	Foundation is in satisfactory condition
NBI item 61 (bridge survey)	6	Channel has widespread minor damage
∴ Scour Vulnerability (guidelines)	6	Not yet evaluated, but probably stable
∴ Annual probability of failure (guidelines)	0.00025	A 1 in 4,000 chance of failure in any given year

This bridge meets the minimum performance level because the annual probability of failure is less than 0.002. However, because the foundation is unknown, we need to determine the most cost effective way to manage this uncertainty.

Is automated scour monitoring warranted?

Automated scour monitoring is considered warranted if the lifetime risk of death is greater than the cost of automated scour monitoring. The lifetime probability of failure for this bridge can be computed from the annual probability of failure and its tentative remaining life (2 years, according to the survey respondent) as follows: $1 - (1 - 0.00025)^2$, or about 0.0005 (a 1 in 2,000 chance of failure in the next 2 years). This and other survey data are now used to calculate the risk of death as follows:

$$\begin{aligned}
 R_{death} &= K \cdot P_L \cdot C_6 \cdot X \\
 &= (1.0) \cdot (0.0005 / \text{yr}) \cdot (\$500,000 / \text{person}) \cdot (2 \text{ people}) = \$500
 \end{aligned}$$

Since the cost of automated scour monitoring was estimated to be \$50,000 and the risk of death is \$500, *automated scour monitoring is probably not warranted.*

Are scour countermeasures warranted?

Scour countermeasures are considered warranted if the lifetime risk of failure is greater than the estimated cost of scour countermeasures, which the survey respondent estimated to be about \$50,000. The first step in estimating the risk of failure is to estimate the potential cost of failure, assuming that it would need to be replaced. The survey respondent estimated that a new bridge would cost about \$99,200. The car and truck running cost associated with the detour for this bridge is computed from the survey data as follows:

$$\begin{aligned} C_{\text{running}} &= \left[C_2 \cdot \left(1 - \frac{T}{100} \right) + C_3 \cdot \frac{T}{100} \right] \cdot D \cdot A \cdot d \\ &= \left[\$0.45 / \text{mi} \cdot \left(1 - \frac{6}{100} \right) + \$1.30 / \text{mi} \cdot \frac{6}{100} \right] \cdot (3 \text{ mi}) \cdot (1,300 / \text{day}) \cdot (365 \text{ days}) \\ &= \$715,035 \end{aligned}$$

The cost of lost wages is computed from the survey data as follows:

$$\begin{aligned} C_{\text{wages}} &= \left[C_4 \cdot O \cdot \left(1 - \frac{T}{100} \right) + C_5 \cdot \frac{T}{100} \right] \cdot \frac{D \cdot A \cdot d}{S} \\ &= \left[(\$6.72 / \text{per}) \cdot (1.63 \text{ per}) \cdot \left(1 - \frac{6}{100} \right) + (\$22.01 / \text{truck}) \cdot \frac{6}{100} \right] \cdot \frac{(3 \text{ mi}) \cdot (1,300 / \text{day}) \cdot (365 \text{ days})}{40 \text{ mi} / \text{hr}} \\ &= \$414,025 \end{aligned}$$

When we include the cost of death, the total cost of bridge failure totals \$2,228,260. Computing the risk of a scour-induced failure over the remaining life of the bridge is just the product of the lifetime probability of failure and the total cost of failure – about \$1,114. *Thus, scour countermeasures are probably not warranted* because the lifetime risk of failure is less than the estimated cost of scour countermeasures.

Recommended management strategy

This bridge meets the performance standards for these guidelines and does not appear to warrant automated scour monitoring or countermeasures. However, because this bridge has an unknown foundation the guidelines strongly recommend that you follow the recommendations in the “Bridge Closure Plan” section of this report.

Furthermore, scour monitoring should be performed with every 2-yr routine bridge inspection for all bridges with unknown foundations. If the scour depth increases more than two feet from baseline conditions (as-built drawings or initial scour survey), action should be taken. The first action is to follow the “Bridge Closure Plan” to take any necessary immediate action. Countermeasures should then be considered for this site; or close or replace the bridge. This two foot trigger can be adjusted based on local geotechnical and engineering considerations and should represent the depth of scour that the bridge engineer feels comfortable with for the individual bridge.

Bridge #9

The Initial Survey

Respondent Information

Name Scott Webb	E-mail Address swebb@dot.state.nc.us
Job Title Transportation Engineer III	Phone 919-250-4088
Job Description (In what way does your job involve bridge maintenance?) Foundation Recommendations	Mailing Address 1589 Mail Service Center Raleigh, NC 27699

Bridge Description

Please provide a general description of the bridge including its name, location, route, and water body.
350032 Gaston County US 321 NBL over Crowden's Creek 0.1 mile south of SR 2416 Dual bridges Not critical

National Bridge Inventory (NBI) Data

Please provide the following information for the bridge. This information should be available in the NBI database. Please provide the NBI Database Values consistent with those required in the 2002 NBI Coding Guide, and specify the units (where appropriate).		
NBI Item No.	NBI Item Description	NBI Database Value
1	State Code	374
5	Inventory Route	121003210
8	Structure Number	00000000710032
19	Bypass, Detour Length (e.g. in miles)	1
26	Functional Classification of Inventory Route	6
27	Year Built	1931
29	Average Daily Traffic	4350
49	Structure Length (e.g. in feet)	189
52	Deck Width, Out-to-Out (e.g. in feet)	23
60	Substructure	7
61	Channel and Channel Protection	7
71	Waterway Adequacy	7
109	Average Daily Truck Traffic	8
113	Scour Critical Bridges (2002 NBI Guidelines)	8

Undocumented Assumptions

Please provide the following information for the bridge which is not documented in the NBI database.	
Description	User Input
Bridge Type (check only one)	<input checked="" type="checkbox"/> Simple Span(s) <input type="checkbox"/> Continuous Span(s) over 100 ft.
Remaining life of bridge in years. If this bridge has already failed, report the actual lifetime of the bridge before it failed	6 years
Total Bridge Rebuilding Cost, if known. If unknown, estimate the cost by multiplying the bridge area by the cost per unit area as shown in Table 1 and the ADT cost multiplier as shown in Table 2. If estimated, provide the assumptions used in the spaces below: Bridge Area: 4350 ft ² ; Cost per unit area: 70 \$/ft ² ; Cost Multiplier: 1.5	\$456,000

Economic Loss Data

Please provide the following economic factors to be associated with the failure of this bridge. Either check the box confirming that the default factor is to be used or provide a different value.		
Description	Default Value	User-Provided Value
Car running cost	\$0.45 per mile <input checked="" type="checkbox"/>	
Truck running cost	\$1.30 per mile <input checked="" type="checkbox"/>	
Duration of detour *	Use Table 2 (days) <input checked="" type="checkbox"/>	365
Value of time per adult *	Use Table 3 (\$/hr) <input checked="" type="checkbox"/>	\$6.72
Average car occupancy rate	1.63 people <input checked="" type="checkbox"/>	
Value of time for trucks	\$22.01 per hour <input checked="" type="checkbox"/>	
Average detour speed	40 miles per hour <input checked="" type="checkbox"/>	
Number of deaths from failure *	Use Table 2 (Number of people) <input checked="" type="checkbox"/>	2
Cost for each life lost	\$500,000 <input checked="" type="checkbox"/>	

* Please select an appropriate value from the reference table listed.

Cost of Analysis or Corrective Actions

Provide estimates for the following costs. Keep in mind that these costs may depend on a number of factors, e.g., the number of piers, abutments, etc. Also keep in mind that the guidelines include many significant broad assumptions, so significant effort is not warranted in estimating this data.	
Description	User Input
Estimated cost of installing automated scour monitoring	\$150,000
Estimated cost of installing scour countermeasures	\$150,000
Estimated cost of field reconnaissance to determine foundation type and depth (nondestructive testing, borings, etc.)	\$75,000
Estimated cost to evaluate scour (survey, hydrology, and hydraulics analysis, if unavailable)	\$75,000

Scour Management Evaluation

9. US 321 NBC over Crosden's Creek

Bridge 710032 in Gaston County, NC was constructed in 1931 and supports a rural minor arterial class road. This bridge's foundation is known with an NBI item 113 rating of "8" (analysis: stable; survey: stable). However, this bridge will be evaluated as if it had an unknown foundation to test the guidelines.

Is it a high-priority bridge?

This bridge supports a rural road, which is not a principal arterial, emergency route, and does not provide direct access to other emergency services (e.g. hospital, fire stations, etc.). *Thus, in this context this bridge is not considered a high priority bridge.*

Does the bridge meet the minimum performance level?

The minimum performance level for a rural minor arterial class bridge, according to the guidelines, is 0.0005 – the threshold probability of failure that this bridge must outperform. To estimate this bridge's annual probability of failure, it is first necessary to estimate the overtopping frequency and scour vulnerability of this bridge, as in the table below.

Data/Parameter (source)	Value	Interpretation
NBI item 26 (bridge survey)	6	Rural minor arterial classification
NBI item 71 (bridge survey)	7	Waterway is better than the minimum criteria
∴ Overtopping Frequency (guidelines)	S	Slight (once in 11-100 years)
NBI item 60 (bridge survey)	7	Foundation is in good condition
NBI item 61 (bridge survey)	7	Channel has some minor drift and damage
∴ Scour Vulnerability (guidelines)	7	Countermeasures installed make it stable
∴ Annual probability of failure (guidelines)	0.00025	A 1 in 4,000 chance of failure in any given year

This bridge meets the minimum performance level because the annual probability of failure is less than 0.0005. However, because the foundation is unknown, we need to determine the most cost effective way to manage this uncertainty.

Is automated scour monitoring warranted?

Automated scour monitoring is considered warranted if the lifetime risk of death is greater than the cost of automated scour monitoring. The lifetime probability of failure for this bridge can be computed from the annual probability of failure and its tentative remaining life (6 years, according to the survey respondent) as follows: $1 - (1 - 0.00025)^6$, or about 0.0015 (a 1 in 667 chance of failure in the next 6 years). This and other survey data are now used to calculate the risk of death as follows:

$$R_{death} = K \cdot P_L \cdot C_6 \cdot X$$

$$= (1.0) \cdot (0.0015 / yr) \cdot (\$500,000 / person) \cdot (2 people) = \$1,500$$

Since the cost of automated scour monitoring was estimated to be \$50,000 and the risk of death is \$1,500, *automated scour monitoring is probably not warranted.*

Are scour countermeasures warranted?

Scour countermeasures are considered warranted if the lifetime risk of failure is greater than the estimated cost of scour countermeasures, which the survey respondent estimated to be about \$150,000. The first step in estimating the risk of failure is to estimate the potential cost of failure, assuming that it would need to be replaced. The survey respondent estimated that a new bridge would cost about \$456,000. The car and truck running cost associated with the detour for this bridge is computed from the survey data as follows:

$$\begin{aligned} C_{\text{running}} &= \left[C_2 \cdot \left(1 - \frac{T}{100} \right) + C_3 \cdot \frac{T}{100} \right] \cdot D \cdot A \cdot d \\ &= \left[\$0.45 / \text{mi} \cdot \left(1 - \frac{8}{100} \right) + \$1.30 / \text{mi} \cdot \frac{8}{100} \right] \cdot (1 \text{ mi}) \cdot (4,350 / \text{day}) \cdot (183 \text{ days}) \\ &= \$412,665 \end{aligned}$$

The cost of lost wages is computed from the survey data as follows:

$$\begin{aligned} C_{\text{wages}} &= \left[C_4 \cdot O \cdot \left(1 - \frac{T}{100} \right) + C_5 \cdot \frac{T}{100} \right] \cdot \frac{D \cdot A \cdot d}{S} \\ &= \left[(\$6.72 / \text{per}) \cdot (1.63 \text{ per}) \cdot \left(1 - \frac{8}{100} \right) + (\$22.01 / \text{truck}) \cdot \frac{8}{100} \right] \cdot \frac{(1 \text{ mi}) \cdot (4,350 / \text{day}) \cdot (183 \text{ days})}{40 \text{ mi} / \text{hr}} \\ &= \$235,694 \end{aligned}$$

When we include the cost of death, the total cost of bridge failure totals \$2,104,359. Computing the risk of a scour-induced failure over the remaining life of the bridge is just the product of the lifetime probability of failure and the total cost of failure – about \$3,155. *Thus, scour countermeasures are probably not warranted* because the lifetime risk of failure is less than the estimated cost of scour countermeasures.

Recommended management strategy

This bridge has a known foundation, and thus does not require any additional action. However, if this bridge had an unknown foundation the guidelines would have strongly recommended that you follow the recommendations in the “Bridge Closure Plan” section of this report.

Furthermore, scour monitoring should be performed with every 2-yr routine bridge inspection for all bridges with unknown foundations. If the scour depth increases more than two feet from baseline conditions (as-built drawings or initial scour survey), action should be taken. The first action is to follow the “Bridge Closure Plan” to take any necessary immediate action. Countermeasures should then be considered for this site; or close or replace the bridge. This two foot trigger can be adjusted based on local geotechnical and engineering considerations and should represent the depth of scour that the bridge engineer feels comfortable with for the individual bridge.

Bridge #10

The Initial Survey

Respondent Information

Name Scott Webb	E-mail Address swebb@dot.state.nc.us
Job Title Transportation Engineer III	Phone 919-250-4088
Job Description (In what way does your job involve bridge maintenance?) Foundation Recommendations	Mailing Address 1589 Mail Service Center Raleigh, NC 27699

Bridge Description

Please provide a general description of the bridge including its name, location, route, and water body.
620013 Moore County SR1102 over Aberdeen Creek 0.2 miles west of SR 1101 No parallel structure Critical structure

National Bridge Inventory (NBI) Data

Please provide the following information for the bridge. This information should be available in the NBI database. Please provide the NBI Database Values consistent with those required in the 2002 NBI Coding Guide, and specify the units (where appropriate).		
NBI Item No.	NBI Item Description	NBI Database Value
1	State Code	374
5	Inventory Route	131011020
8	Structure Number	000000001250013
19	Bypass, Detour Length (e.g. in miles)	6
26	Functional Classification of Inventory Route	8
27	Year Built	1941
29	Average Daily Traffic	1300
49	Structure Length (e.g. in feet)	51
52	Deck Width, Out-to-Out (e.g. in feet)	22
60	Substructure	6
61	Channel and Channel Protection	8
71	Waterway Adequacy	8
109	Average Daily Truck Traffic	6
113	Scour Critical Bridges (2002 NBI Guidelines)	U

Undocumented Assumptions

Please provide the following information for the bridge which is not documented in the NBI database.	
Description	User Input
Bridge Type (check only one)	<input checked="" type="checkbox"/> Simple Span(s) <input type="checkbox"/> Continuous Span(s) over 100 ft.
Remaining life of bridge in years. If this bridge has already failed, report the actual lifetime of the bridge before it failed	15 years
Total Bridge Rebuilding Cost, if known. If unknown, estimate the cost by multiplying the bridge area by the cost per unit area as shown in Table 1 and the ADT cost multiplier as shown in Table 2. If estimated, provide the assumptions used in the spaces below: Bridge Area: 1122 ft ² ; Cost per unit area: 60 \$/ft ² ; Cost Multiplier: 1.5	\$101,000

Economic Loss Data

Please provide the following economic factors to be associated with the failure of this bridge. Either check the box confirming that the default factor is to be used or provide a different value.		
Description	Default Value	User-Provided Value
Car running cost	\$0.45 per mile <input checked="" type="checkbox"/>	
Truck running cost	\$1.30 per mile <input checked="" type="checkbox"/>	
Duration of detour *	Use Table 2 (days) <input checked="" type="checkbox"/>	
Value of time per adult *	Use Table 3 (\$/hr) <input checked="" type="checkbox"/>	
Average car occupancy rate	1.63 people <input checked="" type="checkbox"/>	
Value of time for trucks	\$22.01 per hour <input checked="" type="checkbox"/>	
Average detour speed	40 miles per hour <input checked="" type="checkbox"/>	
Number of deaths from failure *	Use Table 2 (Number of people) <input checked="" type="checkbox"/>	
Cost for each life lost	\$500,000 <input checked="" type="checkbox"/>	

* Please select an appropriate value from the reference table listed.

Cost of Analysis or Corrective Actions

Provide estimates for the following costs. Keep in mind that these costs may depend on a number of factors, e.g., the number of piers, abutments, etc. Also keep in mind that the guidelines include many significant broad assumptions, so significant effort is not warranted in estimating this data.	
Description	User Input
Estimated cost of installing automated scour monitoring	\$50,000
Estimated cost of installing scour countermeasures	\$50,000
Estimated cost of field reconnaissance to determine foundation type and depth (nondestructive testing, borings, etc.)	\$20,000
Estimated cost to evaluate scour (survey, hydrology, and hydraulics analysis, if unavailable)	\$20,000

Scour Management Evaluation

10. State Road 1102 over Aberdeen Creek

Bridge 1250013 in Moore County, NC was constructed in 1941. It supports a rural minor arterial class road. This bridge has an unknown foundation depth, and it is further assumed that foundation records can not be found.

Is it a high-priority bridge?

This bridge supports a rural road, which is an emergency evacuation route. *Thus, in this context this bridge is considered a high priority bridge* and should be given special attention.

Recommended management strategy

This bridge provides a critical emergency evacuation route for local residents and has significant economic value. Thus, the guidelines recommend the following three-step strategy to ensure the safety of this bridge.

1. Perform field reconnaissance to determine foundation type and depth. If the foundation is a spread footing, drill through the footing to determine elevation of the footing bottom. If the foundation is piles, use foundation reconnaissance to determine depth of piles. The parallel seismic test is generally the most effective reconnaissance method. Assume that the foundation information from the field evaluation is accurate. If field reconnaissance is unsuccessful (no access for testing, poor signal from NDT, etc.), assume a foundation depth. For piles, assume a 10 foot depth or use local knowledge. This should be a conservative assumption. Spread footing depths are easily discovered and an assumption should not be necessary for this type of foundation. In other words, continue as if the foundation is known.
2. Evaluate scour using FHWA HEC-18 manual.
3. If scour analysis indicates that countermeasures are warranted, countermeasures should be designed using FHWA HEC-23 manual – or consider replacing or closing the bridge.

Response to Evaluations

Mohammed Mulla, an assistant state geotechnical engineer, responded to the bridge evaluation as follows:

I generally agree with the concept being utilized. It does help in making a decision to be able to quantify variables as opposed to just mentally ranking the variables due to perceptions of their importance. However, after reviewing the response, I felt that most of the effect of the risk analysis was in areas that would not ultimately control the decision, such as whether or not a detour route would be considered too long for local citizens, or that a fatality would be unacceptable regardless of costs. I feel this research is a step forward, but a small step.

Tennessee Bridges*Bridge #1***The Initial Survey**

Respondent Information

Name Denise Glasgow	E-mail Address Denise.glasgow@state.tn.us
Job Title Transportation Associate	Phone 615-532-2445
Job Description (In what way does your job involve bridge maintenance?) Maintenance records for bridge repair	Mailing Address 505 Deaderick Suite 1200, JK Polk Building Nashville, TN 37243-0338

Bridge Description

Please provide a general description of the bridge including its name, location, route, and water body.
Lake County, Madie Thompson Rd over Running Reelfoot Bayou. 5 span timber stringer and timber bents. 2 lanes wide

National Bridge Inventory (NBI) Data

Please provide the following information for the bridge. This information should be available in the NBI database. Please provide the NBI Database Values consistent with those required in the 2002 NBI Coding Guide, and specify the units (where appropriate).		
NBI Item No.	NBI Item Description	NBI Database Value
1	State Code	474
5	Inventory Route	A043
8	Structure Number	480A0430001
19	Bypass, Detour Length (e.g. in miles)	4.97 mi
26	Functional Classification of Inventory Route	R/Local
27	Year Built	1930
29	Average Daily Traffic	40
49	Structure Length (e.g. in feet)	93.8 ft
52	Deck Width, Out-to-Out (e.g. in feet)	21.0 ft
60	Substructure	0
61	Channel and Channel Protection	0
71	Waterway Adequacy	0
109	Average Daily Truck Traffic	2%
113	Scour Critical Bridges (2002 NBI Guidelines)	0

Undocumented Assumptions

Please provide the following information for the bridge which is not documented in the NBI database.	
Description	User Input
Bridge Type (check only one)	<input checked="" type="checkbox"/> Simple Span(s) <input type="checkbox"/> Continuous Span(s) over 100 ft.
Remaining life of bridge in years. If this bridge has already failed, report the actual lifetime of the bridge before it failed	70 years
Total Bridge Rebuilding Cost, if known. If unknown, estimate the cost by multiplying the bridge area by the cost per unit area as shown in Table 1 and the ADT cost multiplier as shown in Table 2. If estimated, provide the assumptions used in the spaces below: Bridge Area: _____ ft ² ; Cost per unit area: _____ \$/ft ² ; Cost Multiplier: _____	\$457,700.00

Economic Loss Data

Please provide the following economic factors to be associated with the failure of this bridge. Either check the box confirming that the default factor is to be used or provide a different value.		
Description	Default Value	User-Provided Value
Car running cost	\$0.45 per mile <input checked="" type="checkbox"/>	
Truck running cost	\$1.30 per mile <input checked="" type="checkbox"/>	
Duration of detour *	Use Table 2 (days) <input type="checkbox"/>	1095
Value of time per adult *	Use Table 3 (\$/hr) <input type="checkbox"/>	6.45
Average car occupancy rate	1.63 people <input checked="" type="checkbox"/>	
Value of time for trucks	\$22.01 per hour <input checked="" type="checkbox"/>	
Average detour speed	40 miles per hour <input checked="" type="checkbox"/>	
Number of deaths from failure *	Use Table 2 (Number of people) <input type="checkbox"/>	0
Cost for each life lost	\$500,000 <input type="checkbox"/>	

* Please select an appropriate value from the reference table listed.

Cost of Analysis or Corrective Actions

Provide estimates for the following costs. Keep in mind that these costs may depend on a number of factors, e.g., the number of piers, abutments, etc. Also keep in mind that the guidelines include many significant broad assumptions, so significant effort is not warranted in estimating this data.	
Description	User Input
Estimated cost of installing automated scour monitoring	\$30,000.00
Estimated cost of installing scour countermeasures	\$70,000.00
Estimated cost of field reconnaissance to determine foundation type and depth (nondestructive testing, borings, etc.)	\$5,000.00
Estimated cost to evaluate scour (survey, hydrology, and hydraulics analysis, if unavailable)	\$8,000.00

Scour Management Evaluation

1. Maidie Thompson Road over Running Reelfoot Bayou

Bridge 480A0430001 in Lake County, TN is two lanes wide with five spans, timber stringers, and timber bents. Constructed in 1930, this bridge supported a rural-local class road before it failed due to scour.

Is it a high-priority bridge?

This bridge supports a rural road, which is not a principal arterial, emergency route or provide direct access to other emergency services (e.g. hospital, fire stations, etc.). *Thus, in this context this bridge is not considered a high priority bridge.*

Conclusion

This bridge could not be properly evaluated because the NBI codes provided do not reveal any information about the condition of the bridge before it failed.

Bridge #2

The Initial Survey

Respondent Information

Name Denise Glasgow	E-mail Address Denise.glasgow@state.tn.us
Job Title Transportation Associate	Phone 615-532-2445
Job Description (In what way does your job involve bridge maintenance?) Maintenance records for bridge repair	Mailing Address 505 Deaderick Suite 1200, JK Polk Building Nashville, TN 37243-0338

Bridge Description

Please provide a general description of the bridge including its name, location, route, and water body.
Bledsoe County; Bedwell Rd over Cove Branch. Single span 1 lane, steel I beams with steel grating deck and stacked precast concrete block abutments.

National Bridge Inventory (NBI) Data

Please provide the following information for the bridge. This information should be available in the NBI database. Please provide the NBI Database Values consistent with those required in the 2002 NBI Coding Guide, and specify the units (where appropriate).		
NBI Item No.	NBI Item Description	NBI Database Value
1	State Code	474
5	Inventory Route	A136
8	Structure Number	040A1360001
19	Bypass, Detour Length (e.g. in miles)	123.65 mi
26	Functional Classification of Inventory Route	R/Local
27	Year Built	1976
29	Average Daily Traffic	30
49	Structure Length (e.g. in feet)	32.2 ft
52	Deck Width, Out-to-Out (e.g. in feet)	13.5 ft
60	Substructure	6
61	Channel and Channel Protection	6
71	Waterway Adequacy	4
109	Average Daily Truck Traffic	2%
113	Scour Critical Bridges (2002 NBI Guidelines)	U

Undocumented Assumptions

Please provide the following information for the bridge which is not documented in the NBI database.	
Description	User Input
Bridge Type (check only one)	<input checked="" type="checkbox"/> Simple Span(s) <input type="checkbox"/> Continuous Span(s) over 100 ft.
Remaining life of bridge in years. If this bridge has already failed, report the actual lifetime of the bridge before it failed	30 years
Total Bridge Rebuilding Cost, if known. If unknown, estimate the cost by multiplying the bridge area by the cost per unit area as shown in Table 1 and the ADT cost multiplier as shown in Table 2. If estimated, provide the assumptions used in the spaces below: Bridge Area: _____ ft ² ; Cost per unit area: _____ \$/ft ² ; Cost Multiplier: _____	\$223,000.00

Economic Loss Data

Please provide the following economic factors to be associated with the failure of this bridge. Either check the box confirming that the default factor is to be used or provide a different value.		
Description	Default Value	User-Provided Value
Car running cost	\$0.45 per mile <input checked="" type="checkbox"/>	
Truck running cost	\$1.30 per mile <input checked="" type="checkbox"/>	
Duration of detour *	Use Table 2 (days) <input type="checkbox"/>	1095
Value of time per adult *	Use Table 3 (\$/hr) <input type="checkbox"/>	\$6.45
Average car occupancy rate	1.63 people <input checked="" type="checkbox"/>	
Value of time for trucks	\$22.01 per hour <input checked="" type="checkbox"/>	
Average detour speed	40 miles per hour <input checked="" type="checkbox"/>	
Number of deaths from failure *	Use Table 2 (Number of people) <input type="checkbox"/>	0
Cost for each life lost	\$500,000 <input type="checkbox"/>	

* Please select an appropriate value from the reference table listed.

Cost of Analysis or Corrective Actions

Provide estimates for the following costs. Keep in mind that these costs may depend on a number of factors, e.g., the number of piers, abutments, etc. Also keep in mind that the guidelines include many significant broad assumptions, so significant effort is not warranted in estimating this data.	
Description	User Input
Estimated cost of installing automated scour monitoring	\$25,000.00
Estimated cost of installing scour countermeasures	\$40,000.00
Estimated cost of field reconnaissance to determine foundation type and depth (nondestructive testing, borings, etc.)	\$2,500.00
Estimated cost to evaluate scour (survey, hydrology, and hydraulics analysis, if unavailable)	\$8,000.00

Scour Management Evaluation

2. Bedwell Road over Cove Branch

Bridge 040A1360001 in Bledsoe County, TN has one span and one lane with steel I-beams and grating deck, and is supported by stacked pre-cast concrete block abutments. Constructed in 1976, this bridge supports a rural-local class road but has an unknown foundation depth. It is further assumed that foundation records can not be found because NBI item 113 is coded “U”.

Is it a high-priority bridge?

This bridge supports a rural road, which is not a principal arterial, emergency route or provide direct access to other emergency services (e.g. hospital, fire stations, etc.). *Thus, in this context this bridge is not considered a high priority bridge.*

Does the bridge meet the minimum performance level?

The minimum performance level for a rural-local class bridge, according to the guidelines, is 0.002 – the threshold probability of failure that this bridge must outperform. To estimate this bridge’s annual probability of failure, it is first necessary to estimate the overtopping frequency and scour vulnerability of this bridge, as in the table below.

Data/Parameter (source)	Value	Interpretation
NBI item 26 (bridge survey)	9	Rural local classification
NBI item 71 (bridge survey)	4	Waterway meets minimum criteria
∴ Overtopping Frequency (guidelines)	0	Occasional (once in 3-10 years)
NBI item 60 (bridge survey)	6	Foundation is in satisfactory condition
NBI item 61 (bridge survey)	6	Channel has widespread minor damage
∴ Scour Vulnerability (guidelines)	6	Not yet evaluated, but probably stable
∴ Annual probability of failure (guidelines)	0.0004	A 1 in 2,500 chance of failure in any given year

This bridge meets the minimum performance level because the annual probability of failure is less than 0.002. However, because the foundation is unknown, we need to determine the most cost effective way to manage this uncertainty.

Is automated scour monitoring warranted?

Automated scour monitoring is considered warranted if the lifetime risk of death is greater than the cost of automated scour monitoring. The lifetime probability of failure for this bridge can be computed from the annual probability of failure and its tentative remaining life (30 years, according to the survey respondent) as follows: $1 - (1 - 0.0004)^{30}$, or about 0.012 (a 1 in 83 chance of failure in the next 30 years). This and other survey data are now used to calculate the risk of death as follows:

$$R_{death} = K \cdot P_L \cdot C_6 \cdot X$$

$$= (1.0) \cdot (0.012) \cdot (\$500,000 / person) \cdot (0 people) = \$0$$

Since the cost of automated scour monitoring was estimated to be \$25,000 and the risk of death is \$0, *automated scour monitoring is probably not warranted.*

Are scour countermeasures warranted?

Scour countermeasures are considered warranted if the lifetime risk of failure is greater than the estimated cost of scour countermeasures, which the survey respondent estimated to be about \$40,000. The first step is to calculate the potential cost of bridge failure. The survey respondent estimated that a new bridge would cost about \$223,000. The car and truck running cost associated with the detour for this bridge is computed from the survey data as follows:

$$\begin{aligned} C_{\text{running}} &= \left[C_2 \cdot \left(1 - \frac{T}{100} \right) + C_3 \cdot \frac{T}{100} \right] \cdot D \cdot A \cdot d \\ &= \left[\$0.45 / \text{mi} \cdot \left(1 - \frac{2}{100} \right) + \$1.30 / \text{mi} \cdot \frac{2}{100} \right] \cdot (123.65 \text{ mi}) \cdot (30 / \text{day}) \cdot (1095 \text{ days}) \\ &= \$1,896,141 \end{aligned}$$

The cost of lost wages is computed from the survey data as follows:

$$\begin{aligned} C_{\text{wages}} &= \left[C_4 \cdot O \cdot \left(1 - \frac{T}{100} \right) + C_5 \cdot \frac{T}{100} \right] \cdot \frac{D \cdot A \cdot d}{S} \\ &= \left[(\$6.45 / \text{per}) \cdot (1.63 \text{ per}) \cdot \left(1 - \frac{2}{100} \right) + (\$22.01 / \text{truck}) \cdot \frac{2}{100} \right] \cdot \frac{(123.65 \text{ mi}) \cdot (30 / \text{day}) \cdot (1095 \text{ days})}{40 \text{ mi} / \text{hr}} \\ &= \$1,090,528 \end{aligned}$$

Given that the chance death is negligible, the total cost of bridge failure totals \$3,209,669. Computing the risk of a scour-induced failure over the remaining life of the bridge is just the product of the lifetime probability of failure and the total cost of failure – about \$38,293. *Thus, scour countermeasures may not be warranted* because the lifetime risk of failure is slightly less than the estimated cost of scour countermeasures.

Recommended management strategy

This bridge meets the performance standards for these guidelines and does not appear to warrant automated scour monitoring or countermeasures. However, because this bridge has an unknown foundation the guidelines strongly recommend that you follow the recommendations in the “Bridge Closure Plan” section of this report.

Furthermore, scour monitoring should be performed with every 2-yr routine bridge inspection for all bridges with unknown foundations. If the scour depth increases more than two feet from baseline conditions (as-built drawings or initial scour survey), action should be taken. The first action is to follow the “Bridge Closure Plan” to take any necessary immediate action. Countermeasures should then be considered for this site; or close or replace the bridge. This two foot trigger can be adjusted based on local geotechnical and engineering considerations and should represent the depth of scour that the bridge engineer feels comfortable with for the individual bridge.

Bridge #3

The Initial Survey

Respondent Information

Name Denise Glasgow	E-mail Address Denise.glasgow@state.tn.us
Job Title Transportation Associate	Phone 615-532-2445
Job Description (In what way does your job involve bridge maintenance?) Maintenance records for bridge repair	Mailing Address 505 Deaderick Suite 1200, JK Polk Building Nashville, TN 37243-0338

Bridge Description

Please provide a general description of the bridge including its name, location, route, and water body.
Carroll County. State Rt. 77 over Branch. 3 span precast concrete channel slab with timber bents and abutments. 2 lanes wide.

National Bridge Inventory (NBI) Data

Please provide the following information for the bridge. This information should be available in the NBI database. Please provide the NBI Database Values consistent with those required in the 2002 NBI Coding Guide, and specify the units (where appropriate).		
NBI Item No.	NBI Item Description	NBI Database Value
1	State Code	474
5	Inventory Route	SR077
8	Structure Number	09ST0770025
19	Bypass, Detour Length (e.g. in miles)	49.7 mi
26	Functional Classification of Inventory Route	R/Maj Col
27	Year Built	1990
29	Average Daily Traffic	850
49	Structure Length (e.g. in feet)	50.10 ft
52	Deck Width, Out-to-Out (e.g. in feet)	28.10 ft
60	Substructure	6
61	Channel and Channel Protection	6
71	Waterway Adequacy	7
109	Average Daily Truck Traffic	3%
113	Scour Critical Bridges (2002 NBI Guidelines)	U

Undocumented Assumptions

Please provide the following information for the bridge which is not documented in the NBI database.	
Description	User Input
Bridge Type (check only one)	<input checked="" type="checkbox"/> Simple Span(s) <input type="checkbox"/> Continuous Span(s) over 100 ft.
Remaining life of bridge in years. If this bridge has already failed, report the actual lifetime of the bridge before it failed	25 years
Total Bridge Rebuilding Cost, if known. If unknown, estimate the cost by multiplying the bridge area by the cost per unit area as shown in Table 1 and the ADT cost multiplier as shown in Table 2. If estimated, provide the assumptions used in the spaces below: Bridge Area: _____ ft ² ; Cost per unit area: _____ \$/ft ² ; Cost Multiplier: _____	\$285,000.00

Economic Loss Data

Please provide the following economic factors to be associated with the failure of this bridge. Either check the box confirming that the default factor is to be used or provide a different value.		
Description	Default Value	User-Provided Value
Car running cost	\$0.45 per mile <input checked="" type="checkbox"/>	
Truck running cost	\$1.30 per mile <input checked="" type="checkbox"/>	
Duration of detour *	Use Table 2 (days) <input type="checkbox"/>	548
Value of time per adult *	Use Table 3 (\$/hr) <input type="checkbox"/>	\$6.45
Average car occupancy rate	1.63 people <input checked="" type="checkbox"/>	
Value of time for trucks	\$22.01 per hour <input checked="" type="checkbox"/>	
Average detour speed	40 miles per hour <input checked="" type="checkbox"/>	
Number of deaths from failure *	Use Table 2 (Number of people) <input type="checkbox"/>	2
Cost for each life lost	\$500,000 <input checked="" type="checkbox"/>	

* Please select an appropriate value from the reference table listed.

Cost of Analysis or Corrective Actions

Provide estimates for the following costs. Keep in mind that these costs may depend on a number of factors, e.g., the number of piers, abutments, etc. Also keep in mind that the guidelines include many significant broad assumptions, so significant effort is not warranted in estimating this data.	
Description	User Input
Estimated cost of installing automated scour monitoring	\$30,000.00
Estimated cost of installing scour countermeasures	\$70,000.00
Estimated cost of field reconnaissance to determine foundation type and depth (nondestructive testing, borings, etc.)	\$2,500.00
Estimated cost to evaluate scour (survey, hydrology, and hydraulics analysis, if unavailable)	\$8,000.00

Scour Management Evaluation

3. State Route 77 over Branch

Bridge 09SR0770025 in Carroll County, TN has three spans and two lanes with timber bents and abutments and a pre-cast concrete channel slab. Constructed in 1990, this bridge supports a rural major collector class road but has an unknown foundation depth. It is further assumed that foundation records can not be found because NBI item 113 is coded “U”.

Is it a high-priority bridge?

This bridge supports a rural road, which is not a principal arterial, emergency route or provide direct access to other emergency services (e.g. hospital, fire stations, etc.). *Thus, in this context this bridge is not considered a high priority bridge.*

Does the bridge meet the minimum performance level?

The minimum performance level for a rural major collector class bridge, according to the guidelines, is 0.0005 – the threshold probability of failure that this bridge must outperform. To estimate this bridge’s annual probability of failure, it is first necessary to estimate the overtopping frequency and scour vulnerability of this bridge, as in the table below.

Data/Parameter (source)	Value	Interpretation
NBI item 26 (bridge survey)	7	Rural major collector classification
NBI item 71 (bridge survey)	7	Waterway exceeds than the minimum criteria
∴ Overtopping Frequency (guidelines)	S	Slight (once in 11-100 years)
NBI item 60 (bridge survey)	6	Foundation is in satisfactory condition
NBI item 61 (bridge survey)	6	Channel has widespread minor damage
∴ Scour Vulnerability (guidelines)	6	Not yet evaluated, but probably stable
∴ Annual probability of failure (guidelines)	0.00025	A 1 in 4,000 chance of failure in any given year

This bridge meets the minimum performance level because the annual probability of failure is less than 0.0005. However, because the foundation is unknown, we need to determine the most cost effective way to manage this uncertainty.

Is automated scour monitoring warranted?

Automated scour monitoring is considered warranted if the lifetime risk of death is greater than the cost of automated scour monitoring. The lifetime probability of failure for this bridge can be computed from the annual probability of failure and its tentative remaining life (25 years, according to the survey respondent) as follows: $1 - (1 - 0.00025)^{25}$, or about 0.0062 (a 1 in 161 chance of failure in the next 25 years). This and other survey data are now used to calculate the risk of death as follows:

$$R_{death} = K \cdot P_L \cdot C_6 \cdot X$$

$$= (1.0) \cdot (0.0062 / yr) \cdot (\$500,000 / person) \cdot (2 people) = \$6,231$$

Since the cost of automated scour monitoring was estimated to be \$30,000 and the risk of death is \$6,231, *automated scour monitoring may not be warranted.*

Are scour countermeasures warranted?

Scour countermeasures are considered warranted if the lifetime risk of failure is greater than the estimated cost of scour countermeasures, which the survey respondent estimated to be about \$70,000. The first step in estimating the risk of failure is to estimate the potential cost of failure, assuming that it would need to be replaced. The survey respondent estimated that a new bridge would cost about \$285,000. The car and truck running cost associated with the detour for this bridge is computed from the survey data as follows:

$$\begin{aligned} C_{\text{running}} &= \left[C_2 \cdot \left(1 - \frac{T}{100} \right) + C_3 \cdot \frac{T}{100} \right] \cdot D \cdot A \cdot d \\ &= \left[\$0.45 / \text{mi} \cdot \left(1 - \frac{3}{100} \right) + \$1.30 / \text{mi} \cdot \frac{3}{100} \right] \cdot (49.7 \text{ mi}) \cdot (850 / \text{day}) \cdot (548 \text{ days}) \\ &= \$11,007,949 \end{aligned}$$

The cost of lost wages is computed from the survey data as follows:

$$\begin{aligned} C_{\text{wages}} &= \left[C_4 \cdot O \cdot \left(1 - \frac{T}{100} \right) + C_5 \cdot \frac{T}{100} \right] \cdot \frac{D \cdot A \cdot d}{S} \\ &= \left[(\$6.45 / \text{per}) \cdot (1.63 \text{ per}) \cdot \left(1 - \frac{3}{100} \right) + (\$22.01 / \text{truck}) \cdot \frac{3}{100} \right] \cdot \frac{(49.7 \text{ mi}) \cdot (850 / \text{day}) \cdot (548 \text{ days})}{40 \text{ mi} / \text{hr}} \\ &= \$6,284,367 \end{aligned}$$

When we include the cost of death, the total cost of bridge failure totals \$18,577,315. Computing the risk of a scour-induced failure over the remaining life of the bridge is just the product of the lifetime probability of failure and the total cost of failure – about \$115,760. *Thus, scour countermeasures are probably warranted* because the lifetime risk of failure is greater than the estimated cost of scour countermeasures.

Is foundation reconnaissance and scour analysis warranted?

The survey respondent estimated the foundation reconnaissance and scour analysis costs to be about \$2,500 and \$8,000, respectively. Since this is about 15% of the estimated cost of installing countermeasures, *foundation reconnaissance and scour analysis is probably warranted before installing the countermeasures.*

Recommended management strategy

Given the discussion above the guidelines recommend the following three-step strategy to ensure the safety of this bridge.

1. Perform field reconnaissance to determine foundation type and depth. If the foundation is a spread footing, you could drill through the footing to determine elevation of the footing bottom. The parallel seismic test is generally the most effective NDT method. Assume that the foundation information from the field evaluation is accurate. If field reconnaissance is unsuccessful (no access for testing, poor signal from NDT, etc.), assume a foundation depth using local knowledge. This should be a conservative assumption. Spread footing depths are easily discovered and an assumption should not be necessary for this type of foundation. In

other words, continue as if the foundation is known.

2. Evaluate scour using FHWA HEC-18 manual.
3. If scour analysis indicates that countermeasures are warranted, countermeasures should be designed using FHWA HEC-23 manual – or consider replacing or closing the bridge.

Bridge #4

The Initial Survey

Respondent Information

Name Denise Glasgow	E-mail Address Denise.glasgow@state.tn.us
Job Title Transportation Associate	Phone 615-532-2445
Job Description (In what way does your job involve bridge maintenance?) Maintenance records for bridge repair	Mailing Address 505 Deaderick Suite 1200, JK Polk Building Nashville, TN 37243-0338

Bridge Description

Please provide a general description of the bridge including its name, location, route, and water body.
Chester County State Rt. 225 over Melton Branch. Single span precast concrete channel slab with timber abutments. 2 lanes.

National Bridge Inventory (NBI) Data

Please provide the following information for the bridge. This information should be available in the NBI database. Please provide the NBI Database Values consistent with those required in the 2002 NBI Coding Guide, and specify the units (where appropriate).		
NBI Item No.	NBI Item Description	NBI Database Value
1	State Code	474
5	Inventory Route	SR225
8	Structure Number	125R2250005
19	Bypass, Detour Length (e.g. in miles)	4.97 mi
26	Functional Classification of Inventory Route	R/Maj Col
27	Year Built	1985
29	Average Daily Traffic	1300
49	Structure Length (e.g. in feet)	28.3 ft
52	Deck Width, Out-to-Out (e.g. in feet)	28.7 ft
60	Substructure	7
61	Channel and Channel Protection	6
71	Waterway Adequacy	7
109	Average Daily Truck Traffic	1%
113	Scour Critical Bridges (2002 NBI Guidelines)	U

Undocumented Assumptions

Please provide the following information for the bridge which is not documented in the NBI database.	
Description	User Input
Bridge Type (check only one)	<input checked="" type="checkbox"/> Simple Span(s) <input type="checkbox"/> Continuous Span(s) over 100 ft.
Remaining life of bridge in years. If this bridge has already failed, report the actual lifetime of the bridge before it failed	20 years
Total Bridge Rebuilding Cost, if known. If unknown, estimate the cost by multiplying the bridge area by the cost per unit area as shown in Table 1 and the ADT cost multiplier as shown in Table 2. If estimated, provide the assumptions used in the spaces below: Bridge Area: _____ ft ² ; Cost per unit area: _____ \$/ft ² ; Cost Multiplier: _____	\$271,000.00

Economic Loss Data

Please provide the following economic factors to be associated with the failure of this bridge. Either check the box confirming that the default factor is to be used or provide a different value.		
Description	Default Value	User-Provided Value
Car running cost	\$0.45 per mile <input checked="" type="checkbox"/>	
Truck running cost	\$1.30 per mile <input checked="" type="checkbox"/>	
Duration of detour *	Use Table 2 (days) <input checked="" type="checkbox"/>	365
Value of time per adult *	Use Table 3 (\$/hr) <input type="checkbox"/>	6.45
Average car occupancy rate	1.63 people <input checked="" type="checkbox"/>	
Value of time for trucks	\$22.01 per hour <input checked="" type="checkbox"/>	
Average detour speed	40 miles per hour <input checked="" type="checkbox"/>	
Number of deaths from failure *	Use Table 2 (Number of people) <input type="checkbox"/>	2
Cost for each life lost	\$500,000 <input checked="" type="checkbox"/>	

* Please select an appropriate value from the reference table listed.

Cost of Analysis or Corrective Actions

Provide estimates for the following costs. Keep in mind that these costs may depend on a number of factors, e.g., the number of piers, abutments, etc. Also keep in mind that the guidelines include many significant broad assumptions, so significant effort is not warranted in estimating this data.	
Description	User Input
Estimated cost of installing automated scour monitoring	\$25,000.00
Estimated cost of installing scour countermeasures	\$40,000.00
Estimated cost of field reconnaissance to determine foundation type and depth (nondestructive testing, borings, etc.)	\$2,500.00
Estimated cost to evaluate scour (survey, hydrology, and hydraulics analysis, if unavailable)	\$8,000.00

Scour Management Evaluation

4. State Route 225 over Melton Branch

Bridge 12SR2250005 in Chester County, TN has one span and two lanes with timber abutments and a pre-cast concrete channel slab. Constructed in 1985, this bridge supports a rural major collector class road but has an unknown foundation depth. It is further assumed that foundation records can not be found because NBI item 113 is coded “U”.

Is it a high-priority bridge?

This bridge supports a rural road, which is not a principal arterial, emergency route or provide direct access to other emergency services (e.g. hospital, fire stations, etc.). *Thus, in this context this bridge is not considered a high priority bridge.*

Does the bridge meet the minimum performance level?

The minimum performance level for a rural major collector class bridge, according to the guidelines, is 0.0005 – the threshold probability of failure that this bridge must outperform. To estimate this bridge’s annual probability of failure, it is first necessary to estimate the overtopping frequency and scour vulnerability of this bridge, as in the table below.

Data/Parameter (source)	Value	Interpretation
NBI item 26 (bridge survey)	7	Rural major collector classification
NBI item 71 (bridge survey)	7	Waterway exceeds the minimum criteria
∴ Overtopping Frequency (guidelines)	S	Slight (once in 11-100 years)
NBI item 60 (bridge survey)	7	Foundation is in good condition
NBI item 61 (bridge survey)	6	Channel has widespread minor damage
∴ Scour Vulnerability (guidelines)	6	Not yet evaluated, but probably stable
∴ Annual probability of failure (guidelines)	0.00025	A 1 in 4,000 chance of failure in any given year

This bridge meets the minimum performance level because the annual probability of failure is less than 0.0005. However, because the foundation is unknown, we need to determine the most cost effective way to manage this uncertainty.

Is automated scour monitoring warranted?

Automated scour monitoring is considered warranted if the lifetime risk of death is greater than the cost of automated scour monitoring. The lifetime probability of failure for this bridge can be computed from the annual probability of failure and its tentative remaining life (20 years, according to the survey respondent) as follows: $1 - (1 - 0.00025)^{20}$, or about 0.005 (a 1 in 200 chance of failure in the next 20 years). This and other survey data are now used to calculate the risk of death as follows:

$$R_{death} = K \cdot P_L \cdot C_6 \cdot X$$

$$= (1.0) \cdot (0.005 / yr) \cdot (\$500,000 / person) \cdot (2 people) = \$4,988$$

Since the cost of automated scour monitoring was estimated to be \$25,000 and the risk of death is \$4,988, *automated scour monitoring may not be warranted.*

Are scour countermeasures warranted?

Scour countermeasures are considered warranted if the lifetime risk of failure is greater than the estimated cost of scour countermeasures, which the survey respondent estimated to be about \$40,000. The first step in estimating the risk of failure is to estimate the potential cost of failure, assuming that it would need to be replaced. The survey respondent estimated that a new bridge would cost about \$271,000. The car and truck running cost associated with the detour for this bridge is computed from the survey data as follows:

$$\begin{aligned} C_{\text{running}} &= \left[C_2 \cdot \left(1 - \frac{T}{100} \right) + C_3 \cdot \frac{T}{100} \right] \cdot D \cdot A \cdot d \\ &= \left[\$0.45 / \text{mi} \cdot \left(1 - \frac{1}{100} \right) + \$1.30 / \text{mi} \cdot \frac{1}{100} \right] \cdot (4.97 \text{ mi}) \cdot (1,300 / \text{day}) \cdot (365 \text{ days}) \\ &= \$1,081,265 \end{aligned}$$

The cost of lost wages is computed from the survey data as follows:

$$\begin{aligned} C_{\text{wages}} &= \left[C_4 \cdot O \cdot \left(1 - \frac{T}{100} \right) + C_5 \cdot \frac{T}{100} \right] \cdot \frac{D \cdot A \cdot d}{S} \\ &= \left[(\$6.45 / \text{per}) \cdot (1.63 \text{ per}) \cdot \left(1 - \frac{1}{100} \right) + (\$22.01 / \text{truck}) \cdot \frac{1}{100} \right] \cdot \frac{(4.97 \text{ mi}) \cdot (1,300 / \text{day}) \cdot (365 \text{ days})}{40 \text{ mi} / \text{hr}} \\ &= \$626,618 \end{aligned}$$

When we include the cost of death, the total cost of bridge failure totals \$2,978,883. Computing the risk of a scour-induced failure over the remaining life of the bridge is just the product of the lifetime probability of failure and the total cost of failure – about \$14,859. *Thus, scour countermeasures are probably not warranted* because the lifetime risk of failure is less than the estimated cost of scour countermeasures.

Recommended management strategy

This bridge meets the performance standards for these guidelines and does not appear to warrant automated scour monitoring or countermeasures. However, because this bridge has an unknown foundation the guidelines strongly recommend that you follow the recommendations in the “Bridge Closure Plan” section of this report.

Furthermore, scour monitoring should be performed with every 2-yr routine bridge inspection for all bridges with unknown foundations. If the scour depth increases more than two feet from baseline conditions (as-built drawings or initial scour survey), action should be taken. The first action is to follow the “Bridge Closure Plan” to take any necessary immediate action. Countermeasures should then be considered for this site; or close or replace the bridge. This two foot trigger can be adjusted based on local geotechnical and engineering considerations and should represent the depth of scour that the bridge engineer feels comfortable with for the individual bridge.

Bridge #5

The Initial Survey

Respondent Information

Name Denise Glasgow	E-mail Address Denise.glasgow@state.tn.us
Job Title Transportation Associate	Phone 615-532-2445
Job Description (In what way does your job involve bridge maintenance?) Maintenance records for bridge repair	Mailing Address 505 Deaderick Suite 1200, JK Polk Building Nashville, TN 37243-0338

Bridge Description

Please provide a general description of the bridge including its name, location, route, and water body.
Davidson County, Coopertown Road over Long Creek. 2 lane, single span, prestressed precast concrete box beams.

National Bridge Inventory (NBI) Data

Please provide the following information for the bridge. This information should be available in the NBI database. Please provide the NBI Database Values consistent with those required in the 2002 NBI Coding Guide, and specify the units (where appropriate).		
NBI Item No.	NBI Item Description	NBI Database Value
1	State Code	474
5	Inventory Route	A989
8	Structure Number	19019430001
19	Bypass, Detour Length (e.g. in miles)	9.94 mi
26	Functional Classification of Inventory Route	U/Local
27	Year Built	1960
29	Average Daily Traffic	1700
49	Structure Length (e.g. in feet)	53.2 ft
52	Deck Width, Out-to-Out (e.g. in feet)	23.11 ft
60	Substructure	7
61	Channel and Channel Protection	7
71	Waterway Adequacy	7
109	Average Daily Truck Traffic	1
113	Scour Critical Bridges (2002 NBI Guidelines)	U

Undocumented Assumptions

Please provide the following information for the bridge which is not documented in the NBI database.	
Description	User Input
Bridge Type (check only one)	<input checked="" type="checkbox"/> Simple Span(s) <input type="checkbox"/> Continuous Span(s) over 100 ft.
Remaining life of bridge in years. If this bridge has already failed, report the actual lifetime of the bridge before it failed	30 years
Total Bridge Rebuilding Cost, if known. If unknown, estimate the cost by multiplying the bridge area by the cost per unit area as shown in Table 1 and the ADT cost multiplier as shown in Table 2. If estimated, provide the assumptions used in the spaces below: Bridge Area: _____ ft ² ; Cost per unit area: _____ \$/ft ² ; Cost Multiplier: _____	\$127,000.00

Economic Loss Data

Please provide the following economic factors to be associated with the failure of this bridge. Either check the box confirming that the default factor is to be used or provide a different value.		
Description	Default Value	User-Provided Value
Car running cost	\$0.45 per mile <input checked="" type="checkbox"/>	
Truck running cost	\$1.30 per mile <input checked="" type="checkbox"/>	
Duration of detour *	Use Table 2 (days) <input type="checkbox"/>	365
Value of time per adult *	Use Table 3 (\$/hr) <input type="checkbox"/>	6.45
Average car occupancy rate	1.63 people <input checked="" type="checkbox"/>	
Value of time for trucks	\$22.01 per hour <input checked="" type="checkbox"/>	
Average detour speed	40 miles per hour <input checked="" type="checkbox"/>	
Number of deaths from failure *	Use Table 2 (Number of people) <input type="checkbox"/>	2
Cost for each life lost	\$500,000 <input checked="" type="checkbox"/>	

* Please select an appropriate value from the reference table listed.

Cost of Analysis or Corrective Actions

Provide estimates for the following costs. Keep in mind that these costs may depend on a number of factors, e.g., the number of piers, abutments, etc. Also keep in mind that the guidelines include many significant broad assumptions, so significant effort is not warranted in estimating this data.	
Description	User Input
Estimated cost of installing automated scour monitoring	\$25,000.00
Estimated cost of installing scour countermeasures	\$40,000.00
Estimated cost of field reconnaissance to determine foundation type and depth (nondestructive testing, borings, etc.)	\$2,500.00
Estimated cost to evaluate scour (survey, hydrology, and hydraulics analysis, if unavailable)	\$8,000.00

Scour Management Evaluation

5. Coopertown Road over Long Creek

Bridge 19019430001 in Davidson County, TN has one span and two lanes with pre-stressed pre-cast concrete box beams. Constructed in 1960, this bridge supports an urban-local class road but has an unknown foundation depth. It is further assumed that foundation records can not be found because NBI item 113 is coded “U”.

Is it a high-priority bridge?

This bridge supports an urban road, which is not a principal arterial, emergency route or provide direct access to other emergency services (e.g. hospital, fire stations, etc.). Thus, in this context this bridge is not considered a high priority bridge.

Does the bridge meet the minimum performance level?

The minimum performance level for an urban-local class bridge, according to the guidelines, is 0.002 – the threshold probability of failure that this bridge must outperform. To estimate this bridge’s annual probability of failure, it is first necessary to estimate the overtopping frequency and scour vulnerability of this bridge, as in the table below.

Data/Parameter (source)	Value	Interpretation
NBI item 26 (bridge survey)	19	Urban local classification
NBI item 71 (bridge survey)	7	Waterway exceeds the minimum criteria
∴ Overtopping Frequency (guidelines)	S	Slight (once in 11-100 years)
NBI item 60 (bridge survey)	7	Foundation is in good condition
NBI item 61 (bridge survey)	7	Channel has some minor drift and damage
∴ Scour Vulnerability (guidelines)	7	Countermeasures were installed and is now stable
∴ Annual probability of failure (guidelines)	0.00025	A 1 in 4,000 chance of failure in any given year

This bridge meets the minimum performance level because the annual probability of failure is less than 0.002. However, because the foundation is unknown, we need to determine the most cost effective way to manage this uncertainty.

Is automated scour monitoring warranted?

Automated scour monitoring is considered warranted if the lifetime risk of death is greater than the cost of automated scour monitoring. The lifetime probability of failure for this bridge can be computed from the annual probability of failure and its tentative remaining life (30 years, according to the survey respondent) as follows: $1 - (1 - 0.00025)^{30}$, or about 0.0075 (a 1 in 133 chance of failure in the next 30 years). This and other survey data are now used to calculate the risk of death as follows:

$$R_{death} = K \cdot P_L \cdot C_6 \cdot X$$

$$= (1.0) \cdot (0.0075) \cdot (\$500,000 / person) \cdot (2 people) = \$7,473$$

Since the cost of automated scour monitoring was estimated to be \$25,000 and the risk of death is \$7,473, *automated scour monitoring is probably not warranted*.

Are scour countermeasures warranted?

Scour countermeasures are considered warranted if the lifetime risk of failure is greater than the estimated cost of scour countermeasures, which the survey respondent estimated to be about \$40,000. The first step in estimating the risk of failure is to estimate the potential cost of failure, assuming that it would need to be replaced. The survey respondent estimated that a new bridge would cost about \$127,000. The car and truck running cost associated with the detour for this bridge is computed from the survey data as follows:

$$\begin{aligned} C_{\text{running}} &= \left[C_2 \cdot \left(1 - \frac{T}{100} \right) + C_3 \cdot \frac{T}{100} \right] \cdot D \cdot A \cdot d \\ &= \left[\$0.45 / \text{mi} \cdot \left(1 - \frac{1}{100} \right) + \$1.30 / \text{mi} \cdot \frac{1}{100} \right] \cdot (9.94 \text{ mi}) \cdot (1700 / \text{day}) \cdot (365 \text{ days}) \\ &= \$2,827,923 \end{aligned}$$

The cost of lost wages is computed from the survey data as follows:

$$\begin{aligned} C_{\text{wages}} &= \left[C_4 \cdot O \cdot \left(1 - \frac{T}{100} \right) + C_5 \cdot \frac{T}{100} \right] \cdot \frac{D \cdot A \cdot d}{S} \\ &= \left[(\$6.45 / \text{per}) \cdot (1.63 \text{ per}) \cdot \left(1 - \frac{1}{100} \right) + (\$22.01 / \text{truck}) \cdot \frac{1}{100} \right] \cdot \frac{(9.94 \text{ mi}) \cdot (1700 / \text{day}) \cdot (365 \text{ days})}{40 \text{ mi} / \text{hr}} \\ &= \$1,638,848 \end{aligned}$$

When we include the cost of death, the total cost of bridge failure totals \$5,593,771. Computing the risk of a scour-induced failure over the remaining life of the bridge is just the product of the lifetime probability of failure and the total cost of failure – about \$41,802. *Thus, scour countermeasures are probably warranted* because the lifetime risk of failure is greater than the estimated cost of scour countermeasures.

Is foundation reconnaissance and scour analysis warranted?

The survey respondent estimated the foundation reconnaissance and scour analysis costs to be about \$2,500 and \$8,000, respectively. Since this is only about 26% of the estimated cost of installing countermeasures, *foundation reconnaissance and scour analysis are probably warranted before installing the countermeasures.*

Recommended management strategy

Given the results explained above, the guidelines recommend the following steps to ensure the safety of the bridge:

1. Perform field reconnaissance to determine foundation type and depth. If the foundation is a spread footing, you could drill through the footing to determine elevation of the footing bottom. The parallel seismic test is generally the most effective NDT method. Assume that the foundation information from the field evaluation is accurate. If field reconnaissance is unsuccessful (no access for testing, poor signal from NDT, etc.), assume a foundation depth using local knowledge. This should be a conservative assumption. Spread footing depths are easily discovered and an assumption should not be necessary for this type of foundation. In

other words, continue as if the foundation is known.

2. Evaluate scour using FHWA HEC-18 manual.
3. If scour analysis indicates that countermeasures are warranted, countermeasures should be designed using FHWA HEC-23 manual – or consider replacing or closing the bridge.

Bridge #6

The Initial Survey

Respondent Information

Name Denise Glasgow	E-mail Address Denise.glasgow@state.tn.us
Job Title Transportation Associate	Phone 615-532-2445
Job Description (In what way does your job involve bridge maintenance?) Maintenance records for bridge repair	Mailing Address 505 Deaderick Suite 1200, JK Polk Building Nashville, TN 37243-0338

Bridge Description

Please provide a general description of the bridge including its name, location, route, and water body.
Grundy County. Bells Mill Road over Caldwell Creek. 2 lane, single span, steel I-beam.

National Bridge Inventory (NBI) Data

Please provide the following information for the bridge. This information should be available in the NBI database. Please provide the NBI Database Values consistent with those required in the 2002 NBI Coding Guide, and specify the units (where appropriate).		
NBI Item No.	NBI Item Description	NBI Database Value
1	State Code	474
5	Inventory Route	2132
8	Structure Number	31021320001
19	Bypass, Detour Length (e.g. in miles)	6.83 mi
26	Functional Classification of Inventory Route	R/Min Col
27	Year Built	1940
29	Average Daily Traffic	220
49	Structure Length (e.g. in feet)	54.2 ft
52	Deck Width, Out-to-Out (e.g. in feet)	22.8 ft
60	Substructure	5
61	Channel and Channel Protection	5
71	Waterway Adequacy	6
109	Average Daily Truck Traffic	5
113	Scour Critical Bridges (2002 NBI Guidelines)	U

Undocumented Assumptions

Please provide the following information for the bridge which is not documented in the NBI database.	
Description	User Input
Bridge Type (check only one)	<input checked="" type="checkbox"/> Simple Span(s) <input type="checkbox"/> Continuous Span(s) over 100 ft.
Remaining life of bridge in years. If this bridge has already failed, report the actual lifetime of the bridge before it failed	5 years
Total Bridge Rebuilding Cost, if known. If unknown, estimate the cost by multiplying the bridge area by the cost per unit area as shown in Table 1 and the ADT cost multiplier as shown in Table 2. If estimated, provide the assumptions used in the spaces below: Bridge Area: _____ ft ² ; Cost per unit area: _____ \$/ft ² ; Cost Multiplier: _____	\$355,000.00

Economic Loss Data

Please provide the following economic factors to be associated with the failure of this bridge. Either check the box confirming that the default factor is to be used or provide a different value.		
Description	Default Value	User-Provided Value
Car running cost	\$0.45 per mile <input checked="" type="checkbox"/>	
Truck running cost	\$1.30 per mile <input checked="" type="checkbox"/>	
Duration of detour *	Use Table 2 (days) <input type="checkbox"/>	730
Value of time per adult *	Use Table 3 (\$/hr) <input type="checkbox"/>	6.45
Average car occupancy rate	1.63 people <input checked="" type="checkbox"/>	
Value of time for trucks	\$22.01 per hour <input type="checkbox"/>	
Average detour speed	40 miles per hour <input checked="" type="checkbox"/>	
Number of deaths from failure *	Use Table 2 (Number of people) <input type="checkbox"/>	1
Cost for each life lost	\$500,000 <input checked="" type="checkbox"/>	

* Please select an appropriate value from the reference table listed.

Cost of Analysis or Corrective Actions

Provide estimates for the following costs. Keep in mind that these costs may depend on a number of factors, e.g., the number of piers, abutments, etc. Also keep in mind that the guidelines include many significant broad assumptions, so significant effort is not warranted in estimating this data.	
Description	User Input
Estimated cost of installing automated scour monitoring	\$25,000.00
Estimated cost of installing scour countermeasures	\$40,000.00
Estimated cost of field reconnaissance to determine foundation type and depth (nondestructive testing, borings, etc.)	\$2,500.00
Estimated cost to evaluate scour (survey, hydrology, and hydraulics analysis, if unavailable)	\$8,000.00

Scour Management Evaluation

6. Bells Mill Road over Caldwell Creek

Bridge 31021320001 in Grundy County, TN has one span and two lanes with steel I-beams. Constructed in 1930, this bridge supports a rural minor collector class road but has an unknown foundation depth. It is further assumed that foundation records can not be found because NBI item 113 is coded “U”.

Is it a high-priority bridge?

This bridge supports a rural road, which is not a principal arterial, emergency route or provide direct access to other emergency services (e.g. hospital, fire stations, etc.). *Thus, in this context this bridge is not considered a high priority bridge.*

Does the bridge meet the minimum performance level?

The minimum performance level for a rural minor collector class bridge, according to the guidelines, is 0.001 – the threshold probability of failure that this bridge must outperform. To estimate this bridge’s annual probability of failure, it is first necessary to estimate the overtopping frequency and scour vulnerability of this bridge, as in the table below.

Data/Parameter (source)	Value	Interpretation
NBI item 26 (bridge survey)	8	Rural local classification
NBI item 71 (bridge survey)	6	Waterway exceeds the minimum criteria
∴ Overtopping Frequency (guidelines)	0	Occasional (once in 3-10 years)
NBI item 60 (bridge survey)	5	Foundation is in fair condition
NBI item 61 (bridge survey)	5	Channel banks are eroding; major damage
∴ Scour Vulnerability (guidelines)	5	Analysis: stable; Survey: scour is within limits
∴ Annual probability of failure (guidelines)	0.00004	A 1 in 25,000 chance of failure in any given year

This bridge meets the minimum performance level because the annual probability of failure is less than 0.001. However, because the foundation is unknown, we need to determine the most cost effective way to manage this uncertainty.

Is automated scour monitoring warranted?

Automated scour monitoring is considered warranted if the lifetime risk of death is greater than the cost of automated scour monitoring. The lifetime probability of failure for this bridge can be computed from the annual probability of failure and its tentative remaining life (5 years, according to the survey respondent) as follows: $1 - (1 - 0.00004)^5$, or about 0.0002 (a 1 in 5,000 chance of failure in the next 5 years). This and other survey data are now used to calculate the risk of death as follows:

$$R_{death} = K \cdot P_L \cdot C_6 \cdot X$$

$$= (1.0) \cdot (0.0002) \cdot (\$500,000 / person) \cdot (1 person) = \$100$$

Since the cost of automated scour monitoring was estimated to be \$25,000 and the risk of death is \$100, *automated scour monitoring is probably not warranted.*

Are scour countermeasures warranted?

Scour countermeasures are considered warranted if the lifetime risk of failure is greater than the estimated cost of scour countermeasures, which the survey respondent estimated to be about \$40,000. The first step in estimating the risk of failure is to estimate the potential cost of failure, assuming that it would need to be replaced. The survey respondent estimated that a new bridge would cost about \$355,000. The car and truck running cost associated with the detour for this bridge is computed from the survey data as follows:

$$\begin{aligned} C_{\text{running}} &= \left[C_2 \cdot \left(1 - \frac{T}{100} \right) + C_3 \cdot \frac{T}{100} \right] \cdot D \cdot A \cdot d \\ &= \left[\$0.45 / \text{mi} \cdot \left(1 - \frac{5}{100} \right) + \$1.30 / \text{mi} \cdot \frac{5}{100} \right] \cdot (6.83 \text{ mi}) \cdot (220 / \text{day}) \cdot (730 \text{ days}) \\ &= \$540,222 \end{aligned}$$

The cost of lost wages is computed from the survey data as follows:

$$\begin{aligned} C_{\text{wages}} &= \left[C_4 \cdot O \cdot \left(1 - \frac{T}{100} \right) + C_5 \cdot \frac{T}{100} \right] \cdot \frac{D \cdot A \cdot d}{S} \\ &= \left[(\$6.45 / \text{per}) \cdot (1.63 \text{ per}) \cdot \left(1 - \frac{5}{100} \right) + (\$22.01 / \text{truck}) \cdot \frac{5}{100} \right] \cdot \frac{(6.83 \text{ mi}) \cdot (220 / \text{day}) \cdot (730 \text{ days})}{40 \text{ mi} / \text{hr}} \\ &= \$304,069 \end{aligned}$$

When we include the cost of death, the total cost of bridge failure totals \$1,699,291. Computing the risk of a scour-induced failure over the remaining life of the bridge is just the product of the lifetime probability of failure and the total cost of failure – about \$340. *Thus, scour countermeasures are probably not warranted* because the lifetime risk of failure is less than the estimated cost of scour countermeasures.

Recommended management strategy

This bridge meets the performance standards for these guidelines and does not appear to warrant automated scour monitoring or countermeasures. However, because this bridge has an unknown foundation the guidelines strongly recommend that you follow the recommendations in the “Bridge Closure Plan” section of this report.

Furthermore, scour monitoring should be performed with every 2-yr routine bridge inspection for all bridges with unknown foundations. If the scour depth increases more than two feet from baseline conditions (as-built drawings or initial scour survey), action should be taken. The first action is to follow the “Bridge Closure Plan” to take any necessary immediate action. Countermeasures should then be considered for this site; or close or replace the bridge. This two foot trigger can be adjusted based on local geotechnical and engineering considerations and should represent the depth of scour that the bridge engineer feels comfortable with for the individual bridge.

Bridge #7

The Initial Survey

Respondent Information

Name Denise Glasgow	E-mail Address Denise.glasgow@state.tn.us
Job Title Transportation Associate	Phone 615-532-2445
Job Description (In what way does your job involve bridge maintenance?) Maintenance records for bridge repair	Mailing Address 505 Deaderick Suite 1200, JK Polk Building Nashville, TN 37243-0338

Bridge Description

Please provide a general description of the bridge including its name, location, route, and water body.
Marion County. Valley View Highway over Owen Spring Creek. 2 lane, 4 span concrete deck girder.

National Bridge Inventory (NBI) Data

Please provide the following information for the bridge. This information should be available in the NBI database. Please provide the NBI Database Values consistent with those required in the 2002 NBI Coding Guide, and specify the units (where appropriate).		
NBI Item No.	NBI Item Description	NBI Database Value
1	State Code	474
5	Inventory Route	1131
8	Structure Number	58SR0270007
19	Bypass, Detour Length (e.g. in miles)	8.07 mi
26	Functional Classification of Inventory Route	R/Min Col
27	Year Built	1939
29	Average Daily Traffic	2340
49	Structure Length (e.g. in feet)	113.10 ft
52	Deck Width, Out-to-Out (e.g. in feet)	36.5 ft
60	Substructure	6
61	Channel and Channel Protection	7
71	Waterway Adequacy	7
109	Average Daily Truck Traffic	26%
113	Scour Critical Bridges (2002 NBI Guidelines)	5

Undocumented Assumptions

Please provide the following information for the bridge which is not documented in the NBI database.	
Description	User Input
Bridge Type (check only one)	<input checked="" type="checkbox"/> Simple Span(s) <input type="checkbox"/> Continuous Span(s) over 100 ft.
Remaining life of bridge in years. If this bridge has already failed, report the actual lifetime of the bridge before it failed	10 years
Total Bridge Rebuilding Cost, if known. If unknown, estimate the cost by multiplying the bridge area by the cost per unit area as shown in Table 1 and the ADT cost multiplier as shown in Table 2. If estimated, provide the assumptions used in the spaces below: Bridge Area: _____ ft ² ; Cost per unit area: _____ \$/ft ² ; Cost Multiplier: _____	\$973,000.00

Economic Loss Data

Please provide the following economic factors to be associated with the failure of this bridge. Either check the box confirming that the default factor is to be used or provide a different value.		
Description	Default Value	User-Provided Value
Car running cost	\$0.45 per mile <input checked="" type="checkbox"/>	
Truck running cost	\$1.30 per mile <input checked="" type="checkbox"/>	
Duration of detour *	Use Table 2 (days) <input type="checkbox"/>	365
Value of time per adult *	Use Table 3 (\$/hr) <input type="checkbox"/>	6.45
Average car occupancy rate	1.63 people <input checked="" type="checkbox"/>	
Value of time for trucks	\$22.01 per hour <input checked="" type="checkbox"/>	
Average detour speed	40 miles per hour <input checked="" type="checkbox"/>	
Number of deaths from failure *	Use Table 2 (Number of people) <input type="checkbox"/>	2
Cost for each life lost	\$500,000 <input checked="" type="checkbox"/>	

* Please select an appropriate value from the reference table listed.

Cost of Analysis or Corrective Actions

Provide estimates for the following costs. Keep in mind that these costs may depend on a number of factors, e.g., the number of piers, abutments, etc. Also keep in mind that the guidelines include many significant broad assumptions, so significant effort is not warranted in estimating this data.	
Description	User Input
Estimated cost of installing automated scour monitoring	\$30,000
Estimated cost of installing scour countermeasures	\$80,000.00
Estimated cost of field reconnaissance to determine foundation type and depth (nondestructive testing, borings, etc.)	\$5,000.00
Estimated cost to evaluate scour (survey, hydrology, and hydraulics analysis, if unavailable)	\$8,000.00

Scour Management Evaluation

7. Valley View Highway over Owen Spring Creek

Bridge 58SR0270007 in Marion County, TN has four spans and two lanes with concrete deck girders. Constructed in 1939, this bridge supports a rural minor collector class road, and has a known foundation with an NBI item 113 rating of “5” (Analysis: stable; Survey: within limits). However, this bridge will be evaluated as if it were unknown.

Is it a high-priority bridge?

This bridge supports a rural road, which is not a principal arterial, emergency route or provide direct access to other emergency services (e.g. hospital, fire stations, etc.). *Thus, in this context this bridge is not considered a high priority bridge.*

Does the bridge meet the minimum performance level?

The minimum performance level for a rural minor collector class bridge, according to the guidelines, is 0.001 – the threshold probability of failure that this bridge must outperform. To estimate this bridge’s annual probability of failure, it is first necessary to estimate the overtopping frequency and scour vulnerability of this bridge, as in the table below.

Data/Parameter (source)	Value	Interpretation
NBI item 26 (bridge survey)	8	Rural local classification
NBI item 71 (bridge survey)	7	Waterway exceeds the minimum criteria
∴ Overtopping Frequency (guidelines)	S	Slight (once in 11-100 years)
NBI item 60 (bridge survey)	6	Foundation is in satisfactory condition
NBI item 61 (bridge survey)	7	Channel has some minor drift and damage
∴ Scour Vulnerability (guidelines)	6	Not yet evaluated, but probably stable
∴ Annual probability of failure (guidelines)	0.00025	A 1 in 4,000 chance of failure in any given year

This bridge meets the minimum performance level because the annual probability of failure is less than 0.001. However, because the foundation is unknown, we need to determine the most cost effective way to manage this uncertainty.

Is automated scour monitoring warranted?

Automated scour monitoring is considered warranted if the lifetime risk of death is greater than the cost of automated scour monitoring. The lifetime probability of failure for this bridge can be computed from the annual probability of failure and its tentative remaining life (10 years, according to the survey respondent) as follows: $1 - (1 - 0.00025)^{10}$, or about 0.0025 (a 1 in 400 chance of failure in the next 10 years). This and other survey data are now used to calculate the risk of death as follows:

$$R_{\text{death}} = K \cdot P_L \cdot C_6 \cdot X$$

$$= (1.0) \cdot (0.0025) \cdot (\$500,000 / \text{person}) \cdot (2 \text{ people}) = \$2,497$$

Since the cost of automated scour monitoring was estimated to be \$30,000 and the risk of death is \$2,497, *automated scour monitoring is probably not warranted.*

Are scour countermeasures warranted?

Scour countermeasures are considered warranted if the lifetime risk of failure is greater than the estimated cost of scour countermeasures, which the survey respondent estimated to be about \$80,000. The first step in estimating the risk of failure is to estimate the potential cost of failure, assuming that it would need to be replaced. The survey respondent estimated that a new bridge would cost about \$973,000. The car and truck running cost associated with the detour for this bridge is computed from the survey data as follows:

$$\begin{aligned} C_{\text{running}} &= \left[C_2 \cdot \left(1 - \frac{T}{100} \right) + C_3 \cdot \frac{T}{100} \right] \cdot D \cdot A \cdot d \\ &= \left[\$0.45 / \text{mi} \cdot \left(1 - \frac{26}{100} \right) + \$1.30 / \text{mi} \cdot \frac{26}{100} \right] \cdot (8.07 \text{ mi}) \cdot (2,340 / \text{day}) \cdot (365 \text{ days}) \\ &= \$4,624,926 \end{aligned}$$

The cost of lost wages is computed from the survey data as follows:

$$\begin{aligned} C_{\text{wages}} &= \left[C_4 \cdot O \cdot \left(1 - \frac{T}{100} \right) + C_5 \cdot \frac{T}{100} \right] \cdot \frac{D \cdot A \cdot d}{S} \\ &= \left[(\$6.45 / \text{per}) \cdot (1.63 \text{ per}) \cdot \left(1 - \frac{26}{100} \right) + (\$22.01 / \text{truck}) \cdot \frac{26}{100} \right] \cdot \frac{(8.07 \text{ mi}) \cdot (2,340 / \text{day}) \cdot (365 \text{ days})}{40 \text{ mi} / \text{hr}} \\ &= \$2,326,694 \end{aligned}$$

When we include the cost of death, the total cost of bridge failure totals \$8,924,620. Computing the risk of a scour-induced failure over the remaining life of the bridge is just the product of the lifetime probability of failure and the total cost of failure – about \$22,286. *Thus, scour countermeasures are probably not warranted* because the lifetime risk of failure is less than the estimated cost of scour countermeasures.

Recommended management strategy

This bridge has a known foundation, and thus does not require any additional action. However, if the foundation was unknown, the guidelines would have strongly recommended that you follow the recommendations in the “Bridge Closure Plan” section of this report.

Furthermore, scour monitoring should be performed with every 2-yr routine bridge inspection for all bridges with unknown foundations. If the scour depth increases more than two feet from baseline conditions (as-built drawings or initial scour survey), action should be taken. The first action is to follow the “Bridge Closure Plan” to take any necessary immediate action. Countermeasures should then be considered for this site; or close or replace the bridge. This two foot trigger can be adjusted based on local geotechnical and engineering considerations and should represent the depth of scour that the bridge engineer feels comfortable with for the individual bridge.

Bridge #8

The Initial Survey

Respondent Information

Name Denise Glasgow	E-mail Address Denise.glasgow@state.tn.us
Job Title Transportation Associate	Phone 615-532-2445
Job Description (In what way does your job involve bridge maintenance?) Maintenance records for bridge repair	Mailing Address 505 Deaderick Suite 1200, JK Polk Building Nashville, TN 37243-0338

Bridge Description

Please provide a general description of the bridge including its name, location, route, and water body.
Cumberland City. State Rt. 233 over Wells Creek. 2 lane, 6 span prestressed precast concrete box beams.

National Bridge Inventory (NBI) Data

Please provide the following information for the bridge. This information should be available in the NBI database. Please provide the NBI Database Values consistent with those required in the 2002 NBI Coding Guide, and specify the units (where appropriate).		
NBI Item No.	NBI Item Description	NBI Database Value
1	State Code	474
5	Inventory Route	SR233
8	Structure Number	81561140007
19	Bypass, Detour Length (e.g. in miles)	4.97 mi
26	Functional Classification of Inventory Route	R/Maj Col
27	Year Built	1961
29	Average Daily Traffic	2950
49	Structure Length (e.g. in feet)	202.1 ft
52	Deck Width, Out-to-Out (e.g. in feet)	34.5 ft
60	Substructure	6
61	Channel and Channel Protection	7
71	Waterway Adequacy	6
109	Average Daily Truck Traffic	4%
113	Scour Critical Bridges (2002 NBI Guidelines)	5

Undocumented Assumptions

Please provide the following information for the bridge which is not documented in the NBI database.	
Description	User Input
Bridge Type (check only one)	<input checked="" type="checkbox"/> Simple Span(s) <input type="checkbox"/> Continuous Span(s) over 100 ft.
Remaining life of bridge in years. If this bridge has already failed, report the actual lifetime of the bridge before it failed	30 years
Total Bridge Rebuilding Cost, if known. If unknown, estimate the cost by multiplying the bridge area by the cost per unit area as shown in Table 1 and the ADT cost multiplier as shown in Table 2. If estimated, provide the assumptions used in the spaces below: Bridge Area: _____ ft ² ; Cost per unit area: _____ \$/ft ² ; Cost Multiplier: _____	\$172,000.00

Economic Loss Data

Please provide the following economic factors to be associated with the failure of this bridge. Either check the box confirming that the default factor is to be used or provide a different value.		
Description	Default Value	User-Provided Value
Car running cost	\$0.45 per mile <input checked="" type="checkbox"/>	
Truck running cost	\$1.30 per mile <input checked="" type="checkbox"/>	
Duration of detour *	Use Table 2 (days) <input type="checkbox"/>	365
Value of time per adult *	Use Table 3 (\$/hr) <input type="checkbox"/>	6.45
Average car occupancy rate	1.63 people <input type="checkbox"/>	
Value of time for trucks	\$22.01 per hour <input checked="" type="checkbox"/>	
Average detour speed	40 miles per hour <input checked="" type="checkbox"/>	
Number of deaths from failure *	Use Table 2 (Number of people) <input type="checkbox"/>	2
Cost for each life lost	\$500,000 <input checked="" type="checkbox"/>	

* Please select an appropriate value from the reference table listed.

Cost of Analysis or Corrective Actions

Provide estimates for the following costs. Keep in mind that these costs may depend on a number of factors, e.g., the number of piers, abutments, etc. Also keep in mind that the guidelines include many significant broad assumptions, so significant effort is not warranted in estimating this data.	
Description	User Input
Estimated cost of installing automated scour monitoring	\$30,000.00
Estimated cost of installing scour countermeasures	\$80,000.00
Estimated cost of field reconnaissance to determine foundation type and depth (nondestructive testing, borings, etc.)	\$5,000.00
Estimated cost to evaluate scour (survey, hydrology, and hydraulics analysis, if unavailable)	\$8,000.00

Scour Management Evaluation

8. State Route 233 over Wells Creek

Bridge 81S61140007 in Stewart County, TN has six spans and two lanes with pre-stressed pre-cast concrete box beams. Constructed in 1961, this bridge supports a rural major collector class roadway, and has a known foundation with an NBI item 113 rating of “5” (Analysis: stable; Survey: within limits). However, this bridge will be evaluated as if it were unknown.

Is it a high-priority bridge?

This bridge supports a rural road, which is not a principal arterial, emergency route or provide direct access to other emergency services (e.g. hospital, fire stations, etc.). *Thus, in this context this bridge is not considered a high priority bridge.*

Does the bridge meet the minimum performance level?

The minimum performance level for a rural major collector class bridge, according to the guidelines, is 0.0005 – the threshold probability of failure that this bridge must outperform. To estimate this bridge’s annual probability of failure, it is first necessary to estimate the overtopping frequency and scour vulnerability of this bridge, as in the table below.

Data/Parameter (source)	Value	Interpretation
NBI item 26 (bridge survey)	7	Rural major collector classification
NBI item 71 (bridge survey)	4	Waterway meets the minimum limits for no action
∴ Overtopping Frequency (guidelines)	S	Slight (once in 11-100 years)
NBI item 60 (bridge survey)	6	Foundation is in satisfactory condition
NBI item 61 (bridge survey)	7	Channel has some minor drift and damage
∴ Scour Vulnerability (guidelines)	6	Not yet evaluated, but probably stable
∴ Annual probability of failure (guidelines)	0.00025	A 1 in 4,000 chance of failure in any given year

This bridge meets the minimum performance level because the annual probability of failure is less than 0.0005. However, because the foundation is unknown, we need to determine the most cost effective way to manage this uncertainty.

Is automated scour monitoring warranted?

Automated scour monitoring is considered warranted if the lifetime risk of death is greater than the cost of automated scour monitoring. The lifetime probability of failure for this bridge can be computed from the annual probability of failure and its tentative remaining life (30 years, according to the survey respondent) as follows: $1 - (1 - 0.00025)^{30}$, or about 0.0075 (a 1 in 133 chance of failure in the next 30 years). This and other survey data are now used to calculate the risk of death as follows:

$$R_{death} = K \cdot P_L \cdot C_6 \cdot X$$

$$= (1.0) \cdot (0.0075) \cdot (\$500,000 / person) \cdot (2 people) = \$7,473$$

Since the cost of automated scour monitoring was estimated to be \$30,000 and the risk of death is \$7,473, *automated scour monitoring is probably not warranted.*

Are scour countermeasures warranted?

Scour countermeasures are considered warranted if the lifetime risk of failure is greater than the estimated cost of scour countermeasures, which the survey respondent estimated to be about \$80,000. The first step in estimating the risk of failure is to estimate the potential cost of failure, assuming that it would need to be replaced. The survey respondent estimated that a new bridge would cost about \$172,000. The car and truck running cost associated with the detour for this bridge is computed from the survey data as follows:

$$\begin{aligned} C_{\text{running}} &= \left[C_2 \cdot \left(1 - \frac{T}{100} \right) + C_3 \cdot \frac{T}{100} \right] \cdot D \cdot A \cdot d \\ &= \left[\$0.45 / \text{mi} \cdot \left(1 - \frac{4}{100} \right) + \$1.30 / \text{mi} \cdot \frac{4}{100} \right] \cdot (4.97 \text{ mi}) \cdot (2,950 / \text{day}) \cdot (365 \text{ days}) \\ &= \$2,590,101 \end{aligned}$$

The cost of lost wages is computed from the survey data as follows:

$$\begin{aligned} C_{\text{wages}} &= \left[C_4 \cdot O \cdot \left(1 - \frac{T}{100} \right) + C_5 \cdot \frac{T}{100} \right] \cdot \frac{D \cdot A \cdot d}{S} \\ &= \left[(\$6.45 / \text{per}) \cdot (1.63 \text{ per}) \cdot \left(1 - \frac{4}{100} \right) + (\$22.01 / \text{truck}) \cdot \frac{4}{100} \right] \cdot \frac{(4.97 \text{ mi}) \cdot (2,950 / \text{day}) \cdot (365 \text{ days})}{40 \text{ mi} / \text{hr}} \\ &= \$1,468,084 \end{aligned}$$

When we include the cost of death, the total cost of bridge failure totals \$5,230,185. Computing the risk of a scour-induced failure over the remaining life of the bridge is just the product of the lifetime probability of failure and the total cost of failure – about \$39,085. *Thus, scour countermeasures are probably not warranted* because the lifetime risk of failure is less than the estimated cost of scour countermeasures.

Recommended management strategy

This bridge has a known foundation, and thus does not require any additional action. However, if the foundation was unknown, the guidelines would have strongly recommended that you follow the recommendations in the “Bridge Closure Plan” section of this report.

Furthermore, scour monitoring should be performed with every 2-yr routine bridge inspection for all bridges with unknown foundations. If the scour depth increases more than two feet from baseline conditions (as-built drawings or initial scour survey), action should be taken. The first action is to follow the “Bridge Closure Plan” to take any necessary immediate action. Countermeasures should then be considered for this site; or close or replace the bridge. This two foot trigger can be adjusted based on local geotechnical and engineering considerations and should represent the depth of scour that the bridge engineer feels comfortable with for the individual bridge.

Bridge #9

The Initial Survey

Respondent Information

Name Denise Glasgow	E-mail Address Denise.glasgow@state.tn.us
Job Title Transportation Associate	Phone 615-532-2445
Job Description (In what way does your job involve bridge maintenance?) Maintenance records for bridge repair	Mailing Address 505 Deaderick Suite 1200, JK Polk Building Nashville, TN 37243-0338

Bridge Description

Please provide a general description of the bridge including its name, location, route, and water body.
Warren County, Old Shelbyville Road over Oakland Branch. 2 lane, single span, steel I-beam bridge.

National Bridge Inventory (NBI) Data

Please provide the following information for the bridge. This information should be available in the NBI database. Please provide the NBI Database Values consistent with those required in the 2002 NBI Coding Guide, and specify the units (where appropriate).		
NBI Item No.	NBI Item Description	NBI Database Value
1	State Code	474
5	Inventory Route	1114
8	Structure Number	89542900017
19	Bypass, Detour Length (e.g. in miles)	4.97 mi
26	Functional Classification of Inventory Route	R/Min Col
27	Year Built	1930
29	Average Daily Traffic	670
49	Structure Length (e.g. in feet)	29.10 ft
52	Deck Width, Out-to-Out (e.g. in feet)	21.0 ft
60	Substructure	5
61	Channel and Channel Protection	5
71	Waterway Adequacy	6
109	Average Daily Truck Traffic	10%
113	Scour Critical Bridges (2002 NBI Guidelines)	3

Undocumented Assumptions

Please provide the following information for the bridge which is not documented in the NBI database.	
Description	User Input
Bridge Type (check only one)	<input checked="" type="checkbox"/> Simple Span(s) <input type="checkbox"/> Continuous Span(s) over 100 ft.
Remaining life of bridge in years. If this bridge has already failed, report the actual lifetime of the bridge before it failed	5 years
Total Bridge Rebuilding Cost, if known. If unknown, estimate the cost by multiplying the bridge area by the cost per unit area as shown in Table 1 and the ADT cost multiplier as shown in Table 2. If estimated, provide the assumptions used in the spaces below: Bridge Area: _____ ft ² ; Cost per unit area: _____ \$/ft ² ; Cost Multiplier: _____	\$253,000.00

Economic Loss Data

Please provide the following economic factors to be associated with the failure of this bridge. Either check the box confirming that the default factor is to be used or provide a different value.		
Description	Default Value	User-Provided Value
Car running cost	\$0.45 per mile <input checked="" type="checkbox"/>	
Truck running cost	\$1.30 per mile <input checked="" type="checkbox"/>	
Duration of detour *	Use Table 2 (days) <input type="checkbox"/>	548
Value of time per adult *	Use Table 3 (\$/hr) <input type="checkbox"/>	6.45
Average car occupancy rate	1.63 people <input checked="" type="checkbox"/>	
Value of time for trucks	\$22.01 per hour <input checked="" type="checkbox"/>	
Average detour speed	40 miles per hour <input checked="" type="checkbox"/>	
Number of deaths from failure *	Use Table 2 (Number of people) <input type="checkbox"/>	2
Cost for each life lost	\$500,000 <input checked="" type="checkbox"/>	

* Please select an appropriate value from the reference table listed.

Cost of Analysis or Corrective Actions

Provide estimates for the following costs. Keep in mind that these costs may depend on a number of factors, e.g., the number of piers, abutments, etc. Also keep in mind that the guidelines include many significant broad assumptions, so significant effort is not warranted in estimating this data.	
Description	User Input
Estimated cost of installing automated scour monitoring	\$30,000.00
Estimated cost of installing scour countermeasures	\$40,000.00
Estimated cost of field reconnaissance to determine foundation type and depth (nondestructive testing, borings, etc.)	\$2,500.00
Estimated cost to evaluate scour (survey, hydrology, and hydraulics analysis, if unavailable)	\$8,000.00

Scour Management Evaluation

9. Old Shelbyville Road over Oakland Branch

Bridge 89S42900017 in Warren County, TN has one span and two lanes with steel I-beams. Constructed in 1930, this bridge supports a rural minor collector class roadway, and has a known foundation with an NBI item 113 rating of “3” (Scour critical and unstable). However, this bridge will be evaluated as if it were unknown.

Is it a high-priority bridge?

This bridge supports a rural road, which is not a principal arterial, emergency route or provide direct access to other emergency services (e.g. hospital, fire stations, etc.). *Thus, in this context this bridge is not considered a high priority bridge.*

Does the bridge meet the minimum performance level?

The minimum performance level for a rural major collector class bridge, according to the guidelines, is 0.001 – the threshold probability of failure that this bridge must outperform. To estimate this bridge’s annual probability of failure, it is first necessary to estimate the overtopping frequency and scour vulnerability of this bridge, as in the table below.

Data/Parameter (source)	Value	Interpretation
NBI item 26 (bridge survey)	8	Rural minor collector classification
NBI item 71 (bridge survey)	6	Waterway is equal to the minimum criteria
∴ Overtopping Frequency (guidelines)	0	Occasional (once in 3-10 years)
NBI item 60 (bridge survey)	5	Foundation is in fair condition
NBI item 61 (bridge survey)	5	Channel banks are eroding; major damage
∴ Scour Vulnerability (guidelines)	5	Analysis: stable; Survey: scour is within limits
∴ Annual probability of failure (guidelines)	0.00004	A 1 in 25,000 chance of failure in any given year

This bridge meets the minimum performance level because the annual probability of failure is less than 0.001. However, because the foundation has been assumed to be unknown, we need to determine the most cost effective way to manage this uncertainty.

Is automated scour monitoring warranted?

Automated scour monitoring is considered warranted if the lifetime risk of death is greater than the cost of automated scour monitoring. The lifetime probability of failure for this bridge can be computed from the annual probability of failure and its tentative remaining life (5 years, according to the survey respondent) as follows: $1 - (1 - 0.00004)^5$, or about 0.0002 (a 1 in 5,000 chance of failure in the next 5 years). This and other survey data are now used to calculate the risk of death as follows:

$$R_{\text{death}} = K \cdot P_L \cdot C_6 \cdot X$$

$$= (1.0) \cdot (0.0002) \cdot (\$500,000 / \text{person}) \cdot (2 \text{ people}) = \$200$$

Since the cost of automated scour monitoring was estimated to be \$30,000 and the risk of death is \$200, *automated scour monitoring is probably not warranted.*

Are scour countermeasures warranted?

Scour countermeasures are considered warranted if the lifetime risk of failure is greater than the estimated cost of scour countermeasures, which the survey respondent estimated to be about \$40,000. The first step in estimating the risk of failure is to estimate the potential cost of failure, assuming that it would need to be replaced. The survey respondent estimated that a new bridge would cost about \$253,000. The car and truck running cost associated with the detour for this bridge is computed from the survey data as follows:

$$\begin{aligned} C_{\text{running}} &= \left[C_2 \cdot \left(1 - \frac{T}{100} \right) + C_3 \cdot \frac{T}{100} \right] \cdot D \cdot A \cdot d \\ &= \left[\$0.45 / \text{mi} \cdot \left(1 - \frac{10}{100} \right) + \$1.30 / \text{mi} \cdot \frac{10}{100} \right] \cdot (4.97 \text{ mi}) \cdot (670 / \text{day}) \cdot (548 \text{ days}) \\ &= \$976,260 \end{aligned}$$

The cost of lost wages is computed from the survey data as follows:

$$\begin{aligned} C_{\text{wages}} &= \left[C_4 \cdot O \cdot \left(1 - \frac{T}{100} \right) + C_5 \cdot \frac{T}{100} \right] \cdot \frac{D \cdot A \cdot d}{S} \\ &= \left[(\$6.45 / \text{per}) \cdot (1.63 \text{ per}) \cdot \left(1 - \frac{10}{100} \right) + (\$22.01 / \text{truck}) \cdot \frac{10}{100} \right] \cdot \frac{(4.97 \text{ mi}) \cdot (670 / \text{day}) \cdot (548 \text{ days})}{40 \text{ mi} / \text{hr}} \\ &= \$532,069 \end{aligned}$$

When we include the cost of death, the total cost of bridge failure totals \$2,761,329. Computing the risk of a scour-induced failure over the remaining life of the bridge is just the product of the lifetime probability of failure and the total cost of failure – about \$552. *Thus, scour countermeasures are probably not warranted* because the lifetime risk of failure is less than the estimated cost of scour countermeasures.

Recommended management strategy

This bridge has a known foundation, and requires action. However, if the foundation was unknown, the guidelines would have strongly recommended that you follow the recommendations in the “Bridge Closure Plan” section of this report.

Furthermore, scour monitoring should be performed with every 2-yr routine bridge inspection for all bridges with unknown foundations. If the scour depth increases more than two feet from baseline conditions (as-built drawings or initial scour survey), action should be taken. The first action is to follow the “Bridge Closure Plan” to take any necessary immediate action. Countermeasures should then be considered for this site; or close or replace the bridge. This two foot trigger can be adjusted based on local geotechnical and engineering considerations and should represent the depth of scour that the bridge engineer feels comfortable with for the individual bridge.

Bridge #10

The Initial Survey

Respondent Information

Name Denise Glasgow	E-mail Address Denise.glasgow@state.tn.us
Job Title Transportation Associate	Phone 615-532-2445
Job Description (In what way does your job involve bridge maintenance?) Maintenance records for bridge repair	Mailing Address 505 Deaderick Suite 1200, JK Polk Building Nashville, TN 37243-0338

Bridge Description

Please provide a general description of the bridge including its name, location, route, and water body.
Sevier County, Railroad Street over Middle Creek. 2 lane, 2 span, steel I-beam.

National Bridge Inventory (NBI) Data

Please provide the following information for the bridge. This information should be available in the NBI database. Please provide the NBI Database Values consistent with those required in the 2002 NBI Coding Guide, and specify the units (where appropriate).		
NBI Item No.	NBI Item Description	NBI Database Value
1	State Code	474
5	Inventory Route	B072
8	Structure Number	780B0720001
19	Bypass, Detour Length (e.g. in miles)	1.86 mi
26	Functional Classification of Inventory Route	U/Local
27	Year Built	1940
29	Average Daily Traffic	960
49	Structure Length (e.g. in feet)	48.11 ft
52	Deck Width, Out-to-Out (e.g. in feet)	25.7 ft
60	Substructure	5
61	Channel and Channel Protection	6
71	Waterway Adequacy	7
109	Average Daily Truck Traffic	2%
113	Scour Critical Bridges (2002 NBI Guidelines)	U

Undocumented Assumptions

Please provide the following information for the bridge which is not documented in the NBI database.	
Description	User Input
Bridge Type (check only one)	<input checked="" type="checkbox"/> Simple Span(s) <input type="checkbox"/> Continuous Span(s) over 100 ft.
Remaining life of bridge in years. If this bridge has already failed, report the actual lifetime of the bridge before it failed	10 years
Total Bridge Rebuilding Cost, if known. If unknown, estimate the cost by multiplying the bridge area by the cost per unit area as shown in Table 1 and the ADT cost multiplier as shown in Table 2. If estimated, provide the assumptions used in the spaces below: Bridge Area: _____ ft ² ; Cost per unit area: _____ \$/ft ² ; Cost Multiplier: _____	\$373,000.00

Economic Loss Data

Please provide the following economic factors to be associated with the failure of this bridge. Either check the box confirming that the default factor is to be used or provide a different value.		
Description	Default Value	User-Provided Value
Car running cost	\$0.45 per mile <input checked="" type="checkbox"/>	
Truck running cost	\$1.30 per mile <input checked="" type="checkbox"/>	
Duration of detour *	Use Table 2 (days) <input checked="" type="checkbox"/>	548
Value of time per adult *	Use Table 3 (\$/hr) <input type="checkbox"/>	6.45
Average car occupancy rate	1.63 people <input checked="" type="checkbox"/>	
Value of time for trucks	\$22.01 per hour <input checked="" type="checkbox"/>	
Average detour speed	40 miles per hour <input checked="" type="checkbox"/>	
Number of deaths from failure *	Use Table 2 (Number of people) <input type="checkbox"/>	2
Cost for each life lost	\$500,000 <input checked="" type="checkbox"/>	

* Please select an appropriate value from the reference table listed.

Cost of Analysis or Corrective Actions

Provide estimates for the following costs. Keep in mind that these costs may depend on a number of factors, e.g., the number of piers, abutments, etc. Also keep in mind that the guidelines include many significant broad assumptions, so significant effort is not warranted in estimating this data.	
Description	User Input
Estimated cost of installing automated scour monitoring	\$30,000.00
Estimated cost of installing scour countermeasures	\$50,000.00
Estimated cost of field reconnaissance to determine foundation type and depth (nondestructive testing, borings, etc.)	\$2,500.00
Estimated cost to evaluate scour (survey, hydrology, and hydraulics analysis, if unavailable)	\$8,000.00

Scour Management Evaluation

10. Railroad Street over Middle Creek

Bridge 780B0720001 in Sevier County, TN has two spans and two lanes with steel I-beams. Constructed in 1940, this bridge supports an urban-local class road but has an unknown foundation depth. It is further assumed that foundation records can not be found because NBI item 113 is coded “U”.

Is it a high-priority bridge?

This bridge supports an urban road, which is not a principal arterial, emergency route or provide direct access to other emergency services (e.g. hospital, fire stations, etc.). Thus, in this context this bridge is not considered a high priority bridge.

Does the bridge meet the minimum performance level?

The minimum performance level for an urban-local class bridge, according to the guidelines, is 0.002 – the threshold probability of failure that this bridge must outperform. To estimate this bridge’s annual probability of failure, it is first necessary to estimate the overtopping frequency and scour vulnerability of this bridge, as in the table below.

Data/Parameter (source)	Value	Interpretation
NBI item 26 (bridge survey)	19	Rural local classification
NBI item 71 (bridge survey)	7	Waterway exceeds the minimum criteria
∴ Overtopping Frequency (guidelines)	S	Slight (once in 11-100 years)
NBI item 60 (bridge survey)	5	Foundation is in fair condition
NBI item 61 (bridge survey)	6	Channel has widespread minor damage
∴ Scour Vulnerability (guidelines)	5	Analysis: stable; Survey: scour is within limits
∴ Annual probability of failure (guidelines)	0.000008	A 1 in 125,000 chance of failure in any given year

This bridge meets the minimum performance level because the annual probability of failure is less than 0.002. However, because the foundation is unknown, we need to determine the most cost effective way to manage this uncertainty.

Is automated scour monitoring warranted?

Automated scour monitoring is considered warranted if the lifetime risk of death is greater than the cost of automated scour monitoring. The lifetime probability of failure for this bridge can be computed from the annual probability of failure and its tentative remaining life (10 years, according to the survey respondent) as follows: $1 - (1 - 0.000008)^{10}$, or about 0.00008 (a 1 in 12,500 chance of failure in the next 10 years). This and other survey data are now used to calculate the risk of death as follows:

$$R_{death} = K \cdot P_L \cdot C_6 \cdot X$$

$$= (1.0) \cdot (0.00008) \cdot (\$500,000 / person) \cdot (2 people) = \$80$$

Since the cost of automated scour monitoring was estimated to be \$30,000 and the risk of death is \$80, *automated scour monitoring is probably not warranted*.

Are scour countermeasures warranted?

Scour countermeasures are considered warranted if the lifetime risk of failure is greater than the estimated cost of scour countermeasures, which the survey respondent estimated to be about \$50,000. The first step in estimating the risk of failure is to estimate the potential cost of failure, assuming that it would need to be replaced. The survey respondent estimated that a new bridge would cost about \$373,000. The car and truck running cost associated with the detour for this bridge is computed from the survey data as follows:

$$\begin{aligned} C_{\text{running}} &= \left[C_2 \cdot \left(1 - \frac{T}{100} \right) + C_3 \cdot \frac{T}{100} \right] \cdot D \cdot A \cdot d \\ &= \left[\$0.45 / \text{mi} \cdot \left(1 - \frac{2}{100} \right) + \$1.30 / \text{mi} \cdot \frac{2}{100} \right] \cdot (1.86 \text{ mi}) \cdot (960 / \text{day}) \cdot (548 \text{ days}) \\ &= \$456,964 \end{aligned}$$

The cost of lost wages is computed from the survey data as follows:

$$\begin{aligned} C_{\text{wages}} &= \left[C_4 \cdot O \cdot \left(1 - \frac{T}{100} \right) + C_5 \cdot \frac{T}{100} \right] \cdot \frac{D \cdot A \cdot d}{S} \\ &= \left[(\$6.45 / \text{per}) \cdot (1.63 \text{ per}) \cdot \left(1 - \frac{2}{100} \right) + (\$22.01 / \text{truck}) \cdot \frac{2}{100} \right] \cdot \frac{(1.86 \text{ mi}) \cdot (960 / \text{day}) \cdot (548 \text{ days})}{40 \text{ mi} / \text{hr}} \\ &= \$262,814 \end{aligned}$$

When we include the cost of death, the total cost of bridge failure totals \$2,092,777. Computing the risk of a scour-induced failure over the remaining life of the bridge is just the product of the lifetime probability of failure and the total cost of failure – about \$167. *Thus, scour countermeasures are probably not warranted* because the lifetime risk of failure is less than the estimated cost of scour countermeasures.

Recommended management strategy

This bridge meets the performance standards for these guidelines and does not appear to warrant automated scour monitoring or countermeasures. However, because this bridge has an unknown foundation the guidelines strongly recommend that you follow the recommendations in the “Bridge Closure Plan” section of this report.

Furthermore, scour monitoring should be performed with every 2-yr routine bridge inspection for all bridges with unknown foundations. If the scour depth increases more than two feet from baseline conditions (as-built drawings or initial scour survey), action should be taken. The first action is to follow the “Bridge Closure Plan” to take any necessary immediate action. Countermeasures should then be considered for this site; or close or replace the bridge. This two foot trigger can be adjusted based on local geotechnical and engineering considerations and should represent the depth of scour that the bridge engineer feels comfortable with for the individual bridge.

Response to Evaluations

Wayne Seger, a Civil engineering manager II, was not able to finish his response to the bridge evaluations. However, the following is his preliminary comments.

I've read through your assessments of the bridge information sent and find it interesting and somewhat thinking of voodoo magic. I didn't really follow, in this first read through, where all of the numbers originated but I'll comb back through it to see if I can make better sense of logic. If you don't mind, I'll share this with my boss for his opinion and thoughts. I think he'll have it done fairly quickly. I'll let you know what he says about it. The overall approach, in my preliminary opinion, is that it has a good thought path and guide. I just want to digest it a bit before passing final judgment.

Texas Bridges*Bridge #1***The Initial Survey**

Respondent Information

Name Alan Kowalik	E-mail Address akowali@dot.state.tx.us
Job Title Bridge Inspection Supervisor	Phone 512-416-2208
Job Description (In what way does your job involve bridge maintenance?) Supervise the bridge inspection program and the NBI Database	Mailing Address 125 East 11 th Street Austin, TX 78701

Bridge Description

Please provide a general description of the bridge including its name, location, route, and water body.
FM 56 over Bosque River – 16-span bridge with continuous steel I-beams. Maximum span length is 75 ft on a concrete spread footing.

National Bridge Inventory (NBI) Data

Please provide the following information for the bridge. This information should be available in the NBI database. Please provide the NBI Database Values consistent with those required in the 2002 NBI Coding Guide, and specify the units (where appropriate).		
NBI Item No.	NBI Item Description	NBI Database Value
1	State Code	486
5	Inventory Route	1-15-1-0056-0
8	Structure Number	090180039801026
19	Bypass, Detour Length (e.g. in miles)	20
26	Functional Classification of Inventory Route	07
27	Year Built	1950
29	Average Daily Traffic	2300
49	Structure Length (e.g. in feet)	535
52	Deck Width, Out-to-Out (e.g. in feet)	29.2
60	Substructure	4
61	Channel and Channel Protection	4
71	Waterway Adequacy	6
109	Average Daily Truck Traffic	13
113	Scour Critical Bridges (2002 NBI Guidelines)	3

Undocumented Assumptions

Please provide the following information for the bridge which is not documented in the NBI database.	
Description	User Input
Bridge Type (check only one)	<input checked="" type="checkbox"/> Simple Span(s) <input type="checkbox"/> Continuous Span(s) over 100 ft.
Remaining life of bridge in years. If this bridge has already failed, report the actual lifetime of the bridge before it failed	20 years
Total Bridge Rebuilding Cost, if known. If unknown, estimate the cost by multiplying the bridge area by the cost per unit area as shown in Table 1 and the ADT cost multiplier as shown in Table 2. If estimated, provide the assumptions used in the spaces below: Bridge Area: 15,622 ft ² ; Cost per unit area: 46 \$/ft ² ; Cost Multiplier: 1.5	\$1,077,918.00

Economic Loss Data

Please provide the following economic factors to be associated with the failure of this bridge. Either check the box confirming that the default factor is to be used or provide a different value.		
Description	Default Value	User-Provided Value
Car running cost	\$0.45 per mile <input checked="" type="checkbox"/>	
Truck running cost	\$1.30 per mile <input checked="" type="checkbox"/>	
Duration of detour *	Use Table 2 (days) <input checked="" type="checkbox"/>	365
Value of time per adult *	Use Table 3 (\$/hr) <input checked="" type="checkbox"/>	\$6.96
Average car occupancy rate	1.63 people <input checked="" type="checkbox"/>	
Value of time for trucks	\$22.01 per hour <input checked="" type="checkbox"/>	
Average detour speed	40 miles per hour <input checked="" type="checkbox"/>	
Number of deaths from failure *	Use Table 2 (Number of people) <input checked="" type="checkbox"/>	2
Cost for each life lost	\$500,000 <input checked="" type="checkbox"/>	

* Please select an appropriate value from the reference table listed.

Cost of Analysis or Corrective Actions

Provide estimates for the following costs. Keep in mind that these costs may depend on a number of factors, e.g., the number of piers, abutments, etc. Also keep in mind that the guidelines include many significant broad assumptions, so significant effort is not warranted in estimating this data.	
Description	User Input
Estimated cost of installing automated scour monitoring	\$ No information
Estimated cost of installing scour countermeasures	\$ No information
Estimated cost of field reconnaissance to determine foundation type and depth (nondestructive testing, borings, etc.)	\$ N/A – depth known
Estimated cost to evaluate scour (survey, hydrology, and hydraulics analysis, if unavailable)	\$5,000.00

Scour Management Evaluation

1. FM 56 over Bosque River

Bridge 090180039801026 in Bosque County, TX was constructed in 1950 and supports a rural major collector class road. This bridge's foundation is known with an NBI item 113 rating of "3" (scour critical and unstable). However, this bridge will be evaluated as if it had an unknown foundation to test the guidelines.

Is it a high-priority bridge?

This bridge supports a rural road, which is not a principal arterial, emergency evacuation route, and does not provide direct access to other emergency services (e.g. hospital, fire stations, etc.). *Thus, in this context this bridge is not considered a high priority bridge.*

Does the bridge meet the minimum performance level?

The minimum performance level for a rural minor arterial class bridge, according to the guidelines, is 0.0005 – the threshold probability of failure that this bridge must outperform. To estimate this bridge's annual probability of failure, it is first necessary to estimate the overtopping frequency and scour vulnerability of this bridge, as in the table below.

Data/Parameter (source)	Value	Interpretation
NBI item 26 (bridge survey)	7	Rural major collector classification
NBI item 71 (bridge survey)	6	Waterway meets the minimum criteria
∴ Overtopping Frequency (guidelines)	S	Slight (once in 11-100 years)
NBI item 60 (bridge survey)	4	Foundation is in poor condition
NBI item 61 (bridge survey)	4	Channel protection/banks have severe damage
∴ Scour Vulnerability (guidelines)	4	Analysis: stable; Survey: foundation is exposed
∴ Annual probability of failure (guidelines)	0.0005	A 1 in 2,000 chance of failure in any given year

This bridge does not meet the minimum performance level because the annual probability of failure is not less than 0.0005.

Recommended management strategy

This bridge has a known foundation, and requires action. Furthermore, this bridge does not meet the minimum performance level for bridges with unknown foundations. Thus, if this bridge had an unknown foundation the guidelines would have recommended the following three-step strategy to ensure the safety of this bridge.

1. Perform field reconnaissance to determine foundation type and depth. If the foundation is a spread footing, drill through the footing to determine elevation of the footing bottom. If the foundation is piles, use foundation reconnaissance to determine depth of piles. The parallel seismic test is generally the most effective reconnaissance method. Assume that the foundation information from the field evaluation is accurate. If field reconnaissance is unsuccessful (no access for testing, poor signal from NDT, etc.), assume a foundation depth. For piles, assume a 10 foot depth or use local knowledge. This should be a conservative assumption. Spread footing depths are easily discovered and an assumption should not be

- necessary for this type of foundation. In other words, continue as if the foundation is known.
2. Evaluate scour using FHWA HEC-18 manual.
 3. If scour analysis indicates that countermeasures are warranted, countermeasures should be designed using FHWA HEC-23 manual – or consider replacing or closing the bridge.

Bridge #2

The Initial Survey

Respondent Information

Name Alan Kowalik	E-mail Address akowali@dot.state.tx.us
Job Title Bridge Inspection Supervisor	Phone 512-416-2208
Job Description (In what way does your job involve bridge maintenance?) Supervise the bridge inspection program and the NBI Database	Mailing Address 125 East 11 th Street Austin, TX 78701

Bridge Description

Please provide a general description of the bridge including its name, location, route, and water body.
SH over Fish Creek – 5-span-concrete T-beams. 5 – 29 ft simple spans on multiple concrete piles.

National Bridge Inventory (NBI) Data

Please provide the following information for the bridge. This information should be available in the NBI database. Please provide the NBI Database Values consistent with those required in the 2002 NBI Coding Guide, and specify the units (where appropriate).		
NBI Item No.	NBI Item Description	NBI Database Value
1	State Code	486
5	Inventory Route	1-13-1-0006-0
8	Structure Number	090740004904052
19	Bypass, Detour Length (e.g. in miles)	6
26	Functional Classification of Inventory Route	02
27	Year Built	1934
29	Average Daily Traffic	7600
49	Structure Length (e.g. in feet)	143
52	Deck Width, Out-to-Out (e.g. in feet)	45.3
60	Substructure	7
61	Channel and Channel Protection	7
71	Waterway Adequacy	6
109	Average Daily Truck Traffic	26
113	Scour Critical Bridges (2002 NBI Guidelines)	3

Undocumented Assumptions

Please provide the following information for the bridge which is not documented in the NBI database.	
Description	User Input
Bridge Type (check only one)	<input checked="" type="checkbox"/> Simple Span(s) <input type="checkbox"/> Continuous Span(s) over 100 ft.
Remaining life of bridge in years. If this bridge has already failed, report the actual lifetime of the bridge before it failed	4 years
Total Bridge Rebuilding Cost, if known. If unknown, estimate the cost by multiplying the bridge area by the cost per unit area as shown in Table 1 and the ADT cost multiplier as shown in Table 2. If estimated, provide the assumptions used in the spaces below: Bridge Area: 6,478 ft ² ; Cost per unit area: 65 \$/ft ² ; Cost Multiplier: 2.0	\$842,140.00

Economic Loss Data

Please provide the following economic factors to be associated with the failure of this bridge. Either check the box confirming that the default factor is to be used or provide a different value.		
Description	Default Value	User-Provided Value
Car running cost	\$0.45 per mile <input checked="" type="checkbox"/>	
Truck running cost	\$1.30 per mile <input checked="" type="checkbox"/>	
Duration of detour *	Use Table 2 (days) <input checked="" type="checkbox"/>	183
Value of time per adult *	Use Table 3 (\$/hr) <input type="checkbox"/>	6.96
Average car occupancy rate	1.63 people <input checked="" type="checkbox"/>	
Value of time for trucks	\$22.01 per hour <input checked="" type="checkbox"/>	
Average detour speed	40 miles per hour <input checked="" type="checkbox"/>	
Number of deaths from failure *	Use Table 2 (Number of people) <input type="checkbox"/>	5
Cost for each life lost	\$500,000 <input checked="" type="checkbox"/>	

* Please select an appropriate value from the reference table listed.

Cost of Analysis or Corrective Actions

Provide estimates for the following costs. Keep in mind that these costs may depend on a number of factors, e.g., the number of piers, abutments, etc. Also keep in mind that the guidelines include many significant broad assumptions, so significant effort is not warranted in estimating this data.	
Description	User Input
Estimated cost of installing automated scour monitoring	\$ No information
Estimated cost of installing scour countermeasures	\$50,000.00
Estimated cost of field reconnaissance to determine foundation type and depth (nondestructive testing, borings, etc.)	\$ N/A – depth known
Estimated cost to evaluate scour (survey, hydrology, and hydraulics analysis, if unavailable)	\$5,000.00

Scour Management Evaluation

2. State Highway 6 over Fish Creek

Bridge 090740004904052 in Falls County, TX was constructed in 1934 and reconstructed in 1958 and supports a rural principal arterial class road. This bridge's foundation is known with an NBI item 113 rating of "3" (scour critical and unstable). However, this bridge will be evaluated as if it had an unknown foundation to test the guidelines.

Is it a high-priority bridge?

This bridge supports a rural principal arterial and thus has significant economic value and may provide critical access to local services. *Thus, in this context this bridge is considered a high priority bridge* and should be given special attention.

Recommended management strategy

This bridge has a known foundation, and requires action. Furthermore, this bridge has significant economic value and provides critical access to local services. Thus, if this bridge had an unknown foundation the guidelines would have recommended the following three-step strategy to ensure the safety of this bridge.

1. Perform field reconnaissance to determine foundation type and depth. If the foundation is a spread footing, drill through the footing to determine elevation of the footing bottom. If the foundation is piles, use foundation reconnaissance to determine depth of piles. The parallel seismic test is generally the most effective reconnaissance method. Assume that the foundation information from the field evaluation is accurate. If field reconnaissance is unsuccessful (no access for testing, poor signal from NDT, etc.), assume a foundation depth. For piles, assume a 10 foot depth or use local knowledge. This should be a conservative assumption. Spread footing depths are easily discovered and an assumption should not be necessary for this type of foundation. In other words, continue as if the foundation is known.
2. Evaluate scour using FHWA HEC-18 manual.
3. If scour analysis indicates that countermeasures are warranted, countermeasures should be designed using FHWA HEC-23 manual – or consider replacing or closing the bridge.

Bridge #3

The Initial Survey

Respondent Information

Name Alan Kowalik	E-mail Address akowali@dot.state.tx.us
Job Title Bridge Inspection Supervisor	Phone 512-416-2208
Job Description (In what way does your job involve bridge maintenance?) Supervise the bridge inspection program and the NBI Database	Mailing Address 125 East 11 th Street Austin, TX 78701

Bridge Description

Please provide a general description of the bridge including its name, location, route, and water body.
IH 35W south-bound at Island Creek – 5 simple span – pan girder (concrete) type bridge on multiple concrete drilled shafts. 4 shafts per bent line founded on shale.

National Bridge Inventory (NBI) Data

Please provide the following information for the bridge. This information should be available in the NBI database. Please provide the NBI Database Values consistent with those required in the 2002 NBI Coding Guide, and specify the units (where appropriate).		
NBI Item No.	NBI Item Description	NBI Database Value
1	State Code	486
5	Inventory Route	1-11-1-0035-4
8	Structure Number	091100001423285
19	Bypass, Detour Length (e.g. in miles)	6
26	Functional Classification of Inventory Route	01
27	Year Built	1965
29	Average Daily Traffic	13,000
49	Structure Length (e.g. in feet)	209
52	Deck Width, Out-to-Out (e.g. in feet)	41.7
60	Substructure	6
61	Channel and Channel Protection	6
71	Waterway Adequacy	6
109	Average Daily Truck Traffic	25
113	Scour Critical Bridges (2002 NBI Guidelines)	3

Undocumented Assumptions

Please provide the following information for the bridge which is not documented in the NBI database.	
Description	User Input
Bridge Type (check only one)	<input checked="" type="checkbox"/> Simple Span(s) <input type="checkbox"/> Continuous Span(s) over 100 ft.
Remaining life of bridge in years. If this bridge has already failed, report the actual lifetime of the bridge before it failed	35 years
Total Bridge Rebuilding Cost, if known. If unknown, estimate the cost by multiplying the bridge area by the cost per unit area as shown in Table 1 and the ADT cost multiplier as shown in Table 2. If estimated, provide the assumptions used in the spaces below: Bridge Area: 8715 ft ² ; Cost per unit area: 60 \$/ft ² ; Cost Multiplier: 2.0	\$1,045,800

Economic Loss Data

Please provide the following economic factors to be associated with the failure of this bridge. Either check the box confirming that the default factor is to be used or provide a different value.		
Description	Default Value	User-Provided Value
Car running cost	\$0.45 per mile <input checked="" type="checkbox"/>	
Truck running cost	\$1.30 per mile <input checked="" type="checkbox"/>	
Duration of detour *	Use Table 2 (days) <input checked="" type="checkbox"/>	183
Value of time per adult *	Use Table 3 (\$/hr) <input checked="" type="checkbox"/>	6.96
Average car occupancy rate	1.63 people <input checked="" type="checkbox"/>	
Value of time for trucks	\$22.01 per hour <input checked="" type="checkbox"/>	
Average detour speed	40 miles per hour <input checked="" type="checkbox"/>	
Number of deaths from failure *	Use Table 2 (Number of people) <input type="checkbox"/>	3
Cost for each life lost	\$500,000 <input checked="" type="checkbox"/>	

* Please select an appropriate value from the reference table listed.

Cost of Analysis or Corrective Actions

Provide estimates for the following costs. Keep in mind that these costs may depend on a number of factors, e.g., the number of piers, abutments, etc. Also keep in mind that the guidelines include many significant broad assumptions, so significant effort is not warranted in estimating this data.	
Description	User Input
Estimated cost of installing automated scour monitoring	\$No information
Estimated cost of installing scour countermeasures	\$50,000.00
Estimated cost of field reconnaissance to determine foundation type and depth (nondestructive testing, borings, etc.)	\$N/A – depth known
Estimated cost to evaluate scour (survey, hydrology, and hydraulics analysis, if unavailable)	\$5,000.00

Scour Management Evaluation

3. I-35W SB over Island Creek

Bridge 091100001423285 in Hill County, TX was constructed in 1965 and supports a rural interstate. This bridge's foundation is known with an NBI item 113 rating of "3" (scour critical and unstable). However, this bridge will be evaluated as if it had an unknown foundation to test the guidelines.

Is it a high-priority bridge?

This bridge supports a rural principal arterial and thus has significant economic value and may provide critical access to local services. *Thus, in this context this bridge is considered a high priority bridge* and should be given special attention.

Recommended management strategy

This bridge has a known foundation, and requires action. Furthermore, this bridge has significant economic value and provides critical access to local services. Thus, if this bridge had an unknown foundation the guidelines would have recommended the following three-step strategy to ensure the safety of this bridge.

1. Perform field reconnaissance to determine foundation type and depth. If the foundation is a spread footing, drill through the footing to determine elevation of the footing bottom. If the foundation is piles, use foundation reconnaissance to determine depth of piles. The parallel seismic test is generally the most effective reconnaissance method. Assume that the foundation information from the field evaluation is accurate. If field reconnaissance is unsuccessful (no access for testing, poor signal from NDT, etc.), assume a foundation depth. For piles, assume a 10 foot depth or use local knowledge. This should be a conservative assumption. Spread footing depths are easily discovered and an assumption should not be necessary for this type of foundation. In other words, continue as if the foundation is known.
2. Evaluate scour using FHWA HEC-18 manual.
3. If scour analysis indicates that countermeasures are warranted, countermeasures should be designed using FHWA HEC-23 manual – or consider replacing or closing the bridge.

Bridge #4

The Initial Survey

Respondent Information

Name Alan Kowalik	E-mail Address akowali@dot.state.tx.us
Job Title Bridge Inspection Supervisor	Phone 512-416-2208
Job Description (In what way does your job involve bridge maintenance?) Supervise the bridge inspection program and the NBI Database	Mailing Address 125 East 11 th Street Austin, TX 78701

Bridge Description

Please provide a general description of the bridge including its name, location, route, and water body.
SH 171 at Ash Creek – 40 simple concrete flat slabs on multiple concrete piling.

National Bridge Inventory (NBI) Data

Please provide the following information for the bridge. This information should be available in the NBI database. Please provide the NBI Database Values consistent with those required in the 2002 NBI Coding Guide, and specify the units (where appropriate).		
NBI Item No.	NBI Item Description	NBI Database Value
1	State Code	486
5	Inventory Route	1-13-1-0171-0
8	Structure Number	091100041802028
19	Bypass, Detour Length (e.g. in miles)	13
26	Functional Classification of Inventory Route	07
27	Year Built	1940
29	Average Daily Traffic	2800
49	Structure Length (e.g. in feet)	800
52	Deck Width, Out-to-Out (e.g. in feet)	35.3
60	Substructure	5
61	Channel and Channel Protection	5
71	Waterway Adequacy	6
109	Average Daily Truck Traffic	22
113	Scour Critical Bridges (2002 NBI Guidelines)	3

Undocumented Assumptions

Please provide the following information for the bridge which is not documented in the NBI database.	
Description	User Input
Bridge Type (check only one)	<input checked="" type="checkbox"/> Simple Span(s) <input type="checkbox"/> Continuous Span(s) over 100 ft.
Remaining life of bridge in years. If this bridge has already failed, report the actual lifetime of the bridge before it failed	9 years
Total Bridge Rebuilding Cost, if known. If unknown, estimate the cost by multiplying the bridge area by the cost per unit area as shown in Table 1 and the ADT cost multiplier as shown in Table 2. If estimated, provide the assumptions used in the spaces below: Bridge Area: 28,240 ft ² ; Cost per unit area: 67 \$/ft ² ; Cost Multiplier: 1.5	\$2,838,120.00

Economic Loss Data

Please provide the following economic factors to be associated with the failure of this bridge. Either check the box confirming that the default factor is to be used or provide a different value.		
Description	Default Value	User-Provided Value
Car running cost	\$0.45 per mile <input checked="" type="checkbox"/>	
Truck running cost	\$1.30 per mile <input checked="" type="checkbox"/>	
Duration of detour *	Use Table 2 (days) <input checked="" type="checkbox"/>	365
Value of time per adult *	Use Table 3 (\$/hr) <input checked="" type="checkbox"/>	6.96
Average car occupancy rate	1.63 people <input checked="" type="checkbox"/>	
Value of time for trucks	\$22.01 per hour <input checked="" type="checkbox"/>	
Average detour speed	40 miles per hour <input checked="" type="checkbox"/>	
Number of deaths from failure *	Use Table 2 (Number of people) <input checked="" type="checkbox"/>	2
Cost for each life lost	\$500,000 <input checked="" type="checkbox"/>	

* Please select an appropriate value from the reference table listed.

Cost of Analysis or Corrective Actions

Provide estimates for the following costs. Keep in mind that these costs may depend on a number of factors, e.g., the number of piers, abutments, etc. Also keep in mind that the guidelines include many significant broad assumptions, so significant effort is not warranted in estimating this data.	
Description	User Input
Estimated cost of installing automated scour monitoring	\$ No information
Estimated cost of installing scour countermeasures	\$ No information
Estimated cost of field reconnaissance to determine foundation type and depth (nondestructive testing, borings, etc.)	\$N/A - depth known
Estimated cost to evaluate scour (survey, hydrology, and hydraulics analysis, if unavailable)	\$5,000.00

Scour Management Evaluation

4. State Highway 171 over Ash Creek

Bridge 091100041802028 in Hill County, TX was constructed in 1940 and reconstructed in 1966 and supports a rural major collector class road. This bridge's foundation is known with an NBI item 113 rating of "3" (scour critical and unstable). However, this bridge will be evaluated as if it had an unknown foundation to test the guidelines.

Is it a high-priority bridge?

This bridge supports a rural road, which is not a principal arterial, emergency route or provide direct access to other emergency services (e.g. hospital, fire stations, etc.). *Thus, in this context this bridge is not considered a high priority bridge.*

Does the bridge meet the minimum performance level?

The minimum performance level for a rural major collector class bridge, according to the guidelines, is 0.0005 – the threshold probability of failure that this bridge must outperform. To estimate this bridge's annual probability of failure, it is first necessary to estimate the overtopping frequency and scour vulnerability of this bridge, as in the table below.

Data/Parameter (source)	Value	Interpretation
NBI item 26 (bridge survey)	7	Rural major collector classification
NBI item 71 (bridge survey)	6	Waterway meets the minimum criteria
∴ Overtopping Frequency (guidelines)	S	Slight (once in 11-100 years)
NBI item 60 (bridge survey)	5	Foundation is in fair condition
NBI item 61 (bridge survey)	5	Channel banks are eroding; major damage
∴ Scour Vulnerability (guidelines)	5	Analysis: stable; Survey: scour is within limits
∴ Annual probability of failure (guidelines)	0.00008	A 1 in 125,000 chance of failure in any given year

This bridge meets the minimum performance level because the annual probability of failure is less than 0.0005. However, because the foundation is assumed to be unknown, we need to determine the most cost effective way to manage this uncertainty.

Is automated scour monitoring warranted?

Automated scour monitoring is considered warranted if the lifetime risk of death is greater than the cost of automated scour monitoring. The lifetime probability of failure for this bridge can be computed from the annual probability of failure and its tentative remaining life (9 years, according to the survey respondent) as follows: $1 - (1 - 0.00008)^9$, or about 0.000072 (a 1 in 13,889 chance of failure in the next 9 years). This and other survey data are now used to calculate the risk of death as follows:

$$R_{death} = K \cdot P_L \cdot C_6 \cdot X$$

$$= (1.0) \cdot (0.000072) \cdot (\$500,000 / person) \cdot (2 people) = \$72$$

Since the cost of automated scour monitoring was estimated to be \$20,000 and the risk of death is \$72, *automated scour monitoring is probably not warranted.*

Are scour countermeasures warranted?

Scour countermeasures are considered warranted if the lifetime risk of failure is greater than the estimated cost of scour countermeasures, which we estimated to be about \$50,000. The first step in estimating the risk of failure is to estimate the potential cost of failure, assuming that it would need to be replaced. The survey respondent estimated that a new bridge would cost about \$2,838,000. The car and truck running cost associated with the detour for this bridge is computed from the survey data as follows:

$$\begin{aligned} C_{\text{running}} &= \left[C_2 \cdot \left(1 - \frac{T}{100} \right) + C_3 \cdot \frac{T}{100} \right] \cdot D \cdot A \cdot d \\ &= \left[\$0.45 / \text{mi} \cdot \left(1 - \frac{22}{100} \right) + \$1.30 / \text{mi} \cdot \frac{22}{100} \right] \cdot (13 \text{ mi}) \cdot (2,800 / \text{day}) \cdot (365 \text{ days}) \\ &= \$8,463,182 \end{aligned}$$

The cost of lost wages is computed from the survey data as follows:

$$\begin{aligned} C_{\text{wages}} &= \left[C_4 \cdot O \cdot \left(1 - \frac{T}{100} \right) + C_5 \cdot \frac{T}{100} \right] \cdot \frac{D \cdot A \cdot d}{S} \\ &= \left[(\$6.96 / \text{per}) \cdot (1.63 \text{ per}) \cdot \left(1 - \frac{22}{100} \right) + (\$22.01 / \text{truck}) \cdot \frac{22}{100} \right] \cdot \frac{(13 \text{ mi}) \cdot (2,800 / \text{day}) \cdot (365 \text{ days})}{40 \text{ mi} / \text{hr}} \\ &= \$4,547,513 \end{aligned}$$

When we include the cost of death, the total cost of bridge failure totals \$16,848,815. Computing the risk of a scour-induced failure over the remaining life of the bridge is just the product of the lifetime probability of failure and the total cost of failure – about \$1,213. *Thus, scour countermeasures are probably not warranted* because the lifetime risk of failure is less than the estimated cost of scour countermeasures.

Recommended management strategy

This bridge has a known foundation, and requires action. If this bridge had an unknown foundation, it would have met the performance standards for these guidelines would not have warranted automated scour monitoring or countermeasures. The guidelines would have strongly recommended that you follow the recommendations in the “Bridge Closure Plan” section of this report.

Furthermore, scour monitoring should be performed with every 2-yr routine bridge inspection for all bridges with unknown foundations. If the scour depth increases more than two feet from baseline conditions (as-built drawings or initial scour survey), action should be taken. The first action is to follow the “Bridge Closure Plan” to take any necessary immediate action. Countermeasures should then be considered for this site; or close or replace the bridge. This two foot trigger can be adjusted based on local geotechnical and engineering considerations and should represent the depth of scour that the bridge engineer feels comfortable with for the individual bridge.

Bridge #5

The Initial Survey

Respondent Information

Name Alan Kowalik	E-mail Address akowali@dot.state.tx.us
Job Title Bridge Inspection Supervisor	Phone 512-416-2208
Job Description (In what way does your job involve bridge maintenance?) Supervise the bridge inspection program and the NBI Database	Mailing Address 125 East 11 th Street Austin, TX 78701

Bridge Description

Please provide a general description of the bridge including its name, location, route, and water body.
FM 34 at Sanders Creek – 6 simple spans prestressed concrete box girders on multiple concrete drilled shafts

National Bridge Inventory (NBI) Data

Please provide the following information for the bridge. This information should be available in the NBI database. Please provide the NBI Database Values consistent with those required in the 2002 NBI Coding Guide, and specify the units (where appropriate).		
NBI Item No.	NBI Item Description	NBI Database Value
1	State Code	486
5	Inventory Route	1-15-1-0039-0
8	Structure Number	091470064302038
19	Bypass, Detour Length (e.g. in miles)	11
26	Functional Classification of Inventory Route	07
27	Year Built	1977
29	Average Daily Traffic	2700
49	Structure Length (e.g. in feet)	316
52	Deck Width, Out-to-Out (e.g. in feet)	36.6
60	Substructure	7
61	Channel and Channel Protection	7
71	Waterway Adequacy	6
109	Average Daily Truck Traffic	10
113	Scour Critical Bridges (2002 NBI Guidelines)	3

Undocumented Assumptions

Please provide the following information for the bridge which is not documented in the NBI database.	
Description	User Input
Bridge Type (check only one)	<input checked="" type="checkbox"/> Simple Span(s) <input type="checkbox"/> Continuous Span(s) over 100 ft.
Remaining life of bridge in years. If this bridge has already failed, report the actual lifetime of the bridge before it failed	_____ years
Total Bridge Rebuilding Cost, if known. If unknown, estimate the cost by multiplying the bridge area by the cost per unit area as shown in Table 1 and the ADT cost multiplier as shown in Table 2. If estimated, provide the assumptions used in the spaces below: Bridge Area: 11,566 ft ² ; Cost per unit area: 63 \$/ft ² ; Cost Multiplier: 1.5	\$1,092,987.00

Economic Loss Data

Please provide the following economic factors to be associated with the failure of this bridge. Either check the box confirming that the default factor is to be used or provide a different value.		
Description	Default Value	User-Provided Value
Car running cost	\$0.45 per mile <input checked="" type="checkbox"/>	
Truck running cost	\$1.30 per mile <input checked="" type="checkbox"/>	
Duration of detour *	Use Table 2 (days) <input checked="" type="checkbox"/>	365
Value of time per adult *	Use Table 3 (\$/hr) <input checked="" type="checkbox"/>	6.96
Average car occupancy rate	1.63 people <input checked="" type="checkbox"/>	
Value of time for trucks	\$22.01 per hour <input checked="" type="checkbox"/>	
Average detour speed	40 miles per hour <input checked="" type="checkbox"/>	
Number of deaths from failure *	Use Table 2 (Number of people) <input checked="" type="checkbox"/>	2
Cost for each life lost	\$500,000 <input checked="" type="checkbox"/>	

* Please select an appropriate value from the reference table listed.

Cost of Analysis or Corrective Actions

Provide estimates for the following costs. Keep in mind that these costs may depend on a number of factors, e.g., the number of piers, abutments, etc. Also keep in mind that the guidelines include many significant broad assumptions, so significant effort is not warranted in estimating this data.	
Description	User Input
Estimated cost of installing automated scour monitoring	\$No information
Estimated cost of installing scour countermeasures	\$50,000.00
Estimated cost of field reconnaissance to determine foundation type and depth (nondestructive testing, borings, etc.)	\$ N/A - depth known
Estimated cost to evaluate scour (survey, hydrology, and hydraulics analysis, if unavailable)	\$5,000.00

Scour Management Evaluation

5. FM 39 over Sanders Creek

Bridge 091470064302038 in Limestone County, TX was constructed in 1977 and supports a rural major collector class road. This bridge's foundation is known with an NBI item 113 rating of "3" (scour critical and unstable). However, this bridge will be evaluated as if it had an unknown foundation to test the guidelines.

Is it a high-priority bridge?

This bridge supports a rural road, which is not a principal arterial, emergency route or provide direct access to other emergency services (e.g. hospital, fire stations, etc.). *Thus, in this context this bridge is not considered a high priority bridge.*

Does the bridge meet the minimum performance level?

The minimum performance level for a rural major collector class bridge, according to the guidelines, is 0.0005 – the threshold probability of failure that this bridge must outperform. To estimate this bridge's annual probability of failure, it is first necessary to estimate the overtopping frequency and scour vulnerability of this bridge, as in the table below.

Data/Parameter (source)	Value	Interpretation
NBI item 26 (bridge survey)	7	Rural major collector classification
NBI item 71 (bridge survey)	6	Waterway meets the minimum criteria
∴ Overtopping Frequency (guidelines)	S	Slight (once in 11-100 years)
NBI item 60 (bridge survey)	7	Foundation is in good condition
NBI item 61 (bridge survey)	7	Channel has only minor damage
∴ Scour Vulnerability (guidelines)	7	Countermeasures now make it stable
∴ Annual probability of failure (guidelines)	0.00025	A 1 in 4,000 chance of failure in any given year

This bridge meets the minimum performance level because the annual probability of failure is less than 0.0005. However, because the foundation is unknown, we need to determine the most cost effective way to manage this uncertainty.

Is automated scour monitoring warranted?

Automated scour monitoring is considered warranted if the lifetime risk of death is greater than the cost of automated scour monitoring. The lifetime probability of failure for this bridge can be computed from the annual probability of failure and its tentative remaining life (47 years, according to the survey respondent) as follows: $1 - (1 - 0.00025)^{47}$, or about 0.012 (a 1 in 83 chance of failure in the next 47 years). This and other survey data are now used to calculate the risk of death as follows:

$$\begin{aligned}
 R_{\text{death}} &= K \cdot P_L \cdot C_6 \cdot X \\
 &= (1.0) \cdot (0.012) \cdot (\$500,000 / \text{person}) \cdot (2 \text{ people}) = \$11,683
 \end{aligned}$$

Since the cost of automated scour monitoring was estimated to be \$20,000 and the risk of death is \$11,683, *automated scour monitoring is probably not warranted.*

Are scour countermeasures warranted?

Scour countermeasures are considered warranted if the lifetime risk of failure is greater than the estimated cost of scour countermeasures, which the survey respondent estimated to be about \$50,000. The first step in estimating the risk of failure is to estimate the potential cost of failure, assuming that it would need to be replaced. The survey respondent estimated that a new bridge would cost about \$1,092,987. The car and truck running cost associated with the detour for this bridge is computed from the survey data as follows:

$$\begin{aligned} C_{\text{running}} &= \left[C_2 \cdot \left(1 - \frac{T}{100} \right) + C_3 \cdot \frac{T}{100} \right] \cdot D \cdot A \cdot d \\ &= \left[\$0.45 / \text{mi} \cdot \left(1 - \frac{10}{100} \right) + \$1.30 / \text{mi} \cdot \frac{10}{100} \right] \cdot (11 \text{ mi}) \cdot (2,700 / \text{day}) \cdot (365 \text{ days}) \\ &= \$5,799,668 \end{aligned}$$

The cost of lost wages is computed from the survey data as follows:

$$\begin{aligned} C_{\text{wages}} &= \left[C_4 \cdot O \cdot \left(1 - \frac{T}{100} \right) + C_5 \cdot \frac{T}{100} \right] \cdot \frac{D \cdot A \cdot d}{S} \\ &= \left[(\$6.96 / \text{per}) \cdot (1.63 \text{ per}) \cdot \left(1 - \frac{10}{100} \right) + (\$22.01 / \text{truck}) \cdot \frac{10}{100} \right] \cdot \frac{(11 \text{ mi}) \cdot (2,700 / \text{day}) \cdot (365 \text{ days})}{40 \text{ mi} / \text{hr}} \\ &= \$3,363,623 \end{aligned}$$

When we include the cost of death, the total cost of bridge failure totals \$11,256,277. Computing the risk of a scour-induced failure over the remaining life of the bridge is just the product of the lifetime probability of failure and the total cost of failure – about \$131,504. *Thus, scour countermeasures are probably warranted* because the lifetime risk of failure is greater than the estimated cost of scour countermeasures.

Is foundation reconnaissance and scour analysis warranted?

We estimated the foundation reconnaissance and scour analysis costs to be about \$10,000 and \$5,000, respectively. Since this is only about 30% of the estimated cost of installing countermeasures, *foundation reconnaissance and scour analysis are probably warranted before installing the countermeasures.*

Recommended management strategy

This bridge has a known foundation, and requires action. If this bridge had an unknown foundation, the guidelines recommend the following steps to ensure the safety of the bridge:

1. Perform field reconnaissance to determine foundation type and depth. If the foundation is a spread footing, you could drill through the footing to determine elevation of the footing bottom. The parallel seismic test is generally the most effective NDT method. Assume that the foundation information from the field evaluation is accurate. If field reconnaissance is unsuccessful (no access for testing, poor signal from NDT, etc.), assume a foundation depth using local knowledge. This should be a conservative assumption. Spread footing depths are

easily discovered and an assumption should not be necessary for this type of foundation. In other words, continue as if the foundation is known.

2. Evaluate scour using FHWA HEC-18 manual.
3. If scour analysis indicates that countermeasures are warranted, countermeasures should be designed using FHWA HEC-23 manual – or consider replacing or closing the bridge.

Bridge #6

The Initial Survey

Respondent Information

Name Alan Kowalik	E-mail Address akowali@dot.state.tx.us
Job Title Bridge Inspection Supervisor	Phone 512-416-2208
Job Description (In what way does your job involve bridge maintenance?) Supervise the bridge inspection program and the NBI Database	Mailing Address 125 East 11 th Street Austin, TX 78701

Bridge Description

Please provide a general description of the bridge including its name, location, route, and water body.
Big Elm Creek Road (#516) over Big Elm Creek – 1 span steel superstructured on concrete piling.

National Bridge Inventory (NBI) Data

Please provide the following information for the bridge. This information should be available in the NBI database. Please provide the NBI Database Values consistent with those required in the 2002 NBI Coding Guide, and specify the units (where appropriate).		
NBI Item No.	NBI Item Description	NBI Database Value
1	State Code	486
5	Inventory Route	1-21-1-0000-0
8	Structure Number	090140AA0268002
19	Bypass, Detour Length (e.g. in miles)	6
26	Functional Classification of Inventory Route	06
27	Year Built	1986
29	Average Daily Traffic	32
49	Structure Length (e.g. in feet)	54
52	Deck Width, Out-to-Out (e.g. in feet)	20
60	Substructure	6
61	Channel and Channel Protection	6
71	Waterway Adequacy	5
109	Average Daily Truck Traffic	Unknown
113	Scour Critical Bridges (2002 NBI Guidelines)	U

Undocumented Assumptions

Please provide the following information for the bridge which is not documented in the NBI database.	
Description	User Input
Bridge Type (check only one)	<input checked="" type="checkbox"/> Simple Span(s) <input type="checkbox"/> Continuous Span(s) over 100 ft.
Remaining life of bridge in years. If this bridge has already failed, report the actual lifetime of the bridge before it failed	30 years
Total Bridge Rebuilding Cost, if known. If unknown, estimate the cost by multiplying the bridge area by the cost per unit area as shown in Table 1 and the ADT cost multiplier as shown in Table 2. If estimated, provide the assumptions used in the spaces below: Bridge Area: 1080 ft ² ; Cost per unit area: 60 \$/ft ² ; Cost Multiplier: 1	\$64,800

Economic Loss Data

Please provide the following economic factors to be associated with the failure of this bridge. Either check the box confirming that the default factor is to be used or provide a different value.		
Description	Default Value	User-Provided Value
Car running cost	\$0.45 per mile <input checked="" type="checkbox"/>	
Truck running cost	\$1.30 per mile <input checked="" type="checkbox"/>	
Duration of detour *	Use Table 2 (days) <input checked="" type="checkbox"/>	1095
Value of time per adult *	Use Table 3 (\$/hr) <input type="checkbox"/>	6.96
Average car occupancy rate	1.63 people <input checked="" type="checkbox"/>	
Value of time for trucks	\$22.01 per hour <input checked="" type="checkbox"/>	
Average detour speed	40 miles per hour <input checked="" type="checkbox"/>	
Number of deaths from failure *	Use Table 2 (Number of people) <input checked="" type="checkbox"/>	0
Cost for each life lost	\$500,000 <input checked="" type="checkbox"/>	

* Please select an appropriate value from the reference table listed.

Cost of Analysis or Corrective Actions

Provide estimates for the following costs. Keep in mind that these costs may depend on a number of factors, e.g., the number of piers, abutments, etc. Also keep in mind that the guidelines include many significant broad assumptions, so significant effort is not warranted in estimating this data.	
Description	User Input
Estimated cost of installing automated scour monitoring	\$ Unknown
Estimated cost of installing scour countermeasures	\$ No information
Estimated cost of field reconnaissance to determine foundation type and depth (nondestructive testing, borings, etc.)	\$ N/A
Estimated cost to evaluate scour (survey, hydrology, and hydraulics analysis, if unavailable)	\$3,000.00

Scour Management Evaluation

6. Big Elm Creek Road over Big Elm Creek

Bridge 12SR2250005 in Bell County, TX was constructed in 1986, and supports a rural minor arterial class road. This bridge has an unknown foundation depth, and it is further assumed that foundation records can not be found.

Is it a high-priority bridge?

This bridge supports a rural road, which is not a principal arterial, emergency route or provide direct access to other emergency services (e.g. hospital, fire stations, etc.). *Thus, in this context this bridge is not considered a high priority bridge.*

Does the bridge meet the minimum performance level?

The minimum performance level for a rural minor arterial class bridge, according to the guidelines, is 0.0005 – the threshold probability of failure that this bridge must outperform. To estimate this bridge’s annual probability of failure, it is first necessary to estimate the overtopping frequency and scour vulnerability of this bridge, as in the table below.

Data/Parameter (source)	Value	Interpretation
NBI item 26 (bridge survey)	6	Rural minor arterial classification
NBI item 71 (bridge survey)	3	Waterway is a high priority for corrective action
∴ Overtopping Frequency (guidelines)	0	Occasional (once in 3-10 years)
NBI item 60 (bridge survey)	6	Foundation is in satisfactory condition
NBI item 61 (bridge survey)	6	Channel has widespread minor damage
∴ Scour Vulnerability (guidelines)	6	Not yet evaluated, but probably stable
∴ Annual probability of failure (guidelines)	0.0004	A 1 in 2,500 chance of failure in any given year

This bridge meets the minimum performance level because the annual probability of failure is less than 0.0005. However, because the foundation is unknown, we need to determine the most cost effective way to manage this uncertainty.

Is automated scour monitoring warranted?

Automated scour monitoring is considered warranted if the lifetime risk of death is greater than the cost of automated scour monitoring. The lifetime probability of failure for this bridge can be computed from the annual probability of failure and its tentative remaining life (30 years, according to the survey respondent) as follows: $1 - (1 - 0.0004)^{30}$, or about 0.012 (a 1 in 83 chance of failure in the next 30 years). This and other survey data are now used to calculate the risk of death as follows:

$$R_{death} = K \cdot P_L \cdot C_6 \cdot X$$

$$= (1.0) \cdot (0.012 / yr) \cdot (\$500,000 / person) \cdot (0 people) = \$0$$

Since the cost of automated scour monitoring was estimated to be \$20,000 and the risk of death is \$0, *automated scour monitoring may not be warranted.*

Are scour countermeasures warranted?

Scour countermeasures are considered warranted if the lifetime risk of failure is greater than the estimated cost of scour countermeasures, which we estimated to be about \$50,000. The first step in estimating the risk of failure is to estimate the potential cost of failure, assuming that it would need to be replaced. The survey respondent estimated that a new bridge would cost about \$64,800. The car and truck running cost associated with the detour for this bridge is computed from the survey data as follows:

$$\begin{aligned} C_{\text{running}} &= \left[C_2 \cdot \left(1 - \frac{T}{100} \right) + C_3 \cdot \frac{T}{100} \right] \cdot D \cdot A \cdot d \\ &= \left[\$0.45 / \text{mi} \cdot \left(1 - \frac{6}{100} \right) + \$1.30 / \text{mi} \cdot \frac{6}{100} \right] \cdot (6 \text{ mi}) \cdot (32 / \text{day}) \cdot (1095 \text{ days}) \\ &= \$105,330 \end{aligned}$$

The cost of lost wages is computed from the survey data as follows:

$$\begin{aligned} C_{\text{wages}} &= \left[C_4 \cdot O \cdot \left(1 - \frac{T}{100} \right) + C_5 \cdot \frac{T}{100} \right] \cdot \frac{D \cdot A \cdot d}{S} \\ &= \left[(\$6.96 / \text{per}) \cdot (1.63 \text{ per}) \cdot \left(1 - \frac{6}{100} \right) + (\$22.01 / \text{truck}) \cdot \frac{6}{100} \right] \cdot \frac{(6 \text{ mi}) \cdot (32 / \text{day}) \cdot (1095 \text{ days})}{40 \text{ mi} / \text{hr}} \\ &= \$62,992 \end{aligned}$$

When we include the cost of death, the total cost of bridge failure totals \$233,122. Computing the risk of a scour-induced failure over the remaining life of the bridge is just the product of the lifetime probability of failure and the total cost of failure – about \$2,781. *Thus, scour countermeasures are probably not warranted* because the lifetime risk of failure is less than the estimated cost of scour countermeasures.

Recommended management strategy

This bridge meets the performance standards for these guidelines and does not appear to warrant automated scour monitoring or countermeasures. However, because this bridge has an unknown foundation the guidelines strongly recommend that you follow the recommendations in the “Bridge Closure Plan” section of this report.

Furthermore, scour monitoring should be performed with every 2-yr routine bridge inspection for all bridges with unknown foundations. If the scour depth increases more than two feet from baseline conditions (as-built drawings or initial scour survey), action should be taken. The first action is to follow the “Bridge Closure Plan” to take any necessary immediate action. Countermeasures should then be considered for this site; or close or replace the bridge. This two foot trigger can be adjusted based on local geotechnical and engineering considerations and should represent the depth of scour that the bridge engineer feels comfortable with for the individual bridge.

Bridge #7

The Initial Survey

Respondent Information

Name Alan Kowalik	E-mail Address akowali@dot.state.tx.us
Job Title Bridge Inspection Supervisor	Phone 512-416-2208
Job Description (In what way does your job involve bridge maintenance?) Supervise the bridge inspection program and the NBI Database	Mailing Address 125 East 11 th Street Austin, TX 78701

Bridge Description

Please provide a general description of the bridge including its name, location, route, and water body.
County Road 302 over Brazos River Slough – 2 simple span timber stringer on multiple timber piling.

National Bridge Inventory (NBI) Data

Please provide the following information for the bridge. This information should be available in the NBI database. Please provide the NBI Database Values consistent with those required in the 2002 NBI Coding Guide, and specify the units (where appropriate).		
NBI Item No.	NBI Item Description	NBI Database Value
1	State Code	486
5	Inventory Route	1-21-1-0302-0
8	Structure Number	090740AA0128001
19	Bypass, Detour Length (e.g. in miles)	3
26	Functional Classification of Inventory Route	06
27	Year Built	1987
29	Average Daily Traffic	87
49	Structure Length (e.g. in feet)	52
52	Deck Width, Out-to-Out (e.g. in feet)	20.3
60	Substructure	7
61	Channel and Channel Protection	6
71	Waterway Adequacy	4
109	Average Daily Truck Traffic	Unknown
113	Scour Critical Bridges (2002 NBI Guidelines)	U

Undocumented Assumptions

Please provide the following information for the bridge which is not documented in the NBI database.	
Description	User Input
Bridge Type (check only one)	<input checked="" type="checkbox"/> Simple Span(s) <input type="checkbox"/> Continuous Span(s) over 100 ft.
Remaining life of bridge in years. If this bridge has already failed, report the actual lifetime of the bridge before it failed	31 years
Total Bridge Rebuilding Cost, if known. If unknown, estimate the cost by multiplying the bridge area by the cost per unit area as shown in Table 1 and the ADT cost multiplier as shown in Table 2. If estimated, provide the assumptions used in the spaces below: Bridge Area: 713 ft ² ; Cost per unit area: 73 \$/ft ² ; Cost Multiplier: 1	\$52,049.00

Economic Loss Data

Please provide the following economic factors to be associated with the failure of this bridge. Either check the box confirming that the default factor is to be used or provide a different value.		
Description	Default Value	User-Provided Value
Car running cost	\$0.45 per mile <input checked="" type="checkbox"/>	
Truck running cost	\$1.30 per mile <input checked="" type="checkbox"/>	
Duration of detour *	Use Table 2 (days) <input checked="" type="checkbox"/>	1095
Value of time per adult *	Use Table 3 (\$/hr) <input checked="" type="checkbox"/>	6.96
Average car occupancy rate	1.63 people <input checked="" type="checkbox"/>	
Value of time for trucks	\$22.01 per hour <input checked="" type="checkbox"/>	
Average detour speed	40 miles per hour <input checked="" type="checkbox"/>	
Number of deaths from failure *	Use Table 2 (Number of people) <input checked="" type="checkbox"/>	0
Cost for each life lost	\$500,000 <input checked="" type="checkbox"/>	

* Please select an appropriate value from the reference table listed.

Cost of Analysis or Corrective Actions

Provide estimates for the following costs. Keep in mind that these costs may depend on a number of factors, e.g., the number of piers, abutments, etc. Also keep in mind that the guidelines include many significant broad assumptions, so significant effort is not warranted in estimating this data.	
Description	User Input
Estimated cost of installing automated scour monitoring	\$ No information
Estimated cost of installing scour countermeasures	\$ No information
Estimated cost of field reconnaissance to determine foundation type and depth (nondestructive testing, borings, etc.)	\$ N/A
Estimated cost to evaluate scour (survey, hydrology, and hydraulics analysis, if unavailable)	\$3,000.00

Scour Management Evaluation

7. County Road 302 over Brazos River Slough

Bridge 090740AA0128001 in Falls County, TX was constructed in 1987 and supports a rural minor arterial class road. This bridge has an unknown foundation depth, and it is further assumed that foundation records can not be found.

Is it a high-priority bridge?

This bridge supports a rural road, which is not a principal arterial, emergency route or provide direct access to other emergency services (e.g. hospital, fire stations, etc.). *Thus, in this context this bridge is not considered a high priority bridge.*

Does the bridge meet the minimum performance level?

The minimum performance level for a rural minor arterial class bridge, according to the guidelines, is 0.0005 – the threshold probability of failure that this bridge must outperform. To estimate this bridge’s annual probability of failure, it is first necessary to estimate the overtopping frequency and scour vulnerability of this bridge, as in the table below.

Data/Parameter (source)	Value	Interpretation
NBI item 26 (bridge survey)	6	Rural minor arterial classification
NBI item 71 (bridge survey)	4	Waterway meets the minimum limits for no action
∴ Overtopping Frequency (guidelines)	0	Occasional (once in 3-10 years)
NBI item 60 (bridge survey)	7	Foundation is in good condition
NBI item 61 (bridge survey)	6	Channel has widespread minor damage
∴ Scour Vulnerability (guidelines)	6	Not yet evaluated, but probably stable
∴ Annual probability of failure (guidelines)	0.0004	A 1 in 2,500 chance of failure in any given year

This bridge meets the minimum performance level because the annual probability of failure is less than 0.0005. However, because the foundation is unknown, we need to determine the most cost effective way to manage this uncertainty.

Is automated scour monitoring warranted?

Automated scour monitoring is considered warranted if the lifetime risk of death is greater than the cost of automated scour monitoring. The lifetime probability of failure for this bridge can be computed from the annual probability of failure and its tentative remaining life (31 years, according to the survey respondent) as follows: $1 - (1 - 0.0004)^{31}$, or about 0.012 (a 1 in 83 chance of failure in the next 31 years). This and other survey data are now used to calculate the risk of death as follows:

$$R_{death} = K \cdot P_L \cdot C_6 \cdot X$$

$$= (1.0) \cdot (0.012 / yr) \cdot (\$500,000 / person) \cdot (0 \text{ people}) = \$0$$

Since the cost of automated scour monitoring was estimated to be \$20,000 and the risk of death is \$0, *automated scour monitoring may not be warranted.*

Are scour countermeasures warranted?

Scour countermeasures are considered warranted if the lifetime risk of failure is greater than the estimated cost of scour countermeasures, which we estimated to be about \$50,000. The first step in estimating the risk of failure is to estimate the potential cost of failure, assuming that it would need to be replaced. The survey respondent estimated that a new bridge would cost about \$64,800. The car and truck running cost associated with the detour for this bridge is computed from the survey data as follows:

$$\begin{aligned} C_{\text{running}} &= \left[C_2 \cdot \left(1 - \frac{T}{100} \right) + C_3 \cdot \frac{T}{100} \right] \cdot D \cdot A \cdot d \\ &= \left[\$0.45 / \text{mi} \cdot \left(1 - \frac{6}{100} \right) + \$1.30 / \text{mi} \cdot \frac{6}{100} \right] \cdot (3 \text{ mi}) \cdot (87 / \text{day}) \cdot (1095 \text{ days}) \\ &= \$143,183 \end{aligned}$$

The cost of lost wages is computed from the survey data as follows:

$$\begin{aligned} C_{\text{wages}} &= \left[C_4 \cdot O \cdot \left(1 - \frac{T}{100} \right) + C_5 \cdot \frac{T}{100} \right] \cdot \frac{D \cdot A \cdot d}{S} \\ &= \left[(\$6.96 / \text{per}) \cdot (1.63 \text{ per}) \cdot \left(1 - \frac{6}{100} \right) + (\$22.01 / \text{truck}) \cdot \frac{6}{100} \right] \cdot \frac{(3 \text{ mi}) \cdot (87 / \text{day}) \cdot (1095 \text{ days})}{40 \text{ mi} / \text{hr}} \\ &= \$85,629 \end{aligned}$$

When we include the cost of death, the total cost of bridge failure totals \$281,613. Computing the risk of a scour-induced failure over the remaining life of the bridge is just the product of the lifetime probability of failure and the total cost of failure – about \$3,471. *Thus, scour countermeasures are probably not warranted* because the lifetime risk of failure is less than the estimated cost of scour countermeasures.

Recommended management strategy

This bridge meets the performance standards for these guidelines and does not appear to warrant automated scour monitoring or countermeasures. However, because this bridge has an unknown foundation the guidelines strongly recommend that you follow the recommendations in the “Bridge Closure Plan” section of this report.

Furthermore, scour monitoring should be performed with every 2-yr routine bridge inspection for all bridges with unknown foundations. If the scour depth increases more than two feet from baseline conditions (as-built drawings or initial scour survey), action should be taken. The first action is to follow the “Bridge Closure Plan” to take any necessary immediate action. Countermeasures should then be considered for this site; or close or replace the bridge. This two foot trigger can be adjusted based on local geotechnical and engineering considerations and should represent the depth of scour that the bridge engineer feels comfortable with for the individual bridge.

Bridge #8

The Initial Survey

Respondent Information

Name Alan Kowalik	E-mail Address akowali@dot.state.tx.us
Job Title Bridge Inspection Supervisor	Phone 512-416-2208
Job Description (In what way does your job involve bridge maintenance?) Supervise the bridge inspection program and the NBI Database	Mailing Address 125 East 11 th Street Austin, TX 78701

Bridge Description

Please provide a general description of the bridge including its name, location, route, and water body.
County Road 2342 at BR Alligator Creek – 2 span continuous steel I-beam on steel piling.

National Bridge Inventory (NBI) Data

Please provide the following information for the bridge. This information should be available in the NBI database. Please provide the NBI Database Values consistent with those required in the 2002 NBI Coding Guide, and specify the units (where appropriate).		
NBI Item No.	NBI Item Description	NBI Database Value
1	State Code	486
5	Inventory Route	1-21-1-0000-0
8	Structure Number	091100AA0878002
19	Bypass, Detour Length (e.g. in miles)	5
26	Functional Classification of Inventory Route	06
27	Year Built	1987
29	Average Daily Traffic	41
49	Structure Length (e.g. in feet)	44
52	Deck Width, Out-to-Out (e.g. in feet)	16.2
60	Substructure	6
61	Channel and Channel Protection	6
71	Waterway Adequacy	4
109	Average Daily Truck Traffic	Unknown
113	Scour Critical Bridges (2002 NBI Guidelines)	U

Undocumented Assumptions

Please provide the following information for the bridge which is not documented in the NBI database.	
Description	User Input
Bridge Type (check only one)	<input checked="" type="checkbox"/> Simple Span(s) <input type="checkbox"/> Continuous Span(s) over 100 ft.
Remaining life of bridge in years. If this bridge has already failed, report the actual lifetime of the bridge before it failed	31 years
Total Bridge Rebuilding Cost, if known. If unknown, estimate the cost by multiplying the bridge area by the cost per unit area as shown in Table 1 and the ADT cost multiplier as shown in Table 2. If estimated, provide the assumptions used in the spaces below: Bridge Area: 713 ft ² ; Cost per unit area: 73 \$/ft ² ; Cost Multiplier: 1	\$52,049.00

Economic Loss Data

Please provide the following economic factors to be associated with the failure of this bridge. Either check the box confirming that the default factor is to be used or provide a different value.		
Description	Default Value	User-Provided Value
Car running cost	\$0.45 per mile <input checked="" type="checkbox"/>	
Truck running cost	\$1.30 per mile <input checked="" type="checkbox"/>	
Duration of detour *	Use Table 2 (days) <input checked="" type="checkbox"/>	1095
Value of time per adult *	Use Table 3 (\$/hr) <input checked="" type="checkbox"/>	6.96
Average car occupancy rate	1.63 people <input checked="" type="checkbox"/>	
Value of time for trucks	\$22.01 per hour <input checked="" type="checkbox"/>	
Average detour speed	40 miles per hour <input checked="" type="checkbox"/>	
Number of deaths from failure *	Use Table 2 (Number of people) <input checked="" type="checkbox"/>	0
Cost for each life lost	\$500,000 <input checked="" type="checkbox"/>	

* Please select an appropriate value from the reference table listed.

Cost of Analysis or Corrective Actions

Provide estimates for the following costs. Keep in mind that these costs may depend on a number of factors, e.g., the number of piers, abutments, etc. Also keep in mind that the guidelines include many significant broad assumptions, so significant effort is not warranted in estimating this data.	
Description	User Input
Estimated cost of installing automated scour monitoring	\$ No information
Estimated cost of installing scour countermeasures	\$ No information
Estimated cost of field reconnaissance to determine foundation type and depth (nondestructive testing, borings, etc.)	\$ N/A
Estimated cost to evaluate scour (survey, hydrology, and hydraulics analysis, if unavailable)	\$3,000.00

Scour Management Evaluation

8. County Road 2342 over BR Alligator Creek

Bridge 091100AA0878002 in Hill County, TX was constructed in 1987 and supports a rural minor arterial class road. This bridge has an unknown foundation depth, and it is further assumed that foundation records can not be found.

Is it a high-priority bridge?

This bridge supports a rural road, which is not a principal arterial, emergency route or provide direct access to other emergency services (e.g. hospital, fire stations, etc.). *Thus, in this context this bridge is not considered a high priority bridge.*

Does the bridge meet the minimum performance level?

The minimum performance level for a rural minor arterial class bridge, according to the guidelines, is 0.0005 – the threshold probability of failure that this bridge must outperform. To estimate this bridge's annual probability of failure, it is first necessary to estimate the overtopping frequency and scour vulnerability of this bridge, as in the table below.

Data/Parameter (source)	Value	Interpretation
NBI item 26 (bridge survey)	6	Rural minor arterial classification
NBI item 71 (bridge survey)	4	Waterway meets the minimum limits for no action
∴ Overtopping Frequency (guidelines)	0	Occasional (once in 3-10 years)
NBI item 60 (bridge survey)	6	Foundation is in satisfactory condition
NBI item 61 (bridge survey)	6	Channel has widespread minor damage
∴ Scour Vulnerability (guidelines)	6	Not yet evaluated, but probably stable
∴ Annual probability of failure (guidelines)	0.0004	A 1 in 2,500 chance of failure in any given year

This bridge meets the minimum performance level because the annual probability of failure is less than 0.0005. However, because the foundation is unknown, we need to determine the most cost effective way to manage this uncertainty.

Is automated scour monitoring warranted?

Automated scour monitoring is considered warranted if the lifetime risk of death is greater than the cost of automated scour monitoring. The lifetime probability of failure for this bridge can be computed from the annual probability of failure and its tentative remaining life (31 years, according to the survey respondent) as follows: $1 - (1 - 0.0004)^{31}$, or about 0.012 (a 1 in 83 chance of failure in the next 31 years). This and other survey data are now used to calculate the risk of death as follows:

$$R_{death} = K \cdot P_L \cdot C_6 \cdot X$$

$$= (1.0) \cdot (0.012 / yr) \cdot (\$500,000 / person) \cdot (0 people) = \$0$$

Since the cost of automated scour monitoring was estimated to be \$20,000 and the risk of death is \$0, *automated scour monitoring may not be warranted.*

Are scour countermeasures warranted?

Scour countermeasures are considered warranted if the lifetime risk of failure is greater than the estimated cost of scour countermeasures, which we estimated to be about \$50,000. The first step in estimating the risk of failure is to estimate the potential cost of failure, assuming that it would need to be replaced. The survey respondent estimated that a new bridge would cost about \$52,049. The car and truck running cost associated with the detour for this bridge is computed from the survey data as follows:

$$\begin{aligned} C_{\text{running}} &= \left[C_2 \cdot \left(1 - \frac{T}{100} \right) + C_3 \cdot \frac{T}{100} \right] \cdot D \cdot A \cdot d \\ &= \left[\$0.45 / \text{mi} \cdot \left(1 - \frac{6}{100} \right) + \$1.30 / \text{mi} \cdot \frac{6}{100} \right] \cdot (5 \text{ mi}) \cdot (41 / \text{day}) \cdot (1095 \text{ days}) \\ &= \$112,462 \end{aligned}$$

The cost of lost wages is computed from the survey data as follows:

$$\begin{aligned} C_{\text{wages}} &= \left[C_4 \cdot O \cdot \left(1 - \frac{T}{100} \right) + C_5 \cdot \frac{T}{100} \right] \cdot \frac{D \cdot A \cdot d}{S} \\ &= \left[(\$6.96 / \text{per}) \cdot (1.63 \text{ per}) \cdot \left(1 - \frac{6}{100} \right) + (\$22.01 / \text{truck}) \cdot \frac{6}{100} \right] \cdot \frac{(5 \text{ mi}) \cdot (41 / \text{day}) \cdot (1095 \text{ days})}{40 \text{ mi} / \text{hr}} \\ &= \$67,257 \end{aligned}$$

When we include the cost of death, the total cost of bridge failure totals \$231,768. Computing the risk of a scour-induced failure over the remaining life of the bridge is just the product of the lifetime probability of failure and the total cost of failure – about \$2,857. *Thus, scour countermeasures are probably not warranted* because the lifetime risk of failure is less than the estimated cost of scour countermeasures.

Recommended management strategy

This bridge meets the performance standards for these guidelines and does not appear to warrant automated scour monitoring or countermeasures. However, because this bridge has an unknown foundation the guidelines strongly recommend that you follow the recommendations in the “Bridge Closure Plan” section of this report.

Furthermore, scour monitoring should be performed with every 2-yr routine bridge inspection for all bridges with unknown foundations. If the scour depth increases more than two feet from baseline conditions (as-built drawings or initial scour survey), action should be taken. The first action is to follow the “Bridge Closure Plan” to take any necessary immediate action. Countermeasures should then be considered for this site; or close or replace the bridge. This two foot trigger can be adjusted based on local geotechnical and engineering considerations and should represent the depth of scour that the bridge engineer feels comfortable with for the individual bridge.

Bridge #9

The Initial Survey

Respondent Information

Name Alan Kowalik	E-mail Address akowali@dot.state.tx.us
Job Title Bridge Inspection Supervisor	Phone 512-416-2208
Job Description (In what way does your job involve bridge maintenance?) Supervise the bridge inspection program and the NBI Database	Mailing Address 125 East 11 th Street Austin, TX 78701

Bridge Description

Please provide a general description of the bridge including its name, location, route, and water body.
County Road 190 (Sandy Road) at Pin Oak Creek – 2 simple span steel I-beams on steel piles

National Bridge Inventory (NBI) Data

Please provide the following information for the bridge. This information should be available in the NBI database. Please provide the NBI Database Values consistent with those required in the 2002 NBI Coding Guide, and specify the units (where appropriate).		
NBI Item No.	NBI Item Description	NBI Database Value
1	State Code	486
5	Inventory Route	1-21-1-01901-0
8	Structure Number	091470AA0173001
19	Bypass, Detour Length (e.g. in miles)	Dean end road
26	Functional Classification of Inventory Route	06
27	Year Built	1987
29	Average Daily Traffic	51
49	Structure Length (e.g. in feet)	31
52	Deck Width, Out-to-Out (e.g. in feet)	15.8
60	Substructure	5
61	Channel and Channel Protection	6
71	Waterway Adequacy	4
109	Average Daily Truck Traffic	Unknown
113	Scour Critical Bridges (2002 NBI Guidelines)	U

Undocumented Assumptions

Please provide the following information for the bridge which is not documented in the NBI database.	
Description	User Input
Bridge Type (check only one)	<input checked="" type="checkbox"/> Simple Span(s) <input type="checkbox"/> Continuous Span(s) over 100 ft.
Remaining life of bridge in years. If this bridge has already failed, report the actual lifetime of the bridge before it failed	31 years
Total Bridge Rebuilding Cost, if known. If unknown, estimate the cost by multiplying the bridge area by the cost per unit area as shown in Table 1 and the ADT cost multiplier as shown in Table 2. If estimated, provide the assumptions used in the spaces below: Bridge Area: 490 ft ² ; Cost per unit area: 73 \$/ft ² ; Cost Multiplier: 1	\$35,770.00

Economic Loss Data

Please provide the following economic factors to be associated with the failure of this bridge. Either check the box confirming that the default factor is to be used or provide a different value.		
Description	Default Value	User-Provided Value
Car running cost	\$0.45 per mile <input checked="" type="checkbox"/>	
Truck running cost	\$1.30 per mile <input checked="" type="checkbox"/>	
Duration of detour *	Use Table 2 (days) <input checked="" type="checkbox"/>	1095
Value of time per adult *	Use Table 3 (\$/hr) <input checked="" type="checkbox"/>	6.96
Average car occupancy rate	1.63 people <input checked="" type="checkbox"/>	
Value of time for trucks	\$22.01 per hour <input checked="" type="checkbox"/>	
Average detour speed	40 miles per hour <input checked="" type="checkbox"/>	
Number of deaths from failure *	Use Table 2 (Number of people) <input checked="" type="checkbox"/>	0
Cost for each life lost	\$500,000 <input checked="" type="checkbox"/>	

* Please select an appropriate value from the reference table listed.

Cost of Analysis or Corrective Actions

Provide estimates for the following costs. Keep in mind that these costs may depend on a number of factors, e.g., the number of piers, abutments, etc. Also keep in mind that the guidelines include many significant broad assumptions, so significant effort is not warranted in estimating this data.	
Description	User Input
Estimated cost of installing automated scour monitoring	\$ No information
Estimated cost of installing scour countermeasures	\$ No information
Estimated cost of field reconnaissance to determine foundation type and depth (nondestructive testing, borings, etc.)	\$ N/A
Estimated cost to evaluate scour (survey, hydrology, and hydraulics analysis, if unavailable)	\$3,000.00

Scour Management Evaluation

9. County Road 190 over Pin Oak Creek

Bridge 091470AA0173001 in Limestone County, TX was constructed in 1987 and supports a rural minor arterial road. This bridge has an unknown foundation depth, and it is further assumed that foundation records can not be found.

Is it a high-priority bridge?

This bridge supports a rural road, which is not a principal arterial, emergency route or provide direct access to other emergency services (e.g. hospital, fire stations, etc.). *Thus, in this context this bridge is not considered a high priority bridge.*

Does the bridge meet the minimum performance level?

The minimum performance level for a rural minor arterial class bridge, according to the guidelines, is 0.0005 – the threshold probability of failure that this bridge must outperform. To estimate this bridge's annual probability of failure, it is first necessary to estimate the overtopping frequency and scour vulnerability of this bridge, as in the table below.

Data/Parameter (source)	Value	Interpretation
NBI item 26 (bridge survey)	6	Rural minor arterial classification
NBI item 71 (bridge survey)	4	Waterway meets the minimum limits for no action
∴ Overtopping Frequency (guidelines)	0	Occasional (once in 3-10 years)
NBI item 60 (bridge survey)	5	Foundation is in fair condition
NBI item 61 (bridge survey)	6	Channel has widespread minor damage
∴ Scour Vulnerability (guidelines)	5	Analysis: stable; Survey: scour is within limits
∴ Annual probability of failure (guidelines)	0.00004	A 1 in 25,000 chance of failure in any given year

This bridge meets the minimum performance level because the annual probability of failure is less than 0.0005. However, because the foundation is unknown, we need to determine the most cost effective way to manage this uncertainty.

Is automated scour monitoring warranted?

Automated scour monitoring is considered warranted if the lifetime risk of death is greater than the cost of automated scour monitoring. The lifetime probability of failure for this bridge can be computed from the annual probability of failure and its tentative remaining life (31 years, according to the survey respondent) as follows: $1 - (1 - 0.00004)^{31}$, or about 0.0012 (a 1 in 833 chance of failure in the next 31 years). This and other survey data are now used to calculate the risk of death as follows:

$$R_{death} = K \cdot P_L \cdot C_6 \cdot X$$

$$= (1.0) \cdot (0.0012 / yr) \cdot (\$500,000 / person) \cdot (0 people) = \$0$$

Since the cost of automated scour monitoring was estimated to be \$20,000 and the risk of death is \$0, *automated scour monitoring may not be warranted.*

Are scour countermeasures warranted?

Scour countermeasures are considered warranted if the lifetime risk of failure is greater than the estimated cost of scour countermeasures, which we estimated to be about \$50,000. The first step in estimating the risk of failure is to estimate the potential cost of failure, assuming that it would need to be replaced. The survey respondent estimated that a new bridge would cost about \$35,770. The car and truck running cost associated with the detour for this bridge is computed from the survey data as follows:

$$\begin{aligned} C_{\text{running}} &= \left[C_2 \cdot \left(1 - \frac{T}{100} \right) + C_3 \cdot \frac{T}{100} \right] \cdot D \cdot A \cdot d \\ &= \left[\$0.45 / \text{mi} \cdot \left(1 - \frac{6}{100} \right) + \$1.30 / \text{mi} \cdot \frac{6}{100} \right] \cdot (6 \text{ mi}) \cdot (51 / \text{day}) \cdot (1095 \text{ days}) \\ &= \$167,870 \end{aligned}$$

The cost of lost wages is computed from the survey data as follows:

$$\begin{aligned} C_{\text{wages}} &= \left[C_4 \cdot O \cdot \left(1 - \frac{T}{100} \right) + C_5 \cdot \frac{T}{100} \right] \cdot \frac{D \cdot A \cdot d}{S} \\ &= \left[(\$6.96 / \text{per}) \cdot (1.63 \text{ per}) \cdot \left(1 - \frac{6}{100} \right) + (\$22.01 / \text{truck}) \cdot \frac{6}{100} \right] \cdot \frac{(6 \text{ mi}) \cdot (51 / \text{day}) \cdot (1095 \text{ days})}{40 \text{ mi} / \text{hr}} \\ &= \$100,393 \end{aligned}$$

When we include the cost of death, the total cost of bridge failure totals \$304,033. Computing the risk of a scour-induced failure over the remaining life of the bridge is just the product of the lifetime probability of failure and the total cost of failure – about \$377. *Thus, scour countermeasures are probably not warranted* because the lifetime risk of failure is less than the estimated cost of scour countermeasures.

Recommended management strategy

This bridge meets the performance standards for these guidelines and does not appear to warrant automated scour monitoring or countermeasures. However, because this bridge has an unknown foundation the guidelines strongly recommend that you follow the recommendations in the “Bridge Closure Plan” section of this report.

Furthermore, scour monitoring should be performed with every 2-yr routine bridge inspection for all bridges with unknown foundations. If the scour depth increases more than two feet from baseline conditions (as-built drawings or initial scour survey), action should be taken. The first action is to follow the “Bridge Closure Plan” to take any necessary immediate action. Countermeasures should then be considered for this site; or close or replace the bridge. This two foot trigger can be adjusted based on local geotechnical and engineering considerations and should represent the depth of scour that the bridge engineer feels comfortable with for the individual bridge.

Bridge #10

The Initial Survey

Respondent Information

Name Alan Kowalik	E-mail Address akowali@dot.state.tx.us
Job Title Bridge Inspection Supervisor	Phone 512-416-2208
Job Description (In what way does your job involve bridge maintenance?) Supervise the bridge inspection program and the NBI Database	Mailing Address 125 East 11 th Street Austin, TX 78701

Bridge Description

Please provide a general description of the bridge including its name, location, route, and water body.
County Road 421 at Pin Oak Creek – 2 span continuous steel I-beam on steel piles

National Bridge Inventory (NBI) Data

Please provide the following information for the bridge. This information should be available in the NBI database. Please provide the NBI Database Values consistent with those required in the 2002 NBI Coding Guide, and specify the units (where appropriate).		
NBI Item No.	NBI Item Description	NBI Database Value
1	State Code	486
5	Inventory Route	1-21-1-0421-0
8	Structure Number	091470AA0327001
19	Bypass, Detour Length (e.g. in miles)	1
26	Functional Classification of Inventory Route	06
27	Year Built	1987
29	Average Daily Traffic	51
49	Structure Length (e.g. in feet)	40
52	Deck Width, Out-to-Out (e.g. in feet)	16.1
60	Substructure	5
61	Channel and Channel Protection	5
71	Waterway Adequacy	3
109	Average Daily Truck Traffic	Unknown
113	Scour Critical Bridges (2002 NBI Guidelines)	U

Undocumented Assumptions

Please provide the following information for the bridge which is not documented in the NBI database.	
Description	User Input
Bridge Type (check only one)	<input checked="" type="checkbox"/> Simple Span(s) <input type="checkbox"/> Continuous Span(s) over 100 ft.
Remaining life of bridge in years. If this bridge has already failed, report the actual lifetime of the bridge before it failed	10 years
Total Bridge Rebuilding Cost, if known. If unknown, estimate the cost by multiplying the bridge area by the cost per unit area as shown in Table 1 and the ADT cost multiplier as shown in Table 2. If estimated, provide the assumptions used in the spaces below: Bridge Area: 644 ft ² ; Cost per unit area: 73 \$/ft ² ; Cost Multiplier: 1	\$47,012

Economic Loss Data

Please provide the following economic factors to be associated with the failure of this bridge. Either check the box confirming that the default factor is to be used or provide a different value.		
Description	Default Value	User-Provided Value
Car running cost	\$0.45 per mile <input checked="" type="checkbox"/>	
Truck running cost	\$1.30 per mile <input checked="" type="checkbox"/>	
Duration of detour *	Use Table 2 (days) <input checked="" type="checkbox"/>	1095
Value of time per adult *	Use Table 3 (\$/hr) <input checked="" type="checkbox"/>	6.96
Average car occupancy rate	1.63 people <input checked="" type="checkbox"/>	
Value of time for trucks	\$22.01 per hour <input checked="" type="checkbox"/>	
Average detour speed	40 miles per hour <input checked="" type="checkbox"/>	
Number of deaths from failure *	Use Table 2 (Number of people) <input checked="" type="checkbox"/>	0
Cost for each life lost	\$500,000 <input checked="" type="checkbox"/>	

* Please select an appropriate value from the reference table listed.

Cost of Analysis or Corrective Actions

Provide estimates for the following costs. Keep in mind that these costs may depend on a number of factors, e.g., the number of piers, abutments, etc. Also keep in mind that the guidelines include many significant broad assumptions, so significant effort is not warranted in estimating this data.	
Description	User Input
Estimated cost of installing automated scour monitoring	\$ No information
Estimated cost of installing scour countermeasures	\$ No information
Estimated cost of field reconnaissance to determine foundation type and depth (nondestructive testing, borings, etc.)	\$ N/A
Estimated cost to evaluate scour (survey, hydrology, and hydraulics analysis, if unavailable)	\$3,000.00

Scour Management Evaluation

10. County Road 421 over Pin Oak Creek

Bridge 091470AA0327001 in Limestone County, TX was constructed in 1987 and supports a rural minor arterial class road. This bridge has an unknown foundation depth, and it is further assumed that foundation records can not be found.

Is it a high-priority bridge?

This bridge supports a rural road, which is not a principal arterial, emergency route or provide direct access to other emergency services (e.g. hospital, fire stations, etc.). *Thus, in this context this bridge is not considered a high priority bridge.*

Does the bridge meet the minimum performance level?

The minimum performance level for a rural minor arterial class bridge, according to the guidelines, is 0.0005 – the threshold probability of failure that this bridge must outperform. To estimate this bridge’s annual probability of failure, it is first necessary to estimate the overtopping frequency and scour vulnerability of this bridge, as in the table below.

Data/Parameter (source)	Value	Interpretation
NBI item 26 (bridge survey)	6	Rural minor arterial classification
NBI item 71 (bridge survey)	3	Waterway is a high priority for corrective action
∴ Overtopping Frequency (guidelines)	0	Occasional (once in 3-10 years)
NBI item 60 (bridge survey)	5	Foundation is in fair condition
NBI item 61 (bridge survey)	5	Channel banks are eroding; major damage
∴ Scour Vulnerability (guidelines)	5	Analysis: stable; Survey: scour is within limits
∴ Annual probability of failure (guidelines)	0.00004	A 1 in 25,000 chance of failure in any given year

This bridge meets the minimum performance level because the annual probability of failure is less than 0.0005. However, because the foundation is unknown, we need to determine the most cost effective way to manage this uncertainty.

Is automated scour monitoring warranted?

Automated scour monitoring is considered warranted if the lifetime risk of death is greater than the cost of automated scour monitoring. The lifetime probability of failure for this bridge can be computed from the annual probability of failure and its tentative remaining life (10 years, according to the survey respondent) as follows: $1 - (1 - 0.00004)^{10}$, or about 0.0004 (a 1 in 2,500 chance of failure in the next 10 years). This and other survey data are now used to calculate the risk of death as follows:

$$R_{death} = K \cdot P_L \cdot C_6 \cdot X$$

$$= (1.0) \cdot (0.0004 / yr) \cdot (\$500,000 / person) \cdot (0 people) = \$0$$

Since the cost of automated scour monitoring was estimated to be \$20,000 and the risk of death is \$0, *automated scour monitoring may not be warranted.*

Are scour countermeasures warranted?

Scour countermeasures are considered warranted if the lifetime risk of failure is greater than the estimated cost of scour countermeasures, which we estimated to be about \$50,000. The first step in estimating the risk of failure is to estimate the potential cost of failure, assuming that it would need to be replaced. The survey respondent estimated that a new bridge would cost about \$47,012. The car and truck running cost associated with the detour for this bridge is computed from the survey data as follows:

$$\begin{aligned} C_{\text{running}} &= \left[C_2 \cdot \left(1 - \frac{T}{100} \right) + C_3 \cdot \frac{T}{100} \right] \cdot D \cdot A \cdot d \\ &= \left[\$0.45 / \text{mi} \cdot \left(1 - \frac{6}{100} \right) + \$1.30 / \text{mi} \cdot \frac{6}{100} \right] \cdot (1 \text{ mi}) \cdot (51 / \text{day}) \cdot (1095 \text{ days}) \\ &= \$27,978 \end{aligned}$$

The cost of lost wages is computed from the survey data as follows:

$$\begin{aligned} C_{\text{wages}} &= \left[C_4 \cdot O \cdot \left(1 - \frac{T}{100} \right) + C_5 \cdot \frac{T}{100} \right] \cdot \frac{D \cdot A \cdot d}{S} \\ &= \left[(\$6.96 / \text{per}) \cdot (1.63 \text{ per}) \cdot \left(1 - \frac{6}{100} \right) + (\$22.01 / \text{truck}) \cdot \frac{6}{100} \right] \cdot \frac{(1 \text{ mi}) \cdot (51 / \text{day}) \cdot (1095 \text{ days})}{40 \text{ mi} / \text{hr}} \\ &= \$16,732 \end{aligned}$$

When we include the cost of death, the total cost of bridge failure totals \$91,723. Computing the risk of a scour-induced failure over the remaining life of the bridge is just the product of the lifetime probability of failure and the total cost of failure – about \$37. *Thus, scour countermeasures are probably not warranted* because the lifetime risk of failure is less than the estimated cost of scour countermeasures.

Recommended management strategy

This bridge meets the performance standards for these guidelines and does not appear to warrant automated scour monitoring or countermeasures. However, because this bridge has an unknown foundation the guidelines strongly recommend that you follow the recommendations in the “Bridge Closure Plan” section of this report.

Furthermore, scour monitoring should be performed with every 2-yr routine bridge inspection for all bridges with unknown foundations. If the scour depth increases more than two feet from baseline conditions (as-built drawings or initial scour survey), action should be taken. The first action is to follow the “Bridge Closure Plan” to take any necessary immediate action. Countermeasures should then be considered for this site; or close or replace the bridge. This two foot trigger can be adjusted based on local geotechnical and engineering considerations and should represent the depth of scour that the bridge engineer feels comfortable with for the individual bridge.

Response to Evaluations

Alan Kowalik, a bridge inspection branch manager, completed the bridge surveys for Keith Ramsey but forwarded the task of commenting on the evaluations to Mark McClellan, a bridge scour engineer. Mark McClellan commented via phone that the guidelines appear to be a good first step, but that they would benefit from better indicators of scour vulnerability. He also stated that he does not think that NBI substructure code (NBI item 60) is a reliable indicator of a foundation's vulnerability.

APPENDIX G. SCOUR EVALUATION FORMS AND TABLES

This appendix collects into one place all of the basic forms and tables that a practitioner will need in order to implement the scour risk management guidelines. Thus, this appendix is intended to help the practitioner who has already read the main report implement the guidelines efficiently.

Data Collection

The following three-page bridge survey (see Appendix F) provides a useful checklist for the input data needed to implement the scour guidelines. It also reproduces useful information from Tables 3, 8, 9, 10, and 11 in the main report.

Bridge # _____**Page 1**

Respondent Information

Name	E-mail Address
Job Title	Phone
Job Description (In what way does your job involve bridge maintenance?)	Mailing Address

Bridge Description

Please provide a general description of the bridge including its name, location, route, and water body.

National Bridge Inventory (NBI) Data

Please provide the following information for the bridge. This information should be available in the NBI database. Please provide the NBI Database Values consistent with those required in the 2002 NBI Coding Guide, and specify the units (where appropriate).		
NBI Item No.	NBI Item Description	NBI Database Value
1	State Code	
5	Inventory Route	
8	Structure Number	
19	Bypass, Detour Length (e.g. in miles)	
26	Functional Classification of Inventory Route	
27	Year Built	
29	Average Daily Traffic	
49	Structure Length (e.g. in feet)	
52	Deck Width, Out-to-Out (e.g. in feet)	
60	Substructure	
61	Channel and Channel Protection	
71	Waterway Adequacy	
109	Average Daily Truck Traffic	
113	Scour Critical Bridges (2002 NBI Guidelines)	

Page 2**Undocumented Assumptions**

Please provide the following information for the bridge which is not documented in the NBI database.	
Description	User Input
Bridge Type (check only one)	<input type="checkbox"/> Simple Span(s) <input type="checkbox"/> Continuous Span(s) over 100 ft.
Remaining life of bridge in years. If this bridge has already failed, report the actual lifetime of the bridge before it failed	_____ years
Total Bridge Rebuilding Cost, if known. If unknown, estimate the cost by multiplying the bridge area by the cost per unit area as shown in Table 1 and the ADT cost multiplier as shown in Table 2. If estimated, provide the assumptions used in the spaces below:	\$ _____
Bridge Area: _____ ft ² ; Cost per unit area: _____ \$/ft ² ; Cost Multiplier: _____	

Economic Loss Data

Please provide the following economic factors to be associated with the failure of this bridge. Either check the box confirming that the default factor is to be used or provide a different value.		
Description	Default Value	User-Provided Value
Car running cost	\$0.45 per mile <input type="checkbox"/>	
Truck running cost	\$1.30 per mile <input type="checkbox"/>	
Duration of detour *	Use Table 2 (days) <input type="checkbox"/>	
Value of time per adult *	Use Table 3 (\$/hr) <input type="checkbox"/>	
Average car occupancy rate	1.63 people <input type="checkbox"/>	
Value of time for trucks	\$22.01 per hour <input type="checkbox"/>	
Average detour speed	40 miles per hour <input type="checkbox"/>	
Number of deaths from failure *	Use Table 2 (Number of people) <input type="checkbox"/>	
Cost for each life lost	\$500,000 <input type="checkbox"/>	

* Please select an appropriate value from the reference table listed.

Cost of Analysis or Corrective Actions

Provide estimates for the following costs. Keep in mind that these costs may depend on a number of factors, e.g., the number of piers, abutments, etc. Also keep in mind that the guidelines include many significant broad assumptions, so significant effort is not warranted in estimating this data.	
Description	User Input
Estimated cost of installing automated scour monitoring	\$ _____
Estimated cost of installing scour countermeasures	\$ _____
Estimated cost of field reconnaissance to determine foundation type and depth (nondestructive testing, borings, etc.)	\$ _____
Estimated cost to evaluate scour (survey, hydrology, and hydraulics analysis, if unavailable)	\$ _____

Table 1 Cost of Bridge Construction**Page 3**

Bridge Superstructure Type	Total Cost (\$/ft ²)
Reinforced concrete flat slab; simple span	\$50-65*
Reinforced concrete flat slab; continuous span	\$60-80*
Steel deck/girder; simple span	\$62-75*
Steel deck/girder; continuous span	\$70-90*
Pre-stressed concrete deck/girder; simple span	\$50-70*
Pre-stressed concrete deck/girder; continuous span	\$65-110*
Post-tensioned, cast-in-place, concrete box girder cast on scaffolding; span length <=240 ft	\$75-110
<i>Steel Box Deck/Girder:</i>	
Span range from 150 ft to 280 ft	\$76-120
For curvature add a 15 percent premium segmental concrete box girders; span range from 150 ft to 280 ft	\$80-110
Movable bridges; bascule spans & piers	\$900-1500
<i>Demolition of existing bridges:</i>	
Typical	\$9-15
Bascule spans & piers	\$63

* Increase the cost by twenty percent for phased construction.

Source: <http://www.dot.state.fl.us/structures/Manuals/LRFDSDG2002AugChap11.pdf> visited on January 12, 2005.**Table 2 Bridge Failure Statistics versus Average Daily Traffic**

Average Daily Traffic (ADT)	Cost Multiplier for Early Replacement	Detour Duration (days)	Number of Lives Lost
ADT < 100	1.0	1,095	0
100 < ADT < 500	1.1	730	1
500 < ADT < 1000	1.25	548	2
1000 < ADT < 5000	1.5	365	2
ADT > 5000	2.0	183	5* - 10†

* Not an interstate or arterial. † Interstate or arterial.

Table 3 Values of Time by State

State	Value of time (\$/hour)	State	Value of time (\$/hour)
Alabama	\$6.29	Montana	\$5.89
Alaska	\$8.31	Nebraska	\$6.51
Arizona	\$6.88	Nevada	\$6.76
Arkansas	\$5.83	New Hampshire	\$7.38
California	\$8.27	New Jersey	\$8.48
Colorado	\$7.85	New Mexico	\$6.51
Connecticut	\$8.75	New York	\$8.59
Delaware	\$7.70	North Carolina	\$6.72
District of Columbia	\$11.43	North Dakota	\$6.04
Florida	\$6.65	Ohio	\$7.08
Georgia	\$7.06	Oklahoma	\$6.14
Guam	\$5.41	Oregon	\$7.29
Hawaii	\$7.24	Pennsylvania	\$7.09
Idaho	\$6.46	Puerto Rico	\$4.35
Illinois	\$7.61	Rhode Island	\$7.54
Indiana	\$6.67	South Carolina	\$6.29
Iowa	\$6.31	South Dakota	\$5.73
Kansas	\$6.66	Tennessee	\$6.45
Kentucky	\$6.34	Texas	\$6.96
Louisiana	\$6.16	Utah	\$6.72
Maine	\$6.60	Vermont	\$6.83
Maryland	\$8.15	Virgin Islands	\$5.58
Massachusetts	\$8.93	Virginia	\$7.71
Michigan	\$7.80	Washington	\$8.06
Minnesota	\$7.85	West Virginia	\$6.01
Mississippi	\$5.65	Wisconsin	\$6.95
Missouri	\$6.79	Wyoming	\$6.41

State wage data is from <http://www.bls.gov/oes/current/oesrcst.htm>, visited on January 12, 2006. This table assumes that the value of time is equal to 41% of the mean hourly wage, as proposed by José A. Gómez-Ibáñez, William B. Tye, Clifford Winston, "Essays in Transportation Economics and Policy: A Handbook in Honor of John R. Meyer", 1999.

Scour Risk Probability Tables

Tables 12 – 14 from the main report are reproduced here to help the practitioner estimate the probability of scour failure.

Table 18 Overtopping Frequency

Functional Class: (NBI Item 26 Code)	Waterway Adequacy (NBI Item 71 Code)										
	(0)	(1)	(2)	(3)	(4)	(5)	(6)	(7)	(8)	(9)	(N)
<i>Principal Arterials, Interstates (01, 11)</i>			O	O	O	O	S	S	S	R	N
<i>Freeways, Expressways (12)</i>	Bridge Closed Unused										
<i>Other Principal Arterials (02, 14)</i>		F	O	O	O	S	S	S	R	N	
<i>Minor Arterials (06, 16)</i>											
<i>Major Collectors (07, 17)</i>											
<i>Minor Collectors (08)</i>		F	F	O	O	O	S	S	R	N	
<i>Locals (09, 19)</i>											

Key: N = Never; R = Remote (T > 100 yr); S = Slight (T = 11-100 yr);
O = Occasional (T = 3-10 yr); F = Frequent (T < 3 yr)

Table 19 Scour Vulnerability

Channel Protection (NBI Item 61 Code)	Substructure Condition (NBI Item 60 Code)										
	(0) Failed	(1) Imminent Failure	(2) Critical Condition	(3) Serious Condition	(4) Poor Condition	(5) Fair Condition	(6) Satisfactory condition	(7) Good Condition	(8) Very Good Condition	(9) Excellent Condition	(N) Not Applicable
<i>(0) Failure</i>	0	0	0	0	0	0	0	0	0	0	0
<i>(1) Failure</i>	0	1	1	1	1	1	1	1	1	1	N
<i>(2) Near Collapse</i>	0	1	2	2	2	2	2	2	2	2	N
<i>(3) Channel Migration</i>	0	1	2	2	3	4	4	4	4	4	N
<i>(4) Undermined Bank</i>	0	1	2	3	4	4	5	5	6	6	N
<i>(5) Eroded Bank</i>	0	1	2	3	4	5	5	6	7	7	N
<i>(6) Bed Movement</i>	0	1	2	3	4	5	6	6	7	7	N
<i>(7) Minor Drift</i>	0	1	2	3	4	6	6	7	7	8	N
<i>(8) Stable Condition</i>	0	1	2	3	4	6	7	7	8	8	N
<i>(9) No Deficiencies</i>	0	1	2	3	4	7	7	8	8	9	N
<i>(N) Not Over Water</i>	0	1	N	N	N	N	N	N	N	N	N

Table 20 Annual Probability of Scour Failure

Scour Vulnerability (from Table 19)	Overtopping Frequency (from Table 18)			
	Remote (R)	Slight (S)	Occasional (O)	Frequent (F)
(0) Failed	1	1	1	1
(1) Imminent failure	0.01	0.01	0.01	0.01
(2) Critical scour	0.005	0.006	0.008	0.009
(3) Serious scour	0.0011	0.0013	0.0016	0.002
(4) Advanced scour	0.0004	0.0005	0.0006	0.0007
(5) Minor scour	0.000007	0.000008	0.00004	0.00007
(6) Minor deterioration	0.00018	0.00025	0.0004	0.0005
(7) Good condition	0.00018	0.00025	0.0004	0.0005
(8) Very good condition	0.000004	0.000005	0.00002	0.00004
(9) Excellent condition	0.0000025	0.000003	0.000004	0.000007

Minimum Performance Levels

Table 27 from the main report is reproduced here to help the practitioner assess the maximum annual probability of scour failure that is acceptable for different bridge classes.

Table 21 Minimum Performance Levels

NBI Code	Description	Minimum Performance Level (Threshold Probability of Failure)
<i>Rural</i>		
01, 02	Principal Arterial – All	0.0001
06, 07	Minor Arterial or Major Collector	0.0005
08	Minor Collector	0.001
09	Local	0.002
<i>Urban</i>		
11, 12, 14	Principal Arterial – All	0.0001
16	Minor Arterial	0.0002
17	Collector	0.0005
19	Local	0.002