



Use of Inclinedometers for Geotechnical Instrumentation on Transportation Projects

DETAILS

0 pages | null | PAPERBACK

ISBN 978-0-309-42952-8 | DOI 10.17226/23074

AUTHORS

BUY THIS BOOK

FIND RELATED TITLES

Visit the National Academies Press at NAP.edu and login or register to get:

- Access to free PDF downloads of thousands of scientific reports
- 10% off the price of print titles
- Email or social media notifications of new titles related to your interests
- Special offers and discounts



Distribution, posting, or copying of this PDF is strictly prohibited without written permission of the National Academies Press. (Request Permission) Unless otherwise indicated, all materials in this PDF are copyrighted by the National Academy of Sciences.

TRANSPORTATION RESEARCH
CIRCULAR

Number E-C129

October 2008

**Use of Inclometers
for Geotechnical
Instrumentation on
Transportation Projects**

State of the Practice

TRANSPORTATION RESEARCH BOARD
OF THE NATIONAL ACADEMIES

**TRANSPORTATION RESEARCH BOARD
2008 EXECUTIVE COMMITTEE OFFICERS**

Chair: Debra L. Miller, Secretary, Kansas Department of Transportation, Topeka

Vice Chair: Adib K. Kanafani, Cahill Professor of Civil Engineering, University of California, Berkeley

Division Chair for NRC Oversight: C. Michael Walton, Ernest H. Cockrell Centennial Chair in Engineering, University of Texas, Austin

Executive Director: Robert E. Skinner, Jr., Transportation Research Board

**TRANSPORTATION RESEARCH BOARD
2008–2009 TECHNICAL ACTIVITIES COUNCIL**

Chair: Robert C. Johns, Director, Center for Transportation Studies, University of Minnesota, Minneapolis

Technical Activities Director: Mark R. Norman, Transportation Research Board

Paul H. Bingham, Principal, Global Insight, Inc., Washington, D.C., *Freight Systems Group Chair*

Shelly R. Brown, Principal, Shelly Brown Associates, Seattle, Washington, *Legal Resources Group Chair*

Cindy J. Burbank, National Planning and Environment Practice Leader, PB, Washington, D.C., *Policy and Organization Group Chair*

James M. Crites, Executive Vice President, Operations, Dallas–Fort Worth International Airport, Texas, *Aviation Group Chair*

Leanna Depue, Director, Highway Safety Division, Missouri Department of Transportation, Jefferson City, *System Users Group Chair*

Arlene L. Dietz, A&C Dietz and Associates, LLC, Salem, Oregon, *Marine Group Chair*

Robert M. Dorer, Deputy Director, Office of Surface Transportation Programs, Volpe National Transportation Systems Center, Research and Innovative Technology Administration, Cambridge, Massachusetts, *Rail Group Chair*

Karla H. Karash, Vice President, TranSystems Corporation, Medford, Massachusetts, *Public Transportation Group Chair*

Mary Lou Ralls, Principal, Ralls Newman, LLC, Austin, Texas, *Design and Construction Group Chair*

Katherine F. Turnbull, Associate Director, Texas Transportation Institute, Texas A&M University, College Station, *Planning and Environment Group Chair*

Daniel S. Turner, Professor, University of Alabama, and Director, University Transportation Center for Alabama, Tuscaloosa, *Operations and Preservation Group Chair*

TRANSPORTATION RESEARCH CIRCULAR E-C129

Use of Inclinometers for Geotechnical Instrumentation on Transportation Projects

State of the Practice

George Machan
Landslide Technology

and

Victoria G. Bennett
Rensselaer Polytechnic Institute (RPI)

Sponsored by
Transportation Research Board
Soils and Rock Instrumentation Committee
Engineering Geology Committee

October 2008

Transportation Research Board
500 Fifth Street, NW
Washington, DC 20001
www.TRB.org

TRANSPORTATION RESEARCH CIRCULAR E-C129

ISSN 0097-8515

The **Transportation Research Board** is one of six major divisions of the National Research Council, which serves as an independent adviser to the federal government and others on scientific and technical questions of national importance. The National Research Council is jointly administered by the National Academy of Sciences, the National Academy of Engineering, and the Institute of Medicine. The mission of the Transportation Research Board is to provide leadership in transportation innovation and progress through research and information exchange, conducted within a setting that is objective, interdisciplinary, and multimodal.

The **Transportation Research Board** is distributing this Circular to make the information contained herein available for use by individual practitioners in state and local transportation agencies, researchers in academic institutions, and other members of the transportation research community. The information in this Circular was taken directly from the submission of the authors. This document is not a report of the National Research Council or of the National Academy of Sciences.

Design and Construction Group

Mary Lou Ralls, *Chair*

Soil Mechanics Section

Njoroge W. Wainaina, *Chair*

Soils and Rock Instrumentation Committee

Anand J. Puppala, *Chair*

Khalid A. Alshibli
Steven F. Bartlett
Christopher C. Benda
Victoria G. Bennett
James Tanner Blackburn
Dar-Hao Chen

Louis Ge
Sarah Rebecca Jersey
Maureen E. Kelley
Aziz Rehman Khan
Kyung Jun Kim
Brian A. Liebich
Songyu Liu

George Machan
Silas Craig Nichols
Kevin M. O'Connor
Phillip Ooi
Peter W. Osborn
Kerry W. Petrasic
Rudy Saavedra

Thomas C. Sandford
Marika Caterina Santagata
Thomas C. Sheahan
T. G. Sitharam
W. J. van der Merwe Steyn
Fulvio Tonon

Geology and Properties of Earth Materials Section

D. Stephen Lane, *Chair*

Engineering Geology Committee

Thomas C. Badger, *Chair*

Richard Dean Andrew
Vanessa C. Bateman
Joseph C. Bigger
Chris Bunce
Jim Coffin
Richard Hurlbut Cross

Krystle J. Day
Marc Fish
Douglas James Hadjin
Robert W. Henthorne
Jerry D. Higgins
Daniel Journeaux
Jody C. Kuhne

Lanbo Liu
Toshimitsu Nomura
Lawrence Albert Pierson
Michel Richard
Benjamin S. Rivers
L. Rick Ruegsegger
Abdul Shakoor

Sunil Sharma
Barry D. Siel
David Stanley
Danny Van Roosendaal
A. Keith Turner
Duncan C. Wyllie

G. P. Jayaprakash, *TRB Staff Representative*
Michael DeCarmine, *Senior Program Assistant*

Transportation Research Board

500 Fifth Street, NW
Washington, DC 20001

www.TRB.org

Glenda J. Beal, Production Editor; Jennifer Corroero, Proofreader and Layout

Foreword

Instrumentation of geotechnical structures in the field has been beneficial in evaluating the movements and failures in the structures under real field conditions, as well as assessing the performance of new materials and methods used in the design and construction of geostructures. Instrumentation that monitors ground deformation response has been used mainly for slope stability studies of natural slopes and performance assessments of earth and pavement structures and the use of new materials such as lightweight embankment materials and construction methods such as mechanically stabilized earth wall systems and deep soil mixing. The Transportation Research Board's (TRB) Soil and Rock Instrumentation Committee initiated the development of an e-circular on the use of inclinometers to facilitate technology transfer to state department of transportation (DOT) engineers and researchers responsible for designing the instrumentation of geotechnical and pavement structures.

This e-circular documents the state of the practice and representative applications on the use of inclinometer systems for measuring ground deformation and performance of geotechnical design elements on transportation projects. Inclinometer components and installation details are described. Information on planning inclinometer installation, acquiring and displaying data, and interpreting test results is provided. Additional references are cited for different areas of interest.

The TRB Soil and Rock Instrumentation and Engineering Geology Committees sincerely thank George Machan for his leadership and hard work in compiling the e-circular. Special thanks also go to coauthor Victoria G. Bennett for her contributions to this report. We also acknowledge Thomas C. Sheahan for initiating the development of the e-circular as the past committee chair. The committees also acknowledge the efforts of members and friends who peer reviewed the document and provided valuable suggestions. Finally, we thank TRB Staff Representative G. P. Jayaprakash for providing continued support and assistance during this project.

—Anand J. Puppala
Chair, Soil and Rock Instrumentation Committee (Lead)

—Thomas L. Badger
Chair, Engineering Geology Committee



Inclinometer used for monitoring roadway stability in Yellowstone National Park (Beckstrand).



Inclinometer installed for monitoring settlement of base (Puppala).

Contents

Introduction	1
Description.....	1
Scope.....	1
Inclinometer Usage in Geotechnical Applications	2
Landslide Investigations	2
Monitoring Slope Stability	2
Monitoring Retaining Structure Performance	2
Monitoring Excavations near Facilities	3
Monitoring Pile and Drilled Pier Performance	3
Monitoring Settlement of Embankments.....	3
Monitoring Deformation of Pavement Base.....	4
Monitoring Performance During Tunneling.....	4
Description of Inclinometer Instrument Components	5
Probe Types	5
Traversing Inclinometer System.....	5
In-Place or Stationary Inclinometers: IPI Systems	8
Inclinometer Instrumentation Planning and Selection	11
Project Parameters	11
Probe Type.....	11
Equipment Compatibility.....	12
Conformance.....	12
Guide Casing Types and Sizes	12
Telescoping Casing Connections.....	14
Data Acquisition: Readout Device	14
Control Cable.....	15
Installation	16
Inclinometer Casing in Vertical Applications	16
Inclinometer Casing in Horizontal Applications	20
Inclinometer Casing Attached or Embedded in Structures.....	21
Protection of Inclinometer Casing	22
Modifications and Repair to Inclinometer Casing.....	22
Extending the Measurement Capabilities of Inclinometer Casings.....	23

Fixed-in-Place Inclinometer Probe	25
Instrumentation Calibration, Care, and Maintenance	26
Measurement and Data Acquisition	27
Traversing Inclinometer Probe	27
Fixed-in-Place Inclinometer Probe and Automated Data Acquisition	29
Data Analysis and Presentation	31
Checking and Evaluating Data Measurements	31
Diagnostics for Systematic Errors	34
Evaluation and Interpretation	36
Other Ground Monitoring Methods	38
Visual Monitoring.....	38
Telltales.....	38
Surface Surveying.....	38
GPS Remote Monitoring Systems	39
TDR Cable.....	39
Settlement Platforms.....	39
Hydraulic Manometers–Gages	39
Electrolevel Sensors.....	39
Interferometric Synthetic Aperture Radar	40
Ground-Based LIDAR.....	40
Developing Technologies for Monitoring Ground Movement	41
TDR Cable.....	41
Digital-Bluetooth Inclinometers	41
Wireless In-Place MEMS Systems	41
Vibrating Wire Inclinometers	41
Fiber-Optic Inclinometers.....	42
Acknowledgments	43
Bibliography	44
List of Manufacturers	48

Appendix: Inclinometer Instrumentation for Transportation Projects
Workshop, January 2008: Powerpoint Presentations49

- Inclinometer Instrumentation in Transportation50
George Machan
- Inclinometer Basics52
George Pecha
- In-Place Inclinometers60
W. Allen Marr
- Inclinometers for Landslide Characterization65
Tom Badger
- Vertical Inclinometers in a Reinforced Abutment Fill70
Chris Kreider
- Earth Retention and Deep Excavation Monitoring with Inclinometers.....72
Tanner Blackburn
- Inclinometer Instrumentation for Transportation Projects:
Embankments and Pavements74
Anand J. Puppala



Inclinometer installed between a shored excavation and an existing building (Blackburn).

Introduction

The purpose of this Circular is to provide updated information on the state of the practice for the use of inclinometers on highway projects. This instrument technology has more than 50 years of experience. Data evaluation and correction procedures have improved with increased knowledge and introduction of analytical and graphing software. However, correcting inclinometer results for systematic errors is not widely understood and is not common practice. Guidance provided by American Association of State Highway and Transportation Officials (AASHTO, 1980) has not been updated since 1980 and ASTM (2005) does not present evaluative procedures. This Circular identifies the key aspects of inclinometer usage and provides references for further guidance and technical descriptions.

DESCRIPTION

Vertical inclinometers are instruments for measuring relative horizontal displacements affecting the shape of a guide casing embedded in the ground or structure. Inclinometer probes usually measure displacement in two perpendicular planes; therefore, displacement magnitudes and directions (vectors) can be calculated. The bottom end of the guide casing serves as a stable reference (datum) and must be embedded beyond the displacement zone. Relative displacement over time is determined by repeating measurements at the same depths and comparing data sets. The guide casing is installed vertically for most applications in order to measure horizontal ground movements. Less common are horizontal installations that use a specialized probe to monitor settlement. In rare cases, guide casings can be installed in inclined boreholes where access is limited and prevents vertical installations in the preferred locations, or where the feature to be monitored is inclined. However, casing inclination is typically restricted to 30 degrees from vertical due to the potential for errors.

SCOPE

This Circular focuses on the most commonly used instrument type, the inclinometer probe with servo-accelerometers, which was introduced to the industry in 1969. The type of inclinometer commonly used is a traversing probe, which is inserted into the casing full depth and used to record casing inclination at predetermined intervals to develop a continuous profile of the shape of the casing. Also discussed are in-place or stationary inclinometer (IPI) applications where one or more probes are positioned at fixed locations in the casing. IPI probes can be combined with automatic data acquisition systems (ADAS) for continuous monitoring. The recently introduced inclinometer probe utilizing solid-state micro-electro-mechanical-sensors (MEMS) is also included. Other ground movement methods and developing technologies are briefly addressed. This Circular also summarizes inclinometer practice and provides references to other publications that provide more detail.

Inclinometer Usage in Geotechnical Applications

The inclinometer is used in a variety of applications. Early usage, developed for monitoring landslide movement and slope stability, has evolved to monitoring the impact of excavations on nearby facilities, deformations of structures, and settlement of embankment fills and roadway subgrades.

LANDSLIDE INVESTIGATIONS

Critical to landslide investigations is the determination of the depth and thickness of slide shear zones: the magnitude, rate, and direction of landslide movement. Inclinometer casing is installed in vertical boreholes. Usually, one to four borings, depending on the landslide size, are made along the central axis of the landslide to develop a model of the landslide for stability analyses. Inclinometers are the most commonly used instrument type when attempting to measure small levels of ground creep or shear zone movement, particularly between 0.1 and 0.5 in. (3 and 13 mm). Traversing-type inclinometer probes are usually used to determine the depth of landslide shear displacement. IPI probes can be used where the depth of the shear zone is already known and the goal of instrumentation is to determine the rate of movement. This method is typically combined with automated data acquisition. To improve the capability of identifying shear zone movements when the depth of the shear zone is not accurately known, a string of fixed IPI sensors can be installed. For details regarding landslide instrumentation applications refer to Mikkelsen (1996) and Cornforth (2005).

MONITORING SLOPE STABILITY

Slopes in cuts or fill embankments can be monitored for stability during and after construction. In such cases, inclinometer casing is installed in vertical boreholes, following similar guidelines as for landslide investigations. Instrument locations are based on slope conditions and the importance of nearby facilities. Monitoring is made to verify performance and to identify whether unstable conditions are developing (Mikkelsen, 1996; Dunncliff, 1988; and Cornforth, 2005).

MONITORING RETAINING STRUCTURE PERFORMANCE

Instrumentation is used when the performance of retaining structures, such as sheet pile walls, soil nail walls, soldier pile walls, or mechanically stabilized earth (MSE) systems, could be adversely affected by lateral pressures or ground movements. Deformations of retaining structures could occur during and after construction. The inclinometer system can measure tilt and differential deformation behind or within the wall face, and bending moments can be determined. The casing can be installed vertically in boreholes adjacent to the wall face or can be embedded within or attached to structural elements. Traversing-type inclinometer probes are usually used to determine the relative shape of the retaining structure and changes to the

structure over time (Dunnicliff, 1988; Abu-Hejleh et al., 2001, 2005; Bentler et al., 2005; Finno and Roboski, 2005; Hu et al., 2003; Leonidou et al., 2001; Ou and Shiau, 1998; Ou et al., 1998; Yoo, 2000; Yoo and Lee, 2003).

MONITORING EXCAVATIONS NEAR FACILITIES

The impact of excavations, whether sloped or shored, can be monitored to determine if significant lateral deformations are occurring that could potentially affect the performance of nearby structures, utilities, and other critical facilities. Inclinometer casing is installed in vertical boreholes located between the excavation boundary and the nearby facilities. The inclinometer casing can also be installed in the excavation support system. This is typically accomplished by grouting the inclinometer casing into larger-diameter polyvinyl chloride (PVC) or thin-walled steel casing that is installed as part of the support system construction. Similar to the application for retaining structures, traversing-type inclinometer probes are usually used to determine the relative shape of the shored ground and changes over time. Refer to Dunnicliff (1988) for general procedure. Finno and Bryson (2002) describe inclinometers used to monitor ground deformations between an excavation supported by a secant pile wall and a nearby reinforced concrete frame building. Other references include Finno and Roboski (2005), Gue and Tan (1998), Hoffman et al. (2004), Hu et al. (2003), Kenwright et al. (2000), Leonidou et al. (2001), Massoudi (2006), Ou and Shiau (1998), and Wong and Chua (1999).

MONITORING PILE AND DRILLED PIER PERFORMANCE

Inclinometers can be used to measure the deformation of deep foundations subjected to large lateral loads. The inclinometer casing can be embedded within or attached to structural elements. The casing is typically embedded by either grouting it into a larger-diameter PVC or thin-walled steel casing that is installed as part of the foundation element, or by coring a hole after installation and grouting the casing into the foundation element. It may also be desirable to extend the inclinometer casing below the tip of the foundation element to achieve a stable reference datum. This is usually accomplished by drilling a hole through the foundation element after it has been installed. Dunnicliff (1988, 1998) and Ooi and Ramsey (2003) describe approaches to estimate bending moments. Hwang et al. (2001) describes the use of vertical inclinometers at various radial distances to monitor lateral ground deformations as a result of pile driving. Additional references include Goh et al. (2003), Kenwright et al. (2000), and Sarhan et al. (2002).

MONITORING SETTLEMENT OF EMBANKMENTS

Horizontally installed inclinometer casing can be used to measure differential settlement along a cross section of an embankment width. In addition, this type of instrumentation avoids interference with embankment fill placement and compaction as commonly occurs with traditional settlement plates that rely on vertical riser pipes for measurement. Traversing inclinometer probes are used for this application. The method to move the traversing probe

through the guide casing should protect the inclinometer probe from damage. This may require a second parallel pipe to contain the guide system alongside the inclinometer casing. Horizontal casing can be installed in a shallow trench and backfilled with sand or fine aggregate. Representative diagrams are presented in Slope Indicator Company (2006b) and Dunnycliff (1998).

MONITORING DEFORMATION OF PAVEMENT BASE

Horizontal inclinometers can be installed inside or at the interfaces of the base–subbase and subgrade materials to monitor the vertical deformations underneath the pavements. Inclinometers can detect small movements earlier than normal pavement surface data-collection equipment. Inclinometer casing and cable return pipe are installed within a narrow trench. Traversing inclinometer probes are used for this application. Ongoing research is evaluating the use of a recycled base material and its compressibility or rutting potential under traffic loads in which horizontal inclinometer data is proving valuable (Puppala and Sirigirpet, 2006; Puppala et al., 2008).

MONITORING PERFORMANCE DURING TUNNELING

Inclinometers can be used to monitor stress relief ground movements and possible displacement of rock blocks during the construction of tunnels and shafts. Inclinometers are used to verify the adequacy of ground supports, detect potential flaws in the construction approach, and serve as a warning system for potential ground failure (Cording, 1977; National Academy of Sciences, 1984; U.S. Army Corps of Engineers, 1997; Karakus and Fowell, 2005; Kavvadas, 2003; Martin, 2006).

Description of Inclinometer Instrument Components

Each measurement system requires a combination of components, based on the application, the type of inclinometer to be used, and the means to obtain the data.

PROBE TYPES

Two types of accelerometers are now being utilized in inclinometer probes available in the United States: the servo-accelerometer or the recently introduced MEMS accelerometer.

- **Servo-accelerometer.** The servo-accelerometer probes, commercially available since 1969, have the highest resolution of the available inclinometers on the market. The force-balanced sensing elements detect the change in tilt (from absolute vertical) of the probe that houses the sensors. The probe contains two biaxial servo-accelerometers and is fitted with two sets of spring-pressured wheels to guide the probe along the longitudinal grooves of the guide casing. A maximum system precision of 0.05 in. per 100 ft (1.2 mm per 30 m) or 1:24,000 is possible with this instrument, but is ordinarily closer to 1:4,000 without corrections for systematic errors. The resolution is nearly linear and constant at inclinations between $\pm 30^\circ$ from vertical. Servo-accelerometers are described in detail by Mikkelsen (1996).

- **MEMS Accelerometer.** MEMS technology has recently been introduced for inclinometer probes and in-place inclinometers. The probe is the same as for the servo-accelerometer type except that MEMS accelerometers are used instead of servo-accelerometers. The primary advantages of the MEMS architecture are low power consumption, durability, wireless transmission and low cost. These attributes have resulted in extensive use of MEMS in the automobile industry. The use of MEMS sensors in inclinometer applications is relatively recent, since 2005. There are limitations to this technology, including temperature sensitivity and related effects, signal noise, and reduced resolution from vertical ($\pm 15^\circ$). A system accuracy of ± 0.1 to 0.25 in. per 100 ft (2.5 to 6 mm per 30 m) or 1:25,000 has been advertised for these probes, but the inclinometer system capability, precision, and reliability have not been independently evaluated and demonstrated.

TRAVERSING INCLINOMETER SYSTEM

The traversing application is the usual means of obtaining data. This is achieved by manually moving the probe to obtain a series of measurements along the length of the casing. Inclinometer instrumentation consists of several components, as shown in [Figures 1 and 2](#) for vertical monitoring applications. Diagrams and photographs of the various components are published in Dunncliff (1988, 1998), Mikkelsen (1996), and Wilson and Mikkelsen (1977).



FIGURE 1 Typical inclinometer probe, cable, and readout device (Landslide Technology).

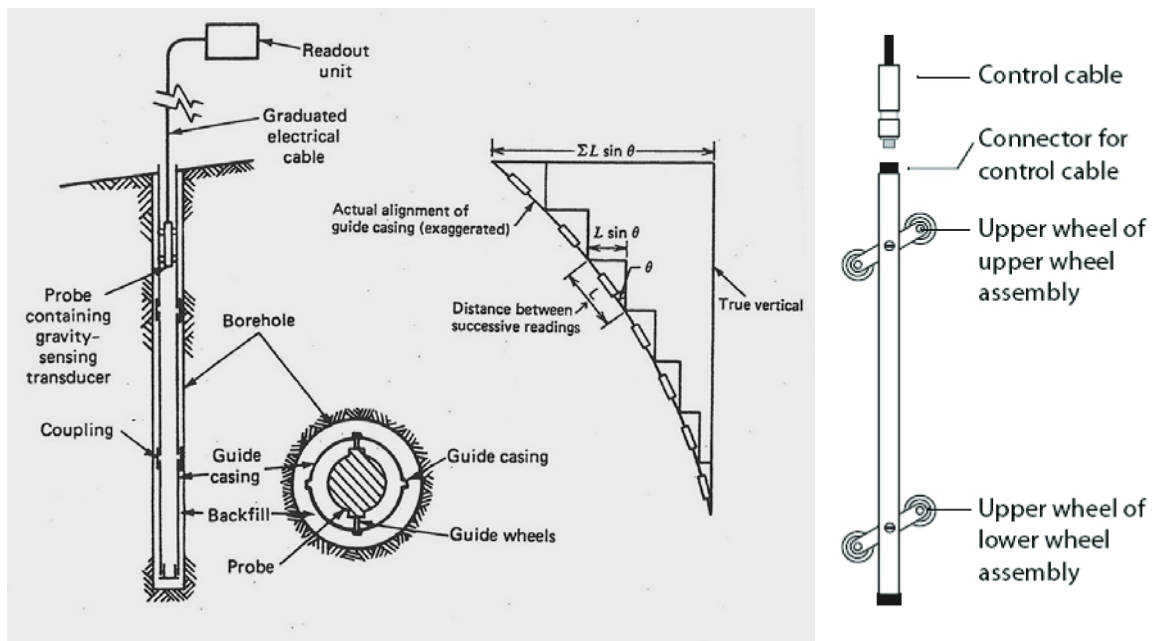

FIGURE 2 Schematic of inclinometer probe inserted in casing that is installed to monitor ground deformations (Mikkelsen).

The instrumentation equipment consists of the following components:

- Traversing inclinometer probe contains two gravity-sensing accelerometers in a stainless steel carriage. The probe is typically fitted with two sets of spring-pressured wheels to precisely guide and orient the probe at any depth in the casing. Spacing between wheel sets is normally 2.0 ft (0.5 m). Measurements are made in the A axis, in the direction of the wheels, and the B axis, which is perpendicular to the A axis. Data variability can be twice as high in the B axis. Probes are made differently for horizontally installed casing; the sensors are mounted to measure vertical displacements and the bottom-tracking wheels are fixed.
- Inclinometer casing is used to guide the inclinometer probe within the casing with four longitudinal wheel-grooves spaced 90° apart. Only one set of opposite grooves, in the anticipated direction of displacement, is actually used. The casing is installed in the ground, usually within drilled holes, and the annular space grouted. Alternative installations include casing that is embedded within concrete structures or attached to structures. Casing connections are specially made to seal out soil, grout, and other materials in order to maintain clean grooves and prevent filling of the casing. Refer to **Figure 3** for example of machine-grooved casing and connection.
- Inclinometer control cable is attached to the inclinometer probe and readout device. It provides two distinctly different functions: (a) to transmit electrical signals during measurements; and (b) to serve as a precise, repeatable depth control for the probe. The cable is of a special design and constructed to provide long-term longitudinal stability to essentially serve as a measuring tape. In other words, it is made to be durable, waterproof, non-stretch, non-shrink with a high torque resistance. The cable typically has durable, visible and permanent markings every 1 ft or 25 cm for reference in accurately positioning the probe for each measurement depth.
- Cable control fixture is attached to the top of the inclinometer casing to aid the lowering and raising of the inclinometer probe/cable and to provide a repeatable depth reference for the cable marks. It is often fitted with a 6 in. (15 cm) pulley wheel to reduce bending of the cable and a clamp or grip to hold the cable steady at each measurement depth (see **Figure 4**).

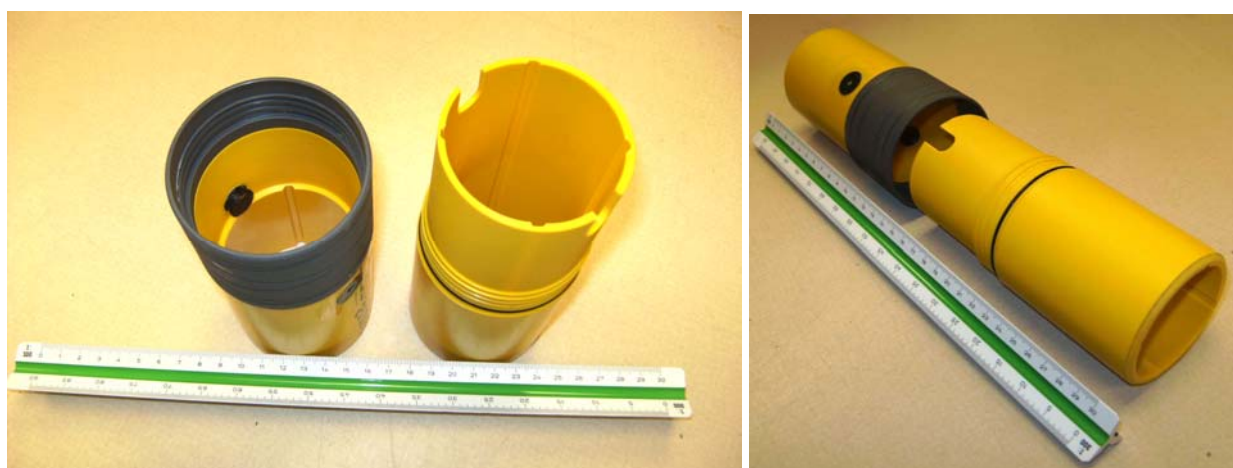

FIGURE 3 Inclinometer casing with machined grooves and connection detail (Roctest).



FIGURE 4 Cable control fixture.

- Inclinometer data acquisition unit (readout box) records the measurement data at each depth interval. The readout device contains a rechargeable power supply and is capable of storing many data sets and can perform field checks to verify the validity of the measurements.
- Computer software for data management provides communication between the data acquisition unit and a computer, allows organization, checking and editing of data, and provides calculated tabular results and simple graphs.
- PC graphics software is used for graphic presentation of results, diagnostic plots, and correction of systematic errors. The software output would include presentations of incremental and cumulative displacements with depth and time for multiple data sets. Diagnostic plots may include checksums, difference in checksums, incremental deviations (casing straightness), and cumulative deviations from vertical (casing profile).

IN-PLACE OR STATIONARY INCLINOMETERS: IPI SYSTEMS

Inclinometers can be used to detect both developing and sudden adverse movements of critical marginally stable slopes and landslide zones. Many marginally stable areas experience ground movement at creep rates that often accelerate during higher groundwater levels, possibly associated with snowmelt or significant periods of precipitation. As previously discussed, inclinometer probes can be used to survey the inclinometer casing to detect the depths where ground movement is occurring. When the zone of movement has been identified, fixed IPIs can be installed in the casing at the desired depths to monitor the movements in near real time using automated data acquisition equipment.

IPIs utilize a wider number of tilt sensors than traversing probes. These instruments can be either uniaxial or biaxial sensors that are made specifically to fit within the grooves of the inclinometer casing. The sensors may be surface mounted or deployed in inclinometer casings singly or in an array of multiple units. The sensors are usually suspended from the top of the

inclinometer casing using cables or rods between each sensor. A diagram of a series of in-place inclinometers is shown in **Figure 5**, along with a photo of one in-place probe.

Many industrial tilt sensors are available, but only three types are most commonly made by manufacturers. For IPI applications these are (a) vibrating wire tilt sensors, (b) electrolytic tilt sensors, and (c) MEMS accelerometers. The servo-accelerometers are typically not used due to high power consumption, higher cost per measuring point and more complex programming for ADAS.

A fixed IPI contains two sensors and is typically fitted with two sets of spring-pressed wheels to guide the insertion of the probe into the casing. Alternatively, the instrument could be made without wheels and permanently embedded within backfill or concrete, as long as other means are provided to determine orientation. A single IPI would only measure a short depth range. If monitoring is required over a greater depth range, a string of IPI inclinometers can be installed.

ADAS provide self-operating data acquisition. One method is to use a data logger, possibly combined with multiplexers if multiple instruments are monitored by the same data logger, to collect and store the data. The data logger would be programmed to collect data at desired time intervals. The data are periodically uploaded into a computer for analysis. When rapid identification of movement is needed (i.e., real-time monitoring), telemetry could be added to send the data automatically utilizing wired or wireless systems. One economic advantage of ADAS is reduced labor time and travel.

The ADAS equipment can be programmed to read the IPIs on a frequent basis and evaluate if predetermined movement or rate of movement thresholds have been exceeded.

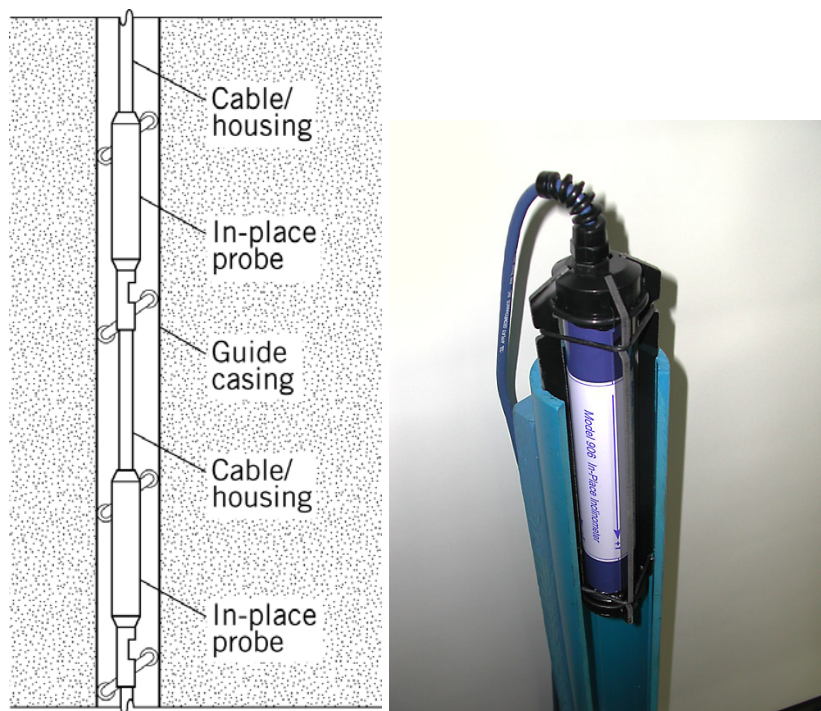

FIGURE 5 IPI installation schematic and photo of individual IPI probe (Landslide Technology, WSDOT).

Notification can then be provided in real time to warn monitoring personnel that a condition of concern may be developing. The data acquisition equipment can also be used to collect background data such as rainfall and groundwater levels to help develop an understanding of historical performance and to detect more subtle trends in the movements. Photos of an ADAS system are shown in [Figure 6](#).

Myers et al. (2000) presents a landslide case history that describes an automated monitoring system, which utilizes inclinometers and tilt meters to track ongoing creep movements and provide early warning of the need to make adjustments to a deep elevator shaft constructed through a landslide basal shear zone. Additional references include Massoudi (2006) and Pennell et al. (2005).

Alternative instruments that can also measure real-time displacements along the full depth of boreholes include MEMS inclinometer strings and time domain reflectometry (TDR) cables, which are described later in this circular. Both instrument types can be integrated with ADAS equipment and wireless communication systems.

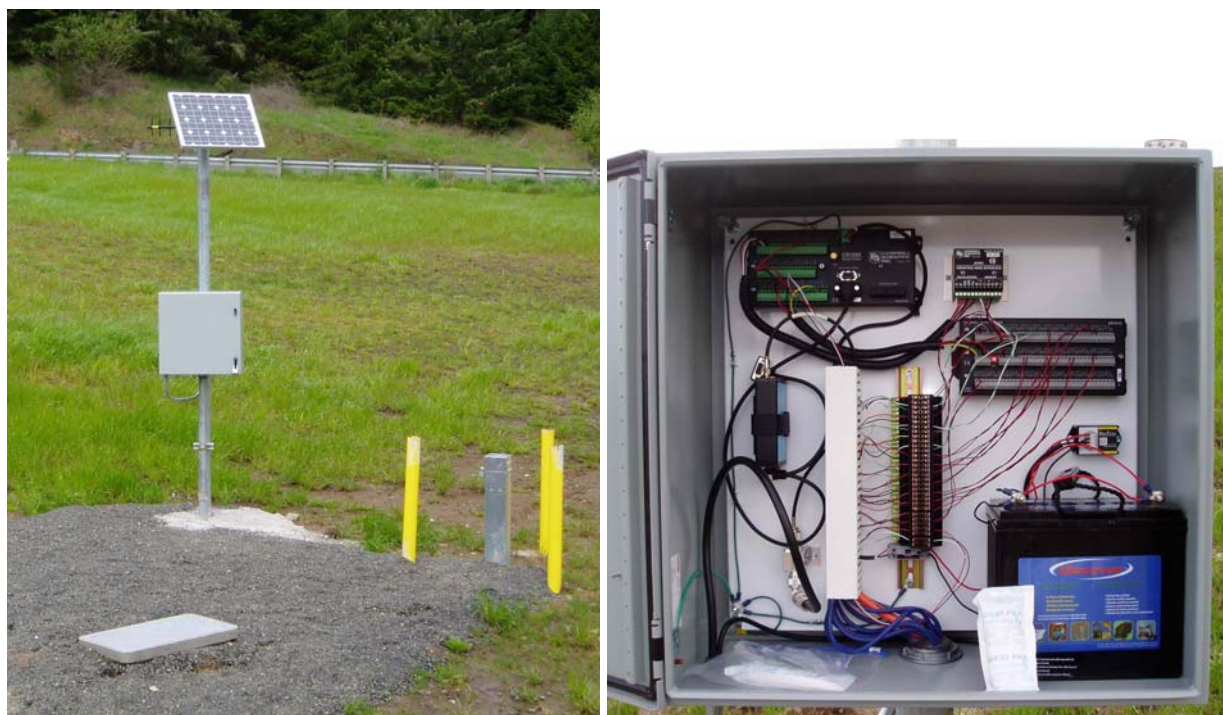

FIGURE 6 Typical remote ADAS system with multiplexer, solar-recharged power, and radio communications (Myers).

Inclinometer Instrumentation Planning and Selection

Planning for instrumentation and monitoring is described in Dunnicliff (1988, 1998) and Mikkelsen (1996). The task of planning an instrumentation program to define and monitor ground movement is a logical and systematic process that accounts for geologic conditions and related engineering issues. This planning effort is based on defining the objectives and understanding the use of resulting data to determine possible implications. The following describes project parameters that influence the selection of instrument types and components.

PROJECT PARAMETERS

The selection of instrumentation materials and installation methods will depend on an understanding of the geology, subsurface material, and groundwater depth. This information is gained through performing geologic reconnaissance and research, followed by subsurface investigations and analysis. First, the purpose of the ground displacement monitoring is defined, which requires an understanding or hypotheses of possible displacement mechanisms. Selection of the type of instruments and installation locations is also based on compatibility with the design of the transportation facility, such that the instrumentation survives the construction.

The selection of the most appropriate instruments is based on the type of ground movements anticipated. It is important to first understand whether the ground movement is at a discrete depth or affecting a larger zone and if both vertical and horizontal movements are anticipated, which could require more complex instrumentation. The anticipated magnitude and rate of movement will also influence the type of instruments best suited for the project.

Instrument accuracy and repeatability are important if ground movements are small. If the movement is large and fast, accuracy is not critical and relatively crude instruments and backfill may suffice.

PROBE TYPE

The selection of inclinometer probe type is based on the project application. If the depth or specific location of potential deflection is unknown, traversing inclinometers would be well suited. Where the location of ground movement is already known, an IPI (or short string of fixed in-place probes) can be considered.

Probes with servo-accelerometers are considered more reliable because they have a long history of use with independent verifications. Alternatively, digital systems provide wireless technology and could be less expensive. However, this relatively recent application is not yet supported by independent research and verification and does not have a long history to identify potential issues. The selection of sensor type would be based on the instrument reliability required for the project application, as well as sensitivity, durability, and cost.

EQUIPMENT COMPATIBILITY

In general, many users prefer to select the inclinometer probe, cable, and readout device from the same manufacturer. Large errors can occur when components are not compatible. Mikkelsen (1996) describes this concern.

CONFORMANCE

The installation of inclinometer casing is designed to conform to the surrounding ground or structure. The type of casing and backfill can affect the ability of the instrument to accurately detect the deflections. Flexible instrument materials–backfill can deform readily as the ground deforms. For example, installations in medium stiff soil often use stable yet deformable plastic casing embedded in a grout comprised of cement with bentonite additive that provides firm support between the casing and the ground. Extreme rigidity or backfill softness–voids can adversely affect results.

GUIDE CASING TYPES AND SIZES

Inclinometer guide casing is available in a range of diameters and connection types. The selection of guide casing diameter depends on the anticipated range of ground movement and installation considerations. The casing is manufactured with four equidistant grooves along the inside of the pipe. It is essential that the casing manufacturer produces grooves that are linear to avoid spiral effects. Grooves in higher quality casing are machine-cut rather than extrusion-formed during casing manufacture. Guide casing is typically free of gaps that could allow grout or backfill materials to accidentally enter into the casing. The most common casing material is ABS, whereas steel and aluminum have become less common. Metal casing has been reported to be not desirable in corrosive environments. Small diameter casing is available for small diameter drill holes. Larger diameter casing is used to measure larger deflections and slide shear movements and to survive longer monitoring periods, but will require drilling with larger rods/bits. The most commonly used inclinometer casing diameter is 2.75 in. (70 mm) O.D. because it fits within common HQ [3.0 in. (77.7 mm) I.D.] drill holes and allows for an adequate annular space for grouting. One-way valves can be used at the tip of the inclinometer casing to facilitate grouting. Other casing sizes include 1.9 in. and 3.34 in. (48 mm and 85 mm) O.D. Examples of ABS and aluminum inclinometer casing and connections are shown in [Figures 7 and 8](#), respectively.

The length of inclinometer casing is also an important consideration. For most applications, the guide casing needs to extend to stable ground to serve as a stable reference datum. In unusual applications where stable ground does not exist within reasonable distance, the upper or entry casing end is surveyed each time measurements are collected to determine reference coordinates for comparing datasets. In this case, however, inaccuracies will be inherent due to surveying errors. Generally, the casing is installed at least 10 ft (3 m) below the anticipated zone of movement to develop verifiable fixity. Mikkelsen (1996) recommends a depth of 20 ft (6 m) below the movement zone in order to verify inclinometer calibration each time readings are made, which would provide the data necessary for performing systematic error corrections, as discussed later.



FIGURE 7 ABS inclinometer casing, diameter in mm (Slope Indicator Company).

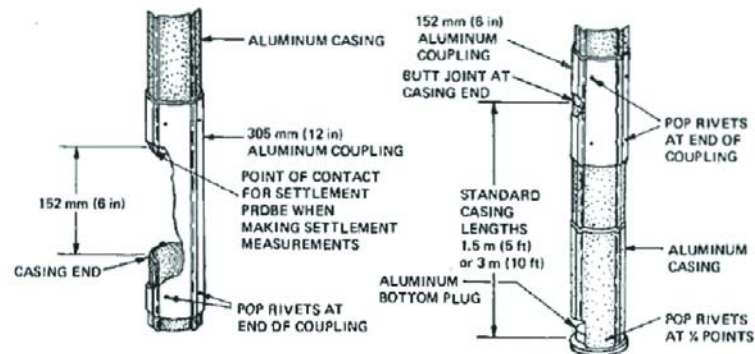
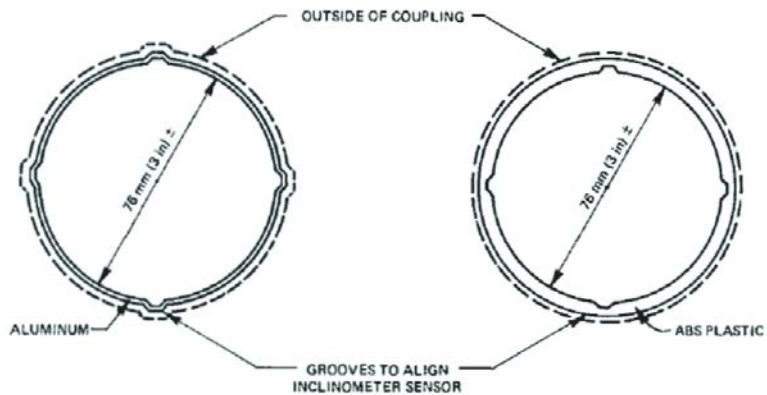

FIGURE 8 Example of aluminum inclinometer casing and connections (Mikkelsen).

TELESCOPING CASING CONNECTIONS

Telescoping connections are sometimes installed in vertical boreholes when the ground is expected to settle, such as embankments placed over soft ground. Example connections are shown in [Figure 9](#). Alignment of each measurement depth between data sets over time can be problematic. Means to account for settlement are described by Dunnycliff (1988). Refer also to Slope Indicator Company (1997, revised 2000).

DATA ACQUISITION: READOUT DEVICE

The readout instrument and accompanying data reduction software are provided by manufacturers of inclinometer probes to be compatible with their systems. The readout device stores previous datasets for reference and for beginning new datasets. When the probe has stabilized inside the casing, the stable readings are confirmed by the operator and recorded by the

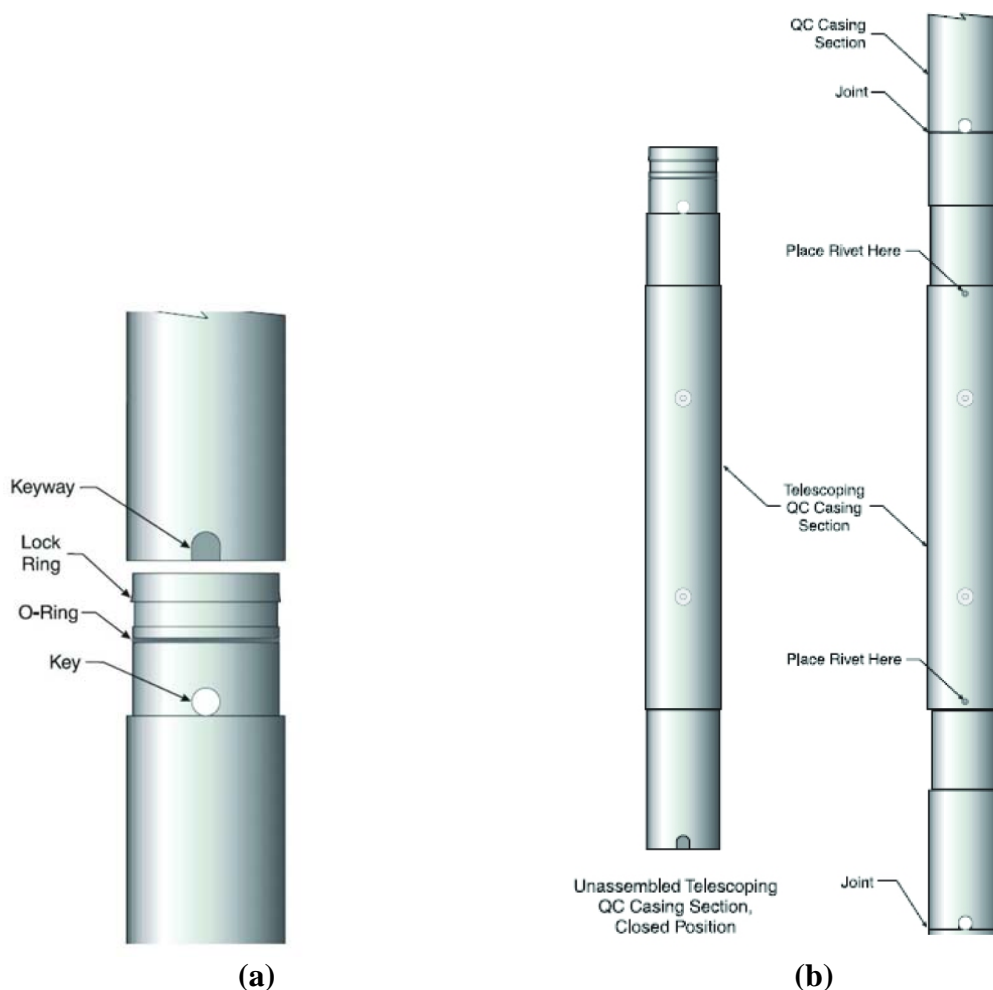

FIGURE 9 Inclinometer casing connections: (a) regular and (b) telescoping (Slope Indicator Company).

device. Upon completion of a data set, the readout device can be used to confirm the quality of the data by checking standard deviations and other diagnostic tools, as described later. Important features also include rugged housing, weather resistance, portability, and reliability. Less expensive data loggers have been used in lieu of the manufacturer's readout devices but lack field-check capabilities and may be less rugged. Simple readout systems that display measurements but do not record them are becoming antiquated and seldom used since they introduce additional human errors and are more time consuming.

CONTROL CABLE

Commonly available control cable transmits electrical signals along encased wire, which is reinforced by a central steel rope to prevent elongation. The cable typically is waterproof and has accurate and durable markings to show the depth into the casing. The cable needs to be durable to survive repeated usage, where kinks could potentially cause damage to the encapsulated internal wiring.

Installation

The accuracy of the inclinometer instrumentation depends on the quality of the installation as well as the measurement capability of the inclinometer probe and readout device. Data can be wrong or misleading if the design, installation, and readings are not performed correctly for the actual site conditions and instrumentation objectives. For further information, refer to Slope Indicator Company (1997, revised 2000), which describes inclinometer casing installation and protection practices. The following installation topics are described:

- Inclinometer casing in vertical applications;
- Inclinometer casing in horizontal applications;
- Inclinometer casing attached or embedded in structures;
- Protection of inclinometer casing;
- Modifications and repair to inclinometer casing;
- Extending the measurement capability of inclinometer casing; and
- Fixed IPI probe.

INCLINOMETER CASING IN VERTICAL APPLICATIONS

The type of inclinometer casing and backfill material for vertical installations is selected to conform to the surrounding ground to reflect ground deformations accurately. Conformance is accomplished by selecting materials that are similar in shear and bending.

The borehole diameter needs to be sufficiently large to allow insertion of the inclinometer casing and to ensure that grout or backfill can be accomplished around the entire annulus without leaving voids or soft zones. The drilling method may need to include measures to prevent borehole caving. **Figure 10** shows the lowering of inclinometer casing into a vertical borehole and the connection of another section of casing. Insertion of the inclinometer casing needs to be centered in the borehole to allow the grout–backfill to completely surround–support the casing. The borehole and inclinometer casing need to be made as vertical as possible to minimize reading errors. Selection of the type of coupling and method of attachment will depend on the application and casing type. Installation practices are described by Cornforth (2005), Dunnycliff (1988), and Mikkelsen (1996).

The guide casing grooves need to be kept clean during the installation process; otherwise inclinometer probe tracking problems could result. The grooves can be cleaned by hosing with water and gentle brushing. Manufacturers provide casing connections that seal out groundwater and soil to maintain clean grooves and prevent grout or sediment from entering the casing, which would shorten the effective depth of the casing. For this reason, perforations in the casing, as sometimes is done to make the casing also function as an observation well, are risky. Prior to backfilling, the casing should be oriented with a pair of grooves in the expected direction of ground movement.

If groundwater or drilling fluids are present within the borehole, the inclinometer casing may need to be weighted to counteract buoyancy. Applying forces or twisting motions to the top of the casing are to be avoided because this could cause adverse spiraling and snaking of the casing, which would lead to erroneous data and interpretations. A common practice to



FIGURE 10 Installation of inclinometer casing in a vertical borehole (Landslide Technology).

overcome buoyancy is to fill the casing with water. An alternative is to attach an anchor to the bottom of the casing that would embed itself into the borehole when activated. This approach also applies when grouting, which causes temporary buoyancy. Refer to Dunnycliff and Mikkelsen (2000), and Dunnycliff (1998).

Grouting is the backfill method preferred by many because the annular space is reliably free of voids and soft zones. Grouting is often preferred over backfilling with granular materials if the casing is needed to detect very small ground movements. Granular backfill could be preferred when ground movements are occurring rapidly and monitoring is to be performed immediately before the casing is damaged (no time available for grout to cure). Sand and gravel backfill are sometimes used to avoid the need for grouting and usually costs less; however, placement and compaction of the backfill can be difficult to achieve and would need a larger annular space for insertion of a rod or pipe for tamping. There is a risk that backfilling could result in bridging and voids that can negatively affect the performance of the inclinometer (Cornforth, 2005; Dunnycliff, 1988).

A non-shrink grout is typically used, typically requiring a combination of cement and bentonite. Example of the mix is presented in the [Table 1](#). Non-shrink grouting provides a tight casing installation that can conform to very small ground deformations.

TABLE 1 Cement–Bentonite Grout Mix Example

Materials	Soft Soil Environment	Medium to Hard Soil Environment
Portland Cement	94 lb (43 kg)	94 lb (43 kg)
Bentonite (powder)	39 lb (18 kg) (as required)	25 lb (11 kg) (as required)
Water	75 gal (284 l)	30 gal (114 l)

Examples of the sequence of grouting are illustrated in **Figure 11**. A tremie tube can be used to place the grout from the bottom up. Alternatively, the grout can be introduced through the inclinometer casing by inserting a tremie pipe and connecting it to a one-way valve at the tip of the casing (**Figure 12**). In this case, the tremie pipe includes a steel pipe at the tip that rests on a rubber gasket at the top of the one-way valve. Upon completion of grouting, the tremie pipe and steel pipe are removed and the inside of the inclinometer casing is flushed clean. If a grout valve is used, care should be taken to screen the grout for paper originating from the cement–bentonite bags and other foreign debris that could clog the valve and prevent it from closing.

Problems with borehole caving and construction techniques during grouting or backfilling can introduce erratic casing movements as the ground reacts to voids or disturbance around the casing. This can lead to difficulties in interpreting the measured ground deformations. In boreholes that encounter voids and fractures (possibly indicated by loss of circulation of drill fluid), sand or chemical additives can be mixed with the grout to thicken the slurry.

Conventional practice is to avoid installing other instrumentation in the same borehole as the inclinometer casing to avoid compromising the instruments. McKenna (1995) reports that, under favorable conditions, Syncrude sometimes installs up to two grouted-in piezometer tips alongside inclinometer casing when using large diameter boreholes. Some state departments of transportation are installing vibrating wire piezometers within the grout backfill and are experiencing generally favorable results. There is a concern for possible short circuiting of water pressures from two different aquifers, particularly if sand backfill is used. The grout should be of lower permeability than the formations to prevent this. Piezometers installed in inclinometer boreholes are to be placed at least 2 ft (0.6 m) away from any coupling (McKenna, 1995).

Telescoping couplings may be necessary in situations where significant ground settlement is expected to occur. For example, vertical inclinometers installed in soft ground in advance of embankment fill construction would be influenced by settlements at depth. The telescoping couplings allow the casing to shorten in response to settlement (Dunnicliff, 1988; Slope Indicator Company, 1997, revised 2000). However, trying to calculate deflection change between data sets can be a challenge since the corresponding readings are likely to not be at precisely the same depths. Monley and Soderborg (2000) describe potential difficulties with monitoring inclinometer casings fitted with telescoping couplings.

The casing stick-up can be measured and subtracted from reading lengths to determine the depths below the ground surface for each measurement.

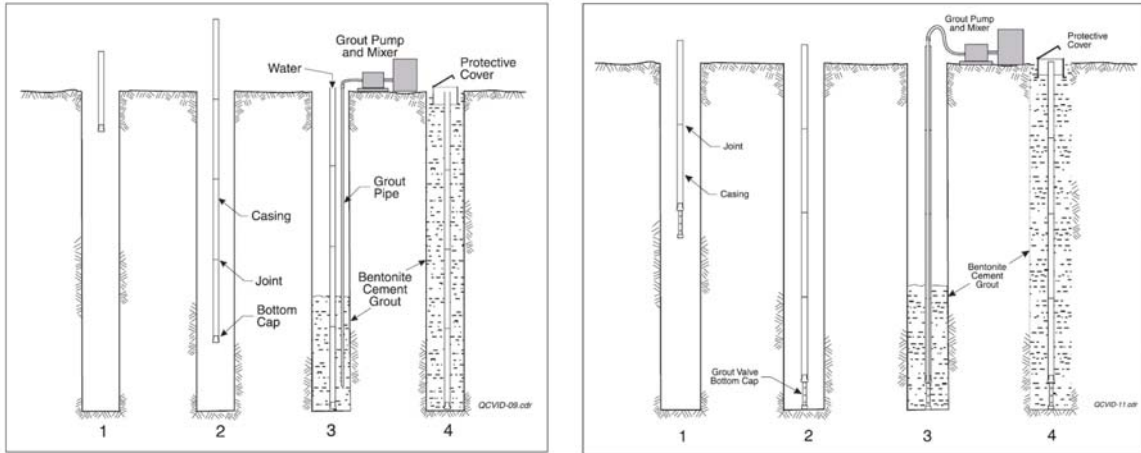

FIGURE 11 Examples of grouting the annulus between the inclinometer casing and the borehole (Slope Indicator Company).

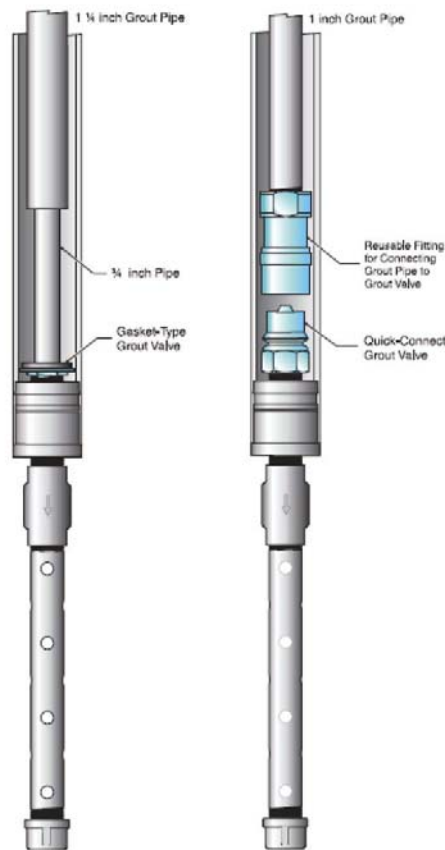

FIGURE 12 Schematic of grout pipe and valve (Slope Indicator Company).

INCLINOMETER CASING IN HORIZONTAL APPLICATIONS

Inclinometer casing is typically installed along the prepared foundation for the embankment, or within a shallow trench, and backfilled to protect the instrument from construction traffic. The casing can be open at both ends or closed at the far end. When the casing is closed at one end, a dead-end pulley and cable-return pipe are installed. Instrument components and a pulley system are shown in **Figure 13**. Manholes or pits are usually constructed on one or both ends to access and protect the inclinometer system. A special inclinometer probe is required for this application. The sensors are mounted differently within the probe than for vertical inclinometer systems. The Slope Indicator Company (2006b) manual presents detailed descriptions of components and guidelines for installation.

Installation of an inclinometer system with a closed end and a pulley system underneath a pavement is described by Puppala et al. (2008). The inclinometer casing is typically inclined about 3% down towards the open end to prevent water from entering. The trench bottom must be made linear and smooth so that the casing can be placed in a straight line. Sand bedding is used to provide a straight grade and competent foundation support. Backfill around and above the inclinometer system to the top of the ditch provides a cushion against crushing from construction equipment.

The guide casing grooves need to be kept clean during the installation process; otherwise inclinometer probe tracking problems could result. Deposits can readily collect along the lower

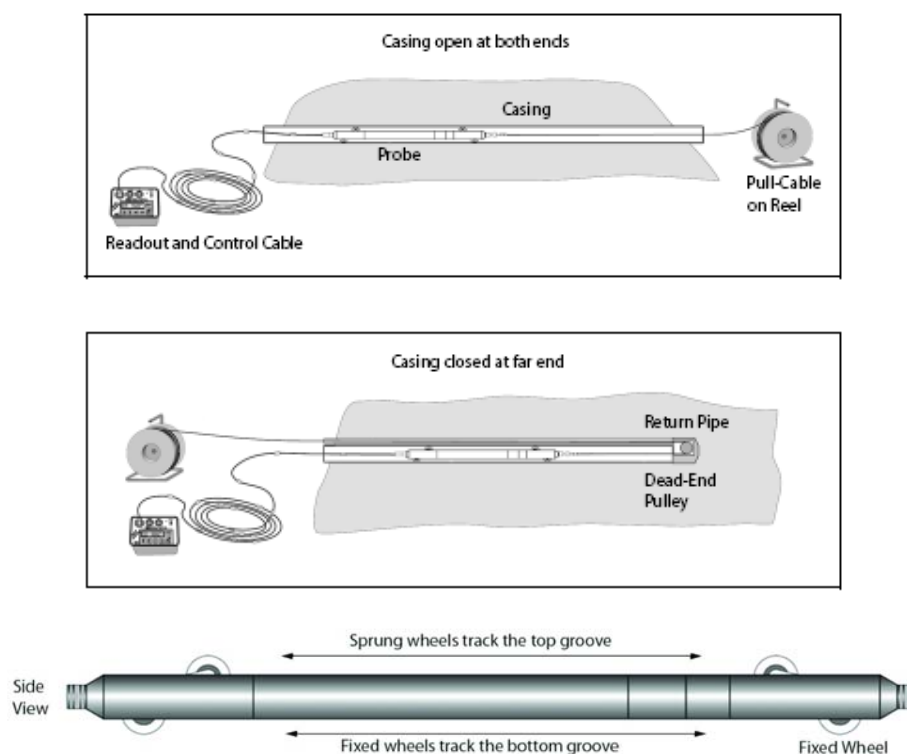

FIGURE 13 Components of horizontal inclinometer and pulley system (Slope Indicator Company).

groove. The grooves can be cleaned by hosing with water and gentle brushing. The casing must be installed with one set of grooves aligned absolutely vertical and without any twisting (to avoid rotation errors in the data measurement sets). As each section of casing is added, the vertical plumbness of the grooves is typically verified with a plumb bob or carpenter's level. Reading errors become larger the further the grooves deviate from vertical.

Initial readings are performed after construction of backfill layers to verify the inclinometer casing and guide system are not damaged. The open end of the guide casing can be surveyed each time inclinometer measurements are made to determine if settlement is occurring at the end of the instrument casing.

INCLINOMETER CASING ATTACHED OR EMBEDDED IN STRUCTURES

Inclinometer casing can be very effective for monitoring deformations in structural components. In structures, movements usually occur over the entire structural component. **Figure 14** shows steel casing placed within rebar reinforcement for a diaphragm wall. Inclinometer guide casing can be installed within the steel casing for monitoring potential lateral displacements.



FIGURE 14 Eight-inch steel pipe placed within diaphragm wall reinforcement for housing inclinometer casing (Case Foundation Co.).

To effectively measure tilt in a rigid structure or deflection of a flexible structure, the casing needs to be integral with the structure when it tilts or deflects. This is typically accomplished by embedding the casing within the structural component. The two methods for embedding the casing are (a) to include a casing in the construction of the structure that can be used to place and grout in the inclinometer casing after the structure is completed, and (b) drill or core a hole in the completed structure and grout in the inclinometer casing. The first method works well for new structures where a casing can be incorporated into the design. Casing types need to be selected and installed to suitably conform to the structure deformations. The construction casing diameter should be 4 to 6 in. (10 to 15 cm) depending upon the diameter of the inclinometer casing that is planned. The inclinometer casing is then placed inside the construction casing and grouted into place. The construction casing allows for rough handling and impacts during construction that could damage the inclinometer casing if it was installed directly in the structure. This approach is generally less expensive than drilling or coring a hole after construction. However, if monitoring is required for an existing structure or the inclinometer installation depth needs to extend below the base of the structure to obtain a stable reference, then the drilling–coring method is required. The drill hole needs to be large enough in diameter to allow room for the inclinometer casing and tremie pipe.

Another consideration when installing inclinometer casing in structures for long-term monitoring is maintaining access to the top of the casing for taking manual readings or installing in place sensors. This can be very challenging for certain structures. For example, the superstructure is generally constructed on top of the foundation elements, limiting access to the top of a vertical inclinometer casing. Special installations allow the top of the inclinometer casing to be accessed horizontally through the side of the structure. This requires an access tube to transition from the horizontal to vertical orientation and a placement tool to insert the inclinometer sensor into the casing grooves in the correct orientation.

PROTECTION OF INCLINOMETER CASING

Casing that is exposed is vulnerable to vandalism and accidental damage. Common practice is to install a metal monument with a locking cap around the casing at the ground surface. Installations in paved areas require flush-mount monuments and covers. For further protection from impacts by construction traffic, bollards, or barriers can be installed to create a buffer distance from each instrument location.

MODIFICATIONS AND REPAIR TO INCLINOMETER CASING

Modification of inclinometer casing installations may be necessary when the ground in the vicinity is being excavated, causing the top of the casing to stick up excessively, or when fill is being added to raise site grades. Casing repair may be necessary when it is damaged (e.g., broken or bent at the top). When cutting the guide casing, the cut can be made at the closest 2-ft or 50-cm interval in order to be able to correlate new readings to previous data sets. A tool is available for ensuring proper alignment of grooves when adding sections of guide casing. The length of added casing sections are typically to the nearest 2 ft or 50 cm. If the guide casing length is not

perfectly matched to the previous series of 2-ft or 50-cm increments, new “initial” data sets are typically measured to initiate a new datum.

When the inside diameter of the guide casing is obstructed, possibly by insertion of debris or soil–rock, a remedial action is to dislodge the obstructing materials and to clean the casing grooves. Air or water can be used to flush obstructions. A dummy probe can be used to verify adequate guide casing conditions for monitoring, rather than risking damage to the more expensive inclinometer probe.

EXTENDING THE MEASUREMENT CAPABILITIES OF INCLINOMETER CASINGS

In landslide applications where the shear movements become large, the casing can become bent or sheared, which would prevent the insertion of an inclinometer probe for continued monitoring. There are several methods available to continue monitoring when this occurs. If large ground movements are anticipated, a “poor man’s” method can be combined with a common inclinometer casing installation. When the casing has become bent or obstructed after initial monitoring has determined the depth of shear movement, continued measurements can be accomplished either by surveying, extensometer cables, or TDR cables.

Poor Man’s Inclinometer Method

A short section of pipe attached to a wire cable can be left at the bottom of the casing and pulled up to determine the bottom of the deformed section of the casing. In addition, a similar pipe can be lowered from the ground surface to detect the upper portion of the deformed casing. This method is often referred to as a poor man’s inclinometer. An example of the poor man’s inclinometer method is shown in Figure 15.

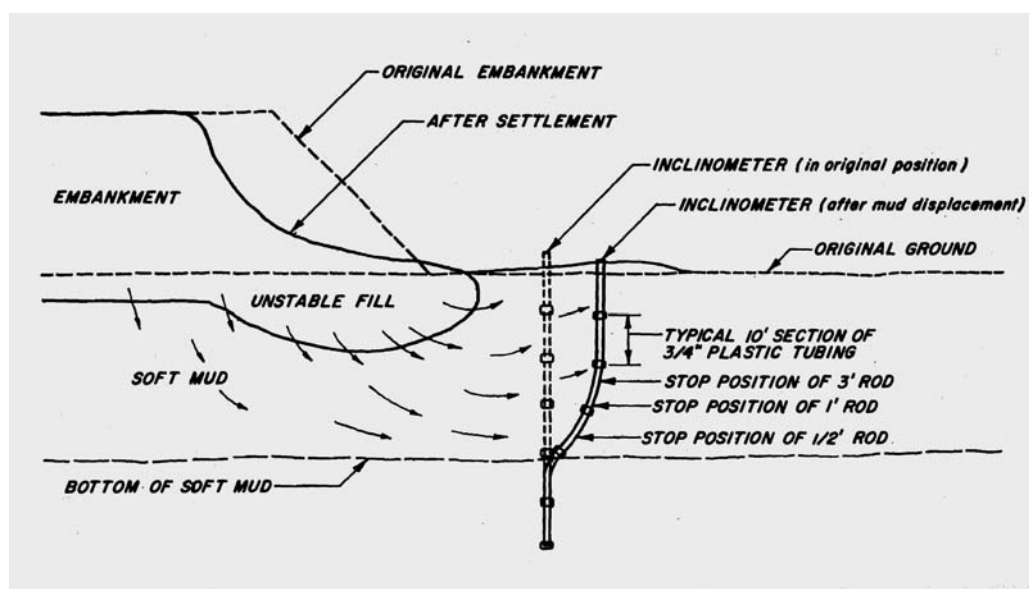

FIGURE 15 Example of poor man’s inclinometer method (California Department of Transportation).

Survey Method

The top of the casing can be surveyed presuming the rate and direction of movement are the same at the shear zone. Surveying can determine both horizontal and vertical changes so that movement rates and vectors can be calculated.

Extensometer Method

Extensometer cables can be added to vertical inclinometer casing installations to extend measurement capabilities when the casing has become obstructed or excessively distorted. In this method, the wire cable is typically anchored to the bottom of the casing with a grout plug. Refer to Deschamps et al. (1998) and to [Figure 16](#).

TDR Method

A coaxial cable for TDR monitoring can be inserted either into the annular space surrounding the inclinometer casing at the time of casing installation or within the inclinometer casing once it is discovered that the casing is bent and no longer measurable with an inclinometer probe. An example of this TDR technique is described in Dowding and O'Connor (2000). Photos of a TDR cable installed and grouted into an inclinometer casing are shown in [Figure 17](#).

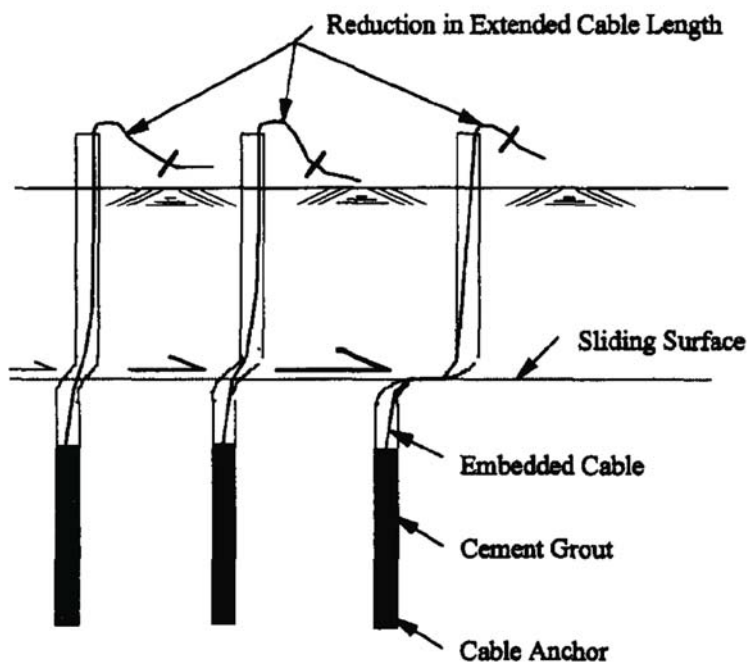

FIGURE 16 Extensometer cable installed in inclinometer casing to extend monitoring (Deschamps, 1998).

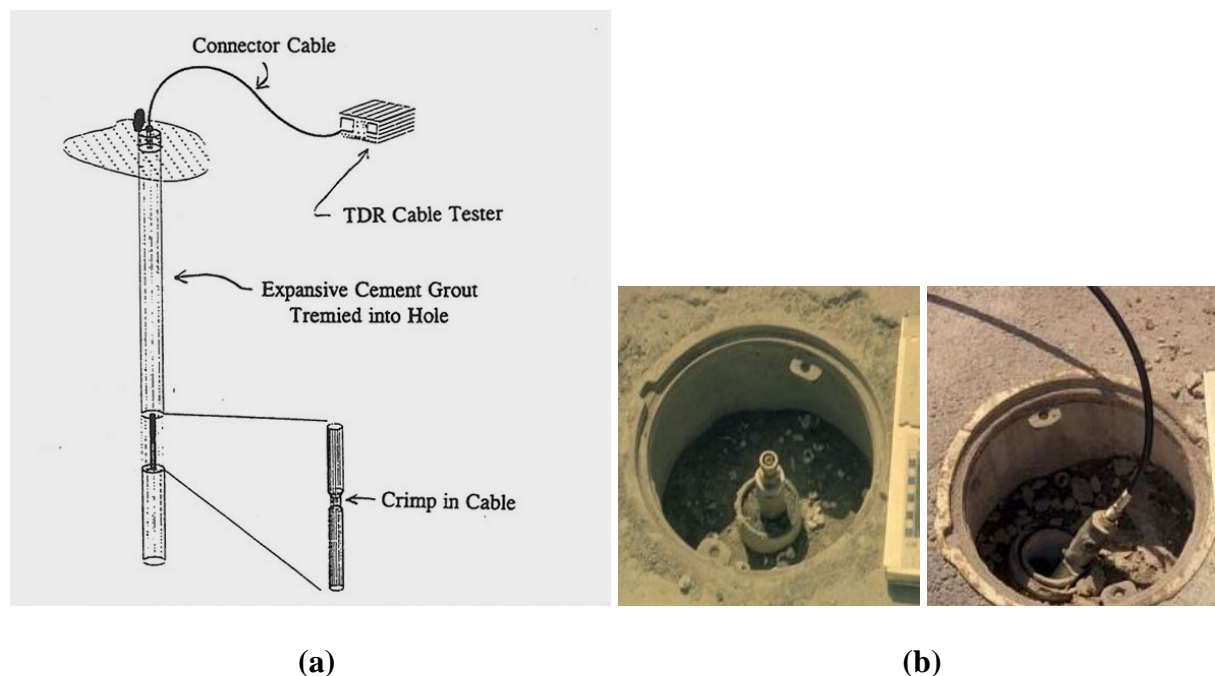

FIGURE 17 (a) TDR cable installed in inclinometer casing to extend monitoring (O'Connor, 2000) and (b) fixed IPI probe.

FIXED-IN-PLACE INCLINOMETER PROBE

For cases where the ground movement is occurring at discrete depths, fixed-in-place sensors can be installed in the casing to monitor movements at these depths. The benefit of this approach is the savings in time and labor to perform the manual measurements and the ability to collect continuous data using ADAS equipment. Continuous data collection can be valuable in understanding movements that are occurring in response to changing environment parameters such as rainfall, groundwater levels, temperature, or tidal influences. Automated data acquisition can also be used for remote monitoring and near real-time notification of increases in the magnitude or rate of movement (Cornforth, 2005).

Instrument Calibration, Care, and Maintenance

The inclinometer probe is initially calibrated by the manufacturer. Frequent use of the inclinometer system can cause change in the calibration, therefore, periodic calibration is needed. If errors or discrepancies are observed during use of the instrument, it is possible that calibration issues may exist. Simple calibrations can be performed in the laboratory to verify satisfactory performance prior to each monitoring site visit. ASTM (2005) and Dunnicliff (1988) describe calibration procedures using near-vertical test casing or a test stand. When calibration attempts indicate unresolved problems, detailed recalibrations and diagnostic evaluations should be referred to the manufacturer. ASTM (2005) recommends that recalibrations be performed at least annually.

Inclinometer probes are sensitive instruments and need to be used carefully and protected during storage and transportation. Abrupt knocks can dislodge or reorient sensors, causing internal misalignment. Energy absorbing packages and storage containers are usually available from the manufacturer. One common mistake made by inexperienced users is to let the probe impact the bottom of the casing which can cause damage to the sensors. The first reading location, usually a short distance off the bottom, is approached slowly in case conditions in the bottom of the casing have changed. Instrument manufacturers provide advice on checking the operation of the inclinometer probe prior to each monitoring visit and the proper use to avoid accidental damage or misalignment (Dunnicliff, 1998, Chapter 12).

Maintenance operations include drying the connections and lubricating the wheel assemblies on the probe after each set of readings. The cable is inspected for visible damage and condition of depth markings. The instruments and cable are typically protected from moisture and stored in a dry environment. The Slope Indicator Company (2006a) manual presents detailed guidelines for system maintenance and inspection. Marr (2000) identifies potential problems with excessive inclinometer usage on large projects, that resulted in adverse effects on the collected data. Marr recommends coupling the same instrument components on the same project and having a back-up probe and cable in the event that problems are identified with the primary system. If possible, a back-up system can be used to obtain another set of initial readings at the same time as the primary system.

When using the instrument in wet environments, the readout device may require additional protection to prevent water from penetrating connections and internal electronic components. Cable connections must be watertight; however, over-tightening may cause damage.

The inclinometer sensors can experience a zero drift (a change in the sensors zero point with time) if they are not recalibrated on a regular basis such as in the case of in-place sensors deployed for long-term monitoring. The difference between drift and a real trend in movement is that the drift is erratic or random and real trends are typically affected by other changing parameters such as rainfall, groundwater levels, loading–unloading, and temperature.

The spiral sensor is a calibration tool that can measure the spiral in the grooves of inclinometer casing before installation or casing already installed. In the event that twisting (spiraling) of the casing during installation is suspected, particularly in very deep installations, a tool can be used to determine the azimuth orientation of the grooves. This is not a common problem and therefore spiral correction is seldom done. Readings that indicate movements are in the wrong direction could be a symptom that spiraling could exist. Use of this tool may be necessary for very deep installations, typically greater than 200 ft (60 m), and when installation difficulties are encountered (Dunnicliff, 1988; Mikkelsen, 1996).

Measurement and Data Acquisition

Instrument measurement depends on the type of system installed, whether the inclinometer is required to traverse along a casing, or is fixed in place.

TRAVERSING INCLINOMETER PROBE

The sensors record the amount of tilt of the inclinometer probe in the guide casing. The shape of the casing is determined by taking successive 2 ft or 50 cm increment measurements, which is the distance between the wheels, providing a continuous profile of the casing. In special applications, measurements could be made at smaller intervals in order to better define the shape of the guide casing and to more accurately define the depth of ground movement. Cornforth (2005) provides detailed guidance on performing initial data sets and subsequent monitoring measurements.

A typical setup for making measurements with a traversing inclinometer is shown in [Figure 18](#). This example application is for a vertical casing installed in a landslide.

Data readings are added from the bottom up to develop cumulative plots, assuming that the casing tip is installed in a stable zone (reference datum). However, where the tip of the inclinometer casing is not in stable ground (such as for casings installed horizontally at the base of embankments), data readings are referenced to the top of the casing, which are optically surveyed with each monitoring visit. It is essential that highly accurate surveys be performed to try to match the precision of the inclinometer readings.



FIGURE 18 Performing measurements using a traversing inclinometer probe and data recording device (Landslide Technology).

Because the measured movement is determined from cumulative changes in the orientation of the casing at a specific depth between the current reading and the previous readings, it is very important that the depth measurement reference point does not change. For most installations the zero depth point is the top of the casing. For monitoring during construction it is especially important to survey the elevation of the top of the casing and periodically verify that it has not changed. Consistency with the orientation of the probe for the readings is important. The probe wheels are placed in the same set of grooves every time and in a similar manner. For example, the wheels in the “up position” for the first reading, aligned in the A_0 groove, and then rotated 180° for the second reading (see Figure 19). Typically, the A_0 groove is positioned in the direction of anticipated ground movement and marked in a permanent manner at the top of the casing. The A axis of the inclinometer probe is more accurate than the B axis.

Prior to making measurements, the top of the casing is square, or perpendicular to the axis of the casing, which is accomplished by making a symmetrical cut (preferably using a pipe cutter).

The inclinometer probe is inserted into the guide casing and lowered to the lowest depth to be measured. In horizontal applications, the inclinometer probe is extended to the furthest end of the casing. It may be necessary to start measurements above the original bottom reading level if sediments or debris have entered the casing. The depths where measurements are to be made are selected such that no measurement is taken where the wheels of the probe coincide with a casing joint. The probe is allowed to rest at the end of the casing for 10 to 15 min so that the sensors stabilize with ground temperatures (Dunnicliff, 1997; Slope Indicator Company, 2006a). Procedures to set the inclinometer probe at the bottom depth are consistent to achieve accuracy in comparative analyses. The bottom readings can be compared with previous data sets to confirm that the depth of the bottom reading and system functionality appears reasonable. Readings are checked in the field to confirm reliability and stability of the measurements. Incremental readings are made at each 2 ft or 50 cm interval as the probe is pulled up. The measurement operation is repeated by rotating the probe 180° and reinserting it into the same groove set of the guide casing. The numerical difference between corresponding readings at each

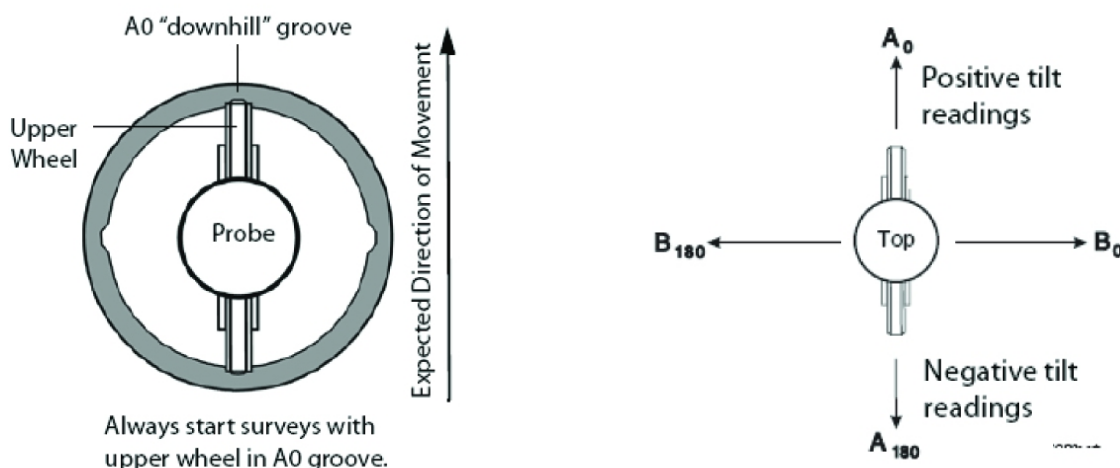

FIGURE 19 Orientation of probe within inclinometer casing (Slope Indicator Company).

depth is determined. The theoretical aspects of tilt measurement and computation are described in Wilson and Mikkelsen (1977) and Dunnicliff (1988).

The initial readings are only made after the backfill is complete and the grout has cured. Two series of initial data sets are needed to verify repeatability and accuracy since these readings will serve as the baseline measurement sets. Subsequent data measurements can be field checked to verify reasonableness of data, including comparisons with previous data sets and evaluating check-sums and standard deviations to determine if anomalies (random or systematic errors) are present. Repeat the measurement set if anomalies occur. Check-sums and standard deviations are discussed further in the following section (Dunnicliff, 1988; Cornforth, 2005; ASTM, 2005; and Mikkelsen, 1996).

Dunnicliff (1988) recommends the use of the same technician, inclinometer probe, and cable for all measurements on the same project in order to attain a high level of consistency. If different components must be used, data corrections may be necessary.

The Slope Indicator Company (2006a, 2006b) manuals present detailed guidelines for performing and checking data measurements.

FIXED-IN-PLACE INCLINOMETER PROBE AND AUTOMATED DATA ACQUISITION

Continuous tilt data can be obtained with a fixed IPI. Reading and logging this data is usually accomplished by one of two general approaches: automated data logging or real-time monitoring.

The first approach is to configure a data logger to collect and store data at predetermined time intervals. This data is then periodically downloaded by monitoring personnel to view a continuous set of time history data. Other background parameters such as rainfall, groundwater levels and temperature can also be read and logged by the data acquisition equipment to allow for direct correlation with the tilt data on a common timeline. Some data logging equipment can also be programmed to conditionally log data based on trigger events. The events could be the exceedence of a threshold level or the change in an environmental parameter such as the amount of rainfall over a period of time. The logging frequency can vary from a normal rate to more frequent data collection during the events of interest. For data acquisition equipment that allows higher level programming, the trigger can also be a user-developed algorithm based on measured site specific conditions and changing with the results of ongoing monitoring.

The second approach is implemented when the monitoring personnel need real-time feedback in addition to continuous time history data. This approach is generally more expensive because it also requires a communication infrastructure. An ADAS with communication capability is shown in [Figure 20](#).

The architecture for these automated monitoring systems can vary significantly depending upon the monitoring needs. For example, a system may be configured simply to provide a near real-time display of the monitoring results to operations or engineering personnel on site. It may also need to provide different data display formats to different users at multiple remote locations and provide immediate notification to personnel at different remote locations of a change in conditions on site. The tools to accomplish this level of automated monitoring are readily available and are currently being used for many types of civil infrastructure projects. However, successful implementation requires expertise in automated monitoring system design, system component integration, and installation.



FIGURE 20 ADAS with solar power and communication system (Myers et al., 2000).

Myers et al. (2000) presents a case history where two elevator shafts for an underground train station had to be constructed through an ancient landslide that was expected to experience ongoing creep movements. An automated monitoring system was implemented to collect a continuous time history of the creep movements measured by inclinometers. The automated system was designed to provide an alarm when movements exceeded 0.25 in. (6 mm) in the elevator shafts.

Data Analysis and Presentation

Inclinometer data measures the tilt of the probe and determines the shape of the inclinometer casing. Figure 21 presents schematics of the inclinations that are being measured. Data sets from different monitoring visits are compared to identify whether changes in shape have occurred, which could represent ground deformation or movement. The theoretical background of inclinometer data calculations is described in ASTM (2005), Dunnicliff (1988), Mikkelsen (1996), Cornforth (2005), Wilson and Mikkelsen (1977), and Slope Indicator Company (2006a). Data evaluation of IPIs would depend on whether multiple inclinometer instruments are linked in the same installation or if single units are installed (refer to manufacturer recommended procedures).

CHECKING AND EVALUATING DATA MEASUREMENTS

The Slope Indicator Company (2006a) manual presents detailed guidelines for checking and evaluating data measurements. ASTM (2005) states that precision and bias issues can arise, but no standards are presented for evaluation because no accepted practice has been approved. System field accuracy is ± 0.3 in. per 100 ft (± 7.6 mm per 30 m), which includes a combination of random and systematic errors, as illustrated in Figure 22. Random errors can occur within the sensors, limiting the precision of the probe. Systematic errors occur due to human actions that affect the condition of the sensors–probe and the data collection procedure. Guidelines for these evaluations are referenced herein.

The first evaluation of the data is a review of the checksums, which consists of adding the two values obtained in diametrically opposite directions at the same depth. The checksum

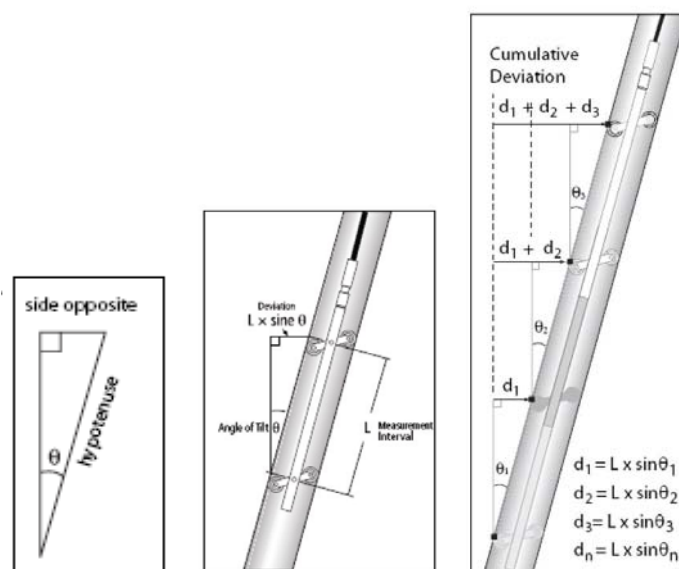

FIGURE 21 Measurement principles (Slope Indicator Company, 2006a).

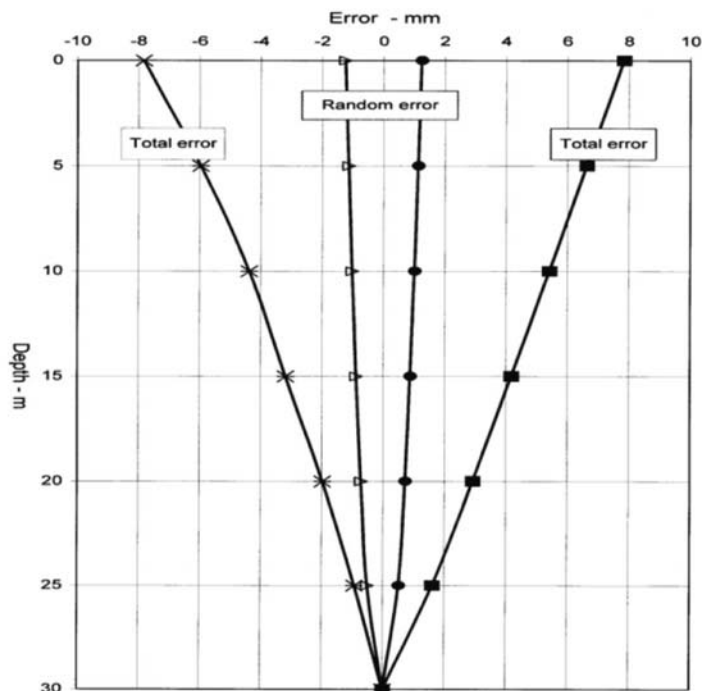

FIGURE 22 Total and random errors in inclinometer data (Mikkelsen, 1996).

evaluation is performed on site upon completing each data set. Theoretically, the checksums should be zero because the readings have opposite signs. In practice, the checksums produce a constant value, where a low standard deviation would confirm data quality. Checksums are used to evaluate the data for possible errors. The checksums ideally are constant for all depth intervals in a data set. There are several factors that can cause checksums to vary, including casing groove condition and local variations, instrument performance (internal zero-offset of the probe), probe positioning accuracy, and operator inconsistencies—errors. Small variations do not indicate a problem since slight variations are nearly impossible to eliminate. Checksum variations can become a concern if the standard deviation exceeds about 5 to 10 units of the mean checksum for the primary axis (A). If large checksum differences are localized to one depth, the data can be corrected based on the mean of the other checksums. However, if large checksums and variations occur in a dataset, the readings should be repeated until satisfactory checksums are achieved (Dunncliff, 1988; Mikkelsen, 1996; Mikkelsen, 2003; and Cornforth, 2005).

Office analyses include the preparation of graphs showing the relative shape of the inclinometer casing relative to the initial condition. Plotting the magnitude of change at each reading depth is useful to identify potential zones of movement. The most common type of graph displays cumulative lateral deformation with depth, starting at the bottom of the casing and summing increments of displacement for each measured interval up to the ground surface. A typical horizontal scale is 1 in. = 1 in. and a vertical scale of 1 in. (2.5 cm) = 10 ft (3 m) or 1 in. = 20 ft (6 m) for deep installations. The use of exaggerated horizontal scales is avoided because errors are magnified and could cause misinterpretations (ASTM, 2005; Cornforth, 2005; Mikkelsen, 1996; and Dunncliff, 1988). Example change and cumulative displacement plots are shown in [Figure 23](#).

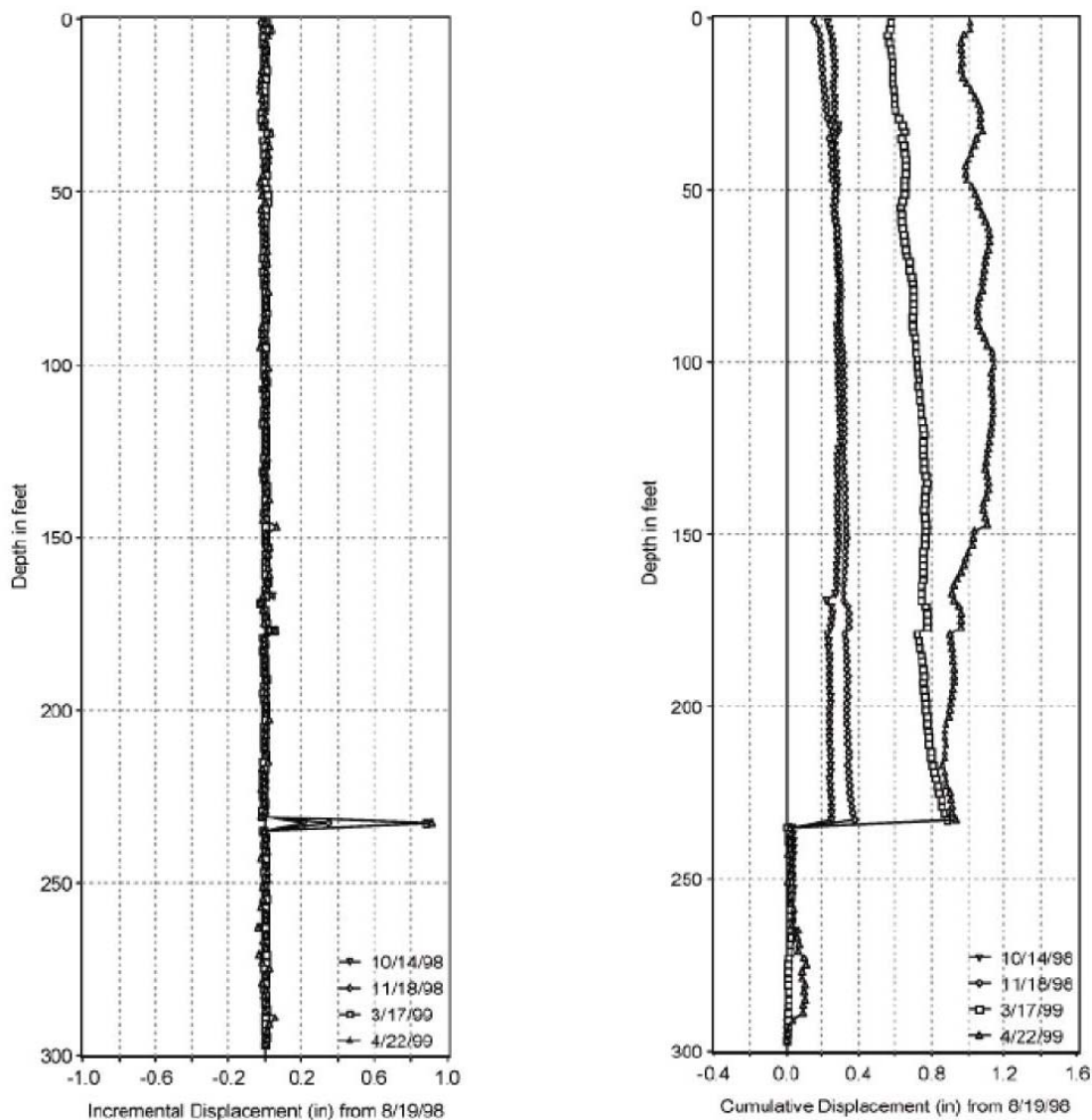

FIGURE 23 Comparison of data sets using incremental and cumulative displacement profiles (Slope Indicator Company, 2006a).

“Change” plots can be developed in order to dramatize the location of deformation zones. Change plots show the incremental deformation at each depth, which theoretically plots as a straight vertical line if there is no ground deformation, assuming no systematic errors. If ground deformation exists at a discrete depth, then the plot would show a lateral deformation only at that depth. For examples, refer to Dunnycliff (1988) and Slope Indicator Company (2006a).

If deformation is suspected when observing the data results, a repeat monitoring visit may be used to verify the accuracy of the readings and resulting interpretation. When movements are detected, calculations of rates of ground movement can be performed. Typically, only the deformations occurring at the discrete depth(s) are analyzed rather than plotting the apparent cumulative displacement at the ground surface. The latter can include cumulative systematic errors and could therefore exaggerate or understate the actual ground deformation. Movement

rate graphs show the discrete deformation plotted with time. Evaluation of such graphs can discern whether ground movements are accelerating, slowing down or coming to rest (Dunnicliff, 1988; and Mikkelsen, 1996).

DIAGNOSTICS FOR SYSTEMATIC ERRORS

Graphs of cumulative displacement versus depth and change plots can be affected by systematic errors. The possible types of systematic errors are described by Mikkelsen (2003), Green and Mikkelsen (1988) and Cornforth (2005). Tracking errors and random errors account for a small portion of potential errors and cannot be readily corrected. Systematic errors can be significant when data is combined to show cumulative displacement. Additional sources of error include operational variances by the instrumentation monitoring technician. Systematic errors can usually be separated from displacement data by analysis techniques.

Software is available to perform these analyses readily; however, experience and judgment are used to properly apply correction factors. Refer to Mikkelsen (2003) for detailed discussion and guidelines for systematic error correction.

- **Bias shift.** The bias shift is a function of the inclinometer probe calibration and performance, which is also referred to as “zero shift” or “offset error.” This is the most common type of systematic error, is relatively simple to correct, and is the first type of correction applied to the data set. This type of error is evident in graphs depicting cumulative displacement with depth, where the resulting plot radiates linearly from the base of the casing within the stable ground, as shown in [Figures 24 and 25](#). Refer to Cornforth (2005) for a detailed description of performing the bias correction manually. Alternatively, software exists that performs the correction.

- **Rotation error.** This error can be caused by excessive deviation of the inclinometer casing from vertical and is exacerbated by using worn or different inclinometer probes on the same project. For example, the measurement in the direction of the ideal A axis could measure part of the deflection in the B axis direction due to worn wheel yolks or a shift of the wheel in the grooves, resulting in a slight rotation of the probe. Variations of this type of error occur from probe to probe. The effect of this type of error is shown in [Figure 25](#). Correction can be applied using a trial and error procedure, but requires expertise. This type of correction is not routinely performed.

- **Sensitivity drift.** This error is usually due to a drift in the preamplifier for the inclinometer probe. This type of error is difficult to identify and is the least common. Factory calibration or repair of the inclinometer probe are usually necessary to correct this type of instrument error.

- **Depth positioning error.** This error is caused by the sensor being positioned at different levels than the initial data set. The error can be caused by ground settlement, vertical distortion or damage of the inclinometer casing, cable stretching or a replacement cable with variances in depth markings, or operator procedural inconsistencies. This type of error requires specialized experience and can take considerable time to analyze and correct.

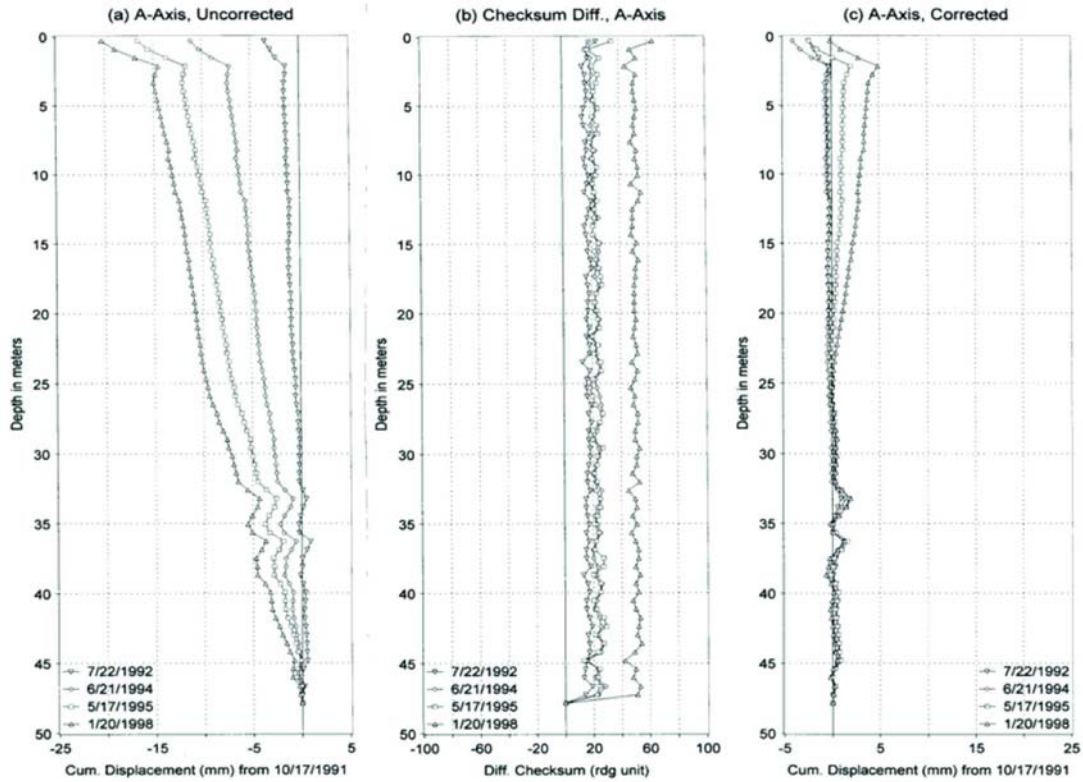

FIGURE 24 Bias-shifted data, checksums, and corrected results (Mikkelsen, 2003).

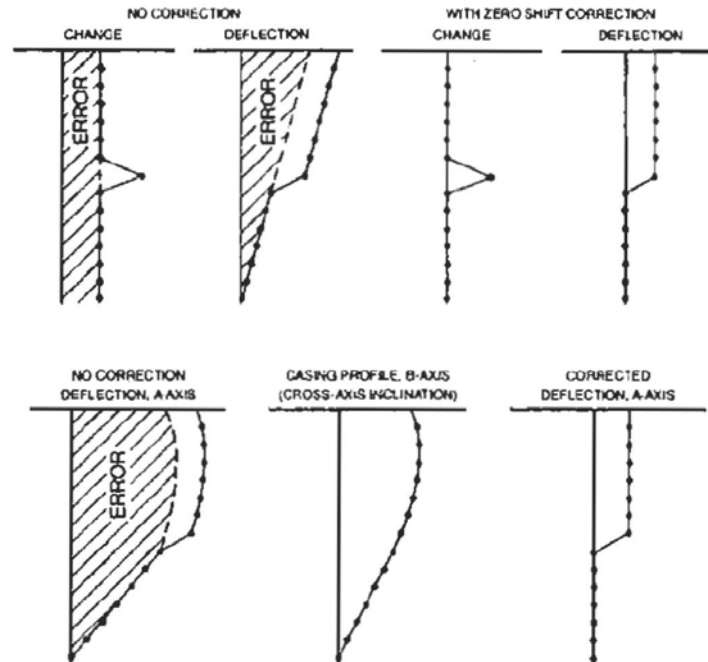

FIGURE 25 Typical bias shift and rotation errors (Mikkelsen, 2003).

Evaluation and Interpretation

After the instrumentation data is checked for accuracy and reliability, the next step is to identify whether ground movement is indicated by the data and the type of ground movement that is inferred. It is important to understand the cause of the apparent deformation, probable trends, and potential concerns.

When evaluating inclinometer results, it is important to be familiar with common deformation trends for various types of ground movement. In addition, experience with troubleshooting instrument problems and data errors is helpful in identifying anomalies. Are apparent displacements shown as occurring in a reasonable direction? Are movement magnitudes and rates reasonable? Is the shape of the cumulative displacement graph consistent with the type of movement occurring? Deformations that are counterintuitive are scrutinized for possible errors. Data that appear to be false are evaluated and possibly measured again to check if the original data is in error. Systematic and random errors can create the appearance of deformation where there is none.

For example, plots of cumulative displacement in landslides are typically near-vertical over most of the boring depth, with movement usually indicated by deformation in the downslope direction over the depth range corresponding to the landslide basal shear zone. Some users have incorrectly implied that the landslide movement is equivalent to the cumulative displacement at the ground surface. However, the incremental landslide movement is calculated only over the depth range of the basal shear zone or the zone of active ground deformation, as shown in Figure 26. For examples, refer to Cornforth (2005) and Mikkelsen (2003).

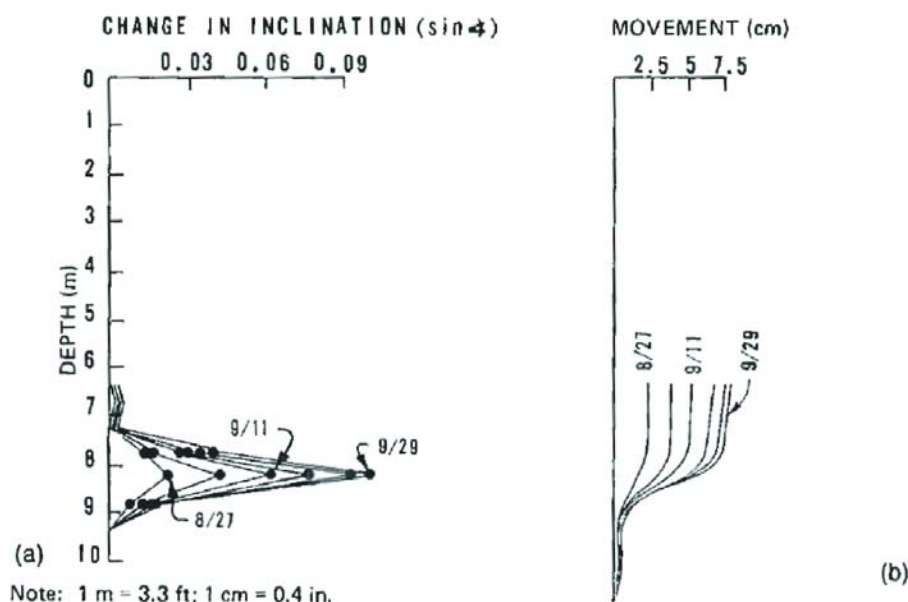

FIGURE 26 Discrete range of ground displacement at landslide shear zone (Mikkelsen, 2003).

The determination of whether ground movement is occurring can be a difficult task when movements are very small and creep like. The instrument typically measures casing deflections to 0.01 to 0.02 in. (0.25 to 0.50 mm) accuracy at a single reading increment (accounting for possible random and systematic errors). Systematic error accumulates arithmetically for the number of reading intervals, but fortunately random error accumulates at rate of only the square root of the number of reading increments. When deflection plots extend a long distance, higher total error can occur. A 100-ft or 25-m casing is typically measured with 50 reading increments, which could result in a combined total error of 0.57 in. (14 mm), which could be reduced to about 0.1 in. (2 mm) if all systematic errors can be removed. However, actual ground deflections that are being monitored usually occur only in portions of the casing installation. For example, if the deflection zone portion of the installed casing is the combination of three consecutive reading intervals, the total possible error could be 0.05 in. (1.2 mm). In practice, the general threshold for verifying the presence of landslide shear movement is at least 0.1 in. (2.5 mm) at the shear zone. Some users will plot exaggerated scales of apparent displacement and could incorrectly conclude shear movements where none really exist. In addition, some users will incorrectly use the apparent cumulative displacement at the ground surface, but this could include a significant accumulation of random and systematic errors. Therefore, it is typical to report deflections at the discrete movement zones rather than for the entire length of casing. While it is valuable to detect possible ground movements as early as possible, caution is needed to avoid causing unnecessary alarm or confusion.

Other Ground Monitoring Methods

Evaluation of ground movement monitoring systems is based on several factors, including sensitivity to detect expected scale of deformations (either small or large) or strain levels (resolution), reliability of the system to function under long-term exposure to the elements, coverage of the monitoring instrument, i.e., monitors one location, a general area, or an entire facility, and relative cost. For a summary of various methods for monitoring facilities in landslide terrain, refer to *Landslide Technology* (2003). Brief descriptions of some ground movement monitoring systems, for both lateral and vertical ground movement applications, are given in the following subsections.

Resolution is defined as the smallest increment of measurement that a system is capable of detecting. Generally, instruments that have a resolution of approximately 0.125 in. (4 mm) have excellent capability of detecting ground movement. While a system that has a resolution of more than 1 in. (25 mm) has fair capability of detecting ground movement. Long-term reliability typically depends on the capability of a system to provide reproducible monitoring results for many years. Factors that affect reliability are corrosion susceptibility of electrical systems and reproducibility of human observation. Frequency of readings affects cost.

VISUAL MONITORING

This approach consists of periodic on-site inspections. Field inspection is a good technique to identify gross signs of distress or change. However, visual observations are typically not accurate in detecting small movements or long-term continual creep. Resolution may be improved with comparative photo documentation. There is no consistent means of quantifying monitoring results.

TELLTALES

Stakes established along a line-of-sight can be used to improve visual observations of relative ground movement.. The observations can be quantified by having a second person hold a tape measure to any stake along the line of sight. This monitoring is accurate to a resolution of about 0.5 in. (12 mm). Movement data can be recorded and compared.

SURFACE SURVEYING

This option consists of establishing benchmark control stations and survey hubs at various locations of interest. The survey points are periodically measured to monitor for potential deformations. For this technique, the control stations are established on stable ground. Establishing stable control might be impractical in areas with widespread slope instability. Surface monitoring is accurate to a resolution of approximately 0.25 in. (6 mm). However, long-term deformation trends can be difficult to establish, due to personnel turnover, susceptibility to damage of control points, etc. This method generally cannot determine the depth(s) of ground

movement. Surveying with Global Positioning System (GPS) methods can improve measurements (higher resolution is possible).

GPS REMOTE MONITORING SYSTEMS

These systems involve placement of self-contained GPS–wireless communication units to detect ground deformation and send the information via the Internet or telecommunication link. Tree coverage, slope azimuth, and slope declination can affect the accuracy of this technique. These systems can have a position accuracy of approximately 1 in. (25 mm). More sophisticated systems using real-time kinetic (RTK) technology can achieve accuracies of approximately 0.125 in. (4 mm). For further details, refer to Duffy et al. (2001).

TDR CABLE

TDR measures shear displacement within a borehole. Additional descriptions are provided in Section 11 of this e-circular. Generally, this technique is effective in fast-moving landslides with thin shear zones. TDR typically detects ground movement when it is in excess of 1 in. (25 mm).

SETTLEMENT PLATFORMS

This is the most commonly used method for measuring the settlement of embankment fills over soft ground. Ground surveying is used to obtain settlement data and the resolution is approximately 0.25 in. (6 mm).

HYDRAULIC MANOMETERS–GAGES

This is an alternative method of monitoring embankment settlement, which is installed at the foundation of the embankment and accessed from the slope toe with minimal impacts to construction traffic. Resolution is approximately 0.25 in. (6 mm) due to the need for survey measurements.

ELECTROLEVEL SENSORS

These instruments measure tilt of an object or a point on the ground surface. Absolute movement is extrapolated from the point of measurement (Rasmussen, 2001; Dunnicliff and LaFonta, 2001).

INTERFEROMETRIC SYNTHETIC APERTURE RADAR

This new technique produces 3-D map views of ground surface deformation with 0.5-in. (1-cm) resolution in images with 60- to 75-ft (20-m) spatial resolution covering 60-mi (100-km) spatial extents. This is a remote-sensing technique that uses radar to repeatedly image a given geographic location by air or space-borne radar methods. The phase differences are sensitive to topography and any intrinsic change in position of a given ground reflector (Haynes, 2000; Haynes et al., 2001).

GROUND-BASED LIDAR

This method utilizes laser scanning techniques. A point cloud with coordinate data and intensity is produced and allows recognition of the ground surface. The point cloud, through reconstruction software, produces a 3-D image of the ground surface. Relative ground movements can be determined by comparing data sets from different dates (Sturzenegger et al., 2007; Hsiao et al., 2004).

Developing Technologies for Monitoring Ground Movement

TDR CABLE

TDR is an alternative method of detecting ground movements that utilizes coaxial cables grouted within boreholes or embedded within fills or structures. Ground displacements deform the cable and change the travel time of an electrical pulse. In theory, the signal alteration through the deformed section also provides an approximate measure of the magnitude of displacement. This technique has been in use for several decades. The benefits of this system include simple–quick readout, remote monitoring and data acquisition, and ability to survive large ground deformations. A limitation is the inability to measure the direction of sliding and small rates of movement. Current research indicates mixed results when ground movements are less than 1 in. (2.5 cm) (Turner, 2006). Research is ongoing to evaluate the effectiveness and limitations of this instrumentation (O’Connor and Dowding, 1999; Kane, 1998; Kane and Beck, 2001; Dowding et al., 2003).

DIGITAL–BLUETOOTH INCLINOMETERS

Digital inclinometer probes have recently been introduced by several manufacturers. MEMS accelerometers are positioned within the inclinometer probe. MEMS are designed to integrate small sensors on a single chip. This type of inclinometer has been previously mentioned as an alternative probe to the existing servo-accelerometer systems, but is mentioned here as a developing technology because it needs greater validation through usage and evaluations.

WIRELESS IN-PLACE MEMS SYSTEMS

This type of instrumentation consists of a string of closely spaced MEMS accelerometers combined with an ADAS that provides near real-time in-place monitoring (Danisch et al., 2004). The sensor array is capable of measuring 3-D ground deformations at 1-ft (30-cm) intervals up to depths of 330 ft (100 m). The sensor diameter is less than 1 in. (25 cm) so it can be utilized even in very small boreholes, horizontally and vertically. A series of full-scale shaking table tests and field tests have been performed (Abdoun et al., 2007; Lemke, 2006).

VIBRATING WIRE INCLINOMETER

These instruments are being developed for IPIs and other ground movement instrumentation (Dunnicliff and LaFonta, 2001; Ma and Wu, 2004; Sweetman and Carayol, 2001).

FIBER-OPTIC INCLINOMETERS

Fiber-optic sensors use light guided in the fiber to perform high-resolution measurements. The measuring core is flexible and contains an optical setup with mirrors. The fully symmetric internal structure of the inclinometer makes it insensitive to temperature variations that affect the whole measuring core. The fiber-optic system is not affected by electromagnetic fields, corrosion, moisture, or aging (SMARTEC, 2006; Huang et al., 2005; Ho et al., 2006).

Acknowledgments

This publication was authorized by the TRB Soils and Rock Instrumentation Committee (AFS20), with assistance from the TRB Engineering Geology Committee (AFP10). The following contributed to the development of this e-circular:

PRINCIPAL AUTHORS

- George Machan (Landslide Technology, Portland, Oregon)
- Victoria Bennett (Rensselaer Polytechnic Institute, Troy, New York)

ADVICE AND INPUT

- Tom Badger (Washington DOT, Olympia, Washington)
- Darren Beckstrand (Landslide Technology, Portland, Oregon)
- Brent Black (Landslide Technology, Portland, Oregon)
- Derek Cornforth (retired, founder of Landslide Technology, Sisters, Oregon)
- Verne McGuffey (retired, formerly New York State DOT, Colonie, New York)
- Erik Mikkelsen (Geometron, Seattle, Washington)
- Barry Myers (Engineered Monitoring Solutions, Tualatin, Oregon)
- Kevin O'Connor (GeoTDR, Westerville, Ohio)
- Anand Puppala (University of Texas, Arlington)

Exhibits in this publication are provided with the consent of the following:

- Tony Allen (Washington DOT, Olympia, Washington)
- Darren Beckstrand (Landslide Technology, Portland, Oregon)
- Tanner Blackburn (Hayward Baker, Odenton, Maryland)
- Case Foundation Co. (Chicago, Illinois)
- Rick Deschamps (Nicholson, Pittsburgh, Pennsylvania)
- George Machan (Landslide Technology, Portland, Oregon)
- Erik Mikkelsen (Geometron, Seattle, Washington)
- Barry Myers (Engineered Monitoring Solutions, Tualatin, Oregon)
- Kevin O'Connor (GeoTDR, Westerville, Ohio)
- Anand Puppala (University of Texas, Arlington)
- Slope Indicator Company (Seattle, Washington)

Bibliography

- AASHTO. *Installing, Monitoring, and Processing Data of the Traveling Type Slope Inclinometer*. AASHTO T 254-80, Standard Specifications for Transportation Materials and Methods of Sampling and Testing. American Association of State Highway and Transportation Officials, Washington, D.C., 1980.
- Abdoun, T., V. Bennett, L. Danisch, T. Shantz, and D. Jang. Field Installation Details of a Wireless Shape-Acceleration Array System for Geotechnical Applications. *Proc., SPIE*, Vol. 6529, San Diego, Calif., March 19–22, 2007.
- Abu-Hejleh, N., G. Hearn, M. McMullen, and J. Zornberg. MSE Walls with Independent Full-Height Facing Panels. In *ASCE GSP 140 Slopes and Retaining Structures under Seismic and Static Conditions*, 2005.
- Abu-Hejleh, N., J. G. Zornberg, T. Wang, M. McMullen, and W. Outcalt. Performance of Geosynthetic-Reinforced Walls Supporting the Founders/Meadows Bridge and Approaching Roadway Structures, Report 2: Assessment of the Performance and Design of the Front GRS Walls and Recommendations for Future GRS Abutments, Report No. CDOT-DTD-R-2001-12. 2001.
- ASTM. *Standard Test Method for Monitoring Ground Movement Using Probe-Type Inclinometers*. ASTM D6230-98. Annual Book of ASTM Standards, Vol. 04.09, ASTM International, West Conshohocken, Pa., 2005.
- Bentler, J. G., J. F. Labuz, and A. E. Schultz. Earth Pressure Behind a Retaining Wall. Final Report 2005-14. Department of Civil Engineering, University of Minnesota, 2005.
- Cording, E. J. Instrumentation in Tunnels. In *TRB Special Report No. 171: Tunnel Construction: State of the Art and Research Needs*, TRB, National Research Council, Washington, D.C., 1977, pp. 27–28.
- Cornforth, D. H. Performance Characteristics of the Slope Indicator Series 200-B Inclinometer. In *British Geotechnical Society, Field Measurements in Geotechnical Engineering*, John Wiley, New York, 1973, pp. 126–135.
- Cornforth, D. H. *Landslides in Practice: Investigation, Analysis, and Remedial/Preventative Options in Soils*, John Wiley, New York, 2005.
- Danisch, L. A., M. S. Lowery-Simpson, and T. Abdoun. *Shape-Acceleration Measurement Device and Method*. Patent Application, 2004
- de Alba, P. Site Selection and Installation of Geotechnical Arrays: Gaps in Our Knowledge. Presented at Workshop 2: International Workshop for Site Selection, Installation, and Operation of Geotechnical Strong-Motion Arrays, San Diego, Calif., May 17–19, 2006.
- Deschamps, R., C. Hynes, and R. Wigh. Extending the Period of Data Retrieval for Vertical Inclinometers. *ASCE Journal of Geotechnical and Geoenvironmental Engineering*, Vol. 124, No. 5, ASCE, 1998, pp. 454–456.
- Dowding, C. H., and K. M. O'Connor. Comparison of TDR and Inclinometers for Slope Monitoring. In *Geotechnical Measurements Lab and Field* (W.A. Marr, ed.), ASCE GSP 106, 2000, pp. 80–90.
- Dowding, C. H., M. L. Dussud, and K. M. O'Connor. New Developments in TDR Cable Surveillance of Potential Instability. Presented at FMGM 2003, 6th International Symposium on Field Measurements in GeoMechanics, Oslo, Norway, 2003.
- Duffy, M. A., C. Hill, C. Whitaker, A. Chrzanowski, J. Lutes, and G. Bastin. An Automated and Integrated Monitoring Program for Diamond Valley Lake in California. Presented at 10th FIG International Symposium on Deformation Measurements, Orange, Calif., March 19–22, 2001.
- Dunncliff, J., assisted by G. E. Green. *Geotechnical Instrumentation for Monitoring Field Performance*, John Wiley, New York, 1988, 1993, pp. 250–268.
- Dunncliff, J. Warm-Up Time for Inclinometer Probes—A Reminder. *Geotechnical News Magazine*, Vol. 15, No. 1, 1997, pp. 41–42.

- Dunnicliff, J. *Geotechnical Instrumentation*. FHWA Training Course in Geotechnical and Foundation Engineering Module 11, NHI Course 13241, Publication No. FHWA HI-98-034. National Highway Institute, Washington, D.C., 1998, pp. 3-1-3-31.
- Dunnicliff, J., and J. G. LaFonta. In-Place Inclinometers: A Significant Test Program. *Geotechnical News*, March 2001, pp. 33-34.
- Dunnicliff, J., and P. E. Mikkelsen. Overcoming Buoyancy During Installation of Inclinometer Casing. *Geotechnical News Magazine*, Vol. 18, No. 3, 2000, pp. 19-20.
- Finno, R., and J. Roboski. Three-Dimensional Responses of a Tied-Back Excavation Through Clay. *ASCE Journal of Geotechnical and Geoenvironmental Engineering*, Vol. 131, No. 3, 2005, pp. 273-282.
- Finno, R., and L. S. Bryson. Response of Building Adjacent to Stiff Excavation Support System in Soft Clay. *ASCE Journal of Performance of Constructed Facilities*, Vol. 16, No. 1, 2002, pp. 10-20.
- Goh, A. T. C., K. S. Wong, C. I. Teh, and D. Wen. Pile Response Adjacent to Braced Excavation. *ASCE Journal of Geotechnical and Geoenvironmental Engineering*, Vol. 129, No. 4, 2003, pp. 383-386.
- Green, G. E., and P. E. Mikkelsen. Measurement of Ground Movement with Inclinometers. *Proc., 4th International Geotechnical Seminar, Field Instrumentation, and In Situ Measurements*, Nanyang Technical Institute, Singapore, 1986, pp. 235-246.
- Green, G. E., and P. E. Mikkelsen. Deformation Measurements with Inclinometers. In *Transportation Research Record 1169*, TRB, National Research Council, Washington D.C., 1988, pp. 1-15.
- Gue, S. S., and Y. C. Tan. Design and Construction Considerations for Deep Excavation. Lecture, IEM Northern Branch, Penang, September 26, 1998.
- Haynes, M., M. Culshaw, and S. Marsh. Remote Monitoring of Natural Survey Point Networks for Precision Surveying of Structural and Ground Movements. *Engineering Surveying Showcase 2001*, Issue 2, 2001, pp. 22-24.
- Haynes, M. Wide-Area Precision Surveying of Land Subsidence from Space Using Radar Interferometry. Presented at SISOLS 2000: Sixth International Symposium on Land Subsidence, Ravenna, Italy, September 24-29, 2000.
- Ho, Y. T., A. B. Huang, and J. T. Lee. Development of a Fibre Bragg Grating Sensored Ground Movement Monitoring System. *Journal of Measurement Science and Technology*, Institute of Physics Publishing, Vol. 17, 2006, pp. 1733-1740.
- Hoffman, J., J. Roboski, and R. J. Finno. Ground Movements Caused by Caisson Installation at the Lurie Excavation Project. *ASCE GSP 126—Geotechnical Engineering for Transportation Projects*, 2004, pp. 1280-1289.
- Hsiao, K. H., J. K. Liu., M. F. Yu, and Y. H. Tseng. Change Deflection of Landslide Terrains Using Ground-Based Lidar Data. International Society for Photogrammetry and Remote Sensing (ISPRS), XXth ISPRS Congress, Istanbul, Turkey, 2004.
- Hu, Z. F., Z. Q. Yue, J. Zhou, and L. G. Tham. Design and Construction of a Deep Excavation in Soft Soils Adjacent to the Shanghai Metro Tunnels. *Canadian Geotechnical Journal*, Vol. 40, 2003, pp. 933-948.
- Hwang, J., N. Liang, and C. Chen. Ground Response during Pile Driving. *ASCE Journal of Geotechnical and Geoenvironmental Engineering*, Vol. 127, No. 11, 2001, pp. 939-949.
- Huang, A. B., J. Ma, B. Zhang, X. Wen, J. Cao, and Y. T. Ho. Safety Monitoring of the Yellow River Dike Using an Optic Fiber Sensor System. Presented at 2nd International Yellow River Forum, Zhengzhou, China, 2005.
- Kane, W. F. Embankment Monitoring with Time Domain Reflectometry. *Tailings and Mine Waste '98*, Colorado State University, Fort Collins, Colo., 1998.
- Kane, W. F., and T. J. Beck. Instrumentation Practice for Slope Monitoring. *AEG Millennium Volume on Engineering Geology Practice in Northern California*, CDMG Bulletin 210, 2001.
- Karakus, M., and R. J. Fowell. Back Analysis for Tunnelling Induced Ground Movements and Stress Redistribution. *Tunnelling and Underground Space Technology*, Vol. 20, No. 6, November 2005, pp. 514-524.

- Kavvasdas, M. J. Monitoring and Modeling Ground Deformations During Tunnelling. *Proc., 11th FIG Symposium on Deformation Measurements*, Santorini, Greece, 2003, 19 pp.
- Kenwright, M. J., R. A. Dickson, and R. Fernie. Structural Movement and Ground Settlement Control for a Deep Excavation within an Historic Building. *Proc., 25th Annual Members' Conference and 8th International Conference and Exposition, Deep Foundations Institute*, New York, N.Y., 2000.
- Landslide Technology. *Report: Landslide Assessment and Monitoring Project, Bull Run Conduit Corridor*. For City of Portland Bureau of Water Works, Portland, Oreg., 2003.
- Lemke, J. In-Place Inclinometer Using Low-G Accelerometer Network. *Proc., GeoCongress 2006*. Atlanta, Ga., February 26–March 1, 2006.
- Leonidou, E. A., G. A. Athanasopoulos, and P. C. Pelekis. Deep Supported Excavation for the Underground Parking of the Hellenic Parliament: Measured Versus Predicted Behavior. *Proc., XVth International Conference on Soil Mechanics and Geotechnical Engineering*, Istanbul, August 27–31, 2001.
- Ma, C. C., and J. T. H. Wu. Field Performance of an Independent Full-Height Facing Reinforced Soil Wall. *ASCE Journal of Performance of Constructed Facilities*, Vol. 18, No. 3, 2004, pp. 165–172.
- Marr, W. E. Advances in Geotechnical Measurements. *Judgment and Innovation: The Heritage and Future of the Geotechnical Engineering Profession* (F. Silva and E. Kavazanjian, ed.). ASCE GSP 111, 2000, pp. 9–12.
- Martin, D. Long-Term Inclinometer Monitoring—An Update. *Proc., 9th International Workshop on Accelerator Alignment*, September 26–29, 2006, 4 pp.
- Massoudi, N. Real-Time and Remote Instrumentation Monitoring at the Virginia State Capitol. *Proc., GeoCongress 2006*, Atlanta, Ga., February 26–March 1, 2006.
- McKenna, G. T., G. Livingstone, and T. Lord. Advances in Slope-Monitoring Instrumentation at Syncrude Canada Ltd. *Geotechnical News Magazine*, Vol. 12, No. 3, 1994, pp. 66–69.
- McKenna, G. Advances in Slope-Monitoring Instrumentation at Syncrude Canada Ltd.—A Follow-Up. *Geotechnical News Magazine*, Vol. 13, No. 1, 1995 pp. 42–44.
- Mikkelsen, P. E. Chapter 11—Field Instrumentation. In *TRB Special Report 247: Landslides: Investigation and Mitigation* (A. K. Turner and R. L. Schuster, eds.), TRB, National Research Council, Washington, D.C., 1996, pp. 278–316.
- Mikkelsen, P. E. Advances in Inclinometer Data Analysis. *Proc., 6th International Symposium on Field Measurements in Geomechanics* (F. Myrvoll, ed.), Oslo, Norway, 2003.
- Mikkelsen, P. E., and S. D. Wilson. Field Instrumentation: Accuracy, Performance, Automation and Procurement. *Proc., International Symposium on Field Measurements in Geomechanics*, Vol. 1, Zurich, Rotterdam, Balkema, 1983, pp. 251–272.
- Monley, G. J., and A. H. Soderborg. I-15 Instrumentation Monitoring Program—Lessons Learned. *Geotechnical News Magazine*, Vol. 18, No. 3, 2000, pp. 29–31.
- Myers, B. K., L. R. Squier, M. P. Biever, and R. K. H. Wong. Performance Monitoring for a Critical Structure Built Within a Landslide. In *Geotechnical Measurements Lab and Field* (W. A. Marr, ed.), ASCE GSP 106, 2000, pp. 91–108.
- National Academy of Sciences. *Geotechnical Site Investigations for Underground Projects*, Vol. 1 and 2. Subcommittee on Geotechnical Site Investigations (E.B Waggoner, Chairman). U.S. National Committee on Tunneling Technology, National Research Council, ISBN: 0-309-07782-6, National Academy Press, 1984, 423 pp.
- O'Connor, K. M., and C. H. Dowding. *GeoMeasurements by Pulsing TDR Sensor Cables and Probes*, CRC Press, Boca Raton, Fla., 1999, 420 pp.
- O'Connor, K. M. Geotechnical, Environmental, and Infrastructure Applications of Metallic Ltd. *Geotechnical News*, Vol. 14, No. 2, June 1996, pp. 37–40.
- Ooi, P. S. K., and T. L. Ramsey. Curvature and Bending Moments from Inclinometer Data. *International Journal of Geomechanics*, Vol. 3, No. 1, 2003, pp. 64–74.

- Ou, C. Y., J. T. Liao, and H. D. Lin. Performance of Diaphragm Wall Constructed Using Top-Down Method. *ASCE Journal of Geotechnical and Geoenvironmental Engineering*, Vol. 124, 1998, pp. 798–808.
- Ou, C. Y., and B. Y. Shiau. Analysis of the Corner Effect on Excavation Behaviors. *Canadian Geotechnical Journal*, Vol. 35, Technical Notes, 1998, pp. 532–540.
- Pennell, R., D. Ruberu, and P. Flentje. Real-Time Display of Landslide Monitoring Data. Presented at 11th Australasian World Wide Web Conference, University of Wollongong, New South Wales, Australia, July 5, 2005.
- Puppala, A. J., and S. Sirigirpet. Field Instrumentation Studies on SH360 at Green Oaks Boulevard. Interim Report—Task 3, Interagency Contract 02-6XXIA003. Submitted to Texas Department of Transportation, Fort Worth District, 2006, 15 pp.
- Puppala, A. J., S. Saride, S. K. Sirigiripet, and R. Williammee. Evaluation of Cemented Quarry Fines as a Pavement Base Material. ASCE Geocongress Meeting, New Orleans, La., 2008 (under review).
- Rassmussen, C. Electrolevels: A European View. *Geotechnical News*, March 2001, pp. 31–33.
- Sarhan, H. A., M. W. O'Neill, and K. M. Hassan. Flexural Performance of Drilled Shafts with Minor Flaws in Stiff Clay. *ASCE Journal of Geotechnical and Geoenvironmental Engineering*, Vol. 128, No. 12, 2002, pp. 974–985.
- Slope Indicator Company. *Digitilt Inclinometer Probe Manual*, Mukilteo Wash., 2006a, 14 pp.
- Slope Indicator Company. *Horizontal Digitilt Inclinometer Probe Manual*, Mukilteo Wash., 2006b, 15 pp.
- Slope Indicator Company. *QC Inclinometer Casing Installation Guide*, Mukilteo Wash., 1997 (revised 2000), 27 pp.
- SMARTEC. *SOFO Fibre Optic Inclinometer*, Switzerland, 2006. Available at www.smartec.ch.
- Sturzenegger, M., D. Stead, C. Froese, F. Moreno, and M. Jaboyedoff. Ground-Based and Airborne LiDAR for Structural Mapping of a Large Landslide: The Frank Slide. Presented at 1st Canada–U.S. Rock Mechanics Symposium, Vancouver, B.C., 2007.
- Sweetman, J., and S. Carayol. Vibrating Wire In-Place Inclinometers: A Case History. *Geotechnical News*, March 2001, pp. 26–31.
- Turner, J. P. *Time Domain Reflectometry for Monitoring Slope Movements*. Publication FHWA-WY-03/02F. Report to Wyoming Department of Transportation, DOT, 2006, 50 pp.
- U.S. Army Corps of Engineers. *Engineering and Design—Tunnels and Shafts in Rock*. Design Manual EM-1110-2-2901. 1997, pp 10-1–10-6.
- Wilson, S. D., and P. E. Mikkelsen. *Foundation Instrumentation—Inclinometers*, FHWA TS-77-219. FHWA, U.S. Department of Transportation, 1977.
- Wilson, S. D., and P. E. Mikkelsen. Chapter 5—Field Instrumentation. *TRB Special Report 176: Landslides: Analysis and Control* (R. L. Schuster and R. J. Krizek, eds.), TRB, National Research Council, Washington D.C., 1976, pp. 112–138.
- Wong, I. H., and T. S. Chua. Ground Movements Due to Pile Driving in an Excavation in Soft Soil. *Canadian Geotechnical Journal*, Vol. 36, Technical Notes, 1999, pp. 152–160.
- Yoo, C., and K. M. Lee. Instrumentation of Anchored Segmental Retaining Wall. *ASTM Geotechnical Testing Journal*, Vol. 26, No. 4, 2003, pp. 382–389.
- Yoo, C. Measured Behaviour of Anchored Segmental Retaining Wall. *Proc., International Conference on Geotechnical and Geological Engineering—GeoEng 2000, Melbourne*, Technomic Publishing, 2000.
- Young, D. Sacramento's One-Two Punch: North and South River Crossings Ahead of Schedule and Under Budget. *Tunnel Business Magazine*, October 2006.

List of Manufacturers

The following list includes contact information for some of the manufacturers of inclinometer systems and components in North America:

Applied Geomechanics
1336 Brommer Street, Suite A8
Santa Cruz, CA 95062 USA
831-462-2801; fax: 831-462-4418
www.geomechanics.com

Geokon, Inc.
48 Spencer Street
Lebanon, NH 03766 USA
603-448-1542; fax: 603-448-3216
www.geokon.com

Geonor, Inc.
P.O. Box 903
109 Greenwood Circle
Milford, PA 18337
570-296-4884; fax: 570-296-4886
www.geonor.com

Roctest Telmac
665 Pine Avenue
St. Lambert, Quebec, Canada J4P 2P4
450-465-1113; fax: 450-465-1938
www.roctest.com

RST Instruments Ltd.
200-2050 Hartley Ave.
Coquitlam, British Columbia, Canada V3K 6W5
604-540-1100; fax: 604-540-1005
www.rstinstruments.com

Slope Indicator
12123 Harbor Reach Drive
Mukilteo, WA 98275
425-493-6200; fax: 425-493-6250
www.slopeindicator.com

Geo Instruments (North American Supplier for
Soil Instruments Ltd)
24 Celestial Drive, Suite B
Narragansett, RI 02882
401-782-1045; fax: 401-633-6021
www.geo-instruments.com

Soltec Corporation (North American Supplier
for Kyowa Electronic Instruments
Company, Ltd.)
12977 Arroyo Street
San Fernando, CA 91340
800-423-2344, ext. 411; fax: 818-365-7839
www.solteccorp.com

Terrascience Systems Ltd.
2040 West 10th Avenue
Vancouver, British Columbia, V6J 2B3, Canada
604-734-3443; fax: 604-732-4801
www.weir-jones.com

Note: Publication of this list is for information only and does not imply endorsement by TRB or its parent institutions.

APPENDIX

PowerPoint Presentations for Inclinometer Instrumentation for Transportation Projects Workshop



Workshop Agenda—January 13, 2008

Time	Topic	Speaker
1:30	Introduction. New TRB Circular	G. Machan (Landslide Technology)
1:50	Casing and Installation	J. Pecha (Slope Indicator)
2:15	Data Analysis and Diagnostics	J. Pecha (Slope Indicator)
2:50	Automated Data Acquisition	A. Marr (GEOCOMP)
3:10	Break	
3:25	Landslides	T. Badger (WSDOT)
3:45	Reinforced Abutment Fill	C. Kreider (NCDOT)
4:00	Shored Excavations	T. Blackburn (Hayward–Baker)
4:15	Embankments–Pavement	A.J. Puppala (University of Texas, Arlington)
4:30	Panel Discussion	All speakers and Rudy Saavedra (DGSI)
5:00	Adjourn	

Inclinometer Instrumentation in Transportation

GEORGE MACHAN, P.E.

TRB Annual Meeting
January 2008

TRB E-CIRCULAR
State of Practice

Sponsored by AFS20 and AFP10

... in final review

APPLICATIONS

- Landslide Investigations
- Monitoring Slope Stability
- Retaining Structure Performance
- Excavations Near Facilities
- Pile and Drilled Pier Performance
- Settlement of Embankments
- Deformation of Pavement Base
- Performance During Tunneling

TRB E-Circular Contents

- GEOTECHNICAL APPLICATIONS
- INSTRUMENT COMPONENTS
- PLANNING AND SELECTION
- INSTALLATION
- CALIBRATION, CARE, AND MAINTENANCE
- MEASUREMENT AND DATA ACQUISITION
- DATA ANALYSIS AND PRESENTATION
- EVALUATION AND INTERPRETATION
- OTHER GROUND MONITORING METHODS
- DEVELOPING TECHNOLOGIES

WORKSHOP AGENDA

Inclinometer Basics

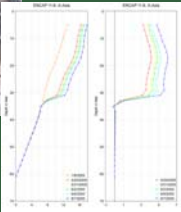
Jon Pecha
Durham Geo Slope Indicator

Automated Data Acquisition

W. Allen Marr
GEOCOMP Corp.



Landslide Characterization and Monitoring

Tom Badger
Washington DOT



Performance of Geogrid-Reinforced Foundation

Chris Kreider
North Carolina DOT



Deep Excavations

Tanner Blackburn
Hayward-Baker



Pavement Base Settlement

Anand J. Puppala
University of Texas at Arlington



- 2 presentations
- Break about 3:15 pm
- 4 presentations
- Panel questions 4:30 pm

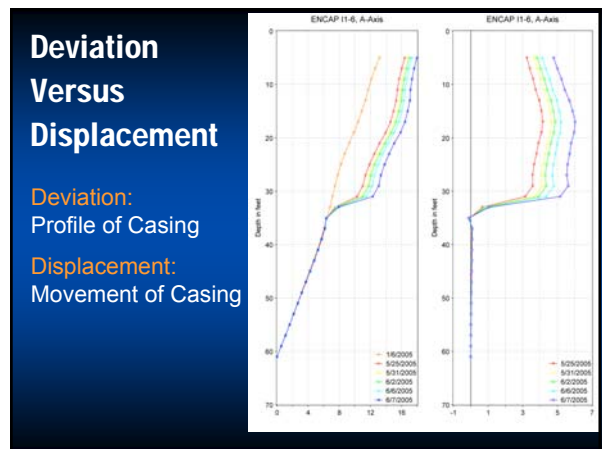
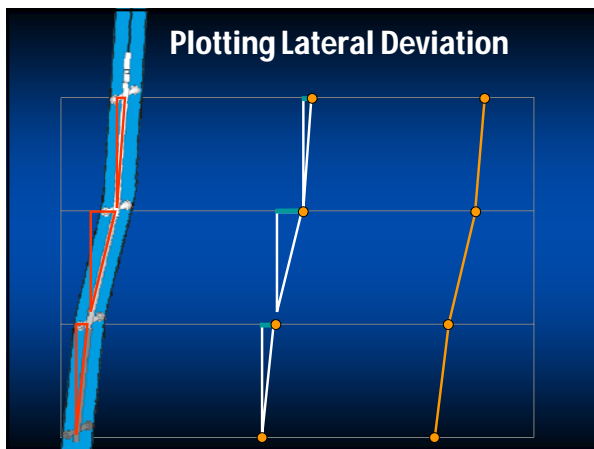
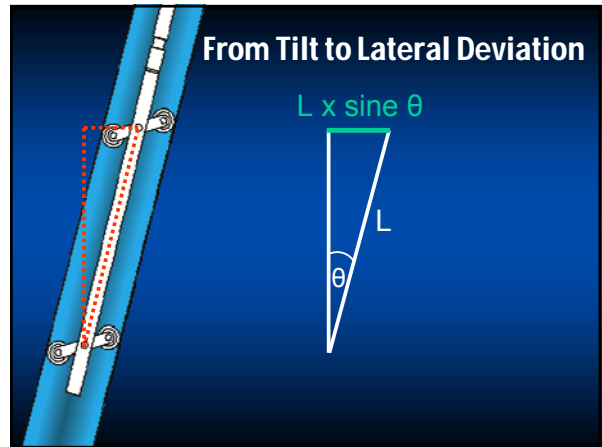
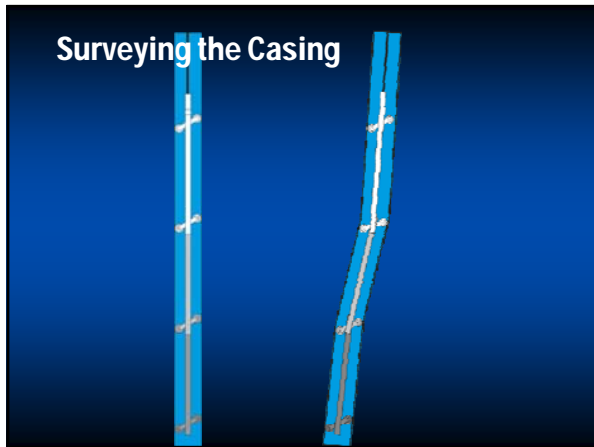
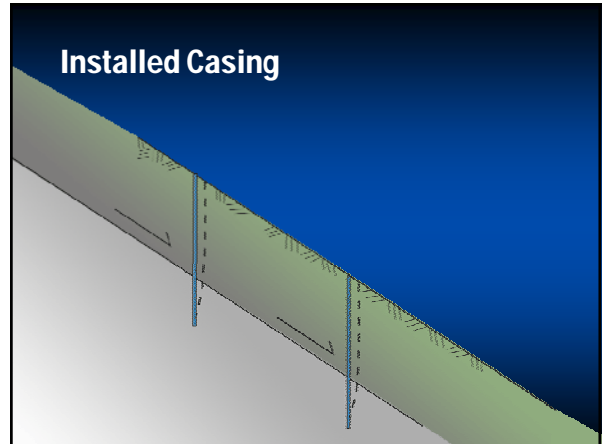

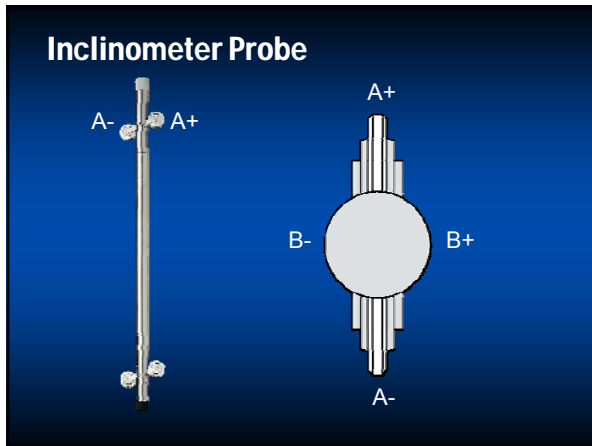

Graphing Inclinometer Data

Presentation Graphs

- Displacement Versus Depth Incremental
- Displacement Versus Depth Cumulative
- Displacement Versus Time Cumulative, Selected Xone

Diagnostic Graphs

- Incremental Deviation
- Cumulative Deviation
- Checksums

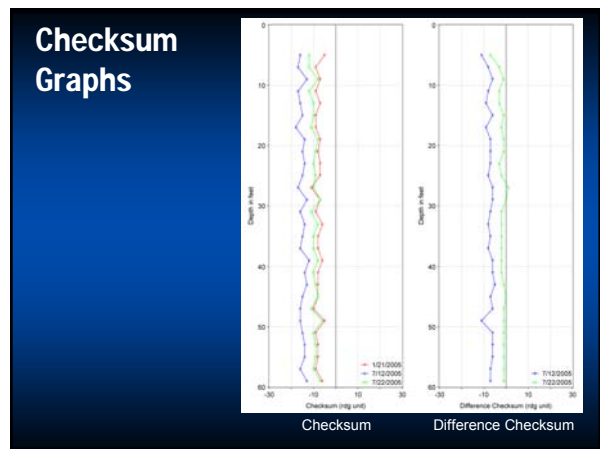
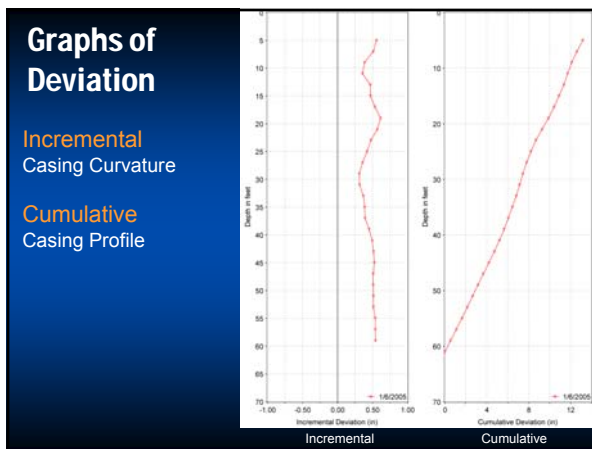
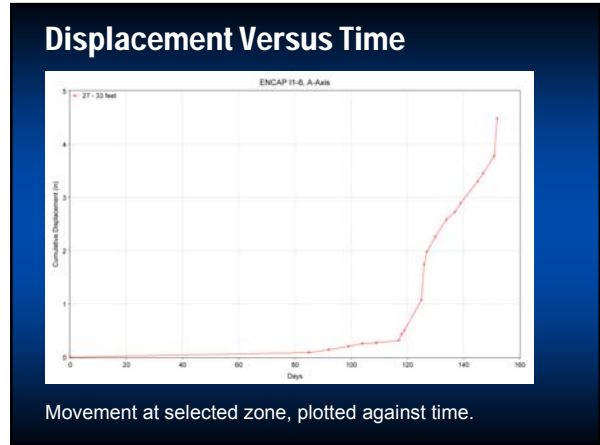
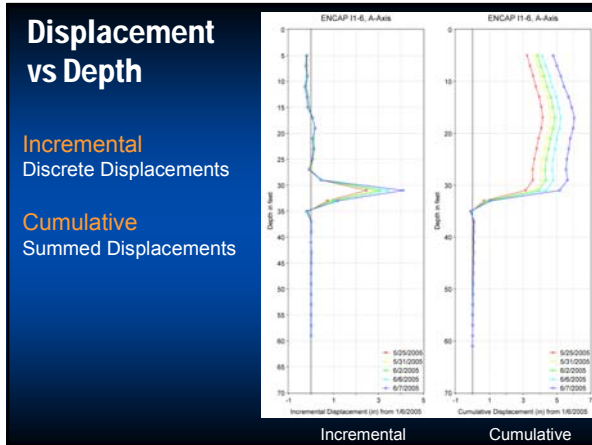

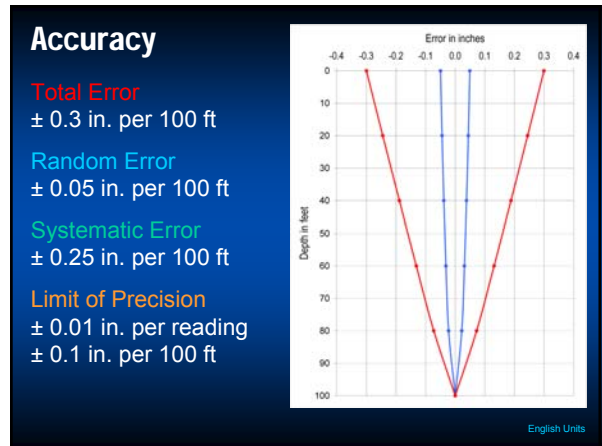
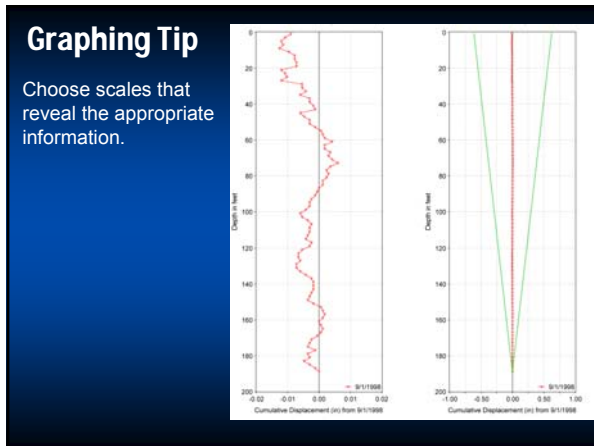

Sources of Error

Probe	Cable	Readout	Casing
Bias shift*	Depth control*	Set up	Inclination*
Rotation*	Poor storage	Operation	Curvature*
Connectors	Aging		Backfill
Wheels			Grooves
			Couplings

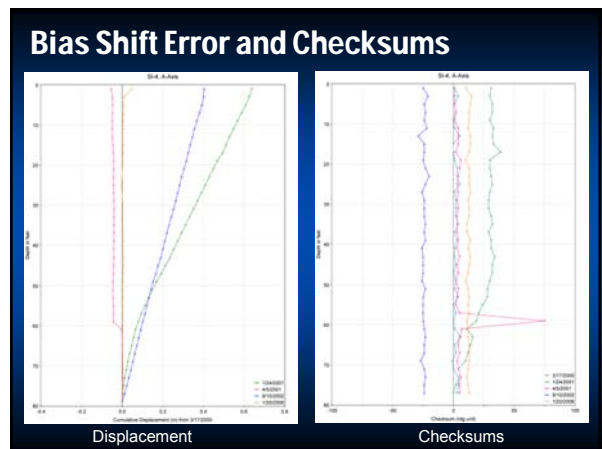
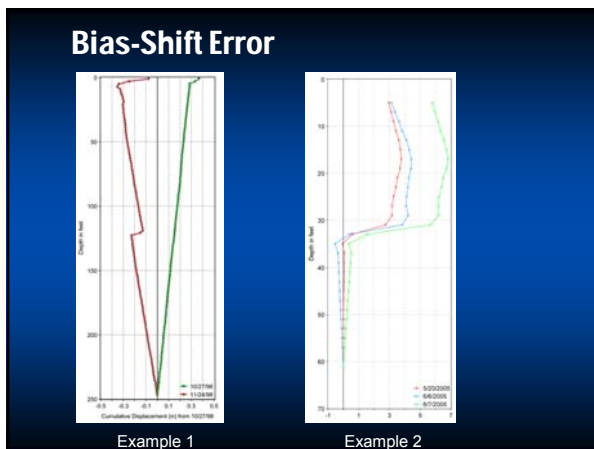
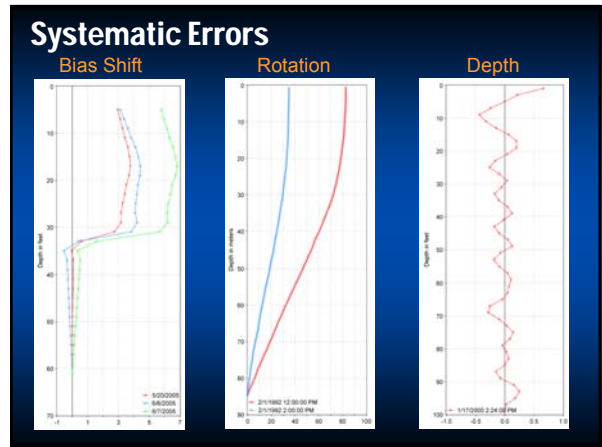

Bias-Shift Error

- Straight line segments tilting left or right.
- Apparent movement where none is likely.
- Checksum plot will show shift.

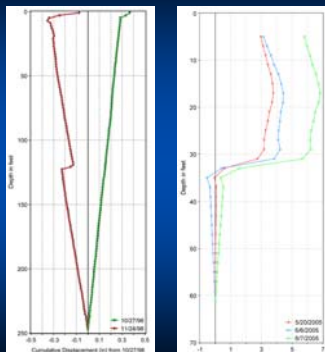

Example 1

Example 2

Rotation Error

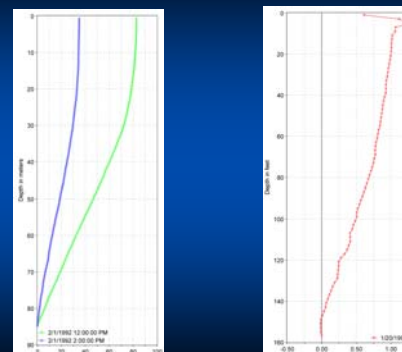

Example 1

Example 2

Rotation Error

- Curved segments showing movement where none is likely.
- Cross-axis profile has similar (or mirrored) shape.

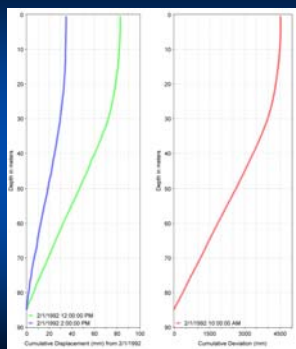

Displacement A

Profile B

Depth Error

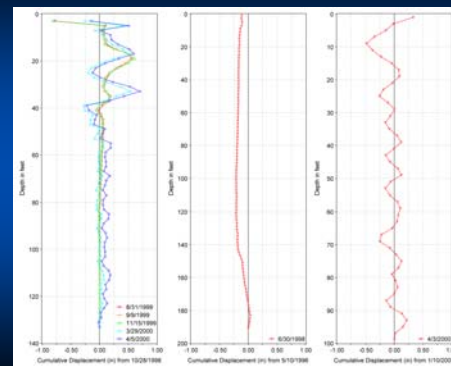

Probe Position: High or Low?

Probe is lower if ...

- Casing was cut off.
- Use of pulley halted.
- Casing settled.
- Cable lengthened.

Probe is higher if ...

- Casing was added.
- Use of pulley started.
- Cable twisted.
- Cable shortened.

Depth Error

- Displacements are exaggerated.
- Displacements are mirrored.
- Displacements are offset vertically.
- Graph of curvature has similar appearance.

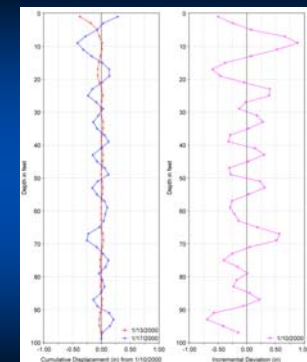

Displacement

Curvature

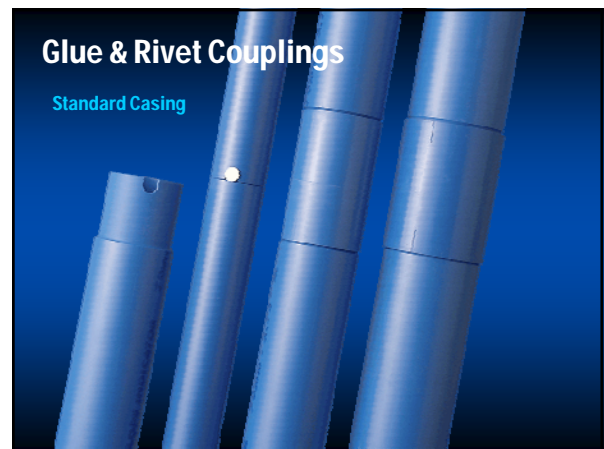
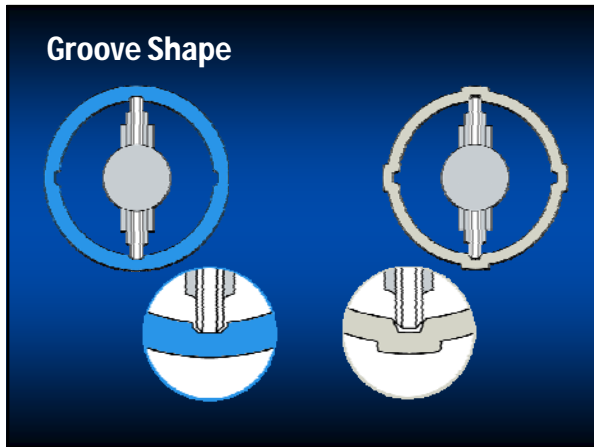
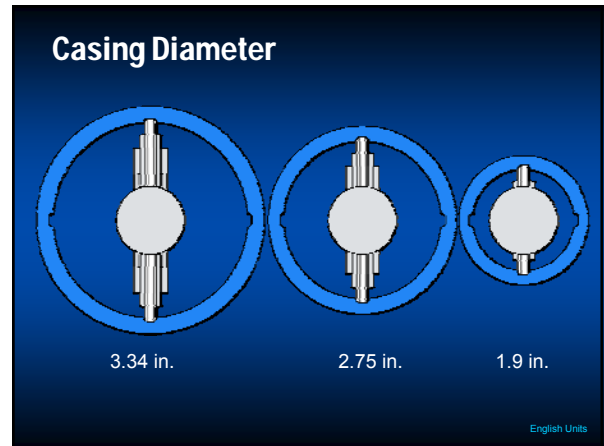



Couplings: Summary

Quick Connect	QC	Rapid assembly Flush couplings
Glue and Riv	Standar	Very strong Flush couplings
	EPIC	Very strong Cut-and-couple
Shear Wire	CPI	Rapid assembly Very strong Cold weather
	Shear-Wire	Rapid assembly Cold weather

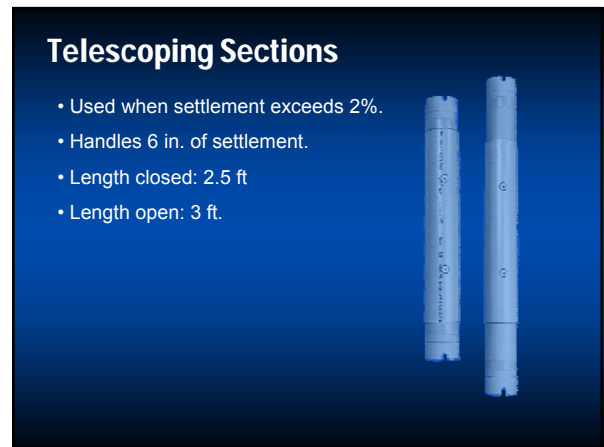

Borehole Requirements

Depth
Need 5 readings in stable ground.
Add extra depth for casing anchor or grout valve.

Diameter
Large enough for tremie pipe, if possible.

Verticality
Keep within 1° of vertical in A and B axes.

Installation Requirements

Install in the Proper Orientation
Align the A grooves as casing is installed.

Use a Stable Backfill
Bentonite-Cement grout works best.

Minimize Casing Curvature
Counteract buoyancy at the bottom of the casing.

Terminate for Pulley Assembly
Provide adequate clearance for pulley.

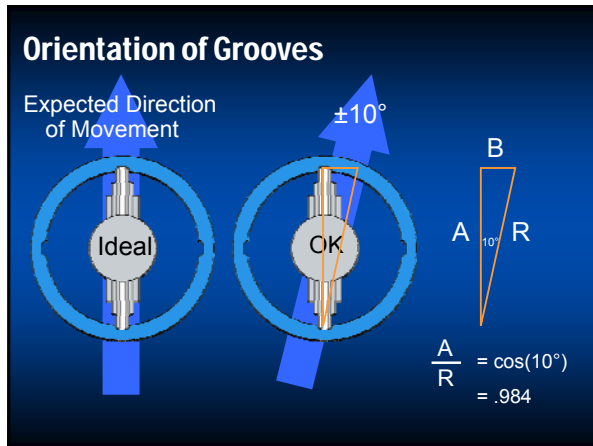

Backfilling the Borehole

- Bentonite-Cement Grout (provides uniform support).
- Pea Gravel (provides support, but might be loose and contain voids).
- Sand (difficult to achieve reliable support).

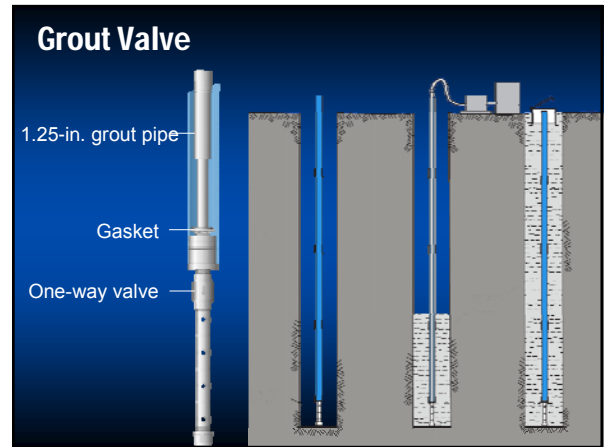
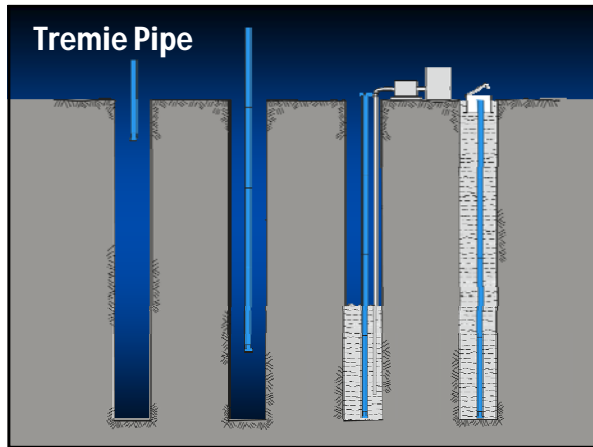

Grout Mixes

For Hard Soil	Volume	Weight
Cement	94 lb ba	1
Water	30 gal	2.5
Bentonite	25 lb	0.3

For Soft Soil	Volume	Weight
Cement	94 lb ba	1
Water	75 gal	6.6
Bentonite	39 lb	0.4

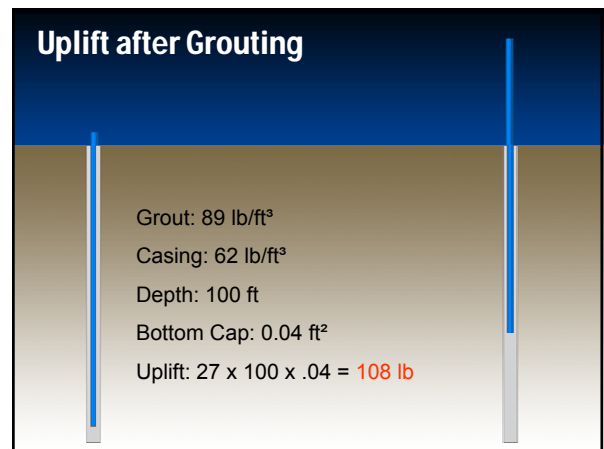

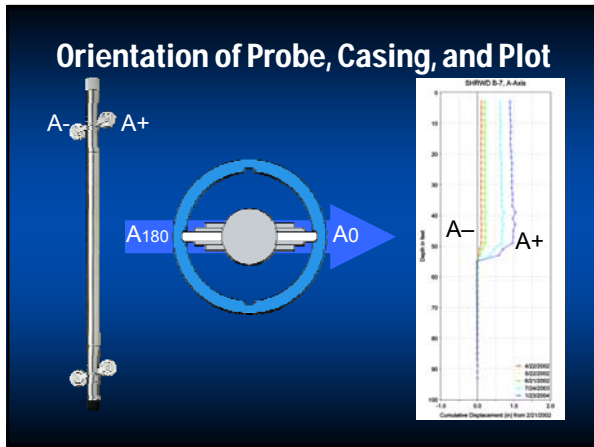
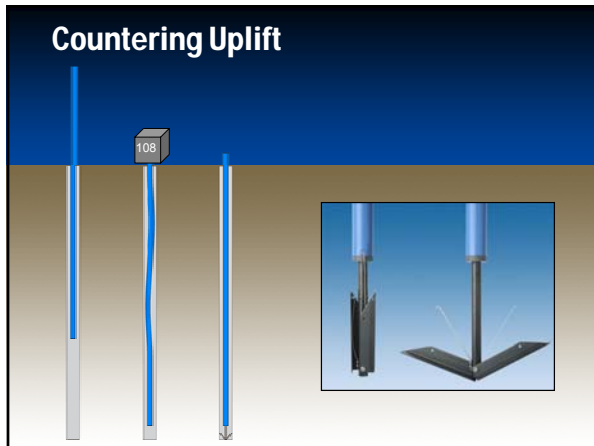

In-place Inclinerometers

TRB Workshop on Inclinerometers
January 13, 2008

W. Allen Marr, PE
Geocomp Corporation
Boxborough, MA
www.geocomp.com

Boston New York City Atlanta

Agenda

- Objectives – uses
- System components
- IPI types
- System design and installation
- Reading and reporting
- Examples
- Interpretations and limitations
- Benefits

Definition of IPI

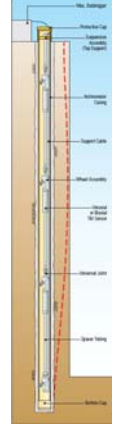

- Inplace inclinometer – a string of tilt sensors connected together and placed permanently in the ground or on a structure to measure change in position of the string in a direction perpendicular to the axis of the string.

Illustration courtesy of Geokon

System components

- Casing – standard inclinometer casings or mounted onto beams
- Sensor
- Aligning wheels – spring loaded and low friction
- Connecting rods/cables – rods must be sufficiently stiff, cables must be taught
- Weight – to keep string in constant tension
- Readout – must be sensitive <math><1/5000</math>
- Data logger – for remote monitoring
- Communications – move data to where it is needed

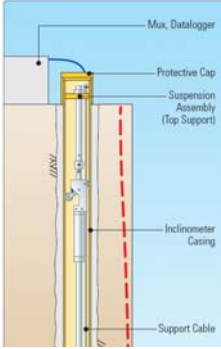

Illustration courtesy of Geokon

In place inclinometers



Reliably measure deflections to 0.1 mm / m.

Tilt

Tilt sensor



Tilt beam-Electro-level

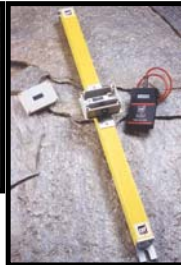

Resolution to better than 0.01 mm per m

IPI types

- **Electrolevel** – “Little Dipper” from Applied Geomechanics, Slope Indicator’s EL and ELS sensors
- **Vibrating wire** – Geokon
- **MEMS** – Geokon, Soil Instruments
 - uses solid state surface and bulk micromachining technologies that provide a DC response in that they can sense static acceleration such as gravity. As the amplitude of the response of such sensors is proportional to the sine of the angle formed between the axis of sensitivity and the horizontal, it is possible to measure degrees of tilt by reading the static acceleration data generated by the sensor

Factors Affecting System Design

- Range and Accuracy required – affects choice of sensor
- Locations along string where measurements are desired – affects number of sensors per string.
- How finely does the shear zone need to be identified – affects number of sensors per string.
- Data collection, management, transfer and reporting -

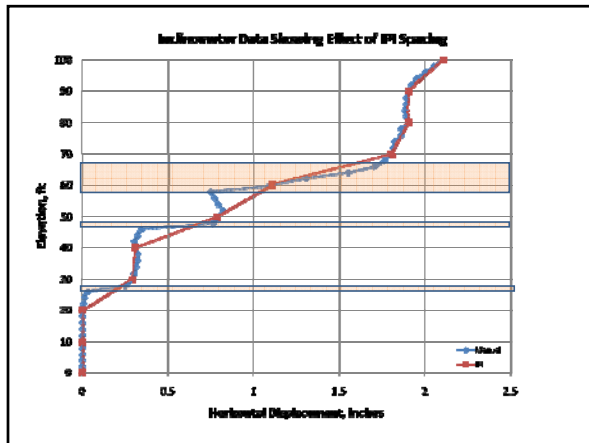

System Installation

- Read casing position with a manual inclinometer at least three times to provide baseline location.
- Verification that all elements function correctly before field installation is begun
- Proper installation of casing – good grouting, minimal or known twist, seated outside zone of movement.
- Positioning of guide wheels in casing grooves
- Process to have all elements hang from top without slack.
- Assemble on ground and with two people insert into casing.
- Check output of all sensors to make sure they are working and are near center of sensors’ output range.
- Install data logger, power supply and check their functionality.
- Install communications, check and stress test the system.
- Protect installation from potential damage by weather and vandals.



Reading Sensors

- Manual readouts
- Data loggers with manual recovery
- Data loggers with communications links
 - Landline, cell modem, IP phone

Handheld readouts do not exploit the benefits of IPI systems.

Reporting Data

- Spreadsheet
- Application specific software
- WEB-based

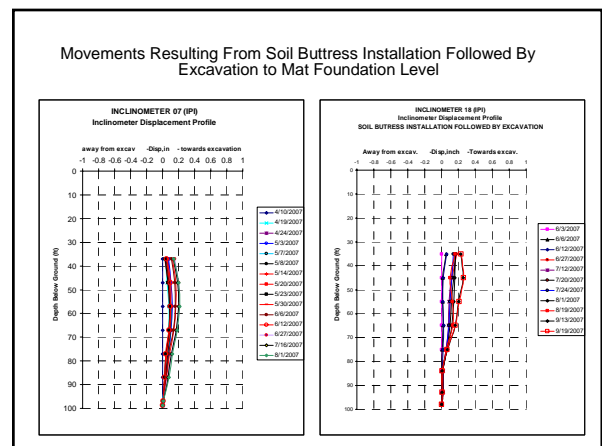
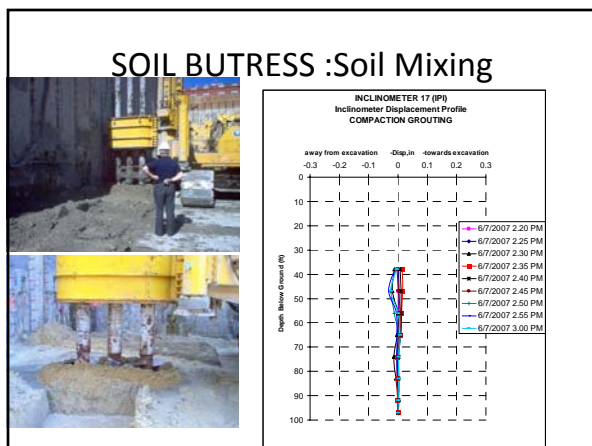
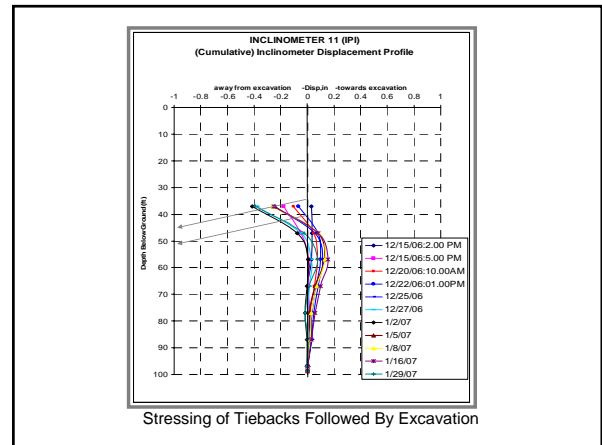
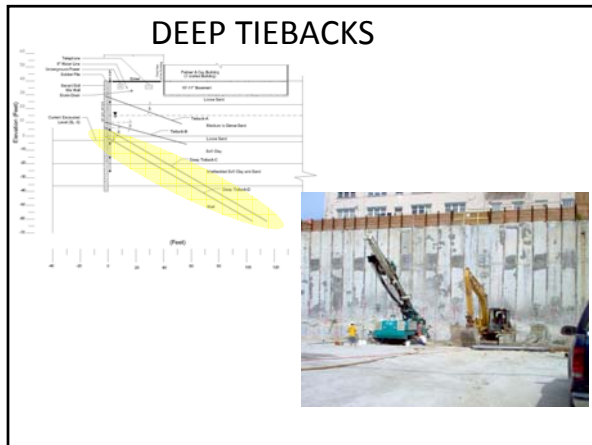
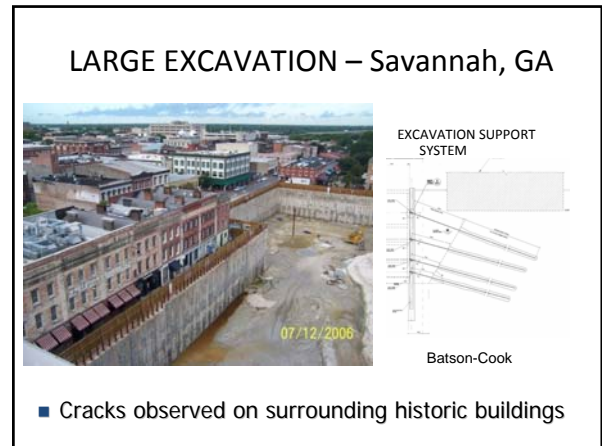
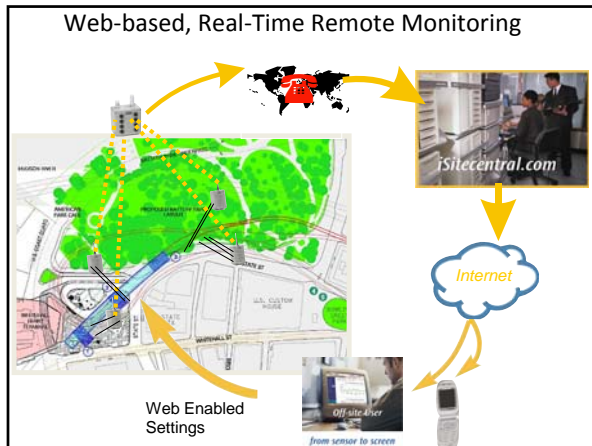

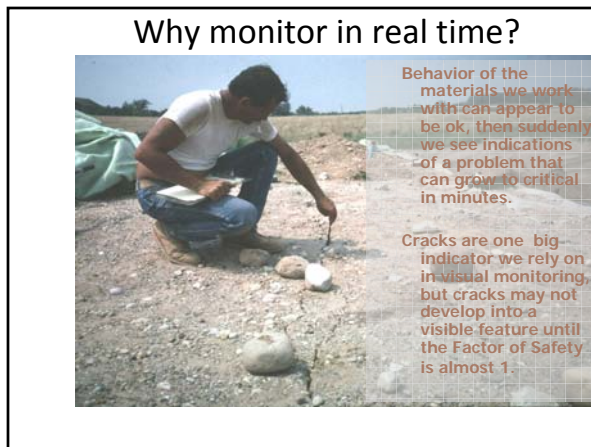
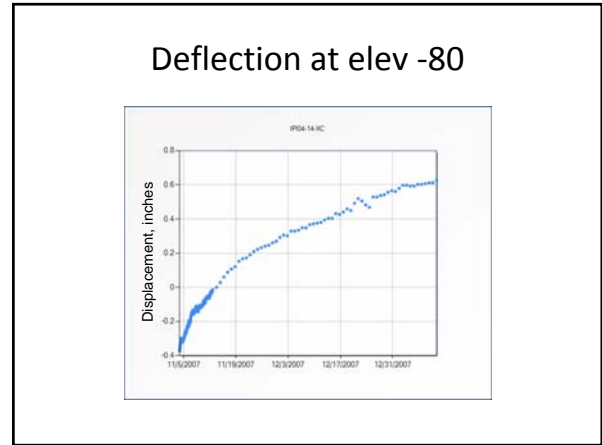
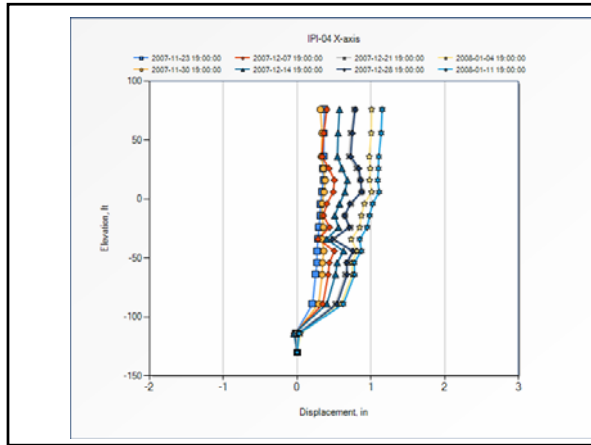
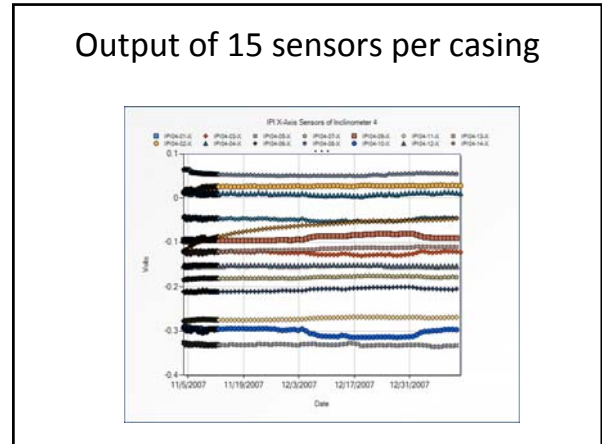
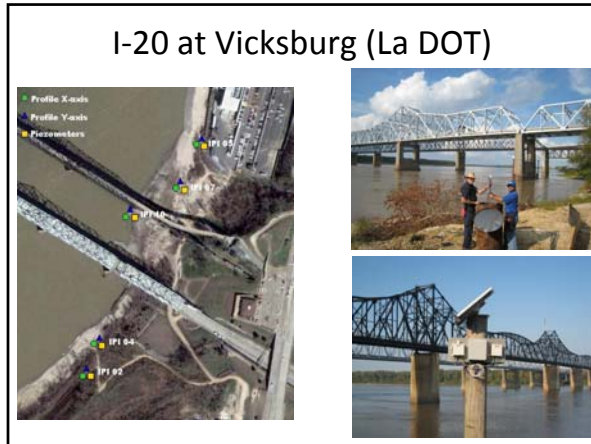

- ### Why monitor in real time?
- Failure can occur rapidly with little visible warning, even for an excavation that has been stable for years.
 - Global instability – shear slide
 - few hours to weeks
 - Internal instability – internal erosion – piping
 - few hours to years
 - Other – soil/structural failure sudden to years
 - Failure may be avoided using preventative actions, if we have adequate warning.
 - Consequences can be reduced significantly if we have a reliable warning.

Factors affecting monitoring frequency

- Rate at which performance mechanism can change
 - (deformations for excavation may be so small they can't be reliably detected with manual monitoring; then within hours rate accelerates to failure)
- Consequences of poor performance
 - Are lives or major facilities at risk?
- Environmental effects on facilities and instrumentation
 - Temperature, humidity, precipitation, sun, wind

[For monitoring to be effective, data retrieval, evaluation and action are to occur fast enough to capture early warning signs and avoid unacceptable performance.](#)

Interpreting Data

- Lots of data so allow some time to be able to look at it in detail.
- Are the data believable?
 - Look at trends of individual sensors with time to see if they are consistent and make sense.
 - Look for fluctuations with environmental changes, (temperature, groundwater levels, river levels, etc.) to see if they make sense.
- Summarize data into few key plots that non-specialists can understand.
 - Vertical profile plot showing readings at key times.
 - Movement versus time at key locations.

Limitations/Issues

- Short experience record so we don't know long-term stability for in service conditions.
- Uncertain life for in service conditions.
- Shortage of best practices for installation to give best performance.
- More pieces so more opportunity for things to go wrong.
- Very temperature sensitive- protect from direct sunlight and monitor temperature.

Benefits

- Lots of data over time to see how installation is actually behaving.
- Less prone to errors inherent in manual logging of inclinometer casings.
- Can remove from the casing for repair, recalibration and independent check with manual inclinometer.
- Can reuse the equipment.
- Tremendous opportunity to monitor horizontal or vertical movements over a line in real-time via Internet so instrument can be used to manage the impact of construction.

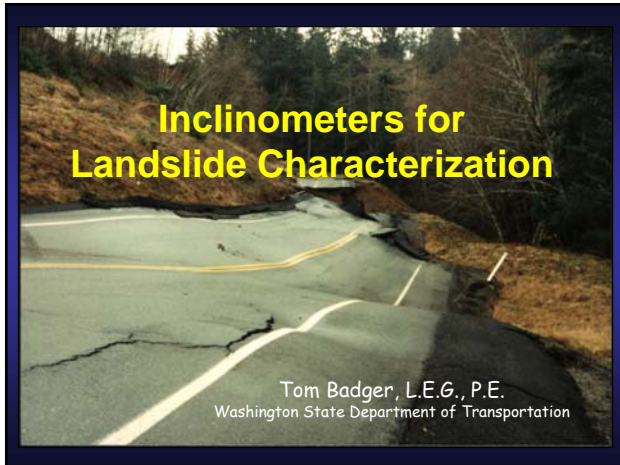

Objectives

- Define extent of movement
- Define direction of movement
- Determine movement rates
- Evaluate response to events
- Characterize deformation style and behavior

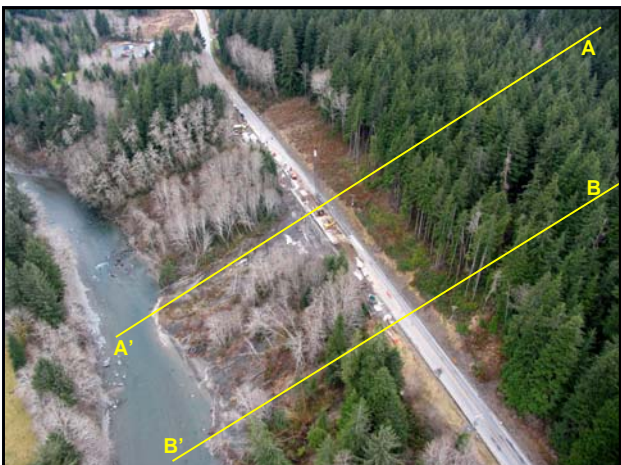
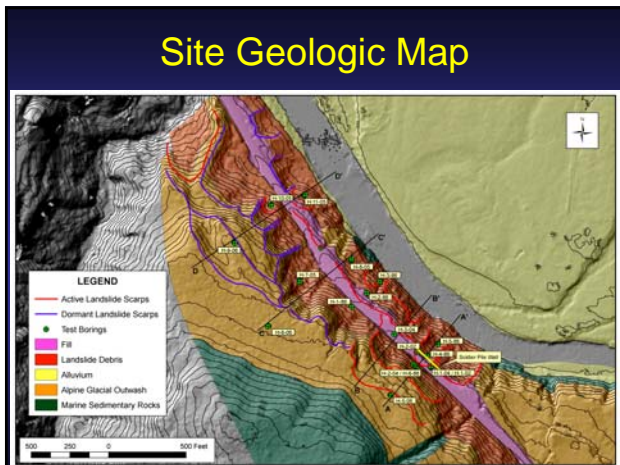
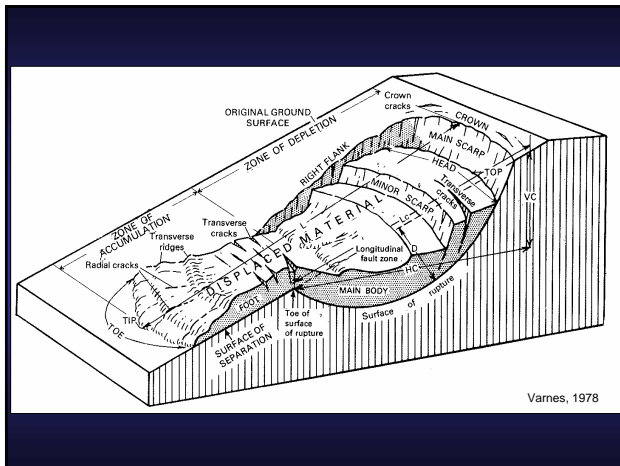

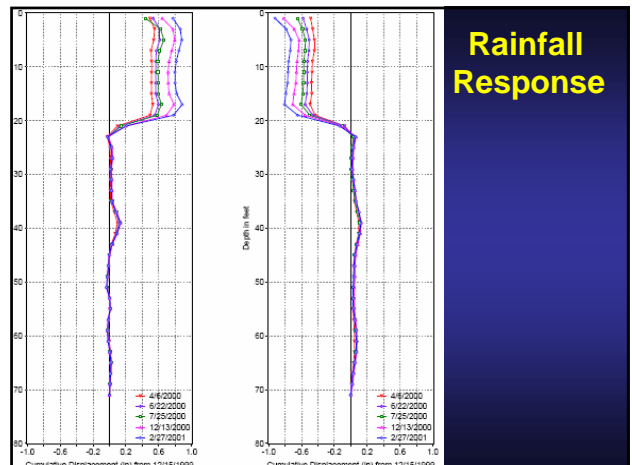
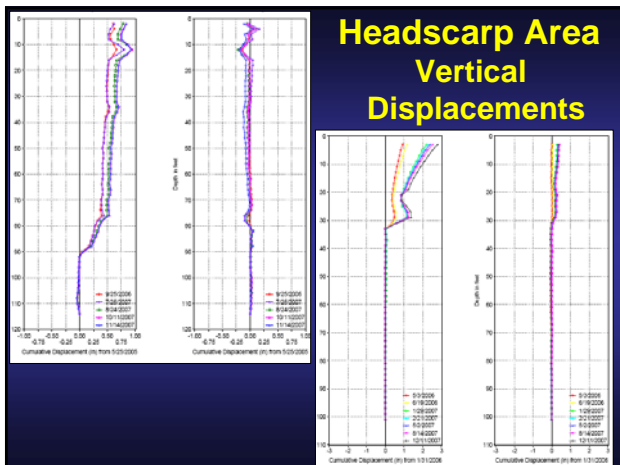
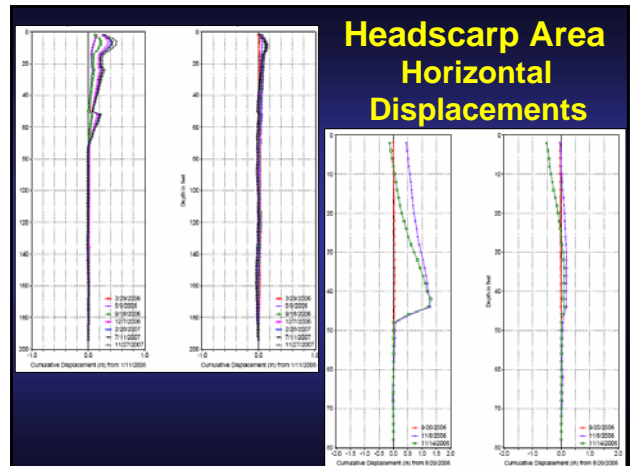
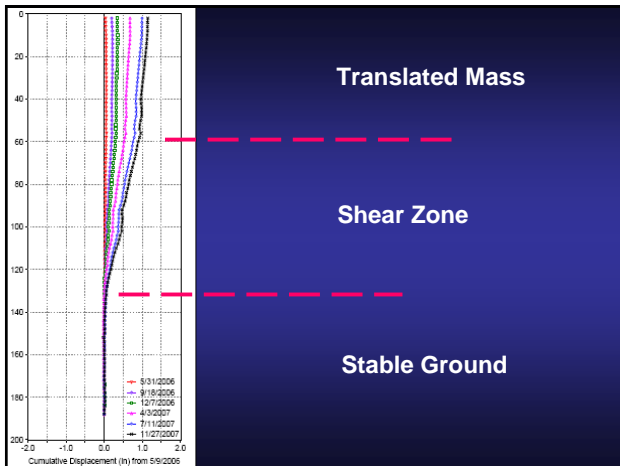
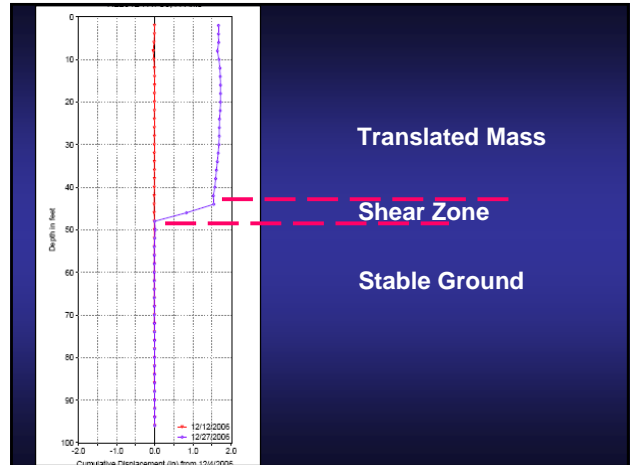
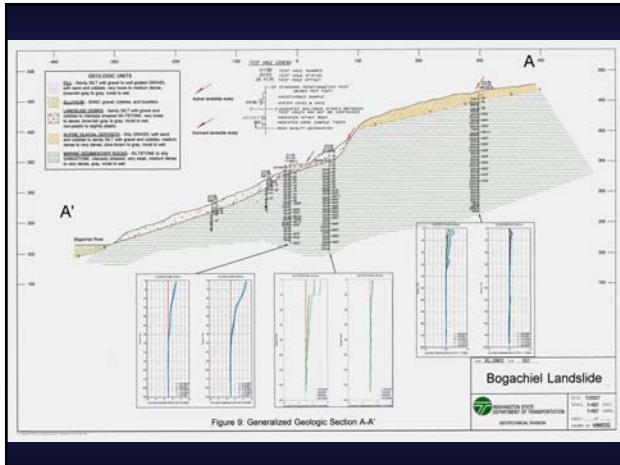

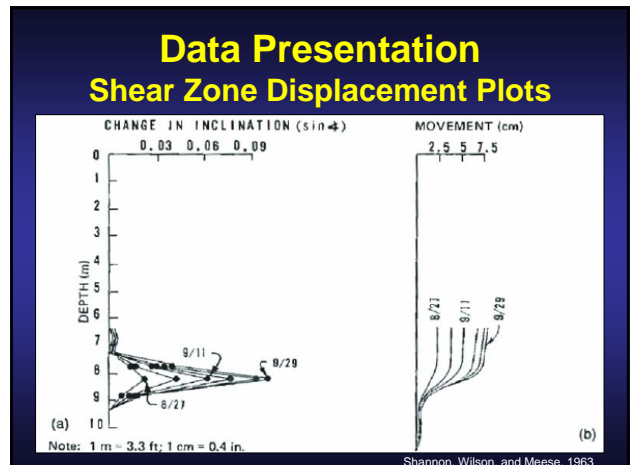
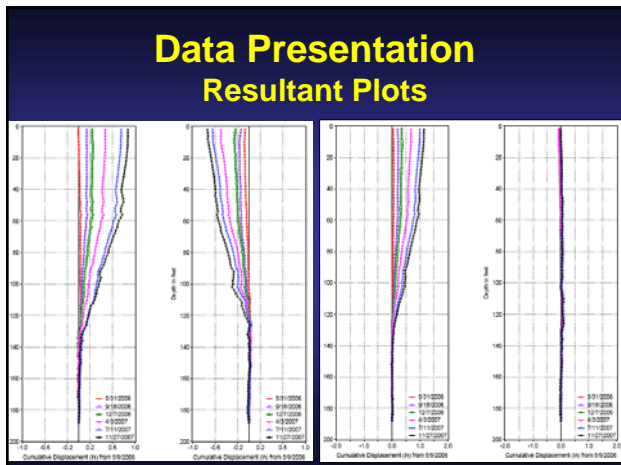
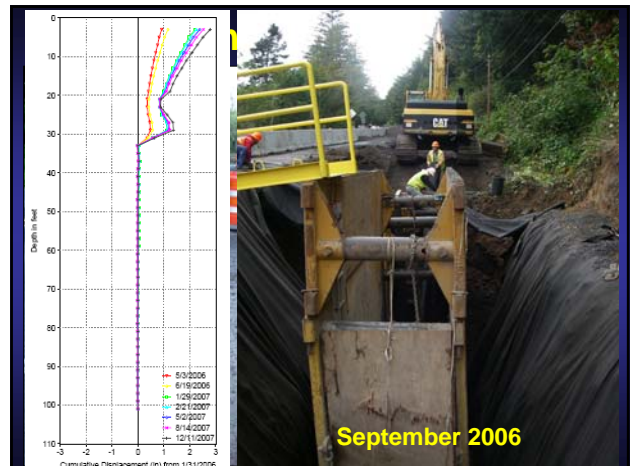
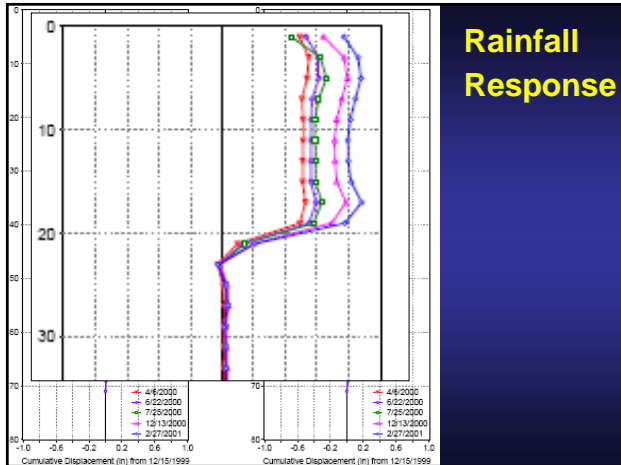

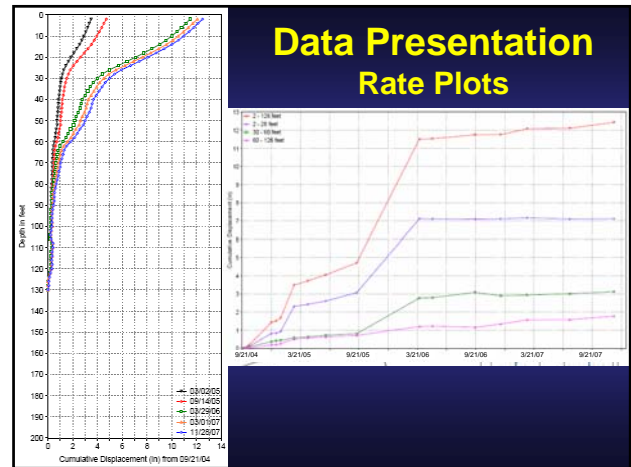
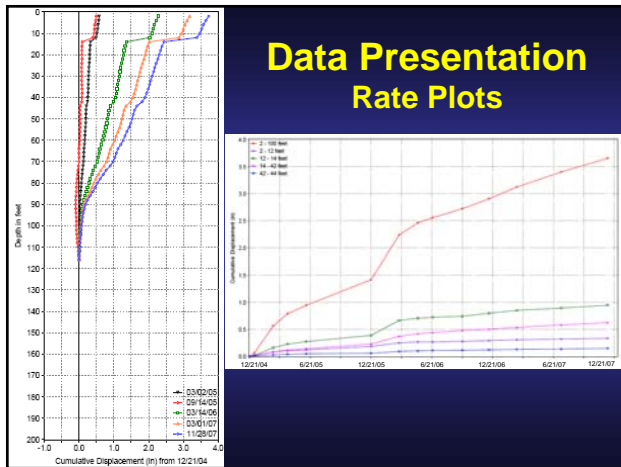

Extending Monitoring Longevity

- Steel casing stiffener
- TDR
- Mikkelsen's Method
- Surface monitoring
- "Poor Man's" inclinometer
- Extensometer

This figure shows a plot of cumulative displacement (in) versus depth (in feet) from 0 to 100. It compares data from 10/13/2006 (red line) and 12/21/2006 (purple line), demonstrating the stability of the measurement over time.

Extending Monitoring Longevity

- "Poor Man's" inclinometer

The diagram illustrates the "Poor Man's" inclinometer setup. It shows a sliding surface with an embedded cable that passes through a sliding surface. The cable is secured with cement grout and a cable anchor. A label "Reduction in Extended Cable Length" points to the top part of the cable assembly.

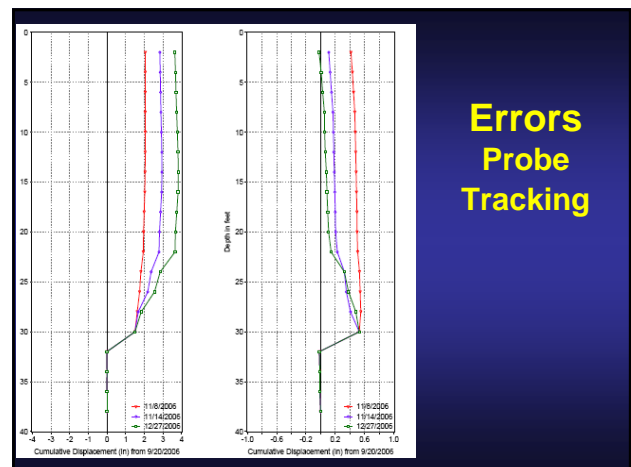
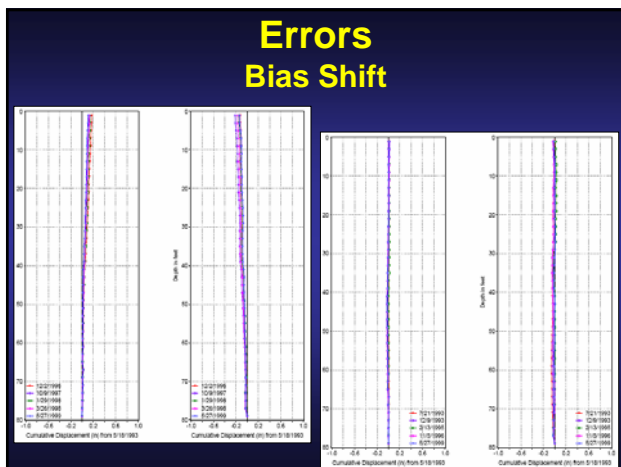

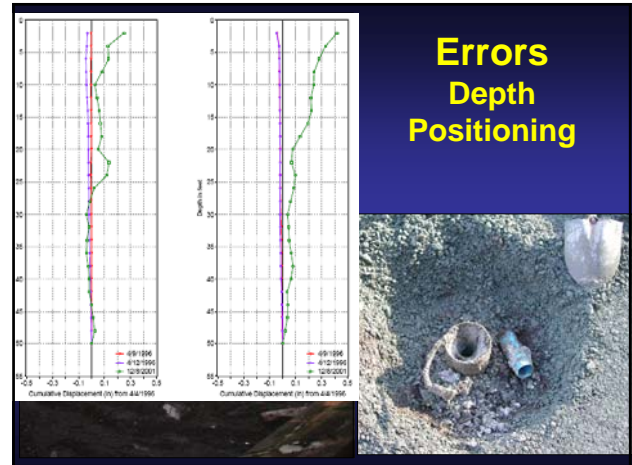
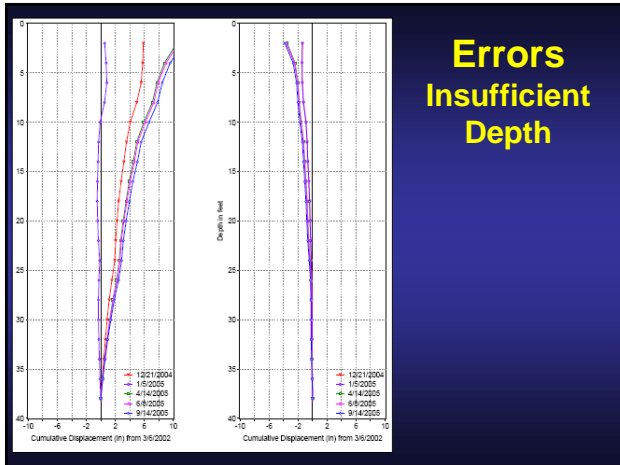

- ### Conclusions
- State-of-practice for LS investigations
 - Minimum two inclinometers
 - Pair w/continuous precipitation/GW data
 - Well-planned monitoring schedule
 - Scrutinize results; correct errors

Vertical Inclinerometers in a Reinforced Abutment Fill

- Introduction
- Instrumentation
- Installation
- Monitoring
- Results
- Lessons Learned

Chris Kreider

NCDOT



Introduction

- Vibration concerns forced change from piles to spread footings for bridge abutments.
- A geogrid reinforced embankment supported the spread footings.
- First spread footing on fill for an interstate project. Instrument to satisfy designers that structure performs as predicted.

Instrumentation

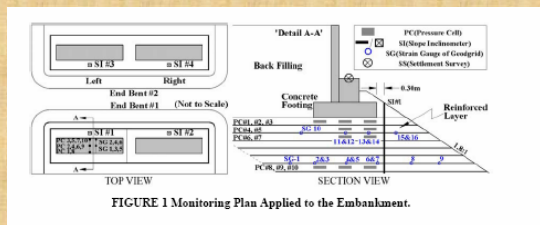

FIGURE 1 Monitoring Plan Applied to the Embankment.

4 Vertical Slope Inclinerometers were installed to depths of 26 to 34 ft to determine the lateral ground deformation profile under the abutment footings.

Installation

Plan ahead and layout instrumentation



Check equipment and calibrate if needed

Installation continued

Drilling through reinforced slope.

Inclinometer pipe w/Sondex and tremie tube.

Pipes installed through geogrid reinforced fill, fill and about 15 ft into natural ground.



Inserting pipe and grouting.

Grout mix by weight:

- 1 part bentonite
- 2.5 parts cement
- 15 parts water



Monitoring

- Begin 6/1/06 after footing is poured.
- Read after each new load applied—cap, backwall, approach fill, girders, bridge deck, and traffic.
- Final reading on 5/4/07 with traffic surcharge.



Results

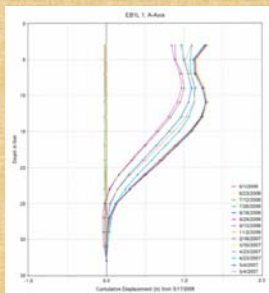

Digipro Software

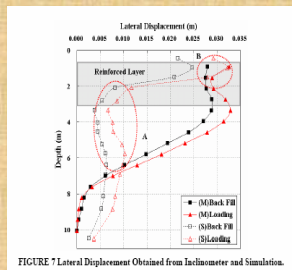

FIGURE 7 Lateral Displacement Obtained from Inclinometer and Simulation.

Measured versus Simulated

Inclinometer Installation Conclusions

- Inclinometers appeared capable of measuring deformations within 0.1 in. resolution.
- Bias shift moved consistently one direction from +4 to -28 over 1 year.
- Inclinometers confirmed the performance of the reinforced fill beneath the abutment.

Lessons Learned

- Drill a straight hole.
- Blockout space in geogrid to drill through.
- Run checksum in field before returning.
- Have the same person perform readings.
- Use locked caps in urban areas.
- Can't stand up 34 ft of inclinometer pipe w/Sondex sleeve.
- Automated recording and downloading would have saved \$\$\$.

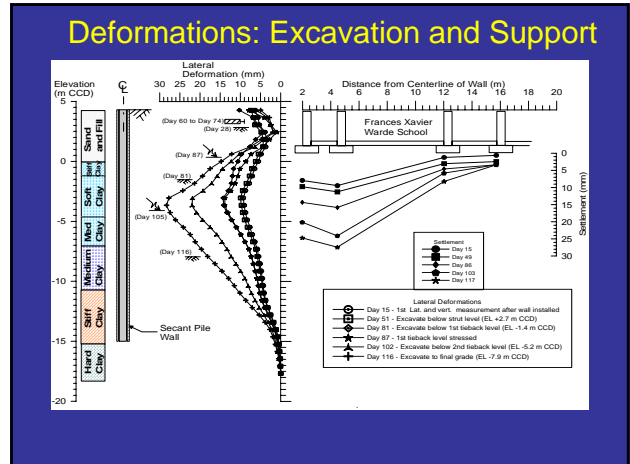
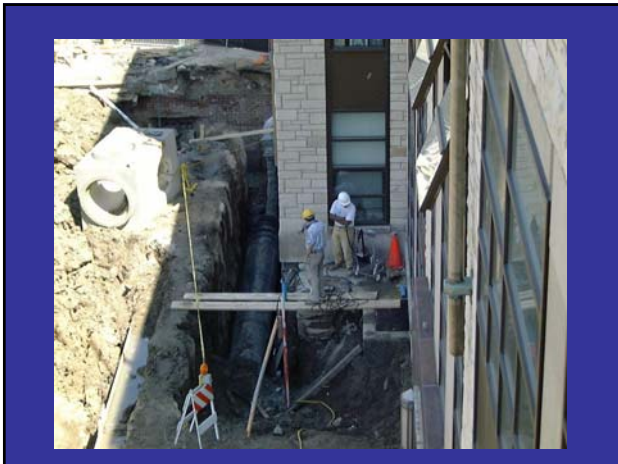
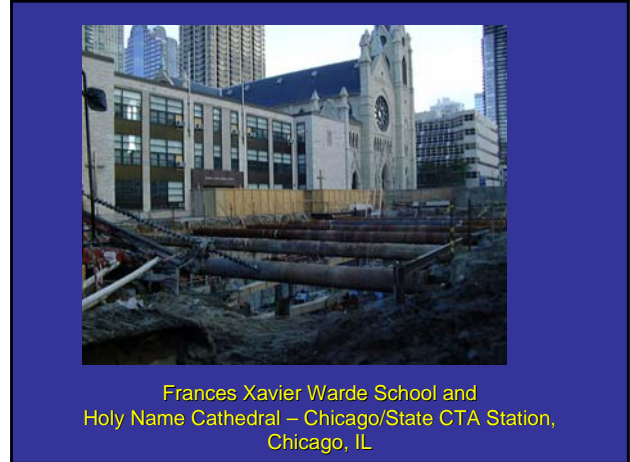

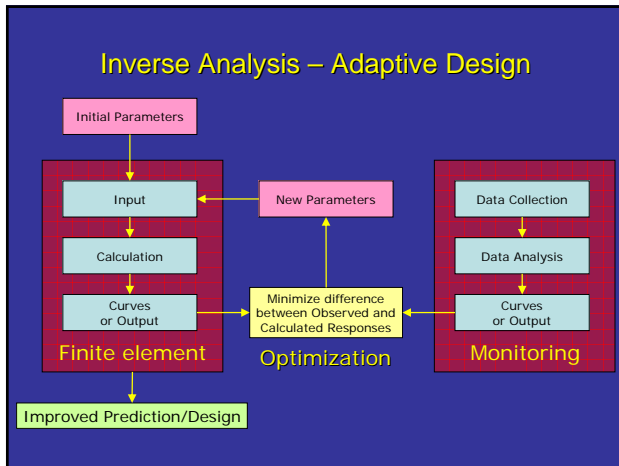
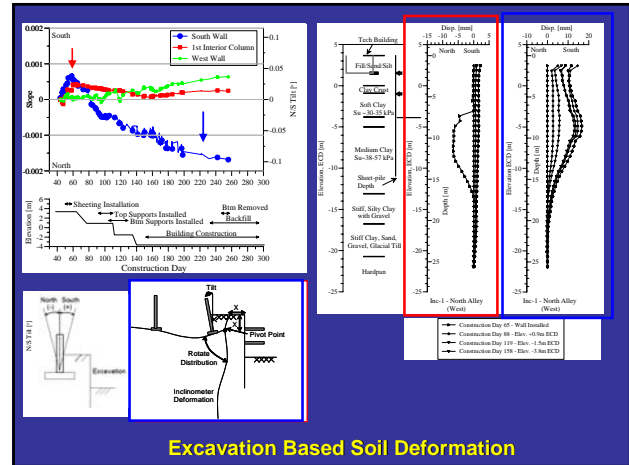
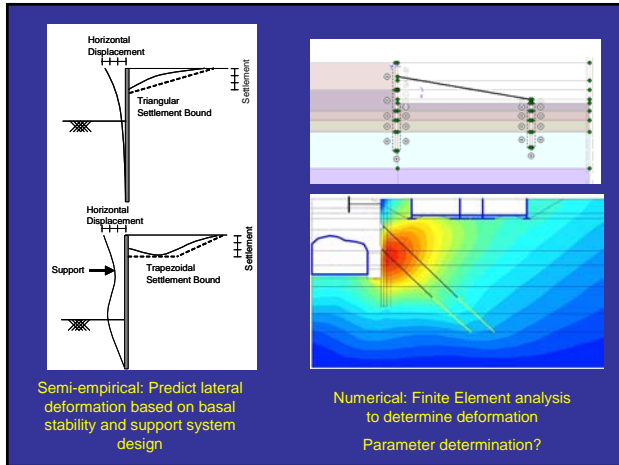

Diaphragm Wall Deflection/Moments

$$Moment = (EI)_{wall} \frac{d^2x}{dy^2}$$

$$Slope = \frac{dx}{dy} \text{ (Directly from inclinometer)}$$

Need to have good idea of $(EI)_{wall}$ and use additional instrumentation (strain gages).



- ### Summary/Conclusions
- Inclinometers are widely used for deep excavation monitoring
 - Real-time, remote access inclinometers are gaining traction
 - Can give indication of expected surface deformation or potential failure locations
 - Bending moments in stiff walls (diaphragm walls).

Inclinometer Instrumentation for Transportation Projects: Embankments and Pavements

Anand J. Puppala, PhD, PE
Professor
Department of Civil and Environmental Engineering
The University of Texas at Arlington

[Inclinometer Instrumentation for Transportation Projects](#)

Workshop on Inclinerometers
AFS 20 Committee
Transportation Research Board Annual Meeting
Washington, DC



Outline

- Introduction
- Installation of H & V Inclinerometers
- Typical Results
 - Embankments | Vertical & Horizontal Inclinerometers
 - Pavements
- HI Data and Analysis
- Problems
- Summary



Sites

- **SH 360 Site @ Arlington, Texas**
 - Embankment Section: Recycled materials (Expanded Clay Shale)
 - Vertical Inclinerometers
 - Pavement section: RAP and Cemented Quarry Fines (CQF) as Bases
 - Horizontal Inclinerometers
- **IH 820 Site @ Fort Worth, Texas**
 - Pavement Section: DSM Technique
 - Vertical Inclinerometers
 - Horizontal Inclinerometers

Both Projects Were Supported by Texas DOT





Basic Principle (VI)

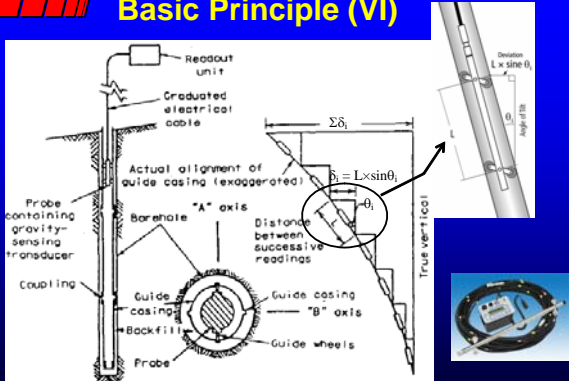

The diagram illustrates the basic principle of a Vertical Inclinometer (VI). It shows a borehole with a probe containing a gravity-sensing transducer. The probe is connected to a readout unit via a graduated electrical cable. The probe's actual alignment is shown as an exaggerated curve, with the distance between successive readings labeled as $\Delta \delta_i$. The true vertical axis is also shown, and the deviation is labeled as $L \times \sin \theta$, where L is the length of the probe and θ is the angle of tilt.



Basic Principle (HI)

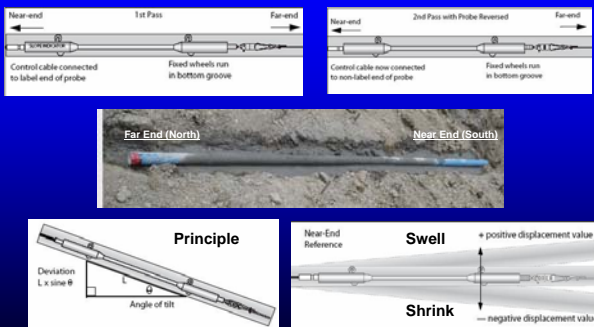

The diagram illustrates the basic principle of a Horizontal Inclinometer (HI). It shows the 1st Pass and 2nd Pass of the probe, with the control cable connected to the labeled end of the probe. A photograph shows the probe in a borehole, with the far end (North) and near end (South) labeled. A diagram shows the probe's deviation from the true vertical axis, with the deviation labeled as $L \times \sin \theta$, where L is the length of the probe and θ is the angle of tilt. The diagram also shows the probe's response to swell (positive displacement value) and shrink (negative displacement value).

Source: Slope Indicator



Sites

- **SH 360 Site @ Arlington, Texas**
 - Embankment Section: Recycled materials (Expanded Clay Shale)
 - Vertical Inclinerometers
 - Pavement section: RAP and Cemented Quarry Fines (CQF) as Bases
 - Horizontal Inclinerometers
- **IH 820 Site @ Fort Worth, Texas**
 - Pavement Section: DSM Technique
 - Vertical Inclinerometers
 - Horizontal Inclinerometers





Installation: Sites

Test Locations

IH 820 site, Fort Worth, TX

SH 360 site, Arlington, TX

Test Site

SH 360 Site

South bound Pavement layers North bound

Slope 6:1 VI.2 VI.3 44° VI.4 Slope 6:1

ECS backfill Vertical inclinometers (40 feet deep)

24' Pavement

11" CRCP
4" HMA (QCQA) TY
Base material

Vertical & Horizontal Inclinometers installation - SH 360, Arlington, TX

IH 820, Fort Worth

IH 820, Fort Worth

IH 820, Fort Worth

IH 820, Fort Worth

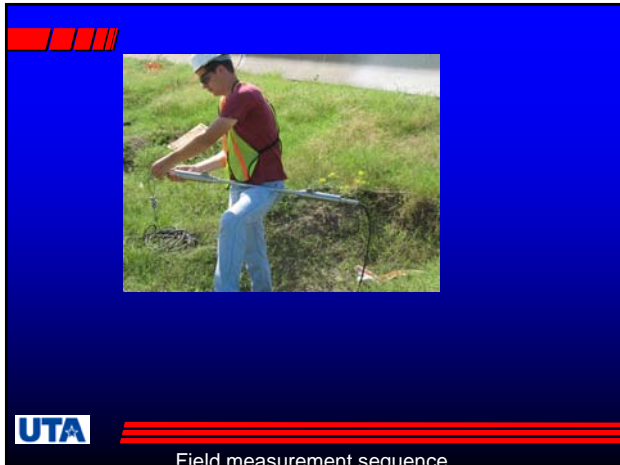

SH 360 Site:
Results

UTA

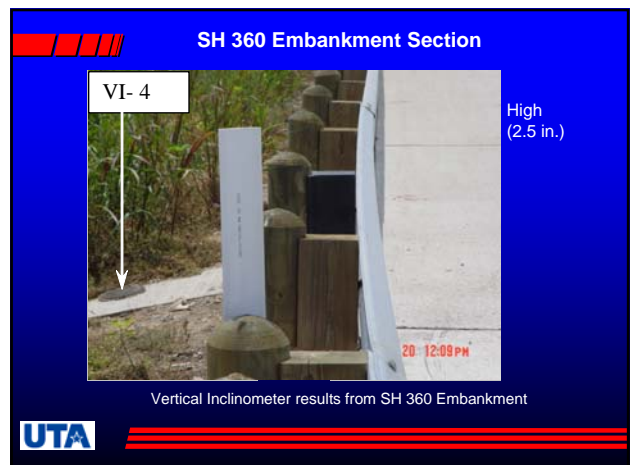
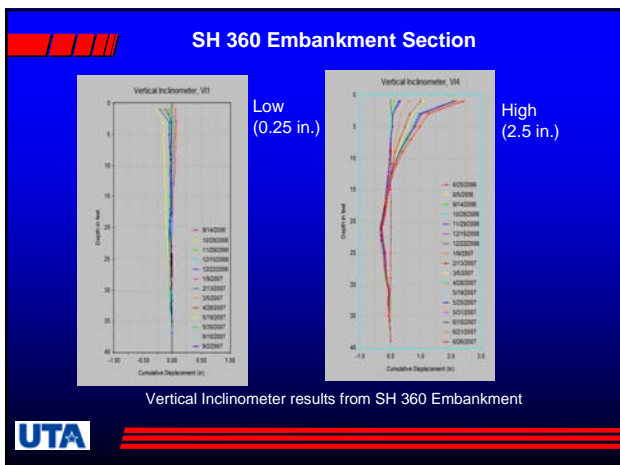

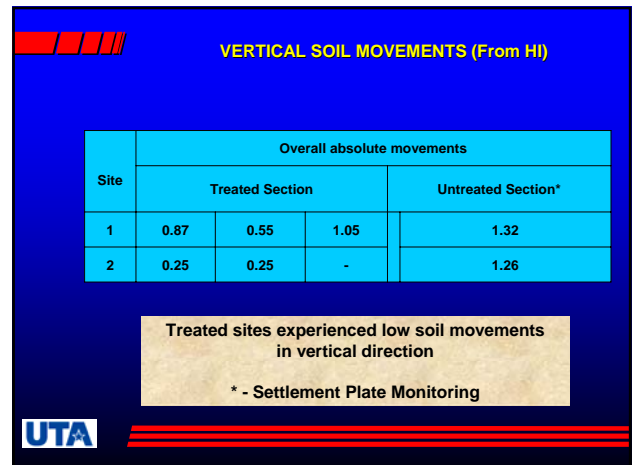
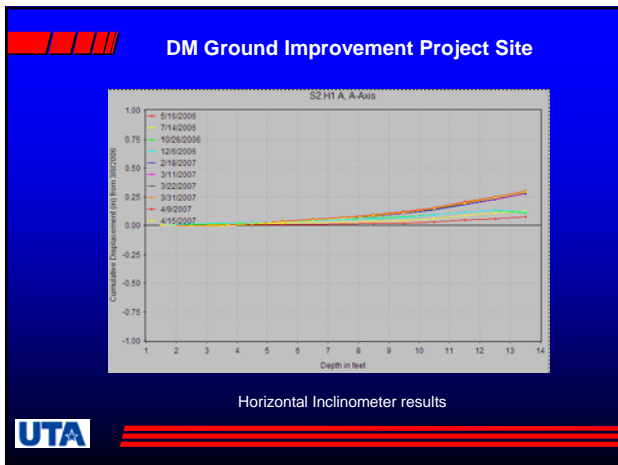
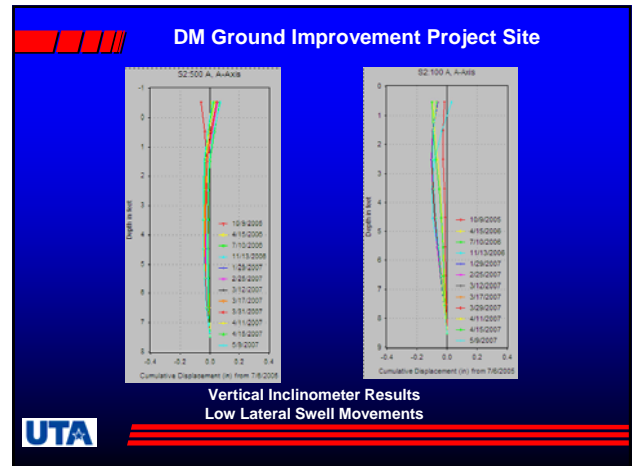
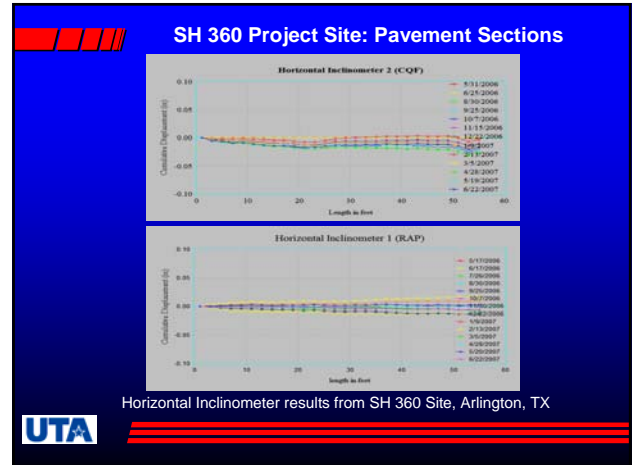

Comparisons of Field Data with Analytical Calculations

◆ Heave Prediction (Fredlund and Rahardjo, 1993)

$$\Delta h = \frac{C_{s,comp} h}{1 + e_o} \sum_{i=1}^n \log \frac{p'_f}{p_{s,comp}}$$

$$C_{s,comp} = C_{s,col} \times a_r + C_{s,soil} \times (1 - a_r)$$

$$p_{s,comp} = p_{s,col} \times a_r + p_{s,soil} \times (1 - a_r)$$

UTA

Design Chart & Comparison

Swell Pressure

Depth, z

$(1 - a_r) P_s$

P_o

P_s

Swell Index, C_s of 0.1 and 0.2

UTA

Design Chart & Comparison

Comparisons

Swell Pressure

Depth, z

$(1 - a_r) P_s$

P_o

P_s

▲ Untreated
■ treated section edge
● treated section center

UTA

Problems

UTA

Problems

Debris

UTA

Problems

UTA



- Summary**
- Embankment Section (Recycled Shingles)
 - Outward movements – high
 - Inward movements – Low
 - Stability and compressibility – Good
 - Vertical movements are in permissible limits
 - Monitoring is still taking place
 - DM Section - Both vertical and horizontal movements are low – DM treatment effective
 - Vertical Movements match with Theory
 - Problems experienced are summarized
- UTA

**Both Projects Sponsored by TxDOT
 (Richard Willamsee, PE; David
 Head, PE; German Claros, PhD, PE
 and Stanley Yin, PE)**

Questions ???

UTA

THE NATIONAL ACADEMIES

Advisers to the Nation on Science, Engineering, and Medicine

The **National Academy of Sciences** is a private, nonprofit, self-perpetuating society of distinguished scholars engaged in scientific and engineering research, dedicated to the furtherance of science and technology and to their use for the general welfare. On the authority of the charter granted to it by the Congress in 1863, the Academy has a mandate that requires it to advise the federal government on scientific and technical matters. Dr. Ralph J. Cicerone is president of the National Academy of Sciences.

The **National Academy of Engineering** was established in 1964, under the charter of the National Academy of Sciences, as a parallel organization of outstanding engineers. It is autonomous in its administration and in the selection of its members, sharing with the National Academy of Sciences the responsibility for advising the federal government. The National Academy of Engineering also sponsors engineering programs aimed at meeting national needs, encourages education and research, and recognizes the superior achievements of engineers. Dr. Charles M. Vest is president of the National Academy of Engineering.

The **Institute of Medicine** was established in 1970 by the National Academy of Sciences to secure the services of eminent members of appropriate professions in the examination of policy matters pertaining to the health of the public. The Institute acts under the responsibility given to the National Academy of Sciences by its congressional charter to be an adviser to the federal government and, on its own initiative, to identify issues of medical care, research, and education. Dr. Harvey V. Fineberg is president of the Institute of Medicine.

The **National Research Council** was organized by the National Academy of Sciences in 1916 to associate the broad community of science and technology with the Academy's purposes of furthering knowledge and advising the federal government. Functioning in accordance with general policies determined by the Academy, the Council has become the principal operating agency of both the National Academy of Sciences and the National Academy of Engineering in providing services to the government, the public, and the scientific and engineering communities. The Council is administered jointly by both the Academies and the Institute of Medicine. Dr. Ralph J. Cicerone and Dr. Charles M. Vest are chair and vice chair, respectively, of the National Research Council.

The **Transportation Research Board** is one of six major divisions of the National Research Council. The mission of the Transportation Research Board is to provide leadership in transportation innovation and progress through research and information exchange, conducted within a setting that is objective, interdisciplinary, and multimodal. The Board's varied activities annually engage about 7,000 engineers, scientists, and other transportation researchers and practitioners from the public and private sectors and academia, all of whom contribute their expertise in the public interest. The program is supported by state transportation departments, federal agencies including the component administrations of the U.S. Department of Transportation, and other organizations and individuals interested in the development of transportation. www.TRB.org

www.national-academies.org



TRANSPORTATION RESEARCH BOARD

500 Fifth Street, NW

Washington, DC 20001

THE NATIONAL ACADEMIES™

Advisers to the Nation on Science, Engineering, and Medicine

The nation turns to the National Academies—National Academy of Sciences, National Academy of Engineering, Institute of Medicine, and National Research Council—for independent, objective advice on issues that affect people's lives worldwide.

www.national-academies.org