



## In the Light of Evolution: Volume III: Two Centuries of Darwin

### DETAILS

---

430 pages | 6 x 9 | HARDBACK  
ISBN 978-0-309-13986-1 | DOI 10.17226/12692

### AUTHORS

---

John C. Avise and Francisco J. Ayala, Editors; National Academy of Sciences

BUY THIS BOOK

FIND RELATED TITLES

### Visit the National Academies Press at [NAP.edu](http://NAP.edu) and login or register to get:

---

- Access to free PDF downloads of thousands of scientific reports
- 10% off the price of print titles
- Email or social media notifications of new titles related to your interests
- Special offers and discounts



Distribution, posting, or copying of this PDF is strictly prohibited without written permission of the National Academies Press. (Request Permission) Unless otherwise indicated, all materials in this PDF are copyrighted by the National Academy of Sciences.

In the Light of Evolution  
**Volume III: Two Centuries of Darwin**



In the Light of Evolution  
**Volume III: Two Centuries of Darwin**

JOHN C. AVISE and FRANCISCO J. AYALA, *Editors*

NATIONAL ACADEMY OF SCIENCES  
*THE NATIONAL ACADEMIES*

THE NATIONAL ACADEMIES PRESS  
Washington, D.C.  
**[www.nap.edu](http://www.nap.edu)**



THE NATIONAL ACADEMIES PRESS    500 Fifth Street, N.W.    Washington, DC 20001

This volume is based on the Arthur M. Sackler Colloquium of the National Academy of Sciences, “In the Light of Evolution III: Two Centuries of Darwin,” held January 16–17, 2009, at the Arnold and Mabel Beckman Center of the National Academies of Sciences and Engineering in Irvine, California. The articles appearing in these pages were contributed by speakers at the colloquium and have been anonymously reviewed. Any opinions, findings, conclusions, or recommendations expressed in this volume are those of the authors and do not necessarily reflect the view of the National Academy of Sciences.

In the light of evolution / John C. Avise and Francisco J. Ayala, editors.

p. cm.

Vol. I based on a colloquium of the National Academy of Sciences, held December 1–2, 2006, in Irvine, California.

Includes bibliographical references.

ISBN-13: 978-0-309-10405-0 (hardcover)

ISBN-10: 0-309-10405-X (hardcover)

ISBN-13: 978-0-309-66786-9 (pdf)

ISBN-10: 0-309-66786-0 (pdf)

1. Evolution (Biology)—Congresses. I. Avise, John C, 1948–. II. Ayala, Francisco José, 1934–  
III. National Academy of Sciences (U.S.)

QH359.I55 2007

576.8—dc22

2007032455

Additional copies of this book are available from the National Academies Press, 500 Fifth St., N.W., Lockbox 285, Washington, DC 10055; (800) 624-6242 or (202) 334-3313 (in the Washington metropolitan area); Internet, <http://www.nap.edu>.

*Cover image:* Three species of *Chaetodon* butterflyfish [from Cuvier B, Latrielle M (1837) *The Animal Kingdom*, Vol. II (Henderson, London)]. Charles Darwin preserved (“in spirits of wine”) many fish that he collected during the voyage of the *Beagle* [Pauly, D (2004) *Darwin’s Fishes* (Cambridge University Press, Cambridge, UK)], including a species of butterflyfish from the Cocos Islands.

Copyright 2009 by the National Academy of Sciences. All rights reserved.

Printed in the United States of America

## THE NATIONAL ACADEMIES

### *Advisers to the Nation on Science, Engineering, and Medicine*

The **National Academy of Sciences** is a private, nonprofit, self-perpetuating society of distinguished scholars engaged in scientific and engineering research, dedicated to the furtherance of science and technology and to their use for the general welfare. Upon the authority of the charter granted to it by the Congress in 1863, the Academy has a mandate that requires it to advise the federal government on scientific and technical matters. Dr. Ralph J. Cicerone is president of the National Academy of Sciences.

The **National Academy of Engineering** was established in 1964, under the charter of the National Academy of Sciences, as a parallel organization of outstanding engineers. It is autonomous in its administration and in the selection of its members, sharing with the National Academy of Sciences the responsibility for advising the federal government. The National Academy of Engineering also sponsors engineering programs aimed at meeting national needs, encourages education and research, and recognizes the superior achievements of engineers. Dr. Charles M. Vest is president of the National Academy of Engineering.

The **Institute of Medicine** was established in 1970 by the National Academy of Sciences to secure the services of eminent members of appropriate professions in the examination of policy matters pertaining to the health of the public. The Institute acts under the responsibility given to the National Academy of Sciences by its congressional charter to be an adviser to the federal government and, upon its own initiative, to identify issues of medical care, research, and education. Dr. Harvey V. Fineberg is president of the Institute of Medicine.

The **National Research Council** was organized by the National Academy of Sciences in 1916 to associate the broad community of science and technology with the Academy's purposes of furthering knowledge and advising the federal government. Functioning in accordance with general policies determined by the Academy, the Council has become the principal operating agency of both the National Academy of Sciences and the National Academy of Engineering in providing services to the government, the public, and the scientific and engineering communities. The Council is administered jointly by both Academies and the Institute of Medicine. Dr. Ralph J. Cicerone and Dr. Charles M. Vest are chair and vice chair, respectively, of the National Research Council.

**[www.national-academies.org](http://www.national-academies.org)**



## Arthur M. Sackler, M.D. 1913–1987

Born in Brooklyn, New York, Arthur M. Sackler was educated in the arts, sciences, and humanities at New York University. These interests remained the focus of his life, as he became widely known as a scientist, art collector, and philanthropist, endowing institutions of learning and culture throughout the world.

He felt that his fundamental role was as a doctor, a vocation he decided upon at the age of four. After completing his internship and service as house physician at Lincoln Hospital in New York City, he became a resident in psychiatry at Creedmoor State Hospital. There, in the 1940s, he started research that resulted in more than 150 papers in neuroendocrinology, psychiatry, and experimental medicine. He considered his scientific research in the metabolic basis of schizophrenia his most significant contribution to science and served as editor of the *Journal of Clinical and Experimental Psychobiology* from 1950 to 1962. In 1960 he started publication of *Medical Tribune*, a weekly medical newspaper that reached over one million readers in 20 countries. He established the Laboratories for Therapeutic Research in 1938, a facility in New York for basic research that he directed until 1983.

As a generous benefactor to the causes of medicine and basic science, Arthur Sackler built and contributed to a wide range of scientific institutions: the Sackler School of Medicine established in 1972 at Tel Aviv University, Tel Aviv, Israel; the Sackler Institute of Graduate Biomedical Science at New York University, founded in 1980; the Arthur M. Sackler Science Center dedicated in 1985 at Clark University, Worcester, Massachusetts; and the Sackler School of Graduate Biomedical Sciences, established in 1980, and the Arthur M. Sackler Center for Health Communications, established in 1986, both at Tufts University, Boston, Massachusetts.

His pre-eminence in the art world is already legendary. According to his wife Jillian, one of his favorite relaxations was to visit museums and art galleries and pick out great pieces others had overlooked. His interest in art is reflected in his philanthropy; he endowed galleries at the Metropolitan Museum of Art and Princeton University, a museum at Harvard



University, and the Arthur M. Sackler Gallery of Asian Art in Washington, D.C. True to his oft-stated determination to create bridges between peoples, he offered to build a teaching museum in China, which Jillian made possible after his death, and in 1993 opened the Arthur M. Sackler Museum of Art and Archaeology at Peking University in Beijing.

In a world that often sees science and art as two separate cultures, Arthur Sackler saw them as inextricably related. In a speech given at the State University of New York at Stony Brook, *Some reflections on the arts, sciences and humanities*, a year before his death, he observed: "Communication is, for me, the *primum movens* of all culture. In the arts . . . I find the emotional component most moving. In science, it is the intellectual content. Both are deeply interlinked in the humanities." The Arthur M. Sackler Colloquia at the National Academy of Sciences pay tribute to this faith in communication as the prime mover of knowledge and culture.

# Contents

---

Arthur M. Sackler Biography	vii
Preface to the <i>In the Light of Evolution</i> Series	xiii
Preface to <i>In the Light of Evolution, Volume III: Two Centuries of Darwin</i>	xv
<b>PART I NATURAL SELECTION, OR ADAPTATION TO NATURE</b>	<b>1</b>
1 Natural Selection in Action During Speciation <i>Sara Via</i>	5
2 Adaptive Radiations: From Field to Genomic Studies <i>Scott A. Hodges and Nathan J. Derieg</i>	27
3 Genetics and Ecological Speciation <i>Dolph Schluter and Gina L. Conte</i>	47
4 Cascades of Convergent Evolution: The Corresponding Evolutionary Histories of Euglenozoans and Dinoflagellates <i>Julius Lukeš, Brian S. Leander, and Patrick J. Keeling</i>	65

<b>PART II ARTIFICIAL SELECTION, OR ADAPTATION TO HUMAN DEMANDS</b>	<b>85</b>
5 From Wild Animals to Domestic Pets, an Evolutionary View of Domestication <i>Carlos A. Driscoll, David W. Macdonald, and Stephen J. O'Brien</i>	89
6 Tracking Footprints of Maize Domestication and Evidence for a Massive Selective Sweep on Chromosome 10 <i>Feng Tian, Natalie M. Stevens, and Edward S. Buckler IV</i>	111
7 Human-Induced Evolution Caused by Unnatural Selection Through Harvest of Wild Animals <i>Fred W. Allendorf and Jeffrey J. Hard</i>	129
8 In the Light of Directed Evolution: Pathways of Adaptive Protein Evolution <i>Jesse D. Bloom and Frances H. Arnold</i>	149
<b>PART III SEXUAL SELECTION, OR ADAPTATION TO MATING DEMANDS</b>	<b>165</b>
9 Mate Choice and Sexual Selection: What Have We Learned Since Darwin? <i>Adam G. Jones and Nicholas L. Ratterman</i>	169
10 Sexual Selection and Mating Systems <i>Stephen M. Shuster</i>	191
11 Reproductive Decisions Under Ecological Constraints: It's About Time <i>Patricia Adair Gowaty and Stephen P. Hubbell</i>	213
12 Postcopulatory Sexual Selection: Darwin's Omission and Its Consequences <i>William G. Eberhard</i>	243
<b>PART IV THE DARWINIAN LEGACY, 150 YEARS LATER</b>	<b>263</b>
13 Darwin and the Scientific Method <i>Francisco J. Ayala</i>	267

14	The Darwinian Revolution: Rethinking Its Meaning and Significance <i>Michael Ruse</i>	287
15	Did Darwin Write the <i>Origin</i> Backwards? <i>Elliott Sober</i>	307
16	Darwin's Place in the History of Thought: A Reevaluation <i>Robert J. Richards</i>	329
17	Darwin's "Strange Inversion of Reasoning" <i>Daniel Dennett</i>	343
	References	355
	Index	399





## Preface to the *In the Light of Evolution* Series

---

**B**iodiversity—the genetic variety of life—is an exuberant product of the evolutionary past, a vast human-supportive resource (aesthetic, intellectual, and material) of the present, and a rich legacy to cherish and preserve for the future. Two urgent challenges, and opportunities, for 21st-century science are to gain deeper insights into the evolutionary processes that foster biotic diversity, and to translate that understanding into workable solutions for the regional and global crises that biodiversity currently faces. A grasp of evolutionary principles and processes is important in other societal arenas as well, such as education, medicine, sociology, and other applied fields including agriculture, pharmacology, and biotechnology. The ramifications of evolutionary thought also extend into learned realms traditionally reserved for philosophy and religion.

In 1973, Theodosius Dobzhansky penned a short commentary entitled “Nothing in biology makes sense except in the light of evolution.” Most scientists agree that evolution provides the unifying framework for interpreting biological phenomena that otherwise can often seem unrelated and perhaps unintelligible. Given the central position of evolutionary thought in biology, it is sadly ironic that evolutionary perspectives outside the sciences have often been neglected, misunderstood, or purposefully misrepresented.

The central goal of the *In the Light of Evolution* (ILE) series is to promote the evolutionary sciences through state-of-the-art colloquia—in the series of Arthur M. Sackler colloquia sponsored by the National Academy of Sciences—and their published proceedings. Each installment explores

*xiv / Preface to the In the Light of Evolution Series*

evolutionary perspectives on a particular biological topic that is scientifically intriguing but also has special relevance to contemporary societal issues or challenges. Individually and collectively, the *ILE* series aims to interpret phenomena in various areas of biology through the lens of evolution, address some of the most intellectually engaging as well as pragmatically important societal issues of our times, and foster a greater appreciation of evolutionary biology as a consolidating foundation for the life sciences.

The organizers and founding editors of this effort (Awise and Ayala) are the academic grandson and son, respectively, of Theodosius Dobzhansky, to whose fond memory this *ILE* series is dedicated. May Dobzhansky's words and insights continue to inspire rational scientific inquiry into nature's marvelous operations.

John C. Awise and Francisco J. Ayala  
Department of Ecology and Evolutionary Biology,  
University of California, Irvine (January 2007)

## Preface to *In the Light of Evolution, Volume III: Two Centuries of Darwin*

---

Charles Darwin's enthusiasm and expertise in natural history contributed hugely to his elucidation of evolution by natural selection, which stands as one of the grandest intellectual achievements in the history of science. Darwin was a lifelong observer of nature, stating in correspondence that some of his happiest times in youth were spent fishing on rainy days and "entomologizing" when England's weather was nice. At the age of 22, he boarded the HSM *Beagle* for a 5-year stint as Captain Fitzroy's traveling companion and the ship's naturalist, an appointment that introduced him to biodiversity on a global geographic scale. Darwin's breadth and depth of natural-history experience would later be on full display in his most defining scientific works (Darwin, 1859, 1868a, 1871/1959) and also in his detailed treatises on coral reefs (Darwin, 1842), barnacles (Darwin, 1851b), insectivorous plants (Darwin, 1875a), orchids (Darwin, 1877b), and earthworms (Darwin, 1881).

The year 2009 marks the 200th anniversary of Charles Darwin's birth and the 150th anniversary of his most influential publication (Darwin, 1859). Darwin transformed the biological sciences in much the same way that Nicolaus Copernicus, Galileo Galilei, and Isaac Newton, centuries earlier, transformed the physical sciences—by demonstrating that the universe operates according to natural laws that fall within the purview of rational scientific inquiry. In 1543, Copernicus published *De revolutionibus orbium coelestium* ("On the Revolutions of the Celestial Spheres") which challenged conventional wisdom that the Earth was the center of Creation, and instead promoted the idea that natural laws govern the

motion of physical objects in the universe. In 1859, in *On the Origin of Species*, Darwin developed the equally revolutionary concept that a natural but nonrandom process—natural selection—yields biological adaptations that otherwise can give the superficial impression of direct intelligent craftsmanship.

Darwin's impacts have been felt far beyond science. Prior to Darwin, most scientists as well as theologians accepted what seemed obvious: that divine intervention must have underlain nature's design. The traditional "argument from design" traces back at least to the classical Greek philosopher Socrates more than 400 B.C. [see Sedley (2008)], and it was expressed again in a thoughtful and elegant treatise (*Natural Theology*) published by the Reverend William Paley (1802). Darwin later recalls in his autobiography [see Barlow (1958)] that Paley's logic "gave me as much delight as did Euclid" and that it was the "part of the Academical Course [at the University of Cambridge] which . . . was the most use to me in the education of my mind." Darwin was still a natural theologian when he boarded the *Beagle* in 1831 on what would become a fateful voyage, for Darwin and for humanity, into uncharted philosophical (as well as scientific) waters.

This book is the outgrowth of the Arthur M. Sackler Colloquium "Two Centuries of Darwin," which was sponsored by the National Academy of Sciences on January 16–17, 2009, at the Academy's Arnold and Mabel Beckman Center in Irvine, California. It is the third in a series of colloquia under the umbrella title "In the Light of Evolution." The first book in this series was titled *In the Light of Evolution, Volume I: Adaptation and Complex Design* (Avisé and Ayala, 2007). The second was *In the Light of Evolution, Volume II: Biodiversity and Extinction* (Avisé et al., 2008).

In the chapters of this book, leading evolutionary biologists and science historians reflect upon and commemorate the Darwinian Revolution. They canvass modern research approaches and current scientific thought on each of the three main categories of selection (natural, artificial, and sexual) that Darwin addressed during his career. Although Darwin's legacy is associated primarily with the illumination of natural selection in *The Origin*, he also contemplated and wrote extensively about what we now term artificial selection and sexual selection, as reflected for example in two books titled, respectively, *The Variation of Animals and Plants Under Domestication* (1868) and *The Descent of Man and Selection in Relation to Sex* (1871/1959). In a concluding section of this book, several science historians comment on Darwin's seminal contributions. Thus, this book is organized in four parts: *Natural Selection, or Adaptation to Nature; Artificial Selection, or Adaptation to Human Demands; Sexual Selection, or Adaptation to Mating Demands; and The Darwinian Legacy, 150 Years Later.*

# Part I

---

## NATURAL SELECTION, OR ADAPTATION TO NATURE

**T**he concept of natural selection—as the unconscious broker of adaptive evolution—is Darwin’s seminal contribution. It provided a materialistic account of nature’s operations that contrasted sharply with the traditional invocations of supernatural causation that predominated before *The Origin*. The basic logic of natural selection is astonishingly simple. As phrased by Darwin in *The Origin*,

As many more individuals of each species are born than can possibly survive; and as, consequently, there is a frequently recurring struggle for existence, it follows that any being, if it vary however slightly in any manner profitable to itself, under the complex and sometimes varying conditions of life, will have a better chance of surviving, and thus be naturally selected. From the strong principle of inheritance, any selected variety will tend to propagate its new and modified form.

Darwin’s clear elucidation of natural selection launched a revolutionary new paradigm in biology wherein organismal traits could be studied and interpreted as products of natural (rather than supernatural) forces amenable to rational scientific inquiry. Scientific studies of natural selection are now more popular and powerful than ever, and they have revealed the evolutionary origins and trajectories of numerous biological features and taxa.

A major limitation in Darwin’s characterization of evolution concerned hereditary mechanisms, a difficulty that the field began to rectify early in the 20th century by incorporating Mendelian genetics and popu-

lation genetics into the emerging evolutionary synthesis (Dobzhansky, 1937). Today, in the genomics era, scientists routinely extend studies of natural selection and trait evolution to the level of DNA itself, as several chapters in this book will attest. Genomic dissections are also providing fresh insights into the ancient mystery alluded to in the title of Darwin's seminal work: how species originate. Ironically, *The Origin* says relatively little about the evolution of reproductive isolating barriers, which under the modern biological species concept are key to understanding cladogenetic (speciational) processes.

In the opening chapter of this book, Sara Via takes a fresh perspective on the origin of species by characterizing genomic regions that appear to be diverging early in a speciation process. She calls this the “magnifying glass” approach for speciation in action, and contrasts it with the more traditional “spyglass” approach in which each completed speciation is characterized retrospectively by scrutinizing genetic differences between established sister taxa. Via develops and presents genetic evidence for a model in which incipient species become, in effect, genealogical mosaics in which ecologically important genomic regions (i.e., those under divergent ecological selection, sometimes even in sympatry) become resistant to genetic exchange, while gene flow remains possible over most of the genome. The key genomic regions under divergent selection become focal points for “divergence hitchhiking” by linked loci, as they reduce the porosity of the emerging species boundary to gene exchange. Under this scenario, Via views divergent selection as the motivator of genealogical differences (in these particular genomic regions) that later will crystallize into the branching pattern in the species phylogeny. Eventually, in responses to selection, genetic drift, and mutation, gene genealogies in the remainder of the genome will come into topological concordance with the species phylogeny, but these additional genetic differences will have been the effect of speciation rather than its cause.

Some of the richest biological quarries for extracting information about natural selection and speciation involve clades (monophyletic groups) that have arisen via rapid adaptive radiations. Darwin presaged such evolutionary analyses in his considerations of different forms of mockingbirds in the Galápagos Islands, and in the various finch species he collected there that now bear Darwin's name (but whose evolutionary appraisal mostly awaited later researchers). In Chapter 2, Scott Hodges and Nathan Derieg take a modern approach to speciation analysis by integrating observations from field studies with molecular and phylogenetic dissections of genes for traits (especially flower color) that probably played key cladogenetic roles in a spectacular evolutionary radiation of *Aquilegia* (columbine) plants. The authors describe how molecular investigations of genomes can

complement traditional approaches and contribute to a better mechanistic understanding of how new species arise.

In Chapter 3, Dolph Schluter and Gina Conte emphasize a theme—ecological speciation—that would please Darwin. Under ecological speciation, reproductive isolation between populations emerges from the effects of ecology-based divergent natural selection. The authors address this speciation mode generally (with respect to the genetics of postzygotic isolation and prezygotic isolation under gene flow, and the role of standing genetic variation in the process) as well as specifically (with reference to speciation in stickleback fishes). For the sticklebacks, they develop an interesting “transporter model” of ecological speciation in which ecological selection pressures in freshwater streams consistently select for alleles different from those normally present in marine populations. However, occasional hybridization between freshwater and marine forms ensures a continual supply of freshwater alleles in the sea, at low frequency and disassembled by genetic recombination. When marine fish colonize a newly opened stream, natural selection can act on this standing pool of genetic variation to reconstitute the freshwater genotype. The analogy in the title of their model is to a fictional process in the movie *Star Trek*, wherein an organic body placed in the transporter is disintegrated only to be reassembled at a future time in a distant location.

The vast majority of phylogenetic diversity in eukaryotes is to be found not in the lineages of multicellular plants and animals, but rather in unicellular microbes (protists). Perhaps it is not surprising, therefore, that these microeukaryotes provide a wealth of opportunities (heretofore relatively untapped) for scientific investigations into natural selection and evolutionary operations. In Chapter 4, Julius Lukeš, Brian Leander, and Patrick Keeling exemplify the utility of protists for providing evolutionary insights by summarizing numerous phenotypic as well as genomic features in representatives of two huge protistan phylads: Alveolata and Euglenozoa. They underscore the mind-boggling diversity in protists of molecular genetic as well as phenotypic features, ranging from cellular ultrastructures to mechanisms of mRNA processing and the organization of organellar genomes. The picture that emerges is one of extraordinary evolutionary experimentation in these protists, sometimes channeled into convergent outcomes by natural selection, sometimes constrained by the idiosyncrasies of phylogeny, but always tinkered endlessly by various mixes of both chance and necessity.





# 1

## Natural Selection in Action During Speciation

---

SARA VIA

The role of natural selection in speciation, first described by Darwin, has finally been widely accepted. Yet, the nature and time course of the genetic changes that result in speciation remain mysterious. To date, genetic analyses of speciation have focused almost exclusively on retrospective analyses of reproductive isolation between species or subspecies and on hybrid sterility or inviability rather than on ecologically based barriers to gene flow. However, if we are to fully understand the origin of species, we must analyze the process from additional vantage points. By studying the genetic causes of partial reproductive isolation between specialized ecological races, early barriers to gene flow can be identified before they become confounded with other species differences. This population-level approach can reveal patterns that become invisible over time, such as the mosaic nature of the genome early in speciation. Under divergent selection in sympatry, the genomes of incipient species become temporary genetic mosaics in which ecologically important genomic regions resist gene exchange, even as gene flow continues over most of the genome. Analysis of such mosaic genomes suggests that surprisingly large genomic regions around divergently selected quantitative trait loci can be protected from interracial recombination by “divergence hitchhiking.” Here, I describe the formation of the genetic mosaic during early ecological speciation, consider

---

Departments of Biology and Entomology, University of Maryland, College Park, MD 20742.

the establishment, effects, and transitory nature of divergence hitchhiking around key ecologically important genes, and describe a 2-stage model for genetic divergence during ecological speciation with gene flow.

**T**he origin of species is only slightly less mysterious now than it was 150 years ago when Darwin published his famous book (Darwin, 1859). Although Darwin's idea that natural selection drives speciation has finally been widely accepted (Coyne and Orr, 2004), we still have much to learn about the nature and time course of the genetic changes that cause speciation under natural selection (Schluter, 2001, 2009; Via and West, 2008).

### THE SPYGLASS

Pivotal ideas developed during the modern synthesis of the 1930s–1940s have largely determined the course of modern speciation research. Ernst Mayr (1942) developed the biological species concept, putting reproductive isolation at the center of speciation and making analysis of the evolution of reproductive isolation a clear target for speciation research. Mayr also stressed that the evolution of reproductive isolation is a fragile process that can only proceed if geographical separation renders gene flow impossible, firmly establishing allopatric speciation as the norm. Theodosius Dobzhansky (1937) identified a wide array of traits that could cause reproductive isolation, but focused much of his own research into speciation on postzygotic genetic incompatibilities (Dobzhansky, 1934), as did H. J. Muller (1942). At the time, hybrid sterility was a particularly problematic aspect of speciation because it had been unclear since Darwin (1859) how such a disadvantageous trait could evolve under natural selection. By providing a clear mechanism by which hybrid sterility could evolve (Coyne and Orr, 2004, pp. 269 and 270), Dobzhansky-Muller genetic incompatibilities (DMIs) took center stage in the genetic analysis of speciation, where they have remained ever since. Collectively, the architects of the synthesis outlined a retrospective approach to speciation that I call “the spyglass,” because it starts late in the process (or after it is complete) and looks back in time to infer the causes of speciation (Fig. 1.1A).

Unquestionably, this approach has been a rich source of information about the kinds of barriers to gene flow that can isolate species [e.g., Otte and Endler (1989); Howard and Berlocher (2003)], but alternative ideas about speciation and how to study it have met with considerable resistance during the past 70 years. Even today, allopatric speciation remains the null model against which all other mechanisms for speciation must be tested (Coyne and Orr, 2004, p. 158), and DMIs are widely regarded as

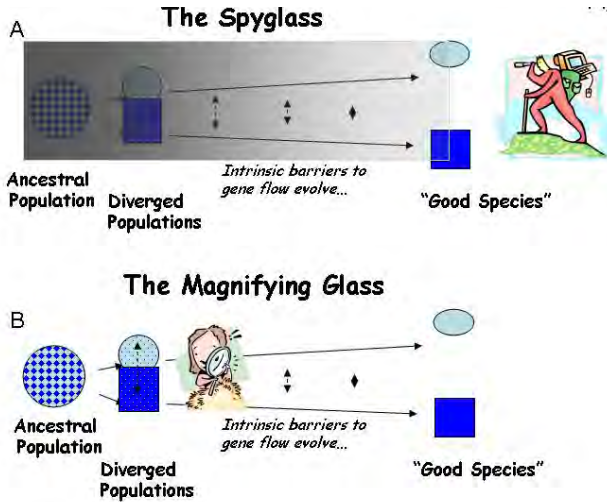

FIGURE 1-1 Two ways to study the process of speciation, which is visualized here as a continuum of divergence from a variable population to a divergent pair of populations, and through the evolution of intrinsic barriers to gene flow to the recognition of "good species." (A) Using "the spyglass," the process is studied by attempting to look back to see the details of speciation from the vantage point of the present. (B) Using "the magnifying glass," the mechanisms of reproductive isolation are studied in partially isolated divergent ecotypes, which are used as models of an early stage of speciation.

the appropriate focus of research in speciation genetics (Ting et al., 2000; Masly and Presgraves, 2007; Mihola et al., 2009; Phadnis and Orr, 2009; Willis, 2009).

### THE MAGNIFYING GLASS

A different view of speciation genetics is now gaining in popularity: the population-level analysis of how ecology and genetics interact in various situations to cause the evolution of barriers to gene flow (Schemske, 2000; Schluter, 2001; Via, 2001). By analyzing partially reproductively isolated ecotypes or races, the genetic changes contributing to reproductive isolation can be studied before they become confounded by additional genetic differences between species that accumulate after speciation is complete. Indeed, studying barriers to gene flow in populations that are not yet completely reproductively isolated may reveal important aspects of the process that have never been seen clearly before. This approach is particularly suitable for the analysis of speciation under divergent

selection, now called “ecological speciation” (Schluter, 2001). To contrast this approach with the more classic retrospective analyses, I call the population-level analysis of the ecological and genetic causes of reproductive isolation the “magnifying glass” (Fig. 1.1B).

The validity of population-level analyses of the ecology and genetics of the partial reproductive isolation has occasionally been questioned. Because there is no guarantee that ecotypes or races will ever attain species status, some argue that barriers to gene flow between them caused by divergent selection are irrelevant to the study of speciation (Futuyma, 1987; Coyne and Orr, 2004). Others disregard ecologically based reproductive isolation between ecotypes because it lacks permanence and could be reversed if the pattern of divergent selection changes (Coyne and Orr, 2004). However, many valid species concepts do not require or even consider permanence, and doing so simply underscores the observation that different species concepts apply at different points along a continuum of divergence from populations to well-established and permanent species (Harrison, 1998).

To supporters of the population-level approach, divergent populations are an early stage on that continuum. They argue that barriers to gene flow in partially isolated ecological races or ecotypes must be similar to those that would have been seen long ago between a pair of present-day sister species in a similar ecological situation. Although it is certainly true that not all divergent races will go on to become full species, many contemporary species must have passed through the stage of population divergence typified by ecotypes. Because the particular ecological conditions associated with divergence under selection cannot be seen clearly through the spyglass, that approach is unlikely to reveal much about the initial causes of reproductive isolation during speciation under divergent selection.

Speciation research is plagued by this awkward gulf between population-level and species-level analyses. To fully understand the mechanisms of speciation, we must cross that space, integrating magnifying glass analyses of the early parts of the process with the view of the end products through the spyglass.

## HOW DOES NATURAL SELECTION CAUSE SPECIATION?

With the possible exception of reinforcement, natural selection does not directly favor phenotypic traits or genetic incompatibilities simply because they block gene flow. Instead, it is generally thought that reproductive isolation occurs indirectly, as a “by-product” of the genetic changes that increase adaptation (Coyne and Orr, 2004, p. 385). However, pooling ecologically based reproductive isolation with that caused by the accumulation

of genetic incompatibilities under the term by-product does not do much to advance our mechanistic understanding of speciation. To fully connect the views through the magnifying glass and the spyglass, we must understand how different ecological situations lead to particular types of barriers to gene flow and on what timetable these different forms of reproductive isolation evolve. It is particularly important to ask under what circumstances and how often ecologically based reproductive isolation produce virtually complete reproductive isolation before appreciable genetic incompatibility has evolved (Ramsey et al., 2003; Coyne and Orr, 2004, pp. 57–59).

### THE EFFECT OF GEOGRAPHY ON SPECIATION

Ecological speciation can occur in either geographically isolated populations (allopatry) or in settings with no physical barriers to gene flow (sympatry or parapatry). When gene exchange is physically impossible, the conditions under which reproductive isolation can evolve are nonrestrictive: allopatric speciation can be driven by strong or weak divergent selection, sexual selection, uniform selection, or even stabilizing selection. It may occur quickly under divergent selection or extremely slowly under uniform or balancing selection.

In contrast, the conditions under which sympatric or parapatric speciation with gene flow can occur are not so forgiving: genetically based phenotypic divergence requires much stronger selection to occur and be maintained when gene flow is possible than when geography makes it an impossibility [e.g., Rice and Hostert (1993); Via (2001)]. In the presence of migration, the establishment of genomic regions that resist gene flow sufficiently to maintain phenotypic differentiation is only likely if divergent (or possibly sexual) selection is strong, and so the initial barriers to gene flow in sympatry are likely to evolve quickly (Rice and Hostert, 1993; Via, 2001; Hendry et al., 2007). Speciation with gene flow (Rice and Hostert, 1993) is thus unlikely to occur under weak divergent selection, and it is certainly not expected under uniform or balancing selection (except perhaps by polyploidy). One fortuitous effect of the strong selection required for speciation with gene flow is that the genomic regions that cause reproductive isolation become particularly distinctive relative to the rest of the genome. This facilitates their discovery in empirical analyses.

Until recently, genetic models of speciation with gene flow have been extremely simplified, and they have suggested quite a restrictive set of conditions for sympatric speciation. In particular, critics cite the difficulty of evolving assortative mating in the face of free recombination (Coyne and Orr, 2004, pp. 127–141). Although Felsenstein (1981) showed that this constraint is significantly reduced under linkage between genes affecting performance and mating, that result has been largely ignored (Via, 2001).

A variety of conditions that facilitate ecological speciation with gene flow are now well described (Rice and Hostert, 1993; Via, 2001). They include strong divergent selection on multiple traits associated with resource or habitat use and ecologically based selection against migrants and/or hybrids. Recent work suggests that assortative mating can evolve rather easily if habitat choice determines the choice of mates (Rice and Hostert, 1993; Via, 2001), if mate choice is a correlate of the traits under divergent selection (Schluter, 2001), or if recombination is reduced by physical linkage or pleiotropy (Felsenstein, 1981; Hawthorne and Via, 2001). Some of the best-studied divergent races in the wild, including the ecologically specialized host races of the pea aphid [*Acyrtosiphon pisum* (Harris)] satisfy these conditions (Via, 2001), providing strong empirical support for the argument that reproductive isolation can evolve, or at least persist, in the face of gene flow.

The first step in using the magnifying glass to study speciation involves estimating the magnitude of gene flow between a pair of partially reproductively isolated taxa. That process is not as straightforward as it may seem.

### POTENTIAL VS. REALIZED GENE FLOW DURING ECOLOGICAL SPECIATION UNDER DIVERGENT SELECTION

Empirical estimates of gene flow assume neutrality of markers and a balance between migration and random drift [e.g., Hartl and Clark (1997)]. This emphasis on gene flow under neutrality implies that there is just 1 “true” estimate of gene exchange between 2 taxa. Moreover, the minimal gene flow required to counter drift under Wright’s island model (Hartl and Clark, 1997, pp. 194 and 195) conjures up a picture of gene flow as a force that will easily homogenize adjacent populations (Fig. 1.2A). Yet, one can easily find phenotypically divergent and ecologically specialized populations living in close adjacency with no physical barrier to gene flow. Is this a contradiction? Not necessarily, because the degree to which a genomic region affecting a given trait is homogenized by migration depends not on the estimated gene flow under neutrality, but on the realized gene flow at that region after selection.

It is a maxim of population genetics that migration and genetic drift affect the entire genome, whereas the effects of natural selection are limited to genomic regions harboring loci that affect the selected phenotypic traits. In ecologically specialized populations, divergent selection on traits associated with the use of resources or habitats is strong enough to maintain divergence in the parts of the genome that affect those traits, while gene flow continues in other genomic regions (Figs. 1.2B and 1.3). Between such populations, the estimated gene flow under neutrality may

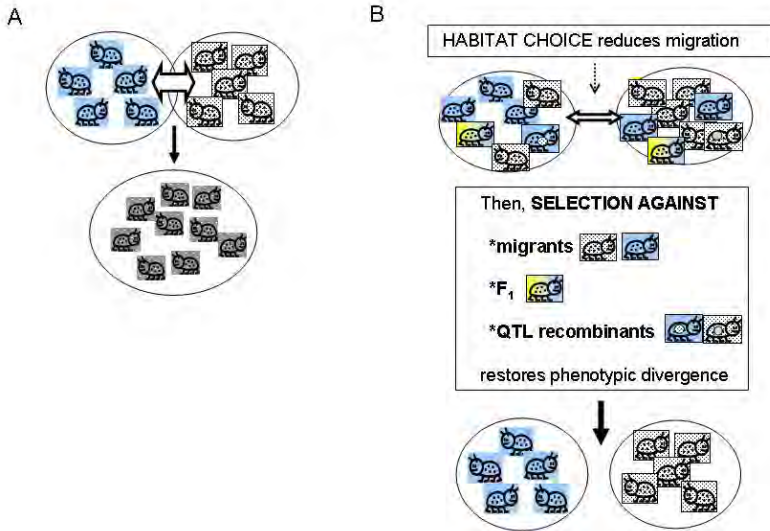

FIGURE 1-2 (A) The simple vision of gene flow as a homogenizing force in populations. Free migration and random mating between locally adapted populations is simplistically visualized as homogenizing populations and eradicating local adaptation. (B) Ecologically based barriers to gene flow under divergent selection permit genetically based phenotypic divergence under selection to be maintained in the face of the possibility of gene flow: habitat choice reduces migration, then selection against migrants and  $F_1$ , and selection against QTL recombinants reduce introgression of locally adapted alleles, maintaining divergence.

grossly overestimate the realized gene exchange experienced by divergently selected genomic regions.

Because of the localized genomic effects of divergent selection on realized gene exchange, divergence early in ecological speciation with gene flow is expected to be greater in genomic regions that harbor key quantitative trait loci (QTL) than it is in regions that have no effect on the phenotypic divergence of the populations (Fig. 1.3). If, as usually thought, speciation with gene flow involves only a handful of characters (Rice and Hostert, 1993), these divergent regions may comprise a relatively small fraction of the genome, leaving the genomes of incipient species largely homogenized by ongoing gene flow and “profoundly genetically similar” [Fig. 1.3 and Kondrashov et al. (1998)]. We call the resulting pattern of genomic heterogeneity in divergence and gene exchange early in ecological speciation with gene flow “the genetic mosaic of speciation” (Via and West, 2008).



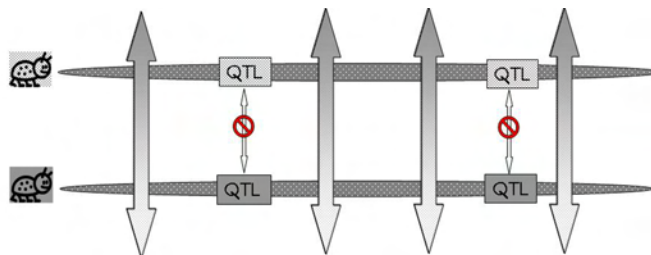

FIGURE 1-3 A cartoon version of genomic heterogeneity of gene exchange and genetic divergence under divergent selection. One chromosome from each specialized parental population is shown, with the genomic regions that contain locally adapted genes (QTL) indicated in boxes shaded to correspond to the specialized parent from which it came. Bidirectional arrows indicate gene exchange, with the pattern in the arrow tips showing that alleles from the other population are introgressing. Gene exchange can occur outside the regions containing the specialized genes, but is blocked from occurring within those regions for the reasons shown in Fig. 1.2B. This heterogeneous pattern of gene exchange under selection establishes the “genetic mosaic of speciation,” in which genetic divergence is restricted to divergently selected portions of the genomes, while other regions share polymorphisms freely through ongoing gene exchange.

### USING $F_{st}$ OUTLIER ANALYSIS TO IDENTIFY SELECTED GENOMIC REGIONS IN THE GENETIC MOSAIC

Wright’s  $F_{st}$  is a widely used measure of genetic divergence between populations (Hartl and Clark, 1997). Lewontin and Krakauer (1973) proposed that genetic markers with aberrantly high  $F_{st}$  values (“outliers”) could be inferred to be affected by divergent selection. Recently, outlier analyses have enjoyed a renaissance because of the development of new methods based on coalescent simulation (Beaumont and Nichols, 1996; Beaumont and Balding, 2004).  $F_{st}$  variation is still used to eliminate selected markers from population genetic analyses that require neutrality (Luikart et al., 2003), but it is now of primary interest as a signature of divergent selection that permits detection of genomic regions involved in adaptive divergence (Beaumont, 2005; Storz, 2005).

Significant heterogeneity in marker  $F_{st}$  has been documented between ecologically divergent races (Wilding et al., 2001; Emelianov et al., 2004; Rogers and Bernatchez, 2005; Bonin et al., 2006; Oetjen and Reusch, 2007), with the interpretation that  $F_{st}$  outliers must be linked to loci affecting the phenotypic traits known to distinguish the divergent ecotypes, races, or subspecies. However, outlier analysis alone cannot reveal the cause of deviant  $F_{st}$  values, and the conclusion that  $F_{st}$  outliers must be associ-

ated with genes causing the most obvious differences between ecotypes is premature.

Using a linkage map that shows locations of the QTL affecting phenotypic traits known to be under divergent selection, the hypothesis that outliers are linked to key phenotypic traits under divergent selection can be tested: Are  $F_{st}$  outliers scattered randomly on the map, or are they clustered near divergently selected QTL? This approach requires a system in which the phenotypic traits involved in divergence and reproductive isolation are well known, the strength of selection on these traits has been measured, and QTL affecting the key traits have been localized on a linkage map, so that mapped markers can be used in an  $F_{st}$  analysis of field-collected samples. The pea aphid host races on alfalfa and red clover [*A. pisum pisum* (Harris)] are such a system.

### PEA APHIDS ON ALFALFA AND RED CLOVER: ECOLOGICAL SPECIATION IN ACTION?

The pea aphid complex is a worldwide group of phloem-feeding insects, found primarily on legumes (Eastop, 1971). Although the pea aphid host races on alfalfa and red clover are in the same subspecies, *A. pisum pisum*, sympatric pea aphid populations on alfalfa, red clover, and other legumes are highly genetically divergent and ecologically specialized in the eastern United States (Via, 1991b), Europe (Sandstrom, 1996; Simon et al., 2003; Ferrari et al., 2007, 2008), and South America (Peccoud et al., 2008).

Experimental studies in both the field and laboratory have documented extensive ecologically based reproductive isolation between the pea aphid host races in eastern North America because of strong selection against migrants to the alternate host (Via, 1989, 1991a,b, 1999), environmentally mediated selection against hybrids (Via et al., 2000), and habitat choice (Via et al., 2000). It is unknown whether divergence between the pea aphid host races began in sympatry [e.g., Coyne and Orr (2004, pp. 163 and 164)]. However, conditions of the initial split are far less relevant to the study of speciation than is the fact that divergent selection currently maintains genetically based phenotypic differentiation and significant ecologically based reproductive isolation between sympatric populations.

Via and West (2008) estimated  $F_{st}$  between the pea aphid host races for 45 markers with known locations on a QTL map of genomic regions affecting early fecundity and behavioral acceptance of each plant. They then estimated the map distance from each marker to the nearest QTL for one of the key host use traits and found that  $F_{st}$  outliers were significantly clustered around the QTL involved in reproductive isolation ( $P < 0.05$ ; Fig. 1.4).

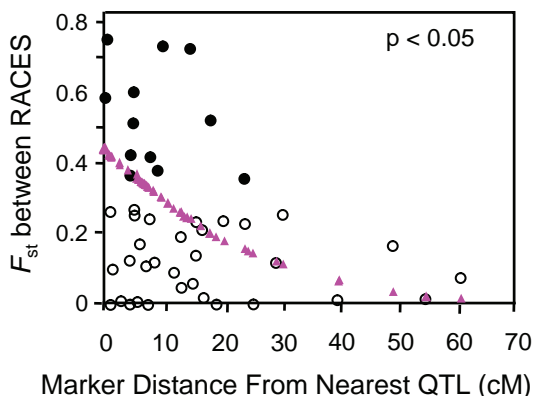

FIGURE 1-4 The relationship between the  $F_{st}$  values of AFLP markers, and their map distance from the nearest QTL involved in reproductive isolation between pea aphids on alfalfa and red clover.  $F_{st}$  outliers are shown with solid circles, and the dotted line at 10.6 cM marks the average distance from an outlier to the nearest QTL. The triangles are the predicted values from a logistic regression of the probability that a marker was an outlier on its distance to the nearest QTL (modified from Via and West, 2008).

Surprisingly, the spatial distribution of the mapped  $F_{st}$  outliers suggests that the signature left by divergent phenotypic selection on neutral markers can extend far from major QTL: the average outlier was 10.6 cM from the nearest QTL. A similar result was found for traits involved in the divergence of whitefish morphs in postglacial lakes (Rogers and Bernatchez, 2007), where the average outlier was 16.2 cM from the nearest QTL. In both systems, the hitchhiking regions around divergently selected QTL are far larger than expected. After a selective sweep through a large panmictic population, linkage disequilibrium rapidly erodes except in areas of reduced recombination (Begun and Aquadro, 1992). Although reduced recombination is, in fact, the explanation for the large hitchhiking regions we observed, they arise not from suppression of recombination *per se*, but from a reduction in the “effective recombination” between locally adapted QTL alleles in divergent populations that are subdivided (i.e., no longer randomly mating).

Charlesworth et al. (1997) analyzed the potential for hitchhiking when populations are subdivided by divergent (local) selection. Using a simulation analysis, they found that regions of linkage disequilibrium of the size we observed (Via and West, 2008) can be maintained around a divergently selected locus. This unexpected result occurs because subdivision reduces the opportunity for recombination between locally adapted QTL

alleles. In other words, divergent selection leads to fewer than expected interpopulation matings, which reduces the effective recombination of locally adapted QTL alleles below what is expected based on a map from a controlled cross.

Because speciation is, by definition, a process in which populations become increasingly subdivided, reduced effective recombination under subdivision is an important aspect of speciation with gene flow, although it has been largely unappreciated. As populations become subdivided by divergent selection and ecological specialization increases, the opportunity for interracial recombination is increasingly reduced by selection against migrants, extrinsic selection against  $F_1$  hybrids, and/or habitat choice. When recombination between QTL alleles does occur, the local disadvantage of the recombinant QTL allele further reduces the frequency of migrant alleles in advanced generation hybrids or backcrosses.

So, despite free recombination within subpopulations, the effective recombination between genotypes with different QTL alleles begins to decline as soon as divergent selection foils panmixia in early ecological speciation with gene flow, and it may also be a significant factor maintaining divergence after secondary contact. To emphasize that this form of hitchhiking is maintained only in divergent populations, and that it differs from hitchhiking after a selective sweep, I call it “divergence hitchhiking” (Via and West, 2008).

The reduction in effective recombination between divergent races means that the nominal map distance estimated from  $F_{st}$  outliers to the nearest QTL (Fig. 1.4) overestimates the actual probability that recombination will separate a divergent outlier allele from a locally adapted allele at a nearby QTL. In other words, the “effective map distance” between a locally adapted QTL and a nearby marker is much less than that estimated from a linkage map made using controlled matings.

We can empirically approximate the effective marker-QTL distance in pea aphids by estimating the extent to which habitat choice and divergent selection limit the opportunity for interracial mating and recombination (e.g., Fig. 1.2B). We used field sampling to estimate that habitat choice reduces migration to the alternate host to  $\approx 11\%$  (suggesting that 89% of possible migrants reject the alternate host plant; Via et al., 2000). The fitness of migrants from alfalfa to clover is  $\approx 30\%$  of that of nonmigrants, whereas the fitness of migrants from clover to alfalfa is only  $\approx 5\%$  of that expected for nonmigrants, for an average relative fitness of migrants of  $\approx 17\%$  (estimated selection against migrants of  $s = 0.83$ ; Via et al., 2000).  $F_1$  hybrids do not feed as effectively on either host as the parental specialist, which reduces their fecundity (and the realized number of recombinations) by  $\approx 50\%$  (Via et al., 2000). So, without accounting for sexual selection against migrants, the probability of recombination between races for

a marker 10.6 cM from a QTL is the original recombination probability (0.106) discounted by the probability that a migrant will choose the alternate habitat and survive there ( $0.11 \times 0.17$ ), and the relative fecundity of  $F_1$  hybrids (0.5), making the effective recombination rate for that marker  $(0.106) \times (0.11) \times (0.17) \times (0.5) = 0.001$ .

This calculation suggests that the average outlier, at a nominal distance of 10.6 cM from the nearest QTL on the linkage map (Via and West, 2008), has an effective map distance to that QTL of only  $\approx 0.1$  cM. In these populations, even a marker 50 cM from a divergently selected QTL has an effective map distance of only 0.5 cM as a result of the large decrease in effective migration caused by extensive ecologically based reproductive isolation. This estimated difference between nominal recombination and effective recombination between subdivided populations shows why such a large genomic region is expected to remain in linkage disequilibrium with a QTL under divergent selection during ecological speciation with gene flow.

It is of interest that the magnitude of effective recombination in a given genomic region changes over time as ecological specialization evolves, because greater specialization increases the magnitude of resource-based selection against migrants and hybrids. This can be illustrated with a simple example. Imagine that early in divergence only a few QTL have differentiated such that extent of habitat choice and the disadvantage of migrants or  $F_1$  is only 25% as strong as at present. Then, only 22% of potential migrants would refuse the alternate host (78% accept), selection against a migrant would be  $s = 0.21$  (relative fitness of migrants = 0.79), and the relative fecundity of an  $F_1$  hybrid would be 0.875, making the effective rate of recombination of the average outlier with the nearest QTL  $(0.106) \times (0.78) \times (0.79) \times (0.875) = 0.057$ . Thus, at this earlier point in divergence, the average outlier would have an effective map distance of 5.7 cM from the nearest QTL. Although smaller than the nominal map distance of 10.6 cM, it is far from the tight effective linkage seen at present. The size of each region of divergence hitchhiking therefore depends not only on the strength of divergent selection directly on that genomic region, but also on the extent to which effective migration is reduced by the earlier divergence of other QTL alleles throughout the genome.

Divergence hitchhiking has the same general effect on interracial recombination and speciation as a chromosomal inversion that happens to contain 1 or more key QTL [e.g., Noor et al. (2001), Rieseberg (2001), Machado et al. (2007)]. However, unlike inversions, which must occur relatively infrequently at the site of key QTL, divergence hitchhiking appears automatically around any QTL under strong divergent selection. More-

over, regions of divergence hitchhiking are dynamic. They increase in size as the evolution of specialization reduces the effective migration between diverging races, and regions of divergence hitchhiking around loosely linked QTL may overlap and merge. Perhaps most importantly, however, regions of divergence hitchhiking leave no permanent signature because they do not involve physical alterations to chromosomes. These regions of reduced interracial recombination can only be detected while divergence elsewhere in the genome is low. They will not be seen in retrospective analyses of good species, because as speciation progresses they become assimilated into the overall genomewide pattern of genetic divergence and by the time speciation is complete, they have disappeared.

### HOW MANY QTL ARE THERE WITHIN A REGION OF DIVERGENCE HITCHHIKING?

Hawthorne and Via (2001) found that QTL for different traits under divergent selection in the pea aphid host races tended to colocalize on the linkage map. Colocalization of QTL increases selection experienced by that genomic region, thereby increasing the size of the region of divergence hitchhiking, and facilitating both QTL detection and the accumulation of additional QTL. In addition, any given QTL may actually be a cluster of several genes. Thus, it seems likely that most regions of divergence hitchhiking will contain multiple genes that affect 1 or more traits under divergent selection.

### How Are Regions of Divergence Hitchhiking Delineated?

Determining the size of a given region of divergence hitchhiking is not entirely straightforward. There are 2 contrasting views:

#### *I. A Single Region of Divergence Hitchhiking Extends Across a Cluster of $F_{st}$ Outliers Around a Given QTL or Group of QTL (Fig. 1.5A).*

Via and West (2008) proposed that a cluster of outliers defines a single region of divergence hitchhiking, which may include 1 or more QTL. They suggested that the boundaries of a given region of divergence hitchhiking be estimated by curve fitting in a genome scan of  $F_{st}$  values at various map distances around individual QTL under divergent selection (Fig. 1.5A). In this view, markers with low  $F_{st}$  values that lie within hitchhiking regions are interpreted as polymorphisms that predate divergence at the QTL. They are thus uninformative about population divergence and should not be used to mark the boundaries of divergence hitchhiking.

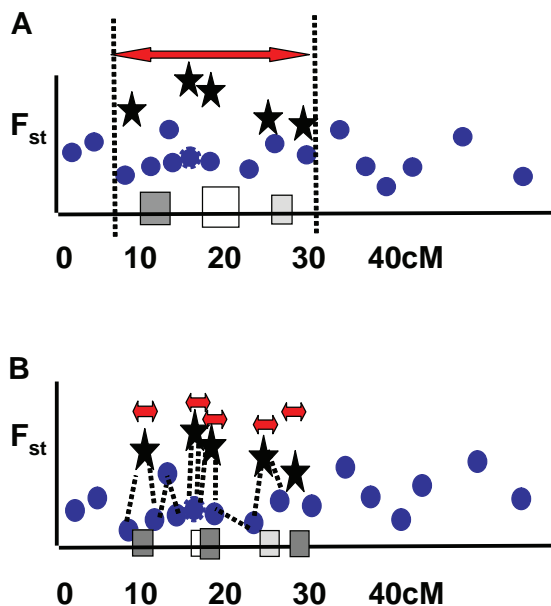

FIGURE 1-5 Two views of how to delineate regions of divergence hitchhiking. (A) A single region of divergence hitchhiking around QTL affecting one or more traits (indicated by differently shaded squares) is defined by a cluster of  $F_{st}$  outliers. (B) Each outlier defines a separate hitchhiking region, bounded by a low  $F_{st}$  marker. In this view, outliers are thought to be either under direct divergent selection, or tightly linked to a selected gene.

## II. Each Outlier Corresponds to a Gene or QTL Under Selection or Is Itself Under Selection (Fig. 1.5B).

Ting et al. (2000) found that a DNA sequence just 1,100 bp away from the hybrid sterility gene *Odysseus* (*Ody*) was not divergent between the 2 parental species, and from this single observation they concluded that the hitchhiking region around *Ody* must be extremely small. Wood et al. (2008) and Smadja et al. (2008) extend this idea by suggesting that the nearest genomic region of low genetic divergence to an  $F_{st}$  outlier marks the boundary of its hitchhiking region (Fig. 1.5B).

Several observations are inconsistent with this hypothesis. First, outliers are easy to find. Even in studies with just a few markers (Wilding et al., 2001; Emelianov et al., 2004; Rogers and Bernatchez, 2007; Via and West, 2008), 5% or more of tested markers are generally  $F_{st}$  outliers. Taking 5% as a minimal estimate, this observation implies either that hitchhiking



regions are large enough that they capture 5% of randomly chosen markers (Via and West, 2008), or that so many genes are under divergent selection that 5 of them can be found with only 100 markers (Wood et al., 2008). If the latter were true, we would expect that in an average-sized genome of  $\approx 25,000$  genes,  $\approx 1,250$  of them (5%) would be involved in ecotypic differentiation and early speciation. This seems unlikely, given the prevailing view that speciation with gene flow typically involves just a handful of traits, each influenced by just a few major genes (Rice and Hostert, 1993). Second, even with very strong phenotypic selection during population divergence, the selection coefficients on each of 1,250 genes would be far too small to generate either a detectable QTL or an  $F_{st}$  outlier.

### THE TWO STAGES OF ECOLOGICAL SPECIATION WITH GENE FLOW

Consideration of the mosaic nature of the genome during early ecological speciation with gene flow suggests that genetic change in this form of speciation occurs in 2 distinct stages:

#### **Stage 1: Response to Divergent Selection (Fig. 1.6A and B)**

During the first stage of ecological speciation with gene flow, genomic regions containing major QTL for key traits quickly diverge under selection and become resistant to gene exchange. This establishes the commonly observed pattern of genomic heterogeneity in divergence between incipient species, which we call the genetic mosaic.

As divergent selection proceeds, ecologically based reproductive isolation increases because of resource-based selection against migrants and hybrids and the evolution of habitat choice. These factors limit “effective migration,” i.e., the joint probability that a migrant will choose the alternate resource, survive to mate with a resident, and then that a subsequent  $F_1$  will produce a recombinant gamete. This reduction in migration increases the size of hitchhiking regions genomewide and tips the migration-selection balance, which permits QTL of smaller effect to diverge between the populations. By the end of stage 1, ecologically based reproductive isolation may be nearly complete between the new lineages, and genetic divergence is expected to be concentrated in just a handful of genomic regions.

Although this first stage of divergence may involve relatively few traits and a small fraction of the genome, the divergence of QTL for key phenotypic traits under selection defines the branching pattern with which other loci will eventually become phylogenetically concordant. The phenotypic traits that diverge under selection are those that are likely



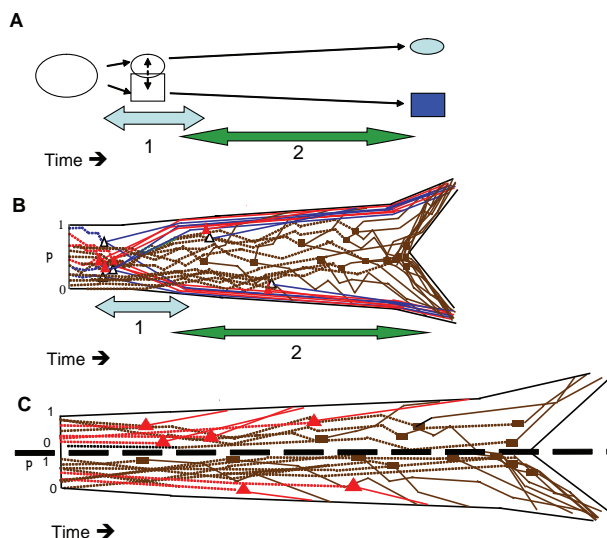

FIGURE 1-6 The two stages of ecological speciation-with-gene-flow. (A) The duration of Stage 1 is noted by the light gray, Stage 2 by the darker arrow. Events during each stage are as described in the text. (B) Cartoon of gene trees within a species tree for ecological speciation-with-gene-flow. Each gene is polymorphic in the original population, with a frequency ( $p$ ) as noted on the axis at the left of the drawing. As time goes on, some loci quickly diverge at about the same time under divergent selection. Solid triangles denote selected QTL, open triangles are divergence hitchhikers. This divergence is mostly complete by the end of Stage 1. During Stage 2, a handful of additional loci diverge under selection, and loci that were unaffected by divergent selection diverge by independent responses to uniform or balancing selection, or by drift (solid rectangles). (C) Gene trees in a species tree under allopatry, symbols are as in (B). If an allopatric population enters a new environment, there may be a period of rapid response to divergent selection similar to Stage 1 in (A). Otherwise, genes diverge over a long time period under any combination of divergent selection, independent responses to uniform or balancing selection, or drift, eventually all coming into concordance to produce the branching pattern of the new species.

to distinguish the eventual species, and genetic divergence at the major QTL for these traits defines the branches of what will ultimately become the species tree. Because selection accelerates progression to reciprocal monophyly (Avice, 2000), loci within these genomic regions are expected to become reciprocally monophyletic long before the rest of the genome, on approximately the same timescale as the divergence of the quantitative traits that these genes affect. During this phase, few other genetic differences are expected between the incipient species. This restriction of genetic

differentiation to the genomic regions affecting key divergently selected QTL is what makes it possible to use outlier analysis during stage 1 to distinguish genomic regions harboring these branch-defining loci.

At the end of stage 1, the gene trees for loci unaffected by divergent selection will still resemble a discordant collection of “tangled twigs” (Avice, 2000, p. 307), which reflects a combination of unresolved ancestral polymorphism, recent gene flow, and stochastic effects of the coalescent process (Maddison, 1997). At this point, any phylogeographic or phylogenetic analysis based on a set of randomly chosen neutral markers is likely to yield discordant results (Beltran et al., 2002; Machado and Hey, 2003; Mallarino et al., 2004; Dopman et al., 2005; Pollard et al., 2006). If  $F_{st}$  outliers can be identified in such analyses, their gene trees will reflect a clear branching pattern consistent with the phenotypic divergence, but most randomly chosen markers will produce noisy and uninformative phylogenetic patterns [examples in Wilding et al. (2001), Campbell and Bernatchez (2004), Emelianov et al. (2004), Dopman et al. (2005), and Via and West (2008)].

An important prediction of this model of speciation is that phylogenetic discordance will persist through speciation and possibly well beyond. Therefore, to detect the evolutionary story of lineage branching that will be reflected in the future species tree, it is necessary to focus on analyses of  $F_{st}$  outliers that are in linkage disequilibrium with QTL under divergent selection [see examples in Wilding et al. (2001), Emelianov et al. (2004), Dopman et al. (2005), and Via and West (2008)]. Early in speciation, these outliers will reveal the history of adaptive divergence. The truly neutral markers in other genomic regions will still be useful, however, for analyses of demographic events such as bottlenecks or range expansion.

Preferentially using markers affected by divergent selection for phylogeographic or phylogenetic analysis of populations conflicts with the clear preference for neutral markers in species-level phylogenetics. This apparent contradiction results from the gene tree-species tree mismatch, which persists until phylogenetic concordance is reached. Until that time, variability among gene trees leads will inevitably produce highly variable “cloudograms,” instead of the simple species-level cladograms that will eventually be visible (Maddison, 1997).

In sum, there are 2 key ideas in this model: first, the branching pattern of the QTL and their linked outliers reveals the branching pattern with which all of the discordant gene trees will eventually fall in line, and second, this pattern can be seen even during the period of rampant gene tree discordance if one analyzes  $F_{st}$  outliers rather than a random sample of markers.

As the portions of the genome affected by divergent selection become increasingly resistant to interracial gene exchange during stage 1, genes and

sequences within regions of divergence hitchhiking can begin to diverge by genetic drift or independent responses to directional and stabilizing selection within each race. The free recombination enjoyed within races can accelerate divergence at these loci by allowing beneficial mutations to spread within races, while divergence hitchhiking blocks their export to the other race. Some allelic substitutions within regions of divergence hitchhiking may produce genetic incompatibilities between the new species. Thus, an additional prediction of this model is that genes for hybrid sterility or inviability that are found close to “branch-defining” QTL will have, on average, a greater time to most recent common ancestor than will those found in other genomic regions.

### **Stage 2: Divergence by Genetic Drift and Independent Responses to Directional or Balancing Selection (Fig. 1.6A and B)**

By the end of stage 1, most gene exchange is likely to have already been blocked by the ecologically based reproductive isolation that reduces effective migration. The incipient species are now essentially “ecologically allopatric.” Thus begins stage 2, in which the parts of the genome outside regions of divergence hitchhiking begin to differentiate by genetic drift or independent responses to selection within the new lineages. This secondary divergence will eventually bring all of the variation in polymorphic gene trees into widespread phylogenetic concordance with the branching pattern determined earlier by divergent selection on QTL affecting the key ecologically important traits.

Given that only a small fraction of the genome may be affected by divergent selection during stage 1, most of the eventual genetic divergence between new ecological species is likely to occur during stage 2. Genetic analyses of hybrid sterility and inviability reveal that genetic incompatibilities are numerous and scattered throughout the genome (Masly and Presgraves, 2007). It is thus probable that by the end of stage 2, the number of genetic incompatibilities that have accumulated could far outnumber, and potentially obscure, the adaptive genetic changes that were actually involved in the initial evolution of reproductive isolation under divergent selection during stage 1. This is one of the major drawbacks of the exclusive use of the spyglass in the study of speciation genetics.

In many cases of speciation by divergent selection, enough ecologically based reproductive isolation will evolve to isolate a pair of new species before many DMIs can accumulate. Even so, the genetic incompatibilities that lead to hybrid sterility and inviability play a very important role in ecological speciation because they make the ecologically based reproductive isolation that evolved earlier permanent and irreversible. By the end of stage 2, it is likely that enough genetic incompatibilities will

have accumulated that the new species and their diverse adaptations will persist even if the pattern of natural selection changes.

This 2-stage model reverses the roles that are sometimes assumed for different forms of reproductive isolation during speciation (Coyne and Orr, 1989, 1997). In allopatric speciation, postzygotic genetic incompatibilities accumulate while populations are geographically isolated. These cause reproductive isolation when populations come back into contact. It is then that ecologically based prezygotic isolation plays its secondary role, evolving under selection to “reinforce” the existing postzygotic isolation and prevent the production of sterile or inviable hybrids. In contrast, in ecological speciation with gene flow, various ecologically based barriers to gene flow evolve first, as a result of adaptation under divergent selection. Once migration between the incipient species is essentially eliminated, they become ecologically allopatric, and postzygotic incompatibilities can accumulate. These DMIs then play the secondary reinforcing role by rendering the earlier evolution of ecologically based reproductive isolation difficult to reverse.

### **WHY HASN'T DIVERGENCE HITCHHIKING BEEN SEEN BEFORE?**

One hazard of the retrospective spyglass approach to speciation is that patterns of genetic divergence early in the process of speciation can become obscured or even invisible over time as additional divergence between the new species accumulates. This is likely to be the fate of divergence hitchhiking during the process of ecological speciation.

Early in ecological speciation with gene flow, populations diverge under selection at genomic regions that affect key ecologically important traits, while gene flow continues across the rest of the genome (Fig. 1.3).  $F_{st}$  outliers found during this period (stage 1) will tend to map to these selected regions, as suggested by our analyses (Via and West, 2008). However, by the time most of the genome is phylogenetically concordant and retrospective analyses begin, the genomic signature of the original divergent selection will have faded. Outliers might be found, but they should not be expected to mark the genomic regions under early divergent selection.

During stage 2 of ecological speciation with gene flow, genetic divergence occurs mostly in genomic areas that were not originally affected by divergent selection. As overall genomic divergence between the new species increases through drift or independent responses to selection, the distinctive genetic signature of divergence hitchhiking (excessive divergence in regions near divergently selected QTL) becomes assimilated into a more widespread pattern of genetic divergence between the new species. So, it is perhaps not surprising that decades of retrospective analyses

have not seen these important, but transient, regions of interracial linkage disequilibrium around divergent QTL.

$F_{st}$  outliers may still be found late in stage 2 or in hybrid zones between “good species” [e.g., Yatabe et al. (2007)], but interpreting their cause becomes increasingly difficult as the overall level of genetic divergence between the new species grows. A high  $F_{st}$  marker seen late in speciation or in a hybrid zone is more likely to be the result of genetic drift or a recent selective sweep within 1 species than it is to be a signature of the divergent selection that caused speciation. Therefore, outliers found between new species or in hybrid zones, or between incipient species in secondary contact after a period of allopatric divergence, should not necessarily be expected to mark genomic regions affected by divergent phenotypic selection during the initial phases of ecological speciation.

Outlier analyses of races or morphs that have become partially reproductively isolated under divergent selection thus offer a privileged, but transient, view of the genetic mechanisms involved in early ecological speciation. It is in regions of divergence hitchhiking that ecological speciation with gene flow begins, and the divergence of the ecologically important QTL at their center determines the eventual pattern of branching seen later in the species tree. However, by the time that good species are recognized, the distinctive pattern of divergence hitchhiking around key QTL is gone, and the opportunity to analyze the genomic regions pivotal to ecological speciation with gene flow has been lost.

### THE REAL DIFFERENCE BETWEEN SYMPATRIC AND ALLOPATRIC SPECIATION

In allopatric populations, where there is no possibility for gene exchange, virtually any type or strength of selection will eventually lead to reproductive isolation, and barriers to gene flow may be of virtually any kind. In their classic survey of reproductive isolation between *Drosophila* species, Coyne and Orr (1989, 1997) found that in allopatry, prezygotic (ecologically based) and postzygotic reproductive isolation (from DMIs) appeared to evolve at about the same rate.

In contrast, for speciation to occur without physical barriers to gene flow, divergent selection must be strong and “multifarious,” i.e., affecting several different traits, which causes ecologically based isolation to evolve relatively rapidly (Rice and Hostert, 1993; Schluter, 2001; Via, 2001; Hendry et al., 2007). Consistent with this, Coyne and Orr’s comparative analyses (Coyne and Orr, 1989, 1997) suggest that in sympatric populations, prezygotic isolation precedes the evolution of postzygotic isolation. The primacy of ecologically based isolation in speciation with gene flow is supported by empirical analyses of taxa in which divergent selection is

thought to have been involved in speciation. They reveal extensive prezygotic ecologically based isolation, with little or no isolation attributable to postzygotic genetic incompatibilities (Schluter, 2001; Via, 2001).

In the 2-stage model of speciation described here, allopatric speciation can occur without stage 1, but sympatric speciation cannot. There is essentially only 1 path for purely sympatric speciation: rapid divergence at genomic regions harboring QTL for traits under divergent selection, leading to significant ecologically based reduction of successful interbreeding between incipient species and ecological allopatry by the end of stage 1. Then, during stage 2, genetic incompatibilities can accumulate to reinforce the ecologically based isolation and make it permanent.

In contrast, allopatric speciation cannot be divided into distinct stages, because the accumulation of DMIs by independent responses to uniform or balancing selection can occur at the same time as the evolution of ecologically based isolation driven by divergent selection. In allopatry, any combination of divergent selection, uniform selection, and genetic drift could produce speciation (Fig. 1.6C). Because the rapid divergence under selection that characterizes ecological speciation with gene flow is not required when populations are geographically isolated (although it can happen), allopatric speciation will often take much longer than speciation with gene flow.

### **DIVERGENCE HITCHHIKING MAKES SYMPATRIC SPECIATION MUCH MORE LIKELY THAN COMMONLY BELIEVED**

Divergence hitchhiking neutralizes the most long-standing criticism of sympatric speciation, the difficulty of maintaining linkage disequilibrium between genes involved in resource use and those that produce assortative mating [e.g., Coyne and Orr (2004, pp. 127–137); Felsenstein (1981); Hawthorne and Via (2001); Via (2001)]. Although it has been clear for some time that this problem is mitigated if the traits under divergent selection for resource use also affect mate choice (Schluter, 2001), or if there is pleiotropy or physical linkage between the 2 classes of genes (Felsenstein, 1981; Hawthorne and Via, 2001; Via, 2001), these observations have done little to quell the controversy.

By providing a simple mechanism by which combinations of genes that produce assortative mating can accumulate and be protected from recombination, divergence hitchhiking removes the major constraint on sympatric speciation that prevented its acceptance for so long. The controversy over sympatric speciation has occupied a tremendous number of researchers over the past 50 years. If additional studies in other taxa show that divergence hitchhiking is a general phenomenon, we may finally be able to put this issue behind us.

## CONCLUSIONS

The genetic changes that produce speciation have fascinated researchers for many years. To date, most research on this crucial aspect of evolution has taken a retrospective approach that I call the spyglass. However, population-level analysis of the ecological and genetic mechanisms that produce reproductive isolation between partially isolated ecotypes or races (the magnifying glass) can provide a very different perspective on the problem of speciation. Both the spyglass and the magnifying glass are useful tools in the genetic analysis of speciation; any truly general theory of how speciation occurs must be consistent not only with observations from fully differentiated species, but also with mechanisms seen at the population level in partially isolated ecological races. Speciation is a multidimensional problem, and we will not solve Darwin's mystery unless we scrutinize it from every possible vantage point.

## ACKNOWLEDGMENTS

I thank John Avise and Francisco Ayala for the invitation to discuss these ideas at the Sackler Colloquium; Dolph Schluter and an anonymous referee for exceptionally thoughtful comments on the manuscript; Gina Conte for developing the multiplexed microsatellites for the new linkage map; Justin Malin for some clever computational assistance; and Casey Mason-Foley, Kelly Mills, and Jeffrey Lew for PCRs without end. My work on speciation is supported by National Science Foundation Grants DEB9796222, DEB0221221, and DEB0528288 and the U.S. Department of Agriculture National Research Initiative, Gateways to Genomics Program.



## 2

# Adaptive Radiations: From Field to Genomic Studies

---

SCOTT A. HODGES and NATHAN J. DERIEG

Adaptive radiations were central to Darwin's formation of his theory of natural selection, and today they are still the centerpiece for many studies of adaptation and speciation. Here, we review the advantages of adaptive radiations, especially recent ones, for detecting evolutionary trends and the genetic dissection of adaptive traits. We focus on *Aquilegia* as a primary example of these advantages and highlight progress in understanding the genetic basis of flower color. Phylogenetic analysis of *Aquilegia* indicates that flower color transitions proceed by changes in the types of anthocyanin pigments produced or their complete loss. Biochemical, crossing, and gene expression studies have provided a wealth of information about the genetic basis of these transitions in *Aquilegia*. To obtain both enzymatic and regulatory candidate genes for the entire flavonoid pathway, which produces anthocyanins, we used a combination of sequence searches of the *Aquilegia* Gene Index, phylogenetic analyses, and the isolation of novel sequences by using degenerate PCR and RACE. In total we identified 34 genes that are likely involved in the flavonoid pathway. A number of these genes appear to be single copy in *Aquilegia* and thus variation in their expression may have been key for floral color evolution. Future studies will be able to use these sequences along with next-generation sequencing

---

Department of Ecology, Evolution, and Marine Biology, University of California, Santa Barbara, CA 93106.



technologies to follow expression and sequence variation at the population level. The genetic dissection of other adaptive traits in *Aquilegia* should also be possible soon as genomic resources such as whole-genome sequencing become available.

**A**daptive radiations have played, and continue to play, a central role in the development of evolutionary theory. After his exploration of the Galápagos Islands, Darwin recognized that variants of species were confined to specific islands. In particular, Darwin (1963) noted that mockingbirds he collected on different islands represented 3 distinct forms and that all of the forms were similar to mockingbirds from the mainland of South America. He further noted that the different islands were within sight of one another, all quite similar in their habitats, and apparently geologically young. Based on these observations, Darwin (1876) began to suspect that species gradually became modified. Thus began his search for a process that could account for such observations, leading to his formulation of the theory of natural selection.

Key to Darwin's suspicion of common ancestry was the close proximity of environmentally similar islands comprising the Galápagos archipelago. In fact, many classic examples of adaptive radiations involve islands or lakes; notable examples include Darwin's finches of the Galápagos, honeycreeper birds and silversword plants of Hawaii, and cichlid fish of lakes Malawi and Victoria in Africa. The power of these examples for inferring the force of natural selection in evolution stems from the marked diversity in form and function among a group of clearly closely related taxa. The isolation of islands and lakes makes plausible the inference that the taxa are descended from a single ancestor, and the link between variation in form and function makes credible the notion that natural selection and evolution have played key roles.

A great deal of research effort has gone into substantiating the assumptions behind examples of adaptive radiation. In an influential book, Schluter (2000) laid out the definition of adaptive radiation as having 4 features: (i) common ancestry, (ii) a phenotype–environment correlation, (iii) trait utility, and (iv) rapid speciation. Monophyly and rapid speciation for many of the classic examples of adaptive radiation have been established by using molecular techniques [e.g., cichlids (Meyer et al., 1990), Galápagos finches (Petren et al., 1999; Sato et al., 1999), and Hawaiian silverswords (Baldwin and Sanderson, 1998)]. Ecological and manipulative experiments are used to identify and test phenotype–environmental correlations and trait utility. Ultimately, such studies have pointed to the link between divergent natural selection and reproductive isolation and, thus, speciation (Schluter, 2000).

Studies of adaptive radiations have exploded during the last 20 years. In a search of the ISI Web of Science with “adaptive radiation” (limited to the subject area of evolutionary biology) we found 80 articles published in 2008 compared with only 1 in 1990. Furthermore, citations of these articles have grown exponentially, from 34 citations in 1990 to >3,000 in 2008. The growing interest in adaptive radiations may be ascribed to several factors. First, molecular phylogenetics has allowed the identification of monophyly and rapid speciation in taxa outside of the traditionally recognized examples from isolated islands and lakes [e.g., Hodges and Arnold (1994)] and thus has expanded the repertoire of study systems. Second, there has been a resurgence in the study of speciation (Coyne and Orr, 2004). Speciation research has often focused on the development of genetic incompatibilities [e.g., Mihola et al. (2009) and Phadnis and Orr (2009)], whereas studies of adaptive radiations have focused attention on the role of divergent natural selection to alternate environments as a primary cause of reproductive isolation (Schluter, 1996, 2000, 2001; Rundle et al., 2000; Via, 2001). Thus, studies of adaptive radiations focus on both the evolution of adaptations and reproductive isolation.

Understanding the processes of adaptation and speciation requires considering taxa that have not yet fully attained reproductive isolation. Fundamentally, the ability to make hybrids allows the dissection of the genetic basis of traits and permits tests of how individual genetic elements could affect individual fitness. For example, Bradshaw and Schemske (2003) made near-isogenic lines of *Mimulus cardinalis* and *Mimulus lewisii*, each containing the alternate allele from the other species for a flower color locus. They found that pollinator visitation patterns radically changed and that, in the proper ecological setting, an adaptive shift in pollinator preference could possibly occur with a single mutation (Bradshaw and Schemske, 2003). In addition, studying speciation and adaptation early in the process has significant advantages because subsequent genetic changes can obscure the actual causal mutations [Via and West (2008); see also Via, Chapter 1, this volume]. For example, loss-of-function mutations that confer an adaptive advantage may be followed by additional mutations that would, on their own, cause loss of function but were not involved with the evolution of the trait itself (Zufall and Rausher, 2004). Thus, recent adaptive radiations are especially fruitful resources for dissecting the genetic basis of adaptations and speciation.

Adaptive radiations have also played a major role in identifying evolutionary trends. This area of study is important because trends imply predictable patterns in evolutionary history. There has been, for example, much debate about whether body size and complexity increase through time (Damuth, 1993; Jablonski, 1997; Hibbett and Binder, 2002; Hibbett, 2004; Van Valkenburgh et al., 2004). One way to test for repeatable trends

has been to test whether the evolution of particular traits is associated with species diversity. For example, clades of flowering plants that have independently evolved floral nectar spurs show a statistically significant trend for increased species diversity compared with nonspurred clades (Hodges and Arnold, 1995; Hodges, 1997; Kay et al., 2006). This finding has led to the nectar spurs being considered a “key innovation” with the implication that they mechanically increase the likelihood of speciation.

Another way to test for trends during evolutionary history is to test explicitly for directionality of trait evolution on a phylogeny. Critical to such analyses is the reconstruction of ancestral states (Schluter et al., 1997; Mooers and Schluter, 1999). Here, maximum-likelihood methods have been used to statistically distinguish between a 1-rate model (in which both directions of evolution have the same rate) and a 2-rate model (Pagel et al., 2004). However, the ability to test between such models depends on the number of shifts observed (Mooers and Schluter, 1999). Because adaptive radiations often are composed of a large number of species and have entailed multiple shifts in characters, they are prime foci for tests of directional trends [e.g., Mooers and Schluter (1999)].

As the development, use, and availability of genomic tools for non-model organisms has increased (Abzhanov et al., 2008), the ability to determine the genetic basis of adaptations and speciation is becoming possible for an increasing number of taxa. Long-standing questions about whether particular kinds of genes [e.g., regulatory versus structural; see Britten and Davidson (1969), King and Wilson (1975), Barrier et al. (2001), Hoekstra and Coyne (2007)] and/or particular types of mutations such as substitutions, duplications, or transposable elements are responsible for adaptation and speciation can now be addressed. Adaptive radiations are especially amenable to such studies for a number of reasons. First, because adaptive radiations have been studied for some time, particular trait values have often been substantiated as adaptations. Second, recent adaptive radiations often consist of taxa that can be hybridized, thus making possible the genetic dissection of traits. Third, adaptive radiations may entail a diversity of adaptive traits or the repeated evolution of the same traits in different lineages providing multiple comparisons within and between traits in a single system. Finally, because recent and rapid adaptive radiations necessarily consist of closely related taxa, the development of genomic tools for 1 species will likely provide tools for analysis across the entire group (Abzhanov et al., 2008). Thus, adaptive radiations offer the possibility of determining general molecular trends across traits and whether convergence at the phenotypic level involves convergence at the molecular level.

Here, we illustrate the use of adaptive radiations to understand the processes of adaptation and speciation by reviewing studies of the col-

umbine genus, *Aquilegia*. We first outline the broad evolutionary trends pointing to specific traits as being important in this adaptive radiation and briefly review the studies explicitly testing the function of these traits. We then highlight how genomic studies are aiding in our understanding of the genetic basis of adaptation and speciation, emphasizing flower color as a primary model. We end with a look toward how the genetic dissection of more complex traits will be possible in the near future.

### EVOLUTIONARY TRENDS IN *AQUILEGIA*

In a classic prediction of an evolutionary trend, Darwin (1862) hypothesized that the spurs of flowers and the tongues of pollinators could undergo a coevolutionary “race” and become increasingly long. However, an alternative hypothesis posited that spurs evolve to fit the already-established tongue length of pollinators, and that spur length increases only when a shift to a new and longer-tongued pollinator occurs (Wallace, 1867; Wasserthal, 1997). This second hypothesis also predicts a directional evolutionary trend: shifts to shorter spurs may be less likely because shorter-tongued pollinators will avoid visiting flowers whose nectar reward they cannot reach. Recently these alternative hypotheses were explicitly tested with a species-level phylogeny of the North American adaptive radiation of *Aquilegia* (Whittall and Hodges, 2007). Transitions between major classes of pollinators were found to be significantly directional, consisting of bee to hummingbird and hummingbird to hawkmoth but no reversals and no bee to hawkmoth transitions. Concomitant with these shifts were increases in spur length. In addition, models of the tempo of evolution strongly indicated the concentration of spur-length evolution at times of speciation. Thus, as with the broad correlation between the evolution of spurs themselves and species diversity, this study suggests that spur length is intimately linked with the speciation process, at least in North American species of *Aquilegia* (Whittall and Hodges, 2007; Hodges and Whittall, 2008). Functionally, matching of spur length to tongue length has been shown to be adaptive because *Aquilegia* flowers with artificially shortened spurs have less pollen removed from their anthers, and presumably deposited on their stigmas, because of the body of the pollinator being held further away from the flower (Fulton and Hodges, 1999).

The pollinator shifts found in *Aquilegia* entail transitions in other traits besides spur length. The orientation of flowers at anthesis can be either pendent or upright (Hodges et al., 2002). All hummingbird-pollinated species of *Aquilegia* have pendent flowers, which is common in other hummingbird-pollinated species as well (Cronk and Ojeda, 2008). All 5 inferred shifts from hummingbird to hawkmoth pollination entail a transition from fully pendent flowers to upright flowers. This shift is adaptive,

because experimental manipulation of upright *Aquilegia pubescens* flowers to the pendent orientation reduced hawkmoth visitation by an order of magnitude (Fulton and Hodges, 1999). One bee-pollinated species, *Aquilegia jonesii*, has upright flowers; however, the entire plant is only 2–10 cm tall and the flowers are held just above the foliage (Munz, 1946). Given these constraints, upright flowers offer the best access to the spurs and pollen by bee pollinators.

Perhaps one of the most visually striking features of the North American adaptive radiation of *Aquilegia* is the diversity of floral color, resulting from multiple, independent shifts (Figs. 2.1 and 2.2). Using the same *Aquilegia* phylogeny as for pollinator transitions, Whittall et al. (2006b) reconstructed the ancestral states for the presence (blue or red) or absence (yellow or white) of floral anthocyanins and inferred a significant trend of 7 independent losses and no gains (Fig. 2.2). These shifts in color appear to be largely adaptive because all 5 inferred shifts to hawkmoth pollination are coincident with loss of anthocyanin production (Whittall et al.,

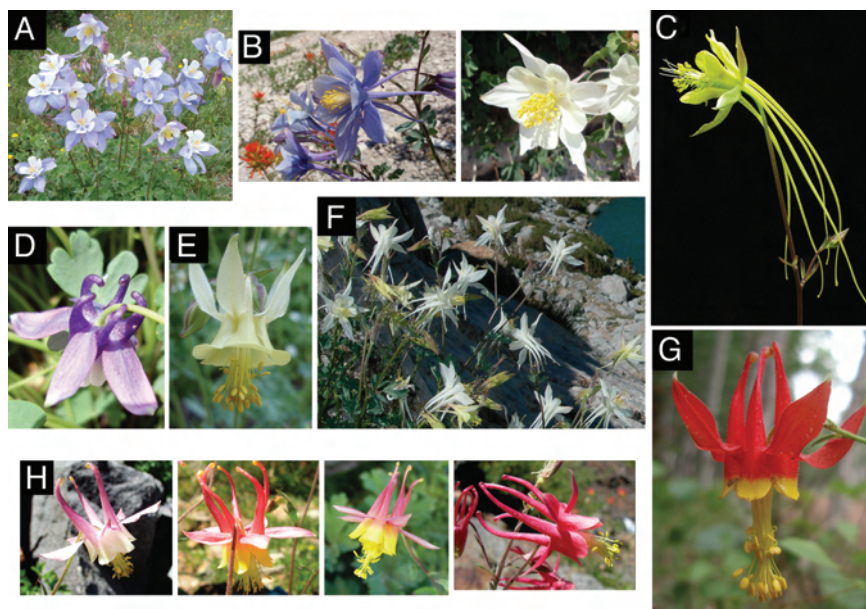

FIGURE 2.1 Photographs of *Aquilegia* flowers. (A) *A. coerulea* (blue/white). (B) *A. scopulorum*, which can be polymorphic for blue (Left) and white (Right) flowers. (C) *A. longissima* (yellow). (D) *A. saximontana* (purple). (E) *A. flavescens* (yellow). (F) *A. pubescens* (white). (G) *A. formosa* (red/yellow). (H) Natural hybrids between *A. formosa* and *A. pubescens*. Photos by N. Derieg (A, B, D, E, and G) and S. Hodges (C, F, and H).



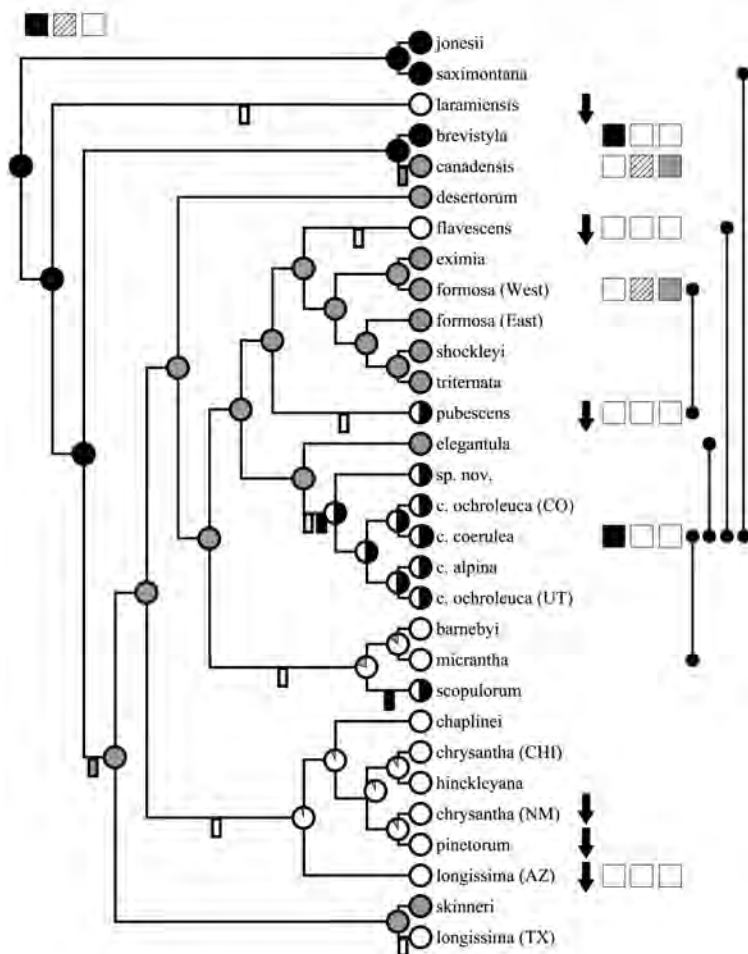

FIGURE 2.2 Phylogeny of the North American species of *Aquilegia* [see Whittall and Hodges (2007)]. Shading at the branch tips indicates flower color: black indicates blue; gray indicates red; and open indicates white or yellow. Taxa may be fixed for a flower color (whole circles at branch tips) or polymorphic (half circles at branch tips). Shading (as above) at nodes indicates the most parsimonious reconstruction of color, with the likelihood of producing anthocyanins indicated by shaded pie diagrams. To the right of taxon names are 3 boxes indicating, from left to right, the absence (open symbols) or production of delphinidins (black filled), cyanidins (hatched), and pelargonidins (gray) based on Taylor (1984). Arrows indicate down-regulation of genes late in the core anthocyanin pathway in flowers of that species compared with the regulation in the anthocyanin-producing species *A. formosa*, *A. canadensis*, and *A. coerulea* (Whittall et al., 2006b). Lines on the right indicate species that form natural hybrids.

2006b), pale flowers set more seed when hawkmoths are present (Miller, 1981), and in manipulative studies hawkmoths preferentially visit pale flowers (Hodges et al., 2002). To consider trends in color shifts when anthocyanin production is maintained, we inferred the color produced at ancestral nodes in the *Aquilegia* phylogeny by using the inferred pollination syndrome as a guide (Whittall and Hodges, 2007). Given that hummingbird-pollinated flowers in general tend to be red (Cronk and Ojeda, 2008) and all but 1 hummingbird-pollinated species of *Aquilegia* have red flowers (*Aquilegia flavescens* has yellow flowers), we inferred ancestral nodes reconstructed as hummingbird-pollinated anthocyanin producers to be red-flowered (Fig. 2.2). Similarly, given that bee-pollinated flowers tend to be blue and all but 1 bee-pollinated species of *Aquilegia* have blue flowers (*Aquilegia laramiensis* has white flowers) we inferred ancestral nodes reconstructed as bee-pollinated anthocyanin producers to be blue-flowered (Fig. 2.2). These reconstructions suggest that there have been 2 shifts from blue to red flowers and 2 shifts from red to blue. Thus, color shifts in *Aquilegia*, where anthocyanin production is maintained, do not exhibit an evolutionary trend.

## FLOWER COLOR AND THE GENETICS OF ADAPTATION

The significant trends in pollinator evolution in *Aquilegia*, together with field experimentation on the functional relevance of specific traits, make variation in spur length, flower orientation, and flower color obvious targets for understanding the genetic basis of adaptive traits and traits affecting reproductive isolation. However, focusing on the genetics of flower color evolution is also advantageous for practical reasons. Since Mendel's first experiments, flower color has been a primary system for dissecting the genetics of a biochemical pathway because the phenotype is readily observable and relatively simple. Many genes in the anthocyanin biosynthetic pathway (ABP) and their regulators have been described, thus facilitating efforts to identify the likely targets of selection. Reds and blues of most flowers result from the accumulation of anthocyanin pigments in the vacuoles of floral tissue cells (Fig. 2.1A, D, and G). When anthocyanins are absent, flowers are yellow or white, largely depending on, respectively, the presence or absence of carotenoid pigments (Fig. 2.1C and E). Anthocyanin biosynthetic genes are a central core to the larger flavonoid biosynthetic pathway and are expressed in multiple tissues other than flowers (Grotewold, 2006). The production of all anthocyanins involves 6 enzymes [in functional order chalcone synthase (CHS), chalcone flavone isomerase (CHI), flavanone-3-hydroxylase (F3H), dihydroflavonol 4-reductase (DFR), anthocyanidin synthase (ANS), and UDP flavonoid glucosyltransferase (UFGT); Fig. 2.3]. There are 3 basic types of anthocya-

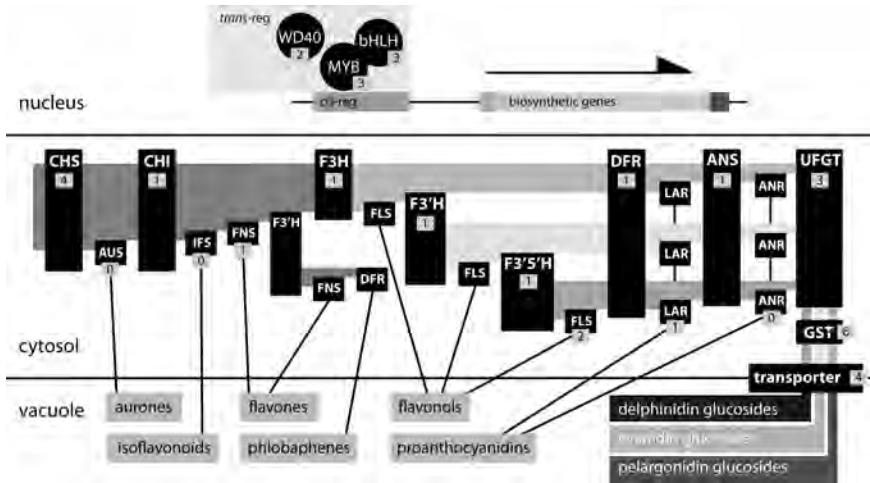

FIGURE 2.3 A generalized flavonoid biosynthetic pathway. In the nucleus, 3 transregulators (a WD40, a bHLH, and a Myb) coordinately affect the expression of multiple genes of the core pathway by binding to their *cis*-regulatory elements. Enzymes are indicated in the cytosol with black boxes, and the number of candidate genes identified in *Aquilegia* is indicated. Biochemical intermediates are indicated with light shading in the cytosol, with the substrate for each enzyme to the left and the product to the right. Specific anthocyanins (indicated by darker shading in the vacuole) are glucosides of pelargonidins, cyanidins, and delphinidins. Lines from enzymes to their products in the vacuole indicate side-branch pathways. Enzymes are: CHS, CHI, UFGT, anthocyanin GST (GST), F3'H, F3'5'H, aurone synthase (AUS), isoflavone synthase (IFS), flavone synthase (FNS), FLS, leucoanthocyanidin reductase (LAR), and ANR.

nins: pelargonidins (orange/red), cyanidins (blue/magenta/red), and delphinidins (blue/purple). The production of pelargonidins requires just the core enzymes, but the production of cyanidins and delphinidins depends on 2 enzymes [flavonoid 3'-hydroxylase (F3'H) and flavonoid 3'5'-hydroxylase (F3'5'H)] that add 1 or 2 hydroxyl groups, respectively, on the  $\beta$ -ring of the product of F3H (Grotewold, 2006; Rausher, 2008). Subsequently, DFR, ANS, and UFGT act to produce anthocyanins, which are then transported into the vacuole where they accumulate and produce visual colors (Fig. 2.3).

Rausher (2008) has described general trends in flower color evolution: shifts are generally blue to red or from producing anthocyanin to not, although exceptions do occur. Considering the biochemical pathway for anthocyanins, Rausher pointed out that these trends likely arise because mutations causing loss of function are more likely than those causing



gain of function. Loss of function of any enzyme in the core ABP would cause a loss of anthocyanin production and loss of function of F3'H or F3'5'H would cause a shift from blue to red. Transitions in the opposite directions would necessitate the gain of enzymatic function. Furthermore, after a loss-of-function transition, additional loss-of-function mutations may accumulate, making reversals even less likely (Zufall and Rausher, 2004). In the case of blue to red shifts, substrate specificity for the product of F3H may evolve, making reversals less likely as well (Zufall and Rausher, 2003).

Changes in flower color could also occur because of altered metabolic flux in side branches of the flavonoid pathway. At each of the intermediate steps in the ABP, side branches lead to the production of other important compounds such as flavones, flavonols, and proanthocyanidins (tannins) (Fig. 2.3). In fact, the entire flavonoid pathway is likely to be more complicated than that depicted in Fig. 2.3. For instance, in *Arabidopsis* recent profiling of both flavonoid production and gene expression in flavonoid mutants resulted in the identification of 15 new compounds and the functional characterization of 2 new genes in the pathway (Yonekura-Sakakibara et al., 2008). Changes in the abundance or activity of side-branch enzymes could result in flux away from or toward anthocyanin production and affect changes in flower color. For instance, deep-pink flowers of *Nicotiana glauca* can be converted to white by overexpressing a side-branch enzyme [anthocyanidin reductase (ANR)] (Xie et al., 2003). Similarly, conversion of white flowers to those producing anthocyanins has been achieved in *Petunia* by silencing the side-branch enzyme flavonol synthase (FLS) and activating DFR (Davies et al., 2003). Given that the side-branch pathways result in compounds that are important for a number of other plant functions such as UV protection and herbivore resistance (Winkel-Shirley, 2002; Treutter, 2006), selection for these compounds could result in pleiotropic changes in flower color (Strauss and Whittall, 2006). However, changes in flower color caused by altered biosynthetic flux requires increases in expression levels or enzyme activity and are thus gain-of-function mutations, which, although certainly possible, are likely rarer than loss-of-function mutations (Orr, 2005).

A few studies have begun to determine the genetic basis of natural flower color variation. In *Petunia axillaris*, white flowers can be made pink by the introduction, either through introgression or transgenetics, of a functional copy of *AN2*, the R2R3-myb transcription factor that controls expression of genes late in the core ABP (Fig. 2.3). Sequence analysis of *AN2* alleles from a range of collections indicated 5 independent loss-of-function mutations, suggesting that loss of color arose multiple times (Hoballah et al., 2007). However, most of these alleles also displayed strong down-regulation and thus it is possible that the loss-of-function

alleles arose subsequent to the down-regulation of *AN2* expression. In *Mimulus aurantiacus*, segregation analysis of an  $F_2$  population for both color and sequence variants of the core ABP genes, along with analysis of their expression and functional capabilities, indicated that a locus acting *in trans* accounts for 45% of color variation (Streisfeld and Rausher, 2009). These 2 studies provide the strongest evidence that changes in trans-regulators are responsible for shifts involving changes in the production of anthocyanins as a whole. Shifts from blue to red flowers have been studied in *Ipomoea* (Zufall and Rausher, 2004). Two mutations, 1 causing a loss of F3'H expression and 1 causing a change in the specificity of DFR for the substrate produced by F3H rather than that produced by F3'H, are sufficient for this color transition. However, which of these mutations occurred first and thus produced the initial color shift is unclear. In these examples, the primary focus has been on the core ABP genes and their regulators. We know of no study that also has considered how changes in flux from side branches of the core ABP may have affected anthocyanin production in natural systems.

### AQUILEGIA AS A MODEL FOR STUDYING FLORAL COLOR EVOLUTION

*Aquilegia* has been used for nearly 50 years to study the evolution and genetics of flower color. Prazmo (1961, 1965) made extensive crossing studies among purple-, white-, red-, and yellow-flowered species of *Aquilegia* and followed segregation ratios in  $F_2$ ,  $F_3$ , and backcross populations. She found that flower color variation could largely be ascribed to 4 independently assorting factors (Prazmo, 1965): Y, which regulates the existence of yellow chromoplasts; C and R, which are needed for the formation of anthocyanins; and F, which modifies red anthocyanins into bluish-violet pigments. In crosses between either *Aquilegia chrysantha* or *Aquilegia longissima* (both of which lack floral anthocyanins) and species with floral anthocyanins, Prazmo (1961, 1965) found that a single gene (R) could account for anthocyanin production. Whittall et al. (2006b) found that multiple genes late in the core anthocyanin pathway, especially DFR and ANS, were down-regulated in *A. chrysantha*, *A. longissima*, and *Aquilegia pinetorum*, which together form a clade of taxa lacking floral anthocyanins (Fig. 2.2). These results suggest that Prazmo's factor R is a transregulator of genes late in the ABP. In crosses with the white form of *Aquilegia flabellata*, Prazmo also found that a second gene (C) could account for anthocyanin production. Whittall et al. (2006b) found that only CHS was down-regulated in white *A. flabellata*. Thus, Prazmo's factor C is likely a mutation in either a transregulator or the *cis*-regulatory region of CHS. Significantly,  $F_1$  progeny from crosses between white *A. flabellata* and

yellow *A. longissima* or *A. chrysantha* produce anthocyanins, confirming independent mutations blocking anthocyanin production (Prazmo, 1965; Taylor, 1984). Finally, Prazmo's factor F is a mutation that most likely affects either the expression or the function of F3'5'H (Fig. 2.3), because blue/purple-flowered species of *Aquilegia* primarily produce delphinidins [Fig. 2.2; Taylor (1984)].

Biochemical analyses of anthocyanins found in *Aquilegia* species have also been conducted (Taylor and Campbell, 1969; Taylor, 1984; Whittall et al., 2006b). These studies suggest that losses of floral anthocyanins are likely caused by changes in expression patterns of the core enzymatic genes of the ABP or changes causing substrate flux away from anthocyanin production. In an extensive analysis of flavonoids and other phenolic compounds, Taylor and Campbell (1969) found that species that lack floral anthocyanins (*A. pubescens*, *A. longissima*, *A. flavescens*) all produce anthocyanins in other tissues. Thus, genes in the ABP must be functional and, if expressed, would result in flowers with anthocyanins. Similarly, Whittall et al. (2006b) found that both flavones and flavonols are produced in the flowers of species that lack anthocyanins, confirming that the genes expressed early in the ABP are functional.

In an analysis of floral anthocyanins, Taylor (1984) found that species with blue/purple flowers produced either just delphinidins or a combination of delphinidins and cyanidins, whereas red-flowered species produced both cyanidins and pelargonidins. From North America, he included 2 red-flowered species (*Aquilegia formosa* and *Aquilegia canadensis*) and 2 blue-flowered species (*Aquilegia brevistyla* and *Aquilegia coerulea*). According to our reconstruction of ancestral flower colors (Fig. 2.2), these species represent the descendants of 1 shift from blue to red (*A. canadensis* from the common ancestor with *A. brevistyla*) and 1 shift from red to blue (the *A. coerulea* clade from the common ancestor with the *A. formosa* clade). The first case likely resulted from loss of function or down-regulation of F3'5'H and a concomitant increase in flux down the cyanidin and pelargonidin portions of the ABP. This finding suggests that DFR in the ancestor of *A. canadensis* was a substrate generalist, unlike some taxa (e.g., *Nicotiana*) where DFR is specialized for the products of F3'H and F3'5'H and cannot act on the product of F3H to produce red pelargonidins (Nakatsuka et al., 2007). The second case appears to be an example of a reversal, with the recovery of F3'5'H activity and delphinidin production. Interestingly, F3'5'H is likely expressed and functional in rare individuals of *A. pubescens* with blue-lavender flowers (Chase and Raven, 1975), suggesting that a functional copy of this gene has been maintained in this species as well.

## IDENTIFYING CANDIDATE GENES FOR THE FLAVONOID PATHWAY IN *AQUILEGIA*

As we have illustrated, a variety of genes could be involved with evolutionary shifts in flower color in *Aquilegia*. Flower color could be affected by the enzymatic function/activity of genes in either the core or side branches of the flavonoid biochemical pathway or by mutations affecting gene expression either through *cis* or *trans* regulation. Multiple copies of genes could also be involved. Although some researchers have predicted that changes are more likely to occur at transregulators (Clegg and Durbin, 2000; Whittall et al., 2006a), because this would allow the structural genes to be used in other tissues, no study to date has considered the expression and function of the entire flavonoid pathway (Fig. 2.3). To initiate such a study, we sought to identify candidate genes for the flavonoid pathway in *Aquilegia*. Using genes of known function (primarily from *Arabidopsis*) we conducted tblastn searches of the *Aquilegia* gene index (<http://compbio.dfci.harvard.edu/tgi/cgi-bin/tgi/gimain.pl?gudb=aquilegia>). This database is derived from EST sequencing from a broad range of tissues and developmental stages of greenhouse hybrids between *A. formosa* and *A. pubescens*, including floral tissue producing anthocyanins. The current gene index contains 13,556 tentative consensus (TC) sequences and 7,278 singleton ESTs and, thus, likely represents a large fraction of the expressed genes in *Aquilegia*. From these initial searches, we used the strongest *Aquilegia* hits in tblastx searches of The *Arabidopsis* Information Resource and National Center for Biotechnology Information, and those that resulted in best hits to the original characterized gene were retained as potential flavonoid pathway genes.

Several genes in the flavonoid pathway belong to large multigene families, making the criterion of reciprocal best hit for identifying homologous genes suspect. However, phylogenetic analysis of a number of these multigene families has identified clades that contain proteins with common function (Gebhardt et al., 2005; Bogs et al., 2006; Nakatsuka et al., 2008b). Thus, after we identified candidates for these genes through tblastx searches, we then included their inferred protein sequences in ClustalW alignments of genes from these studies and conducted neighbor-joining analysis. We then assigned genes to functional groups based on their phylogenetic clustering. For instance, F3H, FLS, and ANS all belong to a large gene family of 2-oxoglutarate-dependent dioxygenases (2-ODDs). However, across multiple species, genes with the same enzymatic function form monophyletic clades in phylogenetic analyses of 2-ODDs (Gebhardt et al., 2005) (Fig. 2.4A). Inclusion of *Aquilegia* sequences in the alignment of 2-ODDs resulted in a tree with 1 *Aquilegia* sequence in each of the F3H and ANS clades and 2 sequences in the FLS clade (Fig. 2.4A). We used a similar approach to identify F3'H and F3'5'H homologs using the

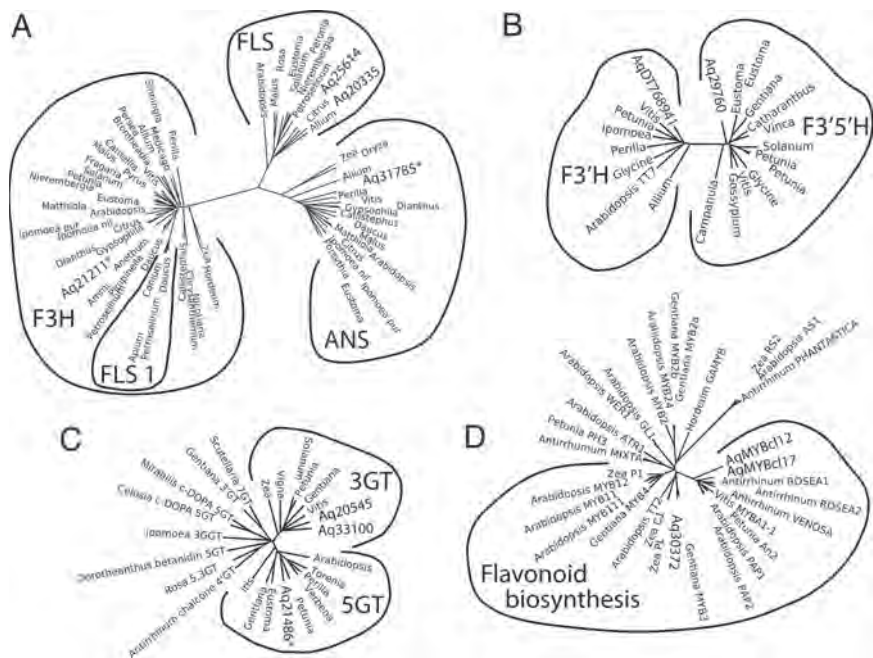

FIGURE 2.4 Gene trees of loci with known function and candidate loci for similar function from *Aquilegia*. (A) Flavonoid 2-ODDs, including F3H, FLS 1, FLS, and ANS. (B) Flavonoid hydroxylases (F3'H and F3'5'H). (C) Glycosyltransferases (3GT, 5GT, and various others). (D) Myb transcription factors (Mybs affecting the regulation of genes in the flavonoid pathway). Within each tree, the outer lines indicate groups of genes that carry out the same enzymatic function. *Aquilegia* sequences are indicated by Aq followed by the TC number from the *Aquilegia* Gene Index or AqMYBcl12 and AqMYBcl17.

sequences from Bogs et al. (2006) and those from Nakatsuka et al. (2008b) to identify homologs of UF3GT and UF5GT (Fig. 2.4B and C). Support for the identification of UF3GT and UF5GT homologs in *Aquilegia* but not one for UF7GT is the fact that Taylor (1984) found only 3- and 5-glucosides and 3,5-diglucoside classes of anthocyanins in *Aquilegia*.

Using the *Aquilegia* gene index we identified candidates for nearly all major genes in the flavonoid pathway (Table 2.1 and Fig. 2.4A–C). However, 1 key gene, the R2R3-myb transcription factor that controls the expression of multiple genes in the ABP in other systems (Hoballah et al., 2007), appeared to be absent from the gene index. When we searched the index with AN2, the myb transcription factor that controls anthocyanin production in *Petunia* flowers (Hoballah et al., 2007), the best hit, TC30372,

TABLE 2.1 Candidate Genes from *Aquilegia* for the Flavonoid Pathway and Its Regulation

Gene	Characterized Gene	<i>Aquilegia</i> Candidate
CHS	AT5G13930	TC22565
		TC32786
		TC22820
		TC26722, DR947012
CHI	AT3G55120	TC22751
F3H	AT3G51240	TC21211
F3'H	AT5G07990	DT768941
F3'5'H		TC29760
DFR	AT5G42800	TC21880, TC30546
ANS	AT4G22880	TC31785
UF3GT	AT1G05530	TC21486
UF5GT	AT5G17050	TC20545
		TC33100
R2R3-MYB	EF423868	TC30372
		AqMYB12
		AqMYB17
bHLH	AT5G41315	TC30032
	AB232775	DR940663
WD40	AT5G24520	TC21922, DT757614, DR953251
	AT1G12910	TC20110
FNS	AB193314	TC26594, TC29308
FLS	AT5G08640	TC20335
		TC25614
LAR	DQ129686	TC32378
ANR	AT1G61720	
GST	AT5G17220	TC22760
		TC24814
		TC29438
		DR949706
		TC25908
		TC26513
		TC27360
Transporters	AT2G34660	TC23071
	AY609318	TC33309
	AT3G59030	TC30722
	AY348872	

NOTES: The accession numbers are given (from The Arabidopsis Information Resource and the National Center for Biotechnology Information) of characterized genes used to search the *Aquilegia* Gene Index. Functional characterizations, other than for Arabidopsis genes, can be found in Mathews et al. (2003); Goodman et al. (2004); Nakatsuka et al. (2005), and Morita et al. (2006). When >1 *Aquilegia* sequence is noted, they differ because of the presence/absence of large sequence blocks, suggesting they represent either alternative splice variants or incompletely processed RNA.



did not result in a reciprocal best hit to any known myb transcription factor controlling flower color. Given that changes in expression are likely causes of many of the shifts in flower color in *Aquilegia*, identifying the transregulators of the pathway is particularly important. Using RT-PCR and 3' and 5' RACE we identified 2 novel myb sequences, AqMyb12 and AqMyb17 (GenBank accession nos. FJ908090 and FJ908091) expressed in sepals of *A. formosa*. After alignment with the inferred amino acid sequences of other myb proteins (Nakatsuka et al., 2008a) we found that AqMyb12 and AqMyb17 clustered with other known regulators of floral anthocyanins (e.g., *Antirrhinum* ROSEA1, ROSEA2, and VENOSA and *Petunia* AN2; Fig. 2.4D) suggesting that these 2 genes are strong candidates as key regulators of the ABP in *Aquilegia*.

Our analysis revealed 27 candidates for enzymatic genes in the flavonoid pathway and 7 candidates for transcription factors regulating the core anthocyanin pathway. Interestingly, 4 genes of the core ABP (CHI, F3H, DFR, and ANS) appear to exist as single copies. Loss of enzymatic function of any of these genes would cause the loss of anthocyanin production. However, if these genes are truly single copy then such mutations would also eliminate the products of the side-branch pathways dependent on each enzyme and these losses would occur in all tissues (Fig. 2.3). These potentially detrimental pleiotropic effects likely favor mutations that only change the expression of these genes in floral tissues. In fact, down-regulation of DFR and ANS has been correlated with loss of anthocyanin production in most white/yellow-flowered species of *Aquilegia*, suggesting that mutations in a common transregulator are responsible for these color shifts (Whittall et al., 2006b). Loss of expression of these 2 enzymes would enable the continued production of most other products of the flavonoid pathway such as flavones and flavonols in floral tissue and may be particularly favored (Whittall et al., 2006b). We also found single copies of F3'H and F3'5'H and thus changes in expression patterns of these genes is most likely responsible for shifts between blue and red flowers. As described above, loss of enzymatic function in these genes in red-flowered species would make future transitions to blue flowers especially unlikely. Because red to blue transitions have apparently occurred in *Aquilegia* (Fig. 2.2) we would predict that F3'H and F3'5'H have likely retained enzymatic function but lost expression in red-flowered *Aquilegia* species.

## MOLECULAR DISSECTION OF FLOWER COLOR VARIATION IN *AQUILEGIA*

In addition to identified candidates for nearly all major genes in the flavonoid pathway, 2 features of *Aquilegia* make it a particularly powerful system for identifying the molecular basis of flower color evolution. First

is the ability to cross virtually any 2 species (Prazmo, 1965; Taylor, 1967). Segregating populations allows for quantitative trait loci (QTL) analysis and the subsequent ability to identify whether genes in the ABP cosegregate with QTL. In an initial analysis of flower color in *A. formosa* and *A. pubescens* a single QTL was identified (Hodges et al., 2002) and it should now be possible to determine which, if any, of the genes in the flavonoid pathway cosegregate with flower color. The ability to cross species also allows introgression and the creation of near-isogenic lines as described above. Second is the high degree of sequence similarity among species of *Aquilegia* (Whittall et al., 2006a), which makes molecular resources developed in 1 species very likely to be transferable to others. For example, a reverse genetic approach, virus-induced gene silencing (VIGS), was developed in *A. vulgaris*, a European species, but using sequence information of ANS from North American species (*A. formosa* and *A. pubescens*) (Gould and Kramer, 2007). Silencing the ANS gene in *A. vulgaris* converted the normally deep-purple flowers to white (Gould and Kramer, 2007), confirming that a single copy of ANS is expressed in floral tissue. Furthermore, the VIGS technique itself is applicable across species of *Aquilegia* (Gould and Kramer, 2007).

Natural populations of *Aquilegia* that vary in flower color also will offer distinct advantages for uncovering the genetic basis of flower color. The production of controlled crosses in the laboratory can be labor intensive and does not necessarily break up genes linked even at relatively great physical distances. Thus, a single QTL may harbor many genes that could potentially affect the trait of interest. For instance, we have identified 34 genes that may play a role in the core ABP and its side-branch pathways (Table 2.1), thus implicating an average of nearly 5 such genes per chromosome (there are 7 pairs of chromosomes in *Aquilegia*). Of course, there may be even more genes involved in the flavonoid pathway as the *Aquilegia* gene index likely does not contain all paralogs of the ABP genes and additional side-branch enzymes are possible (Yonekura-Sakakibara et al., 2008). Thus, it is likely that any 1 QTL region may harbor multiple genes in the ABP. However, natural populations polymorphic for flower color are likely to have had long histories of recombination and low linkage disequilibria. In such populations, it should be possible to follow sequence variation at all of the genes in the ABP and identify specific genes that correlate with (and actually influence) flower color.

*Aquilegia* offers many examples of pronounced variation in flower color. For example, populations of *A. coerulea* (Miller, 1978, 1981) and *Aquilegia scopulorum* are often polymorphic for this trait (Fig. 2.1B). In addition, many natural hybrids exist between several *Aquilegia* species. Hybrid populations of *A. formosa* (red; Fig. 2.1G) and *A. pubescens* (primarily white; Fig. 2.1F) have been studied for many years and produce a broad range of



floral phenotypes (Fig. 2.1H). In addition, we have identified numerous hybrid populations between taxa with different flower colors (Fig. 2.2). All such populations offer research opportunities to increase the precision of genotype/phenotype correlations, and perhaps even allow definitive verification of specific genes underlying color variation in *Aquilegia*.

## THE FUTURE OF GENETIC ANALYSIS OF ADAPTATIONS

Despite identification of the likely players in flavonoid pathway function and evolution in *Aquilegia* (Table 2.1), following the expression and sequence variation in all of these genes in natural or laboratory populations is daunting. With advances in DNA sequencing, such analyses may nonetheless soon become possible in *Aquilegia* and other natural systems. First, genome sequencing provides a scaffold for mapping variation and identifying the candidate genes that underlie QTL. The *Aquilegia* genome is currently in production for 8× sequencing (at the Joint Genome Institute), and as sequencing costs decline, similar genomic resources should become available for many additional natural systems. Second, next-generation sequencing techniques open the prospects for sequencing whole transcriptomes from population samples (Kahvejian et al., 2008; Shendure and Ji, 2008). As we have shown here, even without a whole-genome sequence, characterization of ESTs can provide the necessary scaffolds for analyzing the short reads these technologies produce. Thus, if such population-level analysis becomes a reality, then it will be possible to quickly obtain both expression and sequence data for genes underlying flower color (Gilad et al., 2008) in a large number of populations.

Genomic resources will also greatly aid in our ability to dissect traits about which we currently understand little in terms of underlying biochemistry and genetics. Although traits such as petal spur length and flower orientation have strong effects on pollinator visitation and resulting pollen transfer (Hodges et al., 2004), our knowledge of how these traits are genetically influenced and biochemically expressed is meager. Genes affecting cell size or cell number may cause spur-length differences between species. Variation in flower orientation among species is the result of heterochrony as all flowers of *Aquilegia* go through a similar pattern of orientation during development (Hodges et al., 2002). Early developmental stages of buds are upright; they then become pendent and ultimately become upright again. Differences between species arise because of differences when anthesis occurs in this sequence (Hodges et al., 2002). Little is known about the types of genes that may affect such floral differences and thus the genetic dissection of these traits is more challenging. However, as noted above, the existence of hybrid zones between species that differ in these traits offers the possibility that genomic techniques, such as

association mapping, will allow the identification of the genes underlying traits such as these.

## CONCLUSIONS

Adaptive radiations continue to offer a rich resource for understanding the process of evolution. As we have outlined here, they are ideal for identifying general evolutionary trends and often consist of the repeated evolution of the same traits, allowing tests of whether evolution follows predictable trajectories. As we move forward in an era when genomic resources will be increasingly available, adaptive radiations offer additional advantages. Because recent rapid radiations have resulted in closely related taxa with distinct adaptive features, the genomes are likely to be remarkably similar overall, thus leaving relatively clear signals of which genes are likely involved with speciation and adaptation [e.g., Turner et al. (2005)]. Furthermore, the development of genomic tools for 1 species will likely be transferable to other taxa in an adaptive radiation (Abzhanov et al., 2008). Exploration of phenotypes in the field and their genetic basis provides a powerful approach for describing evolutionary processes that have shaped biodiversity. For the reasons outlined above, adaptive radiations maximize our ability to detect patterns and test both long-standing and emerging hypotheses about the nature of adaptive evolutionary change.

## ACKNOWLEDGMENTS

We thank John Avise and Francisco Ayala for the opportunity to discuss our work at the Sackler Colloquium and John Avise, Dolph Schluter, and an anonymous referee for providing comments that greatly improved the manuscript. This work was supported by National Science Foundation Grant EF-0412727.



# 3

## Genetics and Ecological Speciation

---

DOLPH SCHLUTER and GINA L. CONTE

Species originate frequently by natural selection. A general mechanism by which this occurs is ecological speciation, defined as the evolution of reproductive isolation between populations as a result of ecologically based divergent natural selection. The alternative mechanism is mutation-order speciation in which populations fix different mutations as they adapt to similar selection pressures. Although numerous cases now indicate the importance of ecological speciation in nature, very little is known about the genetics of the process. Here, we summarize the genetics of premating and postzygotic isolation and the role of standing genetic variation in ecological speciation. We discuss the role of selection from standing genetic variation in threespine stickleback (*Gasterosteus aculeatus*), a complex of species whose ancestral marine form repeatedly colonized and adapted to freshwater environments. We propose that ecological speciation has occurred multiple times in parallel in this group via a “transporter” process in which selection in freshwater environments repeatedly acts on standing genetic variation that is maintained in marine populations by export of freshwater-adapted alleles from elsewhere in the range. Selection from standing genetic variation is likely to play a large role in ecological speciation, which may partly account for its rapidity.

---

Biodiversity Research Centre and Department of Zoology, University of British Columbia, Vancouver, BC, Canada V6T 1Z4.

One of Darwin's greatest ideas was that new species originate by natural selection (Darwin, 1859). It has taken evolutionary biologists almost until now to realize that he was probably correct. Darwin looked at species mainly as sets of individuals closely resembling each other (Darwin, 1859), in which case adaptive divergence in phenotype eventually leads to speciation almost by definition. Later, Dobzhansky (1937) and Mayr (1942) defined species and speciation by the criterion of reproductive isolation instead. Recent evidence indicates that reproductive isolation also evolves frequently by natural selection (Schluter, 2000, 2009; Coyne and Orr, 2004; Price, 2008).

Speciation by natural selection occurs by 2 general mechanisms (Price, 2008; Schluter, 2009). The first of these is ecological speciation, defined as the evolution of reproductive isolation between populations, or subsets of a single population, as a result of ecologically based divergent natural selection (Schluter, 2000, 2001; Rundle and Nosil, 2005; Funk, 2009). Under this process natural selection acts in contrasting directions between environments, which drives the fixation of different alleles, each advantageous in one environment but not in the other (Fig. 3.1). In contrast,

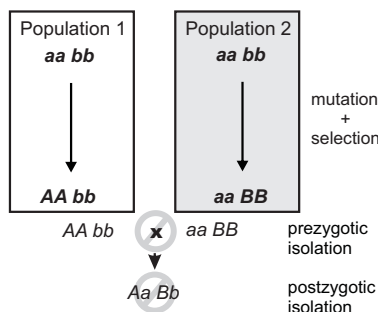

FIGURE 3.1 A simple genetic model for speciation by natural selection, after Dobzhansky (1937). Two initially identical populations accumulate genetic differences by mutation and selection. In population 1, mutation  $A$  arises and spreads to fixation, replacing  $a$ , whereas mutation  $B$  replaces  $b$  in population 2. Selection is divergent under ecological speciation, favoring allele  $A$  over  $a$  in one environment and  $B$  over  $b$  in the other (emphasized by shading). Under the alternative mutation-order process, selection is uniform and favors  $A$  and  $B$  in both environments, with divergence then occurring by chance. If  $A$  and  $B$  are "incompatible" then populations in contact will produce fewer hybrids than expected (prezygotic isolation) or hybrids will be less fit (postzygotic isolation). The process is identical if instead both genetic changes occur sequentially in one population and the other retains the ancestral state. For example, the final genotypes shown could occur instead if the ancestral genotype is  $AA\ bb$ , and  $a$  replaces  $A$ , and then  $B$  replaces  $b$  in population 2.

under mutation-order speciation (Mani and Clarke, 1990; Schluter, 2009), populations diverge as they accumulate a different series of mutations under similar selection pressures (Fig. 3.1). Natural selection drives alleles to fixation in both speciation mechanisms, but selection favors divergence only under ecological speciation. Divergence occurs by chance under the mutation-order process.

There is growing evidence in support of both ecological and mutation-order speciation in nature (Price, 2008; Schluter, 2009), yet numerous aspects of these mechanisms remain obscure. One of the most glaring deficiencies is the almost complete absence of information on the genetics of ecological speciation. Here, we review several aspects of the problem. We address characteristics of genes underlying premating isolation; the evolution and genetics of postzygotic isolation; and the role of standing genetic variation as a source of alleles for the evolution of reproductive isolation. Although data are not plentiful, it is possible to reach some conclusions about how the genetic process of ecological speciation should work and how it might differ from that mutation-order speciation. We end with a summary of evidence for ecological speciation in a threespine stickleback system and address the possible role of standing genetic variation in their adaptation to freshwater environments. We present a hypothesis for the repetitive origin of freshwater stickleback species involving natural selection of standing genetic variation.

## GENETICS OF PREMATING ISOLATION

Premating isolation is the reduced probability of mating between individuals from different populations as a result of behavioral, ecological, or other phenotypic differences. In ecological speciation, premating isolation is of 2 general types. The first is selection against migrants or “immigrant inviability” between locally adapted populations (Via et al., 2000; Nosil et al., 2005). Interbreeding is reduced when spatial proximity of individuals is required for mating, and when the survival, growth, or reproductive success of immigrant individuals is diminished because their phenotype is less well adapted than the resident population to local conditions. This form of premating isolation is unique to ecological speciation, although it is not always present (e.g., when populations or gametes move between environments during mating). Immigrant inviability can account for a high fraction of total reproductive isolation (Nosil et al., 2005; Lowry et al., 2008).

Because it arises from direct selection on the phenotypes of individuals, the genetics of immigrant inviability is identical to the genetics of local adaptation. Any locus under divergent natural selection between parental environments contributes to immigrant inviability and therefore

may contribute to speciation. The contribution to reproductive isolation increases directly with the strength of selection on genes (Rice and Hostert, 1993; Nosil et al., 2009). For example, Hawthorne and Via (2001) discovered several quantitative trait loci (QTL) responsible for host-specific performance of specialized aphid populations. Each type survives poorly on the other's host plant. Because aphids must survive in their chosen habitat to mate there, these QTL indirectly influence who mates with whom (Via et al., 2000). Color pattern differences under divergent selection between spatially separated species of *Heliconius* butterflies map to a QTL identified as *wingless* (Kronforst et al., 2006). The hybrid sunflower *Helianthus paradoxus* inhabits salt marshes in which both its parent species have reduced viability. Reduced viability of the parental species in this habitat mapped to a QTL identified as the salt tolerance gene *CDPK3* (Lexer et al., 2004). Great progress is now being made in identifying genes responsible for local adaptation in natural populations (Abzhanov et al., 2008). The contribution of such genes to the evolution of reproductive isolation, however, should not be assumed until the magnitudes of effects are quantified in nature.

Assortative mating is the other component of premating reproductive isolation important to ecological speciation. The genetic mechanisms that permit its evolution and/or persistence have received considerable attention, particularly when there is gene flow between populations. Felsenstein (1981) pointed out that in the absence of very strong reproductive isolation between hybridizing populations, recombination between genes governing assortative mating and genes under divergent natural selection will cause existing levels of assortative mating between populations to decay and inhibit the evolution of even stronger assortative mating. Numerous ways around this dilemma have been proposed (Gavrilets, 2004), including low recombination between the genes for assortative mating and those under divergent selection, close proximity between genes for assortative mating and genes under divergent selection, and pleiotropic effects of the genes under divergent selection on assortative mating. Finally, the dilemma is overcome by the evolution of a "1-allele" mechanism for premating isolation in which individuals choose mates according to their values of a trait under divergent selection (e.g., "mate with someone the same size as oneself") (Felsenstein, 1981).

Genetic mechanisms for premating isolation that overcome the antagonism between selection and recombination have been confirmed in nature. For example, genes for assortative mating between host-specialized aphid populations map to the same regions of the genome as those determining performance on the alternative host plants (Hawthorne and Via, 2001). Adaptive differences in wing color patterns between *Heliconius* butterfly species are also cues in assortative mating, and both trait and assorta-

tive mating map to the same candidate gene, *wingless* (Kronforst et al., 2006). Finally, the *YUP* locus and other QTL affecting flower color and shape differences between the monkeyflowers *Mimulus cardinalis* and *Mimulus lewisii* have pleiotropic effects on assortative mating through their attractiveness to alternative pollinators (Schemske and Bradshaw, 1999; Bradshaw and Schemske, 2003).

## DIVERGENT SELECTION AND POSTZYGOTIC ISOLATION

The genetics of postzygotic isolation in ecological speciation has received little attention. Ecological speciation uniquely predicts the evolution of ecologically based postzygotic isolation (also called “extrinsic,” or “environment-dependent” reproductive isolation). As populations in different environments evolve toward different adaptive peaks, intermediate forms, including hybrids, increasingly fall between the peaks and suffer reduced fitness in both parental environments (Hatfield and Schluter, 1999; Rundle and Whitlock, 2001; Schluter, 2001). Such ecologically dependent hybrid fitness has been detected in a few study systems, including pea aphids (Via et al., 2000) and threespine stickleback (Rundle, 2002). The fitness of hybrids between divergently adapted populations may also be affected by heterosis (hybrid vigor), especially in the  $F_1$  hybrids (Barton, 2001), and this has not been controlled in most field estimates of ecologically based postzygotic isolation. However, if heterosis is strong the impact of ecologically based postzygotic isolation is diminished (Lowry et al., 2008).

Most of the populations and species that have been studied from an ecological perspective are young and appear to manifest little “intrinsic” (environment-independent) postzygotic isolation. Exceptions include mine populations of *Mimulus guttatus*, which possess an unidentified copper tolerance gene or gene complex that is favored by ecological selection but that interacts with 1 or more other loci to cause the death of  $F_1$  hybrids in crosses to nonmine populations (MacNair and Christie, 1983). Another exception involves sympatric dwarf and normal forms of lake whitefish (*Coregonus clupeaformis*), which show elevated mortality of embryos (Rogers and Bernatchez, 2006). In a laboratory experiment, Dettman et al. (2007) recorded intrinsic postzygotic isolation affecting growth rate and frequency of meiosis in hybrids between yeast populations that had evolved for 500 generations in 2 distinct environments. Without more evidence on the mechanism of selection we are unable to determine which, if any, of the genes recently discovered to underlie intrinsic postzygotic isolation in *Drosophila*, yeast, and mice (Coyne and Orr, 2004; Brideau et al., 2006; Lee et al., 2008; Mihola et al., 2009; Tang and Presgraves, 2009) fixed as a result of ecologically based divergent natural selection.



Barton (2001) used the Fisher-Orr geometric model of adaptation (Orr, 1998) to demonstrate that both intrinsic and extrinsic postzygotic isolation should evolve as a by-product of adaptation to contrasting environments. To illustrate, he assumed that divergent selection acted on just a single trait between populations (Fig. 3.2), whereas multiple additional traits were under stabilizing selection, favoring the same mean in both environments. Mutations were assumed to be pleiotropic, which means that while they change the population mean for the trait under directional selection in each environment, they have the side-effect of changing the mean in other traits, too. As each population attains its local adaptive peak by a sequence of mutational steps, advantageous mutations fixing later compensate for deleterious side-effects of advantageous mutations that fixed earlier (Fig. 3.2). These compensatory mechanisms fail in hybrids containing a sample of mutations from each of the parent populations, resulting in a phenotype that deviates from the optimum in the secondary traits (Barton, 2001). Thus, as populations adapt to different environments, the fitness of hybrids between them evolves below that predicted from the hybrid's phenotype for the trait under divergent selection, the amount depending on genetic details such as

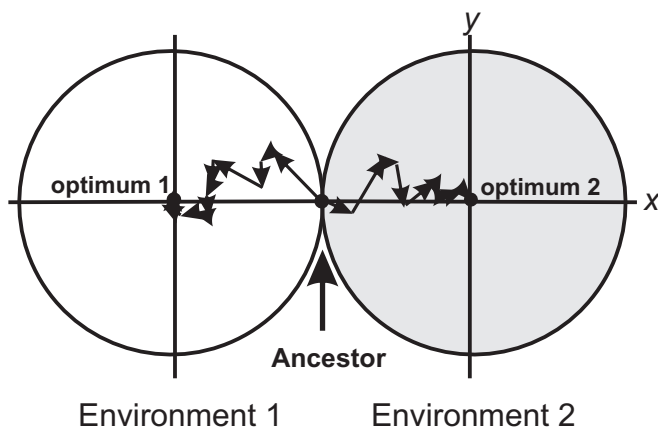

FIGURE 3.2 A model for the buildup of postzygotic isolation between 2 populations descended from a common ancestor adapting to distinct ecological environments, after Barton (2001). The perimeter of each circle represents a contour of equal fitness; fitness in each environment is higher inside the circle than outside. Trait  $x$  is under divergent natural selection, represented by separate adaptive peaks. Other traits, here represented by a single dimension  $y$ , are under stabilizing selection in both environments, as indicated by identical optima along this axis. A population adapts by fixing new advantageous mutations that bring the mean of trait  $x$  toward the optimum. An example of a sequence of adaptive steps is shown for each population by the linked arrow segments.

dominance relationships at individual loci. This extra component of postzygotic isolation is intrinsic in that it is manifested in both environments, and it represents a Dobzhansky-Muller incompatibility (Coyne and Orr, 2004) because it results from an interaction within hybrids of genes that are favored in the genetic background of the parent populations. Barton (2001) pointed out that the model might not be able to account for cases of very strong hybrid incompatibility, such as the lethality of gene combinations in hybrids between mine and nonmine populations of *M. guttatus*.

Surprisingly, Barton (2001) also found that intrinsic postzygotic isolation evolves just as readily between populations experiencing parallel selection as between populations under divergent selection. This finding conflicts with empirical studies that typically find faster evolution of reproductive isolation, including intrinsic postzygotic isolation (Dettman et al., 2007), between populations adapting to different environments than between populations adapting to similar environments (Rice and Hostert, 1993; Schluter, 2000, 2001). Broad comparative studies have found that intrinsic postzygotic isolation is highest between species that are ecologically differentiated (Bolnick et al., 2006; Funk et al., 2006). This discrepancy may be accounted for by features of nature not incorporated in the model. For example, Barton's model assumes that adaptation occurred entirely from new mutations of which an infinite variety is available. Yet, the number of advantageous mutations for a given trait may be restricted, with the result that the same mutations occur and fix repeatedly under parallel selection (Palmer and Feldman, 2009; Unckless and Orr, 2009), preventing divergence. The same is expected if populations adapt from the same standing genetic variation (Colosimo et al., 2005; Barrett and Schluter, 2008) and if there is gene flow between separate populations evolving under parallel selection (Morjan and Rieseberg, 2004). Finally, divergent selection may be more effective than parallel selection simply because it acts on more traits and on more genes (Nosil et al., 2009). These factors help to explain why ecological speciation may generally be faster than mutation-order speciation even though selection is driving alleles to fixation under both mechanisms.

### ECOLOGICAL SPECIATION FROM STANDING GENETIC VARIATION

Speciation occurs from standing genetic variation when reproductive isolation between 2 or more populations evolves from alleles already present within the common ancestral population, rather than from new mutations. Theory to describe the buildup of Dobzhansky-Muller incompatibilities often explicitly assumes that speciation occurs from new mutations [e.g., Barton (2001) and Gavrilets (2003)] rather than from standing

variation. In contrast, quantitative genetic models of speciation assume that response to selection, at least in the early stages of divergence, is based on standing genetic variation (Dieckmann and Doebeli, 1999; Burger and Schneider, 2006). There is little direct evidence for either assumption (Noor and Coyne, 2006). The topic is interesting because speciation from standing variation is potentially more rapid than that from new mutations, because the waiting time for new mutations is skipped and alleles present as standing variation begin at higher frequency (Hermisson and Pennings, 2005; Barrett and Schluter, 2008). Standing genetic variation can result in the same alleles being used repeatedly in separate speciation events, enhancing the probability of parallel evolution of reproductive isolation.

The apple maggot, a recently evolved race of the haw fly, *Rhagoletis pomonella*, provides a possible example of standing genetic variation contributing to speciation. The haw fly exploits haw fruits, but in the 1880s it expanded its host range to domestic apple. Haw and apple differ in their peak fruiting times, and accordingly the 2 races have diverged in pupal diapause traits (affecting overwinter dormancy) that also affect their timing of emergence as adults. This seasonal difference contributes to strong (although still incomplete) reproductive isolation. Significantly, racial differences in pupal diapause traits map to genomic regions that are polymorphic for chromosomal inversions. Each inverted version of a specific chromosomal region is at higher frequency in the apple race than in the ancestral haw race (Feder et al., 2003b). Remarkably, phylogenies based on gene sequences within the inverted regions reveal that the inversions themselves are old and that they occur as standing variation within *R. pomonella* across its geographic range. The frequency of the inversions declines from the southern to northeastern United States (Feder et al., 2003a). The pattern suggests that formation and divergence of the apple race involved selection of preexisting genetic variation for pupal diapause traits located on inversions, although the presence of these traits in southern populations needs to be confirmed.

A second possible example occurs in the Lake Victoria cichlids, *Pundamilia pundamilia* and *Pundamilia neyereri*, which have different alleles at the long-wave sensitive opsin gene. These alleles affect sensitivity to wavelengths of ambient light at the different depths in the lake where the 2 species reside (Seehausen et al., 2008), and they may also influence the color (red vs. blue) of males chosen by breeding females, contributing to assortative mating. However, whereas the red and blue *Pundamilia* are sister species, each being the other's closest relative, the 2 long-wave-sensitive alleles are not sister lineages on the phylogenetic tree of opsin gene sequences (Seehausen et al., 2008). Rather, the 2 opsin alleles share a common ancestral opsin sequence at a time well before the divergence of the 2 *Pundamilia* species, perhaps even before the appearance of Lake Victoria itself. This implies that speciation in *Pundamilia* used preexisting genetic variation.

In the next section we evaluate the possibility of speciation from standing genetic variation in threespine stickleback, a model system for which considerable evidence of ecological speciation has accumulated.

### ECOLOGICAL SPECIATION FROM STANDING VARIATION IN STICKLEBACK

We focus on progress in understanding ecological speciation between adjacent marine and stream-resident threespine stickleback populations. The marine species or ecotype is the ancestral form to all freshwater populations. Most marine populations are anadromous, migrating to streams to breed and returning to sea afterward. While breeding in streams they may encounter stream-resident stickleback populations that are highly divergent in morphology and behavior (Fig. 3.3A) but that are descended within the past 10,000 years or so from the same marine form. In many streams the 2 forms show little introgression and exhibit premating isolation when measured in the laboratory (McKinnon et al., 2004).

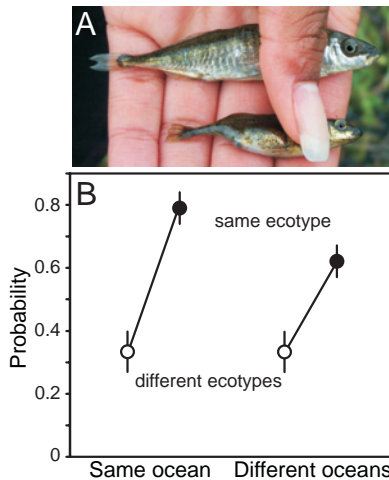

FIGURE 3.3 Parallel speciation between marine and stream-resident stickleback. (A) Photo showing typical specimens from the marine (*Upper*) and stream-resident populations (*Lower*). The forms differ in defensive body armor and body size (both greater in the marine form), along with many other morphological traits. (Photo by J. McKinnon.) (B) Mating compatibility between males and females taken from different marine and stream stickleback populations around the Northern Hemisphere. Compatibility is measured by the proportion of mating trials reaching the penultimate stage of the courtship sequence. Fish were sampled from multiple populations in both the Atlantic and Pacific ocean basins.

SOURCE: Reproduced with permission from McKinnon et al. (2004) (Copyright 2004, Nature Publishing Group).

The stream stickleback populations exhibit rampant parallel evolution of morphological traits. Virtually everywhere it occurs, the stream ecotype is smaller in size, less streamlined in shape, and has reduced armor compared with the marine species. Size and other differences between stickleback populations have been shown in laboratory common-garden studies to be substantially heritable (McKinnon et al., 2004). Phylogenies based on microsatellite markers (McKinnon et al., 2004) and nuclear gene SNPs (Fig. 3.4A) suggest that the stream ecotype has originated multiple times independently in coastal bodies of water around the Northern Hemisphere. The ancestral marine form has persisted over this same period in similar but geographically widespread marine habitats. The parallel evolution of stream forms, and the maintenance of the large anadromous phenotype in often distant but similar marine habitats, suggests that morphological differences between the freshwater and anadromous forms represent adaptations to contrasting environmental selection regimes (McKinnon et al., 2004).

The alternative explanation for these phylogenetic data (Fig. 3.4A) is that each freshwater population was formed by individuals immigrating directly from other freshwater populations nearby, via the sea, and that subsequent gene flow between adjacent marine and stream populations erased the signature of freshwater-to-freshwater colonization at neutral marker loci. However, this alternative hypothesis is difficult to reconcile with years of observational studies that find freshwater-adapted alleles in the sea (see below) but no freshwater individuals. Direct movement of fish between closely adjacent streams emptying into the sea might be feasible, but migration of freshwater individuals between streams in separate ocean basins and across other long distances is very unlikely.

The strongest evidence for ecological speciation in this group comes from a test of “parallel speciation” demonstrating repeated evolution of reproductive isolation between populations across a similar environmental gradient (McKinnon et al., 2004). When brought to the laboratory, individuals from different populations were more likely to mate with one another if they were the same ecotype and came from the same type of

FIGURE 3.4 Phylogenies of populations and genes. (A) Global phylogeny of marine and freshwater populations of threespine stickleback based on SNP markers at a sample of 25 nuclear genes. High-armor, marine populations are in black, low-armor freshwater populations are in gray. (B) Global phylogeny of *Eda* gene sequences from marine high-armor and freshwater low-armor stickleback populations. The *Eda* sequence in *Gasterosteus wheatlandi* was used as the outgroup. (C) Phylogeny of *Kitlg* sequences from 4 freshwater and 1 marine population in the Pacific basin. Branch lengths are not scaled to a comparable age between plots. SOURCE: A and B are reproduced with permission from Colosimo et al. (2005) (Copyright 2005, American Association for the Advancement of Science). C is reproduced with permission from Miller et al. (2007) (Copyright 2007, Elsevier).

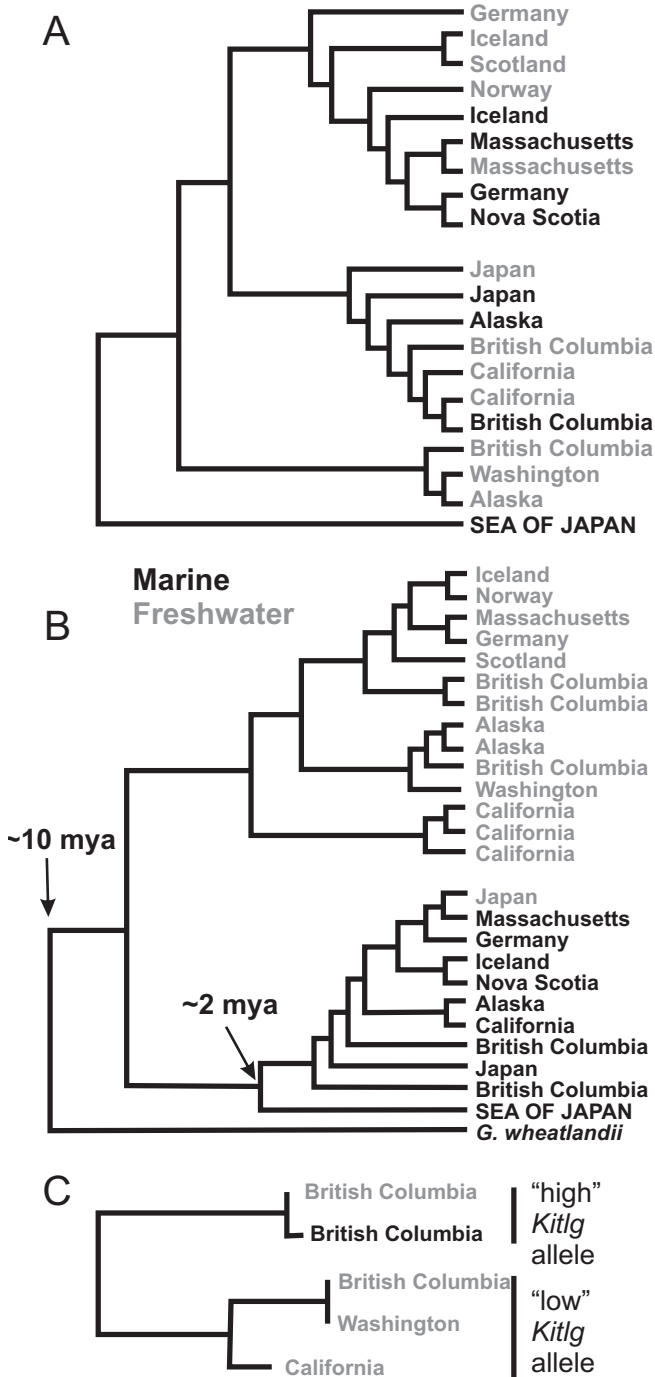

environment (e.g., both were from streams, or both were from the sea) than if they were from different environments (i.e., one was marine and the other was from a stream) (Fig. 3.3B). This was true even in those mating trials involving fish sampled from separate ocean basins (Fig. 3.3B). Such a consistent pattern of phenotypic divergence implies that divergent natural selection is driving the evolution of reproductive isolation between marine and stream populations.

Body size appears to be an important trait influencing mating compatibility (McKinnon et al., 2004). Fish from different populations were more likely to mate with one another if they were similar in body size than if they were different in size. In addition, altering body size of females experimentally (by food and density manipulation) changed between-population mate preferences in the predicted direction: reducing female size increased mating probability with the small stream males, whereas increasing female size increased mating probability with large marine males. These findings imply that the differences in body size between marine and stream populations are partly responsible for assortative mating. Size differences between stickleback populations are partly heritable when fish are grown in a laboratory common garden (McKinnon et al., 2004). In the “common garden” of the wild, adult body size difference between marine and stream fish breeding in the same stream are also likely to be enhanced by the divergent habitat choices of young fish (i.e., to remain in the stream or migrate to sea), a decision presumably also under genetic control. In contrast, body size variation generated by phenotypic plasticity within populations likely weakens reproductive isolation between marine and stream populations.

The genes underlying assortative mating between marine and stream populations have not yet been located and identified. However, studies linking assortative mating to body size differences suggest that a large part of premating isolation between marine and stream populations will be determined by genes underlying ordinary phenotypic traits. Possibly, strong selection maintaining phenotypic differences between adjacent marine and stream populations negatively impacts the fitness of hybrids, which would also contribute to postzygotic isolation. These considerations justify looking to genes causing phenotypic differences between marine and freshwater populations as a first step toward understanding the genetics of reproductive isolation in this group.

Studies of genes underlying phenotype traits implicate selection from standing genetic variation in marine-freshwater divergence events. An example is *Ectodysplasin* (*Eda*), a gene that accounts for most of the transition from a marine phenotype having a large number of bony plates down each side of the body to the armor-reduced forms found almost everywhere in freshwater (Colosimo et al., 2005). One of the most remarkable discoveries about this gene is that the low-armor *Eda* allele found in



almost every freshwater population around the Northern Hemisphere belongs to the same clade of low-armor alleles (Fig. 3.4B). The origin of this clade predates the ages of all known freshwater populations, in most cases by orders of magnitude, suggesting that the original low-armor mutation occurred long ago. This fact implies that low-armor alleles were brought into lakes and streams by the marine species when it colonized those waters at the end of the last ice age  $\approx 10,000$  years ago. Sampling has confirmed that the partly recessive, low-armor allele is present as standing variation in the marine population (Colosimo et al., 2005; Barrett et al., 2008). Approximately 1% of marine adult fish are heterozygous at the *Eda* locus, containing 1 low- and 1 high-armor allele, which represents ample standing variation for selection to act on in freshwater.

It is likely that other traits in freshwater stickleback populations are the result of selection of standing genetic variation brought from the sea. We now have a second example of this in *Kitlg*, a gene responsible for lighter skin pigmentation in a subset of freshwater stickleback populations (Miller et al., 2007). Not as many populations have been surveyed as in the case of *Eda*, but the low-pigmentation alleles present in 3 freshwater populations in British Columbia, Washington state, and California form a monophyletic clade (Fig. 3.4C). This finding again implies that the allele was present in the marine population at the time of freshwater colonization and has been repeatedly selected in widespread freshwater populations.

Given these findings for *Eda* and *Kitlg*, it would not be far-fetched to suppose that the same process of repeated selection from standing genetic variation has occurred at many loci. Selection from standing variation provides a ready explanation for rapid parallel evolution in so many phenotypic traits that characterizes this group, including those affecting reproductive isolation. However, the question remains as to where the standing variation in the sea comes from and how it is maintained. Below, we develop the hypothesis that standing variation in the ancestral marine population was and continues to be maintained by recurrent gene flow from existing freshwater populations. Gene flow from freshwater populations provides a better explanation for the maintenance of low-armor alleles than mutation-selection-drift balance in the sea because recurrent mutation would generate many novel freshwater alleles at each locus, whereas very few origins of the freshwater *Eda* and *Kitlg* alleles are indicated (Fig. 3.4B and C).

Our “transporter”<sup>\*</sup> hypothesis is founded on what we know already about *Eda* and *Kitlg* and adds what we suspect regarding the source of standing variation in the marine population. In the first step of the trans-

---

<sup>\*</sup>The hypothesis was inspired by the analogous transporter process of the science fiction serial *Star Trek*. In that setting, the bodies of individual humans placed in the transporter would disintegrate and then be reassembled at a future time and a distant location.



porter process (Fig. 3.5), alleles from a stream-adapted population are exported to the sea by a hybridization event between individuals from the marine and stream populations. Multiple generations of recombination cause the disintegration of the freshwater-adapted genotype, such that each member of the marine population carries 0, 1, or only a small number of freshwater-adapted alleles. In the third step, a new stream is formed elsewhere, such as at the front of a receding glacier, and is colonized by the marine species, which brings standing genetic variation from the sea. In the last step, selection with recombination increases the frequency of freshwater-adapted alleles in the new location, gradually reassembling the freshwater-adapted genotype at a new site (Fig. 3.5). This transporter process is a special case of the broad view that hybridization is a creative force in evolution and diversification (Arnold, 1992; Rieseberg, 1997; Seehausen, 2004). In our model, gene flow facilitates multitrait parallel evolution and speciation on a large geographic scale. The hypothesis does not address where or when an advantageous mutation arose, but proposes that once a mutation reaches appreciable frequency in a freshwater population it could participate in the transporter process.

A key assumption of this transporter hypothesis is that existing freshwater populations are the source of standing genetic variation in the marine ancestral population. Existing data allow a preliminary test. The most likely sources of alleles present as standing variation in a given marine population are nearby freshwater populations, because the freshwater-adapted alleles are presumably selected against in the sea, which will shorten the distance that an allele copy can disperse before it is eliminated by selection. It follows that the source of freshwater-adapted alleles brought by the marine species when it colonized a new stream is most likely to have been close by. To test this idea we examined the similarity of the DNA sequences of low alleles at the *Eda* locus between nearby freshwater populations compared with that between more distant freshwater populations (Fig. 3.6). We confined our attention to freshwater populations in the Pacific basin, because there is currently no dispersal route for stickleback between the Atlantic and Pacific oceans. Fig. 3.6 displays the

FIGURE 3.5 The 4 stages of the transporter process: (1) Hybridization between the marine and derived freshwater population exports freshwater alleles to the sea. (2) Recombination in the marine population breaks apart the freshwater combination of alleles. Each allele is now present as rare standing variation in the sea. (3) Colonization of a new freshwater environment by marine fish brings along standing variation. (4) Selection with recombination in the new freshwater population drives the freshwater-adapted alleles to high frequency and reassembles the freshwater genotype. In each panel the vertical line separates the ocean from terrestrial environments containing streams that drain into the sea.

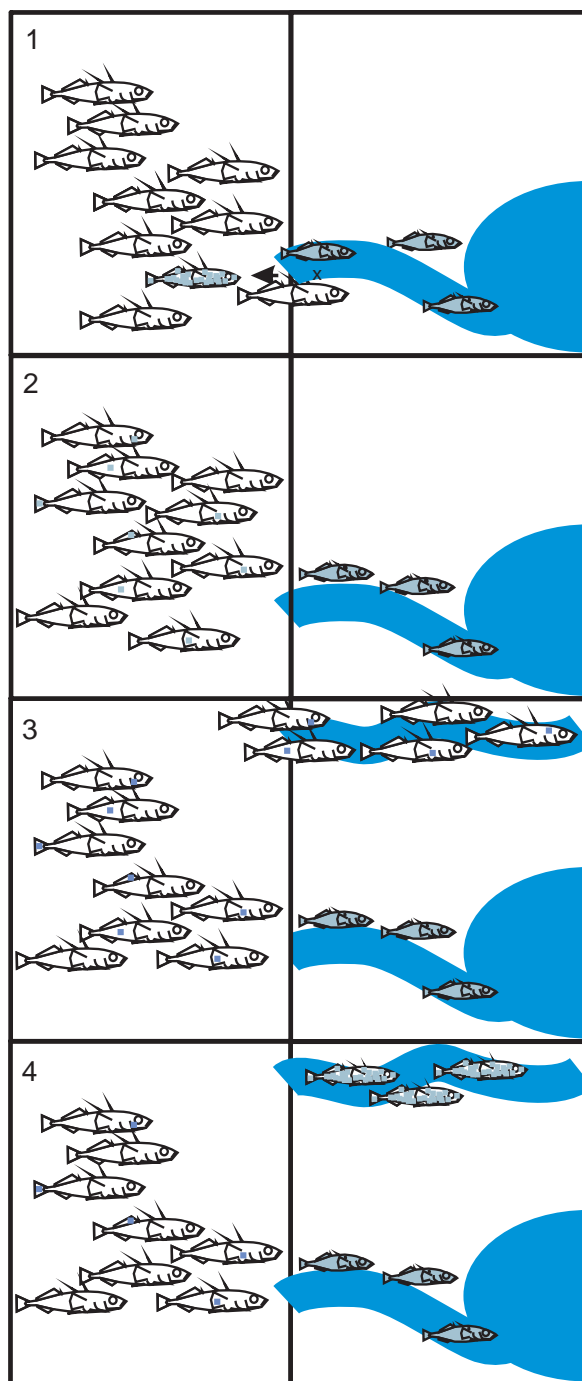

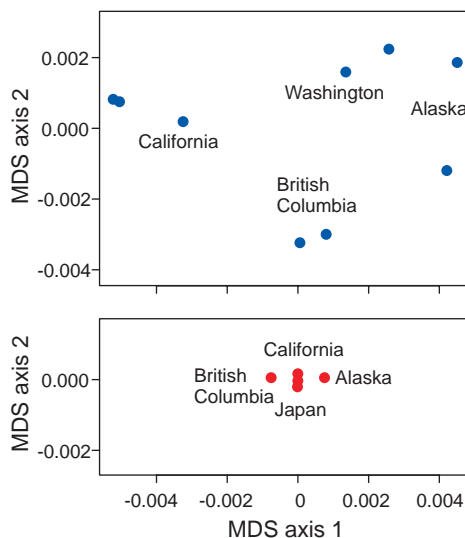

FIGURE 3.6 Multidimensional scaling (MDS) of low-armor *Eda* sequences from different freshwater populations (*Upper*) and of high-armor *Eda* sequences from marine populations (*Lower*), all within the Pacific basin. Axes are scaled so that magnitudes are comparable in both plots and along both axes.

SOURCE: Data are from Colosimo et al. (2005).

results of a multidimensional scaling analysis (R Development Core Team, 2008) based on pairwise percentage sequence similarity between populations in 1,328 bp of the *Eda* gene (Colosimo et al., 2005). Points next to one another indicate populations that have similar *Eda* sequences, whereas points far apart indicate populations with more different *Eda* sequences. The findings reveal that indeed nearby freshwater populations have similar low-armor alleles at the *Eda* locus. This result is confirmed by a high Mantel correlation between percentage sequence divergence and geographic distance ( $z = 0.97, P = 0.002$ ). This similarity cannot be explained as the result of direct gene flow between the populations because they have always been isolated from one another by the sea. Instead, we attribute the similarity of *Eda* alleles between nearby populations to the transport of low alleles from one population to the other by a process that included an intermediate stage during which alleles exported from freshwater were present as standing variation in the marine population. Such a transport process may continue today in moving allele copies between freshwater populations that still hybridize with marine populations.

The strong biogeographic pattern seen in freshwater-adapted low-armor *Eda* alleles contrasts strikingly with the absence of geographic structure in the high-armor *Eda* alleles found in contemporary marine popula-

tions (Fig. 3.6). Absence of geographic structure in high-armor *Eda* alleles is associated with a low overall level of sequence heterogeneity, suggesting that the marine populations of the Pacific are well mixed compared with freshwater populations (Fig. 3.6). Such mixing would also be expected to eliminate any geographic pattern in the sequences of low *Eda* alleles present as standing variation in the sea. The presence of geographic structure in freshwater implies that standing variation for low-armor alleles in the sea was also structured biogeographically at the time of colonization. The most likely cause of such structure in an otherwise well-mixed sea would have been continuous replenishment from nearby freshwater sources as proposed in the transporter hypothesis.

This transporter hypothesis helps to explain the parallel evolution of premating reproductive isolation in widely distant freshwater populations (McKinnon et al., 2004). Further tests are warranted aimed at distinguishing this hypothesis from the alternative hypothesis that speciation is the result of new mutations that occurred in freshwater populations after colonization (or in the sea immediately before colonization). Both hypotheses make the same prediction regarding expected phylogenetic histories of neutral markers, namely that the alleles present in freshwater populations should be descended from alleles present in nearby marine populations (e.g., Fig. 3.4A). If selected genes arose by new mutation after (or immediately before) freshwater colonization, then they should show a similar history to that of neutral markers. However, under the transporter process, genes underlying reproductive isolation in freshwater populations were positively selected from standing variation maintained in the sea, in which case the genes should be most closely related to gene copies found in other freshwater populations nearby. Further tests await the discovery of genes underlying reproductive isolation.

## CONCLUSIONS

Ecological speciation differs conspicuously from the mutation-order speciation by the pattern of selection on genes. Under ecological speciation, alleles at diverging loci are favored in the environment of one population but not that of the other. In contrast, under the mutation-order process the same alleles are favored in both populations, at least initially; yet by chance each allele arises and fixes in just one of them. An immediate consequence is that ecologically based prezygotic and postzygotic isolation should evolve only under ecological speciation. In contrast, the buildup of intrinsic postzygotic isolation by incompatible side-effects of selected loci can occur under either mechanism (Barton, 2001). Under the right conditions both mechanisms would leave a signature of positive selection at the molecular level, and it is difficult to think of an easy way

to discriminate ecological from mutation-order speciation solely from examination of features of the underlying genes.

Evidence from laboratory experiments and field studies suggests that reproductive isolation accumulates more rapidly between populations adapting to different environments (ecological speciation) than between populations adapting to similar environments (potentially, mutation-order speciation). This difference might have a genetic explanation. There is a higher probability that the same or equivalent mutations will fix under parallel selection than under divergent selection, which will slow the rate of divergence between populations experiencing similar selection pressures. Alternatively, divergent selection may simply act on more genes.

Other genetic processes during ecological speciation become apparent when there is gene flow between populations, either continuously during their divergence or after secondary contact. With significant gene flow, premating isolation is unlikely to arise or persist unless the genes underlying it somehow overcome the antagonism between selection and recombination, such as by pleiotropy or by reduced recombination with genes under divergent natural selection. No such genetic features are predicted for premating isolation under either ecological or mutation-order speciation in the absence of gene flow.

Finally, for similar reasons the role of standing genetic variation in speciation is likely to be greater under ecological speciation than under mutation-order speciation. Selection from standing variation will increase the chances that separate populations experiencing similar selection pressures will fix the same rather than different alleles, inhibiting divergence. The repetitive origin of species under the transporter process proposed herein seems possible only under ecological speciation. The reason is that while a derived population with a distinct set of strongly interacting alleles built under a mutation-order process and conferring significant reproductive isolation can persist after secondary contact in the face of some gene flow with an ancestral population (Barton, 2001), the export of individual alleles will be resisted by these same interactions. Individual alleles that succeed in spreading to the ancestral population may be favored there, in which case differentiation at the locus will be eliminated.

#### ACKNOWLEDGMENTS

We thank J. Avise and F. Ayala for their kind invitation; J. Avise, R. Barrett, P. Nosil, S. Via, and another reviewer for helpful comments on the manuscript; and P. Colosimo (Stanford University) and D. Kingsley (Stanford University) for the *Eda* sequences. Research in D.S.'s laboratory is supported by the Natural Sciences and Engineering Research Council (Canada) and the Canada Foundation for Innovation.

## 4

# Cascades of Convergent Evolution: The Corresponding Evolutionary Histories of Euglenozoans and Dinoflagellates

---

JULIUS LUKEŠ,\* BRIAN S. LEANDER,<sup>†</sup> and  
PATRICK J. KEELING<sup>†</sup>

The majority of eukaryotic diversity is hidden in protists, yet our current knowledge of processes and structures in the eukaryotic cell is almost exclusively derived from multicellular organisms. The increasing sensitivity of molecular methods and growing interest in microeukaryotes has only recently demonstrated that many features so far considered to be universal for eukaryotes actually exist in strikingly different versions. In other words, during their long evolutionary histories, protists have solved general biological problems in many more ways than previously appreciated. Interestingly, some groups have broken more rules than others, and the Euglenozoa and the Alveolata stand out in this respect. A review of the numerous odd features in these 2 groups allows us to draw attention to the high level of convergent evolution in protists, which perhaps reflects the limits that certain features can be altered. Moreover, the appearance of one deviation in an ancestor can constrain the set of possible downstream deviations in its descendents, so features that might be independent functionally can still be evolutionarily linked. What functional advantage

---

\*Biology Centre, Institute of Parasitology, Czech Academy of Sciences, and Faculty of Sciences, University of South Bohemia, 37005 České Budějovice, Czech Republic; and <sup>†</sup>Canadian Institute for Advanced Research, Program in Integrated Microbial Biodiversity, Departments of Botany and Zoology, University of British Columbia, Vancouver, Canada V6T 1Z4.

may be conferred by the excessive complexity of euglenozoan and alveolate gene expression, organellar genome structure, and RNA editing and processing has been thoroughly debated, but we suggest these are more likely the products of constructive neutral evolution, and as such do not necessarily confer any selective advantage at all.

**T**he vast majority of eukaryotes on the planet, in terms of both abundance and diversity, are microbial. Generalities about fundamental biological processes are based on knowledge of a few model organisms, yet many microeukaryotes have deviated well beyond these generalities over the course of evolutionary history, which is a reflection of the deep phylogenetic distances between eukaryotic lineages that are neither plants nor animals nor fungi. It is also clear that some groups of protists have broken more rules than others, and 2 diverse lineages that particularly stand out in this regard are the Euglenozoa and the Alveolata (Fig. 4.1). In members of both of these groups, fundamental structures and processes have substantially deviated from those of other eukaryotes; however, perhaps even more interestingly, both groups have frequently departed in the same general fashion, resulting in surprising levels of convergence that suggest limits to the ways these features can be altered.

The Euglenozoa is a monophyletic group within the Excavata consisting of single-celled flagellates composed of 2 major subgroups (kinetoplastids and euglenids), and 1 smaller subgroup (diplonemids) (Fig. 4.1). Members of Euglenozoa have diverse modes of nutrition, including predation, parasitism, and photoautotrophy. Predatory euglenozoans are phylogenetically widespread within the group and tend to have diverse feeding apparatuses, feeding strategies, and prey preferences (Leander et al., 2007). For instance, some predatory species are limited to small prey such as bacteria, whereas other species frequently consume larger prey, such as other eukaryotic cells. Photoautotrophy is restricted to a specific subclade of euglenids and originated via secondary endosymbiosis between a predatory euglenid and a green algal prey (Leander et al., 2007). Parasitic and commensalic euglenozoans appear to have evolved independently several times within kinetoplastids (Simpson et al., 2006), and some species (e.g., *Trypanosoma* and *Leishmania*) cause important human illnesses such as African sleeping sickness, Chagas's disease, and leishmaniases.

The Alveolata, another monophyletic group of primarily single-celled eukaryotes that have adopted similarly diverse modes of life, is composed of 3 major subgroups: ciliates, apicomplexans, and dinoflagellates (Fig. 4.1). All 3 subgroups contain predatory and parasitic species, and only dinoflagellates and an unusual lineage called *Chromera* are known



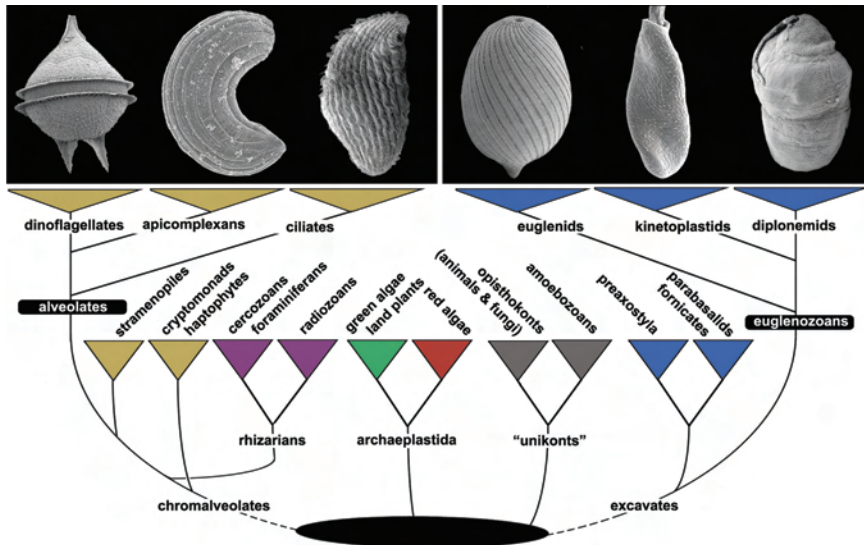

FIGURE 4.1 The tree of eukaryotes showing the relative positions of Alveolata and Euglenozoa. This tree is a reflection of many kinds of evidence that are summarized in Keeling et al. (2005), Hampl et al. (2009), and Keeling (2009). The Alveolata consists of 3 main groups, dinoflagellates, apicomplexans, and ciliates (illustrated in *Upper Left*; scanning electron micrographs of *Protoperidinium*, *Selenidium*, and an unidentified ciliate), whereas the Euglenozoa consists of euglenids, kinetoplastids, and diplomonids (illustrated in *Upper Right*; scanning electron micrographs of *Lepocinclis*, *Leptomonas*, and *Diplonema*). Alveolates are members of the supergroup Chromalveolata, whereas euglenozoans are members of a different supergroup, the Excavata. Neither supergroup is without controversy (e.g., the rhizarian supergroup is shown within chromalveolates to reflect recent phylogenetic analyses), but the relationships of alveolates and euglenozoans to some other eukaryotic groups to the exclusion of one another, and the relationships within alveolates and euglenozoans, are both consistently well supported by molecular analyses.

to contain fully integrated and photosynthetic plastids (Oborník et al., 2009). Photosynthetic dinoflagellates play important roles as planktonic primary producers in oceanic ecosystems, and some of the lineages form symbiotic relationships with corals (e.g., *Symbiodinium*) and are critical for maintaining the health of reef systems around the world. Nonphotosynthetic plastids have independently evolved in some dinoflagellates and in apicomplexans, which are all obligate parasites of animals and a few are exceedingly important disease organisms of vertebrates (e.g., *Cryptosporidium*, *Toxoplasma*, and *Plasmodium*). Although plastids have not been definitively demonstrated in ciliates, several independent lineages



in this group harbor photosynthetic symbionts that are intermittently replenished by feeding.

Both euglenozoans and alveolates have a reputation for “doing things their own way,” which is to say that they have developed seemingly unique ways to build important cellular structures or carry out molecular tasks critical for their survival. Why such hotspots for the evolution of novel solutions to problems should exist in the tree of life is not entirely clear. However, the deeper we look into these groups, the more often it is found that they are also evolving strikingly similar mechanisms for achieving these essential biological functions. Significantly, however, there is a great weight of phylogenetic data that show these lineages are not closely related: of the 5 eukaryotic supergroups hypothesized to explain all eukaryotic diversity, alveolates and euglenozoans fall into 2 different supergroups, chromalveolates and excavates, respectively (Fig. 4.1). The support for these supergroups as a whole remains contentious (Keeling et al., 2005; Leander, 2008; Hampl et al., 2009; Keeling, 2009), but there is strong support from phylogenomics and many individual phylogenies and rare genomic characters for a specific relationship between alveolates and stramenopiles on one hand, and euglenozoans and heteroloboseans on the other hand (Hampl et al., 2009). Moreover, no analysis of eukaryotic phylogeny has ever suggested they are closely related to one another. Still more significantly, the majority of the characteristics we discuss below are not universal to all members of either alveolates or euglenozoans, but rather appear to have evolved within a subgroup of each lineage. Altogether, the distribution of these characteristics can really only adequately be explained by convergent evolution. Below, we will examine some of these examples of convergence and what the cooccurrence of convergent traits may tell us about how they evolved.

## CONVERGENT EVOLUTION

Recognizing the independent origins of similar traits in distantly related lineages—convergent evolution—allows us to better understand how different environmental and intrinsic conditions have shaped the characteristics of organisms over time; each specific example of convergence reflects a fundamental biological problem and its possible solutions. The causes of convergent evolution are varied and can involve camouflage, mimicry, biomechanical optimization, molecular constraints, developmental canalization, and character-state reversals. Examples of convergent evolution range from the biochemical level to the behavioral level and are best characterized within animals and land plants (Conway Morris and Gould, 1998; Zakon, 2002; Emery and Clayton, 2004; Arndt and Reznick, 2008), which collectively represent only a small portion of the full

tree of eukaryotes (Keeling et al., 2005; Leander, 2008). The occurrence and adaptive significance of convergent evolution in microbial eukaryotes, by contrast, is poorly understood, but it is clear from several examples that convergent traits can evolve over vast phylogenetic distances (Leander, 2008). Convergence in very distantly related lineages is particularly compelling because the influence of homologous developmental programs (i.e., intrinsic conditions) in constraining subsequent evolution should be minimal if not absent altogether (Leander, 2008). Therefore, improved understanding of convergent evolution in distantly related microbes will provide a much broader framework for evaluating the forces of natural selection and the potential role of constructive neutrality during the evolution of ultrastructural systems and complex molecular processes.

Eukaryotic cells are built from a few core systems that have become tremendously diverse over the course of evolutionary history. Some systems are remarkably conserved, in particular fundamental molecular processes such as information flow or core metabolism, but even in these systems substantial modifications accumulated in some lineages. In other cases, conserved ancestral building blocks (such as the proteinaceous cytoskeleton involved in locomotion and feeding) are widely shared, but have been used in different ways with diverse outcomes. The origins of other components are less clear and likely more recent, but also show a great deal of morphological variation (examples include photoreception systems or surface armor). Taken together, the diversity of cellular and molecular systems in microbial eukaryotes is simply staggering, and some emerging patterns indicate that convergent evolution played a major role in shaping the overall organization of eukaryotic cells at all levels (Arndt and Reznick, 2008; Leander, 2008).

Below, several features will be described, for which an excessive complexity is a common denominator. This is counterintuitive in single-celled organisms, especially when selective advantages for these complex structures and/or mechanisms remain elusive. We argue that the theory of constructive neutral evolution (Stoltzfus, 1999), which invokes nonselective factors such as excess capacities, can best account for their emergence.

### CELLULAR ORGANIZATION OF EUGLENIDS AND DINOFLAGELLATES

The comparable combinations of ultrastructural features in euglenozoans and alveolates have been appreciated for decades (Taylor, 1987; Bouck and Ngo, 1996). For instance, the cells of benthic predatory species of euglenids and dinoflagellates are streamlined and dorsoventrally flattened and possess batteries of extrusive organelles, or extrusomes, that are similar in morphology and behavior (Fig. 4.2). The mucocysts of euglenids

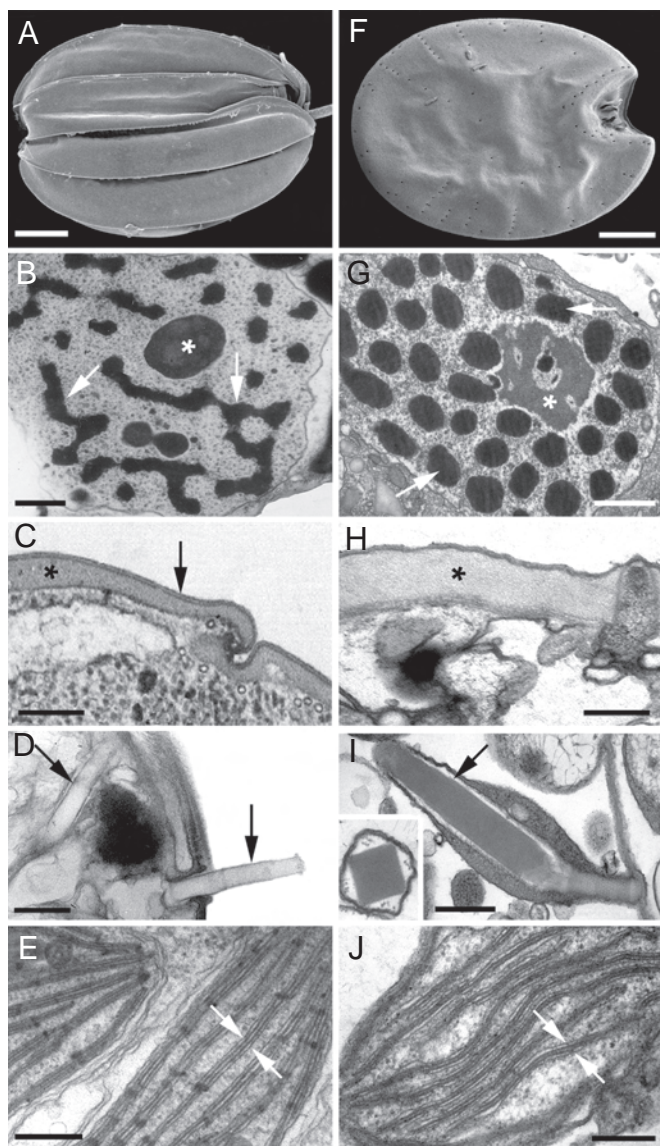

FIGURE 4.2 Electron micrographs showing convergent ultrastructural features in some euglenozoans (A–E) and dinoflagellates (F–J). (A) Scanning electron micrograph (SEM) of a benthic euglenid (*Ploetia*) showing a dorsoventrally compressed cell with broad longitudinally arranged pellicle strips. (B) Transmission electron micrograph (TEM) through the nucleus of a euglenid cell (*Phacus*) showing a large nucleolus (asterisk) and permanently condensed chromosomes (arrows). (C) TEM through the cell surface or pellicle of a euglenid cell showing the proteinaceous strips (asterisk) beneath the plasma membrane (arrow). (D) TEM through the

and the trichocysts of dinoflagellates are compact, linear bodies containing a highly organized latticed framework of carbohydrates. When these bodies are released through discrete pores through the surface of the cell, the extrusomes become hydrated and rapidly extend in length as spear-like threads (Fig. 4.2D and I) (Hausmann, 1978). Although the origin and function of extrusomes in both groups are not clear, they probably play a role in escape responses, defense, and capturing prey cells.

Benthic euglenids and dinoflagellates, in particular, adhere to substrates and are capable of gliding motility using 2 heterodynamic flagella equipped with flagellar hairs (or mastigonemes). In both groups, the recurrent flagellum sits within a groove on the ventral surface of the cell and is oriented backward. Euglenids and dinoflagellates also possess cytoskeletal elements (called “paraxial/paraflagellar rods,” which run in parallel to the 9 + 2 microtubular axonemes within each flagellum) that are not found in any other group of eukaryotes. A major difference between euglenids and dinoflagellates, however, is the structure, orientation, and motility of the anterior flagellum. The anterior paraxial rod in euglenids is oriented on the ventral side of the axoneme, is stiff and held straight in front of the cell; the paraxial rod functions with the flagellar hairs to produce gliding forces (Saito et al., 2003). By contrast, the anterior flagellum of dinoflagellates forms a transverse loop or spiral around the circumference of the cell and usually sits within a transverse groove called the cingulum (Fig. 4.1). The coiled transverse flagellum bears hairs and a flagellar membrane that connects it to the base of the cingulum, and this entire apparatus is capable of producing forces on the surrounding medium that tend to spin the cell around its longitudinal axis.

Many free-living euglenids and dinoflagellates engulf prey organisms using sophisticated feeding apparatuses positioned on the ventral side of the cell. Although the evolution of these apparatuses is a shared fea-

cell surface of a euglenid cell (*Peranema*) showing mucocysts (arrows). (E) TEM through a euglenophyte cell (*Euglena*) showing chloroplasts with thylacoids in stacks of 3 (stack between the arrows). (F) SEM of a benthic dinoflagellate (*Procentrum*) showing a dorsoventrally compressed cell with broad thecal plates. (G) TEM through the nucleus of a dinoflagellate cell (*Apicoporus*) showing a large nucleolus (asterisk) and permanently condensed chromosomes (arrows). (H) TEM through the cell surface of a dinoflagellate cell (*Apicoporus*) showing the proteinaceous “dinoflagellate pellicle” (asterisk) that sits beneath the alveoli and plasma membrane (both missing in this preparation). (I) TEM through the cell surface of a dinoflagellate cell (*Polykrikos*) showing trichocysts (arrows). (Inset) TEM showing a cross section through a trichocyst of *Polykrikos*. (J) TEM through a dinoflagellate cell (*Apicoporus*) showing chloroplasts with thylacoids in stacks of 3 (stack between the arrows). (Scale bars: A and F, 10  $\mu\text{m}$ ; B and G, 1  $\mu\text{m}$ ; C, H, and J, 0.3  $\mu\text{m}$ ; D, E, and I, and 0.5  $\mu\text{m}$ .)

ture, the details of these ultrastructural systems are quite distinctive. For instance, there are a few chief components present in most of the predatory species of euglenids described so far, namely “rods” and “vanes.” Two feeding rods oriented longitudinally within the cell are composed of microtubules and amorphous proteinaceous material. These stiff elements provide structural support for gripping and internalizing prey cells and work in concert with 4–5 membranous vanes that are usually reinforced with additional microtubules (Leander et al., 2007). The vanes originate from the rods, form the inside core of the feeding apparatus, and create space within the apparatus by opening up in a pinwheel-like fashion; the same mechanism can cause the apparatus to protrude from the cell when feeding. By contrast, the diversity and complexity of feeding apparatuses in dinoflagellates probably reflect independent origins in different lineages within the group. The feeding apparatus in dinoflagellates can be simple pockets that unzip when prey is drawn into the cell, dynamic siphons that suck out the cytoplasm of prey cells in a straw-like fashion or expansive veils that completely envelop large filamentous prey and fold it methodically into manageable packets small enough to ingest. Different kinds of feeding apparatuses are often associated with different kinds of photoreceptive eyespots and ocelloids, suggesting that in some dinoflagellates, photoreceptors are adaptations for detecting and capturing photosynthetic prey. Some predatory euglenids with a rod-and-vane feeding apparatus also possess a photoreceptor system, as a putative stigma and photosensory swelling (Leander et al., 2001), and this combination of features may serve the same basic function as in dinoflagellates.

Another convergent similarity between benthic euglenids and dinoflagellates is the tendency to reinforce their cell surfaces with robust proteinaceous layers beneath the plasma membrane (Fig. 4.2C and H). Euglenids possess a distinctive (and synapomorphic) pellicle consisting of discontinuous strips that run longitudinally or helically over the entire cell surface (Leander et al., 2007). The strips articulate along their lateral margins, and in many euglenids these zones facilitate sliding between strips that produce rhythmic deformations in cell shape, called “euglenoid movement.” Benthic dinoflagellates can also change their shape, especially after engulfing large and oddly shaped prey cells. The proteinaceous surface layer in dinoflagellates, called the “dinoflagellate pellicle” forms a continuous and flexible sheath beneath alveolar vesicles, which may in turn be filled with cellulosic material. Both the euglenid and the dinoflagellate pellicles comprise novel classes of proteins: articulins and epiplasmins (Bouck and Ngo, 1996). Although it is unclear whether these proteins represent an example of molecular convergence or distant homology, their presence in both euglenids and dinoflagellates underscores the striking similarities between these 2 very distantly related groups of eukaryotes.



At different points in their evolutionary history, both euglenids and dinoflagellates independently acquired photosynthesis via secondary endosymbiosis. Accordingly, some representatives of both groups contain at least 3 different genomes within 3 different cellular compartments: the nucleus, the plastid, and the mitochondrion. The general organization of the nucleus is a particularly notable feature that is shared by euglenids and dinoflagellates; both groups possess a conspicuous nucleus with a relatively large nucleolus and permanently condensed chromosomes (Fig. 4.2B and G). The plastids in both groups also share the unusual features of 3 envelope membranes and a tendency to have thylacoids in stacks of 3 (Fig. 4.2E and J) (Taylor, 1987). However, the analogous similarities between euglenozoans and dinoflagellates do not end at the ultrastructural level. As described in the next 3 sections, the molecular processes associated with the nucleus, plastid, and mitochondrion also reflect high levels of convergent evolution.

### THE NUCLEUS: SPLICED LEADERS AND POLYCISTRONIC mRNA PROCESSING

The nuclear genomes of kinetoplastids and dinoflagellates have both acquired a long list of unusual characteristics. Some of these are unique to one lineage and very different in the other. For example, dinoflagellates have among the largest nuclear genomes known, and these genomes have a very low gene density and permanently condensed chromosomes that lack nucleosomes (McEwan et al., 2008). Kinetoplastid genomes, however, are relatively small, are gene-dense, and remain uncondensed during the cell cycle (Berriman et al., 2005). Both genomes are notorious for their rich representation of modified nucleotides, but the nucleotides themselves are not the same: the hypermodified base J ( $\beta$ -D-glucopyranosyloxymethyluracil) is common in kinetoplastid telomeric regions, whereas dinoflagellates have a high proportion of 5-hydroxymethyluracil and 5-methylcytosine.

However, other dramatic alterations to these genomes have taken place convergently, and interestingly, several characteristics have been altered in the same way in both lineages, in particular relating to how genes are arranged and transcribed, and how transcripts are processed. The canonical, simplified view of eukaryotic gene expression involves a single gene transcribed, capped, polyadenylated, spliced (if introns are present), and exported to the cytosol. Both kinetoplastids and dinoflagellates deviate from this canonical view in 2 significant ways that impact the way expression may be controlled.

The first of these is *trans*-splicing. The spliceosome is a large multi-subunit complex that normally recognizes GT-AG bounded spliceosomal

introns within eukaryotic genes, and catalyzes their removal and the ligation of the flanking exons. Spliceosomal introns are very rare in trypanosomes (Berriman et al., 2005), and available evidence suggests they are relatively so in dinoflagellates as well (Bachvaroff and Place, 2008). In contrast, every mRNA in both groups has a 5' spliced leader (SL) sequence that is added by *trans*-splicing. The SL, also called a miniexon, is a short conserved sequence that is encoded by a high-copy-number family of genes throughout the genome. In dinoflagellates, the same 22-bp fragment is added to all transcripts, and the sequence is also conserved across the entire group (Zhang et al., 2007; Slamovits and Keeling, 2008). In kinetoplastids, the SLs are conserved within a given genome, but vary in size and sequence between species (Campbell et al., 2003). The SL is expressed as a short RNA consisting of the leader sequence followed by a GT dinucleotide and a short stretch of sequence. Complimenting this, mRNAs for protein-coding genes begin with a short stretch of sequence ending with an AG dinucleotide, followed by the 5' untranslated region and the coding region. The spliceosome brings these 2 elements together and mediates the removal of the 2 intronic fragments and ligation of the SL to the 5' end of the mRNA (Fig. 4.3) (Campbell et al., 2003).

The second major oddity shared by kinetoplastid and dinoflagellate nuclear gene expression is the presence of polycistronic messages. Once again, the canonical view of nuclear gene expression in eukaryotes centers around the transcription of a single gene at a time; this stands in contrast to prokaryotes, where multiple genes can be expressed on a single, multifunctional mRNA and many genes can be coregulated in operons. Complete genomic sequences from trypanosomatids demonstrate an organization where genes are distributed in contiguous clusters, ranging in size from a handful of genes to several hundreds. In these clusters, stretching up to >1 Mb, genes are oriented on the same strand, usually toward the telomeres, with adjacent clusters located on opposite strands (Berriman et al., 2005). All of the genes within a contiguous cluster are transcribed on a single, sometimes very long, polycistronic mRNA. Relatively short AT-rich regions separate the clusters and are considered to contain the sites for transcription initiation and termination. Comparison of trypanosomatid genomes shows a high degree of conservation in gene order, even within clusters between flagellates that diverged 200–500 Mya (Ghedini et al., 2004).

It is important to point out that, in contrast to prokaryotes, these clusters do not contain genes of related function (Berriman et al., 2005) and they are not coordinately regulated like bacterial operons, so they should not be considered operons. These polycistronic messages are not even translated intact, but are processed to monomeric mRNAs before translation; these monomeric mRNAs are the substrate for *trans*-splicing by the

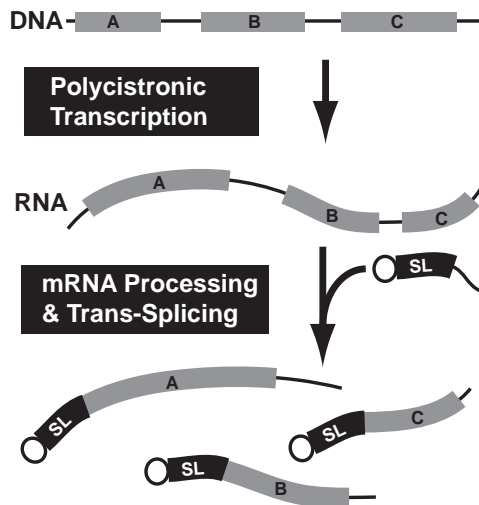

FIGURE 4.3 Convergent nuclear gene expression in kinetoplastids and dinoflagellates. In both kinetoplastids and dinoflagellates, genes (gray) may be arranged in tandem arrays (*Top*) that are expressed on a single polycistronic mRNA (*Middle*). This mRNA is broken into multiple monocistronic mRNAs concomitantly with *trans*-splicing, which adds a short, capped spliced leader sequence (black) to the 5' end of all monocistronic mRNAs. In kinetoplastids, the genes (A–C) are arranged randomly and are functionally unrelated, but, in dinoflagellates, the coding sequences on a single polycistronic mRNA are tandem repeats of 1 gene.

addition, at the 5' end, of an SL already equipped with a methylated cap, followed by the polyadenylation at the 3' end (Campbell et al., 2003).

Far less is known about the organization of dinoflagellate genomes. Due to the enormous size of their nuclear DNA, nearly all sequencing of dinoflagellate genes performed to date has focused on expressed sequence tags, which do not provide information on the context of the gene. Nevertheless, what little is known about dinoflagellate genomes suggests a fascinating parallel with kinetoplastids. It now appears that some genes are isolated in the genome, but others are organized as tandem repeats (Bachvaroff and Place, 2008). These gene repeats are cotranscribed, resulting in polycistronic messages, and different from those of kinetoplastids because mRNAs have so far only been found to carry multiple copies of a single gene (Bachvaroff and Place, 2008). These transcripts are apparently processed into monocistronic mRNAs, which are presumably the substrates for *trans*-splicing.

In kinetoplastids, the presence of polycistronic mRNAs, together with the absence of introns, is frequently argued to be an ancient holdover,



frozen since their early divergence from other eukaryotes (Gunzl et al., 2007). However, this interpretation is flawed for several reasons, particularly because there is no evidence whatsoever for an ancient divergence of kinetoplastids (Keeling et al., 2005). Nonetheless, the independent origin of the same features in dinoflagellates raises an intriguing alternative explanation, namely that the evolutionary origins of polycistronic mRNAs and *trans*-splicing are linked. This is all the more compelling when one considers that both features are also found together in the nematode *Caenorhabditis elegans* (Graber et al., 2007). It is unlikely that this is either functionally advantageous or an evolutionary relict, but rather that the evolution of one feature preconditions the genome by removing deleterious effects of the second feature. For example, the establishment of widespread SL addition in a nuclear genome could precondition that genome for the subsequent establishment of polycistronic transcription. Polycistronic mRNAs that would otherwise be deleterious could flourish simply because the processing pathway eliminates their deleterious effect (the inability to translate all but the first cistron). SL addition appears to be universal in both dinoflagellates and kinetoplastids [in *C. elegans* 70% of mature mRNAs are produced through *trans*-splicing: Graber et al. (2007)]. Polycistronic messages, however, are also near universal in kinetoplastids, whereas in dinoflagellates (and *C. elegans*) only a subset of genes are expressed on polycistronic mRNAs (Bachvaroff and Place, 2008). Since so far only tandem duplications of closely related copies of the same gene are known in dinoflagellates, it would appear they may arise and dissolve continuously.

The functional impacts of SL addition and polycistronic transcription are also different in the 2 lineages. Posttranslational control may be somewhat restricted by the absence of sequence diversity at the 5' end of mRNAs, but more importantly a heavy use of polycistronic messages eliminates the possibility of transcription-level differentiation of expression of any genes within the same cluster. In kinetoplastids, there is only a handful of promoters and a marked paucity of transcription factors (Gunzl et al., 2007), unavoidably leading to the general lack of control over transcription initiation. Indeed, in the well-studied *T. brucei*, virtually all nuclear DNA seems to be permanently transcribed. Consequently, control levels in kinetoplastids are confined to RNA processing, export, and half-life, as well as translation and protein stability (Clayton, 2002). This is a good illustration of how convergent processes differ in the details in different lineages. In this case, the kinetoplastids cotranscribe many different genes whereas dinoflagellates cotranscribe many copies of the same gene, and as a result, transcription-level control is likely not so severely affected in the latter group.

### THE PLASTID: THREE MEMBRANE PLASTIDS AND UNIQUE TARGETING SYSTEM

Plastids are known in both alveolates and euglenozoans to have been derived from secondary endosymbiosis: the uptake of a eukaryotic alga by another eukaryote. In the Euglenozoa, plastids are derived from a green alga and are relatively restricted, being found in a subset of euglenids and nowhere else, namely the “euglenophytes” (Leander, 2004). In the Alveolata, plastids are derived from a red alga and are more widespread and ancient, being known in dinoflagellates and apicomplexans, and suspected of originating before the divergence of alveolates (Keeling, 2009). As with nuclear genomes, plastids have evolved a number of unusual characteristics, some unique and some arising convergently. Euglenophyte plastid genomes are home to some unique self-splicing introns (Coperlino and Hallick, 1993), whereas the dinoflagellate plastid genome has been massively reduced in coding content and broken into single gene minicircles with polyuridylylated transcripts (Wang and Morse, 2006). Curiously, both features are also found in kinetoplastid mitochondria (Lukeš et al., 2005).

Once again, however, 2 probably interconnected features have arisen in both groups. The vast majority of secondary plastids are bounded by 4 membranes. Most proteins in these plastids are encoded in the nucleus and are posttranslationally targeted to the organelle by way of a 2-part pathway beginning with the endomembrane system and followed by the original primary plastid targeting system. In dinoflagellates and euglenophytes, however, the plastid is novel in that it is bounded by 3 membranes rather than 4. It was argued that this may reflect a different mechanism of plastid uptake, specifically that in these lineages plastids arose through myzocytosis whereas other secondary plastids arose through endocytosis. Myzocytosis is a mode of predation where a cell pierces its prey and sucks the prey cytoplasm directly into a digestive vacuole, leaving the prey wall and membrane behind. Although not as common as endocytosis of whole prey cells, myzocytosis is known in both dinoflagellates and euglenozoans, leading to the suggestion that their plastids originated from a myzocytosed alga, and therefore lacked its plasma membrane (Schnepf and Deichgraber, 1984). However, plastids in the closest relatives of dinoflagellates, apicomplexans and *Chromera*, are bounded by 4 membranes and have now been shown to be orthologous to the dinoflagellate plastid (Oborník et al., 2009). Accordingly, in at least dinoflagellates, plastids must have originated in the same fashion as some 4-membrane counterparts and at one time been bounded by 4 membranes, which means that the origins of 3 membranes around the plastids in dinoflagellates and euglenophytes cannot be attributed to a shared, unusual mechanism such as myzocytosis.

Interestingly, the system used to target proteins to 3 membrane plastids is also different in subtle but important ways to that of canonical secondary plastids with 4 enveloping membranes, and the same variations have been adopted in dinoflagellates and euglenophytes. The N-terminal leaders that direct proteins to canonical secondary plastids include a signal peptide (to enter the endomembrane system) and a transit peptide (to cross the 2 plastid membranes), and are similar in secondarily derived red and green plastids. In dinoflagellates and euglenophytes, however, an additional hydrophobic domain is found following the transit peptide of some, but intriguingly not all, proteins (Patron et al., 2005; Durnford and Gray, 2006). This domain is thought to anchor the proteins in the endomembrane, so as the protein moves through the Golgi apparatus the leader lays in the lumen but the mature protein remains in the cytosol (Sulli et al., 1999; Nassoury et al., 2003). The number of membranes and these unusual characteristics of targeting have both evolved convergently in dinoflagellates and euglenophytes, which suggests some link in how these 2 features evolved. Unfortunately, the mechanism by which proteins cross the membrane that is missing in both dinoflagellates and euglenophytes (the plasma membrane of the engulfed alga) is the most poorly understood step in the targeting pathway to canonical secondary plastids, so any specific model for preconditioning would be highly speculative.

### THE MITOCHONDRION: RNA EDITING AND GENOME BREAKDOWN

The mitochondrial genomes of dinoflagellates and kinetoplastids are both highly unorthodox, and once again have evolved some unique features and several common complex characteristics. The kinetoplastid mitochondrion contains uniquely structured, protein-rich mitochondrial ribosomes with a reduced RNA component, unusual fatty acid synthesis and respiratory complexes such as the prokaryotic-like complex I, alternative terminal oxidase, massive tRNA import, and incomplete Krebs cycle. The complex genome of the kinetoplastid mitochondrion is known as kinetoplast DNA or kDNA, its genes being subjected to unprecedented levels of RNA editing (Fig. 4.4) (Lukeš et al., 2005). Dinoflagellate mitochondria have received far less attention, but it is now emerging that their genomes have also evolved a number of highly unusual characteristics, including *trans*-splicing, tRNA import, fragmented rRNAs, the loss of start and stop codons, and an oligouridine tail (Slamovits et al., 2007; Nash et al., 2008). Most strikingly, however, the structure of dinoflagellate mitochondrial genomes has also broken down into many fragments, the transcripts of which have high levels of RNA editing; however, as we discuss below, the details of both systems differ between kinetoplastids and dinoflagellates (Fig. 4.4).

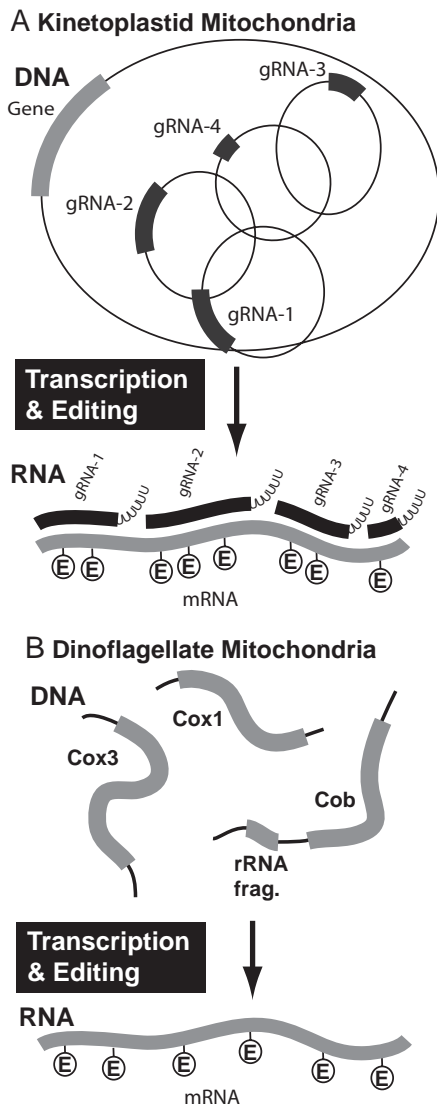

FIGURE 4.4 Convergent organization and processing in kinetoplastid and dinoflagellate mitochondria. (A) In kinetoplastids the genome is composed of maxi- and minicircles. mRNAs expressed from maxicircles (gray) require extensive RNA editing, specifically the insertion and deletion of uridine residues. The process is mediated by several multiprotein complexes, but the information comes from small gRNAs (black), that are encoded on minicircles. In dinoflagellates, the genome is also fragmented but into multiple potentially linear pieces encoding 1 or more genes or gene fragments. Only 3 genes are encoded in the genome (*cox1*, *cox3*, and *cob*), and mRNAs are subject to extensive RNA editing. In this case, however, bases are substituted rather than inserted or deleted.

Within the Euglenozoa as a whole, mitochondrial genomes are generally odd. The euglenid mitochondrial genomes are experimentally refractive and remain poorly known (M. W. Gray, personal communication). The mitochondrion of related diplomonids was recently shown to harbor genomes of unprecedented organization, with fragments of genes residing on minicircles, which are assembled in the correct order posttranscriptionally by means as yet unknown (Marande et al., 2005). Virtually nothing is known about the form or content of the giant kDNAs in bodonid flagellates, which are estimated to comprise millions of base pairs (Lukeš et al., 1998), whereas the kDNA networks of trypanosomatids are among the best studied and most complex mitochondrial genomes known. They are composed of circular DNA molecules that are relaxed and catenated into a single 3-dimensional network. These networks are composed of dozens of maxicircles, which are equivalents of classical mitochondrial genome, and thousands of minicircles (Lukeš et al., 2005) involved in editing, discussed below. The gene content of the maxicircle genome is not unusual, except for the complete absence of tRNA genes. tRNAs have been demonstrated to be imported from the cytosol into the tRNA-lacking organelle of *T. brucei*, so that the prokaryotic translation system of the mitochondrion must cope with imported eukaryotic tRNAs (Crausaz-Esseiva et al., 2004). The only exception is tRNA<sup>Met-i</sup>, the import of which is blocked because it cannot function in the prokaryotic system. Instead, tRNA<sup>Met</sup> formyl-transferase is present, which formylates the translation initiator tRNA<sup>Met-e</sup> upon import (Tan et al., 2002).

Within alveolates, mitochondrial genome evolution has also taken more than its share of strange turns. Although the circular mitochondrial genome of ciliates is undistinguished in both form and content, the genomes in apicomplexans and dinoflagellates are both highly reduced and often scrambled (Feagin, 2000; Slamovits et al., 2007; Nash et al., 2008). These lineages have the smallest mitochondrial genomes known, with most species examined with just 3 protein-coding genes: *cox1*, *cox3*, and *cob* (strictly speaking, the dinoflagellate *Oxyrrhis* has only 2 genes since *cob* and *cox3* are expressed as a fusion) (Slamovits et al., 2007). The only other coding regions are small fragments of rRNAs. These do not amount to an entire copy of either large or small subunit rRNAs, so fragments are all thought to be important and the functional RNAs assembled by base pairing interactions. As with kinetoplastids, no tRNAs are encoded in these genomes, and they have been shown to be imported into apicomplexan mitochondria. Moreover, apicomplexans also block the import of tRNA<sup>Met-i</sup>, and use tRNA<sup>Met</sup> formyl-transferase to formylate the translation initiator tRNA<sup>Met-e</sup>. Indeed, kinetoplastids and apicomplexans have independently evolved very similar tRNA import mechanisms to cope with this unique lack of tRNAs (Bouzaidi-Tiali et al., 2007). In apicomplexans,

the 3 protein-coding genes map to a linear, tandem repeat with rRNA fragments interspersed (Feagin, 2000). In dinoflagellates, the same coding regions are present, but the organization is much more complex. Here, multiple copies of each gene are found in various orientations on linear chromosomes of varying size. In some species, all possible permutations of 3 genes are adjacent, whereas in others chromosomes seem to contain copies of only 1 gene. Chromosomes also contain rRNA fragments, and substantial noncoding regions, and some have been shown to have structurally complex ends characterized by families of repeats (Jackson et al., 2007; Slamovits et al., 2007; Nash et al., 2008).

In kinetoplastids, the evolution of the complex genome organization is tightly linked to how genes are expressed, and specifically to RNA editing. The genes, such as they are, are encoded on the maxicircles and expressed as polycistronic mRNAs, but after processing into monocistrons these messages are then massively altered by the insertion and deletion of uridine residues (up to 553 insertions and 89 deletions in a single mRNA). Editing is mediated by hundreds of small guide (g) RNAs in an elaborate process involving numerous multisubunit protein complexes (Lukeš et al., 2005; Hashimi et al., 2008). The gRNAs that contain the information that directs editing are encoded on the minicircles, so the breakup of the genome into 2 chromosome types is likely linked to the evolution of editing.

In dinoflagellates, RNA editing has also been found to be widespread, but the process is mechanistically different and in no way related to the breakdown of the genome structure. Here, transcripts are edited at  $\approx 2\%$  of their positions via substitutional editing, as opposed to insertion/deletion editing (Lin et al., 2002; Nash et al., 2008; Zhang and Lin, 2008). Although A to G is the most common substitution, several others have been observed (U  $\rightarrow$  C, G  $\rightarrow$  C, G  $\rightarrow$  A, A  $\rightarrow$  C, and C  $\rightarrow$  U), suggesting a highly flexible and sophisticated editing mechanism (Nash et al., 2008; Zhang and Lin, 2008). Fragments of edited gene sequences have been found in dinoflagellate mitochondrial genomes, prompting the suggestion that they employ gRNAs similar to that of kinetoplastids (Nash et al., 2007). However, the genomes are prone to recombination, so the significance of these fragments remains unclear; overall, there is no direct evidence for any particular editing mechanism at present. It is worth noting that mitochondrial transcripts in dinoflagellates have substantial polyadenylated tails, a feature linked to the editing process in kinetoplastids (Etheridge et al., 2008), and generally very rare in organelles.

The limited data further indicate that uridine insertion type of RNA editing might even coexist with *trans*-splicing in diplomonids (Marande and Burger, 2007). We predict that the extreme diversity of editing types documented in the dinoflagellate mitochondrion (Zhang and Lin, 2008) also requires poorly understood albeit complex protein machinery that is

the result of constructive neutrality similar to that described above for the kinetoplastid mitochondrion.

## CONCLUSIONS

The deeper we look at protist biology, the greater the variety we discover in how cells can accomplish fundamental processes. Not only do protists represent the majority of the phylogenetic tree of eukaryotes, and therefore the greatest evolutionary diversity, but they also have pushed the limits of many biological systems and bending the “rules” of biology (such as the central dogma) far beyond what we see in the better studied multicellular eukaryotes. The alveolates and the euglenozoans may be “hotspots” for the generation of diverse solutions to fundamental processes, but it is also possible that they only appear this way because they are among the best studied protist groups. Other odd protists abound, but we know next to nothing about many of them, particularly at the molecular and genomics levels. All this is presently changing, and to interpret genomic diversity in eukaryotes we will have to set aside many of our preconceptions.

Comparing the alveolates and the euglenozoans is also appealing because they have broken many of the same rules in the same general way. Because they are so distant on the phylogenetic tree of eukaryotes (Keeling et al., 2005; Hampl et al., 2009), convergence between the 2 groups would ultimately be influenced only by intrinsic factors of a very basic nature (i.e., that are likely common to most or all eukaryotes) (Leander, 2008). In contrast, where multiple aspects of a system have all converged similarly, it is likely that the convergent appearance of one new characteristic can be a strong factor in the convergent evolution of others. Even if these characteristics are not obligatorily functionally linked, their evolution may be tightly linked. For example, polycistronic mRNAs can exist without an SL, but they are evolutionarily linked because adding the SL allows the polycistronic mRNA to function. Conversely, one can imagine other ways to get a polycistronic mRNA to function without SL processing (e.g., changes to translation initiation), but because no such system is known, these are evidently less likely than the advent of SL processing. In other words, within the limited universe of acceptable changes, one change closes some possibilities, but opens new ones as well.

So why have protists in general and alveolates and euglenozoans in particular engaged in so much evolutionary experimentation? Many characteristics discussed here have been considered individually and concluded to be ancient relicts, going back even so far as the RNA world, or to



have been favored by selection over the canonical way of accomplishing the same task (Speijer, 2007; Ochsenreiter et al., 2008). We find neither of these arguments to be particularly compelling given the narrow distribution of these characters in nature, and their often extreme complexity. For example, dozens of nuclear-encoded proteins are required for *T. brucei* to edit just 12 mRNAs (Lukeš et al., 2005; Etheridge et al., 2008; Hashimi et al., 2008). Despite considerable controversy, no obvious evolutionary advantage has ever been demonstrated for this type of editing, and such possible advantages that have been proposed (e.g., the generation of 2 proteins from 1 gene) (Ochsenreiter et al., 2008) are more than outweighed by the demonstrated cost (i.e., “save” 1 gene at the cost of dozens of genes). We argue that constructive neutral evolution offers a more compelling explanation (Covello and Gray, 1993; Stoltzfus, 1999). This is a very simple and intuitive way of explaining complexity in biological systems, but one that has not received much attention. Briefly, it is possible for a biological system to increase in complexity (i.e., to increase the number of components or interactions needed to sustain the system) by making a series of neutral changes that collectively do not affect fitness. Pan-editing is often thought of as an error correcting system, but as Stoltzfus (1999) pointed out, the duplicated information (e.g., gRNAs) must have been created before the mutations they are correcting, or they too would carry the mutations—so the error-then-solution model is backward. Instead, if a gratuitous duplication of information took place first (i.e., the origin of a gRNA), then a subsequent mutation could be neutralized by the presence of the duplicated information needed to change it. The fixation of such a mutation would render the gRNA essential, and would also allow for further mutations as long as the gRNAs could mediate their reversal. This last point is important because it would bias the system against the loss of the gRNA since mutations at many sites will further establish the gRNA as essential, whereas only complete reversion to the original sequence could render it unnecessary. Overall, the editing activity and the sites that are edited will coevolve, and the complexity of the system will inevitably grow while conferring no real selective advantage (for many other case studies and much greater detail) [see Covello and Gray (1993) and Stoltzfus (1999)].

Within this framework, together with the recognition that the evolution of an unusual character can be an intrinsic factor in the subsequent evolution of additional, specific characters, a complex cellular system may be explained simply by identifying the event(s) that preconditioned the cell for such a system. Convergence may offer a glimpse into these conditions by revealing how characters are linked when the same events are played out multiple times.



### ACKNOWLEDGMENTS

We thank Mona Hoppenrath and Susan Breglia for providing the images in Figs. 4.1 and 4.2F, respectively. This work was supported by the Grant Agency of the Czech Republic Grant 204/09/1667 (to J.L.); Ministry of Education of the Czech Republic Grants LC07032, 2B06129, and 600766580 (to J.L.); a grant from the Tula Foundation to the Centre for Microbial Diversity and Evolution (to B.S.L. and P.J.K.); and the Canadian Institute for Advanced Research (J.L., B.S.L., and P.J.K.).

## Part II

---

### ARTIFICIAL SELECTION, OR ADAPTATION TO HUMAN DEMANDS

Darwin titled the first chapter in *The Origin of Species* “variation under domestication,” probably because he felt that developing a case for the effectiveness of human-mediated selection in generating new domestic varieties would facilitate his efforts in later chapters to communicate the concept of how natural selection can generate new varieties and species in nature. In chapter 1 of *The Origin*, Darwin discussed several domesticated plant and animal species, ranging from beans, melons, and plums to dogs, cattle, and horses. He devoted a long section to how selective breeding had altered the domestic pigeon, fancy varieties of which were widely prized in the Victorian era. Nearly 10 years later, he would expand greatly on these themes in *The Variation of Animals and Plants Under Domestication*.

In chapter 1 of *The Origin*, Darwin lamented that “We hardly know anything about the origin or history of our domestic breeds”; and “The origin of most of our domestic animals will probably for ever remain vague.” Darwin would therefore be both pleased and surprised by recent scientific progress in deciphering the evolutionary origins of many domesticated plant and animal species. Much of this evidence has come from molecular genetic and phylogenetic analyses of domesticated breeds vis-à-vis their wild ancestors. Carlos Driscoll, David Macdonald, and Steve O’Brien tabulate some of this evidence in Chapter 5, for various domestic animals, and then provide a detailed case in point by describing the phylogenetic and biological history of the domestic cat. The cat appears to be nearly unique among animal domesticates (including dogs) in the sense that it

was initially self-selected for tolerance to humans, rather than actively selected by humans for tameness or for desired services such as companionship, hunting or guard duties, or food. According to the authors' reconstruction, cat domestication probably began near some of the earliest agricultural settlements of the Neolithic, in the Fertile Crescent region of the Near East, as wildcats became accustomed to feeding on rodents and refuse near human towns. If so, their evolution to companion animals, and their ecological isolation from wildcats, was initially a response to natural selection more so than to conscious artificial selection.

Apart from appraising the phylogenetic histories of domestic organisms, the field of molecular genetics is also uncovering the genes responsible for key phenotypes that have emerged from artificial selection. In Chapter 6, Feng Tian, Natalie Stevens, and Edward Buckler IV provide cases in point involving domestic corn (maize), the ancestors of which are wild teosinte grasses native to Mexico. The evolutionary transformation from teosinte to maize ranks among the most impressive of all feats of artificial selection. For example, teosinte lacks a cob-like inflorescence and instead produces only 6–12 kernels in two rows protected by a hard covering, whereas each cob of modern maize consists of approximately 20 rows with numerous exposed kernels; and teosinte has long lateral branches terminated by male tassels, whereas modern maize has short lateral branches tipped by female ears. The authors review current knowledge about the genetic loci responsible for these and other such morphological transitions. Several genes with major effect can be specified, and many others are implicated, including a newly discovered region on chromosome 10 that spans more than 1,000,000 base pairs and retains the molecular footprints of strong artificial selection during the domestication process.

In Chapter 7, Fred Allendorf and Jeffrey Hard describe another form of human-induced selection that they term unnatural selection. When breeders artificially select domestic animals for food or companionship, they purposefully try to propagate traits that people deem desirable. However, hunting and fishing (especially for trophies) routinely violate such ground rules by culling rather than propagating the animals that humans prize most. In other words, unnatural selection via hunting, unlike artificial selection by people (or natural selection by nature), often eventuates biotic outcomes that run counter to what humans (or nature) otherwise would strive to achieve. For example, the evolutionary responses to the continued selective removal of larger or healthier animals from a population of deer or fish could include, in principle, earlier sexual maturation and smaller adult body sizes. The authors review arguments and empirical evidence for unnatural selection imposed by human harvests of wild animal populations, and they discuss the management problems generated by such selective mortality. Darwin mostly overlooked this important topic,

which continues to be neglected by many wildlife and fishery agencies today. This paper may help to rectify that situation by bringing to broader attention the important contrasts between standard hunting and fishing practices (unnatural selection) on the one hand and standard agricultural and aquacultural practices (artificial selection) on the other.

Artificial selection traditionally refers to human-mediated differential propagation of plants or animals with desirable hereditary traits. In the modern biotechnology era, an entirely different form of genetic engineering is possible in which particular proteins are subjected to repeated rounds of mutation and selection, in laboratory test tubes, for improved stability or biochemical function. In Chapter 8, Jesse Bloom and Frances Arnold review this form of directed evolution, which is becoming a powerful approach to the design of new proteins for medicine and pharmacology. Directed protein evolution has also yielded new insights into the fundamental nature of evolutionary processes. The authors emphasize three major conclusions from directed evolution experiments: *(i)* most desirable protein properties can be incrementally improved through successions of single mutation steps; *(ii)* much of the epistatic coupling between mutations is due to protein stability and its influence on mutational robustness and protein evolvability; and *(iii)* adaptive protein evolution is heavily reliant on the prevalence of promiscuous protein functions (initial traces of activity that proteins routinely display on foreign substrates) that in turn are routinely influenced by neutral mutations. Directed protein evolution goes far beyond the wildest imaginings of Darwin, who would doubtless be impressed that the general principles of selection he illuminated would prove to be so universal.



## 5

# From Wild Animals to Domestic Pets, an Evolutionary View of Domestication

---

CARLOS A. DRISCOLL,<sup>\*†</sup> DAVID W. MACDONALD,<sup>\*</sup>  
and STEPHEN J. O'BRIEN<sup>†</sup>

Artificial selection is the selection of advantageous natural variation for human ends and is the mechanism by which most domestic species evolved. Most domesticates have their origin in one of a few historic centers of domestication as farm animals. Two notable exceptions are cats and dogs. Wolf domestication was initiated late in the Mesolithic when humans were nomadic hunter-gatherers. Those wolves less afraid of humans scavenged nomadic hunting camps and over time developed utility, initially as guards warning of approaching animals or other nomadic bands and soon thereafter as hunters, an attribute tuned by artificial selection. The first domestic cats had limited utility and initiated their domestication among the earliest agricultural Neolithic settlements in the Near East. Wildcat domestication occurred through a self-selective process in which behavioral reproductive isolation evolved as a correlated character of assortative mating coupled to habitat choice for urban environments. Eurasian wildcats initiated domestication and their evolution to companion animals was initially a process of natural, rather than artificial, selection over time driven during their sympatry with forbear wildcats.

---

<sup>\*</sup>Wildlife Conservation Research Unit, Department of Zoology, University of Oxford, Tubney House, Abingdon Road, Tubney, Oxon OX13 5QL, United Kingdom; and <sup>†</sup>Laboratory of Genomic Diversity, National Cancer Institute, Frederick, MD 21702.

Darwin famously first described natural selection in 1859 with his classic monograph *On the Origin of Species*. Sexual selection was addressed in *Descent of Man, and Selection Related to Sex* in 1871. In between those two, in 1868, Darwin published a 2-volume work, *The Variation of Animals and Plants Under Domestication*, in which he expands upon a third distinct stream of evolutionary mechanism—artificial selection—that he first had outlined in *Origin*.

### NATURAL VS. ARTIFICIAL SELECTION

Artificial selection is unique in that, as the name suggests, it is wholly unnatural. That insight seems at first trivial, but reflection reveals just how extraordinary and fundamental artificial selection (manifest as domestication) has been to human success as a species. It was no more than 12,000 years ago that humankind began to consciously harness the 4-billion-year evolutionary patrimony of life on Earth. Exploiting the genetic diversity of living plants and animals for our own benefit gave humans a leading role in the evolutionary process for the first time. Agricultural food production (*sensu lato*, including animal husbandry) has allowed the human population to grow from an estimated 10 million in the Neolithic to 6.9 billion today, and still expanding (Groube, 1996). Today, 4.93 billion hectares are used for agricultural practices, which also account for 70% of all freshwater consumed (World Resources Institute, 2000). The world's species are going extinct at a rate 100–1,000 times faster than the historic “background” rate, primarily as a result of habitat loss, which is itself overwhelmingly driven by conversion of natural habitats to agriculture. However, to date no domestic animal has gone extinct (Zeder, 2008). The consequences for the planet (as well as for humanity and its domesticates) have been profound, and have included the complete transformation of almost every natural ecosystem on Earth.

Domesticating animals and plants brought surpluses of calories and nutrients and ushered in the Neolithic Revolution. However, the Neolithic Revolution involved more than simple food production; it was also the growth of an agricultural economy encompassing a package of plant and animal utilization that allowed for the development of urban life and a suite of innovations encompassing most of what we today think of as culture (Bar-Yosef, 1998; Peters et al., 2005). Much of modernity is an indirect consequence of artificial selection. The plow has come to symbolize the Neolithic Revolution, but viewing history in the light of evolution we see that it was intelligently designed changes to the genetic composition of natural biota that made the real tools. In some sense, Neolithic farmers were the first geneticists and domestic agriculture was the lever with which they moved the world.



## VARIATION OF ANIMALS AND PLANTS UNDER DOMESTICATION

Modern summaries (and this colloquium) arrange the drivers of “descent with modification” into natural, sexual, and artificial selection, but Darwin’s conceptual organization was somewhat different from our own. He saw sexual selection as a part of natural selection, and artificial selection as a coin with 2 sides, one he called Methodical and the other Unconscious (Darwin, 1890). Unconscious selection supposes no conscious wish or expectation to permanently alter a breed, whereas Methodical selection is guided by some predetermined standard as to what is best; intention therefore is the substantial difference (Darwin, 1890). This distinction has largely lapsed in today’s debate, although Darwin thought it worth discussing.

We perceive today, as did Darwin, that natural selection is the environmentally driven mechanistic process by which more advantageous traits are, on the whole, passed on to succeeding generations more often than less advantageous traits because of differential reproduction of the individuals possessing them. Sexual selection is a natural process of intraspecific competition for mating rights. Artificial selection, generally the motive force behind domestication, is often equated with selective breeding. This often amounts to prezygotic selection (where mates are chosen by humans) versus postzygotic selection (where the most fit progeny reproduce differentially) as in natural selection. Although natural selection plays a considerable role in the evolution of many traits (e.g., disease resistance) during the animal domestication process, sexual selection is effectively trumped by the human-imposed arrangements of matings and often by the human desire for particular secondary sexual characters. Artificial selection is a conscious, if unintentional, process, and therefore is generally considered to be effected only by humans [but see Schultz et al. (2005)].

We suggest that artificial selection has both a “weak” and a “strong” form. In weak artificial selection, selection pressure is applied postzygotically (selectively culling a herd of deer, for example) and natural selection proceeds from this modified genetic baseline. In strong artificial selection, selection is prezygotic, as well as postzygotic (e.g., mating male offspring of high-yielding dairy cows to high-yielding cows). This will result in a dramatic acceleration of evolutionary processes and entail a much greater level of control over the selected organism.

Darwin’s *The Variation of Animals and Plants Under Domestication* (Darwin, 1890) offers a litany of facts and examples of artificial selection in action at the hands of plant and animal breeders. Darwin felt that an understanding and appreciation of the depth of artificial selection was fundamental to the acceptance of natural selection. In *Variation*, Darwin

wanted to expand on this artificial mechanism of evolution beyond examples in *Origin*, where he describes familiar and tangible results of husbandmen in his argument that selection by the analogous natural means—survival of the fittest—was not just plausible or possible, but probable. Darwin considered any variety, breed, or subspecies, no matter how it was derived, as an incipient species, irrespective of the particular selective mechanism driving the group's evolution (Darwin, 1890). He sought to illustrate that tremendous changes can be wrought through the “gradual and accumulative force of selection,” but he also emphasized that evolution by selection of any type can only work where variation is present; “[t]he power of selection . . . absolutely depends on the variability of organic beings” (Darwin, 1890). Thus, genetic differences between domesticates and their wild counterparts substantially reflect the native genetic variation (i.e., standing variation) present in the wild population before any selection (natural or artificial) for tameness, and the secondary effects of isolation (Darwin, 1890).

Through the plethora of examples laid out in *Variation*, Darwin was making a case that the consequences of artificial selection are similar in spirit to those of natural selection, but, moreover, that artificial selection (whether methodical or unconscious) was practiced a very long time ago. Darwin further suggested that there had been little need for humans to understand the mechanism of artificial selection, so long as the process operated effectively and produced tangible results.

### DOMESTICATION GENERALLY

Are domesticated strains separate species (either from one another, or from their wild ancestors)? The answer generally is “no,” under the conceptual framework of the Biological Species Concept (Dobzhansky, 1937; Mayr, 1942; O'Brien and Mayr, 1991a,b; Avise, 2004). Breeds typically are interfertile and intercross if given the opportunity. When domesticates are sympatric with populations of the parent wild species (if the latter still persist), gene flow generally can occur. When is an animal truly domesticated? Hard definitions are elusive because domestication is a continuous transition, attributes differ by species, and genes and environment interact to produce selectable characters that may vary with circumstance (Price, 1984). However, an interconnected and characteristic suite of modifiable traits involving physiology, morphology, and behavior are often associated with domestication (Coppinger and Smith, 1983; Price, 1984; Hemmer, 1990; Morey, 1994). Critically, all domesticates manifest a remarkable tolerance of proximity to (or outright lack of fear of) people. Reproductive cycle changes such as polyestrousness and adaptations to a new (and often poorer) diet are typical (Hemmer, 1990). Common

physical and physiological recurrences among domesticated mammals include: dwarfs and giants, piebald coat color, wavy or curly hair, fewer vertebrae, shorter tails, rolled tails, and floppy ears or other manifestations of neoteny (the retention of juvenile features into sexual maturity) (Clutton-Brock, 1999). Behaviorally too, domestication is not a single trait but a suite of traits, comprising elements affecting mood, emotion, agnostic and affiliative behavior, and social communication that all have been modified in some way.

The appreciable metabolic and morphological changes that often accompany behavioral adaptation to the human environment usually lead to a significant dependence on humans for food and shelter. However, domestication should not be conflated with taming. Taming is conditioned behavioral modification of an individual; domestication is permanent genetic modification of a bred lineage that leads to, among other things, a heritable predisposition toward human association. And domestic animals need not be “tame” in the behavioral sense (consider a Spanish fighting bull) and, conversely, wild animals can be quite tame (consider a hand-raised cheetah or tiger). A domestic animal is one whose mate choice is influenced by humans and whose tameness and tolerance of humans is genetically determined. Controlled breeding amounts to prezygotic selection, a critical element to domestication (because captive breeding allows for the strongest, most direct artificial selection). However, an animal merely bred in captivity is not necessarily domesticated. Tigers, gorillas, and polar bears breed readily in captivity but are nevertheless not “domesticated.” Likewise, Asian elephants are wild animals that with taming manifest outward signs of domestication, yet their breeding is not human controlled and thus they are not true domesticates (Lair, 1997).

## NEOLITHIC WORLD OF THE FERTILE CRESCENT

Most of today’s domesticates began as food, but all domesticates, including dogs and cats, have one thing in common: They are all tolerant of people. Where, how, and why did this tolerance develop? To understand this phenomenon, we have to step back to a time when humans began living in settled groups.

Accumulated archaeological, cultural, and genetic evidence points to the Terminal Pleistocene ( $\approx 12,000$  years ago) in the Fertile Crescent (Fig. 5.1) as the primary locus of domestication for many western domesticates (Zeuner, 1963; Smith, 1995; Clutton-Brock, 1999; Peters et al., 2005; Zeder et al., 2006a; Bellwood, 2007; Zeder, 2008). Estimated dates for these events range from 15,000 years B.P. for the dog to 8,000 B.P. for cattle (Table 5.1). The term Fertile Crescent was coined by James Henry Breasted who characterized the region by both ecological and cultural features pres-

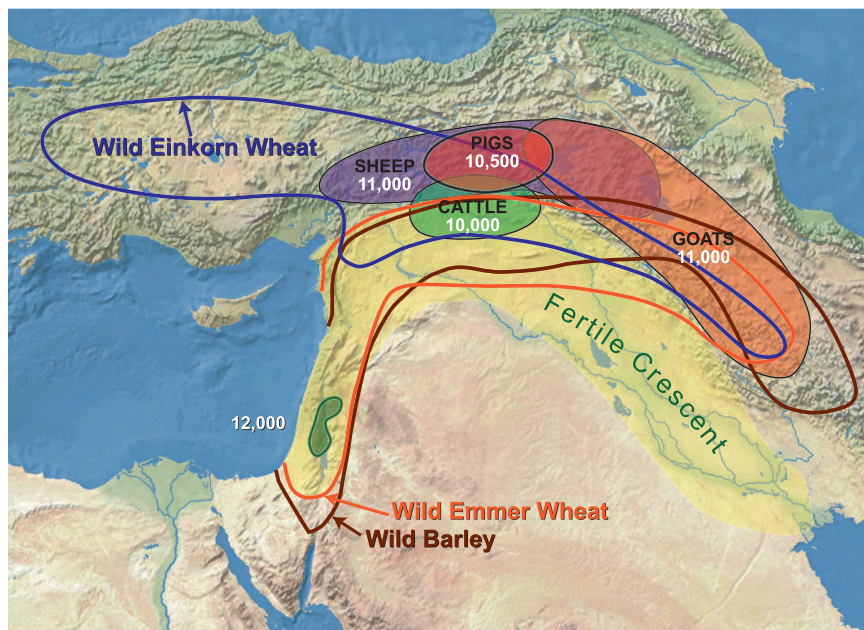

FIGURE 5.1 Map of the Near East indicating the Fertile Crescent [according to Breasted (1916)]. Shaded areas indicate the approximate areas of domestication of pig, cattle, sheep, and goats with dates of initial domestication in calibrated years b.p. [after Zeder (2008)]. Lines enclose the wild ranges of einkorn wheat, emmer wheat, and barley [after Smith, (1995)]. Shaded area in southern Levant indicates the region where all 3 grains were first domesticated 12,000 years B.P.

ent at the time of earliest civilization (Breasted, 1916). In his conception, the Fertile Crescent extends from the Mesopotamian plains, through the Taurus mountains and along the Mediterranean coast to the Levant, and does not include Egypt (Fig. 5.1). Here, hunter-gatherers first became sedentary, domesticated plants and animals, developed agriculture, and built urban villages—the suite of cultural innovations and consequences known as the Neolithic Revolution. The Fertile Crescent during the terminal Pleistocene was much different from the thorny, overgrazed scrub that is present today. Gazelle and deer, wild cattle, boar, horses, and goats and sheep flourished through an oak/pistachio parkland (Bar-Yosef, 1998; Clutton-Brock, 1999). Among the hundred or so species of edible seeds, leaves, fruits, and tubers, there were thick natural stands of cereals (barley, einkorn, and emmer wheat) and pulses (pea, chickpea, lentil), which provide a rich source of calories and a balance of nutrients. Together

with flax (used for fiber) and bitter vetch, these plants would later form a package that became our 8 founder crops (Bellwood, 2007). For >100,000 years, humans had been nomadic hunter-gatherers. However, because the Fertile Crescent was so bountiful, the inhabitants of the Levant at this time (known archaeologically as Natufians) were able to hunt and gather all they needed with only short forays from base camps; they became a “hunter-gatherer elite” (Bar-Yosef, 1998). Over time, movable camps evolved into permanent semisubterranean pit-houses where (we suppose) the Natufians stored wild grains for use throughout the year (Bar-Yosef, 1998).

Between 13,000 and 11,000 B.P. the Natufian hunter-gatherers developed tools such as the sickle and grinding stones to harvest and process wild grains (Bar-Yosef, 1998). Subsequently (11,000 to 10,300 B.P.), a cold and dry period reduced the available wild plant food and increased the Natufian’s dependence on cultivated grasses and legumes (the founder crops mentioned above). This climatic shift, called the Younger Dryas event, may have been the trigger for a change in emphasis away from hunting-gathering and toward true agriculture via improvised cultivation. With a reliable food source, human populations began to rise, technology for collecting grains further improved, and settlements initially encouraged by naturally abundant food led to larger settlements. Although hunter-gatherers throughout the world had long manipulated plants and animals (for instance by using fire to encourage edible plants or animals that thrive on disturbed land), Neolithic agriculture moved well beyond the raising and harvesting of plants and animals and into an entrenched economic system enforced by labor demands and ecological transformations. Productive land, now the predominant venue for food supply and valued at a premium, would be cultivated and defended year round. This commitment to an agricultural life entailed permanent buildings and facilities for storing surpluses of food, and it created the first farm communities.

Domestication of today’s barnyard animals proceeded as a result of pressure by these early hunter-gatherers as they intuitively sought to stabilize their food resources (Clutton-Brock, 1999; Zeder, 2006; Zeder et al., 2006b). Among the successful domesticates, most were behaviorally preadapted to domestication. Behavioral characteristics considered favorable and unfavorable are presented in Table 5.2. Barnyard animals descend from herd-living herbivores whose ancestors followed a dominant individual through a territory shared with other herds. Neolithic peoples exploited this dominance hierarchy by, in effect, supplanting the alpha individual and thereby gaining control of the herd. Herd-living animals were predisposed to tolerate close living quarters, and their temperament allowed them to adapt easily to confinement. They also had a flexible diet

TABLE 5.1 Common Western Domestic Animals and Their Context

Domestic Animal		Wild Ancestor		Earliest Human Association/ Domestication
Common Name	Scientific Name	Common Name	Scientific Name	Time
Dog	<i>Canis familiaris</i>	Gray wolf	<i>C. lupus</i>	13,000–17,000 B.P.
House sparrow	<i>Passer domesticus</i>	Sparrow	<i>Passer predomesticus</i>	Earliest Neolithic
Pigeon	<i>Columba livia</i>	Rock dove	Same	Upper Pleistocene?
House mouse	<i>Mus domesticus</i>	Gray mouse	<i>Mus musculus</i>	12,000 B.P.
Black rat	<i>Rattus rattus</i>	Same	Same	<12,000 B.P.
Brown rat	<i>Rattus norvegicus</i>	Same	Same	<5,500 B.P.
Goat	<i>Capra hircus</i>	Bezoar	<i>Capra aegagrus</i>	11,000 B.P.
Sheep	<i>Ovis aries</i>	Mouflon	<i>O. orientalis</i>	12,000 B.P.
Taurine cattle	<i>Bos taurus</i>	Auroch	<i>Bos primigenius primigenius</i>	11,000–10,500 B.P.
Zebu cattle	<i>Bos indicus</i>	Auroch	<i>Bos primigenius namadicus</i>	9,000 B.P.
Pig	<i>Sus domesticus</i>	Wild boar	<i>Sus scrofa</i>	10,500 B.P.



Locus	First Special Breed Formation	Initial Utility	Primary Initial Selective Mechanism	Reference
Central Europe	3,000–4,000 B.P.	Sentry, food, hunting	NS/AS	Clutton-Brock (1995), Vila et al. (1997), Wayne et al. (2006)
Fertile Crescent	None	None <sup>a</sup>	NS	Tchernov (1984), Ericson et al. (1997)
Fertile Crescent	Unknown	Food?	?NS/AS	Tchernov (1984)
Fertile Crescent	<300 years	None <sup>a</sup>	NS	Tchernov (1984), Auffray et al. (1988), Boursot et al. (1996)
SE Asia	None	None <sup>a</sup>	NS	Tchernov (1984)
Central Asia	1856	None <sup>a</sup>	NS	Tchernov (1984), Hedrich (2000)
SE Anatolia-Zagros	>5,000 B.P.	Food	AS	Hole (1996), Legge (1996), Luikart et al. (2001, 2006), Fernandez et al. (2005), Peters et al. (2005), Zeder (2005, 2008)
SE Anatolia; Iraq	6,000–5,500 B.P.	Food	AS	Hole (1996), Legge (1996), Peters et al. (2005), Bruford and Townsend (2006), Zeder (2008)
SE Anatolia; Upper Euphrates	> 4,500 B.P.	Food	AS	Buitenhuis (1984), Helmer et al. (2005), Peters et al. (2005), Bradley and Magee (2006), Zeder (2008)
NW South Asia	Unknown	Food	AS	Zeuner (1963), Meadow (1996), Baig et al. (2005), Bradley (2006)
At least 6; includes SE Anatolia	Neolithic	Food	AS	Haber et al. (2005), Larson et al. (2005), Peters et al. (2005), Zeder (2008)



TABLE 5.1 continued

Domestic Animal		Wild Ancestor		Earliest Human Association/ Domestication
Common Name	Scientific Name	Common Name	Scientific Name	Time
Donkey	<i>Equus asinus asinus</i>	African wild ass	<i>Equus asinus africanus</i>	4,800 B.P.
Horse	<i>Equus caballus</i>	European forest horse (Tarpan)	<i>Equus ferus</i>	5,000–4,000 B.P.
Dromedary camel	<i>Camelus dromedarius</i>	Same	Same	≈5,000 B.P.
Bactrian camel	<i>Camelus bactrianus</i>	Same	Same	4,600 B.P.
Cat	<i>F. silvestris catus</i>	Wildcat	<i>F. silvestris lybica</i>	9,700 B.P.

<sup>a</sup>These species were commensals that seized advantage of anthropogenic habitat.

(enough to live on what early farmers might provide), grew fast (and thus did not unduly expend farmers' resources), and would freely breed in the presence of people (Zeuner, 1963; Hemmer, 1990; Clutton-Brock, 1999). A comparison of the occurrence of preadaptive characters among wild species of the Fertile Crescent is presented in Table 5.3. The predecessors of today's farm animals were undoubtedly selectively managed in hunts in natural habitats (corresponding to our weak artificial selection) before individuals were taken into captivity and bred (Darwin, 1890; Clutton-Brock, 1999; Zeder, 2006; Zeder et al., 2006b). Animals that bred well could then be selected (either consciously or unconsciously) for favorable traits (corresponding to our strong artificial selection). Domestication in these cases is a mixture of artificial selection (both weak and strong) for favorable traits and natural selection for adaptation to captivity, with artificial selection being the prime mover.

### DOMESTICATION OF DOGS

The domestication of dogs and cats (today's two most popular companion animals) was a bit different from the barnyard animals. And

Locus	First Special Breed Formation	Initial Utility	Primary Initial Selective Mechanism	Reference
Eastern Africa	Unknown	Food, transportation	AS	Bruford and Wayne (1993), Beja-Pereira et al. (2004), Vila et al. (2006)
Pontic steppes, Central Asian steppes	>2,800 B.P.	Food, transportation	AS	Jansen et al. (2002), Olsen (2006), Vila et al. (2006)
Arabia	Unknown	Food, transportation	AS	Kohler (1984), Wapnish (1984), Kohler-Rollefson (1996)
East Iran	Unknown	Food, transportation	AS	Wapnish (1984)
Cyprus/Fertile Crescent	<300 years	None <sup>a</sup>	NS	Vigne et al. (2004), Driscoll et al. (2007)

although Darwin began *Variation* with a discussion of the dog and the cat, the two could hardly be more different from each other (or from contemporary barnyard domesticates) in temperament, utility, and evolutionary origin. Farm animals were food items (“walking larders”) brought into the human sphere at the transition point from hunting-gathering to agriculture (Clutton-Brock, 1999). Dogs, the earliest domesticate, proved useful as guards and as hunters for the hunting-gatherers, and perhaps offered necessary lessons for subsequent domestication of other species (Muller, 2005). By contrast, cat domesticates arose much later ( $\approx 10,000$  B.P.), after humans built houses, farms, and settlements.

The preponderance of molecular evidence points to an origin of dogs from the wolf, *Canis lupus* (Vila et al., 1997; Leonard et al., 2002). The molecular findings are also supported by a large body of archaeological evidence that implicates the Near East as a likely locus of definitive domestication [although dog domestication may have begun in Central Europe as early as the Upper Late Paleolithic (Clutton-Brock, 1999; Muller, 2005)]. Wolf domestication is seen as the result of 2 interwoven processes originating >14,000 years ago during our hunter-gatherer nomadic period (Clutton-Brock, 1995). First, a founder group of less-fearful wolves

TABLE 5.2 Favorable and Unfavorable Ecological and Behavioral Pre-adaptations to Domestication

Favorable	Unfavorable
	Social structure
Dominance hierarchy	Territoriality
Large gregarious groups	Family groups or solitary
Male social group affiliation	Males in separate groups
Persistent groups	Open membership
	Food preferences
Generalist herbivorous feeder or omnivore	Dietary specialist or carnivore
	Captive breeding
Polygamous/Promiscuous mating	Pair bonding prior to mating
Males dominant over females	Females dominant or males appease females
Males initiate	Females initiate
Movement or posture mating cues	Color or morphological mating cues
Precocial young	Altricial young
Easy divestiture of young	Difficult divestiture of young
High meat yield per food/time	Low meat yield
	Intra- or interspecies aggressiveness
Nonaggressive	Naturally aggressive
Tameable/readily habituated	Difficult to tame
Readily controlled	Difficult to control
Solicits attention	Avoids attention/independent
	Captive temperament
Low sensitivity to environmental change	High sensitivity to environmental change
Limited agility	Highly agile/difficult to contain
Small home range	Large home range
Wide environmental tolerance	Narrow environmental tolerance
Non-shelter seeking	Shelter seeking
Implosive herd reaction to threat	Explosive herd reaction
Commensal initiative	
Exploits anthropic environments	Avoids anthropic environments

SOURCE: Developed from Hale (1969), Garrard (1984), and Price (2002).

would have been pulled toward nomadic encampments to scavenge kills or perhaps salvage wounded escapees from the hunt. Thereafter, these wolves may have found utility as barking sentinels, warning of human and animal invaders approaching at night (Lindsay, 2000). Gradually, natural selection and genetic drift resulting from human activities began to differentiate these wolves from the larger autonomous population. Once people had direct interaction with wolves, a subsequent, "cultural process" would have begun. Suitable "preselected" wolf pups taken as pets would have been socialized to humans and unconsciously and unin-

tentionally selected for decreased flight behavior and increased sociality (Muller, 2005), 2 trademarks of tameness. Eventually, people established control over proto-dog mating. From this point forward the wolf in effect became a dog, under constant observation and subject to strong artificial selection for desired traits. Selection for tameness entails morphological and physiological changes through polygenes governing developmental processes and patterns (Trut, 1999; Muller, 2005), and these provide grist for the mill of further iterations of selection. For wolf domestication, the phases of natural and artificial selection blend one into the other, eventuating in “man’s best friend” with doting and obedient behaviors. Although dogs have been prized as household companions for thousands of years, the wide phenotypic variation of modern dog breeds began more recently (3,000–4,000 B.P.), leading to the ≈400 breeds recognized today by the Dog Breeders Associations (Fogle and Morgan, 2000).

### DOMESTICATION OF CATS

The domestication of cats took a different trajectory. Wildcats are improbable candidates for domestication (see Table 5.3). Like all felids, wildcats are obligate carnivores, meaning they have a limited metabolic ability to digest anything except proteins (Bradshaw et al., 1996). Cats live a solitary existence and defend exclusive territories (making them more attached to places than to people). Furthermore, cats do not perform directed tasks and their actual utility is debatable, even as mousers (Elton, 1953). [In this latter role, terrier dogs and the ferret (a domesticated polecat) are more suitable.] Accordingly, there is little reason to believe an early agricultural community would have actively sought out and selected the wildcat as a house pet. Rather, the best inference is that wildcats exploiting human environments were simply tolerated by people and, over time and space, they gradually diverged from their “wild” relatives (Wandeler et al., 2003; Driscoll et al., 2009). Thus, whereas adaptation in barnyard animals and dogs to human dominion was largely driven by artificial selection, the original domestic cat was a product of natural selection.

A comprehensive genetic examination of the *Felis silvestris* species complex by our group revealed the relationships between domestic cats and their indigenous wild congeners (Driscoll et al., 2007). We typed 36 short tandem repeat loci and sequenced 2.6 kb of the mitochondrial genes ND5 and ND6 in ≈1,000 cats from wild and domestic settings, including representatives of registered-breed and random-bred pet cats from both feral and household environments. Phylogenetic and clustering analyses identified 5 genetically distinctive *F. silvestris* wildcat subspecies (Fig. 5.2) present in: Europe (*F. silvestris silvestris*, clade I), Southern Africa (*F. silvestris cafra*, clade II), Central Asia (*F. silvestris ornata*, clade III), the Near

TABLE 5.3 Pre-adaptive Features of Some Commonly Encountered Neolithic Fauna

Ostensible Wild Progenitor		Amenable	Food
Common Name	Latin Name	Social Structure	Preferences
Bezoar	<i>C. aegagrus</i>	Y	Y
Mouflon	<i>Ovis orientalis</i>	Y	Y
Auroch	<i>B. primigenius</i>	Y	Y
Wild pig	<i>S. scrofa</i>	Y	Y
Red deer	<i>Cervus elaphus</i>	N	Y
Persian fallow deer	<i>Dama mesopotamica</i>	N	Y
Common fallow deer	<i>Dama dama</i>	Y	Y
Arabian gazelle	<i>Gazella gazella</i>	N	Y
Goitered gazelle	<i>Gazella subgutturosa</i>	N	Y
Dorcas gazelle	<i>Gazella dorcas</i>	N	Y
Forest horse	<i>E. caballus</i>	Y	Y
Nubian wild ass	<i>E. asinus africanus</i>	N	Y
Syrian onager	<i>Equus hemionus hemionus</i>	N	Y
Persian onager	<i>E. hemionus hemippus</i>	N	Y
Dromedary camel	<i>C. dromedarius</i>	Y	Y
Bactriam camel	<i>C. bactrianus</i>	Y	Y
Indian elephant	<i>Elephas maximus</i>	Y	Y
Forest elephant	<i>Loxodonta africana</i>	Y	Y
Cape hare	<i>Lepus capensis</i>	N	Y
Black rat	<i>R. rattus</i>	Y	Y
Brown rat	<i>R. norvegicus</i>	Y	Y
Gray mouse	<i>M. musculus</i>	Y	Y
Sparrow	<i>P. domesticus</i>	Y	Y
Weasel	<i>Mustela nivalis</i>	Y	N
Marbled polecat	<i>Vormela peregusna</i>	Y	N
European otter	<i>Lutra lutra</i>	Y	N
European badger	<i>Meles meles</i>	N	N
Ichneumon	<i>Herpestes ichneumon</i>	Y	N
Steppe polecat	<i>Mustela eversmanni</i>	Y	N
Gray wolf	<i>C. lupus</i>	Y	Y
Red fox	<i>Canis vulpes</i>	Y	Y
Ruppell's fox	<i>Vulpes ruppellii</i>	N	N
Golden jackal	<i>Canis aureus</i>	Y	Y
Wildcat	<i>F. silvestris (lybica)</i>	N	N
Jungle cat	<i>Felis chaus</i>	N	N
Sand cat	<i>Felis margarita</i>	N	N
Cheetah	<i>Acinonyx jubatus</i>	N	N
Leopard	<i>Panthera pardus</i>	N	N
Lion	<i>Panthera leo</i>	Y	N

NOTES. Categories synthesized from Hale (1969), Garrard (1984), Price (2002), and Diamond (2005); q.v. for discussion and original reports. See also Fraser et al. (1997) for a schematic useful in understanding the role of pre-adaptations in inceptive domestication.

<sup>a</sup>No selective breeding, individuals are turned out to the wild to breed and are subsequently recaptured. Very slow growth of young makes raising uneconomical (Garrard, 1984; Lair, 1997).

Captive Breeding	Intra- or Interspecies Aggressiveness	Amenable Captive Temperament	Commensal Initiative	Common Name of Descendent Domestic Form
Y	N	Y	N	Goat
Y	N	Y	N	Sheep
Y	N	Y	N	Cattle
Y	N	Y	N	Pig
Y	N	Y	N	
Y	N	Y	N	
Y	N	Y	N	
N	N	N	N	
N	N	N	N	
N	N	N	N	
Y	N	Y	N	Horse
Y	N	Y	N	Donkey
N	Y	N	N	
N	Y	N	N	
Y	N	Y	N	Camel
Y	N	Y	N	Camel
N <sup>a</sup>	N	Y	N	
N <sup>b</sup>	N	Y	N	
Y	N	?	N	
Y	N	Y	Y	Rat
Y	N	Y	Y	Rat
Y	N	Y	Y	House mouse
Y	N	Y	Y	House sparrow
Y	N	Y	?	
Y	N	Y	?	
?	N	Y	N	
?	N	Y	N	
Y	N	Y	?	
Y	N	Y	N	Ferret
Y	Y	Y	Y	Dog
Y	N	Y	Y	Silver fox <sup>c</sup>
?	N	?	N	
?	N	Y	N	
Y	N	Y	Y	Cat
Y	N	Y	N	
N	N	Y	N	
N	Y	Y	N	
Y	Y	Y	N	
Y	Y	Y	N	

<sup>b</sup>Economic and breeding considerations are projected to be the same for *L. africana* as for *E. maximus*.

<sup>c</sup>Experimentally domesticated (Trut, 1999).

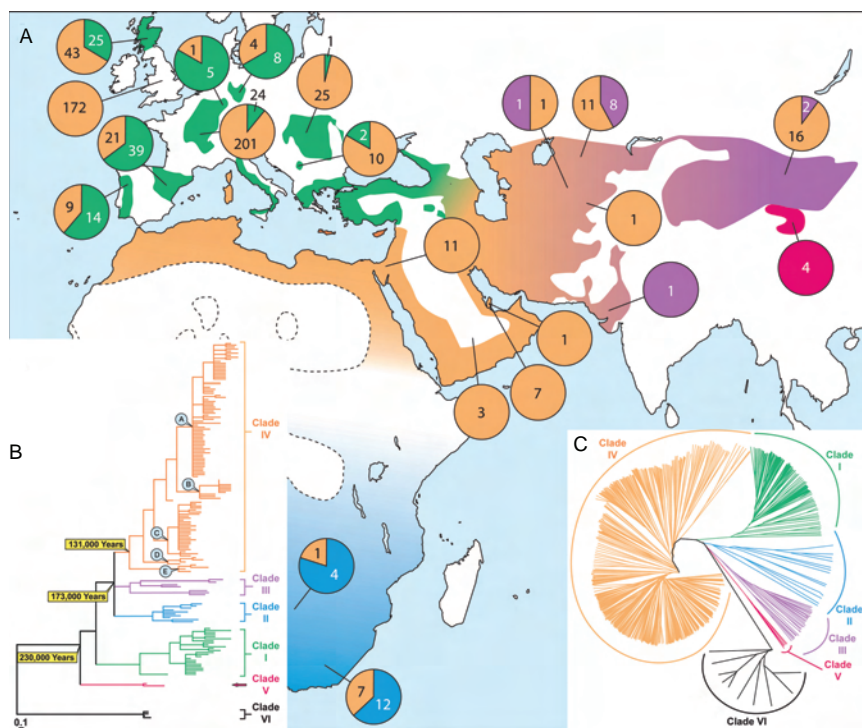

FIGURE 5.2 Distribution of *F. silvestris* microsatellite and mitochondrial genotypes with associated dendrograms. (A) Textured regions on map reflect the distribution of different STR genotype clades (see key at top). The mtDNA haplotype frequencies are indicated in pie charts specifying the number of specimens carrying each mtDNA haplotype clade. Domestic cats, *F. silvestris catus*, are distributed worldwide and overwhelmingly carry mtDNA clade IV mtDNA haplotypes. (B) Minimum evolution/neighbor-joining phylogram of 2,604 bp of the ND5 and ND6 gene of 176 mitochondrial haplotypes discerned from 742 specimens sampled across the range of the wildcat (from Europe, Asia, and Africa), Chinese mountain cat, domestic cat, and sand cat. Genetic distance estimators [see Driscoll et al. (2007) for details] provided concordant topologies that specified 6 clusters corresponding to the following subspecies designations: (1) *F. silvestris silvestris* wildcats from Europe ( mtDNA Clade I); (2) *F. silvestris cafra* wildcats from Southern Africa (mtDNA Clade II); (3) *F. silvestris ornata* wildcats from central Asia east of the Caspian Sea (mtDNA Clade III); (4) *F. silvestris lybica* wildcats from the Near East (mtDNA Clade IV); (5) *F. silvestris bieti*, Chinese mountain cats (mtDNA Clade V); and (6) *F. margarita*, sand cat (mtDNA Clade VI). The Chinese mountain cat is here referred to as a wildcat subspecies, *F. silvestris bieti*, as supported by data presented in Driscoll et al. (2007). The coalescence-based age of mtDNA ancestral nodes for all *F. silvestris* mtDNA lineages was estimated with the linearized tree method (Takezaki et al., 1995). The estimated age for the ancestor of *F. silvestris*



East (*F. silvestris lybica*, clade IV), and the northern edge of the Tibetan plateau (*F. silvestris bieti*, clade V). Local wildcat populations retained genetic signatures that tied them to their respective regions (Fig. 5.2A). In contrast, the world's domestic cats carried genotypes that differentiated them from all local wildcats except those from the Near East. Domestic cats show no reduction in genetic diversity compared with the wild subspecies (Driscoll et al., 2007), thus giving no indication for a founding genetic bottleneck. Multiple genetic analyses produced concordant results, in each case tracing the maternal origins of cat domestication to at least 5 wildcat lines (A through E, Fig. 5.2B) originating in the Near East. The domestic cat is referred to as a sixth subspecies, *F. silvestris catus*, although it is clear that domestic cats derive very recently from *F. silvestris lybica* (Driscoll et al., 2007).

Cat domestication dates to at least 3,600 B.P., when what are clearly house cats are depicted in tomb paintings of the Egyptian New Kingdom (Clutton-Brock, 1993, 1999). However, the oldest archaeological evidence of cat taming dates to  $\approx$ 9,500 B.P. in Crete (Vigne et al., 2004) and cat remains have also been dated to 8,700 B.P. from Jericho (Zeuner, 1963). Given that, a reasonable window for cat domestication is 9,500–3,600 B.P. However, we estimated a coalescence date of 131,000 years ago for the *catus/lybica* mtDNA clade (Driscoll et al., 2007). This date is greater by at least an order of magnitude than any plausible domestication event but can in principle be explained by multiple maternal-lineage recruitments from the wild source population (Jones and Brown, 2000). Considering the broadest range of dates for domestication to be from 11,000 to 4,000 B.P., and applying an internally calibrated mutation rate for cat mitochondrial DNA (mtDNA) (Lopez et al., 1997), we expect 0–3 mutations over the 2.6-kb mtDNA surveyed in modern domestic cats (Driscoll et al., 2007). We note that  $\approx$ 90% of domestic cats share haplotypes that are 1 nucleotide diverged from each other, a finding that is consistent with these mutations having occurred very recently. Domestic cat mtDNA is therefore expected to have few, if any, widely divergent domestic-specific haplotypes. Our sample, in effect, represents a sampling of the source wildcat population's

*lybica* and domestic cats (mtDNA clade IV) is 131,000 years. Other methods of date estimation suggested a range from 107,000 to 155,000 years (Driscoll et al., 2007). These estimates are all greater by an order of magnitude than archaeological evidence for cat domestication (Vigne et al., 2004). The persistence within mtDNA clade IV of 5 well-supported mtDNA matriline (A–E) dating back a hundred thousand years before any archaeological record of domestication indicates that domestic cats originated from at least 5 wildcat mtDNA haplotypes. (C) A phenogram [based on short tandem repeat (STR) data] for 851 domestic and wild specimens of *Felis silvestris*. Clade designations as in B.

mitochondrial genetic diversity. In sum, the genetic evidence appears to be most consistent with a single protracted domestication episode, one incorporating multiple wildcat matrilineages over the broad Near Eastern human cultural area. We feel this development can best be understood in the context of agricultural development patterns. The following scenario for cat domestication seems likely.

### SYMPATRIC DIVERGENCE AND PLURAL MITOCHONDRIAL ORIGINS

The available archaeological evidence indicates that the process of wildcat domestication began in the Neolithic in the same place and time as the development of year-round settlements and the onset of an agricultural economy (Clutton-Brock, 1993; Vigne et al., 2004; Driscoll et al., 2007). As far as the local fauna was concerned, these permanent human settlements developed *ex nihilo*. Opportunistic animals apparently ventured into this new urban environment, rich in food year-round and free of most predators, and found fertile new ecological niches to exploit (Zeuner, 1963; Coppinger and Smith, 1983). The ability to live around people therefore conferred important advantages to those animals that adapted to it (Morey, 1994). Commensal species such as mice, rats, and sparrows that adapted to human village environs (and their trash) probably emerged first. Although the earliest grain cache (of wild, not domestic, grains) in the Near East is dated to 21,000 B.P. (Tanno and Willcox, 2006), the origin of agriculture per se in the region is dated to between 12,500 and 11,250 B.P. (Hillman et al., 2001), and it is from approximately this period that house mice locally appeared (Auffray et al., 1988). Resident populations of peridomestic rodents sustained by trash dumps and stockpiles of grain provided a reliable food source for native wildcats, which then became adapted to an “urban” environment as peridomestic human commensals themselves (Serpell, 1990; Sunquist and Sunquist, 2002).

Cereal domestication in the Fertile Crescent is characterized by multiple independent domestication of multiple grain species in multiple centers from the southern Levant through Syria to southern Anatolia (Willcox, 2005). If cat domestication is largely a sequela of the development of towns (enhanced by the domestication of grains), divergent mitochondrial lineages (A–E in Fig. 5.2B) may not be unexpected, because recruitment of naturally occurring wildcat mitochondrial lineages would reflect the wide distribution of human settlements. Bearing in mind that an mtDNA gene tree represents only a tiny subset of the species’ genetic history (MacHugh and Bradley, 2001; Avise, 2004), and considering domestication as a polygenic trait affecting behavior (Trut, 1999), the polygenic allelic series behind domesticity and mtDNA need not have congruent

histories. Over time and space, multiple wildcat matrilineages would have been incorporated into the domestic cat gene pool through the admixture of an initial domesticate with additional wild female conspecifics, thereby spreading genes for the domestic phenotype through the early Fertile Crescent agricultural area. Thus, the relatively profound depth (131,000 years) of the *catus/lybica* clade may be best explained by a protracted wildcat domestication process that spanned thousands of years and extended over much of the Fertile Crescent (Fig. 5.1). The alternative hypothesis—of multiple independent domestication events—seems unlikely for 2 reasons: First, the vast majority of sampled domestic cats fall into the same mtDNA clade, which also includes *F. silvestris lybica*; and second, the clade lacks biogeographic structure. Individual house cats from any one sampling area may fall into any lineage, and even the most genetically divergent lineages have domestic individuals from the same sampling area. An important validation of this hypothesis awaits the identification of the causal mutations mediating domestic behavior in cats. Finding different mutations for the tame phenotype would suggest the multiple independent invention of domestication in cats, whereas finding the identical mutation(s) in all 5 domestic cat lineages would support a single origin for the gene complex spread by population diffusion.

Taken together, these results provide both phylogenetic and phylogeographic evidence that the divergence of domestic cat from wildcat occurred sympatrically. First, with respect to phylogeny, the monophyly of distinct taxa from the same environment (domestic cat and wildcat from the Near East) (Fig. 5.2B and C) is clearly consistent with sympatric divergence. Second, with respect to phylogeography, sympatric divergence seems plausible because domestic cat and Near Eastern wildcat are phenotypically divergent (in terms of behavior) yet are more closely related to one another than Near Eastern wildcat are to more phenotypically similar allopatric groups (such as Asiatic wildcat or Southern African wildcat) (Fig. 5.2A). This scenario supposes a model of sympatric habitat-race formation in which habitat-specific beneficial mutations accumulated by assortative mating into a coherent allelic series. Importantly, this model avoids the “selection-recombination antagonism” described by Felsenstein (1981), whereby genes required for mating and genes required for assortative mating must be linked, because the same genes that drive habitat choice also drive assortative mating [see Via (2001) for review].

It seems likely that behavioral genes affecting domestication were initially selected by habitat choice of individual wildcats better fit for urban life, and that these genes were later transferred to geographically disparate spots, promoted by a human preference for tameness and perhaps the translocation of these individuals. However, it is also possible that individual component polygenes contributing to domestication derive

from different population recruitments as well. Each adaptive locus/allele may have been independently selected in a different Fertile Crescent population and through time these combined, each allele contributing an increasingly additive effect, until their genomic consilience in an irrefutably domestic animal. Domestication in cats could thus be an allelic series of independently selected alleles from throughout the wildcat natural range, but assembled as a composite. In an analogous fashion, modern pig and cattle breeds are routinely “improved” via the introduction of advantageous alleles through crossbreeding distant strains (descended from independent Oriental and European domestications in pigs, and from European and Southeastern Asia in cattle), rather than by independent selection of each trait within each lineage.

### IS WILDCAT DOMESTICATION COMPLETE?

At its most basic, domestication is a dependence on humans for food, shelter, and control of breeding (Price, 2002). Because 97% or more of the nearly 1 billion domestic cats living today are random-bred house cats, or are feral and intact, the overwhelming preponderance of domestic cats choose their own mates. Only a tiny fraction of cats (mostly those in registered breeds) have mates chosen for them (prezygotic selection). Furthermore, the majority of feral cats obtain what they eat without human assistance. Additionally, the domestic cat varies little morphologically from the wildcat body plan (Yamaguchi et al., 2004a,b), although, as Darwin noted, domestic cats have longer intestines than wildcats, a trait he attributed to a “less strictly carnivorous diet” as a result of feeding on kitchen scraps (Darwin, 1890). So an argument can be made that cat domestication is <200 years old and may yet be incomplete (Serpell, 1990). Domestic cats have, however, become polyestrous, and their coat colors often depart wildly from the wildcat’s striped mackerel tabby. And domestication did socialize the wildcat (cats are the only domesticate that is social under domestication yet solitary in the wild). However, the most noticeable adaptation is the cat’s overwhelming tolerance of people, a key attribute of any domesticated animal, but certainly the primary feature that has made cats the delightful and flourishing profiteers in our homes that they are.

The modern domestic cat is the product of 11 million years of natural selection in a world free of people (Johnson et al., 2006; O’Brien and Johnson, 2007), and 12,000 years of natural selection in a world increasingly dominated by humanity (Johnson et al., 2006; O’Brien and Johnson, 2007). In 1868, Darwin commented that there are no breeds of cats native to England because of a lack of selective breeding (Darwin, 1890, Vol. I,

p. 50 and Vol. II, p. 222). The power of artificial selection to produce modern fancy cat breeds has only recently—within the last 200 years—been brought to bear on the accumulated store of wildcat genetic variation (Fogle, 2001; Stephens and Yamazaki, 2001). But already the pace of change is quickening, and the previously uniform wildcat is found in varieties of hairless and longhair, dwarf and giant, which Darwin himself would have wondered at.

### ACKNOWLEDGMENTS

We thank John Avise and 2 anonymous reviewers for helpful comments on an earlier draft of this manuscript.



## 6

# Tracking Footprints of Maize Domestication and Evidence for a Massive Selective Sweep on Chromosome 10

---

FENG TIAN,\* NATALIE M. STEVENS,\* and  
EDWARD S. BUCKLER IV\*<sup>†‡</sup>

Maize domestication is one of the greatest feats of artificial selection and evolution, wherein a weedy plant in Central Mexico was converted through human-mediated selection into the most productive crop in the world. In fact, the changes were so astounding that it took much of the last century to identify modern maize's true ancestor. Through modern genetic studies, the molecular basis of this evolution is being unraveled. Maize's new morphology and adaptation to diverse environments required selection at thousands of loci, and we are beginning to understand the magnitude and rates of these genetic changes. Most of the known major genes have experienced strong selection, but only small regions surrounding the selected genes exhibit substantially reduced genetic diversity. Here, we report the discovery of a large region on chromosome 10 involved in adaptation or domestication that has been the target of strong selection during maize domestication. Unlike previously described regions in the maize genome, 1.1 Mb and >15 genes lost genetic diversity during selection at this region. Finally, the prospects of a detailed understanding of maize evolution are discussed with consideration of both top-down and bottom-up approaches.

---

\*Institute for Genomic Diversity and <sup>†</sup>Department of Plant Breeding and Genetics, Cornell University, Ithaca, NY 14850; and <sup>‡</sup>United States Department of Agriculture, Agricultural Research Service, Ithaca, NY 14850.

Although man does not cause variability and cannot even prevent it, he can select, preserve, and accumulate the variations given to him by the hand of nature almost in any way that he chooses; and thus he can certainly produce a great result.

Charles Darwin (1868b)

**W**ith its meager ear containing only 2 entwined rows of well-armored kernels, teosinte grows on Mexican hillsides. This grass might easily have been overlooked were it not for its abundant variation, a gift not lost on early agriculturists. Within the last 10,000 years, early Native Americans were able to transform teosinte into a plant whose ears would feed the world. It was a transformation so striking and so complex that some researchers did not believe it was possible, leading to years of competing theories and intense debate. But as Darwin himself recognized, when the desires of humans meet the diversity of nature the result can indeed be astounding.

The molecular revolution of the last 2 decades has provided compelling evidence that teosinte is the progenitor of modern maize. Here, we discuss the rich genetic diversity at the source of this morphological conversion and examine how human selection has impacted this diversity. One key question concerning maize domestication remains to be resolved: Was maize domestication the result of selection on a small number of loci with large effects, a large number of loci with small effects, or both? Recent genetic evidence has provided clues about the relative contributions of large-effect and small-effect loci. We discuss how future studies will help unravel the mysteries surrounding maize domestication and how this information is key to future improvements of maize.

## ORIGINS OF MAIZE

Maize (Poaceae) is a member of the world's most successful family of agricultural crops, including wheat, rice, oats, sorghum, barley, and sugarcane. Maize belongs to the genus *Zea*, a group of annual and perennial grasses native to Mexico and Central America. The genus *Zea* includes wild taxa known collectively as teosinte (*Zea mays* ssp. *parviglumis*) and domesticated corn or maize (*Z. mays* ssp. *mays*).

For many years, relationships within the genus *Zea* were the subject of much controversy. The central difficulty in the taxonomy of maize and the identification of its closest relatives was the absence of a cob-like pistillate inflorescence, or "ear," in any other known plant. Whereas teosinte produces only 6–12 kernels in 2 interleaved rows protected by a hard outer covering (Fig. 6.1), modern maize boasts a cob consisting of as





FIGURE 6.1 The seed spike, or ear, of teosinte (*Z. mays* ssp. *parviglumis*) consists of 2 interleaved rows of 6–12 kernels enclosed in a hard fruitcase (cupule). This female inflorescence, which differs so dramatically from that of maize, has led to much controversy and debate surrounding the origins of maize. (Photos by John Doebley.)

many as 20 rows or more with numerous exposed kernels. In fact, teosinte is so unlike maize in the structure of its ear that 19th-century botanists failed to recognize the close relationship between these plants, placing teosinte in its own genus, *Euchlaena* (Doebley, 1990). Essentially, every new genetic technology and approach developed over the last century has been applied in an effort to resolve the question of precisely how teosinte and modern maize are related genetically.

The tremendous differences in morphology between teosinte and maize led Paul Mangelsdorf and his colleague Robert Reeves in the late 1930s to propose the Tripartite Hypothesis (Mangelsdorf and Reeves, 1938, 1939; Mangelsdorf, 1974). This hypothesis stated that maize was domesticated from a now-extinct wild maize from South America; teosinte originated from a cross between maize and another grass, *Tripsacum*; the abundant diversity in maize was thought to be caused by “contamination” of *Tripsacum* chromosomes. This hypothesis was validated by their successful cross of maize and *Tripsacum*, although only a few, largely sterile maize-*Tripsacum* hybrids were obtained through surgical rescue of embryos. They also analyzed backcross populations of maize-teosinte hybrids and identified 4 factors (which they interpreted as 4 *Tripsacum* chromosomal segments)

responsible for the morphological differences between maize and teosinte (Mangelsdorf and Reeves, 1938, 1939; Mangelsdorf, 1974).

For George Beadle, however, the morphological differences between maize and teosinte were not so large as to require an extinct ancestor. In his Teosinte Hypothesis, Beadle stated that maize is simply a domesticated form of teosinte (Beadle, 1939). He believed that, through artificial selection by ancient humans, several mutations with relatively large effects could have transformed teosinte into maize. Beadle actually used Mangelsdorf and Reeves's own data against them, claiming that their 4 factors might just as well correspond to 4 major genes, each of which controlled a single trait that differentiated teosinte from maize. He also challenged their idea that a cross between maize and *Tripsacum*, which took Herculean efforts, would have ever occurred in nature.

Despite these profound physical differences and controversial hypotheses, various morphological, cytological, and genetic studies would eventually delineate relationships within the genus *Zea*. H.G. Wilkes laid the foundation for the current classification scheme in 1967 with the first thorough monograph on teosinte (Wilkes, 1967). This work was expanded by the rigorous evaluation of numerous traits and the discovery of many new populations by Sanchez et al. (1998). In 1980, Hugh Iltis and John Doebley (Doebley and Iltis, 1980; Iltis and Doebley, 1980) produced a system of classification that considered the probable evolutionary relationships between *Zea* taxa.

The issue was further resolved through numerous molecular and cytogenetic studies over the last century. One early indication that maize is strongly allied with teosinte came from studies of both chromosome morphology and number. Most *Zea* species and subspecies, including maize, have 10 chromosomes (Kato, 1976; Kato and Lopez, 1990), whereas most *Tripsacum* species have either 18 or 36 chromosomes (Mangelsdorf and Reeves, 1938, 1939). Additionally, the cytogenetic chromosomal knobs of maize are most similar to knobs of *Z. mays* ssp. *parviglumis* and *mexicana* (Mangelsdorf, 1974; Kato, 1976; McClintock et al., 1981). Molecular genetic findings have consistently refined these relationships with data from isozymes (Doebley et al., 1984), chloroplast DNA (Doebley et al., 1987), and ribosomal DNA (Buckler and Holtsford, 1996), all of which implicate ssp. *parviglumis* as the closest living relative of modern maize. Simple sequence repeat markers later suggested that maize was derived in a single domestication event from ssp. *parviglumis* from the Balsas River valley (Matsuoka et al., 2002). That study revealed that ssp. *mexicana* is separated from all maize (ssp. *mays*) samples, whereas samples of ssp. *parviglumis* overlap those of maize, documenting the close relationship between ssp. *parviglumis* and maize and supporting the phylogenetic inference that the latter subspecies was the sole progenitor of maize (Matsuoka et al., 2002).

The overall result of these analyses is that the 2 relevant subspecies of *Z. mays* (i.e., *Z. mays* ssp. *mays*, and *Z. mays* ssp. *parviglumis*) are only slightly differentiated from one another throughout most of their genomes but have, in a very short period, evolved very different morphologies.

Maize has varied in an extraordinary and conspicuous manner.

Charles Darwin (1868b)

## VARIATION: THE FOOD OF EVOLUTION

The ability of Native Americans and modern breeders to transform a wild grass into the world's largest production grain crop is not only the product of skillful breeding, but also a tribute to the tremendous diversity of the teosinte genome. Millennia before Darwin's time, these ancient farmers first practiced what Darwin would later preach, that selection must be combined with natural variation for evolution to take place. As it turns out, teosinte is extremely diverse, with modern molecular studies measuring nucleotide diversity at silent sites in *Z. mays* ssp. *parviglumis* at  $\approx 2\text{--}3\%$  (Goloubinoff et al., 1993; Eyre-Walker et al., 1998; Hilton and Gaut, 1998; White and Doebley, 1999; Whitt et al., 2002). This begs the question as to why *Z. mays* ssp. *parviglumis* has such high genetic diversity. In general, population genetic theory predicts that the level of selectively neutral molecular diversity is a joint function of mutation rate and effective population size, both of which would seem to be large in *Z. mays* ssp. *parviglumis*. A high rate of mutation has been documented in grasses (Gaut et al., 1996), and population size for this wild grass has historically been quite large, especially for the teosintes near maize's region of origin (Moeller et al., 2007).

Any 2 maize varieties differ from one another in 1.4% of their DNA (silent sites) (Tenaillon et al., 2001). This level of nucleotide diversity is 2- to 5-fold higher than that of other domesticated grass crops and 14 times higher than that of humans. Indeed the divergence between 2 maize lines is approximately equivalent to the difference between humans and chimpanzees (Chen and Li, 2001). This high level of genetic diversity results mainly from the unusually large amount of genetic diversity in its wild progenitor, *Z. mays* ssp. *parviglumis*, and the absence of a severe domestication bottleneck. Indeed, maize has apparently maintained a substantial proportion (60–70%) of the variation of its wild progenitor (Tenaillon et al., 2001; Wright et al., 2005), probably because humans (both ancient and modern) rely heavily on domesticated corn as a basis for subsistence, requiring thousands of plants to produce sufficient food for even small family groups (Hillman and Davies, 1990; Buckler et al., 2001). However, this is not the case for some other domesticated crops.

For example, tomato experienced a very severe genetic bottleneck as the crop was carried from the Andes to Europe, resulting in a loss of  $\approx 95\%$  of genetic diversity (Miller and Tanksley, 1990; Bai and Lindhout, 2007), probably because the selection of a horticultural crop like tomato is usually done on a single-plant basis with small numbers of selected plants (Bai and Lindhout, 2007).

### WHAT WERE THE STEPS OF DOMESTICATION LIKE?

On the surface, both dueling hypotheses (i.e., Tripartite Hypothesis and Teosinte Hypothesis) focused on the origins of corn, but at the core of the controversy was a Darwinian debate that was much more fundamental and far-reaching. In one corner were evolutionary traditionalists who held that evolution proceeds slowly over time, because of the accumulation of many small changes in numerous genes. For them, the dramatic transformation from teosinte to maize was deemed impossible in the mere 10,000 years that humans have been domesticating plants, and a more “logical” starting point for natural selection was needed. In the other corner were people like Beadle and Emerson who saw evolution as being more rapid if propelled by changes in a few significant genes. So, although teosinte and maize look strikingly different, the observed differences might be accounted for by only a few major genes, thus explaining why the 2 plants were otherwise genetically similar.

Indeed, the size of the individual evolutionary step depends strongly on the trait under consideration. As we will show below, the initial morphological changes that enabled the shift from a wild grass to a grass whose reproduction depends on humans likely involved only a few genes with large effects. Adaptation to different environments and the increase in harvestable yield, however, probably involved thousands of genes with small effects.

Recent quantitative trait loci (QTL) analyses have provided evidence supporting the notion that a few regions of the maize genome specify the key traits that distinguish maize from teosinte. Beadle conducted what could be considered the intellectual precursors of such QTL analyses. Using basic Mendelian ratios from 50,000 maize and teosinte hybrids, Beadle (1972, 1977, 1980) recognized that as few as 5 loci might be involved in important ear and plant morphological changes. More than 20 years later, QTL mapping would validate this hypothesis, identifying 5 regions of the maize genome with large effects on basic morphology (Doebley et al., 1990; Doebley and Stec, 1991). Two of these regions have now been characterized thoroughly.

A single major locus, *teosinte glume architecture1* (*tga1*), has been identified as a QTL controlling the formation of the tough protective covering on

teosinte kernels that is mostly lacking in maize (Dorweiler et al., 1993). The stone-like fruitcase surrounding teosinte kernels assures their unscathed passage through an animal's digestive tract, allowing seed dispersal. Because teosinte's hard glumes made it very difficult to eat, Native Americans were likely growing, harvesting, and grinding teosinte kernels themselves before the mutation leading to a softer glume came along. Thus, this mutation was probably among the first targets of selection during the domestication process. We now know that a single amino acid mutation in a transcription factor is the most likely cause of this radical change (Wang et al., 2005). And given the radical change in phenotype, it is not surprising that this mutation is not present in teosinte, which would likely be very deleterious in the wild. Given a number of assumptions, the selection intensity can be estimated at 3–4% (Wang et al., 2005). Despite this high intensity, the genomic region encompassed by this selective sweep is relatively small (the 3' end of the gene retains substantial diversity in common with teosinte), an outcome that appears to be consistent with the maintenance of rather large population sizes and relatively unrestricted recombination throughout the domestication process.

A second locus, *teosinte branched1* (*tb1*), which dictates a difference in plant architecture (long lateral branches terminated by male tassels in teosinte vs. short lateral branches tipped by female ears in maize) has been successfully cloned (Doebley et al., 1995, 1997; Wang et al., 1999). Because this locus represents a key step in maize domestication, its nucleotide diversity should be reduced when compared with neutral sites. Indeed, within the promoter region of *tb1*, maize possesses only 3% of the diversity found in teosinte (Wang et al., 1999). As is also true for *tga1*, selection does not appear to have reduced diversity throughout the entire gene. However, the low-diversity region extends 60 kb upstream regions containing some repetitive DNA but no other genes (Clark et al., 2004). Although there is some evidence for multiple functional elements in *tb1*, the major element is 60 kb upstream of the gene (Clark RM, et al., 2006). There is also evidence for a second, distant interfering sweep at this locus (Camus-Kulandaivelu et al., 2008). The timing and sequence of such character selection by early farmers is now being revealed by the fusion of molecular biology and archaeological research. Surveys of *tb1* in ancient DNA have suggested that selection at this locus occurred 4,400 years ago (Jaenicke, 2003). It appears that the allele for this transformation is present in teosinte, but this possibility needs to be tested rigorously (i.e., by unraveling the full allelic series). The fitness of this locus in wild plants and whether the gene might be advantageous in particular environments is also unclear.

The large phenotypic effects of *tga1* and *tb1* undoubtedly facilitated their molecular cloning. However, how representative are these genes for

the genetic basis of the domestication syndrome? With the development of a larger QTL mapping population with more power to detect QTL, Briggs et al. (2007) were able to identify more regions that contributed to the morphology of domesticated maize. In total, they detected 314 QTLs for 22 morphological traits over 2 locations. Of these, only 14 QTLs individually explained >10% of the phenotypic variation in a given trait. Most of these 14 QTLs are large-effect loci identified as essential for the transformation of teosinte to maize (Doebley and Stec, 1993). The number of QTLs detected per trait varied substantially from 6 to 26. Interestingly, for some traits they did not detect large-effect QTLs but only a number of small-effect QTLs. These results suggested that although a few genes may make the species dependent on humans for propagation, the subsequent process of genetic modification to meet human needs such as increased harvestable yield and better kernel quality or adaptation to local environments might have involved more loci with small effects, resulting in a more complex evolutionary pattern. Indeed, large-scale surveys of molecular diversity have indicated that thousands of genes might have been involved in the domestication and improvement processes. Recently, the characterization of agronomically important pathways and the dissection of complex traits have further enhanced our understanding of maize domestication.

Surveys of random markers and genes throughout the maize genome suggested that numerous genes have been targets of selection since domestication (Vigouroux et al., 2002, 2005; Wright et al., 2005; Yamasaki et al., 2005). In screens of microsatellites,  $\approx 5\%$  of the genome was deduced from indirect evidence to have been targeted by selection (Vigouroux et al., 2002, 2005). In their survey of 774 maize genes, Wright et al. (2005) provided another estimate of the proportion of the genes under selection:  $\approx 2\text{--}4\%$ . If the maize genome contains 59,000 genes, Wright et al.'s estimation suggested that a minimum of 1,200 genes throughout the genome have been targets of selection during maize domestication.

Starch is the key product of maize, accounting for 73% of the kernel's total weight. The genes involved in starch synthesis are among the most important for grain production, critical to both the yield and the quality of the grain. Association analysis of 6 major candidate genes involved in starch biosynthesis (*ae1*, *bt2*, *sh1*, *sh2*, *su1*, and *wx1*) revealed that 4 of them were significantly associated with either starch concentration or composition, each of which explained <10% of phenotypic variation (Wilson et al., 2004). The survey of the nucleotide diversity and selection testing at these 6 genes was striking. Four of the 6 loci exhibited evidence of selection (Whitt et al., 2002). Ancient DNA analysis from maize samples unearthed in Mexico and the southwestern United States has also revealed that the *su1* alleles known to occur in modern maize were



likely under selection between 1,800 and 900 years ago (Jaenicke, 2003). These results suggested that Native Americans and modern breeders might have focused on improving the yield of starch and favored different amylopectin qualities.

The genetic dissection of maize flowering time and kernel composition has also argued that, despite large changes in phenotype, the alleles at the basis of these traits generally have small effects. Today, maize landraces flower from 36 days to >180 days after planting (M. Goodman, personal communication). But even at the *Vgt1* locus, one of the biggest effect genes involved in the adaptation to northern environments has only a 1.5-day effect (Salvi et al., 2007; J. Peiffer, personal communication).

To investigate the genetic architecture of kernel oil content, the University of Illinois has conducted the world's longest controlled selection experiment; they have selected for maize with high and low kernel oil concentration for >70 generations. This selection has expanded the range of phenotypic variation  $\approx$ 20-fold between high and low oil lines. However, a molecular QTL analysis suggested that >50 genes control the variation with no major genes (Laurie et al., 2004).

## SELECTION ON CHROMOSOME 10

Several large-effect QTLs for local adaptation (Ribaut et al., 1996; Bouchez et al., 2002; Mano et al., 2008; Wang et al., 2008) and domestication traits (Briggs et al., 2007) have been localized to the vicinity of bin 10.04 on chromosome 10. These studies suggest that recent positive selection for domestication and adaptation traits may have played an important role in shaping patterns of genetic diversity in this region. We evaluated this hypothesis by resequencing a diverse panel of maize and teosinte germplasm (see *Materials and Methods*). Here, we demonstrate that this region exhibits a more extensive signal for positive selection than any other known region in the maize genome.

Initially, sequencing of candidate genes under a chromosome 10 QTL peak highlighted *ZmETR2*, a maize orthologue of the *Arabidopsis* ethylene receptor *ETR2* (Sakai et al., 1998). *ZmETR2* had unusually low genetic diversity in maize relative to teosinte, suggesting possible selection at this locus. To investigate the signature of selection in this region in more detail, we sequenced 22 loci spanning  $\approx$ 4 Mb in a panel of 28 diverse maize inbreds and 16 teosinte (*Z. mays* ssp. *parviglumis*) inbreds (see *Materials and Methods*). Maize exhibits severely reduced nucleotide diversity relative to teosinte across a 1.1-Mb region of chromosome 10 (Fig. 6.2A). Only 3.6% of the silent site diversity was retained in maize as compared with teosinte (Table 6.1). This extreme reduction of diversity suggested that functional variants within this 1.1-Mb region might have experienced recent and strong positive selection.

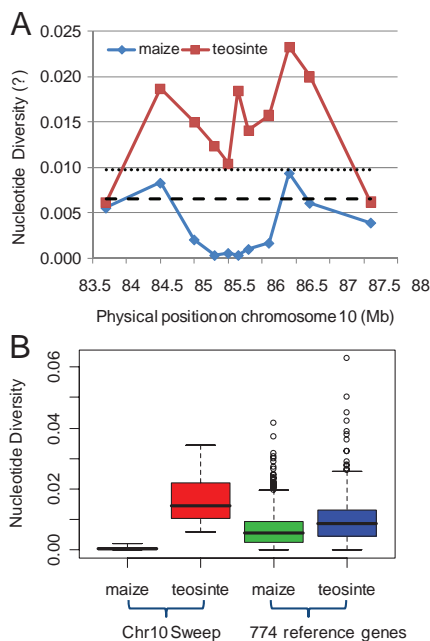

FIGURE 6.2 Nucleotide variation of studied regions on chromosome 10. (A) Nucleotide diversity ( $\pi$ ) for maize and teosinte along the investigated regions on chromosome 10. The dotted line and dashed line represent the average nucleotide diversity of 774 genes (Wright et al., 2005) in teosinte and maize samples, respectively. (B) The comparison of nucleotide diversity ( $\pi$ ) between chromosome 10 selective sweep and 774 reference genes (Wright et al., 2005).

To delimit the region affected by the selective sweep, we performed 3 selection tests. (i) We compared the observed heterozygosity in maize and teosinte samples to those from simulations to determine whether the empirical pattern is significantly different from that expected under the standard neutral demographic models. We detected significant deviations from neutral expectation at loci 4–20 in maize ( $P < 0.05$ ) (Table 6.1). No significant deviations from neutral expectations were observed at loci 1–3 and loci 21–23 in maize samples and all loci in teosinte samples. (ii) We used the HKA test (Hudson et al., 1987) to examine within-species polymorphisms and between-species divergence. Under the neutral theory of molecular evolution, the amount of within-species diversity should be correlated with levels of between-species divergence (Kimura, 1983). We first examined the heterogeneity of the polymorphism to divergence ratio across the studied loci. We found significant heterogeneity across investigated loci in maize ( $\chi^2 = 17.65$ ,  $P = 0.016$ ), suggesting that these loci



TABLE 6.1 Summary of Sequence Data of Chromosome 10 Regions Investigated

Locus	Position, Mb	Maize										Teosinte										$\pi_{\text{maize}}/\pi_{\text{teosinte}}$ (%)
		Tajima's D					Tajima's D					Tajima's D					Tajima's D					
		N	L	S	$\pi_{\text{silent}}$	$\theta_{\text{silent}}$	N	L	S	$\pi_{\text{silent}}$	$\theta_{\text{silent}}$	N	L	S	$\pi_{\text{silent}}$	$\theta_{\text{silent}}$	N	L	S	$\pi_{\text{silent}}$	$\theta_{\text{silent}}$	
1	83.70	14	191	2	0.0056	0.0032	1.932	NA	13	198	4	0.0062	0.0065	-0.153	NA	89.7						
2	84.50	27	497	4	0.0083	0.0069	0.550	0.024	15	462	9	0.0187	0.0201	-0.524	0.023	44.4						
3	85.00	21	377	2	0.0021	0.0061	-1.514	0.027	8	467	11	0.0150	0.0138	-0.958	0.028	14.0*						
4	85.30	26	413	1	0.0004**	0.0006**	-0.714	NA	12	400	19	0.0124	0.0157	-0.930	NA	3.2**						
5	85.50	27	474	0	0.0000**	0.0000**	NA	NA	11	475	25	0.0152	0.0180	-0.718	NA	0.0**						
6	85.50	28	334	1	0.0006**	0.0008**	-0.363	NA	12	336	15	0.0104	0.0148	-1.268	NA	5.8**						
7	85.65	27	405	0	0.0000**	0.0000**	NA	NA	9	429	16	0.0157	0.0146	0.385	NA	0.0**						
8	85.65	28	446	1	0.0002**	0.0006**	-1.151	0.052	11	465	12	0.0061	0.0066	-0.758	0.054	3.3**						
9	85.65	25	559	1	0.0000**	0.0000**	-1.151	0.041	10	683	26	0.0219	0.0230	-0.283	0.05	0.0**						
10	85.65	28	626	1	0.0016**	0.0009**	1.213	0.026	12	627	11	0.0132	0.0139	-0.212	0.027	12.1*						
11	85.65	27	582	1	0.0000**	0.0000**	-0.338	0.009	12	552	5	0.0142	0.0134	0.227	0.003	0.0**						
12	85.65	27	716	0	0.0000**	0.0000**	NA	0.021	8	714	7	0.0086	0.0100	-0.667	0.020	0.0**						
13	85.65	28	561	0	0.0000**	0.0000**	NA	0.057	11	515	14	0.0089	0.0093	-0.183	0.057	0.0**						
14	85.65	27	787	1	0.0002**	0.0003**	-0.728	NA	14	751	20	0.0068	0.0084	-0.784	NA	2.9**						
15	85.65	27	610	1	0.0003**	0.0004**	-0.338	NA	11	570	48	0.0290	0.0300	0.045	NA	1.0**						
16	85.65	26	466	3	0.0009**	0.0017*	-1.090	NA	8	558	51	0.0344	0.0353	0.035	NA	2.6**						
17	85.65	28	660	3	0.0006**	0.0012**	-1.165	NA	10	652	64	0.0338	0.0352	-0.200	NA	1.8**						
18	85.65	26	501	3	0.0006**	0.0016*	-1.513	NA	11	557	48	0.0296	0.0307	-0.165	NA	2.0**						
19	85.80	27	720	9	0.0010**	0.0036	-2.275**	NA	11	750	29	0.0142	0.0129	-0.073	NA	7.0**						
20	86.10	26	421	3	0.0017**	0.0019*	-0.216	NA	14	461	28	0.0158	0.0191	-0.743	NA	10.8**						
21	86.40	26	595	21	0.0094	0.0161	-1.496	NA	13	586	28	0.0233	0.0261	-0.421	NA	40.3						
22	86.70	27	487	12	0.0061	0.0089	-0.846	NA	15	467	22	0.0200	0.0206	-0.241	NA	30.5*						
23	87.60	25	670	5	0.0039	0.0023	1.967	0.025	11	666	12	0.0063	0.0068	-0.411	0.026	61.9						

NOTES. 1 Locus 1, pza00048 obtained from Wright et al. (2005); 2, pzb03525; 3, pzb03526; 4, pzb03527; 5, pzb03528; 6, pzb03529; 7-18, pzb03530-pzb03532, pzb02831, pzb03533-pzb03540; 19, pzb03541; 20, pzb03542; 21, pzb03543; 22, pzb02753; 23, pzb02851. The relative physical locations of investigated regions are based on the Maize Agarose FPC Map ([www.genome.arizona.edu/fpc/maize](http://www.genome.arizona.edu/fpc/maize)). N, number of sequence; L, the length of a given locus; S, number of segregating sites;  $\pi$  and  $\theta$  were estimated for noncoding and synonymous sites; k, divergence between maize or teosinte and *Tripsacum dactyloides*. NA, not available.

\*Significant at the 0.05 level.

\*\*Significant at the 0.01 level.

have experienced different evolutionary histories. Then, using 9 known unlinked neutral genes (Tenailon et al., 2001) as controls, we found significant departures from neutral expectation at loci 8–13 ( $\chi^2 = 54.08$ ,  $P < 0.0001$ ) in maize. Locus 3 is marginally significant ( $\chi^2 = 12.83$ ,  $P = 0.095$ ), and loci 2 and 23 are not significant ( $P = 0.186$  and  $0.119$ , respectively). We did not detect any significant departure from neutral expectations in teosinte samples in any of the tests. Moreover, we can exclude selective constraints and low mutation rates as reasons for the observed pattern because neither divergences in maize or teosinte were found to be significantly different from the genomewide average when using *Tripsacum dactyloides* as an outgroup (Table 6.1). (iii) We evaluated the probability of the observed reduction of genetic diversity in maize relative to teosinte under the neutral maize domestication bottleneck model. We simulated a population bottleneck for each studied locus by using parameters of the maize domestication bottleneck model established in Wright et al. (2005) (see *Materials and Methods*). Significant deviations from expectations under a neutral domestication bottleneck were detected at loci 3–20 ( $P < 0.05$ ), suggesting that the severe loss of genetic diversity at loci 3–20 in maize relative to teosinte cannot be explained by the maize domestication bottleneck alone. Thus, selection might have strongly shaped the genetic diversity of these loci.

Phylogenetic analysis of the investigated region revealed a star-like phylogeny within this swept region, a typical characteristic of selective sweep (Kaplan et al., 1989; Meiklejohn et al., 2004). Outside of the swept regions, however, the genealogies reverted to neutral expectation, with all maize samples interspersed with teosinte samples.

The large interval (1.1 Mb) affected by this selective sweep suggested that selection was recent and strong. However, the size of this sweep could be caused by a low local recombination rate. Preliminary evidence from mapping populations suggested that the local recombination is suppressed  $\approx 5$ -fold (M. McMullen, personal communication). Indeed, the nucleotide estimates of population recombination rate indicated that the recombination rate across the sweep region ( $R_n = 0.0414$ ) was  $\approx 3$ -fold lower than it was at the known selection target, *tga1* [ $R_n = 0.1205$  (Wang et al., 2005)]. This result suggested that low recombination has contributed to the size of the sweep, but probably, low recombination does not fully explain the 10- to 30-fold difference in size of the selective sweeps between the chromosome 10 region and those at *tga1* and *tb1*.

We next assessed the strength of selection responsible for the chromosome 10 sweep. Kim and Stephan (2002) proposed a composite likelihood ratio (CLR) test for detecting positive selection along a recombining chromosome. This method compares the likelihood of the observed pattern of nucleotide sequence variation under either a selective sweep or a standard

neutral model. If the resulting LR ratio is significant, this test will provide estimates of selection strength and selection target. We applied the CLR test to a contiguous region in the *ZmETR2* region (loci 7–18), because discontinuous sequences increase the chance of false positives (Pool et al., 2006). This restriction made our results more conservative. We detected a significant LR for a selective sweep model versus a neutral model (LR = 64.7,  $P < 0.001$ ). However, because the CLR test is under the assumption of a randomly mating population of constant size, undetected population structure or a recent bottleneck might produce a similar nucleotide variation pattern as selective sweep (Jensen et al., 2005). To accommodate this weakness in the CLR test, Jensen et al. (2005) proposed a goodness of fit (GOF) test to discriminate between positive selection and nonselective effects. In the GOF test, the selection scenario produced by the CLR test was used as null distribution to evaluate the significance of observed GOF value. We detected a nonsignificant GOF value ( $\chi^2_{\text{GOF}} = 52.37$ ;  $P = 0.661$ ), suggesting that our rejection of the neutral model in the CLR test is not caused by population structure or demographic forces. In other words, positive selection rather than demography is the likely cause of the pattern observed. Furthermore, the estimated selection strength parameter ( $2Ns = 22,187.8$ ) is far greater than the value for *tga1* ( $2Ns = 9,232$ ) (Wang et al., 2005). Assuming an effective population size for maize of 100,000 (Wang et al., 2005), the selection coefficients for *tga1* and the chromosome 10 selective sweep are 0.046 and 0.111, respectively. Because we used a more conservative parameter of  $\theta$ , the selection coefficient of the selective sweep on chromosome 10 is at least 2.4 times larger than that of *tga1*. Strong selection strength surely contributed to the size of the sweep.

Although this large sweep region was not detected by a 774-gene survey by Wright et al. (2005), large sweeps like this have been found in other situations. Among American maize varieties in the 1920s, there was also very strong selection for yellow color, which produced a large sweep around the *y1* locus in maize breeding lines (Palaisa et al., 2003, 2004). A similar pattern was observed at the *waxy* locus in rice (Olsen et al., 2006) and the *Sod* locus in *Drosophila melanogaster* (Saez et al., 2003). The challenge for the future is to reconcile how these extremely different patterns of evolution and selection have occurred.

## THE FUTURE OF THE REVOLUTION

It was 150 years ago that Darwin so skillfully used domesticated plants and animals to help argue for evolution and natural selection. Over the last 100 years, maize has been a prime example for studying evolution, and tremendous strides have been made in understanding its origins, the genetics of the evolution, the strength of selection, and the archaeological

context. For understanding selection, the patterns are tremendously varied. We have examples of nearly every type of selection footprint: on standing variation and on novel mutations, a few large-effect genes and large numbers of selected genes with apparently small phenotypic effects, small single selective sweeps, and a few massive sweeps. Because we are in the midst of a genomics revolution, tremendous opportunities exist to advance our understanding of molecular processes. Over the next 2 decades we should be able to identify more genes involved in domestication, pinpoint the allelic variants favored through time, and evaluate successful and failed genetic alterations through time and space. Top-down and bottom-up approaches (Ross-Ibarra et al., 2007) are complementary and can be combined to improve our understanding of the domestication process.

The bottom-up approaches are being supercharged by next-generation sequencing, which is providing tremendous opportunities for understanding the regions of selection across the maize genome. With the completion of maize genome sequencing, and the first-generation resequencing to produce a high-resolution maize HapMap, we should soon be able to screen the entire genome for selection and identify a basic set of genes that have been targeted by selection during the domestication of maize. Indeed, we might start to evaluate the relative importance of all kinds of selection patterns. However, such genomic analyses alone will not provide precise information on when, where, and why these regions were targets of selection.

How did varieties of maize adapt to diverse environments throughout the globe? Through the exceptional efforts of maize germplasm curators over the last century, well over 20,000 landraces of maize have been collected throughout the Americas. By combining a global sample of landraces (Vigouroux et al., 2008) with whole genome sequencing, adaptation can be evaluated. Additionally, by relating presumptive adaptations to the increasingly rich Geographic Information System databases on climate and soils, the polymorphisms involved with environmental differentiation may be identified. Although similar molecular studies have been conducted to understand human differentiation around the globe (Rosenberg et al., 2002), these targets of differentiation in maize can be studied experimentally and, most importantly, can be applied to adapting future maize varieties to the world's rapidly changing environments.

What is the timing and tempo of these selection events? The tempo of selection was important to Darwin and is still a central issue today. With molecular data, we can estimate the intensity of selection and the time since a selective sweep. However, each assessment requires a number of assumptions that include modeling population size, historical recombination rates, migration, and mutation rates. Although there have been some tremendous strides in such modeling, domesticated crops provide a great opportunity to empirically test particular assumptions. Millions

of archaeological botanical samples are available for DNA analysis that can provide hard data on the progress of selection at particular places and times (Piperno et al., 2007; Pohl et al., 2007). Small-scale studies of this style have been conducted in maize (Jaenicke, 2003; Lia et al., 2007), but the future of sequencing whole genomes from well-preserved maize paleobotanic materials is very exciting.

The reason why particular genes have been under selection is a much more difficult question, but resolving it has important implications for future crop development. In the case of *tb1* and *tga1*, we know much about why these loci were selection targets; but in the case of the chromosome 10 region the reasons are currently much less clear. Did selection target only 1 gene and 1 trait in this region or multiple genes and traits? We will not know until mapping identifies the causative nucleotides. Although, with these approaches, it can take years to find a single gene, the maize community is now assembling an unrivaled set of tools for forward trait dissection that will greatly accelerate the process. Altogether, ≈15,500 maize and teosinte genetic stocks have been constructed, which ultimately may permit the dissection of virtually any trait ([www.panzea.org](http://www.panzea.org)). With next-generation sequencing of key founders of this germplasm and community-wide efforts to phenotype a wide range of traits, the top-down approach will likely accelerate rapidly. We expect to make regular connections between top-down and bottom-up approaches.

Maize is at the crossroads of 2 great legacies. Native Americans and nature have worked to produce a species with tremendous natural variation and selective potential that has adapted to numerous environments. The Darwinian intellectual revolution, enabled by modern technology, allows us to understand how maize arrived at its current position and provides the tools to mold maize ever more efficiently for new societal needs with directed evolution. In fact, we are continuing to follow the steps of early Native Americans who transformed teosinte into maize millennia ago. Through allele mining in existing germplasm, beneficial alleles can be discovered and potentially applied to practical breeding. Wild relatives can also be tapped to recover superior alleles that have been lost during domestication and improvement processes. Guided by lessons from past domestication, we are practicing selection magic to pyramid useful genes to produce best varieties.

## MATERIALS AND METHODS

### Plant Materials and DNA Sequencing

We sampled DNA sequence diversity in a panel of 28 diverse maize inbreds and 16 teosinte (*Z. mays* ssp. *parviglumis*) inbreds. The panel was

selected to maximize the genetic diversity of maize (Liu et al., 2003; Flint-Garcia et al., 2005; Yu et al., 2008) and represents a wide geographical distribution of wild teosinte germplasm ([www.panzea.org](http://www.panzea.org)). A total of 28 maize inbred lines are 26 founders of Nested Association Mapping (NAM) (Yu et al., 2008) population and 2 other inbred lines, Mo17 and W22 R-r:std. Sixteen teosinte inbred lines (TIL01-TIL12 and TIL14-TIL17) were kindly provided by John Doebley (University of Wisconsin, Madison). A *Tripsacum dactyloides* sample (MIA34597) was used as an outgroup to estimate divergence. A total of 23 loci were surveyed to identify the physical boundary of the selective sweep region based on the maize FPC map ([www.genome.arizona.edu/fpc/maize](http://www.genome.arizona.edu/fpc/maize)). Sequencing reactions were performed on PCR products in both directions with BigDye v3.1 on an Applied Biosystem 3730 automated sequencer. Base calling, quality checks, and sequence assembly were conducted with PHRED and PHRAP (Ewing et al., 1998). Multiple sequence alignments were made by using Biolign (<http://en.bio-soft.net/dna/BioLign.html>) and manually edited if necessary.

## Data Analysis

The number of segregating sites ( $S$ ), the nucleotide diversity  $\theta$  (Watterson, 1975) and  $\pi$  (Tajima, 1983) at silent sites, the divergences in maize and in teosinte from *Tripsacum*, and Tajima's  $D$  statistic (Tajima, 1989) were estimated by using DNAsp 4.10 (Rozas et al., 2003). Insertions and deletions were not included in the analysis. We used the multilocus Hudson-Kreitman-Aguade (HKA) test (Hudson et al., 1987) to test the ratios of DNA sequence polymorphisms to divergence across loci using the *Tripsacum dactyloides* sequence as an outgroup. We used Hudson's ms program (Hudson, 2002) to do 10,000 coalescent simulations to estimate the probability of observing a given level of genetic diversity under a standard neutral model with the conservative assumption of no recombination (Hudson, 1990). The expected heterozygosity implemented in the simulation was  $\theta = 0.0064$  and  $0.0112$  in maize and teosinte, respectively, estimated from 774 reference genes (Wright et al., 2005). Coalescent simulations that incorporated the domestication bottleneck (Eyre-Walker et al., 1998; Tenaillon et al., 2004) were performed for each studied locus with the ms program. All parameters in the model were assigned to the established values (Wright et al., 2005). Based on a survey of 774 genes, the best fit of the severity of maize domestication bottleneck ( $k$ ), the ratio of population size during bottleneck ( $N_b$ ) to the duration of bottleneck ( $d$ ), was 2.45 (Wright et al., 2005). The population mutation parameter  $\theta$  (Watterson, 1975) and population recombination parameter  $4Nc$  (Hudson, 1987) were estimated from the teosinte data. Using the neutral domestica-



tion bottleneck as the null distribution, we evaluated the probability of the observed loss of genetic diversity in maize relative to teosinte based on 10,000 coalescent simulations. The CLR test proposed by Kim and Stephan (2002) was used to test the hitchhiking effect and estimate the selection coefficient. We focused this analysis on the *ZmETR2* region (loci 7–18) containing  $\approx 7$  kb of contiguous sequence. Ancestral and derived alleles at polymorphic sites were identified by comparing to the *Tripsacum* sequence. If the derived state of a segregating site could not be determined because of unavailable *Tripsacum* sequence, we assumed the base with the higher frequency to be ancestral. This assumption is conservative and has little effect in detecting selection (Kim and Stephan, 2002; DuMont and Aquadro, 2005). In those loci with a missing state for particular lines, we assumed the segregating sites at these missing sequences had the ancestral state, which is a conservative assumption as shown by the study of Orengo and Aguadé (2007). We did not provide a selection target estimation for 2 reasons: (i) a partially sequenced region will give a less reliable estimate of the selection target (Jensen et al., 2005; Pool et al., 2006); (ii) this selective sweep affected so many regions that estimating the selection target based on a single region is not meaningful. The basic analysis strategy of the CLR test is the same as that described by Wang et al. (2005) with minor modifications. Instead of estimating  $\theta$  from local teosinte data as Wang et al. (2005) did for *tga1*, we used a more conservative estimate of  $\theta = 0.0064$ , estimated from a genomewide value (Wright et al., 2005) as the expected nucleotide diversity in maize. The scaled per-nucleotide recombination parameter  $R_n = 0.0414$  (Hudson, 1987) is the length-weighted mean of  $R_n$  across the *ZmETR2* region (loci 7–18) estimated from teosinte data. The significance of the resulting likelihood ratio was evaluated by 1,000 simulations of neutral datasets. The GOF test (Jensen et al., 2005) was further used to distinguish between selective sweep and demographic forces. The significance of the GOF value for the observed data was evaluated by 1,000 simulations under the selection scenario produced by the above CLR test.

## ACKNOWLEDGMENTS

We thank Carlyn Buckler, Peter Bradbury, Jason Peiffer, Pat Brown, Rob Elshire, Elhan Ersoz, Sean Myles, Michelle Denton, Joan Zhao, and Linda Rigamer Lirette for excellent comments and editorial assistance. This work was supported by the U.S. Department of Agriculture Agricultural Research Service and National Science Foundation Grants DBI-0321467 and DBI-0820619.





# 7

## Human-Induced Evolution Caused by Unnatural Selection Through Harvest of Wild Animals

---

FRED W. ALLENDORF\*<sup>†</sup> and JEFFREY J. HARD<sup>‡</sup>

Human harvest of phenotypically desirable animals from wild populations imposes selection that can reduce the frequencies of those desirable phenotypes. Hunting and fishing contrast with agricultural and aquacultural practices in which the most desirable animals are typically bred with the specific goal of increasing the frequency of desirable phenotypes. We consider the potential effects of harvest on the genetics and sustainability of wild populations. We also consider how harvesting could affect the mating system and thereby modify sexual selection in a way that might affect recruitment. Determining whether phenotypic changes in harvested populations are due to evolution, rather than phenotypic plasticity or environmental variation, has been problematic. Nevertheless, it is likely that some undesirable changes observed over time in exploited populations (e.g., reduced body size, earlier sexual maturity, reduced antler size, etc.) are due to selection against desirable phenotypes—a process we call “unnatural” selection. Evolution brought about by human harvest might greatly increase the time required for overharvested populations to recover once harvest is curtailed because harvesting often creates strong selection differentials, whereas curtailing harvest will often result in less

---

\*Division of Biological Sciences, University of Montana, Missoula, MT 59812; <sup>†</sup>School of Biological Sciences, Victoria University of Wellington, P.O. Box 600, Wellington 6140, New Zealand; and <sup>‡</sup>Conservation Biology Division, Northwest Fisheries Science Center, National Marine Fisheries Service, Seattle, WA 98112.

intense selection in the opposing direction. We strongly encourage those responsible for managing harvested wild populations to take into account possible selective effects of harvest management and to implement monitoring programs to detect exploitation-induced selection before it seriously impacts viability.

**H**umans have exploited wild populations of animals for food, clothing, and tools since the origin of hominids. Human harvest of wild populations is almost always nonrandom. That is, individuals of certain size, morphology, or behavior are more likely than others to be removed from the population by harvesting. Such selective removal will bring about genetic change in harvested populations if the selected phenotype has at least a partial genetic basis (Table 7.1). For example, the frequency of elephants (*Loxodonta africana*) without tusks increased from 10% to 38% in South Luangwa National Park, Zambia, apparently brought about by poaching of elephants for their ivory (Jachmann et al., 1995). Similarly, trophy hunting for bighorn sheep (*Ovis canadensis*) in Alberta, Canada, caused a decrease in horn size because rams with larger horns had a greater probability of being removed from the population by hunting (Coltman et al., 2003). It has also been suggested that the greater difficulty of catching introduced brown trout (*Salmo trutta*) than native North American species of trout is the result of angling for brown trout in Europe for hundreds of years before their introduction to North America (Miller, 1957). Moreover, harvest need not be selective to cause genetic change; uniformly increasing mortality independent of phenotype will select for earlier maturation (Law, 2007).

In agriculture, the practice for thousands of years has been to use the most productive animals (and plants) as breeding stock, with the goal of increasing the frequency of desirable phenotypes. Aquaculture has adopted similar objectives over its shorter history (Gjedrem, 2005). In contrast, the opposite has been true in the exploitation of wild animal populations. The most desirable individuals have been harvested, leaving behind the less desirable to reproduce and contribute genes to future generations. Therefore, harvest of wild populations has tended to increase the frequency of less desirable phenotypes in wild populations.

There has been surprisingly little consideration of human-induced selection in the wild until recently [reviewed in Allendorf et al. (2008)]. Even more surprising perhaps is the absence of any detailed consideration of this effect by Darwin because he had such a passion for hunting as a young man. In several places, Darwin commented on the lack of wildness of birds on islands where they have not been hunted by humans (Darwin, 1958b, p. 231; 1962, p. 400). In his lengthy consideration of “Selection by

TABLE 7.1 Traits Likely to Be Affected by Unnatural Selection in Harvested Populations

Trait	Selective Action	Response(s)	Remedy
Age and size at sexual maturation	Increased mortality	Sexual maturation at earlier age and size, reduced fertility	Reduce harvest mortality or modify selectivity of harvest
Body size or morphology, sexual dimorphism	Selective harvest of larger or more distinctive individuals	Reduced growth rate, attenuated phenotypes	Reduce selective harvest of large or distinctive individuals
Sexually selected weapons (horns, tusks, antlers, etc.)	Trophy hunting	Reduced weapon size or body size	Implement hunting regulations that restrict harvest based on size or morphology of weapons under sexual selection
Timing of reproduction	Selective harvest of seasonally early or late reproducers	Altered distribution of reproduction (truncated or altered seasonality)	Harvest throughout reproductive season
Behavior	Harvest of more active or aggressive or bolder (more vulnerable to predation) individuals	Reduced boldness in foraging or courtship behavior, potentially reduced productivity	Implement harvest methods less likely to impose selection on activity or aggressive behavior
Dispersal/migration	Harvest of individuals with more predictable migration patterns	Altered migration routes	Interrupt harvest with key time and area closures tied to primary migration routes

Man" (Darwin, 1896), Darwin considered in great detail the 3 types of selection that have produced domesticated plants and animals: methodological, unconscious, and natural, but he did not apply these principles to wild animals and plants. Nevertheless, he was aware that removing desirable animals by hunting could decrease the frequency of more desirable phenotypes, as indicated by the quote below. However, Darwin did not discuss the evolutionary consequences of hunting and how they might influence natural or sexual selection.

"Natural" is sometimes defined as not being affected by human influence (Anonymous, 2008). We adopt the term "unnatural" to describe unintended selection through exploitation because it is imposed by human

activity in contrast to natural selection. Unnatural selection generally acts at cross purposes to the long-term goal of sustainable harvest of wild populations and can reduce the frequency of phenotypes valued by humans.

Harvest can affect sexual selection because it tends to remove individuals with particular characteristics, such as large size or elaborate weapons from those of the breeding pool. Sexual selection can act in concert with natural selection on some of these same traits (as well as others), with complex results [e.g., Hamon and Foote (2005)]. Sexual and natural selection can act simultaneously to change the frequency of particular phenotypes, depending on the intensity of natural prebreeding mortality (e.g., through predation or disease), breeding density, and the characteristics of breeding adults (e.g., frequency-dependent selection). Because different environmental conditions and population features favor different phenotypes, natural and sexual selection can interact in complex ways in different places and at different times to affect the characteristics of successful breeders.

The objective of this chapter is to summarize the consequences of unnatural selection and sexual selection in wild populations of animals (Fig. 7.1), outline why these consequences threaten future yield and population viability, and suggest some measures to address this problem.

## HISTORY OF UNNATURAL SELECTION

So that the Incas followed exactly the reverse system of that which our Scottish sportsman are accused of following, namely, of steadily killing the finest stags, thus causing the whole race to degenerate.

Darwin (1896, p. 192)

Recognition that exploitation of wild animals can produce evolutionary change is not new. It was recognized for fishing by the late 19th century and for hunting by the early 20th century. However, few studies have been able to clearly document evolutionary response to exploitative selection, and the possibility that exploitation-induced evolutionary change can oppose adaptive responses to natural and sexual selection has not been widely appreciated. Nevertheless, Coltman (2008) argued that rapid contemporary evolution has now been shown to occur in response to invasive species, habitat degradation, climate change, and exploitation, and he went on to say that exploitation-induced evolution may well have the most dramatic impact of any of these anthropogenic sources of selection to date. Mace and Reynolds (2001) asked why sustainable exploitation is so difficult, and pointed to limits of biological knowledge and limits of control as the 2 primary factors that cause exploitation to be such a challenge for conservation.

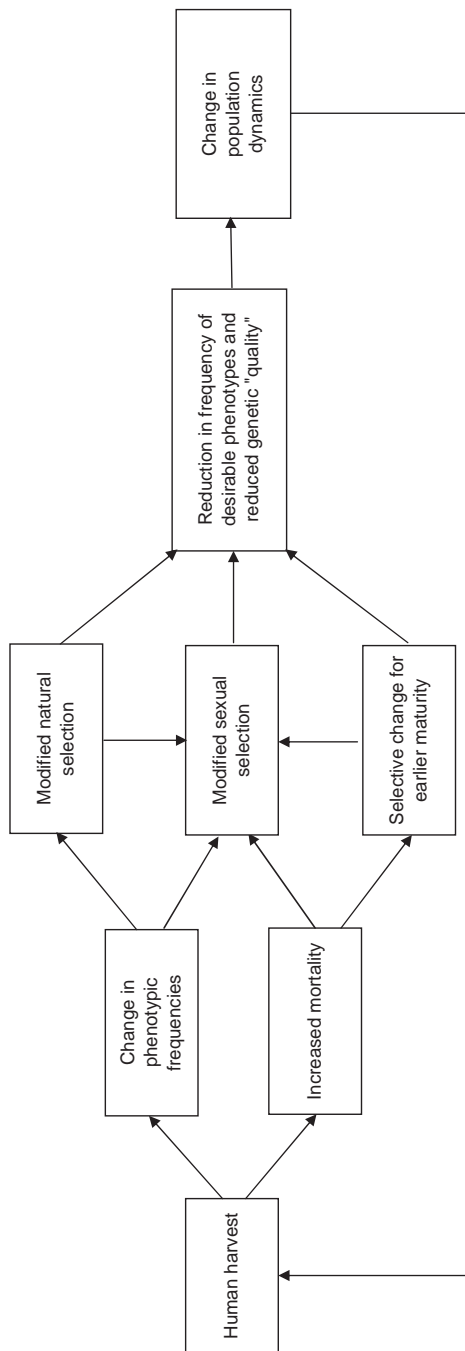

FIGURE 7.1 Human harvest can have a variety of direct and indirect genetic effects on populations, and it has the potential to affect the future yield and viability of exploited populations.

Fisheries and wildlife managers have yet to adopt management strategies that guard against rapid evolutionary response to exploitation. Managers have focused on demographic parameters that affect population abundance and growth rate because their primary goal is sustainable yield in the short term. However, recognition is growing that evolution under exploitation can reduce population growth and viability and ultimately might reduce yield (Law, 2000; Milner et al., 2006). A recent analysis has concluded that phenotypic changes in response to human harvest are much more rapid on average than changes in natural systems (Darimont et al., 2009). Sustainable harvests will eventually require that fisheries and wildlife managers incorporate genetic principles into the management of wild populations. Allendorf et al. (2008) recommended that managers begin by acknowledging that exploitation produces some genetic change and implementing routine monitoring to detect harmful evolutionary change before it threatens productivity.

Fish can be killed through fishing either as immature or mature individuals, depending on the characteristics of the individual fishery; the point in the life history at which fishing mortality is exacted has important ramifications for fisheries-induced evolution (Hard et al., 2008). The relatively high fecundities and high natural mortality rates, especially early in life, for many fishes, mean that although fishing mortality can be high in some years, it is not often as high as natural mortality. By contrast, hunting mortality is often substantially higher than natural mortality for adult game animals (Festa-Bianchet, 2003), a contrast that has important implications for evaluating the differences between fishing and hunting.

## Fishing

Evidence is mounting that fish populations will not necessarily recover even if overfishing stops. Fishing may be such a powerful evolutionary force that we are running up a Darwinian debt for future generations.

Loder (2005)

Fish size is of primary interest to fishermen; larger fish are often of higher value. Larger, older fish can also contribute disproportionately to productivity through greater weight-specific fertility and larval quality [e.g., Sogard et al. (2008) and Venturelli et al. (2009)]. There are widespread accounts supporting claims that large fish were caught more frequently in commercial fisheries in the early years of those industries. For example, a gigantic Atlantic cod (*Gadus morhua*) weighing nearly 100 kg was caught off Massachusetts in May 1895, and large cod (>30 kg) were frequently taken from New England waters before 1900 (Jordan and Evermann, 1902).



Concern that removal of the larger individuals from breeding populations could affect populations emerged shortly after commercial fisheries for salmon expanded in the western United States in the late 19th century. In California, Rutter (1904) speculated that salmon fisheries might enhance representation of smaller, younger fish among breeding males and that removal of larger adults could eventually reduce adult size and fishery yield. Smith (1920) stated that capture of immature fish in ocean salmon fisheries could reduce future yield if maturation became earlier under such fishing mortality. However, others such as Miller (1957), although acknowledging the potential of evolutionary response to selective fishing, apparently believed that the extensive plasticity of growth and maturation would mitigate against selection for rapid growth and early maturation of fish like salmon. Nevertheless, some scientists remained concerned about deleterious fisheries-induced evolution. Handford et al. (1977) stated that management was “seriously deficient in [its failure] to take into account the possibility of adaptive genetic change in exploited stocks of fish.”

In the last few years, such concerns about capture fisheries for a variety of species have escalated (Birkeland and Dayton, 2005; Law, 2007; Fenberg and Roy, 2008; Hutchings and Rowe, 2008). Nevertheless, in large part because direct evidence for fisheries-induced evolution in specific cases remains elusive (Hard et al., 2008), fishery management almost nowhere yet incorporates evolutionary considerations: Fisheries are managed on the basis of demographic considerations alone—primarily adult abundance. Unfortunately, fisheries tend to impose selection that alters distributions of characteristics that affect fitness and population viability, principally through removal of larger and older fish that differ in growth, development, and reproductive characteristics. To the extent that size, age, and correlated traits in such fish are heritable (Walsh et al., 2006; Law, 2007; Carlson and Seamons, 2008), fishing selection will tend to reduce means and alter variability for these traits over time.

This form of selection is thought to oppose natural and sexual selection on these traits, and the fisheries-induced evolution that is likely to result from such selection will favor trait phenotypes among breeders that differ substantially from those targeted in fisheries (Naish and Hard, 2008). That is, fisheries-induced evolution will tend to proceed along a trajectory that is counter to one that maintains trait combinations desirable to fishermen. Exploitative selection imposed by fishing tends to reduce the frequency of desirable phenotypes through directional selection for alternative phenotypes, unlike other human-induced forms of selection, such as domestication, which often produce maladapted phenotypes indirectly by favoring alternative optima through alteration of the natural selection regime [e.g., Araki et al. (2007)].

Recreational fisheries can also bring about a genetic response to angling. However, there has been little work done in this area. Some authors have reported differences in angling vulnerability between domestic and wild strains of fish (Beukema, 1969; Biro et al., 2004). Biro and Stamps (2008) argued that behaviors such as boldness and activity, which are often correlated with growth rate, are likely to affect productivity and could respond to selective mortality. Philipp et al. (2009) reported differences in hook-and-line angling vulnerability between individual largemouth bass (*Micropterus salmoides*) in a wild population. The authors estimated a realized heritability of 0.15 through a 3-generation selection experiment.

Few studies have estimated the intensity of selection that fishing exerts. Although mortality of fish caught in many fisheries tends to increase with fish size, producing negative selection differentials (Falconer and Mackay, 1996), these estimates also appear to vary substantially from place to place and over time (Handford et al., 1977; Ricker, 1981; Law and Rowell, 1993; Sinclair et al., 2002; Hindar et al., 2007; Hard et al., 2008; Hilborn and Minte-Vera, 2008) and between the sexes (Hamon et al., 2000). Kendall et al. (2009) estimated standardized selection differentials for a 60-year dataset of Bristol Bay sockeye salmon (*Oncorhynchus nerka*) and found that selection intensity often differed substantially between sexes of returning fish and among years, although selection was generally higher on larger fish (especially females). Hard et al. (2008) concluded that estimates of selection intensity resulting from fishing were generally modest and typically less than the few estimates of natural and sexual selection differentials that have been reported for species like Pacific salmon (Fleming and Gross, 1994; Hamon, 2005; Hamon and Foote, 2005; Ford et al., 2008). Nevertheless, even fisheries that are not highly selective are expected to produce evolutionary change if fishing mortality is high enough (Policansky, 1993).

Estimates of natural selection gradients in salmon, for example, can vary widely but are typically in the range of 0.5 standard deviations (SD) or less [e.g., Ford et al. (2008)]. Hamon and Foote [(2005); see also Hamon (2005)] estimated standardized sexual selection differentials on morphology and run timing that ranged between  $-0.14$  and  $+0.52$  (linear) and between  $-0.29$  and  $+0.11$  (nonlinear), and sexual selection gradients on these traits that ranged between  $-0.16$  and  $+0.33$  (linear) and between  $-0.33$  and  $0$  (nonlinear). Total selection estimates that combined natural and sexual selection intensities tended to be smaller, in general, and sexual selection on morphology was often stronger than natural selection. Furthermore, several of the predicted consequences of selective fishing (such as earlier maturation and greater reproductive effort) are similar to those expected from ecological changes after a decrease in population density.

For this reason, ecological and evolutionary responses are usually difficult to tease apart with temporal phenotypic trends alone.

Nevertheless, selection of this intensity is not inconsistent with estimates of natural selection in nature (Kingsolver and Pfennig, 2007) and might be sufficiently strong to produce rapid evolutionary change in many cases. In their long-term study of Windermere pike (*Esox lucius*) in England, Edeline et al. (2007) contrasted temporal patterns of natural and fishing selection on this species; it was the first study to relate these patterns to long-term trends in life-history characteristics of wild fish (Coltman, 2008). They estimated a substantial, fishing-induced negative selection differential on the reaction norm describing variation in gonad weight/body length, a measure of reproductive investment, in age-3 females. The temporal dynamics of life history appear to reflect the combined influences of a half century of natural and fishing selection; growth rate and reproductive investment at younger ages tended to decline during periods of higher exploitation, a pattern that diminished when fishing rates eased.

## Hunting

I suggest that minimizing the impact of sport hunting on the evolution of hunted species should be a major preoccupation of wildlife managers.

Marco Festa-Bianchet (2003)

Like fishery managers, wildlife managers have typically placed a primary emphasis on the demographic consequences of hunting, with little direct consideration of potential evolutionary effects (Rhodes and Smith, 1992). European wildlife managers have paid more attention than their North American counterparts to the selective effects of hunting, and hunting in Europe has often targeted specific phenotypic characteristics of game; as a result, European hunting regulations are typically more specific than American regulations (Harris et al., 2002; Festa-Bianchet, 2003).

Game and especially trophy hunting generally differ from fishing in several ways. For example, key aspects of the life histories of the 2 groups of animals often differ. Game hunting often focuses on animals with relatively low reproductive output, and relatively low natural mortality rates; many fishes have higher fecundities and higher natural mortality rates than game animals. We expect that hunting selection could have a considerable effect on the evolution of adult characteristics, particularly those in prime-aged adults under sexual selection because hunting mortality is often substantially higher than natural mortality for adult game animals (Festa-Bianchet, 2003; Gaillard et al., 2003).

Virtually all hunting invokes selective elements of some kind. These elements are often associated with particular phenotypic characteristics

such as body size, coat color, and weapons or ornaments such as horns and antlers. As is the case for fishing, hunting for many animals can produce the paradoxical situation of selecting against the traits that are preferred by hunters (Festa-Bianchet, 2003). Because variation in many of these traits has an appreciable genetic component (FitzSimmons et al., 1995; Hartl et al., 1995; Moorcroft et al., 1996; Lukefahr and Jacobson, 1998), such selection is likely to produce detectable evolutionary responses that reduce the ability of breeders with desirable characteristics to contribute to reproduction (Mills, 2007). Harris et al. (2002) argued that available information is sufficient to recommend hunting patterns that minimize deviations of sex- and age-specific mortality rates from natural mortality rates.

Harris et al. (2002) and Allendorf et al. (2008) identified 3 primary genetic consequences of hunting: alteration of population structure, loss of genetic variation, and evolution resulting from selection. These general consequences apply to all forms of human exploitation. An early study by Voipio (1950) was one of the first to show that the genetic consequences of selective hunting were likely to vary with the phenotypic characteristics of the hunted animals. In a simple, discrete-locus simulation of harvest of antlered male red deer (*Cervus elaphus*), Thelen (1991) demonstrated how the frequency of alleles influencing large antler size, and therefore the yield of trophy males, would decline under different harvest management strategies. With regard to the loss of genetic diversity that can result from hunting mortality, Harris et al. (2002) and Allendorf et al. (2008) focused on the relationship between harvest and decline in heterozygosity or allelic diversity and how they are reflected in reduced effective population size ( $N_e$ ) and the ratio of  $N_e$  to census size ( $N_c$ ). These metrics are important indicators of a population's evolutionary potential, and substantial reductions in them can indicate unsustainable practices.

Several key population characteristics can affect genetic variability and adaptive potential. In most ungulates, for example, breeding population size, generation length and adult longevity, and mating structure, including the breeding sex ratio and harem size, can have a large influence on the dynamics of genetic and phenotypic variation under exploitation (Ryman et al., 1981; Martinez et al., 2002; Mysterud et al., 2002; Wade and Shuster, 2004). Exploitation tends to skew the breeding sex ratio (Clutton-Brock and Loneragan, 1994) and reduce adult longevity, especially of males, and mean male reproductive success and variance in progeny number per family. However, sex ratio can also be sensitive to population density (Kruuk et al., 1999; Bonenfant et al., 2003). These factors have a direct influence on  $N_e$ . If the mean generation length differs for males and females, which is common for several of these species, exploitation can also contribute to a reduction in  $N_e$ . The consequences of reduced  $N_e$  for adaptive

potential can be serious, but they depend critically on the characteristics of the life history (Lande and Barrowclough, 1987).

The reduction in the frequency of the silver morph in the red fox (*Vulpes vulpes*) between 1834 and 1933 in eastern Canada was perhaps the first documented change over time resulting from selective harvest (Elton, 1942). J. B. S. Haldane used these data to provide one of the first estimates of the strength of selection in a wild population using his then recently developed mathematical models of the effects of selection on a single locus (Haldane, 1942). The fur of the homozygous silver morph ( $RR$ ) was worth approximately 3 times as much as the fur of the cross ( $Rr$ ) or red ( $rr$ ) fox to the furrier, and, therefore, was more likely to be pursued by hunters. The fur of the heterozygous cross fox ( $Rr$ ) was smoky red and was classified as red in the fur trade. The frequency of the desirable silver morph declined from  $\approx 16\%$  in 1830 to 5% in 1930 (Fig. 7.2). Haldane (1942) concluded that this trend could be explained by a slightly greater harvest rate of the silver than the red and cross phenotypes. The lines in Fig. 7.2 show the expected change in phenotypic frequencies, assuming that the relative fitness of the silver phenotype was 3% less than both the red and cross phenotypes, and the generation interval was 2 years.

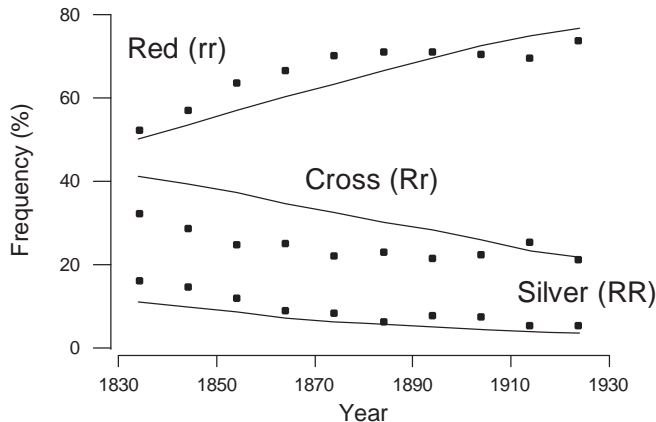

FIGURE 7.2 Reduction in frequency of the silver morph of the fox in eastern Canada resulting from the preferential harvest by hunters of the more valuable silver morph (Elton, 1942; Haldane, 1942). The points represent data presented by Elton (1942). The lines represent the expected change in frequencies of the 3 phenotypes via selection at a single locus, assuming that the silver fox morph has a 3% survival disadvantage per generation relative to the red and cross morphs. The initial frequency of the  $R$  allele was 0.3 and the mean generation interval was 2 years (Haldane, 1942).

For roe deer, Hartl et al. (1991) concluded that the intensity of harvest influenced the degree of selection against large body size, larger number of antler points and yearling males with small spikes; harvest intensity also affected the length of the antler main beam and produced changes in allele frequencies [see also Malo et al. (2005)]. For mountain sheep, Coltman et al. (2003) showed that harvest of trophy rams led to selection for lighter and smaller-horned rams. Different hunters invoke different methods in being selective, and Martínez et al. (2005) argued that the urge for hunters to kill males with large antlers and to maximize opportunity to be selective by hunting early in the season were primary motivations. Myrsetrud et al. (2006) found that hunter type (local vs. “foreign”) provided substantial variation in terms of temporal and spatial components of hunting activity, and that although the activities of the different hunter types influenced the relationship between age and antler mass, much of this influence arose from variation in the timing and location of hunting.

In their simulation of the evolution of exploited red deer, Hard et al. (2006) found that selective hunting could reduce  $N_e$  and  $N_e/N_c$  if annual hunting mortality of males is high enough (>25–30%), and they concluded that reducing hunting mortality on males to keep breeding stag:hind ratios during the rut sufficiently high ( $\geq 18$  stags:100 hinds) is important to maintain adequate  $N_e$  and, therefore, long-term adaptive potential. They also found that size-selective hunting is likely to result in only modest short-term evolutionary changes in life-history traits unless the annual harvest rate on males is high (>30%) or realized genetic variance components were large.

Coltman et al. (2003) used a quantitative genetic analysis of a reconstructed pedigree for a wild population of Canadian bighorn sheep to show how hunting selection affected body weight and horn size. They showed that selection was most intense against rams with high breeding values because of hunter preference for large rams with large horns, with the consequence that breeding values for both ram traits declined steeply over 35 years. Because both traits are highly heritable and positively genetically correlated (Coltman et al., 2003), continued selection against large rams with large horns is expected to directly reduce horn size with a correlated response in reduced body mass. Such selection will reduce the frequencies of these phenotypes to lower levels, with likely adverse consequences for male breeding success. Both ram weight and horn size are undoubtedly subject to sexual selection through male-male competition during the rut, but it is unclear to what extent such sexual selection can alter the rate of evolution under hunting selection because sexual selection gradients have not been estimated. However, they must be high for some heavily hunted populations, where heritabilities for traits under selection are high and observed temporal declines in breeding values for

these traits are often substantial [e.g., Coltman et al. (2003)]. Garel et al. (2007) found similar patterns in morphology and life history resulting from trophy ram hunting in Europe.

### Exploitation by Specimen Collectors

Understanding the response of consumers and hunters to perceived rarity is vital for predicting the impact of intervention strategies that seek to minimize extinction risk.

Hall et al. (2008)

Another human activity that can impose exploitative selection on wild populations is specimen collecting, whether for private, commercial, or scientific use. The actions of collectors, which most commonly target vertebrates, such as tropical fishes, and invertebrates, such as arthropods and gastropods, could impose selection on wild populations through the removal of specimens conspicuous by their large size and appearance. Such selection is likely to be effective when populations are rare, phenotypes are dramatic, and opportunity for harvest by humans is substantial. Highly selective collection practices could affect the sustainability of these trades and the conservation of rare species (Slone et al., 1997; Hall et al., 2008).

Terrestrial snails are one of the most imperiled groups in the world, and overcollecting has been one of the major threats to many of these species. For example, collecting of live tree snails (*Liguus* and *Orthicalus* spp.) found on isolated hardwood hammocks in the Florida Everglades began in the early 19th century and peaked in the 1940s before regulations were enacted because of conservation concerns (Humes, 1965). The loss of prized forms led collectors to translocate valuable morphs to places unknown to other snail collectors (Humes, 1965). In addition, collection of especially attractive morphs was competitive so that some attractive morphs were purposefully overcollected because they were more valuable when they became rare. Similarly, major snail collecting took place in the late 19th and early 20th centuries in Hawaii, focusing on the brightly colored and variable Achatinellinae tree snails. Overcollecting did lead to extinctions, but it is unknown if there was any differential selective effects on morphs (Hadfield, 1986). In Moldova, Andreev (2006) compared land snail (*Helix pomatia*) characteristics from exploited and unexploited sites and found that sites where land snails were exploited for food had much lower densities and a higher proportion of adult snails than sites that were not exploited. Specimen collecting can therefore provide an opportunity for selection that might reduce population viability.



## SEXUAL SELECTION

Fishing techniques could remove certain sexes or sizes of squids, thus leading to “unnatural” sexual selection processes that affect recruitment.

Hanlon (1998)

Sexual selection has been largely overlooked as a factor that can influence evolution under exploitation. In an important article, Hutchings and Rowe (2008) concluded that the effects of fishing on the distributions of traits subject to sexual selection in an Atlantic cod life history could have a major impact on the rate and magnitude of fisheries-induced evolution. How mating systems influence the resistance of wild animals to collapse under exploitation and their ability to rebound when conditions improve remains an open question. Rowe and Hutchings (2003) suggested that mate competition, mate choice, and other components of mating systems are almost certain to have an impact on population growth rate at low levels of abundance. For example, if larger individuals enjoy greater reproductive success, sexual selection for increased body size could counter selection against larger size imposed by fishing.

Selective harvest can directly affect mating and have a strong effect on subsequent recruitment because it tends to remove individuals with particular characteristics, such as large size or elaborate weapons from those of the breeding pool (Kingsolver et al., 2001). Hunting and fishing often impose direct selection against particular phenotypes by targeting individuals with sexually selected characters (e.g., antlers, horns, hooked jaws on salmon, or deep bodies). These activities can also indirectly alter sexual selection by affecting the distributions of traits under sexual selection (Hanlon, 1998; Walsh et al., 2006) by decreasing population size, or by favoring earlier maturation at the expense of later-maturing individuals [e.g., Hard et al. (2008)]. In this way, exploitative selection can change both the means and variability of traits that determine mating and reproductive success. For example, reducing the maximum and compressing the variation in body size of breeding adults through exploitation is likely to change the dynamics of courtship and mate selection, and it might reduce overall mating success and productivity as well.

Harvest can also affect sexual selection by modifying the ratio of males and females available for mating. Hunting regulations for most mammal and bird species have traditionally favored greater harvest rates for males. Sex ratios of less than 1 adult male per 10 adult females are not uncommon in species where males are selectively hunted (Harris et al., 2002). Fishing also can produce biased sex ratios if one sex is larger than the other or is geographically more vulnerable to fishing (Vincent and Sadovy, 1998). Theory predicts that the more abundant sex will become



less choosy in mate choice and more aggressive in competition for mates (Emlen and Oring, 1977).

Estimates of sexual selection in large mammals where some populations are subjected to hunting are relatively uncommon, but they evidently can be large. Sexual selection on male phenotypes is expected to be strongest when there is intense competition among males for mates, as when the operational sex ratio is highly skewed toward males (Emlen and Oring, 1977). For example, Kruuk et al. (2002) estimated large total (natural plus sexual) selection gradients on antler weight and leg length in unhunted male Scottish red deer. Lifetime breeding success was positively correlated with antler weight. In an elasticity path analysis that links selection gradients between phenotypes and components of fitness with the contributions of these components to population growth rate (mean absolute fitness), Coulson et al. (2003) estimated selection gradients on a number of life history traits in unhunted red deer, including survival rates, birth date, and birth weight. They showed that, although many of them were statistically significant, most estimates varied widely over time, presumably in response to environmental and ecological factors that differ in importance in different years.

Some investigators have suggested that the effects of selection for smaller body size associated with fishing or hunting might be countered by sexual selection favoring larger individuals (Hutchings and Rowe, 2008). Fig. 7.3 depicts a hypothetical example to illustrate how sexual and natural selection might affect evolution in response to exploitative selection in sockeye salmon. In this case, combined natural and sexual selection impose a selection gradient on a bivariate phenotype that opposes the selection gradient imposed by exploitation. As a result, a suboptimal phenotype in the wild breeding population can increase in frequency as the effectiveness of natural and sexual selection is reduced.

Intense sexual selection can be common in populations of spawning salmon (Quinn, 2005). The intensity of sexual selection might be diminished when fishing mortality is high because of reduced population sizes and human activities that have increased the cost of migration and changed the balance between natural and sexual selection. As migration becomes more difficult, individuals have less energy to devote to secondary sexual characteristics (Kinnison et al., 2003), which can further erode the strength of sexual selection beyond the effects related solely to smaller population size.

What are the possible long-term effects of reduced sexual selection that might ensue from continued exploitation? One possibility is reduced genetic quality of progeny resulting from relaxed sexual selection and reduced female mate choice [e.g., Drickamer et al. (2000) and Neff and Pitcher (2005)]. Pitcher and Neff (2007) found in their breeding study of

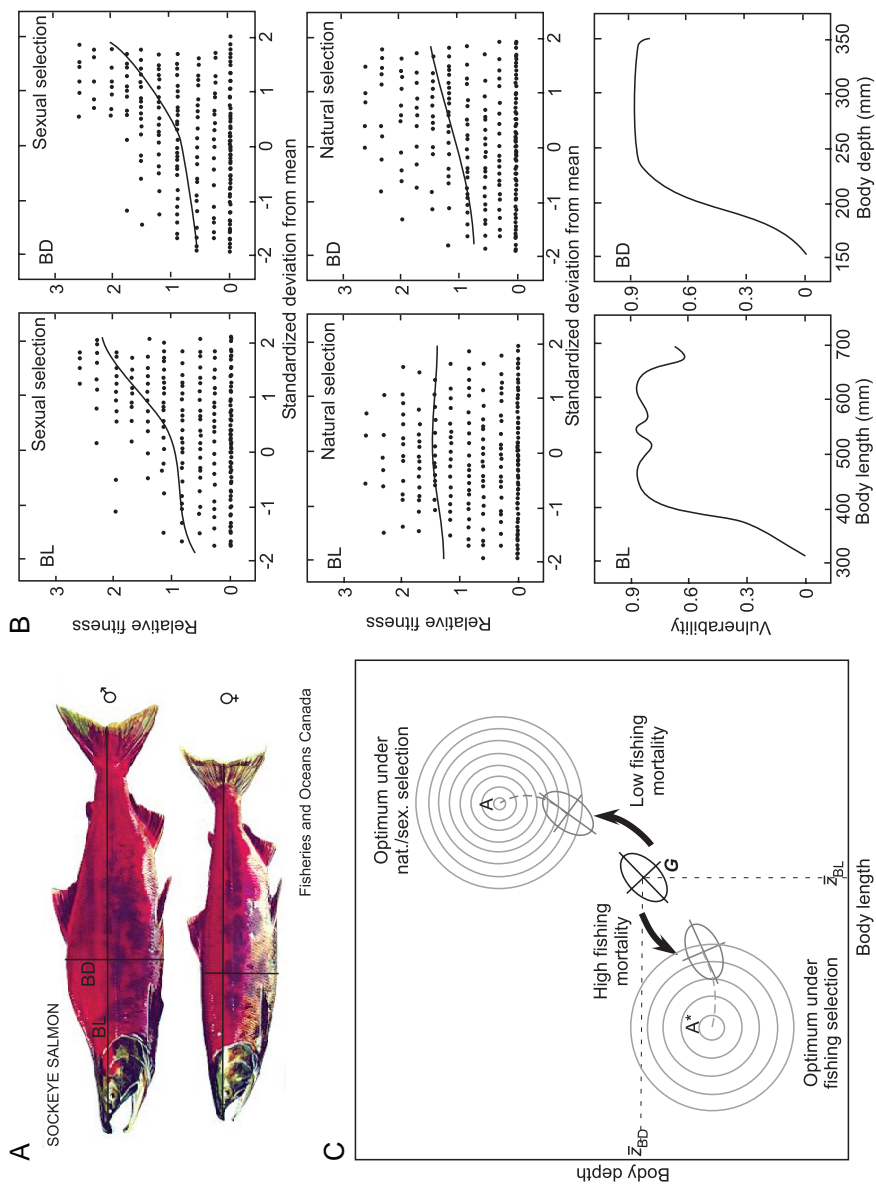

Chinook salmon (*Oncorhynchus tshawytscha*) that additive and nonadditive genetic effects together increased survival of fish during early development by nearly 20%. They concluded that incorporating information on genetic quality of parents into breeding designs could increase survival by some 3 times over designs that exclude sexual selection processes by relying on random mating alone.

## IMPLICATIONS

Several authors (Law, 2000; Harris et al., 2002; Coltman et al., 2003; Allendorf et al., 2008) have recently emphasized that selection is an important but often ignored consequence of human exploitation of wild animals and that adaptation to exploitation can produce undesirable evolutionary change. Fisheries and wildlife management that does not incorporate evolutionary considerations is at risk of reducing wild productivity and eventual yield because exploitation removes phenotypes that might be those most favored by natural and sexual selection in the wild. Accounting for selection that is at odds with natural adaptive processes is therefore an important component of a comprehensive and effective sustainable management strategy. For this situation to change, at least 3 questions must be addressed: What are the primary genetic consequences of exploitation, and what is the evidence for them? Do these consequences influence

FIGURE 7.3 Potential consequences of natural, sexual, and fishing-induced selection in exploited sockeye salmon. (A) Typical morphological phenotypes for adult male and female sockeye salmon. BL, body length; BD, body depth. (B) Hypothetical relative fitness, as measured by reproductive success, among breeders that vary in body length and body depth. (Top) Sexual selection favors individual breeders with higher BL and BD phenotypes. (Middle) Natural selection favors individual breeders with intermediate BL and larger BD phenotypes. (Bottom) Individuals with larger values of BL and especially BD are more vulnerable to fishing mortality. (C) Potential evolution of the genetic covariance matrix ( $G$ ) for the bivariate body length (BL)–body depth (BD) phenotype under combined natural, sexual, and fishing-induced selection. The box represents the bivariate adaptive landscape [in the sense of Simpson (1953)].  $G$  is represented by the oval. Under natural and sexual selection on BL and BD in the absence of fishing,  $G$  will tend to move toward the “global” optimum bivariate phenotype A. When the population is subjected to substantial selective fishing mortality that targets potential breeders of larger BL and BD,  $G$  will tend to move toward the “local” alternative optimum bivariate phenotype A\*. Natural and sexual selection impose a selection gradient on the bivariate phenotype, which tends to oppose the selection gradient imposed by selective fishing. The result is a suboptimal phenotype in the wild breeding population that might deviate substantially from A. Note the difference in elevation and steepness of fitness for the 2 alternative fitness optima.

demography in a way that would affect yield and concern managers? How effective can management be in detecting and countering these effects? Recently, promising strides have been made to address the first question but the evidence is still largely circumstantial [e.g., Hard et al. (2008)]. The other questions have seldom been addressed directly except through simulation [e.g., Bromaghin et al. (2008) and Hard et al. (in press)].

### **Sustainable Harvest**

Sustainable exploitation requires that phenotypic changes induced by harvest do not appreciably reduce yield and viability. Although we cannot be certain that many of the observed phenotypic trends in a variety of exploited animals are solely the result of exploitative selection, it would be imprudent to assume that such selection has not had an effect. The coupling of such trends with evidence for reduced productivity and yield is reason enough to adopt a risk-averse approach in considering sustainable harvest practices. One means of maintaining viability is by reducing selectivity in exploitation; assuming that the level of exploitation is not so high that it poses excessive demographic risk, reducing selectivity ameliorates the potential for selection to erode viability through phenotypic evolution. It also maintains the opportunity for natural and sexual selection to maximize reproductive fitness. Sustainable harvest practices require adequate monitoring of traits that are sensitive to selection and influence viability (Allendorf et al., 2008), and promote management that maintains breeding populations that are large and diverse enough to foster the full range of phenotypes that natural and sexual selection can act on (Hutchings and Rowe, 2008). Moreover, sustainable management strategies should adapt quickly and appropriately to detected changes (Kuparinen and Merilä, 2007).

### **Recovery**

Recovery after relaxation, or even reversal, of selective harvest is likely to be slower than the initial accumulation of harmful genetic changes (Heino, 1998). This is because harvesting can create strong selection differentials, whereas relaxation of this selective pressure will more often produce weaker selection in the opposing direction (Swain et al., 2007). De Roos et al. (2006) used an age-structured fishery model to show that exploitation-induced evolutionary regime shifts can be irreversible under likely fisheries management strategies such as belated or partial fishery closure. Swain et al. (2007) concluded that human-induced adaptation to fishing may be a primary reason for lack of recovery of northwest Atlantic cod because harvest has been reduced after the collapse of this

fishery. This effect has been termed “Darwinian debt,” and has been suggested to have general applicability (Loder, 2005). That is, timescales of evolutionary recovery are likely to be much longer than those on which undesirable evolutionary changes occur. Conover et al. (2009) provided the first experimental test of this expectation with laboratory populations of *Menidia menidia*. They found that the selective effects of fishing were reversible, but recovery took more than twice as many generations as the original period of fishery selection. Bromaghin et al. (2008) and Hard et al. (in press), in their simulation studies of Chinook salmon, found that complete recovery of size and age structures generally required 15–20 generations or more of substantial reductions in exploitation rate or no harvest at all. However, gene flow has the potential to accelerate the rate of recovery by restoring alleles or multiple-locus genotypes associated with the trait. For example, trophy hunting might reduce or eliminate alleles for large horn size, but gene flow from areas with no hunting might quickly restore alleles associated with large horn size (Coltman, 2008).

No-take protected areas have considerable potential for reducing the effects both of loss of genetic variation and harmful exploitative selection. Models of reserves in both terrestrial (Tenhumberg et al., 2004) and marine (Baskett et al., 2005) systems support this approach for a wide variety of conditions. However, the actual effectiveness of such reserves on exploited populations outside of the protected area depends on the amount of interchange between protected and nonprotected areas and on understanding the pattern and drivers of dispersal, migration, and genetic subdivision (Palumbi, 2003; Kritzer and Sale, 2004). Some have suggested that as exploitation pressure intensifies outside protected areas, local protection could select for decreased dispersal distance and thereby increase isolation and fragmentation and potentially reduce the genetic capacity of organisms to respond to future environmental changes (Dawson et al., 2006).

### ACKNOWLEDGMENTS

We dedicate this chapter to Hampton Carson who failed through no fault of his own to convince F.W.A. of the importance of sexual selection in the conservation of salmon. We thank Joel Berger, Steve Chambers, Dave Coltman, Roger Cowley, Doug Emlen, Marco Festa-Bianchet, Mike Ford, Roger Hanlon, Rich Harris, Wayne Hsu, Dan Jergens, Gordon Luikart, and Robin Waples for providing references and helpful comments. This article is based partially on work supported by the U.S. National Science Foundation Grant DEB 074218 (to F.W.A.) and by the Arctic-Yukon-Kuskokwim Sustainable Salmon Initiative Project 607 (to J.J.H.).



## 8

# In the Light of Directed Evolution: Pathways of Adaptive Protein Evolution

---

JESSE D. BLOOM\* and FRANCES H. ARNOLD†\*

Directed evolution is a widely used engineering strategy for improving the stabilities or biochemical functions of proteins by repeated rounds of mutation and selection. These experiments offer empirical lessons about how proteins evolve in the face of clearly defined laboratory selection pressures. Directed evolution has revealed that single amino acid mutations can enhance properties such as catalytic activity or stability and that adaptation can often occur through pathways consisting of sequential beneficial mutations. When there are no single mutations that improve a particular protein property, experiments always find a wealth of mutations that are neutral with respect to the laboratory-defined measure of fitness. These neutral mutations can open new adaptive pathways by at least 2 different mechanisms. Functionally neutral mutations can enhance a protein's stability, thereby increasing its tolerance for subsequent functionally beneficial but destabilizing mutations. They can also lead to changes in "promiscuous" functions that are not currently under selective pressure, but can subsequently become the starting points for the adaptive evolution of new functions. These lessons about the coupling between adaptive and neutral protein evolution in the laboratory offer insight into the evolution of proteins in nature.

---

Divisions of \*Biology and †Chemistry and Chemical Engineering, California Institute of Technology, Pasadena, CA 91125.



Proteins are the molecular workhorses of biology, responsible for carrying out a tremendous range of essential biochemical functions. The existence of proteins that can perform such diverse tasks is a testament to the power of evolution, and understanding the forces that shape protein evolution has been a long-standing goal of evolutionary biology. More recently, it has also become a subject of interest among bioengineers, who seek to tailor proteins for a variety of medical and industrial applications by mimicking evolution. Although they approach the study of protein evolution from different perspectives and with different ultimate goals, evolutionary biologists and bioengineers are interested in many of the same broad questions.

In examining these questions, we begin by considering the continuing relevance of one of the earliest analyses of protein evolution, performed >40 years ago by the great chemist Linus Pauling and his colleague Emile Zuckerkandl (Zuckerkandl and Pauling, 1965). Working at the time when it was first becoming feasible to obtain amino acid sequences, Pauling and Zuckerkandl assembled the sequences of hemoglobin and myoglobin proteins from a range of species. They compared the sequences with an eye toward determining the molecular changes that accompanied the evolutionary divergence of these species. But although it was already known [in part from Pauling's earlier work on sickle cell anemia (Pauling et al., 1949; Ingram, 1957)] that even a single mutation could alter hemoglobin's function, the number of accumulated substitutions seemed more reflective of the amount of elapsed evolutionary time than any measure of functional alteration. Summarizing their research, Pauling and Zuckerkandl (1965) wrote:

Perhaps the most important consideration is the following. There is no reason to expect that the extent of functional change in a polypeptide chain is proportional to the number of amino acid substitutions in the chain. Many such substitutions may lead to relatively little functional change, whereas at other times the replacement of one single amino acid residue by another may lead to a radical functional change. Of course, the two aspects are not unrelated, since the functional effect of a given single substitution will frequently depend on the presence or absence of a number of other substitutions.

This passage highlights 2 key issues that continue to occupy researchers nearly a half-century later. First, natural proteins evolve through a combination of neutral genetic drift and functionally selected substitutions. Although probably every evolutionary biologist would acknowledge the existence of both types of substitutions, their relative prevalence is debated with often startling vehemence (Gillespie, 1984; Blum, 1992). The intractability of this debate is caused in large part by the difficulty

of retrospectively determining whether long-ago substitutions were the subject of selective pressures.

The second issue highlighted by Pauling and Zuckerkandl, the potential for an adaptive mutation's effect to depend on the presence of other possibly nonadaptive mutations, has been a topic of much discussion among protein engineers (Lockless and Ranganathan, 1999; Reetz et al., 2005; Weinreich et al., 2006). The reason is that the presence of epistatic coupling between mutations has the potential to profoundly affect the success of protein optimization strategies. In the absence of epistasis, a protein can always be improved by a simple hill-climbing approach, with each successive beneficial mutation moving further up the path toward some desired objective. But such a hill-climbing approach can in principle be confounded by epistasis, because selectively favored "uphill" steps (beneficial mutations) may only be possible after several "sideways" or "downhill" steps (neutral or deleterious mutations).

Over the last decade, protein engineers have performed hundreds of directed evolution experiments to improve properties such as catalytic activity, binding affinity, or stability (Eijsink et al., 2005; Johannes and Zhao, 2006; Jackel et al., 2008). The results of these experiments offer substantial insight into the possible pathways of adaptive protein evolution and the interplay between adaptive and neutral mutations. In the next section, we describe how a typical directed evolution experiment is implemented. We then provide a specific example of how directed evolution was successfully applied to a cytochrome P450 enzyme. Drawing on this example and a wealth of other work, we then generalize to draw what we consider to be three of the main empirical lessons from directed evolution. Finally, we discuss how these lessons can help inform an understanding of natural protein evolution.

## DESIGN OF A DIRECTED EVOLUTION EXPERIMENT

Although directed evolution experiments vary widely in their details, they all use the same basic evolutionary algorithm illustrated in Fig. 8.1. The experiment begins with a parent protein and an engineering goal (e.g., 10-fold improved catalytic activity on a particular substrate). The gene for the parent protein is mutagenized to produce a library of mutant genes. Proteins encoded by these mutant genes are then produced and screened (or selected) for the desired function, and the improved proteins are used as the parents for another round. Beneficial mutations are accumulated until the goal is reached or no further improvements are found. The success of the experiment obviously depends on the feasibility of the target function and whether measurable improvements can be accumulated to reach the goal.

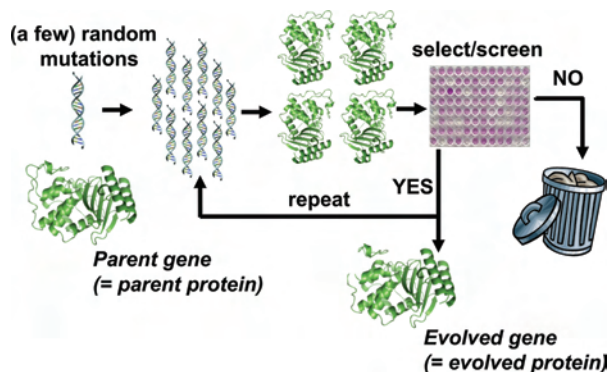

FIGURE 8.1 Schematic outline of a typical directed evolution experiment. The researcher begins with the gene for the parent protein. This parent gene is randomly mutagenized by using error-prone PCR or some similar technique. The library of mutant genes is then used to produce mutant proteins, which are screened or selected for the desired target property (e.g., improved enzymatic activity or increased stability). Mutants that fail to show improvements in the screening/selection are typically discarded, while the genes for the improved mutants are used as the parents for the next round of mutagenesis and screening. This procedure is repeated until the evolved protein exhibits the desired level of the target property (or until the student performing the experiments graduates).

There are myriad ways to implement the 3 key steps of this evolutionary algorithm: mutagenesis, screening/selection, and the decision on how to choose the parents for the next round. These choices obviously affect how successfully an experiment achieves its engineering goal and determine how closely the experiment mimics the process of natural molecular evolution. Here, we do not address how the implementation affects the experiment's engineering success, because this issue is widely discussed in the directed evolution literature (suffice it to say that the reason that many implementations are in use is that no one approach has been decisively proven to be more effective than the others). Instead, we simply give a general overview of the most common implementations, so that a reader from outside of the field can gain a sense of the extent to which directed and natural evolution are comparable.

The 2 most common procedures for mutagenizing the parent genes are error-prone PCR and DNA shuffling (Stemmer, 1994). As its name suggests, error-prone PCR copies the parent genes while introducing a few mutations (usually 1 or 2 per gene), and therefore mimics imperfect DNA replication. DNA shuffling is a procedure that both mutagenizes and recombines homologous genes at crossover points of high sequence iden-

tity and therefore approximately imitates the natural process of homologous recombination (although the parents are often more diverged than naturally recombining proteins). A common variation on both of these techniques is to bias the creation of mutant proteins with the goal of increasing the fraction of improved mutants, for example, by targeting functionally important residues for mutagenesis (Park et al., 2005) or choosing recombination crossover points based on structural information (Voigt et al., 2002). Researchers also sometimes use techniques to specifically change several residues simultaneously with the goal of finding coupled beneficial mutations, although (as discussed below) the mutations discovered by such approaches often turn out to have been individually beneficial, and so presumably could have also been discovered separately with lower mutation rates.

The procedure used to identify improved mutants depends on the details of the particular protein and engineering goal. In some cases, the protein property of interest can be coupled to the survival of the host cell, thereby allowing for direct genetic selection of cells carrying improved mutants. Such selections can often be applied to libraries consisting of millions of different mutants. More frequently, it is not possible to design an effective selection, and mutants must be assayed directly in a high-throughput screen. In these cases, the researcher is typically able to examine libraries of a few thousand different mutants. Such screening is nonetheless sufficient to examine most of the possible individual mutations to a parent protein, because a 200-aa protein possesses only  $19 \times 200 = 3,800$  unique single mutants (even fewer are accessible via single nucleotide changes).

The last step in the evolutionary algorithm is using the results from the screening/selection to choose the parents for the next generation. For reasons that are not entirely clear, directed evolution experiments rarely use schemes in which each mutant contributes to the next generation with a probability proportional to its measured fitness. (In contrast, fitness-proportionate selection is widely used in computational genetic algorithms.) Instead, researchers typically choose one or a few of the best mutants as parents for the next generation. Proteins undergoing directed evolution therefore experience a series of population bottlenecks in which most of the genetic variation is purged. At the same time, the adaptive-walk nature of these experiments provides little opportunity for deleterious or neutral mutations to spread (unless they hitchhike along with beneficial ones). These experiments therefore typically fail to fully recapitulate the evolutionary dynamics of either small populations (rapid genetic drift including the occasional fixation of deleterious mutations) or large populations (the maintenance of substantial levels of standing genetic variation). Directed evolution therefore probably sheds more light on the question of

how beneficial mutations arise, rather than on how these mutations would actually spread in a naturally evolving population.

### **AN EXAMPLE OF DIRECTED EVOLUTION: CONVERTING A CYTOCHROME P450 FATTY ACID HYDROXYLASE INTO A PROPANE HYDROXYLASE**

As an example of protein adaptation via directed evolution, we describe how the substrate specificity of a cytochrome P450 enzyme was dramatically altered (Fasan et al., 2007, 2008). The cytochrome P450 monooxygenase superfamily provides a beautiful example of how nature has generated a whole spectrum of catalysts from one common framework: >7,000 P450 sequences identified from all kingdoms of life catalyze the oxidation of a vast array of organic compounds. We wanted to know how easily we could alter one of these natural enzymes (P450 BM3, a bacterial fatty acid hydroxylase) to hydroxylate small alkanes such as propane and ethane, a reaction that is catalyzed in nature by a different class of monooxygenase enzymes.

Although wild-type P450 BM3 has only weak activity on long-chain alkanes (and no measurable activity on short alkanes), we hypothesized that mutants of this enzyme displaying enhanced alkane activity might acquire measurable ability to hydroxylate slightly shorter alkanes. Further mutagenesis of active variants, with screening on progressively shorter-chained substrates, could ultimately generate activity on the smallest, gaseous alkanes. This approach of breaking down an apparently difficult problem (such as obtaining activity on a substrate very different from the native substrate) into a series of smaller problems lowers the bar for each evolutionary step and can even allow new activities to be acquired 1 mutation at a time.

Iterative rounds of random mutagenesis, recombination of beneficial mutations, and screening for activity on successively smaller alkanes, or alkane surrogates, led to the creation of P450 PMO, whose ability to hydroxylate propane is comparable with the wild-type enzyme's activity on fatty acids (Fasan et al., 2007). This enzyme contains 23 amino acid substitutions relative to its wild-type ancestor; complete respecialization for the new substrate required changing only a little more than 2% of the amino acid sequence.

At one point during the evolution, however, no further improvements in activity on propane were found, even though the activity remained well below the native enzyme's activity on its preferred substrates. Upon measuring the stability of the evolved enzyme and its precursors, we found that the mutations that had enhanced activity on propane had also decreased the protein's stability to the extent that the enzyme could tolerate only a low fraction of new mutations. Intentionally selecting for several

stabilizing mutations recovered much of the lost stability and allowed for the subsequent discovery of further mutations that improved activity. Fig. 8.2 summarizes the overall changes in activity and stability that occurred during the entire directed evolution trajectory (Fasan et al., 2008).

### EMPIRICAL LESSONS FROM THE DIRECTED EVOLUTION OF PROTEINS

In this section, we offer what we consider to be some of the general lessons about protein adaptation that can be drawn from directed evolution experiments.

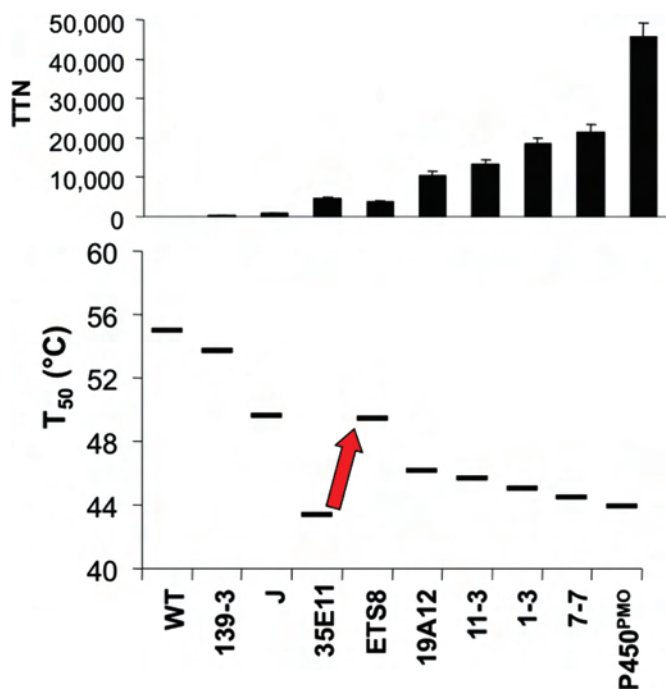

FIGURE 8.2 Activity and stability changes during the directed evolution of a cytochrome P450 enzyme for activity on short-chain alkanes. (*Upper*) The changes in activity on propane (total turnover number, TTN) during steps along the directed evolution trajectory. (*Lower*) The changes in protein stability (measured as  $T_{50}$  values for heat inactivation). During the steps of directed evolution, the protein was selected for activity on progressively shorter alkanes, without regard to stability. The exception is the step indicated by the arrow, where stabilizing mutations were intentionally selected to recover some of the lost stability. Data are taken from Fasan et al. (2008).

## Many Desirable Protein Properties Can Be Improved Incrementally, Through Single Mutations

Perhaps the most surprising result from directed evolution experiments is simply how effectively random mutation and selection are able to enhance target protein properties. In most cases where the researcher has been able to devise a high-throughput and sensitive screening assay, it has proved possible to find mutations that improve function (usually a catalytic activity or binding affinity). Directed evolution experiments naturally classify mutations as beneficial, neutral, or deleterious, depending on how they affect the target property. These studies tend to reach remarkably similar conclusions about the fractions of mutations that fall into each of these 3 classifications, despite applying different methodologies to different proteins to optimize different properties. Typically,  $\approx 30\text{--}50\%$  of random mutations are strongly deleterious (Shafikhani et al., 1997; Guo et al., 2004; Drummond et al., 2005),  $50\text{--}70\%$  are approximately neutral (Shafikhani et al., 1997; Guo et al., 2004; Drummond et al., 2005), and perhaps  $0.5\text{--}0.01\%$  are beneficial (Castle et al., 2004; Garrett et al., 2004; Palackal et al., 2004; Reetz et al., 2004; Aharoni et al., 2005; Solbak et al., 2005; Bloom et al., 2006). These experiments therefore make clear that, in a laboratory context, it is almost always possible to find a substantial number of neutral mutations and usually at least a few that enhance stability or an existing function.

Most cases where directed evolution fails to immediately find beneficial mutations come when the bar is set too high, such as searching for activity on a new substrate on which the parent protein is completely inert. Such functional jumps may simply be too big for single mutations. However, these functions can usually still be generated by taking a more incremental path, as in the case described above where a cytochrome P450 became a propane hydroxylase by first becoming an octane hydroxylase (Meinhold et al., 2005; Fasan et al., 2008). A similar approach of identifying appropriate intermediate challenges was used to engineer a steroid receptor to respond to a novel ligand (Chen and Zhao, 2005). In both cases, the target activity was absent in the initial parent protein, making it refractory toward improvement by any single mutation. Selection on the intermediate substrates gave rise to low levels of the target activities, which were rapidly improved by beneficial single mutations.

These findings indicate that directed protein evolution can usually avoid being stymied by local fitness peaks, where no further incremental improvements are possible. Concern about becoming trapped on local optima probably comes from viewing evolution as occurring on a landscape created by assigning a fitness to each possible genotype. Although fitness landscapes are conceptually valid constructs, the mind effectively visualizes only 3D spaces, which are often reduced to 2 dimensions for ease



of representation on paper. However, a 300-residue protein can undergo 5,700 unique single amino acid mutations, each of which represents a different direction on the fitness landscape. For a protein to occupy a peak in such a multidimensional landscape, a step in each of these directions must lead to a decrease in fitness, meaning that all 5,700 possible mutations are deleterious. In contrast, every protein evolved in the laboratory has many possible neutral mutations, and often several beneficial ones, at least as measured by a specific biochemical assay. It may therefore be more helpful to think of protein evolution in terms of neutral networks (Smith, 1970; Huynen et al., 1996) rather than in terms of fitness peaks (see Fig. 8.3). The key difference is that fitness peaks imply a need for multiple simultaneous mutations to escape from a trap, whereas the neutral network view emphasizes the availability of many possible evolutionary pathways, which may include initially neutral and immediately beneficial mutations.

### Much of the Epistatic Coupling Between Mutations Is Simply Explained in Terms of Protein Stability, Which Can Underlie Variation in Both Mutational Robustness and Evolvability

The fact that most proteins can be engineered through sequential single mutations must not be interpreted to indicate that epistatic coupling between mutations does not exist. Both directed evolution and retro-

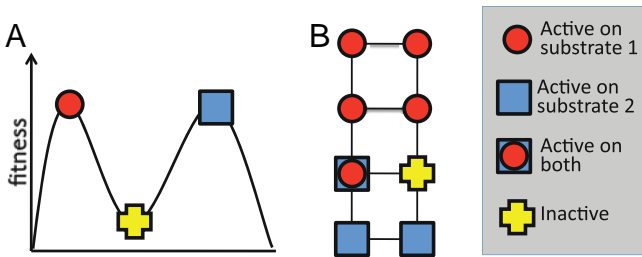

FIGURE 8.3 Fitness landscapes and neutral networks. (A) A fitness landscape in which a protein at a peak corresponding to activity on substrate 1 can only reach the peak corresponding to activity on substrate 2 by taking a downhill step corresponding to a deleterious mutation. (B) A neutral network in which a protein that is active on substrate 1 may initially be unable to achieve activity on substrate 2 with a single mutational step, but can reach activity on the latter substrate through a series of neutral steps. Although both fitness landscapes and neutral networks are conceptually valid views of evolution, fitness landscapes tend to emphasize the possibility of becoming trapped on peaks, whereas neutral networks emphasize the availability of neutral mutations and their potential coupling to adaptation. In the context of directed evolution, proteins have been found empirically to always have many possible neutral mutations.

spective analyses of natural evolution have uncovered clear examples of mutations whose beneficial effects are contingent on the existence of other initially neutral or even slightly deleterious mutations. The surprising empirical lesson is that such epistasis frequently occurs through a simple mechanism, allowing it to be both easily understood and leveraged for engineering purposes.

Early experimental clues to the common origin of much of protein mutational epistasis came from genetic studies that found that the same “global suppressor” mutations could often remedy the effects of several different deleterious mutations (Shortle and Lin, 1985; Rennell and Poteete, 1989). In many cases, the global suppressor mutations stabilized the protein’s folded structure, suggesting that they compensated for destabilization caused by the deleterious mutations (Shortle and Lin, 1985). The role of stability compensation in adaptive evolution was demonstrated in a study showing that a naturally occurring antibiotic-resistance enzyme acquired activity on new antibiotics by pairing a stabilizing mutation with one or more catalytically beneficial but destabilizing mutations (Wang et al., 2002).

The contribution of directed evolution experiments has been to demonstrate the ubiquity of such stability-mediated epistasis. Introducing just 1 stabilizing mutation into a lactamase enzyme reduced the fraction of random single amino acid mutations that inactivated the protein by one-third (Bloom et al., 2005). A cytochrome P450 enzyme that had been engineered to contain a handful of stabilizing mutations was nearly twice as tolerant to random mutations (Bloom et al., 2006). And a thermostable chorismate mutase was a remarkable 10-fold more tolerant to randomization of a large helical region than its mesostable counterpart (Besenmatter et al., 2007). The extensive stability-mediated epistasis suggested by these experiments can be visualized in terms of a protein stability threshold, as illustrated in Fig. 8.4. In a directed evolution experiment, stability is under selection only insofar as the protein must fold to its proper 3D structure with sufficient stability to perform the target biochemical function. Mutations that increase or decrease stability are therefore neutral as long as the protein remains more stable than some threshold value. But because most mutations are destabilizing, an initially neutral stabilizing mutation can increase a protein’s robustness to other, subsequent mutations.

Directed evolution has shown the crucial role that stability-based epistasis can play in adaptive evolution. One experiment directly compared the frequency with which a marginally stable and a highly stable cytochrome P450 enzyme could acquire activities on a set of new substrates upon random mutation. Libraries of mutants of both enzymes were screened, and a markedly higher fraction of mutants of the stable protein were found to exhibit the new activities (Bloom et al., 2006). This increased evolvability of the stable enzyme was caused by its ability to better toler-

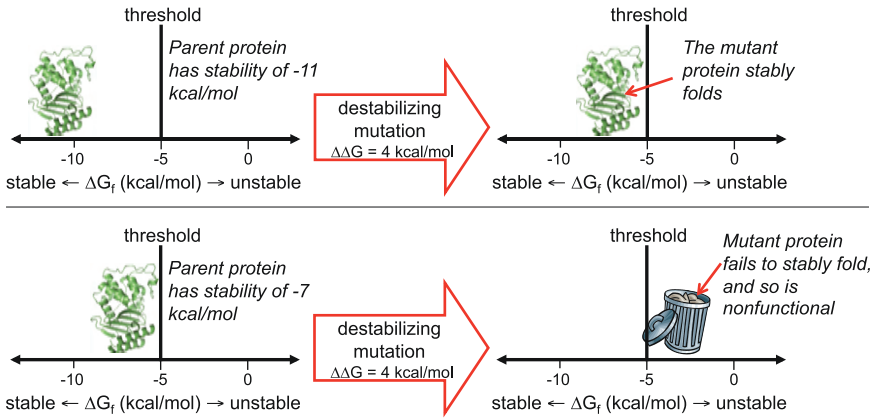

FIGURE 8.4 The effect of a mutation can depend on the stability of the protein into which it is introduced. As shown here, proteins that are more stable than the threshold can fold and function, whereas those that are less stable than the threshold fail to fold and are therefore nonfunctional. A particularly functionally beneficial but destabilizing mutation may therefore only be tolerated by a protein that has previously accumulated one or more stabilizing substitutions.

ate catalytically beneficial but destabilizing mutations (Bloom et al., 2006). These results indicate that stabilizing mutations increase evolvability by the same mechanism that they increase mutational robustness.

The existence of widespread stability-mediated epistasis further explains why trapping on fitness peaks is not an important concern in directed protein evolution, although it does emphasize a role for neutral mutations. A protein that has been pushed to the margins of tolerable stability may lose access to functionally beneficial but destabilizing mutations. But this protein is still not stuck on a fitness peak, because it can regain its mutational robustness and evolvability by accumulating initially neutral but stabilizing mutations. In a nondirected context, such a process might require a time-consuming wait for stabilizing mutations to spread by neutral drift. But in a directed evolution experiment, the process can be expedited by intentional selection for stabilizing mutations, as was done in the cytochrome P450 experiment described above.

### Adaptive Protein Evolution Relies Heavily on the Prevalence of Promiscuous Functions, and Protein Promiscuity in Turn Fluctuates with Neutral Mutations

Directed protein evolution experiments have demonstrated that once a biochemical function is present at even a low level, it can usually be

improved via an adaptive pathway of sequential beneficial single mutations. But how can a bioengineer induce a protein to take the first step of acquiring a trace of the target activity? One answer is, conveniently, the desired activity is often already there. Naturally occurring enzymes frequently possess low levels of various “promiscuous” activities, which can rapidly expand during laboratory evolution (O’Brien and Herschlag, 1999; Copley, 2003; Aharoni et al., 2005; Khersonsky et al., 2006).

Preexisting promiscuous activities have been used as starting points for many directed evolution experiments (Aharoni et al., 2005; Yoshikuni et al., 2006). For example, the cytochrome P450 directed evolution experiment described above used as a starting point the native enzyme’s promiscuous activity on octane. A particularly compelling example comes from phosphotriesterase and lactonase enzymes. These enzymes have been engineered for efficient activity on several new substrates through selection of mutations that enhance existing promiscuous functions (Harel et al., 2004; Aharoni et al., 2005; Amitai et al., 2006). Complementary work has shown that selection for a promiscuous activity likely explains the natural origin of a bacterial enzyme that hydrolyzes a synthetic compound only recently introduced into the environment (Afriat et al., 2006).

Laboratory evolution also indicates that promiscuous activities themselves can fluctuate substantially with neutral mutations. In separate experiments, lactonase (Amitai et al., 2007) and cytochrome P450 (Bloom et al., 2007c) enzymes were neutrally evolved by mutagenesis and selection for retention of the primary target function. Neutrally evolved variants were then examined for activity on several nontarget substrates. In many cases, the neutral mutations had led to changes in these promiscuous activities (Amitai et al., 2007; Bloom et al., 2007c). Neutral mutations can therefore set the stage for adaptation by providing a varied set of evolutionary starting points. Actually performing neutral evolution in the laboratory may be of limited engineering value because of the considerable experimental effort required to accumulate a substantial number of substitutions. But protein engineers routinely screen and recombine naturally occurring protein homologs (Crameri et al., 1998; Landwehr et al., 2007), thereby exploiting the genetic drift that underlies the divergence of their sequences and promiscuous activities. Recombination is therefore an excellent way to tap into the benefits of natural neutral evolution.

### IMPLICATIONS FOR UNDERSTANDING NATURAL PROTEIN EVOLUTION

What is implied about natural protein evolution by the foregoing lessons from the laboratory? The main complication in applying these observations to natural protein evolution is determining whether similar

general selection pressures apply. Interpretation of mutational steps during directed evolution is performed in an objective way by scoring the mutant protein in a prespecified experimental assay. Therefore, it is always clear whether a mutation is beneficial, neutral, or deleterious. Of course, mutations that are scored as neutral may still affect any of an almost interminable list of other properties not measured in the assay (stability, expression level, codon usage, promiscuous activity, etc.). And herein lies the main argument against generalizing the results of directed evolution to natural evolution: experimental assays are relatively insensitive, and natural proteins evolve under pleiotropic constraints not present in the laboratory. A similar argument has been invoked against the idea of widespread neutral evolution of natural proteins, namely that apparently neutral mutations actually induce subtle, but important, alterations that do affect fitness (Blundell and Wood, 1975; Gillespie, 1991).

In the absence of an experimental method for measuring how changes in a protein affect biological fitness, these issues will always to some degree remain a matter of speculation [hence the intractability of the long-standing debate between selectionism and neutralism (Nei, 2005)]. Clearly, natural proteins are subject to additional constraints not present in most laboratory experiments, because they must function *in vivo* while minimizing deleterious interactions with other cellular components or pathways. In addition, laboratory evolution experiments usually impose a very strong selection for the target protein property, such that mutations that benefit the target property may be selected even to the detriment of other properties. The fact that laboratory evolution tends to impose fewer pleiotropic constraints and stronger positive selection means that it almost certainly overestimates the frequency of neutral and beneficial mutations relative to natural evolution. Therefore, whereas 50–70% of protein mutations are neutral in a laboratory assay, the percentage is surely lower in nature. The degree to which this is true will of course vary in accordance with the principles of population genetics, with proteins from viruses being more highly optimized than those from species like mammals with large genomes and small effective population sizes (Lynch, 2007). But Pauling and Zuckerkandl's nearly half-century old observation (Zuckerkandl and Pauling, 1965) that "many substitutions may lead to relatively little functional change" seems more true than ever in an era where abundant genome sequences have revealed numerous proteins with diverged sequences that nonetheless perform largely conserved functions. This fact strongly suggests that one of the key lessons from directed evolution also applies to natural protein evolution: rather than occupying completely optimized fitness peaks, most proteins have many available evolutionary paths and often direct adaptive paths to improve potentially useful functions.

The prevalence of stability-mediated epistasis revealed by laboratory evolution also has important implications for understanding natural protein evolution. As is suggested by Fig. 8.4, whether a mutation is neutral or deleterious can be conditional on the stability of the protein in which it occurs. In contrast, most mathematical treatments of neutral evolution make the (often unspoken) assumption that a constant fraction of mutations is neutral. Several classic results commonly attributed to the neutral theory are no longer necessarily true if the fraction of neutral mutations is conditional on protein stability. In particular, in such a scenario, neutral evolution can lead to overdispersion of the molecular clock (Takahata, 1987; Bloom et al., 2007b), an influence of population size on substitution rate (Bloom et al., 2007b), and a dependence of mutational load and robustness on both population size and the structure of the underlying neutral space (van Nimwegen et al., 1999; Wilke and Adami, 2003; Bloom et al., 2007a). These results suggest the importance of continually updating theories of molecular evolution to reflect expanding knowledge about the details of the molecules in question.

The lessons of directed evolution also caution against attributing all properties of natural proteins to adaptive causes. For example, most enzymes are only marginally more stable than is required by their natural environment (Somero, 1995). This marginal stability was long argued to be an adaptive trait, providing an optimal degree of flexibility that favored high catalytic activity (Somero, 1995; Fields, 2001). This adaptive argument has been undermined by evolutionary engineering experiments demonstrating that enzyme stability can be dramatically increased without concomitant loss of catalytic activity (Serrano et al., 1993; Giver et al., 1998; Van den Burg et al., 1998). Instead, both simulations (Taverna and Goldstein, 2002) and theory (Bloom et al., 2007b; Zeldovich et al., 2007) show that the marginal stability of proteins can arise neutrally because most mutations are destabilizing. Although there are a few proteins whose marginal stability is clearly adaptive (Canadillas et al., 2006), the marginal stability of most proteins is likely the result of neutral mutation-driven processes. Other properties, such as catalytic or substrate promiscuity, that arise naturally during laboratory evolution should probably also be assigned neutral rather than adaptive origins.

Another important contribution of directed evolution has been to demonstrate 2 clear mechanisms whereby neutral mutations shape the available adaptive pathways. Selectively neutral mutations that increase stability can promote evolvability by allowing for subsequent beneficial but destabilizing mutations (Bloom et al., 2006), whereas neutral mutations that alter promiscuous activities (Amitai et al., 2007; Bloom et al., 2007c) can create the starting points for subsequent adaptive evolution. Evolutionary engineers leverage the coupling between neutral and adaptive mutations

in at least 2 ways: directly selecting for functionally neutral but stabilizing mutations and screening and recombining pools of diverged homologous sequences (Cramer et al., 1998; Landwehr et al., 2007). Natural evolution does not so deliberately exploit the potential benefits of neutral mutations, but genetic drift and preexisting diversity may play a similarly important role in natural adaptive evolution. Indeed, ancestral protein reconstruction experiments have elucidated specific adaptive events that appear to have been contingent on the initial occurrence of approximately neutral substitutions (Ortlund et al., 2007).

The overall picture that emerges from evolutionary engineering is that proteins, although clearly highly refined by evolution, retain a substantial capacity for neutral and adaptive change. In many ways, this picture is complementary to that offered by more traditional biochemical characterizations, which often focus on the exquisitely tuned interactions that can underlie a protein's evolved function. Directed evolution does not dispute the subtlety of such interactions, nor does it usually offer such a careful description of the details of protein function. But although biochemists typically choose for their studies the most interesting examples, evolutionary engineers by necessity deal with the broader statistics of random mutations and evolutionary possibilities. These statistics suggest that proteins enjoy access to many neutral mutations, which can in turn open new adaptive avenues. Ultimately, a more detailed understanding of these evolutionary pathways will be of value in both protein engineering and evolutionary biology.

### ACKNOWLEDGMENTS

F.H.A. is supported by the U.S. Department of Energy and the U.S. Army. J.D.B. is supported by a Caltech Beckman Institute Postdoctoral Fellowship and the Irvington Institute Fellowship Program of the Cancer Research Institute.





## Part III

---

### SEXUAL SELECTION, OR ADAPTATION TO MATING DEMANDS

In *The Descent of Man, and Selection in Relation to Sex*, Darwin defined sexual selection as the “advantage which certain individuals have over other individuals of the same sex and species, in exclusive relation to reproduction.” Darwin appreciated that sexual selection could be mediated by intrasexual combat (e.g., between males) or by intersexual preferences (e.g., female choice of attractive mates). He also appreciated that sexual selection could be in opposition to natural selection with respect to particular phenotypic traits (such as a peacock’s tail), but he generally viewed sexual selection as less effective than natural selection.

After discussing Darwin’s original ideas about sexual selection (especially as presented in *The Descent of Man*), Adam Jones and Nicholas Ratterman in Chapter 9 identify three modern triumphs in sexual selection research: the introduction and widespread use of molecular markers to assess genetic parentage (the key to describing mating systems in nature) unequivocally; a better conceptual understanding (at least in formal models) of the mechanisms and consequences of mate choice by females (or by males in role-reversed taxa); and a better appreciation of why differences exist among lineages in the intensity of various forms of sexual selection. For the latter two topics, the histories of ideas on sexual selection—beginning with Darwin—are interwoven with how those notions laid the foundation for categorizing various forms of sexual selection, and for extending and expanding modern research into various aspects of sexual selection both in theory and empirically. The authors close by suggesting several lines of future research on sexual selection.

In Chapter 10, Stephen Shuster provides a comprehensive overview (and contrast) of how sexual selection has been measured and studied in plant systems versus animal systems. One general theme that he emphasizes is the need to reconcile Darwin's idea that sexual selection tends to be less rigorous than natural selection with the observation that sexual selection would seem to be responsible for many if not most differences between the two genders (in features other than the primary sex organs). In *The Origin*, Darwin wrote that sexual selection "depends, not on the struggle for existence, but on a struggle between males for possession of the females; the result is not death of the unsuccessful competitor, but few or no offspring. Sexual selection is, therefore, less rigorous than natural selection." Shuster, by contrast, views sexual selection as being "among the most powerful of evolutionary forces." The author proposes to reconcile these two stances in evolutionary models that combine quantitative differences in the fitness variances between the sexes (an approach traditionally applied to animal systems) with phenotypic and genotypic correlations underlying reproductive traits among breeding pairs (an approach often taken in plant systems). The net result, he claims, will be the ability to predict the magnitudes of sexual dimorphism and classify mating systems using existing genetic and life history data.

In Chapter 11, Patricia Gowaty and Stephen Hubbell offer a novel perspective on what underlies the individual decision-making process that in turn underlies patterns of mate choice and sexual selection in various species. Their central thesis is that even stochastic variation in various parameters that predict the time available for mating might promote considerable flexibility in individual decision making with regard to mate choice; and that even consistent sex differences in these mating proclivities might therefore, in at least some cases, reflect ecological constraints (habits-of-life considerations) rather than behavioral differences that might otherwise be genetically hardwired between the sexes. The parameters that might impact available time for mating include the probabilities of encountering mates, individual survivorships, mating latencies (times-out between mating events), and fitness distributions, all of which are likely to vary as functions of the natural histories as well as the evolutionary histories of species. Such considerations lead the authors to their switch point theorem, which in principle can quantitatively evaluate what proportion of potential mates in a population a focal individual should find acceptable as mating partners if it is to maximize its relative lifetime fitness.

In an uncharacteristic conceptual lapse, Darwin failed to appreciate that sexual selection (including both male-male competition and female choice) can continue even after copulation has begun. The intrasexual (male-male) component can happen via sperm competition for the fertilization of ova, and the intersexual component can occur via cryptic female

choice of alternative sperm, all within the female's reproductive tract. William Eberhard reviews the history of ideas for these underappreciated but nevertheless intense forms of postcopulatory sexual selection in Chapter 12. The miniature worlds of gametic competition and gametic choice have proven to be every bit as fascinating and compelling as the macroscopic worlds of mating competition and mate choice that have been the traditional foci of sexual selection studies. Eberhard brings this miniature Kama Sutra realm to light by detailing fascinating examples of sexual selection in the time interval (which is often but not invariably brief) between the onset of copulation and the completion of fertilization.



## 9

# Mate Choice and Sexual Selection: What Have We Learned Since Darwin?

---

ADAM G. JONES and NICHOLAS L. RATTERMAN

Charles Darwin laid the foundation for all modern work on sexual selection in his seminal book *The Descent of Man, and Selection in Relation to Sex*. In this work, Darwin fleshed out the mechanism of sexual selection, a hypothesis that he had proposed in *The Origin of Species*. He went well beyond a simple description of the phenomenon by providing extensive evidence and considering the far-reaching implications of the idea. Here we consider the contributions of Darwin to sexual selection with a particular eye on how far we have progressed in the last 150 years. We focus on 2 key questions in sexual selection. First, why does mate choice evolve at all? And second, what factors determine the strength of mate choice (or intensity of sexual selection) in each sex? Darwin provided partial answers to these questions, and the progress that has been made on both of these topics since his time should be seen as one of the great triumphs of modern evolutionary biology. However, a review of the literature shows that key aspects of sexual selection are still plagued by confusion and disagreement. Many of these areas are complex and will require new theory and empirical data for complete resolution. Overall, Darwin's contributions are still surprisingly relevant to the modern study of sexual selection, so students of evolutionary biology would be well advised to revisit his works. Although we have made significant

---

Department of Biology, Texas A&M University, 3258 TAMU, College Station, TX 77843.

progress in some areas of sexual selection research, we still have much to accomplish.

Charles Darwin proposed the concept of sexual selection 150 years ago in *On the Origin of Species by Means of Natural Selection* (Darwin, 1859), but his definitive work on sexual selection was undoubtedly *The Descent of Man, and Selection in Relation to Sex*, which was published in 1871. Now—200 years after Darwin's birth—is an excellent time to reflect on the modern relevance of his work and on progress that has been made in the study of sexual selection since his time. In typical Darwinian fashion, *The Descent of Man, and Selection in Relation to Sex* is a colossal tome (with a tongue-tripping title that we will henceforth abbreviate as *The Descent of Man*) that strolls through myriad topics relevant to evolutionary biology and ecology. Consequently, it is futile to attempt to characterize the full spectrum of topics addressed in this book, which touched upon such sundry issues as species concepts, taxonomy, correlated evolution, sex-limited inheritance, and group selection, to name a few. Rather, we focus on the contributions of Darwin in light of modern research in sexual selection, and in so doing we identify a few important topics for which a thread of reasoning can be traced from Darwin to the present.

One of the great strengths of Darwin was that he often constructed his literary works with a clear argument in mind and marshaled vast amounts of evidence to support his case. *The Descent of Man* is most famous for Darwin's contribution to the hypothesis of sexual selection, but the main goal of the book was to provide evidence that evolutionary principles applied to humans and that humans descended from some ape-like common ancestor. Darwin believed that sexual selection played a major role in the evolution of humans and the divergence among distinct human populations, so he felt a lengthy description of sexual selection was necessary. Indeed, the bulk of the book concerns sexual selection, but many of Darwin's insights regarding sexual selection appear in his chapters on humans.

Darwin's most lasting achievement with respect to sexual selection must be his definition of the term, as it is essentially the same as the one still in use today. It is difficult to find a quote from Darwin that captures the full essence of his concept of sexual selection, but he provides the following definition:

We are, however, here concerned only with that kind of selection, which I have called sexual selection. This depends on the advantage which certain individuals have over other individuals of the same sex and species, in exclusive relation to reproduction.

Darwin (1871, Part I, pp. 254–255)



However, Darwin makes it clear that not all selection related to reproduction constitutes sexual selection, as primary sexual traits—like ovaries and testes—can evolve as a consequence of natural selection. Even though he never spells it out in so many words, Darwin’s working definition of sexual selection is essentially identical to the one used by Andersson (1994) and most other scientists studying sexual selection. In particular, “sexual selection arises from differences in reproductive success caused by competition for access to mates” (Andersson, 1994, p. 3). This definition admittedly focuses primarily on precopulatory sexual selection, so a more complete definition should also include postcopulatory processes, which can be accomplished by tagging the phrase “or fertilization opportunities” onto the end of Andersson’s definition.

Aside from the definition of sexual selection, what did Darwin accomplish in *The Descent of Man*? In a book as rich as Darwin’s, every reader could potentially identify different sets of key conclusions, depending on the reader’s background and research emphasis. Here we try to focus on those parts of the book that are still relevant to modern research, and from our perspective Darwin identified 2 major themes that set the stage for work on sexual selection. The first theme concerned the question of why sexual selection occurs in the first place. In the context of this question, Darwin identified the 2 major categories of sexual selection, namely intrasexual and intersexual selection, although he didn’t use those terms (Darwin, 1871). The second theme is related to the question of why sexual selection is strong in some lineages but not others. This question continues to be a major theme of modern research, but Darwin expressed an amazingly modern, intuitive understanding of some of the explanations for the patterns of sexual selection among diverse evolutionary lineages (Darwin, 1871).

In this chapter, we summarize Darwin’s contributions to these 2 major topics and consider how far we have progressed in our understanding of them. Rather than review all of the relevant literature, which for many of these topics has been done recently, we try to paint the current state of sexual selection with broad strokes. Like Darwin (1871), we focus on precopulatory sexual selection, leaving the treatment of postcopulatory processes for a different chapter in this volume (Eberhard, Chapter 12). Our sojourn through sexual selection literature leads to the identification of at least 2 major triumphs of precopulatory sexual selection research since Darwin. It also identifies numerous areas ripe for additional work. We hope that this paper will inspire our fellow scientists by showing (*i*) that Darwin, despite having tremendous insight given the state of biology in the 19th century, did not get everything right, (*ii*) that we have made tremendous progress since Darwin’s time, especially in the last several decades, and (*iii*) that many important questions regarding sexual selection remain to be answered.

## THE MECHANISMS OF SEXUAL SELECTION AND THE FIRST MAJOR TRIUMPH

Darwin (1871) correctly realized that sexual selection could be mediated by male-male combat or by a female's choice of attractive males. His original definition of sexual selection, which appeared in *The Origin of Species*, appears to emphasize male-male combat [i.e., "a struggle between the males for possession of the females" (Darwin, 1859, p. 88)], but even then he was clearly aware of female choice. Thus, Darwin identified the 2 main categories of sexual selection that persist to this day.

### The Law of Battle

Sexual selection would be relatively simple if there were nothing but what we call intrasexual selection. In fact, Darwin's understanding of intrasexual selection was essentially complete. In some species, males engage in fierce struggles among one another, and the victors in these contests tend to mate with the receptive females. Darwin provided numerous examples of species in which intrasexual combat for access to mates prevailed, some of the more interesting of which include male narwhals fencing with their tusks [which remains to be studied, but see Gerson and Hickie (1985)], male scarab beetles (family Scarabaeidae) battling with their elaborate horns (Emlen et al., 2005), and female buttonquail (genus *Turnix*) fighting like gamecocks for reproductive access to the males (Starck, 1991). The latter example illustrates Darwin's appreciation of the fact that sexual selection, which normally acted most strongly on males, could sometimes operate on females, a point to which we will return later.

However, intrasexual selection is not a sufficient mechanism by which to explain all of the diversity wrought by sexual selection. Modern work shows that intersexual selection is a major aspect of sexual selection, a point that was deeply appreciated by Darwin. In fact, Darwin correctly realized that even in species characterized by the "law of battle," mate choice often is important. As Darwin stated:

The female could in most cases escape, if wooed by a male that did not please or excite her; and when pursued, as so incessantly occurs, by several males, she would often have the opportunity, whilst they were fighting together, of escaping with, or at least temporarily pairing with, some one male.

Darwin (1871, Part II, p. 269)

Thus, any treatment of sexual selection will be incomplete without a treatment of mate choice.

## Female (or Sometimes Male) Choice

If the number of words devoted to each topic can serve as a guide, then Darwin felt that the topic of female choice required much more explanation than did male-male combat. Here we will treat female choice, while keeping in mind that Darwin knew that in some systems mirror-image processes could occur through male choice. Sexual selection as a consequence of female choice is easy to understand, provided we are willing to accept that female preferences exist. If females show a preference, then males with the preferred trait will leave greater numbers of offspring, and their trait values will tend to increase in frequency in the population.

But why would female preferences exist in the first place? The answer to this question is not entirely obvious. Darwin's approach was to contend that it was inconceivable that preferences did not exist and to provide evidence of female preferences in various animal species. Some of these examples, like the female mallard duck that experienced "love at first sight" upon encountering a male pintail (Darwin, 1871, Part II, p. 115), are rather humorous, but they do serve to show that females are not mating at random in most cases. Numerous passages in *The Descent of Man* address this issue, the following quote among them:

Nevertheless, when we see many males pursuing the same female, we can hardly believe that the pairing is left to blind chance—that the female exerts no choice, and is not influenced by the gorgeous colours or other ornaments with which the male alone is decorated.

Darwin (1871, Part I, p. 421)

Here we see the essence of Darwin's argument: Given the variation among males with respect to their beautiful ornaments, it is difficult to believe that females have no preference whatsoever, and even a weak preference would be sufficient for sexual selection to operate. Hence, Darwin clearly understood that female preferences existed, but he never compellingly explained why such preferences would evolve.

The flavor of Darwin's argument for female choice may represent one of the largest shortcomings of his treatment of sexual selection because it gave the impression that animals would need a human-like sense of aesthetics for sexual selection to operate. Indeed, Darwin himself seemed to subscribe to this point of view, as he went to great lengths to argue that arthropod, insect, and vertebrate females possess sufficient intelligence to appreciate beauty. He further asserted that the "lowest classes" of animals, including echinoderms, annelids, mollusks, and so forth, "have too imperfect senses and too low mental powers to feel mutual rivalry, or to appreciate each other's beauty or other attractions" (Darwin, 1871, Part I, p. 321). However, Darwin also clearly appreciated that different spe-

cies could possess different standards of beauty, explaining why not all sexually selected traits appear attractive to us. Regardless, in the midst of Darwin's tremendous insights pertaining to sexual selection, the suggestion that a sense of aesthetics is necessary for sexual selection to operate may have been his most significant shortcoming. It can be argued that it took almost 100 years for the study of sexual selection to overcome this erroneous view of mating preferences.

### **The First Major Triumph of Modern Sexual Selection Research**

The study of sexual selection entered its modern era during the latter half of the 20th century when scientists identified the evolution of female choice as a legitimate topic in its own right by expanding the ideas laid out much earlier by Fisher (1915, 1930). In other words, it was no longer sufficient to assume that females had preferences or even to provide empirical evidence of such preferences. Rather, we needed mechanisms that could explain the evolution of female preferences (O'Donald, 1962, 1980; Williams, 1966; Zahavi, 1975; Lande, 1981; Kirkpatrick, 1982). Once the evolution of preferences could be explained, our understanding of selection of the preferred trait became entirely straightforward, and it remains today essentially as Darwin described it. Thus, the difficulty, which partly remains unsolved, is to understand the evolution of female (or male) preferences. We will briefly review the modern models, but we start with the one explicit model proposed by Darwin. Although his model is missing some elements and comes up short as a complete explanation for choice evolution, it does provide the core of a model with potential explanatory power.

### **Darwin's Model of Sexual Selection**

Darwin's model, which later came to be known as the Darwin-Fisher model (Kirkpatrick, 1982; Kirkpatrick et al., 1990), has been invoked as a potential explanation for sexual selection in monogamous taxa. In Darwin's version of the model (Darwin, 1871, Part I, pp. 261–262), he assumes a population with 2 types of females: “the more vigorous and better-nourished individuals” and “the less vigorous and healthy” (Fig. 9.1A). Males also are variable in quality, and they arrive before females on the breeding grounds (Fig. 9.1B). The higher-quality females are ready to breed before the lower-quality females, and they choose to pair with the higher-quality males (Fig. 9.1C). Thus, the model predicts assortative mating by quality (Fig. 9.1D), and Darwin argues that the higher-quality pairs will produce more offspring than the lower-quality pairs. In Darwin's

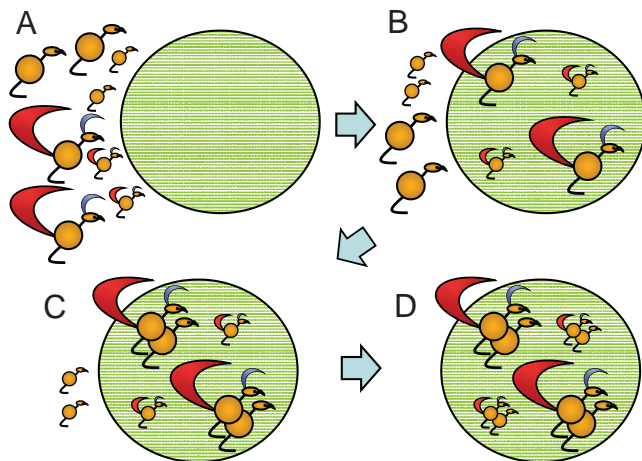

FIGURE 9.1 Darwin's model of sexual selection. (A) First, males and females are variable with respect to phenotypic quality. (B) Males, which have the ornaments, move to the breeding area (large circle) before the females. (C) The highest-quality females are ready to mate sooner, so they pair with the highest-quality males. (D) Finally, the lower-quality females pair with the lower-quality males. Sexual selection occurs because the higher-quality pairs produce more offspring than the lower-quality pairs.

discussion of this model, we find the only occurrence of a clear explanation for the evolution of mate choice in his entire book:

Such pairs would have an advantage in rearing offspring, more especially if the male had the power to defend the female during the pairing-season, as occurs with some of the higher animals, or aided in providing for the young.

Darwin (1871, Part I, p. 263)

Unfortunately, Darwin did not elaborate much on this line of reasoning, and he never provided a convincing explanation for the evolution of a preference for ornaments or other sexually selected characters not directly involved in territory defense or parental care. However, if we merge Darwin's model with a more modern understanding of sexual selection, as has been done by Fisher (1915) and subsequent researchers (Kirkpatrick et al., 1990; Dearborn and Ryan, 2002), we find a model that could explain female-choice evolution while retaining the main features of Darwin's original model. However, surprisingly little research has been directed at

this model, and so far it has been used exclusively as an explanation for sexual selection in males of monogamous taxa. Additional theoretical and empirical work on this model is warranted, and attempts should be made to extend it to sexual selection on females and in nonmonogamous taxa.

### Models of Direct Benefits

Models for the evolution of mating preferences fall into 2 major categories: direct-benefits models and indirect-benefits models (Table 9.1). The direct-benefits models suppose that females (or males for sex-role-reversed species) choose mates that provide some immediate benefit to the chooser, such as parental care, a nuptial gift, or territory defense (Williams, 1975; Kirkpatrick and Ryan, 1991; Møller and Jennions, 2001; Andersson and Simmons, 2006). We provide a list of some of the most commonly invoked direct benefits in Table 9.1, along with a few empirical examples.

TABLE 9.1 Some Empirical Examples Supporting Various Models of Mate Preference Evolution

Mechanism of Preference Evolution	Some Sample Organisms	References
Direct-benefits models	Bushcrickets	Gwynne (1984)
Resource acquisition	Elephant seals, dung flies	Galimberti et al. (2000), Borgia (1981)
Protection	Blackbirds, sticklebacks	Préault et al. (2005), Östlund and Ahnesjö (1998)
Parental care	Lemon tetras, fruit flies	Nakatsuru and Kramer (1982), Markow et al. (1978)
Fertility	Grain beetles	Worden and Parker (2005)
Parasite avoidance		
Indirect-benefits models		
Fisherian process	Guppies, sandflies	Brooks (2000), Jones et al. (1998)
Condition-dependent indicator	Ambush bugs, bank voles	Punzalan et al. (2008), Lopuch and Radwan (2009)
Condition-independent indicator	Possibly cockroaches	Moore (1994)
Other models		
Sensory bias	Three-spined sticklebacks, Anolis lizards	Smith et al. (2004), Fleishman (1992)
Sexual conflict	Cichlids, fireflies	Maan and Taborsky (2008), Demary and Lewis (2007)
Genetic compatibility	Oldfield mice	Ryan and Altmann (2001)

The evolution of choice for direct benefits is conceptually simple, as the selective advantage to choosing is entirely obvious (Andersson, 1994). However, the situation is slightly more complex when the female prefers an ornament in the male that somehow indicates that the male will provide better-than-average parental care, resources, defense, and so forth (Table 9.1). Under these circumstances, there must be a mechanism that produces a correlation between the secondary sexual trait and the direct benefit provided by the male to the female. Our reading of the literature indicates that direct-benefits models enjoy excellent empirical support and are mostly not controversial, so we will treat them no further here.

### **Models of Indirect Benefits**

In some species, the males appear to provide nothing to the females but sperm, yet they have elaborate ornaments for which females show preferences (Taylor and Williams, 1982; Reynolds and Gross, 1990; Kirkpatrick and Ryan, 1991; Kokko et al., 2003). These systems are especially perplexing from a sexual selection standpoint because the benefits of choice are not at all obvious. Consequently, a tremendous amount of effort has been devoted to creating explanatory models of female-choice evolution in such systems (Lande, 1981; Kirkpatrick, 1982; Andersson, 1994; Mead and Arnold, 2004). These types of models have commonly been described as indirect-benefits models because the female's choice of males provides her with no immediate, measurable benefits. Rather, the female's fitness increases as a consequence of her offspring having higher fitness if she pairs with a preferred male. Several excellent reviews have addressed the dizzying array of such models (Kokko et al., 2003; Mead and Arnold, 2004; Andersson and Simmons, 2006; Kotiaho and Puurtinen, 2007), so rather than review them, we attempt here to organize them into a few major categories. We would like to suggest that there are 3 main categories of indirect-benefits models. We have no doubt that such a categorization will be controversial. Indeed, we are at odds with at least one other perspective that suggests that all indirect-benefits models should be lumped into a single category of Fisher-Zahavi models (Eschel et al., 2000; Kokko et al., 2006). We believe there is much heuristic value in keeping them separate, so to stimulate discussion we propose the following 3 classes of models.

#### **Model 1: The Fisherian Model**

This model involves a single preference trait in females and a single ornament trait in males (ignoring multivariate preferences and signals for the moment). To understand this model, we must appreciate that females with a preference for a large ornament, for example, will have offspring



with both the genes for the large ornament from the father and genes for the preference for large ornaments from the mother (Fisher, 1915, 1930; Lande, 1981). Consequently, mate choice results in a genetic correlation between the ornament and preference (Lande, 1981; Mead and Arnold, 2004). The ornament evolves as a consequence of sexual selection imposed by female mate choice, and the preference is carried along as a consequence of a correlated response to selection (Lande, 1981). Almost any outcome is possible in the Fisherian model, depending on the strength of the genetic correlation between the ornament and the preference (Lande, 1981; Kirkpatrick, 1982; Mead and Arnold, 2004). However, under some circumstances, this model results in a self-reinforcing, open-ended process that produces never-ending trait elaboration. Eventually, the process is opposed by natural selection when the ornament becomes so large as to be a major impediment to survival, a point that was actually well appreciated by Darwin (1871). This model has intuitive appeal because it seems like such a process can explain some of the most elaborate traits present in the animal world, such as the peacock's tail or the bowerbird's bower. It is also worth noting that some amount of a genetic correlation between ornament and preference will occur in any system in which mate choice operates, so a Fisherian process could act in concert with almost any other model of mate-choice evolution.

## **Model 2: The Condition-Dependent Indicator Model**

The condition-dependent indicator model is the most widely used of the "good genes" models (Maynard Smith, 1991; Andersson, 1994; Mead and Arnold, 2004). This model requires at least 3 traits (i.e., ornament, preference, and a viability trait), so it is clearly distinct from the Fisherian model (Maynard Smith, 1991). In the condition-dependent indicator model, the ornament is a costly condition-dependent trait. Thus, males closer to the optimum with respect to the viability trait will be in better condition and will be able to maintain a more elaborate version of the ornament (Zahavi, 1975, 1977). Female choice evolves because females choosing males with more elaborate ornaments produce offspring with higher viability or that will be in good condition as adults. Of the indirect-benefits models, the condition-dependent indicator model works most easily from a theoretical standpoint and enjoys the most empirical support (Andersson, 1994). Because the ornament is condition dependent, it is always a reliable indicator of genetic quality, and for female preferences to evolve or be maintained, the condition-dependent indicator model does not require any variation in the genes determining the ornament (although the ornament may appear genetically variable due to genetic variation in condition). Of course, for the male trait to evolve it must be genetically



variable. This model also requires genetic variation for fitness for the males in the population, so a complete understanding must address the mechanisms maintaining genetic variation for viability or vigor, an issue that has yet to be satisfactorily resolved (Kirkpatrick and Ryan, 1991; Kokko et al., 2003).

### **Model 3: The Condition-Independent Indicator Model**

Even though this model still involves 3 traits—ornament, preference, and viability—it differs from the condition-dependent indicator model in that the ability of a male to produce an elaborate ornament is no longer dependent on his condition (or nearness to the optimum for the viability trait). For the model to work, all 3 traits must exhibit genetic variation, and they may or may not have environmental variation. This model functions as a consequence of a genetic correlation between the ornament and the viability trait. Clearly, such a genetic correlation will allow a female to produce higher-fitness offspring by choosing males with better ornaments, and hence female choice will evolve (Pomiankowski, 1988; Maynard Smith, 1991; Andersson, 1994). However, this model, if it works at all, requires more restrictive conditions than the condition-dependent indicator model. The major remaining challenges for this model are to explain what could maintain a genetic correlation between male viability and the ornament trait and to find additional empirical examples of this process.

### **Other Models of Mate-Choice Evolution**

In addition to the direct- and indirect-benefits models of mate choice, several other models have been proposed. For example, the sensory exploitation model suggests that males evolve sexually selected traits that take advantage of preexisting inclinations inherent to the female sensory systems (West-Eberhard, 1984; Ryan, 1990; Fuller et al., 2005). Thus, females may exhibit a preference simply because they are predisposed to do so, and the preference may have evolved as a consequence of evolutionary mechanisms, such as natural selection or drift, unrelated to sexual selection. Not only could sensory exploitation lead to the evolution of male secondary sexual traits, but it also could play a role in jump-starting other mechanisms of mate-choice evolution, such as the Fisherian process. Another class of models focuses on genetic compatibility by suggesting that females choose males who complement their own genome (Zeh and Zeh, 1996; Tregenza and Wedell, 2000; Neff and Pitcher, 2005). Finally, sexual conflict, which occurs when the sexes have incompatible optima with respect to some aspects of reproduction (e.g., mating rate), has been suggested as a mechanism for female-choice evolu-

tion (Holland and Rice, 1998; Cameron et al., 2003; Parker, 2006). All of these models enjoy some empirical and theoretical support, but all remain controversial. Of these 3 models, it seems that the sensory exploitation model is the most likely to explain the exaggerated traits that interested Darwin (1871). Nevertheless, all 3 of these models present extremely fertile ground for future work.

### **Summary and Future Directions**

Although Darwin appreciated the importance of mating preferences in sexual selection, he did not cleanly identify the evolution of mate choice as a key topic in its own right. The progress in this area of research since Darwin has been nothing short of spectacular. It is now clear that the evolution of mate choice is one of the most important topics in sexual selection research, and we have several plausible models with which to work. We find that direct-benefits models and condition-dependent indicator models seem to be the most well-supported explanations for the evolution of elaborate traits via sexual selection. Nevertheless, definitive tests of these models are difficult to find, and the subject remains controversial. The Fisherian process is probably operating in some systems, but we do not know how ubiquitous it is. Maybe this process is operating in the background in all systems characterized by mate choice or maybe it comes into play episodically when conditions are especially favorable for its operation. On the other hand, depending on the evolution and maintenance of genetic correlations between traits and preferences, the possibility remains that the Fisherian process explains very little with respect to the evolution of female preferences. We will need more data before we can decide. Even more controversial are the models of condition-independent indicators and sensory exploitation, so they should be studied in more detail. Finally, genetic compatibility and sexual conflict models almost certainly describe real phenomena (Holland and Rice, 1999; Tregenza and Wedell, 2002; Gillingham et al., 2009), but their role in the evolution of secondary sexual traits remains to be resolved.

One important success of these models is that we no longer need to invoke a human-like sense of aesthetics in animals as Darwin (1871) did. Rather, it is sufficient for the choosing sex to respond to a stimulus (e.g., an ornament) if the response to the stimulus increases the fitness of the chooser. Why the ornaments used by birds and other nonhuman animals usually appear so strikingly beautiful to humans is another question, but it's a mystery that does not have to be solved for us to understand sexual selection.

Despite our tremendous success so far, there remains much to be accomplished. Here, we suggest the following 5 areas in which we see a pressing need for additional research:

1. *Costs of choice.* Every model of choice evolution is affected by assumptions regarding the costs of choosing, but insufficient empirical data exist from this challenging area of inquiry to properly parameterize the models. Perhaps we need a new concept called “the environmental potential for mate choice” in which costs of choice are considered in light of reproductive ecology.

2. *The evolution of genetic correlations between ornaments and preferences.* The genetic correlations between ornaments and preferences affect the strength of the Fisherian process, which could be operating in tandem with any other model for preference evolution. In addition, we know that genetic correlations can be evolutionarily unstable (Jones et al., 2003, 2004; Mead and Arnold, 2004), so how does the evolution of genetic correlations (and genetic variation) affect the Fisherian process and other processes of mate-choice evolution?

3. *Mutual mate choice.* This topic is gaining momentum, but we need to understand the circumstances under which both sexes will be choosy and how easily sexual selection can simultaneously operate on both sexes. Should we expect sexual selection on both sexes to be the norm, or will it only occur under very special circumstances?

4. *The evolution of multiple sexually selected traits and preferences.* The choosing sex may be integrating information from multiple traits assessed using several sensory modalities. Some theoretical work has been done regarding models of sexual selection when multiple traits and preferences are involved (Pomiankowski and Iwasa, 1993; Iwasa and Pomiankowski, 1994), but we are far from a complete understanding.

5. *The relative contributions of the various models of mate-choice evolution within and between taxa.* In many cases, several of the models may be working in concert to produce selection on mating preferences, and it would be of interest to assess empirically and theoretically the relative contributions of the different models. Such studies, applied within taxa and in a comparative phylogenetic framework, would help us to understand the relative contributions of the various models to the evolution of preferences.

## THE INTENSITY OF SEXUAL SELECTION AND THE SECOND TRIUMPH

### Why Do Lineages Differ in Sexual Dimorphism?

One important question in morphological and behavioral evolution, especially from a human perspective, concerns why the sexes differ from one another more dramatically in some lineages than in others. Darwin (1871, Part II, p. 388) identified this topic as a key question, and he presented an example from butterflies to illustrate the issue. We are more familiar with fishes of the family Syngnathidae, which includes seahorses, sea dragons, and pipefish, so we will use examples from this family to illustrate the same problem. One interesting aspect of this group of fishes is that the entire family is characterized by male brooding of offspring, with the embryos either glued to the surface of the male or residing in an enclosed pouch. Despite the ubiquity of this “male pregnancy” in syngnathids, however, different species differ from one another with respect to their degrees of sexual dimorphism. For example, seahorses (genus *Hippocampus*) tend to be sexually monomorphic (Vincent et al., 1992), but a related pipefish, *Syngnathus scovelli*, is extremely sexually dimorphic with secondary sexual traits appearing only in females (Jones and Avise, 2001). Several other species in *Syngnathus*, such as *S. typhle* and *S. floridae*, are sexually dimorphic but not nearly as much so as *S. scovelli* (Dawson, 1985; Jones and Avise, 1997). There are other species of pipefish, like *Doryrhamphus excisus*, in which both sexes are brightly colored with flag-like caudal fins (Dawson, 1985), and in the sexually monomorphic leafy sea dragons, *Phycodurus eques*, both sexes are characterized by extremely elaborate leafy appendages (Dawson, 1985), resulting in one of the most beautiful and bizarre examples of fish morphology.

### Why Do Some Lineages Display Striking Colorations, Sexual Dimorphism, and Pronounced Morphological Traits While Others Do Not?

Of course, there are many potential answers to this question. Some of the differences among species are almost certainly due to natural selection on the traits or differences in sex-limited inheritance, but in some cases, especially in the case of secondary sexual characteristics, the differences among lineages are due to dissimilar intensities of sexual selection. In other words, while keeping in mind that observable sexual dimorphism is not an entirely reliable guide to the strength of sexual selection, a complete explanation for morphological differences among taxa requires consideration of factors affecting sexual selection in populations of organisms. Thus, one important question, which Darwin (1871) originally posed and

which is still valid today, is why the intensity of sexual selection varies in different populations or evolutionary lineages.

### **Darwin's Perspective**

Perhaps Darwin's thinking regarding factors affecting the intensity of sexual selection is most obvious when he considers sex-role-reversed taxa. In these species, sexual selection acts more strongly on females than on males, so there has been a reduction in the strength of sexual selection on males and an increase in the strength of selection on females relative to most other sexually selected taxa. One example of a sex-role-reversed species is the barred buttonquail (*Turnix suscitator*) mentioned by Darwin or the Gulf pipefish (*S. scovelli*), a species Darwin did not bring up. How did Darwin explain sex-role reversal? The following quote provides the flavor of his perspective:

Now if we might assume that the males in the present class have lost some of that ardour which is usual for their sex, so that they no longer search eagerly for the females; or, if we might assume that females have become much more numerous than the males—and in the case of the Indian Turnix the females are said to be “much more commonly met with than the males”—then it is not improbable that females would have been led to court the males, instead of being courted by them.

Darwin (1871, Part II, p. 207)

This quote illustrates 2 of the main causes that Darwin pointed out for variation in the intensity of sexual selection. The first, a loss of “ardour” by the males, is not a very satisfying explanation in the context of our modern understanding of sexual selection. However, the second explanation, a skewed sex ratio, does fit well with our current view of behavioral ecology. In addition, Darwin clearly had a good intuitive understanding of the concept of the operational sex ratio (which is the ratio of males ready to mate to receptive females in the population) and the implications of mating patterns. This understanding appears throughout the book, but is demonstrated clearly when he states that “the practice of polygamy leads to the same results as would follow from an actual inequality in the number of the sexes” (Darwin, 1871, Part I, p. 266). Thus, Darwin provided a glimmer of insight that has expanded over the ages into our current understanding of factors affecting sex roles and sexual selection.

### **The Second Major Triumph**

In our view, another major triumph in sexual selection research came from advances in quantitative genetics and formal selection theory, which

resulted in quantitative techniques for the measurement of selection in natural populations (Robertson, 1966; Price, 1970; Lande and Arnold, 1983). These approaches lead to the stark realization that what we are really talking about are selection coefficients on sexually selected phenotypic traits, which leads to the seemingly simple question of what determines the magnitude of a selection coefficient in a natural population.

### **Selection Coefficient Thinking**

For the purposes of this discussion, we are going to focus mainly on premating sexual selection of the type Darwin (1871) discussed. Assuming that a population is characterized by female choice or male-male combat, males with traits favorable for success in this mating competition will leave more offspring than males with unfavorable traits. Consequently, there will be a covariance between trait values and mating success (i.e., number of mates), which we would like to call a “mating differential” (Jones, 2009). Mathematically, how do we get from a mating differential to a selection differential? Recall that a selection differential can be measured as the covariance between trait values and relative fitness (Robertson, 1966; Price, 1970; Lande and Arnold, 1983). For a positive mating differential to result in a positive selection differential, then, there must be a mechanism to convert mating success into fitness. This conversion is partially measured by a quantity known as the “Bateman gradient,” which is the relationship between number of mates and number of offspring (Arnold and Duvall, 1994; Andersson and Iwasa, 1996; Jones et al., 2000; Jones, 2009). If the Bateman gradient is positive, success at mating will result in an increase in number of offspring (Arnold and Duvall, 1994). Hence, a nonzero mating differential will result in a nonzero selection differential only if the Bateman gradient is positive. The central path in Fig. 9.2 illustrates this important relationship.

If all offspring are equal with respect to fitness, then numerical counts of offspring are sufficient for the measurement of sexual selection. However, we know that mate choice and postcopulatory sexual selection (Eberhard, Chapter 12, this volume) can influence offspring quality (Andersson, 1994), so ideally each offspring would be weighted somehow by its quality in the calculation of fitness. The precise way in which such a weighting could be accomplished in the context of sexual selection is a subject for future work, and the solution will no doubt be complex (Moore et al., 1997; Wolf et al., 1999a; Wolf and Wade, 2001). Nevertheless, as Fig. 9.2 shows, mate quality and postcopulatory sexual selection (Eberhard, Chapter 12, this volume) are 2 factors that must also be considered for a complete characterization of the intensity of sexual selection. We find the topic complicated enough without these factors, so we will not treat them further here.

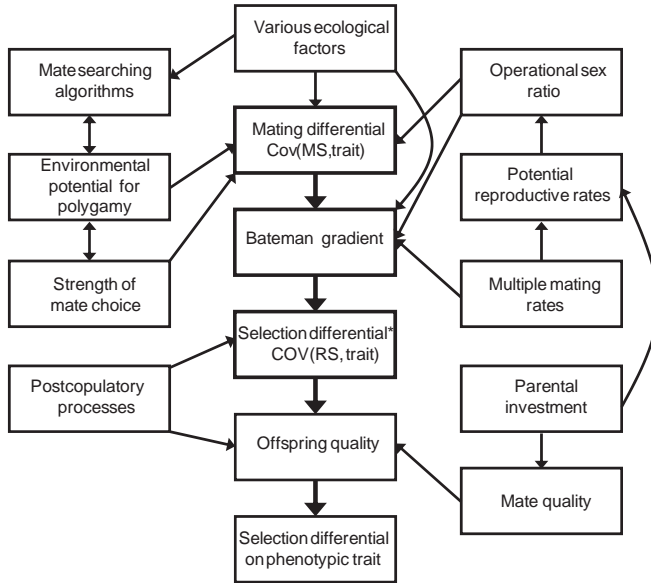

FIGURE 9.2 One possible depiction of a “reproductive ecology web” showing the relationships between important ecological factors and variables that ultimately result in a selection gradient on a sexually selected trait. This figure was inspired especially by Andersson’s (1994) figure 7 and Arnold and Duvall’s (1994) path diagram. Note that our figure only deals with a single selective episode, such as a breeding season. The selection differential marked with an asterisk is the covariance between number of offspring and trait values, so the final selection differential (lowest box) takes into account the number of offspring and offspring quality. The exact locations and sizes of the effects remain subjects for future research.

If we accept this central path in Fig. 9.2, then we have 2 major questions to address in precopulatory sexual selection (Jones, 2009). First, what factors determine the magnitude of mating differentials? And second, how is the slope of the Bateman gradient established? In Fig. 9.2, we provide one tentative hypothesis for the relationships among important mating-system variables that interact to produce a selection differential on a sexually selected trait. This figure is not meant to be the final word on the subject, as we believe there is a great need for additional work.

### Factors Affecting Mating Differentials

The question here is how ecological factors can either enhance or decrease the likelihood of a correlation between sexually selected trait values and mating success. This topic has been a central one in sexual



selection work for quite some time. We will give only a partial list of some of the most important factors, and these are shown in Fig. 9.2. Perhaps the most obvious cause is strong mate choice, so if a mechanism of female-preference evolution is especially effective in a population, we might expect a strong covariance between an ornament and male mating success. In addition, mating differentials can be caused by a high “environmental potential for polygamy,” which in turn could be affected by the spatial distribution of resources or temporal synchrony of female receptivity (Emlen and Oring, 1977; Shuster and Wade, 2003). Another factor, which has been somewhat neglected, concerns mate-searching algorithms (Parker, 1978; Real, 1990). Environmental constraints, such as predation, may affect how mates find one another. If mate searching is efficient, very strong mating differentials may result, whereas constrained searching may impose limitations. In addition, the operational sex ratio (Emlen and Oring, 1977) is almost certainly important, because as more individuals are excluded from reproduction, the magnitude of the mating differential will change. Finally, there may be numerous other ecological

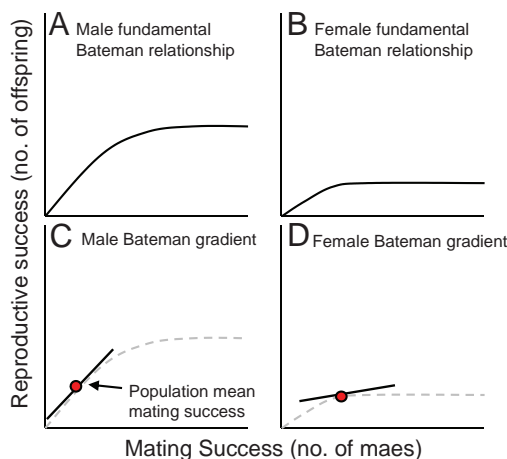

FIGURE 9.3 One way to think about the Bateman gradient. (A and B) The “fundamental Bateman relationship” for males (A) and females (B) in a species like *Drosophila melanogaster*. For either sex, reproductive success will initially increase with an increasing number of mates, but both sexes will eventually reach a point at which they are limited by factors other than access to mates. This plateau could be caused by limitations imposed by time, parental care demands, gamete production, or other resources required for reproduction. (C and D) The Bateman gradient can then be conceptualized as the slope of the fundamental Bateman relationship evaluated at the population mean for mating success.



factors, such as population density (Kokko and Rankin, 2006) and others that have yet to be appreciated, that affect mating differentials.

### Factors Affecting Bateman Gradients

As noted above, a mating differential will result in a selection differential on a trait only if high mating success results in high relative fitness, and the Bateman gradient describes this conversion (Arnold and Duvall, 1994; Andersson and Iwasa, 1996; Jones et al., 2000; Jones, 2009). To stimulate thought about Bateman gradients, we would like to propose a heuristic way of thinking about them (Fig. 9.3). Regardless of sex or species, there will be some point at which an individual runs out of reproductive potential, by running out of either gametes, time, or other resources required for reproduction. When the individual reaches this upper limit of reproductive potential, access to additional mates will no longer provide any increase in reproductive success. This curve, describing the potential relationship between number of mates and number of offspring can be thought of as the “fundamental Bateman relationship.” In Fig. 9.3, we show 2 such curves for males and females of a species like *Drosophila melanogaster*, in which males have much greater reproductive potential than females. After only a few mating events, a female will achieve her full reproductive output, whereas a male can go on mating for quite some time before he runs out of sperm (Bateman, 1948). Note that in this treatment we are ignoring factors like sexual conflict that could cause a downward trajectory as the number of mates increased beyond some optimum. Given the fundamental Bateman relationship for a sex, the Bateman gradient is the slope of this curve at the population-mean mating success (Fig. 9.3C and D). Thus, the Bateman gradient tells us whether, in the population under consideration, a sex is on the increasing part of the curve (and thus limited primarily by access to mates) or on the plateau (limited by intrinsic reproductive capacity).

Given the heuristic way of thinking about Bateman gradients in Fig. 9.3, we can now consider the factors that might affect the magnitude of a Bateman gradient. Anything that could lower the point at which the relationship plateaus could potentially change the Bateman gradient, for example. A factor such as parental investment (Trivers, 1972), through its effect on potential reproductive rates of the sexes (Clutton-Brock and Parker, 1992), certainly could change the location of the plateau. Factors such as nuptial gifts or rates of multiple mating could in principle change the slope of the increasing part of the fundamental Bateman relationship (Arnold and Duvall, 1994; Lorch, 2002; Lorch et al., 2008), resulting in a change in the slope of the Bateman gradient. Finally, factors that change the position of the population-mean mating success on the  $x$  axis of the

fundamental Bateman relationship graph certainly could affect the Bateman gradient. The most obvious such factor is the operational sex ratio (Emlen and Oring, 1977), as a skewed sex ratio can easily change which sex is limiting for reproduction. When a sex becomes limiting, it is by definition on the plateau of the curve, so its Bateman gradient should be near zero. This view of mating systems based on the Bateman gradient remains controversial and is the subject of continuing debate (Parker and Tang-Martinez, 2005; Tang-Martinez and Ryder, 2005; Snyder and Gowaty, 2007), so much work remains to be done. Nevertheless, we hope our hypothesis in Fig. 9.2 will stimulate additional research.

### Future Directions

In some ways, our understanding of the causes of differences in sexual selection intensity among lineages is less well developed than our understanding of models of female mate-choice evolution, so there are many potential avenues for future work. We suggest the following 5 areas as the most pressing targets:

1. *Comparative studies of mating systems among populations within species.* Such studies will be difficult, because in most cases they will require genetic studies of parentage to completely characterize mating systems (Mobley and Jones, 2009). However, the benefits would be worth the effort, because such studies could facilitate the identification of putative ecological factors affecting mate choice and the intensity of sexual selection on traits.

2. *Better integration of the ideas surrounding the mating differential and the Bateman gradient with the ecology of sexual selection.* This goal could be accomplished by focusing on diagrams like our Fig. 9.2 and attempting to establish the locations and magnitudes of the various arrows through empirical work in natural systems.

3. *Explicit consideration of age structure in sexual selection.* Studies of sexual selection often focus on a single breeding season, and the results can be difficult to interpret in terms of lifetime fitness. Thus, a complete understanding of the intensity of sexual selection would seem to call for explicit consideration of age structure in the populations under study. For a complete picture, lifetime fitness should be conceptualized in terms of selection episodes so that effects of sexual selection can be separated from natural selection and stochastic effects.

4. *Integration of models for the evolution of female choice with theory related to the intensity of sexual selection and mating-system evolution.* These areas of thought are often dealt with separately from theoretical and empirical

standpoints, but the merging of these 2 areas of inquiry could result in interesting insights.

5. *Integration of precopulatory and postcopulatory sexual selection.* To completely understand the entire selective history of any sexually selected trait, we will need to resolve the entire set of paths depicted in Fig. 9.2, including those that affect fitness after mating.

## Summary and Conclusions

Darwin presented an incredibly detailed and clear description of sexual selection in *The Descent of Man*. Even though Darwin's account of sexual selection was by no means complete and he had a garbled understanding of inheritance, Darwin was correct about almost every topic related to sexual selection that he discussed. For instance, he laid out essentially the modern version of intrasexual selection, and he correctly realized that female choice was an important mechanism in sexual selection. He also recognized that sexual selection could sometimes act on both sexes or more strongly on females than on males, and he demonstrated a good intuitive understanding of the effects of the operational sex ratio and mating systems on the intensity of sexual selection. However, Darwin did not clearly identify the evolution of female choice as a key topic for study in its own right. Rather, he tended to invoke a human-like sense of aesthetics in animals to explain their preferences for ornaments. He also never produced a clear picture of why some lineages seem to be experiencing stronger sexual selection than others. Regardless, *The Descent of Man* is an impressive scientific work, and well worth a read for anyone interested in sexual selection. Not only does it provide a clear intuitive explanation of the process, but the vast array of empirical examples could serve as the launching point for countless new studies.

Since Darwin, progress in the study of sexual selection has been astounding. Two of the greatest triumphs included the proliferation of models explaining the evolution of female preferences and quantitative approaches to the measurement of selection differentials. These advances provide clear, plausible mechanisms for the evolution of female choice and allow us to begin to address why sexual selection varies among species. A third major triumph in the study of sexual selection, which we did not have space to discuss, was the introduction of molecular markers into behavioral ecology (Gowaty and Karlin, 1984; Burke and Bruford, 1987; Hughes, 1998; Jones and Ardren, 2003). Molecular studies of parentage provide unprecedented opportunities to study patterns of mating in natural populations, so they have become a cornerstone of sexual selection research.

Despite the triumphs of modern sexual selection research, there are still many topics that need to be addressed. For example, some models of the evolution of mate choice enjoy only limited empirical support, and for the most part we are not sure which model explains the majority of choice evolution within or between systems. With respect to factors determining the intensity of sexual selection, there may be even more confusion. We are still in the process of building connections between reproductive ecology and selection differentials. Finally, there seems to be a lack of connections between theory related to mate-choice evolution and theory related to sexual selection intensity. There are many other unanswered questions, many of which will require new theory and empirical work.

Overall, the study of sexual selection has been a rich and exciting endeavor, especially in the last several decades. We owe a lot to Darwin for establishing a framework for all modern work in this area. However, we are far from complete resolution on many topics, so the next several decades should be at least as exciting as the recent past.

#### ACKNOWLEDGMENTS

We thank John Avise and Francisco Ayala for inviting us to participate in the Arthur M. Sackler Colloquium of the National Academy of Sciences, *In the Light of Evolution III: Two Centuries of Darwin*. We also are grateful to John Avise, Steve Shuster, and an anonymous referee for helpful comments on this manuscript.

# 10

## Sexual Selection and Mating Systems

---

STEPHEN M. SHUSTER

Sexual selection is among the most powerful of all evolutionary forces. It occurs when individuals within one sex secure mates and produce offspring at the expense of other individuals within the same sex. Darwin was first to recognize the power of sexual selection to change male and female phenotypes, and, in noting that sexual selection is nonubiquitous, Darwin was also first to recognize the importance of mating systems—the “special circumstances” in which reproduction occurs within species. Analyses of mating systems since Darwin have emphasized either the genetic relationships between male and female mating elements, usually among plants, or the numbers of mates males and females may obtain, usually among animals. Combining these schemes yields a quantitative methodology that emphasizes measurement of the sex difference in the variance in relative fitness, as well as phenotypic and genetic correlations underlying reproductive traits that may arise among breeding pairs. Such information predicts the degree and direction of sexual dimorphism within species, it allows the classification of mating systems using existing genetic and life history data, and with information on the spatial and temporal distributions of fertilizations, it may also predict floral morphology in plants. Because this empirical framework identifies selective forces and genetic architectures responsible for observed male-female differences, it complements discoveries of nucleotide sequence variation and the expression of quantitative

---

Department of Biological Sciences, Northern Arizona University, Flagstaff, AZ 86011-5640.

traits. Moreover, because this methodology emphasizes the process of evolutionary change, it is easier to test and interpret than frameworks emphasizing parental investment in offspring and its presumed evolutionary outcomes.

**A**lthough sexual dimorphism and sexual differences were well known in his time, Charles Darwin (1859/1964, 1871, 1874) was first to recognize both their selective context as well as their evolutionary cause. Darwin's initial observations about sexual selection focused mainly on the context in which sexual selection occurred, e.g., during combat involving "special weapons, confined to the male sex" (Darwin, 1859/1964, p. 88), as well as during female mate choice, wherein females "standing by as spectators, at last choose the most attractive partner" (Darwin, 1859/1964, p. 89). Darwin (1871, 1874) later identified the evolutionary process by which sexual selection occurs (see below), but his initial emphasis on context had already taken hold. Considerations of the context in which sexual selection occurs predominate to the present day [see reviews in Jones et al. (2002) and Shuster and Wade (2003)]. One goal of this chapter is to explain why it is time to deemphasize Darwin's initial focus on context, and continue to develop Darwin's later, more cause-oriented evolutionary approach.

Darwin recognized too that sexual selection is nonubiquitous (Darwin, 1871, p. 208). His statement that "[i]n many cases, special circumstances tend to make the struggle between males particularly severe" demonstrates his intuitive grasp of mating system—the "special circumstances" in which reproduction occurs within individual species. Since Darwin, 2 emphases in mating systems have developed. The first is expressed in terms of the genetic relationships between males and females and is applied mainly to plants and domestic breeding designs. The second emphasis is expressed in terms of mate numbers per male or female, an approach usually applied to animals and mainly for typological classification. Contrary to Darwin's description of the cause of sexual selection, evolutionary trends within animal mating systems are identified mainly in terms of energetic investment in individual offspring (Bateman, 1948; Williams, 1966; Trivers, 1972).

A second goal of this chapter, then, is to explain how disparate existing approaches to mating system analysis can be combined to yield a quantitative methodology that emphasizes measurement of the sex difference in the variance in relative fitness, as well as genetic correlations underlying reproductive traits arising from the spatial and temporal distributions of fertilizations. Such information predicts the degree and direction of sexual dimorphism within animal species, and may explain variation in floral

morphology among plants. This approach makes similar use of existing genetic, life history, and ecological data. It complements ongoing discoveries of nucleotide sequence variation and the expression of quantitative traits. It also may allow classification of plant and animal mating systems, using a common evolutionary framework.

## TWO PERSPECTIVES ON SEXUAL SELECTION

Darwin (1859/1964) argued convincingly that male combat and female mate choice were the contexts in which sexual differences appeared. Yet Darwin observed too that sexual selection “depends, not on a struggle for existence, but on a struggle between males for possession of the females; the result is not death of the unsuccessful competitor, but few or no offspring. Sexual selection is, therefore, less rigorous than natural selection” (p. 88). Darwin’s observations on the relative strength of sexual selection raise what can be considered a quantitative paradox (Shuster and Wade, 2003). How can sexual selection seem to be such a powerful evolutionary force, specifically responsible for causing the sexes to become distinct from one another, when sexual selection is less rigorous than natural selection? Stated differently, how can it be that sexual selection is strong enough to counter the opposing forces of male and female viability selection and still cause the sexes to become distinct (Shuster and Wade, 2003)?

Darwin provided an answer to this question when he devoted an entire volume to subject in 1871 (Darwin, 1871, 1874) and identified the specific cause of sexual selection: “if each male secures two or more females, many males cannot pair” (Darwin, 1874, p. 212). This relationship provided a conceptual solution to the quantitative paradox because it identified an evolutionary process responsible for causing the sexes to diverge. Darwin did not develop quantitative aspects of this particular hypothesis further himself but he was clearly aware of its power. Darwin likened the effect of this process to a bias in sex ratio, wherein particular males might disproportionately contribute to future generations, observations that set the stage for the development of the quantitative approaches now used to document sexual selection (Bateman, 1948; Wade, 1979; Wade and Arnold, 1980; Arnold and Wade, 1983; Arnold and Duvall, 1994; Jones et al., 2002; Shuster and Wade, 2003).

We can visualize the evolutionary process Darwin identified by noting, as Darwin did, that when sexual selection occurs, it creates two classes of males, those who mate and those who do not [cf. Wade (1979); Wade and Shuster (2004)]. If we let  $p_S$  equal the fraction of males in the population who mate, and  $p_0 = (1 - p_S)$  equal the fraction of nonmating males, the average fitness of the mating males is  $p_S(H)$ , where  $H$  is the average number of mates per mating male. By the same principle, the average fit-



ness of the nonmating males is  $p_0(0)$ . The average number of mates for all males equals the sex ratio,  $R = N_{\text{♀}}/N_{\text{♂}}$ , which can now be rewritten as

$$R = p_0(0) + p_S(H), \quad (1a)$$

wherein each term on the right side of the equation equals the fraction of males belonging to each mating class, multiplied by the average number of mates members of that class obtain. Because  $p_S = (1 - p_0)$ , and because  $p_0(0) = 0$ , we can rewrite Eq. 1a as

$$p_0 = 1 - (R/H), \quad (1b)$$

and if we allow the sex ratio,  $R$ , to equal 1, Eq. 1b can be expressed as

$$p_0 = 1 - (1/H). \quad (1c)$$

Eq. 1c shows that when the value of  $H$  increases, the fraction of males without mates,  $p_0$ , also must increase, a quantitative expression that captures what Darwin appears to have had in mind.

When females mate more than once, postcopulatory sexual selection via sperm competition is possible. This process can intensify sexual selection, but it need not (Shuster and Wade, 2003). Sperm competition intensifies sexual selection beyond that which occurs because of nonrandom mating only when a subset of the males who mate are also disproportionately successful in sperm competition. This condition increases the fraction of unsuccessful males overall because some of the males who successfully mate ultimately fail to sire offspring. In contrast, when mating success and fertilization success among males are uncorrelated, multiple mating by females always decreases the intensity of sexual selection because it increases the total number of males contributing to each generation. In general, because every offspring has one mother and one father (Fisher, 1930), when certain males fertilize ova disproportionately, other males must obtain fewer fertilizations. As Darwin suggested, differential success by some individuals must come at the expense of other individuals of the same sex. When this does not occur, sexual selection does not exist.

## DARWIN ON MATING SYSTEMS

Darwin contributed two separate discussions on mating systems. The first concerned animal mating systems (Darwin, 1871). Here Darwin explained the diversity of male and female phenotypes attributable to the “special circumstances” in which sexual selection occurs (see above), confirming his understanding that sexual differences arose within this



context. Darwin's second contribution on mating systems concerned those of plants. In *The Different Forms of Flowers on Plants of the Same Species* (Darwin, 1877a), Darwin detailed the various contrivances by which plants encourage or discourage cross-pollination. Although many plants appeared capable of selfing, Darwin observed (Darwin, 1877a, p. 266), "Various hermaphrodite plants have become heterostyled, and now exist under two or three forms and we may confidently believe that this has been effected in order that cross-fertilisation should be assured." This statement confirms Darwin's understanding that selfing was nonubiquitous among plants, and that floral differences arose within this context.

Like most of his contributions, Darwin's original emphases have determined the research avenues pursued today. The two distinct emphases in current mating system research are almost certainly the result of Darwin's distinction between plants and animals. The emphasis developed mainly for plants and domestic breeding designs is expressed in terms of the genetic relationships between males and females. The emphasis developed mainly for animals, following Darwin's lead, is expressed in terms of mate numbers per male or per female.

### PLANT MATING SYSTEMS

Darwin's (1877a) approach to plant mating systems was mainly classificatory. He cataloged floral morphology according to its rich existing lexicon, and only secondarily developed hypotheses for why this variation might have evolved (Table 10.1). However, Darwin's catalog seems intended to have been provocative. He described not only species with exclusive selfing, but also considered in careful, parallel detail the mechanisms by which selfing was prevented in certain species. Wright (1922) and Fisher (1941) later explored the population genetic consequences of various levels of selfing and outcrossing; Wright (1922) showed how selfing increased allelic autozygosity, and thus often resulted in inbreeding depression. Fisher (1941) showed how despite inbreeding's potentially deleterious effects, selfing could increase in frequency when selfers contributed selfed as well as outcrossed seeds to each generation.

Consistent with these early emphases, recent research on plant mating systems has focused primarily on deviations from random mating (Barrett and Harder, 1996), and, with increasing resolution of genetic markers, population genetic approaches to plant mating systems and their theoretical foundations have become increasingly sophisticated. Selfing, self-incompatibility, dioecy and gynodioecy all appear to have evolved by remarkably simple means (Charlesworth and Charlesworth, 1978, 1987; Charlesworth, 2006). Obligate selfing and obligate outcrossing appear to persist as alternative stable states (Lande and Schemske, 1985),

TABLE 10.1 A Summary of Plant Mating Systems

General Category	Fertilization Mode	Definition	Associated Terminology
Perfect flowers	Self-pollination	Pollen fertilizes ovules on the same flower	Autogamy, cleistogamy
	Cross-pollination	Pollen fertilizes ovules on different flowers	Chasmogamy
	Heterostyly	Physical separation of style and stamen	Distyly, tristyly
	Dichogamy	Temporal separation of anther and stigma maturation	Protandry, protogyny
	Self-incompatibility	Pollen cannot fertilize ovules on the same plant	Sporophytic, gametophytic self-incompatibility
Imperfect flowers	Outcrossing	Flowers are sex specific or exist as combinations of perfect and imperfect flowers	Dioecy; androdioecy, gynodioecy

whereas mixed mating systems seem constrained by the deleterious effects of inbreeding, despite frequent assumptions that a continuum can exist (see Schemske and Lande, 1985). Nevertheless, frequency-dependent and density-dependent processes in pollination transmission appear to have a powerful influence on whether selfing or outcrossing are stable within a given species (Holsinger, 1991). This result is consistent with observations that wind-pollinated plants conform to the predictions of Lande and Schemske (Lande and Schemske, 1985; Schemske and Lande, 1985), whereas animal-pollinated plants do not (Vogler and Kalisz, 2001), and furthermore, that patterns of floral morphology correspond to the relative amount of pollen available for export as well as to the density of conspecifics (Barrett and Harder, 1996).

Debate on the possibility that sexual selection can operate within plants (Willson and Burley, 1983; Cruzan et al., 1988; Lyons et al., 1989; Delph et al., 2002; Slogsmyr and Lankinen, 2002; Shuster and Wade, 2003) has identified three primary contexts in which sexual selection might occur: (i) differential pollen transfer, (ii) differential pollen tube growth, and (iii) maternal control of seed set. However, although male and female fitness may vary within each of these contexts in plants, the extreme variance in male fitness seen in animals appears to be constrained by limited opportunities for pollen dispersal, by inconsistent success of particular pollen tubes among different stigmas, or by large within-individual variation in seed size and seed set, often due to pollen limitation (Ashman et al., 2004; Knight et al., 2005). Although male-male competition and female

preferences seem possible in plants, they do not lead to a sex difference in fitness variance comparable in magnitude to that of animals. Thus, despite the rigor of their theoretical foundations, and hints of similarities in mechanisms, studies of plant mating systems have remained conceptually divorced from those of animals.

### ANIMAL MATING SYSTEMS

Perhaps because of Darwin's observations on the greater physical modification of males and their greater eagerness to mate compared to females ["The exertion of some choice on the part of the female seems a law almost as general as the eagerness of the male" (Darwin, 1874, p. 217)] researchers in animal mating systems have primarily sought explanations for sexual differences in patterns of mating behavior, parental care, or in energetic allocations to progeny of each sex (Bateman, 1948; Williams, 1966; Trivers, 1972; Charnov, 1979). The resulting "parental investment theory" (Thornhill and Alcock, 1983) proposes that females, with their greater initial investment in offspring, are more inclined to provide parental care and that the small per-gamete investment in offspring by males predisposes males to abandon parental responsibilities in favor of additional copulations. The few, large ova of females are consistently identified as the limited resource for which males must compete to reproduce. Thus, the intensity of sexual selection on males is thought to depend on the degree to which females are rare.

Applying this reasoning, Emlen and Oring (1977) proposed two measures for understanding mating systems and for quantifying sexual selection, respectively. With the environmental potential for polygamy (EPP), these authors presumed to measure the degree to which the social and ecological environment allows males to monopolize females as mates. Emlen and Oring considered EPP highest when resources or females were spatially clumped and female receptivity was asynchronous, and lowest when resources were uniformly distributed and female receptivities were synchronous. This scheme has formed the basis for most considerations of animal mating system evolution [reviewed in Shuster and Wade (2003)], although EPP itself has proven difficult to define and quantify.

The second Emlen and Oring measure, the operational sex ratio (OSR), usually expressed as  $N_{\sigma}(\text{sexually mature})/N_{\text{♀}}(\text{sexually receptive}) = \text{OSR} = R_O$ , suggests that sexual selection results from competition among males for mates (Darwin, 1874). Thus, the OSR can be viewed as a reproductive competition coefficient among mating males. The greater the number of mature males relative to the number of receptive females, the greater the OSR and the stronger the presumed intensity of male-male competition for mates (Sutherland, 1985b; Ahnesjö et al., 2001).

Biases in OSR within populations are presumed to have significant evolutionary consequences, with effects ranging from both positive and negative influences on variance in mating success (Emlen, 1976; Shuster et al., 2001), to positive and negative influences on the intensity of sperm competition (Møller, 1989; Pen and Weissing, 1999) to the reversal of sex roles (Forsgren et al., 2004), to influences on mate selection and relative choosiness (Kokko and Monahagn, 2001), to influences on family sex ratio (Warner and Shine, 2007), aggressive behavior (Grant and Foam, 2002), female body temperature (Alsop et al., 2006), and declining population size (Stifetten and Dale, 2006). Methods for estimating OSR have used a wide range of modifications since their original identification, most notably including the ratio of male to female potential reproductive rates (PRR) (Clutton-Brock and Vincent, 1991).

These measures consider the effect on the intensity of sexual selection of particular receptive individuals at a particular time and in a particular place. The justification for this approach is that only certain individuals reproduce at any time, and including all males and females in such measurements could bias estimates of competition intensity. However, ignoring nonbreeding males, for example, omits those males whose numbers significantly increase the variance in male reproductive success, resulting in two kinds of errors in estimates of actual selection (Shuster and Wade, 2003). When nonmating individuals are ignored, a significant fraction of the among-group component of fitness variance goes unrecognized. This causes the mean fitness among mating individuals to be overestimated, and variance in fitness to be underestimated, respectively (Fig. 10.1). The stronger sexual selection becomes, the larger the possible error, because as fewer males mate, more of the male population is excluded from mating altogether. A similar problem exists for potential reproductive rates. Only a fraction of the actual population is considered in most measurements—those with the largest potential values. Under most circumstances, few if any individuals may ever achieve this rate.

A related difficulty involving field measurements of OSR compounds its unreliability as a metric for the intensity of sexual selection. Because instantaneous estimates of OSR during the breeding season fail to distinguish between males who mate and males who do not, such estimates tend to overestimate the intensity of sexual selection that exists over the entire breeding season (Shuster and Wade, 2003). To illustrate this point, consider two possible scenarios within a hypothetical breeding season in which 5 females mate with 5 males (Fig. 10.2). In this example, we assume that females mate once and their receptivity is maximally asynchronous; i.e., individual females mate sequentially across the breeding season. In Scenario 1, each female mates with the same male in a different  $j$ th interval (Fig. 10.2), whereas, in Scenario 2, each female mates in a different

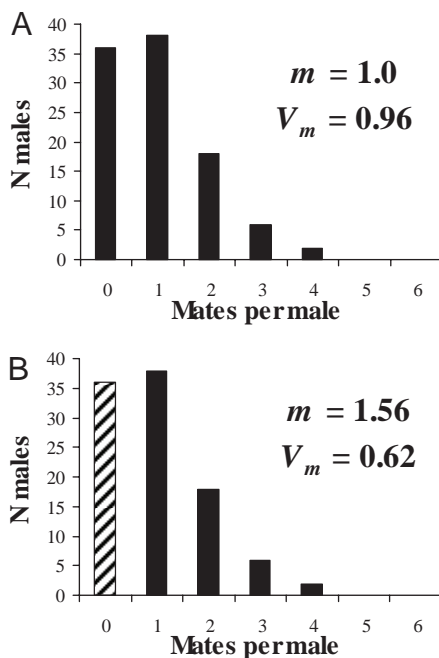

FIGURE 10.1 The effect of excluding nonmating males from estimates of average male mating success [cf. Shuster and Wade (2003)]. Shown are the outcomes for 100 randomly mating males and females when females are assumed to mate only once but males may mate repeatedly.  $m$ , mean mating success;  $V_m$ , variance in mating success when all males are included in parameter estimates (A) and when the zero class of males (hatched bars) is excluded from parameter estimates (B). The effect of omitting nonmating individuals from estimates of mating success tends to overestimate the average mating success and underestimate the variance in mating success for males.

$j$ th interval with a different male (Fig. 10.2). Although these scenarios are clearly distinct in their influence on sexual selection (one male mates with all of the females vs. each male mates with a different female), each case generates identical and thus indistinguishable instantaneous and overall values for OSR [ $R_{O(j)} = N_{\delta} / N_{\varphi;(j)} = 5$ ;  $\sum R_{O(j)} = 25$ ;  $R_O = N_{\delta} / N_{\varphi} = 5/5 = 1$ ]. Note, too, that the sum of the instantaneous estimates of OSR,  $\sum R_{O(j)}$ , exceeds the overall estimate of OSR by 25-fold. There can be no doubt that the concept of OSR has stimulated considerable research. However, despite its conceptual utility, it is difficult to see how such an inconsistent measure can be responsible for the evolutionary power the operational sex ratio is now thought to possess.

**Scenario 1:**

Patches w/ males	Intervals w/ females->					$N_i$
	1	2	3	4	5	
1	1	1	1	1	1	5
2	0	0	0	0	0	0
3	0	0	0	0	0	0
4	0	0	0	0	0	0
5	0	0	0	0	0	0
						?
$N_j$	1	1	1	1	1	5
$K(t)$	5	5	5	5	5	
$R(t)$	0.20	0.20	0.20	0.20	0.20	1.00
$R_0(t)$	5	5	5	5	5	25.00

**Scenario 2:**

Patches w/ males	Intervals w/ females ->					$N_i$
	1	2	3	4	5	
1	1	0	0	0	0	1
2	0	1	0	0	0	1
3	0	0	1	0	0	1
4	0	0	0	1	0	1
5	0	0	0	0	1	1
						?
$N_j$	1	1	1	1	1	5
$K(t)$	5	5	5	5	5	
$R(t)$	0.20	0.20	0.20	0.20	0.20	1.00
$R_0(t)$	5	5	5	5	5	25.00

FIGURE 10.2 Instantaneous estimates of the operational sex ratio (OSR) during the breeding season fail to distinguish between males who mate and males who do not, and overestimate the intensity of sexual selection that exists over the entire breeding season. Shown are two scenarios illustrating a hypothetical breeding season in which 5 females mate with 5 males on territorial patches (rows). Within each  $j$ th interval of the breeding season (each column), the total number of receptive females,  $N_j$ , divided by the total number of males,  $K_j$ , equals  $R_j$ , the interval sex ratio, or the average number of females per male. The total number of males,  $K_j$ , divided by the total number of receptive females per interval,  $N_j$  equals the interval operational sex ratio,  $R_{0(t)}$ . In Scenario 1, each female mates with the same

## QUANTITATIVE ANALYSES OF MATING SYSTEMS

### Covariance Methods

The most direct approach for investigating how sexual selection operates is to measure selection itself. Arnold and Duvall (1994) identified sexual selection gradients, which isolate the statistical relationship between male and female trait values and mating success relative to other components of selection. Using this method for pipefish (*Syngnathus typhle*), Jones et al. (2002) quantified the sex difference in “Bateman gradients,” in which females had a stronger positive association between mate numbers and fertility than males, and changes in sex ratio influenced the slopes of these relationships, as predicted by Emlen and Oring (1977). Bateman gradients are useful for studies of sexual selection because they quantify the slope of the regression of reproductive success (offspring) on mating success (mates that bear progeny). This standardized covariance between phenotype and fitness provides a direct measure of selection intensity on a particular trait, in this case, how mating success correlates with offspring numbers. Bateman gradients are part of the selection that acts on every sexually selected trait; thus they represent the final common path between sexually selected traits and fitness. When the gradient is zero, it shows that sexual selection is negligible and that selection in other contexts is likely to prevail.

Wade and Shuster (2005) used selection gradients as a means for understanding sex differences in eagerness to mate, by examining the covariance between average promiscuity and fitness for males and for females. This relationship provides a quantitative measure for “sexual conflict” as the sex difference in the sign of the covariance between numbers of matings and fitness. Such relationships show that when the sign of the covariance is negative, additional matings are favored in one sex but are selected against in the other, providing a simple statistical explanation for observed sex differences in eagerness to copulate not involving gametic differences [cf. Bateman (1948) and Trivers (1972)].

Again, because each offspring has a mother and a father (Fisher, 1930; Queller, 1997) and because each mating involves one male and one female (Wade and Shuster, 2005), this relationship shows too that it is impossible

male in a different  $j$ th interval. In Scenario 2, each female mates in a different  $j$ th interval with a different male; each case generates identical and thus indistinguishable instantaneous and overall values for OSR ( $R_{O(j)} = N_{\delta} / N_{\varrho(j)} = 5$ ;  $\sum R_{O(j)} = 25$ ;  $R_O = N_{\delta} / N_{\varrho} = 5/5 = 1$ ). Note that the sum of the instantaneous estimates of OSR,  $\sum R_{O(j)}$ , exceeds the overall estimate of OSR by 25-fold.



for one sex to be more promiscuous on average than the other, as is often implied in extensions of parental investment theory (Thornhill and Alcock, 1983). The covariance approach also provides a means for predicting evolutionary trajectories if a genetic basis exists for particular traits associated with fitness. Under such circumstances genetic correlations may become established by the co-occurrence of particular male-female behaviors. For example, female tendencies to aggregate could become associated with male tendencies to defend breeding aggregations (Shuster and Wade, 1991, 2003; Wade and Shuster, 2005). Thus, in addition to the classic Fisherian runaway process, a wide range of correlated traits among the sexes could arise, beyond those involved in mate choice alone.

A related theoretical framework for understanding the evolution of correlated male traits as well as for considering how female traits may become enhanced or reduced as a result of interactions with males, is the covariance approach to social interactions (Frank, 1997; Moore et al., 1997; Roff, 1997; Wolf et al., 1999b). This methodology separates the effects of natural selection acting on traits possessed by focal individuals from the effects of social selection on these same traits, caused by interactions focal individuals may have with potential rivals or with potential mates themselves. The approach is applicable in the context of male-male interactions alone, as well as through female mate choice based on male phenotype, in the manner of Fisher's (1930) runaway hypothesis of sexual selection.

The covariance approach provides a means for measuring the opportunity for social selection that exists whenever individual fitness varies as a result conspecific interactions (Wolf et al., 1999b). That is, it measures the maximum possible change in phenotype that is possible as a result of a single episode of social selection. This approach is conceptually similar to methods used to measure the opportunity for sexual selection (Wade, 1979; Wade and Arnold, 1980; Shuster and Wade, 2003) (see below), and it is analogous to contextual models of multilevel selection (Goodnight et al., 1992; Whitham et al., 2003), in which the effects of group structure or membership on individual fitness are each identified and quantified using partial regression models.

### **A Sex Difference in the Opportunity for Selection**

The above methods rely on the experimenter's ability to identify specific traits that are associated with fitness variance. Another method for identifying the intensity of sexual selection that does not require such specificity compares the fitness of parents who successfully breed, with the fitness of the population before reproduction occurs. Crow (1958, 1962) showed that this comparison provides an estimate of the opportunity for selection, an empirical estimate of the maximum possible change in a



phenotypic distribution as a result of one episode of selection. The opportunity for selection,  $I$ , is equivalent to the variance in fitness,  $V_W$ , divided by the squared average in fitness,  $W^2$ , and equals the variance in relative fitness,  $V_w$  (Wade, 1979; Shuster and Wade, 2003).

When paternity data are available, the sex difference in the opportunity for selection is estimated by calculating the opportunity for selection separately for each sex. Here, the value of  $I$  for each sex is expressed as the ratio of the variance in offspring numbers,  $V_{O_i}$ , to the squared average in offspring numbers,  $O_i^2$ , among the members of each sex, or,  $I_\delta = V_{O_\delta} / O_\delta^2$  and  $I_\phi = V_{O_\phi} / O_\phi^2$  (Shuster and Wade, 2003; Wade and Shuster, 2005; Shuster, 2008). Because each offspring has a mother and a father (Fisher, 1930),  $I_\delta$  and  $I_\phi$  are linked through the sex ratio and mean fitness in terms of offspring numbers, which also must be equal for both sexes (Wade and Shuster, 2005). The sex difference in the variance in relative fitness,  $\Delta I = (I_\delta - I_\phi)$ , when considered in this way may be positive, negative, or zero (Shuster, 2008). The value of  $\Delta I$  determines whether and to what degree the sexes will diverge in character because fitness variance is proportional to selection intensity.

When  $\Delta I > 0$ , sexual selection modifies males and  $\Delta I = I_{\text{males}}$ , the opportunity for sexual selection as described initially by Wade (1979). When  $\Delta I < 0$ , the variance in offspring numbers is greater for females than it is for males and sexual selection modifies females, as is expected to occur when sex roles are reversed (Shuster, 2008). When  $\Delta I = 0$ , there is no sexual selection in either sex or sexual selection is equally strong in both sexes, a condition that can lead to extreme sexual dimorphism because sexual selection is likely to favor distinct, divergent evolutionary trajectories for males and for females (Shuster and Wade, 2003). The opportunity for selection identifies the maximum possible change in phenotype because it contains all of the variance in fitness, selected as well as random. Some authors have criticized the usefulness of  $I$  because chance alone can influence variance mating success as well as offspring numbers (Sutherland, 1985b; Hubbell and Johnson, 1987). Indeed, bad things can happen to good genes and vice versa (Shuster and Wade, 2003). However, because mate numbers and offspring numbers are the currency by which  $I$  is measured, the outcomes of chance on mating success and fertilization success are already incorporated into these estimates of selection opportunities. Crow (1958, 1962) identified  $I$  as the opportunity for selection for good reason. Because random processes can diminish the effectiveness of selection,  $I$  estimates an upper limit on the response to selection.

This approach is distinct from that currently used by parental investment theory (Bateman, 1948; Williams, 1966; Trivers, 1972; Thornhill and Alcock, 1983). According to this latter framework, males and females are defined by differences in energetic investment in gametes. However, a

causal scheme based on sex differences in parental investment fails to explain the details of male parental care within and among even closely related taxa. Among syngnathid fish, for example, stickleback males (*Gasterosteus aculeatus*) build benthic nests, use their bright red undersides to attract mates, and care for multiple clutches of eggs. In this species, male care enhances a male's ability to mate (Baker J, et al., 1998; Ah-King et al., 2005), whereas, in seahorses (*Hippocampus* spp.), males and females form pairs, males receive the eggs of a single female into their brood pouch and provide exclusive parental care to young that eliminates further male mating opportunities (Vincent and Sadler, 1995). It is unclear how such diversity can possibly evolve if initial parental investment is the cause of sex differences in phenotype and parental care.

When paternity data are unavailable, it is still possible to estimate opportunities for selection by exploiting the multiplicative properties of male and female fitness (Shuster and Wade, 2003). This approach makes use of the fact that the average male fitness equals the average number of mates per male,  $m$ , multiplied by the average number of offspring per female,  $O$ . Thus, the total variance in offspring numbers for males,  $V_{O\delta}$ , can be estimated in terms of the average number of mates per male and the average number of offspring per female. As in a standard ANOVA problem, the total variance in male fitness can be partitioned into the sum of two components: (i) the average variance in offspring numbers for males within the classes of males who sire progeny, and (ii) the variance in the average number of progeny sired by males among these same mating categories (Shuster and Wade, 2003; Wade and Shuster, 2004; Shuster, 2008).

### Spatial and Temporal Distribution of Matings

The above approach for estimating the intensity of sexual selection relies on the availability of information on the mean and variance in clutch sizes and numbers in females, and the mean and variance in mate numbers among males. When such information is unavailable, an alternative approach for measuring sexual selection builds on the conceptual framework of Emlen and Oring (1977) and examines the spatial and temporal distribution of matings. Although the Emlen-Oring estimates of the environmental potential for polygamy (EPP) and the operational sex ratio (OSR) have proven unsatisfying from an empirical standpoint as described above, two methods by Shuster and Wade (2003) capture these authors' unique insight that spatial and temporal variation in the availability of mates provides crucial information on whether multiple mating by particular individuals can occur.

How does each method work? The first method involves construction of a matrix whose rows represent resource patches or other territories con-

taining males and whose columns represent intervals during the breeding season during which females may be receptive (cf. Figs. 10.3 and 10.4; rows may also represent territorial females in sex-role-reversed species). As described in Shuster and Wade (2003) the duration of each interval equals the average duration of receptivity among all females. The cells of the matrix may contain zeros or larger numbers identifying the number of mates males obtain within each interval. If multiple males inseminate the same female, these numbers may also represent the fraction of the total fertilizations with a given female that a male obtains, providing a specific means for considering the effects of postcopulatory sexual selection. The more precise paternity data are, the more detailed such analyses can be, and fractions of clutches instead of individual matings can be substituted into the matrix.

Although algebraically complex, partitioning the total variance in mate numbers among males into spatial and temporal components is in practice straightforward (Fig. 10.3) (Shuster and Wade, 2003), amounting to an ANOVA problem in which the total numbers of matings (Fig. 10.3, upper left rectangle) are partitioned into the within- and among-

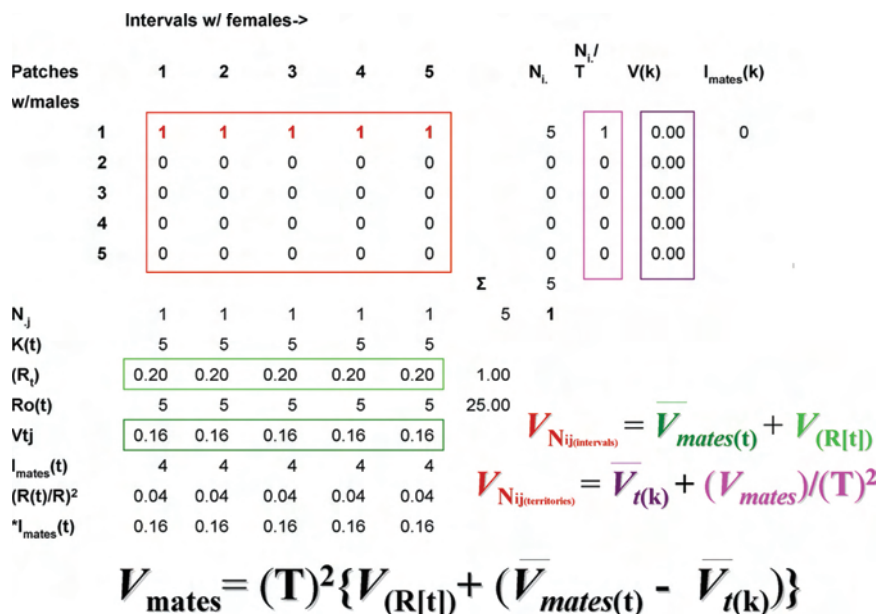

FIGURE 10.3 Methods for partitioning the total variance in mate numbers among males into spatial and temporal components (explanation in *Spatial and Temporal Distribution of Matings*).

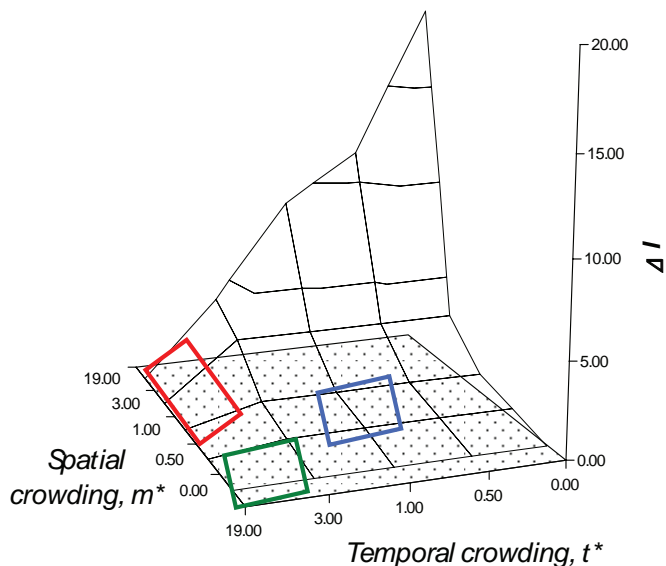

FIGURE 10.4 The  $\Delta I$  surface. As explained in detail in Shuster and Wade (2003), simultaneous consideration of the mean spatial crowding of matings,  $m^*$ , and the mean temporal crowding of matings,  $t^*$ , provides opportunities to visualize how spatial and temporal distributions of matings influence the opportunity for sexual selection,  $\Delta I$ , as well as the dynamic nature of mating system evolution. Changes in mating system character occur as a result of modifications in the spatial and temporal distribution of matings. When  $m^*$  is low and  $t^*$  is high, males are likely to seek out, remain with, and provide parental care for isolated, synchronously receptive females, forming persistent pairs (lower left rectangle); when  $m^*$  is moderate to high,  $t^*$  is high, males are expected to defend individual females, but breeding is expected to occur in large aggregations or mass matings (upper left rectangle). Polygamy is likely when  $m^*$  and the mean temporal crowding of matings,  $t^*$  are both moderate (right rectangle).

male components of mating success obtained in space and in time. As in ANOVA, we identify two components of variance: that arising within the classes of mating males and that arising among all males, mating as well as nonmating. To begin, note that within each  $j$ th interval of the breeding season (each column), the total number of receptive females,  $N_{ij}$ , divided by the total number of males,  $K_{ij}$ , equals  $R_{ij}$ , the interval sex ratio, or the average number of females mated by each male within the  $j$ th interval (upper horizontal rectangle, Fig. 10.3). The average of the squared number of females mated by males within each  $j$ th interval,  $\sum N_{ij}^2 / K_{ij}$ , minus the squared interval sex ratio,  $R_{ij}^2$ , equals  $V_{ij}$ , the variance in mates per

male, per  $j$ th interval (lower horizontal rectangle, Fig. 10.3). The temporal distribution of matings then equals the variance in male mating success across all  $j$  intervals,  $V_{Nij(\text{intervals})}$ , which equals the average of the variances in mates per male per  $j$ th interval,  $V_{\text{mates}(t)} (= \Sigma V_{ij}/T)$ , plus the variance of the average sex ratio across all  $j$  intervals,  $V_{(R)} (= \Sigma [R_j]^2/T - \bar{R}_j)$ , or

$$V_{Nij(\text{intervals})} = \bar{V}_{\text{mates}(t)} + V_{(R[t])}. \quad (2a)$$

Within each  $i$ th male territory (row), the total number of receptive females,  $N_i$ , divided by the total number of intervals containing at least one female,  $T$ , equals  $N_i/T$ , the number of females mated by the male in the  $i$ th territory, averaged across all  $T$  intervals (left vertical rectangle, Fig. 10.3). The average of the squared number of females mated by each male within the  $i$ th territory per  $T$ th interval,  $\Sigma Ni^2/T$ , minus the squared average number of mated females across all  $T$  intervals,  $(N_i/T)^2$ , equals  $V_{(k)}$ , the variance in mate number across all  $T$  intervals for the  $i$ th territorial male (right vertical rectangle, Fig. 10.3). The spatial distribution of matings then equals the variance in male mating success across all  $i$  territories,  $V_{Nij(\text{territories})}$ , which equals the average of the variances in mate number across all  $T$  intervals per  $i$ th territorial male,  $\bar{V}_{t(k)} (= \Sigma V_{(k)}/T)$ , plus the variance of the average number of females mated by the  $i$ th male across all  $T$  intervals,  $(V_{\text{mates}})/(T)^2$ , or,

$$V_{Nij(\text{territories})} = \bar{V}_{t(k)} + (V_{\text{mates}})/(T)^2. \quad (2b)$$

Shuster and Wade (2003) showed that these two estimates of the variance in mate numbers among males can be combined so that the total variance in male mating success across all  $j$  intervals (Eq. 2a) and  $i$  territories (Eq. 2b) equals the total variance in male mating success,  $V_{\text{mates}}$ , and that

$$V_{\text{mates}} = (T)^2 \{V_{(R[t])} + \bar{V}_{\text{mates}(t)} - \bar{V}_{t(k)}\}. \quad (2c)$$

Noting that the average mating success for all males equals the sex ratio,  $R = N_{\text{♀}}/N_{\text{♂}}$ , Shuster and Wade also showed that when  $V_{\text{mates}}$  (cf. Eq. 2c) is divided by  $R^2$ , this ratio equals the opportunity for sexual selection,  $I_{\text{mates}}$  ( $= \Delta I$  when  $I_{\text{♂}} > I_{\text{♀}}$ ), which can be rewritten as

$$I_{\text{mates}} = I_{\text{sex ratio}} + [^*I_{\text{mates}(t)} - ^*I_{\text{mates}(k)}]. \quad (3)$$

Eq. 3 shows how the total opportunity for sexual selection, determined from the temporal distribution of matings among spatially distinct territorial males, can be partitioned into three components: (i)  $I_{\text{sex ratio}}$ , the opportunity for sexual selection caused by temporal variation in the sex

ratio (this is what the OSR appears to have been designed to measure, but does not because it overestimates the intensity of sexual selection within intervals in which females are abundant); (ii)  $*I_{\text{mates}(t)}$ , the weighted opportunity for sexual selection caused by temporal variation in the availability of females (this value may be small or large depending on whether females are synchronous or asynchronous in their receptivities, and is weighted by the number of females that appear in each interval, with larger numbers of females per interval contributing the largest effects); and (iii)  $*I_{\text{mates}(k)}$ , the weighted opportunity for sexual selection caused by spatial variation in the availability of females, which may be small or large depending on whether females are spatially dispersed or spatially clumped. Note that  $*I_{\text{mates}(k)}$  erodes  $*I_{\text{mates}(t)}$  because the latter term is an estimate of the variance in mate number within individual territorial males. Increases in the variance in relative fitness within males tend to decrease the variance in relative fitness that occurs among males.

### Spatial and Temporal Crowding of Sexual Receptivity

The above method considers the total variation in mating success as separate opportunities for selection arising from (i) variation in sex ratio across the breeding season, (ii) the temporal availability of mates, and (iii) the spatial availability of mates. In effect, this scheme captures the elements of mating system variation identified by Emlen and Oring (1977) (i.e., EPP and OSR) and expresses them in terms of their relative influences on the intensity of sexual selection. This approach does not require data on parentage (although such information can make this approach more precise), but it does require specific information on which males mate with which females. When only the spatial and/or temporal distributions of sexually receptive individuals are available, yet another method for estimating  $\Delta I$  involves calculating the mean spatial crowding,  $m^*$  and the mean temporal crowding,  $t^*$ , of such individuals (Lloyd, 1967; Wade, 1995; Shuster and Wade, 2003).

The mean crowding approach for estimating  $\Delta I$  requires simply that the spatial and temporal distributions of matings be identified. In most cases, the spatiotemporal distribution of receptive females provides this information. For example, the mean crowding of receptive females (matings) on resources defended by males,  $m^*$ , can be expressed as

$$m^* = m + [(V_m/m) - 1], \quad (4)$$

where  $m$  equals the average number of receptive females per resource patch, and  $V_m$  is the variance around that average. In this context,  $m^*$  represents the number of other females the average female experiences

on her resource patch. When females are maximally dispersed among patches,  $m^*$  approaches zero, whereas when females tend to aggregate on particular patches,  $m^*$  increases.

Similarly, when the breeding season is divided into intervals whose width equals the average duration of female receptivity, the mean temporal crowding of female receptivity over the breeding season,  $t^*$ , can be expressed as

$$t^* = t + [(V_t/t) - 1], \quad (5)$$

where  $t$  equals the average number of receptive females per interval and  $V_t$  equals the variance around that average. In this context,  $t^*$  represents the number of other receptive females the average receptive female experiences when she becomes sexually receptive. When female receptivity is maximally asynchronous within the breeding season,  $t^*$  approaches zero, whereas when female receptivities overlap within a single interval, the value of  $t^*$  becomes large.

Although values of  $m^*$  and  $t^*$  can each estimate the opportunity for sexual selection,  $\Delta I$  ( $= I_{\text{mates}}$  when  $I_{\sigma} > I_{\text{f}}$ ), in most cases it is necessary to measure both values because the effects spatial and temporal crowding of females may have on male fertilization success are distinct. Whereas the relationship between  $m^*$  and  $\Delta I$  is proportional, i.e., at  $m_{\text{max}}$  one or a few males could defend and mate with all of the females in the population, the relationship of between  $t^*$  and  $\Delta I$  is reciprocal, i.e., at  $t_{\text{max}}$ , the ability of one or a few males to mate with multiple females is reduced. The combined effects of  $m^*$  and  $t^*$  on sexual selection generate a surface (Fig. 10.4) that bears striking resemblance to Emlen and Oring's (1977) diagram of possible values for the environmental potential for polygamy. However, unlike these authors' conceptual model, the  $\Delta I$  surface provides actual estimates of selection intensity from empirical estimates of female spatial and temporal distributions.

### Common Ground for Plant and Animal Mating Systems

As explained in detail in Shuster and Wade (2003), simultaneous consideration of  $m^*$  and  $t^*$  provides opportunities to visualize the dynamic nature of mating system evolution. Unlike typological classifications, this framework predicts that even slight modifications in the spatial and temporal distribution of matings can cause rapid changes in mating system character. Furthermore, when similar values of  $m^*$  and  $t^*$  exist among taxonomically diverse species, the mating systems of these species should begin to converge. For example, when  $m^*$  is low and  $t^*$  is high, males are likely to seek out, remain with, and provide parental care for isolated,



synchronously receptive females, forming what can be called “persistent pairs” (Shuster and Wade, 2003) (Fig. 10.4). Examples of such mating systems may occur in sponge shrimp (*Spongocola* spp.) (Saito and Konishi, 1999), which enter the bodies of spatially dispersed glass sponges (Hexactinellidae) as larvae, and later differentiate into male-female pairs that remain imprisoned within the sponge for life. Similar spatial dispersion and temporal synchrony in reproductive activity appear to characterize the mating systems of desert isopods (Baker M, et al., 1998) and solitary sandpipers (Oring, 1973).

If females become more spatially aggregated,  $m^*$  is moderate to high,  $t^*$  is high, males are expected to defend individual females, but breeding is expected to occur in large aggregations, forming what can be called “mass mating” (Shuster and Wade, 2003) (Fig. 10.4). Examples of such mating systems may occur in explosively breeding frogs (Wells, 1979), grunion (Thomson and Muench, 1977), or simultaneously spawning cnidarians (Kruger and Schleyer, 1998) and, although seldom discussed in this way, perhaps in dioecious wind-pollinated plants such as junipers (Thomas et al., 2007).

Polygamy appears to occur when the mean spatial crowding of matings,  $m^*$ , and the mean temporal crowding of matings,  $t^*$  are both moderate (Shuster and Wade, 2003) (Fig. 10.4). Here, not only do males and females have approximately similar variance in mating success and so tend to show little sexual dimorphism, but when individuals are limited in their mobility or are restricted to patchy habitats, they may also be simultaneously or sequentially hermaphroditic. Examples of this mating system are found in caridean and pandalid shrimp (Charnov, 1979; Bauer, 2000), as well as in barnacles (Hoch, 2008), and terrestrial slugs (Reise et al., 2007). Again, although seldom discussed with the breeding systems of animals, similar mating systems may also exist in plants with perfect flowers, or that show tendencies toward heterostyly and dichogamy (Darwin, 1877a).

Considerations of mean spatial and temporal crowding of matings provide insight into the character of animal mating systems, but this approach may also be useful for plants (Fig. 10.5). A possible scheme for variation of this sort might place self-fertilizing (cleistogamous) plants in circumstances in which both  $m^*$  and  $t^*$  are low, i.e., spatially dispersed and temporally asynchronous, conditions that could lead to extreme pollen limitation and favor individuals who self. In contrast, outcrossing species could be most commonly represented in circumstances in which ecological conditions favor higher densities of breeding individuals and relative synchrony of breeding phenology. Wind-pollinated plants may typically occur when natural selection favors synchronous breeding, regardless of their spatial distribution, whereas animal-pollinated plants may be most



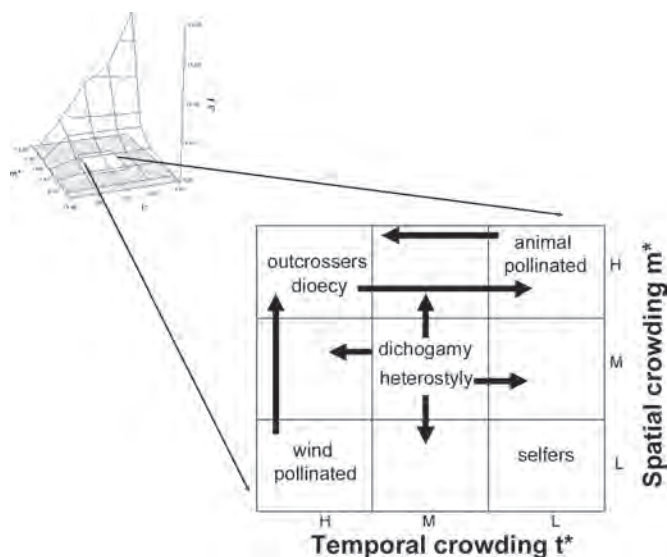

FIGURE 10.5 The location on the  $\Delta I$  surface in which plant mating systems and animal mating systems may be considered within the same empirical framework. Such conditions exist in the center of the distribution, at approximately the same conditions in which polygamy is favored in animals and where sexual selection is relatively weak.

common when plants are spatially aggregated, regardless of whether flowering is temporally clumped or aggregated (Fig. 10.5).

Heterostylous plants may be represented at intermediate values of  $m^*$  and  $t^*$  but show greater representation at lower spatial density and temporal asynchrony, as such conditions could favor the long-distance, asynchronous arrival of pollinators, whereas dichogamous plants may also be represented at intermediate values of  $m^*$  and  $t^*$  but show greater representation at higher spatial densities and synchronous flowering, as such conditions could favor temporal specialization via male or female function. Dioecy could be favored when pollen limitation seldom occurs, as when plants are relatively clumped in space and temporally synchronous in their flowering, but could also exist when spatially clumped flowers open asynchronously and allow plants to attract pollinators over long durations and gain considerable fitness through pollen.

Sexual selection is considered relatively weak among plants because of approximately equivalent fitness variance within each sex (Shuster and Wade, 2003). Such conditions seem most likely to occur when the values of  $m^*$  and  $t^*$  are moderate. The location on the  $\Delta I$  surface in which such conditions exist for animals is the center of this distribution, where polyg-

amy is favored and sexual selection also tends to be relatively weak (Fig. 10.5). Thus, the most productive place to begin investigation of how the spatial and temporal distributions of fertilizations are similar in plants and animals may be with these polygamous species. Few data are now available that could test the generality of this hypothesis. However, sufficient anecdotal information exists to justify efforts by researchers to close the conceptual and empirical gap between studies of plant and animal mating systems. As if to invite collaborative research, the population genetic tools, both theoretical and empirical, that characterize research in plant mating systems are less well developed for animals, while the spatiotemporal data and quantitative genetic methods for measuring selection that characterize research in animal mating systems are less well developed for plants. Each discipline has much to offer the other and much exciting work remains to be done.

#### ACKNOWLEDGMENTS

I thank Michael J. Wade for his fundamental role in developing the ideas presented in this manuscript, John Avise and Francisco Ayala for organizing *In the Light of Evolution III*, and 2 anonymous reviewers for their comments on an earlier draft of this manuscript. This work was supported by National Science Foundation Grants NSF FIBR-0425908 and DBI-0552644.

# 11

## Reproductive Decisions Under Ecological Constraints: It's About Time

---

PATRICIA ADAIR GOWATY and STEPHEN P. HUBBELL

The switch point theorem (SPT) is the quantitative statement of the hypothesis that stochastic effects on survival, mate encounter, and latency affect individuals' time available for mating, the mean and variance in fitness, and thus, originally favored the evolution of individuals able to make adaptively flexible reproductive decisions. The SPT says that demographic stochasticity acting through variation in (i) individual survival probability,  $s$ ; (ii) individual encounter probability,  $e$ ; (iii) latency,  $l$ ; (iv) the number of potential mates in the population,  $n$ ; and (v) the distribution of fitness conferred, the  $w$  distribution, together affect average lifetime fitness, and induce adaptive switches in individual reproductive decisions. The switch point is the rank of potential mates at which focal individuals switch from accepting to rejecting potential mates, a decision rule that the SPT proves maximizes the average lifetime fitness of a focal individual under given values of ecological constraints on time. The SPT makes many predictions, including that the shape of the distribution of fitness conferred affects individual switch points. All else equal, higher probabilities of individual survival and encounter decrease the fraction of acceptable potential mates, such that focal individuals achieve higher average lifetime fitness by rejecting more potential mates. The primary prediction of the SPT is that each decision a focal

---

Department of Ecology and Evolutionary Biology and Institute of the Environment, University of California, Los Angeles, CA 90095 and Smithsonian Tropical Research Institute, APO, AA 34002.

individual makes is determined jointly by  $e$ ,  $s$ ,  $l$ ,  $n$ , and the  $w$  distribution.

When Darwin's critics said that natural selection (Darwin, 1859) could not explain the evolution of traits such as the outrageous tails of peacocks that reduce their bearers' survival probabilities, he countered with sexual selection (Darwin, 1871). He argued that costly traits would evolve if they also increased males' abilities to attract females or to win behavioral contests over access to females. In "Principles of Sexual Selection," the first chapter of Part II of *The Descent of Man, and Selection in Relation to Sex* (Darwin, 1871), Darwin defined sexual selection as that type of selection that "depends on the advantage which certain individuals have over other individuals of the same sex and species, in exclusive relation to reproduction" (1871, p. 256). Darwin distinguished sexual selection from natural selection as selection that arises from some individuals having a reproductive advantage over other same-sex, conspecific individuals, not from different "habits of life," but from reproductive competition with rivals. Darwin's discussion focused overwhelmingly on traits in males that could be explained by 2 mechanisms of sexual selection—male-male competitive interactions and female choice—each of which could result in variation among males in fitness and thereby favor traits that helped males win fights and attract females (see Jones and Ratterman, Chapter 9, this volume). Most modern discussions of typical sex roles begin with Darwin's 1871 volume, and statements about choosy females and profligate, competitive males. However, Darwin probably suspected that male choice was common; he argued in Part I of the 1871 book that men's choice of mates was seemingly more common than women's at least in "civilized societies." He even argued that the beauty of women was due to male choice. In Part II he also described cases of male domestic and companion animals refusing to copulate with some females. He was aware too of gaudy, pugnacious, and competitive females in some bird species. Controversy over whether females had the esthetic capability for discrimination dogged Darwin and his followers into the 20th century.

After most people finally agreed that females had the sensibilities to choose, focus narrowed so that modern students of sexual selection simply assumed that males were competitive and indiscriminate and females "coy," passive, and discriminating. For example, when Bateman (1948) studied sex differences in fitness variances in *Drosophila melanogaster*, he attributed the larger variances of males to their "undiscriminating eagerness" and the "discriminating passivity" of the females (p. 367), even though he did not watch behavior (Dewsbury, 2005). Bateman's study

also led many to infer that female multiple mating was unlikely to be very common as it was unlikely to enhance female fitness.

Resistance to such “narrow-sense sexual selection” was afoot in Darwin’s century [see citations in Gowaty (2007)], and accelerated with the flush of empirical papers that followed Parker et al. (1972) and Trivers (1972). Parker argued that the sexes are what they are because of the size of the gametes they carry: females having large, relatively immobile, resource-accurring gametes and males having smaller, mobile gametes that competed for access to the larger ones. Trivers argued, echoing Williams (1966), that females were usually the choosy sex because in most species females bore the greater cost of reproduction. Challenges to the generalizations of parental investment theory included Hrdy’s (1981) book about the near ubiquity of competitiveness of primate females and their anything but “coy” and “passive” sexual behavior; discovery that females fight females to defend “genetic maternity” in birds (Gowaty, 1981; Gowaty and Wagner, 1987), documentation of multiple mating by wild-living female *Drosophila pseudoobscura* (Anderson, 1974), *Sialia sialis* and other bird species (Gowaty and Karlin, 1984; Gowaty, 1985); and the first study of male mate choice in beetles with typical female-biased parental investment (Johnson and Hubbell, 1984). Importantly, Sutherland (1985a,b, 1987) showed theoretically that the sex differences in fitness variances could arise in the absence of mate choice and intramale competition and could be due entirely to chance. Building on Sutherland’s insights, Hubbell and Johnson (1987) showed that the variation in lifetime mating success results from chance and selection, so that measures of selection should rely only on the residual variance that cannot be ascribed to known and quantifiable nongenetic life history variation. Hrdy and Williams (1983) and Hrdy (1986) offered an explanation for why, in the face of so much evidence, so many biologists seem invested in the “myth of the coy female.” In response to the failures of the simpler versions of parental investment theory, new theory to explain reproductive decisions appeared (Hubbell and Johnson, 1987; Crowley et al., 1991; Clutton-Brock and Parker, 1992) predicting that variation in encounters, latencies, survival, and their more complex proxies (relative reproductive rate, the operational sex ratio, and density) favored shifts in mean behavior of the sexes, and as a result more nuanced reports of ecologically induced variation in sex-typical behavior appeared [e.g., Magnhagen (1991), Forsgren (1992), Shelly and Bailey (1992), Berglund and Rosenqvist (1993), Hedrick and Dill (1993), Berglund (1994, 1995), Poulin (1994), Simmons (1995), Dill et al. (1999), Grand and Dill (1999), Itzkowitz and Haley (1999), Gowaty et al. (2002), Jiggins (2002), Drickamer et al. (2003)]. Currently, few investigators think that sex role behavior is entirely fixed for either sex, particularly in females in species with female-biased parental investment in which many observations of

changes in mating behavior exist (Magnhagen, 1991; Gong, 1997; Grand and Dill, 1999). Nevertheless, we know little about how male mate choice behavior varies under ecological constraints, because few investigators study male mate choice in species with female-biased parental investment. The possibility of sex role flexibility has seldom been simultaneously tested in both sexes (Gowaty et al., 2003b).

Most modern theories of sex roles begin with Trivers's (1972), and Parker et al.'s (1972) ideas about sex differences to predict further sex differences. The derivative theories assume that the origin theories are an accurate reflection of past selection, which is an intuitive place to begin in refinement of theory—until one seriously considers the explicit challenges to the embedded assumptions about sex differences in fitness variances. Consider what Hubbell and Johnson (1987) proved theoretically: that demographic stochasticity gives rise to chance variances in lifetime reproductive success. They proved that nonheritable environmental variation in an individual's lifetime number of mates could have favored the evolution of mate assessment in the first place. They showed that variances in number of mates similar or identical to those usually attributed to sexual selection could arise without mate choice and other sources of intrasexual competition. In other words, the arrow of causation linking classic mechanisms of sexual selection to fitness variances can go in either direction (Gowaty and Hubbell, 2005). This means that fitness variances can arise from demographic stochasticity, acting through chance effects on individual encounter probabilities with potential mates, individual survival probabilities, and latencies, which are variables that can then induce individual behavior (Fig. 11.1). This conclusion is turned around from the usual conclusion that mate choice and intrasexual competition cause fitness variances. This observation was profound, just as Sutherland's (1985a) earlier one was, because it showed that the usual linkage between

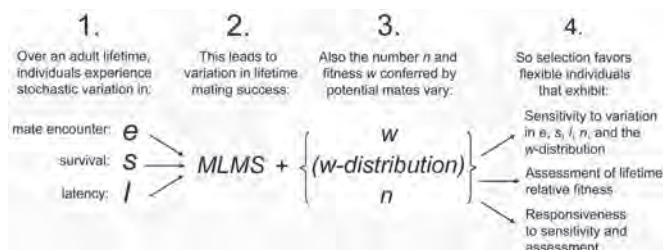

FIGURE 11.1 Scheme showing a scenario of the evolution of switches in reproductive decisions.

SOURCE: Modified from Gowaty and Hubbell (2005).

mechanisms of sexual selection and means and variances in number of mates is best interpreted as correlation rather than causation until one partitions the deterministic and stochastic components of means and variances in number of mates.

Most recent sex roles research has focused on female mate choice for fancy male traits, much of which was inspired by Hamilton and Zuk's (1982) hypothesis that fancy male traits indicate good genes for offspring viability, a compelling hypothesis given Red Queen dynamics between hosts and pathogens. Later quantitative genetics theory suggested that indirect fitness effects are less likely than direct fitness effects to favor the evolution of such traits (Kirkpatrick, 1985; Wolf and Wade, 2001). Additionally, until relatively recently, few data existed in support of the good genes hypothesis of mate choice. However, female and male choice studies in flies (Anderson et al., 2007), cockroaches (Moore et al., 2001, 2003), ducks (Bluhm and Gowaty, 2004a,b), and mice (Drickamer et al., 2000, 2003; Gowaty et al., 2003a) have demonstrated that offspring viability was significantly higher when choosers were mated with discriminatees they preferred, as was productivity (the number of offspring surviving to reproductive age). In contrast, fecundity (the numbers of eggs laid or offspring born) was almost always lower and sometimes significantly lower when choosers were experimentally paired with partners they preferred compared with partners they did not prefer (Gowaty et al., 2007). These findings are consistent with the hypothesis of reproductive compensation (Gowaty, 2008) and inconsistent with theories predicting that mate choice favors enhanced fecundity.

Why were these studies (Drickamer et al., 2000, 2003; Moore et al., 2001, 2003; Bluhm and Gowaty, 2004a,b; Anderson et al., 2007; Gowaty et al., 2007) successful in showing the predicted associations between mate choice and offspring viability, when others were not? There are at least 3 reasons. First, the studies had controls that eliminated the effects of intra-sexual behavioral contests and intersexual coercion that often confound mate choice studies (Kingett et al., 1981). Second, these studies were not designed to understand the evolution of traits mediating preferences, but to test the effects of mate choice independent of their effect on the evolution of discriminatee traits. The investigators picked choosers and discriminatees at random with respect to their phenotypes, so these studies are silent about the traits in the discriminatees that mediated choosers' preferences. Questions about the evolution of fancy traits are really 2 separate questions: one about the fitness payouts of preferences, and the other about the evolution of the traits that mediate the preferences. Multiple traits may mediate preferences (Candolin, 2003). However, few have evaluated the hypothesis that fancy traits may exploit preexisting sensory biases that could manipulate choosers in ways that could decrease rather



than increase their fitness. Third, the investigators (Gowaty et al., 2007) were motivated to study the effects of constraints on the free expression of mate preferences, so their methodologies were designed to get unambiguous pretouching behavioral indicators that choosers preferred one discriminatee more than the other. Once the investigators knew whom the choosers liked and did not like, they randomly assigned the choosers to breed with one of the discriminatees. In that way, they captured the effects of constraints on the fitness payouts for choosers in unconstrained and constrained partnerships.

Why are these studies (Drickamer et al., 2000, 2003; Moore et al., 2001, 2003; Gowaty et al., 2003a, 2007; Bluhm and Gowaty, 2004a,b; Anderson et al., 2007) of interest in an article on sex roles? (i) They provide powerful empirical counterpoint to theory that argues that indirect fitness effects are unlikely to accrue from mate preferences. (ii) They demonstrate trade-offs in components of fitness for choosers breeding under constraints, thus suggesting that to understand selection from mate choice, investigators may profit from knowing about as many components of fitness as possible, including fecundity, productivity, and offspring viability, when individuals breed under constraints. (iii) They show that individuals—both males and females—can and do make pretouching assessments of likely fitness payouts before mating. They made clear that males, not just females, are able to modify their behavior and physiology when breeding under constraints (Gowaty et al., 2007), observations inconsistent with typical ideas about sex role variation in species with female-biased parental investment.

What is needed now is a theory that will allow investigators to parse differential effects on fitness and behavior, and the direction of their effects on each other (behavior to fitness/fitness to behavior) on both females and males. Such a theory will allow investigators to attribute reproductive decisions and behavior to 3 causal factors: (i) chance variation in ecological contingencies that may induce flexible and adaptive individual reproductive decisions; (ii) competitive forces including natural and sexual selection; and (iii) fixed sex differences. The model we present facilitates these goals.

To describe the model, which we call the switch point theorem (SPT), we (i) discuss individual reproductive time budgets, which encapsulate some of the most important ecological constraints on reproduction. (ii) We introduce the concept of the fitness conferred by alternative potential mates. (iii) We verbally describe the steps in model construction (the mathematical description is in the Appendix to this chapter). (iv) We show some of the results of the model. In the discussion, we (v) list what the SPT does and does not do, and (vi) describe several possible empirical tests and applications of the SPT.

## CONSTRAINTS ON INDIVIDUAL REPRODUCTIVE TIME BUDGETS

For all mortal individuals, their time is finite. Time available for mating affects means and variances in number of mates (Fig. 11.1) (Gowaty and Hubbell, 2005), and chance effects on life history that affect time available for mating can have strong effects on fitness means and variances (Sutherland, 1985a; Hubbell and Johnson, 1987). The simplest set of parameters to affect lifetime variance in numbers of mates is based on stochastic effects on an individual's survival and the individual's encounters with potential mates, and, if the individual is a nonvirgin (i.e., a remating individual), its latency from one copulation to receptivity for the next (Sutherland, 1985a; Hubbell and Johnson, 1987; Gowaty and Hubbell, 2005). Indeed, in order for a receptive individual to mate, it must encounter a potentially mating opposite-sex individual; thus an individual's encounter probability ( $e$ ) with potential mates affects how much time the focal individual spends searching for mates. Likewise, for already-mated individuals in iteroparous species, the time they spend "handling" the reproductive consequences of mating, during which they are in latency ( $l$ ) and unavailable for further mating, affects the time remaining for future matings and the opportunity cost of the past mating (Sutherland, 1985a,b, 1987; Gowaty and Hubbell, 2005). Importantly, individuals vary in reproductive life span, a function of their survival probability ( $s$ ). All else equal, when search time and latencies are short, and life span is long, individuals have more time for reproduction than when search time and latencies are long, and life span is short. Individuals with short search times and long lives have more opportunities to mate than individuals whose search time is long and whose probability of future life is short. Intuitively (Fig. 11.2), it is easy to see that when opportunities vary, the costs and benefits of accepting or rejecting potential mates also vary. This means that for individuals with many opportunities, the costs of rejecting more potential mates are smaller, whereas, when focal individuals have fewer opportunities, the costs of rejecting potential mates are greater. However, relative opportunities predict only means and variances in number of mates; to predict adaptive, flexible reproductive decisions of an individual, one must also know the fitness that would be conferred if a focal individual were to mate with any given alternative potential mate.

## FITNESS DISTRIBUTIONS

Just as most models of mate preferences do (Andersson, 1994), the SPT assumes that individuals assess the fitness that would be conferred ( $w$ ) by potential mates before making reproductive decisions. We further assume that individuals obtain information during their development of

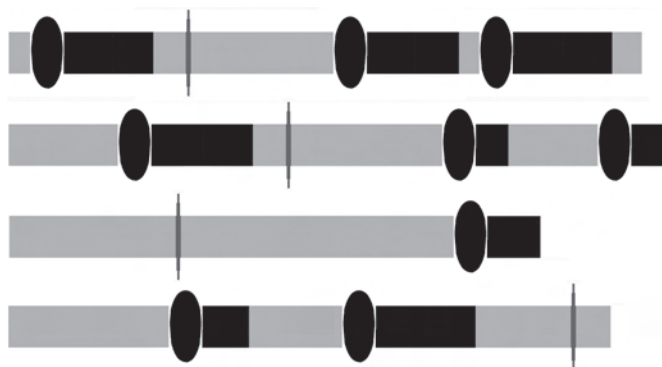

FIGURE 11.2 Four stick models of idealized reproductive careers of 4 individuals. On each stick, the gray bars represent the stage, search. The ovals attached to black bars represent the time used when an individual encounters and accepts for mating a potential mate, and enters a latency, a period during which the individual is unreceptive to further mating. The gray vertical ovals attached to gray bars represent encountering and rejecting a potential mate, after which the individual reenters search. Some sticks are longer than others, indicating that some individuals die before others, when they enter the absorbing state, death.

the distribution of fitness that would be conferred (the  $w$  distribution) by potential mates in their population. To conceptualize the meaning of  $w$  distributions, imagine an experiment with no carryover effects in which every female in a population is mated with every male and every male with every female. Fill in every cell of a matrix with the fitness that would result from each pairwise mating. This matrix specifies what we mean by “fitness conferred by alternative potential mates.” We assume that focal individuals have information about the distribution, which is a key component of expected mean reproductive success. The fitness components one might consider empirically or theoretically include: fecundity (the number of eggs laid or offspring born), productivity (the number of their offspring that survive to reproductive age), or offspring viability (the proportion of eggs laid or offspring born that survive to reproductive age). On completion, one would have a matrix of values representing “fitness conferred by alternative potential mates,  $w$ .” One can imagine a variety of scenarios for how fitnesses are distributed in such a fitness matrix. For example, one might observe a situation in which  $w$  is as an absolute, meaning that all focal individuals rank a potential mate the same way, as predicted by many theories of sexual selection (Andersson, 1994). Alternatively,  $w$  might often differ from one focal individual to another, as we think likely, and be an interaction effect and self-referential, meaning that each focal individual will not rank specific potential mates in the

same way. Such self-referential mate preferences occur in mice and other organisms (Ryan and Altmann, 2001; Ryan and Lacy, 2003). The entries in the fitness matrix have some statistical distribution, which we call the  $w$  distribution.

In the SPT, we assume the  $w$  distributions are beta distributions. The beta distribution is convenient because a beta random variate takes values from 0 to 1, as fitness does, and a beta distribution can assume a very large diversity of shapes depending on its 2 parameters, nu ( $\nu$ ) and omega ( $\omega$ ), from flat to strongly unimodal, left or right skewed, and even bimodal. We illustrate several possible fitness distributions in the analyses including beta (1, 1), which gives a uniform probability density from 0 to 1; beta (8, 3), which is skewed to high values; beta (3, 8), which is skewed to low values; and beta (5, 5), which has a strong central tendency. Note that although we use a beta probability density function in the SPT, there is no necessity for the  $w$  distribution to be beta for the SPT to be valid.

### THE SWITCH POINT THEOREM

The SPT arises from a Markov chain state transition model. The SPT is a generalization of an earlier model (Hubbell and Johnson, 1987; Gowaty and Hubbell, 2005) in which focal individuals made mating decisions when potential mates occurred in only 2 qualities. In the current model, focal individuals make mating decisions when potential mates may occur in up to  $n$  qualities, where  $n$  is the number of potential mates in the population, so that there is a state for mating each potential mate. In Markov state transition models, individuals move from one state to another with some probability. The model is an absorbing Markov chain, so individuals continue to move through states until death (a terminal state individuals cannot leave). The solution to the model is a theorem that specifies the mean and the variance of the number of times the individual enters each state. The solution to the SPT (below) is  $f^*$ , the number of potential mates a focal individual finds acceptable that maximizes relative lifetime fitness. The SPT says that focal individuals should accept all potential mates whose rank (with 1 being the highest fitness rank) is less than or equal to the rank at which average lifetime fitness would be maximized ( $f^*$ ); and reject all whose fitness rank is above  $f^*$ .

The SPT assumes that individuals encounter potential mates at random with respect to their rank, and shows that focal individuals who follow the mating decision rule to accept any potential mate  $i$  for which  $w_i > w_{f^*}$  and reject any potential mate  $j$  for which  $w_j < w_{f^*}$  will maximize their average lifetime reproductive fitness. Note that any given focal individual in this stochastic ensemble may not actually mate with all individuals having  $w_i > w_{f^*}$  in their lifetime. However, the rule that maxi-

mizes lifetime reproductive success is to find acceptable any individual encountered whose  $w$  is greater than  $w_{f^*}$ , the fitness of the potential mate at rank  $f^*$  (Fig. 11.3).

### DERIVATION OF THE SPT

The SPT proof is provided in the Appendix. Here, we describe the steps that allowed us to analytically solve for the number of potential mates that a focal individual should find acceptable to maximize the focal's average lifetime fitness.

In step 1, we constructed a series of absorbing Markov chain models for each decision rule associated with  $n$ , under specified ecological constraints affecting values of  $e$ ,  $s$ ,  $l$ , and the  $w$  distribution. If  $n = 3$ , for example, there are 3 decision rules, and 3 matrices are required to deduce the rule that would maximize average lifetime fitness: (i) accept the potential mate ranked 1 and reject potential mates ranked 2 and 3; (ii) accept potential mates ranked 1 and 2 and reject the potential mate ranked 3; and (iii) accept all 3 potential mates. If  $n = 100$ , there are 100 decision rules and, without the SPT proof by induction, 100 matrices would have been required to deduce the rule that would maximize the focal individual's

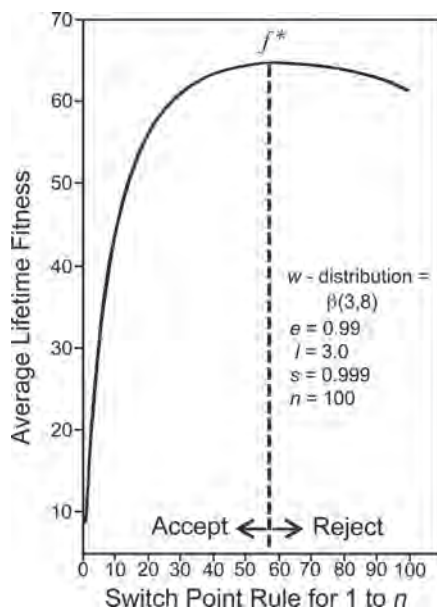

FIGURE 11.3 An example of a switch point graph.

average lifetime fitness under specified values of  $e$ ,  $s$ ,  $l$ ,  $n$ , and  $w$  distribution. The 100 rules take the following form: accept up to rank  $f^*$  (where  $f^*$  equals the highest acceptable rank), reject all from rank  $n - f^*$ . The probabilities associated with  $e$ ,  $s$ , and  $l$  determine the mean number of times the focal will pass through each cell in each matrix. It is possible to solve this algebraically without specifying numerical values of  $e$ ,  $s$ ,  $l$ , or  $n$ .

In step 2, we computed for each decision rule the mean number of times that an individual passed through the mating state with each acceptable potential mate and multiplied this mean by the fitness,  $w$ , that would be conferred if the focal actually mated with the acceptable mate. The  $w$  for each potential mate comes from the specified beta distribution.

In step 3, we summed up these products from each decision rule for a focal with specified  $e$ ,  $s$ ,  $l$ ,  $n$ , and  $w$  distribution to find  $f^*$ , the decision rule that would maximize average lifetime fitness, if the focal actually mated with each acceptable mate.

Because of social and ecological constraints (Gowaty et al., 2007), it is unlikely that focal individuals actually mate with all potential mates who are acceptable to them. Therefore, we characterize the rule as the “switch-point” at which focal individuals switch from accepting potential mates to rejecting them. That is, it is important to keep in mind that the SPT does not state that individuals actually mate up to  $f^*$ , only that they will accept any potential mate they encounter whose rank is 1 to  $f^*$ . Thus, the SPT is only a decision rule, not a statement of how many mates a focal individual will have. The SPT specifies whether to accept or reject a potential mate under chance effects from demographic and environmental stochasticity. The information embodied in the SPT is about future opportunities, and, if one actually mates with a potential mate, the opportunity costs associated with having mated with a particular potential mate. We hypothesize that individuals use this information to adjust their reproductive decisions as their ecological circumstances change. The “two body” problem that occurs when 2 individuals meet and one accepts but the other rejects cannot be studied in the current Markov chain model.

The analytical solution for a switch point set at  $f$ , for which the derivation is the SI, is:

$$W \left\{ \sum_f M | SA \right\} = \frac{es^2 \left( \sum_{i=1}^f w_i / n \right)}{(1-s) + es[1 - fs^{l+1} - g/n]} \quad (1)$$

where  $g = n - f$ .

The solution is the decision rule  $f^*$  that maximizes Eq. 1. Note that  $e$ ,  $s$ ,  $l$ ,  $n$ , and the  $w$  distribution could be functions of 1 or more of the other parameters. There is nothing in the theorem that precludes such functional interactions between the parameters. We have presented the version without interaction for heuristic simplicity.



The SPT allows us to predict how an individual's switch point changes with changing ecological and life-history circumstances that affect  $e$ ,  $s$ ,  $l$ ,  $n$ , and  $w$  distribution, which we present next.

## RESULTS

### Fitness Distributions Affect the Switch Points of Focal Individuals

Figs. 11.4 and 11.5 show how the switch point changes for a focal individual experiencing identical values of  $e$ ,  $s$ ,  $l$ , and  $n$ , when the  $w$  distribution varies. When the  $w$  distribution is right skewed, the fitness conferred at  $f^*$  is on average higher than when the  $w$  distribution is left skewed; and the fraction of acceptable mates is greater when  $w$  distributions are strongly right skewed with many potential mates conferring high fitness.

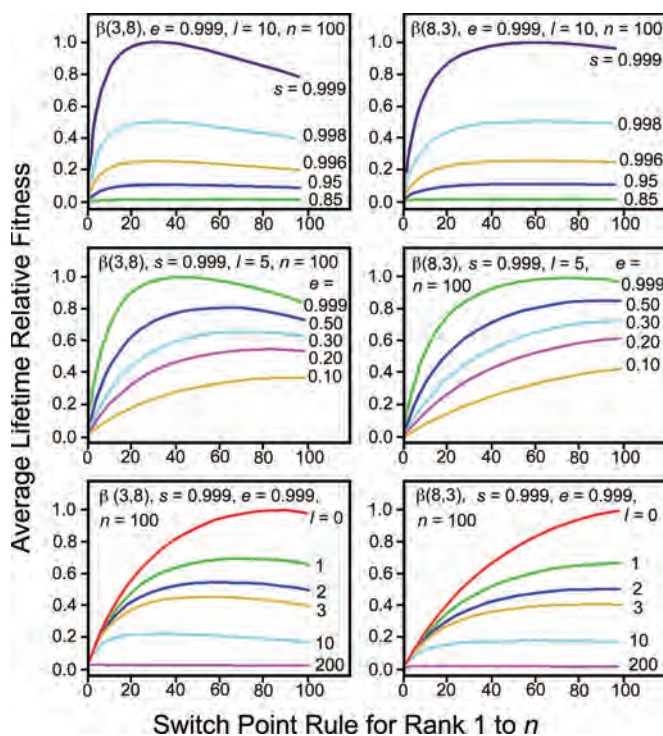

FIGURE 11.4 Comparison of the effects of different  $w$  distributions on the switch point when  $e$ ,  $s$ ,  $l$ , and  $n$  are held constant.



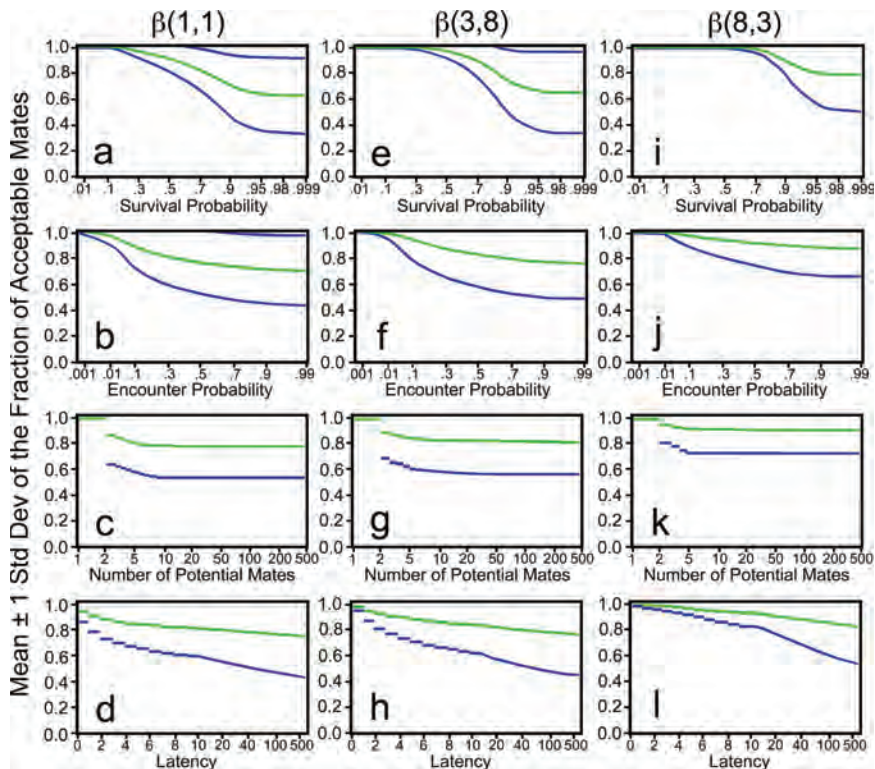

FIGURE 11.5 The means (top lines) plus or minus 1 standard deviation (bottom lines) of the fraction of acceptable mates for the marginal distributions of  $s$ ,  $e$ ,  $n$  and  $l$  for three different distributions of fitness. The left panel is for  $\beta(1,1)$ , the middle for  $\beta(3,8)$ , and the right for  $\beta(8,3)$ . The standard deviations are plotted as lines below and above the means. Because no values can be above 1 in these graphs, most show the standard deviation below the mean.

### Variation in Number of Potential Mates

In populations of different sizes, individuals with identical  $e$  will see different numbers of potential mates, with those in larger populations seeing more than those in small. The SPT predicts that individuals in larger populations, when holding  $e$ ,  $s$ ,  $l$ , and the  $w$  distribution constant, reject a larger fraction of potential mates than those in smaller populations (see Fig. 11.6). This is because for a given  $e$ ,  $s$ , or  $l$  a larger  $n$  allows focal individuals to sample a larger portion of the fitness distribution. Likewise, for a given  $e$ ,  $s$ , and  $l$ , individuals in smaller populations will

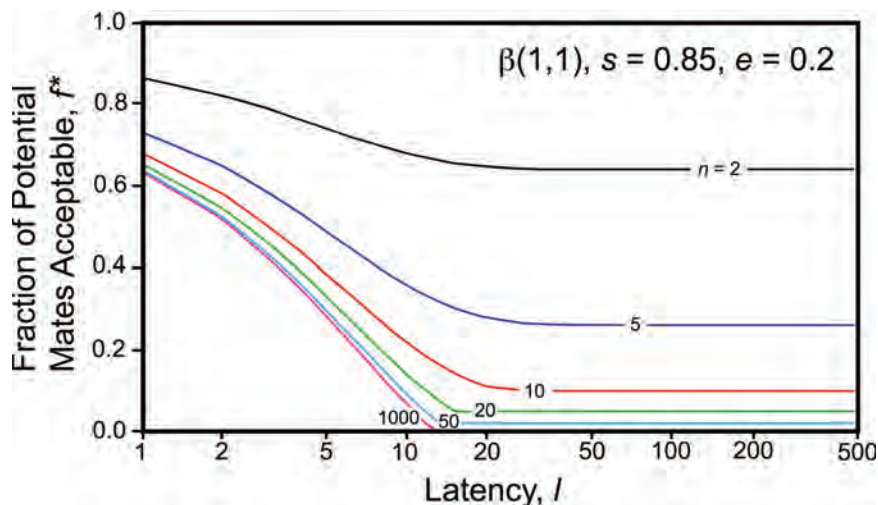

FIGURE 11.6 Effect of latency  $l$  and population size  $n$  on the fraction of acceptable mates, for a uniform  $w$ -distribution of fitnesses conferred,  $\beta(1,1)$ . Encounter probably  $e = 0.2$ ; survival probability  $s = 0.85$ .

accept more mates, because they will sample a smaller portion of the fitness distribution.

### Variation in $s$ Changes Individual Switch Points Most

A sensitivity analysis of Eq. 1 indicates that changes in fitness with respect to changes in  $s$ ,  $e$ , and  $l$  are such that  $dw/ds > dw/de > dw/dl$  (Figs. 11.7 and 11.8 and further discussion in the Appendix). Of the 3 parameters, the greatest sensitivity is to  $s$ , and the least sensitivity is to  $l$ . As  $s \rightarrow 1$ , the focal individual has a longer and longer mean life span, and the derivatives increase without bound. This is because total lifetime fitness at  $f^*$  is the sum of mean fitness conferred over all acceptable mates from rank 1 to rank  $f^*$ . Lifetime fitness at  $f^*$  is approximately 2 orders of magnitude less sensitive to changes in  $e$  than to changes in  $s$ . Lifetime fitness at  $f^*$  is least sensitive to  $l$ . The parameters also interact in their sensitivity effects on fitness. The interactions are manifest in the fact that the sensitivity of the fitness function at  $f^*$  to  $e$ ,  $s$ , and  $l$  is a function of the specific values of the other parameters. For example, increasing  $e$  increases the sensitivity of fitness to  $s$ . Similarly, increasing  $s$  strongly increases the sensitivity of fitness to  $e$ .

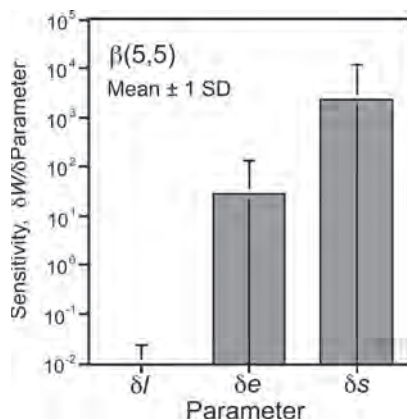

FIGURE 11.7 The mean and standard deviation in the rate of change in log average lifetime fitness relative to changes in  $s$ ,  $e$ , and  $l$  for a beta distribution with a strong central tendency.

### Time Available for Mating Affects the Switch Points of Focal Individuals

Increases in  $e$ ,  $s$ , and  $n$  decrease the time to finding potential mates, thereby increasing reproductive opportunities for focal individuals, an effect that enhances the fitness benefit of rejecting more potential mates. The SPT shows that within a sex, individuals experiencing longer latencies must make up opportunity costs relative to individuals that experienced shorter latencies.

### Changing More Than One Parameter at a Time

All else is seldom equal, and the SPT allows evaluation of the effects of variation in  $e$ ,  $s$ ,  $l$ ,  $n$ , and  $w$  distribution on  $f^*$  while varying only 1 parameter, 2 parameters (Fig. 11.9), or all 5 parameters at a time.

## DISCUSSION

### What the SPT Does and Does Not Do

The SPT makes no assumptions about underlying sex differences. We assume that individuals' time available for reproduction is finite, and we characterize variation in individual reproductive careers in terms of constraints on time available for mating. We simplify the parameters of previous theories and unify them in a general framework that provides

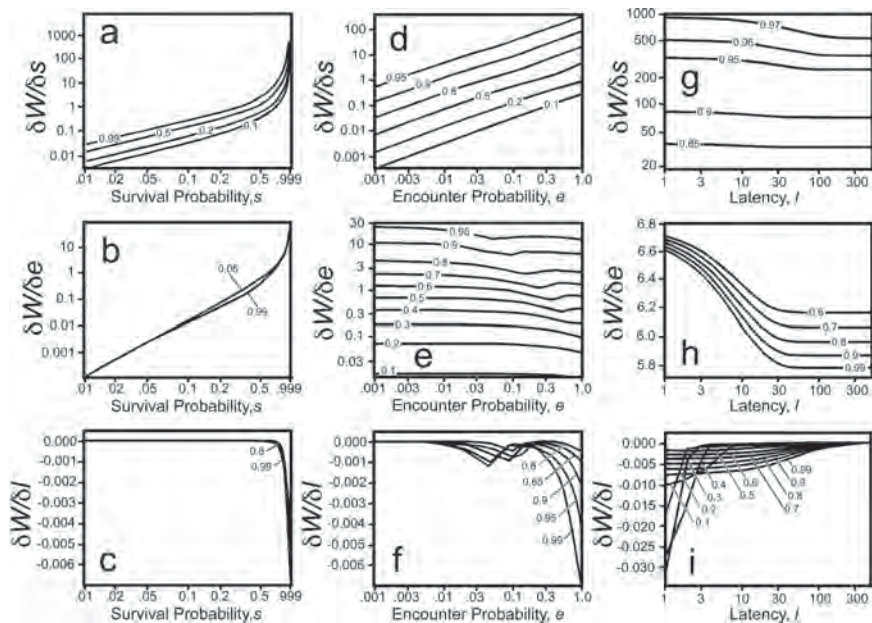

FIGURE 11.8 *Top three panels:* Sensitivity of the derivative of lifetime fitness at the switch point  $f^*$  with respect to the survival probability  $s$ , **a**, as a function of survival probability  $s$  ( $x$  axis), for several sample values of the probability of encounter  $e$  (contour lines), and for a latency  $l = 10$ ; **d**: as a function of encounter probability  $e$  ( $x$  axis), for several sample values of the probability of survival  $s$  (contour lines), and for a latency of  $l = 10$ ; **g**: as a function of latency  $l$  ( $x$  axis), for several sample values of the probability of survival  $s$  (contour lines), and an encounter probability  $e = 0.99$ . *Middle three panels.* Sensitivity of the derivative of lifetime fitness at the switch point  $f^*$  with respect to the encounter probability  $e$ , **b**, as a function of survival probability  $s$  ( $x$  axis), for several sample values of the probability of encounter  $e$  (contour lines), and for a latency  $l = 10$ ; **e**: as a function of encounter probability  $e$  ( $x$  axis), for several sample values of the probability of survival  $s$  (contour lines), and for a latency of  $l = 10$ ; **h**: as a function of latency  $l$  ( $x$  axis), for several sample values of the probability of survival  $s$  (contour lines), and an encounter probability  $e = 0.99$ . *Bottom three panels.* Sensitivity of the derivative of lifetime fitness at the switch point  $f^*$  with respect to latency  $l$ , **c**, as a function of survival probability  $s$  ( $x$  axis), for several sample values of the probability of encounter  $e$  (contour lines), and a latency  $l = 10$ ; **f**: as a function of encounter probability  $e$  ( $x$  axis), for several sample values of the probability of survival  $s$  (contour lines), and for a latency of  $l = 10$ ; **i**: as a function of latency  $l$  ( $x$  axis), for several sample values of the probability of survival  $s$  (contour lines), and an encounter probability  $e = 0.99$ .

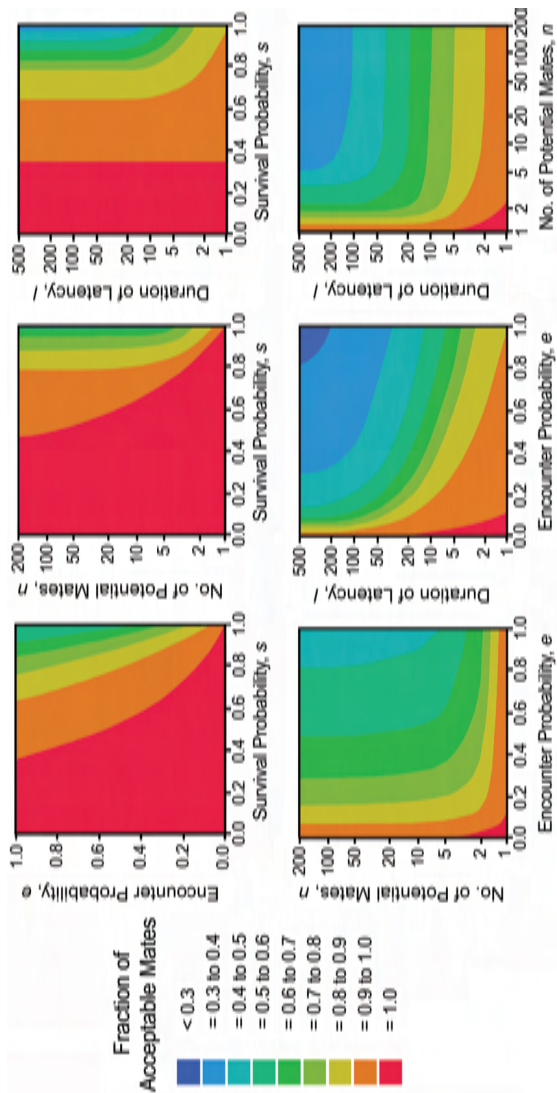

FIGURE 11.9 Contour plots of the marginal means in fraction of acceptable mates when 2 parameters vary.

a unique way to think about reproductive decisions (Fig. 11.1). We start simply with an individual and its time budget.

The SPT predicts the fraction of potential mates that a focal individual finds acceptable to mate. Each calculation of the switch point is about a single individual under specific values of ecological constraints on their time available for future reproduction. The SPT assumes that individuals assess the likely fitness that would be conferred by alternative potential mates before accepting or rejecting a potential mate. Furthermore, it ranks potential mates from highest fitness conferred (rank 1) to lowest fitness conferred (rank  $n$ , where  $n$  is the total number of alternative potential mates in the population). The SPT assumes that focal individuals encounter potential mates at random with respect to the rank the focal assigns them. The switch point is the rule (what lowest fitness rank to accept), which if obeyed, maximizes average lifetime fitness for a focal individual under specified time constraints. These constraints arise from social or ecological factors. The primary prediction of the SPT is that  $e$ ,  $s$ ,  $l$ ,  $n$ , and the  $w$  distribution jointly determine each reproductive decision a focal individual makes.

The SPT is silent about how many times a focal individual actually mates, so that the SPT is accurately characterized as a model of the decision rule that a focal individual would use, if it encounters a particular potential mate. Because the absorbing Markov chain model is stochastic, some focal individuals may be unlucky during their entire lives and never encounter a potential mate. Because the SPT provides an analytical solution, one can calculate how many focal individuals, under different time constraints, may never encounter a potential mate. So, the SPT is a model of the decision rules—accept this one, reject that one, when potential mates come in up to  $n$  qualities, if the focal individual encounters that potential mate. We hypothesize that flexible individuals should use these rules under variation in opportunities for future matings and opportunity costs of realized matings.

The SPT is silent also about the proximate mechanisms mediating preferences. The SPT may be used to inform models of trait evolution under sexual selection (see below), but the SPT by itself is not a model about the evolution of traits in preferred individuals.

With the SPT, we are able to design studies to answer whether sex differences primarily are due to past selection on females for choosy behavior and on males for profligate, competitive behavior. With it, we are able to ask by what ways, and to what effects on fitness, do ecological and social constraints influence sex roles. With it, we are able to determine if contemporary assessments of future fitness costs and benefits induce individual reproductive decisions.



### Are Both Sexes Flexible?

It is possible to empirically test the hypothesis that both sexes make flexible reproductive decisions, as the SPT predicts. Imagine an experiment in which individuals of both sexes develop in social environments in which they have controlled exposures to future potential mates. Imagine also that the population has been managed so that the  $w$  distribution for all individuals of either sex has the same shape (such as might occur in large outbred populations without sex-biased dispersal) and that  $n$  is equal. In our thought experiment, investigators move all individuals into same-sex holding arenas just before they reach sexual maturity to guarantee that mating does not occur. Then, they carry out pretouching arena [such as the one pictured in Anderson et al. (2007)] tests, to measure the fraction of potential mates acceptable to focal individuals. Note that the experiments evaluating accept/reject responses must be tightly controlled so that subjects' responses are not contaminated by intrasexual interactions among the discriminatees or sexual coercion (Kingett et al., 1981). Then investigators manipulate one variable, say,  $e$  so that in similar time periods some focal individuals encounter fewer potential mates, and in other trials the same focal individuals encounter more potential mates. This experimental procedure would vary the focal individual's encounter rate with potential mates and, if carried out, would provide a strong within-subject test of the prediction that focal individuals reject more potential mates as  $e$  increases. Importantly, the SPT predicts that if  $e, s, l, n$ , and the  $w$  distribution are the same for all tested individuals, males and females will show no significant differences in their accept/reject behavior.

### The SPT is an Alternative Hypothesis to Anisogamy Theory

The SPT is not only a predictive hypothesis of when individuals should switch their reproductive decisions. It is also a strong alternative hypothesis that can be simultaneously tested along with classic ideas about the evolution of sex roles. Anisogamy theory is silent about ecological and temporal constraints on reproductive decision making. It predicts that in species with gamete size asymmetries, such as *D. pseudoobscura* and *D. melanogaster*, the sex with the larger gametes will reject more potential mates (i.e., "be choosier") than individuals of the sex with the smaller gametes. In species such as *Drosophila hydei*, with little or no gamete size asymmetries, anisogamy theory predicts that males and females should be similarly "choosy" and similarly "indiscriminate." In contrast the SPT predicts that for both sexes in all 3 species, individuals will flexibly adjust their decisions to accept or reject particular mates as  $e, s, l, n$ , and  $w$  distribution vary. These alternatives could be tested with a crucial experiment (Platt, 1964) in which a test of a single prediction—about accepting or



rejecting potential mates—could simultaneously reject one hypothesis and provide support for the alternative.

### The SPT is an Alternative Hypothesis to Parental Investment Theory

For species in which parental investment is biased toward one sex, investigators could compete the predictions of the SPT with parental investment theory. Controlling for  $s$ ,  $e$ ,  $n$ ,  $l$ , and  $w$  distribution for experimental subjects, the predicted behavior of individuals of different sexes would be the same under the SPT. Parental investment theory, by contrast, predicts that in a species with female-biased parental investment, females would reject more and males would accept more potential mates, whereas, in a species with male-biased parental investment, females would accept more and males reject more potential mates. Another valuable test would be of virgins of both sexes, for whom  $l = 0$ , in species with female-biased parental investment and in species with male-biased parental investment. As with anisogamy theory, these alternative predictions of the SPT and parental investment theory could be tested with a crucial experiment.

### Almost Nothing Is Known Empirically About $w$ Distributions

The  $w$  distribution has only been characterized for a few populations (unpublished data), and no one to our knowledge has tested the effects of  $w$  distributions on individual reproductive decisions. For laboratory populations of flies and other organisms with short generation times and no sex biases in dispersal, it is relatively easy to estimate the shape of the  $w$  distribution, measuring fecundity, productivity, and offspring viability from a sample of random pairs breeding under enforced monogamy. An experiment that we plan to do will begin with flies cultured under inbreeding and outbreeding, which may produce  $w$  distributions with different shapes, and then to test the predictions (Fig. 11.7) for virgins ( $l = 0$ ) when  $e$ ,  $s$ , and  $n$  are held constant, using pretouching arenas.

### Implications for Experimental Studies of Mate Preferences for Fancy Male Traits

The SPT is not a hypothesis for the evolution of fancy male traits, nor does it predict the evolution of traits mediating preferences. Nevertheless, the SPT suggests that selection should favor traits that increase a focal individual's encounters with potential mates. Enhanced encounters increase reproductive opportunities, thereby reducing the opportunity costs of accepting potential mates who would confer low  $w$ . Traits, such as bizarre or easily seen plumage, loud calls, songs, or pheromones that travel over

large distances may attract more potential mates to the focal individual. In contrast to classic sexual selection ideas, however, the SPT predicts a different payout, not necessarily more mates, but in more reproductive opportunity. The SPT thus predicts that attractive focal individuals reject more potential mates than other, less attractive same-sex conspecifics, all else equal (i.e., if  $s$ ,  $l$ ,  $n$ , and  $w$  distribution are equal for attractive and unattractive focals). This prediction has not been made by any hypothesis of classic sexual selection.

The SPT suggests that many previous failures to associate fitness rewards for female mate choice for fancy traits in males might be explained by experimentally uncontrolled variation in  $e$ ,  $s$ ,  $l$ ,  $n$ , or  $w$  distribution. The SPT predicts that a focal individual exposed only to a small number of potential mates would fail to show a preference. It is also possible that investigators have exposed females to males of nearly equivalent fitness. If this were the case, adaptively flexible females would more often accept potential mates, because the differences in  $w$  between potential mates may be very small, thus reducing the opportunity costs from any particular mating. Thus, the SPT may inform previous ambiguities in mate preference studies.

### **The Ecology of Sex Roles**

Thinking about time constraints on reproductive decisions suggests a new, powerful framework for sex differences research. If individuals of different sexes have different feeding niches and/or different exposure to pathogens or predators, there are likely to be associated differences in  $e$ ,  $s$ , and  $l$  experienced by individuals of different sexes and, as the SPT predicts, differences in the typical reproductive decisions of individuals of different sexes. Or, if species in which one sex disperses, but the other does not, individuals of different sexes may see different  $w$  distributions and therefore express differences in the fraction of potential mates acceptable. Thus, it is possible that sex differences in typical reproductive decisions may have more to do with what Darwin called "habits of life," rather than with fixed sex differences. Data on how different habits of life affect  $e$ ,  $s$ ,  $l$ ,  $n$ , and  $w$  distribution of individuals are not yet systematically collected to our knowledge, and may prove interesting indeed, perhaps providing a path toward resolution of the some of the controversies that have dogged Darwin and his followers up to the current day.

### **ACKNOWLEDGMENTS**

We thank John Avise and Francisco Ayala for inviting P.A.G. to contribute to the Arthur M. Sackler Colloquium of "In the Light of Evolution

III: Two Centuries of Darwin" and J. P. Drury, Brant Faircloth, Graham Pyke, Steve Shuster, and Elliott Sober for comments on a previous version of the manuscript. This work was supported by National Science Foundation grant "Beyond Bateman," which has allowed us and our collaborators, W.W. Anderson and Y.K. Kim, to study variances in number of mates and reproductive success in 3 species of flies with different gamete size asymmetries.

## APPENDIX

In this Appendix, we derive Eq. 1 for the switch point theorem given in the paper, and we also give the equations used in the sensitivity analysis of lifetime fitness to changes in each of the model parameters. We also present some graphical results.

### Derivation of the Switch Point Theorem

The switch point theorem is an analytical solution to the question of how many potential mates a focal individual should accept or reject to maximize lifetime fitness. Consider a focal individual with a finite reproductive life span, during which the individual searches for potential mates, accepting some and rejecting others, and having to take time out from searching and mating every time it mates and reproduces, a latency period from the onset of one copulation to receptivity to remating. We can represent movement of the individual through its reproductive lifetime as a series of states, each lasting 1 time unit, such as searching but no potential mate is encountered in a given time step, searching and potential mate  $i$  is encountered, mating with potential mate  $i$ , and in time period  $j$  of a latency period of length  $l$ .

Let  $e$  be the probability that a potential mate is encountered per unit time. Let there be  $n$  potential mates, and let  $p_i$  be the probability that the encountered potential mate is individual  $i$ , where  $\sum p_i = 1$ . The relative fitness conferred on the focal individual by mating <sup>$i$</sup>  with potential mate  $i$  is a beta-distributed random variable,  $\beta(\omega, \nu)$  where  $\omega$  and  $\nu$  determine the shape of the fitness distribution. Let  $s$  be the probability of survival of the focal individual over 1 unit of time. The reproductive life span of the focal individual is the time from the onset of reproductive maturity until the individual's death. In terms of the probability of survival per unit time, the expected reproductive life span of the focal individual is  $1/(1-s)$ . Note that small changes in the probability of survival when  $s$  is near unity can cause large changes in life span. Thus, for example, survival probabilities of 0.9, 0.99, and 0.999 correspond to mean life span of 10, 100, and 1000 time units, respectively. In a Markov chain there are discrete time steps. When  $s = 0$ , the individual lives one time step and dies. When  $s = 1$ , the

ratio of  $1/1 - s$  is infinite and the reproductive life span is infinite, the individual lives forever. Thus,  $s = 1$  is not a biologically meaningful value. Values of  $s > 0$  and  $s < 1$  are the biologically meaningful values and these are the ones we use in our sensitivity analyses.

The relative fitness of potential mates influences whether the focal individual should or should not mate a particular potential mate. To illustrate the Markovian process, we analyze a case of 3 potential mates ( $n = 3$ ). In this simple case, we can distinguish 3 possible decisions. A focal individual could accept all 3 potential mates as encountered. Or an individual might accept 2 and reject 1 of the 3 potential mates. Or a focal individual might accept only 1 of 3, rejecting the other 2 potential mates.

Consider the "accept all 3" case first. The state of the focal individual can be receptive and searching for a mate, but it does not encounter a potential mate in the current time step. Label this state SA. Or the focal individual may encounter a potential mate in the current time step, in which case there are 3 possible states: encountering potential mate number 1 (state  $S_1$ ), encountering potential mate number 2 (state  $S_2$ ), or encountering potential mate number 3 (state  $S_3$ ). Because the focal individual accepts all 3, it will then mate with the potential mates as encountered (i.e., enter mating states  $M_1, M_2,$  and  $M_3,$  respectively). Let  $l$  be the length of time that the focal individual is in latency before returning to the pool of receptive individuals. Measure the duration of the latency period in the same time units used for measuring  $s$  and  $e$ . In this example, let the latency  $l = 1$ . Let the state of latency be labeled  $L_1$ , and the absorbing state of death  $D$ . The matrix of transition probabilities for the case "accept all 3" is thus:

From:	To:	$D$	$M_1$	$M_2$	$M_3$	$S_1$	$S_2$	$S_3$	$SA$	$L_1$
$H =$	$D$	1	0	0	0	0	0	0	0	0
	$M_1$	$1-s$	0	0	0	0	0	0	0	$s$
	$M_2$	$1-s$	0	0	0	0	0	0	0	$s$
	$M_3$	$1-s$	0	0	0	0	0	0	0	$s$
	$S_1$	$1-s$	$s$	0	0	0	0	0	0	0
	$S_2$	$1-s$	0	$s$	0	0	0	0	0	0
	$S_3$	$1-s$	0	0	$s$	0	0	0	0	0
	$SA$	$1-s$	0	0	0	$esp_1$	$esp_2$	$esp_3$	$(1-e)s$	0
	$L_1$	$1-s$	0	0	0	$esp_1$	$esp_2$	$esp_3$	$(1-e)s$	0

[1]

We list "to" and "from" states along the top and left side of matrix  $H$ , respectively. The column state ("to") is the next state reached after the states ("from") listed on the rows. Note that the focal individual has a probability  $1 - s$  of dying during every time step, and moving to state  $D$  (death). If death occurs, this is the terminating point of the absorbing

Markov chain. In the “accept all 3” case, whenever the focal individual encounters a potential mate, it mates, with a probability simply equal to the survival probability (because the only behavior the individual exhibits next is to mate) (e. g.,  $\Pr\{M_1 | S_1\} = \Pr\{M_2 | S_2\} = \Pr\{M_3 | S_3\} = s$ ). During search, the focal individual encounters a potential mate of quality  $i$  with probability  $\Pr\{SAS | S_j\} = esp_i$ . Since the encounter probability is  $e$ , the probability that the search fails in the current time step and the focal individual has to continue searching in the next time step is:  $\Pr\{SA | SA\} = (1 - e)s$ .

We can solve Eq. (1) for the expected number of times the focal individual passes through each state before death, by computing  $E = (I-H)^{-1}$ . Matrix  $E$  always exists and its element  $e_{ij}$  is the expected number of times over its lifetime that the focal individual is in column state  $j$  given that the focal individual starts in row state  $i$ . By convention we assume a newly mature focal individual begins the reproductive portion of its life in state  $SA$ , searching for a mate. From Eq. (1), the expected number of matings of a focal individual with potential mate  $i$  is

$$E \{M_i | SA\} = \frac{es^2 p_i}{(1-s) + es [1 - s^2 (p_1 + p_2 + p_3)]}. \tag{2}$$

Therefore, the total lifetime mating success of the focal individual over all potential mates is

$$E \{M_1 + M_2 + M_3 | SA\} = \frac{es^2 (p_1 + p_2 + p_3)}{(1-s) + es [1 - s^2 (p_1 + p_2 + p_3)]} = \frac{es^2}{(1-s) + es (1 - s^2)}. \tag{3}$$

Generalizing this expression to a latency of  $l$  time units yields a total lifetime mating success of

To:	$D$	$M_1$	$M_2$	$M_3$	$S_1$	$S_2$	$S_3$	$SA$	$L_1$	$L_2$
From:	$D$	$M_1$	$M_2$	$M_3$	$S_1$	$S_2$	$S_3$	$SA$	$L_1$	$L_2$
$H =$	1	0	0	0	0	0	0	0	0	0
	$1-s$	0	0	0	0	0	0	0	$s$	0
	$1-s$	0	0	0	0	0	0	0	$s$	0
	$1-s$	0	0	0	0	0	0	0	$s$	0
	$1-s$	$s$	0	0	0	0	0	0	0	0
	$1-s$	0	$s$	0	0	0	0	0	0	0
	$1-s$	0	0	$s$	0	0	0	0	0	0
	$1-s$	0	0	0	$esp_1$	$esp_2$	$esp_3$	$(1-e)s$	0	0
	$1-s$	0	0	0	0	0	0	0	0	$s$
	$1-s$	0	0	0	$esp_1$	$esp_2$	$esp_3$	$(1-e)s$	0	0

The total lifetime mating success for a latency of two time units ( $l = 2$ ) is therefore

$$E \{M_1 + M_2 + M_3 | SA\} = \frac{es^2(p + p_2 + p_{31})}{(1-s) + es[1-s^3(p_1 + p_2 + p_3)]} = \frac{es^2}{(1-s) + es(1-s^3)}. \quad [5]$$

Generalizing this expression to a latency of  $l$  time units yields a total lifetime mating success of

$$E \{M_1 + M_2 + M_3 | SA\} = \frac{es^2(p + p_2 + p_{31})}{(1-s) + es[1-s^{l+1}(p_1 + p_2 + p_3)]} = \frac{es^2}{(1-s) + es(1-s^{l+1})}. \quad [6]$$

Now, consider when a focal individual mates with 2 of the 3 potential mates but not the third. In this case, state  $M_3$  no longer exists (although potential mate 3 is still encountered, which is state  $S_3$ ), so the transition matrix becomes:

To:	$D$	$M_1$	$M_2$	$S_1$	$S_2$	$S_3$	$SA$	$L_1$	
From:									
$H =$	$D$	1	0	0	0	0	0	0	0
	$M_1$	1-s	0	0	0	0	0	0	s
	$M_2$	1-s	0	0	0	0	0	0	s
	$S_1$	1-s	s	0	0	0	0	0	0
	$S_2$	1-s	0	s	0	0	0	0	0
	$S_3$	1-s	0	0	$esp_1$	$esp_2$	$esp_3$	$(1-e)s$	0
	$SA$	1-s	0	0	$esp_1$	$esp_2$	$esp_3$	$(1-e)s$	0
	$L_1$	1-s	0	0	$esp_1$	$esp_2$	$esp_3$	$(1-e)s$	0

[7]

Note that when the focal individual encounters potential mate 1 ( $S_1$ ) it moves to the state of mating with individual 1 ( $M_1$ ) and likewise when the focal individual encounters potential mate 2 ( $S_2$ ), it moves to mating that individual ( $M_2$ ). However, note that when potential mate 3 is encountered, the focal individual does not mate with it (there is no state  $M_3$ ), but it resumes search, enters states  $S_1$ ,  $S_2$ ,  $S_3$ , and  $SA$ , depending on what the search results are.

For a focal individual with a latency of 1, this decision rule yields a total lifetime mating success of:

$$E \{M_1 + M_2 | SA\} = \frac{es^2(p + p_2)}{(1-s) + es[1-s^2(p_1 + p_2) - p_3]} \quad [8]$$

and for a focal individual with a latency of  $l$  time units:

$$E \{M_1 + M_2 | SA\} = \frac{es^2(p + p_{21})}{(1-s) + es[1 - s^{l+1}(p_1 + p_2) - p_3]}. \quad [9]$$

In the case in which the focal individual mates with only 1 of the 3 possible potential mates, 1 but not 2 or 3, the transition matrix is

To:	$D$	$M_1$	$S_1$	$S_2$	$S_3$	$SA$	$L_l$	
From								

$$\mathbf{H} = \begin{matrix}
 D \\
 M_1 \\
 S_1 \\
 S_2 \\
 S_3 \\
 SA \\
 L_l
 \end{matrix} \begin{bmatrix}
 1 & 0 & 0 & 0 & 0 & 0 & 0 & 0 \\
 1-s & 0 & 0 & 0 & 0 & 0 & 0 & s \\
 1-s & s & 0 & 0 & 0 & 0 & 0 & 0 \\
 1-s & 0 & esp_1 & esp_2 & esp_3 & (1-e)s & 0 & 0 \\
 1-s & 0 & esp_1 & esp_2 & esp_3 & (1-e)s & 0 & 0 \\
 1-s & 0 & esp_1 & esp_2 & esp_3 & (1-e)s & 0 & 0 \\
 1-s & 0 & esp_1 & esp_2 & esp_3 & (1-e)s & 0 & 0
 \end{bmatrix} \quad [10]$$

Focal individuals with a latency,  $l = 1$ , with this decision rule gain a lifetime mating success of

$$E \{M_1 | SA\} = \frac{es^2(p_1)}{(1-s) + es[1 - s^2 p_1 - (p_2 + p_3)]}. \quad [11]$$

For the generalization of this decision rule to focal individuals with latency of  $l$  time units, expected lifetime mating success becomes

$$E \{M_1 | SA\} = \frac{es^2(p_1)}{(1-s) + es[1 - s^{l+1} p_1 - (p_2 + p_3)]}. \quad [12]$$

One can find by induction the general solution for the lifetime mating success of a decision rule in which the focal individual mates with  $f$  individuals out of a total of  $n$  total potential mates, where  $f \leq n$ . The solution is

$$E \left\{ \sum_f M | SA \right\} = \frac{es^2 \left( \sum_{i=1}^f p_i \right)}{(1-s) + es \left[ 1 - s^{l+1} \left( \sum_{i=1}^f p_i \right) - \sum_{i=f+1}^n p_i \right]}. \quad [13]$$



We are now in a position to evaluate the cumulative lifetime fitness for focal individuals exhibiting this decision rule. If the fitness of the focal individual of mating with potential mate  $i$  is  $w_i$ , then the focal individual's cumulative lifetime fitness is simply its mating success with potential mate  $i$  multiplied by  $w_i$ , summed over all of the focal individuals' mates:

$$W \left\{ \sum_f M|SA \right\} = \frac{es^2 \left( \sum_{i=1}^f p_i w_i \right)}{(1-s) + es \left[ 1 - s^{l+1} \left( \sum_{i=1}^f p_i \right) - \sum_{i=f+1}^n p_i \right]}. \quad [14]$$

The expression in Eq. (14) is the analytically derived mean of cumulative lifetime fitness computed over an stochastic ensemble of focal individuals, each of whom assesses the fitness distribution of potential mates in the same way, experiences the same values of  $e$ ,  $s$ , and  $l$ , and has the same mating decision rule. Eq. (14) takes on different values as we change  $f$ , the number of acceptable mates, out of a total of  $n$  potential mates. The objective is to find the value of  $f$ , call it  $f^*$ , which maximizes Eq. (14);  $f^*$  is the switch point. Given values of  $e$ ,  $s$ , and  $l$  and a distribution of fitnesses  $w_i$  across a set of  $n$  potential mates, the recipe for maximizing Eq. (14) is as follows: (1) Rank the  $n$  potential mates in fitness conferred on the focal individual from high to low. (2) Next, compute the average focal individual's expected cumulative lifetime reproductive fitness for these parameters and fitness distribution, assuming that the focal individual mates with only one potential mate, the highest fitness-conferring individual, and rejects the remaining  $n - 1$  individuals. This corresponds to  $f = 1$  in the Eq (14). (3) Now, repeat step 2, but assume that the focal individual mates with the top two potential mates, so that  $f = 2$  in Eq. (14). (4) Continue this process, adding 1 more mate at a time and computing the expression in Eq. (14) until  $f = n$ . (5). Plot the curve of reproductive fitness as a function of  $f$ , the number of ranked potential mates that are accepted, and find that value of  $f$ ,  $f^*$ , that produces the highest average reproductive fitness. This is the switch point, and  $f^*/n$  is the fraction of acceptable mates that maximizes the cumulative lifetime fitness.

If the potential mates are equally likely to be encountered, then we can further simplify Eq. (14)

$$W \left\{ \sum_f M|SA \right\} = \frac{es^2 \left( \sum_{i=1}^f w_i \right)}{(1-s) + es \left[ 1 - fs^{l+1} - g \right]}, \text{ where } g = n-f. \quad [15]$$

This is the expression given by Eq. (1) in the text of the paper.

### Sensitivity Analysis

We studied the sensitivity of the fitness function to changes in the encounter probability  $e$ , the survival probability  $s$ , and the latency  $l$ , by computing the derivatives of Eq. (14) with respect to each of the parameters. We evaluated the derivatives at the switch point,  $f^*$ . The sensitivity of the fitness function at  $f^*$  to changes in encounter probability  $e$  is given by

$$dW \left\{ \sum_{f^*} M|SA \right\} / de = \frac{s^2 \sum_{i=1}^{f^*} p_i w_i}{(1-s) + es(1-s^{l+1}P - Q)} - \frac{(1-s^{l+1}P - Q) es^3 \sum_{i=1}^{f^*} p_i w_i}{[(1-s) + es(1-s^{l+1}P - Q)]^2}, \quad [16]$$

where  $P = \sum_{i=1}^{f^*} p_i$  and  $Q = \sum_{i=f^*+1}^n p_i$ .

The sensitivity of the fitness function at  $f^*$  to changes in the survival probability  $s$  is

$$dW \left\{ \sum_{f^*} M|SA \right\} / ds = \frac{2es \sum_{i=1}^{f^*} p_i w_i}{(1-s) + es(1-s^{l+1}P - Q)} + \frac{es^2 [(1-e) + (2+l)es^l P + eQ] \sum_{i=1}^{f^*} p_i w_i}{[(1-s) + es(1-s^{l+1}P - Q)]^2}. \quad [17]$$

Finally, the sensitivity of the fitness function at  $f^*$  to changes in latency  $l$  is

$$dW \left\{ \sum_{f^*} M|SA \right\} / dl = \frac{e^2 s^{l+4} \ln(s) P \sum_{i=1}^{f^*} p_i w_i}{(1-s) + es(1-s^{l+1}P - Q)}. \quad [18]$$

### Results

Fig. 11.6 shows the effect of varying latency  $l$  and the population size of acceptable mates  $n$  on the fraction of mates acceptable, for a  $w$  distribution of  $\beta(1,1)$ . The fraction of acceptable mates declines with population

size, and with increasing latency, but the effect of latency is minimal for long latency times. Fig. 11.5 shows how the mean fraction of acceptable mates and its standard deviation change as a function of the  $w$  distribution and of each of the model parameters. The left-most column of graphs ( $a-d$ ) are for a uniform  $w$  distribution of  $\beta(1,1)$ . The middle column of graphs ( $e-h$ ) are for a  $w$  distribution,  $\beta(3,8)$ , skewed to low fitness values, and the right-most columns of graphs ( $i-l$ ) are for a  $w$  distribution,  $\beta(8,3)$ , skewed to high fitness values. Note that a higher fraction of potential mates are acceptable when the fitness distribution is skewed high than when it is skewed low or is uniform. Fig. 11.8 presents a graphical representation of the results of the sensitivity analysis. The top row of panels ( $a, d, g$ ) represents how the sensitivity of lifetime fitness to survival rate  $s$  is affected by variation in  $s, e,$  and  $l$ . The middle row of panels ( $b, e, h$ ) show how the sensitivity of lifetime fitness to encounter rate  $e$  is affected by variation in  $s, e,$  and  $l$ . The bottom row of panels ( $c, f, i$ ) show how the sensitivity of lifetime fitness to latency  $l$  is affected by variation in  $s, e,$  and  $l$ . Note that in general, the sensitivity of lifetime fitness to survival is much greater than sensitivity to encounter rate, which in turn is much greater than the sensitivity to latency. Note also that the parameters interact in complex nonlinear ways in their impact on the sensitivity.



## 12

# Postcopulatory Sexual Selection: Darwin's Omission and Its Consequences

---

WILLIAM G. EBERHARD

In one of his few major oversights, Darwin failed to appreciate that male-male competition and sexual selection can continue even after copulation has begun. The postcopulatory equivalents of both direct male-male battles (sperm competition) and female choice (cryptic female choice) occur within the female's body. Recognition of this hidden, but intense, sexual competition provides new insights into a variety of fields. These include the hyperdiverse and paradoxically elaborate morphology of both sperm and male genitalia, the equally puzzling and elaborate morphology of nongenitalic male structures that are specialized to grasp and stimulate females, powerful manipulative effects of substances in male semen on female reproductive physiology, paradoxical male courtship behavior that occurs after copulation has already begun, variability in parental investments, and the puzzlingly complex and diverse interactions between sperm and female products that surround animal eggs and between male gametophytes and female tissues in flowering plants. Many bizarre traits are involved, including male genitalia that are designed to explode or fall apart during copulation leaving behind parts within the female, male genitalia that "sing" during copulation, potent seminal products that invade the female's body cavity and her nervous system to influence her behavior, and a virtual Kama Sutra of courtship behavior performed after rather

---

Smithsonian Tropical Research Institute and Escuela de Biología, Universidad de Costa Rica, San José, Costa Rica.

than before genital coupling, including male-female dialogues during copulation.

**P**icture a pile of freshly cut weeds at the sunny edge of a tropical forest. Metallic green flies dart and circle over it, chasing one another in short dashes. Your eye is caught when a chase ends as one fly grasps another in midair and the pair immediately lands on the pile of weeds. Their genitalia are already coupled, and the male immediately turns to face away from the female. After a few seconds, paradoxically (because he is already securely attached), he begins to court, rhythmically waving his colorful hind legs and tapping the female's abdomen. The courtship continues for a few minutes as the pair remains coupled, and then the flies separate. The female walks down into the pile where she lays eggs (her larvae will feed on the rotting vegetation), while the male rejoins the frenetic chases above the pile.

Why would a male fly wait to court a female until after he has already achieved his evolutionary objective of copulating with her? The answer (recently worked out by a Brazilian graduate student, F. Barbosa, personal communication) had to wait for >100 years after Darwin's great book on sexual selection (Darwin, 1871/1959) that explained so many other aspects of male-female sexual interactions.

### THE PUZZLE OF DARWIN'S OMISSIONS

Darwin was uncannily on target about most of the topics he discussed, and he seldom missed general phenomena that had important consequences for his ideas. Strangely, however, there is a major missing piece in Darwin's thinking on sexual selection. He discussed at length how competition between males for sexual access to females leads to sexual selection (Darwin, 1871/1959), but failed to realize that sexual selection [sperm competition and cryptic female choice (CFC) in Table 12.1] can also occur even after males have initiated copulation. Simply stated, Darwin missed the fact that not all copulations result in insemination, and that not all inseminations result in fertilization of the female's eggs. Any male ability to improve the chances that his copulations will lead to fertilizations of eggs will give him an advantage in competition with other males who mate with the same female.

It was not until 99 years after Darwin's 1871 book that Geoff Parker (1970) awakened evolutionary biologists to the evolutionary importance of processes that occur after the male has already achieved genital coupling (conventionally called, somewhat imprecisely, postcopulatory pro-

TABLE 12.1 Different Types of Competition Among Males for Access to Conspecific Females and Their Gametes (Types of Sexual Selection) That Occur Before and After Copulation

Time	Intrasexual Selection	Intersexual Selection
Before copulation	Male-male battles	Classic female choice
During and after copulation	Sperm competition	Cryptic female choice

cesses; they include processes during copulation). Parker saw that they, too, like the precopulatory events emphasized by Darwin, can result in sexual selection on a male by affecting his success in competition with other males. There are postcopulatory equivalents inside the female of Darwin's precopulatory male-male struggles and female choice (Table 12.1). If a female copulates with >1 male, and if one of these males is better than others at, for instance, removing sperm stored from previous males (Waage, 1979), this male will stand to sire more offspring and win out over the others. Appreciation that female biases can also have postcopulatory effects on male reproductive success, and thus exercise the postcopulatory equivalent of female choice among males, lagged behind (Thornhill, 1983; Eberhard, 1985), and was not presented as a general theory, however, until 1996 (Eberhard, 1996). After an initial period of negative reactions (Birkhead and Møller, 1997; Parker, 1997; Birkhead, 1998), CFC is now routinely included as a possible factor in studies of possible postcopulatory sexual selection (Simmons, 2001; Arnqvist and Rowe, 2003; Hosken and Stockley, 2004). Because important postcopulatory events are played out inside the female's body, where she is largely in control of what happens, female choice seems a priori more likely to be important after copulation than it is leading up to copulation. There is a surprisingly long list of female-controlled processes that must be executed if insertion of the male's genitalia into the female is to result in siring her offspring (Table 12.2). Other things being equal, any male better able to induce the female to carry out one of these processes more completely than she does when mating with other males stands to produce more offspring.

### CONSEQUENCES OF THE HISTORICAL ISOLATION OF RELATED FIELDS FROM EVOLUTIONARY BIOLOGY

Whatever the reasons for Darwin's original oversights, they correlate with a general failure by subsequent workers to link sexual selection to a variety of postcopulatory phenomena. Recently this isolation has been eroded. In this chapter I will explore several newly established connections with previously isolated fields and their consequences for evolutionary ideas. The phenomena I will discuss include the often elaborate structure



TABLE 12.2 Female-Controlled Processes That Occur in Different Species and Are Known to Increase the Chances That a Given Male Will Sire Her Offspring

- 
1. Permit penetration deep enough to allow sperm deposition at the optimum site for storage or fertilization
  2. Refrain from terminating copulation prematurely
  3. Transport sperm to storage and fertilization sites
  4. Modify internal conditions (e.g., pH) inside reproductive tract to reduce defenses against microbial invasion that kill sperm
  5. Nourish or otherwise maintain sperm alive in storage site
  6. Refrain from discarding sperm from current male
  7. Discard sperm from previous male
  8. Move sperm from previous male to site where current male can remove them
  9. Accede to male manipulations that result in discharge of his spermatophore
  10. Grow more immature eggs to maturity (vitellogenesis)
  11. Ovulate
  12. Produce eggs with more nutrients
  13. Oviposit all available mature eggs
  14. Prepare uterus for implantation
  15. Refrain from removing copulatory plug produced by male
  16. Aid male in the formation of copulatory plug
  17. Modify morphology following first copulation to make subsequent insemination more difficult
  18. Refrain from removing spermatophore before all sperm are transferred
  19. Abort previously formed zygotes
  20. Refrain from aborting zygotes from current sperm
  21. Allow germination of pollen grains
  22. Promote growth of pollen tubes and guide them toward ova
  23. Refrain from mating with other males in the future
  24. Invest more in caring for offspring
- 

of male genitalia; the diverse morphology of sperm and the chemical constitution of male seminal products and their striking physiological effects on female reproductive processes; the common, but paradoxical, male courtship behavior that occurs after copulation has already begun; and the otherwise puzzling complexity and diversity of interactions between sperm and eggs and between the pollen tube and the female tissue through which it grows in plants.

## MECHANISMS OF POSTCOPULATORY SEXUAL SELECTION

### Direct Male-Male Interactions (Sperm Competition)

Sperm competition was originally defined in a general sense, as “competition between the sperm from 2 or more males for the fertilization of a given set of ova” (Parker, 1970, p. 4). A more restrictive definition is now used, to distinguish male from female effects on this competition (Table 12.1). Sperm competition is presently restricted to cases in which there is a

direct action by 1 male or his semen on the sperm of another male. Sperm competition was quickly accepted as a potentially important evolutionary force after Parker's pioneering article (Parker, 1970). In fact, some studies have claimed to demonstrate sperm competition without having eliminated alternative possibilities such as female choice (below).

Males use several mechanisms in sperm competition, and sperm competition explains a number of hitherto paradoxical observations. A male can dilute the sperm from previous males with his own voluminous ejaculate, engaging in what is called "raffle competition" (Parker, 1997). This tactic is apparently common in vertebrates, where testes size (and thus ejaculate size) correlates with the degree of female polyandry (Harcourt et al., 1981; Birkhead and Møller, 1992). Behavioral traits of males to prevail in sperm competition include transferring larger ejaculates when more males are in the vicinity (Gage and Baker, 1991) and performing "retaliatory" copulations when the female with which a male is paired copulates with another male (Birkhead and Møller, 1992). Another tactic involves the behavior and morphology of the sperm themselves, with the sperm from a male linking together so that the group can swim more vigorously (Pizzari and Foster, 2008). The male can also use his own genitalia or a spermatophore to physically displace sperm from previous males that are present in the female (Gack and Peschke, 1994; Simmons, 2001). Waage's classic study of sperm removal in a damselfly (Waage, 1979) showed that during the first portion of copulation the female's sperm storage organs (spermathecae) gradually become depleted of sperm as the male moves his genitalia in and out, snagging sperm on thick arrays of spines on his genitalia. Then after the spermathecae are nearly empty, the male ejaculates and fills them again with his own sperm.

The male can also increase his chances of winning out in sperm competition by using defensive strategies, such as reducing the danger of competition for his own sperm by guarding the female from copulation with additional males (by staying with her after copulation, physically plugging her genitalia, or inducing nonreceptive behavior). Several other competitive mechanisms have been proposed, including "kamikaze" sperm that kill or disable the sperm of other males (Baker and Bellis, 1988), and douche-like flushing out stored sperm from the female with a jet of water (Eberhard, 1985), but they have not been convincingly documented [see Whitney et al. (2004) for rejection of the douche hypothesis in a shark].

### **Female Effects on Male-Male Competition [CFC and Sexually Antagonistic Coevolution (SAC)]**

There are many different ways in which a female can bias the likelihood that 1 male rather than another with which she has mated will father

her offspring (Table 12.2). If such a female bias is associated with some particular male trait, then it can result in selection favoring that trait. This phenomenon has been called CFC. The word “cryptic” emphasizes that the female selection is invisible with respect to Darwinian criteria for reproductive success, which supposed that all copulations are equally effective in producing offspring. Male traits associated with such biases include morphology, behavior, and physiology (e.g., differences in ejaculate composition). The likelihood that natural selection will favor female mechanisms to trigger her reproductive processes on the basis of whether she has mated makes the subsequent evolution of sexual selection via female-imposed biases particularly likely to occur. Natural selection on females will favor repression of reproductive responses such as oviposition, sperm transport, resistance to further mating, etc. (Table 12.2) while she is a virgin and will also favor female mechanisms that trigger such processes by using stimuli associated with mating. These triggering mechanisms favored by natural selection produce results that are favorable to the male’s reproductive interests (e.g., induce ovulation, sperm transport, inhibit further mating). Thus, any male ability to emphasize such stimuli and thereby to elicit more a complete female response would be favored in competition with other males that might copulate with the same female. Sexual selection is also expected to mold female responsiveness. A female that makes it somewhat more difficult for the male to elicit these responses can be favored, because her offspring will be fathered by males who are better than average in eliciting these responses.

A more recent alternative hypothesis involving postcopulatory biases in sperm use that are imposed by females proposes that males and females are in a coevolutionary arms race over control of reproductive events (Holland and Rice, 1998; Arnqvist and Rowe, 2003) is SAC. Male adaptations to promote the use of their own sperm rather than that of other males are thought to damage the female’s reproductive interests by reducing her direct reproductive output. For instance, a male ability to induce the female to lay more of her eggs soon after copulation (and before mating with another male) may result in some eggs being laid at suboptimal times or sites. A female evolutionary response that makes it more difficult for the male to induce a damaging response of this sort would be favored by natural selection on the female and would incidentally result in further sexual selection on males to improve their abilities to induce the response.

There are 2 extreme versions of SAC. One emphasizes physical coercion by the male (Alexander et al., 1997; Arnqvist and Rowe, 2002a,b), and has been tested by checking for physical or chemical coercion of the female by the male and coevolution of potential resistance mechanisms in the female. Several types of indirect data do not fit its predictions, at least with respect to genital evolution (Eberhard, in press). A second version,

which emphasizes male stimuli that act as sensory traps (Arnqvist, 2006), is less easily evaluated: the male produces a stimulus that elicits a particular female response because previous natural selection on the female in another context favored such a response to the same (or a similar) stimulus. An example would be the possible disadvantage just mentioned to the female from responding to male stimuli eliciting oviposition, when such stimuli mimic the triggering stimuli that females originally evolved to use under natural selection.

It is not clear whether the sensory trap version is likely to be a general phenomenon, because it depends on the female not being able to evolve an effective defense against this damaging manipulation by the male (Arnqvist, 2006). But a simple female defense, such as modifying her tendency to respond to the stimulus depending on the context in which she receives it, would free her from this "trap." Even in the absence of such decoupling, if the female responds to the evolution of a new male trap stimulus by simply raising her response threshold to this stimulus, she will gain from both a decrease in the maladaptiveness of her response in the sexual context and an increase in the fitness because of the expected increase in the quality of her sons (as in the CFC argument). Still another simple female defense would be to avoid multiple mating altogether.

Whether CFC or SAC has been more important in the evolution of female postcopulatory influence on sperm use is currently hotly debated. The 2 theories are difficult to distinguish in practice and are not mutually exclusive; both types of selection could act sequentially or even simultaneously in a given trait (Arnqvist and Rowe, 2003; Cordero and Eberhard, 2005). The difference between the theories revolves around the benefits that females are thought to derive from influencing sperm use patterns: the payoff from increased offspring quality from biasing paternity (an indirect benefit) is thought to be larger under the CFC hypothesis; that from increased numbers of the female's own offspring from avoiding male manipulations (a direct benefit) is thought to be larger under SAC. The heat in the debate is partly because of the lack of data that convincingly address directly the question of which female benefit is larger. This unfortunate situation promises to be protracted, because it will be devilishly hard to obtain such data.

The logical, direct way to test the crucial difference between CFC and SAC theories would be to measure the direct and indirect benefits and losses that a female derives from cooperating or failing to cooperate with males. Such data have been obtained in the laboratory with respect to the effects of male seminal products on female reproductive physiology in *Drosophila melanogaster* (Chapman et al., 1995; Rice, 1996), and these results have been widely cited (Arnqvist and Rowe, 2003; Pizzari and Snook, 2003; Arnqvist, 2004). But unfortunately the gains and losses measured

under laboratory conditions may be quite different from those experienced by flies in the field (Cordero and Eberhard, 2003). For instance, even the selective significance of such a radical male effect as reducing the female's life span and thus her total reproductive output is uncertain, because it is possible that flies in the field (where they are subject to predation, parasites, bad weather, greater need for dispersal to find oviposition sites, etc.) may never live to the advanced ages they achieve in captivity; the reproductive output of wild females is almost certainly unlikely to suffer as much from reduced longevity as that of females in the laboratory. Male and female traits evolved in the field, so laboratory data cannot be expected to be reliable indicators of the balance in gains and losses. An attempt to get around this problem used a strain of *D. melanogaster* that had been in captivity for many generations (Orteiza et al., 2005). But (not surprisingly) this laboratory strain still has traits (probably hangovers from selection in the field) that are not favored in captivity (Eberhard, in press). In fact, *D. melanogaster* is an especially poor species for discovering the selective significance of such traits, because its natural habitat is not even known for certain (Smith, 1997).

I believe that the best data available to judge the relative importance of CFC and SAC are indirect tests that involve the morphology of genitalia and nongenital male contact organs, and I will discuss them in the section on genitalia.

## EVOLUTIONARY CONSEQUENCES OF POSTCOPULATORY SELECTION

### Genitalia (and General Lessons)

Genitalia offer a large and taxonomically diverse set of data that can be used to illustrate arguments regarding postcopulatory sexual selection in general. Male genitalia, like peacock trains and other sexually selected traits, are often very complex in form and frequently differ sharply even among closely related species. Taxonomists working on many different animal groups with internal insemination have found that the shapes of male genitalia are often more useful in distinguishing closely related species than the forms of most other body parts. This is true for many groups, including flatworms, nematodes, annelids, insects, spiders, mites, fish with internal insemination, snakes, bats, primates, and rodents (Eberhard, 1985). In other words, the male genitalia of many animals tend to evolve divergent forms especially rapidly when compared with other structures. Many male genitalia also have complex and baroque designs that seem paradoxical in view of the relatively simple basic task of transferring sperm to the female. The widespread use of male genitalia in taxonomy

means that there is more known about the genital morphology of many (perhaps most) animal species than about any other aspect of their morphology, behavior, or physiology.

This immense taxonomic literature grew in absence of insights linking genital morphology with sexual selection. Probably the earliest and historically most widely cited hypothesis to explain genital divergence is the "lock and key" hypothesis proposed by Dufour in 1844 (Shapiro and Porter, 1989), which proposed that natural selection favored differences in genitalia to prevent cross-specific fertilizations; only the genital key of a conspecific male could fit into the lock of the female's genitalia. This idea explained both the baroque aspects of male genitalia and their rapid evolutionary divergence. And it fit well with ideas about speciation in the modern synthesis that emphasized the evolution of prezygotic reproductive isolation. Gradually, however, accumulating data contradicted several important predictions.

Most importantly, female locks are simply absent in many groups in which males have species-specific genitalia [summaries in Eberhard (1985), Shapiro and Porter (1989), and Eberhard (2004b)]. In addition, the hypothesis predicts that genitalia should not diverge rapidly in groups in which species have evolved in strict isolation from all close relatives and in which mistaken cross-specific matings have thus been impossible throughout the history of the species. Such "isolated" groups include species endemic to isolated islands or caves and parasitic species isolated from all relatives because they live in different species of hosts. Again, the data clearly fail to show this trend (Eberhard, 1985). In fact, in some groups of such isolated species, the male genitalia are the most important of all morphological traits for distinguishing species (Poinar and Herre, 1991). Still another failed lock and key prediction was that there should be geographic "character displacement" in genital form. In regions in which a species coexisted with other closely related species (and females were thus subject to the danger of cross-specific mating), the differences in both the female locks and the male keys of the 2 species were predicted to be greater than in regions in which no other closely related species were present. Nevertheless, character displacement seems to be generally absent in genital morphology (Eberhard, 1985; Shapiro and Porter, 1989; Ware and Opell, 1989). Finally, lock-and-key theory does not explain the positive correlation found in some groups between the degree of interspecific genital divergence and the frequency with which females of different species mate with different males (Eberhard, 1985; Roig-Alsina, 1993; Arnqvist, 1998; Dixson, 1998).

As it gradually became clear that the species isolation hypothesis does not work as a general explanation, Mayr (1963) proposed another alternative: that the diversity of genitalia was an incidental (pleiotropic)



by-product of selection on alleles that affected other, ecologically important traits. These alleles were proposed to have pleiotropic and selectively neutral effects on the genitalia. Aside from the problem of hypothesizing neutral variation in such selectively crucial structures as those responsible for transferring gametes, this pleiotropism theory was incapable of explaining a large array of facts (Eberhard, 1985). Why do the genitalia of groups with external fertilization, in which males do not contact females directly, never show these incidental effects? Why are genitalia, rather than other body parts, so consistently subject to such pleiotropic effects, and only in the males? Why in groups in which males use organs other than their primary genitalia to introduce sperm into the female do the primary genitalia never show the incidental effects, whereas the other intromittent structures in these groups (“secondary genitalia”) consistently do display them? The pleiotropy hypothesis has been largely abandoned in recent discussions.

Both the CFC and the SAC hypotheses attempt to explain the frequency of rapid divergent evolution of male genitalia, and the abundant data on genitalia permit strong tests. One test contrasts genital evolution in groups in which SAC would seem a priori much more likely to occur with that in others in which it is less likely. The prediction is for more consistent divergence in male genitalia in groups more likely to show sexual conflict between males and females. In mating systems in which males frequently encounter and attempt to mate with females that are relatively unreceptive to mating (for instance, males defend resources such as food or oviposition sites, and oblige females to mate before allowing them access to the resources), conflict seems likely; in those in which conflict is much less likely because females only encounter males when they are receptive (for instance, species in which the male can only locate the female when she is receptive enough to emit a long-distance attractant pheromone or respond to a male calling song), male-female conflict over mating seems much less likely.

An extensive review of groups of insects and spiders in which SAC should be more or less common nevertheless showed no trend toward lack of rapid divergent genital evolution (to have less distinctive male genitalia) in groups in which male-female conflict over copulation is less likely (Eberhard, 2004a). Several reanalyses of these data, in attempts to mitigate possible biases in the literature, failed to reveal any trend in the predicted direction; in fact, the only significant difference found in the reanalyses was in the opposite direction from that predicted by SAC. The very large sample (involving literally hundreds of thousands of species) and the lack of even a trace of a trend in the expected direction speaks strongly against SAC. A second survey of genital evolution groups in which male-female reproductive conflict is probably unusually intense (for instance, groups



with hypodermic insemination) again failed to find the especially elaborate male genitalia predicted by SAC (Eberhard, 2006a).

Another study (Eberhard, 2004b) checked for the defensive morphological female coevolution that is predicted by SAC in species with rapidly evolving male genitalia or other nongenital structures that are specialized to contact females in sexual contexts (see next section). More than half of the 84 different groups showed no female coevolution at all, and in only  $\approx 20\%$  was it even feasible that female morphology was coevolving defensively. A sample of literally thousands of species of spiders failed to reveal a single case of a particularly likely female SAC design, involving structures that can be deployed facultatively to defend against males.

### **Male Contact Organs**

Males of many species have nongenital structures that are specialized to make contact with females during or immediately preceding copulation. These structures, which include Darwin's "prehensile organs" (Darwin, 1871/1959), include modifications of nearly all parts of the body. They are modified to clasp, press against, or otherwise contact the female directly during sexual interactions (Fig. 12.1). Comparisons of these contact organs among related species show that they diverge rapidly among closely related species, and have otherwise puzzling, "overly complex" designs to accomplish relatively simple mechanical tasks, just as in genitalia. The same hypotheses discussed for genitalia also apply here. Because in many cases the portion of the female's body that is contacted by these structures is easily studied, it is especially easy to test (and in many cases confidently reject) both lock-and-key and coercive SAC explanations for the male diversity: females often simply lack any sign of species-specific counterparts to these male structures (Robson and Richards, 1936; Eberhard, 2004b; Ingram et al., 2008). The relative ease with which the male and female structures can be modified (e.g., coating them with glue or paraffin) makes experimental studies of how they function possible. The data available to date indicate that male contact organs function to stimulate the female (Kreiger and Krieger-Loibl, 1958; Belk, 1984; Eberhard, 2002).

### **Courtship Behavior During and After Copulation**

"Paradoxical" male courtship behavior that is performed after copulation has already begun, as in the fly described in the Introduction, may be common. A survey using 131 randomly chosen species and conservative behavioral criteria showed that copulatory courtship occurred in just  $>80\%$  of the species (Eberhard, 1994). Male insects and spiders use virtually all parts of their bodies as they tap, slam, squeeze, bite, lick, rub,

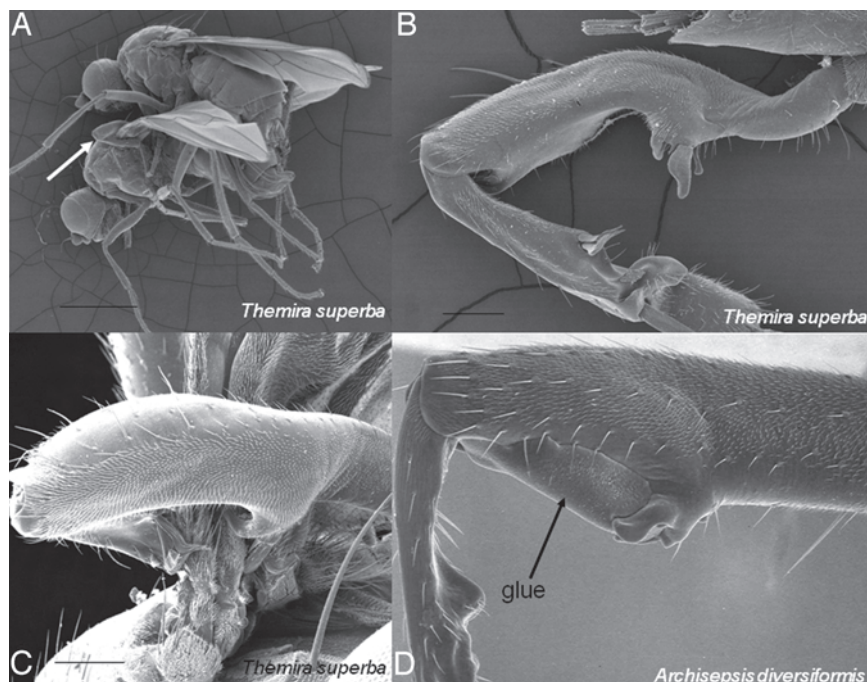

FIGURE 12.1 Male contact organs whose elaborate species-specific forms probably function to stimulate the female. (A) The front legs of male sepsid flies are specialized to grasp the female's wings (arrow) before and during copulation. (B) As in many such male contact organs, these legs are generally species-specific and sometimes quite complex in form. (C) Nevertheless, the portion of the female wing that they grasp is relatively uniform, giving little sign of the defensive coevolution predicted by the SAC hypothesis. (D) In 1 species, experimental modification of the male's femur (arrow) did not reduce his ability to grasp the female, but did result in decreased reproductive cooperation from the female; further experiments showed that the changes in female behavior were caused by changes in stimulation of her wing, as expected if the male legs have evolved under sexual selection by female choice. (Scale lines in A–C = 1 mm, 0.1 mm, and 0.1 mm, respectively; width photo bottom right = 0.46 mm.) [Adapted with permission from Ingram et al. (2008) (Copyright 2008, *Biol J Linn Soc*).] (D) [Adapted with permission from Eberhard (2002) (Copyright 2002, *J Ins Behav*).]

shake, gently rock, or twist the female, coat her with liquid, cover her eyes with semitransparent colored plates, wrap her symbolically in weak silken lines, feed her, wave at her, and sing to her (Eberhard, 1991, 1994). Similar behavior also occurs in other groups of animals (Eberhard, 1996). Unless one makes the unlikely supposition that this behavior, which is often energetic, persistent, and stereotyped, represents selectively neutral

"mistakes" or incidental movements by the males (Eberhard, 1994; Shuker et al., 2002), courtship at this late stage would seem to function to induce favorable female responses. None of the male copulatory courtship behavior patterns observed to date involve direct manipulation of the female reproductive organs in a way that would suggest sperm competition, and in only a very few species is physical coercion of the female even feasible, so this courtship did not evolve under sperm competition or coercive SAC. As expected if it is under sexual selection, male copulatory courtship consistently differs among closely related species (Eberhard, 1991, 1994, 1996). Also as expected, sex roles are inverted in 2 species in which males apparently donate resources to the female, and the female rather than the male courts during copulation (Ortiz, 2002; Eberhard, 2006b).

The discovery of copulatory courtship has opened the door on an entire new field of study, testing for the predicted effects of copulatory courtship on female reproductive processes, which is only beginning to be explored [e.g., Arnqvist and Danielsson (1999), Edvardsson and Arnqvist (2000), Tallamy et al. (2003), Cuantianquiz and Cordero (2006), Peretti et al. (2006)]. The prejudice that courtship ends as soon as copulation begins probably caused earlier researchers (myself included) to overlook copulatory courtship behavior, because it did not seem to make adaptive sense. Research has already revealed a variety of copulatory courtship effects on female processes, including biased sperm use, sperm dumping, rapid oviposition, and resistance to remating. For instance, the copulatory courtship of the fly described in the introduction has the effect of inducing the female to lay eggs immediately after copulation: if the male is prevented from courting during copulation, the female flies away without having laid any eggs (F. Barbosa, personal communication). Other effects likely await discovery as increasing numbers of taxa are studied in this expanding field. A recent study suggests the further possibility that male signals elicit female signals in response, and that male-female dialogues occur during copulation. Females of a spider "sing" periodically during copulation, apparently in attempts to induce the male to relax the squeezes that he performs with his powerful genitalia and rewarding cooperative males with greater paternity (Peretti et al., 2006).

### **Sperm Morphology**

Sperm morphology is another important trait influenced by postcopulatory sexual selection. Sperm morphology differs widely and has been used to study phylogenetic relationships in many different groups (Jamieson, 1987; Alberti, 1991). Much of this diversity probably results from postcopulation sexual selection, which can potentially act within the female in competition among sperm in a single ejaculate and competition

between sperm from different males. The functions of sperm modifications are just beginning to be understood, however, and speculations are far ahead of the data. Discovering sperm function by direct observation is difficult, because both the morphology and the chemical milieu of the female reproductive tract can affect sperm behavior.

Perhaps the most general pattern is that sperm morphology tends to be simple and uniform in externally fertilizing animals and more complex and diverse in those with internal fertilization (Baccetti and Afzelius, 1976). This pattern argues for the importance of sexual selection and the influence of female “playing fields.” Correlations have been found between the length and the form of sperm cells and the length of female storage organs or ducts in birds and insects (Kotrba, 1995, 2006; Miller and Pitnick, 2002; Pitnick et al., 2002; Swallow and Wilkinson, 2002; Minder et al., 2005); the functional effects of longer or shorter female structures are not clear, however, nor are the selective pressures that result in changes in these traits.

Swimming speed is one frequently mentioned sperm competition mechanism that may exercise selection on sperm morphology. Greater flagellum length may correlate in some cases with greater swimming speed or greater force as the sperm nears the egg, but the functional significance of sperm length is often unclear. Sperm length is positively correlated with the probability of encountering sperm competition in some groups of animals, but not in others (Miller and Pitnick, 2002; Oppliger et al., 2003; Minder et al., 2005). Sperm length does not appear to be correlated with the thickness of the zona pellucida in mammals (Gomendio et al., 1997). The sperm of internally fertilizing species of fish and echinoids, which would seem to need less swimming ability, are nevertheless longer than those of external fertilizers in the same groups. In several vertebrate and invertebrate taxa, sperm have traits such as hook-shaped heads that allow individual sperm cells to link up with each other at least temporarily; in several of these species the resulting collaborative groups may swim straighter or more rapidly (Pizzari and Foster, 2008). Groupings of this sort seem to correlate with competition between sperm from different males, rather than between sperm cells in the same ejaculate (Pizzari and Foster, 2008).

Males of some groups routinely produce both fertile sperm, and sperm that are designed to be infertile (parasperm); some even lack nuclei. Parasperm are widespread in Lepidoptera, have evolved repeatedly in other groups (Swallow and Wilkinson, 2002), and constitute more than half of the ejaculate in some species. Hypotheses for parasperm functions (Swallow and Wilkinson, 2002; Holman and Snook, 2006) include provisioning the female with nutrients, displacing or killing rival sperm, blocking access for rival sperm, promoting movement of fertile sperm within the female,

influencing CFC (for instance, by packing female storage organs to induce the female not to remate), influencing long-term vs. short-term survival in the female, and defense against female spermicides (Holman and Snook, 2008). The data needed to test these hypotheses are largely lacking [see critical discussions in Swallow and Wilkinson (2002)]. Changes in the percentage of the ejaculate dedicated to parasperm under conditions of different intensities of sperm competition suggest that sperm competition is an important function of parasperm in some species (Oppliger et al., 1998) but not others (Weddell and Cook, 1999).

### **Seminal Products**

A similar disconnect regarding sexual selection occurred in studies of semen and of its effects on the female. Insect physiologists developed a tradition of experimentally implanting glandular portions of the male reproductive tract or injecting extracts into the female and determining the effects of these treatments on female behavior and reproductive physiology. Their consistent finding was that these glandular products are diverse (Chen, 1984; Swanson and Vacquier, 2002; Kern et al., 2004) and they induce females to oviposit or resist mating attempts from additional males; additional effects include inducing oogenesis, ovulation, or sperm storage (Chen, 1984; Eberhard, 1996; Andrés et al., 2006). These kinds of data accumulated for many years in the absence of any theoretical expectations, but recognition of the importance of postcopulatory competition among males to trigger such female responses made immediate sense (under both CFC and SAC) of their diversity, their consistent effects on females (Eberhard and Cordero, 1995; Eberhard, 1996), and molecular signatures indicating that they evolved under selection (Swanson et al., 2001; Andrés et al., 2006). The rapid divergence in *Gryllus*, in which females are thought to benefit (Wagner et al., 2001) rather than suffer from repeated copulations, constitutes evidence against SAC being responsible for this divergence (Andrés et al., 2006). Rapid divergence under selection has also occurred in seminal proteins of both primates and rodents (Dorus et al., 2004; Karn et al., 2008).

### **Interactions Between Egg and Sperm Molecules**

Recent summaries reveal that the genes coding for molecules involved in fertilization in mammals and marine invertebrates such as sea urchins and abalone show a general evolutionary pattern strikingly similar to the patterns seen in male genital morphology: in essentially all steps of animal fertilization where the molecular interactions between sperm and egg proteins have been studied, there is evidence for rapid divergence of

the corresponding sperm and egg genes among closely related species (Clark NL, et al., 2006; Zigler, 2008), and changes in the genes coding for several of these divergent proteins indicates that many of these changes have resulted from positive selection. There are also informative exceptions to this rule (below). Strictly speaking, the term postcopulation is not appropriately applied to free-spawning species such as sea urchins, but they offer interesting comparisons. As in genitalia, species isolation hypotheses played a large role in early interpretations, but recent discoveries also suggest important roles for sexual selection.

Sperm proteins in free-spawning marine gastropods are among the most rapidly evolving proteins known (Clark NL, et al., 2006). The abalone sperm molecule lysin, which digests a hole in the vitelline egg membrane, has evolved up to 15 times faster than introns (Metz et al., 1998), and there is a link between sites of positive selection and functional changes (Clark NL, et al., 2006). Egg molecules with which lysin interacts have also undergone rapid divergence under selection (Swanson and Vacquier, 2002; Aagaard et al., 2006). Similarly, the bindin molecule of sea urchin sperm, which both attaches the acrosomal process of the sperm to the glycoprotein bindin receptor molecules in the egg's vitelline layer and promotes fusion of egg and sperm membranes, also shows rapid divergence (Zigler, 2008). The section of the bindin molecule that is involved in attachment to the egg varies sharply among species in 3 genera, in each of which there is evidence that positive selection produced the changes; in 3 other genera, divergence in the attachment portion is low, and there is no evidence for positive selection (Zigler, 2008). Egg molecules involved in both induction of the acrosome reaction and the docking process on the egg have diverged in 1 genus that has rapidly diverging bindin (Kamei and Glabe, 2003).

A SAC explanation of this divergence would posit a coevolutionary race between males and females over control of sperm entry into the egg. When multiple sperm enter the same egg (polyspermy), usually the embryo dies, so sperm competition favoring sperm cells that are especially quick to enter eggs might also result in loss of some eggs because of polyspermy. Females could respond by making it more difficult for sperm to enter, and the resulting coevolutionary race could result in rapid divergent evolution of both sperm and egg molecules. A CFC explanation is that females are under selection to favor sperm cells with particularly effective designs, to obtain sons with these same designs; increased female selectivity could result in competition among males to evolve even more effective designs, resulting in rapid coevolution between male and female molecules.

A species isolation function for the rapid divergence of the fertilization molecules of sea urchins and abalone is also attractive because their gametes meet in open water. Species that have evolved in the presence of close relatives would be expected to show greater divergence in their



fertilization molecules than species that evolved in isolation from other congeneric species. Neither SAC nor CFC predicts this pattern. This predicted biogeographic pattern occurs in sea urchins: the 3 genera with rapidly diverging bindin molecules contain species that live in sympatry with congeners; in contrast, species in 3 other genera that do not show rapid divergence in bindin do not have overlapping geographic ranges (Zigler and Lessios, 2003a). In addition, 1 species that overlaps with a congener at some locations but not others shows the predicted accentuation of differences in areas of sympatry (Zigler, 2008). Species isolation is a feasible (although not proven) explanation for the rapid divergence of their fertilization molecules of the abalone species, which are generally sympatric with congeners.

Nevertheless, further details suggest that sexual selection may have played a role, at least in bindin evolution. In the first place, cause and effect are not clear in the biogeographic correlation: perhaps the divergence in bindin was originally caused by other selective factors and only incidentally allowed congeneric species to subsequently coexist in sympatry without fusing or becoming extinct (Zigler and Lessios, 2003b). In addition, there is rapid intraspecific divergence with signs of positive selection in 2 genera with sympatric congeners, contrary to species isolation predictions (Zigler and Lessios, 2003b), and there is no evidence of selection having produced the substantial differences in the bindin (relative to mDNA) of 2 sympatric species of 1 genus (Zigler and Lessios, 2004). Furthermore, a possible explanation for intraspecific divergence in some but not other parts of a species' range that is based on the species isolation hypothesis is not supported in 1 group: the same bindin occurs in areas of overlap and nonoverlap with another congeneric species (H. Lessios, personal communication). Zigler (2008) concluded that different types of selection may have acted on bindin, and that final answers are not yet available.

Both species isolation and sexual selection hypotheses predict that once an egg has responded to 1 sperm by erecting a barrier that excludes other sperm proteins that are involved in subsequent interactions should fail to show the rapid divergence typical of fertilization molecules. The data appear to support this prediction in sea urchin bindin. In sea urchins the raising of the egg's fertilization membrane, which prevents the entry of further sperm, is triggered by the sperm-egg membrane fusion that follows attachment of sperm to the vitelline membrane. The core of the bindin molecule, which is involved in the fusion of egg and sperm membranes is, as predicted, uniform even among quite distantly related sea urchins and other echinoids (Zigler, 2008). Thus, 2 patterns occur in the same molecule: the portion involved in an early stage of fertilization is highly diverse in some lineages, whereas another portion that is involved in a later stage (after paternity has been decided) is very conservative.



The rapid diversification of fertilization molecules in mammals (Clark NL, et al., 2006) is not likely to be explained by selection for species isolation, because the complex male-female interactions before copulation, and internal female barriers such as reduced sperm transport, probably make interactions between heterospecific eggs and sperm very rare (Gomendio et al., 1997). Both sperm proteins and egg coat zona pellucida glycoproteins show rapid divergence because of selection (Swanson et al., 2003), and the ZP2 and ZP3 egg glycoproteins are among the 10% most different proteins between rodents and humans (Clark NL, et al., 2006). Presumably SAC or CFC was involved in the divergence of these molecules.

### Postcopulatory Sexual Selection in Plants

Darwin did not apply his principle of sexual selection to plants, and this extension was a long time in coming (Willson and Burley, 1983; Anderson, 1994; Delph and Havens, 1997). Competition between males leading to sexual selection can occur both before and after the plant equivalent of insemination (arrival of pollen on the stigma). There is ample opportunity for females to exercise postcopulatory choice in processes such as pollen germination, growth of the pollen tube to reach the ovule, and maturation (versus abortion) of the resulting seeds and their fruit. Some otherwise paradoxical traits of females, like the production of inhibitors of pollen grain germination at the site where pollen grains must germinate (the stigma) until it is loaded with pollen, and initiation of many more seeds and fruit than will eventually mature, may be female-imposed mechanisms that impose “rules of the game” for male-male competition (Delph and Havens, 1997). The consistent finding that a female’s offspring show greater vigor when the competition among pollen grains from a single donor plant is more intense indicates a payoff for female selectivity that is compatible with CFC explanations (and contrary to those of SAC). Plant reproductive proteins are as yet only incompletely investigated, and evolutionary patterns of the genes and molecules involved cannot be checked (Clark NL, et al., 2006).

Two widespread traits make postcopulatory selection in plants likely to differ from that in most animals. Many plants are hermaphroditic, and their largely passive roles in pollination can lead to a common postcopulatory problem that is largely absent in animals: avoidance of self-fertilization. Some of the diversity in postcopulatory traits in plants is probably related to selection favoring avoidance of fertilization with self-pollen (Kao and Tsukamoto, 2004). Species-specific diversity may also result from selection to avoid hybridization between species. For instance, specificity in the structural complexity of the outer cell wall of the pollen grain is apparently responsible for its ability to adhere to the conspecific

stigma in species with “dry” stigmas (Zinkl et al., 1999; Clark NL, et al., 2006). But crucial data (see previous section) are generally not available to discriminate among the inbreeding avoidance, species isolation, CFC, and SAC explanations for generating these traits.

Second, female plants may be more likely than female animals to be able to reap indirect payoffs from screening among pollen grains. A large fraction of the genome of a pollen grain is expressed during the growth of the pollen tube [up to  $\approx 2/3$  of the expressed genome in a mature plant; Mascarenhas (1990)]. In contrast, the genome of a sperm cell is largely silent (Pizzari and Foster, 2008). More vigorous pollen tube growth tends to correlate with more vigorous growth by the resulting offspring (Rocha and Stephenson, 1990; Delph and Havens, 1997), thus favoring female abilities to select among pollen tubes.

A further potentially intense filter of males in plants is the often substantial rate of abortion of zygotes before maturation of seed and fruit. One yet to be explored possibility is that sexual selection on males promoted genetic imprinting as a mechanism to reduce the chances that the male's offspring would be aborted.

## CONCLUDING THOUGHTS

The traits just reviewed share a strong trend: rapid divergent evolution. There are reasons to suppose that sexual selection has been important in many cases, but it is possible that no single explanation accounts for all cases or rapid divergence. Selection for species isolation mechanisms may have had an important role in the evolution of abalone lysins, but species isolation has probably been of little importance in producing the widespread rapid divergent evolution of male genitalia or mammal sperm and egg proteins.

It is impressive to see the long shadow that one of Darwin's few omissions had in the history of studies of sexual selection. Despite the resulting delays, Darwin's theory of sexual selection is now inspiring progress in explaining new findings and directing research in various fields that involve postcopulatory male-female interactions.

## ACKNOWLEDGMENTS

I thank F. Ayala and J. Avise for inviting me to participate in the colloquium and M.-J. West-Eberhard, H. Lessios, and 2 referees for useful comments. This work was supported by the Smithsonian Tropical Research Institute and the Universidad de Costa Rica.



## Part IV

---

### THE DARWINIAN LEGACY, 150 YEARS LATER

**B**eyond his numerous books and autobiography (Darwin F, 1887a), Darwin left a wealth of personal correspondence (Darwin F, 1887b) and additional written material that science historians can now sift through to better understand Darwin's developing ideas at different stages of his life. Prominent among these were notebooks that Darwin wrote during the voyage of the *Beagle*, and a lettered series of Transmutation Notebooks that he wrote in the 2 years following his return. Several authors in this concluding part of the ILE III Proceedings scrutinize these writings to illuminate Darwin's thought processes and thereby better appreciate and contextualize his scientific legacy.

In Chapter 13, Francisco Ayala describes a fundamental discrepancy between Darwin's scientific methodology and how Darwin portrayed his methods to the general public. The version for public consumption emphasized how Darwin proceeded on the principles of Baconian induction, which at that time were favored by British philosophers such as John Stuart Mill. Under this approach, facts are collected wholesale—presumably without the bias of preconceived notions—and broader biological principles eventually emerge. The actual methods of Darwin, Ayala contends, were far different from this depiction, falling instead squarely within a hypothetico-deductive framework. The latter scientific method has two steps: the formulation of one or more conjectures or hypotheses about the natural world; and the design and implementation of critical empirical tests of whether deductions derived from each hypothesis are consistent with real-world observations. In support of his contention that

Darwin consistently used the hypothetico-deductive method, Ayala cites examples from Darwin's work and even uses some of Darwin's own words, such as "How odd it is that anyone should not see that all observation must be for or against some view if it is to be of any service." Ayala speculates on why Darwin sometimes pretended to be a Baconian inductivist when in fact he mostly practiced what today would be considered modern hypothesis-driven deductive science.

In considering Darwin's legacy from the current vantage, in Chapter 14 Michael Ruse asks three related questions: Was there a Darwinian revolution? Was there a *Darwinian* revolution? And, was there a *Darwinian* revolution? Ruse's answers to these questions are two resounding yes's and a qualified yes, respectively. The first resounding yes comes from the fact that after Darwin, rational observers could no longer accept the old picture of humans as somehow the miraculous products of special creation. In other words, the *revolution* challenged us to rethink dramatically—both emotionally and intellectually—what it means to be human. The second resounding yes comes from the evidence that it was Darwin, rather than his predecessors or contemporaries, who was primarily responsible for the scientific and the metaphysical shifts that society entailed in coming to terms with natural selection's role in the evolutionary process. The qualified yes comes from the realization that the third question is somewhat philosophical; the answer depends in part on whether to interpret major transformations of thought as continuous and gradual, or discontinuous and abrupt. Ruse discusses philosophical nuances of his own position on these issues.

Natural selection is the key Darwinian concept, and the evolutionary force given top billing in *The Origin*. But common ancestry is a key concept too, a co-star (albeit not originating strictly with Darwin) of the evolutionary theater. In Chapter 15, Elliott Sober considers how natural selection and common ancestry are related under Darwin's worldview, and he argues that the latter has a sort of logical (as well as historical) priority over the former. This is because, under Darwinian logic, arguments about natural selection often require the supposition or backdrop of common ancestry (i.e., genealogy and heredity), whereas the logical defense of common ancestry does not require natural selection. In this epistemological sense, Darwin ordered things backward, Sober argues, when he presented natural selection, rather than common ancestry, first and foremost in *The Origin*. Rather than "evolution by natural selection," Darwin's theory might better be described as "common ancestry plus natural selection."

In Chapter 16, Robert Richards presents a revisionary argument that seems likely to be highly controversial. Using excerpts from Darwin's writings, Richards makes a case that "Darwin's theory originally re-infused

nature with moral purpose and employed teleological means of doing so," and that "Darwinian evolution had the goal of reaching a fixed end, namely man as a moral creature." These conclusions fly in the face of conventional wisdom, which holds that Darwin's elucidation of natural selection was philosophically as well as scientifically revolutionary precisely because it banished the necessity for invoking ultimate purpose or goal-directedness in biological evolution. Nevertheless, Richards contends that many of Darwin's writings are infused with teleological statements, and that to dismiss these, or to rationalize them as rhetorical devices (for example, if Darwin was trying to assuage Victorian readers) is unwarranted. Richards bolsters this argument by tracing various of Darwin's ideas to his early life, and how these concepts eventually played into the construction of Darwin's theory. Thus, Richards interprets many of Darwin's writings as consistent with notions of evolutionary purpose and biological progress. It will be interesting to monitor the responses of other evolutionary historians to this provocative suggestion.

The title of Daniel Dennett's Chapter 17—Darwin's Strange Inversion of Reasoning—refers to a quote from one of Darwin's critics who in 1868 wrote that Darwin, "by a strange inversion of reasoning, seems to think Absolute Ignorance [*natural selection; editors' addition*] fully qualified to take the place of Absolute Wisdom [*God*] in all the achievements of creative skill." Dennett likens Darwin's strange inversion of reasoning to another such profound inversion of reasoning, this time by Alan Turing in the physical sciences. In the 1930s, Turing argued that it would be possible to design exquisite calculating machines [*such as modern computers*] that were absolutely ignorant yet fully capable of performing highly complex mathematical tasks. Whereas the truth of Turing's strange inversion in physics is universally acknowledged today, many people (namely, creationists) still cannot abide Darwin's strange inversion in biology. Dennett explores the philosophical ramifications for Darwin's inversion of reasoning, and finds them to be truly profound.

A recent article in the *New York Times* (July 15, 2008) was entitled "Let's get rid of Darwinism." It was written by Olivia Judson, an evolutionary biologist and the author of a best-selling evolutionary book (Judson, 2002). In that article, Judson wrote, "I'd like to abolish the insidious terms Darwinism, Darwinist, and Darwinian. They suggest a false narrowness to the field of modern evolutionary biology, as though it was the brainchild of a single person 150 years ago, rather than a vast, complex and evolving subject to which many other great figures have contributed. . . . Obsessively focusing on Darwin, perpetually asking whether he was right about this or that, implies that the discovery of something he didn't think of or know about somehow undermines or threatens the whole enterprise of evolutionary biology today." The term Darwinism also "suggests that Darwin

was the beginning and the end, the alpha and the omega, of evolutionary biology, and that the subject hasn't changed much in the 150 years since the publication of *The Origin*." Judson went on to suggest that constantly using terms such as Darwinism and Darwinian is rather like calling all of modern aeronautical engineering "Wrightism" after the Wright brothers, or referring to all fixed-wing aircraft as "Wrightian" planes. Similar sentiments were expressed by another well-known biologist, Carl Safina, in a *New York Times* article (Feb. 10, 2009), entitled "Darwinism must die so that evolution may live."

Our intent in the Sackler Colloquium and in this book has not been to idolize Charles Darwin, but rather to celebrate the field of evolutionary biology that he played such an important role in developing nearly 2 centuries ago. We submit that if Darwin were alive today, he would be satisfied with his own pioneering efforts, but also completely astonished at the breadth, depth, and vibrancy of the modern field.



# 13

## Darwin and the Scientific Method

---

FRANCISCO J. AYALA

There is a contradiction between Darwin's methodology and how he described it for public consumption. Darwin claimed that he proceeded "on true Baconian [inductive] principles and without any theory collected facts on a wholesale scale." He also wrote, "How odd it is that anyone should not see that all observation must be for or against some view if it is to be of any service!" The scientific method includes 2 episodes. The first consists of formulating hypotheses; the second consists of experimentally testing them. What differentiates science from other knowledge is the second episode: subjecting hypotheses to empirical testing by observing whether or not predictions derived from a hypothesis are the case in relevant observations and experiments. A hypothesis is scientific only if it is consistent with some but not other possible states of affairs not yet observed, so that it is subject to the possibility of falsification by reference to experience. Darwin occupies an exalted place in the history of Western thought, deservedly receiving credit for the theory of evolution. In *The Origin of Species*, he laid out the evidence demonstrating the evolution of organisms. More important yet is that he discovered natural selection, the process that accounts for the adaptations of organisms and their complexity and diversification. Natural selection and other causal processes of evolution are investigated by formulating and testing hypotheses. Darwin advanced hypotheses in multiple fields,

---

Department of Ecology and Evolutionary Biology, University of California, Irvine, CA 92697.

including geology, plant morphology and physiology, psychology, and evolution, and subjected them to severe empirical tests.

## DARWIN AND THE PHILOSOPHERS

There is an apparent contradiction between how Darwin (Fig. 13.1) proceeded in his scientific research and how he described it for public consumption, between what he said in his published writings about his scientific methodology and what he wrote in his notebooks, correspondence, and autobiography.

The opening paragraph of *The Origin of Species* (Fig. 13.2) reads as follows:

When on board H.M.S. *Beagle*, as naturalist, I was much struck with certain facts in the distribution of the inhabitants of South America, and in the geological relations of the present to the past inhabitants of that continent. These facts seemed to me to throw some light on the origin of species—that mystery of mysteries, as it has been called by one of our greatest philosophers. On my return home, it occurred to me, in 1837, that something might perhaps be made out on this question by patiently accumulating and reflecting on all sorts of facts which could possibly have any bearing on it. After 5 years' work I allowed myself to speculate on the subject, and drew up some short notes; these I enlarged in 1844 into a sketch of the conclusions, which then seemed to me probable: from that period to the present day I have steadily pursued the same object.

Darwin claims to have followed the inductionist canon prevalent among British contemporary philosophers and economists, such as John Stuart Mill (1843), and earlier authorities, notably the statesman and philosopher, Francis Bacon in his *Novum Organum* (Anderson, 1960). The inductionist canon called for making observations without prejudice as to what they might mean and accumulating observations related to a particular subject so that a universal statement or conclusion could eventually emerge from them. Indeed, in one place in his *Autobiography*, Darwin affirms that he proceeded “on true Baconian principles and without any theory collected facts on a wholesale scale” (Barlow, 1958, p. 119).

The facts are very different from these claims, however. Darwin's notebooks and private correspondence show that he entertained the hypothesis of the evolutionary transmutation of species shortly after returning from the voyage of the *Beagle* and, all important, that the hypothesis of natural selection occurred to him in 1838; several years before he claims to have allowed himself for the first time “to speculate on the subject.” Between the return of the *Beagle* on October 2, 1836, and publication of

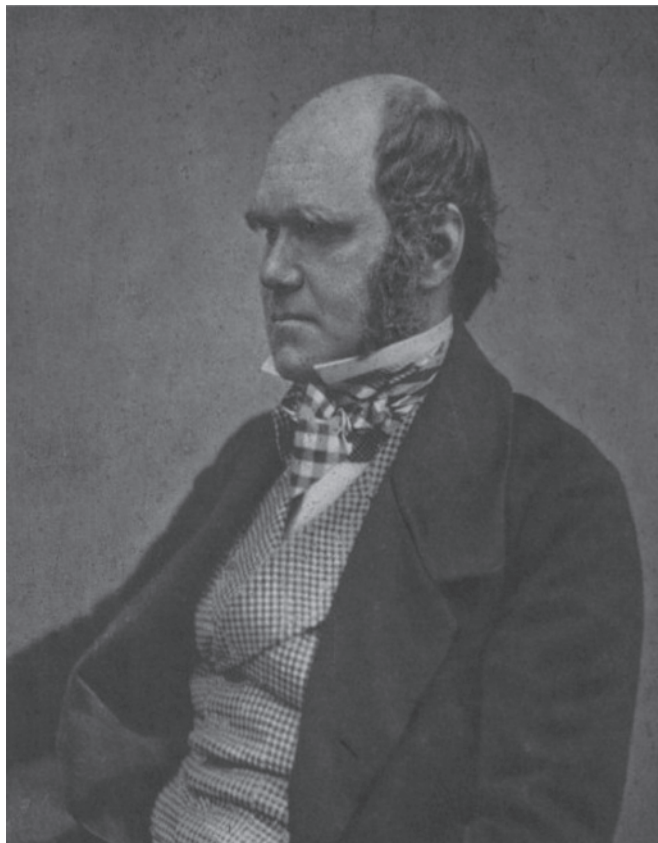

FIGURE 13.1 Charles Darwin, circa 1854 (courtesy of Professor G. Evelyn Hutchison).

*Origin of Species* in 1859 (Darwin, 1859, 6th ed.) (and, indeed, until the end of his life), Darwin relentlessly pursued empirical evidence to corroborate the evolutionary origin of organisms and to test his theory of natural selection, which he saw as the explanatory process accounting for the adaptive organization of living beings and their diversification and change through time.

Why this disparity between what Darwin was doing and what he claimed? There are at least 2 reasons. First, in the temper of the times, “hypothesis” was a term often reserved for metaphysical speculations without empirical substance. This is the reason Newton, the greatest-ever theorist among scientists, had also claimed, *hypotheses non fingo* (“I fabricate no hypotheses”). Darwin expressed distaste and even contempt

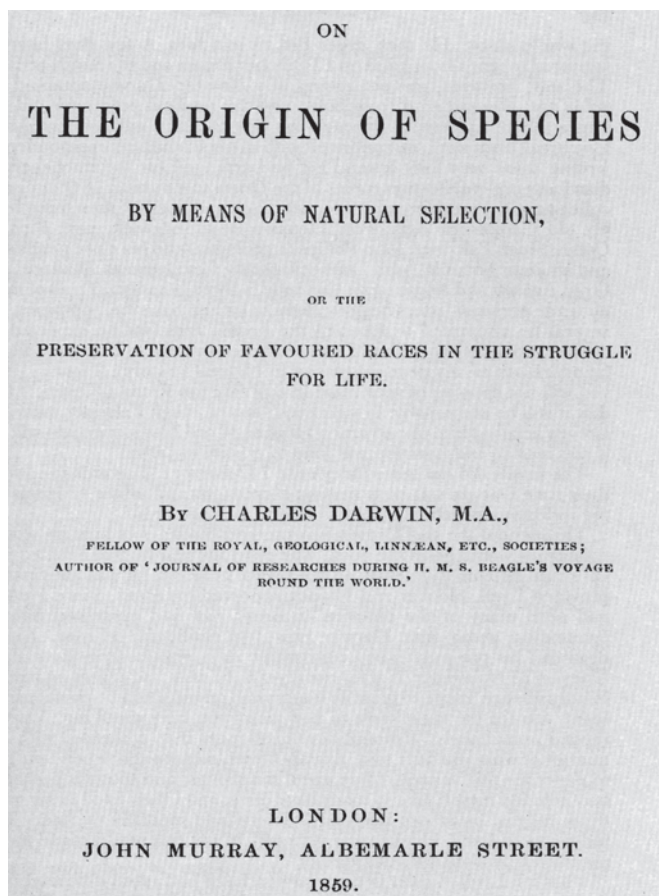

FIGURE 13.2 Title page of *The Origin of Species*.

for empirically untestable hypotheses. He wrote of Herbert Spencer: "His deductive manner of treating any subject is wholly opposed to my frame of mind. His conclusions never convince me. His fundamental generalizations (which have been compared in importance by some persons with Newton's Laws!), which I daresay may be very valuable under a philosophical point of view, are of such a nature that they do not seem to me to be of any strictly scientific use. They partake more of the nature of definitions than of laws of nature. They do not aid me in predicting what will happen in any particular case" (Barlow, 1958, p. 109).

There is another reason, a tactical one, Darwin claimed to proceed according to inductive canons: he did not want to be accused of subjective

bias in the evaluation of empirical evidence. Darwin's true colors are shown in a letter to a young scientist written in 1863: "I would suggest to you the advantage, at present, of being very sparing in introducing theory in your papers (I formerly erred much in Geology in that way); let theory guide your observations, but till your reputation is well established, be sparing of publishing theory. It makes persons doubt your observations" (Darwin, 1903, Vol. 2, p. 323). Nowadays also, scientists, young or old, often report their work so as to make their hypothesis appear as afterthoughts, conclusions derived from the observations or experiments made, rather than as preconceptions tested by empirical observations designed precisely, as it is most often the case in many scientific disciplines, for the purpose of testing a particular "preconception," a hypothesis. Nevertheless, it is becoming more and more the case that experiments and observations are planned and reported as specific tests of a particular hypothesis.

"Let theory guide your observations." Indeed, Darwin had no use for the empiricist claim that a scientist should not have a preconception or hypothesis that would guide his work. Otherwise, as he wrote, one "might as well go into a gravel pit and count the pebbles and describe the colors. How odd it is that anyone should not see that observation must be for or against some view if it is to be of any service" (Darwin, 1903, Vol. 1, p. 195). He acknowledged the heuristic role of hypotheses, which guide empirical research by suggesting what is worth observing, what evidence to seek. In his *Autobiography*, he acknowledges that "I cannot avoid forming one [hypothesis] on every subject" (Barlow, 1958, p. 141).

Darwin advanced hypotheses in multiple fields, including geology, plant morphology and physiology, psychology, and evolution, and subjected his hypotheses to severe empirical tests. Herein lies the solution to the historical conundrum, often noted by historians and philosophers, that he delayed for 2 decades publication of his theory of natural selection as an explanation for the adaptations and diversification of organisms, which he had discovered in 1838, but did not publish until 1859, in *Origin*. (The delay might have been longer were it not for Wallace's letter of 1858 announcing his independent discovery of natural selection.) Darwin was aware of the major implications of his theory, namely, bringing the adaptations and diversity of organisms into the realm of science rather than being accounted for by direct creation, as was generally accepted at the time (Ayala, 2007). He spent many years testing his theory of natural selection with observations and experiments that seemed likely to contradict his theory, if it were not correct. Historians have often thought that his 4 volumes on barnacles, living and fossils (Darwin, 1851a,b, 1854a,b) and his studies on the fertilization of orchids (Darwin, 1862), and others, were distractions. They were not distractions, but rather severe tests of his theory of natural selection.

## INDUCTION AND EMPIRICISM

It is a common misconception, shared by many scientists, that science proceeds by “accumulating experimental facts and drawing up a theory from them,” as François Jacob (1988, pp. 224–225) had believed when he started the research on bacteriophage replication that would lead to his receiving, in 1965, the Nobel Prize for physiology or medicine. This misconception is encased in the much repeated assertion that science is inductive, a notion that can be traced to the English statesman and essayist Francis Bacon (1561–1626). Bacon had an influential role in shaping modern science by his criticism of the prevailing metaphysical speculations of medieval scholastic philosophers. In the 19th century the most articulate proponent of inductivism was John Stuart Mill (1806–1873).

Induction was proposed by Bacon and Mill as a method of achieving objectivity while avoiding subjective preconceptions and obtaining empirical rather than abstract or metaphysical knowledge. In its extreme form the inductivist canon would hold that a scientist should observe any phenomena that he encounters in his experience and record them without any preconceptions as to what to observe or what the truth about his observations might be. Truths of universal validity would be expected eventually to emerge, as a result of the relentless accumulation of unprejudged observations. The methodology proposed may be trivially exemplified as follows. A scientist measuring and recording everything that confronts him observes a tree with leaves. A second tree, and a third, and many others, are all observed to have leaves. Eventually, he formulates a universal statement, “all trees have leaves.”

This inductive process fails to account for the actual methodology of science. First of all, no scientist works without any preconceived plan as to what kind of phenomena to observe. Scientists choose for study objects or events that, in their opinion, are likely to provide answers to questions that interest them. Otherwise, as Darwin wrote, “one might as well go into a gravel pit and count the pebbles and describe the colors.” A scientist whose goal was to record carefully every event observed in all waking moments of his life would not contribute much to the advance of science; more likely than not, he might be considered mad by his colleagues.

Moreover, induction fails to arrive at universal truths. No matter how many singular statements may be accumulated, no universal statement can be logically justified by such an accumulation of observations. Even if all trees so far observed have leaves, or all swans observed are white, it remains a logical possibility that the next tree will not have leaves, or the next swan will not be white. The step from numerous singular statements to a universal one involves logical amplification. The universal statement has greater logical content (it says more) than the sum of all singular statements.

Another serious logical difficulty with the proposal that induction is the method of science, is that scientific hypotheses and theories are formulated in abstract terms that do not occur at all in the description of empirical events. Mendel, the founder of genetics, observed in the progeny of hybrid plants that alternative traits segregated according to certain proportions. Repeated observations of these proportions could never have led inductively to the formulation of his hypothesis that “factors” (genes) exist in the sex cells and are rearranged in the progeny according to certain rules. The genes were not observed and thus could not be included in statements reflecting what Mendel observed. Natural selection, like gravity or electricity, is not directly observed by a simple examination of nature at a particular time or place. The most interesting and fruitful scientific hypotheses are not simple generalizations. Instead, scientific hypotheses are creations of the mind, imaginative suggestions as to what might be true.

Induction fails in all 3 counts pointed out. It is not a method that ensures objectivity and avoids preconceptions, it is not a method to reach universal truths, and it is not a good description of the process by which scientists formulate hypotheses and other forms of scientific knowledge. It is a different matter that a scientist may come upon a new idea or develop a hypothesis as a consequence of repeated observation of phenomena that might be similar or share certain traits. But how we come upon a new idea is quite a different matter from how is it that we come to accept something as established scientific knowledge.

### THE HYPOTHETICO-DEDUCTIVE METHOD

New ideas in science are advanced in the form of conjectures or hypotheses, which may be more or less precisely formulated and be of lesser or greater generality. However, it is essential to the scientific process that any hypothesis be “tested” by reference to the natural world that we experience with our senses. The tests to which scientific ideas are subjected include contrasting any hypothesis with the world of experience in a manner that must leave open the possibility that one might reject a particular hypothesis if it leads to wrong predictions about the world of experience. The possibility of empirical falsification of a hypothesis is carried out by ascertaining whether or not precise predictions derived as logical consequences from the hypothesis agree with the state of affairs found in the empirical world. A hypothesis that cannot be subject to the possibility of rejection by observation and experiment cannot be regarded as scientific.

There are 2 basic components in the process by which scientific knowledge advances. The first component consists of the formulation of a con-



jecture or hypothesis about the natural world. The second component consists of testing the hypothesis by ascertaining whether deductions derived from the hypothesis are indeed the case in the real world. This procedural practice has become known as the hypothetico-deductive method, often characterized as “the” scientific method. It is of the essence of the testing process that the predictions derived from the hypothesis to be tested not be already known, if the observations to be made are to serve as a genuine test of the hypothesis. If a hypothesis is formulated to account for some known phenomena, these phenomena may provide credibility to the hypothesis, but by themselves do not amount to a genuine empirical test of it for the purpose of validating it. The value of a test increases to the extent that the predicted consequences appear to be more and more unlikely before the observations are made.

The analysis of the hypothetico-deductive method may be traced to William Whewell (1794–1866) and William Stanley Jevons (1835–1882) in England and Charles S. Peirce (1838–1914) in the United States. In the 20th century, 2 philosophers who greatly contributed to identify the key features of the hypothetico-deductive method, and are broadly credited for this work, are Karl Popper (1902–1994) (Popper, 1959, 1963) and C. G. Hempel (1905–1997) (Hempel, 1965). But there is no better way of understanding the basic components of the scientific method, and its variations in different disciplines and peculiarities in different practitioners, than examining the work of great scientists, whose enormous accomplishments were made possible by their appropriate methodology. Early eminent practitioners of the hypothetico-deductive methodology include Blaise Pascal (1623–1662) and Isaac Newton (1624–1727). Among biologist contemporaries of Darwin, one might mention Claude Bernard (1813–1878), Louis Pasteur (1822–1895), and Gregor Mendel (1822–1884).

## IMAGINATION AND CORROBORATION

Some of these scientists explicitly described the methodology they followed in their research. Notable is the case of Claude Bernard (1865), who clearly describes the 2 stages of the scientific method: formulation of a testable hypothesis and testing it. Moreover, Bernard explicitly asserts that scientific theories of necessity are only partial and provisional.

A hypothesis is . . . the obligatory starting point of all experimental reasoning. Without it no investigation would be possible, and one would learn nothing: one could only pile up barren observations. To experiment without a preconceived idea is to wander aimlessly. . . . Those who have condemned the use of hypotheses and preconceived ideas in the experimental method have made the mistake of confusing the contriving of the experiment with the verification of its results. . . . When propounding a

general theory in science, the one thing one can be sure of is that, in the strict sense, such theories are mistaken. They are only partial and provisional truths which are necessary. . . to carry the investigation forward; they represent only the current state of our understanding and are bound to be modified by the growth of science.

A contemporary scientist, the Nobel Prize recipient François Jacob, has described research in the lab as an interplay between imagination (hypothesis formulation) and experiment:

What had made possible analysis of bacteriophage multiplication, and understanding of its different stages, was above all of the play of hypotheses and experiments, constructs of the imagination and inferences that could be drawn from them. Starting with a certain conception of the system, one designed an experiment to test one or another aspect of this conception. Depending on the results, one modified the conception to design another experiment. And so on and so forth. That is how research in biology worked. Contrary to what once I thought, scientific progress did not consist simply in observing, in accumulating experimental facts and drawing up a theory from them. It began with the invention of a possible world, or a fragment thereof, which was then compared by experimentation with the real world. And it was this constant dialogue between imagination and experiment that allowed one to form an increasingly fine-grained conception of what is called reality.

Jacob (1988, pp. 224–225)

As pointed out above, science is a complex enterprise that essentially consists of 2 interdependent episodes, one imaginative or creative, the other critical. To have an idea, advance a hypothesis, or suggest what might be true is a creative exercise. However, scientific conjectures or hypotheses must also be subject to critical examination and empirical testing. Scientific thinking may be characterized as a process of invention or discovery followed by validation or confirmation. One process concerns the formulation of new ideas (“acquisition of knowledge”), the other concerns their validation (“justification of knowledge”).

Scientists like other people come upon new ideas in all sorts of ways: from conversation with other people, reading books and newspapers, inductive generalizations, and even dreams and mistaken observations. Newton is said to have been inspired by a falling apple. Kekulé had been unsuccessfully attempting to devise a model for the molecular structure of benzene. One evening he was dozing in front of the fire. The flames appeared to Kekulé as snake-like arrays of atoms. Suddenly one snake appeared to bite its own tail and then whirled mockingly in front of him. The circular appearance of the image inspired in him the model of benzene as a hexagonal ring. The model to explain the evolutionary diversification

of species came to Darwin while riding in his coach and observing the countryside. "I can remember the very spot in the road . . . when to my joy the solution came to me. . . . The solution, as I believe, is that the modified offspring . . . tend to become adapted to many and highly diversified places in the economy of nature" (Barlow, 1958, pp. 120–121).

Hypotheses and other imaginative conjectures are the initial stage of scientific inquiry. It is the imaginative conjecture of what might be true that provides the incentive to seek the truth and a clue as to where we might find it. Hypotheses guide observation and experiment because they suggest what to observe. The empirical work of scientists is guided by hypotheses, whether explicitly formulated or simply in the form of vague conjectures or hunches about what the truth might be. However, imaginative conjecture and empirical observation are mutually interdependent episodes. Observations made to test a hypothesis are often the inspiring source of new conjectures or hypotheses. As described by Jacob, the results of an experiment often inspire the modification of a hypothesis and the design of new experiments to test it.

The starting point of scientific inquiry is the conception of an idea, a process that is, however, not a subject of investigation for logic or epistemology. The complex conscious and unconscious events underlying the creative mind are properly the interest of empirical psychology. The creative process is not unique to scientists. Philosophers and novelists, poets, and painters are also creative; they, too, advance models of experience and also generalize by induction. What distinguishes science from other forms of knowledge is the process by which this knowledge is justified or corroborated, at least provisionally, by observation and experimentation.

### THE CRITERION OF DEMARCATION

Testing a hypothesis involves at least 4 different activities (Ayala, 1994). First, the hypothesis must be examined for internal consistency. A hypothesis that is self-contradictory or not logically well formed in some other way should be rejected.

Second, the logical structure of the hypothesis must be examined to ascertain whether it has explanatory value, i.e., whether it makes the observed phenomena intelligible in some sense, whether it provides an understanding of why the phenomena do in fact occur as observed. A hypothesis that is purely tautological should be rejected because it has no explanatory value. A scientific hypothesis identifies the conditions, processes, or mechanisms that account for the phenomena it purports to explain. Thus, hypotheses establish general relationships between certain conditions and their consequences or between certain causes and their effects. For example, the motions of the planets around the Sun

are explained as a consequence of gravity, and respiration as an effect of red blood cells that carry oxygen from the lungs to various parts of the body.

Third, a hypothesis must be examined for its consistency with hypotheses and theories commonly accepted in the particular field of science and to see whether it represents any advance with respect to well-established alternative hypotheses. Lack of consistency with other theories is not always ground for rejection of a hypothesis, although it will often be. Some of the greatest scientific advances occur precisely when it is shown that a widely held and well-supported hypothesis is replaced by a new one that accounts for the same phenomena that were explained by the preexisting hypothesis, and other phenomena it could not account for. One example is the replacement of Newtonian mechanics by the theory of relativity, which rejects the conservation of matter and the simultaneity of events that occur at a distance, 2 fundamental tenets of Newton's theory.

Examples of this kind are pervasive in rapidly advancing disciplines, such as molecular biology at present. The so-called "central dogma" holds that molecular information flows only in one direction, from DNA to RNA to protein. The DNA contains the genetic information that determines what the organism is, but that information has to be expressed in the enzymes (and other proteins) that guide all chemical processes in cells. The information contained in the DNA molecules is conveyed to proteins by means of intermediate molecules, called messenger RNA. David Baltimore (1970) and Howard Temin (Temin and Mizutani, 1970) were awarded the Nobel Prize for discovering independently that information could flow in the opposite direction, from RNA to DNA, by means of the enzyme reverse transcriptase. They showed that some viruses, as they infect cells, are able to copy their RNA into DNA, which then becomes integrated into the DNA of the infected cell, where it is used as if it were the cell's own DNA.

Other examples are the following. Biochemists assumed that only the proteins known as enzymes could catalyze the chemical reactions in cells. However, Thomas Cech (1985) and Sidney Altman received in 1989 the Nobel Prize for independently showing that certain RNA molecules act as enzymes and catalyze their own reactions. One more example concerns the so-called "colinearity" between DNA and protein. Molecular biologists thought that the sequence of nucleotides in the DNA of a gene is expressed consecutively in the sequence of amino acids in the protein. This conception was shaken by the discovery that genes come in pieces, separated by intervening DNA segments that do not code for protein; Richard Roberts and Philip Sharp received the 1993 Nobel Prize for this discovery (Crick, 1979; Chambon, 1981).

These revolutionary hypotheses were published after their authors had subjected them to severe empirical tests. Theories that are inconsistent

with well-accepted hypotheses in the relevant discipline are likely to be ignored when they are not availed by convincing empirical evidence. The microhistory of science is littered with farfetched or ad hoc hypotheses, often proposed by individuals with no previous or posterior scientific achievements. Theories of this sort usually fade away because they are ignored by most of the scientific community, although on occasion they engage their interest because the theory may have received attention from the media or even from political or religious bodies. The fiasco 2 decades ago over “cold fusion” was an example of an unlikely and poorly tested hypothesis that received some attention from the scientific community because its proponents were well-established scientists (Taubes, 1993).

The fourth and most distinctive step in testing a scientific hypothesis consists of putting the hypothesis on trial by ascertaining whether or not predictions about the world of experience derived as logical consequences from the hypothesis agree with what is actually observed. This is the critical element that distinguishes the empirical sciences from other forms of knowledge: the requirement that scientific hypotheses be empirically falsifiable. Scientific hypotheses cannot be consistent with all possible states of affairs in the empirical world. A hypothesis is scientific only if it is consistent with some but not with other possible states of affairs not yet observed in the world, so that it may be subject to the possibility of falsification by observation. The predictions derived from a scientific hypothesis must be sufficiently precise that they limit the range of possible observations with which they are compatible. If the results of an empirical test agree with the predictions derived from a hypothesis, the hypothesis is said to be provisionally corroborated; otherwise it is falsified.

The requirement that a scientific hypothesis be falsifiable has been appropriately called the criterion of demarcation of the empirical sciences because it sets apart the empirical sciences from other forms of knowledge (Popper, 1959, 1963). A hypothesis that is not subject to the possibility of empirical falsification does not belong in the realm of science.

The requirement that scientific hypotheses be falsifiable rather than simply verifiable seems surprising at first. It might seem that the goal of science is to establish the “truth” of hypotheses rather than attempt to falsify them, but it is not so. There is an asymmetry between the falsifiability and the verifiability of universal statements that derives from the logical nature of such statements. A universal statement can be shown to be false if it is found to be inconsistent with even 1 singular statement, i.e., a statement about a particular event. But, a universal statement can never be proven true by virtue of the truth of particular statements, no matter how numerous these may be.

Consider a particular hypothesis from which a certain consequence is logically derived. Consider now the following argument: If the hypothesis

is true, then the specific consequence must also be true; it is the case that the consequence is true; therefore the hypothesis is true. This is an erroneous kind of inference called by logicians the “fallacy of affirming the consequent.” The error of this kind of inference may be illustrated with the following trivial example: If apples are made of iron, they should fall on the ground when they are cut off a tree; apples fall when they are cut off; therefore, apples are made of iron. The conclusion is invalid even if both premises are true. The reason is that there may be some other explanation or hypothesis from which the same consequences or predictions are derived. The observed phenomena are true because they are consequences from this different hypothesis, rather than from the one used in the deduction.

The proper form of logical inference for conditional statements is what logicians call the *modus tollens* (manner of taking away). It may be represented by the following argument. If a particular hypothesis is true, then a certain consequence must also be true; but evidence shows that the consequence is not true; therefore the hypothesis is false. The *modus tollens* is a logically conclusive form of inference. If both premises are true, the conclusion falsifying the hypothesis necessarily follows.

It follows from this reasoning that it is possible to show the falsity of a universal statement concerning the empirical world; but it is never possible to demonstrate conclusively its truth. This asymmetry between verification and falsification is recognized in the statistical methodology of testing hypotheses. The hypothesis subject to test, the null hypothesis, may be rejected if the observations are inconsistent with it. If the observations are consistent with the predictions derived from the hypothesis, the proper conclusion is that the test has failed to falsify the null hypothesis, not that its truth has been established. Accordingly, scientific theories are never established as definitive truths. As Claude Bernard stated, theories “represent only the current state of our understanding and are bound to be modified by the growth of science” (Bernard, 1865).

## DARWIN

Charles Robert Darwin (1809–1882) was the son and grandson of physicians. In 1825 he enrolled as a medical student at the University of Edinburgh. After 2 years, however, he left Edinburgh to study at the University of Cambridge and prepare to become a clergyman. He was not an exceptional student, but he was deeply interested in natural history. On Dec. 27, 1831, a few months after his graduation from Cambridge, he sailed as a naturalist aboard the HMS *Beagle* on a round-the-world trip that lasted until October 1836. Darwin was often able to disembark for extended trips ashore to collect natural specimens. The discovery of fossil bones from



large extinct mammals in Argentina and the observation of numerous species of finches in the Galápagos Islands were among the events credited with stimulating Darwin's interest in how species originate. In 1859 he published *On the Origin of Species by Means of Natural Selection* (Darwin, 1859), a treatise establishing the theory of evolution and, most important, the role of natural selection in determining its course. He published many other books as well, notably *The Descent of Man and Selection in Relation to Sex* (Darwin, 1871, 2nd ed.), which extends the theory of natural selection to human evolution.

Darwin occupies an exalted place in the history of Western thought, deservedly receiving credit for the theory of evolution. In *The Origin of Species*, he laid out the evidence demonstrating the evolution of organisms: 2 chapters dedicated to the geological record, 2 chapters dedicated to biogeography, and 1 chapter dedicated to comparative anatomy and embryology (Darwin, 1859, chapters IX–XIII). However, Darwin accomplished something much more important than demonstrating evolution. Indeed, accumulating evidence for common descent with diversification may very well have been a subsidiary objective of Darwin's masterpiece. Darwin's *Origin of Species* is, first and foremost, a sustained argument to solve the problem of how to account scientifically for the "design" of organisms. Darwin seeks to explain the adaptations of organisms, their complexity, diversity, and marvelous contrivances as the result of natural processes. Darwin brings about the evidence for evolution because evolution is a necessary consequence of his theory of natural selection. Nine chapters (I–VIII and XIV) of *Origin* (Darwin, 1859) are dedicated to natural selection. He explains how natural selection works and the role of hereditary variation (the mechanics of which were not well understood in Darwin's time), and he considers possible objections to his theory.

The evolution of organisms was commonly accepted by naturalists in the middle decades of the 19th century. The distribution of exotic species in South America, in the Galápagos Islands and elsewhere, and the observation of fossil remains of long-extinguished animals during his voyage on the *Beagle*, would contribute to confirm the reality of evolution in Darwin's mind. The intellectual challenge after his return to Britain was not simply to accumulate evidence showing that species evolve. Rather, the fundamental challenge was to explain the origin of distinct species of organisms and how they adapted to their environments, that "mystery of mysteries," as it had been labeled by Darwin's older contemporary, the prominent scientist and philosopher Sir John Herschel (1792–1871). As Darwin wrote in his *Autobiography* (Barlow, 1958), "I had always been much struck by such adaptations, and until these could be explained it seemed to me almost useless to endeavor to prove by indirect evidence that species have been modified."



Darwin had come to accept the evolution of organisms by the time he returned from the voyage of the *Beagle* in October 1836 or shortly thereafter. This is apparent from the notebooks he wrote during the voyage, and those known as the “Transmutation Notebooks,” which he wrote in the ensuing 2 years, after his return (Darwin, 1960). Important as it was to obtain evidence of the origin of species by evolution, this seemed to him to pale compared with the need for demonstrating how the complex adaptations of organisms, their design, came about, namely, by natural selection.

The advances of physical science accomplished by the “Copernican Revolution” of the 16th and 17th centuries had brought the workings of the universe under the domain of science: explanation by natural laws that can be tested by observation and experiment. The fundamental commitment was to the postulate that the universe consists of matter in motion governed by natural laws. All physical phenomena could be accounted for as long as the causes became adequately known. However, the origin and configuration of living creatures had been left out, because it seemed that the complex design of organisms could not have come about by chance or by the mechanical laws of physics, chemistry, and astronomy.

The notion that the design of organisms could not be accounted for by the laws of nature had been argued at length by philosophers and theologians. William Paley, for example, made the case with considerable biological detail and thoughtful argumentation in his *Natural Theology* (Paley, 1802), a book that Darwin read as part of his studies at Cambridge University. Paley argued that in the same way that the harmony of the parts making a watch manifest that it had been designed by a skilled watchmaker, so the design of the human eye, with its transparent lens, its retina placed at the precise distance for forming a distinct image, and its large nerve transmitting signals to the brain, manifested to have been designed by the Creator.

Darwin’s theory of natural selection brought the adaptations of organisms within the realm of explanation by natural laws. Darwin completed the Copernican Revolution by drawing out for biology the notion of nature as a lawful system of matter in motion that human reason can explain without recourse to supernatural or extranatural agencies. The origin and adaptations of organisms in their profusion and wondrous variations were thus brought into the realm of science.

## NATURAL SELECTION

Darwin considered natural selection, rather than his demonstration of evolution, his most important discovery and designated it as “my theory,” a designation he never used when referring to the evolution of organ-

isms. The discovery of natural selection, Darwin's awareness that it was a greatly significant discovery because it was science's answer to Paley's argument-from-design, and Darwin's designation of natural selection as "my theory" can be traced in Darwin's "Red Notebook" and "'Transmutation Notebooks B to E,'" which he started in March 1837, not long after returning (on October 2, 1836) from his 5-year voyage on the *Beagle*, and completed in late 1839 [Darwin (1960) and see Eldredge (2004)].

Early in the notebooks of 1837–1839, Darwin registers his discovery of natural selection and repeatedly refers to it as "my theory." From then until his death in 1882, Darwin's life would be dedicated to substantiating natural selection and its companion postulates, mainly the pervasiveness of hereditary variation and the enormous fertility of organisms, which much surpassed the capacity of available resources. Natural selection became for Darwin "a theory by which to work." He relentlessly pursued observations and performed experiments to test the theory and resolve presumptive objections. These studies were reported in numerous papers and volumes dedicated to barnacles (fossil and living), orchids and their fertilization by insects, insectivorous and climbing plants, earthworms, and much more.

This is how Darwin describes his discovery of natural selection in the *Autobiography*: "In October, 1838, that is, 15 months after I had begun my systematic enquiry, . . . it at once struck me that under these circumstances [struggle for existence, as in Malthus] favorable variations would tend to be preserved, and unfavorable ones to be destroyed. . . . Here then I had at last got a theory by which to work; but I was so anxious to avoid prejudice, that I determined not for some time to write even the briefest sketch of it" (Barlow, 1958).

Darwin had in natural selection an explanatory hypothesis to account for the adaptations of organisms that would allow him to design observations and experiments for testing the hypothesis' validity. "What Darwin meant by 'a theory by which to work' was no less than natural selection and trying to derive—as 'predictions'—the expected consequences of natural selection in action over long periods of time. From natural selection, Darwin tried to derive those very same basic patterns that he had seen in the natural world" (Eldredge, 2004).

Despite occasional claims by Darwin himself that he proceeded according to Baconian principles or that he accumulated wholesale facts without any preconceived idea as to what they might imply, Darwin was an excellent practitioner of the hypothetico-deductive method of science. Such claims are little more than "window dressing," seeking to allay the concerns of his contemporaries, whether philosophers or other possible critics, who would surely find his theory of natural selection hard to take and would be prompt to denounce it as a prejudicial abstraction without

empirical foundation. In his correspondence and *Autobiography*, Darwin recognized the primary role played by theory. When he came upon the hypothesis of natural selection in 1838, he became aware of its enormous explanatory power to account for the adaptations of organisms and their diversification. He would dedicate much of his scientific activity for the rest of his life to developing the theory of natural selection by considering possible objections and by subjecting it to severe tests, investigating precisely those adaptations (behavioral, sexual, anatomical) that would seem contrived more by preconceived design than as adaptations by natural selection.

Modern students of Darwin have convincingly shown Darwin's exemplary scientific methodology [e.g., De Beer (1964), Mayr (1964, 1982, 1988), Ghiselin (1969), Hull (1973), Ruse (1979), Eldredge (2004)]. Darwin's 4 monographs on barnacles (Darwin, 1851a,b, 1854a,b) and his books on the fertilization of orchids (Darwin, 1862), human evolution and sexual selection (Darwin, 1871), climbing plants (Darwin, 1875b), insectivorous plants (Darwin, 1875a), the formation of vegetable mold by worms (Darwin, 1881), and others must be seen as severe tests of natural selection, carried out precisely by investigating biological phenomena, including some seemingly quite peculiar, that would seem, at least at first sight, incompatible with his theory of natural selection.

Michael Ghiselin (1969) has perceptively shown in *The Triumph of the Darwinian Method* that the lion's share of Darwin's research and publications were a sustained effort to subject the hypothesis of natural selection to severe tests. "Unless one understands this—that Darwin applied, rigorously and consistently, the modern, hypothetico-deductive scientific method—his accomplishments cannot be appreciated. His entire scientific accomplishment must be attributed not to the collection of facts, but to the development of theory. . . . That Darwin realized the great importance of hypothesis in his work can be documented by his numerous remarks on that subject. In a letter to a colleague, he explicitly compares his hypothesis of natural selection to the undulatory theory of light with its ether, and to the attractive power in Newton's theory of gravitation" (p. 4).

Darwin advanced hypotheses in multiple fields, including geology, plant morphology and physiology, psychology, and evolution, and subjected his hypotheses to empirical test. "The line of argument often pursued throughout my theory is to establish a point as a probability by induction and to apply it as a hypothesis to other parts and see whether it will solve them" [cited in De Beer (1964, p. 94)]. Popper (1959, 1963) has made clear that falsifiability is the criterion of demarcation of the empirical sciences from other forms of knowledge, but also that falsification of seemingly true hypotheses contributes to the advance of science. Darwin recognized the same: "False facts are highly injurious to the progress of

science, for they often endure long; but false views, if supported by some evidence, do little harm, for every one takes a salutary pleasure in proving their falseness; and when this is done, one path toward error is closed and the road to truth is often at the same time opened" (Darwin, 1960).

Darwin saw natural selection as an overarching explanatory hypothesis that gave a causal explanation of evolutionary change, was consistent with the experience of plant and animal breeders, and made sense of a host of facts, such as he had uncovered in his research on barnacles, orchids, climbing plants, and many others. The evidence for natural selection, he asserts in a letter is "(i) On its being a *vera causa*, from the struggle for existence; and the certain geological fact that species do somehow change. (ii) From the analogy of change under domestication by man's selection. (iii) And chiefly from this view connecting under an intelligible point of view a host of facts" (Darwin F, 1887c, Vol. III, p. 25).

### PHYLOGENY AND CLASSIFICATION

Some philosophers of science have claimed that evolutionary biology is a historical science that does not need to satisfy the requirements of the hypothetico-deductive method. The evolution of organisms, it is argued, is a historical process that depends on unique and unpredictable events, and thus is not subject to the formulation of testable hypotheses and theories. Such claims emanate from a monumental misunderstanding. There are 2 kinds of questions in the study of biological evolution. One concerns history: the study of phylogeny, the unraveling and description of the actual course of evolution on Earth that has led to the present state of the biological world. The scientific disciplines contributing to the study of phylogeny include taxonomy, systematics, paleontology, biogeography, comparative anatomy, comparative embryology, and comparative molecular biology. The second kind of question concerns the elucidation of the mechanisms or processes that bring about evolutionary change. These questions deal with causal, rather than historical, relationships. Population genetics, population ecology, paleobiology, molecular biology, and many other branches of biology are the relevant disciplines.

There can be little doubt that the causal study of evolution proceeds by the formulation and empirical testing of hypotheses, according to the hypothetico-deductive methodology that is also characteristic of the physicochemical sciences and other empirical disciplines concerned with causal processes. But the study of evolutionary history is also based on the formulation of empirically testable hypotheses. Consider a simple example. For many years specialists proposed that the evolutionary lineage leading to humans separated from the lineage leading to the great apes (chimpanzee, gorilla, orangutan) before the lineages of the great apes

separated from each other. Some recent authors have suggested instead that humans, chimpanzees, and gorillas are more closely related to each other than the chimpanzee and the gorilla are to the orangutan and other Asian apes. A wealth of empirical predictions can be derived logically from these competing hypotheses. One prediction concerns the degree of similarity between enzymes and other proteins. It is known that the rate of amino acid substitutions is approximately constant when averaged over many proteins and long periods of time. If the older hypothesis is correct, the average amount of protein differentiation should be greater between humans and the African apes than among these and orangutans. However, if the newer hypothesis is correct, humans, gorillas, and chimpanzees should have greater protein similarity than any of the 3 has with orangutans. These alternative predictions provide a critical empirical test of the hypotheses. The available data favor the second hypothesis. Humans, chimpanzees, and gorillas appear to be phylogenetically more closely related to each other than any one of them is related to orangutans, and chimpanzees are more closely related to humans than they are to gorillas.

Certain biological disciplines relevant to the study of evolution are largely descriptive and classificatory. Description and classification are necessary activities in all branches of science, but play a greater role in certain biological disciplines, such as systematics and biogeography, than in other disciplines, such as population genetics. Nevertheless, taxonomy, systematics, and biogeography also use the hypothetico-deductive method and formulate empirically testable hypotheses (Brooks and McLennan, 1991; Hillis et al., 1996).



# 14

## The Darwinian Revolution: Rethinking Its Meaning and Significance

---

MICHAEL RUSE

The Darwinian revolution is generally taken to be one of the key events in the history of Western science. In recent years, however, the very notion of a scientific revolution has come under attack, and in the specific case of Charles Darwin and his *Origin of Species* there are serious questions about the nature of the change (if there was such) and the specifically Darwinian input. This chapter considers these issues by addressing these questions: Was there a Darwinian *revolution*? That is, was there a revolution at all? Was there a *Darwinian* revolution? That is, what was the specific contribution of Charles Darwin? Was there a *Darwinian revolution*? That is, what was the conceptual nature of what occurred on and around the publication of the *Origin*? I argue that there was a major change, both scientifically and in a broader metaphysical sense; that Charles Darwin was the major player in the change, although one must qualify the nature and the extent of the change, looking particularly at things in a broader historical context than just as an immediate event; and that the revolution was complex and we need the insights of rather different philosophies of scientific change to capture the whole phenomenon. In some respects, indeed, the process of analysis is still ongoing and unresolved.

---

Department of Philosophy, Florida State University, Tallahassee, FL 32306.



Thirty years ago I (Ruse, 1979) published a book with the main title *The Darwinian Revolution*. No one questioned whether or not I had a real topic. There was a Darwinian revolution and my book was about it. Today, one could not be so sure. The idea of scientific revolutions has been questioned; Darwin's contribution has been challenged; and even if you can come up positively on these matters, what on earth are we talking about anyway? These are the 3 questions I shall address in this article.

### WAS THERE A DARWINIAN REVOLUTION?

Historian Jonathan Hodge (2005) has been one of the strongest naysayers on this matter. He thinks that the whole talk of scientific revolutions, something of an obsession by many historians and philosophers of science in the years after Thomas Kuhn's engaging and influential *The Structure of Scientific Revolutions* (1962), is deeply misleading. The term is obviously taken by analogy from politics and even there it is doubtful that there are such things (at least that there are such things with common features) and in science likewise we have no reason to think that there are such things with common features. In any case, the talk is wrong-headed because it drives you to concentrate on some people and events and downplay or ignore other people and events.

In response, let us agree at once that focusing on revolutions (in science) does rather skew things in certain ways. Dwelling at length on Darwin carries the danger of ignoring the contributions of others in the 19th century, from the *Naturphilosophen* (people like the German anatomist Lorenz Oken who saw homologies everywhere) at the beginning to the orthogeneticists (people like the American paleontologist Henry Fairfield Osborn who thought that evolution has a momentum that carries it beyond adaptive success) at the end. Worse, it gives the impression that unless you have something dramatic and crisis-breaking, the science is of little value. Remember, the alternative to Kuhn's revolutionary science is normal science, and this has (a perhaps undeserved) reputation of a 3-hour sermon by a Presbyterian minister on a wet Sunday in Scotland.

Against this, however, one can point out that the history of science as a professional discipline is little more than 50 years old and that you have to start somewhere. In the case of Darwin, even 30 years ago there was no real synthesis. The tragedy would have been if historians of science had stopped there and gone no further. But this is clearly not true. In the past 30 years or more, staying just with the history of evolutionary thinking, there has been a huge amount of work on people before and after Darwin, and on his contemporaries like Thomas Henry Huxley [for instance, Desmond (1999)]. To name but 3 researchers, one can pick out Robert J. Richards

(1987, 1992, 2002, 2008b) and the work he has done on German evolutionary thinking in the 19th century, before and after Darwin; Peter Bowler (1976, 1984, 1988, 1996), who started with paleontology in the 18th century and since has written extensively on the post-Darwinian figures in the 19th century, now extending his grasp into the 20th century; and William Provine (1971, 1986), who has offered detailed and brilliant analyses of the impact of genetics on the understanding of evolution. It just has not been the case that focusing first on Darwin led us to an inescapable dead end with respect to the rest of evolution's history.

Should we nevertheless persist with the term "revolution"? Well, it surely depends on the case to be made. Obviously we can legitimately use the term revolution somewhat generically in politics. No one thinks the American Revolution and the French Revolution were the same, but they did share characteristics that, for example, the move from Ronald Reagan as president to George H. W. Bush did not. There was a break from the old government and this was done by a group seizing power, leading to dramatic changes. I see no reason we should not extend the term metaphorically. Think of the technological revolution in the past 20 years or so. Laptop computers are commonplace, electronic use of libraries is the norm, and search engines like Google and Yahoo have transformed the gathering of information. If this does not all add up to a revolution of some kind, it is hard to know what does. There is as much of a break with the past as there was for an American ruled from Washington rather than London. At an immediate level, the change is probably even greater.

So if you want to extend the term revolution to science, if it captures something of what goes on, then all power to the use. But now the question is whether the Darwinian revolution merits the use. Was there a big break with the past, sufficiently significant to speak of revolution? Did something big, really big, happen around 1859, and does it still merit a special place in the history of evolutionary thought? In respects, our appreciation of what happened is even greater than it was 30 years ago: If you like, today in 2009 the 200th anniversary of Darwin's birth as opposed to 1982, the 100th anniversary of Darwin's death. Daniel Dennett (1995) has referred to Darwin's idea about natural selection as the greatest ever. One could debate this (Plato's theory of forms gives it a good run for its money), but all will certainly agree that something really big happened around and because of the *Origin* in 1859 (Darwin, 1859). But here, let us take note of some of Hodge's worries. The basic question is: What are we talking about? In the Darwinian case there are 2 levels of activity and interest. Without pretending that the divisions are completely simon-pure, there is the level of science and the level of metaphysics (recognizing that this includes things that might be considered scientific at one end and religious or otherwise ideological at the other end).

On one hand, there is the scientific theory of evolution through natural selection, the central topic of the *Origin*. On the other hand, there is what scholars like Robert M. Young (1985), borrowing a title from Thomas Henry Huxley (1863), used to refer to as the debate over “man’s place in nature.” While today we would never dare to use that kind of language, in essence they got it absolutely right. At some level, the Darwinian revolution destroyed forever the old picture of humans as somehow miraculously special, symbolically and literally as touched by magic. Admittedly, to this day Christian fundamentalists (and those of other religions) refuse to accept this, but it is true. Even if you think that you can still be religious, a Christian even, you have to rethink dramatically, emotionally even more than intellectually, what it means to be a human. Starting with a certain modesty about ourselves (Ruse, 2001).

It is hard to know how one would respond to someone who questioned the significance of the changes at either of these 2 levels. At the level of science, changing over to the idea of evolution in itself is a massive change to make, whether you are moving from a Greek theory of eternal life without change or a more Christianized vision of the instantaneous appearance of life. And then you add in the mechanism of natural selection, used by at least 90% of today’s evolutionists, and you have an even greater break with the pre-*Origin* past. At the level of metaphysics, the change is yet deeper if that is possible. The violent opposition of the American above-mentioned fundamentalists or creationists shows that if anything could. It is not just a question of who we are but also of how we should live our lives (Ruse, 2005). Although it is hardly the only factor, Darwinian thinking is at the center of the move to modernism, in some broad sense. Are we still to be subject to the old ways (women inferior, gays persecuted, abortion banned) or are we to look forward to a truly post-Enlightenment world, with reason and evidence making the running in an entirely secular fashion?

Grant then that something big did happen. But are we right in putting it all on 1859 and the publication of the *Origin of Species*? This raises my second big question. Divide the answer according to the levels of inquiry.

### WAS THERE A DARWINIAN REVOLUTION? SCIENCE

Start with one indubitable fact. There always have been and there always will be people who think that not only was Alfred Russel Wallace, the codiscoverer of natural selection, unappreciated but that Charles Darwin pinched all of the good ideas from the younger evolutionist. It should be called the Wallacean revolution with Charles Darwin but a minor footnote. [Brackman (1980) is the classic exemplification.] There

are other candidates for the job. Edward Blyth, an English-born Indian naturalist, has long been a popular name. [Eiseley (1958) was the source for this one.] More recently, in an award-winning book, James Secord (2000) argued that really it was Robert Chambers, the anonymous Scottish author of the *Vestiges of the Natural History of Creation* (Chambers, 1844), who did the heavy lifting. Darwin came along at the end to inherit all of the glory. (Try [www.darwin-legend.org](http://www.darwin-legend.org) for a cross-sample of these sorts of charges.)

There is little need to spend much time on these claims because basically they don't hold much water. Let it be shouted out loud. Darwin did not steal from Wallace. Darwin's ideas—the ideas of the *Origin* that is—are all right there in the 35-page *Sketch* of his ideas that he wrote in 1842 (Darwin and Wallace, 1958). There was some tweaking about the nature of adaptation; perhaps he hit in the early 1850s on the principle of divergence—although there are certainly hints of that in the species notebooks—but the mechanisms (natural and sexual selection) are there, as is the structure of the argument of the *Origin* (more on this in a moment). Even some of the flowery passages, notably the final paragraph about grandeur in views of life, can be found in the early writings. Wallace certainly stimulated Darwin to get moving, but that was it. And incidentally, if you study Wallace's essay carefully, you see differences from Darwin. Wallace, for instance, denied the pertinence of artificial selection. Wallace never had the term “natural selection.” Wallace had inclinations to group selection in a way absent from the *Origin* or earlier writings. This is not to belittle Wallace. Not at all! But he was not Charles Darwin.

The claims of others can be dismissed as well. Before Darwin, there were several people who had thoughts of natural selection and we know that he read some of them. For instance, in a pamphlet by the breeder John Sebright, there is an explicit reference to the force of natural selection, a reference that stimulated Darwin to underline the words and make a comment in the margin (Ruse, 1975a). But there is no real question that these people sparked full evolutionary thoughts in Darwin, and generally the last thing they wanted to do was use natural selection to promote evolution. Edward Blyth (1835), with whom Darwin was to have very cordial and helpful correspondence (he actually drew Darwin's attention to an important earlier essay by Wallace) explicitly denied that his thinking had evolutionary implications. And as far as others were concerned, pre-Darwinian (that is pre-*Origin*) evolutionists in particular, they certainly had effects on general opinion, but not like Darwin. Chambers's *Vestiges* undoubtedly took the sting out of evolution, so by the time that Darwin published, it was to a certain extent old hat, but it did not have the effect of the *Origin*. The same is true of others, like Herbert Spencer. For all that Spencer (1852), too, hit on the idea of selection, he always thought that

Lamarckism is the chief cause of evolutionary change, and while his thinking did influence some, including his big friend Thomas Henry Huxley, he likewise did not swing people in the way that the *Origin* did.

Having said all of this, however, there are some interesting questions about the extent to which the revolution was truly Darwinian. Clearly some nuanced thinking is needed, starting with the fact that there was 150 years of evolutionary thinking before Darwin, including speculations by his own grandfather Erasmus Darwin. Toward a fuller analysis, divide the history of evolutionary thinking into 3 periods (Ruse, 1996). The first period, from the early 18th century (the time of the French encyclopediast and early evolutionist Denis Diderot) to the publication of the *Origin* in 1859, was the time when the status of evolutionary thinking was that of a pseudo science: an emergent on the cultural value of progress. Second, from the *Origin* to the full incorporation of Mendelism into evolutionary thinking, say  $\approx$ 1930 with the work of Ronald Fisher, J. B. S. Haldane, and Sewall Wright, evolution had the status of a popular science. There was some professional work going on, particularly in the area of phylogeny tracing, but generally evolution was a museum science, still a vehicle for thoughts of progress. Causal thinking was second-rate or (often) absent entirely. Top-quality work in biology was increasingly by young researchers who turned from phylogeny tracing to microscope-based sciences, especially cytology, and then on to genetics in the 20th century. Finally, from 1930 to the present we have a fully professional science of evolutionary biology. We entered the era of neo-Darwinism (as it was called in Britain) or the synthetic theory of evolution (as it was called in the United States).

Now, frame the discussion against the background of this 3-fold division of history. If we consider the revolution in a broad sense, from the beginning of the 18th century to the beginning of the 21st century, there are 2 major points at which we want to say that it is a Darwinian revolution. The first was in the transition from being a pseudo science to being a popular science. Before the *Origin*, the evidence for evolution just was not there. If you believed in evolution, you were fueled primarily by ideological reasons. It is true that people knew about homologies, the fossil record was starting to fill out, embryology was suggestive, and so forth. But the full picture was not there. After the *Origin*, being an evolutionist was just plain common sense. And people did become evolutionists. Even church people. With the notable exception of American evangelicals, especially in the South, evolution was accepted (Roberts, 1988). It is true that there was some backsliding, in the Catholic Church especially by century's end, but overall people became evolutionists (Artigas et al., 2006).

This change was thanks to Darwin, especially to the structure of the argument in the *Origin*. The methodologists of science of the day, more

particularly, the methodologists of science of the 1830s when Darwin was discovering and formulating his theory, insisted that the best science has at its heart a true cause, a *vera causa*. They differed over what is the mark of a *vera causa*. John F. W. Herschel (1830), with empiricist leanings, insisted that we have direct sensory evidence or something analogical. We know that a force pulls the moon toward the Earth because swinging a stone around on a piece of string requires you to pull the stone in toward you. William Whewell (1837, 1840), with rationalist leanings, insisted that we justify the acceptance of our hypothesis through its implying a whole range of empirical evidence, thus manifesting what Whewell called a “consilience of inductions.” As in a court of law, where the guilt is ascribed through the wide range of clues that it explains, Darwin set about satisfying both *vera causa* criteria (Ruse, 1975b). First, he argued analogically from artificial selection (the work and triumphs of the animal and plant breeders) to natural selection, from something known and seen to something not known and seen. Then he turned around, and showed how evolution through selection throws light on topics across biology, instinct, paleontology, biogeography, systematics, anatomy, embryology, and more. As evolution through selection explains, so conversely the explained areas justify our faith in evolution through selection.

There are questions about how effective was the appeal to artificial selection. Generally before the *Origin* it was taken as a reason not to believe in ongoing change (no one has turned a horse into a cow) and I have mentioned how Wallace denied explicitly that it was relevant to the evolution issue. After the *Origin*, people like Huxley took the failure to create new species artificially as a reason to hesitate before full acceptance of natural selection’s powers. However, undoubtedly at some level the analogy softened people up to evolution. Part of Darwin’s genius was always to put his ideas into comfortable contexts. He argued to natural selection via the struggle for existence, which was something that came out of the thinking of the Reverend Thomas Robert Malthus (1826), who pointed out that population demands will always outstrip potential gains in space and food. Everyone knew about these Malthusian calculations, and, even if they did not much like them, generally they accepted the conclusions. Likewise with the world of breeders, people at least took some comfort from the arguments provided by Darwin, even if they were not definitive.

The consilience was a different matter. Here, Darwin did persuade. At least, he persuaded to a point. As noted, evolution after the *Origin* was nigh a truism. The mechanism was another matter. No one denied natural selection. Very few accepted that it could be as powerful as Darwin suggested. People became evolutionists in droves. The number of pure Darwinians, as we might term selectionists, was very few, and the most



prominent after Darwin himself, namely Wallace (1870), became enamored of spiritualism in the 1860s and he started to deny selection when it came to humans. The reasons for this halfway acceptance are well known. On one side, there were scientific problems with selection. It was thought that it could never be strong enough to overcome the supposed averaging nature of heredity. Even the best new variations would be swamped into nonbeing in a generation or two (Greg, 1868). Added to this the physicists (ignorant as they were of the warming effects of radioactive decay) denied that there was time enough for such a leisurely process as natural selection (Burchfield, 1975). On the other side, there was the matter of adaptation. Selection does not just bring about change. It brings about adaptive change. This ran into trouble from folk at both ends of the spectrum. German-influenced biologists like Huxley (1884) thought that adaptation is but a minor phenomenon, and hence felt no need to embrace selection on that score. Nonadaptive saltations (jumps, what we today would call “macromutations”) would do the job for evolution. Heavily Christian evolutionists like American botanist Asa Gray (1876) thought that selection could not fully explain adaptation and so they wanted (God-) directed variations. As Darwin said, this rather made natural selection redundant.

So after 1859, it was evolution yes; natural selection, much less so. This meant that the dream that Darwin had had of founding a professional science of evolutionary studies, based on natural selection, never really got off the ground. There certainly was professional evolutionism, particularly that around the German biologist Ernst Haeckel (1866). But, increasingly, a lot of what was produced lost touch with reality as fantabulous tales were spun using the unreliable biogenetic law, ontogeny recapitulates phylogeny. In Britain you had the incredible paradox that the chief post-*Origin* evolutionist in the second half of the 19th century, a man deeply involved in and highly influential on postsecondary education, Thomas Henry Huxley, never taught evolution to his students. He thought they should concentrate on physiology and morphology (Ruse, 1996).

So evolution became the subject of the popular lecture hall, working men’s clubs, and the public-friendly British Association for the Advancement of Science, and the leading evolutionists moved from the universities to the museums. Huxley student E. Ray Lankester ran the British Museum (Natural History) in London and Huxley student Henry Fairfield Osborn ran the American Museum of Natural History in New York. And what you want in museums are displays, with an educational and cultural message. So this is what was supplied. Terrific displays of fossils, especially of all of those dinosaurs now being discovered and brought back from the American West, and all put in a progressive fashion to demonstrate



that life may have started as blobs but that it ends as humans, especially white humans.

Finally, ≈1930 came the move from popular science to professional science. First there were the mathematicians, the population geneticists mentioned above. Then came the empiricists, the experimenters, and naturalists, who put flesh on the mathematical bones: E. B. Ford and his school in Britain and Theodosius Dobzhansky and his fellow evolutionists in the United States. Now we had university posts, researchers, graduate students and grants, journals, societies, and everything else we associate with professional science, and not just at the sociological level, because the work produced was firmly based on empirical studies with mathematical models doing the explaining. The epistemic virtues of science (consistency, coherence, predictability, fertility, simplicity) were taken seriously and the worth of work was judged by its success against these virtues. And right at the heart was natural selection, which continues to this day. Here, again then Darwin has made a major contribution to evolutionary studies.

### WAS THERE A DARWINIAN REVOLUTION? METAPHYSICS

What of the Darwinian revolution in the broader sense, the side dealing with our metaphysical view of ourselves, our place in nature? Here, Darwin was crucially important if not completely successful. He himself was stone-cold certain that we humans are part of the world of nature. His experience with the native people from the bottom of South America, the Tierra del Fuegians, had convinced him of that (Darwin, 1969). And he made his case publicly, as is well known, not in the *Origin* (which was somewhat reticent on the human question) but in the *Descent of Man*, published some 12 years later (Darwin, 1871). However, now we must ask what it means to put ourselves in nature. There are 3 possible answers. First, it can simply be to make humans part of the natural order of things. We are ruled by the laws of physics and chemistry and biology and so forth just like anything else. Second, it can be showing that natural selection was the chief causal force making us what we are, and perhaps that selection is still significant. Third, it can be to claim that we are no different from anything else, at least in value or worth. An oak tree, a wart hog, a human, ontologically and axiologically they are the same.

If you are thinking of the first of these claims, if you think of the Darwinian revolution as an attempt to make humans entirely natural, in the sense of produced and working according to the same laws of nature as everyone else, one can truly say that for many people this revolution has succeeded and Darwin played a major role in its success. The *Origin* put us firmly in the natural picture and then following up the *Descent of Man* was a major analysis of humankind from a naturalistic perspective, cover-

ing not just our physical frames but also our moral beliefs and social and intellectual natures generally. No one would want to say that it was Darwin alone. Huxley and his *Man's Place in Nature* (1863) was a key figure back then and of course there have been literally hundreds of other contributors, in and out of biology, since. But Darwin deserves his name up there. Even those who may not much care for the work actually being produced seem to agree that the naturalistic program is the right one and that it must take evolution into account. Although having said this, it must be admitted that there are many for whom this program is unacceptable, and who would deny that Darwin has succeeded or indeed could succeed. The official Catholic position, for instance, is that we have souls and these are created and inserted miraculously into human frames, actually, human zygotes (John Paul II, 1997). And this obviously is but one end of the spectrum that goes all of the way, through the kind of directed evolution allowed by some members of the intelligent design theorists (Behe, 1996), across to the hard-line young earth creationists who think that humans were created miraculously on the sixth day (Whitcomb and Morris, 1961).

Second, what about natural selection? Again, Darwin is very important, perhaps indeed more important than just the naturalism part. The *Descent of Man* showed in detail how natural selection (combined with sexual selection) is a crucial explanatory factor behind much that we think of as human, physical, and social. This is a path that many have followed, most notably in recent times by Harvard biologist Edward O. Wilson in his *On Human Nature* (1978), a work that covers morality, religion, conflict, and much more. Wilson is not a hard-line evolutionary determinist, but he does argue that (in his language) the twig is bent. The human mind is not a *tabula rasa* but shaped by the forces of natural selection. And many workers in the evolutionary field today would agree, from physical anthropologists through human behavioral ecologists and on to evolutionary psychologists.

However, 2 reservations must be expressed. First, much that has been claimed in the name of Darwinian selection bears but a passing resemblance to the program of the *Descent*. Historically, one thinks of social Darwinism, a movement that covered many different ideologies and that generally owed more to Herbert Spencer than to Charles Darwin (Ruse, 2000). When, to take a particularly egregious example, German general Friedrich von Bernhardi (1912) claimed that Darwin showed that might is right and that the Motherland has almost an obligation to seize from its neighbors, he owed little to the old evolutionist who had worked away in his study in the English countryside. One might as much credit Plato because the doctrine more closely resembled the thinking of Thrasymachus in the *Republic*. Today one has similar divisions. For instance, philosopher Peter Singer (2000) has claimed the authority of Darwin for an explicitly

left-wing manifesto. Philosopher Larry Arnhart (2005) has no less enthusiastically claimed Darwin's support for a right-wing view of society.

Second, it must be appreciated that (apart from those who reject the naturalistic program in itself) there are those who argue that natural selection is not the appropriate tool to analyze human nature. Clearly a lot of social scientists think this, but so also do prominent biologists. The Harvard geneticist Richard Lewontin, a committed Marxist, is one who denies that evolutionary biology is the key to understanding *Homo sapiens*. He opts rather for economic and like forces (Levins and Lewontin, 1985). It may well be that the late Stephen Jay Gould shared his sentiments. With some few exceptions, notably Elliott Sober (1981) who has not only argued for the influence of selection on our modes of thinking in the realm of science but who has also coauthored a spirited defense of the selection-based nature of human morality (Sober and Wilson, 1997), the philosophical community feels negatively inclined to the selection-explains-humans program. The particulars are thought wrong; feminist philosopher Lisa Lloyd (2005) launched a heavy attack on the putative biological basis of the human female orgasm. But more importantly the overall program is declared ideological and inadequate. Even those who think there might be a possibility of a selection-based approach to human nature declare regretfully that the quality of the work produced thus far falls far short of the standards of adequate science (Buller, 2005; Richardson, 2007).

We come to the third claim, namely that we humans are not in any way special. You might think that proving this was Darwin's intent; after all, he did caution himself never to use the terms "higher" and "lower" (writing this on the flyleaf of his copy of *Vestiges*) and the mechanism of natural selection is nothing if not egalitarian. What is it better to be, the AIDS virus or a lowland gorilla? Speaking purely biologically, there are few who would speak up for the ape. However, it cannot be gainsaid that if this was indeed the intent of the Darwinian revolution it would have been news to Darwin himself. He always thought of humans as being at the top of the tree of life and European humans as being on the highest branches of all (Richards, 1992; Ruse, 1996). Indeed, in later editions of the *Origin* he added material suggesting that natural selection leads to progress and ultimately to intelligence. He invoked what today's evolutionists call "arms races" where lines compete against each other, improving adaptations in the process, and argued that eventually this would lead to intelligence and progress.

If we take as the standard of high organisation, the amount of differentiation and specialization of the several organs in each being when adult (and this will include the advancement of the brain for intellectual purposes), natural selection clearly leads toward this standard: for all

physiologists admit that the specialization of organs, inasmuch as in this state they perform their functions better, is an advantage to each being; and hence the accumulation of variations tending toward specialisation is within the scope of natural selection.

Peckham (1959)

Although most of Darwin's contemporaries did not rely on selection, they, too, virtually automatically assumed that evolution was progressive, with humans at the top. One possible exception was the older Thomas Henry Huxley who in 1893, 2 years before his death, argued that evolution is not progressive and that if we are to succeed morally we must conquer the evolved beast within (Huxley, 1893). Perhaps even he thought we are special; it is just that we must use our evolved moral senses and intelligence to claim our rightful places at the top.

Where do we stand today? Few actual working scientists are going to make any such claims, especially not in their science. The exceptions, people like the Cambridge paleontologist Simon Conway Morris (2003) who argues that there are niches and that organisms seek them out and occupy them and that at the topic is the intelligence-cultural niche that we humans uniquely have found, tend to keep such speculations for books that are aimed at the general audience. Moreover, there are those, Stephen Jay Gould (1988, 1989) was a leader in this respect, who would say that there is no progress and that the Darwinian revolution shows that there cannot be. Ultimately, natural selection is not a progress-producing mechanism. So we could say that the Darwinian revolution does prove the nonspecial status of humans, and finally today people recognize the fact. However, this may not be the entire truth. A case can be made for saying that still today the popular perception is of progress leading to humans. That was Gould's lament. Surveys suggest that this is what schoolteachers, even those favorable to evolution, tend to teach to their students (Zimmerman, 1987). And museums as often as not give the same impression. Go to the Museum d'Histoire Naturelle in Paris and find that the display starts with blobs and ends with you yourself on television. If you are in any doubt as to the message, the floor above has a display of technology from the crudest beginnings to the sophisticated forms that we have today.

Summing up: Darwin played a major role in moving us to a naturalistic view of human nature, although there are those (generally if not always working from a religious perspective) who would deny that this can ever be done completely and successfully. Darwin played no less (and perhaps more of) a role in convincing people that natural selection is the key causal factor in molding and perhaps today controlling human nature, although one should be wary of all that is claimed in his name and now there are

many more critics (not necessarily religious) who are uncomfortable with this program and would reject it in part or in whole. One can make an argument that Darwin paved the way for a view of humankind that gives us no special status here on this earth, although this was certainly not Darwin's own aim and, especially in the public domain, beliefs privileging humans persist today.

### WAS THERE A DARWINIAN REVOLUTION?

Finally, how does one analyze conceptually what happened because of the *Origin of Species*? Let us start with 2 basic theories of theory change. On one hand, we have the fairly traditional view, represented by the logical empiricists like Ernest Nagel (1961) and Carl Hempel (1966). This view tends to stress continuity, with moves made driven by the evidence and reason. To a certain extent, there will be replacement of old theories by newer, truer theories. Something like this happened when Copernicus knocked out Ptolemy. But there will probably be continuity. There was in the Copernican case. It was the same world that the two were describing: the same earth, the same sun, the same moon, the same planets, the same stars. Both sides agreed that circular motion must be preserved. Both sides used epicycles and deferents. It is true that almost all of this was changed as the years went on, but the growth of science was evolutionary not revolutionary. You can have revolutions, but they are gradual, not abrupt, and important is the notion of reduction, when one theory is absorbed in another, or more accurately when one theory can be shown the special consequence of another theory. Supposedly the macroscopic understanding of gases (Boyle's law and so forth) could be shown a special instance of the kinetic theory of gases.

On the other hand, we have the revolutionary view of Thomas Kuhn (1962). Here, the change is abrupt. In Kuhn's terminology we go from one paradigm to another, and there is no continuity. Hence, the change of viewpoint, from one paradigm to another, can never be fueled by reason. It always has to be more of a conversion experience. This is the reason there is often such bitter fighting between scientists. There is no common or shared set of beliefs that can be decisive. As with political disputes, everyone argues from within their own system.

Without wanting to homogenize everything into a gray blandness, it is probable that both positions have things to say that throw light on Darwin and his achievements. Clearly, as the logical empiricists would lead one to expect, in some respects Darwin was replacing old positions with new ones. If you think for instance of Darwin's old friend and mentor, the violently antievolutionist, Cambridge paleontologist Adam Sedgwick (1850), Darwin is simply saying that Sedgwick's reading of the

fossil record is wrong. Sedgwick argues that there are and always will be gaps in the record and that these represent real breaks in the continuity. Darwin is saying that the gaps are artifacts of incomplete fossilization and that there were bridging organisms, even if we never find them, although that should never stop us in the pursuit of such links. An analogous argument holds for the problem of the pre-Cambrian period. At the time of the *Origin*, there were no organisms at all from this period and their absence was rightly taken as a major problem for Darwin's theory. The earliest organisms of all, like trilobites, were highly complex and sophisticated invertebrates. How could they have just arrived on the scene? Sedgwick said simply that there were no pre-Cambrian organisms. Darwin said that they had existed. Two conflicting views and as Darwin's overall theory was accepted, Sedgwick was pushed out. Today we have many such organisms, and we know that Darwin was right (Knoll, 2003). We had a simple case of one theory being right and the other wrong, and the right one pushing out the wrong one.

What about reduction? One does not see any cases of whole positions being taken up by Darwin's theory, but if you look at the range of other pre-*Origin* positions, talk of reduction does not seem entirely inappropriate. Think of the position of someone like Richard Owen, deeply influenced by the *Naturphilosophen*. In a work like *On the Nature of Limbs* (Owen, 1849), it is hard to say if he is actually endorsing evolution; the answer is that he probably was but that he wanted to be sufficiently ambiguous to escape the critics. (Even as it was, Sedgwick was highly suspicious.) More importantly, although Owen certainly does not deny adaptation, he stresses homology in a very big way. Now when Darwin comes along with the *Origin*, he is certainly not going to stress homology over all other things as did Owen, but he is not going to deny it either. Most interestingly, he argues that it follows as a consequence of evolution through natural selection.

It is generally acknowledged that all organic beings have been formed on two great laws: unity of type and the conditions of existence. By unity of type is meant that fundamental agreement in structure, which we see in organic beings of the same class and which is quite independent of their habits of life. On my theory, unity of type is explained by unity of descent. The expression of conditions of existence, so often insisted on by the illustrious Cuvier, is fully embraced by the principle of natural selection. For natural selection acts by either now adapting the varying parts of each being to its organic and inorganic conditions of life; or by having adapted them during long-past periods of time: the adaptations being aided in some cases by use and disuse, being slightly affected by the direct action of the external conditions of life, and being in all cases subjected to the several laws of growth. Hence, in fact, the law of



the conditions of existence is the higher law; as it includes, through the inheritance of former adaptations, that of unity of type.

Darwin (1859)

This is what theory reduction is all about. Darwin would not have accepted every aspect of Owen's thinking. But there was continuity, with older ideas being absorbed into newer ones, and this is an important thing to note about Darwin and his work and his importance.

Now let us express some sympathy for the Kuhnian view. Take the question of homology and pick up on the point where Darwin and his supporters would break with Owen. Huxley (1857–1859) brings out this opposition in his Croonian lecture on the vertebrate skull, given at the Royal Society the year before the *Origin* appeared. He faulted Owen for being an idealist rather than a naturalist, claiming (correctly) that for Owen the archetype represents a divine platonic pattern rather than something produced purely by mechanical laws. As it happens, he also claimed correctly that this led Owen to see more than was justified, namely that the skull is made from transformed vertebrae, a claim that Darwin had accepted and that he dropped smartly before the *Origin* appeared. The point is that, evolutionist or not, Owen did have a vision of the world that was fundamentally different from that of Darwin. And it persisted after the *Origin*, as he tied himself in knots over the hippocampus, present or not in humans and apes (Rupke, 1994). It was not the facts as such that counted, but different visions of reality.

So in this sense, we do have something Kuhnian going on, different paradigms if you will. But note that it is not just a question of evolution or not evolution, and certainly not of selection or not selection. Nor is it simply a matter of biblical literalism. There were literalists, increasingly in the American South, but by and large this is not an issue in the debate around the *Origin*. Literalism had more to do with a defense of slavery than with the interpretation of fossils (Noll, 2002; Ruse, 2005). The big religious critics like Sedgwick and Bishop Wilberforce all accepted an old earth and a lot more. It is rather "man's place in nature" that was at stake. Owen was on one side. So was Sedgwick. Darwin's great American supporter Asa Gray was on this side, too, a point that Darwin saw, when he grumbled that Gray's appeal to directed variations took the discussion out of the realm of science. And we could include more, especially Darwin's old friend, the geologist Charles Lyell, who staggered across the evolutionary line but bitterly regretted having "to go the whole orang" (Wilson, 1970). On the other side, we have Darwin and Huxley (for all that the latter downplayed the significance of selection). And also there was Joseph Hooker, the botanist, and increasingly a host of younger workers



who did not depend on church appointments for their incomes and who wanted to work and think in a secular fashion.

And in confirmation of Kuhn, this is where we tend to get the nastiness: Sedgwick (1860a,b) writing irate letters to the newspaper about Darwin's methodology; Bishop Wilberforce (Huxley, 1900) sneering at Huxley's ancestry; Owen (1860) doing everything he could to give the Darwinians a bad name; and so forth. There were certainly vigorous debates about the science, but rarely did the science itself cause unpleasantness. It was always (as in the Huxley-Owen squabble over the brain) in the cause of the bigger metaphysical picture. Very instructive is the age-of-the-earth question. Physicist William Thompson (later Lord Kelvin) did not much like Darwin's naturalistic approach to humankind, but he objected publicly to the long time span that Darwin needed. As it happens, Thompson's research assistant was none other than George Darwin, Charles Darwin's mathematically gifted son. So Charles Darwin was not allowed to forget or escape the problem. However, even though in the end they simply had to disagree, neither Charles Darwin nor Kelvin thought that the disagreement was personal or ideological. It was just not that sort of difference (Burchfield, 1974). So in the sense that there were differences of that sort, differences where because of rival metaphysical views people talked past each other, one could claim that the Darwinian revolution was Kuhnian.

There is another way in which Kuhn's thinking is insightful. A paradigm is a world picture, within which a scientist works, that gives him or her tasks for the future, and which seems obvious or certain in some sense. Obvious or certain in the sense that (as just noted) you cannot see the point of view of others not in the paradigm (Ruse, 1999). Think again of the divide in biology between formalism and functionalism and put it in a broader historical context. As Aristotle pointed out, on one hand we have the adaptive side to organisms, what he called final causes, meaning that the parts function for the benefit of the whole. On the other hand, we have homologies (isomorphisms) where the parts may well be used for different ends. Down through the ages people have continued to note these 2 sides to organisms, and interestingly people tend not to be ecumenical on the matter. Like Darwin, they are partisans for one side or the other. Either they opt for function with form secondary or form with function secondary. What is fascinating is the way that this divide goes right across the Darwinian revolution. At the beginning of the 19th century one had formalists who did not accept evolution, many of the *Naturphilosophen* for instance. The philosopher Hegel (1817) is a case in point. One also had functionalists who did not accept evolution. The great French comparative anatomist Georges Cuvier (1817), with his theory about the conditions of

existence (that he explicitly tied to final-cause thinking), was one such person. Then at the time of the *Origin* we have people who crossed the evolutionary divide who were one or the other, but not both. Darwin was a hard-line functionalist. That is the whole point of natural selection. Huxley equally was a hard-line formalist (Huxley and Martin, 1875). That's why he could not see much need of natural selection. Today, the differences persist. Take the 2 great popularizers of evolution, Englishman Richard Dawkins and American Stephen Jay Gould. Dawkins (1976, 1986) is and always has been an ardent functionalist. For him, it is adaptation all of the way and the only problem really worth solving. He thinks natural selection is a universal law of nature. Gould (1977b, 1989, 2002) was notoriously ambivalent about natural selection and function, thinking it a holdover from English natural theology, and he again and again stressed form. This was the central message of his famous paper on spandrels, cowritten with geneticist Richard Lewontin (Gould and Lewontin, 1979).

I would argue that in a real sense we have Kuhnian paradigm differences operating here. Different visions, unable to bridge the gap (Ruse, 2003). I find it interesting that metaphors are involved, things that Kuhn stresses as being important in paradigm thinking. We have the organic world as a human artifact. [See Darwin's use of this metaphor in the little post-*Origin* book on orchids (Darwin, 1862).] We also have the organic world as a snowflake [Kant's 1790 picture (Kant, 1951)] or as a crystal [used by Whewell (2001)]. Admittedly, this sense of paradigm does not fit exactly with the senses of paradigm found in the *Structure of Scientific Revolutions*. For a start, both sides do recognize some of the merits of the other side. It is hard to think that the ontologies are completely different. For a second, with respect to the same things 2 people could be in and out of different paradigms. With respect to homology, Owen and Huxley were divided over the idealistic/naturalistic issues, and yet with respect to thinking that homology more important than function, they were together. Third, perhaps most importantly, the 2 paradigms (without prejudice, let us call them this) persist, down through the ages. It is not a matter of one beating out the other. It is true that today functionalism has the upper hand, but things could change. In fact, in the past 20 years things have moved, with evolutionary development enthusiasts coming inside in a very strong way for formalism. The homologies they find, for instance between humans' and fruitflies' genetic sequences, strike them as absolutely fundamental and calling for a total revision of evolutionary thinking.

The homologies of process within morphogenetic fields provide some of the best evidence for evolution, just as skeletal and organ homologies did earlier. Thus, the evidence for evolution is better than ever. The

role of natural selection in evolution, however, is seen to play less an important role. It is merely a filter for unsuccessful morphologies generated by development. Population genetics is destined to change if it is not to become as irrelevant to evolution as Newtonian mechanics is to contemporary physics.

Gilbert et al. (1996)

We shall have to see how this all pans out. An ardent Darwinian like me is less than overwhelmed (Ruse, 2006, 2008). But then I am an ardent functionalist, so I am proof of the point I am making about the divide. Obviously, the ideas do persist and not just as fossils.

### CONCLUSION

If the point being made now is well taken, then perhaps Hodge was right all along. There was no Darwinian revolution. The paradigms of form and function went in before Darwin and came out after Darwin. This taken as a general conclusion is obviously false. Because of Darwin and the *Origin of Species*, major things did happen in biological science. Less paradoxically, let us say that a complex phenomenon like the Darwinian revolution demands many levels of understanding. Blunt instruments will fail us as we try to understand scientific change. It is necessary to tease strands apart and consider them individually as we try to understand and to assess what is going on.

There are other controversies (unmentioned thus far here) very active today. Often these involve not just the events directly around Darwin but aspects of the broader picture. Robert J. Richards (who has been noted as a major contributor to the history of evolutionary biology) argues that the post-Darwinian period, especially that influenced by the German evolutionist Ernst Haeckel, was much more pure-Darwinian than people have recognized. He thinks that Darwin was deeply Romantic in his thinking, influenced by the currents that came from Germany at the beginning of the 19th century, and that after the *Origin* people like Haeckel were simply responding to and building on that which was already there (Bowler, 1976; Richards, 2002). Other students of the period (including myself) disagree strongly, thinking that (as Karl Marx noted) Darwin was quintessentially English in his thinking and that it is right to see Haeckel as responding to non-Darwinian themes, an attitude that inflected evolutionary biology until the synthesis of the 1930s (Ruse, 2004). Another controversy centers on the work and interpretations of Peter J. Bowler (also noted above as a major contributor). He agrees that post-Darwinian thought was deeply non-Darwinian, but he nevertheless thinks that it was good-quality science and that it fed smoothly into the synthesis. Indeed the latter would not have occurred without the former (Bowler, 1988, 1996). Others, again

including me, disagree strongly, arguing that post-Darwinian evolutionary biology was often really poor-quality science (notoriously following Haeckel in spinning unsustainable analogies between embryology, ontogeny, and paleontology, phylogeny) and that the synthesizers of the 1930s had to cleanse the Augean stables and return to the thinking of the *Origin* (melded admittedly with the new genetics) before further advance was possible (Ruse, 1996).

These controversies, however, must be the topic of another essay. Here, I rest confident that I have shown why, for a philosopher and historian of science, analyzing the Darwinian revolution is such a worthwhile challenge.



# 15

## Did Darwin Write *the Origin Backwards?*

---

ELLIOTT SOBER

After clarifying how Darwin understood natural selection and common ancestry, I consider how the two concepts are related in his theory. I argue that common ancestry has evidential priority. Arguments about natural selection often make use of the assumption of common ancestry, whereas arguments for common ancestry do not require the assumption that natural selection has been at work. In fact, Darwin held that the key evidence for common ancestry comes from characters whose evolution is *not* caused by natural selection. This raises the question of why Darwin puts natural selection first and foremost in the *Origin*.

### WHAT IS DARWIN'S THEORY?

**T**o characterize Darwin's theory, what could be more natural than to cite the title that Darwin gave to his own book (Darwin, 1859)? How could this formulation lead us astray? In fact, there is trouble here, and it is of Darwin's own making. Although Darwin (1859, p. 1) says that the origin of species is the "mystery of mysteries" that he proposes to solve, his solution of the problem is in some ways a dissolution. I say this because Darwin had doubts about the species category; he regarded the difference between species and varieties as arbitrary. When 2 popula-

---

Philosophy Department, University of Wisconsin, Madison, WI 53706.

tions split from a common ancestor and diverge from each other under the influence of different selection pressures, they begin as 2 populations from the same variety, then they become 2 varieties of the same species, and finally they reach the point where they count as different species. It is convenience, not fact, that leads us to classify different degrees of divergence in different ways (1859, pp. 48–52). This vague boundary between variety and species is no reason to deny the existence of individual species, nor did Darwin do so (Ereshefsky, 2009; Sloan, 2009). This is the lesson we learn from other vague concepts—from rich and poor, hairy and bald, tall and short; a vague boundary does not entail that no one is rich, or hairy, or tall. Even so, “species” is not the central concept in Darwin’s theory. True, the process he describes produces species, but it produces traits and taxa at all levels of organization. For these reasons, Darwin’s theory is better described as “the origin of *diversity* by means of natural selection.”

Darwin’s concept of natural selection has several noteworthy features. Although the *Origin* introduced the idea of natural selection by first describing artificial selection, Darwin hastened to emphasize that natural selection is not an agent who intentionally chooses. When cold climate causes polar bears to evolve longer fur, the weather is not an intelligent designer who wants polar bears to change. The weather kills some bears while allowing others to survive, but the weather does not need to have a mind to do this. It is in this sense that natural selection is a mindless process (for a different assessment, see Richards, Chapter 16, this volume). So concerned was Darwin to emphasize this point that, in the 5th edition of the *Origin*, he followed Alfred Russel Wallace’s advice and used Herbert Spencer’s phrase “the survival of the fittest” to characterize his theory (Darwin, 1959, p. 164). Darwin hoped this new label would make it harder for readers to misunderstand his theory.

Another important feature of Darwin’s concept is that the direction in which selection causes populations to evolve depends on accidents of the environment. There is no inherent tendency for life to grow bigger or faster or harder or slimier or smarter. Everything depends on which traits do a better job of allowing organisms to survive and reproduce in their environments. This is the vital contrast that separates Darwin from Lamarck, who saw evolution as leading lineages to move through a pre-programmed sequence of steps, from simple to complex. Of course, if life starts simple, evolution by natural selection will lead the average complexity of the biota to increase. However, that is not because the “laws of motion” of natural selection inherently favor complexity. Parasites evolve from free-living ancestors, and the effect is often a move toward greater simplicity, with parasites losing organs and abilities possessed by their ancestors (Darwin, 1859, p. 148). Complexity increases from life’s beginning because of the initial conditions, not the laws. This is analogous to the



random walk depicted in Fig. 15.1. A marker on a line changes position as a result of a coin toss. If the coin lands heads, you move the marker one space to the right; if the coin lands tails, you move the marker one space to the left. These are the rules of change unless the marker happens to be at the left-most or the right-most points. If the coin lands tails when the marker is at the extreme left, you simply toss again. Suppose the game begins with the marker placed at the left-most point on the line. Where do you expect the marker to be after 5 or 50 or 500 coin tosses? Probably not at square 1. The line in this game represents complexity, with 1 being the least complex and 100 the most. Selection can be indifferent to simplicity versus complexity and yet evolution by natural selection can be expected to manifest a net increase in complexity (Sober, 1994).

A third important feature of Darwin's concept is that selection acts on "random" variation. This is a loaded word, apt to mislead. Darwin says in the *Origin* (1859, p. 131) that "random" just means that the cause of a new variant's appearance in a population is unknown. However, "random" for Darwin was more than a confession of ignorance. What he meant was that variations do not occur because they would be useful to the organism in which they occur. In *The Variation of Animals and Plants Under Domestication*, Darwin explains his point in terms of a beautiful analogy:

Let an architect be compelled to build an edifice with uncut stones, fallen from a precipice. The shape of each fragment may be called accidental; yet the shape of each has been determined by the force of gravity, the nature of the rock, and the slope of the precipice,—events and circumstances all of which depend on natural laws; but there is no relation between these laws and the purpose for which each fragment is used by the builder. In the same manner the variations of each creature are determined by fixed and immutable laws; but these bear no relation to the living structure which is slowly built up through the power of natural selection, whether this be natural or artificial selection.

Darwin (1868c, p. 236)

A fourth important feature concerns the level at which Darwin took natural selection to act. In almost all of the examples that Darwin discusses, traits are said to be selected because they help the individual organisms that



FIGURE 15.1 A random walk on a line with 100 locations. Unless the marker is at the left-most or the right-most location, it moves 1 space to the right if the tossed coin lands heads and 1 space to the left if the coin lands tails.

possess them to survive and reproduce. Tigers have sharp teeth because tigers with sharp teeth do better than tigers with dull teeth. The reason the trait evolved is not that sharp teeth help the species to avoid extinction or somehow keep the ecosystem from collapsing. In examples of this sort, Darwin embraces what biologists now call “individual” selection. An exception to this pattern of thinking occurs when Darwin considers the evolution of human morality. Why do human beings often sacrifice their welfare for the good of the group? This is how Darwin sets the problem in the *Descent of Man*:

It is extremely doubtful whether the offspring of the more sympathetic and benevolent parents, or of those which were the most faithful to their comrades, would be reared in greater number than the children of selfish and treacherous parents of the same tribe. He who was ready to sacrifice his life, as many a savage has been, rather than betray his comrades, would often leave no offspring to inherit his noble nature. The bravest men, who were always willing to come to the front in war, and who freely risked their lives for others, would on an average perish in larger number than other men.

Darwin (1871, p. 163)

Then he proposes his solution:

It must not be forgotten that although a high standard of morality gives but a slight or no advantage to each individual man and his children over the other men of the same tribe, yet that an increase in the number of well-endowed men and an advancement in the standard of morality will certainly give an immense advantage to one tribe over another. A tribe including many members who, from possessing in a high degree the spirit of patriotism, fidelity, obedience, courage, and sympathy, were always ready to aid one another, and to sacrifice themselves for the common good, would be victorious over most other tribes; and this would be natural selection. At all times throughout the world tribes have supplanted other tribes; and as morality is one important element in their success, the standard of morality and the number of well-endowed men will thus everywhere tend to rise and increase.

Darwin (1871, p. 166)

Here, Darwin invokes the hypothesis of group selection. When groups compete, characteristics that are deleterious to the individuals who have them can evolve because they are good for the group in which they occur. Biologists now call such traits “altruistic.” For Darwin, natural selection can involve both individual and group selection.

Darwin discusses 2 examples of altruism in the *Origin*—the barbed stinger of honeybees and the sterility of workers found in many species

of social insect (1859, pp. 202 and 236). Both traits are deleterious to the individuals that have them. Bees that sting intruders to the nest eviscerate themselves; sterile workers have a reproductive success of zero. In each case, Darwin explains the trait's evolution by pointing out that it is advantageous to the community. Some modern commentators interpret Darwin's discussion of these traits as anticipating the idea of kin selection, which they view as a type of individual, not group, selection (Ruse, 1980). Others regard kin selection as a kind of group selection and so regard Darwin's theorizing about barbed stingers and worker sterility as following the same pattern he later used to think about human morality (Sober and Wilson, 1998). For those who prefer the former interpretation, there is an interesting interpretive question: Why did Darwin embrace group selection to account for human morality, but decline to do so in connection with the stinger and the sterility?

Regardless of how one interprets this small handful of examples, it is clear that Darwin invoked group selection hypotheses only rarely. Was this because he thought that group selection occurs more rarely and is a less important cause of evolution than individual selection? In the first edition of the *Origin*, Darwin (1859, p. 87) does make a general comment about selection's effect on traits that are good for the group. He says that "in social animals it will adapt the structure of each individual for the benefit of the community; if each in consequence profits by the selected change." This is not an endorsement of group selection, since traits that are good for the group can evolve by individual selection if they also happen to be good for the individuals who have them. However, in the 6th edition of 1872, Darwin revised this sentence to read: "in social animals it [selection] will adapt the structure of each individual for the benefit of the community; if the community in consequence profits by the selected change (Darwin, 1959, p. 172)." This is an endorsement of the general role played by group selection.

The last facet of Darwin's concept of natural selection that I want to mention concerns his comment in the *Origin* (1859, p. 6) that selection is "the main but not the exclusive cause" of evolution. One part of this pronouncement is clearer than the other. The idea that selection is not the exclusive cause of evolution just means that there are other causes. Darwin (1859, pp. 134–139) allows for the Lamarckian mechanism of "use and disuse," the inheritance by offspring of traits (phenotypes, in modern parlance) because they were acquired by their parents and turned out to be useful. A standard example is the blacksmith's growing big muscles because of his work and then transmitting these big muscles to his children, who develop those muscles without needing to do what their father did to get them. Darwin also had the idea that descendants retain the traits that their ancestors had, sometimes even though these traits are no longer

avored by selection. This is the idea of “ancestral influence”; it explains many rudimentary features (Darwin, 1859, pp. 199, 416, and 450–456) as vestiges of a bygone age; for example, this is why human beings have tail bones and why human fetuses have gill slits (1859, p. 191). Darwin also discusses correlation of characters as a cause of evolution. If a trait favored by selection is correlated with a trait that is neutral or even deleterious, the latter may evolve by piggybacking on the former (Darwin, 1859, pp. 143–147). To use a modern example, our blood is red, not because the color promotes survival and reproduction, but because hemoglobin is red, and hemoglobin was selected for its ability to transport oxygen. Darwin discusses other nonselective causes of evolution, but the point is clear—he denied that selection is the only cause of evolution.

Unfortunately, Darwin does not explain what he meant by saying that selection is the “main.” I take it that if selection is the main cause, then it is the most important cause. This might mean that selection is the most frequent—that selection is implicated in the evolution of more traits in more populations than any other cause. Or it could mean that selection is more powerful than the other causes that affect the evolution of a given trait. Here we must consider the different causes that influence a trait’s evolution in a population and then imagine how the outcome would have been different if selection had been absent and the other causes present, and how the outcome would have been different if selection had been present and one of the other causes absent (and do this for each of the other causes). Important causes are big difference makers while causes of modest importance make only a small difference in the outcome. Applying this format for separating more important from less to Darwin’s theory (and to the evolutionary theory of the present) is an interesting exercise, but it cannot be pursued here.

Given his statement that selection is the main cause of evolution, how are we to interpret the following comment in the *Origin* concerning the importance of ancestral influence: “the chief part of the organization of every being is simply due to inheritance; and consequently, although each being assuredly is well fitted for its place in nature, many structures now have no direct relation to the habits of life of each species (1859, p. 199)?” If ancestral influence has played so large a role, how can natural selection have been the main cause? Perhaps Darwin should simply have said that selection has been very important. Was it needlessly audacious for Darwin to put selection at the top of a list whose members he had no reason to think he could completely foresee?

### COMMON ANCESTRY

With these caveats about natural selection duly noted, is “evolution by natural selection” a good characterization of Darwin’s theory?

The answer is emphatically no, as can be seen by considering Fig. 15.2. Darwin's theory gives the concept of common ancestry a central place. The phrase "evolution by natural selection" does not capture this idea, nor does "descent with modification" (Mayr, 1985; Sober and Orzack, 2003). Instead of describing Darwin's theory as evolution *by* natural selection, the theory is better described as common ancestry plus natural selection. This is not a trivial correction, since the idea of common ancestry plays a central role in the big picture that Darwin painted, or so I will argue.

How much common ancestry did Darwin embrace? In the last paragraph of the *Origin*, where Darwin waxes poetic in his description of the "grandeur in this view of life" (1859, p. 490), he says that, in the beginning, "life was breathed into a few forms, or into one." A few pages earlier, he is less cautious:

I believe that animals have descended from at most only four or five progenitors, and plants from an equal or lesser number. Analogy would lead me one step further, namely to the belief that all animals and plants have descended from some one prototype. But analogy may be a deceitful guide. Nevertheless all living things have much in common, in their chemical composition, their germinal vesicles, their cellular structure, and their laws of growth and reproduction. We see this even in so trifling a circumstance as that the same poison often similarly affects plants and animals; or that the poison secreted by the gall-fly produces monstrous growths on the wild rose or oak-tree. Therefore I should infer from analogy that probably all organic beings which have ever lived on this earth have descended from some one primordial form, into which life was first breathed.

Darwin (1859, p. 484).

Both these passages may suggest that Darwin's view was that there was one start-up of life from nonliving materials, or just a few of them. How-

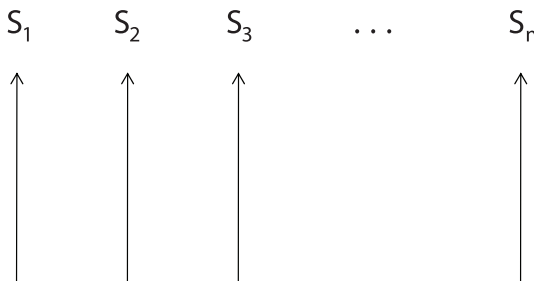

FIGURE 15.2 A set of genealogically unrelated lineages, each evolving by natural selection. This is not Darwin's theory.

ever, this is not what his theory really says. In the fifth edition of the *Origin*, Darwin adds the following remark:

No doubt it is possible, as Mr. G. H. Lewes has urged, that at the first commencement of life many different forms were evolved; but if so, we may conclude that only a few have left modified descendants.

Darwin (1959, p. 753)

Darwin was not changing his mind here, but was merely clarifying what he intended all along. The idea was already in the first edition of the *Origin*—not in words, but in a picture. In fact, it was in the book’s only picture, shown in Fig. 15.3. Darwin’s view about common ancestry concerns tracing-back, not the number of start-ups. Perhaps life started up one time or many; this may be unknowable and, in any event, was not something that Darwin thought he knew. Darwin’s claim is that all of the life that exists now, and all of the fossils that are around now too, trace back to one or a few original progenitors.

Tracing back to a single common ancestor does not entail that there was exactly one start-up. Nor does it entail that all but one of the start-ups failed to have descendants that exist now. If a genealogy is strictly tree-like (with branches splitting but never joining), all but one start-up must go extinct if all current life is to trace back to a single common ancestor. However, if there are reticulations (with branches joining and splitting), this need not be so (Sober and Steel, 2002). This point is illustrated in Fig. 15.4.

One of the main objections to Darwin’s theory, both when the *Origin* was published and in the minds of many present-day Creationists, is the idea that species (or “fundamental kinds” of organism) are separated from each other by walls. No one doubted, then or now, that natural selection

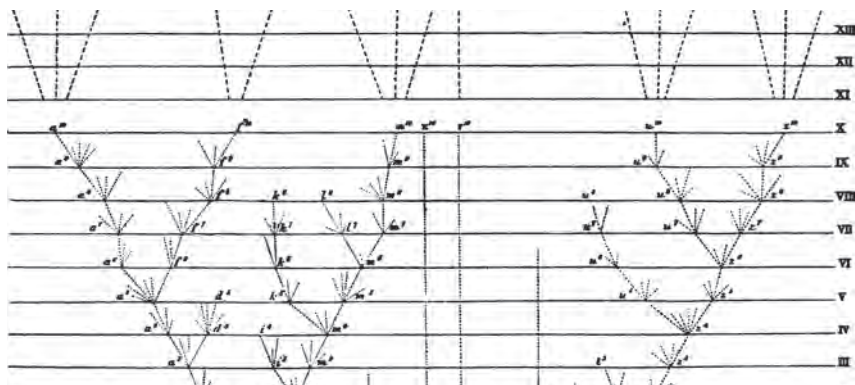

FIGURE 15.3 The only diagram in the *Origin*.

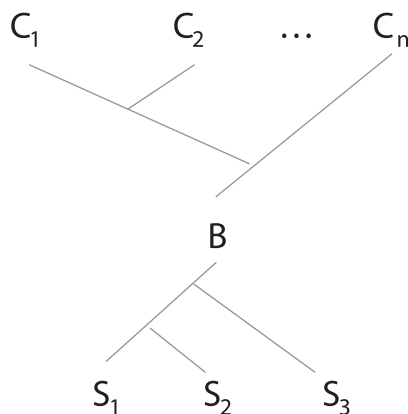

FIGURE 15.4 Life with multiple start-ups and a bottleneck. In this example, all current life ( $C_1, C_2, \dots, C_n$ ) traces back to a single common ancestor, but this does not require that 2 of the 3 start-ups ( $S_1, S_2, S_3$ ) fail to have descendants now. Reticulation leading to a bottleneck ( $B$ ) is the reason why.

can cause small changes within existing species. The question was whether the process Darwin described can bring about large changes. Maybe a species can be pushed only so far. Darwin was an extrapolationist, inspired by the geological gradualism of Charles Lyell. Darwin reasoned that if artificial selection has achieved what it did in the brief span of time with which plant and animal breeders have had to work, then natural selection can bring about changes that are far more profound since it has operated over the far larger reaches of time that have been available since life began on an ancient Earth. Darwin extrapolated from small to large; many of his critics refused to follow him here. If we focus just on natural selection, it is hard to see why Darwin had the more compelling case. However, if we set natural selection aside and consider instead the idea of common ancestry, the picture changes. Darwin thought he had strong evidence for common ancestry. This is enough to show that insuperable species boundaries (and insuperable boundaries between “kinds”) are a myth; if different species have a common ancestor, the lineages involved faced no such walls in their evolution. And the case for common ancestry does not depend on natural selection at all.

### DARWIN’S PRINCIPLE

Darwin tells us in the *Origin* that when it comes to finding evidence for common ancestry, the adaptive features that provide evidence for natural selection are precisely where one ought not to look:



[A]daptive characters, although of the utmost importance to the welfare of the being, are almost valueless to the systematist. For animals belonging to two most distinct lines of descent, may readily become adapted to similar conditions, and thus assume a close external resemblance; but such resemblances will not reveal—will rather tend to conceal their blood-relationship to their proper lines of descent.

Darwin (1859, p. 427).

Two of the facts mentioned earlier—that humans and monkeys have tailbones, and that human fetuses and fish have gill slits—are evidence for common ancestry precisely because tailbones and gill slits are useless in humans. Contrast this with the torpedo shape that sharks and dolphins share; this similarity is useful in both groups. One might expect natural selection to cause this trait to evolve in large aquatic predators whether or not they have a common ancestor. This is why the adaptive similarity is almost valueless to the systematist.

Let's distinguish the two parts in this idea and give it a name:

*Darwin's Principle.* Adaptive similarities provide almost no evidence for common ancestry while similarities that are useless or deleterious provide strong evidence for common ancestry.

Darwin's Principle can be justified in terms of something deeper. The principle is an application of an idea about probabilistic reasoning called

*The Law of Likelihood.* Observation  $O$  favors hypothesis  $H_1$  over hypothesis  $H_2$  precisely when  $\Pr(OH_1) > \Pr(OH_2)$ . And the strength of the favoring relation is to be measured by the likelihood ratio  $\Pr(OH_1)/\Pr(OH_2)$  (Hacking, 1965).

The expression " $\Pr(OH)$ " means "the probability of  $O$ , given  $H$ ." R. A. Fisher chose to call this quantity the likelihood of the hypothesis. This was an unfortunate choice of terminology, but it has stuck. In ordinary English, "likelihood" and "probability" are synonyms, but the Law of Likelihood concerns the likelihood of  $H$ ,  $\Pr(OH)$ , not its probability,  $\Pr(HO)$ . These can have different values. And anti-Bayesians maintain that  $\Pr(HO)$  often has no objective meaning at all, while  $\Pr(OH)$  does (Sober, 2008).

Notice that the Law of Likelihood has 2 parts, one qualitative, the other quantitative. To see the intuitive plausibility of the qualitative part of the law, consider an example that has nothing to do with common and separate ancestry. Suppose you draw some balls from an urn of unknown composition. You draw 100 times, with replacement, and find that 81 of the draws are green. What does this evidence tell you about the following 2 hypotheses?

$H_1$ : Exactly 80% of the balls in the urn are green.

$H_2$ : Exactly 10% of the balls in the urn are green.

It seems obvious that the evidence favors the first hypothesis over the second, and the Law of Likelihood explains why. The observations would be more surprising if  $H_2$  were true than they'd be if  $H_1$  were true. I will not try to motivate the quantitative part of the Law of Likelihood, except to note that  $\Pr(OH_1)$  and  $\Pr(OH_2)$  are both small in this example. The likelihood difference, therefore, is tiny, far smaller than the difference there would be if you had drawn just one ball from the urn and it was green. However, the likelihood ratio for the 100 draws is far larger than the ratio for the 1. This is a point in favor of using the ratio measure.

How does the Law of Likelihood bear on Darwin's Principle? Let  $X$  and  $Y$  be 2 species (or organisms) that both have trait  $T$ . This is our observation. We wish to know what this observation says about the common ancestry (CA) and the separate ancestry (SA) hypotheses. Darwin's principle is correct to the extent that

$\Pr(X \text{ and } Y \text{ have trait } T | CA) / \Pr(X \text{ and } Y \text{ have trait } T | SA) \approx 1$  when  $T$  is adaptive for both  $X$  and  $Y$ .

$\Pr(X \text{ and } Y \text{ have trait } T | CA) / \Pr(X \text{ and } Y \text{ have trait } T | SA) \gg 1$  when  $T$  is not adaptive for both  $X$  and  $Y$ .

The torpedo shape of sharks and dolphins involves a likelihood ratio that is close to 1; the tailbones of humans and monkeys and the gill slits of human fetuses and fish involve likelihood ratios that are much larger than unity.

Darwin's Principle applies outside of biology, both in other sciences and in everyday life. For example, suppose 2 students in a philosophy class submit essays on an assigned topic that are word-for-word identical (Salmon, 1984). The common cause hypothesis says that the students plagiarized from the same source (a file they found on the Internet, perhaps). The separate cause hypothesis says that the students worked separately and independently. The matching is more probable under the first hypothesis than it is under the second. And the kinds of matching features that provide strong evidence for a common cause and the kinds that provide only weak evidence or none at all are the ones that Darwin's principle describes. That both essays use nouns is not worth much. In contrast, that both misspell the same words in the same way is more telling. And what should we make of both essays quoting the same passage from Darwin? It matters if the passage is relevant to the assigned topic.

If Darwin's Principle is to be understood in terms of the Law of Likelihood, there is an important part of his theory that fails to conform to the dictates of hypothetico-deductivism, which some see as Darwin's key methodological innovation (Ghiselin, 1969). This methodology says that theories are tested by deducing observational predictions from them. However, if hypotheses merely confer non-extreme probabilities on observational outcomes, the relationship of hypothesis to observation is not deductive. It is not true that human beings and monkeys must both have tail bones if they share a common ancestor and it is not true that they cannot both have tail bones if they do not share a common ancestor. What is true is that the probability of this similarity is greater under the common ancestry hypothesis.

### EXCEPTIONS TO DARWIN'S PRINCIPLE

Although Darwin's Principle is often correct, the two parts of the principle are each sometimes mistaken. Let's take the second part first, the one about neutral or deleterious characters. If a drift process goes on long enough, the resulting character states of the descendants  $X$  and  $Y$  will have about the same probability, regardless of whether the common ancestry or the separate ancestry hypothesis is true. In a drift process as well as in others, time is a destroyer of information about ancestry. A second counterexample to the second half of Darwin's Principle may be found in characteristics that confer no advantage or disadvantage but are correlated with ones that do. These are the features that now are called "spandrels" (Gould and Lewontin, 1979). As mentioned earlier, having red blood confers no advantage, but having hemoglobin does, and the redness is a consequence of the hemoglobin. If hemoglobin is widespread because of its adaptive advantage, 2 species having red blood will not provide strong evidence for common ancestry.

The other side of Darwin's Principle has exceptions as well; there are adaptive similarities that sometimes provide substantial evidence of common ancestry. There are 2 cases in which this is true. The first simply involves lots of data. Suppose we know of  $n$  adaptive similarities that unite species  $X$  and  $Y$ . Each of them may provide only negligible evidence favoring common ancestry over separate ancestry. However, put them together and the likelihood ratio may be substantially greater than unity. This will happen if the different features ( $T_1, T_2, \dots, T_n$ ) are independent of each other, conditional on each of the 2 genealogical hypotheses:

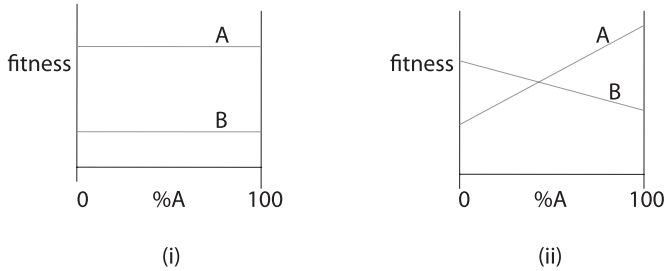

FIGURE 15.5 Two fitness functions for the traits *A* and *B*. When 2 populations each exhibit 100% *A*, this is not strong evidence that they have a common ancestor if the fitness function is the one shown in (i); the evidence for common ancestry is stronger if the fitness function is the one shown in (ii).

$$\frac{\Pr(T_1 \& T_2 \& \dots \& T_n | CA)}{\Pr(T_1 \& T_2 \& \dots \& T_n | SA)} = \frac{\Pr(T_1 | CA)}{\Pr(T_1 | SA)}$$

$$\times \frac{\Pr(T_2 | CA)}{\Pr(T_2 | SA)} \times \dots \times \frac{\Pr(T_n | CA)}{\Pr(T_n | SA)}$$

If each term on the right-hand side has a value just a bit larger than unity, their product will have a value that is much larger than unity. This point might underlie the thought that complex adaptations can provide substantial evidence of common ancestry even if simple ones do not.\*

The second context in which Darwin is wrong to dismiss adaptive similarities is a bit less obvious. Consider the 2 fitness functions shown in Fig. 15.5. Each describes how an individual's fitness depends on whether it has trait *A* or trait *B*. In Fig. 15.5*i*, *A* is always fitter than *B*, regardless of the frequency of trait *A* in the population; in Fig. 15.5*ii*, *A* is fitter than *B* when *A* is common, but the reverse is true when *A* is rare. Now suppose you encounter 2 populations that both have trait *A* at 100%. Is this evidence that the two populations trace back to a common ancestor? Darwin's principle seems right in connection with the fitness function in Fig. 15.5*i*; you'd expect *A* to evolve to fixation, whether or not the two populations share a common ancestor. The inferential situation with respect to Fig. 15.5*ii* is different. When there is selection favoring the majority trait, a population will evolve to 100% *A* or to 100% *B* depend-

\*Perfect independence is not essential here; the weight of evidence grows if the separate traits have some degree of conditional independence.

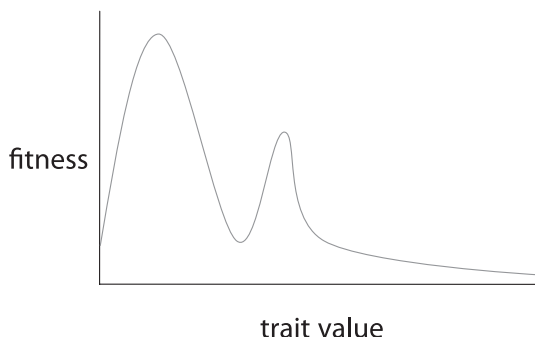

FIGURE 15.6 The fitnesses of different trait values of a quantitative character. There are 2 adaptive peaks.

ing on what the trait's starting frequency is. In what state do the lineages leading to the two observed populations begin? Suppose that all starting frequencies have the same probability. Then the probability that a lineage starts with *A* in the majority is  $1/2$ . If the two populations have a common ancestor, the probability of them both exhibiting 100% *A* is  $\approx 1/2$ . If the separate ancestry hypothesis is true, the probability that both lineages will have 100% *A* is approximately  $(1/2)(1/2) = 1/4$ . So the common ancestry hypothesis has twice the likelihood as the separate ancestry hypothesis. The likelihood ratio will be bigger if it is very improbable that a lineage will start with *A* in the majority. If the probability of this is  $p$ , then the likelihood ratio of the two hypotheses is approximately  $p/p^2 = 1/p$ . If  $p$  is small, the evidence favoring common ancestry is very strong (Hacking, 1965, chap. 4).\*

What is true for frequency-dependent selection for the majority trait also is true when there is frequency-independent selection with multiple peaks of the sort depicted in Fig. 15.6. A population that starts with a given average trait value will evolve toward a local adaptive peak and then selection will serve to keep the population at that equilibrium value. The larger the population is, the harder it is for the population to traverse a valley and evolve from one peak to another. If 2 populations are at the same adaptive peak, this is evidence that they share a common ancestor. The higher the peaks and the wider the valleys, the more strongly their similarity favors common ancestry over separate ancestry.

These last two cases, in which adaptive similarities provide strong evidence for common ancestry, are not just abstract possibilities. They

---

\*Consider the effect of population size on this inference problem. In Fig. 15.5*i*, the bigger the population, the more valueless the observation is that the two populations are each 100% *A*; in Fig. 15.5*ii*, the reverse is true.

underlie the reasoning that leads biologists to cite the near-universality of the genetic code as evidence that all current life traces back to a single common ancestor (Knight et al., 2001). This is an important part of the reason that most biologists would now regard Darwin's "one or a few" original progenitors as too cautious. An organism with a given genetic code will usually have its viability drastically decline if its code changes to one that is "nearby" in the space of possible changes. And if the organism is at least partly sexual, its ability to produce viable fertile offspring will be impaired if its code changes to one not shared by conspecifics. So there is both a frequency-independent and a frequency-dependent effect. As long as there are multiple codes that each would work, a shared code is evidence for common ancestry. And the more such codes there are, the stronger the evidence that the near-universality of the code provides for common ancestry. This point holds even if the shared code we observe in the life around us turns out to be optimal.

Although Darwin's Principle is overstated, a rational kernel can be extracted. Nonadaptive characters often provide strong evidence for common ancestry. And adaptive characters often provide little or no evidence for common ancestry.

#### HOW COMMON ANCESTRY AND NATURAL SELECTION ARE RELATED IN DARWIN'S THEORY

Darwin (1859, p. 459) says that the *Origin* is "one long argument," and scholars have puzzled over what his argument is. Thinking about this requires that a question about logic be separated from a question about rhetoric. There is the logical structure of his theory and its relation to the evidence he musters. However, there is also the question of how Darwin chooses to present that body of theory and evidence. Why did Darwin organize the book as he did? He front-loads his discussion of natural selection and lets his full argument for common ancestry emerge only later, and in a somewhat fragmented form. Inspired by John Herschel's ideas on *vera causae* (Herschel, 1830), he starts with artificial selection; this is a context in which selection has been observed. From this he extrapolates to natural selection, where selection must usually be inferred, and argues that selection is competent to produce the traits we now observe in nature and that it has actually done so (Hodge, 1977; Ruse, 1979; Waters, 2003). Darwin could have begun with common ancestry and still pursued this Herschelian strategy. The exposition would start with observed cases of common ancestry (in human family trees and in the ones recorded by plant and animal breeders), with conjectured instances of common ancestry developed subsequently, the argument culminating with his conclusion that all life traces back to one or a few original progenitors.

Darwin does do some of this in the book's beginning. In the Introduction he says that species belonging to the same genus have a common ancestor. And in the first chapter, on artificial selection, he argues that all varieties of domesticated pigeons descended from the rock dove. Still, the big picture, wherein all current life traces back to one or a few start-ups, is mostly developed at the end of the book. On the whole, it is natural selection that comes first.

Four years after the *Origin's* publication, Darwin wrote to Asa Gray about his priorities; he says that "personally, of course, I care much about Natural Selection, but that seems to me utterly unimportant, compared with the question of Creation or Modification" (Darwin C, 1887). Why, then, did Darwin give selection top billing in the *Origin*? Perhaps he thought that this was his theory's more novel element. Or perhaps he chose this ordering to recapitulate his own intellectual odyssey in which selection came into focus before common ancestry (Ospovat, 1981; Schweber, 1988). Or maybe he realized that if he began with the grand idea of common ancestry, readers would immediately contemplate the genealogical connection of human beings to monkeys, a subject that he very much wanted to avoid.

There are other explanations to consider that are more rooted in the details of what Darwin says in the *Origin*. Perhaps he placed natural selection at center stage because he thought that selection is more important than common ancestry. This seems to be the point he is making in the following passage:

It is generally acknowledged that all organic beings have been formed on 2 great laws: Unity of Type, and the Conditions of Existence. By unity of type is meant that fundamental agreement in structure which we see in organic beings of the same class, and which is quite independent of their habits of life. On my theory, unity of type is explained by unity of descent. The expression of conditions of existence, so often insisted on by the illustrious Cuvier, is fully embraced by the principle of natural selection. For natural selection acts by either now adapting the varying parts of each being to its organic and inorganic conditions of life; or by having adapted them during past periods of time: the adaptations being aided in many cases by the increased use or disuse of parts, being affected by the direct action of the external conditions of life, and subjected in all cases to the several laws of growth and variation. Hence, in fact, the law of the Conditions of Existence is the higher law; as it includes, through the inheritance of former variations and adaptations, that of Unity of Type.

Darwin (1859, p. 206)

We can understand this passage by thinking about its application to the example of human and monkey tail bones. Human beings have tail bones



because the trait was present in the common ancestor that human beings share with monkeys, not because the trait is adaptive for humans. Darwin adds to this the further thought that the trait occurs in the common ancestor because it was adaptive for that common ancestor.

Darwin's point in this passage is not specifically about the importance of common ancestry; his thought applies equally to evolution in a single lineage. Consider a lineage of polar bears extending from an ancestral population  $A$  to a current population  $C$ . Suppose  $C$ 's fur length is closer to  $A$ 's than it is to the fur length that would be optimal for  $C$  to have under current conditions. For example, suppose the trait values (in some unit of length) are  $A = 40$  and  $C = 50$  and that the optimum for  $C$  is  $O_c = 100$ . Arguably ancestral influence has had a bigger effect on trait evolution than natural selection has had because 50 is closer to 40 than it is to 100. Darwin is saying that even when ancestral influence has been very strong (as in the hypothetical case we are considering), it still is true that the ancestor has its trait value because of natural selection. How he knows this is not so clear. If a descendant can have a trait value that is far from optimal, why can't an ancestor? After all, that ancestor itself had an ancestor and the problem recurs. In any event, to show that selection had a stronger effect than ancestral influence on  $C$ , it does no good to show that selection had a strong influence on  $A$ .

A better answer to the question of why Darwin put selection first in the *Origin* is provided by his thought that selection explains branching. This is the point of his Principle of Divergence (Kohn, 2009). A single population of generalists will often be driven by selection to evolve into 2 populations of specialists, which become increasingly different as each accumulates adaptations specifically suited to its unique way of life. Here, Darwin was influenced by the increasing specialization and division of labor that he saw in the British economy of his time. The idea that selection leads to branching may have been Darwin's reason for putting selection before common ancestry, but it is important to recall our earlier distinction between tracing back and number of start-ups. That selection leads to branching does not entail that all of current life traces back to one or a few original progenitors.\* Here we may add Darwin's idea that selection also leads lineages to go extinct. Selection causes branching *and* extinction, which means that selection does explain why the life around us traces back to one or a few original progenitors. Selection is the source

---

\*Although tree diagrams like Fig. 15.3 often are used to portray both divergence and genealogy, the two concepts are importantly different. Organisms can be identical and still trace back to a common ancestor; in this case, there is no divergence, since the variance in each generation is always zero. And lineages can diverge from each other even if they have no common ancestry.

of what the single figure in the *Origin* depicts. So there is a logical reason why selection should come first—it has causal priority.

Darwin faced a choice. Selection has causal priority; common ancestry has evidential priority. What should the order of exposition be? For some authors, the problem does not arise. Consider, for example, the relation of axioms to theorems in Euclidean geometry. If the axioms make the theorems true and the axioms are intuitively obvious while the theorems become obvious only when we see how they are related to the axioms, then the axioms have a “causal” and an evidential priority. But when the causal and the evidential orderings differ, which should be followed? There is no right or wrong here. Darwin led with the part of his theory that has causal priority, but he could have done otherwise. There are many good ways to write a book.

This duality of causal and evidential orderings is hardly unique to Darwin’s theory. Consider the relation of temperature and thermometer readings. We know what the temperature is by looking at the thermometer, but it is the temperature that causes the thermometer reading, not vice versa. We often know about causes by looking at their effects. Even so, there is a special feature of the relationship between common ancestry and natural selection in Darwin’s theory. Natural selection and common ancestry fit together, but only if selection has not been all-powerful. If all traits evolve because there is selection for them, Darwin’s Principle will conclude that we have little or no evidence for common ancestry. What is needed is that selection causes branching and extinction but that some traits persist in lineages for nonadaptive reasons. Darwin’s claim that selection is not the exclusive cause of evolution plays an essential role in allowing him to develop his evidence for common ancestry. His conjunction—common ancestry and natural selection—would be unknowable, according to Darwin’s Principle, if the second conjunct described the only cause of trait evolution.

In broad outline, the evidential structure of Darwin’s argument for his theory of common ancestry plus natural selection goes like this:

1. The argument for common ancestry. Here neutral and deleterious traits (vestigial organs, embryology, biogeography) do the main work.
2. It follows from (1) that populations have evolved across species boundaries.
3. The argument that natural selection is an important part of the explanation of many adaptive traits. Here artificial selection and the Malthusian argument for the power of selection are important, as are Darwin’s many examples of adaptive traits in nature.

The expository order in the *Origin* has (3) first, and then (1), with (2) more or less implied.

It is not just that common ancestry answers the question addressed in (2). In addition, common ancestry can be used to answer questions about natural selection. Consider what Darwin says about the vertebrate eye, which was William Paley's most famous example of a complex adaptive feature that, he thought, cries out for explanation in terms of intelligent design (Paley, 1802). Darwin discusses this in chapter 6 of the *Origin*, which he called "Difficulties for the Theory." He begins by noting that if the different eye designs found in nature can be arrayed in a graded sequence, from simpler and cruder to more complex and more adaptive, this will be the beginning of an argument that the trait evolved by natural selection. But then he adds:

In looking for the gradations by which an organ in any species has been perfected, we ought to look exclusively to its lineal ancestors; but this is scarcely ever possible, and we are forced in each case to look to species of the same group, that is to the collateral descendants from the same original parent-form.

Darwin (1859, p. 187)

If it is the lineal ancestors of present-day vertebrates that matter to understanding how natural selection has produced the vertebrate eye, why look at current organisms that are not vertebrates? If Darwin's modest goal were to argue merely that it is possible that the vertebrate eye evolved through a series of simpler eye designs, then seeing the different eye designs found in collateral descendants would be relevant because this would allow one to imagine a sequence of steps that might have been taken in the lineal ancestors. I think Darwin wanted to draw a stronger conclusion and contemporary biologists certainly do. They want to argue that the designs found in collateral descendants provide evidence about the designs found in lineal ancestors. But why should the one be relevant to the other? Darwin's language of lineages reveals the reason why. It is common ancestry that makes the characteristics of nonvertebrates that are alive now relevant to inferring the characteristics of the lineal ancestors of present-day vertebrates.

A simplified example of the kind of inference problem that Darwin faced is depicted in Fig. 15.7. As we move from current vertebrates and their camera eyes back through their lineal ancestors, Darwin thought we'd find cup eyes and then no eyes at all. Why think that this is the most plausible assignment of character states to ancestors? Many contemporary biologists would answer by appealing to parsimony. A different assignment of character states to ancestors would be less parsimonious in the sense that it would require more changes in character state in the tree's

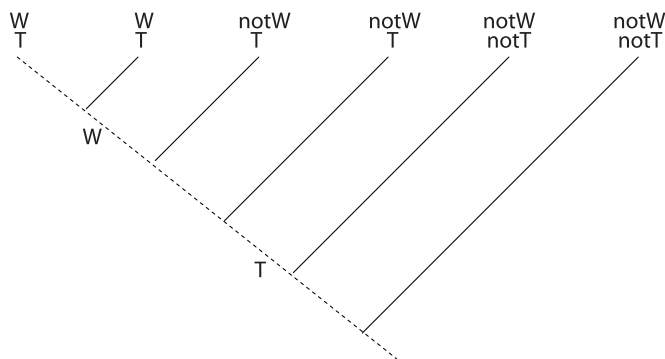

FIGURE 15.7 A simplified example in which the camera eye, the cup eye, and the complete absence of an eye are distributed across the tips of a phylogenetic tree. Parsimony considerations dictate that the best reconstruction of ancestral character states is that  $A_1$  had no eyes,  $A_2$  had a cup eye, and  $A_3$  had a camera eye.

interior. The thought that this is the right way to make inferences about the historical process does not require an a priori commitment to evolution's always moving from simple to complex. Rather, Darwin's idea about the history of eye designs is a plausible reconstruction, given an independently justified phylogeny, if parsimony makes for plausibility.

The use of parsimony to reconstruct ancestral character states is intuitively attractive. If 2 or more descendants have a given trait, it seems natural to infer that the trait was present in their most recent common ancestor. But what is the logical justification of this inference from present to past? Cladists influenced by Will Hennig (1966) have sought to justify the principle in terms of Popperian ideas about falsifiability (Eldredge and Cracraft, 1980; Wiley, 1981) and explanatory power (Farris, 1983). At about the same time that Hennig's work was translated into English, Anthony Edwards and Luigi Cavalli-Sforza (1964), students of R. A. Fisher, proposed a principle of minimum evolution as a heuristic device for inferring phylogenies, one that they thought was justified to the extent that it coincides with the dictates of likelihood. The justification of parsimony, and the question of whether there are better methods of phylogenetic inference, is a subject of continuing investigation (Sober, 1988; 2008, chaps. 3 and 4).

The Darwinian reconstruction of the history of eye evolution uses the fact of common ancestry to infer the states of lineal ancestors from the states of collateral descendants. Parsimony considerations, applied to an independently attested phylogeny, also play an important role in testing hypotheses about natural selection. Consider, for example, the hypothesis that land vertebrates evolved 4 limbs to help them walk on dry land. Biolo-

gists reject this hypothesis because they think that the morphological trait was present in the lineage before vertebrates came out of the water. Why do they think this? Again, the traits of collateral descendants allow one to infer the traits of lineal ancestors. Fig. 15.8 provides a simple example of this “chronological test” of adaptive hypotheses. We infer from current organisms (and from fossils) that there were ancestors of land vertebrates that had 4 limbs before vertebrates came up on dry land. Tetrapody evolved before walking in the vertebrate line.

As far as I know, Darwin does not explicitly describe the use of parsimony to infer ancestral character states; however, he does deploy this pattern of reasoning in applying his theory to examples. Consider his comment in the *Origin* concerning why mammals in utero have skull sutures that allow them to pass through the birth canal:

The sutures in the skulls of young mammals have been advanced as a beautiful adaptation for aiding parturition, and no doubt they facilitate, or may be indispensable for this act; but as sutures occur in the skulls of young birds and reptiles, which have only to escape from a broken egg, we may infer that this structure has arisen from the laws of growth, and has been taken advantage of in the parturition of the higher animals.

Darwin (1859, p. 197)

The sutures predate mammalian parturition; we know this because the sutures, but not the parturition, are found in contemporary birds and reptiles. Darwin is explicit, here and elsewhere, that what makes a trait currently useful may differ from what made the trait initially evolve. It

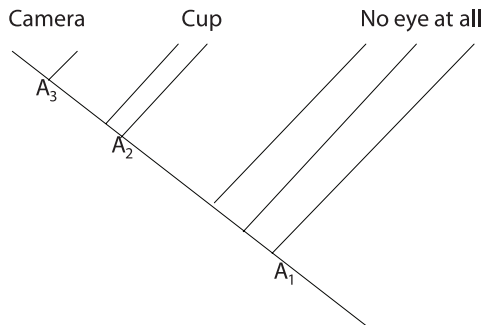

FIGURE 15.8 The use of parsimony to reconstruct the character states of ancestors in the lineage leading to modern land vertebrates (which is represented by the dashed line). Given the tree shown and the character states ( $W$  = walking and  $T$  = tetrapody) at the tips, the inference is that tetrapody evolved before walking.

is common ancestry that permits him to say something more—that the reason a trait initially evolved actually differs from the reason the trait is now useful.

For Darwinians, a lineage is like a mineshaft that extends from the surface to deep in the earth, with multiple portholes connecting surface to shaft at varying depths. By peering into these portholes, we obtain fallible guidance about what is happening in the shaft; the more portholes there are, the more evidence we can obtain. Common ancestry is not an unrelated add-on that supplements Darwin's hypothesis of natural selection; rather, common ancestry provides a framework within which hypotheses about natural selection can be tested. It is because of common ancestry that facts about the history of natural selection become knowable.

### TREE-THINKING

Tree-thinking is central to reasoning about natural selection, both for Darwin and for modern biology (O'Hara, 1998; Baum and Offner, 2008). The reverse dependence is not part of the Darwinian framework, as we learn from Darwin's *Principle*. You do not need to assume that natural selection has been at work to argue for common ancestry; in fact, what Darwin thinks you need to defend hypotheses of common ancestry are traits whose presence cannot be attributed to natural selection. This is the evidential asymmetry that separates common ancestry from natural selection in his theory. So, did Darwin write the *Origin* backwards? The book is in the right causal order; but evidentially, it is backwards.

### ACKNOWLEDGMENTS

I thank Jason Alexander, Francisco Ayala, David Baum, Luc Bovens, James Crow, Daniel Dennett, Marc Ereshefsky, Joshua Filler, Jonathan Hodge, Ronald Numbers, Robert Richards, Michael Ruse, Silvan Schweber, and Mark Taylor for useful discussion.

## 16

# Darwin's Place in the History of Thought: A Reevaluation

---

ROBERT J. RICHARDS

Scholars have usually given Darwin's theory a neo-Darwinian interpretation. A more careful examination of the language of Darwin's notebooks and the language of the *Origin of Species* indicates that he reconstructed nature with a definite purpose: the final goal of man as a moral creature. In the aftermath of the *Origin*, Darwin, however, became more circumspect.

**E**ven before the publication of the *Origin of Species* in 1859, Darwin had begun his ascendancy to a premier place in the history of biology, and he has yet to cede that position. When we examine the list of those great scientists who have transformed our vision of the world, we discover that Darwin has few rivals: Aristotle, Harvey, Copernicus, Galileo, Newton, Einstein—the pantheon is not large. And if it comes down to individuals who have altered our understanding of who we are, what we have been and, perhaps, what we can become, then, I think, Darwin stands alone. And if the concept of revolution still carries conceptual weight, which I believe it does, he staged a singular revolution in thought, as Michael Ruse and Daniel Dennett have argued in this symposium. Darwin accomplished this revolution, however, not so much by discarding the older framework as by reconstructing from within it.

---

Department of History, University of Chicago, Chicago, IL 60637.



The danger of Darwin's ideas resides in the extraordinary way he used rather traditional conceptions. The usual assumption is that Darwin killed those barren virgins of teleology and of purpose, scorned moral interpretations of nature, and strode into the modern world escorting the stylish concepts of modern materialism and secularism. I believe, on the contrary, that Darwin's theory preserved nature's moral purpose and used teleological means of doing so. Darwinian evolution had the goal of reaching a fixed end, namely man as a moral creature. This is something Darwin implied in the peroration at the end of the *Origin*, when in justifying the death and destruction wrought by natural selection, he contended that "the most exalted object we are capable of conceiving" is "the production of the higher animals" (Darwin, 1859, p. 490). To understand Darwin's place in history, I think we must first consider what his theory actually entailed.

In the argument that follows, I will assume what might seem like a pedantically obvious principle, namely that Darwin's theory is embedded in his language. The principle contends that the conceptual import of Darwin's language—particularly the deployment of tropes, metaphors, and other linguistic and logical devices—constitutes the operative theory advanced in the *Origin*. Darwin began formulating this language in his early notebooks and essays; and his constructions form the bedrock of the sometimes altered versions in his book. This means that it will occur that the language of Darwin's theory will at times say more—or less—than he himself might reflectively have wished to say. I will argue this position in the spirit of the 1950s New Criticism—the movement that prized the well-wrought urn as an autonomous aesthetic object.

### DARWIN'S EARLY LIFE

Most are familiar with the trajectory of Darwin's career, but to set the context of his work, let me briefly fill in the broad outlines of his early life.

Darwin's place in human thought could hardly have been predicted from the fortunes of that young boy who went to Edinburgh Medical School at age 16, following in the footsteps of his famous grandfather Erasmus Darwin, his father Robert Waring Darwin, and his older brother Erasmus. However, his prospects were not golden. In his *Autobiography*, Darwin recounts the attitude of that distant self, and his father's own estimation of his son's abilities:

I believe I was considered by my [school] masters and by my Father as a very ordinary boy, rather below the common standard in intellect. To my deep mortification my father once said to me, "You care for nothing but

shooting, dogs, and rat-catching, and you will be a disgrace to yourself and all your family.

Darwin (1958a, p. 28)

Darwin, however, adds to that recollection: "But my father, who was the kindest man I ever knew, and whose memory I love with all my heart, must have been angry and somewhat unjust when he used such words."

Darwin came down from Edinburgh after 2 years, being unable to tolerate the medical curriculum. His father decided that the only place for a younger son of the gentry with few prospects would be a country parsonage, and so Darwin went to Cambridge University in 1828 with the professional goal vaguely in mind of entering the ministry. Although he did not doubt the literal truth of the Bible, he later remarked of his acquiescence in the decision: "It never struck me how illogical it was to say that I believed in what I could not understand and what is in fact unintelligible" (Darwin, 1958a, p. 57).

During the 3 years he spent at Cambridge, he did become acquainted with the rudiments of botany and a bit of geology, but he judged the time mostly wasted. He occupied himself with beetle collecting and dinner parties—not unknown to Cambridge students today, except for the beetle collecting.

Of course, Darwin's life dramatically changed in 1831 when he got a chance to ship out on the surveying vessel HMS *Beagle*. He was inspired to attempt the effort because of the book in which he had been engrossed during his last year at university: *Personal Narrative of Travels to the Equinoctial Region of the New Continent, 1799–1804* (Humboldt and Bonpland, 1818–1829). It was a scientific travel adventure written by Alexander von Humboldt, the German romantic and friend of the poet Johann Wolfgang von Goethe.

Humboldt told of his own 5-year voyage to South and Central America, with a concluding trip to the wilds of Eastern America to speak with Thomas Jefferson. The tale filled the 21-year-old Darwin with enthusiasm for exotic travel. On the *Beagle*, Darwin packed into his very small quarters several of Humboldt's other books, which he consumed on the outward voyage—in between bouts of debilitating sea-sickness and retching over the side of the ship.

Humboldt's own conception of both science and nature would seep deeply into Darwin's later theory of evolution by natural selection. This German Romantic scientist portrayed a nature that was fecund and creative, and not standing in need of Divine agency. During the course of his later research, Darwin would receive several more booster shots of German Romanticism, such that his theory would become resistant to the usual interpretations imposed by neo-Darwinian scholars (Richards, 2002, pp. 514–554).

There is no substantial evidence that Darwin doubted the stability of species while on his 5-year voyage. However, his own heritage and reading of his Grandfather's book *Zoonomia* (Darwin, 1794–1796) and the works of Jean Baptiste de Lamarck—both the elder Darwin and Lamarck argued for the transmutation of species—they would have primed him to be conscious of the possibility of species mutation, a possibility rejected at the time by virtually all naturalists of standing in England.

It seems that it was only after his return in October 1836, while cataloguing his specimens from the voyage the following March, that he began seriously to entertain the hypothesis of species transformation (Sulloway, 1982). It was the mockingbirds he brought back from the Galapágos that tripped a mind at the ready. Then from spring of 1837 through summer of 1859, he labored in putting together his theory. His notebooks and manuscripts reveal the less than certain path he traveled.

### DARWIN'S CONSTRUCTION OF HIS THEORY

Initially Darwin tried several devices of a Lamarckian character to explain the alteration of species—especially the direct impact of the environment and the inherited effects of habit. Both of these devices were retained in the *Origin* and used as well in *The Descent of Man*. Darwin never relinquished his belief in the inheritance of acquired characters and even formulated a theory of heredity to explain that phenomenon. On September 28, 1838, he read Thomas Malthus's *Essay on the Principle of Population*, which, as he declared in his *Autobiography*, gave him a theory by which to work (Darwin, 1958a, p. 120). What Malthus supplied was the notion of population dynamics, population pressure. Darwin already had the idea that the breeder's picking would produce transformations in domestic organisms; now he understood, although vaguely, how it might occur in nature. The vagueness, I believe, has to be emphasized, because it still took several years for the idea to take the shape with which we are today familiar.

### MORAL PURPOSE OF EVOLUTION

One recurring problem that Darwin faced, from the very first page of his initial transmutation notebook, was the explanation for sex (Darwin, 1987, p. 170). It was a problem his grandfather had introduced in *Zoonomia* (Darwin, 1794–1796). The purpose of sex, as Darwin quickly appreciated, was to adjust organisms to the features of the environment that would produce progress. Sexual generation had the purpose of eliminating changes that were only locally adaptive while adjusting them to slow, Lyellian alterations leading to continued progress. As Darwin put it a few days after reading Malthus:

The final cause of sexes to obliterate differences, final cause of this because the great changes of nature are slow. If animals became adapted to every minute change, they would not be fitted to the slow great changes really in progress.

Darwin (1987, p. 386)

Thus, there is sex for the purpose of adjusting organisms to future, long-term changes. However, Darwin quickly came to specify what the ultimate object or purpose of that progressive development might be: namely, man as a moral creature. At the beginning of November, 1838, he put it this way:

My theory gives great final cause «I do not wish to say only cause, but one great final cause . . . » of sexes . . . for otherwise, there would be as many species, as individuals, . . . we see it is not the order in this perfect world, either at the present, or many anterior epochs.—but we can see if all species, there would not be social animals . . . hence not social instincts, which as I hope to show is «probably» the foundation of all that is most beautiful in the moral sentiments of the animated beings. If man is one great object, for which the world was brought into present state . . . & if my theory be true then the formation of sexes rigidly necessary.

Darwin (1987, p. 409; wedge quotes indicate later additions)

Darwin's final-cause explanation goes this way: Sexual generation exists for the purpose of bringing social animals into existence; and the final cause or purpose of social animals is to bring into existence animals with moral sentiments, namely human beings. Darwin concluded this final-cause consideration with: "Man is [the] one great object" of nature. In Darwin's early construction, then, sex thus developed in ancient animals so that moral creatures might eventually appear. As one can see, Darwin's theory, as he himself construed it, was hardly inimical to teleology, even in the vulgar sense of that term. And as he considered it, the goal of nature's species transformations was eventually man as a moral creature.

Within a day or two of formulating this teleological argument, Darwin opened up his *N Notebook*, in which he began constructing his theory of human moral evolution. As the above passages indicate, he considered moral behavior to be a species of social instinct. One difficulty he recognized immediately was that the social instincts benefited not their carriers but their recipients. This meant that his new device of natural selection would not appear to provide their account, which is probably why Darwin initially relied on the inheritance of acquired habit to explain these innate behaviors. Darwin would apply his device of natural selection to explicate moral behavior only after he had solved a significant problem that threatened to overturn his entire theory—or at least he so judged.

He encountered the problem while reading works in entomology. The several castes in social-insect colonies had distinctive traits. Soldier bees, for instance, displayed aggressive instincts and body shapes that were different from the workers. They were also neuters and did not reproduce. However, natural selection operates on individuals to give them a survival advantage, thus allowing them to reach reproductive age and pass on their traits to offspring. Neuter bees and ants leave no offspring. How then could natural selection account for the evolution of social-insect castes? Darwin was still fumbling with that problem while composing the *Origin of Species*. In the throes of working on his chapter on instinct, he hit upon the solution: Selection operates on the whole hive or community of insects. Later, in *The Descent of Man*, he would advance precisely the model of the social insects to explain the human acquisition of innate, altruistic impulses.

### NATURAL SELECTION AS AN INTELLIGENT AND MORAL FORCE

No expression of Darwin's principle of evolutionary change comes more trippingly to our lips than "the mechanism of natural selection." But it's a phrase that did not pass Darwin's lips, because he had anything but a mechanistic conception of the actions of selection. Indeed, the terms "mechanical," "mechanism," or "machine" never appear in the *Origin* as in any way characterizing the operations of natural selection. The model of natural selection is not a Manchester spinning loom, but mind as an intelligent and compassionate force (Richards, 2008a).

In the early 1840s, Darwin wrote 2 essays, one in 1842, the other in 1844, that outlined the book he would publish a decade and a half later (Darwin, 1909). In these essays, as in the *Origin*, he looked to artificial selection to get a purchase on selection in nature. He thought that variation in nature, as in the domestic situation, would be generally available, even though it might occur only occasionally over a great period. However, what might perform the role of the breeder in nature? He asked himself in the first essay: "Is there any means of selecting those offspring which vary in the same manner, crossing them and keeping their offspring separate and thus producing selected races?" (Darwin, 1909, p. 5). There are 2 issues here: What in nature is comparable with the picking or selecting done by the domestic breeder; and what in nature will prevent the swamping out of any favorable trait through crossing with organisms that lack the trait? The breeder prevents backcrosses by segregating his favored animals and allowing only them to breed. To deal with these questions, Darwin immediately, in both essays, formed for himself a model for the selecting activity of nature. In the 1844 essay, he wrote:

Let us now suppose a Being with penetration sufficient to perceive the differences in the outer and innermost organization quite imperceptible to man, and with forethought extending over future centuries to watch with unerring care and select for any object the offspring of an organism produced under the foregoing circumstances; I can see no conceivable reason why he could not form a new race (or several were he to separate the stock of the original organism and work on several islands) adapted to new ends. As we assume his discrimination, and his forethought, and his steadiness of object, to be incomparably greater than those qualities in man, so we may suppose the beauty and complications of the adaptations of the new races and their differences from the original stock to be greater than in the domestic races produced by man's agency.

Darwin (1909, p. 85)

The model by which Darwin attempted to explain to himself the operations of natural selection was that of a very powerful, intelligent being that manifested "forethought" and prescience, as well as moral concern, for the creatures over which it tended. Thus, as Darwin initially conceived natural selection, it hardly functioned in a mechanical or machine-like way; rather, it acted as an intelligent and moral force.

The difficulties the model was meant to solve were ultimately 3. I've just mentioned the problem of what does the selecting and the problem of swamping out. The third difficulty is that of the general moral trajectory of the entire theory—that is, how nature could have a moral purpose. I'll return to these problems as they appear and are handled in the *Origin*.

After composing his essays in the early 1840s, Darwin continued to work on various aspects of his theory. He also became preoccupied with barnacles. He had intended to deal with the curious structure of one species in 1846, but by the time he finished his investigations, he had described all of the known species of barnacle, extant and fossil, concluding his labors with 4 large monographs on the subject in 1851 and 1854. Then in 1856, he started work on a book he intended to call *Natural Selection*, which was to be the public expression of his theory of descent (Darwin, 1975). However, 2 years later, he got Wallace's letter and quickly turned to summarizing what had grown into a very large manuscript. He hastily compressed the already existing chapters and composed what he had planned as the remaining chapters. The *Origin of Species* debuted in November of 1859. Let me now sketch the lineaments of those ideas about natural selection and the moral trajectory of nature as they subtly structured Darwin's book.

### *Origin of Species*

In the *Origin of Species*, Darwin devotes 2 chapters—Chapters 3 and 4—to a discussion of natural selection. Chapter 3 is on the struggle for

existence, and furnishes the analogue for his model of the prescient, intelligent selector. Competitive struggle, as a real-world force, seems to act viciously and without the kind of compassion suggested by Darwin's original model in the early essays. At the end of the third chapter, however, Darwin ameliorates the apparent brutality of nature:

When we reflect on this struggle, we may console ourselves with the full belief that the war of nature is not incessant, that no fear is felt, that death is generally prompt, and that the vigorous, the healthy and the happy survive and multiply.

Darwin (1859, p. 79)

In the fourth chapter of the *Origin*, the intelligent, compassionate being that Darwin had described in his earlier essays reappears. It reassuringly manifests the wisdom and moral concern that Darwin had originally supposed. In this respect, its behavior is far superior to that of the human breeder.

Man can act only on external and visible characters: nature cares nothing for appearances, except in so far as they may be useful to any being. She can act on every internal organ, on every shade of constitutional difference, on the whole machinery of life. Man selects only for his own good; Nature only for that of the being which she tends. . . . Can we wonder, then, that nature's productions should be far "truer" in character than man's productions; that they should be infinitely better adapted to the most complex conditions of life, and should plainly bear the stamp of far higher workmanship?

Darwin (1859, pp. 83–84)

At one level, the Biblical cadences of these passages had an assuaging effect on Darwin's Victorian readers. Some, like Asa Gray (1861), would yet find the mysterious hand of the Creator still stirring in the depths of Darwin's language. So his audience might have been initially shocked by the audacity of the *Origin's* claims but oddly soothed by the familiar resonances. Where Lamarck could make little headway and Chambers was scorned and Spencer ignored, Darwin began to convince. A sophisticated reader could accept Darwin as harbinger of the modern world while still taking comfort in the verities of the ancient world. One of Darwin's first reviewers, T. V. Wollaston, thought he had been unconsciously seduced by the language of the *Origin* (Wollaston, 1860). Part of Darwin's success must be attributed to his skillful, albeit intuitive, use of compelling linguistic constructions. However, the impact of Darwin's model reached far below what might seem surface rhetoric.

Consider, for example, Darwin's claim in the above passage that, unlike the human breeder who acts for selfish ends—selecting animals for his



own good—Nature selects only for the good of the being which she tends. But, of course, nature, at least as we would understand her operations, hardly works for the good of each being in her selections—she destroys most of the beings which she tends. Darwin's formulation, however, is not a slip of his pen. In the same section of the *Origin*, he reiterates:

It may be said that natural selection is daily and hourly scrutinizing, throughout the world, every variation, even the slightest; rejecting that which is bad, preserving and adding up all that is good; silently and insensibly working, whenever and wherever opportunity offers, at the improvement of each organic being in relation to its organic and inorganic conditions of life.

Darwin (1859, p. 84)

The conceit that nature is working for “the improvement of each organic being” is repeated several more times throughout the *Origin* (1859, pp. 149, 194, 201, and 489). Despite the ravages of natural selection, the nature that appears in Darwin's theory nonetheless expresses compassion and altruistic concern—and thus hardly acts as a mechanical, indifferent force.

Darwinian evolution, under the aegis of natural selection, is also progressive. As Darwin expresses it in the penultimate paragraph of the book: “And as natural selection works solely by and for the good of each being, all corporal and mental endowments will tend to progress toward perfection” (Darwin, 1859, p. 489). This kind of progress is not merely local. In chapter 10 of the *Origin*, for instance, Darwin asserts that “the more recent forms [of creatures] must, on my theory, be higher than the more ancient; for each new species is formed by having had some advantage in the struggle for life over other and preceding forms” (1859, pp. 336–337). This is a universal proposition, not confined to a local population. He then provides an operational test—at least in imagination—of this consequence. If Eocene creatures adapted to a particular environment were put in competition with modern animals, Darwin conjectures, “the Eocene fauna or flora would certainly be beaten and exterminated” (1859, p. 337). He assumes that the accumulation of improvements would give the advantage to more progressive (i.e., recent) creatures—even if compared with animals adapted to the same environment. This presumption of cumulative adaptational advantage, of course, does not play a role in neo-Darwinian theory. But then, as I've pedantically argued, Darwin was not a neo-Darwinian.

Stephen Jay Gould (1977a, 1989) and others have assumed that any acquiescence in the idea of global evolutionary progress would suggest a teleological structure to biological history. I don't think that logically follows. Michael Ruse has found that many leading evolutionary biologists in the 20th century, as secular in their orientation as one could desire, yet

harbored the conviction that evolutionary history evinced a progressive character, as vague as the idea of progress might be (Ruse, 1996). For Darwin, the conviction of progress was a deeply embedded part of his theory. And he does seem to have believed that this progress had a definite trajectory. He may have succumbed to some of the traps that Francisco Ayala (1988) has identified; but the idea is nonetheless part of his theory.

Let me approach this line of thought a bit indirectly. I've already indicated Darwin's early views as to the purpose of sexual generation, ultimately for the production of moral creatures. Now let me come at it from the other temporal end, Darwin's considerations in *The Descent of Man*. In *The Descent*, Darwin devotes 2 chapters to his theory of the evolution of morality. For the British reader, the barrier between animals and human beings was not erected on man's luminous intellect. The British empiricists had maintained that ideas were but faint sensory images and that reasoning amounted to the association of ideas. Of course, animals would be quite capable of both. This attitude even infected British idealists, such as F. H. Bradley, the great metaphysician, who once confessed to Conwy Lloyd Morgan: "I never could see any difference at bottom between my dogs & me, although some of our ways were certainly a little different" (Richards, 1987, p. 105). But man was a moral creature, and that singular trait seemed to be denied of every animal. Hence, Darwin had to give an evolutionary account of man's distinctive acquirement, if his theory were to be successful and if its ultimate concern should be realized.

### *The Descent of Man*

Most contemporary interpreters of Darwin's accomplishment presume that evolutionary theory left man morally naked to the world. Michael Ghiselin, for instance, in a fit of overheated hyperbole, asserted: "Scratch an altruist and watch a hypocrite bleed" (Ghiselin, 1974). Had Ghiselin scratched the master himself, he would have found the blood of naturalized compassion; Darwin thought his theory removed "the reproach of laying the foundation of the most noble part of our nature in the base principle of selfishness" (Richards, 1987, pp. 185–242, and Darwin, 1871, Vol. 1, p. 98). He opposed his own theory of moral conscience to that of utilitarians, like Jeremy Bentham and James Mill. I doubt he would have found Ghiselin's characterization any more agreeable.

In *The Descent of Man*, Darwin applied the conception of community selection, which he first developed to account for the traits of social insects, to construct a theory of human moral behavior. Those proto-human tribes whose members had the instinct for cooperation, fidelity, sympathy, and altruistic impulse would have the advantage over other tribes, even if members bearing those traits would be at a disadvantage

within their group. As he concluded: "At all times throughout the world tribes have supplanted other tribes; and as morality is one element in their success, the standard of morality and the number of well-endowed men will thus everywhere tend to rise and increase" (Darwin, 1871, Vol. 1, p. 166). Although moral impulses would initially be confined to tribal members, cultural evolution and progressive learning, Darwin believed, would gradually instruct our ancestors that we were all part of the same human family; so that now, at least among members of advanced civilizations, moral instincts would be activated by any and all human beings. The Biblical story told of a fall from grace. By contrast, Darwin's conception proposed a gradual advance from a lower to a higher state; and compared with the ancient narrative he contended that his theory was "truer and more cheerful" (Darwin, 1871, Vol. 1, p. 184).

But to this progressivist and cheerful British view, there appeared one salient objection: the Irish. Richard Rathbone Greg, a Scottish political theorist who was an advocate of the new Darwinian theory, pointed out in an article published 3 years before *The Descent*, that natural selection had been thrown out of gear. He mounted an argument that Darwin took extremely seriously. Greg, the dour Scotsman, wrote:

The careless, squalid, unambitious Irishman multiples like rabbits: the frugal, foreseeing, self-respecting, ambitious Scott, stern in his morality, spiritual in his faith, sagacious and disciplined in his intelligence, passes his best years in struggle and in celibacy, marries late, and leaves few behind him. Given a land originally peopled by a thousand Saxons and a thousand Celts—and in a dozen generations five-sixths of the population would be Celts, but five-sixths of the property, of the power, of the intellect, would belong to the one-sixth of Saxons that remained. In the eternal "struggle for existence," it would be the inferior and less favoured race that had prevailed—and prevailed by virtue not of its good qualities but of its faults.

Greg (1868)

Darwin immediately understood the force of Greg's argument. The British had identifiable, superior fitness traits, but the propagational race—that is, the race that counts for Darwin—was going to the less fit. It looked like natural selection had been disengaged. This would not be the trajectory that nature apparently designed for man.

In *The Descent*, Darwin analyzed the situation carefully; and based on a raft of statistics, he ascertained that a good many Irish men wound up in jail; that and drunkenness, he felt, would put a check on generation. And, moreover, infant mortality was very high among the Irish. That meant, in Darwin's estimation, the Irish actually were not increasing at a rate in excess of the British rate. But, as he concluded, progress was not an

intrinsic, necessary feature of nature, but only an extrinsic, general feature instituted by natural selection (Darwin, 1909, p. 47, and 1871, Vol. 1, p. 177). Darwin's concluding analysis suggested that the promise of the *Origin* could indeed be realized despite the Irish. However, let me conclude by more carefully specifying that promise and what has been made of it.

### CONCLUSION

When Darwin traveled through the interior of South America, he always stuck in his saddlebags his well-worn copy of Milton's *Paradise Lost*, a favorite of both English and German Romantics. In Milton's great poem, he pictures Satan approaching the Garden of Eden, although the evil one is stopped by an entangled bank:

Now to the ascent of that steep savage hill  
Satan had journeyed on, pensive and slow,  
But further way found none, so thick entwined,  
As one continued brake, the undergrowth  
Of shrubs and tangling bushes had perplexed  
All path of man or beast that passed that way. . .  
Thence up he flew, and on the Tree of Life,  
The middle tree and highest there that grew,  
Sat like a cormorant, yet not true life  
Thereby regained, but sat devising death  
To them who lived, not on the virtue thought  
Of that life-giving plant, but only used  
For prospect what, well-used, had been the pledge  
Of Immortality.

John Milton, *Paradise Lost*, 4.11.172–301

With the Fall, Milton yet foresees the coming of the Redeemer whose own death will transform the world and bring a transformed life.

At the end of the *Origin*, Darwin as well imagines an "entangled bank, with birds singing on the bushes, with various insects flitting about, and with worms crawling through the damp earth" (1859, p. 489). He wishes his reader to reflect that these very different forms have been produced by laws acting on them, the chief of which is natural selection, the struggle for life. Darwin then concludes:

Thus, from the war of nature, from famine and death, the most exalted object which we are capable of conceiving, namely the production of the higher animals directly follows.

Darwin (1859, p. 490)

Darwin is here justifying, as Milton did, the death and destruction that has entered the world. Those evils, Darwin suggests, had an exalted object, the most exalted we were capable of conceiving. That most exalted purpose could only be human beings with their moral sentiments.

Now would Darwin admit to this teleological and moral construction that I've given his theory? I suspect that immediately after the completion of the *Origin*, he would have. Certainly the language in which his theory is expressed supports this interpretation. The language, however, was often ignored by both friends and then by enemies, and finally by Darwin himself. Huxley rather quickly started shaving off features of Darwin's theory in his first review in 1860. The slow, gradual, and progressive character that the *Origin* projected, Huxley thought unwarranted, and insisted on a more mechanical, jumpy kind of evolution. Huxley, for quite personal reasons, rejected the sort of moral theory that Darwin—and Spencer—had proposed. In his Romanes Lecture "Evolution and Ethics," he maintained that human beings had to "fight against the cosmic process" that evolution represented (Richards, 1987, pp. 316–318). He located morality in the hidden recesses of man's nature, which he tried to seal off from natural selection. Darwin's great champion in Germany, Ernst Haeckel, also deracinated Darwin's theory, representing the theory in the kind of aggressive, mechanistic language that the master himself never used (Richards, 2008b). Asa Gray, in the United States, did respond to the language, but by emphasizing the role of a personal God, which Darwin could not accept. Finally there was the cofounder of evolution by natural selection, Alfred Russel Wallace. Wallace, during the late 1860s, converted to spiritualism, and began engaging mediums to contact the spirit world. He then discovered features of human nature that only higher spiritual powers could account for. Darwin was aghast.

Darwin gradually came more and more to view the operations of natural selection much as did Huxley and Haeckel, and in friendly opposition to Gray and Wallace. At that point, Darwin became a neo-Darwinian.



# 17

## Darwin's "Strange Inversion of Reasoning"

---

DANIEL DENNETT

Darwin's theory of evolution by natural selection unifies the world of physics with the world of meaning and purpose by proposing a deeply counterintuitive "inversion of reasoning" (according to a 19th century critic): "to make a perfect and beautiful machine, it is not requisite to know how to make it" [MacKenzie RB (1868) (Nisbet & Co., London)]. Turing proposed a similar inversion: to be a perfect and beautiful computing machine, it is not requisite to know what arithmetic is. Together, these ideas help to explain how we human intelligences came to be able to discern the reasons for all of the adaptations of life, including our own.

### TWO STRANGE INVERSIONS OF REASONING

**S**ome of the most important thinkers we philosophers take seriously were not philosophers but scientists—Newton, Einstein, Gödel, and Turing, for instance—but by far the scientist who has made the greatest contribution to philosophy is Charles Darwin. If I could give a prize for the single best idea anybody ever had, I'd give it to Darwin. In a single stroke Darwin's theory of evolution by natural selection united

---

Center for Cognitive Studies, Tufts University, Medford, MA 02155-7059.



the realm of physics and mechanism on the one hand with the realm of meaning and purpose on the other. From a Darwinian perspective the continuity between lifeless matter on the one hand and living things and all their activities and products on the other can be glimpsed in outline and explored in detail, not just the strivings of animals and the efficient designs of plants, but human meanings and purposes: art and science itself, and even morality. When we can see all of our artifacts as fruits on the tree of life, we have achieved a unification of perspective that permits us to gauge both the similarities and differences between a spider web and the World Wide Web, a beaver dam and the Hoover Dam, a nightingale's nest and "Ode to a Nightingale." Darwin's unifying stroke was revolutionary not just in the breadth of its scope, but in the way it was achieved: in an important sense, it turned everything familiar upside down. The pre-Darwinian world was held together not by science but by tradition: all things in the universe, from the most exalted ("man") to the most humble (the ant, the pebble, the raindrop) were the creations of a still more exalted thing, God, an omnipotent and omniscient intelligent creator—who bore a striking resemblance to the second-most exalted thing. Call this the trickle-down theory of creation. Darwin replaced it with the bubble-up theory of creation. One of Darwin's 19th century critics put it vividly:

In the theory with which we have to deal, Absolute Ignorance is the artificer; so that we may enunciate as the fundamental principle of the whole system, that, IN ORDER TO MAKE A PERFECT AND BEAUTIFUL MACHINE, IT IS NOT REQUISITE TO KNOW HOW TO MAKE IT. This proposition will be found, on careful examination, to express, in condensed form, the essential purport of the Theory, and to express in a few words all Mr. Darwin's meaning; who, by a strange inversion of reasoning, seems to think Absolute Ignorance fully qualified to take the place of Absolute Wisdom in all of the achievements of creative skill.

MacKenzie (1868)

This was indeed a "strange inversion of reasoning," and the outrage and incredulity expressed by MacKenzie more than a century ago is still echoing through a discouragingly large proportion of the population in the 21st century. A page from a 20th century creationist pamphlet (Fig. 17.1) perfectly captures the "obviousness" of the intuition that Darwin's theory overthrows.

When we turn to Darwin's bubble-up theory of creation, we can conceive of all of the creative design work metaphorically as lifting in Design Space. It has to start with the simplest replicators, and gradually ratchet up, by wave after wave of natural selection, to multicellular life in all its forms. Is such a process really capable of having produced all of the wonders we observe in the biosphere? Skeptics ever since Darwin have tried to demonstrate that one marvel or another is simply unapproachable

**TEST TWO**

1. Do you know of any building that  YES  NO  
didn't have a builder?

2. Do you know of any painting that  YES  NO  
didn't have a painter?

3. Do you know of any car that didn't  YES  NO  
have a maker?

If you answered "YES," for any of the above give details:

---



---

FIGURE 17.1 An expression of incredulity about Darwin's inversion, from an anonymous creationist propaganda pamphlet, *ca.* 1970.

by this laborious and unintelligent route. They have been searching for a "skyhook," something that floats high in Design Space, unsupported by ancestors, the direct result of a special act of intelligent creation. And time and again, these skeptics have discovered not a miraculous skyhook but a wonderful "crane," a nonmiraculous innovation in Design Space that enables ever more efficient exploration of the possibilities of design, ever more powerful lifting in Design Space. Endosymbiosis is a crane; sex is a crane; language and culture are cranes. (For instance, without their addition to the arsenal of R&D tools available to evolution, we couldn't have glow-in-the-dark tobacco plants with firefly genes in them. These are not miraculous. They are just as clearly fruits of the tree of life as spider webs and beaver dams, but the probability of their emerging without the helping hand of *Homo sapiens* and our cultural tools is nil.)

As we learn more and more about the nano-machinery of life that makes all this possible, we can appreciate a second strange inversion of reasoning, provided by another brilliant Englishman: Alan Turing. Here is Turing's strange inversion, put in language borrowed from MacKenzie:

IN ORDER TO BE A PERFECT AND BEAUTIFUL COMPUTING MACHINE, IT IS NOT REQUISITE TO KNOW WHAT ARITHMETIC IS.

Before Turing there were computers, by the hundreds, working on scientific and engineering calculations. Many of them were women, and many had degrees in mathematics. They were human beings who knew what arithmetic was, but Turing had a great insight: they didn't need to know this! As he noted, "The behavior of the computer at any moment is determined by the symbols which he is observing, and his 'state of mind' at that moment . . ." (Turing, 1936). Turing showed that it was possible to design machines—Turing machines or their equivalents—that were Absolutely

Ignorant, but could do arithmetic perfectly. And, he showed that, if they can do arithmetic, they can be given instructions in the impoverished terms that they do “understand” that permit them to do anything computational. (The Church-Turing Thesis is that all “effective procedures” are Turing-computable—although of course many of them are not feasible because they take too long to run. Because our understanding of effective procedures is unavoidably intuitive, this thesis cannot be proved, but it is almost universally accepted, so much so that Turing-computability is typically taken as an acceptable operational definition of effectiveness.) A huge Design Space of information-processing was made accessible by Turing, and he foresaw that there was a traversable path from Absolute Ignorance to Artificial Intelligence, a long series of lifting steps in that Design Space.

Many people can't abide Darwin's strange inversion. We call them creationists. They are still looking for skyhooks—“irreducibly complex” features of the biosphere that could not have evolved by Darwinian processes. Many people can't abide Turing's strange inversion either. I propose that we call them “mind creationists.” Among them are some eminent thinkers. They argue—so far with no more success than creationists—that there are aspects of (human) minds that are forever and “in principle” inaccessible by the long upward trudge of Turing machines. John Searle (1980, 1992) and Roger Penrose (1989, 1990) are the two best known. Interestingly, in the last few years, several philosophers have come close to embracing both species of creationism: Jerry Fodor (2007, 2008a,b), Thomas Nagel (2008), and Alvin Plantinga (1993, 1996, 2009). Fodor and Nagel deny that religion has anything to do with their skepticism about evolution. Fodor declares that his arguments provide no support for Intelligent Design because he isn't saying that adaptations are due to an Intelligent Designer; he is saying that nobody knows how adaptations arose. He accepts descent with modification, but doesn't think natural selection (“adaptation”) is the explanation of any features of living things. “It is in short one thing to wonder if evolution happens and another thing to wonder if adaptation is the mechanism by which it happens” (Fodor, 2008a). The paleontologist Simon Conway Morris (2009) takes a strikingly different tack: he wholeheartedly accepts adaptationism but still thinks that human minds are inexplicable as a product of natural selection unaided by the intelligence of a Christian God.

#### PLANTINGA'S ATTEMPTED *REDUCTIO AD ABSURDUM* OF NATURALISM

Plantinga also has an explicitly religious foundation for his repugnance, and he covers both kinds of creationism in his attempt at a *reductio ad absurdum* of naturalism (1996, 2009). Where N is naturalism, E is current

evolutionary theory and R is the proposition that our cognitive faculties are reliable:

1.  $P(R|N\&E)$  is low. [The probability of R, conditional on N&E, is low.]
2. One who accepts N&E sees that (1) is true has a defeater for R.
3. This defeater can't be defeated.
4. One who has a defeater for R has a defeater for any belief she takes to be produced by her cognitive faculties, including N&E.

Therefore:

5. N&E is self-defeating and can't rationally be accepted.

Plantinga (2009)

We needn't dwell here on the interpretation of the whole argument because the crucial Premise 1 is false. We can see why in terms of evolution by natural selection. Consider the excellence and reliability of various organs. Across the entire spectrum of, say, vertebrates, hearts are highly reliable pumps, lungs are highly reliable blood oxygenators, and eyes and ears are highly reliable distal-information-acquirers. In each species there is admirable—but not perfect—tuning of these organs to the specific needs of the organisms in their demanding environments. The eagle's eyes are strikingly unlike the rabbit's eyes or the frog's eyes. The effect is that the beliefs (or if you're abstemious about using that term, the information states) that are provoked by those eyes and ears are highly reliable—but far from perfect—truth-trackers. Animals that get it right in general fare better than those whose senses deceive them.

This is adaptationist reasoning, of course, and it is not surprising that creationists of both kinds have typically taken aim at adaptationist thinking in biology, for they see, correctly, that if they can discredit it, they take away the only grounds within biology for assessing the justification or rational acceptability of the deliverances of such organs. We need to put matters in these "reverse engineering" terms if we are to compare organs with respect to their reliability—and not just their mass or density or use of phosphorus, for instance. Such an appeal to the power of natural selection to design highly reliable information-gathering organs would be in danger of vicious circularity were it not for the striking confirmations of these achievements of natural selection using independent engineering measures. The acuity of vision in the eagle and hearing in the owl, the discriminatory powers of electric eels and echolocating bats, and many other cognitive talents in humans and other species have all been objectively measured, for instance.

It might seem that the skeptics could short-circuit this defense of our natural reliability as truth-trackers by showing that there can be no gradualistic path to truth-tracking. They could claim that there are no quasi-

believers, proto-thinkers, hemi-semidemi-understanders; you either have a full-blown mind or you don't. This is where Turing's strange inversion comes usefully into play, for his insight has given us a wealth of undeniable examples of just such partial comprehension: devices that can do all manner of impressive discriminative, predictive, and analytic tasks. We may insist on calling this competence without comprehension, but, as the competence grows and grows, the declaration that there is no comprehension at all embodied in that competence sounds less and less persuasive. This is made especially vivid when we reflect that, as we learn more about the nano-technology within our cells, we discover that they themselves contain trillions of protein robots: motor proteins, proofreaders, snippers, and joiners and sentries of all kinds. It is undeniable that the other necessary competences of life are composable from unliving, uncomprehending parts; why should comprehension itself be the lone exception?

In the gradual path to intelligence, endosymbiosis has played a particularly potent role as a crane. The endosymbiotic origin of the eukaryotic revolution  $\approx 2.5$  billion years ago gives us a telling example of a quite sudden multiplication of competence: each partner in the symbiosis got the potential benefit of over a billion years of independent R&D, a tremendous acquisition of talent not found in one's ancestors. Instead of eating the intruder—disassembling it for raw materials and energy—the host coopted the intruder, preserving most or all of the valuable information embodied in its design. The greater complexity of the resulting eukaryotes permitted greater versatility, allowing for the sorts of division of labor that enabled multicellularity to evolve. (As Lukeš et al., Chapter 4, this volume, show, the evolution of multicellularity also involved reducing the complexity of prokaryotic replication methods, which were temporally and energetically too inefficient to support the profligate cell division of viable multicellular organisms.)

### FREE-FLOATING RATIONALES OF EVOLUTION

When we observe the caddis fly's impressive food sieve (Fig. 17.2) we can see that there are reasons for its features that are strikingly similar to the reasons for the features of another artifact for harvesting food from water, the lobster trap (Fig. 17.3).

The difference is that the reasons in the former case are not represented anywhere. Not in the caddis fly's "mind" or brain, and not in the process of natural selection that "honored" those reasons by blindly homing in on the best design. These are examples of the ubiquitous "free-floating rationales" of evolution (Dennett, 1995). Some of the features of the lobster trap may be similarly the result of blind trial and error by trap-makers over the centuries, but there is little doubt that most if not all of the reasons

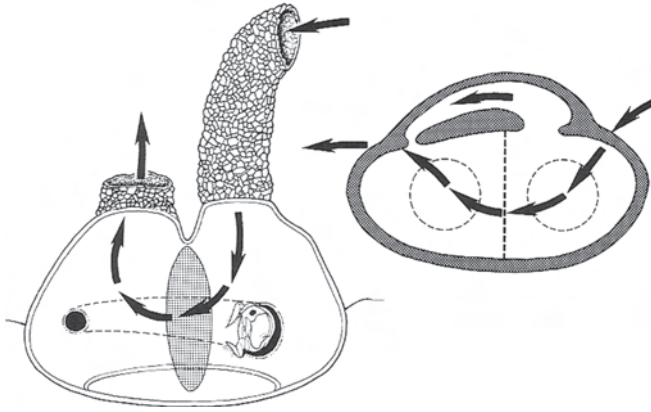

FIGURE 17.2 A caddis larva food sieve, exhibiting design features for which there are good (unrepresented) reasons (Hansell, 2000) that are strikingly similar to the reasons for the features of another artifact for harvesting food from water, the lobster trap (see Fig. 17.3).  
 SOURCE: Reproduced with permission from Hansell (2000) (Copyright 2000, Cambridge University Press).

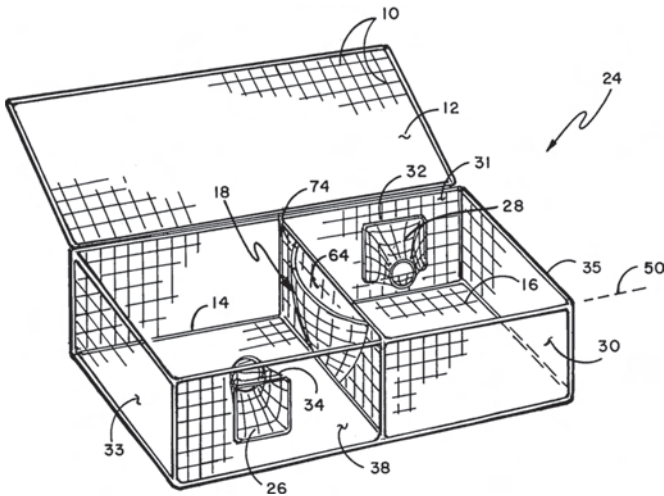

FIGURE 17.3 Lobster trap diagram, exhibiting design features similar to those of the caddis larva food sieve (see Fig. 17.2); the reasons for the design features are described in the patent application (available at [www.freepatentsonline.com/7111427.html](http://www.freepatentsonline.com/7111427.html)).  
 SOURCE: Reproduced with permission from United States Patent 7111427.

for the design features instantiated by today's lobster traps have been represented, understood, appreciated, and communicated by their (more or less intelligent) artificers.

Consider the murderous behavior of the cuckoo chick, pushing the eggs of the host out of the nest to maximize its food intake. The rationale for this behavior is unmistakable, but the chick has no Need to Know; it can be the beneficiary of a routine that it follows without any comprehension of its rationale. This is Turing's strange inversion uncovered in nature. There is a common tendency to overinterpret animals exhibiting such clever behaviors, imputing to them much more comprehension than they need, or have, and an equally common tendency, in reaction, to underestimate them. The literature on animal intelligence reverberates with the contests between the romantics and the killjoys (Dennett, 1983), and long series of ingenious experiments are gradually limning the actual boundaries of these competences. Because we don't have everyday terms for semi-understood quasi-beliefs, we have no stable vocabulary for describing the cascade of Turing powers that climbs to the summit of our particular human levels of comprehension. Is it "metaphorical" to attribute beliefs to birds or chimpanzees? Should we reserve that term, and many others, for (adult) human beings alone? This lexical dearth helps to sustain the illusion that there is an unbridgeable gulf between animal minds and human minds—despite the obvious fact that similar quandaries of interpretation afflict us when we turn to young children. Just when do they exhibit enough prowess in one test or another for us to say, conclusively, that they "have a theory of mind" or understand numbers? How much do we human beings need to know to understand our own concepts? There is no good, principled answer to this question.

### EVOLUTION OF THINKING TOOLS

Rather than attempt to answer such an ill-motivated question about necessary and sufficient conditions we can simply acknowledge, with Maynard Smith and Szathmary (1995), that along the path from amoebas and cuckoos to us, there was a major transition with powers to rival the endosymbiotic birth of the eukaryotes: the evolution of language and culture, one of the great cranes of evolution. In both cases, individual organisms were enabled to acquire, rapidly and without tedious trial and error, huge increases in competence designed elsewhere at earlier times. The effects have been dramatic indeed. According to calculations by MacCready, at the dawn of human agriculture, the worldwide human population plus livestock and pets was  $\approx 0.1\%$  of the terrestrial vertebrate biomass. Today, he calculates, it is 98%!



Over billions of years, on a unique sphere, chance has painted a thin covering of life—complex, improbable, wonderful and fragile. Suddenly we humans . . . have grown in population, technology, and intelligence to a position of terrible power: we now wield the paintbrush.

MacCready (1999)

Unlike the biologically "sudden" Cambrian explosion, which occurred over several million years  $\approx$ 530 million years ago (Gould, 1989), the MacCready explosion occurred in  $\approx$ 10,000 years, or  $\approx$ 500 human generations. There is no doubt that it was the rapidly accumulating products of cultural evolution that made this possible. As Richerson and Boyd (2006) show, in addition to the standard highway, the vertical transmission of genes, a second information highway from parents to offspring is evolvable under rather demanding conditions; and once this path of vertical cultural transmission is established and optimized, it can be invaded by "rogue cultural variants," horizontally or obliquely transmitted cultural items that do not have the same probability of being benign. (The comparison to spam on the internet is hard to avoid.) These rogue cultural variants are what Richard Dawkins (1976) calls "memes," and although some of them are bound to be pernicious—parasites, not mutualists—others are profound enhancers of the native competences of the hosts they infect. One can acquire huge amounts of valuable information of which one's parents had no inkling, along with the junk and scams.

Language is the key cultural element, because it alone provides the digitized base for reliable cumulative evolution. (It is digitized in the sense that it is composed of a finite set of discrete, all-or-nothing elements—phonemes—that can survive noisy transmission, different accents and tones of voice, drawls and lisps, by a process of largely automatic correction to norms.) Other species, such as chimpanzees, have a handful of culturally transmitted traditions—of termite fishing or grooming signals or nut cracking, for instance—but nothing that ramifies the way human culture does. Language, by providing a basic repertoire of readily replicated elements, permits the reliable transmission of semi-understood formulas, recipes, admonitions, techniques. (It is not typically noticed that one of the most valuable features of language is its ability to convey information down a chain of communicators who do *not* really understand what they are "parrotting.") By rendering copying and transmission relatively impervious to variations in comprehension, language optimizes fidelity in the pathway. Words, composed of a finite "alphabet" of phonemes, share with computers and the genetic code the self-normalizing feature of absorbing noise, or permitting many minor variations to "count as the same" for the purposes of computation or replication. This makes it

possible, using language, to create fairly “standardized” thinking tools. Douglas Hofstadter (2007) provides a short list of some of his favorites:

- wild goose chases
- tackiness
- dirty tricks
- sour grapes
- elbow grease
- feet of clay
- loose cannons
- crackpots
- lip service
- slam dunks
- feedback

Each of these is an abstract cognitive tool, in the same way that long division or finding-the-average is a tool; each has a role to play in a broad spectrum of contexts, rendering hypothesis generation more efficient, pattern recognition more probable. Equipped with such tools one is able to think thoughts that would otherwise be relatively hard to formulate. Of course, as the old joke has it, when the only tool you have is a hammer, everything looks like a nail, and each of these can be overused. Acquiring tools and using them wisely are distinct skills, but you have to start by acquiring the tools.

### **BOOTSTRAPPING OUR WAY TO INTELLIGENT DESIGN, AND TRUTH**

In fact, the development of cultural tools for thinking, for designing, for extracting and recording information have led to orders of magnitude of improvement in all our belief-forming competences. Consider, as just one simple example, the evolution of the straightedge. How do you draw a straight line? By placing a pencil on a straightedge and running it across the paper. Where did you get the straightedge? From a straightedge-maker. Where did the straightedge-maker get the straightedge used to make this product? From some earlier toolmaker, and so on, but not to infinity. This is an instance of nonmiraculous bootstrapping, and it has occurred many times. There is a finite regress leading back to the earliest relatively primitive and inaccurate straightedges, but, over time, straightedges have been manufactured to ever more demanding tolerances. The deviations from perfection manifest in a straightedge from the 1960s are shown in Fig. 17.4, magnified a millionfold. Such representations make possible highly efficient, guided, foresighted trajectories in design space.



FIGURE 17.4 A surface trace of a precision gauge block at 1 million times vertical magnification, illustrating the representation of deviations from perfection. SOURCE: Reproduced with permission from Moore (1970) (Copyright 1970, Moore Special Tool Company).

And our indefinitely extendable recursive power of reflection means that not only can we evaluate our progress, but we can evaluate our evaluation methods, and the grounds for relying on evaluation methods, and the grounds for thinking that this iterative process gives us grounds for believing the best fruits of our research, and so forth. Science is a culturally transmitted and maintained system of truth-tracking that has identified and rectified literally hundreds of imperfections in our animal equipment, and yet it is not itself a skyhook, a gift from God, but a product of adaptations, a fruit on the tree of life.

That is, in outline, the response to Plantinga's premise (MacKenzie, 1868). We have excellent internal evidence for believing that science in general is both reliable and a product of naturalistic forces only—natural selection of genes and natural selection of memes. An allegiance to naturalism and to current evolutionary theory not only doesn't undermine the conviction that our scientific beliefs are reliable; it explains them. Our "godlike" powers of comprehension and imagination do indeed set us apart from even our closest kin, the chimpanzees and bonobos, but these powers we have can all be accounted for on Darwin's bubble-up theory of creation, clarified by Turing's own strange—and wonderful—inversion of reasoning.

Our powers of representation permit us, for instance, to represent some of our predicaments as locations on adaptive landscapes (Fig. 17.5).

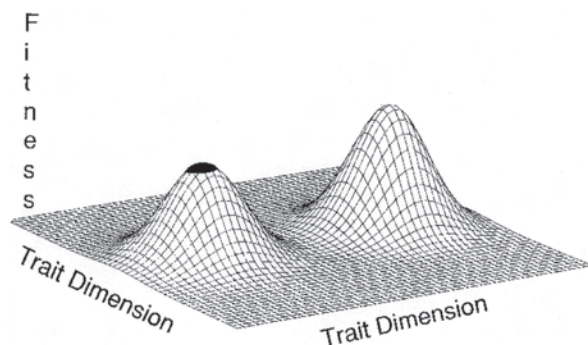

FIGURE 17.5 Adaptive landscape, which can be used as an explicit representation of valuable states of affairs or goals, relative to one's current situation.

SOURCE: Reprinted with permission from Schull (1991) (Copyright 1991, Springer).

Here, we are, we may think, isolated on this sup-optimal peak; is there any way of getting over there, to what seems to be the global summit? Because we can *represent* this state of affairs (in diagrams or words—you don't need to use adaptive landscape sketches, but they often help), we can, for the first time, "see" some of the peaks beyond the valleys, and thereby are motivated to devise ways of traversing those valleys. We, the reason representers, can evaluate our possible futures far more powerfully, far less myopically, than any other species, can now look back at our own prehistory and discover the unrepresented reasons everywhere in the tree of life.

We are not perfect truth-trackers, but we can evaluate our own shortcomings by using the methods we have so far devised, so we can be confident that we are justified in trusting our methods in the foreseeable future.

It took Darwin to discover that a *mindless* process created all those reasons. We "intelligent designers" are among the effects, not the cause, of all those purposes.

## References

---

- Aagaard JE, Yi Z, MacCoss MJ, Swanson WJ (2006) Rapidly evolving zona pellucida domain proteins are a major component of the vitelline envelope of abalone eggs. *Proc Natl Acad Sci USA* 103:17302–17307.
- Abzhanov A, et al. (2008) Are we there yet? Tracking the development of new model systems. *Trends Genet* 24:353–360.
- Afriat L, Roodveldt C, Manco G, Tawfik DS (2006) The latent promiscuity of newly identified microbial lactonases is linked to a recently diverged phosphotriesterase. *Biochemistry* 45:13677–13686.
- Aharoni A, et al. (2005) The evolvability of promiscuous protein functions. *Nat Genet* 37:73–76.
- Ah-King M, Kvarnemo C, Tullberg B (2005) The influence of territoriality and mating system on the evolution of male care: A phylogenetic study on fish. *J Evol Biol* 18:371–382.
- Ahnesjö I, Kvarnemo C, Merilaita S (2001) Using potential reproductive rates to predict mating competition among individuals qualified to mate. *Behav Ecol* 12:397–401.
- Alberti G (1991) Spermatology in the Acari: Systematic and functional implications. In *The Acari: Reproduction, Development and Life-History Strategies*, eds Schuster R, Murphy PW (Chapman and Hall, London), pp 77–105.
- Alexander RD, Marshall D, Cooley J (1997) Evolutionary perspectives on insect mating. In *Social Competition and Cooperation in Insects and Arachnids. I. Evolution of Mating Systems*, eds Choe J, Crespi B (Cambridge Univ Press, Cambridge, UK), pp 4–31.
- Allendorf FW, England PR, Luikart G, Ritchie PA, Ryman N (2008) Genetic effects of harvest on wild animal populations. *Trends Ecol Evol* 23:327–337.
- Alsop D, Warner D, Langkilde T, Du W, Shine R (2006) Do operational sex ratios influence sex allocation in viviparous lizards with temperature-dependent sex determination? *J Europ Soc Evol Biol* 19:1175–1182.
- Amitai G, et al. (2006) Enhanced stereoselective hydrolysis of toxic organophosphates by directly evolved variants of mammalian serum paraoxonase. *FEBS J* 273:1906–1919.
- Amitai G, Gupta RD, Tawfik DS (2007) Latent evolutionary potentials under the neutral mutational drift of an enzyme. *HFSP J* 1:67–78.

- Anderson FH, ed (1960) *The New Organon and Related Writings* (Prentice Hall, New York).
- Anderson WW (1974) Frequent multiple insemination in a natural population of *Drosophila pseudoobscura*. *Am Nat* 108:709–711.
- Anderson WW, Kim Y-K, Gowaty PA (2007) Experimental constraints on female and male mate preferences in *Drosophila pseudoobscura* decrease offspring viability and reproductive success of breeding pairs. 104:4484–4488.
- Andersson M (1994) *Sexual Selection* (Princeton Univ Press, Princeton, NJ).
- Andersson M, Iwasa Y (1996) Sexual selection. *Trends Ecol Evol* 11:53–58.
- Andersson M, Simmons LW (2006) Sexual selection and mate choice. *Trends Ecol Evol* 21:296–302.
- Andreev N (2006) Assessment of the status of wild populations of land snail (Escargot) *Helix pomatia* L. in Moldova: The effect of exploitation. *Biodiv Conserv* 15:2957–2970.
- Andrés JA, Maroja LS, Bogdanowicz SM, Swanson WJ, Harrison RG (2006) Molecular evolution of seminal proteins in field crickets. *Mol Biol Evol* 23:1574–1584.
- Anonymous (2008) Handle with care: Ecologists must research how best to intervene in and preserve ecosystems. *Nature* 455:263–264.
- Araki H, Cooper B, Blouin MS (2007) Genetic effects of captive breeding cause a rapid, cumulative fitness decline in the wild. *Science* 318:100–103.
- Arnold J, Reznick D (2008) Convergence and parallelism reconsidered: What have we learned about the genetics of adaptation? *Trends Ecol Evol* 23:26–32.
- Arnhart L (2005) *Darwinian Conservatism* (Imprint Academic, Exeter, UK).
- Arnold ML (1992) Natural hybridization as an evolutionary process. *Annu Rev Ecol Syst* 23:237–261.
- Arnold S, Duvall D (1994) Animal mating systems: A synthesis based on selection theory. *Am Nat* 143:317–348.
- Arnold S, Wade M (1983) On the measurement of selection in natural and laboratory populations: Theory. *Evolution* 38:709–719.
- Arnqvist G (1998) Comparative evidence for the evolution of genitalia by sexual selection. *Nature* 393:784–786.
- Arnqvist G (2004) Sexual conflict and sexual selection: Lost in the chase. *Evolution (Lawrence, Kans)* 58:1383–1388.
- Arnqvist G (2006) Sensory exploitation and sexual conflict. *Philos Trans R Soc London Ser B* 361:375–386.
- Arnqvist G, Danielsson I (1999) Copulatory behavior, genital morphology, and male fertilization success in water striders. *Evolution (Lawrence, Kans)* 53:147–156.
- Arnqvist G, Rowe L (2002a) Antagonistic coevolution between the sexes in a group of insects. *Nature* 415:787–789.
- Arnqvist G, Rowe L (2002b) Correlated evolution of male and female morphologies in water striders. *Evolution (Lawrence, Kans)* 56:936–947.
- Arnqvist G, Rowe L (2003) *Sexual Conflict* (Princeton Univ Press, Princeton, NJ).
- Artigas M, Martinez TF, Glick RA (2006) *Negotiating Darwin: The Vatican Confronts Evolution, 1877–1902* (Johns Hopkins Univ Press, Baltimore).
- Ashman T-L, et al. (2004) Pollen limitation of plant reproduction: Ecological and evolutionary causes and consequences. *Ecology* 85:2408–2421.
- Auffray J-C, Tchernov E, Nevo E (1988) Origine du commensalisme de la souris domestique (*Mus musculus domesticus*) vis-a-vis de l'homme. *CR Acad Sci Paris* 307:517–522.
- Avise JC (2000) *Phylogeography: The History and Formation of Species* (Harvard Univ Press, Cambridge, MA).
- Avise JC (2004) *Molecular Markers, Natural History, and Evolution* (Sinauer, Sunderland, MA).
- Avise JC, Ayala FJ, eds. (2007) In the Light of Evolution I: Adaptation and Complex Design. *Proc Natl Acad Sci USA* 104(Suppl):8563–8676.

- Awise JC, Hubbell SP, Ayala FJ, eds. (2008) In the Light of Evolution II: Biodiversity and Extinction. *Proc Natl Acad Sci USA* 105(Suppl):11453–11586.
- Ayala F (1988) Can “progress” be defined as a biological concept? In *Evolutionary Progress*, ed Nitecki M (Univ of Chicago Press, Chicago), pp 75–96.
- Ayala FJ (1994) On the scientific method. *Hist Philos Life Sci* 16:205–240.
- Ayala FJ (2007) *Darwin's Gift to Science and Religion* (Joseph Henry Press, Washington, DC).
- Baccetti B, Afzelius BA (1976) *The Biology of the Sperm Cell* (Karger, New York).
- Bachvaroff TR, Place AR (2008) From stop to start: Tandem gene arrangement, copy number and *trans*-splicing sites in the dinoflagellate *Amphidinium carterae*. *PLoS One* 3:e2929.
- Bai Y, Lindhout P (2007) Domestication and breeding of tomatoes: What have we gained and what can we gain in the future? *Ann Bot* 100:1085–1094.
- Baig M, et al. (2005) Phylogeography and origin of Indian domestic cattle. *Curr Sci* 89: 38–40.
- Baker J, Foster S, Heins D, Bell M, King R (1998) Variation in female life history traits among Alaskan populations of the threespine stickleback, *Gasterosteus aculeatus* L (Pisces: Gasterosteidae). *Biol J Linn Soc* 63:141–159.
- Baker M, Shachak B, Brand S (1998) Settling behavior of the desert isopod *Hemilepistus reaumuri* in response to variation in soil moisture and other environmental cues. *Isr J Zool* 44:345–354.
- Baker RR, Bellis MA (1988) Kamikaze sperm in mammals. *Anim Behav* 36:936–939.
- Baldwin BG, Sanderson MJ (1998) Age and rate of diversification of the Hawaiian silversword alliance (Compositae). *Proc Natl Acad Sci USA* 95:9402–9406.
- Baltimore D (1970) Viral RNA-dependent DNA polymerase in virions of RNA tumor viruses. *Nature* 226:1209–1211.
- Barlow N (1958) *The Autobiography of Charles Darwin* (Collins, London).
- Barrett RDH, Schluter D (2008) Adaptation from standing genetic variation. *Trends Ecol Evol* 23:38–44.
- Barrett RDH, Rogers SM, Schluter D (2008) Natural selection on a major armor gene in threespine stickleback. *Science* 322:255–257.
- Barrett S, Harder L (1996) Ecology and evolution of plant mating. *Trends Ecol Evol* 11:73–79.
- Barrier M, Robichaux RH, Purugganan MD (2001) Accelerated regulatory gene evolution in an adaptive radiation. *Proc Natl Acad Sci USA* 98:10208–10213.
- Barton NH (2001) The role of hybridization in evolution. *Mol Ecol* 10:551–568.
- Bar-Yosef O (1998) The Natufian culture in the Levant, threshold to the origins of agriculture. *Evol Anthropol* 6:159–177.
- Baskett ML, Levin SA, Gaines SD, Dushoff J (2005) Marine reserve design and the evolution of size at maturation in harvested fish. *Ecol Appl* 15:882–901.
- Bateman AJ (1948) Intra-sexual selection in *Drosophila*. *Heredity* 2:349–368.
- Bauer R (2000) Simultaneous hermaphroditism in caridean shrimps: A unique and puzzling sexual system in the Decapoda. *J Crust Biol* 20:116–128.
- Baum D, Offner S (2008) Phylogenies and tree thinking. *Am Biol Teach* 70:222–229.
- Beadle GW (1939) Teosinte and the origin of maize. *J Hered* 30:245–247.
- Beadle GW (1972) The mystery of maize. *Field Mus Nat Hist Bull* 43:2–11.
- Beadle GW (1977) The origin of *Zea mays*. In *Origins of Agriculture*, ed Reed CA (Mouton Press, The Hague), pp 615–635.
- Beadle GW (1980) The ancestry of corn. *Sci Am* 242:112–119.
- Beaumont MA (2005) Adaptation and speciation: What can  $F_{st}$  tell us? *Trends Ecol Evol* 20:435–440.
- Beaumont MA, Balding DJ (2004) Identifying adaptive genetic divergence among populations from genome scans. *Mol Ecol* 13:969–980.
- Beaumont MA, Nichols RA (1996) Evaluating loci for use in the genetic analysis of population structure. *Proc R Soc London Ser B* 263:1619–1626.



- Begun DJ, Aquadro CF (1992) Levels of naturally occurring DNA polymorphism correlate with recombination rates in *D. melanogaster*. *Nature* 356:519–520.
- Behe M (1996) *Darwin's Black Box: The Biochemical Challenge to Evolution* (Free Press, New York).
- Beja-Pereira A, et al. (2004) African origins of the domestic donkey. *Science* 304:1781.
- Belk D (1984) Antennal appendages and reproductive success in the Anostraca. *J Crust Biol* 4:66–71.
- Bellwood (2007) *First Farmers, the Origins of Agricultural Societies* (Wiley-Blackwell, Hoboken, NJ).
- Beltran M, et al. (2002) Phylogenetic discordance at the species boundary: Comparative gene genealogies among rapidly radiating *Heliconius* butterflies. *Mol Biol Evol* 19:2176–2190.
- Berglund A (1994) The operational sex-ratio influences choosiness in a pipefish. *Behav Ecol* 5:254–258.
- Berglund A (1995) Many mates make male pipefish choosy. *Behaviour* 132:213–218.
- Berglund A, Rosenqvist G (1993) Selective males and ardent females in pipefishes. *Behav Ecol Sociobiol* 32:331–336.
- Bernard C (1865) *Introduction à l'Étude de la Médecine Expérimentale* (Éditions Garnier-Flammariion, Paris).
- Berriman M, et al. (2005) The genome of the African trypanosome, *Trypanosoma brucei*. *Science* 309:416–422.
- Besenmatter W, Kast P, Hilvert D (2007) Relative tolerance of mesostable and thermostable protein homologs to extensive mutation. *Proteins* 66:500–506.
- Beukema JJ (1969) Angling experiments with carp (*Cyprinus carpio* L.). 1. Differences between wild, domesticated and hybrid strains. *Neth J Zool* 19:596–609.
- Birkeland C, Dayton PK (2005) The importance in fishery management of leaving the big ones. *Trends Ecol Evol* 20:356–358.
- Birkhead T (1998) Cryptic female choice: Criteria for establishing female sperm choice. *Evolution (Lawrence, Kans)* 52:1212–1218.
- Birkhead T, Møller AP (1992) *Sperm Competition in Birds: Evolutionary Causes and Consequences* (Academic Press, New York).
- Birkhead T, Møller AP, eds (1997) *Sperm Competition and Sexual Selection* (Academic Press, New York).
- Biro PA, Stamps JA (2008) Are animal personality traits linked to life-history productivity? *Trends Ecol Evol* 23:361–368.
- Biro PA, Abrahams MV, Post JR, Parkinson EA (2004) Predators select against high growth rates and risk-taking behaviour in domestic trout populations. *Proc R Soc London Ser B* 271:2233–2237.
- Bloom JD, et al. (2005) Thermodynamic prediction of protein neutrality. *Proc Natl Acad Sci USA* 102:606–611.
- Bloom JD, Labthavikul ST, Otey CR, Arnold FH (2006) Protein stability promotes evolvability. *Proc Natl Acad Sci USA* 103:5869–5874.
- Bloom JD, Lu Z, Chen D, Raval A, Venturelli OS, Arnold FH (2007a) Evolution favors protein mutational robustness in sufficiently large populations. *BMC Biol* 5:29.
- Bloom JD, Raval A, Wilke CO (2007b) Thermodynamics of neutral protein evolution. *Genetics* 175:255–266.
- Bloom JD, Romero PA, Lu Z, Arnold FH (2007c) Neutral genetic drift can alter promiscuous protein functions, potentially aiding functional evolution. *Biol Direct* 2:17.
- Bluhm CK, Gowaty PA (2004a) Reproductive compensation for offspring viability deficits by female mallards, *Anas platyrhynchos*. *Anim Behav* 68:985–992.
- Bluhm CK, Gowaty PA (2004b) Social constraints on female mate preferences in mallards *Anas platyrhynchos* decrease offspring viability and mother's productivity. *Anim Behav* 68:977–983.

- Blum D (March 16, 1992) Scientists in open war over “neutral theory” of genetics. *Sacramento Bee* page A1.
- Blundell TL, Wood SP (1975) Is the evolution of insulin Darwinian or due to selectively neutral mutation? *Nature* 257:197–203.
- Blyth E (1835) An attempt to classify the “varieties” of animals, with observations on the marked seasonal and other changes which naturally take place in various British species, and which do not constitute varieties. *Magazine Nat Hist J Zool Bot Mineral Geol Meteorol* 8:40–53.
- Bogs J, Ebadi A, McDavid D, Robinson SP (2006) Identification of the flavonoid hydroxylases from grapevine and their regulation during fruit development. *Plant Physiol* 140:279–291.
- Bolnick DI, Near TJ, Wainwright PC (2006) Body size divergence promotes post-zygotic reproductive isolation in centrarchids. *Evol Ecol Res* 8:903–913.
- Bonenfant C, Gaillard J-M, Loison A, Klein F (2003) Sex-ratio variation and reproductive costs in relation to density in a forest-dwelling population of red deer (*Cervus elaphus*). *Behav Ecol* 14:862–869.
- Bonin A, Taberlet P, Miaud C, Pompanon F (2006) Explorative genome scan to detect candidate loci for adaptation along a gradient of altitude in the common frog (*Rana temporaria*). *Mol Biol Evol* 23:773–783.
- Borgia G (1981) Mate selection in the fly *Scatophaga stercoraria*: Female choice in a male-controlled system. *Anim Behav* 29:71–80.
- Bouchez A, Hospital F, Causse M, Gallais A, Charcosset A (2002) Marker-assisted introgression of favorable alleles at quantitative trait loci between maize elite lines. *Genetics* 162:1945–1959.
- Bouck GB, Ngo H (1996) Cortical structure and function in euglenoids with reference to trypanosomes, ciliates, and dinoflagellates. *Int Rev Cytol* 169:267–318.
- Boursot P, et al. (1996) Origin and radiation of the house mouse: Mitochondrial DNA phylogeny. *J Evol Biol* 9:391–415.
- Bouzaidi-Tiali N, Aeby E, Charriere F, Pusnik M, Schneider A (2007) Elongation factor 1a mediates the specificity of mitochondrial tRNA import in *T. brucei*. *EMBO J* 20:4302–4312.
- Bowler PJ (1976) *Fossils and Progress* (Science History Publications, New York).
- Bowler PJ (1984) *Evolution: The History of an Idea* (Univ of California Press, Berkeley).
- Bowler PJ (1988) *The Non-Darwinian Revolution: Reinterpreting a Historical Myth* (Johns Hopkins Univ Press, Baltimore).
- Bowler PJ (1996) *Life’s Splendid Drama* (Univ of Chicago Press, Chicago).
- Brackman AC (1980) *A Delicate Arrangement: The Strange Case of Charles Darwin and Alfred Russel Wallace* (Times Books, New York).
- Bradley DG (2006) Documenting domestication: Reading animal genetic texts. In *Documenting Domestication: New Genetic and Archaeological Paradigms*, eds Zeder MA, Bradley DG, Emshwiller E, Smith BD (Univ of California Press, Los Angeles), pp 273–278.
- Bradley DG, Magee DA (2006) Genetics and origins of domestic cattle. In *Documenting Domestication: New Genetic and Archaeological Paradigms*, eds Zeder MA, Bradley DG, Emshwiller E, Smith BD (Univ of California Press, Los Angeles), pp 317–328.
- Bradshaw HD, Schemske DW (2003) Allele substitution at a flower color locus produces a pollinator shift in monkeyflowers. *Nature* 426:176–178.
- Bradshaw JWS, Goodwin D, Legrand-Defretin V, Nott HMR (1996) Food selection by the domestic cat, an obligate carnivore. *Comp Biochem Physiol A Comp Physiol* 114:205–209.
- Breasted JH (1916) *Ancient Times, a History of the Early World* (Ginn and Co., Chicago).
- Brideau NJ, et al. (2006) Two Dobzhansky-Muller genes interact to cause hybrid lethality in *Drosophila*. *Science* 314:1292–1295.

- Briggs WH, McMullen MD, Gaut BS, Doebley J (2007) Linkage mapping of domestication loci in a large maize-teosinte backcross resource. *Genetics* 177:1915–1928.
- Britten RJ, Davidson EH (1969) Gene regulation for higher cells: A theory. *Science* 165: 349–357.
- Bromaghin JF, Nielson RM, Hard JJ (2008) An Investigation of the Potential Effects of Selective Exploitation on the Demography and Productivity of Yukon River Chinook Salmon. U.S. Fish and Wildlife Service Technical Report 100 (U.S. Department of the Interior, U.S. Fish and Wildlife Service, Alaska Region, Anchorage).
- Brooks DR, McLennan DA (1991) *Phylogeny, Ecology, and Behavior* (Univ of Chicago Press, Chicago).
- Brooks R (2000) Negative genetic correlation between male sexual attractiveness and survival. *Nature* 406:67–70.
- Bruford MW, Townsend SJ (2006) Mitochondrial DNA diversity in modern sheep: Implications for domestication. In *Documenting Domestication: New Genetic and Archaeological paradigms*, eds Zeder MA, Bradley DG, Emshwiller E, Smith BD (Univ of California Press, Los Angeles), pp 306–316.
- Bruford MW, Wayne RK (1993) Microsatellites and their application to population genetic studies. *Curr Opin Genet Dev* 3:939–943.
- Buckler ES, Holtsford TP (1996) *Zea* systematics: Ribosomal ITS evidence. *Mol Biol Evol* 13:623–632.
- Buckler ES IV, Thornsberry JM, Kresovich S (2001) Molecular diversity, structure, and domestication of grasses. *Genet Res* 77:213–218.
- Buitenhuis H (1984) Some remarks on the possible development of *Bos taurus* breeds in the Near East. In *Animals and Archaeology: 3. Early Herders and Their Flocks*, eds Clutton-Brock J, Grigson C (BAR International, Oxford, UK), pp 213–221.
- Buller D (2005) *Adapting Minds: Evolutionary Psychology and the Persistent Quest for Human Nature* (MIT Press, Cambridge, MA).
- Burchfield JD (1974) Darwin and the dilemma of geological time. *Isis* 65:300–321.
- Burchfield JD (1975) *Lord Kelvin and the Age of the Earth* (Science History Publications, New York).
- Burger R, Schneider KA (2006) Intraspecific competitive divergence and convergence under assortative mating. *Am Nat* 167:190–205.
- Burke T, Bruford MW (1987) DNA fingerprinting in birds. *Nature* 327:149–152.
- Cameron E, Day T, Rowe L (2003) Sexual conflict and indirect benefits. *J Evol Biol* 16: 1055–1060.
- Campbell D, Bernatchez L (2004) Genomic scan using AFLP markers as a means to assess the role of directional selection in the divergence of sympatric whitefish ecotypes. *Mol Biol Evol* 21:945–956.
- Campbell DA, Thomas S, Sturm NR (2003) Transcription in kinetoplastid protozoa: Why be normal? *Microbes Infect* 5:1231–1240.
- Camus-Kulandaivelu L, et al. (2008) Patterns of molecular evolution associated with two selective sweeps in the *Tb1-Dwarf8* region in maize. *Genetics* 180:1107–1121.
- Canadillas JM, et al. (2006) Solution structure of p53 core domain: Structural basis for its instability. *Proc Natl Acad Sci USA* 103:2109–2114.
- Candolin U (2003) The use of multiple cues in mate choice. *Biol Rev* 78:575–595.
- Carlson SM, Seamons TR (2008) A review of quantitative genetic components of fitness in salmonids: Implications for adaptation to future change. *Evol Appl* 1:222–238.
- Castle LA, et al. (2004) Discovery and directed evolution of a glyphosate tolerance gene. *Science* 304:1151–1154.
- Cech TR (1985) Self-splicing DNA: Implications for evolution. *Int Rev Cytol* 93:3–22.
- Chambers R (1844) *Vestiges of the Natural History of Creation* (Churchill, London).
- Chambon P (1981) Split genes. *Sci Am* 244:60–71.

- Chapman T, Liddle LF, Kalb JM, Wolfner ME, Partridge L (1995) Cost of mating in *Drosophila melanogaster* females is mediated by male accessory gland products. *Nature* 373:241–244.
- Charlesworth B, Nordborg M, Charlesworth D (1997) The effects of local selection, balanced polymorphism and background selection on equilibrium patterns of genetic diversity in subdivided populations. *Genet Res* 70:155–174.
- Charlesworth D (2006) Evolution of plant breeding systems. *Curr Biol* 16:R726–R735.
- Charlesworth D, Charlesworth B (1978) A model for the evolution of dioecy and gynodioecy. *Am Nat* 112:975–997.
- Charlesworth D, Charlesworth B (1987) Inbreeding depression and its evolutionary consequences. *Annu Rev Ecol Syst* 18:237–268.
- Charnov E (1979) Natural selection and sex change in pandalid shrimp: Test of a life history theory. *Am Nat* 113:715–734.
- Chase VC, Raven PH (1975) Evolutionary and ecological relationships between *Aquilegia formosa* and *Aquilegia pubescens* (Ranunculaceae), 2 perennial plants. *Evolution* 29:474–486.
- Chen FC, Li WH (2001) Genomic divergences between humans and other hominoids and the effective population size of the common ancestor of humans and chimpanzees. *Am J Hum Genet* 68:444–456.
- Chen PS (1984) The functional morphology and biochemistry of insect male accessory glands and their secretions. *Annu Rev Entomol* 29:233–255.
- Chen Z, Zhao H (2005) Rapid creation of a novel protein function by in vitro coevolution. *J Mol Biol* 348:1273–1282.
- Clark NL, Aagaard JE, Swanson WJ (2006) Evolution of reproductive proteins from animals and plants. *Reproduction* 131:11–22.
- Clark RM, Linton E, Messing J, Doebley JF (2004) Pattern of diversity in the genomic region near the maize domestication gene *tb1*. *Proc Natl Acad Sci USA* 101:700–707.
- Clark RM, Wagler TN, Quijada P, Doebley J (2006) A distant upstream enhancer at the maize domestication gene *tb1* has pleiotropic effects on plant and inflorescence architecture. *Nat Genet* 38:594–597.
- Clayton CE (2002) Life without transcriptional control? From fly to man and back again. *EMBO J* 21:1881–1888.
- Clegg MT, Durbin ML (2000) Flower color variation: A model for the experimental study of evolution. *Proc Natl Acad Sci USA* 97:7016–7023.
- Clutton-Brock J (1993) *Cats, Ancient and Modern* (Harvard Univ Press, Cambridge, MA).
- Clutton-Brock J (1995) Origins of the dog: Domestication and early history. In *The Domestic Dog: Its Evolution, Behaviour, and Interactions with People*, ed Serpell J (Cambridge Univ Press), pp 7–20.
- Clutton-Brock J (1999) *A Natural History of Domesticated Mammals* (Cambridge Univ Press, Cambridge, UK).
- Clutton-Brock TH, Lonergan ME (1994) Culling regimes and sex ratio biases in Highland red deer. *J Appl Ecol* 31:521–527.
- Clutton-Brock TH, Parker GA (1992) Potential reproductive rates and the operation of sexual selection. *Q Rev Biol* 67:437–456.
- Clutton-Brock T, Vincent A (1991) Sexual selection and the potential reproductive rates of males and females. *Nature* 351:58–60.
- Colosimo PF, et al. (2005) Widespread parallel evolution in sticklebacks by repeated fixation of ectodysplasin alleles. *Science* 307:1928–1933.
- Coltman DW (2008) Evolutionary rebound from selective harvesting. *Trends Ecol Evol* 23:117–118.
- Coltman DW, et al. (2003) Undesirable evolutionary consequences of trophy hunting. *Nature* 426:655–658.

- Conover DO, Munch SB, Arnott SA (2009) Reversal of evolutionary downsizing caused by selective harvest of large fish. *Proc R Soc London Ser B* 276:2015–2020.
- Conway Morris S (2003) *Life's Solution: Inevitable Humans in a Lonely Universe* (Cambridge Univ Press, Cambridge, MA).
- Conway Morris S (February 12, 2009) Darwin was right. Up to a point. *Guardian*. Available at [www.guardian.co.uk/global/2009/feb/12/simon-conway-morris-darwin](http://www.guardian.co.uk/global/2009/feb/12/simon-conway-morris-darwin).
- Conway Morris S, Gould SJ (1998) Showdown on the Burgess Shale. *Nat Hist* 107:48–55.
- Copertino DW, Hallick RB (1993) Group II and group III introns of twintrons: Potential relationships with nuclear pre-mRNA introns. *Trends Biochem Sci* 18:467–471.
- Copley SD (2003) Enzymes with extra talents: Moonlighting functions and catalytic promiscuity. *Curr Opin Chem Biol* 7:265–272.
- Coppinger RP, Smith CK (1983) The domestication of evolution. *Environ Conserv* 10:283–292.
- Cordero C, Eberhard WG (2003) Female choice of sexually antagonistic male adaptations: A critical review of some current research. *J Evol Biol* 16:1–6.
- Cordero C, Eberhard WG (2005) Interaction between sexually antagonistic selection and mate choice in the evolution of female responses to male traits. *Evol Ecol* 19:111–122.
- Coulson T, Kruuk LEB, Tavecchia G, Pemberton JM, Clutton-Brock TH (2003) Estimating selection on neonatal traits in red deer using elasticity path analysis. *Evolution* 57:2879–2892.
- Covello PS, Gray MW (1993) On the evolution of RNA editing. *Trends Genet* 9:265–268.
- Coyne JA, Orr HA (1989) Patterns of speciation in *Drosophila*. *Evolution (Lawrence, Kans)* 43:362–381.
- Coyne JA, Orr HA (1997) Patterns of speciation in *Drosophila* revisited. *Evolution (Lawrence, Kans)* 51:295–303.
- Coyne JA, Orr H (2004) *Speciation* (Sinauer, Sunderland, MA).
- Crameri A, Raillard SA, Bermudez E, Stemmer WP (1998) DNA shuffling of a family of genes from diverse species accelerates directed evolution. *Nature* 391:288–291.
- Crausaz-Esseiva A, Naguleswaran A, Hemphill A, Schneider A (2004) Mitochondrial tRNA import in *Toxoplasma gondii*. *J Biol Chem* 279:42363–42368.
- Crick F (1979) Split genes and RNA splicing. *Science* 204:264–271.
- Cronk Q, Ojeda I (2008) Bird-pollinated flowers in an evolutionary and molecular context. *J Exp Bot* 59:715–727.
- Crow J (1958) Some possibilities for measuring selection intensities in man. *Human Biol* 30:1–13.
- Crow J (1962) Population genetics: Selection. In *Methodology in Human Genetics*, ed Burdette WJ (Holden-Day, San Francisco), pp 53–75.
- Crowley PH, et al. (1991) Mate density, predation risk, and the seasonal sequence of mate choices: A dynamic game. *Am Nat* 137:567–596.
- Cruzan M, Neal P, Willson M (1988) Floral display in *Phyla incisa*: Consequences for male and female reproductive success. *Evolution* 42:505–515.
- Cuantianquiz C, Cordero C (2006) Experimental manipulation of male behavior during copulation in *Stenomacra marginella* (Heteroptera: Largidae): Effect on copulation duration, female remating, and oviposition. *Behav Proc* 73:222–227.
- Cuvier G (1817) *The Kingdom of Animals Classified According to Their Organization, in Order to Give a Foundation to the Natural History of Animals and an Introduction to Comparative Anatomy* (Henry G. Bohn, London).
- Damuth J (1993) Cope's rule, the island rule and the scaling of mammalian population density. *Nature* 365:748–750.
- Darimont CT, et al. (2009) Human predators outpace other agents of trait change in the wild. *Proc Natl Acad Sci USA* 106:952–954.

- Darwin CD (1842) *The Structure and Distribution of Coral Reefs* (Smith, Elder & Co., London).
- Darwin C (1851a) *A Monograph on the Fossil Lepadidae; or, Pedunculated Cirripedes of Great Britain* (Palaeontographical Society, London).
- Darwin C (1851b) *A Monograph on the Sub-Class Cirripedia, with Figures of All the Species. The Lepadidae; or, Pedunculated Cirripedes* (Ray Society, London).
- Darwin C (1854a) *A Monograph on the Fossil Balanidae and Verrucidae of Great Britain* (Palaeontographical Society, London).
- Darwin C (1854b) *A Monograph on the Sub-Class Cirripedia, with Figures of All the Species. The Balanidae (or Sessile Cirripedes); the Verrucidae, etc.* (Ray Society, London).
- Darwin C (1859) *On the Origin of Species by Means of Natural Selection, or the Preservation of Favored Races in the Struggle for Life* (John Murray, London).
- Darwin C (1859/1964) *On the Origin of Species. Facsimile of the first edition 1964* (Harvard Univ Press, Cambridge, MA).
- Darwin C (1862) *On the Various Contrivances by Which British and Foreign Orchids Are Fertilized by Insects, and On the Good Effects of Intercrossing* (John Murray, London).
- Darwin CR (1868a) *The Variation of Animals and Plants Under Domestication* (John Murray, London).
- Darwin CR (1868b) *The Variation of Animals and Plants Under Domestication* (Orange Judd & Co., New York), 1st Ed.
- Darwin C (1868c) *The Variation of Animals and Plants Under Domestication* (Appleton, New York), 2nd Ed.
- Darwin C (1871) *The Descent of Man and Selection in Relation to Sex* (John Murray, London, or Appleton, New York).
- Darwin C (1871/1959) *The Descent of Man and Selection in Relation to Sex*; reprinted (1959) (Modern Library, New York).
- Darwin C (1874) *The Descent of Man and Selection in Relation to Sex* (Rand McNally, New York), 2nd Ed.
- Darwin C (1875a) *Insectivorous Plants* (John Murray, London).
- Darwin C (1875b) *The Movements and Habits of Climbing Plants* (John Murray, London).
- Darwin C (1876) *Autobiography*; reprinted (1958) *Autobiography: With Original Omissions Restored* (Cambridge Univ Press, Cambridge, UK).
- Darwin C (1877a) *The Different Forms of Flowers on Plants of the Same Species* (John Murray, London).
- Darwin C (1877b) *The Various Contrivances by Which Orchids Are Fertilized by Insects* (John Murray, London).
- Darwin C (1881) *The Formation of Vegetable Mould, Through the Action of Worms, with Observations on Their Habits* (John Murray, London).
- Darwin C (1887) *The Life and Letters of Charles Darwin*, ed Darwin F (John Murray, London), Vol 2, pp 163–164.
- Darwin C (1890) *The Variation of Animals and Plants Under Domestication* (Appleton, New York).
- Darwin C (1896) *The Variation of Animals and Plants Under Domestication, Vol. II* (Appleton, New York).
- Darwin C (1909) *The Foundations of the Origin of Species: Two Essays Written in 1842 and 1844*, ed Darwin F (Cambridge Univ Press, Cambridge, UK).
- Darwin C (1958a) *Autobiography of Charles Darwin 1809–1882*, ed N Barlow (Norton, New York).
- Darwin C (1958b) *The Origin of Species by Means of Natural Selection, or the Preservation of Favored Races in the Struggle for Life* (Mentor, New York).
- Darwin C (1959) *On the Origin of Species—a Variorum Edition*, ed Peckham M (Univ of Penn Press, Philadelphia).



- Darwin C (1960) Darwin's notebooks on transportation of species. *Bull Br Mus* 2:23–200.
- Darwin C (1962) *The Voyage of the Beagle* (Doubleday, Garden City, NY).
- Darwin C (1963) Darwin's ornithological notes. *Bull Br Mus* 2(7):201–278.
- Darwin C (1969) *Autobiography*, ed Barlow N (Norton, New York).
- Darwin C (1975) *Charles Darwin's Natural Selection: Being the Second Part of His Big Species Book Written from 1856 to 1858*, ed Stauffer RC (Cambridge Univ Press, Cambridge, UK).
- Darwin C (1987) *Charles Darwin's Notebooks, 1836–1844*, eds Paul Barrett, et al. (Cornell Univ Press, Ithaca, NY).
- Darwin C, Wallace AR (1958) *Evolution by Natural Selection* (Cambridge Univ Press, Cambridge, UK).
- Darwin E (1794–1796) *Zoonomia or the Laws of Organic Life* (Johnson, London).
- Darwin F, ed (1887a) *Charles Darwin's Autobiography* (Basic Books, New York), 1959 Ed.
- Darwin F, ed (1887b) *The Life and Letters of Charles Darwin*, Volumes 1–3 (John Murray, London).
- Darwin F, ed (1887c) *The Life and Letters of Charles Darwin, Including an Autobiographical Chapter* (John Murray, London).
- Darwin F (1903) *More Letters of Charles Darwin* (John Murray, London).
- Davies KM, et al. (2003) Enhancing anthocyanin production by altering competition for substrate between flavonol synthase and dihydroflavonol 4-reductase. *Euphytica* 131: 259–268.
- Dawkins R (1976) *The Selfish Gene* (Oxford Univ Press, Oxford).
- Dawkins R (1986) *The Blind Watchmaker* (Norton, New York).
- Dawson CE (1985) *Indo-Pacific Pipefishes, UK*. (Gulf Coast Research Laboratory, Ocean Springs, MS).
- Dawson MN, Grosberg RL, Botsford LW (2006) Connectivity in marine protected areas. *Science* 313:43–44.
- De Beer G (1964) *Charles Darwin, Evolution by Natural Selection* (Doubleday, Garden City, NY).
- de Roos AM, Boukal DS, Persson L (2006) Evolutionary regime shifts in age and size at maturation of exploited fish stocks. *Proc R Soc London Ser B* 273:1873–1880.
- Dearborn DC, Ryan MJ (2002) A test of the Darwin-Fisher theory for the evolution of male secondary sexual traits in monogamous birds. *J Evol Biol* 15:307–313.
- Delph LF, Havens K (1997) Pollen competition in flowering plants. In *Sperm Competition and Sexual Selection*, eds Birkhead T, Møller AP (Academic Press, New York), pp 149–174.
- Delph L, Knapczyk F, Taylor D (2002) Among-population variation and correlations in sexually dimorphic traits of *Silene latifolia*. *J Evol Biol* 15:1011–1020.
- Demary KC, Lewis SM (2007) Male courtship attractiveness and paternity success in *Photinus greeni* fireflies. *Evolution* 61:431–439.
- Dennett D (1983) Intentional systems in cognitive ethology: The “Panglossian Paradigm” defended. *Behav Brain Sci* 6:343–390.
- Dennett D (1995) *Darwin's Dangerous Idea* (Simon & Schuster, New York).
- Desmond A (1999) *Huxley: From Devil's Disciple to Evolution's High Priest* (Basic Books, New York).
- Dettman JR, Sirjusingh C, Kohn LM, Anderson JB (2007) Incipient speciation by divergent adaptation and antagonistic epistasis in yeast. *Nature* 447:585–588.
- Dewsbury DA (2005) The Darwin-Bateman paradigm in historical context. *J Integra Comp Biol* 45:831–837.
- Diamond JM (2005) *Guns, Germs, and Steel: The Fates of Human Societies* (Norton, New York).
- Dieckmann U, Doebeli M (1999) On the origin of species by sympatric speciation. *Nature* 400:354–357.



- Dill LM, Hedrick AV, Fraser A (1999) Male mating strategies under predation risk: Do females call the shots? *Behav Ecol* 10:452–461.
- Dixon AF (1998) *Primate Sexuality* (Oxford Univ Press, Oxford, UK).
- Dobzhansky T (1934) Studies on hybrid sterility. I. Spermatogenesis in pure and hybrid *Drosophila pseudoobscura*. *Z Zellforsch Microsk Anat* 21:169–221.
- Dobzhansky T (1937) *Genetics and the Origin of Species* (Columbia Univ Press, New York).
- Dobzhansky T (1973) Nothing in biology makes sense except in the light of evolution. *Am Biol Teach* 35:125–129.
- Doebley J (1990) Molecular systematics of *Zea* (Gramineae). *Maydica* 35:143–150.
- Doebley JF, Iltis HH (1980) Taxonomy of *Zea* (Gramineae). I. A subgeneric classification with key to taxa. *Am J Bot* 67:982–993.
- Doebley J, Stec A (1991) Genetic analysis of the morphological differences between maize and teosinte. *Genetics* 129:285–295.
- Doebley J, Stec A (1993) Inheritance of the morphological differences between maize and teosinte: Comparison of results for two F<sub>2</sub> populations. *Genetics* 134:559–570.
- Doebley JF, Goodman MM, Stuber CW (1984) Isoenzymatic variation in *Zea* (Gramineae). *Syst Bot* 9:203–218.
- Doebley J, Renfroe W, Blanton A (1987) Restriction site variation in the *Zea* chloroplast genome. *Genetics* 117:139–147.
- Doebley J, Stec A, Wendel J, Edwards M (1990) Genetic and morphological analysis of a maize-teosinte F<sub>2</sub> population: Implications for the origin of maize. *Proc Natl Acad Sci USA* 87:9888–9892.
- Doebley J, Stec A, Gustus C (1995) Teosinte branched1 and the origin of maize: Evidence for epistasis and the evolution of dominance. *Genetics* 141:333–346.
- Doebley J, Stec A, Hubbard L (1997) The evolution of apical dominance in maize. *Nature* 386:485–488.
- Dopman EB, Perez L, Bogdanowicz SM, Harrison RG (2005) Consequences of reproductive barriers for genealogical discordance in the European corn borer. *Proc Natl Acad Sci USA* 102:14706–14711.
- Dorus S, Evans PD, Wyckoff GJ, Choi SS, Lahn BT (2004) Rate of molecular evolution of the seminal protein gene *SEMG2* correlates with levels of female promiscuity. *Nat Genet* 36:1326–1329.
- Dorweiler J, Stec A, Kermicle J, Doebley J (1993) Teosinte glume architecture 1: A genetic locus controlling a key step in maize evolution. *Science* 262:233–235.
- Drickamer LC, Gowaty PA, Christopher CM (2000) Free female mate choice in house mice affects reproductive success and offspring viability and performance. *Anim Behav* 59:371–378.
- Drickamer LC, Gowaty PA, Wagner DM (2003) Free mutual mate preferences in house mice affect reproductive success and offspring performance. *Anim Behav* 65:105–114.
- Driscoll CA, et al. (2007) The Near Eastern origin of cat domestication. *Science* 317:519–523.
- Driscoll CA, Clutton-Brock J, Kitchener AC, O'Brien SJ (2009) The taming of the cat. *Sci Am* 300:68–75.
- Drummond DA, Silberg JJ, Meyer MM, Wilke CO, Arnold FH (2005) On the conservative nature of intragenic recombination. *Proc Natl Acad Sci USA* 102:5380–5385.
- DuMont VB, Aquadro CF (2005) Multiple signatures of positive selection downstream of notch on the X chromosome in *Drosophila melanogaster*. *Genetics* 171:639–653.
- Durnford DG, Gray MW (2006) Analysis of *Euglena gracilis* plastid-targeted proteins reveals different classes of transit sequences. *Eukaryot Cell* 5:2079–2091.
- Eastop VF (1971) Keys for the identification of *Acyrtosiphon* (Hemiptera: Aphididae). *Bull Br Mus Nat Hist Entomol* 26:1–115.
- Eberhard WG (1985) *Sexual Selection and Animal Genitalia* (Harvard Univ Press, Cambridge, MA).

- Eberhard WG (1991) Copulatory courtship in insects. *Biol Rev* 66:1–31.
- Eberhard WG (1994) Evidence for widespread courtship during copulation in 131 species of insects and spiders, and implications for cryptic female choice. *Evolution (Lawrence, Kans)* 48:711–733.
- Eberhard WG (1996) *Female Control: Sexual Selection by Cryptic Female Choice* (Princeton Univ Press, Princeton, NJ).
- Eberhard WG (2002) Physical restraint or stimulation? The function(s) of the modified front legs of male *Archisepsis diversiformis* (Diptera, Sepsidae). *J Insect Behav* 15:831–850.
- Eberhard WG (2004a) Male-female conflicts and genitalia: Failure to confirm predictions in insects and spiders. *Biol Rev* 79:121–186.
- Eberhard WG (2004b) Rapid divergent evolution of sexual morphology: Comparative tests of antagonistic coevolution and traditional female choice. *Evolution (Lawrence, Kans)* 58:1947–1970.
- Eberhard WG (2006a) Sexually antagonistic coevolution in insects is associated with only limited morphological diversity. *J Evol Biol* 19:657–681.
- Eberhard WG (2006b) Sexually reversed copulatory courtship roles and possible nuptial feeding in the soldier beetle *Ditemnus acantholobus* (Coleoptera, Cantharidae). *J Kans Entomol Soc* 79:13–22.
- Eberhard WG (in press) in *Evolution of Primary Sexual Characters in Animals*, eds Leonard J, Cordoba-Aguilar A (Oxford Univ Press, New York).
- Eberhard WG, Cordero C (1995) Sexual selection by cryptic female choice on male seminal products: A new bridge between sexual selection and reproductive physiology. *Trends Evol Ecol* 10:493–496.
- Edeline E, et al. (2007) Trait changes in a harvested population are driven by a dynamic tug-of-war between natural and harvest selection. *Proc Natl Acad Sci USA* 104:15799–15804.
- Edvardsson M, Arnqvist G (2000) Copulatory courtship and cryptic female choice in red flour beetles *Tribolium castaneum*. *Proc R Soc London Ser B* 267:559–563.
- Edwards A-W-F, Cavalli-Sforza L (1964) Reconstruction of evolutionary trees. In *Phenetic and Phylogenetic Classification*, eds Heywood V, McNeill J (New York Systematics Association, New York), Vol 6, pp 67–76.
- Eijsink VG, Gaseidnes S, Borchert TV, van den Burg B (2005) Directed evolution of enzyme stability. *Biomol Eng* 22:21–30.
- Eiseley L (1958) *Darwin's Century: Evolution and the Men Who Discovered It* (Doubleday, New York).
- Eldredge N (2004) *Darwin. Discovering the Tree of Life* (Norton, New York).
- Eldredge N, Cracraft J (1980) *Phylogenetic Patterns and the Evolutionary Process* (Columbia Univ Press, New York).
- Elton CS (1942) *Voles, Mice, and Lemmings: Problems in Population Dynamics* (Clarendon Press, Oxford, UK).
- Elton CS (1953) The use of cats in farm rat control. *Br J Anim Behav* 1:151–155.
- Emelianov I, Marec F, Mallet J (2004) Genomic evidence for divergence with gene flow in host races of the larch budmoth. *Proc R Soc London Ser B* 271:97–105.
- Emery NJ, Clayton NS (2004) The mentality of crows: Convergent evolution of intelligence in corvids and apes. *Science* 306:1903–1907.
- Emlen DJ, Marangelo J, Ball B, Cunningham CW (2005) Diversity in the weapons of sexual selection: Horn evolution in the beetle genus *Onthophagus* (Coleoptera: Scarabaeidae). *Evolution* 59:1060–1084.
- Emlen S (1976) Lek organization and mating strategies in the bullfrog. *Behav Ecol Sociobiol* 1:283–313.
- Emlen ST, Oring LW (1977) Ecology, sexual selection, and the evolution of mating systems. *Science* 197:215–223.

- Ereshefsky E (2009) Darwin's solution to the species problem. *Synthese*, doi:10.1007/s11229-009-9538-4.
- Ericson GPG, Tyrberg T, Kjellberg AS, Jonsson L, Ullen I (1997) The earliest record of house sparrows (*Passer domesticus*) in northern Europe. *J Archaeol Sci* 24:183–190.
- Eschel I, Volovik I, Sansone E (2000) On Fisher-Zahavi's handicapped sexy son. *Evol Ecol Res* 2:509–523.
- Etheridge RD, Aphasizheva I, Gershon PD, Aphasizhev R (2008) 3' adenylation determined mRNA abundance and monitors completion of RNA editing in *T. brucei* mitochondria. *EMBO J* 27:1596–1608.
- Ewing B, Hillier L, Wendl MC, Green P (1998) Base-calling of automated sequencer traces using phred. I. Accuracy assessment. *Genome Res* 8:175–185.
- Eyre-Walker A, Gaut RL, Hilton H, Feldman DL, Gaut BS (1998) Investigation of the bottleneck leading to the domestication of maize. *Proc Natl Acad Sci USA* 95:4441–4446.
- Falconer DS, Mackay TFC (1996) *Introduction to Quantitative Genetics* (Longman Science and Technology, Harlow, UK), 4th Ed.
- Farris J-S (1983) in *Advances in Cladistics—Proceedings of the 2nd Annual Meeting of the Willi Hennig Society*, eds Platnick N, Funk V (Columbia Univ Press, New York), pp 7–36.
- Fasan R, Chen MM, Crook NC, Arnold FH (2007) Engineered alkane-hydroxylating cytochrome P450(BM3) exhibiting navelike catalytic properties. *Angew Chem Int Ed* 46:8414–8418.
- Fasan R, Meharena YT, Snow CD, Poulos TL, Arnold FH (2008) Evolutionary history of a specialized p450 propane monooxygenase. *J Mol Biol* 383:1069–1080.
- Feagin JE (2000) Mitochondrial genome diversity in parasites. *Int J Parasitol* 33:371–390.
- Feder JL, et al. (2003a) Allopatric genetic origins for sympatric host-plant shifts and race formation in *Rhagoletis*. *Proc Natl Acad Sci USA* 100:10314–10319.
- Feder JL, Roethele FB, Filchak K, Niedbalski J, Romero-Severson J (2003b) Evidence for inversion polymorphism related to sympatric host race formation in the apple maggot fly, *Rhagoletis pomonella*. *Genetics* 163:939–953.
- Felsenstein J (1981) Skepticism toward Santa Rosalia, or why are there so few kinds of animals? *Evolution (Lawrence, Kans)* 35:124–138.
- Fenberg PB, Roy K (2008) Ecological and evolutionary consequences of size-selective harvesting: How much do we know? *Mol Ecol* 17:209–220.
- Fernandez H, Taberlet P, Mashkour M, Vigne J-D, Luikart G (2005) Assessing the origin and diffusion of domestic goats using ancient DNA. In *The First Steps of Animal Domestication: New Archaeozoological Approaches*, eds Vigne JD, Peters J, Helmer D (Oxbow Books, Oxford, UK), pp 50–54.
- Ferrari J, Godfray CHJ, Faulconbridge AS, Prior K, Via S (2007) Population differentiation and genetic variation in host choice among pea aphids from eight host plant genera. *Evolution (Lawrence, Kans)* 60:1574–1584.
- Ferrari J, Godfray CHJ, Via S (2008) Population differentiation and genetic variation in performance of pea aphids on eight host plant genera. *Evolution (Lawrence, Kans)* 62:2508–2523.
- Festa-Bianchet M (2003) Exploitative wildlife management as a selective pressure for the life history evolution of large mammals. In *Animal Behavior and Wildlife Conservation*, eds Festa-Bianchet M, Apollonio M (Island Press, Washington, DC), pp 191–207.
- Fields PA (2001) Review: Protein function at thermal extremes: Balancing stability and flexibility. *Comp Biochem Physiol A Physiol* 129:417–431.
- Fisher R (1915) The evolution of sexual preference. *Eugenics Review* 7:184–192.
- Fisher R (1930) *The Genetical Theory of Natural Selection* (Clarendon Press, Oxford, UK).
- Fisher R (1941) Average excess and average effect of a gene substitution. *Ann Eugenics* 11:53–63.

- FitzSimmons NN, Buskirk SW, Smith MH (1995) Population history, genetic variability, and horn growth in bighorn sheep. *Conserv Biol* 9:314–323.
- Fleishman LJ (1992) The influence of the sensory system and the environment on motion patterns in the visual displays of anoline lizards and other vertebrates. *Am Nat* 139: S36–S61.
- Fleming IA, Gross MR (1994) Breeding competition in a Pacific salmon (Coho: *Oncorhynchus kisutch*): Measures of natural and sexual selection. *Evolution* 48:637–657.
- Flint-Garcia SA, et al. (2005) Maize association population: A high-resolution platform for quantitative trait locus dissection. *Plant J* 44:1054–1064.
- Fodor J (2007) Why pigs don't have wings. *London Rev Books* 20:5–8.
- Fodor J (2008a) Against Darwinism. *Mind Language* 23:42–49.
- Fodor J (2008b) *LOT 2: The Language of Thought Revisited* (Oxford Univ Press, Oxford, UK).
- Fogle B (2001) *The New Encyclopedia of the Cat* (DK, New York).
- Fogle B, Morgan T (2000) *The New Encyclopedia of the Dog* (Dorling Kindersley, New York) 2nd Ed.
- Ford M, Hard JJ, Boelts B, Lahood E, Miller J (2008) Estimates of natural selection in a salmon population in captive and natural environments. *Conserv Biol* 22:783–794.
- Forsgren E (1992) Predation risk affects mate choice in a gobiid fish. *Am Nat* 140:1041–1049.
- Forsgren E, Amundsen A, Borg A, Bjelvenmark J (2004) Unusually dynamic sex roles in a fish. *Nature* 429:551–554.
- Frank S (1997) The Price equation, Fisher's fundamental theorem, kin selection and causal analysis. *Evolution* 51:1712–1729.
- Fraser D, Weary DM, Pajor EA, Milligan BN (1997) A scientific conception of animal welfare that reflects ethical concerns. *Anim Welf* 6:187–205.
- Fuller RC, Houle D, Travis J (2005) Sensory bias as an explanation for the evolution of mate preferences. *Am Nat* 166:437–446.
- Fulton M, Hodges SA (1999) Floral isolation between *Aquilegia formosa* and *Aquilegia pubescens*. *Proc R Soc London Ser B* 266:2247–2252.
- Funk DJ (2009) Investigating ecological speciation. In *Speciation and Patterns of Diversity*, eds Butlin RK, Bridle JR, Schluter D (Cambridge Univ Press, Cambridge, UK), pp. 195–218.
- Funk DJ, Nosil P, Etges WJ (2006) Ecological divergence exhibits consistently positive associations with reproductive isolation across disparate taxa. *Proc Natl Acad Sci USA* 103:3209–3213.
- Futuyma DJ (1987) On the role of anagenesis in speciation. *Am Nat* 130:465–473.
- Gack C, Peschke K (1994) Spermathecal morphology, sperm transfer and a novel mechanism of sperm displacement in the rove beetle, *Aleochara curtula* (Coleoptera, Staphylinidae). *Zoomorphology* 114:227–237.
- Gage MJG, Baker RR (1991) Ejaculate size varies with socio-sexual situation in an insect. *Ecol Entomol* 16:331–337.
- Gaillard JM, Loison A, Toigo C (2003) Variation in life history traits and realistic population models for wildlife management: The case of ungulates. In *Animal Behavior and Wildlife Conservation*, eds Festa-Bianchet M, Apollonio M (Island Press, Washington, DC), pp 115–132.
- Galimberti F, Boitani L, Marzetti I (2000) Female strategies of harassment reduction in southern elephant seals. *Ethol Ecol Evol* 12:367–388.
- Garel M, et al. (2007) Selective harvesting and habitat loss produce long-term life history changes in a mouflon population. *Ecol Appl* 17:1607–1618.
- Garrard AN (1984) The selection of south-west Asian animal domesticates. In *Animals and Archaeology: 3. Early Herders and Their Flocks*, eds Clutton-Brock J, Grigson C (BAR International, Oxford), pp 117–132.

- Garrett JB, et al. (2004) Enhancing the thermal tolerance and gastric performance of a microbial phytase for use as a phosphate-mobilizing monogastric-feed supplement. *Appl Environ Microbiol* 70:3041–3046.
- Gaut BS, Morton BR, McCaig BC, Clegg MT (1996) Substitution rate comparisons between grasses and palms: Synonymous rate differences at the nuclear gene *Adh* parallel rate differences at the plastid gene *rbcl*. *Proc Natl Acad Sci USA* 93:10274–10279.
- Gavrilets S (2003) Perspective: Models of speciation: What have we learned in 40 years? *Evolution* 57:2197–2215.
- Gavrilets S (2004) *Fitness Landscapes and the Origin of Species* (Princeton Univ Press, Princeton, NJ).
- Gebhardt Y, et al. (2005) Molecular evolution of flavonoid dioxygenases in the family Apiaceae. *Phytochemistry* 66:1273–1284.
- Gerson HB, Hickie JP (1985) Head scarring on male narwhals (*Monodon monoceros*): Evidence for aggressive tusk use. *Can J Zool* 63:2083–2087.
- Ghedini E, et al. (2004) Gene synteny and evolution of genome architecture in trypanosomatids. *Mol Biochem Parasitol* 134:183–191.
- Ghiselin M (1969) *The Triumph of the Darwinian Method* (Univ of California Press, Berkeley).
- Ghiselin M (1974) *The Economy of Nature and the Evolution of Sex* (Univ of California Press, Berkeley), p 216.
- Gilad Y, Rifkin SA, Pritchard JK (2008) Revealing the architecture of gene regulation: The promise of eQTL studies. *Trends Genet* 24:408–415.
- Gilbert SF, Opitz JM, Raff RA (1996) Resynthesizing evolutionary and developmental biology. *Dev Biol* 173:357–372.
- Gillespie JH (1984) The status of the neutral theory: The neutral theory of molecular evolution. *Science* 224:732–733.
- Gillespie JH (1991) *The Causes of Molecular Evolution* (Oxford Univ Press, New York).
- Gillingham MAF, et al. (2009) Cryptic preference for MHC-dissimilar females in male red jungle fowl, *Gallus gallus*. *Proc R Soc London Ser B* 276:1083–1092.
- Giver L, Gershenson A, Freskgard PO, Arnold FH (1998) Directed evolution of a thermostable esterase. *Proc Natl Acad Sci USA* 95:12809–12813.
- Gjedrem T (2005) *Selection and Breeding Programs in Aquaculture* (Springer, Dordrecht, The Netherlands).
- Goloubinoff P, Pääbo S, Wilson AC (1993) Evolution of maize inferred from sequence diversity of an *Adh2* gene segment from archaeological specimens. *Proc Natl Acad Sci USA* 90:1997–2001.
- Gomendio M, Harcourt AH, Roldán ERS (1997) Sperm competition in mammals. In *Sperm Competition and Sexual Selection*, eds Birkhead T, Møller AP (Academic Press, New York), pp 667–751.
- Gong A (1997) The effects of predator exposure on the female choice of guppies (*Poecilia reticulata*) from a high-predation population. *Behaviour* 134:373–389.
- Goodman CD, Casati P, Walbot V (2004) A multidrug resistance-associated protein involved in anthocyanin transport in *Zea mays*. *Plant Cell* 16:1812–1826.
- Goodnight C, Schwartz J, Stevens L (1992) Contextual analysis of models of group selection, soft selection, hard selection and the evolution of altruism. *Am Nat* 140:743–761.
- Gould B, Kramer EM (2007) Virus-induced gene silencing as a tool for functional analyses in the emerging model plant *Aquilegia* (columbine, Ranunculaceae). *Plant Methods* 6:1–12.
- Gould S (1977a) *Ever Since Darwin* (Norton, New York).
- Gould S (1977b) *Ontogeny and Phylogeny* (Belknap, Cambridge, MA).
- Gould S (1988) On replacing the idea of progress with an operational notion of directionality. *Evolutionary Progress*, ed Nitecki MH (Univ of Chicago Press, Chicago), pp 319–338.

## 370 / References

- Gould S (1989) *Wonderful Life: The Burgess Shale and the Nature of History* (Norton, New York).
- Gould S (2002) *The Structure of Evolutionary Theory* (Harvard Univ Press, Cambridge, MA).
- Gould SJ, Lewontin RC (1979) The spandrels of San Marco and the Panglossian paradigm: A critique of the adaptationist programme. *Proc R Soc London Ser B* 205:581–598.
- Gowaty PA (1981) The aggression of breeding eastern bluebirds *Sialia sialis* toward each other and intra- and inter-specific intruders. *Anim Behav* 29:1013–1027.
- Gowaty PA (1985) Multiple parentage and apparent monogamy in birds. In *Avian Monogamy, Ornithological Monographs*, Vol 37, eds Gowaty PA, Mock DW (Allen Press, Lawrence, KS), pp 11–17.
- Gowaty PA (2007) Perception bias, social inclusion and sexual selection: Power dynamics in science and nature. In *Modern Controversies in Evolutionary Biology in Science and Technology in Society: From Space Exploration to the Biology of Gender*, eds Klienman DL, Handelsman J (Univ of Wisconsin Press, Madison), pp 401–420.
- Gowaty PA (2008) Reproductive compensation. *J Evol Biol* 21:1189–1200.
- Gowaty PA, Hubbell SP (2005) Chance, time allocation, and the evolution of adaptively flexible sex role behavior. *Integr Comp Biol* 45:931–944.
- Gowaty PA, Karlin AA (1984) Multiple maternity and paternity in single broods of apparently monogamous eastern bluebirds (*Sialia sialis*). *Behav Ecol Sociobiol* 143:91–95.
- Gowaty PA, Wagner SJ (1987) Breeding season aggression of female and male eastern bluebirds (*Sialia sialis*) to models of potential conspecific and interspecific eggdumpers. *Ethology* 78:238–250.
- Gowaty PA, Steinichen R, Anderson WW (2002) Mutual interest between the sexes and reproductive success in *Drosophila pseudoobscura*. *Evolution* 56:2537–2540.
- Gowaty PA, Drickamer LC, Holmes S-S (2003a) Male house mice produce fewer offspring with lower viability and poorer performance when mated with females they do not prefer. *Anim Behav* 65:95–103.
- Gowaty PA, Steinechen R, Anderson WW (2003b) Indiscriminate females and choosy males: Within- and between-species variation in *Drosophila*. *Evolution* 57:2037–2045.
- Gowaty PA, et al. (2007) The hypothesis of reproductive compensation and its assumptions about mate preferences and offspring viability. *Proc Natl Acad Sci USA* 104:15023–15027.
- Graber JH, Salisbury J, Hutchins LN, Blumenthal T (2007) *C. elegans* sequences that control *trans*-splicing and operon pre-mRNA processing. *RNA* 13:1409–1426.
- Grand TC, Dill LM (1999) Predation risk, unequal competitors and the ideal free distribution. *Evol Ecol Res* 1:389–409.
- Grant J, Foam P (2002) Effect of operational sex ratio on female-female versus male-male competitive aggression. *Can J Zool* 80:2242–2246.
- Gray A (1861) *Natural Selection not Inconsistent with Natural Theology: A Free Examination of Darwin's Treatise on the Origin of Species* (Trübner, London).
- Gray A (1876) *Darwiniana* (Appleton, New York).
- Greg W (1868) On the failure of “natural selection” in the case of man. *Fraser's Mag* 78:353–362.
- Grotewold E (2006) The genetics and biochemistry of floral pigments. *Annu Rev Plant Biol* 57:761–780.
- Groube L (1996) The impact of diseases upon the emergence of agriculture. *The Origins and Spread of Agriculture and Pastoralism in Eurasia*, ed Harris DR (Univ College London, London), pp 101–129.
- Gunzl A, Vanhamme L, Myler PJ (2007) Transcription in trypanosomes: A different means to the end. In *Trypanosomes After the Genome*, eds Barry D, McCulloch R, Mottram J, Acosta-Serrano A (Horizon Bioscience, Norfolk, UK).



- Guo HH, Choe J, Loeb LA (2004) Protein tolerance to random amino acid change. *Proc Natl Acad Sci USA* 101:9205–9210.
- Gwynne DT (1984) Courtship feeding increases female reproductive success in bushcrickets. *Nature* 307:361–363.
- Haber A, Dayan T, Getz N (2005) Pig exploitation at Hagoshrim: A prehistoric site in the southern Levant. In *The First Steps of Animal Domestication: New Archaeozoological Approaches*, eds Vigne JD, Peters J, Helmer D (Oxbow Books, Oxford, UK), pp 80–85.
- Hacking I (1965) *The Logic of Statistical Inference* (Cambridge Univ Press, Cambridge, UK).
- Hadfield MG (1986) Extinction in Hawaiian achatinelline snails. *Malacologia* 27:67–81.
- Haeckel E (1866) *General Morphology of Organisms* (Georg Reimer, Berlin).
- Haldane JBS (1942) The selective elimination of silver foxes in Canada. *J Genet* 44:296–304.
- Hale EB (1969) Domestication and the evolution of behaviour. In *The Behaviour of Domestic Animals*, ed Hafez ESE (Bailliere, Tindall and Cassell, London), 2nd Ed, pp 22–42.
- Hall RJ, Milner-Gulland EJ, Courchamp F (2008) Endangering the endangered: The effects of perceived rarity on species exploitation. *Conserv Lett* 1:75–81.
- Hamilton WD, Zuk M (1982) Heritable true fitness and bright birds: A role for parasites? *Science* 18:384–387.
- Hamon TR (2005) Measurement of concurrent selection episodes. *Evolution* 59:1096–1103.
- Hamon TR, Foote CJ (2005) Concurrent natural and sexual selection in wild male sockeye salmon, *Oncorhynchus nerka*. *Evolution* 59:1104–1118.
- Hamon TR, Foote CJ, Hilborn R, Rogers DE (2000) Selection on morphology of spawning wild sockeye salmon by a gill-net fishery. *Trans Am Fish Soc* 129:1300–1315.
- Hampel V, et al. (2009) Phylogenomic analyses support the monophyly of Excavata and resolve relationships among eukaryotic “supergroups.” *Proc Natl Acad Sci USA* 106:3859–3864.
- Handford P, Bell G, Reimchen T (1977) A gillnet fishery considered as an experiment in artificial selection. *J Fish Res Bd Can* 34:954–961.
- Hanlon RT (1998) Mating systems and sexual selection in the squid *Loligo*: How might commercial fishing on spawning squids affect them? *CalCOFI Rep* 39:92–100.
- Hansell M (2000) *Bird Nests and Construction Behaviour* (Cambridge Univ Press, Cambridge, UK).
- Harcourt AH, Harvey PH, Larson SG, Short RV (1981) Testis weight, body weight, and breeding system in primates. *Nature* 293:55–57.
- Hard JJ, Mills LS, Peek JM (2006) Genetic implications of reduced survival of male red deer *Cervus elaphus* under harvest. *Wildl Biol* 12:427–441.
- Hard JJ, et al. (2008) Evolutionary consequences of fishing and their implications for salmon. *Evol Appl* 1:388–408.
- Hard JJ, Eldridge WH, Naish KA (in press) The genetic consequences of size-selective fishing and their implications for viability of Chinook salmon (*Oncorhynchus tshawytscha*). In *Sustainability of the Arctic-Yukon-Kuskokwim Salmon Fisheries: What Do We Know About Salmon Ecology, Management, and Fisheries?*, eds Krueger C, Zimmerman C (Alaska Sea Grant and American Fisheries Society, Bethesda, MD).
- Harel M, et al. (2004) Structure and evolution of the serum paraoxonase family of detoxifying and anti-atherosclerotic enzymes. *Nat Struct Mol Biol* 11:412–419.
- Harris RB, Wall WA, Allendorf FW (2002) Genetic consequences of hunting: What do we know and what should we do? *Wildl Soc Bull* 30:634–643.
- Harrison RG (1998) Linking evolutionary pattern and process: The relevance of species concepts for the study of speciation. *Endless Forms*, eds Howard DJ, Berlocher SH (Sinauer, Sunderland, MA), pp 19–31.
- Hartl DL, Clark AG (1997) *Principles of Population Genetics* (Sinauer, Sunderland, MA), 3rd Ed.



- Hartl GB, Reimoser F, Willing R, Köller J (1991) Genetic variability and differentiation in roe deer (*Capreolus capreolus* L) of Central Europe. *Genet Sel Evol* 23:281–299.
- Hartl GB, Apollonio M, Mattioli L (1995) Genetic determination of cervid antlers in relation to their significance in social interactions. *Acta Theriol* 40 (Suppl 3):199–205.
- Hashimi H, Zíková A, Panigrahi AK, Stuart KD, Lukeš J (2008) TbRGG1, a component of a novel multiprotein complex involved in kinetoplastid RNA editing. *RNA* 14:970–980.
- Hatfield T, Schluter D (1999) Ecological speciation in sticklebacks: Environment-dependent hybrid fitness. *Evolution* 53:866–873.
- Hausmann K (1978) Extrusive organelles in protists. *Int Rev Cytol* 52:197–268.
- Hawthorne DJ, Via S (2001) Genetic linkage facilitates ecological specialization and reproductive isolation in pea aphids. *Nature* 412:904–907.
- Hedrich HJ (2000) History, strains, and models. In *The Handbook of Experimental Animals: The Laboratory Rat*, ed Krinke G (Academic Press, San Diego), pp 3–8.
- Hedrick AV, Dill LM (1993) Mate choice by female crickets is influenced by predation risk. *Anim Behav* 46:193–196.
- Hegel GWF (1817) *Philosophy of Nature* (Oxford Univ Press, Oxford, UK).
- Heino M (1998) Management of evolving fish stocks. *Can J Fish Aquat Sci* 55:1971–1982.
- Helmer D, Gourichon G, Monchot H, Peters J, Sana Segui M (2005) Identifying early domestic cattle from pre-pottery Neolithic sites on the Middle Euphrates using sexual dimorphism. In *The First Steps of Animal Domestication: New Archaeozoological Approaches*, eds Vigne JD, Peters J, Helmer D (Oxbow Books, Oxford, UK), pp 86–95.
- Hemmer H (1990) *Domestication: The Decline of Environmental Appreciation* (Cambridge Univ Press, Cambridge, UK).
- Hempel CG (1965) *Aspects of Scientific Explanation* (Free Press, New York).
- Hempel CG (1966) *Philosophy of Natural Science* (Prentice-Hall, Englewood Cliffs, NJ).
- Hendry AP, Nosil P, Rieseberg LJ (2007) The speed of ecological speciation. *Funct Ecol* 21:455–464.
- Hennig W (1966) *Phylogenetic Systematics* (Univ of Illinois Press, Urbana).
- Hermisson J, Pennings PS (2005) Soft sweeps: Molecular population genetics of adaptation from standing genetic variation. *Genetics* 169:2335–2352.
- Herschel JFW (1830) *A Preliminary Discourse on the Study of Natural Philosophy* (Longman, Rees, Orme, Brown, Green, and Longman, London).
- Hibbett DS (2004) Trends in morphological evolution in homobasidiomycetes inferred using maximum likelihood: A comparison of binary and multistate approaches. *Syst Biol* 53:889–903.
- Hibbett DS, Binder M (2002) Evolution of complex fruiting-body morphologies in homobasidiomycetes. *Proc R Soc London Ser B* 269:1963–1969.
- Hilborn R, Minto-Vera CV (2008) Fisheries-induced changes in growth rates in marine fisheries: Are they significant? *Bull Mar Sci* 83:95–105.
- Hillis DM, Mortiz C, Mable BK, eds (1996) *Molecular Systematics* (Sinauer, Sunderland, MA).
- Hillman G, Davies MS (1990) Domestication rates in wild-type wheats and barley under primitive cultivation. *Biol J Linn Soc* 39:39–78.
- Hillman G, Hedges R, Moore A, Colledge S, Pettitt P (2001) New evidence of Lateglacial cereal cultivation at Abu Hureyra on the Euphrates. *Holocene* 11:383–393.
- Hilton H, Gaut BS (1998) Speciation and domestication in maize and its wild relatives: Evidence from the *glubulin-1* gene. *Genetics* 150:863–872.
- Hindar K, de Leaniz G, Koljonen M-L, Tufto J, Youngson AF (2007) Fisheries exploitation. In *The Atlantic Salmon: Genetics, Conservation, and Management*, eds Verspoor E, Stradmeyer L, Nielsen JL (Blackwell, Oxford, UK), pp 299–324.
- Hoballah ME, et al. (2007) Single gene-mediated shift in pollinator attraction in *Petunia*. *Plant Cell* 19:779–790.

- Hoch J (2008) Variation in penis morphology and mating ability in the acorn barnacle, *Semibalanus balanoides*. *J Exp Mar Biol Ecol* 359:126–130.
- Hodge MJS (1977) The structure and strategy of Darwin's "long argument." *Br J Philos Sci* 10:237–246.
- Hodge MJS (2005) Against "revolution" and "evolution." *J Hist Biol* 38:101–124.
- Hodges SA (1997) A rapid adaptive radiation via a key innovation in *Aquilegia*. In *Molecular Evolution and Adaptive Radiation*, eds Givinish T, Sytsma K (Cambridge Univ Press, Cambridge, UK), pp 391–405.
- Hodges SA, Arnold ML (1994) Columbines: A geographically widespread species flock. *Proc Natl Acad Sci USA* 91:5129–5132.
- Hodges SA, Arnold ML (1995) Spurring plant diversification: Are floral nectar spurs a key innovation? *Proc R Soc London Ser B* 262:343–348.
- Hodges SA, Whittall JB (2008) One-sided evolution or two? A reply to Ennos. *Heredity* 100:541–542.
- Hodges SA, Whittall JB, Fulton M, Yang JY (2002) Genetics of floral traits influencing reproductive isolation between *Aquilegia formosa* and *Aquilegia pubescens*. *Am Nat* 159: S51–S60.
- Hodges SA, Fulton M, Yang JY, Whittall JB (2004) Verne Grant and evolutionary studies of *Aquilegia*. *New Phytol* 161:113–120.
- Hoekstra HE, Coyne JA (2007) The locus of evolution: Evo devo and the genetics of adaptation. *Evolution* 61:995–1016.
- Hofstadter DR (2007) *I Am a Strange Loop* (Basic Books, New York).
- Hole F (1996) The context of caprine domestication in the Zagros region. In *The Origins and Spread of Agriculture and Pastoralism in Eurasia*, ed Harris DR (Univ College London, London), pp 263–281.
- Holland B, Rice WR (1998) Chase-away sexual selection: Antagonistic seduction versus resistance. *Evolution (Lawrence, Kans)* 52:1–7.
- Holland B, Rice WR (1999) Experimental removal of sexual selection reverses intersexual antagonistic coevolution and removes a reproductive load. *Proc Natl Acad Sci USA* 96:5083–5088.
- Holman L, Snook RR (2006) Spermicide, cryptic female choice, and the evolution of sperm form and function. *J Evol Biol* 19:1660–1670.
- Holman R, Snook RR (2008) A sterile sperm caste protects brother fertile sperm from female-mediated death in *Drosophila pseudoobscura*. *Curr Biol* 18:292–296.
- Holsinger K (1991) Mass-action models of plant mating systems: The evolutionary stability of mixed mating systems. *Am Nat* 138:606–622.
- Hosken DJ, Stockley P (2004) Sexual selection and genital evolution. *Trends Ecol Evol* 19:87–93.
- Howard DJ, Berlocher SH (2003) *Endless Forms* (Sinauer, Sunderland, MA).
- Hrdy SB (1981) *The Woman That Never Evolved* (Harvard Univ Press, Cambridge, MA).
- Hrdy SB (1986) Empathy, polyandry and the myth of the "coy" female. *Feminist Approaches to Science*, ed Bleier R (Pergamon, New York), pp 119–146.
- Hrdy S, Williams GC (1983) Behavioral biology and the double standard. *Social Behavior of Female Vertebrates*, ed Wasser S (Academic Press, New York), pp 3–17.
- Hubbell SP, Johnson LK (1987) Environmental variance in lifetime mating success, mate choice, and sexual selection. *Am Nat* 130:91–112.
- Hudson RR (1987) Estimating the recombination parameter of a finite population model without selection. *Genet Res* 50:245–250.
- Hudson RR (1990) Gene genealogies and the coalescent process. *Oxf Surv Evol Biol* 7:1–42.
- Hudson RR (2002) Generating samples under a Wright-Fisher neutral model of genetic variation. *Bioinformatics* 18:337–338.

- Hudson RR, Kreitman M, Aguadé M (1987) A test of neutral molecular evolution based on nucleotide data. *Genetics* 116:153–159.
- Hughes C (1998) Integrating molecular techniques with field methods in studies of social behavior: A revolution results. *Ecology* 79:383–399.
- Hull D (1973) *Darwin and His Critics* (Harvard Univ Press, Cambridge, MA).
- Humboldt A, Bonpland A (1818–1829) *Personal Narrative of Travels to the Equinoctial Regions of the New Continent, During the Years 1799–1804*, trans Helen Williams (Longman, Hurst, Rees, Orme, and Brown, London).
- Humes RH (1965) A short history of *Liguus* collecting: With a list of collectors—1744 to 1958. *Tequesta* 25:67–82.
- Hutchings JA, Rowe S (2008) Consequences of sexual selection for fisheries-induced evolution: An exploratory analysis. *Evol Appl* 1:129–136.
- Huxley L (1900) *The Life and Letters of Thomas Henry Huxley* (Macmillan, London).
- Huxley TH (1857–1859) On the theory of the vertebrate skull. Croonian Lecture delivered before the Royal Society, June 17, 1858. *Proc R Soc* ix:381–457.
- Huxley TH (1863) *Evidence as to Man's Place in Nature* (Williams and Norgate, London).
- Huxley TH (1884) The Darwinian hypothesis. In *Collected Essays: Darwiniana* (Macmillan, London), pp 1–21.
- Huxley TH (1893) *Evolution and Ethics*; reprinted (2009), ed Ruse M (Princeton Univ Press, Princeton, NJ).
- Huxley TH, Martin HN (1875) *A Course of Practical Instruction in Elementary Biology* (Macmillan, London).
- Huynen MA, Stadler PF, Fontana W (1996) Smoothness within ruggedness: The role of neutrality in adaptation. *Proc Natl Acad Sci USA* 93:397–401.
- Iltis HH, Doebley JF (1980) Taxonomy of *Zea* (Gramineae). II. Subspecific categories in the *Zea mays* complex and generic synopsis. *Am J Bot* 67:994–1004.
- Ingram KK, Laamanen T, Puniamoorthy N, Meier R (2008) Lack of morphological coevolution between male forelegs and female wings in *Themira* (Sepsidae: Diptera: Insecta). *Biol J Linn Soc* 93:227–238.
- Ingram VM (1957) Gene mutations in human hemoglobin: The chemical difference between normal and sickle cell hemoglobin. *Nature* 180:326–328.
- Itzkowitz M, Haley M (1999) Are males with more attractive resources more selective in their mate preferences? A test in a polygynous species. *Behav Ecol* 10:366–371.
- Iwasa Y, Pomiankowski A (1994) The evolution of mate preferences for multiple sexual ornaments. *Evolution* 48:853–867.
- Jablonski D (1997) Body-size evolution in Cretaceous mollusks and the status of Cope's rule. *Nature* 385:250–252.
- Jachmann H, Berry PSM, Immae H (1995) Tusklessness in African elephants: A future trend. *Afr J Ecol* 33:230–235.
- Jackel C, Kast P, Hilvert D (2008) Protein design by directed evolution. *Annu Rev Biophys* 37:153–173.
- Jackson CJ, et al. (2007) Broad genomic and transcriptional analysis reveals a highly derived genome in dinoflagellate mitochondria. *BMC Biol* 5:41.
- Jacob F (1988) *The Statue Within: An Autobiography* (Basic Books, New York).
- Jaenicke V, et al. (2003) Early allelic selection in maize as revealed by ancient DNA. *Science* 302:1206–1208.
- Jamieson BGM (1987) *The Ultrastructure and Phylogeny of Insect Spermatozoa* (Cambridge Univ Press, Cambridge, UK).
- Jansen T, et al. (2002) Mitochondrial DNA and the origins of the domestic horse. *Proc Natl Acad Sci USA* 99:10905–10910.

- Jensen JD, Kim Y, DuMont VB, Aquadro CF, Bustamante CD (2005) Distinguishing between selective sweeps and demography using DNA polymorphism data. *Genetics* 170:1401–1410.
- Jiggins FM (2002) Widespread “hilltopping” in *Acraea* butterflies and the origin of sex-role-reversed swarming in *Acraea encedon* and *A. encedana*. *African J Ecol* 40:228–231.
- Johannes TW, Zhao H (2006) Directed evolution of enzymes and biosynthetic pathways. *Curr Opin Microbiol* 9:261–267.
- John Paul II (1997) The Pope’s message on evolution. *Q Rev Biol* 72:377–383.
- Johnson LK, Hubbell SP (1984) Male choice: Experimental demonstration in a brentid weevil. *Behav Ecol Sociobiol* 15:183–188.
- Johnson WE, et al. (2006) The late Miocene radiation of modern Felidae: A genetic assessment. *Science* 311:73–77.
- Jones AG (2009) On the opportunity for sexual selection, the Bateman gradient and the maximum intensity of sexual selection. *Evolution* 63:1673–1684.
- Jones AG, Ardren WR (2003) Methods of parentage analysis in natural populations. *Mol Ecol* 12:2511–2523.
- Jones AG, Avise JC (1997) Microsatellite of maternity and the mating system in the Gulf pipefish *Syngnathus scovelli*, a species with male pregnancy and sex-role reversal. *Mol Ecol* 6:203–213.
- Jones AG, Avise JC (2001) Mating systems and sexual selection in male-pregnant pipefishes and seahorses: Insights from microsatellite-based studies of maternity. *J Hered* 92:150–158.
- Jones AG, Rosenqvist G, Berglund A, Arnold SJ, Avise JC (2000) The Bateman gradient and the cause of sexual selection in a sex-role-reversed pipefish. *Proc R Soc London Ser B* 267:677–680.
- Jones A, Arguello J, Arnold S (2002) Validation of Bateman’s principles: A genetic study of sexual selection and mating patterns in the rough-skinned newt. *Proc Roy Soc Lond B* 269:2433–2539.
- Jones AG, Arnold SJ, Bürger R (2003) Stability of the G-matrix in a population experiencing pleiotropic mutation, stabilizing selection, and genetic drift. *Evolution* 57:1747–1760.
- Jones AG, Arnold SJ, Bürger R (2004) Evolution and stability of the G-matrix on a landscape with a moving optimum. *Evolution* 58:1639–1654.
- Jones M, Brown T (2000) Agricultural origins: The evidence of modern and ancient DNA. *Holocene* 10:769–776.
- Jones TM, Quinnell RJ, Balmford A (1998) Fisherian flies: Benefits of female choice in a lekking sandfly. *Proc R Soc London Ser B* 265:1651–1657.
- Jordan DS, Evermann BW (1902) *American Food and Game Fishes: A Popular Account of All the Species Found in America, North of the Equator, with Keys for Ready Identification, Life Histories and Methods of Capture* (Doubleday, New York).
- Judson O (2002) *Dr. Tatiana’s Sex Advice to All Creation: The Definitive Guide to the Evolutionary Biology of Sex* (Holt, New York).
- Kahvejian A, Quackenbush J, Thompson JF (2008) What would you do if you could sequence everything? *Nat Biotechnol* 26:1125–1133.
- Kamei N, Glabe CG (2003) The species-specific egg receptor for sea urchin sperm adhesion is EBR1, a novel ADAMTS protein. *Genes Dev* 17:2502–2507.
- Kant I (1951) *Critique of Judgement* (Haffner, New York).
- Kao T, Tsukamoto T (2004) The molecular and genetic bases of S-RNase-based self-incompatibility. *Plant Cell* 16(Suppl):S72–S83.
- Kaplan NL, Hudson RR, Langley CH (1989) The hitchhiking effect revisited. *Genetics* 123:887–899.
- Karn RC, Clark NL, Nguyen ED, Swanson WJ (2008) Adaptive evolution in rodent seminal vesicle secretion proteins. *Mol Biol Evol* 25:2301–2310.

- Kato YTA (1976) Cytological studies of maize (*Zea mays* L.) and teosinte (*Zea mexicana* Schrader Kuntze) in relation to their origin and evolution. *Mass Agric Exp Sta Bull* 635:1–185.
- Kato YTA, Lopez RA (1990) Chromosome knobs of the perennial teosintes. *Maydica* 35: 125–141.
- Kay KM, et al. (2006) Floral characters and species diversification. *Ecology and Evolution of Flowers*, eds Harder L, Barrett SCH (Oxford Univ Press, Oxford, UK), pp 311–325.
- Keeling PJ (2009) Chromalveolates and the evolution of plastids by secondary endosymbiosis. *J Eukaryot Microbiol* 56:1–8.
- Keeling PJ, et al. (2005) The tree of eukaryotes. *Trends Ecol Evol* 20:670–676.
- Kendall NW, Hard JJ, Quinn TP (2009) Quantifying six decades of fishery selection for size and age at maturity in sockeye salmon. *Evol Appl*, doi: 10.1111/j.1752-4571.2009.00086.x.
- Kern AD, Jones CD, Begun DJ (2004) Molecular genetics of male accessory gland in the *Drosophila simulans* complex. *Genetics* 167:725–735.
- Khersonsky O, Roodveldt C, Tawfik DS (2006) Enzyme promiscuity: Evolutionary and mechanistic aspects. *Curr Opin Chem Biol* 10:498–508.
- Kim Y, Stephan W (2002) Detecting a local signature of genetic hitchhiking along a recombining chromosome. *Genetics* 160:765–777.
- Kimura M (1983) *The Neutral Theory of Molecular Evolution* (Cambridge Univ Press, Cambridge, UK).
- King MC, Wilson AC (1975) Evolution at 2 levels in humans and chimpanzees. *Science* 188:107–116.
- Kingett PD, Lambert DM, Telford SR (1981) Does mate choice occur in *Drosophila melanogaster*? *Nature* 293:492.
- Kingsolver JG, Pfennig DW (2007) Patterns and power of phenotypic selection in nature. *BioScience* 57:561–572.
- Kingsolver JG, et al. (2001) The strength of phenotypic selection in natural populations. *Am Nat* 157:245–261.
- Kinnison MT, Unwin MJ, Quinn TP (2003) Migratory costs and contemporary evolution of reproductive allocation in male chinook salmon. *J Evol Biol* 16:1257–1269.
- Kirkpatrick M (1982) Sexual selection and the evolution of female choice. *Evolution* 36: 1–12.
- Kirkpatrick M (1985) Evolution of female choice and male parental investment in polygynous species: The demise of the “sexy son.” *Am Nat* 125:788–810.
- Kirkpatrick M, Ryan MJ (1991) The evolution of mating preferences and the paradox of the lek. *Nature* 350:33–38.
- Kirkpatrick M, Price T, Arnold SJ (1990) The Darwin-Fisher theory of sexual selection in monogamous birds. *Evolution* 44:180–193.
- Knight R, Freeland S, Landweber L (2001) Rewiring the keyboard—evolvability of the genetic code. *Nat Rev Genet* 2:49–58.
- Knight T, et al. (2005) Pollen limitation of plant reproduction: Pattern and process. *Annu Rev Ecol Syst* 2005:467–497.
- Knoll A (2003) *Life on a Young Planet: The First Three Billion Years of Evolution on Earth* (Princeton Univ Press, Princeton, NJ).
- Kohler I (1984) The dromedary in modern pastoral societies and implications for its progress of domestication. In *Animals and Archaeology: 3. Early Herders and Their Flocks*, eds Clutton-Brock J, Grigson C (BAR International, Oxford, UK), pp 201–206.
- Kohler-Rollefson I (1996) The one-humped camel in Asia: Origin, utilization and mechanisms of dispersal. In *The Origins and Spread of Agriculture and Pastoralism in Eurasia*, ed Harris DR (UCL Press, London).

- Kohn D (2009) Darwin's keystone—the principle of divergence. In *The Cambridge Companion to the "Origin of Species,"* eds Ruse M, Richards R (Cambridge Univ Press, Cambridge, UK), pp 87–108.
- Kokko H, Monaghan P (2001) Predicting the direction of sexual selection. *Evol Lett* 4:159–165.
- Kokko H, Rankin DJ (2006) Lonely hearts or sex in the city? Density-dependent effects in mating systems. *Philos Trans R Soc London Ser B* 361:319–334.
- Kokko H, Brooks R, Jennions MD, Morley J (2003) The evolution of mate choice and mating biases. *Proc R Soc London Ser B* 270:653–664.
- Kokko H, Jennions MD, Brooks R (2006) Unifying and testing models of sexual selection. *Annu Rev Ecol Syst* 37:43–66.
- Kondrashov AS, Yampolsky LY, Shabalina SA (1998) On the sympatric origin of species by means of natural selection. In *Endless Forms*, eds Howard DJ, Berlocher SH (Sinauer, Sunderland, MA), pp 90–98.
- Kotiaho JS, Puurtinen M (2007) Mate choice for indirect genetic benefits: Scrutiny of the current paradigm. *Funct Ecol* 21:638–644.
- Kotrba M (1995) The internal female genital organs of *Chaetodiposis* and *Diasemopsis* (Diptera: Diopsidae) and their systematic relevance. *Ann Natal Mus* 36:147–159.
- Kotrba M (2006) The internal female reproductive tract of *Campichoeta* Macquart, 1835 and *Diastata* Meigen, 1830 (Diptera, Schizophora). *Stud Dipteral* 13:309–315.
- Kreiger F, Krieger-Loibl E (1958) Beiträge zum Verhalten von *Ischnura elegans* und *Ischnura pumilio* (Odonata). *Z Tierpsychol* 15:82–93.
- Kritzer JP, Sale PF (2004) Metapopulation ecology in the sea: From Levins' model to marine ecology and fisheries science. *Fish Fish* 5:131–140.
- Kronforst MR, et al. (2006) Linkage of butterfly mate preference and wing color preference cue at the genomic location of *wingless*. *Proc Natl Acad Sci USA* 103:6575–6580.
- Kruger A, Schleyer M (1998) Sexual reproduction in the coral *Pocillopora verrucosa* (Cnidaria: Scleractinia) in KwaZulu-Natal, South Africa. *Mar Biol* 132:703–710.
- Kruuk LEB, Clutton-Brock TH, Albon SD, Pemberton JM, Guinness FE (1999) Population density affects sex ratio variation in red deer. *Nature* 399:459–461.
- Kruuk LEB, et al. (2002) Antler size in red deer: Heritability and selection but no evolution. *Evolution* 56:1683–1695.
- Kuhn T (1962) *The Structure of Scientific Revolutions* (Univ of Chicago Press, Chicago).
- Kuparinen A, Merilä J (2007) Detecting and managing fisheries-induced evolution. *Trends Ecol Evol* 22:652–659.
- Lair RC (1997) *Gone Astray: The Care and Management of the Asian Elephant in Domesticity* (Regional Office for Asia and the Pacific, Bangkok, Thailand).
- Lande R (1981) Models of speciation by sexual selection on polygenic traits. *Proc Natl Acad Sci USA* 78:3721–3725.
- Lande R, Arnold SJ (1983) The measurement of selection on correlated characters. *Evolution* 37:1210–1226.
- Lande R, Barrowclough GF (1987) Effective population size, genetic variation, and their use in population management. In *Viable Populations for Conservation*, ed Soulé ME (Cambridge Univ Press, Cambridge, UK), pp 87–124.
- Lande R, Schemske D (1985) The evolution of self-fertilization and inbreeding depression. I. Genetic models. *Evolution* 39:24–40.
- Landwehr M, Carbone M, Otey CR, Li Y, Arnold FH (2007) Diversification of catalytic function in a synthetic family of chimeric cytochrome p450s. *Chem Biol* 14:269–278.
- Larson G, et al. (2005) Worldwide phylogeography of wild boar reveals multiple centers of pig domestication. *Science* 307:1618–1621.
- Laurie CC, et al. (2004) The genetic architecture of response to long-term artificial selection for oil concentration in the maize kernel. *Genetics* 168:2141–2155.



- Law R (2000) Fishing, selection, and phenotypic evolution. *ICES J Mar Sci* 57:659–668.
- Law R (2007) Fisheries-induced evolution: Present status and future directions. *Mar Ecol Prog Ser* 335:271–277.
- Law R, Rowell CA (1993) Cohort-structured populations, selection responses, and exploitation of the North Sea cod. In *The Exploitation of Evolving Resources*, eds Stokes TK, McGlade JM, Law R (Springer, Berlin), pp 155–173.
- Leander BS (2004) Did trypanosomatid parasites have photosynthetic ancestors? *Trends Microbiol* 12:251–258.
- Leander BS (2008) A hierarchical view of convergent evolution in microbial eukaryotes. *J Eukaryot Microbiol* 55:59–68.
- Leander BS, Triemer RE, Farmer MA (2001) Character evolution in heterotrophic euglenids. *Eur J Protistol* 37:337–356.
- Leander BS, Esson HJ, Breglia SA (2007) Macroevolution of complex cytoskeletal systems in euglenids. *BioEssays* 29:987–1000.
- Lee HY, et al. (2008) Incompatibility of nuclear and mitochondrial genomes causes hybrid sterility between two yeast species. *Cell* 135:1065–1073.
- Legge T (1996) The beginning of caprine domestication in Southwest Asia. *The Origins and Spread of Agriculture and Pastoralism in Eurasia*, ed Harris DR (Univ College London, London), pp 238–262.
- Leonard JA, et al. (2002) Ancient DNA evidence for Old World origin of New World dogs. *Science* 298:1613–1616.
- Levins R, Lewontin RC (1985) *The Dialectical Biologist* (Harvard Univ Press, Cambridge, MA).
- Lewontin RC, Krakauer J (1973) Distribution of gene frequency as a test of the theory of selective neutrality of polymorphisms. *Genetics* 74:175–195.
- Lexer C, Lai Z, Rieseberg LH (2004) Candidate gene polymorphisms associated with salt tolerance in wild sunflower hybrids: Implications for the origin of *Helianthus paradoxus*, a diploid hybrid species. *New Phytol* 161:225–233.
- Lia VV, et al. (2007) Microsatellite typing of ancient maize: Insights into the history of agriculture in southern South America. *Proc Biol Sci* 274:545–554.
- Lin SJ, Zhang HA, Spencer DF, Norman JE, Gray MW (2002) Widespread and extensive editing of mitochondrial mRNAs in dinoflagellates. *J Mol Biol* 320:727–739.
- Lindsay SR (2000) *Handbook of Applied Dog Behavior and Training* (Iowa State Univ Press, Iowa).
- Liu KJ, et al. (2003) Genetic structure and diversity among maize inbred lines as inferred from DNA microsatellites. *Genetics* 165:2117–2128.
- Lloyd EA (2005) *The Case of the Female Orgasm: Bias in the Science of Evolution* (Harvard Univ Press, Cambridge, MA).
- Lloyd M (1967) Mean crowding. *J Anim Ecol* 36:1–30.
- Lockless SW, Ranganathan R (1999) Evolutionarily conserved pathways of energetic connectivity in protein families. *Science* 286:295–299.
- Loder N (2005) Point of no return. *Conserv Pract* 6(3):29–34.
- Lopez JV, Culver M, Stephens JC, Johnson WE, O'Brien SJ (1997) Rates of nuclear and cytoplasmic mitochondrial DNA sequence divergence in mammals. *Mol Biol Evol* 14:277–286.
- Lopuch S, Radwan J (2009) Condition dependence of sexual attractiveness in the bank vole. *Behav Ecol Sociobiol* 63:339–344.
- Lorch PD (2002) Understanding reversals in the relative strength of sexual selection on males and females: A role for sperm competition? *Am Nat* 159:645–657.
- Lorch PD, Bussiere LF, Gwynne DT (2008) Quantifying the potential for sexual dimorphism using upper limits on Bateman gradients. *Behaviour* 145:1–24.



- Lowry DB, Modliszewski JL, Wright KM, Wu CA, Willis JH (2008) The strength and genetic basis of reproductive isolating barriers in flowering plants. *Philos Trans R Soc London Ser B* 363:3009–3021.
- Luikart G, et al. (2001) Multiple maternal origins and weak phylogeographic structure in domestic goats. *Proc Natl Acad Sci USA* 98:5927–5932.
- Luikart G, England PR, Tallmon D, Jordan S, Taberlet P (2003) The power and promise of population genomics: From genotyping to genome typing. *Nat Rev Genet* 4:981–994.
- Luikart G, Fernandez H, Mashkour M, England PR, Taberlet P (2006) Origins and diffusion of domestic goats inferred from DNA markers: Example analyses of mtDNA, Y chromosome, and microsatellites. In *Documenting Domestication: New Genetic and Archaeological Paradigms*, eds Zeder MA, Bradley DG, Emshwiller E, Smith B (Univ of California Press, Los Angeles), pp 294–305.
- Lukefahr SD, Jacobson HA (1998) Variance component analysis and heritability of antler traits in white-tailed deer. *J Wildl Manag* 62:262–268.
- Lukeš J, Jirků M, Avliyakov N, Benada O (1998) Pankinetoplast DNA structure in a primitive bodonid flagellate, *Cryptobia heliis*. *EMBO J* 17:838–846.
- Lukeš J, Hashimi H, Zíková A (2005) Unexplained complexity of the mitochondrial genome and transcriptome in kinetoplastid flagellates. *Curr Genet* 48:277–299.
- Lynch M (2007) The frailty of adaptive hypotheses for the origins of organismal complexity. *Proc Natl Acad Sci USA* 104(Suppl 1):8597–8604.
- Lyons E, Waser N, Price M, Antonovics J, Motten A (1989) Sources of variation in plant reproductive success and implications for concepts of sexual selection. *Am Nat* 134:409–433.
- Maan ME, Taborsky M (2008) Sexual conflict over breeding substrate causes female expulsion and offspring loss in a cichlid fish. *Behav Ecol* 19:302–308.
- MacCready P (1999) An ambivalent Luddite at a technological feast. Available at [www.designfax.net/archives/0899/899trl\\_2.asp](http://www.designfax.net/archives/0899/899trl_2.asp).
- Mace GM, Reynolds JD (2001) Exploitation as a conservation issue. In *Conservation of Exploited Species*, eds Reynolds JD, Mace GM, Redford KR, Robinson J (Cambridge Univ Press, Cambridge, UK), pp 3–15.
- Machado CA, Hey J (2003) The causes of phylogenetic conflict in a classic *Drosophila* species group. *Proc R Soc London Ser B* 270:1193–1202.
- Machado CA, Haselkorn TS, Noor MAF (2007) Evaluation of the genomic extent of effects of fixed inversion differences on intraspecific variation and interspecific gene flow in *Drosophila pseudoobscura* and *D. persimilis*. *Genetics* 175:1289–1306.
- MacHugh DE, Bradley DG (2001) Livestock genetic origins: Goats buck the trend. *Proc Natl Acad Sci USA* 98:5382–5384.
- MacKenzie RB (1868) *The Darwinian Theory of the Transmutation of Species Examined* (Nisbet, London).
- MacNair MR, Christie P (1983) Reproductive isolation as a pleiotropic effect of copper tolerance in *Mimulus guttatus*. *Heredity* 50:295–302.
- Maddison WP (1997) Gene trees in species trees. *Syst Biol* 46:523–536.
- Magnhagen C (1991) Predation risk as a cost of reproduction. *Trends Ecol Evol* 6:183–186.
- Mallarino R, Bermingham E, Willmott K, Whinnett A, Jiggins CD (2004) Molecular systematics of the butterfly genus *Ithomia* (Lepidoptera: Ithomiinae): A composite phylogenetic hypothesis based on seven genes. *Mol Phylogenet Evol* 34:625–644.
- Malo AF, Roldán ERS, Garde J, Soler AJ, Gomendio M (2005) Antlers honestly advertise sperm production and quality. *Proc R Soc London Ser B* 272:149–157.
- Malthus TR (1826) *An Essay on the Principle of Population* (Everyman, London), 6th Ed.
- Mangelsdorf PC (1974) *Corn: Its Origin, Evolution and Improvement* (Harvard Univ Press, Cambridge, MA).
- Mangelsdorf PC, Reeves RG (1938) The origin of maize. *Proc Natl Acad Sci USA* 24:303–312.

- Mangelsdorf PC, Reeves RG (1939) The Origin of Indian Corn and Its Relatives (Texas Agricultural Experiment Station, College Station), Bulletin 574.
- Mani GS, Clarke BC (1990) Mutational order: A major stochastic process in evolution. *Proc R Soc London Ser B* 240:29–37.
- Mano Y, Omori F, Kindiger B, Takahashi H (2008) A linkage map of maize × teosinte *Zea luxurians* and identification of QTLs controlling root aerenchyma formation. *Mol Breed* 21:327–337.
- Marande W, Burger G (2007) Mitochondrial DNA as a genomic jigsaw puzzle. *Science* 318:415.
- Marande W, Lukeš J, Burger G (2005) Unique mitochondrial genome structure in diplone-mids, the sister group of kinetoplastids. *Eukaryot Cell* 4:1137–1146.
- Markow TA, Quaid M, Kerr S (1978) Male mating experience and competitive courtship success in *Drosophila melanogaster*. *Nature* 276:821–822.
- Martinez JG, Carranza J, Fernandez Garcia JL, Sanchez Prieto CB (2002) Genetic variation of red deer populations under hunting exploitation in southwestern Spain. *J Wildl Manag* 66:1273–1282.
- Martínez M, Rodríguez-Vigal C, Jones OR, Coulson T, Miguel AS (2005) Different hunting strategies select for different weights in red deer. *Biol Lett* 1:353–356.
- Mascarenhas JP (1990) Gene activity during pollen development. *Annu Rev Plant Physiol Mol Biol* 41:317–338.
- Masly JP, Presgraves DC (2007) High-resolution genomewide dissection of the two rules of speciation in *Drosophila*. *PLOS Biol* 5:1890–1898.
- Mathews H, et al. (2003) Activation tagging in tomato identifies a transcriptional regulator of anthocyanin biosynthesis, modification, and transport. *Plant Cell* 15:1689–1703.
- Matsuoka Y, et al. (2002) A single domestication for maize shown by multilocus microsatellite genotyping. *Proc Natl Acad Sci USA* 99:6080–6084.
- Maynard Smith J (1991) Theories of sexual selection. *Trends Ecol Evol* 6:146–151.
- Maynard Smith J, Szathmáry E (1995) *The Major Transitions in Evolution*. (Freeman, Oxford, UK).
- Mayr E (1942) *Systematics and the Origin of Species* (Columbia Univ Press, New York).
- Mayr E (1963) *Animal Species and Evolution* (Harvard Univ Press, Cambridge, MA).
- Mayr E (1964) Introduction. In *On the Origin of Species* (Harvard Univ Press, Cambridge, MA), pp vii–xxvii.
- Mayr E (1982) *The Growth of Biological Knowledge* (Belknap, Cambridge, MA).
- Mayr E (1985) Darwin's five theories of evolution. In *The Darwinian Heritage*, ed Kohn D (Princeton Univ Press, Princeton, NJ), pp 755–772.
- Mayr E (1988) *Toward a New Philosophy of Biology* (Belknap, Cambridge, MA).
- McClintock B, Kato YTA, Blumenschein A (1981) *Chromosome Constitution of Races of Maize* (Colegio de Postgraduados, Chapingo, Mexico).
- McEwan M, Humayun R, Slamovits CH, Keeling PJ (2008) Nuclear genome sequence survey of the dinoflagellate *Heterocapsa triquetra*. *J Eukaryot Microbiol* 55:530–535.
- McKinnon JS, et al. (2004) Evidence for ecology's role in speciation. *Nature* 429:294–298.
- Mead LS, Arnold SJ (2004) Quantitative genetic models of sexual selection. *Trends Ecol Evol* 19:264–271.
- Meadow RH (1996) The origins and spread of agriculture and pastoralism in southwestern South Asia. In *The Origins and Spread of Agriculture and Pastoralism in Eurasia*, ed Harris DR (Univ College London Press, London), pp 390–412.
- Meiklejohn CD, Kim Y, Hartl DL, Parsch J (2004) Identification of a locus under complex positive selection in *Drosophila simulans* by haplotype mapping and composite-likelihood estimation. *Genetics* 168:265–279.
- Meinhold P, Peters MW, Chen MM, Takahashi K, Arnold FH (2005) Direct conversion of ethane to ethanol by engineered cytochrome P450 BM3. *ChemBiochem* 6:1765–1768.

- Metz EC, Robles-Sikisaka R, Vacquiere VD (1998) Nonsynonymous substitution in abalone sperm fertilization genes exceeds substitution in introns and mitochondrial DNA. *Proc Natl Acad Sci USA* 95:10676–10681.
- Meyer A, Kocher TD, Basasibwaki P, Wilson AC (1990) Monophyletic origin of Lake Victoria cichlid fishes suggested by mitochondrial DNA sequences. *Nature* 347:550–553.
- Mihola O, Trachtulec Z, Vlcek C, Schimenti JC, Forejt J (2009) A mouse speciation gene encodes a meiotic histone H3 methyltransferase. *Science* 323:373–375.
- Mill JS (1843) *A System of Logic* (Longmans Green, London).
- Miller CT, et al. (2007) *cis*-Regulatory changes in *Kit ligand* expression and parallel evolution of pigmentation in sticklebacks and humans. *Cell* 131:1179–1189.
- Miller GT, Pitnick S (2002) Sperm-female coevolution in *Drosophila*. *Science* 298:1230–1233.
- Miller JC, Tanksley SD (1990) RFLP analysis of phylogenetic relationships and genetic variation in the genus *Lycopersicon*. *Theor Appl Genet* 80:437–448.
- Miller RB (1957) Have the genetic patterns of fishes been altered by introductions or by selective fishing? *J Fish Res Bd Can* 14:797–806.
- Miller RB (1978) Pollination ecology of *Aquilegia elegantula* and *Aquilegia caerulea* (Ranunculaceae) in Colorado. *Am J Bot* 65:406–414.
- Miller RB (1981) Hawkmoths and the geographic patterns of floral variation in *Aquilegia caerulea*. *Evolution* 35:763–774.
- Mills LS (2007) *Conservation of Wildlife Populations: Demography, Genetics, and Management* (Wiley-Blackwell, New York).
- Milner JM, et al. (2006) Temporal and spatial development of red deer harvesting in Europe: Biological and cultural factors. *J Appl Ecol* 43:721–734.
- Minder AM, Hosken DJ, Ward PI (2005) Coevolution of male and female reproductive characters across the Scathophagidae (Diptera). *J Evol Biol* 18:60–69.
- Mobley KB, Jones AG (2009) Environmental, demographic, and genetic mating system variation among five geographically distinct dusky pipefish (*Syngnathus floridae*) populations. *Mol Ecol* 18:1476–1490.
- Moeller DA, Tenaillon MI, Tiffin P (2007) Population structure and its effects on patterns of nucleotide polymorphism in teosinte (*Zea mays* ssp. *parviglumis*). *Genetics* 176:1799–1809.
- Møller A (1989) Ejaculate quality, testes size and sperm production in mammals. *Funct Ecol* 3:91–96.
- Møller AP, Jennions MD (2001) How important are direct fitness benefits to sexual selection? *Naturwissenschaften* 88:401–415.
- Mooers AO, Schluter D (1999) Reconstructing ancestor states with maximum likelihood: Support for one- and two-rate models. *Syst Biol* 48:623–633.
- Moorcroft PR, Albon SD, Pemberton JM, Clutton-Brock TH (1996) Density-dependent selection in a fluctuating ungulate population. *Proc R Soc London Ser B* 263:31–38.
- Moore AJ (1994) Genetic evidence for the good genes process of sexual selection. *Behav Ecol Sociobiol* 35:235–241.
- Moore AJ, Brodie ED III, Wolf JB (1997) Interacting phenotypes and the evolutionary process: I. Direct and indirect genetic effects of social interactions. *Evolution* 51:1352–1362.
- Moore AJ, Gowaty PA, Wallin WJ, Moore PJ (2001) Sexual conflict and the evolution of female mate choice and male social dominance. *Proc R Soc London Ser B* 268:517–523.
- Moore AJ, Gowaty PA, Moore PJ (2003) Females avoid manipulative males and live longer. *J Evol Biol* 16:523–530.
- Moore WR (1970) *Foundations of Mechanical Accuracy* (Moore Special Tool Co, Bridgeport, CN).
- Morey DF (1994) The early evolution of the domestic dog. *Am Sci* 82:336–347.

- Morita Y, Saitoh M, Hoshino A, Nitasaka E, Iida S (2006) Isolation of cDNAs for R2R3-MYB, bHLH, and WDR transcriptional regulators and identification of *c* and *ca* mutations conferring white flowers in the Japanese morning glory. *Plant Cell Physiol* 47:457–470.
- Morjan CL, Rieseberg LH (2004) How species evolve collectively: Implications of gene flow and selection for the spread of advantageous alleles. *Mol Ecol* 13:1341–1356.
- Muller HJ (1942) Isolating mechanisms, evolution, and temperature. *Biol Symp* 6:71–125.
- Muller W (2005) The Domestication of the Wolf—the inevitable first? In *The First Steps of Animal Domestication*, ed Vigne JD, Peters J, Helmer D (Oxbow Books, Oxford, UK), pp 34–40.
- Munz P (1946) *Aquilegia*: The cultivated and wild columbines. *Gentes Herbarum* 7:1–150.
- Mysterud A, Coulson T, Stenseth NC (2002) The role of males in the dynamics of ungulate populations. *J Anim Ecol* 71:907–915.
- Mysterud A, Tryjanowski P, Panek M (2006) Selectivity of harvesting differs between local and foreign roe deer hunters: Trophy stalkers have the first shot at the right place. *Biol Lett* 2:632–635.
- Nagel E (1961) *The Structure of Science, Problems in the Logic of Scientific Explanation* (Harcourt, Brace and World, New York).
- Nagel T (2008) Public education and intelligent design. *Philos Public Aff* 36:187–205.
- Naish KA, Hard JJ (2008) Bridging the gap between the genotype and the phenotype: Linking genetic variation, selection and adaptation in fishes. *Fish Fish* 9:396–422.
- Nakatsuka T, Nishihara M, Mishiba K, Yamamura S (2005) Temporal expression of flavonoid biosynthesis-related genes regulates flower pigmentation in gentian plants. *Plant Sci* 168:1309–1318.
- Nakatsuka T, Abe Y, Kakizaki Y, Yamamura S, Nishihara M (2007) Production of red-flowered plants by genetic engineering of multiple flavonoid biosynthetic genes. *Plant Cell Rep* 26:1951–1959.
- Nakatsuka T, et al. (2008a) Identification and characterization of R2R3-MYB and bHLH transcription factors regulating anthocyanin biosynthesis in gentian flowers. *Plant Cell Physiol* 49:1818–1829.
- Nakatsuka T, Sato K, Takahashi H, Yamamura S, Nishihara M (2008b) Cloning and characterization of the UDP-glucose:anthocyanin 5-O-glucosyltransferase gene from blue-flowered gentian. *J Exp Bot* 59:1241–1252.
- Nakatsuru K, Kramer DL (1982) Is sperm cheap? Limited male fertility and female choice in the lemon tetra (Pices, Characidae). *Science* 216:753–755.
- Nash EA, et al. (2007) Organisation of the mitochondrial genome in the dinoflagellate *Amphidinium carterae*. *Mol Biol Evol* 24:1528–1536.
- Nash EA, Nisbet RER, Barbrook AC, Howe CJ (2008) Dinoflagellates: A mitochondrial genome all at sea. *Trends Genet* 24:328–335.
- Nassoury N, Cappadocia M, Morse D (2003) Plastid ultrastructure defines the protein import pathway in dinoflagellates. *J Cell Sci* 116:2867–2874.
- Neff BD, Pitcher TE (2005) Genetic quality and sexual selection: An integrated framework for good genes and compatible genes. *Mol Ecol* 14:19–38.
- Nei M (2005) Selectionism and neutralism in molecular evolution. *Mol Biol Evol* 22:2318–2342.
- Noll M (2002) *America's God: From Jonathan Edwards to Abraham Lincoln* (Oxford Univ Press, New York).
- Noor MAF, Coyne JA (2006) Speciation in the new millennium: What's left to know? *Isr J Ecol Evol* 52:431–441.
- Noor MAF, Grams KL, Bertucci LA, Reiland J (2001) Chromosomal inversions and the reproductive isolation of species. *Proc Natl Acad Sci USA* 98:12084–12088.
- Nosil P, Vines TH, Funk DJ (2005) Perspective: Reproductive isolation caused by natural selection against immigrants from divergent habitats. *Evolution* 59:705–719.

- Nosil P, Harmon LJ, Seehausen O (2009) Ecological explanations for (incomplete) speciation. *Trends Ecol Evol* 24:145–156.
- Obornik M, Janouškovec J, Chrudimský T, Lukeš J (2009) Evolution of the apicoplast and its hosts: From heterotrophy to autotrophy and back again. *Int J Parasitol* 39:1–12.
- O'Brien PJ, Herschlag D (1999) Catalytic promiscuity and the evolution of new enzymatic activities. *Chem Biol* 6:R91–R105.
- O'Brien SJ, Johnson WE (2007) Origins of the world's cats. *Sci Am* 297:68–75.
- O'Brien SJ, Mayr E (1991a) Bureaucratic mischief: Recognizing endangered species and subspecies. *Science* 251:1187–1188.
- O'Brien SJ, Mayr E (1991b) Response. *Science* 253:251–252.
- Ochsenreiter T, Cipriano M, Hajduk SL (2008) Alternative mRNA editing in trypanosomes is extensive and may contribute to mitochondrial protein diversity. *PLoS One* 3:e1566.
- O'Donald P (1962) The theory of sexual selection. *Heredity* 22:499–518.
- O'Donald P (1980) *Genetic Models of Sexual Selection* (Cambridge Univ Press, Cambridge, UK).
- Oetjen K, Reusch TB (2007) Genome scans detect consistent divergent selection among subtidal vs. intertidal populations of the marine angiosperm *Zostera marina*. *Mol Ecol* 16:5156–5167.
- O'Hara R (1998) Population thinking and tree thinking in systematics. *Zool Scr* 26: 323–329
- Olsen KM, et al. (2006) Selection under domestication: Evidence for a sweep in the rice waxy genomic region. *Genetics* 173:975–983.
- Olsen SL (2006) Early horse domestication on the Eurasian Steppe. In *Documenting Domestication: New Genetic and Archaeological Paradigms*, eds Zeder MA, Bradley DG, Emshwiller E, Smith BD (Univ of California Press, Los Angeles), pp 245–269.
- Oppliger A, Hosken DJ, Ribi G (1998) Snail sperm production characteristics vary with sperm competition risk. *Proc R Soc London Ser B* 265:1527–1534.
- Oppliger A, Naciri-Graven Y, Ribi G, Hosken DJ (2003) Sperm length influences fertilization success during sperm competition in the snail *Viviparus ater*. *Mol Ecol* 12:485–492.
- Orengo DJ, Aguadé M (2007) Genome scans of variation and adaptive change: Extended analysis of a candidate locus close to the phantom gene region in *Drosophila melanogaster*. *Mol Biol Evol* 24:1122–1129.
- Oring L (1973) Solitary sandpiper early reproductive behavior. *Auk* 90:652–663.
- Orr HA (1998) The population genetics of adaptation: The distribution of factors fixed during adaptive evolution. *Evolution* 52:935–949.
- Orr HA (2005) The probability of parallel evolution. *Evolution* 59:216–220.
- Orteiza N, Linder JE, Rice WR (2005) Sexy sons from remating do not recoup the direct costs of harmful male interactions in the *Drosophila melanogaster* laboratory model system. *J Evol Biol* 18:1315–1323.
- Ortiz P (2002) Historia natural, sitios de apareamiento, comportamiento sexual y posible función de la alimentación nupcial en *Ptilosphen variolatus* (Diptera: Micropezidae). Master's thesis (Universidad de Costa Rica, San José).
- Ortlund EA, Bridgham JT, Redinbo MR, Thornton JW (2007) Crystal structure of an ancient protein: Evolution by conformational epistasis. *Science* 317:1544–1548.
- Ospovat D (1981) *The Development of Darwin's Theory—Natural History, Natural Theology, and Natural Selection 1838–1859* (Cambridge Univ Press, Cambridge, UK).
- Östlund S, Ahnesjö I (1998) Female fifteen-spined sticklebacks prefer better fathers. *Anim Behav* 56:1177–1183.
- Otte D, Endler JA (1989) *Speciation and Its Consequences* (Sinauer, Sunderland, MA).
- Owen R (1849) *On the Nature of Limbs* (Voorst, London).
- Owen R (1860) Darwin on the origin of species. *Edinburgh Rev* 111:487–532.
- Pagel M, Meade A, Barker D (2004) Bayesian estimation of ancestral character states on phylogenies. *Syst Biol* 53:673–684.

- Palackal N, et al. (2004) An evolutionary route to xylanase process fitness. *Protein Sci* 13:494–503.
- Palaisa KA, Morgante M, Williams M, Rafalski A (2003) Contrasting effects of selection on sequence diversity and linkage disequilibrium at two phytoene synthase loci. *Plant Cell* 15:1795–1806.
- Palaisa K, Morgante M, Tingey S, Rafalski A (2004) Long-range patterns of diversity and linkage disequilibrium surrounding the maize Y1 gene are indicative of an asymmetric selective sweep. *Proc Natl Acad Sci USA* 101:9885–9890.
- Paley W (1802) *Natural Theology, or Evidences of the Existence and Attributes of the Deity Collected from the Appearances of Nature* (American Tract Society, New York, or Rivington, London).
- Palmer ME, Feldman MW (2009) Dynamics of hybrid incompatibility in gene networks in a constant environment. *Evolution* 63:418–431.
- Palumbi SR (2003) Population genetics, demographic connectivity, and the design of marine reserves. *Ecol Appl* 13:S146–S158.
- Park S, et al. (2005) Focusing mutations into the *P. fluorescens* esterase binding site increases enantioselectivity more effectively than distant mutations. *Chem Biol* 12:45–54.
- Parker GA (1970) Sperm competition and its evolutionary consequences. *Biol Rev* 45:525–567.
- Parker GA (1978) Evolution of competitive mate searching. *Annu Rev Entomol* 23:173–196.
- Parker GA (1997) Sperm competition and the evolution of ejaculates: Towards a theory base. In *Sperm Competition and Sexual Selection*, eds Birkhead T, Møller AP (Academic Press, New York), pp 3–54.
- Parker GA (2006) Sexual conflict over mating and fertilization: An overview. *Philos Trans R Soc London Ser B* 361:235–259.
- Parker GA, Baker RR, Smith VGF (1972) The origin and evolution of gamete dimorphism and the male-female phenomenon. *J Theor Biol* 36:529–553.
- Parker PG, Tang-Martinez Z (2005) Bateman gradients in field and laboratory studies: A cautionary tale. *Integr Comp Biol* 45:895–902.
- Patron NJ, Waller RE, Archibald JM, Keeling PJ (2005) Complex protein targeting to dinoflagellate plastids. *J Mol Biol* 384:1015–1024.
- Pauling L, et al. (1949) Sickle cell anemia a molecular disease. *Science* 110:543–548.
- Peccoud J, et al. (2008) Host range expansion of an introduced insect pest through multiple colonizations of specialized clones. *Mol Ecol* 17:4608–4618.
- Peckham M, ed (1959) *The Origin of Species by Charles Darwin: A Variorum Text* (Univ Pennsylvania Press, Philadelphia).
- Pen I, Weissing F (1999) Sperm competition and sex allocation in simultaneous hermaphrodites: A new look at Charnov's invariance principle. *Evol Ecol Res* 1:517–525.
- Penrose R (1989) *The Emperor's New Mind*. (Oxford Univ Press, Oxford, UK).
- Penrose R (1990) The nonalgorithmic mind. *Behav Brain Sci* 13:692–705.
- Peretti A, Eberhard WG, Briceño RD (2006) Copulatory dialogue: Female spiders sing during copulation to influence male genitalic movements. *Anim Behav* 72:413–421.
- Peters J, von den Dreisch A, Helmer D (2005) The upper Euphrates-Tigris basin: Cradle of agro-pastoralism? In *The First Steps of Animal Domestication: New Archaeological Approaches*, eds Vigne J-D, Peters J, Helmer D (Oxbow Books, Oxford, UK), p 176.
- Petren K, Grant BR, Grant PR (1999) A phylogeny of Darwin's finches based on microsatellite DNA length variation. *Proc R Soc London Ser B* 266:321–329.
- Phadnis N, Orr HA (2009) A single gene causes both male sterility and segregation distortion in *Drosophila* hybrids. *Science* 323:376–379.
- Philipp DP, et al. (2009) Selection for vulnerability to angling in largemouth bass. *Trans Am Fish Soc* 138:189–199.



- Piperno DR, et al. (2007) Late Pleistocene and Holocene environmental history of the Iguala Valley, Central Balsas Watershed of Mexico. *Proc Natl Acad Sci USA* 104:11874–11881.
- Pitcher TE, Neff BD (2007) Genetic quality and offspring performance in Chinook salmon: Implications for supportive breeding. *Conserv Genet* 8:607–616.
- Pitnick S, Miller GT, Schneider K, Markow TA (2002) Ejaculate-female coevolution in *Drosophila mojavensis*. *Proc R Soc London Ser B* 270:1507–1512.
- Pizzari T, Foster KR (2008) Sperm sociality: Cooperation, altruism, and spite. *PLoS Biol* 130:925–931.
- Pizzari T, Snook R (2003) Sexual conflict and sexual selection: Chasing away paradigm shifts. *Evolution (Lawrence, Kans)* 57:1223–1236.
- Plantinga A (1993) *Warrant and Proper Function* (Oxford Univ Press, New York).
- Plantinga A (1996) Darwin, mind and meaning. *Books and Culture*. Available at [www.veritas-uscb.org/library/plantiga/dennett.html](http://www.veritas-uscb.org/library/plantiga/dennett.html).
- Plantinga A (2009) Religion and science: Where the real conflict lies. Presentation at the American Philosophical Association Central Division 106th Annual Meeting, February 21, 2009, Chicago, IL.
- Platt JR (1964) Strong inference. *Science* 146:347–353.
- Pohl ME, Piperno DR, Pope KO, Jones JG (2007) Microfossil evidence for pre-Columbian maize dispersals in the neotropics from San Andres, Tabasco, Mexico. *Proc Natl Acad Sci USA* 104:6870–6875.
- Poinar GO Jr, Herre EA (1991) Speciation and adaptive radiation in the fig wasp nematode, *Parasitodiplogaster* (Diplogasteridae: Rhabditida) in Panama. *Rev Nematol* 14:361–374.
- Policansky D (1993) Fishing as a cause of evolution in fishes. In *The Exploitation of Evolving Resources*, eds Stokes TK, McGlade JM, Law R (Springer, Berlin), pp 2–18.
- Pollard DA, Iyer VN, Moses AM, Eisen MB (2006) Widespread discordance of gene trees with species tree in *Drosophila*: Evidence for incomplete lineage sorting. *PLOS Genet* 2:1634–1647.
- Pomiankowski A (1988) The evolution of female mate preferences for male genetic quality. *Oxf Surv Evol Biol* 5:136–184.
- Pomiankowski A, Iwasa Y (1993) Evolution of multiple sexual preferences by Fisher run-away process of sexual selection. *Proc R Soc London Ser B* 253:173–181.
- Pool JE, DuMont VB, Mueller JL, Aquadro CF (2006) A scan of molecular variation leads to the narrow localization of a selective sweep affecting both afro-tropical and cosmopolitan populations of *Drosophila melanogaster*. *Genetics* 172:1093–1105.
- Popper KR (1959) *The Logic of Scientific Discovery* (Hutchinson, London).
- Popper KR (1963) *Conjectures and Refutations: The Growth of Scientific Knowledge* (Routledge and Kegan Paul, London).
- Poulin R (1994) Mate choice decisions by parasitized female upland bullies, *Gobiomorphus breviceps*. *Proc R Soc London Ser B* 256:183–187.
- Prazmo W (1961) Cytogenetic studies on the genus *Aquilegia*. II. Crosses between *Aquilegia ecalcarata* Maxim and *Aquilegia chrysantha* Gray. *Acta Soc Bot Pol* 30:57–77.
- Prazmo W (1965) Cytogenetic studies in the genus *Aquilegia*. III. Inheritance of the traits distinguishing different complexes in the genus *Aquilegia*. *Acta Soc Bot Pol* 34:403–437.
- Préault M, Chastel O, Cézilly F, Faivre B (2005) Male bill colour and age are associated with parental abilities and breeding performance in blackbirds. *Behav Ecol Sociobiol* 58:497–505.
- Price EO (1984) Behavioral aspects of animal domestication. *Q Rev Biol* 59:1–32.
- Price EO (2002) *Animal Domestication and Behavior* (CABI, Wallingford, Oxon, UK).
- Price GR (1970) Selection and covariance. *Nature* 227:520–521.
- Price T (2008) *Speciation in Birds* (Roberts, Greenwood Village, CO).
- Provine WB (1971) *The Origins of Theoretical Population Genetics* (Univ of Chicago Press, Chicago).



- Provine WB (1986) *Sewall Wright and Evolutionary Biology* (Univ of Chicago Press, Chicago).
- Punzalan D, Cooray M, Helen Rodd F, Rowe L (2008) Condition dependence of sexually dimorphic colouration and longevity in the ambush bug *Phymata americana*. *J Evol Biol* 21:1297–1306.
- Queller D (1997) Why do females care more than males? *Proc R Soc London Ser B* 264: 1555–1557.
- Quinn TP (2005) *The Behavior and Ecology of Pacific Salmon and Trout* (Univ of Washington Press, Seattle).
- R Development Core Team (2008) *R: A Language and Environment for Statistical Computing* (R Foundation for Statistical Computing, Vienna).
- Ramsey J, Bradshaw HD, Schemske DW (2003) Components of reproductive isolation between the monkeyflowers *Mimulus lewisii* and *M. cardinalis* (Scrophulariaceae). *Evolution (Lawrence, Kans)* 57:1520–1534.
- Rauscher MD (2008) Evolutionary transitions in floral color. *Int J Plant Sci* 169:7–21.
- Real LA (1990) Search theory and mate choice. I. Models of single-sex discrimination. *Am Nat* 136:376–404.
- Reetz MT, et al. (2004) Directed evolution as a method to create enantioselective cyclohexanone monooxygenases for catalysis in Baeyer-Villiger reactions. *Angew Chem Int Ed* 43:4075–4078.
- Reetz MT, Bocola M, Carballeira JD, Zha D, Vogel A (2005) Expanding the range of substrate acceptance of enzymes: Combinatorial active-site saturation test. *Angew Chem Int Ed* 44:4192–4196.
- Reise H, Visser S, Hutchenson J (2007) Mating behaviour in the terrestrial slug *Deroceras gorgonium*: Is extreme morphology associated with extreme behaviour? *Anim Biol* 57:197–215.
- Rennell D, Poteete AR (1989) Genetic analysis of bacteriophage P22 lysozyme structure. *Genetics* 123:431–440.
- Reynolds JD, Gross MR (1990) Costs and benefits of female mate choice: Is there a lek paradox? *Am Nat* 136:230–243.
- Rhodes OE Jr, Smith MH (1992) Genetic perspectives in wildlife population management: The case of large herbivores. In *Wildlife 2001: Populations*, eds McCullough D, Barrett R (Elsevier Science, New York), pp 985–996.
- Ribaut JM, Hoisington DA, Deutsch JA, Jiang C, Gonzalez-de-Leon D (1996) Identification of quantitative trait loci under drought conditions in tropical maize. 1. Flowering parameters and the anthesis-silking interval. *Theor Appl Genet* 92:905–914.
- Rice WR (1996) Sexually antagonistic male adaptation triggered by experimental arrest of female evolution. *Nature* 381:232–234.
- Rice WR, Hostert EE (1993) Laboratory experiments on speciation: What have we learned in 40 years? *Evolution (Lawrence, Kans)* 47:1637–1653.
- Richards R (1987) *Darwin and the Emergence of Evolutionary Theories of Mind and Behavior* (Univ of Chicago Press, Chicago).
- Richards R (1992) *The Meaning of Evolution: The Morphological Construction and Ideological Reconstruction of Darwin's Theory* (Univ of Chicago Press, Chicago).
- Richards R (2002) *The Romantic Conception of Life: Science and Philosophy in the Age of Goethe* (Univ of Chicago Press, Chicago).
- Richards R (2008a) Darwin's theory of natural selection and its moral purpose. In *Cambridge Companion to the "Origin of Species,"* eds Richards RR, Ruse M (Cambridge Univ Press, Cambridge, UK), pp 47–66.
- Richards R (2008b) *The Tragic Sense of Life: Ernst Haeckel and the Struggle over Evolutionary Thought* (Univ of Chicago Press, Chicago).
- Richardson RC (2007) *Evolutionary Psychology as Maladapted Psychology* (MIT Press, Cambridge, MA).

- Richerson P, Boyd R (2006) *Not by Genes Alone: How Culture Transformed Human Evolution* (Univ of Chicago Press, Chicago).
- Ricker WE (1981) Changes in the average body size and average age of Pacific salmon. *Can J Fish Aquat Sci* 38:1636–1656.
- Rieseberg LH (1997) Hybrid origins of plant species. *Annu Rev Ecol Syst* 28:359–389.
- Rieseberg LH (2001) Chromosomal rearrangements and speciation. *Trends Ecol Evol* 16:351–358.
- Roberts JH (1988) *Darwinism and the Divine in America: Protestant Intellectuals and Organic Evolution, 1859–1900* (Univ Wisconsin Press, Madison).
- Robertson A (1966) A mathematical model of the culling process in dairy cattle. *Anim Prod* 8:93–108.
- Robson GC, Richards OW (1936) *The Variation of Animals in Nature* (Longmans, Green & Co, London).
- Rocha O, Stephenson AG (1990) Effect of ovule position on seed production, seed weight, and progeny performance in *Phaseolus coccineus* L. (Leguminosae). *Am J Bot* 77:1320–1329.
- Roff D (1997) *Evolutionary Quantitative Genetics* (Chapman & Hall, New York).
- Rogers SM, Bernatchez L (2005) Integrating QTL mapping and genome scans toward the characterization of candidate loci under parallel selection in the lake whitefish (*Coregonus clupeaformis*). *Mol Ecol* 14:351–361.
- Rogers SM, Bernatchez L (2006) The genetic basis of intrinsic and extrinsic postzygotic reproductive isolation jointly promoting speciation in the lake whitefish species complex (*Coregonus clupeaformis*). *J Evol Biol* 19:1979–1994.
- Rogers SM, Bernatchez L (2007) The genetic architecture of ecological speciation and the association with signatures of selection in natural lake whitefish (*Coregonus* sp., *Salmonidae*) species pairs. *Mol Biol Evol* 24:1423–1438.
- Roig-Alsina A (1993) The evolution of the apid endophallus, its phylogenetic implications, and functional significance of the genital capsule (Hymenoptera, Apoidea). *Bull Zool* 60:169–183.
- Rosenberg NA, et al. (2002) Genetic structure of human populations. *Science* 298:2381–2385.
- Ross-Ibarra J, Morrell PL, Gaut BS (2007) Plant domestication, a unique opportunity to identify the genetic basis of adaptation. *Proc Natl Acad Sci USA* 104:8641–8648.
- Rowe S, Hutchings JA (2003) Mating systems and the conservation of commercially exploited marine fish. *Trends Ecol Evol* 18:567–572.
- Rozas J, Sanchez-DelBarrio JC, Messeguer X, Rozas R (2003) DnaSP, DNA polymorphism analyses by the coalescent and other methods. *Bioinformatics* 19:2496–2497.
- Rundle HD (2002) A test of ecologically dependent postmating isolation between sympatric sticklebacks. *Evolution* 56:322–329.
- Rundle HD, Nosil P (2005) Ecological speciation. *Ecol Lett* 8:336–352.
- Rundle HD, Whitlock MC (2001) A genetic interpretation of ecologically dependent isolation. *Evolution* 55:198–201.
- Rundle HD, Nagel L, Boughman JW, Schluter D (2000) Natural selection and parallel speciation in sympatric sticklebacks. *Science* 287:306–308.
- Rupke NA (1994) *Richard Owen: Victorian Naturalist* (Yale Univ Press, New Haven, CT).
- Ruse M (1975a) Charles Darwin and artificial selection. *J Hist Ideas* 36:339–350.
- Ruse M (1975b) Darwin's debt to philosophy: An examination of the influence of the philosophical ideas of John F. W. Herschel and William Whewell on the development of Charles Darwin's theory of evolution. *Stud Hist Philos Sci* 6:159–181.
- Ruse M (1979) *The Darwinian Revolution: Science Red in Tooth and Claw* (Univ of Chicago Press, Chicago).
- Ruse M (1980) Charles Darwin and group selection. *Ann Sci* 37:615–630.

- Ruse M (1996) *Monad to Man: The Concept of Progress in Evolutionary Biology* (Harvard Univ Press, Cambridge, MA).
- Ruse M (1999) *Mystery of Mysteries: Is Evolution a Social Construction?* (Harvard Univ Press, Cambridge, MA).
- Ruse M (2000) *The Evolution Wars: A Guide to the Controversies* (ABC-CLIO, Santa Barbara, CA).
- Ruse M (2001) *Can a Darwinian Be a Christian? The Relationship Between Science and Religion* (Cambridge Univ Press, Cambridge, UK).
- Ruse M (2003) *Darwin and Design: Does Evolution Have a Purpose?* (Harvard Univ Press, Cambridge, MA).
- Ruse M (2004) The romantic conception of Robert J. Richards. *J Hist Biol* 37:3–23.
- Ruse M (2005) *The Evolution-Creation Struggle* (Harvard Univ Press, Cambridge, MA).
- Ruse M (2006) Forty years as a philosopher of biology: Why evo-devo makes me still excited about my subject. *Biol Theory* 1:35–37.
- Ruse M (2008) *Charles Darwin* (Blackwell, Oxford, UK).
- Rutter C (1904) Natural history of the quinnat salmon. Investigation on the Sacramento River, 1896–1901. *Bull US Fish Comm* 22:65–141.
- Ryan MJ (1990) Signals, species, and sexual selection. *Oxf Surv Evol Biol* 7:157–195.
- Ryan KK, Altmann J (2001) Selection for male choice based primarily on mate compatibility in the oldfield mouse, *Peromyscus polionotus rhoadsi*. *Behav Ecol Sociobiol* 50:436–440.
- Ryan KK, Lacy RC (2003) Monogamous male mice bias behaviour towards females according to very small differences in kinship. *Anim Behav* 65:379–384.
- Ryman N, Baccus R, Reuterwall C, Smith MH (1981) Effective population size, generation interval, and potential loss of genetic variability in game species under different hunting regimes. *Oikos* 36:257–266.
- Saez AG, Tatarenkov A, Barrio E, Becerra NH, Ayala FJ (2003) Patterns of DNA sequence polymorphism at *Sod* vicinities in *Drosophila melanogaster*: Unraveling the footprint of a recent selective sweep. *Proc Natl Acad Sci USA* 100:1793–1798.
- Saito A, et al. (2003) Gliding movement in *Peranema trichophorum* is powered by flagellar surface motility. *Cell Motil Cytoskel* 55:244–253.
- Saito T, Konishi K (1999) Direct development in the sponge-associated deep-sea shrimp *Spongiicola japonica* (Decapoda:Spongicolidae). *J Crust Biol* 19:46–52.
- Sakai H, et al. (1998) *ETR2* is an *ETR1*-like gene involved in ethylene signaling in *Arabidopsis*. *Proc Natl Acad Sci USA* 95:5812–5817.
- Salmon W (1984): *Scientific Explanation and the Causal Structure of the World* (Princeton Univ Press, Princeton, NJ).
- Salvi S, et al. (2007) Conserved noncoding genomic sequences associated with a flowering-time quantitative trait locus in maize. *Proc Natl Acad Sci USA* 104:11376–11381.
- Sanchez G, et al. (1998) *Distribucion y Caracterizacion del Teocintle* (Instituto Nacional de Investigaciones Forestales, Agrícolas y Pecuarias, Guadalajara, Mexico).
- Sandstrom J (1996) Temporal change in host adaptation in the pea aphid, *Acyrtosiphon pisum*. *Ecol Entomol* 21:56–62.
- Sato A, et al. (1999) Phylogeny of Darwin's finches as revealed by mtDNA sequences. *Proc Natl Acad Sci USA* 96:5101–5106.
- Schemske D (2000) Understanding the origin of species. *Evolution (Lawrence, Kans)* 54: 1069–1073.
- Schemske D, Bradshaw HD (1999) Pollinator preference and the evolution of floral traits in monkeyflowers (*Mimulus*). *Proc Natl Acad Sci USA* 96:11910–11915.
- Schemske D, Lande R (1985) The evolution of self-fertilization and inbreeding depression. II. Empirical observations. *Evolution* 39:41–52.
- Schluter D (1996) Ecological causes of adaptive radiation. *Am Nat* 148:S40–S64.
- Schluter D (2000) *The Ecology of Adaptive Radiation* (Oxford Univ Press, Oxford, UK).

- Schluter D (2001) Ecology and the origin of species. *Trends Ecol Evol* 16:372–380.
- Schluter D (2009) Evidence for ecological speciation and its alternative. *Science* 323: 737–741.
- Schluter D, Price T, Mooers AO, Ludwig D (1997) Likelihood of ancestor states in adaptive radiation. *Evolution* 51:1699–1711.
- Schnepf E, Deichgraber G (1984) “Myzocytosis,” a kind of endocytosis with implications to compartmentalization in endosymbiosis. *Naturwissenschaften* 71:218–219.
- Schull J (1991) The view from the adaptive landscape. In *Parallel Problem Solving from Nature* (Springer, Berlin), pp 415–427.
- Schultz TR, Mueller UG, Currie CR, Rehner SA (2005) Reciprocal illumination: A comparison of agriculture of humans and in fungus-growing ants. In *Insect-Fungal Associations: Ecology and Evolution*, ed Vega FE (Oxford Univ Press, New York), pp 149–190.
- Schweber S (1988) The wider British context in Darwin’s theorizing. In *The Darwinian Heritage*, ed Kohn D (Princeton Univ Press, Princeton, NJ), pp 35–70.
- Searle J (1980) Minds, brains and programs. *Behav Brain Sci* 3:417–458.
- Searle J (1992) *The Rediscovery of the Mind* (MIT Press, Cambridge, MA).
- Second JA (2000) *Victorian Sensation: The Extraordinary Publication, Reception, and Secret Authorship of Vestiges of the Natural History of Creation* (Univ of Chicago Press, Chicago).
- Sedgwick A (1850) *Discourse on the Studies at the University of Cambridge* (Cambridge Univ Press, Cambridge, UK), 5th Ed.
- Sedgwick A (24 March, 1860a) Objections to Mr. Darwin’s theory of the origin of species. *Spectator* 285–286.
- Sedgwick A (7 April, 1860b) Objections to Mr. Darwin’s theory of the origin of species. *Spectator* 334–335.
- Sedley D (2008) *Creationism and Its Critics in Antiquity* (Univ of California Press, Berkeley).
- Seehausen O (2004) Hybridization and adaptive radiation. *Trends Ecol Evol* 19:198–207.
- Seehausen O, et al. (2008) Speciation through sensory drive in cichlid fish. *Nature* 455: 620–623.
- Serpell JA (1990) The domestication and history of the cat. In *The Domestic Cat*, eds Turner DC, Bateson P (Cambridge Univ Press, Cambridge, UK), pp 155–158.
- Serrano L, Day AG, Fersht AR (1993) Stepwise mutation of barnase to binase. A procedure for engineering increased stability of proteins and an experimental analysis of the evolution of protein stability. *J Mol Biol* 233:305–312.
- Shafikhani S, Siegel RA, Ferrari E, Schellenberger V (1997) Generation of large libraries of random mutants in *Bacillus subtilis* by PCR-based plasmid multimerization. *BioTechniques* 23:304–310.
- Shapiro AM, Porter AH (1989) The lock-and-key hypothesis: Evolutionary and biosystematic interpretation of insect genitalia. *Annu Rev Entomol* 34:231–245.
- Shelly TE, Bailey WJ (1992) Experimental manipulation of mate choice by male katydids—the effect of female encounter rate. *Behav Ecol Sociobiol* 30(3–4):277–282.
- Shendure J, Ji H (2008) Next-generation DNA sequencing. *Nat Biotechnol* 26:1135–1145.
- Shortle D, Lin B (1985) Genetic analysis of staphylococcal nuclease: Identification of three intragenic “global” suppressors of nuclease-minus mutations. *Genetics* 110:539–555.
- Shuker D, et al. (2002) Mating behavior, sexual selection, and copulatory courtship in a promiscuous beetle. *J Insect Behav* 15:617–631.
- Shuster S (2008) Behavioral ecology: Mating Systems. In *Encyclopedia of ecology*, eds Jorgensen SE, Fath B (Elsevier, Oxford, UK), pp 2266–2273.
- Shuster S, Wade M (1991) Equal mating success among male reproductive strategies in a marine isopod. *Nature* 350:606–610.
- Shuster SM, Wade MJ (2003) *Mating Systems and Strategies* (Princeton Univ Press, Princeton, NJ).

- Shuster S, Ballard J, Zinser G, Sassaman C, Keim P (2001) The influence of genetic and extra-chromosomal factors on population sex ratio in *Paracerceis sculpta*. In *Isopod Systematics and Evolution*, eds Brusca RC, Kensley B (Balkema Press, Amsterdam), pp 313–326.
- Simmons LW (1995) Relative parental expenditure, potential reproductive rates, and the control of sexual selection in katydids. *Am Nat* 145:797–808.
- Simmons LW (2001) *Sperm Competition and Its Evolutionary Consequences in the Insects* (Princeton Univ Press, Princeton, NJ).
- Simon JC, et al. (2003) Host-based divergence in populations of the pea aphid: Insights from nuclear markers and the prevalence of facultative symbionts. *Proc R Soc London Ser B* 270:1703–1712.
- Simpson AGB, Stevens JR, Lukeš J (2006) The evolution and diversity of kinetoplastid flagellates. *Trends Parasitol* 22:168–174.
- Simpson GG (1953) *The Major Features of Evolution* (Columbia Univ Press, New York, NY).
- Sinclair AF, Swain DP, Hanson JM (2002) Measuring changes in the direction and magnitude of size-selective mortality in a commercial fish population. *Can J Fish Aquat Sci* 59:361–371.
- Singer P (2000) *A Darwinian Left: Politics, Evolution, and Cooperation* (Yale Univ Press, New Haven, CT).
- Slamovits CH, Keeling PJ (2008) Widespread recycling of processed cDNAs in dinoflagellates. *Curr Biol* 18:R550–R552.
- Slamovits CH, Saldarriaga JF, Laroque A, Keeling PJ (2007) The highly reduced and fragmented mitochondrial genome of the early-branching dinoflagellate *Oxyrrhis marina* shares characteristics with both apicomplexan and dinoflagellate mitochondrial genomes. *J Mol Biol* 372:356–368.
- Sloan P (2009) Originating species: Darwin on the species problem. In *The Cambridge Companion to the "Origin of Species,"* eds Ruse M, Richards R (Cambridge Univ Press, Cambridge, UK), pp 67–86.
- Slogosmyr I, Lankinen A (2002) Sexual selection: An evolutionary force in plants? *Biol Rev* 77:537–562.
- Slone TH, Orsak LJ, Malver O (1997) A comparison of price, rarity and cost of butterfly specimens: Implications for the insect trade and for habitat conservation. *Ecol Econ* 21:77–85.
- Smadja C, Galindo J, Butlin R (2008) Hitching a lift on the road to speciation. *Mol Ecol* 17:1477–1480.
- Smith BD (1995) *The Emergence of Agriculture* (W.H. Freeman, New York).
- Smith C, Barber I, Wootton RJ, Chittka L (2004) A receiver bias in the origin of three-spined stickleback mate choice. *Proc R Soc London Ser B* 271:949–955.
- Smith JM (1970) Natural selection and the concept of a protein space. *Nature* 225:563–564.
- Smith RL (1997) Foreword. In *Sperm Competition and Sexual Selection*, eds Birkhead T, Møller AP (Academic, New York), pp xv–xxiii.
- Smith VE (1920) *The Taking of Immature Salmon in the Waters of the State of Washington* (State of Washington Department of Fisheries, Olympia).
- Snyder BF, Gowaty PA (2007) A reappraisal of Bateman's classic study of intrasexual selection. *Evolution* 61:2457–2468.
- Sober E (1981) The evolution of rationality. *Synthese* 46:95–120.
- Sober E (1988) *Reconstructing the Past—Parsimony, Evolution, and Inference* (MIT Press, Cambridge, MA).
- Sober E (1994) Progress and directionality in evolutionary theory. In *Creative Evolution?! ed Campbell J (Jones and Bartlett, Boston)*, pp 19–33.
- Sober E (2008) *Evidence and Evolution—the Logic Behind the Science* (Cambridge Univ Press, Cambridge, UK), Chap 1.

- Sober E, Orzack S (2003) Common ancestry and natural selection. *Br J Philos Sci* 54:423–437.
- Sober E, Steel M (2002) Testing the hypothesis of common ancestry. *J Theor Biol* 218: 395–408.
- Sober E, Wilson D (1997) *Unto Others: The Evolution of Altruism* (Harvard Univ Press, Cambridge, MA).
- Sober E, Wilson D (1998) *Unto Others: The Evolution and Psychology of Unselfish Behavior* (Harvard Univ Press, Cambridge, MA).
- Sogard SM, Berkeley SA, Fisher R (2008) Maternal effects in rockfishes *Sebastes* spp: A comparison among species. *Mar Ecol Prog Ser* 360:227–236.
- Solbak AI, et al. (2005) Discovery of pectin-degrading enzymes and directed evolution of a novel pectate lyase for processing cotton fabric. *J Biol Chem* 280:9431–9438.
- Somero GN (1995) Proteins and temperature. *Annu Rev Physiol* 57:43–68.
- Speijer D (2007) Evolutionary aspects of RNA editing. In *RNA Editing*, ed Goring HU (Springer, Berlin).
- Spencer H (1852) A theory of population, deduced from the general law of animal fertility. *Westminster Rev* 1:468–501.
- Starck JM (1991) Biogeography and life history of *Turnix suscitator* Gmelin, 1789: Small adult body size as a consequence of selection for rapid growth. *Z Zoolog Syst Evol Forsch* 29:213–237.
- Stemmer WP (1994) Rapid evolution of a protein in vitro by DNA shuffling. *Nature* 370:389–391.
- Stephens G, Yamazaki T (2001) *Legacy of the Cat: The Ultimate Illustrated Guide* (Chronicle, San Francisco), 2nd Ed.
- Stifetten Ø, Dale S (2006) Viability of an endangered population of ortolan buntings: The effect of a skewed operational sex ratio. *Biol Conserv* 132:88–97.
- Stoltzfus A (1999) On the possibility of constructive neutral evolution. *J Mol Evol* 49:169–181.
- Storz JF (2005) Using genome scans of DNA polymorphism to infer adaptive population divergence. *Mol Ecol* 14:671–688.
- Strauss SY, Whittall JB (2006) Nonpollinator agents of selection on floral traits. In *Ecology and Evolution of Flowers*, eds Harder L, Barrett SCH (Oxford Univ Press, Oxford, UK), pp 120–138.
- Streisfeld MA, Rausher MD (2009) Altered *trans*-regulatory control of gene expression in multiple anthocyanin genes contributes to adaptive flower color evolution in *Mimulus aurantiacus*. *Mol Biol Evol* 26:433–444.
- Sulli C, Fang ZW, Muchhal U, Schwartzbach SD (1999) Topology of *Euglena* chloroplast protein precursors within endoplasmic reticulum to Golgi to chloroplast transport vesicles. *J Biol Chem* 274:457–463.
- Sulloway F (1982) Darwin's conversion: The *Beagle* voyage and its aftermath. *J Hist Biol* 15:325–396.
- Sunquist ME, Sunquist F (2002) *Wild Cats of the World* (Univ of Chicago Press, Chicago).
- Sutherland WJ (1985a) Chance can produce a sex difference in variance in mating success and account for Bateman's data. *Anim Behav* 33:1349–1352.
- Sutherland WJ (1985b) Measures of sexual selection. In *Oxford Surveys in Evolutionary Biology*, eds Dawkins R, Ridley M (Oxford Univ Press, Oxford, UK), Vol 2, pp 90–101.
- Sutherland WJ (1987) Random and deterministic components of variance in mating success. In *Sexual Selection: Testing the Alternatives*, eds Bradbury JW, Andersson MB (John Wiley & Sons, New York), pp 209–219.
- Swain DP, Sinclair AF, Hanson JM (2007) Evolutionary response to size-selective mortality in an exploited fish population. *Proc R Soc Lond Ser B* 274:1015–1022.
- Swallow JG, Wilkinson GS (2002) The long and short of sperm polymorphisms in insects. *Biol Rev* 77:153–182.



- Swanson WJ, Vacquier VD (2002) The rapid evolution of reproductive proteins. *Nat Rev Genet* 3:137–144.
- Swanson WJ, Clark AG, Waldrip-Dail HM, Wolfner MF, Aquando CF (2001) Evolutionary EST analysis identifies rapidly evolving male reproductive products in *Drosophila*. *Proc Natl Acad Sci USA* 98:7375–7379.
- Swanson WJ, Nielsen R, Yang Q (2003) Pervasive adaptive evolution in mammalian fertilization proteins. *Mol Biol Evol* 20:18–20.
- Tajima F (1983) Evolutionary relationship of DNA sequences in finite populations. *Genetics* 105:437–460.
- Tajima F (1989) Statistical method for testing the neutral mutation hypothesis by DNA polymorphism. *Genetics* 123:585–595.
- Takahata N (1987) On the overdispersed molecular clock. *Genetics* 116:169–179.
- Takezaki N, Rzhetsky A, Nei M (1995) Phylogenetic test of the molecular clock and linearized trees. *Mol Biol Evol* 12:823–833.
- Tallamy DW, Darlington MB, Pesk JP, Powell BE (2003) Copulatory courtship signals male genetic quality in cucumber beetles. *Proc R Soc London Ser B* 270:77–82.
- Tan THP, Bochud-Allemann N, Horn EK, Schneider A (2002) Eukaryotic-type elongator tRNA<sup>Met</sup> of *Trypanosoma brucei* becomes formylated after import into mitochondria. *Proc Natl Acad Sci USA* 99:1152–1157.
- Tang SW, Presgraves DC (2009) Evolution of the *Drosophila* nuclear pore complex results in multiple hybrid incompatibilities. *Science* 323:779–782.
- Tang-Martinez Z, Ryder TB (2005) The problem with paradigms: Bateman's worldview as a case study. *Integr Comp Biol* 45:821–830.
- Tanno K, Willcox G (2006) How fast was wild wheat domesticated? *Science* 311:1886.
- Taubes G (1993) *Bad Science: The Short Life and Weird Times of Cold Fusion* (Random House, New York).
- Taverna DM, Goldstein RA (2002) Why are proteins marginally stable? *Proteins* 46:105–109.
- Taylor FJR (1987) *The Biology of Dinoflagellates* (Blackwell Scientific, Oxford, UK).
- Taylor PD, Williams GC (1982) The lek paradox is not resolved. *Theor Pop Biol* 22:392–409.
- Taylor RJ (1967) Interspecific hybridization and its evolutionary significance in genus *Aquilegia*. *Brittonia* 19:374–390.
- Taylor RJ (1984) Floral anthocyanins of *Aquilegia* and their relationship to distribution and pollination biology of the species. *Bull Torrey Bot Club* 111:462–468.
- Taylor RJ, Campbell D (1969) Biochemical systematics and phylogenetic interpretations in genus *Aquilegia*. *Evolution* 23:153–162.
- Tchernov E (1984) Commensal animals and human sedentism in the Middle East. In *Animals and Archaeology: 3. Early Herders and Their Flocks*, eds Clutton-Brock J, Grigson C (BAR International, Oxford, UK), pp 91–115.
- Temin HM, Mizutani S (1970) RNA-dependent DNA polymerase in virions of Rous sarcoma virus. *Nature* 226:1211–1213.
- Tenaillon MI, et al. (2001) Patterns of DNA sequence polymorphism along chromosome 1 of maize (*Zea mays* ssp. *mays* L.). *Proc Natl Acad Sci USA* 98:9161–9166.
- Tenaillon MI, U'Ren J, Tenaillon O, Gaut BS (2004) Selection versus demography: A multilocus investigation of the domestication process in maize. *Mol Biol Evol* 21:1214–1225.
- Tenhumberg B, Tyre AJ, Pople AR, Possingham HP (2004) Do harvest refuges buffer kangaroos against evolutionary responses to selective harvesting? *Ecology* 85:2003–2017.
- Thelen TH (1991) Effects of harvest on antlers of simulated populations of elk. *J Wildl Manag* 55:243–249.
- Thomas P, El-Barghathi M, Polwart A (2007) Biological flora of the British Isles: *Juniperus communis* L. *J Ecol* 95:1404–1440.



- Thomson D, Muench K (1977) Influence of tides and waves on the spawning behavior of the Gulf of California grunion, *Leuresthes sardina* (Jenkins and Evermann). *Bull S Calif Acad Sci* 75:198–203.
- Thornhill R (1983) Cryptic female choice and its implications in the scorpionfly *Harpobittacus nigriceps*. *Am Nat* 122:765–788.
- Thornhill R, Alcock, J (1983) *The Evolution of Insect Mating Systems* (Harvard Univ Press, Cambridge, MA).
- Ting C-T, Tsaur S-C, Wu C-I (2000) The phylogeny of closely related species as revealed by the genealogy of a speciation gene, *Odysseus*. *Proc Natl Acad Sci USA* 97:5313–5316.
- Tregenza T, Wedell N (2000) Genetic compatibility, mate choice and patterns of parentage. *Mol Ecol* 9:1013–1027.
- Tregenza T, Wedell N (2002) Polyandrous females avoid costs of inbreeding. *Nature* 415:71–73.
- Treutter D (2006) Significance of flavonoids in plant resistance: A review. *Environ Chem Lett* 4:147–157.
- Trivers RL (1972) Parental investment and sexual selection. In *Sexual Selection and the Descent of Man, 1871–1971*, ed Campbell B (Heinemann, London), pp 136–179.
- Trut LN (1999) Early canid domestication: The farm-fox experiment. *Am Sci* 87:160–169.
- Turing A (1936) On computable numbers, with an application to the Entscheidungsproblem. *Proc Lond Math Soc* 42:230–265; erratum (1937) 43:544–546.
- Turner TL, Hahn MW, Nuzhdin SV (2005) Genomic islands of speciation in *Anopheles gambiae*. *PloS Biol* 3:1572–1578.
- Unckless RL, Orr HA (2009) Dobzhansky-Muller incompatibilities and adaptation to a shared environment. *Heredity* 102:214–217.
- Van den Burg B, Vriend G, Veltman OR, Venema G, Eijssink VG (1998) Engineering an enzyme to resist boiling. *Proc Natl Acad Sci USA* 95:2056–2060.
- van Nimwegen E, Crutchfield JP, Huynen M (1999) Neutral evolution of mutational robustness. *Proc Natl Acad Sci USA* 96:9716–9720.
- Van Valkenburgh B, Wang XM, Damuth J (2004) Cope's rule, hypercarnivory, and extinction in North American canids. *Science* 306:101–104.
- Venturelli PA, Shuter BJ, Murphy CA (2009) Evidence for harvest-induced maternal influences on the reproductive rates of fish populations. *Proc R Soc Lond Ser B* 276: 919–924.
- Via S (1989) Field estimation of variation in host plant use between local populations of pea aphids from two crops. *Ecol Entomol* 14:357–364.
- Via S (1991a) Specialized host plant performance of pea aphid clones is not altered by experience. *Ecology* 72:1420–1427.
- Via S (1991b) The genetic structure of host plant adaptation in a spatial patchwork: Demographic variability among reciprocally transplanted pea aphid clones. *Evolution (Lawrence, Kans)* 45:827–852.
- Via S (1999) Reproductive isolation between sympatric races of pea aphids. I. Gene flow restriction and habitat choice. *Evolution (Lawrence, Kans)* 53:1446–1457.
- Via S (2001) Sympatric speciation in animals: The ugly duckling grows up. *Trends Ecol Evol* 16:381–390.
- Via S, West J (2008) The genetic mosaic suggests a new role for hitchhiking in ecological speciation. *Mol Ecol* 17:4334–4345.
- Via S, Bouck AC, Skillman S (2000) Reproductive isolation between divergent races of pea aphids on two hosts. II. Selection against migrants and hybrids in the parental environments. *Evolution* 54:1626–1637.
- Vigne JD, Guilaine J, Debue K, Haye L, Gerard P (2004) Early taming of the cat in Cyprus. *Science* 304:259.

- Vigouroux Y, et al. (2002) Identifying genes of agronomic importance in maize by screening microsatellites for evidence of selection during domestication. *Proc Natl Acad Sci USA* 99:9650–9655.
- Vigouroux Y, et al. (2005) An analysis of genetic diversity across the maize genome using microsatellites. *Genetics* 169:1617–1630.
- Vigouroux Y, et al. (2008) Population structure and genetic diversity of New World maize races assessed by DNA microsatellites. *Am J Bot* 95:1240–1253.
- Vila C, et al. (1997) Multiple and ancient origins of the domestic dog. *Science* 276:1687–1689.
- Vila C, Leonard JA, Beja-Pereira A (2006) Genetic documentation of horse and donkey domestication. In *Documenting Domestication: New Genetic and Archaeological Paradigms*, eds Zeder MA, Bradley DG, Emshwiller E, Smith BD (Univ of California Press, Los Angeles), pp 342–353.
- Vincent A, Sadler L (1995) Faithful pair bonds in wild seahorses, *Hippocampus whitei*. *Anim Behav* 50:1557–1569.
- Vincent A, Sadovy Y (1998) Reproductive ecology in the conservation and management of fishes. In *Behavioral Ecology and Conservation Biology*, ed Caro T (Oxford Univ Press, New York), pp 209–245.
- Vincent A, Ahnesjö I, Berglund A, Rosenqvist G (1992) Pipefishes and seahorses: Are they all sex role reversed? *Trends Ecol Evol* 7:237–241.
- Vogler D, Kalisz S (2001) Sex among the flowers: The distribution of plant mating systems. *Evolution* 55:202–204.
- Voigt CA, Martinez C, Wang ZG, Mayo SL, Arnold FH (2002) Protein building blocks preserved by recombination. *Nat Struct Biol* 9:553–558.
- Voipio P (1950) Evolution at the population level with special reference to game animals and practical game management. *Pap Game Res (Helsinki)* 5:1–175.
- von Bernhardt F (1912) *Germany and the Next War* (Edward Arnold, London).
- Waage JK (1979) Dual function of the damselfly penis: Sperm removal and transfer. *Science* 203:916–918.
- Wade M (1979) Sexual selection and variance in reproductive success. *Am Nat* 114:742–764.
- Wade M (1995) The ecology of sexual selection: Mean crowding of females and resource-defence polygyny. *Evol Ecol* 9:118–124.
- Wade M, Arnold S (1980) The intensity of sexual selection in relation to male sexual behaviour, female choice, and sperm precedence. *Anim Behav* 28:446–461.
- Wade M, Shuster S (2004) Sexual selection: Harem size and the variance in male reproductive success. *Am Nat* 164:E83–E89.
- Wade M, Shuster S (2005) Don't throw Bateman out with the bathwater! *Integr Comp Biol* 45:261–268.
- Wagner WE, Kelly RJ, Tucker KR, Harper CJ (2001) Females receive a lifespan benefit from male ejaculates in a field cricket. *Evolution (Lawrence, Kans)* 55:994–1001.
- Wallace A (1867) Creation by law. *Q J Sci* 4:471–488.
- Wallace AR (1870) *Contributions to the Theory of Natural Selection: A Series of Essays* (Macmillan, London).
- Walsh MR, Munch SB, Chiba S, Conover DO (2006) Maladaptive changes in multiple traits caused by fishing: Impediments to population recovery. *Ecol Lett* 9:142–148.
- Wandeler P, Funk SM, Lurgiader CR, Gloor S, Breitenmoser U (2003) The city-fox phenomenon: Genetic consequences of a recent colonization of urban habitat. *Mol Ecol* 12:647–656.
- Wang CL, et al. (2008) Genetic analysis of photoperiod sensitivity in a tropical by temperate maize recombinant inbred population using molecular markers. *Theor Appl Genet* 117:1129–1139.
- Wang H, et al. (2005) The origin of the naked grains of maize. *Nature* 436:714–719.

- Wang RL, Stec A, Hey J, Lukens L, Doebley J (1999) The limits of selection during maize domestication. *Nature* 398:236–239.
- Wang X, Minasov G, Shoichet BK (2002) Evolution of an antibiotic resistance enzyme constrained by stability and activity trade-offs. *J Mol Biol* 320:85–95.
- Wang Y, Morse D (2006) Rampant polyuridylation of plastid gene transcripts in the dinoflagellate *Lingulodinium*. *Nucl Acids Res* 34:613–619.
- Wapnish P (1984) The dromedary and bactrian camel in Levantine historical settings: The evidence from Tell Jemmeh. In *Animals and Archaeology: 3. Early Herders and Their Flocks*, eds Clutton-Brock J, Grigson C (BAR International, Oxford, UK), pp 171–200.
- Ware AD, Opell BD (1989) A test of the mechanical isolation hypothesis in two similar spider species. *J Arachnol* 17:149–162.
- Warner D, Shine R (2007) Reproducing lizards modify sex allocation in response to operational sex ratios. *Biol Lett* 3:47–50.
- Wasserthal LT (1997) The pollinators of the Malagasy star orchids *Angraecum sesquipedale*, *A. sororium* and *A. compactum* and the evolution of extremely long spurs by pollinator shift. *Bot Acta* 110:343–359.
- Waters CK (2003) The arguments in the *Origin of Species*. In *The Cambridge Companion to Darwin*, eds Hodge J, Radick G (Cambridge Univ Press, Cambridge, UK), pp 116–142.
- Watterson GA (1975) On the number of segregating sites in genetical models without recombination. *Theor Popul Biol* 7:256–276.
- Wayne RK, Leonard JA, Vila C (2006) Genetic analysis of dog domestication. In *Documenting Domestication: New Genetic and Archaeological Paradigms*, eds Zeder MA, Bradley DG, Emshwiller E, Smith B (Univ of California Press, Los Angeles), pp 279–293.
- Weddell N, Cook PA (1999) Butterflies tailor their ejaculate in response to sperm competition risk and intensity. *Proc R Soc London Ser B* 266:1033–1039.
- Weinreich DM, Delaney NF, Depristo MA, Hartl DL (2006) Darwinian evolution can follow only very few mutational paths to fitter proteins. *Science* 312:111–114.
- Wells K (1979) Reproductive behavior and male mating success in a neotropical toad, *Bufo typhonius*. *Biotropica* 11:301–307.
- West-Eberhard MJ (1984) Sexual selection, competitive communication and species-specific signals in insects. *Insect Communication*, ed Lewis T (Academic Press, New York), pp 283–324.
- Whewell W (1837) *The History of the Inductive Sciences* (Parker, London).
- Whewell W (1840) *The Philosophy of the Inductive Sciences* (Parker, London).
- Whewell W (2001) *Of the Plurality of Worlds. A Facsimile of the First Edition of 1853: Plus Previously Unpublished Material Excised by the Author Just Before the Book Went to Press; and Whewell's Dialogue Rebutting His Critics, Reprinted from the Second Edition*, ed Ruse M (Univ of Chicago Press, Chicago).
- Whitcomb JC, Morris HM (1961) *The Genesis Flood: The Biblical Record and Its Scientific Implications* (Presbyterian and Reformed Publishing, Philadelphia).
- White SE, Doebley JF (1999) The molecular evolution of *terminal ear1*, a regulatory gene in the genus *Zea*. *Genetics* 153:1455–1462.
- Whitham T, et al. (2003) Community and ecosystem genetics: A consequence of the extended phenotype. *Ecology* 84:559–573.
- Whitney NM, Pratt HL, Carrier JC (2004) Group courtship, mating behavior, and siphon sac function in the whitetip reef shark, *Triaenodon obesus*. *Anim Behav* 68:1435–1442.
- Whitt SR, Wilson LM, Tenailon MI, Gaut BS, Buckler ES (2002) Genetic diversity and selection in the maize starch pathway. *Proc Natl Acad Sci USA* 99:12959–12962.
- Whittall JB, Hodges SA (2007) Pollinator shifts drive increasingly long nectar spurs in columbine flowers. *Nature* 447:706–712.
- Whittall JB, Medina-Marino A, Zimmer EA, Hodges SA (2006a) Generating single-copy nuclear gene data for a recent adaptive radiation. *Mol Phylogenet Evol* 39:124–134.

- Whittall JB, Voelckel C, Kliebenstein DJ, Hodges SA (2006b) Convergence, constraint, and the role of gene expression during adaptive radiation: Floral anthocyanins in *Aquilegia*. *Mol Ecol* 15:4645–4657.
- Wilding CS, Butlin RK, Grahame J (2001) Differential gene exchange between parapatric morphs of *Littorina saxatilis* detected using AFLP markers. *J Evol Biol* 14:611–619.
- Wiley E (1981) *Phylogenetics—The Theory and Practice of Phylogenetic Systematics* (Wiley, New York).
- Wilke CO, Adami C (2003) Evolution of mutational robustness. *Mutat Res* 522:3–11.
- Wilkes HG (1967) *Teosinte: The Closest Relative of Maize* (Harvard Univ Press, Cambridge, MA).
- Willcox G (2005) The distribution, natural habitats and availability of wild cereals in relation to their domestication in the Near East: Multiple events, multiple centres. In *Proceedings of the 13th IWGP Symposium*, eds Buxo R, Jacomet S, Bitmann F (Springer, Berlin), pp 534–541.
- Williams GC (1966) *Adaptation and Natural Selection: A Critique of Some Current Evolutionary Thought* (Princeton Univ Press, Princeton, NJ).
- Williams GC (1975) *Sex and Evolution* (Princeton Univ Press, Princeton, NJ).
- Willis J (2009) Origin of species in overdrive. *Science* 323:350–351.
- Willson M, Burley N (1983) *Mate Choice in Plants* (Princeton Univ Press, Princeton, NJ).
- Wilson EO (1978) *On Human Nature* (Harvard Univ Press, Cambridge, MA).
- Wilson LG, ed (1970) *Sir Charles Lyell's Scientific Journals on the Species Question* (Yale Univ Press, New Haven, CT).
- Wilson LM, et al. (2004) Dissection of maize kernel composition and starch production by candidate gene association. *Plant Cell* 16:2719–2733.
- Winkel-Shirley B (2002) Biosynthesis of flavonoids and effects of stress. *Curr Opin Plant Biol* 5:218–223.
- Wolf JB, Wade MJ (2001) On the assignment of fitness to parents and offspring: Whose fitness is it and when does it matter? *J Evol Biol* 14:347–356.
- Wolf JB, Brodie ED III, Moore AJ (1999a) Interacting phenotypes and the evolutionary process. II. Selection resulting from social interactions. *Am Nat* 153:254–266.
- Wolf JB, Brodie ED III, Moore AJ (1999b) The role of maternal and paternal effects in the evolution of parental quality by sexual selection. *J Evol Bio* 12:1157–1167.
- Wollaston T (1860) On the origin of species by means of natural selection. *Ann Mag Nat Hist* 5:132–143.
- Wood HM, Grahame JW, Humphray S, Rogers J, Butlin RK (2008) Sequence differentiation in regions identified by a genome scan for local adaptation. *Mol Ecol* 17:3123–3135.
- Worden BD, Parker PG (2005) Females prefer noninfected males as mates in the grain beetle *Tenebrio molitor*: Evidence in pre- and postcopulatory behaviours. *Anim Behav* 70:1047–1053.
- World Resources Institute (2000) People and ecosystems: The fraying web of life. Available at [http://pdf.wri.org/world\\_resources\\_2000-2001\\_people\\_and\\_ecosystems.pdf](http://pdf.wri.org/world_resources_2000-2001_people_and_ecosystems.pdf).
- Wright S (1922) Coefficients of inbreeding and relationship. *Am Nat* 51:545–559.
- Wright SI, et al. (2005) The effects of artificial selection on the maize genome. *Science* 308:1310–1314.
- Xie DY, Sharma SB, Paiva NL, Ferreira D, Dixon RA (2003) Role of anthocyanidin reductase, encoded by BANYULS in plant flavonoid biosynthesis. *Science* 299:396–399.
- Yamaguchi N, Driscoll CA, Kitchener AC, Ward JM, Macdonald DW (2004a) Craniological differentiation between European wildcats (*Felis silvestris silvestris*), African wildcats (*F.s. lybica*) and Asian wildcats (*F.s. ornata*): Implications for their evolution and conservation. *Biol J Linn Soc* 83:47–63.

- Yamaguchi N, Kitchener AC, Ward JM, Driscoll CA, Macdonald DW (2004b) Craniological differentiation amongst wild-living cats in Britain and southern Africa: Natural variation or the effects of hybridization? *Anim Conserv* 7:339–351.
- Yamasaki M, et al. (2005) A large-scale screen for artificial selection in maize identifies candidate agronomic loci for domestication and crop improvement. *Plant Cell* 17:2859–2872.
- Yatabe Y, Kane NC, Scotti-Saintagne C, Rieseberg LH (2007) Rampant gene exchange across a strong reproductive barrier between the annual sunflowers, *Helianthus annuus* and *H. petiolaris*. *Genetics* 175:1883–1893.
- Yonekura-Sakakibara K, et al. (2008) Comprehensive flavonol profiling and transcriptome coexpression analysis leading to decoding gene-metabolite correlations in *Arabidopsis*. *Plant Cell* 20:2160–2176.
- Yoshikuni Y, Ferrin TE, Keasling JD (2006) Designed divergent evolution of enzyme function. *Nature* 440:1078–1082.
- Young RM (1985) *Darwin's Metaphor: Nature's Place in Victorian Culture* (Cambridge Univ Press, Cambridge, UK).
- Yu J, Holland JB, McMullen MD, Buckler ES (2008) Genetic design and statistical power of nested association mapping in maize. *Genetics* 178:539–551.
- Zahavi A (1975) Mate selection: A selection for a handicap. *J Theor Biol* 53:205–214.
- Zahavi A (1977) The cost of honesty (Further remarks on the handicap principle). *J Theor Biol* 53:205–214.
- Zakon HH (2002) Convergent evolution on the molecular level. *Behav Evol* 59:250–261.
- Zeder MA (2005) New perspectives on livestock domestication in the Fertile Crescent as viewed from the Zagros Mountains. In *The First Steps of Animal Domestication: New Archaeozoological Approaches*, eds Vigne JD, Peters J, Helmer D (Oxbow Books, Oxford, UK), pp 125–146.
- Zeder MA (2006) Central questions in the domestication of plants and animals. *Evol Anthropol* 15:105–117.
- Zeder MA (2008) Domestication and early agriculture in the Mediterranean Basin: Origins, diffusion, and impact. *Proc Natl Acad Sci USA* 105:11597–11604.
- Zeder MA, Bradley DG, Emshwiller E, Smith B, eds (2006a) *Documenting Domestication: New Genetic and Archaeological Paradigms* (Univ of California Press, Berkeley).
- Zeder MA, Emshwiller E, Smith BD, Bradley DG (2006b) Documenting domestication: The intersection of genetics and archaeology. *Trends Genet* 22:139–155.
- Zeh JA, Zeh DW (1996) The evolution of polyandry. I: Intra-genomic conflict and genetic incompatibility. *Proc R Soc London Ser B* 263:1711–1717.
- Zeldovich KB, Chen P, Shakhnovich EI (2007) Protein stability imposes limits on organism complexity and speed of molecular evolution. *Proc Natl Acad Sci USA* 104:16152–16157.
- Zeuner FE (1963) *A History of Domesticated Animals* (Hutchinson, London).
- Zhang H, Lin S (2008) mRNA editing and spliced-leader RNA *trans*-splicing groups *Oxyrrhis*, *Noctiluca*, *Heterocapsa*, and *Amphidinium* as basal lineages of dinoflagellates. *J Phycol* 44:703–711.
- Zhang H, et al. (2007) Spliced leader RNA *trans*-splicing in dinoflagellates. *Proc Natl Acad Sci USA* 104:4618–4623.
- Zigler KS (2008) The evolution of sea urchin sperm bindin. *Int J Dev Biol* 52:791–796.
- Zigler KS, Lessios HA (2003a) 250 million years of bindin evolution. *Biol Bull* 205:8–15.
- Zigler KS, Lessios HA (2003b) Evolution of bindin in the pantropical sea urchin *Tripleneustes*: Comparisons to bindin of other genera. *Mol Biol Evol* 20:220–231.
- Zigler KS, Lessios HA (2004) Speciation on the coasts of the New World: Phylogeography and the evolution of bindin in the sea urchin genus *Lytechinus*. *Evolution (Lawrence, Kans)* 59:2399–2404.

398 / References

- Zimmerman M (1987) The evolution-creation controversy: Opinions of Ohio high school biology teachers. *Ohio J Sci* 87:115–124.
- Zinkl GM, Zwiebel BI, Grier DG, Preuss D (1999) Pollen-stigma adhesion in *Arabidopsis*: A species-specific interaction mediated by lipophilic molecules in the pollen exine. *Development* 126:5431–5440.
- Zuckerandl E, Pauling L (1965) *Evolutionary Divergence and Convergence in Proteins*, eds Bryson V, Vogel HJ (Springer, New York), pp 97–166.
- Zufall RA, Rausher MD (2003) The genetic basis of a flower color polymorphism in the common morning glory (*Ipomoea purpurea*). *J Hered* 94:442–448.
- Zufall RA, Rausher MD (2004) Genetic changes associated with floral adaptation restrict future evolutionary potential. *Nature* 428:847–850.

# Index

---

## A

- Abalone, 257, 258, 259, 261  
Achatinellinae tree snails, 141  
*Acyrtosiphon pisum* (Harris), 10, 13-17  
Adaptation, Fisher-Orr geometric model, 52-53  
Adaptive protein evolution, 150, 153, 159-163  
Adaptive radiations  
  *Aquilegia*, 2-3, 23, 30-44  
  classic examples, 28  
  convergent evolution in, 30  
  defining features, 28  
  evolutionary trends, 29-30, 31-34  
  genetic dissection of adaptive traits, 27, 28, 29, 30, 42-44  
  phenotype-environment correlations, 28  
  research interests and trends, 28-29  
  research needs, 27-28, 44-45  
  trait directionality, 30, 31-34  
  trait utility, 28  
African sleeping sickness, 66  
Alfalfa, 13-17  
Allendorf, Fred W., 86-87, 129-147  
Allopatric speciation, 6, 9-10, 20, 22, 23, 24-25, 107  
Altman, Sidney, 277  
Altruism, 310-311, 338-339  
Alveolata  
  cellular structures, 66, 68, 69-73  
  convergent evolution with Euglenozoa, 65-84  
  endosymbiosis, 77  
  gene expression, 66, 73-76  
  photosynthetic, 67-68  
  plastids, 77-78  
  RNA editing and processing, 66, 73-76, 81, 83  
  and stramenopiles, 68  
  subgroups and characteristics, 66-67  
  tree structure, 67  
American Museum of Natural History, 294  
Anisogamy theory, 231-232  
Anthocyanidin reductase, 35, 36, 41  
Anthocyanidin synthase, 34, 35, 37, 39, 40, 41, 42, 43  
Anthocyanin biosynthetic pathway, 27, 32-33, 34, 35-36, 37-38, 39, 40-41, 42, 43  
Anthocyanin GST, 35, 41  
Antibiotic-resistance enzyme, 158  
*Antirrhinum*, 42  
AN2 gene, 36-37, 42  
Apicomplexans, 66, 67, 77, 80-81  
*Apicomporus*, 70, 71  
Apple maggot (*Rhagoletis pomonella*), 54



- Aquaculture, 130
- Aquilegia*
- A. brevistyla*, 38
  - A. canadensis*, 33, 38
  - A. chrysantha*, 37-38
  - A. coerulea*, 32, 33, 38, 43
  - A. flabellata*, 37-38
  - A. flavescens*, 32, 34, 38
  - A. formosa*, 32, 33, 38, 39, 42, 43-44
  - A. jonesii*, 32
  - A. laramiense*, 34
  - A. longissima*, 32, 37-38
  - A. pinetorum*, 37
  - A. pubescens*, 32, 38, 39, 43-44
  - A. saximontana*, 32
  - A. scopulorum*, 32, 43
  - A. vulgaris*, 43
- adaptive radiations, 2-3, 23, 30-44
- anthocyanin production, 27, 32-33, 34, 35-36, 37-38, 39, 40-41, 42, 43
- association mapping, 45
- crossing studies, 27, 37-38
- evolutionary trends, 31-34
- flavonoid pathway, 27, 32-33, 35, 39-42, 43, 44
- flower color evolution, 2-3, 32-37, 39-44
- gene index, 27, 39, 40, 41, 43
- genetic analyses, 2-3, 27-28, 32-37, 39-42, 44-45
- genome sequencing, 44
- orientation of flowers, 31-32, 34, 44
- petal spur length, 30, 31, 34, 44
- phylogeny, 33
- pollinators, 31-34, 44
- QTL analysis, 43, 44
- research needs, 44-45
- virus-induced gene silencing, 43
- Arabian gazelle (*Gazella gazelle*), 102-103
- Arabidopsis*, 36, 39, 41, 119
- Argument from design, xvi, 281, 282
- Arnhart, Larry, 297
- Arnold, Frances H., 67, 149-163
- Arthur M. Sackler Colloquium, iv, viii, xvi, 26, 45, 190, 233-234, 266
- Arthur M. Sackler Gallery of Asian Art, viii
- Articulins, 72
- Artificial selection. *See also* Directed protein evolution; Domestication; Unnatural selection
- Darwin's legacy, xvi, 85, 90, 91-92, 99, 108, 293, 308, 321, 322, 334
- defined, 89, 90, 91
- prezygotic selection, 91
- strong, 86, 91, 98, 101, 111, 119, 122, 123, 146
- weak, 86, 91, 98
- Asian elephant, 93
- Association mapping, 45
- Assortative mating, 9, 10, 25, 50-51, 54, 58, 89, 107, 108, 174-176
- Atlantic cod (*Gadus morhua*), 134, 142, 146-147
- Auroch (*Bos primigenius*), 96-97, 102-103
- Avise, John C., iv, xiii-xiv, 26
- Ayala, Francisco J., xiii-xiv, 26, 263-264, 267-285, 338
- ## B
- Bacon, Francis, 268, 272
- Bactrian camel (*Camelus bactrianus*), 98-99, 102-103
- Baltimore, David, 277
- Barley, 94, 112
- Barnacles, xv, 210, 271, 282, 283, 284, 335
- Barred buttonquail (*Turnix suscitator*), 183
- Bateman gradients, 184, 185, 186, 187-188, 192, 193, 197, 201
- Beadle, George, 114, 116
- Bees, 31, 32, 34, 311, 334
- Bentham, Jeremy, 338
- Bernard, Claude, 274-275, 279
- Bernhardi, Friedrich von, 296
- Bezoar (*Capra aegagrus*), 96-97, 102-103
- Bighorn sheep (*Ovis canadensis*), 130, 140
- Bindins, 258, 259
- Biodiversity, defined, xiii
- Biological species concept, 2, 6, 92
- Black rat (*Rattus rattus*), 96-97, 102-103, 106
- Bloom, Jesse D., 67, 149-163
- Blyth, Edward, 291
- Body size and complexity, 29, 55, 58
- Bottlenecks, 21, 105, 115-116, 122, 123, 126-127, 153, 315
- Bowerbird, 178
- Bowler, Peter, 289, 304
- Bradley, F. H., 338
- Breasted, James Henry, 93-94
- British Association for the Advancement of Science, 294
- British Museum, 294

Brown rat (*Rattus norvegicus*), 96-97, 102-103, 106

Brown trout (*Salmo trutta*), 130

Buckler, Edward S., IV, 86, 111-127

Buttonquail (*Turnix*), 172, 183

## C

Caddis fly's food sieve, 348-349

*Caenorhabditis elegans*, 76

Cape hare (*Lepus capensis*), 102-103

Caridean shrimp, 210

Cat (*Felis silvestris catus*) domestication

assortative mating, 89, 107, 108

context, 98-99

distribution of genotypes, 104-105

earliest human association, 98, 105

genetic analysis, 101, 104-106

genetic diversity, 105-106

oldest evidence, 105

preadaptive features, 102-103

selection mechanism, 85-86, 89, 99, 101, 108

selective breeding, 108-109

sympatric divergence and mitochondrial origins, 89, 92, 106-108

Catholic Church, 292, 296

Cattle, 85, 93, 94, 96-97, 102-103, 108

Cavalli-Sforza, Luigi, 326

CDPK3 gene, 50

Cech, Thomas, 277

Central dogma of molecular biology, 277

Cereal cultivation, 94, 106

Chagas's disease, 66

Chalcone flavone isomerase, 34, 35, 41, 42

Chalcone synthase, 34, 35, 37, 41

Chambers, Robert, 291, 336

Cheetah (*Acinonyx jubatus*), 102-103

Chimpanzees, 115, 285, 350, 351, 353

Chinese mountain cats (*Felis silvestris bieti*), 104, 105

Chinook salmon (*Oncorhynchus tshawytscha*), 145, 147

Chromalveolata, 67, 68

*Chromera*, 66-67, 77

Chromosomal inversions, 16, 54

Church-Turing Thesis, 346

Cichlids, 28, 54, 176

Ciliates, 66, 67-68, 80

Climate change, 95, 132

Cnidarians, 210

*cob* gene, 79, 80

Coevolution, 83

flower spurs and pollinator tongues, 31  
sexually antagonistic, 248-250, 252-261

Color. *See also* Flower color

patterns in butterflies, 50

Columbines. *See Aquilegia*

Common ancestry

Darwin's principle, 315-318, 328

evidence of, 315-318, 319-321

exceptions to Darwin's principle, 318-321, 324-325

natural selection and, 264, 312-315, 321-328

parsimony in reconstruction of, 325-327

Common fallow deer (*Dama dama*), 102-103

Complexity, 308-309, 325

Condition-dependent indicator (good genes) model, 178-179, 180, 217

Condition-independent indicator model, 179, 180

Conte, Gina L., 3, 47-64

Convergent evolution, 30, 3, 65, 66, 68-73, 82, 83

Copernican Revolution, 281, 299

Copernicus, Nicolaus, xv-xvi, 299, 329

Copper tolerance gene, 51

Courtship behavior, 243-244, 253-255

*cox1* gene, 79, 80

*cox3* gene, 79, 80

Creationists, 264, 265, 290, 296, 314, 344, 345, 346-347

Crops, 94-95, 106, 116. *See also* Maize

Crossing studies, 27, 37-38, 334

Cryptic female choice, 166-167, 243, 244, 245, 247-248, 249, 250, 252, 256-257, 258, 259, 260, 261

*Cryptosporidium*, 67

Cyanidins, 33, 35, 36, 38

Cytochrome P450 enzyme, 151, 154-155, 156, 158, 160

## D

Damselfly, 247

Darwin, Erasmus, 292, 330

Darwin, Robert Waring, 330

Darwin-Fisher model, 174-176

Darwin's legacy

on altruism, 310-311, 338-339

- artificial selection, xvi, 85, 90, 91-92, 99, 108, 293, 308, 321, 322, 334  
 on common ancestry, 264, 312-328  
 early life, 330-332  
 on HMS *Beagle*, iv, xv, xvi, 263, 268-269, 279-280, 281, 282, 331  
 inductivism and, 267, 268, 269-271, 272  
 mate choice, 169, 173-174  
 mating system analyses, 166, 191, 192, 194-195  
 moral purpose of evolution, 264-265, 295-296, 297, 298, 310-312, 329, 330, 332-340  
 natural selection theory, xvi, 1-2, 28, 48, 214, 308, 271, 275-276, 280-284, 293, 296, 312-328, 334-340  
 Paley's influence, xvi, 281  
 postcopulatory sexual selection, omission of, 166, 244-245  
 scientific methodology and thought processes, 263-264, 267-271, 272, 282-283, 318, 323-328  
 sexual selection, xi, 163, 165, 169, 170-171, 172, 173-174, 182-183, 189, 192, 193, 214  
 on species-variety boundary, 307-308  
 Transmutation Notebooks, 263, 268, 281, 282, 291, 329, 330, 332  
 unnatural selection in wildlife, 86-87, 130-131, 132
- Darwin's finches, 2, 28, 280
- Darwinian debt, 134, 147
- Darwinian revolution  
 conceptual nature of change, 264, 287, 299-304  
 metaphysical context, 264, 287, 290, 295-299  
 and scientific revolutions generally, 287, 288-289  
 scientific context, 264, 287, 289-295
- Dawkins, Richard, 351
- Delphinidins, 32, 35, 38
- Dennett, Daniel, 265, 289, 329, 343-354
- Derieg, Nathan J., 2-3, 27-45
- Diderot, Denis, 292
- Dihydroflavonol 4-reductase, 34, 35, 36, 37, 38, 41, 42
- Dinoflagellates  
 cellular organization, 69-73  
 ecological role, 67  
 euglenid convergent evolution, 66, 67, 68, 69-73, 77, 80
- feeding apparatuses, 72
- flagellum, 71
- gene expression and transcription, 73, 74-76
- mitochondrion, 78-82
- nuclear genome characteristics, 73-76
- parasitic, 66
- pellicle, 72-73
- photoreceptors, 72
- photosynthesis, 66-67, 73
- plastids and protein targeting system, 67, 77-78
- polycistronic mRNA processing, 74-76, 81, 82
- predatory, 66, 69, 77
- RNA editing and genome breakdown, 78-82, 83
- spliced leaders (miniexons), 73-74, 82
- trichocysts, 70, 71
- Diplonema*, 67
- Diplonemids, 66, 67, 80, 81
- Direct-benefits models, 176-177, 180
- Directed protein evolution  
 antibiotic-resistance enzyme, 158  
 choosing next-generation parents, 153-154  
 cytochrome P450 enzyme, 151, 154-155, 156, 158, 160  
 empirical lessons from, 87, 149, 155-160  
 experimental design, 151-154  
 fitness landscapes, 156-157, 159  
 generalizability to natural evolution, 160-163  
 identifying improved mutants, 153, 158, 163  
 lactamase enzyme, 158  
 lactonase enzyme, 160  
 mutagenizing parent genes, 152-153  
 neutral mutations, 87, 149, 151, 153, 156, 157, 158, 159-160, 161, 162-163  
 neutral network view, 157  
 Pauling-Zuckerkandl hemoglobin experiment, 150, 151, 161  
 phosphotriesterase enzyme, 160  
 population bottlenecks, 153  
 promiscuous functions, 87, 149, 159-160, 162  
 single mutations, 149, 156-157, 159-160  
 stability-mediated epistasis, 87, 149, 157-159, 162  
 standing genetic variation, 153  
 thermostable chorismate mutase, 158

- Divergent selection  
 cats, 106-108  
 ecological speciation, 9, 11, 12, 19-22, 48, 49  
 $F_{st}$  outlier analysis, 12-19, 21, 23-24  
 by genetic drift, 2, 10, 22-23, 24, 25, 160  
 genomic effects of, 5, 11, 12, 19-22  
 habitat choice and, 10, 11, 13, 15, 16, 19, 58  
 hitchhiking, 2, 5, 6, 14-19, 21-22, 23-24, 25, 153  
 for mate choice, 25, 50  
 under mutation, 49  
 and postzygotic isolation, 49, 51-53  
 potential vs. realized gene flow, 10-12  
 reproductive isolation, 9, 11, 12, 19-22, 28, 29, 49, 58  
 resource-based, 10, 11, 16, 19, 25  
 size of genomic hitchhiking regions, 17-19  
 in sympatry, 5, 13, 24-25, 89, 92, 106-108
- DNA shuffling, 152-153
- Dobzhansky, Theodosius, xiii, xiv, 6, 48
- Dobzhansky-Muller incompatibilities, 6-7, 22-23, 24, 25, 53-54, 295
- Doebley, John, 114
- Dogs (*Canis familiaris*), 85-86, 89, 93, 96-97, 98-101, 102-103, 338
- Domestication. *See also* Cat; Maize  
 barnyard animals, 95-98, 99, 101  
 birds, 85, 96-97  
 bottlenecks, 115-116, 122, 126-127  
 characteristic traits, 92  
 commensal species, 96-97, 106  
 crops, 94-95, 106, 116  
 dogs, 89, 96-97, 98-101, 102-103  
 ecosystem effects, 90  
 natural selection and, 86, 89, 91, 96-99, 100  
 in Neolithic Fertile Crescent, 86, 89, 93-98, 106, 107-108  
 neoteny, 93  
 preadaptive characteristics, 98, 100  
 selection mechanism, 86, 89, 91, 96-99, 100, 101  
 standing variation, 92  
 sympatric divergence and  
 mitochondrial origins, 89, 92, 106-108  
 taming compared, 93  
 tolerance of humans, 92-93, 106
- Donkey (*Equus asinus asinus*), 98-99, 102-103
- Dorcas gazelle (*Gazella dorcau*), 102-103
- Doryrhamphus excisus*, 182
- Driscoll, Carlos A., 85-86, 89-109
- Dromedary camel (*Camelus dromedarius*), 98-99, 102-103
- Drosophila*  
*D. hydei*, 231  
*D. melanogaster*, 123, 186, 187, 214-215, 249-250  
*D. pseudoobscura*, 215  
 mating differentials, 186, 187, 214-215, 231, 249-250  
 reproductive isolation, 24, 51  
*Sod* gene, 123
- E**
- Eberhard, William G., 166-167, 243-261
- Ecological factors  
 in intensity of sexual selection, 185-187, 197, 204, 208, 209  
 in mate choice, 9, 10-11, 25, 50, 166, 216  
 in mating, 185-187
- Ecological speciation. *See also* Reproductive isolation  
 allopatric vs sympatric speciation, 24-25  
 defined, 3, 47, 48  
 divergent selection, 9, 11, 12, 19-22, 48, 49  
 $F_{st}$  outlier analysis, 12-19, 21, 23-24  
 with gene flow, 2, 3, 5, 6, 7, 9-12, 15, 16, 19-23, 24-25, 50, 53, 56, 59, 60, 62, 64  
 genetics of, 2, 5-6, 11, 12-13, 19-22, 47, 49, 49-51  
 geographic separation (allopatry) and, 6, 9-10, 20, 22, 23, 25, 28  
 hitchhiking and, 2, 5, 6, 14-19, 21-22, 23-24, 25  
 mutation-order speciation compared, 63-64  
 natural selection process in, 8-9  
 pea aphid model, 10, 13-17  
 postzygotic isolation and, 47, 49, 51-53  
 prezygotic isolation and, 47, 49-51, 55, 58, 63, 64  
 QTL analysis, 11, 12, 13, 14-25, 50  
 sexual selection, 9, 10, 50  
 stages of, 19-23

## 404 / Index

- from standing genetic variation, 3, 47, 49, 58-63, 64, 64
  - in sympatry or parapatry, 2, 5, 9, 13, 24-25
  - threespine stickleback model, 47, 49, 55-63
  - Ectodysplasin (Eda)* gene, 56-57, 59, 60, 62-63, 64
  - Edwards, Anthony, 326
  - Egg-sperm molecular interactions, 243, 257-260
  - Egyptian New Kingdom, 105
  - Einkorn wheat, 94
  - Elephant seals, 176
  - Emmer wheat, 94
  - Endosymbiosis, 66, 73, 77, 345, 348
  - Epiplasmins, 72
  - Error-prone PCR, 152
  - Euglena*, 70, 71
  - Euglenids, convergent evolution with dinoflagellates, 66, 67, 68, 69-73, 77, 80
  - Euglenophytes, 3, 47, 71, 77, 78
  - Euglenozoa
    - cellular structures, 66, 68, 69-73
    - convergent evolution, 65-84
    - endosymbiosis, 66, 77
    - gene expression, 66, 73-76
    - and heteroloboseans, 68
    - mitochondrion, 78-82
    - parasitic and commensalic, 66
    - photoautotrophic, 66
    - plastids, 77-78
    - predatory, 66, 69, 72, 77
    - RNA editing and processing, 66, 73-76, 83
    - subgroups and characteristics, 66, 69, 72, 77
    - on tree of eukaryotes, 67
  - Eukaryotes. *See also* Protists
    - convergent evolution in, 68-69
    - nuclear gene expression, 74
    - phylogenetic diversity, 3, 67
    - tree, 67
  - European badger (*Meles meles*), 102-103
  - European otter (*Lutra lutra*), 102-103
  - Evolution, generally
    - arms races, 297-298
    - of language and culture, 350-352
    - moral purpose of, 264-265, 295-296, 297, 298, 310-312, 329, 330, 332-340
    - neutral theory of, 66, 69, 81-82, 83, 120, 122-123, 162
    - non-Darwinian contributions, 288-289, 292
    - postcopulatory sexual selection and, 243, 250-261
    - public acceptance of, 292-294
    - synthetic theory of, 292
    - trends, 29-30, 31-34
  - Excavata, 66, 67, 68. *See also* Euglenozoa
  - Exploitation of wild animals. *See* Harvest of wild populations; Unnatural selection
  - Eye evolution, 325-326
- F**
- Fecundity, 13, 15-16, 134, 137, 173, 174, 175, 184, 185, 186, 193, 201, 203, 204, 217, 218, 220, 232, 245
  - Female-female combat, 172, 215
  - Ferrets, 101, 102-103
  - Fertile Crescent, domestication in, 86, 93-98, 106, 107-108
  - Fisher, Ronald A., 292, 316, 326
  - Fisher-Orr geometric model, 52-53
  - Fisher's runaway hypothesis, 202
  - Fisherian model, 177-178, 180
  - Fishing/fisheries
    - Atlantic cod (*Gadus morhua*), 134, 142, 146-147
    - capture, 135
    - management, 135, 146-147
    - recreational, 136
    - salmon, 135, 136, 142, 143, 144-145, 147
    - selection effects, 86, 129, 130-131, 134-137, 142-143
    - and sexual selection, 142-143
  - Fitness
    - fecundity, 13, 15-16, 134, 137, 173, 174, 175, 184, 185, 186, 193, 201, 203, 204, 217, 218, 220, 232, 245
    - hybrids, 51, 52
    - mate choice and, 166, 213, 214-215, 216-217, 219-221, 224-227
    - migrants, 15
    - offspring viability, 166, 178, 184, 217, 218, 220, 232, 321
    - peaks in directed protein evolution, 156-157, 159

- productivity, 131, 134, 136, 142, 145, 146, 217, 218, 220, 232, 334
- sex differences, 214-218
- Flavanone-3-hydroxylase, 34, 35, 36, 37, 38, 39, 40, 41, 42
- Flavonoid pathway, 27, 32-33, 35, 39-42, 43, 44
- Flavonoid 3'-hydroxylase, 35, 36, 37, 38, 39-40, 42
- Flavonoid 3'5'-hydroxylase, 35, 36, 38, 39-40, 42
- Flower color evolution
- Aquilegia*, 32-44
  - carotenoid pigments, 34
  - flavonoid biosynthetic pathway, 34, 35, 36, 39-42
  - genetics of adaptation, 34-37
  - Mimulus*, 29, 51
  - model, 37-38
  - molecular dissection, 42-44
  - pollinator preferences, 29, 51
  - trends, 35-37
- Flowering plants
- anthesis, 31, 44
  - cross-pollination, 195, 196, 251
  - dioecy, 195, 196, 210, 211
  - gynodioecy, 195, 196
  - heterochrony, 44
  - intrasexual conflict, 196-197, 260
  - mating systems, 166, 191, 192, 195-197
  - morphology of flowers, 196
  - nectar spurs, 30, 31, 34, 44
  - orientation of flowers, 31-32, 34, 44
  - outcrossing, 195-196, 210
  - petal spur length, 30, 31, 34, 44
  - pollinator preferences, 29, 30
  - self-incompatibility, 195, 196
  - selfing, 195-196, 210, 260
  - sexual selection, 191, 192, 195-197, 209-212, 243, 260-261
- Fodor, Jerry, 346
- Ford, E. B., 295
- Forest elephant (*Loxodonta Africana*), 102, 130
- Forest horse (Tarpan) (*Equus ferus*), 94, 98-99, 102-103
- $F_{st}$  outlier analysis, 12-19, 21, 23-24
- G**
- Galapagos Islands, 2, 28, 280, 332
- Galileo, xv, 329
- Gasterosteus wheatlandi*, 56
- Gene expression, 66, 73-76
- Gene flow
- assortative mating and, 50
  - domestication and, 92
  - ecological speciation with, 2, 3, 5, 6, 7, 9-12, 15, 16, 19-23, 24-25, 50, 53, 56, 59-62, 64
  - as homogenizing force, 10, 11
  - in parallel selection, 53, 56, 59, 60
  - and recovery from selective harvest of wild populations, 146-147
  - transporter hypothesis, 59-62
- Gene index, 27, 39, 40, 41, 43
- Genetic analysis of speciation
- adaptive radiations, 27-28, 27, 28, 29, 30, 42-45
  - Aquilegia* flower color, 2-3, 27-28, 32-37, 39-42, 44-45
  - cats, 101, 104-106
  - Dobzhansky-Muller incompatibilities, 6-7, 22-23, 24, 25, 53-54, 295
  - ecological speciation, 2, 5-6, 11, 12-13, 19-22, 47, 49, 49-51
  - $F_{st}$  outlier analysis of genomic regions, 12-19, 21, 23-24
  - hybridization and, 29, 30
  - magnifying glass (population) approach, 2, 7-8, 10, 26
  - pea aphids, 10, 13-17
  - population-level, 7-8
  - spyglass (retrospective) approach, 2, 5, 6-7, 17, 22, 23-24, 26
- Genetic compatibility model, 179, 180
- Genetic drift, 20, 59, 318
- in adaptive protein evolution, 150, 153, 159, 160, 163
  - divergence by, 2, 10, 22-23, 24, 25, 160
  - gene flow and, 10
  - genomic effects, 10
  - human activities and, 100
  - mate-choice evolution, 179
  - neutral, 10-11, 150, 153, 159, 160, 163
  - rapid, 153
- Genetic linkages
- interrace disequilibrium, 14, 16, 21, 23-24, 25
  - performance and mating, 9
  - selective sweep, 14
- Genital evolution, 243, 248-249, 250-253
- Genome
- hitchhiking regions, 17-19
  - sequencing, 44, 124

Ghiselin, Michael, 283, 338  
 Glass sponges (Hexactinellidae), 210  
 Goats (*Capra hircus*), 94, 96-97, 102-103  
 Goethe, Johann Wolfgang von, 331  
 Goitered gazelle (*Gazella subgutturosa*), 102-103  
 Golden jackal (*Canis aureus*), 102-103  
 Gorillas, 93, 284-285, 297  
 Gould, Stephen J., 297, 298, 303, 307, 337  
 Gowaty, Patricia Adair, 166, 213-241  
 Gray, Asa, 294, 301, 322, 336, 341  
 Gray mouse (*Mus musculus*), 96-97, 102-103  
 Gray wolf (*Canis lupus*), 96, 99-101, 102  
 Green alga, 66, 77  
 Greg, Richard Rathbone, 339  
 gRNAs, 79, 81  
 Group selection hypothesis, 202, 310-311, 334, 338-339  
 Grunion, 210  
*Gryllus*, 257  
 Gulf pipefish (*Syngnathus scovelli*), 182, 183

## H

Habitat choice, 10, 11, 13, 15, 16, 19, 58  
 Habitat degradation, 132  
 Haeckel, Ernst, 294, 304, 305, 341  
 Haldane, J. B. S., 139, 292  
 Hard, Jeffrey J., 86-87, 129-147  
 Harvest of wild populations. *See also*  
   Fishing/Fisheries; Hunting;  
   Unnatural selection  
 and intensity of sexual selection, 136, 143  
 management challenges, 132, 141, 145-146  
 and mate choice, 142-144  
 recovery from, 146-147  
 specimen collection, 141  
 sustainable, 131, 132, 134, 146  
 Haw fly, 54  
 Hawaiian silversword, 28  
 Hawkmoths, 31-32, 34  
*Helianthus paradoxus*, 50  
*Heliconius* butterflies, 50-51  
 Hemoglobin, 150, 312, 318  
 Hempel, C. G., 274, 299  
 Hennig, Will, 326  
 Herschel, John F. W., 293  
 Heterochrony, 44  
 Heteroloboseans, 68  
 Heterosis, 51  
 Hitchhiking  
   divergence, 2, 5, 6, 14-19, 21-22, 23-24, 25, 153  
   selective sweep, 15  
 Hodge, Jonathan, 288, 289, 304  
 Hodges, Scott A., 2-3, 27-45  
 Hofstadter, Douglas, 352  
 Honeycreeper birds, 28  
 Horse (*Equus caballus*), 85, 98-99, 102-103  
 House mouse (*Mus domesticus*), 96-97, 102-103, 106  
 House sparrow (*Passer domesticus*), 96-97, 102-103, 106  
 Hubbell, Stephen A., 166, 213-241  
 Human evolution, 115, 284-285, 290, 310, 311, 322-323  
 Humboldt, Alexander von, 331  
 Hummingbirds, 31, 34  
 Hunting  
   bighorn sheep, 140-141  
   deer, 138, 140, 143  
   fox, 139  
   game, 137  
   genetic effects of, 138-141  
   natural mortality, 134  
   no-take protected areas, 147  
   selection effects, 86, 129, 130, 134, 137-141, 142, 143  
   sexual selection, 130, 137-138, 142, 143  
   trophy, 130, 137, 138, 140, 147  
 Huxley, Thomas Henry, 288-289, 290, 292, 293, 294, 296, 298, 301, 302, 303, 341  
 Hybrids/hybridization  
   Dobzhansky-Muller incompatibilities, 53-54  
   fecundity, 16  
   fitness, 51, 52  
   genetic dissection of traits, 29, 30  
   *Mimulus* flower color studies, 29  
   selection against, 13, 14, 16, 19, 260-261  
   sterility genes, 18, 22  
   vigor, 51  
 Hypotheses  
   consistency with commonly accepted hypotheses and theories, 277-278  
   explanatory value, 276-277  
   falsifiability, 178-179, 283-284, 326  
   imagination and corroboration, 274-276  
   internal consistency, 276  
   law of likelihood, 316-318  
   revolutionary examples, 277  
   testing, 276-279



Hypothetical-deductive method, 263-264,  
273-276, 282-285

## I

Ichneumon (*Herpestes ichneumon*), 102-103

Iltis, Hugh, 114

Indian elephant (*Elephas maximus*), 102-103

Indirect-benefits models, 177-179, 217, 218

Individual selection, 310

Induction and empiricism, 263, 264, 267,  
268, 269-271, 272-273, 275, 276, 283,  
293

Intelligent design, 296, 308, 325, 346, 354

Intensity of sexual selection

Bateman gradients, 184, 185, 186, 187-  
188, 192, 193, 197, 201

crowding of sexual receptivity, 191,  
208-209

Darwin's perspective, 163, 182-183, 192  
ecological factors, 185-187, 197, 204, 208,  
209

environmental potential for polygamy,  
185, 186, 197, 204, 208, 209

harvesting of wild populations and,  
136, 143

lineage differences in color and  
morphology and, 171, 182-183

mate searching algorithms and, 186

mating differentials, 184, 185-187

multiple mating rates, 187, 194, 215

nuptial gifts and, 187

parental investment theory, 185, 187,  
192, 198, 201-202, 203-204, 215-216,  
218, 232, 243

research advances, 169, 183-184, 189

research needs, 188-189, 190

secondary sexual characteristics, 182  
selection coefficients, 184-187

sex difference in opportunity for  
selection, 191, 202-204, 208

sex ratios and, 142-143, 186, 188, 194,  
197-201, 203, 204, 206-208

sex-role-reversed taxa, 193, 204, 205

sexual conflict and, 187, 201

sexual dimorphism and, 166, 171, 182-  
183, 192, 210

spatial and temporal distribution of  
matings, 192, 204-208

Intersexual selection. *See* Mate choice;  
Postcopulatory sexual selection

Intrasexual conflict

female-female combat, 172, 215

male-male combat, 140, 166, 172, 173,  
184, 212, 214

in plants, 196-197, 260

sexual dimorphism and, 192

sperm competition, 166, 194, 198, 243,  
244, 247, 255, 256, 257, 258

Invasive species, 132

*Ipomoea*, 37

ISI Web of Science, 29

## J

Jacob, François, 272, 275, 276

Jefferson, Thomas, 331

Jevons, William Stanley, 274

Joint Genome Institute, 44

Jones, Adam G., 165, 169-190

Judson, Olivia, 265-266

Jungle cat (*Felis chaus*), 102-103

## K

Keeling, Patrick, 3, 65-84

Kekulé, Friedrich, 275

Kin selection, 311

Kinetoplast DNA, 78, 80

Kinetoplastids, 66, 67, 73-76, 77, 78, 79, 80,  
81-82

*Kitlg* gene, 56-57, 59

Kuhn, Thomas, 288, 299, 301, 302, 303

## L

Lactamase enzyme, 158

Lactonase enzyme, 160

Lake Malawi, 28

Lake Victoria, 28, 54

Lake whitefish (*Coregonus clupeaformis*),  
14, 51

Lamarck, Jean Baptiste de, 308, 332, 336

Lamarckism, 292, 308, 311, 332

Land snail (*Helix pomatia*), 141

Lankester, E. Ray, 294

Largemouth bass (*Micropterus salmoides*),  
136

Leafy sea dragon (*Phycodurus eques*), 182

Leander, Brian, 3, 65-84

*Leishmania*, 66

Leopard (*Panthera pardus*), 102-103  
 Lepidoptera, 256  
*Leptoclinis*, 67  
*Leptomonas*, 67  
 Lewes, G. H., 314  
 Lewontin, Richard, 297, 303  
 Lion (*Panthera leo*), 102-103  
 Lloyd, Lisa, 297  
 Lock-and-key hypothesis, 251, 253  
 Lukeš, Julius, 3, 65-84  
 Lyell, Charles, 315, 332  
 Lysins, 258, 261

## M

Macdonald, David, 85-86, 89-109  
 Maize (*Zea mays* ssp. *mays*) domestication  
   chromosome morphology and number,  
     114  
   data analysis, 126-127  
   evolutionary process, 86, 116-119  
   flowering time, 119  
   genome diversity of teosinte, 111,  
     115-116  
   genome sequencing, 124  
   HapMap, 124  
   kernel oil content, 119  
   landrace collections, 124  
   large-effect vs. small-effect loci, 112,  
     116-119  
   morphology, 86, 112-113, 116, 117-118  
   origins, 86, 112-115, 117, 118-119  
   plant materials and DNA sequencing,  
     125-126  
   QTL analysis, 116-117, 118, 119  
   research needs, 111, 123-125  
   selective sweep on chromosome 10, 86,  
     111, 119-123, 125-127  
   starch biosynthesis, 118-119  
   Teosinte Hypothesis, 114-115, 116  
   tomato domestication compared, 116  
   Tripartite Hypothesis, 113-114, 116  
   yellow color, 123  
 Male-male combat, 140, 166, 172, 173, 184,  
   212, 214, 246, 247-250  
 Malthus, Thomas Robert, 293, 332  
 Mangelsdorf, Paul, 113, 114  
 Marbled polecat (*Vormela peregusna*),  
   102-103  
 Mate choice  
   anisogamy theory, 231-232

assortative mating, 9, 10, 25, 50-51, 54,  
   58, 89, 107, 108, 174-176  
 condition-dependent indicator (good  
   genes) model, 178-179, 180, 217  
 condition-independent indicator model,  
   179, 180  
 costs of, 181, 219  
 Darwin-Fisher model, 174-176  
 Darwin's view, 169, 173-174  
 direct-benefits models, 176-177, 180  
 divergent selection for, 25, 50  
 ecological constraints, 9, 10-11, 25, 50,  
   166, 216  
 empirical examples, 176  
 Fisherian model, 177-178, 180  
 fitness distributions, 166, 213, 214-215,  
   216-217, 219-221, 224-227  
 genetic compatibility model, 179,  
   180  
 harvesting of wildlife and, 142-144  
 indirect-benefits models, 177-179, 217,  
   218  
 latency in mating, 166, 213, 215, 216,  
   219, 220, 225, 226, 227, 229, 234, 235,  
   236, 237-238, 240-241  
 ornaments and fancy traits, 173, 175,  
   177-178, 179, 180, 181, 186, 189, 214,  
   217-218, 232-233  
 parental investment theory and, 232  
 plant mating systems, 197-198  
 progress in research, 169, 174, 180,  
   189  
 reproductive compensation hypothesis,  
   217  
 research needs, 181, 190  
 sensory exploitation model, 179, 180  
 sex ratios, 198, 213, 225-226  
 sex role behavior and, 214-218, 231-232,  
   233  
 sexual conflict model, 179-180  
 survival probability, 166, 178, 213, 214,  
   215, 216, 219, 225, 226, 228, 234, 236,  
   240, 241  
 switch point theorem, 166, 218, 219-241  
 time available for mating and, 166, 213,  
   219, 227, 230  
 Mate searching algorithms, 186  
 Mating  
   compatibility measurement, 55  
   differentials, 184, 185-187, 214-215, 231,  
     249-250  
   ecological factors, 185-187

- latency, 166, 213, 215, 216, 219, 220, 225, 226, 227, 229, 234, 235, 236, 237-238, 240-241
- mass, 210
- multiple mating rates, 187, 194, 215
- spatial and temporal distribution, 192, 204-208
- time available for, 166, 213, 219, 227, 230
- Mating system analyses
- animal, 166, 191, 192-193, 197-200
  - common ground for plant and animal systems, 209-212
  - covariance methods, 201-202
  - crowding of sexual receptivity, 191, 208-209
  - Darwin's contribution, 166, 191, 192, 194-195
  - mass matings, 210
  - molecular markers, 165, 189
  - plant, 166, 191, 192, 195-197
  - quantitative methodology, 191, 192, 201-212
  - research needs, 188
  - sex difference in opportunity for selection, 191, 202-204, 208
  - spatial and temporal distribution of matings, 192, 204-208
- Mayr, Ernst, 6, 48, 251-252
- Maximum likelihood methods, 30
- Memes, 351
- Mendel, Gregor, 34, 273, 274
- Menidia menidia*, 147
- Mesolithic, animal domestication, 89
- Mice, 51, 96-97, 102-103, 106, 176, 217, 227
- Migration/migrants, 13, 15-17, 19, 49-50
- Mill, James, 338
- Mill, John Stuart, 263, 268, 272
- Milton, John, 340-341
- Mimulus*
- M. aurantiacus*, 37
  - M. cardinalis*, 29, 51
  - M. guttatus*, 51, 53
  - M. lewisii*, 29, 51
- Minixons, 73-74, 82
- Minimum-evolution principle, 326
- Mitochondrion, 78-82
- Mockingbirds, 2, 28, 332
- Molecular clock, 162
- Molecular markers, 165, 189
- Molecular phylogenetics, 29
- Monkeyflowers, 29, 37, 51
- Monophyletic clades, 2, 20, 28, 29, 39, 59, 66, 107
- Morgan, Lloyd, 338
- Morris, Simon Conway, 298, 346
- Mouflon (*Ovis orientalis*), 94, 96-97, 102-103
- mRNA, polycistronic processing, 74-76, 81, 82
- Muller, H. J., 6
- Multidimensional scaling analysis, 60, 62
- Museum d'Histoire Naturelle, 298
- Mutations
- beneficial, 52, 149, 151, 153-154, 156, 157, 158-160, 161, 162
  - color variation in flowers, 37-38
  - deleterious, 52, 76, 117, 151, 153, 156, 157, 158, 161, 162, 312
  - divergent selection under, 49
  - duplications, 30, 39, 76, 83
  - gain of function, 36
  - global suppressor, 158
  - loss-of-function, 29, 35-37, 38
  - neutral, 87, 149, 151, 153, 156, 157, 158, 159-160, 161, 162-163, 252, 312, 318, 324
  - parallel selection, 53
  - pleiotropic, 52
  - selective sweeps, 14, 15, 24, 117
  - speciation by, 47, 49, 52, 53, 63-64
  - stability-mediated epistasis, 87, 149, 157-159, 162
  - substitutions, 22, 30, 81, 150-151, 154, 159, 160, 161, 162, 163, 285
  - transpositions, 30
- Myoglobin, 150
- Myzocytosis, 77
- ## N
- Nagel, Thomas, 346
- Narwhals, 172
- Natufians, 95
- Natural selection
- codiscovery claims, 290-291
  - and common ancestry, 264, 312-315, 321-328
  - and complexity, 308-309, 325
  - Darwin's legacy, xvi, 1-2, 28, 48, 214, 271, 275-276, 280-284, 293, 296, 312-328, 334-340
  - defined, 91, 214
  - and domestication, 86, 89, 91, 96-99, 100

- genomic effects, 10
- group selection hypothesis, 310-311, 334, 338-339
- individual selection, 310
- as intelligent and moral force, 264-265, 295-296, 297, 298, 310-312, 329, 330, 332-340
- intensity, 136
- process in ecological speciation, 8-9
- “random” variation, 309
- sexual selection combined, 132, 136, 165, 171, 248
- stabilizing, 9, 22, 52, 154-155, 158, 159, 162-163
- “survival of the fittest,” 308
- tree thinking, 328
- uniform or balancing, 9, 20, 25, 48, 22-23
- Neolithic
  - domestication of animals, 86, 89, 90, 93-98, 106, 107-108
  - preadaptive features of fauna, 102-103
- Neutral theory of evolution, 66, 69, 81-82, 83, 120, 122-123, 162
- Newton, Isaac, xv, 269, 274, 275, 329, 343
- Newton’s laws, 270
- Newtonian mechanics, 277, 283, 304
- Nicotiana tobacum*, 36, 38
- Nubian wild ass (*Equus asinus africanus*), 98-99, 102-103
- Nuclear genome characteristics, 73-76
- Nuptial gifts, 187
  
- O**
- O’Brien, Stephen J., 85-86, 89-109
- Odysseus (Ody)* gene, 18
- Offspring viability, 166, 178, 184, 217, 218, 220, 232, 321
- Oken, Lorenz, 288
- Opsin gene, 54
- Orangutans, 285
- Orchids, xv, 271, 282, 283, 284, 303
- Osborn, Henry Fairfield, 288, 294
- Outcrossing, 195-196, 210
- Oxyrrhis*, 80
  
- P**
- Paley, William, xvi, 281, 282, 325
- Pan-editing, 83
- Pandalid shrimp, 210
- Parallel selection
  - with gene flow, 53, 56, 59, 60
  - mutations, 53
  - of reproductive isolation, 53, 54, 55, 56, 59, 60, 63, 64
  - threespine stickleback, 55, 56, 59, 60, 63
- Parasperm, 256-257
- Parental investment theory, 184, 185, 187, 192, 198, 201-202, 203-204, 215-216, 218, 232, 243
- Parker, Geoff, 244-245
- Pascal, Blaise, 273
- Pasteur, Louis, 274
- Pauling, Linus, 150, 151, 161
- Pea aphids, 10, 13-17, 50, 51
- Peacocks, 165, 178, 214, 250
- Peirce, Charles S., 274
- Pelargonidins, 33, 35, 36, 38
- Penrose, Roger, 346
- Peranema*, 70, 71
- Persian fallow deer (*Dama mesopotamica*), 102-103
- Persian onager (*Equus hemionus hemippus*), 102-103
- Petunia*, 36, 40-41, 42
  - P. axillaris*, 36
- Phacus*, 70
- Phosphotriesterase enzyme, 160
- Photoreceptors, 72
- Photosynthesis, 67-68, 73
- Phylogeny
  - Aquilegia*, 33
  - disciplines contributing to, 284
  - minimum-evolution principle for inferring, 326
  - tree thinking, 328
- Pig (*Sus domesticus*), 94, 96-97, 108
- Pigeon (*Columba livia*), 85, 96-97, 322
- Plantinga, Alvin, 346-348, 353
- Plants. *See also* Flowering plants
  - herbivore resistance, 36
  - UV protection, 36
- Plasmodium*, 67
- Plastids, 67, 77-78
- Plato, 289, 296
- Pleiotropy, 10, 25, 36, 42, 50, 51, 52, 64, 161, 251-252
- Pleistocene, 93, 94, 96
- Ploetia*, 70
- Polar bears, 93, 308, 323
- Pollinators, 31-34, 44, 51

- Polycistronic mRNA processing, 74-76, 81, 82
- Polygamy, environmental potential for, 185, 186, 197, 204, 208, 209
- Polykrikos*, 70, 71
- Polyploidy, 9
- Polyspermy, 258
- Popper, Karl, 274, 283, 326
- Population genetic theory, 115
- Population pressure, 332
- Postcopulatory sexual selection  
analysis of effects of, 205  
courtship behavior during and after copulation, 243-244, 253-255  
cryptic female choice, 166-167, 243, 244, 245, 247-248, 249, 250, 252, 256-257, 258, 259, 260, 261  
Darwin's omission, 166, 244-245  
defined, 171  
egg-sperm molecular interactions, 243, 257-260  
evolutionary consequences, 243, 250-261  
female effects on male-male competition, 246, 247-250  
flowering plants, 243, 260-261  
free-spawning species contrasted, 258  
genital evolution, 243, 248-249, 250-253  
male contact organs, 243, 253, 254  
parasperm, 256-257  
and parental investments, 184, 243  
research needs, 189  
seminal products, 243, 257  
sensory traps, 248-249  
sexually antagonistic coevolution, 248-250, 252-253, 254, 255, 257, 258-259, 260, 261  
sperm competition, 166, 194, 198, 243, 244, 245, 247, 255, 256, 257, 258  
sperm morphology, 255-257
- Proanthocyanidins, 36
- Productivity, 131, 134, 136, 142, 145, 146, 217, 218, 220, 232, 334
- Prokaryotes, nuclear gene expression, 74  
*Prorocentrum*, 70, 71
- Protein evolution. *See* Adaptive protein evolution; Directed protein evolution
- Protists. *See also* Alveolata; Euglenozoa  
convergent evolution in cellular organization, 3, 65, 66, 68-73  
phylogenetic diversity, 3, 82  
*Protopteridinium*, 67  
Provine, William, 289  
*Pundamilia neyereri*, 54  
*Pundamilia pundamilia*, 54
- ## Q
- Quantitative methodology, mating system analysis, 191, 192, 201-212
- Quantitative trait loci analysis  
ecological speciation under divergent selection, 11, 12, 13, 14-25, 50  
flower color, 43, 44, 51  
maize origins, 116-117, 118, 119
- ## R
- Ratterman, Nicholas L., 165, 169-190
- Red alga, 77
- Red clover, 13-17
- Red deer (*Cervus elaphus*), 102-103, 138, 140, 143
- Red fox (*Canis vulpes*; *Vulpes vulpes*), 102-103, 139
- Reeves, Robert, 113, 114
- Reproductive compensation hypothesis, 217
- Reproductive isolation. *See also* Ecological speciation  
assortative mating, 50-51, 89  
behavioral, 89  
divergent selection to alternate environments, 9, 11, 12, 19-22, 28, 29, 49, 58  
Dobzhansky-Muller incompatibilities, 6-7, 22, 23, 24, 25, 53-54, 295  
Fisher-Orr geometric model of adaptation, 52-53  
genetics of, 49-53  
immigrant inviability, 15-16, 49-50  
intrinsic, 51, 52, 53, 63  
mutation-order speciation, 63-64  
parallel speciation, 53, 54, 55, 56, 59, 60, 63, 64  
postzygotic, 3, 23, 24, 25, 47, 48, 49, 51-53, 58, 63  
prematuring/prezygotic, 25, 47, 48, 49-51, 55, 58, 63, 64
- Resource-based divergence, 10, 11, 16, 19, 25
- Rice, 112, 123

- Richards, Robert J., 264-265, 288-289, 329-341
- RNA editing and processing, 66, 73-76, 78-83
- Roberts, Richard, 277
- Rock dove, 96-97, 322
- Roe deer, 140
- ROSEA1 gene, 42
- ROSEA2 gene, 42
- R2R3-myb transcription factor, 36, 40, 41
- Ruppell's fox (*Vulpes ruppellii*), 102-103
- Ruse, Michael, 264, 287-305, 329, 337-338
- S**
- Sackler, Arthur M., vii-viii. *See also* Arthur M. Sackler Colloquium
- Sackler, Jillian, vii, viii
- Salmon, 135, 136, 142, 143, 144-145, 147
- Salt tolerance gene, 50
- Sand cat (*Felis margarita*), 102-103, 104
- Scarab beetles, 172
- Schluter, Dolph, 3, 47-64
- Scientific method. *See also* Hypotheses
- Darwin's legacy, 263-264, 267-271, 272, 282-283, 318, 323-328
  - hypothetical-deductive method, 263-264, 273-276, 282-285
  - induction and empiricism, 263, 264, 267, 268, 269-271, 272-273, 275, 276, 283, 293
- Sea urchins, 257, 258, 259
- Searle, John, 346
- Seahorses (*Hippocampus*), 182, 204
- Sebright, John, 291
- Secondary sexual characteristics, 182
- Sebright, James, 291
- Selective breeding, 108-109. *See also* Domestication
- Selenidium*, 67
- Self-incompatibility, 195, 196
- Selfing, 195-196, 210, 260
- Self-splicing introns, 77
- Sensory exploitation model, 179, 180
- Sensory traps, 248-249
- Sex differences
- in fitness, 214-218
  - in opportunity for selection, 191, 202-204, 208
- Sex ratios, 142-143, 186, 188, 194, 197-201, 203, 204, 206-208, 213, 225-226
- Sex roles, 193, 198, 203, 204, 205, 214-218, 230, 231-232, 233, 255
- Sexual conflict. *See also* Intersexual; Intrasexual
- and intensity of sexual selection, 187, 201
  - mate choice model, 179-180
- Sexual dimorphism, 166, 171, 173, 175, 177-178, 179, 180, 181, 182-183, 186, 189, 192, 210, 214, 217-218, 232-233
- Sexual receptivity, crowding of, 191, 208-209
- Sexual selection. *See also* Intensity of sexual selection; Intrasexual conflict; Mate choice; Mating system analysis; Postcopulatory sexual selection
- age structure in, 188, 250
  - contextual models of multilevel selection, 202
  - Darwin's legacy, xi, 163, 165, 169, 170-171, 172, 173-174, 182-183, 189, 192, 193, 214
  - defined, 91, 165, 170, 191
  - ecological factors, 185
  - Fisher's runaway hypothesis, 202
  - group structure or membership and, 202
  - harvesting of wild animals and, 130, 137-139, 140, 142-145
  - in ecological speciation, 9, 10, 50
  - lock-and-key hypothesis, 251, 253
  - mechanisms, 172-181
  - monogamous, 174-175, 176
  - and natural selection, 132, 136, 165, 171, 248
  - plants, 191, 192, 195-197, 209-212, 260-261
  - pleiotropism theory, 251-252
  - polygamous, 100, 183, 185, 186, 197, 204, 208, 209, 210, 211, 212, 215
  - precopulatory, 171, 185, 189
  - quantitative approaches, 193-194
  - research needs, 190
  - sex roles, 193, 198, 203, 214, 215-217, 218, 230, 231, 255
  - species isolation hypothesis, 251-252, 258-259, 260, 261
- Sexually antagonistic coevolution, 248-250, 252-253, 254, 255, 257, 258-259, 260, 261
- Sheep (*Ovis aries*), 94, 96-97, 102-103
- Shuster, Stephen M., 166, 191-212

- Sialia sialis*, 215  
 Sickle cell anemia, 150  
 Singer, Peter, 296-297  
 Skull sutures, 327  
 Sober, Elliott, 264, 297, 307-328  
 Social Darwinism, 296  
 Sockeye salmon (*Oncorhynchus nerka*), 136, 143, 144-145  
 Socrates, xvi  
*Sod* gene, 123  
 Spandrels, 318  
 Speciation. *See also* Ecological speciation  
   allopatric, 6, 9-10, 20, 22, 23, 24-25, 28, 107  
   defined, 15, 48  
   error-then-solution model, 83  
   mechanisms, 48-49  
   models, 48, 54  
   mutation-order, 47, 49, 53-54, 63-64, 83  
   rates, 53, 54  
   sympatric, 2, 5, 9, 13, 24-25, 51, 89, 92, 106-108, 259  
 Species isolation hypothesis, 251-252, 258-259, 260, 261  
 Spencer, Herbert, 270, 291-292, 296, 336, 341  
 Sperm  
   competition, 166, 194, 198, 243, 244, 245, 247, 255, 256, 257, 258  
   morphology, 255-257  
 Spliced leaders (minixons), 74, 82  
 Spliceosomal introns, 74-75  
 Sponge shrimp (*Spongocola* spp.), 210  
 Stability-mediated epistasis, 87, 149, 157-159, 162  
 Standing genetic variation, 3, 47, 49, 58-63, 64, 64  
 Steppe polecat (*Mustela eversmanni*), 102-103  
 Stevens, Natalie M., 86, 111-127  
 Stramenopiles, 68  
 Sunflower, 50  
 "Survival of the fittest," 308  
 Survival probability, 166, 178, 213, 214, 215, 216, 219, 225, 226, 228, 234, 236, 240, 241  
 Switch point theorem  
   alternative to anisogamy theory, 231-232  
   alternative to parental investment theory, 232  
   changing more than one parameter at a time, 227, 229  
   derivation, 222-224, 234-241  
   fitness distributions, 219-220, 224-225, 232  
   flexible reproductive decisions in both sexes, 231  
   model description, 221-222, 227, 230  
   number of potential mates, 225-226  
   predictability of fancy male traits, 232-233  
   reproductive time budgets, 219  
   results, 224-227, 240-241  
   sensitivity analysis, 228, 240  
   sex role ecology, 233  
   survival probability, 226-227, 228  
   time available for mating, 219, 227, 230  
*Symbiodinium*, 67  
 Sympatric speciation, 2, 5, 9, 13, 24-25, 51, 89, 92, 106-108, 259  
*Syngnathus typhle*, 182, 201  
 Syrian onager (*Equus hemionus hemionus*), 102-103
- ## T
- Taurine cattle (*Bos taurus*), 96-97, 102-103  
 Temin, Howard, 277  
 Teosinte (*Zea mays* ssp. *parviglumis*). *See also* Maize domestication  
   chromosome morphology and number, 114  
   *Euchlaena* classification, 113  
   genome diversity, 111, 115-116  
   hypothesis, 114-115, 116  
   morphology, 86, 112-113  
   mutation rate, 115  
   peographical distribution, 126  
   selective sweep on chromosome 10, 86, 111, 119-123  
*Teosinte branched1* (*tb1*) gene, 117-118, 122, 125  
*Teosinte glume architecture1* (*tga1*) gene, 116-117, 122, 123, 125, 127  
 Terrestrial slugs, 210  
 Tetrapody, 326-327  
 Thermostable chorismate mutase, 158  
 Threespine stickleback (*Gasterosteus aculeatus*)  
   assortative mating, 58  
   body size, 55, 58  
   defensive body armor, 55, 56-57, 58-59, 62-63  
   ecological speciation, 47, 49, 51, 55-63  
   freshwater-marine hybridization, 3



## 414 / Index

- gene flow, 56, 59, 60, 62  
 hybrid fitness, 51, 58  
 male parental care, 204  
 multidimensional scaling analysis, 60, 62  
 parallel speciation, 55, 56, 59, 60, 63  
 phylogenies of populations and genes, 56-57  
 postzygotic isolation, 58  
 premating isolation, 55, 58, 63  
 selection from standing genetic variation, 47, 58-63  
 skin pigmentation, 56-57, 59  
 transporter hypothesis, 59-63  
 Tian, Feng, 86, 111-127  
 Tigers, 93, 310  
 Tomato, 116  
*Toxoplasma*, 67  
 Trans-splicing, 73, 74-75, 76, 78, 81  
 Tree snails (*Liguus* and *Orthicalus* spp.), 141  
 Trichocysts, 70, 71  
 Tripartite hypothesis, 113-114, 116  
*Tripsacum*, 113-114, 121  
   *T. dactyloides*, 122, 126, 127  
 tRNA, 80  
*Trypanosoma*, 66, 74  
   *T. brucei*, 76, 80, 83  
 Turing, Alan, 265, 343, 345-346, 348, 350, 353  
 2-ODDs gene family, 39-40
- U**
- UDP flavonoid glucosyltransferase, 34, 35  
 Uniform or balancing selection, 9, 20, 25, 48  
 University of Cambridge, xvi, 279, 281, 298, 299, 331  
 Unnatural selection in harvested wildlife  
   artificial selection compared, 86, 87, 130, 135  
   Darwin's legacy, 86-87, 130-131, 132  
   defined, 131-132  
   and dispersal/migration, 131, 143  
   fishing, 86, 129, 130-131, 134-137, 142-143  
   genetic effects on populations, 129, 130, 133, 138-141  
   history of, 132-141  
   hunting, 86, 129, 130, 134, 137-141, 142, 143  
   intensity, 134, 136-137  
   and management practices, 131, 145-147  
   recovery from overharvesting, 129-130, 146-147  
   and sexual selection, 130, 137, 138-139, 140, 142-145  
   from specimen collection, 141  
   and sustainability, 129  
   traits likely to be affected, 86, 129, 131
- V**
- VENOSA* gene, 42  
 Via, Sara, 2, 5-26  
 Virus-induced gene silencing, 43
- W**
- Wallace, Alfred Russel, 271, 290-291, 293-294, 308, 335, 341  
*waxy* gene, 123  
 Weasel (*Mustela nivalis*), 102-103  
 Whewell, William, 274, 293, 303  
 Wild boar (*Sus scrofa*), 93, 96-97, 102  
 Wildcat, 98-99, 101, 102-103, 104-106  
 Wilkes, H. G., 114  
 Wilson, Edward O., 296  
 Windermere pike (*Esox lucius*), 137  
*wingless* gene, 50, 51  
 Wollaston, T. V., 336  
 Wright's island model, 10
- Y**
- Yeast, 51  
 Young, Robert M., 290  
 Young earth creationists, 296  
 Younger Dryas, 95
- Z**
- Zeboid cattle (*Bos indicus*, *Bos primigenius namadicus*), 97-98  
 Zuckerkandl, Emile, 150, 151, 161