



Joint International Light Rail Conference--Growth and Renewal

DETAILS

0 pages | null | PAPERBACK

ISBN 978-0-309-43010-4 | DOI 10.17226/22939

AUTHORS

BUY THIS BOOK

FIND RELATED TITLES

Visit the National Academies Press at NAP.edu and login or register to get:

- Access to free PDF downloads of thousands of scientific reports
- 10% off the price of print titles
- Email or social media notifications of new titles related to your interests
- Special offers and discounts



Distribution, posting, or copying of this PDF is strictly prohibited without written permission of the National Academies Press. (Request Permission) Unless otherwise indicated, all materials in this PDF are copyrighted by the National Academy of Sciences.

TRANSPORTATION RESEARCH
CIRCULAR

Number E-C145

July 2010

**Joint International
Light Rail Conference**

Growth and Renewal

April 19–21, 2009
Los Angeles, California

Cosponsored by
Transportation Research Board
American Public Transportation Association

TRANSPORTATION RESEARCH BOARD
OF THE NATIONAL ACADEMIES

**TRANSPORTATION RESEARCH BOARD
2010 EXECUTIVE COMMITTEE OFFICERS**

Chair: Michael R. Morris, Director of Transportation, North Central Texas Council of Governments, Arlington

Vice Chair: Neil J. Pedersen, Administrator, Maryland State Highway Administration, Baltimore

Division Chair for NRC Oversight: C. Michael Walton, Ernest H. Cockrell Centennial Chair in Engineering, University of Texas, Austin

Executive Director: Robert E. Skinner, Jr., Transportation Research Board

**TRANSPORTATION RESEARCH BOARD
2010–2011 TECHNICAL ACTIVITIES COUNCIL**

Chair: Robert C. Johns, Associate Administrator and Director, Volpe National Transportation Systems Center, Cambridge, Massachusetts

Technical Activities Director: Mark R. Norman, Transportation Research Board

Jeannie G. Beckett, Director of Operations, Port of Tacoma, Washington, *Marine Group Chair*

Cindy J. Burbank, National Planning and Environment Practice Leader, PB, Washington, D.C., *Policy and Organization Group Chair*

Ronald R. Knipling, Principal, safetyforthelonghaul.com, Arlington, Virginia, *System Users Group Chair*

Edward V. A. Kussy, Partner, Nossaman, LLP, Washington, D.C., *Legal Resources Group Chair*

Peter B. Mandle, Director, Jacobs Consultancy, Inc., Burlingame, California, *Aviation Group Chair*

Mary Lou Ralls, Principal, Ralls Newman, LLC, Austin, Texas, *Design and Construction Group Chair*

Daniel L. Roth, Managing Director, Ernst & Young Orenda Corporate Finance, Inc., Montreal, Quebec, Canada, *Rail Group Chair*

Steven Silkunas, Director of Business Development, Southeastern Pennsylvania Transportation Authority, Philadelphia, Pennsylvania, *Public Transportation Group Chair*

Peter F. Swan, Assistant Professor of Logistics and Operations Management, Pennsylvania State, Harrisburg, Middletown, Pennsylvania, *Freight Systems Group Chair*

Katherine F. Turnbull, Executive Associate Director, Texas Transportation Institute, Texas A&M University, College Station, *Planning and Environment Group Chair*

Daniel S. Turner, Professor, University of Alabama, and Director, University Transportation Center for Alabama, Tuscaloosa, *Operations and Maintenance Group Chair*

TRANSPORTATION RESEARCH CIRCULAR E-C145

Joint International Light Rail Conference *Growth and Renewal*

April 19–21, 2009
Los Angeles, California

Cosponsored by
Transportation Research Board and
American Public Transportation Association

July 2010

Transportation Research Board
500 Fifth Street, NW
Washington, DC 20001
www.TRB.org

TRANSPORTATION RESEARCH CIRCULAR E-C145

ISSN 0097-8515

The **Transportation Research Board** is one of six major divisions of the National Research Council, which serves as an independent adviser to the federal government and others on scientific and technical questions of national importance. The National Research Council is jointly administered by the National Academy of Sciences, the National Academy of Engineering, and the Institute of Medicine. The mission of the Transportation Research Board is to provide leadership in transportation innovation and progress through research and information exchange, conducted within a setting that is objective, interdisciplinary, and multimodal.

The **Transportation Research Board** is distributing this circular to make the information contained herein available for use by individual practitioners in state and local transportation agencies, researchers in academic institutions, and other members of the transportation research community. The information in this circular was taken directly from the submission of the authors. This document is not a report of the National Research Council or of the National Academy of Sciences.

Public Transportation Group

Karla H. Karash, *Chair*

2009 Joint Light Rail Conference Planning Committee

John Wilkins, *Chair*

Chair, TRB Light Rail Transit Committee

Director, Capital Planning (retired), New Jersey Transit Corporation, Newark

Winston Simmonds, *Vice Chair*

Chair, APTA Light Rail Transit Technical Forum

Rail Operation—Engineering Officer, Port Authority of Allegheny County, Pittsburgh, Pennsylvania

Harvey Berliner, *InfraCounsel LLC*

Jack W. Boorse, *Parsons Brinckerhoff*

Danielle Boutier, *Los Angeles County*

Metropolitan Transportation Authority

Thomas J. Carmichael, *Los Angeles County*

Metropolitan Transportation Authority

Thomas B. Furmaniak, *LTK Engineering Services*

Thomas R. Hickey, *Metropolitan Transit Authority of Harris County*

Charles Joseph, *Sound Transit*

Jeffrey LaMora, *Utah Transit Authority*

Thomas F. Larwin, *Larwin Consulting*

Anthony Loui, *Federal Transit Administration*

Thomas G. Matoff, *LTK Engineering Services*

Paul O'Brien, *Utah Transit Authority*

Martin P. Schroeder, *American Public*

Transportation Association

John Schumann, *LTK Engineering Services*

Gregory L. Thompson, *Florida State University*

Peter Shaw, *TRB Staff Representative*

Mary Kissi, *Senior Program Associate, LRT Conference Proceedings Coordinator*

Transportation Research Board

500 Fifth Street, NW

Washington, DC 20001

www.TRB.org

Glenda J. Beal, Production Editor; A. Regina Reid and Jennifer Corroero, Proofreading and Layout

Foreword

The National Joint Light Rail Transit Conference: Growth and Renewal is the 11th conference of the Transportation Research Board series that began in Philadelphia in 1975. The American Public Transportation Association became a cosponsor in 1995.

At the Philadelphia conference, the technical sessions focused on introducing—or reintroducing—the concept of light rail transit (LRT) in North America. At that time there were eight systems in operation. Now, 34 years later, there are 30 systems in operation and eight systems in the planning, design, or construction phase in North America.

The focus and related topics of the previous 10 national conferences have paralleled the development and reintroduction of LRT in North America:

- Introduction to LRT—1st National Conference, Philadelphia, Pennsylvania, 1975;
- Light Rail Transit: Planning and Technology—2nd National Conference, Boston, Massachusetts, 1978;
- Light Rail Transit: Planning, Design, and Implementation—3rd National Conference, San Diego, California, 1982;
- Light Rail Transit: System Design for Cost-Effectiveness—4th National Conference, Pittsburgh, Pennsylvania, 1985;
- Light Rail Transit: New System Successes at Affordable Prices—5th National Conference, San Jose, California, 1988;
- Light Rail Transit: Planning, Design, and Operating Experience—6th National Conference, Calgary, Canada, 1992;
- Building on Success, Learning from Experience—7th National Conference, Baltimore, Maryland, 1995;
- Light Rail: Investment for the Future—8th National Conference, Dallas, Texas, 2000;
- Light Rail: Experience, Economics, and Evolution: From Starter Lines to Growing Systems—9th National Conference, Portland, Oregon, 2003; and
- Light Rail Transit: A World of Applications and Opportunities—10th National Conference and First Joint International Light Rail Conference, St. Louis, Missouri, April, 2006.

The technical information in the proceedings of these conferences (*1–10*) provides planners, designers, decision makers, and operators with a valuable collection of experiences and ingredients necessary for a successful transit development project.

More than 350 public transportation industry experts from across the country met at the Los Angeles Millennium Biltmore Hotel in downtown Los Angeles for the 2009 Joint Light Rail Conference, April 19–21. Sponsored by the Transportation Research Board and the American Public Transportation Association and hosted by the Los Angeles County Metropolitan Transportation Authority, the conference focused on the demands of rapidly growing light rail systems.

With 15 sessions, five tours, a workshop, and a products and services showcase, the conference offered up-to-date information on planning, design, construction,

maintenance, and operations involved in running a light rail system. Research papers and MTA exhibits were presented at a special “Meet the Authors” poster paper session.

The objective of each conference is to add to the growing body of knowledge and real-world experiences with modern LRT applications in order to improve continually new systems being planned, as well as those already in operation. This proceeding of 24 peer-reviewed research papers exemplifies the vibrancy of the fields.

Success can be fleeting, and we need to learn from past and current experience to do the best possible job of providing cost-effective public transportation services. The information, data, and research contained in this proceeding are meant to serve this need.

—John D. Wilkins, *Chair*
Chair, TRB Light Rail Transit Committee
Director, Capital Planning, New Jersey Transit Corporation
Newark, New Jersey

—Winston Simmonds, *Vice Chair*
Chair, APTA Light Rail Transit Technical Forum
Rail Operations/Engineering, Officer
Port Authority of Allegheny County
Pittsburgh, Pennsylvania

REFERENCES

1. *Special Report 161: Light Rail Transport*. TRB, National Research Council, Washington, D.C., 1975.
2. *Special Report 182: Light-Rail Transit: Planning and Technology*. TRB, National Research Council, Washington, D.C., 1978.
3. *Special Report 195: Light Rail Transit: Planning, Design, and Implementation*. TRB, National Research Council, Washington, D.C., 1982.
4. *State-of-the-Art Report 2: Light Rail Transit: System Design for Cost-Effectiveness*. TRB, National Research Council, Washington, D.C., 1985.
5. *Special Report 221: Light Rail Transit: New System Successes at Affordable Prices*. TRB, National Research Council, Washington, D.C., 1989.
6. *Transportation Research Record 1361: Light Rail Transit: Planning, Design, and Operating Experience*. TRB, National Research Council, Washington, D.C., 1992.
7. *Conference Proceedings 8: Seventh National Conference on Light Rail Transit*, Vols. 1 and 2, TRB, National Research Council, Washington, D.C., 1995.
8. *Light Rail: Investment for the Future: Eighth National Conference on Light Rail Transit* (CD-ROM). TRB, National Research Council, Washington, D.C., 2000.
9. *Transportation Research Circular E-C058: 9th National Light Rail Transit Conference*. TRB, National Research Council, Washington, D.C., 2003.
10. *Transportation Research Circular E-C112, Joint International Light Rail Conference: A World of Applications and Opportunities* (10th in series), TRB, National Research Council, Washington, D.C., 2007.

Contents

OPENING GENERAL SESSION

- Status of North American Light Rail Transit Systems: Year 2009 Update** 3
John W. Schumann

CONTROLLING CAPITAL COSTS: DESIGN AND DELIVERY

- Civil Information Modeling and Building Information Modeling**..... 17
James W. Palmer and Shawn Pressley

LIGHT RAIL: A TOOL TO IMPROVE REGIONAL TRANSIT RIDERSHIP

- The Role of Systems Planning in Light Rail Transit Success** 31
Gregory L. Thompson and Jeffrey R. Brown
- The Importance of Connecting Light Rail and Destinations**..... 48
Jeffrey S. Wood, Shelley Poticha, and Mariia V. Zimmerman

ENERGY, ENVIRONMENT, AND TRANSIT: GREENER-EFFICIENT

- Effect of Fuel Price Increases on U.S. Light Rail Ridership 2002–2008: Results and Implications for Transit Operation and Policy** 63
Bradley W. Lane
- Energy Efficiency of Light Rail Versus Motor Vehicles** 78
Lyndon Henry, David Dobbs, and Alan Drake
- The Role of Transit in Mitigating Climate Change** 90
Donna L. Day and Jodi Ketelsen
- Light Rail Transit and Climate Change Policy**..... 104
Anthony Loui, Hiroyuki Sakai, and Timothy N. Papandreou

TRAFFIC ENGINEERING ISSUES: LRT PERFORMANCE

- Newark Light Rail Extension to Broad Street Station Traffic and Transit Operations Interface Issues**..... 121
Thomas A. Gawley and Robert C. Conte

BRT AND LRT: WHAT IS THE ROLE FOR EACH MODE?

- Bus Rapid Transit as a Precursor of Light Rail Transit?** 137
Lyndon Henry and David Dobbs

Comparative Performance of Los Angeles’ Transit Modes 151
Richard Stanger

STATIONS, STOPS, AND ARTS IN TRANSIT

Transportation Overlay District in the Valley of the Sun..... 167
Richard Simonetta and Benjamin Limmer

**Los Angeles County Metropolitan Transportation Authority Eastside Extension
 Light Rail Transit Project: Cultural Influence in Station Site Selection for the
 Boyle Heights–Mariachi Plaza Station** 183
Krishniah Murthy and Dennis S. Mori

OPERATIONS PLANNING: COPING WITH CHANGE

Route 100: The Future in Motion..... 193
John F. Calnan

REGULATIONS AND STANDARDS

Track Geometry for Light Rail Systems 215
Margarita Novales, Alfonso Orro, and Miguel R. Bugarín

Adapting Established Safety Outreach to Light and Commuter Rail Systems..... 229
Iyon Rosario and Isabel Kaldenbach

**Development and Application of Structural Design Standards for Safety of
 Light Rail Cars and Streetcars**..... 241
Philip Strong and Steven Kirkpatrick

**Modifications to Light Rail Vehicles for Improved Compatibility in
 Collisions with Automobiles**..... 252
*Steven W. Kirkpatrick, Robert T. Bocchieri, Claudia Navarro-Northrup
 Robert A. MacNeill, and Brian D. Peterson*

INFRASTRUCTURE MAINTENANCE: RENEWAL AND REFURBISHMENT

**NJT–NLR Broad Street Extension: Experiences and Lessons Learned from
 NJT–NLR Rehabilitation of the Penn Station Loop Track and
 Main Line Special Track Work**.....269
Joseph A. Bonsignore and Stelian (Stan) Canjea

Noncontact Ultrasonic Guided-Wave Detection of Rail Defects285
*Stefano Coccia, Ivan Bartoli, Salvatore Salamone, Robert Phillips,
 Francesco Lanza di Scalea, Mahmood Fateh, and Gary Carr*

STREETCAR CIRCULATORS AND THE NEW URBANISM

**The Santa Ana and Garden Grove Streetcar Project Concept:
Assessing the Viability, Exploring the Potential, Evaluating the Feasibility**299
Toni Botte Bates, Melissa Estrada, and Patrick Blankenship

**Best Practices for the Effective Integration of Historic Trolley and
Modern Urban Rail Transit Systems** 315
Brett Wallace

OPERATIONS, SUPERVISION, AND SERVICE QUALITY

Toward an Operating Doctrine for Shared-Use Railways..... 333
Alfred E. Fazio, J. North, and Rob Troup

THE NEXT GENERATION VEHICLE

**New Los Angeles Metropolitan Transportation Authority P2550 LRV:
Energy-Saving Techniques** 351
Luigi Accardo, Ciro Nappo, and David Turner

APPENDICES

A. Transportation Research Board 2010 Executive Committee367

B. American Public Transportation Association Board of Directors369

Opening General Session

OPENING GENERAL SESSION

Status of North American Light Rail Transit Systems
Year 2009 Update

JOHN W. SCHUMANN
LTK Engineering Services

When the Transportation Research Board (TRB) sponsored its first light rail transit (LRT) conference in 1975, only remnants remained of North America's once vast system of city streetcars and intercity, interurban electric railways. Totalling just 200 miles (320 km), these "legacy systems" of one to a few lines ran in seven U.S. cities and Toronto, Canada.

All had at least some, and most had significant portions of their routes on exclusive and semiexclusive alignments. Looking to Europe, where such "stadtbahnen" (city railways) were growing out of old "strassenbahnen" (streetcar lines), the conference organizers adopted the new term, "light rail transit," to provide an English-language equivalent to describe a mode of urban public transportation

1. Located predominantly on reserved but not necessarily grade-separated rights-of-way;
2. Operating electrically propelled vehicles run singly or in trains; and
3. Providing a wide range of passenger capacities and performance characteristics.

These attributes make LRT a highly flexible rail mode in terms of where tracks can be placed (subways, aerial structures, at-grade and in streets), and the volumes of passenger traffic that can be accommodated practically and economically (fitting between buses and heavy rail). This flexibility has resulted in varying systems:

1. Streetcars, with all or most trackage in mixed-traffic lanes;
2. Classic LRT lines using a rich mix of at-grade and separated alignments; and
3. Light rapid transit (also LRT) routes on private right-of-way with no more than a handful of streets crossing the tracks at grade.

Since 1975, there has been a rebirth of interest and activity in LRT, with such services operating now in 24 U.S. cities plus three each in Canada and Mexico. More are under construction, being designed or planned. This paper reports on the progress of U.S. and Canadian LRT projects since the last LRT conference was held in 2006.

NEW STARTS AND EXTENSIONS SINCE 2006

There were two completely new LRT start-ups during this period, Charlotte, North Carolina (2007) and Phoenix, Arizona (2008), as well as a new streetcar line in Seattle, Washington (2007), and "light" DMU lines in San Diego, California and Austin, Texas. In addition, several cities extended existing lines: Salt Lake City, Utah; San Francisco, California; Portland, Oregon (streetcar); and Calgary, Alberta (two). In 2009, Seattle's Central Link LRT and Austin's initial

light DMU line are to open, and further extensions are due to be completed in Edmonton, Ontario; Portland; Los Angeles, California; and Jersey City, New Jersey.

This review will begin with the three most recent new starts. Then, the listing of cities with operating LRT systems work down the Pacific Coast, then east across mid-America and Canada, ending with the eastern United States.

Key descriptive data for the LRT systems are provided in [Table 1](#). Since 2006 in the United States, LRT and modern streetcar miles of line have increased 11% (569.5 to 634.9), the vehicle fleet has grown by 4% (1,761 to 1,829), and weekday rides are up 23% (1.31 million/weekday to 1.61 million/weekday). In Canada, miles of line remained the same, while the LRV fleet grew by 9% (400 to 434), and weekday rides increased by 9% (0.57 million/weekday to 0.62 million/weekday). The most productive systems in terms of weekday passenger boardings per mile of line were in Canadian and large U.S. cities: Calgary—9,818; Boston, Massachusetts—9,273; San Francisco—8,143; Toronto—6,280; Houston, Texas—5,333; and Edmonton—5,185. LRT systems with the most heavily patronized vehicles in terms of passenger boardings per weekday were Houston—2,222; Calgary—1,812; San Francisco—1,634; Salt Lake City—1,300; and three properties in the range between 1,200 and 1,300: Los Angeles—1,287; Toronto—1,238; and Portland Streetcar—1,200.

Phoenix—New Start

The 20-mile Central Phoenix East Valley LRT line opened for revenue service in December 2008. Linking Phoenix, Tempe and Mesa, Arizona, this double-tracked line is located mostly in the medians of arterial main streets, with some mileage in Phoenix on side reservations, as well as some private right-of-way in Tempe through the Arizona State University campus. Kinki-Sharyo supplied 50 LRVs of 70% low floor configuration, and incorporating crash energy management (CEM) and other safety features. The line's trains will make 27 stops each one-way trip, at stations featuring shelters and plantings placed to provide shade during the various times of the day. Final design is complete for a 3.2-mile Northwest extension, which will be built with local funds for completion in 2012. Gradual expansion to a six-branch system of at least 57 miles by 2025 is envisioned, and streetcars are under study for Tempe and Scottsdale.

Charlotte—New Start

November 2007 saw the opening of Charlotte's first 9.6-mile, 16-station south corridor LRT line. Estimated to carry 9,100 weekday passengers initially, by fall 2008 the line was attracting over 16,000 rides, taxing the 16 LRVs acquired as part of the project. An option to acquire four more cars has been exercised. The Charlotte region plans to build on this initial success, with more LRT lines, streetcar routes, and a commuter rail line in a corridor where passenger and freight services will have to share track.

Seattle and Tacoma, Washington—New Start

Washington's Central Puget Sound region is rapidly becoming a multimodal metropolis. Latest to open was the 1.3-mile South Lake Union Streetcar line in late 2007, and running through a burgeoning redevelopment area rapidly filling with new-urbanist commercial and multiunit residential buildings. It joins the 1.6-mile Tacoma Link, opened in 2003 between the Tacoma

TABLE 1 Line Lengths, Car Fleets, and Productivity Indicators

City/System		One-Way Line		Fleet	Cars per		Weekday	Service Productivity, Psgrs per		
		km	mi	Cars	km	mi	Rides	Line km	Line mi	Car
Baltimore, central corridor	d	47.0	29.0	53	1.1	1.8	27.0	574	931	509
Boston, Green Line & Mattapan	b	41.5	25.6	199	4.8	7.8	237.4	5,719	9,273	1,193
Buffalo, MetroRail	a	10.4	6.4	27	2.6	4.2	22.6	2,178	3,531	837
Charlotte	a	15.6	9.6	16	1.0	1.7	16.5	1,060	1,719	1,031
Cleveland, Blue/Green	b	25.0	15.4	48	1.9	3.1	15.1	605	981	315
Dallas, DART LRT	d	73.0	45.0	95	1.3	2.1	73.0	1,001	1,622	768
Denver, RTD LRT	d	56.7	35.0	83	1.5	2.4	61.0	1,075	1,743	735
Houston, MTA	d	12.2	7.5	18	1.5	2.4	40.0	3,289	5,333	2,222
Jersey City and Newark, N.J. Transit	e	34.5	21.3	73	2.1	3.4	62.0	1,795	2,911	849
Los Angeles, Blue/Green/Gold	d	90.3	55.7	121	1.3	2.2	155.7	1,724	2,795	1,287
Minneapolis, Metro Transit	d	19.5	12.0	27	1.4	2.3	32.0	1,645	2,667	1,185
New Orleans, streetcars	b	14.1	8.7	66	4.7	7.6	14.1	1,000	1,621	214
Philadelphia, city and suburban	b	68.9	42.5	159	2.3	3.7	100.0	1,451	2,353	629
Phoenix	a	32.4	20.0	50	1.5	2.5	<i>tbid</i>	<i>tbid</i>	<i>tbid</i>	<i>tbid</i>
Pittsburgh, South Hills	b	38.6	23.8	83	2.2	3.5	26.0	674	1,092	313
Portland, MAX	a	71.3	44.0	105	1.5	2.4	110.0	1,542	2,500	1,048
Portland, Streetcar	d	6.5	4.0	10	1.5	2.5	12.0	1,850	3,000	1,200
Sacramento, RT LRT	a	60.2	37.1	76	1.3	2.0	60.0	997	1,617	789
St Louis, MetroLink	d	87.6	54.0	87	1.0	1.6	80.0	914	1,481	920
Salt Lake City, UTA LRT	d	30.8	19.0	40	1.3	2.1	52.0	1,688	2,737	1,300
San Diego Trolley	a	85.1	52.5	134	1.6	2.6	120.0	1,410	2,286	896
San Francisco, Muni	c	49.8	30.7	153	3.1	5.0	250.0	5,022	8,143	1,634
San Jose, VTA LRT	a	68.4	42.2	100	1.5	2.4	38.0	555	900	380
Seattle/Tacoma	f	4.7	2.9	6	1.3	2.1	3.3	702	1,138	550
Total United States		1,044.0	643.9	1,829	1.8	2.8	1,607.7	1,540	2,497	879
Calgary, C-Train	a	44.6	27.5	149	3.3	5.4	270.0	6,055	9,818	1,812
Edmonton, LRT	a	13.1	8.1	37	2.8	4.6	42.0	3,198	5,185	1,135
Toronto, streetcars	b	79.3	48.9	248	3.1	5.1	307.1	3,873	6,280	1,238
Total Canada		137.0	84.5	434	3.2	5.1	619.1	4,519	7,327	1,426

a - New start since 1977.

b - Major reconstruction/rehabilitation since 1977.

c - Upgraded from streetcar to LRT standards since 1977.

d - New start since 1990.

e - Jersey City-d, Newark-b.

f - Tacoma Link 2003, S Lake Union 2007, Central Link 2009.

Dome area and downtown. Each line is equipped with three Inekon modern streetcars. Set to open in 2009 is the first regional LRT line, the 15.6-mile Central Link between downtown Seattle and the Sea-Tac International Airport, with 13 stations (including four in the renovated Downtown Seattle Transit Tunnel) and 31 Kinki-Sharyo LRVs. Design is in progress on a 3.2-mile extension with two stations, entirely in subway, north to the University of Washington. An option for 27 more LRVs has been exercised to support this extension. Additional LRT lines are in various stages of planning as Sound Transit looks to the future.

Austin—New Start

The latest new start project nearing completion is the 32-mile MetroRail line to suburban Leander, on which it is anticipated service will commence in 2009. A short segment of new in-street track in downtown Austin connects to a former railroad Capital Metro purchased in the late 1980s. A private short line contracts with the agency to provide time-separated local freight service. Built to a very restricted capital budget, the line initially has only six articulated DMUs, built to European railway standards and modified to achieve a waiver from the FRA. The plan is to increase the size of the fleet and expand the limited peaks-oriented service to a frequent all-day transit schedule.

During 2008, the City of Austin evaluated corridors and prepared a plan for a modern streetcar system of three lines to link existing residential neighborhoods, major destinations—downtown, University of Texas, Bergstrom International Airport—and emerging renewal areas—Mueller (the former airport site) and Seaholm (location of a closed power plant).

EXISTING SYSTEMS

Baltimore, Maryland

Double-tracking of 9.4 miles of the Central LRT Line was completed in 2006, bringing a full restoration of service to the entire line. The work areas were four segments north of downtown Baltimore, and three sections south of downtown, one of the latter including the junction and a short section of the branch to BWI airport. Planning for a new 14-mile east–west Red Line is focusing on LRT and BRT, with interest coalescing around LRT.

Boston

The MBTA's Green Line, really a network of a central trunk and four branches, continues to be the most heavily patronized of U.S. LRT systems. A major physical improvement recently completed was relocation of the line in the vicinity of North Station, from the old elevated structure to a new subway and ramp up to the Science Park viaduct. At the Lechmere end of the system, plans are moving forward on two extensions, to West Medford and to Somerville's Union Square. Both are part of a package of transit improvements to offset impacts of the Big Dig highway project. However, it now appears the mixed traffic portion of line from the Arborway to Heath Street will not be restored, and the latter point will be the permanent terminus of that branch. Efforts continue to resolve issues with the Type 8 low floor LRVs; it is anticipated a report on this topic will be on the LRT conference agenda. Finally, the Ashmont–Mattapan Line returned to service after reconstruction of the Red Line's Ashmont station was

completed, during which time the overhead contact system and cars were converted from trolley pole to pantograph operation.

Buffalo, New York

The 6.4-mile Metro continues to link downtown and the State University of New York (SUNY) Buffalo campus. Midlife overhauls are being done on Buffalo's 27 LRVs, the only nonarticulated 4-axle cars built for a North American "new age" LRT project. Plans remain to extend the line to SUNY-Amherst, as well as build other branches, when funding eventually becomes available.

Calgary

With the opening of Calgary's South Line in 1981, Alberta could claim the first two new-age LRT lines in North America. Using virtually the same design criteria as Edmonton, Calgary made one significantly different decision: to live with surface operation through downtown until a regional system was built, and then perhaps build a central subway. As a result, Calgary has been able to sustain an ongoing series of extensions outside downtown, bringing the system now to three lines (South, Northeast and Northwest), all of which have been or are being extended. When the latest Northeast Extension was finished in 2006, the system reached 27.5 miles, served by 116 LRVs (with 26 more on order), and in 2008 was accommodating 270,000 rides each weekday. As in Edmonton, LRT and buses are fully coordinated in a multimodal, multidestinations timed transfer transit system. This system also has been followed by most of the more successful new-age LRT operators in the United States. Future plans include lines to the west by 2020 and southeast by 2025.

Cleveland, Ohio

The Blue and Green LRT lines, including the Waterfront Extension of 1996, continue to serve the cities of Cleveland and Shaker Heights. Overhauls of the early 1980s Breda LRVs continue. During 2008, GCRTA completed the Euclid Avenue bus rapid transit project, now operating as the Health Line between downtown's Public Square past University Circle to a transit center at the heavy rail Red Line's Windermere station.

Dallas–Ft. Worth, Texas

LRT in the Dallas portion of the Metroplex is thriving. The 20-mile Y-shaped system opened in 1996 was more than doubled in length—to 44 miles—and became a two-route elongated "X" in 2002. Now, construction is well-advanced for a third route, the 28-mile Green Line that will connect southeastern Dallas through downtown to the Medical Center and northwest suburbs out to Carrollton, with a branch to DFW airport. DART is buying additional LRVs for this service, scheduled to open in 2009. A branch to DFW airport, the 14-mile Orange Line, is expected to be finished in 2013. To improve accessibility and increase fleet carrying capacity systemwide, a program has begun to stretch all the cars into double-articulated vehicles with a low floor middle section. In the central cities, both Dallas and Ft. Worth are considering downtown circulator streetcar projects.

Denver, Colorado

Planning for Denver area rail transit began in the 1970s; but it was not until 1994 that the Regional Transit District's first 5.5-mile LRT line was opened. An immediate success with riders, it set technology and helped build community consensus for its extension 8.5 miles southwest to Littleton. This longer line's effectiveness and the popularity of the short 1.6-mile Central Platte Valley branch in 2002, led to inclusion of 19 more LRT miles as part of the T-REX project to rebuild I-25 and I-225 in the southeast. This latest mileage opened for service in 2006, on time and on budget. As T-REX construction was progressing, the region's voters approved a referendum in November 2004 that will provide local funds for another 100+ miles of rail transit, a combination of LRT and commuter rail in several more of the Denver area's radial corridors, as well as along circumferential I-225. Although recent spikes in steel and concrete costs have knocked cost estimates askew, these additional lines are to be complete within a decade, making Denver's program one of the country's most aggressive timetables for completing a multiline regional network. When it opens in 2013, the 12.1-mile West Corridor line to Golden will be the first FasTracks LRT line to be completed.

Edmonton

Edmonton, North America's LRT pioneer, coupled an existing railroad r-o-w with a new downtown tunnel to create the very first new-age LRT line in North America, and one for which light rapid transit fairly defines the LRT acronym. Though providing a high-quality alignment, tunneling also was costly. Thus, extension of the system has been rather slow, but as of 2005, the line surpassed the 8-mile mark with a 0.5-mile extension at the University of Alberta. This work also brought the line back up to grade, setting the stage for a substantial 4.7-mile further south extension to Century Park, to open in 2009. Another 26 LRVs are being delivered to serve this extension. Well-integrated with connecting buses, and gradually expanding, Edmonton's LRT line has been a beacon to which others have looked as they developed and implemented their own LRT plans.

Houston, Texas

After decades of trying, the MTA of Harris County was able to locally fund and build the 7.5-mile Main Street LRT line, which opened at the start of 2004. This urban corridor links downtown Houston with the Texas Medical Center and various other intermediate educational and cultural institutions, terminating at the Astroworld complex. Its 18 LRVs carry in excess of 40,000 weekday passenger trips, a very strong showing for a relatively short line. LRT is planned for five other corridors, of which four were for a time slated to be built as BRT convertible to LRT later; but local support generated by the success of the Main Street Line, has led to a decision to build them all as LRT from the start.

Little Rock, Arkansas

The Arkansas capital city became the newest operator of streetcars in 2004, when it opened the 1.5-mile River Rail using three replica double-truck Birney cars from Gomaco. By late 2006, a 0.9-mile extension to the new Clinton Presidential Library was completed and placed in service, with two more replica Birney cars added to the fleet.

Los Angeles

Metro L.A. now has the largest one-way line mileage of LRT in any U.S. or Canadian city (Table 1), and more weekday riders than most others. The three operating lines are Blue (to Long Beach, 1990, 22 miles), Green (Norwalk-El Segundo, 1995, 20 miles), and Gold (to Pasadena, 2003, 13.7 miles). Construction is nearly finished on the 6-mile East Los Angeles extension of the latter, to open in late 2009. At the same time, construction is progressing on the Expo Line Phase 1, an 8.6-mile corridor to the west scheduled to open in 2010, and intended to eventually reach Santa Monica. A plan, for which funding is needed, also has been prepared to extend the Gold Line from Pasadena to Pomona. Cities, including Los Angeles, are starting to evaluate the feasibility of streetcar lines as complements to the region's growing LRT, commuter rail and heavy rail system. In San Pedro, the replicated Red Car Line is an attractive addition to waterfront leisure-time facilities, and the port of Los Angeles has plans to expand it.

Memphis, Tennessee

Opened as a Main Street shuttle in 1993 using vintage cars, this system was extended along the Mississippi River waterfront a few years later. The fleet now includes both vintage and replica streetcars. In 2004, a 2-mile extension on Madison Avenue was opened to reach the Medical Center. It is intended that this serve as the first segment of an eventual 9-mile route to the Memphis airport.

Minneapolis–St. Paul, Minnesota

The 12-mile Hiawatha line opened in two segments in 2004. It connects downtown Minneapolis with the Minneapolis–St. Paul International Airport and the Mall of America in Bloomington, MN. With only 27 cars (three procured after the start of revenue service), the line is carrying over 30,000 rides per day, depending on the scheduling of sporting events, and already has surpassed the daily ridership forecast for 2020. A short extension is under construction to serve transfers from *Northstar* commuter trains; and several extensions are in various stages of planning. Well advanced through preliminary engineering is the 11-mile Central Line, with 31 new LRVs, that would connect the Minneapolis and St. Paul downtowns by way of the University of Minnesota and busy University Avenue. A 2014 opening is planned. Other candidate LRT corridors in planning are southwest to Edina, and Bottineau to the northwest of downtown Minneapolis.

New Jersey

Jersey City

Since 2003, the Hudson-Bergen LRT line has grown from 9.6 miles as the full 20.1-mile project originally envisioned, and as of 2006 extends from Bayonne 34th Street to Tonelle Avenue. The last northwestward extension includes the Bergenline Avenue station in tunnel, and Tonelle Avenue on the Meadows side of the Palisades. Currently, a 1-mile south-end extension in Bayonne is under construction, for completion in 2009. This is one of the few North American LRT systems presently operating both express and local services. There is some consideration

being given to an electric LRT extension to the Meadowlands Sports Complex; and a DMU feeder from Tonelle Avenue 9 miles north to Tenafly is proposed.

Newark

The City Subway was rebuilt, reequipped with new LRVs and extended a mile to Bloomfield in year 2000. Since then, work was begun and is nearing completion on a 1-mile link from Penn Station, on the Amtrak Northeast Corridor, north through downtown Newark at grade to Broad Street Station serving N.J. Transit's Morris & Essex commuter rail lines. This segment connects the two Newark commuter rail stations served by N.J. Transit with each other and with destinations in downtown Newark. In Union County, a separate Cranford-Elizabeth LRT line is in the early planning stage.

River Line

Though not LRT as defined by TRB, because it is not electrically powered, the Camden-Trenton light DMU River Line has several LRT-like characteristics, including frequent service with one- and two-car trains operated by one person, POP fare collection, and some street running in Camden. Widely disparaged prior to completion, it has performed reliably, and is developing patronage, now over 7,000 a day, quite satisfactory given the relatively low population in its service area. It feeds passengers to radial rail transit lines at both ends: N.J. Transit/Amtrak at Trenton and PATCO Lindenwold Line in Camden, where it also serves several leisure venues along the Delaware River waterfront.

New Orleans, Louisiana

As reported in 2006, the 2004 reconversion of Canal Street from bus to streetcar was completed, included 24 new replica streetcars built by the New Orleans RTA in its own shop, and functioned well until inundated in the flooding that occurred in the wake of Hurricane Katrina in 2005. All of the Canal cars and most of the Riverfront fleet were damaged and now are undergoing extensive propulsion system repairs or replacement, as is also the case for substations. Tracks and the overhead contact systems (OCS) on these two routes came through well. On the historic St. Charles Line, the cars remained dry; but the OCS needed rebuilding, a project that already was planned. By 2008, the St. Charles cars again were running over the full route; and Riverfront line and Canal service also was restored, though some of the Canal cars still were being rebuilt by Brookville Equipment Corporation.

Philadelphia, Pennsylvania

In September 2005, Philadelphia enjoyed a rare event, the return of streetcars to a line mothballed for many years. The 8.2-mile Route 15-Girard Avenue, run with buses for more than a decade, was restored as a trolley line, using 18 rebuilt PCCs equipped with new propulsion systems, wheelchair lifts, and air conditioning. At its west end, this line shares the Overbrook loop with Route 10, and this is joined physically to the five subway-surface lines. In Delaware County, the Media-Sharon Hill Lines continue with no significant changes since 2006.

Pittsburgh, Pennsylvania

Port Authority Transit completed Stage 2 of its South Hills Car Lines rebuilding program in 2004. Now, all Library and some South Hills Village trains operate over this shorter line, while some South Hills Village trains continue to operate via Beechview and Mount Lebanon. In 2006, work commenced on the 1.2-mile North Shore Connector, a short but complex project to extend LRT from downtown Pittsburgh under the Allegheny River to the developing North Shore. It's completion in 2011 will set the stage for potential future LRT extensions to suburbs in northern Allegheny County.

Portland

Oregon's single major metro area is the scene of one of transit's best U.S. success stories. After 17 years of improving and expanding the region's bus system, TriMet opened its first LRT line 15.1 miles to Gresham in 1986. Trains were busy from the start, and crowded in a.m. and p.m. peaks. Nonetheless, working through the federal process and building a line that includes a 3.5-mile tunnel consumed fully 12 years before the Westside Line was completed to Hillsboro (1998, 17.5 miles). Thereafter, the pace quickened, with the locally and privately funded Airport Line (5.6 miles) opening in 2001 and federally supported Interstate MAX (5.8 miles) completed in 2004. During these same years, the City of Portland built its initial 2.4-mile streetcar line (2001) and extended it to River Place (2004, 0.6 miles). Two more extensions have added another mile to take streetcars to the new South Waterfront neighborhood of offices and high-density residential developments. On MAX, final design construction is nearing completion for the 6.5-mile I-205 Gateway-Clackamas extension, and 1.2-mile addition of LRT on an updated and rejuvenated Portland Mall through downtown, with both links to open in September 2009. Also new in 2009 will be a new prototype U.S.-built streetcar from Oregon Iron Works' subsidiary, United Streetcar, under license from Inekon.

Sacramento, California

When Regional Transit opened its 18.3-mile LRT "starter line" in March 1987, it became the second new-age LRT property in California, after San Diego, most of whose design criteria were adopted to achieve an effective yet low-cost project. Coordinated with the region's buses, the addition of LRT spearheaded a doubling of total transit ridership in the region during the 1990s. By 1998, the line had been extended 2.3 miles. Then, in 2003, a 6.3-mile South Line was added. Most recently, the eastern end of the starter line was extended in stages in 2004 (2.8 miles) and 2005 (7.4 miles) to reach the City of Folsom. LRT ridership now surpasses 60,000 a day. A further 0.5-mile branch to the Amtrak station in downtown Sacramento opened late in 2006. Extension of this line to the north--eventually 12 miles to the airport--is being planned. A 4.3-mile, four-station extension of the South Line to Cosumnes River College is nearing the construction phase, with completion anticipated in 2011.

Saint Louis, Missouri

Since opening its original line from East Saint Louis to Lambert International Airport (1993, 17 miles), the system has more than doubled in length with the phased opening of the line out into

the Illinois suburbs (2001–2003, 20.5 miles). Presently, a third branch—the 8-mile Cross-County extension—was completed and opened in 2006. It includes a 1.3-mile tunnel. Most of this remarkable system effectively reuses surplus railroad lines, even including the historic Eads Bridge over the Mississippi River and the tunnel under downtown Saint Louis, perfectly located to serve today’s central business district. With no tracks in streets, even in reserved lanes, LRT in Saint Louis really could stand for light rapid transit; it is a very high-quality alignment.

Salt Lake City

This region’s first 15-mile LRT line opened in 1999 to link Salt Lake City and its southern suburb of Sandy. Almost immediately, the Utah Transit Authority secured funds and agreements to build a 4-mile branch from downtown Salt Lake City east to and through the University of Utah campus. This well-placed line now carries 25% of the university’s student-faculty-administrative staff every day, relieving parking demand on campus. In downtown Salt Lake City, the line was extended from the Delta Center to a new intermodal terminal to connect with UTA’s new *Front Runner* commuter trains and intercity services. Construction has begun on a Mid-Jordan extension to southwestern suburbs, and a line west from downtown to the airport. Planning is under way for further extensions north and south. To accommodate new lines as well as growing demand on the present system, UTA purchased 29 surplus LRVs from Santa Clara County to increase its total fleet to 62, and in 2008 placed an order for 77 Siemens S-70 low-floor LRVs to further expand its fleet

San Diego

Oceanside-Escondido—New Start

The 22-mile, 15-station Sprinter project in northern San Diego County began revenue operation in late 2007. Its 12 articulated “light” Euro-DMU vehicles from Siemens transport passengers along the Highway 78 corridor to work, school, shopping centers and other activities. At Oceanside, Sprinter connects with Amtrak Surfliner and Greyhound intercity services, Coaster and Metrolink commuter rail, and local bus routes. The route also is integrated with the local Breeze bus system through connections at all other stations.

San Diego Trolley

The new age of LRT in the United States began in 1981, when San Diego opened its 15.9-mile South Line to the Mexican border at San Ysidro. Like the later initial line in Salt Lake City, the San Diego Trolley coupled about 2 miles of reserved track in downtown streets with a high-quality railroad alignment for the remainder of the line. San Diego’s second line, to El Cajon (1989) and the third line north to Old Town also followed railroad r-o-w’s. This and other shorter extensions grew the system to 40.5 miles by 1996. East of Old Town, the 6.1-mile Mission Valley West Line (1997) required acquisition of new r-o-w, but brought service to the Qualcomm Stadium and a number of transit-friendly communities such as the Hazard Center. In 2004, the Mission Valley East extension opened, adding another 5.9 miles parallel to a freeway, and including a 4,000 foot tunnel, the system’s first, to reach the campus of San Diego State University. Design is in progress for phased development of the 10.7-mile Mid-Coast Corridor Line north from Old Town to the University of California at San Diego and University City.

San Francisco

The San Francisco Municipal Railway operates the only first-generation survivor streetcar system in the western United States, the Muni Metro. Its five routes in western residential neighborhoods merge to reach the financial district in the upper level of the Market Street Tunnel, built in the 1970s as part of BART. Since then, there has been an extension of the outer J Line to Balboa (1991, 2.3 miles), and from the city end of the tunnel up to grade and around to the Caltrain Depot at 4th and King (1998, 1.7 miles). In 2000, the 1.5-mile streetcar line to Fishermen's Wharf was opened and linked with surface tracks on Market Street to form the popular F Line, operated with PCCs and older vintage trolleys. Muni's newest LRT addition opened in 2007: the 5.4-mile line from 4th and King along Third Street through the southeast section of the city to Bayshore. Planning is under way for an E-Embarcadero vintage streetcar line that may eventually extend from the Caltrain Depot all the way to the Presidio, sharing one part of its route with Muni Metro LRVs and another segment with the popular F-Fishermen's Wharf service.

San Jose, Texas

Valley Transportation Authority opened a portion of its Guadalupe Corridor LRT in 1987, and completed the 20.8-mile line in 1991. Attention then turned to the Tasman West Line, opened in 1999 to extend service 7.6 miles to Mountainview. Thereafter, work continued on the 8.5-mile Tasman East and Capitol Lines, which opened in stages between 2001 and 2004. Also completed was the Vasona Line, a 5.3-mile extension from downtown San Jose west to Campbell opened in 2005. Planning for additional LRT lines continues, but their phasing and funding must be coordinated with the proposed extension of BART to Santa Clara County.

Tampa, Florida

The TECO Trolley Line continues to link downtown Tampa with Ybor City and other leisure venues along the 2.3-mile route. A short extension into the heart of Tampa's CBD had been planned. In 2008, the City of Tampa and transit agency, HART, were working on concepts for a larger LRT project.

Toronto

The 11 routes operated by the Toronto Transit Commission represent the only surviving first-generation streetcar system in Canada. Its 49 miles of lines are served by a fleet of 196 4-axle cars and 52 6-axle articulated LRVs. They carry substantially more weekday passengers—over 300,000—than any other LRT or streetcar system in North America, working with TTC subways and buses as part of the city's coordinated public transit network. Perhaps surprisingly, only 11% of the streetcar system's trackage is not in mixed-traffic street lanes shared with automobiles, the median at the west end of the Queensway and on Spadina Avenue and the Waterfront, and the short subway at Union Station. Creation of additional median reservations is being discussed, as is an ambitious Transit City plan that would add, among a larger package of improvements, seven new LRT lines to bring reliable, fast, quiet and comfortable transit service to many Toronto neighborhoods. Also envisioned is acquisition of over 200 new 100% low-floor streetcars/LRVs to supplant the present aging fleet.

FUTURE NEW STARTS

In addition to Seattle, as previously noted, two more completely new start LRT lines are under construction, as is a streetcar line in Washington, D.C.:

- Norfolk, Virginia: A 7.4-mile LRT line has completed final design and is under construction for a planned 2010 opening. There will be 11 stations and nine S-70 LRVs purchased through an option in the Charlotte order;
- Tucson, Arizona: Construction of the heritage trolley line extension through downtown is under way; an outward extension through the University of Arizona to the Arizona Health Sciences Center is in final design and awaiting FTA approval of funds to construct in time for a planned 2010 opening; and
- Washington, D.C.: A system of several lines throughout the District has been proposed to complement the Metro and bus systems. Of these, three Czech streetcars have been built and a portion of the first line is under construction in Anacostia to link that community and its Metro transit center with nearby military bases.

Other cities, not already named, with LRT planning and design in various stages include large cities like Detroit, Michigan, smaller towns such as Rock Hill, South Carolina, and numerous other places.

In other locations, LRT is included as an alternative in multimodal planning studies from which a project may or may not emerge.

CONCLUSION

From eight cities with survivor trolley systems in the mid-1970s, new LRT and streetcar projects have spread across North America so that today about 30 cities in the United States and Canada are served by LRT or streetcars or both. Extensions and more new starts under construction, and additional cities in various stages of project development indicate that LRT has proven to be an attractive addition to local transit systems, and that the appetite for such projects is not yet saturated. LRT continues to offer cities the possibility of meaningful and affordable transit improvement.

Controlling Capital Costs
Design and Delivery

CONTROLLING CAPITAL COSTS: DESIGN AND DELIVERY

Civil Information Modeling and Building Information Modeling

JAMES W. PALMER
SHAWN PRESSLEY
Hill International, Inc.

Information technology has been changing the business landscape for decades. The construction industry has followed this trend with different stages in infrastructure delivery, developing their own set of tools. The level of integration of information technology appears to scale from high in the planning stage to low in construction. Different owners have achieved different levels of integration in the operations and maintenance of their infrastructure. In those areas where information technology has been firmly embedded, the transfer of information through technology from one phase of infrastructure delivery to the next has followed the same pattern as integration within phases, but lagged significantly. Building information modeling (BIM) is the most recent industry effort to take information technology to a much higher level of integration. This integration is really driven by a desire to have the parties, including operations and maintenance, collaborate on the design and construction of the building's systems at the onset. Heavy construction, such as roadway and railway systems, are looking at this delivery tactic for applicability to horizontal construction.

The technology exists to have digital information developed from the start of the delivery process and throughout each stage passed from one stage to the next so that as new participants join the process, they are picking up the digital information from the previous efforts. The new participants then can move forward from there rather than recreating those data files. Software providers to the infrastructure delivery industry have worked towards providing integrated packages that combine all the delivery phases into one integrated suite of applications. (Bentley, a major software provider for highway and rail systems, has recently announced a new suite of software more completely integrated from planning to operations and maintenance.) It is the institutional issues that are and will continue to be a hindrance to the effective use of these integrated systems because of

- Stovepiping among functions where planners, designers, constructors and operators and maintainers are separate entities that function independently with objectives that are not integrated;
- Liability caused by sharing information digitally, particularly in the United States where the body of construction law has been based on the transfer of responsibilities and information through hard copy documents; and
- Difficulties transferring information since the parties responsible for different phases of infrastructure delivery and management do not use the same software systems and do not consider the next phase of the program in assembling and managing their information.

BUILDING INFORMATION MODELING

Building information modeling (BIM), a revolutionary technology that builds a structure in a virtual environment before a grain of dirt is moved, is currently changing the entire process of vertical construction. These same principles can be applied to horizontal (heavy) design and construction in order to efficiently move that grain of dirt. To date, geographic information systems/global positioning systems (GIS/GPS) have been used to capture information in 3-D and to execute and control horizontal construction.

BIM is a building design methodology characterized by the creation and use of coordinated, consistent and computable information about a building project in design and construction. BIM implies a free flow of information about the design among the participants throughout the life cycle of the project.

The idea behind a building information model is that of a single depository. Every item is built only once. Both graphical document drawings and nongraphical document specifications, schedules, and other data are included. Changes are made to items in only one place to ensure

- Increased speed of delivery (time saved),
- Better coordination (fewer errors),
- Reduction of Request for Information (RFIs),
- Reduction of risk,
- Decreased costs (money saved),
- Greater productivity,
- Higher quality work, and
- New revenue and business opportunities.

For each of the three major phases in the building life cycle—planning, design, construction, and management—BIM offers access to the following critical information:

- In the planning phase—mapping and information organized by geographic location;
- In the design phase—design, schedule, and budget information;
- In the construction phase—quality, schedule, and cost information; and
- In the management phase—performance, utilization, and financial information.

Information modeling in the design and construction industry lifts computer-aided design and drafting (CADD) to the next level. Computer-aided design (CAD) involved using computers to create drawings digitally that could be shared among the design team with different layers to represent different disciplines or levels of information. This was a major step forward in coordinating the drawings of the different design disciplines. The digital drawings facilitated taking off quantities and progression to three-dimensional models. These digital drawings could be used by the contractor to do quantity take offs and as a starting point for shop drawings, in particular for fabrication off-site. This passing of digital information from the designer to the contractor was and still is considered a potential risk such that the paper drawings are often considered the contract documents and the digital versions nonbinding. The majority of construction is still being done using paper documents as the primary source and the pass of digital information a step towards creating or verifying those paper documents.

The concept of BIM actually has roots in other industries, primarily manufacturing and industrial design. The need to control information and grow it through iterative design processes—all the way to the manufacturing of the item—was recognized by these industries years ago. As BIM becomes more widespread in building construction, its approach to planning, design and construction is being considered for heavy civil construction such as highways, transit systems and railways. This application is being called civil information modeling (CIM). BIM/CIM is not only drawing elements in space digitally, but also embedding information in those elements so that they more closely approximate constructing the project on paper. For example, a line of a certain thickness in a CAD drawing becomes a beam of a certain size in a BIM model with the related dimensions and strength characteristics. Quantity take offs can now become specific enough to develop detailed estimates from the model itself.

This model introduces four basic concepts to the design process from the point at which the model is first built. Those concepts are

- Visualization—the ability to form picture of the design intent in the design team heads based on understanding the information being presented;
- Communication—the ability to transfer the information being developed as it's been developed which leads to a greater understanding of the project by all the team members;
- Collaboration—the mutual support of all projects stakeholders which leads to a common understanding and a much shorter cycle on decision making; and
- Rapid prototyping—after the model is built, alternatives and permutations can be easily introduced and their impacts measured both in how they look and what they will cost.

While these concepts have obvious benefits in design development, they can only be delivered at a certain cost. That cost includes; first the investment in the training and effort to build and maintain the model, and second the suspension of traditional liability barriers among team members in order to share in the construction of a common model. The liability hurdle is sometimes avoided by the different parties building their own model and sharing information between them. This obviously adds significantly to the model cost itself and requires work to keep all the models the same.

In most cases, architects and engineers create a 3-D model of a building or structure that is used for analysis and design. The model is shared among the various disciplines to improve design and avoid conflicts. For example, the mechanical engineer can use the model to design the HVAC system and avoid interference with the structural system, and the architect and interior designer can use the model to adhere to LEED standards for daylight.

According to the results of a May 2006 structural engineer survey, experienced BIM users report that since one model is shared among the project team, conflicts are identified early in the design process and resolution is expedited. Additionally, schedule and workflow improvements are realized and production costs are reduced. By not relying on paper plans and written specifications, data and details about a project are shared more easily, frequently, and accurately.

Contractors benefit as well. Using the same model during construction, the contractor can better conduct project and construction management efforts. With highly detailed data about the design easily accessible, contractors are less likely to make request-for-information submittals to architects or engineers, according to the structural engineer survey respondents. Project and construction management and scheduling is improved. Additionally, contractors can accomplish

more accurate quantities assessments and expedite change orders. The contractor can also share the model with suppliers such as steel fabricators. Again, working off the same, detailed data set that every other project participant has used, errors are reduced and efficiency is gained during this time-sensitive and expensive stage of a building's development.

Owners benefit during design and construction, but also throughout the life of the building. Structural engineer survey respondents reported that, during design, owners can visualize the 3-D design easily, again improving collaboration. They realize the cost and schedule advantages gained by the architects, engineers, and contractors. And finally, owners can use the model as the basis for its operations and facilities management system. Component characteristics along with their inspection and maintenance requirements can be embedded in the 3-D model so that referencing is simplified by maintenance staff. When rehabilitation is required further along the life cycle of the project, the model will be relied upon again.

CIVIL INFORMATION MODELING

In civil engineering, 3-D data is starting to be shared and applied to various stages of a project's life cycle, professionals are collaborating more, and project data and information are being used in new ways.

Consider this scenario: A highway is being expanded from four lanes to eight, including an extremely busy interchange. GIS is used for site planning and preliminary design, providing information such as soil classifications, power line locations, nearby businesses, traffic flows, and more. Additionally, to acquire accurate data with the least interference to traffic, 3-D laser scanning is used to locate existing topography of the right-of-way, roadway features, and the current interchange structure. The laser scan data, which includes highly detailed X, Y, and Z information, is processed and shared with the civil engineer for more planning and preliminary design. Various scenarios are visualized easily in the 3-D model the civil engineer creates, improving collaboration among the client and designers. Impacts to adjacent land features and property owners can be tracked and impacts measured easily and quickly for alternatives proffered.

Once a final design is agreed upon, the 3-D model is used for detailed design, including the modeling of all proposed topography and features of the expanded roadway—from pavement layer thicknesses to light pole placement to utility crossings.

The 3-D model is shared with the contractor for GPS machine control (automated machine guidance or AMG), improving the speed and accuracy, and therefore cost, of construction.

An as-built laser scan or the 3-D model is shared with the owner for inclusion in its GIS, where the data will be integrated into its system, where more data will be applied to it. Now a part of a comprehensive GIS, the digital data will be used for asset management and as data for planning future projects nearby, among various uses by others with access to the GIS. Eventually, the 3-D model and the rich GIS will be used for future rehabilitation planning and design.

The integrated, 3-D digital workflow that is the cornerstone of BIM is being paralleled in the civil engineering industry. True, not all of the steps in the civil engineering scenario are applied to all projects and the process of data sharing is not as simple. However, projects increasingly are applying some of the elements of this scenario, and eventually, more projects

will apply all. If it hasn't happened already, it's just a matter of time before you will be asked by a client, contractor, or another design consultant to engage in one of these steps. One of your co-workers or organization leaders is going to start discussing the merits of engaging in some—or more—of these new technologies or workflows soon.

The most difficult aspect of the technology-driven changes in the world of engineering isn't the technology itself but the associated work processes. To compete, companies need to learn how to use advanced technologies and change their work processes to match.

This step will be accomplished more easily in the rapidly developing areas of the world, rather than in the developed West, for one simple reason: tradition. In the United States, Canada, and parts of Europe, there are not only old, established firms, but there are old, established ways of doing things. Processes, codes, laws, and procedures have been set the same way for decades, and changing those aspects is difficult in a short time. Despite the age of their cultures, such traditions don't exist in places such as China and India. These countries don't have enormous legacy infrastructure to worry about; for example, there aren't many fiber-optic lines and water mains to puncture with an errant backhoe (which also means that creating the GIS map of a city's infrastructure isn't as challenging).

GEOSPATIAL TECHNOLOGY (GIS)

The days of the static map are long gone. One quick look at the Internet will tell you that. For example, who hasn't zoomed in on their backyard with a tool like Google Earth and checked to see what else that map could tell you? The same level of change is coming to the professional use of combined maps and data. Clearly, during the planning and construction phases of a project, geospatial technology offers many benefits such as analyzing traffic flows and local impacts, as well as determining with precision where underground utilities and structures lie that could affect the plans.

But one of the most fundamental benefits of creating “living” geospatial documents is on the asset management side of the equation. Ten or 15 years after a project is completed, does anyone know exactly where to find all the detailed information about what was built where? Or did some vital detail wind up as a handwritten field note on a single drawing or worse, on a scrap of paper stuffed into a trouser pocket? Imagine, instead, that technology in the field connected to the entire linked set of planning and construction documents is used to create real-time GIS documents, which lead to a complete digital database of the project. There will be no more looking for the lost paper scrap, and no more guesswork about the pedigree of a project or onsite changes. The result will be more efficient and effective management of projects over their lifespan, and the ability to understand precisely the need for and cost of maintenance, repair, and replacement over time.

Consider positioning technology, which is providing innovative solutions for various scales of locating work, from millimeter to meter as needed. Global Navigation Satellite Systems (GNSS)—the U.S. GPS, Russian GLONASS, and the future European Galileo systems— together with augmentation systems are appreciably enhancing terrestrial positioning. And GNSS is further enhanced by VRS systems around the world that make centimeter-level, real-time kinematic (RTK) positioning available to all.

Non-satellite-based positioning is also advancing quickly. Traditional total station distance and angle measurement is becoming faster, more convenient, and more accurate. In addition, with the increase in functionality and focus on ease-of-use, 3-D scanning will

inevitably become essential technology for acquiring spatial data. These improved instruments are not merely faster. Scanners are enabling surveyors and designers to discover new ways to utilize full 3-D images, an improvement to collections of discrete points with x , y , z coordinates. Scanners are also making digitization in the field increasingly practical, closing the gap between office and field.

WIRELESS COMMUNICATION

While positioning technologies are expanding, wireless communication is also exploding. In the last decade, several alternatives for data transfer have emerged—cellular standards such as GPRS, robust point-to-point radio solutions, Bluetooth, and satellite communications. Each of these has a place; none are complete solutions. These solutions range from simple and convenient, such as Bluetooth-enabled survey instruments that eliminate problematic cables, to highly significant, such as cellular standards that make VRS correction delivery easy. Finding ways for these disparate technologies to work together smoothly is a focus of current research.

The construction industry has been working towards paperless documentation for a number of years, making great strides in document control for all of the paperwork being produced. Effective wireless communications pushes this effort towards real-time documentation and reduces the transfer of information from hard copy field books into stationary data sets. In addition, the inspector can have all of the information required to effectively do his or her work at their fingertips where the operation is taking place. Quality control/quality assurance can be much more effectively done with the capture of field information electronically being structured to allow checking on the quality of the work done. If something does go wrong, then forensics to determine cause of responsibility becomes much simpler and more accurate allowing solutions and allocation of responsibility to be quicker and more equitable.

3-D MODELS

Powerful processors, low-cost memory, and fast, widespread Internet availability are enabling solutions unthinkable a few years ago. One example is spatial imaging, which is becoming the new standard for design work. Scanning and digital imaging are significantly speeding up model creation, enabling 2-D and 3-D CAD drawings to be replaced by 3-D models. Increasingly, these models are accessible to all project stakeholders early in the project life cycle. Together with the accurate geolocation that VRS (virtual reference stations) enables, models are becoming the basis of 3-D geographic information systems that will require expert management by surveyors and others who understand the complexities of spatial data maintenance.

Another advantage is obtaining real-time feedback by combining a 3-D model with geospatial information. For example, consider building a few miles of roadway using a model of the project combined with a highly accurate map of the location and construction equipment with built-in GPS. This can provide real-time feedback as to how the construction process is at variance with the model, and allow instant corrections. Using this approach to prevent spreading just an extra 6 inches of gravel on a couple miles of roadbed could save hundreds of thousands of dollars in otherwise wasted materials. In some cases, the simple elimination of the need for repeatedly staking each point means crews can operate with lights 24/7 in shifts, dramatically reducing construction time.

In addition, moving to 3-D can create completely new and more efficient ways of realizing large and costly projects. For example, constructing a large-scale housing development which has several planned phases is a long and expensive undertaking.

Traditionally, a developer might choose to make Phase I the area closest to the main traffic artery serving the development, building future homes farther inside the development. Using technology such as Autodesk Civil 3D, the developer instead can model the entire process before the first dirt is moved—lay out roads, mark out parcels, understand drainage, even match the right home style to the parcels. At the same time, this model can enable development of a more intelligent workflow to construct the project in the most efficient way. It may make the most sense to build Phase I homes well inside the development's boundaries so excavated material can be moved more easily and reused in later phases.

AUTOMATED MACHINE GUIDANCE

Automatic machine guidance (AMG) links sophisticated design software with construction equipment to direct the operation of the machinery to a high level of precision, improving the speed and accuracy of the construction operation. The system is presently being used in highway construction and other grading operations (see [Figure 1](#)). Critical construction data is synthesized into models that create an accurate picture of the terrain and interface with equipment software to guide the operation and provide a stream of information to the operator so that he/she can be sure that the equipment is operating properly. The actions of the equipment are recorded, creating an archive both for reviewing the quality of the work and documenting existing condition for future maintenance and repair operations. The reduction, if not elimination, of workers on the ground directing and measuring improves productivity and safety significantly. The quality of the product is much less impacted by weather conditions, time of day or level of focus of the employees. The accuracy of the work and its measurement is dramatically enhanced resulting in higher quality of products and less wasted material and efforts. DOT's have been on a long quest to make highways smoother and more homogeneous since this not only increases the ride quality for their customers, but also significantly increases the life of the pavement system. AMG is a major step forward in that quest. If the construction model is integrated backwards into the design effort, then the intention of the designer is more likely to be translated into the work product, reducing potential for error. However, in traditional highway and rail infrastructure projects this integration often causes liability issues among the parties sharing.



FIGURE 1 Automated machine guidance.

SOFTWARE SYSTEMS

BIM is not a technology but rather a methodology, but it does require suitable technology to be implemented effectively. Among the tools available to help achieve BIM are

- Revit from Autodesk,
- JetStream (software) from Autodesk,
- ArchiCAD from Graphisoft,
- Constructor from Graphisoft,
- Bentley Architecture from Bentley Systems,
- Building Explorer by Building Explorer LLC BIM,
- VectorWorks Architect from Nemetschek, and
- Digital Project from Gehry Technologies LLC.

The concept of using a single BIM modeling software package to service the needs of all stakeholders isn't appropriate the same way a single model servicing all stakeholders is. With many vendors and many more industry and role specific software available, it is important to not constrict your access to one format. As the building information modeling/civil information modeling paradigm shift within the industry takes place, organizations need to respond properly to it. While we cannot predict the future of civil information modeling, the goal is to have the proper applications so to this project possible can be delivered efficiently.

BIM supports the continuous and immediate availability of project design scope, schedule, and cost information that is high-quality, reliable, integrated, and fully coordinated. This ability to keep this information up-to-date and accessible in an integrated digital environment gives architects, engineers, builders, and owners a clear overall vision of their projects, as well as the ability to make better decisions faster—raising the quality and increasing the profitability of projects.

Gehry Technologies

For 15 years, Frank Gehry's practice has provided an example of a new way of working; communicating project data to the building team in a digitally integrated form, and rethinking the collaborative processes of project teams in light of new design, management, and communication technologies. There is growing interest, within the architectural design, engineering, fabrication and construction communities, in the potential for digital technologies to change the nature of professional practice and address underlying inefficiencies and conflicts resulting from an outdated process.

Building projects are increasingly complex undertakings. Tougher building codes and performance requirements, tighter schedules, distributed teams, and the possibility of new architectural forms, all add up to a building design and construction process whose demands exceed the capabilities of 2-D CAD and paper based delivery processes. Additional complexity in the design phase has created downstream problems in construction where poor data coordination translates directly into an average of 20% costs overruns during construction. The result of this trend is that, while over the last 20 years technology applications have resulted in productivity gains in virtually every industry, AEC has actually experienced productivity losses over the same time period.

Bentley Systems

With an intuitive user interface, extensive libraries of building components, and powerful tools for modeling, drafting, and reporting, Bentley Architecture supports all phases of the architectural workflow, from conceptual design to construction documentation. Integrating design, visualization, drawing production, and reporting, Bentley Architecture is part of Bentley's BIM solution of integrated design, engineering, and management applications for the entire life cycle of constructed assets. Used on large and complex projects around the world,

Bentley Architecture was specifically developed to support workgroups and distributed teams in a managed environment, allowing architects, engineers, and contractors to build as one. BIM enables business-critical benefits over traditional CAD, eliminates waste, significantly reduces errors and omissions, provides greater predictability of costs and performance, allows exploration of more design options, and ultimately results in better buildings.

Synchro

Today, Synchro has technology relationships in the form of technology development agreements with Primavera, Autodesk, TechSoft3D and others. These strategic relationships offer our joint customers the right ingredients to leverage existing software investments and extend benefits beyond information silos, which commonly exist between well-formed industry processes. Synchro Professional provides complete construction visualization, project scheduling, advanced risk management, synchronization with design changes, supply chain management and cost allocation for comprehensive virtual construction simulation. Synchro Professional enables alternative scheduling options, resource allocation, and time and cost savings to be evaluated.

Trimble

Trimble, which has been working on integration of these technologies for more than a decade, has established partnerships and alliances with industry firms to work on the concepts critical to what it calls the Connected Site approach. In addition, last year Trimble added the capabilities of visualization technology pioneer XYZ Solutions and others to its portfolio. XYZ enables users to take fuller advantage of 3-D models and the rich data sets they are built on, eventually enabling field digitization. Effective, rapid visualization is essential to a model-based workflow.

Trimble has also added the capabilities of Meridian Systems to its portfolio. Meridian brings the business and life cycle management software component to the Connected Site initiative, helping building owners, AEC firms, and government agencies facilitate delivery of information throughout the entire plan, build, and operate life cycle.

These and other technologies will only be fully relevant to the infrastructure industries when they are completely accepted and integrated into daily project workflows. Focusing on integration is the best way to serve the five key participants in infrastructure development: owners, government agencies, surveyors, AEC firms, and contractors. Each of these participates in a continuum of interrelated processes and works with a large number of providers. And each can benefit from integrated technological advances that connect participants more tightly.

There are applications which create BIM models (Autodesk's Revit, Bentley's Building, etc.). There are applications that which view and analyze the BIM (Navisworks, Solibri, Commonpoint, etc.) and there are software applications which process information which may be

linked to the BIM (Microsoft applications—Word, Excel, Project, etc., other scheduling or database applications, etc.).

Autodesk

Autodesk is pushing the concept of BIM into areas outside of simply buildings. The company describes BIM as an integrated process that coordinates reliable information about a project through all phases of design and construction, and they see increasing opportunity for the application of the BIM approach in the civil engineering space.

The virtual environment within the software allows the incorporation of design intelligence into the process, with returns in terms of time and materials savings, as well as enhanced road safety. When designing a roadway there are a number of safety considerations, including the road slope, turning radius and signal location that are tied to roadway speed limitations.

Traditionally an engineer would use two-dimensional drawings and formulas to determine if a roadway design met safety standards. With Autodesk's AutoCAD Civil 3D software, the engineer can turn to criteria-based design to automate that process and check the design against criteria as they are designing. The software includes many different design criteria, including the safety criteria from AASHTO used widely in the United States.

Visualization and simulation enhance the rules-based design view to incorporate elements related to how the roadway interacts with the environment around it.

SUMMARY

This paper presents only a sampling of the many applications of information models in civil construction. In the application of BIM, the effort is to build a single model that integrates all information from planning to operations and maintenance. That model is then used to simulate the construction of the project and to visualize the product in order to verify the stakeholders' perceptions of the outcome and to ensure integration of the total design. Once built, this model also allows exploration of alternatives with very fast turnarounds on impact to cost, schedule, and look of the product. Because the various disciplines are defined in the same space, verification that the design is fully integrated does not have to wait until construction to be checked at a detailed level. A major product of the BIM model is clash detection or utilities such as piping that are internal to the building in conflict with other utilities or with structure. While CIM can benefit proportionately from the same kind of utility, civil construction is a different environment that makes its application at least initially more complicated.

Building or vertical construction has certain advantages over horizontal or civil construction in implementing a single information model concept. Buildings infrastructures encourage higher integration of project stakeholders earlier in the process. The major participants that are affected by the work—the owner—developer, the architect engineer, the CM builder and the operator, who is often the same as the owner—are involved in the decisions of what's to be built and how much it will cost earlier in the process than civil construction.

In civil construction, the planning process involves public agencies and adjacent property owners that are only concerned with the negative impacts of the project and not its effectiveness.

Many of the decisions are made to adhere to regulatory requirements, appease adjacent property owners and local politicians as well as achieve the functional objectives of the owner or project sponsor. This environment has encouraged extensive use of information models such as GIS to capture, organize and present planning information. It has not encouraged the construction of full three-dimensional information models because of the protracted project development and the lack of central decision making in the process. The creation of integrated design teams to vet various configuration alternatives to arrive at an optimum solution is proving to be highly effective for buildings using the BIM model. The same sort of process is much more difficult in civil works.

A series of decisions that are made to shape infrastructure projects are considered in many cases external to the project sponsors or the project team. What this means is that the CIM model provides value by pulling many disparate pieces of information into a common framework so that conflicting criteria and impacts can be reviewed and optimized in a cost-effective way. The visualization that a CIM model would provide would be highly effective in visualizing for external stakeholders the impact of the project. Often the project team members for civil works are contracted separately at different times in the project development. Others are reluctant to make the large initial investments that full information models require because they are unsure if the benefit of that investment will be realized by utilization from future stakeholders. The true benefit of this initial investment can only be realized if its use is fully integrated into the design construction and operation and maintenance of the infrastructure being built.

As has been discussed previously, institutional barriers may force different project participants to build their own models either because her predecessor is unwilling to provide theirs or because they do not trust the validity of the predecessor's model. This does not negate the benefit of the 3-D information model, but it does make the process significantly less efficient both in terms of time to execute and cost.

The ability of the industry to function in the 3-D information environment is another major hurdle to its implementation. When CAD first was introduced to the industry, designs were done by a designer looking over the CAD operator shoulder and telling them what to do. Now designers operate in the CAD environment as they develop their designs. The lack of engineering and construction firms and people with knowledge and understanding of either the strategies or the technical skill to create and function in a 3-D information environment will severely hamper its implementation. The technicians who are creating and managing the models will have to work closely with the planners, engineers and constructors to make each party understand how this works and what it can do. Owners will be the major drivers in this change since they set the market value for introducing it into a project. As was discussed previously, software companies are working hard to create platforms that will facilitate the process and are anxious to work with owners since they need to show successes to sell their products. Industry organizations such as AASHTO and TRB are pushing initiatives and studies to test these technologies and educate the industry on their uses.

Light Rail
A Tool to Improve
Regional Transit Ridership

LIGHT RAIL: A TOOL TO IMPROVE REGIONAL TRANSIT RIDERSHIP

The Role of Systems Planning in Light Rail Transit Success**GREGORY L. THOMPSON****JEFFREY R. BROWN***Florida State University, Tallahassee*

Between 1980 and 2005, 16 U.S. metropolitan areas opened rail transit systems (1). Most of the rail lines were applications of light rail concepts and technology. These metropolitan areas joined 10 others whose systems predate the recent rail transit renaissance. Some of these rail transit metropolises have enjoyed increased riding habit and/or service productivity in recent years, while others have experienced stagnant or declining riding habit and/or service productivity. The term riding habit refers to ridership (passenger miles) per capita while service productivity refers to load factor (passenger miles per vehicle mile). The purpose of this paper is to explain why some metropolitan areas with rail transit have experienced performance success and others have not. A specific focus of the paper is to better understand the role that systems planning decisions have played in rail transit success or failure.

This paper examines the transit development history of 10 mid-sized U.S. metropolitan areas that adopted rail transit during the past 30 years: Atlanta, Georgia; Dallas–Fort Worth, Texas; Denver, Colorado; Miami, Florida; Minneapolis–St. Paul, Minnesota; Pittsburgh, Pennsylvania; Portland, Oregon; Sacramento, California; Salt Lake City, Utah; and San Diego, California. Planners in these metropolitan areas have followed different conceptualizations for how rail investments serve larger transit development goals. We call such conceptualization systems planning, and we demonstrate that it matters in subsequent transit performance.

All 10 metropolitan areas have become increasingly decentralized over the past century in employment as well as residential location, and urban decentralization has posed significant challenges for transit planners. Some planners have by design or inadvertently used rail transit investments to increase the usefulness of the overall transit network in reaching decentralized destinations. Others have used rail transit to provide superior service to the regional central business district (CBD) in competition with bus services also serving the CBD. We hypothesize that the decision to either decentralize service to reach dispersed destinations or focus service on the CBD accounts for the variation in transit system performance across the 10 metropolitan areas.

METHOD AND DATA SOURCES

Our method is based on categorization of the 10 metropolitan areas according to how their transit systems have been conceived at the regional level. We first define two archetypes, each defining a vision for how transit systems function at the regional level. One archetype has transit focus on a regional CBD; the other has transit serving dispersed regional destinations. We next place the 10 metropolitan areas into three groups that are arrayed on a continuum between the two archetypes. We then examine the transit performance of the median metropolitan area in each of the three groups over a 20-year period, using three indicators: riding habit, service productivity,

and cost effectiveness. We define riding habit as passenger miles per capita, service productivity as passenger miles per vehicle mile, and cost effectiveness as operating expense per passenger mile (adjusted to 2007 dollars). The service productivity measure can be interpreted as the average number of passengers on board a vehicle every mile that it operates.

When comparing performance between metropolitan areas with bus and rail systems, we considered a criterion that would measure capital cost, such as annualized capital expenses per passenger mile. Unfortunately, there are no databases that report capital investments in U.S. transit systems, and the task of freshly compiling such a database for the 10 regions in this paper is beyond its scope. We are not disturbed by this absence, however, because studies documenting capital expenses in those cities making either bus or rail capital investments suggest that capital expenses for bus improvements approach those of light rail. Kain and Liu (2) in comparing transit performance in Houston and San Diego found that the combined capital and operating expense per passenger mile for all transit users in 1992 was about \$.45 in San Diego (a bus and rail city) and about \$.52 in Houston (a bus-only city). At that time 34 miles of light rail line were in operation in San Diego, and 64 miles of transitway [high occupancy vehicle (HOV) lanes] were in operation in Houston. The transit capital charges in Houston included only part of the capital cost of the HOV lanes, because car and van pools also used the lanes in addition to express buses. Another study found similar results for the express bus oriented cities of Seattle, Houston, and Minneapolis–St. Paul compared to the light rail and bus cities of Portland, San Diego, and Sacramento (3).

Rail investments have increased since 1998 in most of these cities, but so have bus capital investments. In 2000, Metro Transit in Minneapolis–St. Paul, for example, operated express buses over 170 miles of exclusive freeway and express highway shoulder lanes for buses and 37 miles of HOV lanes (Metro Transit 2001). In 2008, Metro Transit operated express buses over 269 miles of bus-only freeway shoulder lanes, 7 miles of exclusive busways, 10 miles of bus lanes, and 39 miles of HOV and HOT lanes in freeways (4). In 1998, Pittsburgh's Port Authority of Allegheny County Transit operated two busways totaling 11 miles and numerous on-line stations, in addition to its light rail corridor. In 2002 it opened a third, 5-mile long busway at a cost of \$327 million and a year later extended one of its earlier busways by 2.3 miles at a cost of \$68 million (5, 6). These figures suggest to us no meaningful difference in the capital expenses per passenger miles between cities choosing to invest in bus rapid transit facilities and those investing in light rail transit facilities. What differs among these cities is the subsequent performance of their transit investments.

To carry out the three steps outlined above, we prepared several sources of data over 20- to 30-year time periods (see [Table 1](#)). These include 30-year trends in the spatial distribution of population and employment and their relation to service, 20-plus-year time series of the three transit performance variables, and descriptions of the evolving systems planning vision over roughly a 30-year time frame as elicited from planning documents and interviews. For most metropolitan areas, we interviewed two key informants who had a long-term perspective on both bus and rail transit development in their metropolitan area to provide the agencies' motives for the major changes in system design that we observe. We also obtained geographic information systems (GIS) shapefiles of the transit systems in each of the metropolitan areas, which we used to produce the system maps shown throughout the paper.

The 10 metropolitan areas that we examine are all mid-sized with populations between 1 million and 6 million persons. Most metropolitan areas are growing in population and

TABLE 1 Data Sources

Information	Data Sources
Case study details (interviews, histories)	(9, 10)
CBD definitions, CBD and non-CBD employment, metropolitan population	(18, 9, 19, 20, 21)
Passenger miles, revenue miles, and operating expense (by agency by mode)	(15)
GIS shapefiles of metropolitan bus and rail systems	(22, 23, 24, 25, 26, 27, 28, 29, 30, 31)

employment, although a couple are stagnant or in decline. All 10 metropolitan areas are decentralized and continue to decentralize (see [Table 2](#)). The CBD contains less than 10% of metropolitan employment in all 10 metropolitan areas, ranging between 3.57% and 9.10%. In seven of 10 metropolitan areas, the share of metropolitan employment in the CBD declined between 1985 and 2000. In the three cases where CBD employment shares increased, the increases were marginal. In two of the cases the CBD accounted for less than 4% of metropolitan employment in 2000.

DEFINING TWO REGIONAL NETWORK ARCHETYPES

To frame the narratives of transit development in the 10 case studies, we use [Figure 1](#) to set forth two archetypes of regional transit system development, and we use [Figure 2](#) to set forth the process by which some transit systems began to decentralize their bus systems when they introduced rail transit (7, 8, 9). The left panel of [Figure 1](#) reflects the idea that there is only one significant transit market in the metropolitan area. That market is work trips destined to the metropolitan area's dominant central business district (CBD). Planners lay out the regional transit routes to provide direct, high-speed service from far-flung suburbs to the CBD. Commuter rail lines and express buses using HOV lanes provide this type of service. Service often operates only during weekday peak hours in the peak direction.

The right panel in [Figure 1](#) reflects the idea that transit should connect to all major regional destinations, of which the CBD is only one. The connections are accomplished by a grid of regional routes that provide higher speed service than what typical local bus lines provide. The regional routes have stations to provide pedestrian access to and from the major destinations as well as to provide transfer connections to other regional routes, local routes, and automobile connections. In this concept routes operate frequently (at least once every half hour) all day and into the evening. The market consists of people traveling to a wide variety of destinations for a variety of purposes throughout the day, during evenings, and on weekends. Regional rapid transit and regional light rail lines typically provide this type of service. Express buses on HOV lanes theoretically could provide this type of service but typically do not, because they usually lack the stops for accessing regional destinations and for providing transfer opportunities.

[Figure 2](#) depicts the rationale and process by which some transit systems inadvertently began to decentralize their bus services when they introduced rail transit. The left panel depicts duplication of bus routes that occurs as CBD-bound buses converge on the CBD. The amount of service duplication becomes more acute in larger metropolitan regions, where more and longer

TABLE 2 CBD Versus Non-CBD Employment in 10 Metropolitan Areas: 1970, 1985, and 2000 (32, 19, 20)

MSA	CBD employment as percent of regional employment (%)			Non-CBD employment as percent of regional employment (%)			Regional employment		
	1970	1985	2000	1970	1985	2000	1970	1985	2000
Atlanta	9.75	9.10	6.36	90.25	90.90	93.64	534,612	1,090,203	1,819,500
Dallas–Fort Worth	8.02	6.04	4.25	91.98	93.96	95.75	820,425	1,606,378	2,286,011
Denver	6.84	6.85	7.49	93.16	93.15	92.51	617,783	1,193,416	1,754,056
Miami	1.99	2.20	3.59	98.01	97.80	96.41	1,054,093	1,934,165	2,773,734
Minneapolis-Saint Paul	9.43	7.12	3.94	90.57	92.88	96.06	914,008	1,354,673	1,885,771
Pittsburgh	7.94	11.88	9.10	92.06	88.12	90.90	866,074	888,161	1,049,541
Portland	6.35	8.38	8.16	93.65	91.62	91.84	472,746	719,324	1,182,408
Sacramento	5.20	8.43	8.89	94.80	91.57	91.11	281,531	488,110	728,803
Salt Lake City	5.12	6.10	4.62	94.88	93.90	95.38	356,097	628,570	1,098,327
San Diego	3.23	3.20	3.57	96.77	96.80	96.43	647,900	1,166,795	1,733,524

NOTE: Regional employment refers to total employment in the core counties of the metropolitan statistical area.

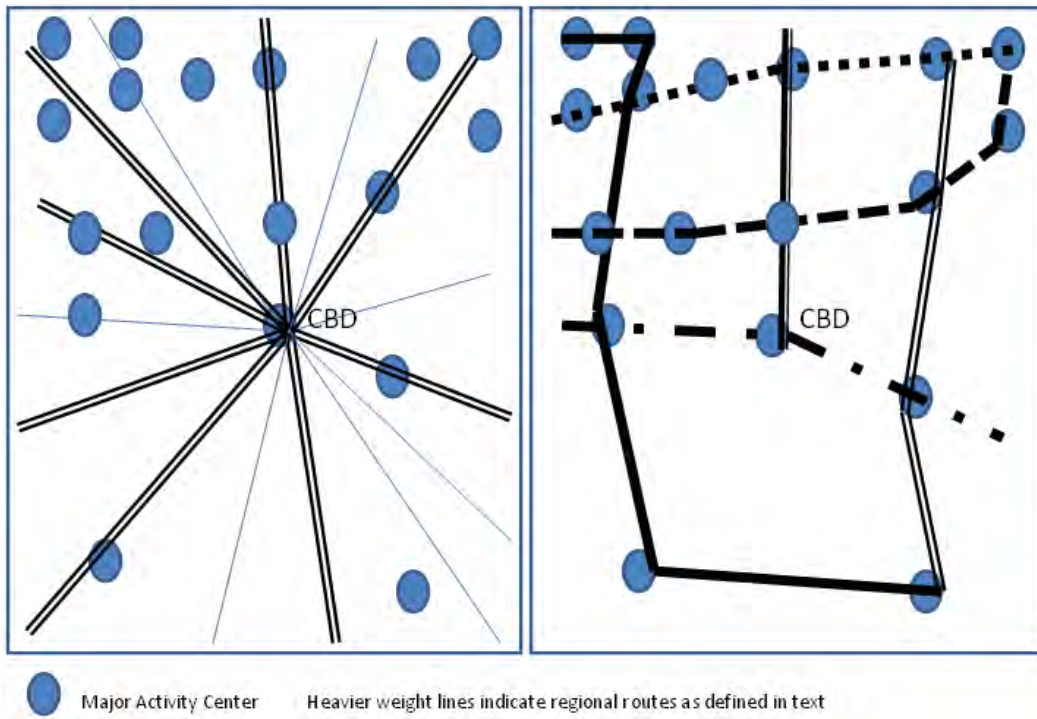

FIGURE 1 Radial versus grid regional route coverage.

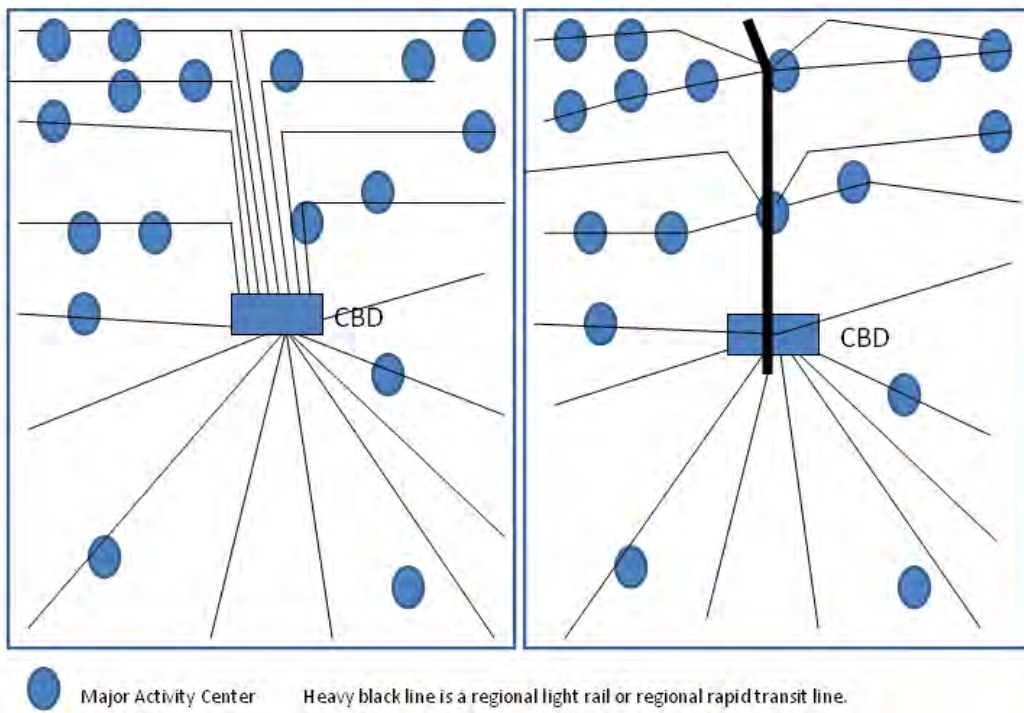

FIGURE 2 Using rail transit to improve transit productivity; unintended consequence: improved transit accessibility.

bus routes from more distant suburbs join other routes coming from closer-in points. The right panel offers a productivity solution to the duplication of CBD-bound bus routes. A rail transit line merely replaces the duplicative parts of the bus routes. Although the intent of introducing the rail line is to increase productivity and not to change service orientation, the latter may happen inadvertently (9). New transit users may take advantage of new origin-destination pairs that are possible because of the bus-to-bus, rail-to-bus, and bus-to-rail transfer stations that have opened in the suburbs.

CATEGORIZATION OF REGIONAL TRANSIT NETWORKS

The regional transit systems of the 10 metropolitan areas fall on a continuum between the two systems planning archetypes. Portland's and San Diego's transit systems come closest to the ideal presented in the right panel of Figure 1. These two metropolitan areas possess regional dispersed, or multidestination, bus-and-rail transit systems with light rail transit serving as a framework around which the bus system is organized (9). The trunk portions of bus routes that previously operated from Gateway, Beaverton, and Cedar Hills in Portland, and El Cajon and Old Town in San Diego, all shown in Figure 3, were replaced by light rail lines, in the manner depicted in Figure 2. The light rail lines reach many of the major destinations in their respective MSAs with service that operates at roughly double the scheduled speed of local bus service with headways of 15 minutes or better. (Major destinations are circles by black lines in Figure 3.) The light rail lines have transfer connections to many other destinations that they do not reach directly. In both metropolitan areas, the light rail lines intercept many major bus routes as well as commuter rail and other light rail lines at stations such as 82nd Street, 69th Street, Hollywood in Portland and Chula Vista H Street, 12th/Imperial, Fashion Valley, National City, and Old Town in San Diego, among others. At such stations the light rail lines take bus, commuter rail, and other light rail line passengers to destinations not reached by those lines, and those lines take rail passengers to destinations not reached by the trains.

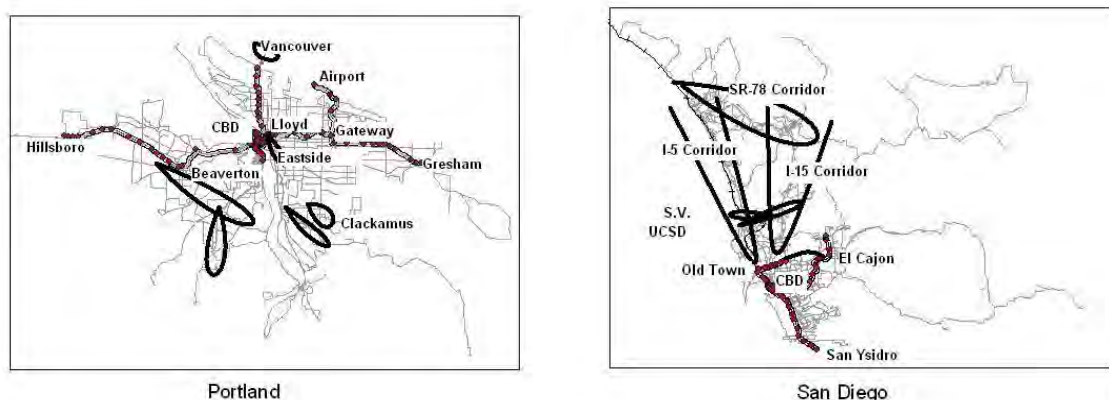

FIGURE 3 Metropolitan areas with regional multidestination bus–rail transit systems.

Underlying the regional light rail lines in both Portland and San Diego are networks of local bus routes that cover the entire region with multidestination route configurations. Portland began reorganizing its bus routes in 1979 from CBD-radial to timed transfer and grid configurations, 7 years before its first light rail line opened, but it did so with the idea that light rail would replace CBD-bound trunk portions of routes, as in Figure 2 (9, 10). San Diego adopted the German Vehrkehrsverbund approach to regional transit integration in 1979, the only metropolitan region in the United States to do so. In the Vehrkehrsverbund approach, a regional board establishes service plans and standards for coordinated transit service throughout the region. It provides for uniform fares, coordinated schedules, and the issuance of regional maps and timetables. It then contracts with numerous operators to provide the various specified services (11). From the public's point of view, the entire system functions as an integrated whole, but numerous smaller operators in contrast to a monolithic public monopoly can maintain better reliability while better controlling costs.

Neither Portland nor San Diego fully achieve the ideal shown in the right panel of Figure 1, however, because the higher-speed light rail lines do not service all of the major employment corridors (see Figure 3). Portland's light rail lines do not serve major employment centers to the southeast and southwest of the CBD. In addition, all the light rail lines serve the CBD, resulting in duplication of service and crowding of trains on tracks entering the CBD. In San Diego express buses and commuter rail run in the northern corridors not served by light rail, providing partial regional service (9). Regional service in these corridors is deficient, however. Express buses serve relatively few intermediate destinations because of the severe time penalty they endure for those intermediate destinations they do serve. Commuter trains are very infrequent. In the south part of the county, the regional light rail lines contribute mightily to transit performance. Each of the light rail corridors boards between 25,000 and 50,000 passengers per day. In the north part of the county no express bus or commuter train corridor boards more than 6,000 passengers per day (12, 13). In both San Diego and Portland, light rail lines provide only about 19 % of transit service, but they attract between 40% and 45% of all transit passenger miles in the regions (see Table 3).

The Minneapolis–St. Paul, Pittsburgh, and Salt Lake City transit systems come closest to achieving the ideal represented by the left panel in Figure 1 at the time of the study. These three transit systems focused their service on the central business district (see Figure 4). Both Minneapolis–St. Paul and Pittsburgh possessed CBD-radial local bus systems that blanket their respective metropolitan areas. In the case of Minneapolis–St. Paul there are three CBDs: Minneapolis, St. Paul, and the university lying in between, but 85% of all bus miles operated within the metropolitan area terminate or originate in the Minneapolis CBD, shown in Figure 4 (9). Both the Minneapolis–St. Paul and Pittsburgh systems operated CBD radial express bus routes that use grade-separated facilities to link more distant neighborhoods to the CBDs (9). Express buses in the Minneapolis–St. Paul metropolitan area make some intermediate stops to serve dispersed destinations indicated in the figure, and there is growing recognition in the Twin Cities that express buses will have to do much more of this in the future (9). Figure 4 shows three grade-separate busways entering Pittsburgh. The Pittsburgh busways contain on-line stations; the stations on the east busway shown access important university and medical destinations in the Oakland area, about 3 miles east of the CBD. Overall, however, the focus of the express bus services in both metropolitan areas is on their respective CBDs.

Both metropolitan areas possess single light rail corridors, though Pittsburgh's corridor diverges south of the CBD into two lines that come together again and then split into two outer

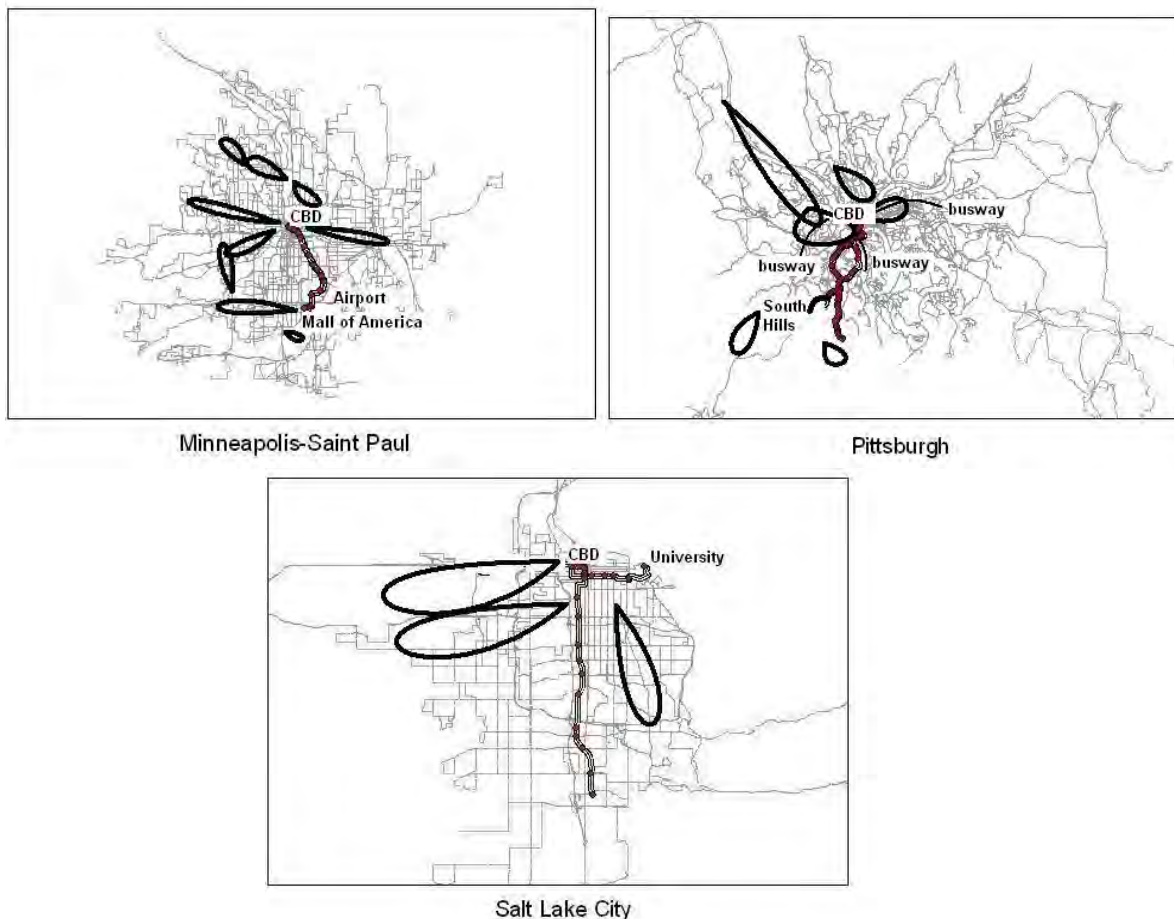

FIGURE 4 Metropolitan areas with CBD-radial bus–rail transit systems.

branches. The Pittsburgh lines are a rebuilding of a streetcar corridor that survived from the streetcar era and operate no faster than local buses, while the Twin Cities' light rail line opened in 2003 (9, 10). As of the time of the study, Pittsburgh's light rail line functions (as of this writing) like a standard radial bus route to the CBD with almost no integration with other transit services. Although it passes through areas with substantial employment, it serves primarily to connect residential districts with the CBD. In most of the Pittsburgh bus and rail system, passengers transferring from one route to another pay an additional fare, and few do so. There are two exceptions to these statements (9). One of the two outer branches terminates near a mall at South Hills, and there is substantial light rail traffic to the mall. In the CBD the line operates in a subway and circulates passengers transferring from buses to their final destinations. Transferring is possible in the CBD, because there is no fare in the CBD. In terms of the left panel of Figure 1, the Pittsburgh light rail corridor functions largely as one of the radial lines.

The light rail line serving Minneapolis–St. Paul was built to interconnect major destinations along its entire length, and bus services in its corridor were restructured around it. It functions similar to the right panel of Figure 2. The light rail line in Minneapolis provides about 5.3% of regional transit service and attracts about 14.5% of passenger miles. The light rail in Pittsburgh provides about 6.5 % of transit service while attracting about 11% of passenger miles.

The Salt Lake City transit system is also CBD-radial, but as of the time of this writing it differs from the radial orientation in Minneapolis–St. Paul and Pittsburgh by the sparseness of its bus service prior to the introduction of light rail. Salt Lake’s light rail line, which opened in phases between 1999 and 2003, serves suburban as well as CBD and university destinations (see Figure 4). However, most bus services in its corridor were not restructured around it. About 70% of the bus routes in the Salt Lake area, but not including bus service in Ogden or Provo, continued operating to the CBD in parallel to the light rail line (9). The light rail line is fast, averaging 23.6 miles per hour on its 15-mile journey from downtown Salt Lake City to Sandy. It has proven popular, attracting new passengers to transit as well as diverting former bus riders. However, because the sparse bus service was not restructured around light rail to feed passengers into it and to serve new destinations, its productivity fell. In 2006 light rail comprised 11% of transit service in the metropolitan area and attracted 29% of passenger miles.

The remaining five metropolitan areas possess transit systems that lie between the two archetypes. These metropolitan areas are Atlanta, Dallas–Fort Worth, Denver, Miami, and Sacramento. We provide maps of their regional transit systems in Figure 5. The Atlanta and Dallas–Fort Worth metropolitan areas possess multideestination local transit systems structured around rail transit lines in parts of the metropolitan area, but large destinations in many growing parts of the metropolitan areas are not served by high-quality transit service. In Atlanta, the urban core counties are served by the dispersed, bus-and-rail Metropolitan Atlanta Rapid Transit Authority (MARTA) system, whose entire system evolved in the manner depicted by Figure 2 (14). However, the growing job centers in the suburban counties of Cobb, Gwinnett, and Clayton lack rail service and either lack bus service or are served by agencies geared toward taking commuters by express buses from residences in these counties to jobs in the Atlanta CBD in accordance with the left panel of Figure 1 (9). Overall, in Atlanta the rail lines provide 40.3% of transit service in the metropolitan area while attracting 56.5% of the passenger miles.

In Dallas–Fort Worth, Dallas Area Rapid Transit (DART) provides a dispersed, bus-and-rail system in the eastern part of the metropolitan area, with a large part of the local bus network restructured around two north–south regional light rail lines, much as in Atlanta (see Figure 5) (9). However, in the western part of the metropolitan area the Fort Worth Transportation Authority operates a CBD-radial local and express bus system with much sparser service than DART provides. The Trinity Railway Express (TRE) commuter rail connects the two cities, but its service is somewhat less frequent than hourly and does not operate on Sundays. It also does not have connections to the large and growing employment centers in Arlington, which are devoid of any transit service. Overall the two light rail lines in Dallas account for 15.3% of the metropolitan area’s service and attract 36.0% of its passenger miles.

Sacramento has some of the strengths and deficiencies of Atlanta and Dallas–Ft. Worth, although overall it (as Salt Lake City) operates much less bus and rail service per capita than the other cities in the study. Its original light rail line, which opened in 1987, was sold to the community as a productivity-enhancing strategy following the principles laid out in Figure 2 (7). More recent light rail extensions to the east and south have not benefited from the same degree of bus–rail integration, however, and both riding habit and productivity have suffered as a consequence (10). The south light rail line ran somewhat west of the established transit spine in its corridor, much as was the case for San Diego’s first light rail line. Rather than relocating transit centers from that spine to the new light rail line, as San Diego did when its first line



FIGURE 5 Metropolitan areas with partial regional bus-rail transit systems.

opened in 1981, Sacramento made few changes to its southern bus services when light rail service opened there in 1999 (10).

Sacramento’s eastern light rail extension to Folsom serves a jobs-rich area, but planners intended the service to take commuters only from that area into the center city (9). There are few buses in the extensive employment centers around Folsom, making it similar to the job-rich areas of Arlington, Texas, and few passengers ride trains outbound to Folsom in the morning to those jobs (see Figure 5). In contrast, Portland and San Diego experience strong commuter patronage

to jobs located near their outer ends, and Sacramento has strong patronage via bus connections to jobs located outside of the CBD along its original light rail lines (9). Job concentrations in other parts of the Sacramento metropolitan area (Davis, Woodland, and Roseville) are served only by express buses oriented to taking commuters from those areas to the Sacramento CBD, following the principle of the left panel of Figure 1. In 2006 light rail provided 24.4% of all transit service in the Sacramento region and attracted 47.5% of passenger miles.

The Miami metropolitan area possesses dispersed transit systems within each of the three counties, but it lacks meaningful integration of these individual services into a metropolitan whole (see Figure 5) (9). Dade and Broward Counties provide local bus service operating in a grid pattern on major boulevards, serving all of the counties' urbanized areas. Palm Beach County offers sparser service to all of its urbanized area, as well. The local services are effective. That serving Broward County, for example, offers twice as much service and carries three times as many passengers in a county with similar population, employment, and growth patterns as Tarrant County, Texas where Fort Worth is located (15). These contrasts prevail, although Broward County has no discernable center in contrast to Fort Worth's well-developed CBD.

As noted before, the main transit problem in the Miami metropolitan area is the lack of regional overlay. Metrorail, a rapid transit line about 20 miles long, extends northwest and southwest from the Miami CBD in Dade County, and it is well integrated with the Dade county bus services. However, it is relatively short, and its northwestern end serves an impoverished area with very little patronage. A commuter rail line connects the three counties, but service is not frequent enough to function as a regional rail line, and local bus services are not integrated with it (9). There is no Verkehrsverbund concept to integrate the various transit operators in the Miami area, in contrast to San Diego. Metrorail is not completely ineffective, however. It provides 17.4% of transit service in the three-county area and attracts 28.2% of passenger miles.

Transit in the Denver metropolitan area also possesses mixed qualities. A single agency provides local bus service to all parts of the urbanized area. The local services, operating at an average scheduled speed of 16 miles an hour, operate on a grid pattern along many of the area's arterial roads. This quality would place the region's transit service close to the left panel of Figure 1 if it were not for the fact that routes coming within 4 miles of the CBD are diverted into the CBD, meaning that the bus grid is in reality more like a CBD radial system. The intent seems to be to reduce transferring for passengers bound for the CBD, but such deviations result in significant service redundancy (see left panel of Figure 2), thereby compromising productivity, while also dampening the attractiveness of service for many non-CBD-oriented riders (16, 17, 9).

The Denver metropolitan region possesses an overlay of faster regional services, but these are only weakly developed. The light rail lines, operating at a scheduled speed of 24 miles an hour, offer the only quality regional service, but the light rail lines serve only two corridors. More than half of the light rail system shown in Figure 5 opened in 2006, when the southeast line began serving a heavy collection of suburban jobs in contrast to the older, largely residential southwest corridor. Elsewhere, there is a regional overlay of 18 regional bus services that operate at an average speed of 30 miles per hour. These connect the area's larger centers, but 15 of the 18 routes provide only a handful of trips on weekdays only. Another system of fast (27 miles per hour) but infrequent express buses focus on the Denver CBD, in the manner of the left panel of Figure 1 (16, 17).

Figures shown in Table 3 for Denver reflect a system in transition (the southeast light rail line opening in 2006). Data provided by RTD for early 2007 show that light rail accounted for 8.5% of weekday scheduled vehicle miles while it attracted 19.9% of passenger boardings for the

system for the month of February 2007. Regional and intercity buses accounted for 10.7% of scheduled vehicle miles while they attracted 3.7% of passenger boardings. Express buses accounted for 3.8% of scheduled vehicle miles while they attracted 2.3% of passenger boardings (16, 17).

REGIONAL PERFORMANCE OF SYSTEMS IN THE THREE CATEGORIES

The discussion about systems planning places the 10 metropolitan areas into three groups: regional multideestination (Portland, San Diego), CBD-radial (Minneapolis–St. Paul, Pittsburgh, Salt Lake City), and partial regional (Atlanta, Dallas–Fort Worth, Denver, Miami, Sacramento). To examine the relationship between systems planning and transit performance, we focus on three measures of regional transit performance during the period 1984–2006. The first measure, passenger miles per capita (PM per capita), is a measure of transit riding habit. The second measure, passenger miles per revenue mile (PM per revenue mile), is load factor, a measure of service productivity. The final measure, operating expense per passenger mile (OE per PM, 2007\$), is a measure of cost effectiveness expressed in inflation-adjusted dollars. These three measures are calculated for the entire set of fixed-route transit services in each metropolitan area. We focus on the median value in each of the three groups as the indicator of overall performance for each of the three groups. The panels in [Figure 6](#) provide transit performance trends.

The top panel of Figure 6 reports riding habit (PM per capita). The median metropolitan area in each group has seen riding habit increase between 1984 and 2006. The increase for the median metropolitan area in the regional multideestination group (labeled regional MD) far exceeds its counterparts in the other groups. Since 1986, the median metropolitan area in the CBD-radial group has had the lowest riding habit of the three groups.

The middle panel of Figure 6 reports productivity (PM per revenue mile). In contrast with riding habit, productivity has tended to be stagnant or in decline between 1984 and 2006. The three groups traded positions through the middle 1990s when the regional multideestination group leapt in front. From the mid-1990s until 2005, the CBD-radial group performed worst on the productivity measure, while the partial regional group ranked in the middle.

The lower panel of Figure 6 reports cost effectiveness (OE per PM) in inflation-adjusted dollars. Between 1984 and 2006, cost effectiveness deteriorated in the median metropolitan area in two of the groups while it improved in the third group. Since the late 1980s, the regional multideestination group has been the most cost effective. Between the mid 1990s and 2005, the CBD-radial group has tended to be the least cost effective.

DISCUSSION OF REGIONAL PERFORMANCE

The analysis of transit performance just discussed indicates that metropolitan areas with regional multideestination systems outperform their CBD-radial and partial regional counterparts. The CBD-radial metropolises tend to be the poorest performers. These metropolitan areas do not perform poorly because they are different in terms of urban structure than the other metropolitan

TABLE 3 Rail Transit Ridership, Service, and Productivity by MSA, 2006 (15)

MSA	Rail Ridership (passenger miles)	Rail as % of All Transit Ridership	Rail Service (revenue miles)	Rail as % of All Transit Service	Rail Productivity (PM per RM)
Atlanta	488,528,763	56.46	21,091,467	40.33	23.16
Dallas-Fort Worth	169,820,820	35.99	6,183,623	15.28	27.46
Denver	59,137,058	12.73	4,366,864	9.45	13.54
Miami	224,387,452	28.22	12,638,981	17.40	17.75
Minneapolis-Saint Paul	52,584,623	13.62	1,785,159	5.39	29.46
Pittsburgh	33,034,896	11.01	2,010,415	6.47	16.43
Portland	179,875,394	39.39	6,377,513	19.21	28.20
Sacramento	78,181,014	47.49	3,888,222	24.42	20.11
Salt Lake City	86,039,042	29.30	2,827,710	10.69	30.43
San Diego	251,845,913	44.75	9,479,111	18.90	26.57
NOTE: Rail includes all rail transit modes.					

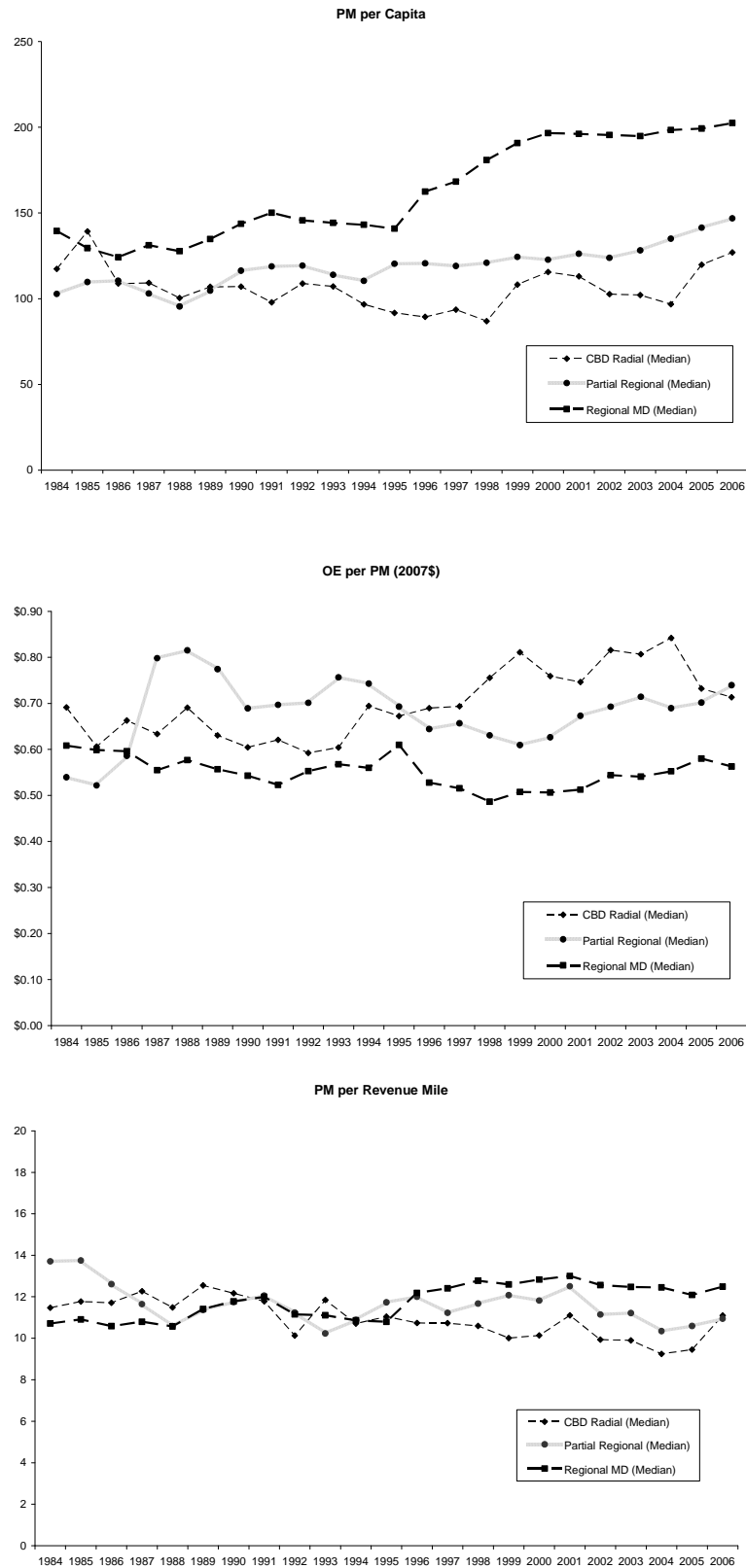

FIGURE 6 Regional transit performance by type of system, 1984–2006.

areas. All 10 metropolitan areas are decentralized, as Table 2 showed earlier. Rather, the CBD-radial metropolises perform poorly because their CBD-focused route structures do not match the dispersed pattern of destinations to which transit users wish to travel. The regional multidestination metropolises perform well because their decentralized transit networks match the dispersed pattern of destinations. The partial regional metropolises lie somewhere in between because parts of their networks match some of the dispersed pattern of regional destinations.

During the period covered by our analysis, no metropolitan area possessed an ideal regional transit network. Portland and San Diego came closest, but even they were deficient in serving some of their rapidly growing employment corridors with networks of high-speed, frequent service. However, the regional services they possessed were performing quite well, and perhaps the best of all transit services in their respective regions. They accounted for a small proportion of the service provided, but carried sizeable proportions of total regional transit patronage. One can imagine that a metropolitan area with a fully developed regional network would see: (a) higher riding habit, (b) greater productivity, (c) lower operating expense, and (d) a large share of metropolitan transit patronage on the regional service. This class of service has been the object of much scholarly criticism in the past, but this study clearly demonstrates that these services are both performing well when used correctly and this correct use is critical for strong regional transit performance.

CONCLUSION

The metropolitan areas whose transit systems most closely resemble the regional multidestination archetype perform best on all three measures of transit performance. The two metropolitan areas that come closest to the ideal, Portland and San Diego, do so as a consequence of planning decisions. Planners in Portland explicitly decided to decentralize the bus system several years before opening its first LRT line and did so in a way that LRT and bus could leverage one another to more effectively serve dispersed destinations. Planners in San Diego recognized the same synergies between bus and rail as Portland but did so by coordinating a diverse array of transit operators into a seamless whole while better controlling operating expense than any of the other metropolitan areas studied. In both metropolitan areas, planning decisions were critical to transit success.

The metropolitan areas with partial regional systems typically approached the adoption of rail transit as a means of reducing operating costs. This indicates a level of planning limited to achieving certain specific cost and productivity objectives. Much to their surprise, planners in many of these metropolitan areas found that the service changes they made to reduce cost and improve productivity also opened up new, unanticipated sets of origins and destinations which riders quickly discovered. Typically, however, planners in these metropolitan areas lacked a regional vision for transit—partially due to their service areas covering limited sections of the region but also due to a planning focus limited to achieving specific cost and productivity objectives in specific corridors. Had they taken a truly regional approach to planning, their systems would likely experience stronger performance.

Finally, planning decisions also played a role in the performance of transit systems in the CBD-radial metropolises. Here, planners made an explicit decision to focus on one market—and to serve it well—but in so doing they unintentionally turned their backs on many other potential markets. A consequence of this approach is that rail transit is not fully leveraged, as it essentially

functions like a CBD-serving bus route. Thus, it does not achieve the ridership or productivity that we find in the metropolitan areas where rail plays a different role.

Observing the 10 metropolitan areas, we see considerable variation in transit performance, but within the same context of urban decentralization. The variation we find is due to differences in planning decisions. Planning decisions that serve to achieve the regional multidestination archetype by leveraging the rail transit investments to promote synergies between bus and rail result in the highest riding habit, highest productivity, and lowest operating costs. In the final analysis, planning decisions about how regional transit systems should be designed are critical to the ultimate success of rail transit.

ACKNOWLEDGMENTS

The authors thank the Mineta Transportation Institute at San Jose State University for their generous financial support of this research. Also thanked are those who agreed to be interviewed for the project from which this paper is drawn: Douglas Allen, Mick Crandall, Derek Crider, John Dillery, Rod Diridon, Paul Grether, Jim Howell, Gary Hufstedler, Bill Lieberman, David Minister, Anthony Palmere, Robert Pearsall, Robert Rynerson, Edson Tennyson, Clark Turner, William Van Meter, Jeff Weidner, Michael Wiley, Cain Williamson, David Wohlwill, and Ken Zatarain. The authors also thank John Schumann for identifying many of these interviewees and the transit agencies and metropolitan planning organizations in each of the study areas for providing data used in this analysis.

REFERENCES

1. Demery, L. U.S. Urban Rail Transit Lines Opened from 1980. Publictransit.us as part of the Traffic Density Series, October 18, 2005.
2. Kain, J. F. and Z Liu. Secrets of Success: Assessing the Large Increases in Transit Ridership Achieved by Houston and San Diego Transit Providers. *Transportation Research Part A*, 33, 1999, pp. 601–624.
3. Thompson, G. L. and T. G. Matoff. Keeping Up with the Joneses: Planning for Transit in Decentralizing Regions. *Journal of the American Planning Association*, Vol. 69, No. 3, 2003, pp. 296–312.
4. Metro Transit. E-mail communication from Jason Podany, Transit/GIS Planner, Metro Transit, to G. L. Thompson, May 23, 2008.
5. Port Authority Transit. Port Authority Statistics, General Statistics, <http://www.portauthority.org/PAAC/CompanyInfo/GeneralStatistics/tabid/68/Default.aspx>. Accessed June 25, 2007.
6. Federal Transit Administration. *Evaluation of Port Authority of Allegheny County's West Busway Bus Rapid Transit Project*. Report No. FTA-PA-26-7010-03, 2003.
7. Schumann, J. Assessing Transit Changes in Columbus, Ohio, and Sacramento, California: Progress and Survival in Two State Capitals, 1985–2002. In *Transportation Research Record: Journal of the Transportation Research Board*, No. 1930, Transportation Research Board of the National Academies, Washington, D.C., 2005, pp. 62–67.
8. Thompson, G. L. Planning Considerations for Alternative Transit Route Structures. *Journal of the American Institute of Planners*, Vol. 43, 1977, pp. 158–168.
9. Brown, J. R. and G. L. Thompson. *The Influence of Service Planning Decisions on Rail Transit*

- Success or Failure*. Mineta Transportation Institute, San Jose, CA, 2008d.
10. Brown, J. R. and G. L. Thompson. *Timelines of Rail Transit Development in Eleven Metropolitan Areas*. Florida Planning and Development Lab. Florida State University, Tallahassee, 2008e.
 11. Cervero, R. *The Transit Metropolis: A Global Inquiry*. Island Press, Washington, D.C., 1998.
 12. San Diego Association of Governments. Passenger Boardings by Route. <http://pcp.sandag.org/Home.aspx>. Accessed October 2007.
 13. San Diego Metropolitan Transit System. Monthly Trolley Ridership by Route, 2004–2007. Provided by Anika Smart, Associate Transit Planner by e-mail to Greg Thompson, February 20, 2008.
 14. Brown, J. R. and G. L. Thompson. The Relationship Between Transit Ridership and Urban Decentralization: Insights from Atlanta. *Urban Studies*, Vol. 45, 2008, pp. 1,119–1,139.
 15. Florida Department of Transportation. Florida Transit Information System 2006. lctr.eng.fiu.edu/ftis/. Accessed September 2008.
 16. Regional Transportation District. Service Recap Summary Report—All Operations, District Summary Statistics for Schedule Effective: January 14, 2007, Regional Transit District, Denver, Colo. 2007.
 17. Regional Transportation District (RTD). 2007c. Systemwide Monthly and 12-month Boarding Averages for February 2007.
 18. Atlanta Regional Commission. ARC Employment Data for Atlanta CBD and ARC Counties. Provided by Mike Carnathan of ARC, e-mail message to authors, May 31, 2006.
 19. U.S. Bureau of Economic Analysis. Total Employment by County. From Table CA25 Total Employment by Industry. <http://www.bea.gov/bea/regional/reis>. Accessed August 21, 2007.
 20. U.S. Census Bureau. 1970–2000. Employment by Census Tract, 1970, 1980, 1990, 2000. Used for estimation of CBD employment. <http://www.census.gov>. Accessed August 21, 2007.
 21. U.S. Census Bureau. Population by County: 1970–2006. Constructed from 1970s Intercensal Population Estimates, 1980s Intercensal Population Estimates, 1990s Intercensal Population Estimates, and 2001–2006 Population Estimates Data, 2006. <http://www.census.gov>. Accessed May 31, 2007.
 22. Atlanta Regional Commission. Transit Route GIS Shapefiles. Provided by Jim Bohn of ARC, e-mail message to authors, June 20, 2006.
 23. Miami-Dade Transit. Miami MSA Transit Route Shapefiles. Provided by MDT staff, 2007.
 24. Metropolitan Council. Minneapolis Area Transit System Shapefiles. Provided by Metropolitan Council staff, 2007.
 25. Metropolitan Transit System. San Diego Area Transit System Shapefiles. Provided by MTS staff, 2007.
 26. North Central Texas Council of Governments. Year 2007 Dallas–Fort Worth MSA Transit System Route Shapefiles. Provided by NCTCOG staff, 2007.
 27. Regional Transportation District. Denver Metropolitan Area Transit System GIS Shapefiles. Provided by Denver RTD staff, 2007.
 28. Sacramento Area Council of Governments. Sacramento Area Transit System Shapefiles. Provided by SACOG staff, 2007.
 29. Southwestern Pennsylvania Commission (SPC). Transit System Shapefiles for Pittsburgh Area Operators. Provided by W. Kirk Brethauer of SPC, 2007.
 30. Tri-Met. Transit System Shapefiles for Tri-Met. Provided by Tri-Met staff, 2007.
 31. Utah Transit Authority (UTA). Transit Route Shapefiles. Provided by UTA staff, 2007.
 32. Atlanta Regional Commission (ARC). ARC Employment Data for Atlanta CBD and ARC Counties. Provided by Mike Carnathan of ARC, e-mail message to authors, May 31, 2006.

LIGHT RAIL: A TOOL TO IMPROVE REGIONAL TRANSIT RIDERSHIP

The Importance of Connecting Light Rail and Destinations

JEFFREY S. WOOD
SHELLEY POTICHA
MARIA V. ZIMMERMAN
Reconnecting America

Since discussion of transit-oriented development (TOD) began to reach prominence in the 1990s much research has gone into the residential densities needed to support transit. While this is important, recent research seems to suggest that the destination is just as important. To this end, connections to job centers and shopping districts with major transit investments can often be overlooked when choosing transit alignments, specifically since cost is often a major consideration in choosing new transit corridors. It is also a part of the political dance that is performed during the planning and implementation of major capital projects. This paper seeks to discuss the importance of connecting regional destinations with new transit alignments and the role networks can play in increasing non auto mode share and ridership.

DESTINATIONS MATTER WHEN CHOOSING ALIGNMENTS

The function of the transit line and where it goes has a clear and observable impact on ridership. For example, a commuter rail line that stops every 2 miles, connects suburban communities to downtown jobs, and depends on patrons driving to the station is likely to function differently than a subway line located in a busy urban area with stops every few blocks, and surrounded by intensive development and a pedestrian-oriented environment. These differences need to be acknowledged and measured when deciding which transit line should receive funding or which mode best fits local conditions.

In order to more accurately estimate the ridership differences between a bus-only system and a bus and rail system, the Federal Transit Administration (FTA) has developed “modal constants” for their capital funding evaluation process. Currently, regions that are building light rail for the first time are not able to put in a modal constant or “bias” into the model.¹ This stems from the fact that each region has a different reaction to improved transit. After an initial line is completed, a bias can be derived based on actual performance to inform the modeling of future expansions.

For example, Minneapolis is now allowed to use a rail bias for the Central Corridor now that it has a working example of how the Hiawatha Line outperforms local transportation models. However, the lack of a “modal constant” for all projects is a disadvantage for project sponsors that are seeking to introduce a new mode and could result in a low cost effective rating for a “new start,” essentially killing a worthy project. Currently, a medium rating is needed to pass.

¹Federal Transit Administration, Office of Environment and Planning, Proposed Policy Guidance on Evaluation Measures for New/Small Starts. U.S. Department of Transportation, August 3, 2007.

Recently, Houston was able to upgrade their Federal New Starts projects to light rail from bus rapid transit (BRT) because network modeling showed greater ridership numbers than modeling the individual lines alone, allowing Metro to reach cost targets for a medium rating that would support rail technology that voters wanted.²

But relying extensively on modeled ridership and cost alone illustrates only part of the benefits of transit investments. A local decision to build a transit line is as much, if not more, about connecting people to jobs, education and cultural opportunities, and stimulating economic development as it is about the expected cost of the capital expenditure. Thus, an inherent tension arises between the interests of local and federal proponents of transit investments. Furthermore, research has shown that not only do residential developments around the station areas matter in terms of generating transit ridership, but the presence of business districts affect the use of transit much more than waiting for residential uses to sprout up along the line. In fact, research by Professor Gary Barnes at the University of Minnesota suggests that for every increase of 1,000 residents per square mile, transit usage to central city jobs increases at a much greater rate than to jobs in the suburbs.³ If this research were to be recreated in other locations, it would seem that connecting and building up destinations is a sound strategy for generating ridership gains.

Similar to the research conducted by Professor Barnes, several recently built light rail lines were chosen to compare with proximate jobs in order to test the relation between the two factors. By using GIS to pull block-level data from the 2004 Census Longitudinal Employer Household Dynamics (LEHD)⁴ jobs data, ½-mile radii were drawn around new stations and jobs were aggregated within the transit zones.⁵ When plotted on x and y axis' (Figure 1) the number of jobs that are in light rail transit zones seem to have a direct effect on ridership. While there are many other factors which are important to ridership, this would seem to back up Professor Barnes research discussing the roles of destinations in increasing transit share.

However, connecting destinations with transit can be difficult and getting connectivity from door-to-door is even more challenging. One example is when officials in St. Louis County made a conscious decision to build the new Cross County Line along the outskirts of Clayton, a major regional employment center, instead of into the heart of the employment district.⁶ Given that most of the Metro system is built with limited-grade crossings and in a former railroad right-of-way, the result might have been a subway section through the center of the business district or a street-running section of the line. Instead, the Cross County Line skirts the side of a major employment center in favor of avoided construction costs.

Similarly, the ability of the Southeast Corridor in Denver to allow riders to easily access job opportunities on foot is limited due to its location along the side of an interstate highway. As an additional penalty, one-half of the station areas are unavailable for TOD development due to barrier represented by the highway. Furthermore, the location of the highway between the station and jobs as well as the lack of good pedestrian connections at stations near the Tech Center has been seen as a deterrent to more ridership.⁷

²Editorial Staff. Connecting the Tracks. *Houston Chronicle*. October 20, 2007. Accessed October 30, 2007. <http://www.chron.com/disp/story.mpl/editorial/5230480.html>.

³Barnes, G. The Importance of Trip Destination in Determining Transit Share. *Journal of Public Transportation*, Vol 8, No.2, 2005.

⁴LEHD data was obtained through Cornell University. <http://www.vrdc.cornell.edu/news/>.

⁵It is recommended that LEHD data be aggregated to the track level. Discrepancies in the data have been found in the past leading to over and underestimation of jobs in a certain district. A spot check of the Dallas data found an empty parking lot containing a significant amount of jobs.

⁶Shrout, T. Citizens for Modern Transit Advocacy Group. Correspondence, May 25, 2007.

⁷Denver RTD Staff. E-mail correspondence July 5, 2007.



SOURCE: 2004 LEHD Data, NTD Q4 2007, transit agency data, CTOD

FIGURE 1 Jobs and ridership on recently constructed light rail lines.

Figure 2 below shows the urban context of the Cross County Line in St. Louis discussed above and the Southeast Corridor in Denver. Notice in Denver that the high employment density Tech Center is on the opposite side of the freeway from the station. The decision to build the line with the freeway was one that saved money for the transit budget and helped keep the cost-effectiveness rating low⁸, but created the need for “last mile” connections to be made by bridges that cross the busy highway. These last mile connections are often difficult to fund through local public works budgets and make riding transit less comfortable than taking an automobile to work, especially in more suburban employment districts where parking is provided right outside the building.

In San Diego, the Green Line was built along side Interstate 8 (see Figure 3). It is grade separated and the system’s first subway station was built at San Diego State University.⁹ The decision to build along the highway in mostly elevated structures made the cost considerably higher than if the rail was placed at-grade, but makes travel times along the line faster. With the exception of the subway segment through the University, though, the Green Line delivers patrons to the edge of districts instead of to their centers. The freeway alignment, much like in Denver, severely splits opportunities for connections on both sides of the station. While it is not apparent how it would have been done differently, the emphasis on running the line alongside the freeway has resulted in less than optimal outcomes for ridership and connections to destinations.

⁸USDOT. Innovative Financing Primer. Case Study – GARVEEs. Denver T-Rex Project. April 2002. Accessed <http://www.fhwa.dot.gov/innovativefinance/ifp/ifprimer.pdf>.

⁹Linthicum, J., Director of Engineering and Construction at SANDAG. E-mail correspondence, May 24, 2007.

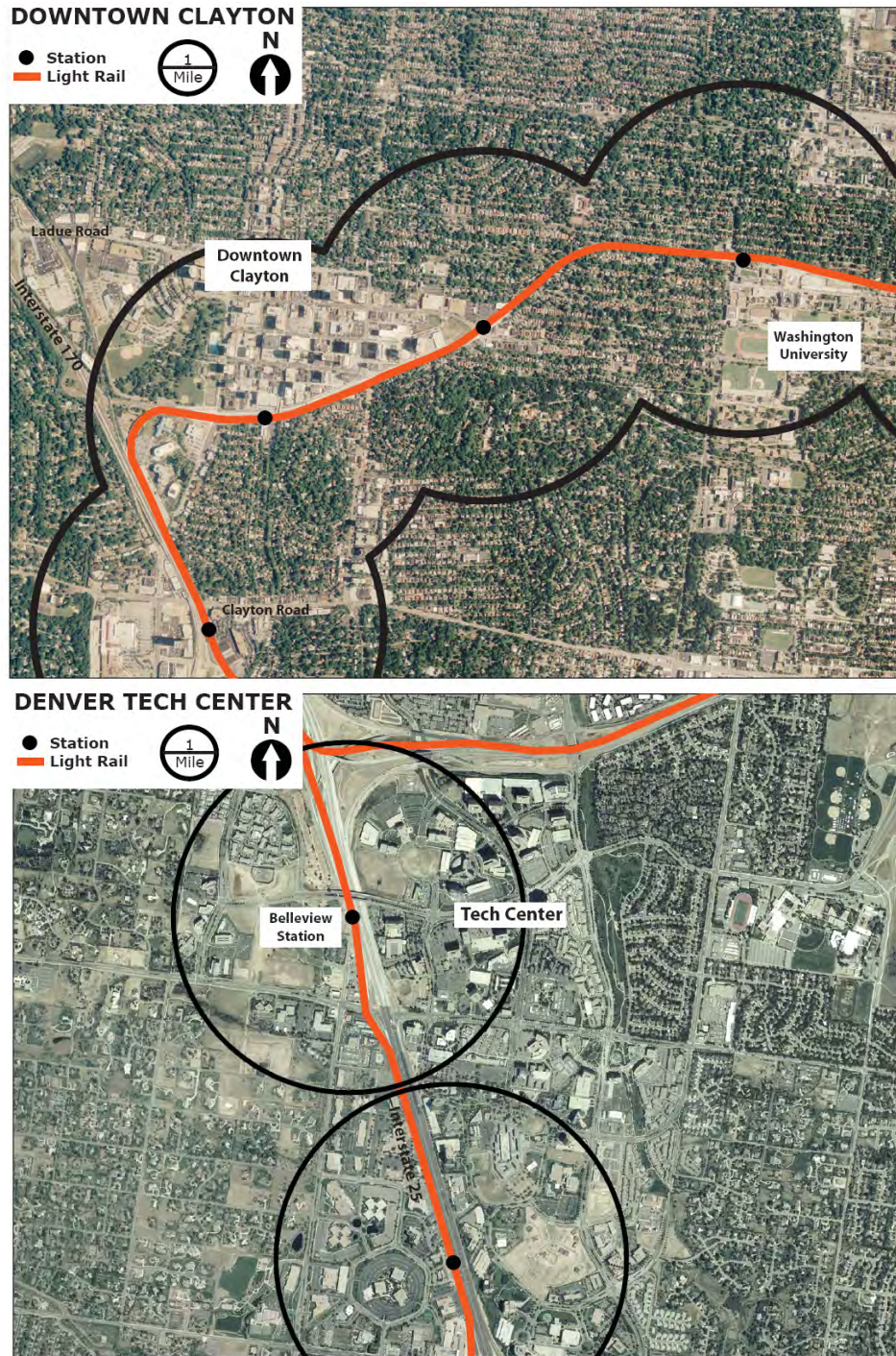

SOURCE: USDA Aerial Photography, RTD-Denver, Metro St. Louis, CTOD, 2007.

FIGURE 2 Downtown Clayton and Denver Tech Center light rail alignments.



Photo by Brad Pennock on Flickr

FIGURE 3 San Diego State University with Green Line train in foreground.

Houston's Main Street Line has drawn local criticism for collisions with drivers who ignored signs, but the routing along a major arterial street is also credited with its success. It runs straight through the largest medical center in the world, with over 73,000 jobs,¹⁰ and into the downtown of the United States' fourth largest city (see [Figure 4](#)). Local officials say that it was difficult to agree on this alignment, but that the routing has paid large ridership dividends.¹¹ The Houston light rail line has the highest passenger density per mile of any new light rail line in the United States and does so by going through the center of employment districts rather than skirting them.

Lines in other cities, such as Los Angeles and Sacramento, have built on existing railroad rights-of-way. Using these available lands helps avoid disruption to businesses during construction and expensive land acquisition costs but often serves to skirt major employment centers and destinations. The Gold Line, for example, delivers riders to the outer edge of the Los Angeles CBD, which according to LEHD data from 2004 has over 191,000 jobs. The Gold Line itself is within walking distance of only 120,000 jobs (see [Figure 5](#)). Most riders have to walk through Union Station and connect to the Red Line subway to reach their place of employment. Planning has begun for a downtown connector¹² to connect the Gold Line, Gold Line Eastside and the Blue Line in order to make connections seamless.¹³

¹⁰Greater Houston Partnership website. *Health Care Industry Guide*. Accessed August 21, 2007. <http://www.houston.org/industryGuide/healthCare.asp>.

¹¹Mason, T., Houston Metro Vice President of Real Estate Services. Phone interview, September 17, 2007.

¹²The downtown connector is envisioned as a subway that would directly connect the Gold Line to the Blue Line and the Expo Line that terminate on the opposite side of downtown from each other.

¹³LACMTA. Regional Connector Study Page. Accessed February 15, 2008. http://www.metro.net/projects_programs/connector/default.htm.

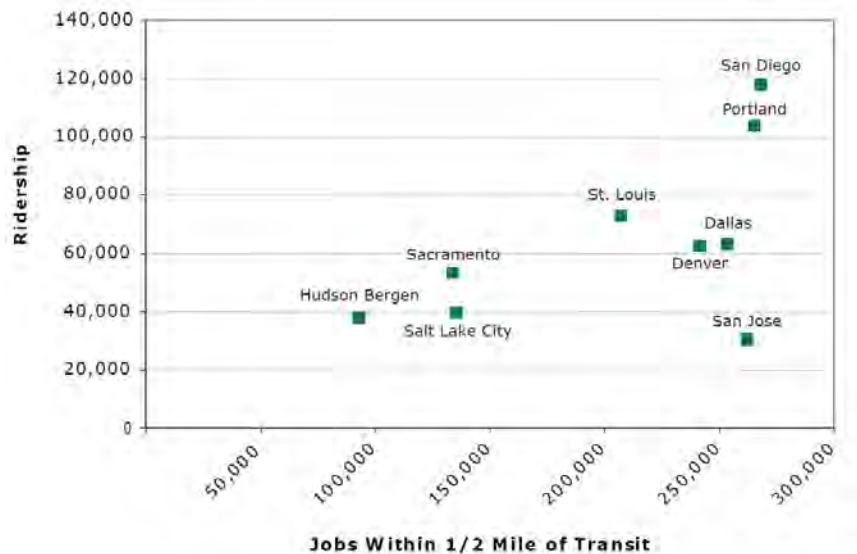

FIGURE 4 Houston light rail in the medical center.

And, while lines such as these might be adjacent to a significant amount of underutilized property and easily redevelopable as TOD, the costs of brownfield cleanup and providing new infrastructure on these sites might be larger than it would have been if the transit lines were located along arterial corridors with existing water, sewer, and road infrastructure. The trade-off is the expense of relocating utilities that might be under the street during light rail construction. The federal model is not calibrated to allow a nuanced assessment of these types of trade-offs that relate not to ridership and travel time, but investment and relational issues such as routing through a job center.

In some instances, the reason for placing lines in existing rail corridors is that construction impacts to existing users are minimized. Transit projects located in the center of arterial streets, such as Houston's, cause a disruption to businesses during construction and create ancillary costs to reconstruct streets and utilities, and reprogram and replace traffic signals. These costs are often included in the capital transit budget but effectively reduce the "cost-effectiveness" rating of a project and are what cause many cities to look at alternatives to street-running rail lines through the districts for which it would be most useful. Unfortunately, this "cost shock" causes many cities to choose alignments that do not maximize potential ridership, but serve to lower costs and provide less connected service.

An example is readily available in Austin, Texas, where a 2000 light rail ballot measure was defeated primarily by suburban voters. Voters within the City of Austin passed the measure however the line lost districtwide by less than 2,000 votes during the 2000 presidential election in which then Texas governor George W. Bush was on the ballot. In mid-2004 a measure crafted by the transit agency and state politicians led to a 2004 commuter rail plan that passed by over



SOURCE: 2004 LEHD, National Transit Database ridership Q4 2007, CTOD

FIGURE 5 Jobs and ridership of recently built light rail systems.

60% of the vote.¹⁴ The lines both would have connected the downtown with the northwest suburbs, yet the initial line that had mainly arterial segments and a higher cost of \$739 million would have generated 37,000 riders¹⁵, versus a \$90 million commuter rail line on existing tracks that is predicted to generate only 2,000. The difference in cost to generated riders is rather staggering.

This is often the political trade off many cities face when making a decision on a first or second rail line. Often the choice to locate a line in an existing right-of-way instead of through destination-rich centers is the choice between there being a line or no rail line at all. This emphasis on cost savings has led many cities and citizens to think first about cost and political implications and impact second. This emphasis could be the biggest opponent to locating lines near job centers that would generate much higher ridership to offset the costs.

It could also possibly be disastrous to future network expansion. Political will for future expansion often hinges on the success of the existing lines. Many of the lines discussed above are undergoing expansion partly because political will was built on the success of the initial line. Denver voted in 2004 to expand its successful existing rail network to the whole region after trying for several decades and voters in Salt Lake City recently approved an increase in sales tax levies to pay for a four-line expansion of the region's light rail network.

Minneapolis' Hiawatha light rail line success spurred discussions of a regional rail network and recently the state legislature overrode a veto by the governor to raise the sales tax for capital transit expansion. It is hard to believe that such political backing was not made possible at least in part by the Hiawatha line's ability to beat 2025 forecasted ridership. And while the ridership forecast was low, the number of jobs connected by the line put the Hiawatha

¹⁴Wood, J. Voting for Buses: How Austin's Transit Friendly Electorate Missed the First Train. An Assessment of the Political Battle Behind Rail Transit in Austin Texas. Master's Thesis. 2005. University of Texas at Austin.

¹⁵2001 Annual Report on New Starts. Austin Texas Light Rail Corridors.

http://www.fta.dot.gov/publications/reports/reports_to_congress/planning_environment_2915.html.

in line with every other light rail line in Figure 1. These examples could lead one to believe that connecting job and activity centers is a region's best bet for ensuring continued rail expansion.

WHERE YOU ARE GOING DETERMINES HOW YOU GET THERE

Recent research shows that destinations are major determinants of increases in transit share of work trips. Regression analysis showed in a study of the Twin Cities that for every increase of 1,000 residents per square mile, transit share to the central city increased by 1.15 percentage points. The central city in this study represents the job-rich downtowns of Minneapolis and St. Paul as well as the surrounding close-in job clusters. The same increase of 1,000 residents per square mile led to a .63 increase in transit share to suburban jobs. Transit shares to the region's two downtowns, Minneapolis and St. Paul, increased 2.43% for every 1,000 residents per square mile. Low income residents also increased the share positively for every 1% increase in their numbers.¹⁶ So, when residential densities increase, going towards the central city is more likely to increase the usage of transit. Given the spread-out nature of the suburbs and historical commuting patterns, it makes sense that even if residential densities increased, transit usage to the suburbs would not grow as fast as to the city and residents are more likely to use automobiles to get to suburban jobs.

Along those same lines, light rail connecting major universities and regional special events destinations have been experiencing significant ridership, particularly during the off-peak times. Special event trip generators, universities and regional destinations like airports can each garner significant episodic and long-term transit ridership.¹⁷ The ability of transit to successfully and conveniently transport new riders during these kinds of episodic events can also be influential in generating long-term choice transit riders. But this also shows the importance of density and price factors that play into mode choice decisions. Universities and special event venues are often auto traffic constrained. Similarly, as mentioned in the Barnes paper, parking rates in downtowns and central cities are higher than in the region as a whole, creating a value added and incentive for transit usage.

Network agglomeration is also important. The addition of a single line can create more quick connections with existing rail and bus networks. In Portland, local officials believe better connections could have been made to Vancouver Washington bus service.¹⁸ In San Diego, a city loop was created with the addition of the Green Line light rail allowing people to travel to destinations along the Blue and Orange Lines without having to always route through downtown.¹⁹ In Denver and St. Louis, the new line created a spur from the existing network, increasing the connectivity between downtown destinations and employment centers along the line. In Denver specifically, aside from the student ridership gained, off-peak trips to the Denver Tech Center also surprised planners.²⁰ And in St. Louis, the initial network allows riders on the Cross County Line to get downtown and to Lambert International Airport.

¹⁶Barnes, G. Importance of Trip Destination in Determining Market Share. *Journal of Public Transportation*, Vol. 8. No. 2, 2005.

¹⁷For many of the studied lines, episodic events actually occur with a high frequency. In St. Louis for example, Metrolink serves three stadiums. In some years there are more than 200 special events in these venues including sporting and other events.

¹⁸Detweiler, J., Tri-Met Senior Land Development Planner. E-mail correspondence, August 17, 2007.

¹⁹Linthicum, J. Director of Engineering and Construction at SANDAG. E-mail correspondence, May 24, 2007.

²⁰Denver RTD Staff. E-mail correspondence, July 5, 2007.

Another issue to consider at greater length in future research is the influence of rail network size and nonauto usage. It is important to note that new fixed-route transit lines often reconfigure bus routes to feed into the higher capacity mode and extensions of existing networks allow for more connections to a greater number of destinations. Equally important is the impact of network size to achieving multiplier effects as a greater share of people living near a fixed guideway station walk, bike or take transit to work. Excluding the New York CMSA, a statistical outlier, 31% of people that live within a ½-mile of a transit station walk, bike or take transit to work. Nationally, this mode split is only 6%.²¹

Figure 6 shows mode split to work for households living within a ½-mile of fixed guideway transit stations including commuter rail, heavy rail, and light rail stations, compared to the region as a whole. Extensive systems include those with more than 200 stations. Large systems are those with between 70 and 200 stations. Medium systems are classified as having 25 to 69 stations and small systems are those with fewer than 25 stations, however they are not represented.

Figure 6 shows that the more extensive the transit system, the greater the influence it has on nonauto modes including walking, biking and transit. In every case, mode split of residents who live near transit is much higher than elsewhere in the region. Not surprisingly, system size also has a profound effect on behavior, as more opportunities can be accessed through transit as the system extends and connects destinations. New York is an example of what can be accomplished when a transit network is able to more closely mimic the connectivity of the road network. Nonauto modes capture 60% of the work trips made by people living within a ½-mile of a rapid transit station. It will be interesting to revisit these statistics when the next census is published.

Connecting destinations to create ridership may seem like an obvious conclusion, but plans and policies have not reflected this approach. Most TOD policies have focused on residential development, rather than promoting agglomeration of jobs and commercial space in

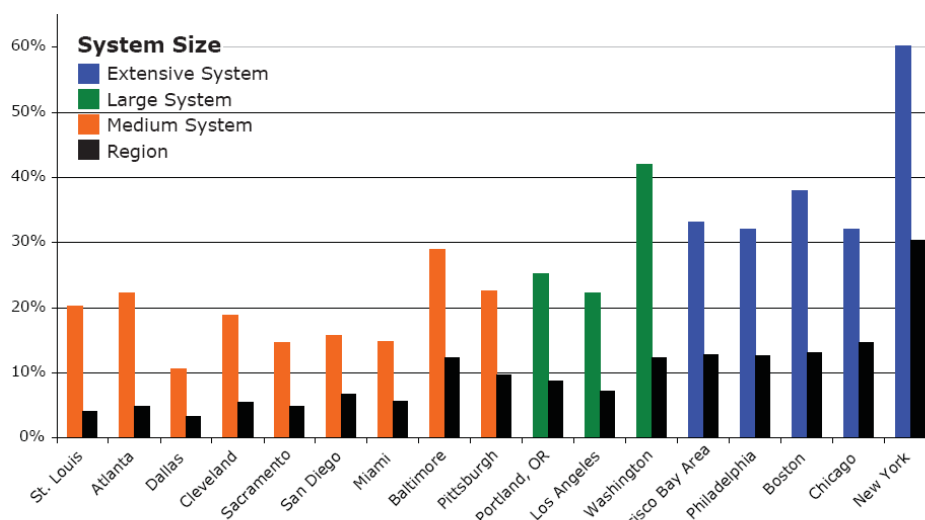

Source: 2000 Census, CTOD Database, 2005

FIGURE 6 Nonauto modes to work, transit zones versus the region, 2000.

²¹National CTOD Station Area Database. Census 2000 Data. Updated November 2005.

regional centers served by transit. This points to the fact that destinations, such as major regional centers and downtowns, are serving the most transit riders in the region and their connection to each other would promote higher ridership.

Table 1 shows recent transit networks and their connectivity to jobs. There seems to be a correlation between jobs connected and ridership as seen in Figures 1 and 5. High job numbers with low ridership, in the case of San Jose, can partially be explained by the poor orientation of employment land use to the transit line (as seen in **Figure 7**) and vast parking lots available to commuters surrounding the buildings. A simple regression analysis reveals that the *r*-squared is more than doubled from .32 to .66 when San Jose is taken out of the equation. A regression done on the lines in **Table 2** reveals a .95 *r*-squared.

There are obviously a lot of other related important variables including job density, residential density, system frequency, and income levels, but as a basic measure this analysis seems to indicate that the number of jobs near transit is correlated to ridership. This finding could be a good way to relieve a bit of the possible tensions between cost and transit effectiveness by giving politicians, policy makers, and advocates a better understanding of why transit works better in some places rather than others. If this can move decisions towards what is most effective, it is likely that we will see more ridership due to smart alignment and connectivity decisions.

CONCLUSION

A basic GIS analysis of jobs near transit ridership seems to show an almost direct correlation between the two variables. In individual recently-built stand-alone lines, this is more apparent than when the network is considered. Other variables must be tested in order to assess the specific importance of the jobs variable, but it is clear that it is one of the more important ones in determining transit ridership on a given line. It should also be noted that San Jose proves a basic point about where job density might fit into the equation. For example, even though San Jose has a lot of jobs along the corridor, the ridership along the line is lacking and the pattern of employment development is much different than in these other regions which have higher density clusters.

TABLE 1 Jobs and Ridership of Recently Built Light Rail Systems

Light Rail System	1/2 Mile Jobs	Recent Ridership
San Diego System	267,540	118,400
Portland System	265,136	104,300
San Jose System	261,559	30,400
Dallas System	253,080	63,400
Denver System	241,277	62,900
St. Louis System	206,570	73,200
Salt Lake City System	135,139	39,700
Sacramento System	133,494	53,500
Hudson Bergen System	92,494	38,200

SOURCE: 2004 LEHD, National Transit Database ridership Q4 2007, CTOD

TABLE 2 Jobs and Ridership on Recently Constructed Light Rail Lines²²

Light Rail System	1/2 Mile Jobs	Recent Ridership
Houston Red Line	221,431	40,000
Denver SE Corridor	220,254	36,000
Minneapolis Hiawatha	177,453	30,100
San Diego Green	133,157	26,923
Los Angeles Gold	120,441	22,231
Portland Yellow	100,434	13,600

SOURCE: 2004 LEHD, National Transit Database ridership Q4 2007, CTOD

When planning alignments for new transit investments such as light rail lines, many policy makers are constrained by cost considerations and political realities. The current practice of “cost-effectiveness” planning used by the FTA and the public is likely to change over time, but project benefits from transit investments are long-lasting. Given the fact that funding large mobility projects will always be a tough political process, connecting destinations and planning alignments that serve more jobs and garner greater ridership as this paper suggests could be a good way to mitigate some of the political pressure during project planning.



Photo Courtesy of Google Earth.

FIGURE 7 Employment sprawl in San Jose.

²²Table 2 shows the ridership and jobs on six of the eight lines. In order to compare like information, lines were compared that were constructed and operated as one line. St. Louis and Sacramento’s recent lines blend with existing service and ridership numbers, making the effects hard to compare with the six shown below. Ridership information was acquired from the APTA and transit agency data.

However, continued success can not be achieved without plans and policies that strengthen job centers in future and existing transit zones. Because current practice in TOD planning is aimed predominantly at residential development that makes up the origin of trips, more attention must be paid to the destination. This paper discusses job destinations, which is good for the work trip, but more research must be done to determine its effectiveness for nonwork trips as well. As Barnes' paper discussed, the answer does not seem to be where we live, but rather where we are going that determines whether transit is used. The findings in this paper on jobs and light rail form the basis for continued discussion on where people are going and what planners and decision makers can do to design transit lines that will get them there.

Energy, Environment, and Transit
Greener-Efficient

ENERGY, ENVIRONMENT, AND TRANSIT: GREENER--EFFICIENT

**Effect of Fuel Price Increases on
U.S. Light Rail Ridership, 2002–2008**
Results and Implications for Transit Operation and Policy

BRADLEY W. LANE
Indiana University

The drastic change in fuel costs and fuel price fluctuations since August of 2005 in the United States has focused significant public attention toward the travel behavior of Americans. Among the potential disincentives for driving is raising travel costs through fuel prices. While some of the reduction in driving could be achieved through improving trip efficiency and changing the built environment, if automobile travel is to be displaced other transport modes must absorb some of that travel.

One relatively unexplored direction of how travelers respond to fluctuating fuel prices is the effect on transit usage. Numerous cities have made a significant investment in light rail lines to draw new ridership and develop or redevelop areas around stations. The continued expansion of U.S. light rail transit (LRT) during a period of petroleum price increases presents a benchmark convergence of two long-term trends in the country's public transit systems. While systems are generally limited in extent, there is also the phenomenon of light rail tending to draw riders to transit that would otherwise not take transit due to its higher levels of service (1).

Understanding the potential of public transport to absorb displaced auto travel is critical. In this study, monthly totals for unlinked passenger trips for individual transit modes are compiled for eight U.S. cities and estimated as a function of monthly service characteristics, seasonality, trending with time, and fuel prices. The results for light rail are discussed against the results for other modes of rail and bus and their implications for transit operation and policy.

LITERATURE REVIEW

There is little recent academic research into the relationship between transit and fuel prices. Some contemporary work (2, 3) argued that an integral component of transport sustainability has to be increasing the cost of driving, particularly for fuel, as it could lead to more efficient travel behavior and long-term market changes that encourage more transit-friendly development. There appears to be a relatively rapid effect on travel behavior due to increases in fuel costs, with the likelihood of shifting to transit being greater where transit was more prevalent and inversely to age and income (4). In car-dependent places, the willingness to shift to transit would be greater if more public transit and monetary incentives not to drive were present (5). However, the potential role of transit in absorbing displaced automobile trips may be limited, since many of those trips would occur during peak period travel where transit is already used near capacity (6).

Role of Fuel Costs in Transit Ridership

Earlier research suggests a limited and difficult role for transit in scenarios of higher fuel prices. Horowitz (7) stated that shifting to transit will not be the first option for most changing their travel behavior, with reductions in discretionary travel and increases in trip chaining occurring first. Among the research about travel response to fuel allocation plans, several studies find a significant and inelastic relationship between fuel cost fluctuations and transit ridership (8–10). Research examining the response to transit ridership of fuel price changes occurring outside of fuel shortages also found a significant, inelastic effect (11–13). More recent studies have likewise found a significant, inelastic effect, but also variability across modes. Some places seem to have had the greatest response to light rail, while others have seen the largest effects of fuel prices on commuter lines (14–15). Results of elasticities found in different studies are listed in Table 1.

Long-Term and Modal Effects

An increase in fuel costs would effectively increase the size of the population captive to transit, as well as decrease transit's convenience costs. Growth in transit ridership could occur where auto trips were already relatively expensive and in larger cities with a larger transit-captive population (16). Keyes (17) argued that the elasticity to transit ridership could increase over time if the price change stayed high, as long-term changes to the incentive structure in the market of land-use, and transport stock could encourage more transit-friendly development. There is some potential for fuel prices to have a specific effect on LRT. Several studies (7, 8, 16, 18) suggested that improvements will be required to serve rising transit demand in locales not already well served by transit. Light rail has usually been such an improvement built to instigate transit demand (3), and in cities where there was already comparatively large amounts of transit usage relative to other cities (19). Light rail may thus be particularly open to increasing ridership due to fuel prices, as these systems are better positioned to absorb displaced auto travel as well as tend to attract riders that don't otherwise take transit but could be induced by high fuel prices.

TABLE 1 Elasticities

Research	Elasticity	Context
Navin (16)	0.42 (short run)	Midwestern U.S. cities, oil shocks
Agathe and Billings (8)	0.42 (short run)	Tucson, oil shocks
Wolff and Clark (10)	0.26 (short run)	Fort Worth, oil shocks
Wang and Skinner (13)	0.08 to 0.80	U.S. cities, oil shocks
Rose (12)	0.11 (short run), 0.18 (long run)	Chicago, oil shocks
Mayasuki and Allen (11)	0.11–0.18	Philadelphia, oil shocks and after
Storchmann (6)	0.07 (short run)	Germany, post-2000
Currie and Phung (14)	0.04–0.38	United States, nationally, 1998–2005
Haire and Machemehl (15)	0.05–0.54	U.S. cities, 1999–2006

RESEARCH DESIGN AND ANALYSIS

Regression analysis is used to estimate monthly ridership on bus modes and rail modes separately for eight U.S. cities, with separate models generated for each mode in each city. Table 2 lists the eight cities ranked by their metropolitan statistical area (MSA) size and the respective transit agencies from which transit data was collected for this analysis. Several cities featured more than one transit agency. In those cases, the transit agencies of the primary city of the MSA were summed together to get total ridership; these are also listed in Table 2. Data come from the National Transit Database (NTD), which publishes a compilation of transit usage and service data (20).

The models estimate ridership between either January 2002 or June 2003 and April 2008 for the cities. The dependent variables come from counts of unlinked passenger trips (UPT) on a single mode of transit. These models are listed in Table 3 and include automated guideway (AG), commuter rail (CR), heavy rail (HR), light rail (LR), motor bus (MB), and trolley bus (TB).

Variable Definitions and Data Sources

Fuel prices were obtained from the Energy Information Administration (EIA) of the U.S. Department of Energy (DOE) (21), which produces publicly accessible data of average weekly fuel prices for 10 major U.S. cities, eight of which are used here. The figures for “All Grades, Areas, and Formulations” were used. The weekly estimates of average fuel prices were deflated by using the U.S. Consumer Price Index (22), and prices for each city were deflated using the regional deflator for all goods. Deflated prices reflect 1982–1984 real prices. These deflated prices were then averaged for each respective month.

TABLE 2 Cities in Analysis

City	MSA Pop./ Rank (2006)	Agencies (Mode)	Dates
Los Angeles	12,950,129/2nd	Los Angeles County Metropolitan Transit Authority (HR, LR, MB) Southern California Railroad (CR) Long Beach Transit Authority (MB)	January 2002–April 2008
Chicago	9,505,748/3rd	Chicago Transit Authority (HR, MB)	January 2002–April 2008
Houston	5,539,949/6th	Metropolitan Transit Authority of Harris County, Texas (LR, MB)	January 2002–April 2008
Miami	5,463,857/7th	Miami–Dade Transit Agency (AG, MB)	January 2002–April 2008
Boston	4,455,271/11th	Massachusetts Bay Transportation Authority (CR, HR, MB, TB)	January 2002–April 2008
San Francisco	4,180,027/12th	Bay Area Rapid Transit (HR) San Francisco Municipal Railway (LR, MB, TB) Peninsula Corridor/Caltrain (CR)	January 2002–April 2008
Cleveland	2,114,155/24th	Cleveland Regional Transit Authority (HR, LR, MB)	January 2002–April 2008
Denver	2,408,750/21st	Denver Regional Transit District (LR, MB)	January 2002–April 2008

TABLE 3 Model Structure

City	Dependent Variable
Boston	UPT CR
Boston	UPT HR
Boston	UPT LR
Boston	UPT MB
Boston	UPT TB
Chicago	UPT HR
Chicago	UPT MB
Cleveland	UPT HR
Cleveland	UPT LR
Cleveland	UPT MB
Denver	UPT LR
Denver	UPT MB
Houston	UPT LR
Houston	UPT MB
Los Angeles	UPT CR
Los Angeles	UPT HR
Los Angeles	UPT LR
Los Angeles	UPT MB
Miami	UPT AG
Miami	UPT MB
San Francisco	UPT CR
San Francisco	UPT HR
San Francisco	UPT LR
San Francisco	UPT MB

Service is estimated in the model through two figures of transit operations provided by the NTD report (20). Monthly totals for vehicle revenue miles (VRM) operated and vehicles operated in maximum service (VOMS) are used as estimates of service coverage and frequency. Service values used as predictors are for each mode of service offered by the agency.

Seasonality is estimated in the models with the presence of binary variables for fall, spring, and summer. A “1” is assigned to the “Fall” variable if the month of ridership being estimated is September, October, or November. Likewise, “Spring” is March, April, and May, while “Summer” is June, July, and August, and they are assigned values accordingly. A variable, “Time,” is included as a predictor to estimate trends in transit ridership occurring independent of the effect of service changes, fuel prices, or seasonal variation. It is a linear trend, with “1” assigned to the first month of data in the analysis, “2” to the second, and continuing to the final time point in the analysis for each city, which is “59” for Boston, Massachusetts; Cleveland, Ohio; Miami, Florida; and Seattle, Washington and “76” for Chicago, Illinois; Denver, Colorado; Houston, Texas; Los Angeles, California; and San Francisco, California.

Model Calibration

Possible issues with time series regression analysis include autocorrelation of errors and multicollinearity among the predictor variables. To neutralize this, the logarithm of the values for the data for ridership, fuel prices, and service were taken and then differenced. The regression

coefficients for the continuous variables represent an elasticity of the effect of changes in a predictor on changes on ridership. Similar procedures have been used in time-series regression for transit analysis, such as in Brown and Thompson (23). Diagnostic tests were run on these modified data, and Durbin–Watson scores and normal probability plots revealed no autocorrelation in the results. Correlation coefficients revealed some minor multicollinearity among the service variables, but none large enough to warrant concern.

MODEL RESULTS

The elasticity of the effect of fuel prices on transit ridership is displayed in [Table 4](#). Values significant at a 0.10 level are highlighted. The full model results are displayed in [Tables 5](#) through [8](#).

TABLE 4 Fuel Effect Comparison

City	Mode	Fuel Coefficient	Fuel p-value	Fuel SD Coefficient	Fuel SD p-value
Cleveland	MB	0.5543	0.2227	-0.0729	0.0605
Denver	LR	0.4878	0.0048	-0.0086	0.4182
Boston	TB	0.3497	0.2620	0.0037	0.8465
Boston	LR	0.3449	0.0494	0.0135	0.2049
Boston	HR	0.2808	0.0663	-0.0112	0.2301
Chicago	HR	0.2759	0.0181	-0.0089	0.3081
Chicago	MB	0.2511	0.0383	-0.0119	0.1921
Denver	MB	0.1780	0.1378	0.0039	0.6016
Houston	LR	0.1557	0.5919	0.0219	0.2891
San Francisco	CR	0.1276	0.1397	-0.0088	0.1742
Los Angeles	LR	0.1258	0.2446	0.0272	0.0019
San Francisco	HR	0.1237	0.0775	0.0002	0.9696
Houston	MB	0.1225	0.3420	0.0075	0.4114
Los Angeles	CR	0.1072	0.1588	0.0094	0.1129
Los Angeles	HR	0.0914	0.3610	0.0010	0.8954
Los Angeles	MB	0.0899	0.2555	0.0078	0.2055
Boston	CR	0.0897	0.3418	-0.0101	0.0878
Cleveland	LR	0.0569	0.9016	-0.0033	0.9317
Cleveland	HR	0.0058	0.9871	-0.0617	0.0480
San Francisco	MB	-0.0033	0.9830	0.0187	0.1096
San Francisco	TB	-0.0075	0.9622	0.0205	0.0886
Boston	MB	-0.0182	0.9134	-0.0045	0.6662
San Francisco	LR	-0.0210	0.9005	0.0292	0.0238
Miami	MB	-0.0510	0.7196	0.0013	0.8128
Miami	AG	-0.4648	0.0439	-0.0073	0.4191

TABLE 5 MB Results

Dependent Variable: UPT MB								
Variable	Boston	Chicago	Cleveland	Denver	Houston	Los Angeles	Miami	San Francisco
Intercept (p-value)	-0.0250 (0.1311)	-0.0121 (0.1476)	0.0075 (0.8605)	-0.0004 (0.9623)	0.0021 (0.8781)	-0.0049 (0.4196)	0.0015 (0.8901)	0.0083 (0.4911)
Time (p-value)	0.0000 (0.9911)	0.0001 (0.5942)	-0.0002 (0.8277)	0.0001 (0.6922)	-0.0001 (0.6083)	0.0000 (0.7482)	-0.0001 (0.7318)	0.0000 (0.9682)
Gas (p-value)	-0.0182 (0.9134)	0.2511 (0.0383)	0.5543 (0.2227)	0.1780 (0.1378)	0.1225 (0.3420)	0.0899 (0.2555)	-0.0510 (0.7196)	-0.0033 (0.9830)
Gas SD (p-value)	-0.0045 (0.6662)	-0.0119 (0.1921)	-0.0729 (0.0605)	0.0039 (0.6016)	0.0075 (0.4114)	0.0078 (0.2055)	0.0013 (0.8128)	0.0187 (0.1096)
VRM AG (p-value)							0.0859 (0.2287)	
VRM CR (p-value)	-0.7915 (0.1862)	0.0536 (0.6305)				0.3336 (0.0073)		0.0442 (0.7708)
VRM HR (p-value)	-0.0669 (0.8468)	0.1799 (0.4432)	0.3295 (0.5320)			0.2080 (0.3172)	0.5070 (0.0000)	0.2155 (0.5216)
VRM LR (p-value)	-0.1286 (0.6182)		-0.3228 (0.7582)	-0.1405 (0.1026)	-0.2081 (0.1559)	-0.0128 (0.8596)		-0.0159 (0.9085)
VRM MB (p-value)	0.3558 (0.4194)	0.5905 (0.0298)	-0.0865 (0.9044)	1.1313 (0.0000)	1.1294 (0.0000)	0.3149 (0.1473)	0.2078 (0.0634)	1.0345 (0.2940)
VRM TB (p-value)	0.9901 (0.0279)							0.1135 (0.9117)
VOMS AG (p-value)							0.0097 (0.9506)	
VOMS CR (p-value)	-7.6561 (0.1522)	0.4427 (0.3156)				-0.3644 (0.0248)		-0.4236 (0.6846)
VOMS HR (p-value)	24.0805 (0.3895)	-0.0696 (0.9697)				-0.1026 (0.4432)	0.1388 (0.5123)	-0.9179 (0.2854)
VOMS LR (p-value)	-8.3987 (0.2448)		-0.0023 (0.9990)	0.0958 (0.3623)	0.0606 (0.8066)	0.2558 (0.1749)		-0.9530 (0.3272)
VOMS MB (p-value)	-9.5802 (0.0292)	2.5775 (0.0046)	-0.7848 (0.5988)	-0.0295 (0.9234)	0.5656 (0.1220)	0.1123 (0.8843)	-0.0113 (0.9639)	0.6398 (0.4964)

continued on next page

TABLE 5 (continued) MB Results

Dependent Variable: UPT MB								
Variable	Boston	Chicago	Cleveland	Denver	Houston	Los Angeles	Miami	San Francisco
VOMS TB (p-value)	-4.9155 (0.5582)							1.0708 (0.2351)
Fall (p-value)	0.0303 (0.0279)	0.0120 (0.1367)	0.0099 (0.7776)	0.0055 (0.5031)	0.0090 (0.3539)	-0.0031 (0.5890)	0.0043 (0.6087)	-0.0247 (0.0358)
Spring (p-value)	0.0303 (0.0529)	0.0156 (0.0691)	-0.0193 (0.6194)	-0.0022 (0.8053)	0.0063 (0.5260)	0.0027 (0.6645)	0.0039 (0.6732)	-0.0022 (0.8783)
Summer (p-value)	0.0153 (0.3353)	-0.0004 (0.9613)	-0.0024 (0.9458)	-0.0070 (0.4022)	0.0078 (0.4100)	-0.0082 (0.1579)	0.0028 (0.7335)	-0.0022 (0.8646)
N	58	75	58	75	51	72	58	75
R ²	0.4096	0.4863	0.1267	0.4876	0.7834	0.7205	0.6260	0.6146
R ² Adj	0.1793	0.3967	0.0000	0.4075	0.7292	0.6518	0.5263	0.5083
F (p-value)	1.778 (0.0695)	5.423 (0.0000)	0.607 (0.8132)	6.090 (0.0000)	14.464 (0.0000)	10.495 (0.0000)	6.277 (0.0000)	5.781 (0.0000)

TABLE 6 LR Results

Dependent Variable: UPT LR						
Variable	Boston	Cleveland	Denver	Houston	Los Angeles	San Francisco
Intercept (p-value)	-0.0178 (0.2867)	0.0162 (0.7085)	-0.0008 (0.9427)	-0.0012 (0.9694)	-0.0016 (0.8460)	0.0154 (0.2425)
Time (p-value)	-0.0001 (0.8096)	-0.0003 (0.6993)	0.0001 (0.7688)	-0.0001 (0.8783)	-0.0001 (0.5563)	-0.0001 (0.6803)
Gas (p-value)	0.3449 (0.0494)	0.0569 (0.9016)	0.4878 (0.0048)	0.1557 (0.5919)	0.1258 (0.2446)	-0.0210 (0.9005)
Gas SD (p-value)	0.0135 (0.2049)	-0.0033 (0.9317)	-0.0086 (0.4182)	0.0219 (0.2891)	0.0272 (0.0019)	0.0292 (0.0238)
VRM AG (p-value)						
VRM CR (p-value)	-0.0836 (0.8899)				0.0995 (0.5469)	0.1229 (0.4592)
VRM HR (p-value)	0.5415 (0.1301)	1.0404 (0.0573)			0.1436 (0.6127)	0.3133 (0.3936)
VRM LR (p-value)	-0.0756 (0.7736)	-1.5244 (0.1583)	0.5484 (0.0000)	0.2503 (0.4465)	0.0461 (0.6406)	-0.0546 (0.7182)
VRM MB (p-value)	-0.7324 (0.1070)	-0.2641 (0.7192)	0.3374 (0.0582)	1.1305 (0.0008)	0.5542 (0.0637)	1.1512 (0.2845)
VRM TB (p-value)	0.4473 (0.3179)					-0.4625 (0.6789)
VOMS AG (p-value)						
VOMS CR (p-value)	-15.0129 (0.0076)				-0.3502 (0.1108)	-0.5676 (0.6179)
VOMS HR (p-value)	-17.5134 (0.5381)				-0.1166 (0.5235)	-1.0502 (0.2628)
VOMS LR (p-value)	-18.1416 (0.0164)	0.0433 (0.9810)	-0.0453 (0.7590)	1.2460 (0.0308)	0.4183 (0.1060)	-0.7364 (0.4867)
VOMS MB (p-value)	-3.7353 (0.3921)	-0.8076 (0.5954)	-0.3767 (0.3849)	0.7581 (0.3515)	-0.9997 (0.3456)	0.0946 (0.9264)
VOMS TB (p-value)	11.6059 (0.1788)					1.3724 (0.1639)
Fall (p-value)	0.0266 (0.0563)	-0.0060 (0.8666)	0.0089 (0.4396)	0.0123 (0.5705)	0.0029 (0.7250)	-0.0260 (0.0432)
Spring (p-value)	0.0283 (0.0754)	-0.0067 (0.8655)	-0.0113 (0.3718)	-0.0056 (0.8053)	0.0130 (0.1498)	-0.0045 (0.7700)
Summer (p-value)	0.0182 (0.2612)	0.0099 (0.7824)	-0.0017 (0.8829)	0.0255 (0.2375)	0.0096 (0.2444)	-0.0144 (0.3020)
N	58	58	75	51	72	75
R ²	0.4314	0.1033	0.4876	0.6403	0.6150	0.4883
R ² Adj	0.2094	0.0000	0.4075	0.5503	0.5205	0.3471
F (p-value)	1.944 (0.0439)	0.482 (0.9051)	6.090 (0.0000)	7.119 (0.0000)	0.6504 (0.0000)	3.459 (0.0003)

TABLE 7 HR Results

Dependent Variable: UPT HR					
Variable	Boston	Chicago	Cleveland	Los Angeles	San Francisco
Intercept (p-value)	-0.0141 (0.3359)	-0.0129 (0.0772)	0.0085 (0.8039)	-0.0116 (0.1365)	-0.0042 (0.4316)
Time (p-value)	0.0001 (0.8073)	0.0000 (0.7967)	-0.0001 (0.8335)	0.0001 (0.4044)	0.0000 (0.9525)
Gas (p-value)	0.2808 (0.0663)	0.2759 (0.0181)	0.0058 (0.9871)	0.0914 (0.3610)	0.1237 (0.0775)
Gas SD (p-value)	-0.0112 (0.2301)	-0.0089 (0.3081)	-0.0617 (0.0480)	0.0010 (0.8954)	0.0002 (0.9696)
VRM AG (p-value)					
VRM CR (p-value)	0.1194 (0.8210)	0.2420 (0.0261)		-0.0345 (0.8214)	0.2738 (0.0002)
VRM HR (p-value)	-0.1082 (0.7257)	0.1572 (0.4840)	0.2161 (0.6093)	-0.1881 (0.4750)	0.3547 (0.0214)
VRM LR (p-value)	0.0769 (0.7376)		-0.4065 (0.6291)	-0.2042 (0.0290)	0.0443 (0.4767)
VRM MB (p-value)	0.1302 (0.7392)	0.4717 (0.0683)	0.5347 (0.3569)	1.1093 (0.0001)	0.5968 (0.1786)
VRM TB (p-value)	0.0383 (0.9215)				-0.6128 (0.1854)
VOMS AG (p-value)					
VOMS CR (p-value)	-3.6742 (0.4363)	0.7611 (0.0742)		-0.4102 (0.0455)	-0.0656 (0.8884)
VOMS HR (p-value)	-10.7394 (0.6654)	0.3964 (0.8215)		0.0673 (0.6913)	-0.3792 (0.3250)
VOMS LR (p-value)	4.6356 (0.4687)		-0.4070 (0.7760)	0.2279 (0.3387)	0.1490 (0.7318)
VOMS MB (p-value)	-12.9705 (0.0014)	2.2009 (0.0110)	-1.1415 (0.3417)	-0.5855 (0.5505)	-0.2674 (0.5262)
VOMS TB (p-value)	-15.4311 (0.0437)				-0.0195 (0.9614)
Fall (p-value)	0.0134 (0.2630)	0.0098 (0.2018)	-0.0061 (0.8292)	0.0070 (0.3606)	0.0033 (0.5254)
Spring (p-value)	0.0134 (0.3273)	0.0149 (0.0701)	0.0118 (0.7045)	0.0209 (0.0146)	0.0094 (0.1453)
Summer (p-value)	0.0102 (0.4719)	0.0100 (0.1927)	0.0010 (0.9719)	0.0043 (0.5698)	0.0045 (0.4328)
N	58	75	58	72	75
R ²	0.4803	0.5522	0.1381	0.6372	0.7570
R ² Adj	0.2775	0.4656	0.0000	0.5480	0.6900
F (p-value)	2.368 (0.0134)	6.372 (0.0000)	0.670 (0.7589)	7.149 (0.0000)	11.295 (0.0000)

TABLE 8 Results for Other Modes

Variable	Cities (Mode)					
	Miami (AG)	Boston (CR)	Los Angeles (CR)	San Francisco (CR)	Boston (TB)	San Francisco (TB)
Intercept (p-value)	0.0190 (0.2793)	-0.0024 (0.7931)	0.0036 (0.5324)	-0.0227 (0.0011)	-0.0010 (0.9728)	0.0086 (0.4845)
Time (p-value)	-0.0003 (0.2896)	0.0001 (0.6163)	0.0000 (0.9509)	0.0001 (0.1889)	0.0000 (0.9966)	0.0000 (0.9975)
Gas (p-value)	-0.4648 (0.0439)	0.0897 (0.3418)	0.1072 (0.1588)	0.1276 (0.1397)	0.3497 (0.2620)	-0.0075 (0.9622)
Gas SD (p-value)	-0.0073 (0.4191)	-0.0101 (0.0878)	0.0094 (0.1129)	-0.0088 (0.1742)	0.0037 (0.8465)	0.0205 (0.0886)
VRM AG (p-value)	0.4065 (0.0007)					
VRM CR (p-value)		0.7462 (0.0284)	1.1386 (0.0000)	0.3570 (0.0001)	-1.2234 (0.2652)	0.0112 (0.9430)
VRM HR (p-value)	0.1621 (0.2771)	-0.3560 (0.0707)	-0.5036 (0.0137)	0.1166 (0.5326)	0.1735 (0.7853)	0.2711 (0.4335)
VRM LR (p-value)		-0.0146 (0.9192)	-0.0425 (0.5398)	0.1226 (0.1149)	-0.0712 (0.8806)	0.0530 (0.7100)
RM MB (p-value)	-0.1730 (0.3237)	0.1675 (0.4951)	0.3664 (0.0802)	1.5104 (0.0073)	0.3987 (0.6219)	0.6653 (0.5105)
VRM TB (p-value)		0.5773 (0.0219)		-1.5650 (0.0076)	1.1982 (0.1413)	0.4007
VOMS AG (p-value)	0.2988 (0.2337)					
VOMS CR (p-value)		2.5553 (0.3877)	-0.4626 (0.0035)	1.6917 (0.0048)	-6.6804 (0.4928)	-0.4657 (0.6642)
VOMS HR (p-value)	0.1131 (0.7363)	9.6129 (0.5370)	-0.1016 (0.4289)	0.5119 (0.2836)	-29.7009 (0.5629)	-0.9197 (0.2979)
VOMS LR (p-value)		5.5797 (0.1674)	0.0422 (0.8143)	0.5886 (0.2765)	-6.9601 (0.5979)	-1.1378 (0.2560)
VOMS MB (p-value)	-0.2933 (0.4610)	-0.3263 (0.8909)	-2.0331 (0.0078)	-0.8565 (0.1044)	1.9150 (0.8072)	0.8163 (0.3992)
VOMS TB (p-value)		-3.9281 (0.4025)		-0.9705 (0.0551)	18.3781 (0.2371)	1.1012 (0.2351)
Fall (p-value)	-0.0199 (0.1415)	0.0032 (0.6701)	-0.0031 (0.5890)	0.0057 (0.3769)	0.0209 (0.3972)	-0.0245 (0.0426)
Spring (p-value)	0.0158 (0.2893)	-0.0055 (0.5182)	0.0027 (0.6645)	0.0334 (0.0001)	-0.0033 (0.9071)	-0.0029 (0.8434)
Summer (p-value)	0.0018 (0.8932)	-0.0007 (0.9375)	-0.0082 (0.1579)	0.0208 (0.0045)	-0.0078 (0.7884)	-0.0038 (0.7743)
N	58	58	72	75	58	75
R ²	0.3967	0.8672	0.8562	0.7664	0.3911	0.6042
R ² Adj	0.2358	0.8154	0.8209	0.7019	0.1535	0.4951
F (p-value)	2.466 (0.0143)	16.737 (0.0000)	24.238 (0.0000)	11.893 (0.0000)	1.646 (0.0995)	5.534 (0.0000)

Most of the models explain a large amount of the variation in ridership. The lone exceptions are in the Cleveland models. The Boston models also slightly underperform the explanatory ability of the other cities in the analysis.

The model results indicate a small but significant effect of fuel prices on transit usage. Most bus lines did not appear to receive a significant effect on ridership due to fuel prices; exceptions include the system in Chicago and to a lesser degree Cleveland. HR systems in Boston, Chicago, and San Francisco had positive associations with fuel prices, while an effect was unclear on the systems in Los Angeles and Cleveland. CR lines in the sample did not receive a significant impact on ridership from fuel prices. LR lines appeared to most consistently benefit from increases in fuel, indicating large significant elasticities with respect to gasoline on the light rail systems in Denver and Boston. The systems in Houston and Los Angeles also had notable fuel elasticities, though the coefficient was insignificant. This could be due to interruptions in the Los Angeles dataset from two strikes and service changes, and due to the relatively recent introduction of the LR line in Houston.

Increasing variability in fuel prices had a negative effect on transit in Boston and Cleveland, and a positive effect in Los Angeles and San Francisco. Fuel price variability didn't affect LR ridership in Cleveland, while it discouraged HR use less and bus use more. In San Francisco and Los Angeles, LR ridership increased the most, relative to other modes, due to variability in fuel prices.

The data transformations smoothed out most of the trending and the seasonal fluctuations in the ridership trends. Variables for fall, spring, and summer increased ridership on bus and LR in Boston, while most modes in San Francisco decline with fall. HR ridership increases in Chicago in the spring. There is an association of increasing ridership on all modes with increasing service. Most service modes also tend to dominate their respective ridership figures, with increases in VRM and VOMS positively related to their respective mode of ridership and negatively related to other modes. There is evidence of a mutually beneficial relationship between increasing bus VRM and increasing LR ridership in Denver, Houston, and Los Angeles. This could represent the re-orientation of bus routes to feed into rail lines.

Modal Response

As a percentage change in ridership, there appears to be a greater response to rail than to bus. Some of the cities generally thought of as having less transit service available and being more auto-dependent appeared to experience a similar response to fuel prices than cities generally thought of as being more transit oriented. While some modes in Boston and Chicago experienced notable responses, so did modes in Cleveland, Denver, and Houston, though the significance of the Cleveland and Houston response is less clear. This might imply that there is a greater sensitivity to cost of driving in more auto-dependent cities, and that one response to rising costs is to change to a less expensive mode. Cities that are more auto dependent and offer relatively little transit may be in position to see unexpectedly large increases in transit demand.

LR specifically appears to play a notable role among fuel prices. In the LR-only cities of Denver and Houston, the effect on rail is greater than seen on bus. LR out performs other modes in Boston and Los Angeles. In every city but Cleveland, the rail line sees a greater response to ridership from gasoline prices than the bus mode. This bodes well for LR, which most recently has been built or expanded in cities that feature it as the sole rail mode.

LR systems appear to experience between a 13% and 50% increase in ridership for every 100% increase in gasoline prices. This outperforms most of the bus systems, which experience no significant effect with some coefficients suggesting a decrease in ridership. Most of the HR lines experience between a 12% and a 28% increase in ridership for every 100% increase in gasoline prices. This is a notable comparison with LR, given the larger system extent and footprint of HR systems.

Implications for Light Rail

Larger transitions to LR than bus or other modes may indicate continued success for LR in meeting goals of a modal shift and attracting transit-oriented development. Much of the academic research into the performance of LR during its late 20th century revival suggested that it had consistently underperformed expectations to attract ridership and instigate development (e.g., 3, 24, 25). One reason has been the lack of concomitant constraints on automobile use (24, 26). These have been difficult to implement in the United States, due to political unpopularity and a transport network geared toward facilitating automobile travel. Increasing fuel costs represent a constraint on automobile use which may instigate a change in local-level transport and housing markets that make taking LRT a more appealing and logical alternative to automobile travel. There is the suggestion (27) that people move to redeveloped areas around LR stations for the quality of life brought by denser, mixed-use neighborhoods without actually shifting their travel over to the LR line. Increasing the cost of travel through escalating fuel costs may be prompting people who have chosen to live near access to LRT in these cities to shift some of their travel over to the train.

Context of Price Increases

An important inference that should be discussed is the context of fuel price changes. There is a difference between traveler response to price fluctuations and traveler response to something such as a fuel tax increase or a permanent market increase in the cost of fuel. This study, like most previous studies, is tracking dramatic changes in the short-term and their effects on LR and transit ridership. However, given a well-documented world outlook for declining future fuel supplies with increasing global fuel demand, it could be expected that long-term fuel prices should only continue to increase. Other responses described in previous research as long term, such as purchasing a more fuel-efficient car, relocating residence and workplace to shorten commuting distances, and an increase in transit and walking-friendly development may occur with greater frequency over time if fuel prices continue to escalate. As fuel prices increase, land-uses that are auto dependent become more expensive for consumers as the advantages of travel allowed by cheap fuel costs dissipate. This narrows the relative difference in the cost of low-density land use and high-density land use. Developers and city planners should see higher-density development become more profitable than lower-density development. This could help some of the issues with development around rail transit lines, which while popular is also plagued by high land costs that limit the range of options for residential or commercial tenants. These high land and rent costs are also indicative of a demand for these types of development that isn't being met, which rising fuel costs should only further increase.

Implications for Agency Operation and Management

Anecdotal analyses of the data find that, beginning in January of 2008, in all of the cities there is a marked decrease in service unrelated to seasonal fluctuations. At the same time, there also appears to be a marked increase in ridership similarly unrelated to seasonal fluctuations. While this does not constitute enough data points in this particularly analysis to affect the results, there are some important considerations for how well transit operations can handle escalating costs. Surveys by the APTA (28–29) have indicated that transit companies are faced with either cutting inefficient routes or raising fares due to the rise in operating costs despite reported increases in ridership. While partially due to increasing fuel costs, they nonetheless only amount to around 12% of agency operating costs at maximum levels of fuel cost escalation. A bigger concern is decreasing revenue streams for their local, state, and federal funding sources related to the 2008–2009 U.S. and global recession (29). This is a potentially damaging aspect for bus usage, which appears to be experiencing service cutbacks and reorganization at the same time that there is a market increase in demand. Comparatively, most LR systems are electric powered, and their load factors and limited extent mean their operating costs are lower and less susceptible to fuel costs. There is also the potential for bus agencies to continue to realign bus service to feed riders into the rail, potentially increasing the efficiency of transit operations. If fuel costs are recognized to be permanently increasing, it may encourage a reorganization of transit funding and prioritization emphasizing light rail construction and expansion, in addition to continued development around stations.

CONCLUSION

This research has estimated the effect of fuel costs on transit ridership. It is suggested that there are significant contextually and policy implications for fuel costs on transit ridership. Fuel costs should only continue to increase as global supply tightens and global demand increases. A global economic downturn likewise increases the demand for transit by decreasing the convenience costs of transit use relative to automobile use.

These developments also have the potential to impact transit agencies in negative ways, as transit agencies are susceptible to increased fuel costs and decreased revenue streams. Serious consideration may need to be given at multiple levels of government as to how transit agencies handle transit provision. Funding sources and other elements such as the potential role of transit agencies in urban development could also use critical examination. LR appears to be the mode best positioned to handle future increases in fuel costs and strains on operating costs, and has shown elsewhere to be an effective tool in instigating redevelopment that is oriented to generating more transit trips. Instead of cutting back funding and decreasing operating costs to meet pre-established budgets, a prioritization of transit expansion now, during a time of increasing transit demand, may have the greatest long-term effect on securing more long-term riders for LR and other modes of transit.

FUTURE RESEARCH

This research constitutes one of a series of pilot studies done to estimate data sources, initial results, and identify key issues for a larger research project. A research plan follows that pursues several key questions raised by the results here. These include the level of price changes, the response of travelers if pressures on automobile travel (whether or not they come from fuel cost increases) continue to grow, the willingness of commuters to adapt, and how transit agencies will respond to increases in demand and operating costs.

This analysis has included a relatively small set of cities and modes, and future research will look to more cities and agencies to strengthen and clarify the results here. A further investigation of the time-series behavior is also warranted. The nature of the relationship between fuel prices, service provision, capital investment, and ridership demand might have fundamentally changed, perhaps in August 2005 or perhaps in January 2008 as discussed earlier. More extensive predictor variables estimating important city characteristics and other important factors, such as economic trends, will also be included in future research.

Lastly, the possibility exists of simultaneity in the relationship among transit ridership, fuel prices, and service provision. This may lie in the effect discussed earlier of feedback on transit agencies, as they are forced to make changes to service provision as fuel costs mount over time. This will be explored in future research.

ACKNOWLEDGMENTS

Initial results of this research were presented as part of the NSF New Scholars Conference in Sustainable Transport held at Indiana University in Bloomington, Indiana, in May 2006, and the 54th Annual North American Meetings of the Regional Science Association International in Savannah, Georgia, in November 2007. The attendees of the conferences provided valuable insight and comments that have contributed to the quality and direction of the research, for which the author is sincerely grateful. The author is also grateful to the three reviewers of the paper, whose contributions have provided valuable improvements to the work. The author thanks Lewis Ames for his time and insightful thoughts about the research and the results.

REFERENCES

1. Ben-Akiva, M., and T. Morikawa. Comparing Ridership Attraction of Rail and Bus. *Transport Policy* 9, 2002, pp. 107–116.
2. Litman, T. London Congestion Pricing: Implications for Other Cities. Victoria Transport Policy Institute, 2005. www.vtpi.org. Accessed October 6, 2005.
3. Mackett, R. L., and M. Edwards. The Impact of New Urban Public Transport Systems: Will the Expectations Be Met? *Transportation Research Part A*, Vol., 32, No. 4, 1998, pp. 231–245.
4. Gas Prices: The Tipping Point Toward Better Development? Urban Land Institute's Nationwide Survey Explores Consumer Attitudes. Urban Land Institute, 2005. www.uli.org. Accessed November 8, 2005.
5. Baldassare, M., S. Ryan, and C. Katz. Suburban Attitudes Toward Policies Aimed at Reducing Solo Driving. *Transportation*, Vol. 25, No. 1, 1998, pp. 99–117.
6. Storchmann, K.-H. The Impact of Fuel Taxes on Public Transport—An Empirical Assessment for Germany. *Transport Policy* 8, 2001, pp. 19–28.

7. Horowitz, J. Modeling Traveler Response to Alternative Fuel Allocation Plans. *Transportation Research 18A*, Vol. 2, 1982, pp. 117–133.
8. Agathe, D. E., and R. B. Billings. The Impact of Fuel Prices on Urban Bus Ridership. *Annals of Regional Science*, Vol. 12, No. 1, 1978, pp. 90–96.
9. Nizlek, M. C., and L. Duckstein. A System Model for Predicting the Effect of Energy Resources on Urban Modal Split. *Transportation Research*, Vol. 8, 1974, pp. 329–334.
10. Wolff, G. J., and D. M. Clark. Impact of Gasoline Price on Transit Ridership in Fort Worth, Texas. *Transportation Engineering Journal*, Vol. 108, No. 4, 1982, pp. 362–375.
11. Masayuki, D., and W. B. Allen. A Time Series Analysis of Monthly Ridership for an Urban Rail Rapid Transit Line. *Transportation*, Vol. 13, No. 3, 1986, pp. 257–269.
12. Rose, G. Transit Passenger Response: Short- and Long-Term Elasticities Using Time Series Analysis. *Transportation*, Vol. 13, No. 2, 1986, pp. 131–144.
13. Wang, G. H. K., and D. Skinner. The Impact of Fare and Fuel Price Changes on Monthly Transit Ridership: Empirical Evidence from Seven U.S. Transit Authorities. *Transportation Research B*, Vol. 18, No. 1, 1984, pp. 29–41.
14. Lane, B. W. Significant Characteristics of the Urban Rail Renaissance: A Discriminant Analysis. *Transportation Research Part A*, Vol. 42, No. 2, 2008, pp. 279–295.
15. Litman, T. Appropriate Response to Rising Fuel Prices: Citizens Should Demand, “Raise My Prices Now!”, Victoria Transport Policy Institute, 2005. www.vtpi.org. Accessed October 18, 2005.
16. Navin, F. P. Urban Transit Ridership in an Energy Supply Shortage. *Transportation Research*, Vol. 8, 1974, pp. 317–327.
17. Keyes, D. L. Energy for Travel: The Influence of Urban Development Patterns. *Transportation Research 16A*, Vol. 1, 1982, pp. 65–70.
18. Sagner, J. The Impact of the Energy Crisis on American Cities Based on Dispersion of Employment, Utilization of Transit, and Car Pooling. *Transportation Research*, Vol. 8, 1974, pp. 307–316.
19. Lane, B. W. Significant Characteristics of the Urban Rail Renaissance: A Discriminant Analysis. *Transportation Research Part A*, Vol. 42, No. 2, 2008, pp. 279–295.
20. Monthly Module Adjusted Data Release June 9 2008. National Transit Database, 2008. www.ntdprogram.gov/ntdprogram/data.htm. Accessed June 25, 2008.
21. U.S. Retail Fuel Historical Prices DOE data. Energy Information Administration, U.S. Department of Energy, 2008. <http://eia.doe.gov>. Accessed June 9, 2008.
22. Consumer Price Index, All Urban Consumers (Current Series), U.S. All-items, 1982–1984=100. Bureau of Labor Statistics, U.S. Department of Labor, 2008. www.bls.gov/cpi/home.htm. Accessed June 9, 2008.
23. Brown, J., and G. L. Thompson. The Relationship Between Transit Ridership and Urban Decentralization: Insights from Atlanta. *Urban Studies*, Vol. 45, 2008, pp. 1119–1139.
24. Hass-Klau, C., and G. Crampton. Future of Urban Transport, Learning from Success and Weaknesses: Light Rail. Environmental and Transport Planning, Brighton, U.K., 2002.
25. Pickrell, D. H. A Desire Named Streetcar: Fantasy and Fact in Rail Transit Planning. *Journal of the American Planning Association*, Vol. 58, No. 2, 1992, pp. 158–176.
26. Babalik-Sutcliffe, E. Urban Rail Systems: Analysis of the Factors Behind Success. *Transport Reviews*, Vol. 22, No. 4, 2002, pp. 415–447.
27. Kobayashi, T., and B. W. Lane. Spatial Heterogeneity and Transit Use. Proc., 11th World Conference on Sustainable Transport, Berkeley, Calif., 2007.
28. APTA. Survey of Motor Fuel Price Increases and Impact on Transit Services: Summary of Findings. American Public Transportation Association, Washington, D.C., 2004. www.apta.com. Accessed January 20, 2009.
29. APTA. Impact of Rising Fuel Costs on Transit Services: Survey Results. American Public Transportation Association, Washington, D.C., 2008. www.apta.com. Accessed January 21, 2009.

ENERGY, ENVIRONMENT, AND TRANSIT: GREENER—EFFICIENT

Energy Efficiency of Light Rail Versus Motor Vehicles**LYNDON HENRY****DAVID DOBBS****ALAN DRAKE***Capital Metropolitan Transportation Authority*

On the basis of various professional studies, it is widely assumed among public transport planners that electric light rail transit (LRT) provides a clean, energy-efficient form of mobility, representing a significant tool to address problems of peaking of global petroleum supplies (peak oil) and global warming and the effects of carbon (CO₂) emissions. Nevertheless, critics of public transport and rail passenger services often disparage the energy efficiency of electric rail. In recent years, some critics claim that electric rail consumes, on average, more energy per passenger mile than personal automobiles and motor buses—a criticism based particularly on an assessment of the total energy losses involved in electric power generation and distribution. For example, in a commentary titled *Does Rail Transit Save Energy or Reduce Greenhouse Gas Emissions?* published in *Policy Analysis* (April 14, 2008) of the Cato Institute, Randal O’Toole (a consistent critic of rail transit) contends that

Far from protecting the environment, most rail transit lines use more energy per passenger mile, and many generate more greenhouse gases, than the average passenger automobile. Rail transit provides no guarantee that a city will save energy or meet greenhouse gas targets.

However, faulty assumptions and calculations may underlie such claims. Any comparison of electrically powered versus petroleum-fueled transportation modes must include equitable assumptions. This includes fully accounting for the comparative production and distribution losses associated with petroleum-fueled motor vehicle transportation, if such losses are assumed for electric propulsion. The present analysis attempts to derive such a more equitable comparison of energy consumption and carbon emissions and attempts to estimate the total production and distribution energy involved with motor fuels, as well as electric power, and provides energy comparisons of electric LRT versus motor vehicles, both as a national average and for a number of important individual transit systems, based on actual performance data. However, the authors must emphasize that there is no precise measure available of efficiency in electricity generation or of energy lost in the production, transportation, and distribution of petroleum products.

In addition, only about 72% of U.S. electric power is derived from CO₂-emitting sources [calculated from Table 1.1: Net Generation by Energy Source by Type of Producer, 1995 through 2006 in Energy Information Administration (EIA): Net Generation by Energy Source by Type of Producer (1)]. The remainder is derived from noncarbon-emitting sources such as hydroelectric, nuclear, geothermal, and wind power conversion. Therefore, it is useful to compare energy intensity with respect to carbon-emitting energy sources.

COMPARING ENERGY AT THE POINT OF PRODUCTION–DISTRIBUTION

In the United States, transportation energy consumption is typically measured in terms of the Btu, or British thermal unit, a commonly used measure of heat-energy that enables a comparison between diverse forms of energy production and consumption, such as coal, natural gas, petroleum, nuclear, etc. (The equivalent metric unit of energy measure is the joule.) Traditionally, an energy conversion value of 3,412 Btus per kilowatt-hour (kWh)—reflecting the energy consumed at the point of use by the vehicle—has been a commonly accepted worldwide measure for converting electric power into equivalent Btus. Use of this conversion figure facilitated reasonably equitable comparisons of electrical energy consumption by electrically powered transportation modes with transport modes powered by motor fuel (including natural gas). This conversion factor has proven useful and widely accepted because it assesses energy content at the point of use and thus enables a fair comparison of electric-powered modes with the energy content of, say, a gallon of diesel fuel, a cubic foot of natural gas, or other power sources for transportation also measured at the point of use.

However, some energy researchers and agencies, such as the U.S. Department of Energy (DOE) and its Oak Ridge National Laboratory (ORNL), in recent years have emphasized a different figure for assessing the energy content of electric power. This revised conversion figure is based on an analysis that attempts to account for total energy of electric power generation and distribution, i.e., an assessment beginning back at the power plant, the point of production and distribution, rather than the point of use (consumption by the electric transit system). This factor is presented in ORNL's *Transportation Energy Data Book*, of which the latest (2008) version is Edition 27 (2). In Table B.6: Energy Unit Conversions, the energy value of one kWh is given as 3,412 Btu. However, in a footnote the Data Book states "This figure does not take into account the fact that electricity generation and distribution efficiency is approximately 33%." The footnote goes on to suggest that, if generation and distribution efficiency are taken into account, one kWh equals 10,339 Btu. In other words, to deliver a kWh equivalent in energy to 3,412 Btu it is necessary to burn fuel to the extent of somewhat more than 10,000 Btu.

Curiously, critics of electric rail public transport have cited this substantially higher DOE–ORNL *Data Book* Btu figure to produce what appear to be basically invalid comparisons of electric rail transit with automobiles and buses. Thus, calculations highly favorable to petroleum-fueled modes, particularly private motor vehicles and motor buses, are presented as proof of the wastefulness of electric rail. Yet there seems to be a clear logical fallacy in comparing electrical energy produced at a distant power plant with diesel, gasoline, or natural gas fuel in the tank of a motor vehicle—a seemingly apples-to-oranges comparison, using a methodology not widely accepted for such a comparison.

To express this issue another way: It would seem to be a serious logical and procedural error to take the diesel fuel in the fuel tank, ignore all the energy it took to get it there, and then compare that energy content with the energy all the way back at a power plant, hydroelectric dam, or other source of electricity production. Undoubtedly, that need for equivalency may explain why the world standard for such comparison has preferred end-user energy consumption as the basis of comparison, and has accepted conversion values generally at or near the more standardized value of 3,412 Btu/kWh.

Nevertheless, to derive a more reasonably equitable comparison, it is useful to calculate the relative energy efficiency of electric versus motor fuel transportation modes with generation

and distribution energy investments included. That has been the approach in the analysis presented in this paper.

Toward this end, one of the more interesting efforts in this regard is an analysis presented by the *Light Rail Now* (LRN) website (lightrailnow.org) in an article titled “Transport Energy Debate: How Many BTUs on the Head of a Pin? ...er...Power Line?” (3). The LRN analysis uses several methods to arrive at an estimate of the relative production/distribution efficiency of motor fuel-propelled versus electric transport modes. This includes an end-user energy pricing analysis, the outcome of which “suggests that the relative production/distribution efficiency of motor fuel is fairly close to that of electric power.”

Electric Power Energy Content

Assessing the total energy content of electric power involves some controversy, particularly since estimates and approximations are involved. The efficiency of electric power may be greater than the 33% assumed by DOE. For example, in their 2006 study, *The 21st Century Electric Car* (4), Eberhard and Tarpinning calculate generation–distribution–to–end-user efficiency of electric power at 52.5%—but this is for a high-efficiency combined-cycle system. The LRN analysis cites evidence for an efficiency range of 40% to 45%, and on the basis of this and other studies, concludes that “it is reasonable to assume a slightly higher efficiency (35%) than that estimated by the (ORNL) Data Book researchers—reflecting the USA’s gradual introduction of more efficient power generation processes in recent years.”

On the other hand, some reliable sources cite lower efficiency values—less than 32%, for example, presented for an array of years in the *Buildings Energy Data Book* (5). For the analysis presented in this paper, the researchers have conservatively opted to embrace the efficiency figure of approximately 33% currently assumed by DOE. (It should be kept in mind that 33% efficiency for generation and distribution of electricity means that 67% of the energy produced is lost before reaching the end user—the electric railcar in this case.)

Estimated values for the energy content of electric power, including losses, also vary. As noted above, the ORNL *Data Book* assumes a value of 10,339 Btu/kWh. However, this conversion factor is apparently rather rough, and may be high. In a discussion of this issue titled *Evaluation of Electricity Consumption in the Manufacturing Division* (5), the EIA presents conversion estimates ranging from 10,447 Btu/kWh in 1985 to 10,280 in 1980—a clear downward trend in energy-intensity (and conversely, an upward trend in efficiency), that is consistent with reported analyses and data from the electric power industry. Having presented these conversion estimates, the EIA proceeds to warn that

...the accuracy of the overall conversion factor given above varies across industry groups. Estimates of primary electricity using this conversion factor should thus be treated with caution. They should be considered rough alternative measures to site energy as indicators of the importance of electricity as a manufacturing energy source.

For the purposes of the analysis in the current paper, the researchers have opted for a compromise conversion value of 10,300 Btu/kWh to account for electricity generation and production losses.

Motor Fuel Energy Content

As previously noted, if an assessment of transportation energy assumes production and distribution losses, any comparative analysis must examine the production and distribution losses associated with petroleum-fueled motor vehicle transportation as well as electrically powered modes. The previously cited analysis by Eberhard and Tarpenning attempts to fully account for significant losses in motor fuel production and distribution, including from the refinery to the fueling station. These researchers conclude that

...production of the gas[oline] and its transportation to the gas station is on average 81.7% efficient, meaning that 18.3% of the energy content of the crude oil is lost to production and transportation (1).

A key source used by Eberhard and Tarpenning for their 81.7% figure (cited as Reference 3 in their own paper) is a 2001 report from several major petroleum industry corporations and Argonne National Laboratory titled Well-to-Tank Energy Use and Greenhouse Gas Emissions of Transportation Fuels (6).

Based on the foregoing analyses, it is plausible to assume that electrical energy constitutes a significant proportion of the total energy input in the refining process, and also in the operation of pipelines and other fuel distribution facilities. However, in tallying the total electrical energy consumed in the refining, transportation, fueling, and other components of the motor fuel production and distribution process, DOE analyses may not fully account for the total energy inputs of generation and distribution. For example, a related DOE document—Energy Bandwidth for Petroleum Refining Processes (7), prepared by Energetics Incorporated in 2006 for the DOE—provides the following caveat:

Current Average Energy

Current process energy values from the Energy and Environmental Profile of the U.S. Petroleum Refining industry were used to estimate CAE. Electricity losses incurred during the generation and transmission of electricity are excluded [DOE 1998].

If electricity production–distribution losses are assumed for electric power, these same losses must be assumed in the calculation of electric power used in the production and distribution of motor fuels, including natural gas. By allowing for some energy losses in the operation of fueling stations (including service stations), and by assuming additional electric power losses in the refining and distribution process (e.g., pipelines and fueling facilities), it is plausible to assume an additional 5% to 10% reduction in the efficiency figure calculated by Eberhard and Tarpenning. For this project, the researchers have assumed a net efficiency of 75% for petroleum products.

This seems to be consistent with other studies of this issue, including the GREET model (Greenhouse Gases, Regulated Emissions, and Energy Use in Transportation) developed mainly by Argonne National Laboratory and DOE, and the LRN study, which also concludes that “the assumption of 75% efficiency is probably acceptable as a very conservative value for production and distribution of motor fuel energy to the fuel tanks of end-user vehicles.”

It should be noted that this assessment of the total energy efficiency of motor fuel does not take into account the energy losses incurred in transportation of the unrefined crude oil to the refinery. Taking this step would in turn require an analysis of the transportation of coal and other fuels to power plants. In the case of electricity, the analysis would need to be performed separately for each fuel source (bunker oil, coal, nuclear fuel, etc.), and the results averaged across the proportion of electricity generated by each fuel. By the same token, the transportation of crude oil across half of the world should be taken into account in the calculation of the efficiency of motor fuels.

This more comprehensive study would certainly be beneficial to the ongoing analysis of this issue, and a more rigorous comparison of electric rail versus motor vehicle transport on this basis would be recommended as a topic of future research. However, it must be emphasized that for the purposes of this study, the authors have limited their analysis to the allegations and assertions of critics of electric rail transit who have confined their own energy efficiency focus to encompass energy losses from power plants to end users (i.e., rail transit systems). Accordingly, our own focus for petroleum-fuel energy efficiency has been limited to encompass the refinery to the end-user (i.e., motor vehicle operations). Certainly, at the very least, a more rigorous explanation of why the author elected to compare the two modes in this manner is required.

For natural gas motor fuels, because “the refining component is minimal,” the LRN analysis estimates a production–distribution efficiency of 85%. To evaluate the plausibility of this estimate, this analysis examined two data sources from the EIA: Natural Gas Consumption by End Use (8) and Natural Gas Gross Withdrawals and Production (9). Totaling gas extraction losses, pipeline and other distribution energy losses, pipeline and other distribution leakage losses, and plant processing losses, this research calculates an efficiency of 82.5%. For the purposes of this study, to ensure conservatism, the efficiency for natural gas and other gas-based motor fuels of has been assumed at 85%. [We must note that liquefied petroleum gas (LPG) and compressed natural gas (CNG) values, as provided by ORNL and APTA, have been assumed to account for pressure in the volumetric measures provided.]

Based on these efficiency conversion factors, the Btu content of various common motor fuels has been estimated as shown in [Table 1](#). This table shows the intrinsic Btu content of the fuel, and the adjusted Btu content value that accounts for production–distribution losses.

**COMPARATIVE ENERGY EFFICIENCY AND CARBON EMISSIONS:
MOTOR VEHICLES VERSUS LRT**

To produce a comparison of electric light rail energy efficiency with that of both personal motor vehicles and motor buses, it has been necessary to calculate energy consumption and energy-

TABLE 1 Btu Conversions for Motor Fuels

	Intrinsic Btu/gal	Adjusted Btu/gal
Gasoline	125,000	166,667
Diesel	138,700	184,933
Biodiesel	126,206	168,275
CNG–LPG	90,800	106,824
Hydrogen	35,600	35,600

intensity on the basis of both operational data and the energy conversion values discussed previously. This energy-intensity (where the lower value is better) will be expressed as Btu per passenger mile (pm).

In its own comparison of transportation modes, for automobiles the ORNL's *Transportation Energy Data Book* presents a figure of 3,512 Btu/pm, but for a comparison with urban transit, this figure has problems. First, it is based on a mix of both urban and intercity travel and vehicle occupancies, yielding a multiuse (urban and intercity) average of 1.57. However, a more realistic figure for the occupancy rate strictly for urban automobile travel (comparable to urban LRT) is approximately 1.49; the basis for this is detailed in another article on the LRN website—USA: Determining urban all-purpose automobile Average Vehicle Occupancy (10).

Furthermore, urban personal travel involves a mix of personal trucks (including SUVs) as well as automobiles. Both these types of motor vehicles were examined, using ORNL *Data Book* data. The researchers totaled Btus and vehicle miles from the ORNL *Data Book*, divided for a composite figure of Btus per vehicle mile, then divided by average urban occupancy value of 1.49 to calculate Btus/pm. The Btu figure was then adjusted for the production–distribution loss (i.e., net efficiency) value previously discussed. The result, as a national urban average, is 4,000 Btu/pm without adjusting for losses (efficiency), and 5,333 Btu/pm with efficiency included. This latter figure will be assumed roughly valid as an average for American cities in general, and will be compared with the results calculated for specific cities or transit systems.

To compare LRT versus motor bus modes in specific cities or transit systems, data from the National Transit Database (NTD), 2007 edition, of the FTA has been used (11). For LRT, the total power usage (kWh) has been tallied, then multiplied by the average BTUs/kWh value of 10,300 Btu/kWh (as previously discussed), then divided by passenger miles, to calculate energy-intensity accounting for net efficiency. For bus, Btus for each type of fuel have been calculated, based on the Btu conversion values previously listed, then all the Btus for each system's bus operations have been totaled and then divided by bus passenger miles, again to calculate energy-intensity accounting for net efficiency.

Electric LRT versus motor bus energy use has been examined in most cities operating LRT in a “corridor” mode. Circulator-type streetcar services (such as those in Memphis, Tennessee; Kenosha, Wisconsin; Tampa, Florida; and Tacoma, Washington), have been excluded, since a comparison between these and longer-distance, higher-speed bus services would be invalid. The New Orleans, Louisiana streetcar system has been omitted because of ongoing operational problems following Hurricane Katrina. New Jersey LRT systems (Newark and Hudson–Bergen) have been excluded, because New Jersey Transit combines its reporting of these with the diesel-powered RiverLine light railway. The new Charlotte, North Carolina LRT system is omitted since it did not experience a full year of operation until 2008.

In terms of transit system age, the LRT systems examined cover a fairly wide range, but include a mix of older legacy systems, renovated legacy systems, and newer “New Start” systems. These are listed in Table 2 with their system age designations, including year of opening for the newer (New Start systems). (Agency order is based on FTA's transit agency ID number.)

For the selected transit agencies, Tables 3 and 4 present raw energy consumption and passenger miles data from the NTD for 2007. Table 3 provides electric power consumption (kWh) for LRT and Table 4 provides gallons of various types of fuel for motor bus.

TABLE 2 Selected Cities with LRT Classified by Age of System

City/Agency	System Age Category
Portland TriMet	New (1986)
Boston MBTA	Legacy
Buffalo NFTA	New (1985)
Philadelphia SEPTA	Legacy
Pittsburgh Port Authority	Legacy-renovated
Baltimore MTA	New (1992)
Cleveland GCRTA	Legacy-renovated
Minneapolis Metro Transit	New (2004)
Houston Metro	New (2004)
Dallas DART	New (1996)
St. Louis Metro	New (1993)
Salt Lake City UTA	New (1999)
Denver RTD	New (1994)
San Jose VTA	New (1987)
San Francisco MUNI	Legacy-renovated
Sacramento RTD	New (1987)
San Diego MTS	New (1981)
Los Angeles MTA	New (1990)

Table 5 provides a tabular presentation of total gross energy-intensiveness calculations (in Btu/pm) for these transit systems. From these calculated data, it can readily be seen that, for most of these cities (12 out of 18, or 67%), the electric LRT operation exhibited significantly greater energy efficiency (i.e., lower energy intensity) than buses; in addition, another group of 12 systems exhibited significantly greater energy efficiency than private automobiles (for which the national average of 5,333 Btu/pm has been assumed) in the year studied.

We must note that, while NTD data are used as reported, up to as many as 10 significant digits, actual data are probably not accurate to anywhere near this degree of precision. In particular, while public transit agencies count passengers within probably 1% accuracy (two to three significant digits), the distance the passengers ride is estimated rather than measured. However, we have followed standard industry practice in our analysis and used operating data as reported in the NTD, including as the basis for our energy calculations.

On the basis of the 18 systems examined, LRT passenger miles total 1,653,349,805 and Btus consumed total 6,180,872,461,500. Bus passenger miles total 5,626,333,545 and Btus total 25,248,018,585,903. Using these totals, we calculate average gross energy-intensity as 3,738 Btu/pm for LRT and 4,487 Btu/pm for bus. In both cases, the average is less than the national average for the private motor vehicle (5,333 Btu/pm).

TABLE 3 Kilowatt-Hours Consumed and Passenger Miles Traveled for Selected Light Rail Systems, 2007

Agency Name	kWh Propulsion	Annual pm
Portland TriMet	43,058,913	186,540,535
Boston MBTA	51,524,950	176,196,470
Buffalo NFTA	7,942,481	14,323,752
Philadelphia SEPTA	34,955,140	69,595,848
Pittsburgh Port Auth.	30,735,501	34,681,135
Baltimore MTA	33,485,570	41,318,845
Cleveland GCRTA	12,542,075	19,202,136
Minneapolis Metro Transit	16,605,772	52,693,748
Houston Metro	7,931,800	28,317,753
Dallas DART	59,538,192	138,867,254
St. Louis Metro	35,678,674	137,439,468
Salt Lake City UTA	20,796,900	82,248,010
Denver RTD	44,350,259	119,749,823
San Jose VTA	28,034,392	54,527,623
San Francisco MUNI	49,904,556	106,543,428
Sacramento RTD	35,631,920	78,760,310
San Diego MTS	41,485,953	207,726,689
Los Angeles MTA	88,940,570	291,157,513

In terms of carbon-emitting energy sources (again, on the basis of fully assessed energy, including production, distribution, and end-use), these emissions were estimated using the factor of 72% previously discussed (with the assumption that most electric transit systems ultimately derive their energy from the national electric power grid). The results of this study are even more dramatic. [Table 6](#) provides a tabular presentation of carbon-emissions energy-intensiveness calculations (again, expressed in Btu/pm) for the selected transit systems.

When carbon emissions are taken into account, it can be seen that, in most cases, electric LRT scores higher in energy efficiency (i.e., lower in energy intensity) compared with motor buses for the systems included in the study in 2007. In terms of an average for these 18 systems, carbon emissions energy intensity for LRT averages 2,691 Btu/pm versus 4,487 for bus. In addition, in most cases the energy-efficiency of electric rail is better than that of the private automobile—thus refuting contentions of some critics.

While our calculations suggest that nine bus systems (Boston, Massachusetts; Buffalo, New York; Philadelphia, Pennsylvania; Pittsburgh, Pennsylvania; Cleveland, Ohio; Dallas, Texas; St. Louis, Missouri; San Jose, Texas; and Sacramento, California) and several LRT systems (Pittsburgh, Pennsylvania and Baltimore, Maryland) consume on average more carbon

TABLE 4 Gallons of Motor Bus Fuel Consumed by Type and Bus Passenger Miles for Selected Transit Agencies, 2007

Agency Name	Diesel	Gasoline	LNG	CNG	Hydrogen	Biodiesel	Annual pm
Portland TriMet	5,634,668	0	0	0	0	209,018	223,265,805
Boston MBTA	5,016,583	0	0	4,395,304	0	0	214,521,392
Buffalo NFTA	2,325,349	0	0	0	0	0	69,062,881
Philadelphia SEPTA	15,921,182	0	0	0	0	0	476,535,831
Pittsburgh Port Authority	8,823,932	0	0	0	0	0	288,378,870
Baltimore MTA	7,632,486	0	0	0	0	0	347,986,479
Cleveland GCRTA	5,393,502	0	0	434,773	0	0	178,890,643
Minneapolis Metro Transit	0	0	0	0	0	7,750,627	303,491,661
Houston Metro	10,247,374	0	0	0	0	0	494,223,175
Dallas DART	7,126,856	0	5,282,757	0	0	0	241,312,509
St. Louis Metro	4,467,092	0	0	350,240	0	0	122,820,571
Salt Lake City UTA	4,595,112	0	0	1,685	0	0	170,197,957
Denver RTD	6,076,071	0	0	154,857	0	0	396,495,470
San Jose VTA	4,676,583	23,934	0	0	8,778	0	129,533,714
San Francisco MUNI	5,119,763	0	0	0	0	0	198,255,019
Sacramento RTD	45,590	25,796	0	2,816,596	0	0	54,550,645
San Diego MTS	714,105	0	0	4,193,617	0	0	172,276,674
Los Angeles MTA	2,471,406	0	0	39,409,681	0	0	1,544,534,249

TABLE 5 Urban Transport Mode Gross Energy-Intensity, 2007: Cities with LRT

City/ Agency	LRT pm	Bus pm	LRT Btu	Bus Btu	LRT Btu/pm	Bus Btu/pm
Portland TriMet	186,540,535	223,265,805	443,506,803,900	1,077,208,561,194	2,378	4,825
Boston MBTA	176,196,470	214,521,392	530,706,985,000	1,397,255,698,435	3,012	6,513
Buffalo NFTA	14,323,752	69,062,881	81,807,554,300	430,033,766,617	5,711	6,227
Philadelphia SEPTA	69,595,848	476,535,831	360,037,942,000	2,944,351,950,806	5,173	6,179
Pittsburgh Port Authority	34,681,135	288,378,870	316,575,660,300	1,631,836,216,556	9,128	5,659
Baltimore MTA	41,318,845	347,986,479	344,901,371,000	1,411,498,533,438	8,347	4,056
Cleveland GCRTA	19,202,136	178,890,643	129,183,372,500	1,043,880,696,318	6,728	5,835
Minneapolis Metro Transit	52,693,748	303,491,661	171,039,451,600	1,304,236,758,425	3,246	4,297
Houston Metro	28,317,753	494,223,175	81,697,540,000	1,895,077,615,942	2,885	3,834
Dallas DART	138,867,254	241,312,509	613,243,377,600	1,882,316,094,416	4,416	7,800
St. Louis Metro	137,439,468	122,820,571	367,490,342,200	863,526,762,596	2,674	7,031
Salt Lake City UTA	82,248,010	170,197,957	214,208,070,000	849,967,845,936	2,604	4,994
Denver RTD	119,749,823	396,495,470	456,807,667,700	1,140,208,482,411	3,815	2,876
San Jose VTA	54,527,623	129,533,714	288,754,237,600	869,211,172,113	5,296	6,710
San Francisco MUNI	106,543,428	198,255,019	514,016,926,800	946,813,130,879	4,824	4,776
Sacramento RTD	78,760,310	54,550,645	367,008,776,000	313,610,488,506	4,660	5,749
San Diego MTS	207,726,689	172,276,674	427,305,315,900	580,040,522,373	2,057	3,367
Los Angeles MTA	291,157,513	1,544,534,249	916,087,871,000	4,666,944,288,942	3,146	3,022

**TABLE 6 Urban Transport Mode Carbon-Emissions
Energy-Intensity, 2007: Cities with LRT**

City/Agency	LRT Btu/pm	Bus Btu/pm
Portland TriMet	1,712	4,825
Boston MBTA	2,169	6,513
Buffalo NFTA	4,112	6,227
Philadelphia SEPTA	3,725	6,179
Pittsburgh Port Auth.	6,572	5,659
Baltimore MTA	6,010	4,056
Cleveland GCRTA	4,844	5,835
Minneapolis Metro Transit	2,337	4,297
Houston Metro	2,077	3,834
Dallas DART	3,180	7,800
St. Louis Metro	1,925	7,031
Salt Lake City UTA	1,875	4,994
Denver RTD	2,747	2,876
San Jose VTA	3,813	6,710
San Francisco MUNI	3,474	4,776
Sacramento RTD	3,355	5,749
San Diego MTS	1,481	3,367
Los Angeles MTA	2,265	3,022

emissions BTUs/pm than the national average for a private automobile, this does not necessarily mean that these cities will save energy (or money) if they transported their riders by automobile. Specific factors (e.g., hilly terrain or other local conditions) would need to be evaluated, and local automobile travel and energy data would need to be assessed, before definitive conclusions on this particular issue could be made. One should keep in mind that, averaged nationally, both LRT and bus seem superior to the automobile in terms of energy efficiency.

We also note that there is some variation between LRT and bus in relative energy efficiency in a few cities compared with the majority. Carbon-emissions energy intensity seems significantly higher for LRT in Pittsburgh and Baltimore, and roughly equal in Denver (when we allow for some statistical variation). Very specific local conditions may account for some of this, including terrain, operating conditions, and rider travel characteristics. In Pittsburgh, for example, LRT operates in very hilly terrain and incurs the cost of operating the downtown subway facilities and the long Mt. Washington tunnel. In addition, as a legacy system, the LRT may experience shorter trip lengths than the bus system as a whole, which includes numerous longer-distance express routes—thus rendering lower passenger miles. These kinds of specific factors merit further exploration in these cities.

CONCLUSIONS

This analysis, using actual performance data from FTA (for 2007) and DOE, and adjusting for production and distribution energy losses of both electric- and fuel-powered modes, has found that, in the majority of cases, electric LRT appears to provide relatively higher energy efficiency compared with fuel-powered motor vehicle modes. In addition, in the majority of cases, LRT exhibits substantially better carbon-based energy efficiency than petroleum-fueled motor vehicles, either motor bus or private car. These findings suggest that electric LRT represents a very promising mechanism within urban transportation to reduce the consumption of petroleum-based fuels, to contribute to the reduction of carbon emissions, and thus to address the conjoined problems of peak oil and global warming.

For future research, we would recommend a more comprehensive study aimed at assessing the total energy efficiency of motor fuel that takes into account the energy losses incurred in transportation of the unrefined crude oil to the refinery, as well as an analysis of the transportation of coal and other fuels to power plants: bunker oil, coal, nuclear fuel, etc. Such an analysis should also consider the energy implications of transporting crude oil across half the world, as well as the energy impacts of military protection of supply lines and resources. Such a more comprehensive, rigorous comparison of electric rail versus motor vehicle transport on this basis is recommended as a topic for further investigation.

REFERENCES

1. Energy Information Administration. Net Generation by Energy Source by Type of Producer. October 22, 2007. www.eia.doe.gov/cneaf/electricity/epa/epat1p1.html.
2. *Transportation Energy Data Book*, Edition 27. U.S. Department of Energy, Oak Ridge National Laboratory, 2008. <http://cta.ornl.gov/data/index.shtml>.
3. Light Rail Now. Transport Energy Debate: How Many BTUs on the Head of a Pin? ...er...Power Line? August 2007. www.lightrailnow.org/facts/fa_lrt_2007-08a.htm.
4. Eberhard, M., and M. Tarpenning. The 21st Century Electric Car, October 6, 2006. www.teslamotors.com/display_data/twentyfirstcenturycar.pdf.
5. Evaluation of Electricity Consumption in the Manufacturing Division. Energy Information Administration, August 25, 1998. www.eia.doe.gov/emeu/mecs/mecs94/ei/elec.html.
6. General Motors Corporation, Argonne National Laboratory, BP, ExxonMobil, and Shell. Well-to-Tank Energy Use and Greenhouse Gas Emissions of Transportation Fuels—North American Analysis, June 2001, Vol. 3, p. 59.
7. Energetics Incorporated. Energy Bandwidth for Petroleum Refining Processes, October 2006. Prepared for U.S. Department of Energy, Office of Energy Efficiency and Renewable Energy, Industrial Technologies Program. www1.eere.energy.gov/industry/petroleum_refining/pdfs/bandwidth.pdf.
8. Energy Information Administration. Natural Gas Consumption by End Use, October 31, 2008. http://tonto.eia.doe.gov/dnav/ng/ng_cons_sum_dcu_nus_m.htm.
9. Energy Information Administration. Natural Gas Gross Withdrawals and Production, October 31, 2008. http://tonto.eia.doe.gov/dnav/ng/ng_prod_sum_dcu_NUS_m.htm.
10. Light Rail Now. Determining Urban All-Purpose Automobile Average Vehicle Occupancy, September, 10, 2007. www.lightrailnow.org/news/n_newslog2007q3.htm#USA_20070910.
11. *National Transit Database*, 2007 edition. Federal Transit Administration.

ENERGY, ENVIRONMENT, AND TRANSIT: GREENER--EFFICIENT

The Role of Transit in Mitigating Climate Change

DONNA L. DAY
JODI KETELSEN
CH2M HILL Inc.

Global climate change refers to changes in average climatic conditions on Earth as a whole, including changes in temperature, wind patterns, precipitation, and storms. Global warming is a regional and ultimately a worldwide concern. Data show that the current global changes differ from past climate changes in rate and magnitude.

Global climate change is directly correlated to the increase of greenhouse gases (GHGs) in the atmosphere. In contrast to most criteria pollutants, emissions of GHGs have been rising from many sources (such as industrial, residential, commercial, and transportation). Two of the largest contributors to GHG emissions worldwide are transportation and energy production.

GHG emissions from transportation sources are directly related to energy consumption and primarily result from the combustion of fossil fuels in vehicles. In North America, more than one-third of GHG emissions result from the transportation sector. The transportation sector results in a higher share of GHG emissions in the western states and provinces because hydropower, which is a non-GHG emitting source, is the primary source of electricity, thus reducing the energy sector's contribution to GHG emissions.

In 2003, it was found that combustion of transportation fuels, the largest source of carbon dioxide equivalent (CO₂e), contributed 28% of the U.S. GHG emissions. CO₂e is the standard equivalency of a combination of GHG; fossil fuel combustion also emits small amounts of nitrous oxide (N₂O) and methane (CH₄). The total CO₂e emissions take into account the other pollutants and their global warming potential. In addition, the transportation sector GHG emissions are increasing faster than those from the other sectors of the economy, and are more difficult to control since the responsibility for addressing emissions from mobile sources lies with individuals throughout the population.

The GHG emissions associated with electrical transportation vary widely depending on the source of electricity. For example, hydroelectric generation produces much less GHG emissions than coal plants do. Generally, combusting fuel at a power plant to produce electricity is more efficient than in vehicles.

There are three different categories of approaches to reducing GHG emissions in the transport sector: increasing the energy efficiency of the vehicles and engines themselves, decreasing the carbon content of the fuels, and managing travel demand [i.e., reducing vehicle miles traveled (VMT)]. Although some progress is now being made in improving vehicle technology and changing fuel content (especially policy actions at the upper levels of government), managing travel demand is more difficult and the overall problem of managing mobility is growing.

From 1980 through 2004, FHWA statistics show that the VMT in the United States grew three times faster than the population and almost twice as fast as the new vehicles registered—more vehicles are moving longer distances and therefore emitting increasing amounts of GHG. There is evidence (1) that the projected increase in VMT will continue to drive CO₂e emissions up, even if vehicle efficiency and fuels changes help to hold them down.

The upper levels of government in the industrialized economies of Europe and North America are responding to the growing climate change concern by establishing targets for reduced GHG emissions and by developing climate action programs to attempt to achieve these targets. While few have yet to produce real solutions for reducing overall emissions from the transportation sector, nearly all agree that reducing VMT and increasing the use of more energy-efficient transportation service are necessary.

This paper offers insights collected from the analysis of European cities regarding transit use and urban development, and examines selected approaches being taken in North America to reduce GHG emissions from the transportation sector.

PURPOSE AND METHODOLOGY OF THE RESEARCH

The purpose of this study was to investigate the potential for reducing GHG emission reductions through transit system expansion, and to research the different approaches being taken by selected governments in their quest to achieve GHG reductions in the transportation sector.

The study involved the following steps:

1. A review of the literature to identify the transit system characteristics, transit mode share, and urban development patterns for selected cities in Europe;
2. A review of the literature and other available sources to identify policy approaches being taken by selected state/provincial and local jurisdictions in the western United States and Canada to use transit system expansion to meet their GHG emissions reduction targets;
3. A review of the analyses being carried out by selected transit agencies in the United States (e.g., Sound Transit in Seattle, Washington) to evaluate the GHG emissions impacts of individual rail transit expansion projects, including how the agencies are assessing GHG emissions from construction versus operation of the systems; and
4. Based on the results of the above research, a review of the potential for reducing GHG emissions through transit system expansion and other related means, and an analysis of the different governmental approaches being taken to achieve this end.

CHARACTERISTICS OF EUROPEAN CITIES WHERE TRANSIT MODE SHARE IS HIGH

To reduce GHG emissions from transportation sources, effective planning must incorporate modes of transportation that use less energy per person per mile traveled or use energy derived from fuels that have low carbon content per unit of energy. For example, by changing bus fleets from diesel to natural gas, GHG emissions can be reduced through the use of a low carbon-intensity fuel, and they can be further reduced by increasing regional transit ridership, which uses less energy per person per mile traveled than single-occupant vehicles. Additionally, the emphasis should be on reducing overall VMT. Ultimately, living conditions that increase the share of nonautomobile travel, and instead use walking, bicycling, and transit (especially noncarbon fuel powered transit) can lead to reduced GHG emissions.

European cities have advanced planning practices to enhance transit use. This section explores the transit characteristics, mode share, and various policies that have made this possible and those that might serve as lessons for Northern American regions.

Table 1 lists several cities that may offer valuable lessons on increasing transit use and how they compare with selected North American cities in terms of population density and the number of cars per 1,000 residents. Note that in North American cities, the share of transit usage is considerably lower than their European counterparts. These European cities also have a high percentage of walking trips. A more detailed discussion of these cities follows.

Stockholm, Sweden

One example city is Stockholm. While the transit ridership is higher than the northwestern cities in North America, the density is not particularly higher. The key difference is that the density is concentrated around transit stations. Since the 1990s, Stockholm's city planning has integrated public transport (PT) such as light rail lines within new urban developments. Current developments continue to organize new neighborhoods and regional centers around transit stations or along transit routes. The transit system and the land use nodes were actively planned simultaneously, emphasizing transit usage as land use developed.

Stockholm has regional rail and tramways, buses, and ferries as part of their transit system. Stockholm is served by a local rail network (the Tunnelbanan) consisting of three radial lines and several branches. Tvärbanan is a newer light rail line that serves the urban fringes of Stockholm. It is elevated and underground in some sections, but also travels on surface streets. Additionally, the regional railways terminate at Slussen, an important intermodal node at the south side of Stockholm's center. Stockholm is also served by many bus lines; however, bus mobility is impaired by congestion (2).

Stockholm continues to focus on densification of existing settlements. For example, some of the former industrial zones within the city will be transformed into compact residential areas. Such control of land use to prevent urban sprawl has minimized changes to the city's density (18.5 persons/ha) over the 1995 to 2001 period. In addition to effective land use planning, Stockholm has levied high parking fees for the inner city, established toll roads, developed multiple transit lines, and increased transit service quality (e.g., frequency, comfort, branding etc.). All of these measures help this city maintain its relatively high transit share level amidst increasing population and economic growth.

TABLE 1 Transit Share Comparison Between European and Northwestern Regions

	Stockholm	Geneva	Helsinki	Zurich	Metro Vancouver	Seattle Region
Public transit share (%)	28.9	21.7	34.6	27.6	10.8	10
Population density (inhabitants/hectare)	18.1	49.2	44.0	44.5	22	15
Number of cars per 1,000 inhabitants	397	508	361	495	530	673

Geneva, Switzerland

Geneva is another city where the transit agency and the local planning agency work together. In 1987, a public referendum forced the transfer of public transportation services within the canton (state) of Geneva from private operators to a public agency, Transports Publics Genevois (TPG), which provides bus, tram (train), and boat public transportation services within the city of Geneva and surrounding suburban areas. Office des Transports et de la Circulation (OTC) is the state body that serves as the public transportation authority for greater Geneva and oversees the work of TPG. It oversees management of public transit, highways, and parking in the Geneva Canton, and coordinates with Geneva's urban planning department (3). Together, TPG and OTC have altered the development over time to emphasize transit. Additionally, they actively seek input from the public on how to improve transit system attractiveness. Their successes can be summarized by the following activities:

- Key investments in transit infrastructure that serve centers of high and mixed-use activities;
- A focus on high quality service that includes high transit frequency, reliability, and responsive action based on customer input;
- Robust intermodal connections including all forms of public transit and nonmotorized modes; and
- Controls on car access.

Geneva prioritizes transit access and controls car access, which are believed to contribute to the high transit mode share observed because the convenience of driving to the city center is reduced. Car access to the center of the city is limited through traffic signals during peak travel times in order to avoid congestion. Car access to the historic area of the city is permanently restricted. Geneva has prioritized transit by establishing transit-only retail streets that allow access for taxis, bicycles, and deliveries (4).

Helsinki, Finland

Much like Geneva, Helsinki employs a heavy public campaign complete with rider satisfaction surveys, and demonstrates improvements to the transportation system to meet public demand. Each municipality is responsible for public transport, but the Helsinki Metropolitan Area Council, a regional government body, is responsible for regional transportation coordination and has special authority to ensure cooperation among cities (5). Helsinki City Transport Authority (HKL), Helsinki's public transit authority, serves a region of 264 mi². More than 176 million passenger trips are made annually on the 115 trams, 450 buses, 54 metro trains (underground), and ferries HKL operates. The city's general plan calls for regional rail service with a supportive feeder bus services. City culture places a high emphasis on the environmental benefits of transit (3).

The following factors are thought to have contributed to a 34.6% transit mode share in 2001 (4):

- High population density of 44.0 inhabitants/ha;

- Integration of land use planning and the provision of transit;
- A focus on high-quality service, ease of use, and customer satisfaction; and
- Public campaigns promoting the use of transit.

Zurich, Switzerland

Zurich, Switzerland's largest city, has a strong history of public transit. The city had trams powered by horses starting in 1864. Streetcars eventually developed and today, Verkehrsbetriebe der Stadt Zurich (VBZ), Zurich's public transit agency, operates streetcars of varying sizes, types, and vintages, and a bus network. In 1962 and 1973, Zurich citizens voted down the construction of a subway because of costs, but in 1975, Zurich's parliament passed a resolution giving transit priority on public streets. Zurich authorities aim to reduce car use and improve air quality through the provision of attractive public transit. They have set a goal of having a tramway stop within 300 m of all city residents. Zurich has focused on transit system efficiency and reliability as a means to maintain and increase transit mode share (6).

Zurich has concluded that what matters most is reliability; people want their trains on time. Trams have short headways of 6 min. One method that helps achieve this frequency is Zurich's developed transit-only lanes. In 2002, more than 90% of intersections were equipped with sensors that detect approaching transit vehicles and give them priority, creating a "green wave." Additionally, the system limits automobile entrance to the city of Zurich if the system monitor indicates that congestion is unacceptably high (5). These approaches are relatively simple, but implemented widely throughout the system so that they can increase transit efficiency:

- Eliminate on-street parking and loading zones along transit routes;
- Restrict turns for automobiles;
- If turns are restricted, allow transit vehicles to turn if it is the most direct route;
- Locate transit stops to places with fewer traffic conflicts and consider consolidating stops, being careful to not reduce accessibility; and
- Use transit boarding islands that enable a vehicle to pick up passengers without moving out of the travel lane.

Summary of Lessons Learned from European Cities' Experience

The European cities described above offer many lessons that can assist in increasing transit ridership in North America, and in turn decreasing GHG emissions. The following list summarizes those lessons in the order of those actions thought to contribute most to a high transit mode share:

- Maintaining and promoting high population densities;
- The provision of transit as the central, organizing piece of public infrastructure;
- Integration of land use planning and transit;
- Increases in the cost of car use (temporal and monetary); and
- Expanding transit service strategically to serve destinations or activity centers.

Other factors thought to also contribute to a high transit mode share by increasing the overall appeal of transit are

- Intermodal connections,
- Customer input and high customer service,
- Prioritization of transit, and
- Universal fare media.

Many of the strategies used by the European cities are regional approaches addressing transportation and land use planning in order to achieve high transit ridership. Some may think it would be a challenge for North American cities to reach high transit mode share. However, an increase of +0.4% per year is not infeasible. When comparing the percent of daily mechanized or motorized trips by public transport, also known as the PT market share, in Europe, six cities (London, Madrid, Zurich, Geneva, Vienna, and Athens) have shown a rate of growth that is higher than 0.4% per year.

London has exhibited a 2.9% change in PT market share over the past 6 years (+0.48% per year) through an integrated approach. In addition to substantial PT infrastructure investment aided by private partnership arrangements, London has launched congestion charging schemes in the central business district (CBD) that also directly affect the service quality of buses. Combined measures such as enforcement of strict parking regulations, reduction in the ratio of CBD parking availability per job by 27% over 6 years, and the launch of bus priority schemes make transit a much more attractive mode choice than personal vehicles. A similar approach is taken in Zurich (+0.55% per year), where a dense, optimized, and high-quality public transit network is coupled with stringent commuter traffic policies, notably the banning of through traffic in residential areas and restrictive parking regulations. These cities that have shown remarkable results in PT market share change have taken active and extensive measures to address transit mode change on several fronts. These integrative approaches shift public perceptions on taking transit versus driving.

POLICY APPROACHES IN WESTERN STATES AND PROVINCES TO REDUCE GHG EMISSIONS

A growing number of U.S. states and Canadian provinces have now established significant GHG emissions reduction targets, but they differ in approach on how to plan and implement initiatives to reach the targets. At the federal and state levels in the United States, the focus is mainly on changing vehicle efficiency and fuel characteristics to reduce GHG emissions, while the responsibility for transportation, land use, and other mobility-related planning and implementation generally takes place at the local level.

On December 19, 2007, President George W. Bush signed into law the Clean Energy Act of 2007, which requires in part that automakers boost fleet-wide gas mileage to 35 miles per gallon (mpg) by the year 2020. The current corporate average fuel economy (CAFE) standard for cars, set in 1984, requires manufacturers to achieve an average of 27.5 mpg, while a second CAFE standard requires an average of 22.2 mpg for light trucks such as minivans, SUVs, and pickups.

State of Washington

Like many states, Washington State is taking a strong position on actively reducing GHG emissions. On May 3, 2007, the Washington legislature passed Senate Bill 6001, which, among other things, adopted Governor Christine Gregoire's climate change goals into state law. The law aims to achieve 1990 GHG levels by 2020, a 50% reduction below 1990 levels by 2030, and more by 2050. However, the legislature did not offer instructions or directives on how to meet this reduction goal. In reaction to this policy, local agencies are exploring methods of evaluating GHG as part of the Washington State Environmental Policy Act procedures, which evaluate the environmental effects of new projects.

The transportation-related policies being implemented by Washington State to reduce GHG emissions from the transportation sector include adopting vehicle energy efficiency standards, increasing the production and use of bio-fuels, transportation planning strategies to reduce VMT, and employer-based commuter trip reduction programs such as high-occupancy vehicle lanes, carpools, and vanpools (7). VMT is somewhat dictated by land use planning which is controlled by the local jurisdictions. The Washington Growth Management Act of 1990 was created because "uncoordinated and unplanned growth posed a threat to the environment, sustainable economic development, and the quality of life in Washington." It forces local agencies to plan for anticipated growth and transportation infrastructure. The Puget Sound Regional Council (comprising the greater Seattle metropolitan region) has worked with local jurisdictions to prepare the recently adopted Vision 2040. The plan promotes a sustainable development pattern, in which new housing and jobs are focused within regional growth centers and encouraged by linking transportation investments with meeting the urban density goals. The urban growth center concept reduces reliance on the automobile and minimizes growth in the region's rural areas.

Additionally, Puget Sound regional transportation agencies have formed a committee to explore other methods of evaluating and reducing GHG emissions. Sound Transit, the regional transit agency for the Puget Sound region, is actively researching methods of determining their GHG emissions and savings. The GHG emission impacts of specific Sound Transit capital projects are identified in the local or regional transportation planning process. Section VI of this paper discusses this approach in more detail. All these activities will be collectively monitored and reported to the state legislature, as a bottom-up report.

Province of British Columbia

In the United States, the federal and state governments are establishing legislative goals but delegating to industry and local governments much of the responsibility for determining the methods for achieving the goals. In British Columbia, the provincial government is taking a strategic top-down approach, establishing policies and programs directed at improving vehicle technology and fuel content as well as guiding both transportation and land use planning and implementation within the urban regions of the province. The government is proactively applying such methods to reduce future GHG emissions in the major urban areas.

In early 2007, Gordon Campbell, the Premier of the Province of British Columbia, announced a provincial commitment to reduce GHG emissions by 33% by 2020 based on 2007 levels. This ambitious goal was then entered into provincial law. In support of this target, the province is developing a climate action strategy across all sectors of the economy. Notable

policy measures include North America's first revenue-neutral carbon tax. This tax will reward low-carbon consumers without placing an additional levy on taxpayers. As a member of the Western Climate Initiative, the province will also be participating in a cap-and-trade system for a carbon emissions market.

Each ministry within the provincial government has been tasked with developing measures to address the overall provincial commitment for GHG emissions reductions. The British Columbia Ministry of Transportation and Infrastructure is responsible for achieving the reduction of GHG emissions in the transportation sector and has formed a Transportation Climate Action Program to oversee this work. In support of developing the Transportation Climate Action Program, the province identified opportunities for GHG emission reductions from changes in vehicle technology, vehicle fuel characteristics, transit investment, land use planning and regulation, and the costs of automobile operations, including fuel prices and parking prices. The research included analyses of the effectiveness of each of these measures, the range of potential outcomes in terms of potential GHG reductions, the associated risks, and recommendations for further action.

The following provincial policy initiatives and investments that emphasize vehicular demand management and the use of non-single-occupancy motorized modes of travel will significantly contribute to the province's 2020 goal on GHG emissions reduction:

- Implementation of the CAFE standards from the United States or the California Tailpipe Standards (Pavley);
- Implementation of low-carbon clean fuel and renewable fuels standards; and
- Implementation of major improvements to the transit systems in the urban areas, as outlined in the Provincial Transit Plan.

The \$14 billion Provincial Transit Plan announced in February 2008 is a key element of the Ministry's Climate Action Program initiatives to achieve the provincial GHG reduction goals by increasing the transit market share, and by encouraging local communities to enact land use strategies to guide the development of more compact communities around new rapid transit stations. The plan includes four new and expanded rail transit lines in Metro Vancouver, nine new rapid bus lines, and 1,500 new energy-efficient buses. The \$14 billion required to deliver the projects will come from a funding partnership with the other levels of government.

Significant transit investment, in addition to the improvements to vehicle efficiency and fuel content, will take the province a long way toward achieving the GHG reduction targets. This will be aided by the increase in the price of transportation fuels, as has already been demonstrated by the rapid increase in transit usage which occurred in 2008 as gasoline prices rose. It is expected that further land use changes and other demand management changes will assist in meeting the GHG reduction targets by the year 2020.

Existing transit mode share in the Metro Vancouver region is approximately 11%. The stated provincial goal for future daily transit mode share in this region is 17% by 2020 and 22% by 2030. According to the census data for commuter mode share in Metro Vancouver, people who took transit to work increased from 11.5% to 16.5% from 2001 to 2006. At the same time, those who drove to work decreased. However, other modes such as bicycle, walk, or passenger occupancy have largely remained unchanged (Figure 1).

The province has been researching GHG emission reducing strategies, like those summarized in Section IV on European cities. British Columbia has been studying the realistic

application of some of these strategies and concluded that it is realistic to assume an overall 30% cut in VMT in compact urban development areas. Over time, this decrease in travel could have a significant impact on GHG emissions reductions. The Urban Land Institute report, *Growing Cooler* (8), suggests that this type of land use change could reduce CO₂ emissions from current levels by 7% to 10% as of 2050. While land use changes are not immediate, they can create a permanent benefit that would compound over time, where many other more immediate strategies would not.

The GHG benefits of land use changes will take time to achieve, and require coordinated intergovernmental action. Government staff and consultants must be familiar with the state of the practice in transportation and land use planning at the regional, local, and neighborhood levels.

Three overall factors are expected to have an influence on land use intensification and transit ridership: the time required designing and building the transit investments; the time required adopting policies and informing and influencing citizens; and the time required for new settlement patterns to evolve.

In summary, in surveying a wide range of potential policy initiatives, the British Columbia provincial effort analyzed the prospects for British Columbia’s transportation sector to meet the provincial GHG targets, suggested a strategy for implementation, and addressed critical risks that may affect the success or timing of these initiatives, with broad application to other jurisdictions that are seeking to address similar issues.

Estimating Reduction Potential of Transportation Projects

As stated earlier, the United States is looking to industry and local governments to find methods of reducing GHG emissions. Regulatory and computational approaches in this area are rapidly evolving, and both industry and government policy makers want reliable data on the efficacy of various investments in reducing GHG emissions.

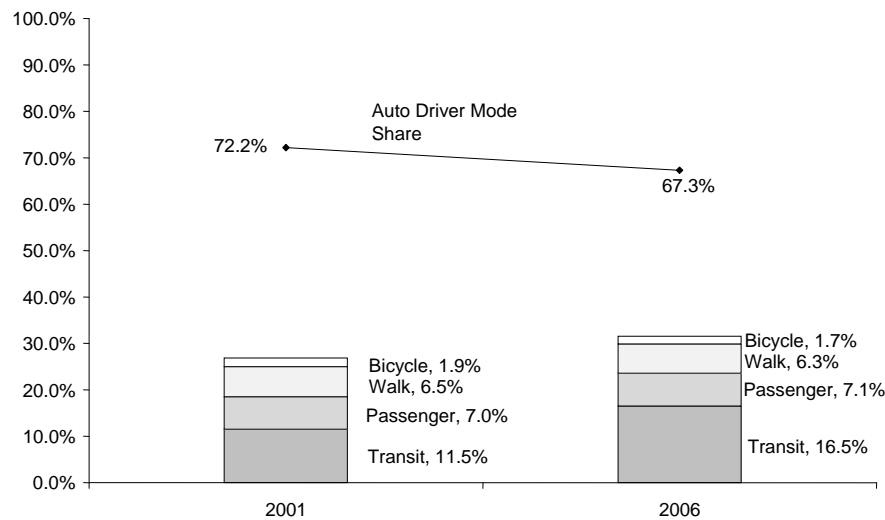

FIGURE 1 Travel to Work Mode Share for Vancouver CMA.

The methodologies and techniques for analyzing potential GHG emission reductions in the transportation sector are just being developed. There is a variety of tools and approaches under development around the world for applications ranging from regional planning to project planning and evaluation. In the introduction, we explained that expending combustible fuels causes GHG emissions, and therefore reducing vehicle miles (or kilometers) traveled can be one safe measure of estimating GHG emissions. Regional agencies across the United States currently use the software MOBILE6, which estimates VMT and the composition of vehicle types to indicate GHG emissions. This approach does not capture savings of differing fuels, nor reduction of GHG emissions due to higher burning efficiencies as a result of improving congestion conditions and traffic moving at higher speeds. The U.S. Environmental Protection Agency's Office of Transportation and Air Quality is developing a new software application to replace MOBILE6 called Motor Vehicle Emission Simulator (MOVES). MOVES takes into account congestion in estimating GHG emissions. However, it should be noted that GHG emission reductions are only realized up to 45 mph, after which no additional efficiencies are gained.

Sound Transit, the greater Seattle region's transportation agency, is proposing nearly \$18 billion of regional transit improvements. The state legislature requires Sound Transit to estimate GHG savings of their projects. The following description includes both a project-level estimate, as applied one 18-mi project named the East Link Light Rail Project, and the roll-up of cumulative GHG emission reductions of the entire regional transit investment. The methodology covers three main areas: operations, construction, and cumulative effects, including a discussion of forecasted changes in land use and mode share.

Operations

The operations step in the analysis estimates fuel or energy consumption by vehicle type from vehicles operating in the region. Fuel and energy consumption factors are applied to the VMT estimates by mode. The regional on-road VMT is separated into passenger, heavy truck, and bus (diesel, hybrid, compressed natural gas) miles to account for differences in fuel consumption levels and emission factors. The analysis also considers energy used for trolley buses, commuter rail, and light rail. This includes electrical use to operate the new system. All fuel and energy consumed is converted to metric tonnes of CO₂e emitted by vehicle type.

An additional step was applied to project-level energy use because the energy provided for light rail includes non-GHG emission energy sources. Electricity would be drawn from Seattle City Light for the portions of the route in Seattle and from Puget Sound Energy for other portions of the project. Both Seattle City Light and Puget Sound Energy rely heavily on hydropower and other nonpetroleum energy generating resources that have low GHG emissions. In fact, Seattle City Light plans to continue to meet a goal of zero net GHG emissions.

In 2006 and 2007, Puget Sound Energy sources ranged between 30% and 40% zero-GHG-emission and the company may soon offer clients the ability to choose their energy sources, thereby offering Sound Transit the option to only use non-GHG-emitting power, such as wind, hydropower, and solar. Therefore, to be conservative, energy use for East Link was reduced by 30% and light rail miles in Seattle were removed from the GHG calculation.

The build scenarios show that there would be a range of 34,310 to 37,960 metric tonnes annual reduction of CO₂e emissions in the region due to the reduction of VMT for automobiles and the use of cleaner energy sources for operating the light rail system. Implementing the East Link project could reduce the Puget Sound region's yearly GHG by almost 0.2%.

According to the EPA web site (9), the regional saving for the high ridership East Link Project estimated as 37,960 metric tonnes of CO₂e per year is the equivalent of the following:

- Electricity for 4,561 homes for 1 year;
- 80,085 barrels of oil per year; and
- Planting 882,993 trees or saving 240 acres of forest from deforestation.

Construction

The cumulative GHG savings with project operation cannot be realized without expended energy during construction. The amount of GHG emissions produced by fossil-fueled construction equipment is directly proportional to the quantity of fuel used. A detailed estimate of fuel use was calculated for each construction process as described below:

1. Determine the quantities of construction material needed by segment for each type of material—concrete, asphalt, and steel. Different types of construction (tunnel, elevated, at-grade, retained cut, retained fill) have differing needs for materials. Typical material needs for each profile were estimated by the cost estimator projections;
2. Estimate the fuel use per amount of construction material. The quantity of fuel used includes the fuel required for construction equipment and transit required to install materials as well as other construction steps; and
3. Estimate hauling of imported and waste material by trucks to and from the project site. The trips required to move the material to and from the site are used to calculate the VMT for each alternative.

The construction methodology does not include life-cycle analysis such as the GHG emissions resulting from the manufacturing of LRVs or cement production.

It was conservatively assumed that all of the fossil fuel used during construction would be diesel. The CO₂e factor for diesel used in the analysis is from The Climate Registry General Reporting Protocol (10). Construction fuel consumption is based on recent experience in building light rail in the Seattle region and provides an order of magnitude estimate of GHG emissions. The estimate includes the following factors:

- Transportation of construction materials, waste, and fill material;
- Equipment used during construction site preparation; and
- Construction of the rail track and guideway, rail stations, associated park-and-ride lots, and a representative maintenance facility.

The fuel used also encompasses the difference in building at-grade, elevated, retained cut and tunnel light rail profiles, specific station design, and parking structures as well as the need for a maintenance facility for the project.

Depending on the alternatives selected, constructing the East Link project would result in 94,893 to 173,197 metric tonnes of CO₂e of the GHG emissions. The construction of one maintenance facility is included in the full project emissions calculation, which alone would be approximately 1,740 tonnes of CO₂e. Reflecting on the GHG savings from operation, it is estimated that it would require less than 5 years of project operation to realize the savings of

GHG emissions in order to make up for the expended GHG emissions during construction.

Cumulative GHG Estimate: Regional GHG Implications of the Larger Transit Improvement Plan

The East Link Project is part of the ST2 Plan, an estimated \$18-billion-dollar transit investment plan. In addition to East Link, this plan would extend an initial light rail system north and south of Seattle and make several other transit improvements throughout the Puget Sound region. East Link alone and as part of the ST2, in conjunction with other reasonably foreseeable future land use development projects, would result in reduced automotive VMT for the Puget Sound region and, therefore, less petroleum consumed in the region.

The ST2 Plan reduction of VMT, compared to the no build scenario, is predicted to reduce overall regional CO₂e by approximately 99,552 metric tonnes annually using current electric power fuel mix assumptions. Under the possible scenario of using noncarbon energy sources, the reduction could be as much as 178,334 metric tonnes—the equivalent of 414,731 barrels of oil a year, 931 railcars of coal a year, or preserving 1,244 acres of forest from deforestation (9).

East Link and other transportation improvement projects in the study area would cumulatively improve travel speeds for automotive travel as compared to the No Build Alternative for 2030, which, according to an Urban Land Institute study, would reduce the GHG emissions compared to automobiles that are idling or moving at slow speeds due to traffic congestion (8).

While all these projects would expend energy to build and develop, the long-term operation is an improvement over low-density growth patterns that use more land area, requiring longer vehicle trips and more energy consumption.

Cumulatively, the ST2 plan may result in greater unquantifiable benefits of reducing GHG emissions in the long term. Light rail projects, under the right conditions, can result in higher concentrations of employment and housing developments than if the project did not exist, especially near stations—given comparable market conditions, land use zoning, and enlightened developer interest. In anticipation of light rail, the cities of Bellevue and Redmond, Washington, have approved land use plans to increase densities at transit stations to 20 dwelling units to the acre and to accommodate millions of square feet of office and commercial building space. This in turn may further reduce GHG emissions. Denser developments generally have lower per-unit energy consumption and, depending on the availability of services nearby, can result in fewer vehicle trips, which in turn results in lower GHG emissions over the equivalent lower-density employment and housing developments.

CONCLUSIONS

The lessons learned from the review of selected cities in Europe suggest that there is potential for United States and Canadian jurisdictions to significantly increase their transit mode shares, and to thereby reduce GHG emissions from the transportation sector.

Different approaches are being taken toward achieving this end. In the United States, the states are legislating GHG reduction targets and adopting policies and programs to improve vehicle technology and fuel content, but are delegating the responsibility for planning and

implementing transportation and land use initiatives to the regional agencies and local jurisdictions and industries. GHG emission reductions are being planned at the local level and analyzed at an individual project level. In Canada, the Province of British Columbia is also legislating targets and addressing vehicle technology and fuels, but it is taking a strategic top-down approach, analyzing all potential policies and their GHG emission implications, and also taking responsibility for guiding transportation and land use planning and transit implementation in the province.

The governmental approaches, whether top-down or bottom-up, are all working to achieve reductions in GHG emissions. The northwest areas of Northern America are learning, planning, and implementing transit and land use combinations to do their part in addressing the global warming situation. Both approaches have their limitations. First, while the Sound Transit model shows a reduction in GHG, this may be attributable more to the unique characteristics of the region than to the installation of light rail. Deciding to switch from single-occupancy vehicles to transit is a multifaceted decision process. Transit can only be effective in reducing GHG emissions if restrictions or disincentives are placed on automobile transport, and if land use development supports transit as an efficient transportation option.

The Seattle, Washington, and Vancouver, British Columbia, regions pose several geographic constraints that make infrastructure expansion difficult. Also, the urban growth centers in the regions have become mixed-use, high-density centers. Under these conditions, a dedicated light rail system offers significant time savings. In many other areas of North America, freeways are still operating at less than capacity and therefore transit becomes a personal preference. Under these scenarios, transit ridership may increase with improvements in the transit system, but this may not reflect a significant reduction in the VMT of automobiles. Transit is only one piece of the puzzle for reducing GHG emissions for a region.

In summary, the northwest parts of the United States and Canada are providing some interesting and innovative strategies to reducing GHG emissions from the transport sector, but much more is necessary to change the overall trend in GHG emissions. GHG emission reductions can be best realized in relatively dense urban centers, where transit provides a viable transportation alternative.

REFERENCES

1. Annual Energy Outlook. U.S. Department of Energy, 2007.
2. Transit in Stockholm. *Lightrail*, 2008. <http://www.lightrail.nl/stockholm/>.
3. Mullins, M. International Transit Studies Program, Excellence in Customer Service in Transit Operations in Small to Medium-Sized Cities in Western Europe. *Transit Cooperative Research Research Result Digest*, No. 64, 2003.
4. International Association of Public Transport. Mobility-in-Cities Database, 2006.
5. National Reviews: Implementing Sustainable Urban Travel Policies. European Conference of Ministers of Transport, Paris, 2003.
6. Harrington-Hughes, K. International Transit Studies Program, Emerging Trends in European Public Transport. *Transit Cooperative Research Research Result Digest*, No. 54, 2002.
7. www.wsdot.wa.gov/Environment/ClimateChange/stewardship.htm. Washington State Department of Transportation, 2008. Accessed November 9, 2008.
8. Growing Cooler: The Evidence on Urban Development and Climate Change. Urban Land Institute, Washington, D.C., October 2007.

9. U.S. Environmental Protection Agency, 2008. www.epa.gov/solar/energy-resources/calculator.html. Accessed August 27, 2008.
10. Climate Registry May 2008. General Reporting Protocol, Version 1.1. www.theclimateregistry.org/downloads/GRP.pdf. Accessed May 30, 2008.

ENERGY, ENVIRONMENT, AND TRANSIT: GREENER--EFFICIENT

Light Rail Transit and Climate Change Policy

ANTHONY LOUI

Federal Transit Administration

HIROYUKI SAKAI

Railway Technical Research Institute, Japan Railways

TIMOTHY N. PAPANDREOU

San Francisco Municipal Transportation Agency

Climate change is a field of science, which deals with the effects of global greenhouse gas (GHG) and other processes in the Earth's atmosphere. Global climate change is defined as the "shift of average weather" and "the variability of temperature, precipitation and wind for a region over a period of time."⁽¹⁾ Typically, GHG absorbs heat radiated from the Earth's surface to create the greenhouse effect. The science is inexact because measurements associated with the Earth's production; movement, and distribution of carbon dioxide are difficult to measure, attracting biased or uncertain results over a long duration of time.

Light rail transit (LRT) is generally perceived as a public transportation mode with many environmental benefits. It is perceived as being quiet, nonpolluting using overhead electric power and is generally flexible, operating in streets or reserved right-of-way. According to the U.S. Environmental Protection Agency, GHG emissions from transportation accounts for 28% of all the GHG emissions in the United States ⁽²⁾. Within surface transportation, these modes emit the following carbon dioxide pounds per passenger mile: private automobiles, 0.96; bus transit, 0.65; LRT, 0.41; commuter rail, 0.35; heavy rail, 0.24 and van pool, 0.22 ⁽³⁾. Moreover, GHG emissions from LRT use account for less than 1% of the total GHG emissions in the U.S. transportation sector ⁽⁴⁾.

Based on the above emissions comparisons made, why would there be concerns regarding LRT use and GHG when this mode has little effect at the national level? Perhaps there are concerns because LRT use may potentially affect local and regional emissions that are also air quality related as well as GHG related. Many LRT projects are typically planned and built to take advantage of the mode's delivery of transit service while emitting zero pollutants such as carbon monoxide, nitrous oxide, and particulate matter compared to the same emissions generated by mobile sources of emissions from motorized vehicles such as automobiles. Energy usage, stationary power sources, grade separations, land use, urban design, traffic near the alignment, and pedestrian and bicycle connections are also contributing factors associated with the design and operations of LRT systems. These factors can either contribute to an LRT line's worsening or betterment of air quality and may ultimately have some effect on climate change. Station area influences and construction effects are also contributing factors affecting air quality. Almost all of these contributing factors are analyzed through trips shifted from automobile use to transit use (mode shift or mode split) and vehicle miles traveled (VMT) when planning LRT projects.

Traditionally, most LRT lines developed in the United States are planned as transit corridor projects using regional models for air quality and transportation systems analysis. This planning methodology is typically used so that the corridor project being analyzed demonstrates its effects on the air quality, land use, and the transportation system of a region as a whole. Less emphasis has been given on project-level planning regarding air quality and energy effects. Current climate change analysis being developed however; is focused on project-level and operational analysis. The results of relying upon regional analysis to plan key elements of LRT projects many times promises poor predicted air quality emissions reductions compared to emissions stemming from actual operations of the LRT line and its effect on its surrounding environment. Using contributing factors mentioned above to plan LRT projects would make a case for more project-level analysis to be done within specific corridors to understand the effects of LRT use next to areas surrounding the guideway and stations. The goal of this type of analysis would be to plan and design LRT projects using methodologies to further improve air quality, reduce the effects of climate change and are compatible within their environments. These factors will be illustrated through case study examples of LRT use in this paper, where both regional analysis and project-level analysis are discussed. Historical LRT use and new LRT innovations supporting this type of analysis will also be touched upon in later sections of the paper.

Within the last 10 years, the scientific and environmental community has expressed concerns that the Earth's temperature has increased more during this time than in other preceding decades due to increased levels of GHGs. Many predict that higher Earth temperatures will be inevitable in the future. Debate still continues in the scientific community, which casts doubts whether GHG is a key contributing factor to such concerns as temperature rise, as global research to that end has produced skeptical results (5). Related to this debate is the growing concern that carbon dioxide accumulation is the result of human activity versus natural processes. Most recent analysis methods now support evidence of GHG accumulation accelerated by human activity, which would affect climate change. Emerging policies are being developed that would contain methodologies organized to reduce GHG accumulation through monitoring systems performance. A brief overview on new methodologies to report GHG emissions through transit performance will be mentioned as part of this paper.

For the purposes of this paper, air emissions in general will be discussed in analyzing LRT use with air quality and climate change studies. Energy usage will also be discussed in conjunction with emissions with the goals of demonstrating different strategies for emissions reductions and improving energy efficiency using LRT.

CASE STUDY EXAMPLES OF LRT USE AND AIR QUALITY ANALYSIS

Two case study LRT projects being planned in the United States are illustrated, using a typical environmental process including air quality analysis for two regional geographic study areas. Federal Clean Air Act regulations and local governing regulations are used. An impact assessment is prepared based on an existing identified inventory of emissions given in a regional study area without the transit project, together with an analysis of the proposed air quality impacts the transit project will have. Current federal air quality regulations do not mandate GHG emissions analysis or assessments for transportation projects, however, one case study has included a local jurisdictional review of GHG as part of the overall environmental process.

These LRT case studies presented are located in California. The study examples include documentation using the following contributing factors:

- Regional analysis level: air quality and VMT, energy usage; and
- Project-level synopsis of air emissions effects: stationary power sources, grade separations, land use and urban design, adjacent traffic interfaces, pedestrian and bicycle connections (multimodal connections), station area influences, construction effects.

The case studies primarily utilize these contributing factors in conjunction with emissions reductions and energy savings to analyze the result of LRT alignment planning. Comparisons on key points between case studies will be made and summarized.

Exposition LRT

The Los Angeles Exposition LRT project Phase 1 (Exposition LRT) is an urban transit line that will run approximately 9.8 mi in length within Los Angeles County, from the existing 7th Street–Metro Center in downtown Los Angeles to Culver Junction Station in Culver City (6). The line, to be operated by Los Angeles County Metro, will run primarily at grade with three grade separations where cross street traffic is the heaviest. Exposition LRT will operate in an at-grade semiexclusive right-of-way within city streets for over 2 mi. The rest of its operations will be on existing and historic exclusive right-of-way built over 100 years ago. Nine new stations will be built in addition to the shared use of two existing stations in the downtown Los Angeles area.

Air Quality and VMT

The LRT project is located in a Los Angeles area that is designated by the California Air Resources Board as a nonattainment area, where ozone (O₃), carbon monoxide (CO), and suspended particulate matter (PM₁₀) had exceeded state and federal standards for the three preceding calendar years. The study area used was the South Coast Air Basin (SCAB), which covers four counties and 6,480 mi². Total VMT without the transit project in the study area was compared against total VMT projected with the transit project. It is assumed that automobiles will operate cleaner in the future, thereby reducing overall emissions in the study area. The greatest sources of emissions in the SCAB are from mobile sources. CO, nitrogen oxides (NO_x), reactive organic gas (ROG), PM₁₀, and fine particulate matter (PM_{2.5}) are reduced from .01% to .05% in emission tons per year due to the Exposition LRT. Total VMT in the study area is reduced by .05%.

The air quality impact analysis for Exposition LRT also states that CO concentrations are typically used as the sole indicator of conformity to local air quality standards. CO levels in this case are directly related to vehicular traffic volume, which is the main source of air pollution in the study area. CO concentrations generally follow the spatial and temporal distributions of vehicular traffic. CO is produced almost entirely from automobiles where the highest concentrations within the study area are associated with heavy traffic. Moreover, the highest CO concentrations outside of the roadway area are typically located along sidewalk areas directly adjacent to congested roadway intersections.

The analysis also indicates that PM₁₀ and PM_{2.5} are the most lethal of gases in the study area. Very small particles of PM_{2.5} can cause damage to the lungs and elsewhere in the human

body when absorbed. Obvious emitters of PM_{10} are dust and fume-producing operations. Manmade sources of PM_{10} and $PM_{2.5}$ include fuel combustion and vehicle travel. Motor vehicle travel is a major source of PM_{10} , where brake dust and tire dust are major emitters. The study assumed that CO, PM_{10} , and $PM_{2.5}$ emissions near the Exposition LRT's guideway and stations would substantially be reduced as auto traffic is reduced when more trips are taken via LRT. Higher spots of emissions would occur near Exposition LRT stations that have parking facilities and transit centers.

Energy Use

The Exposition LRT Project's energy resource analysis indicated that California's overall energy consumption in 2004 would continue to be dominated by growth in passenger vehicles, which would grow faster than the population without Exposition LRT. Although the average vehicle fuel economy had improved, the fuel savings achieved was less noticeable because VMT had increased. Automobiles consume the most energy in terms of British thermal units (Btu) and barrels of oil. Light-heavy rail (urban rail), in contrast, uses the least Btus and barrels of oil of all of the surface transportation modes. Annual transit bus Btu will increase by almost 2% because of more bus feeder service available with Exposition LRT. The Exposition LRT Project will not affect annual commuter rail Btu. Although annual urban rail Btu will increase with Exposition LRT operations compared to other modes, there will be a reduction of automobile Btu because of mode shift. The Exposition LRT Phase I project will consume approximately 25,000 million Btu a year. Overall however, a total reduction of 17,000 million Btu per year of energy would be realized by the implementation of the Exposition LRT Phase I project.

Stationary Power Sources

Exposition LRT will be using energy from existing stationary power plant sources for its operations, where emissions generated by these power plants may contain GHG and other pollutants. These pollutants may cancel out the benefits associated with supplying power to a zero-polluting mobile source, such as traction power used on LRT vehicles. Data is not available at this time to determine this, as Exposition LRT is not operating yet. However, based on the historical data of three other operating Los Angeles County Metro LRT lines, a range of 11,000 metric tons to 18,177 metric tons of emissions has been collected over the span of the first 6 months of 2007 (7). To reduce emissions at stationary power sources, a hot spot analysis could be conducted at these sources to analyze emissions reduction strategies and determine the appropriate mitigation measures for these impacts.

Grade Separations

The location, quantity, and length of grade separations used in Stadtbahn (City Line) or in other words, full LRT operations can be significant along an alignment, with respect to air quality and energy used in train operations. Exposition LRT's 7,900 ft of aerial and undercrossing grade separations will remove LRT operations from vehicular cross traffic, where significant traffic delays at intersections can occur to diminish air quality. These grade separations will maintain air quality levels consistent with growth factors.

Land Use, Urban Design, and Adjacent Traffic Interfaces

The land uses located along the Exposition LRT alignment range from high to low housing and office densities, mixed-uses, entertainment and retail uses, and institutional uses. No new building projects outside of the Exposition LRT project are being planned or built close to the alignment that will be high-pollution emitters.

The design of Exposition LRT's guideway on historic exclusive right-of-way will have extensive landscaping, bicycle, and pedestrian improvements. This design is also known as the Exposition Transit Parkway. To achieve the Parkway concept, which includes a double track way, landscaping on both sides of the track way, and bicycle lanes on parallel streets that are adjacent to the right-of-way, two vehicular traffic lanes are removed to increase right-of-way width. These existing parallel streets already have low volume before lanes are removed. These streets are also discontinuous compared to the rail right-of-way. Existing traffic moving parallel to the right-of-way are already using other streets such that there is low traffic volume next to the LRT alignment and therefore result in lower vehicular emissions. The Parkway's design also takes advantage of using street trees located across the right-of-way and median landscaping not only as visual screening but also helps to curtail vehicular pollutants near the guideway.

Multimodal Connections

There will be two transit centers and three parking facilities provided at three Exposition LRT stations, which will provide connections to automobile access and bus transfers thereby increasing mode choice, while reducing VMT and emissions. Bicycle parking at stations and a bikeway will be included as part of the Exposition LRT project, which will also increase mode split to transit and nonmotorized transportation thereby lowering emissions. A Clean Mobility Center, which is a facility to house bicycle and car sharing will be located at the western terminus of the Phase I line in Culver City to enhance a greater mode share for customers traveling to and from this station.

Central Subway

The Central Subway—Third Street Light Rail Phase 2 (Central Subway) is an urban LRT line that will run approximately 1.7 mi in length within the city of San Francisco, from an existing terminal of the current T Third line at Fourth and King Street in Mission Bay to a new station located in Chinatown (8). The line, to be operated by the San Francisco Municipal Railway (MUNI), will run at-grade from Fourth and King Street Station to a portal under Interstate 80 (I-80). The line will then operate in a tunnel to the northern terminus at Chinatown Station. The at-grade segment of the alignment will be designed in a semi-exclusive right-of-way within city streets or in mixed traffic for approximately 700 ft. The tunnel segment from portal to Chinatown station is approximately 1 mi. There will be four new stations built, with one at-grade station and three underground stations in the tunnel segment.

Air Quality and VMT

The LRT project is located in the San Francisco area that is designated by the California Air Resources Board as a nonattainment area, where ozone had exceeded state and federal standards. The same analysis also indicated that PM₁₀ had been recognized by the state legislature as basically intractable and was excluded from basic planning requirements. The study area used was the San Francisco Bay Area Air Basin, which covers nine counties and approximately 5,560 mi². Total VMT without the transit project in the study area was compared against VMT projected with the transit project. It is assumed that future automobiles will operate cleaner in the future, thereby reducing overall emissions in the study area. The Central Subway project would reduce total daily VMT by 1,730. NO_x, ROG, and PM₁₀ are reduced from one to two emission pounds per day due to the Central Subway project. The LRT project would reduce CO by 19 lbs a day.

A GHG impact analysis was also performed for the Central Subway project. The project's environmental document states that an individual project does not generate enough GHG emissions to substantially influence climate change and that climate change is a cumulative impact. Moreover, the analysis also indicates that CO₂ emissions are expected to increase in the future as VMT increases and that although automobiles will operate cleaner in the future, the improvement is not enough to offset the VMT increase. The impact analysis also assumes that since more than 80% of the total amount of GHG is CO₂. Change to CO₂ emissions is an indicator of impacts from all GHG.

Energy Use

The Central Subway project would consume 3,996 million Btu per year. However, the project will also reduce consumption of fossil fuels for passenger vehicles by 3,345 million Btu per year. A reduction of fossil fuels will also be realized for diesel buses by 1,231 million Btu per year and a reduction of electric consumption by electric bus will be realized by 469 million Btu per year. A total reduction of 1,049 million Btu per year of energy would be realized by the implementation of the Central Subway project.

Stationary Power Sources

The Central Subway's utility and energy analysis identified electrical power used to supply MUNI's existing electric powered fleet of transit vehicles. The analysis indicated that power supply is generated from the San Francisco Public Utilities Commission Hetch Hetchy hydroelectric facility. No emissions calculations were made based on this analysis.

Grade Separations

Central Subway includes a protected guideway in a tunnel that runs for almost 75% of its alignment, alleviating the LRT line from operating with vehicular traffic, removing intersection delay while maintaining air quality levels consistent with growth factors.

Land Use, Urban Design, and Adjacent Traffic Interfaces

The land uses surrounding the alignment of the Central Subway project gradually change from mixed-use neighborhood commercial and medium-density housing north and south of Market Street to high-density office uses along Market Street. The air quality impact analysis also includes a study on sensitive receptors, which noted that CO concentrations are typically used as the sole indicator of conformity to local air quality standards. Air pollutants that have the greatest impact next to the Central Subway project would be CO and PM, where the highest concentrations of these pollutants outside of the roadway area are typically located along sidewalk areas, boarding platforms, and areas directly adjacent to congested roadway intersections along the at-grade alignment. Existing land uses adjacent to the LRT project would be subject to the longest lasting impacts where habitation occurs over an extended time, not because of the LRT project, but because of poor ambient air quality surrounding the LRT project in concert with land use locations with sensitive receptors.

The Central Subway project has performed a local CO analysis. In this case, traffic studies were performed along the alignment, regardless of LRT grade separations, to determine CO emissions levels at intersections. Factors considered in the analysis were receptor locations, roadway geometry, average vehicular delay, percent of vehicles in cold start mode, percent of heavy-duty gas trucks, and background CO concentrations. The LRT project's at-grade alignment includes options for a semi-exclusive guideway operation to optimize train speeds at street running segments. The other option to use LRT operations in mixed traffic optimizes existing street width for median landscaping and additional street parking. The analysis found that the project's LRT operations at-grade, either in mixed traffic or in semi-exclusive guideway would increase the average delay at nine to 11 roadway intersections, assuming current growth in traffic volume. This delay would potentially worsen air quality at these intersections.

Multimodal Connections

The Central Subway project identified a number of pedestrian-oriented streets within the project's study area, which will connect pedestrians from these streets to the project's stations. A pedestrian level of service study was also conducted at these streets to ensure that existing sidewalks were adequate to handle pedestrian circulation as the result of implementing the Central Subway project. The study also identified possible sidewalk extensions near Chinatown station to improve pedestrian flow. A separate bicycle study was also prepared for this project. While no new bikeway facilities are planned for the Central Subway project, the study indicated that existing bikeways located in the study area would not be negatively impacted by the LRT alignment. Extensive bikeway connections at 4th and King Street Station would be made, in addition to a connection to Bay Trail, which is a continuous bicycle and pedestrian trail connecting downtown to San Francisco Bay's waterfront. While none of the pedestrian or bicycle studies analyzed the connection between nonmotorized transportation use and mode split in order to reduce emissions due to the Central Subway project, these studies indicate that most nonmotorized access to stations would be adequate to encourage ridership growth on the LRT project, while anticipating that emissions reductions would occur.

Comparisons Between LRT Case Studies

Table 1 compares some key points of the case studies.

TABLE 1 Summary of LRT Case Studies

Case Study Example	Exposition LRT	Central Subway
Alignment length	9.8 mi	1.7 mi
Number of stations	9 new, 2 existing	4 new, one existing
Air quality, energy usage, VMT		
Area of regional air shed	6,480 mi ²	5,560 mi ²
Total annual regional emissions reduced	.01% to .05% emissions tons per year	Up to .02% emissions tons per year
Total annual energy reduction (in millions)	17,000 Btu	1,049 Btu
Total daily regional VMT reduction (annual percent)	1,133 (.05%)	1,730 (approximately .02%)
GHG analysis prepared	No	Yes
Advantages to Emissions Reductions		
Grade separations	10% of the entire alignment where cross traffic is heaviest.	75% of entire alignment under medium to high-density urban core with high traffic volume.
Multimodal connections/station area influences	Bikeway being built as part of the LRT project, with bicycle facilities located at most stations; transit centers provided for bus feeder transfers; strategies to define station areas to assess existing and future conditions.	Study determined that no impacts to pedestrian and bicycle circulation or capacity will be made; bikeway and Bay Trail connections at 4th and King Street Terminal.
Trade-Off Comparisons Between Projects		
Stationary power sources	Emissions generated from conventional electrical power plants to provide traction power.	No emissions generated from hydroelectric power plant to provide traction power
Land use, urban design, adjacent traffic interfaces	Segment of existing right-of-way located next to low volume adjacent streets compatible with at-grade LRT operations; low traffic volume not subject to delay or increase in emissions; lower PM ₁₀ and CO levels along alignment at sidewalks next to right-of-way due to implementation of LRT, removal of traffic lanes and implementation of Exposition Transit Parkway design.	Traffic adjacent to at-grade segment subject to delay at intersections with growth in traffic volume; potential increase in emissions to occur; at-grade station platforms and sidewalk areas near intersections subject to delay may receive more CO and PM ₁₀ emissions.
Station area influences	Three station areas that have transit centers and parking areas are subject to emissions hot spots.	Bikeway connections not apparent at Chinatown Station, Moscone Station, Market Street Station to encourage nonmotorized transfers.

Air Quality, Energy Use, and VMT

Regional Air Shed Analysis Produces Minimal Results

Air quality analysis using VMT and mode split data to determine regional benefits to air quality and energy for Exposition LRT and Central Subway produces minimal results. This type of analysis uses project specific data applied to the regional transportation system model and typically a very large air shed resulting in little change or benefit of the air shed as a result of LRT implementation. Also, the regional travel demand model may not be calibrated to address changes in transit availability. The results of this type of analysis may vary in results and may not be comparable from one region to another (8).

Conformity Challenges

Air quality conformity and projections to meet GHG targets may become issues in themselves when costs to develop fixed guideway projects do not yield major regional benefits. An earlier study of LRT implementation in several other U.S. cities reported similar results (9). The Central Subway and Exposition LRT's project cost in comparison to maintaining conformity is in line with this earlier study's findings if only project cost and conformity are being considered.

Station Area Influences

The areas around an LRT station, also known as station influence areas, contains the potential to include the most transfer connections from the LRT line to other transportation modes and land uses. These connections affect ridership and emissions at the project and regional levels. Both the Central Subway and Exposition LRT projects studied station area influences in terms of compatibility with existing general and community plans. The Central Subway project focused its impact analysis at entrance locations and linkages to surrounding uses. The Exposition LRT project included a method to study station area influences in terms of surrounding station area radii and their walk distances to potential transit-oriented uses from the center point of the station platform. This provided a vision for station planning concepts that would foster a transit oriented district (TOD) policy to study existing conditions and impacts as well as future growth scenarios after the LRT project is opened. The overall goals of these concepts would be to encourage mode split and reduce VMT so that emissions are reduced at the local level.

Construction Impacts

Emissions from construction impacts in LRT projects should be accounted for on a project-level analysis. The state of California for example, has procedures to assess these impacts under the California Environmental Quality Act for the case study projects listed above. Cumulative and long-lasting impacts as the result of station and guideway construction may play a larger role in determining GHG impacts, as GHG emissions tend to remain in the atmosphere for a long duration of time. In both case study examples listed above, the major construction impacts these projects will have are the following: (a) Exposition LRT will have moderate emissions due to excavation, construction of aerial and undercrossing structures, parking facilities, adjacent roadway improvements, at-grade guideway, station construction, traction power station

construction; and (b) Central Subway will have emissions due to excavation of the guideway and stations. The project will also have surface daylight areas above tunnel alignments and station areas, which will be a major source of emissions near sensitive receptors when spoils and debris due to tunnel construction are exposed. Both projects have provided mitigations for these impacts.

HISTORICAL USES AND NEW INNOVATIONS

One historical LRT line and two streetcar projects are noted as potential innovators for improving air quality based on a brief review of their operations. They are the following.

Legacy Example of LRT Use: Hiroden

Japan historically kept a few LRT systems that were in operation long before automobiles become popular in the 1960s (10). One system that is still operating today is located in the city of Hiroshima. Hiroshima has a commercially owned electric railroad company called Hiroden, which has been operating LRT continuously for more than 100 years without public subsidy, with the exception of being out of service for 2 days after the atomic bomb attack in 1945. In the 1960s, however, Hiroden came to be perceived as a disruption as Hiroshima's auto use increased. Its LRT cars were unwelcome, occupying two lanes on streets with mixed-use traffic. A brave city decision to commit and continually support LRT in Hiroshima at that time has led to the development of highly organized transportation services within the city. Hiroden negotiated with a local commission in Hiroshima to do something unheard of at that time, which was to expel autos from existing rail tracks on roads where both LRT and autos operate in mixed traffic. The commission then developed regulations to allow LRT to operate with priority in converted semi-exclusive lanes within city streets, while letting customers cross tracks at intersections to board or alight LRT cars. This strategy enabled LRT cars to run faster and on time without disturbance to autos even when the auto traffic was congested on the same road. At the time this plan was implemented, very few transportation services in Japan were able to implement this type of service citywide. Hiroshima was able to retain a higher mode split back to transit, as Hiroden services were immediately popular. This type of LRT implementation occurred 40 years ago, when few people were concerned about reducing carbon dioxide emissions and other pollutants. Today, Hiroden is still operating with newer, faster LRT cars with quicker acceleration, better ride quality, and low-floor boarding. Hiroden now boards 107,000 customers daily on its 19-km route system. In the case of Hiroden, an analysis of 20 years of emissions data from Hiroden operations was attempted to understand CO effects against localized impacts of climate change. To this date, ongoing historical air quality analysis is still being done and no data is yet available.

LRT Project Innovations: Portland Downtown Streetcar, Vision 42

The Portland Downtown Streetcar in Portland, Oregon is a streetcar line primarily providing transit service from new mixed-use development north of downtown Portland through downtown and then to Portland State University and hospitals (11). The streetcar line runs along downtown streets with low traffic volume and in mixed traffic with very frequent stops along the streetcar

line. Many customers travel on the streetcar for trips within downtown. The line essentially provides a secondary transit mall type service where many customer trips occur within the Fareless Square or fare free zone of downtown. The success of the streetcar is dependent on its ability to operate with more frequent stops on a low volume street. Connectivity with many adjacent land uses within walking distance to the line seems to be the goal of this service rather than travel time savings. In essence, this streetcar line is performing a role as a horizontal elevator, where many pedestrians will board and ride the streetcar for one or more city blocks to complete their walking trip. If an air quality analysis of this line is prepared, emissions reductions based on this streetcar's unique operations capabilities should be demonstrated.

Vision 42, an Auto-Free Light Rail Boulevard for 42nd Street, is an urban design improvement project located in Manhattan, primarily along 42nd Street in New York City (12). The project consists of developing a pedestrian boulevard along 42nd Street, with wide sidewalks, street trees, pedestrian lighting, sidewalk cafes, and other pedestrian amenities to connect two ferry terminals along the east and west ends of this boulevard. A new LRT line will be included, where the alignment will be median running along a car-free 42nd Street. To implement the LRT line, existing traffic lanes with very low volume will be removed. Existing traffic surrounding the pedestrian boulevard and LRT alignment would be reconfigured. A specific air quality analysis for these types of projects, where the LRT line is part of a whole menu of streetscape urban design improvements, can be done on a true "building line to building line" analysis in a dense urban area, where all elements of the design improvement project can be evaluated between building street wall faces, including pedestrian level of service and LRT service in order to determine emissions reductions and energy savings.

Policy Innovations: GHG Analysis Methods for Transit

New GHG methodologies are now being developed to normalize GHG emissions in global climate change reporting mechanisms. A framework of methodologies and guidelines to calculate GHG emissions for transit will be available through organizations such as the APTA (13). The framework will include the analysis of emissions produced and displaced by transit operations. Standard methods of reporting GHG emissions compatible to policies such as Kyoto Protocol will be developed. Methodologies for using modeled data or actual data as part of the reporting are also being developed. Land use factors and mode split calculations based on national best practices will also be included in these methodologies and guidelines. A framework is being developed as a standard reporting mechanism focused towards the performance of transit systems operations and long duration of climate change effects due to emissions generation.

EFFECTS ON PUBLIC POLICY

Based on some of the LRT examples above, the following observations can be summarized:

- Careful attention given to LRT guideway design and traffic studies was demonstrated in the case study examples analyzing emissions and energy use for both air quality impacts and GHG effects. Measurements in traffic volume and delay as the result of these studies at the project level are one of the most effective tools to determine if a proposed LRT project will

actually reduce or increase air quality and GHG impacts. Low-traffic-volume streets were either proposed or implemented in some case study examples illustrated. Careful design and planning are needed to determine if these streets used in conjunction with LRT implementation are not causing additional traffic volume, delay, and emissions impacts on other streets adjacent to the guideway or crossings occurring at alignment intervals;

- Most projects have used methodologies and techniques to forecast the “transit-friendliness” of a station area in terms of station area policies, development potential, type, and density of mixed uses, transit ridership projections, walkability, and multimodal connections (14). Many of these methodologies and techniques were used in order to study VMT reductions, mode split and emissions reductions within station areas, corridor alignments, as well as local and regional plans and policies. Others have used these techniques to develop TOD vision concepts for stations in concert with fixed-guideway transit planning. Similar studies indicate that in general, the implementation of a fixed guideway transit project in conjunction with planning prepared for transit-friendly station areas have some effect in emissions and energy reductions. These reductions may occur in localized areas if the following are done: a) There is evidence of planned and actual reduction of energy consumption, higher station access, and higher mode splits in a TOD–station area; and b) Steps are taken to reduce emissions during building construction of the station and the surrounding TOD;

- Emissions from stationary power sources used to power LRT operations can be quite high, depending on the type of power plant. Reducing energy usage and emissions due to production of traction power is critical to the operating efficiency of this transit mode. Studies have shown that employing risk-reducing strategies for carbon reduction can mitigate long duration of GHG (14). This means that strategies should be tied to the implementation of energy-efficient technologies in the transportation sector where surface transportation generates the majority of GHG emissions. Curbing power plant emissions and developing clean traction power are potential initiatives for the LRT industry, which can also be used to reduce fossil fuel power generation. More innovative measures such as creating in-vehicle or wayside energy for traction power should also be explored to reduce dependency on all power generated from a polluting power plant source;

- There seems to be confusion in priorities regarding the benefits of LRT use, air quality effects and GHG effects. Air quality effects are immediate and affect human health, whereas GHG effects are long-term effects that change global climate. Many GHG studies recommend that reduction of GHG emissions is more important than the reduction of other pollutants. Some recommendations note that most GHG emissions are CO₂ and that a reduction of CO₂ would result in a reduction of GHG emissions as a whole (8). CO₂ however, is a proposed pollutant, whereas other gases within GHG are pollutants. In fact, according to the Kyoto Protocol, there are other gases within GHG, which have more global warming potential even though their quantities may be smaller within an aggregate GHG study (15). CO₂ poses the most concerns because of the amount of accumulation and even dispersal in the atmosphere, and long-lasting duration of its existence that was originally generated over 150 years ago during the Industrial Revolution (4). Future strategies to reduce CO₂ accumulation during LRT operations may involve reporting the amount of GHG expended to manufacture a light rail vehicle and reporting long lasting GHG accumulation due to construction and the use of materials of the LRT guideway and stations (12);

- Traditional air quality analysis prepared for LRT projects as shown in the above case studies have resulted in minimal projected emissions reductions using a regional transportation

planning model when planning corridor specific projects. Air quality emissions data however, could also be measured at the same project level as the corridor project being planned. For example, pounds per track mile can be used to describe LRT emissions extracted from a regional model. However, if this scale of analysis were being considered, the regional transportation model would need to be disaggregated from the regional level to the corridor project level in order to provide a fair study. The likelihood of disaggregating models for every planned LRT project would be extremely expensive and time consuming. On the other hand, emissions per track mile data from actual operations in conjunction with energy usage are available. This data can be developed in conjunction with data from point source power plant emissions, in order to study the environmental effects of LRT use; and

- Performance level data used from actual LRT operations to measure GHG and other pollutants will provide more reliable emissions information as compared to analyzing air quality and pollutants using traditional modeling methods during the planning stages of the project.

CONCLUSIONS

Compared to other transportation modes, LRT use has minimal impact on climate change. Recent studies have shown that even when vehicle manufacture, project construction, and maintenance are considered, LRT use will still produce half of the emissions compared to automobile use. However, there should not be confusion between LRT use, GHG, and air quality impacts. While air emissions affects climate change and air quality, the most benefits and impacts air emissions and LRT use will have is upon air quality. Lethal air pollutants still come from other vehicle sources of emissions such as CO, NO_x, ROG, and PM₁₀ near an at-grade LRT alignment. These emissions in the near term can result in poor air quality immediately surrounding an LRT line affecting human health. GHG impacts due to LRT use however, come from many other sources and are more related to regional and even global climate where the effects are cumulative over a long period of time.

Overall, the most effective actions to mitigate both human health and climate change impacts when planning LRT are to target VMT reduction, improve energy efficiency, and target higher mode split goals through the use of LRT in combination with other transit, carsharing—carpooling and other nonmotorized modes. These modes should be connected with compact, walkable development to further reduce emissions. The contributing factors described in this paper are analysis tools used in best practices to further reduce emissions surrounding the LRT project's immediate environment, while allowing at the same time to compare these effects the LRT project will have on a region the project is located in.

Steps can be taken to analyze both air quality health impacts and GHG effects in a manner that can compare planned to actual data providing reconciliation between disappointing emissions results from a regional model versus significant results in LRT corridor operations. Before and after studies and other simplified means of analyzing regional air quality and GHG data compared against actual project-level data from operations should be investigated. Before and after studies can provide more economical and less time intensive approaches to study LRT performance without utilizing complex and expensive models. These studies can also supplement current air quality and GHG study methods already in place. Human health effects from a traditional air quality analysis should also be studied separately from GHG and climate change

studies for the same LRT project under consideration. This should be done to avoid confusion of priorities when mitigation measures for both GHG and air quality impacts are being considered.

In conclusion, mitigation from air quality impacts affecting human health is still a national concern. At the same time, mitigation for potential long-term global climate change effects will somehow need to be addressed with immediacy. To create efficiencies when planning future LRT corridors and networks, mitigations addressing both air quality and climate change impacts, while immediately placing priority on near term impacts due to air emissions should be a transportation and health priority.

The opinions and findings of this paper are those of the authors and do not necessarily represent those of the FTA or the U.S. Department of Transportation.

REFERENCES

1. *Article 2. The United Nations Framework Convention on Climate Change*. Kyoto Protocol. http://en.wikipedia.org/wiki/Kyoto_Protocol. Accessed October 30, 2008.
2. *Greenhouse Gas Emissions from the U.S. Transportation Sector, 1990–2003*. Office of Transportation and Air Quality, U.S. Environmental Protection Agency, March 2006.
3. *Public Transportation's Role in Responding to Climate Change*. Office of Budget and Policy, Federal Transit Administration, U.S. Department of Transportation. <http://www.fta.dot.gov/sustainability>. Accessed January 2009.
4. Pachauri, R. K., and A. Reisinger. *Summary for Policymakers, Climate Change 2007 Synthesis Report*. Intergovernmental Panel on Climate Change, 2008.
5. Everett, J. The Global Warming Debate-The Facts. *Global Climate Change Facts: The Truth, The Consensus, and the Skeptics*, June 2008. www.climatechangefacts.info. Accessed October 19, 2008.
6. *Los Angeles Mid-City Westside Transit Corridor, Mid-City Exposition Light Rail Transit Project, Final Environmental Impact Statement/Environmental Impact Report*. Federal Transit Administration, Vol. 1, 2005.
7. Papandreou, T. *Metro Sustainability Implementation Plan*. Los Angeles County Metropolitan Transportation Authority, June 2008.
8. *Central Subway Final Supplemental Environmental Impact Statement/Supplemental Environmental Impact Report*. Federal Transit Administration, Vol. I, 2008.
9. Howitt, A., and E. Moore. Chapter 5: Conformity Effects on Transportation and Air Quality Plans. *Linking Transportation and Air Quality Planning: Implementation of the Transportation Conformity Regulations in 15 Nonattainment Areas*. Taubman Center for State and Local Government, John F. Kennedy School of Government, Harvard University, March 1999, pp. 77–78, 81–84.
10. Sakai, H. *LRT's Advantages to Reduce Air Pollution Including Carbon Dioxide Emission from Motor Vehicles by Inviting Commutation Passengers There from*. Railway Technical Research Institute, Japan Railways, Tokyo, Japan, October 2008.
11. Loui, A. Transportation Research Board Rail Caucus. Portland Downtown Streetcar, Portland, Oregon, October 2007.
12. *Vision 42, Auto-Free Light Rail Boulevard*. Institute for Rational Urban Mobility Inc., www.vision42.org. Accessed January 2009.
13. Recommended Practice for Quantifying Greenhouse Gas Emissions from Transit. American Public Transportation Association Working Group, 2008.
14. Feigon, S., D. Hoyt, L. McNally, and R. Mooney-Bullock with S. Campbell and D. Leach. Travel Matters: Mitigating Climate Change with Sustainable Surface Transportation. In *Transit Cooperative*

Research Program Report 93, Transportation Research Board of the National Academies, Washington D.C., 2003.

15. The Climate Registry, General Reporting Protocol, Version 1.0 Los Angeles. The Climate Registry. 2008.

Traffic Engineering Issues
LRT Performance

TRAFFIC ENGINEERING ISSUES: LRT PERFORMANCE

Newark Light Rail Extension to Broad Street Station

Traffic and Transit Operations Interface Issues

THOMAS A. GAWLEY
ROBERT C. CONTE
Parsons Brinckerhoff

The Newark (New Jersey) City Subway was constructed over a multiyear period starting in the early 1930s. The original line, from Military Park (formerly Broad Street Station) to Heller Parkway on the western edge of Branch Brook Park, opened in 1935. By 1940 the line had been extended northward to the Branch Brook Park Station (formerly Franklin Avenue) and eastward to the new Newark Penn Station. During the 1940s and 1950s, the subway served as a spine for a number of streetcar lines that branched from the subway at principal radial streets (e.g., Main Street via ramps at Warren Street, Central Avenue, Orange Street, and Bloomfield Avenue). By the mid 1950s service on the street car routes was converted to bus, leaving the original spine served by second-hand, single-ended PCC cars.

The line operated continuously as the No. 7 Public Service Transit route until acquired by New Jersey TRANSIT (NJT) in 1980. In 2002 service was extended west from the Branch Brook Park station through the Silver Lake section of Belleville to a new end-of-line station (and new shop and yard) at Grove Street in Bloomfield Township. The resultant 5-mi line was then outfitted with articulated, double-ended, low-floor light rail vehicles (LRVs) of the type purchased for the contemporaneous Hudson–Bergen Light Rail Transit System. Upon completion of the extension, two service routes were operated: Penn Station to Branch Brook Park and Penn Station to Grove Street. Today, most trains operate over the entire line, although some trains terminate at Branch Brook Park. Service during peak periods operates on headways of 3 to 4 min.

Even while planning and design for the Grove Street Extension was underway, NJT was setting the stage for a new 1-mi segment of the city subway, this time an extension to connect Newark's two commuter rail stations: Newark Penn Station serving Amtrak and NJT's Northeast Corridor, North Jersey Coast Line, and Raritan Valley Line and Newark Broad Street Station serving NJT's Morris and Essex lines. These stations are approximately 1 mi apart. From the earliest planning stages, this new transit link was conceived as a branch of the pre-existing Newark City Subway, with an established easterly terminus located in the lower level of Newark Penn Station. The current city subway is illustrated in [Figure 1](#).

THE BROAD STREET EXTENSION: OVERVIEW

Proceeding from the platforms at Newark Penn Station, the Broad Street Extension uses the tracks of the original city subway tunnel, situated beneath Raymond Boulevard which had been the route of the historic Morris Canal ([Figure 2](#)). Several hundred feet west of the station is a subsurface flyover junction with a branch line to the Public Service Trolley Terminal.

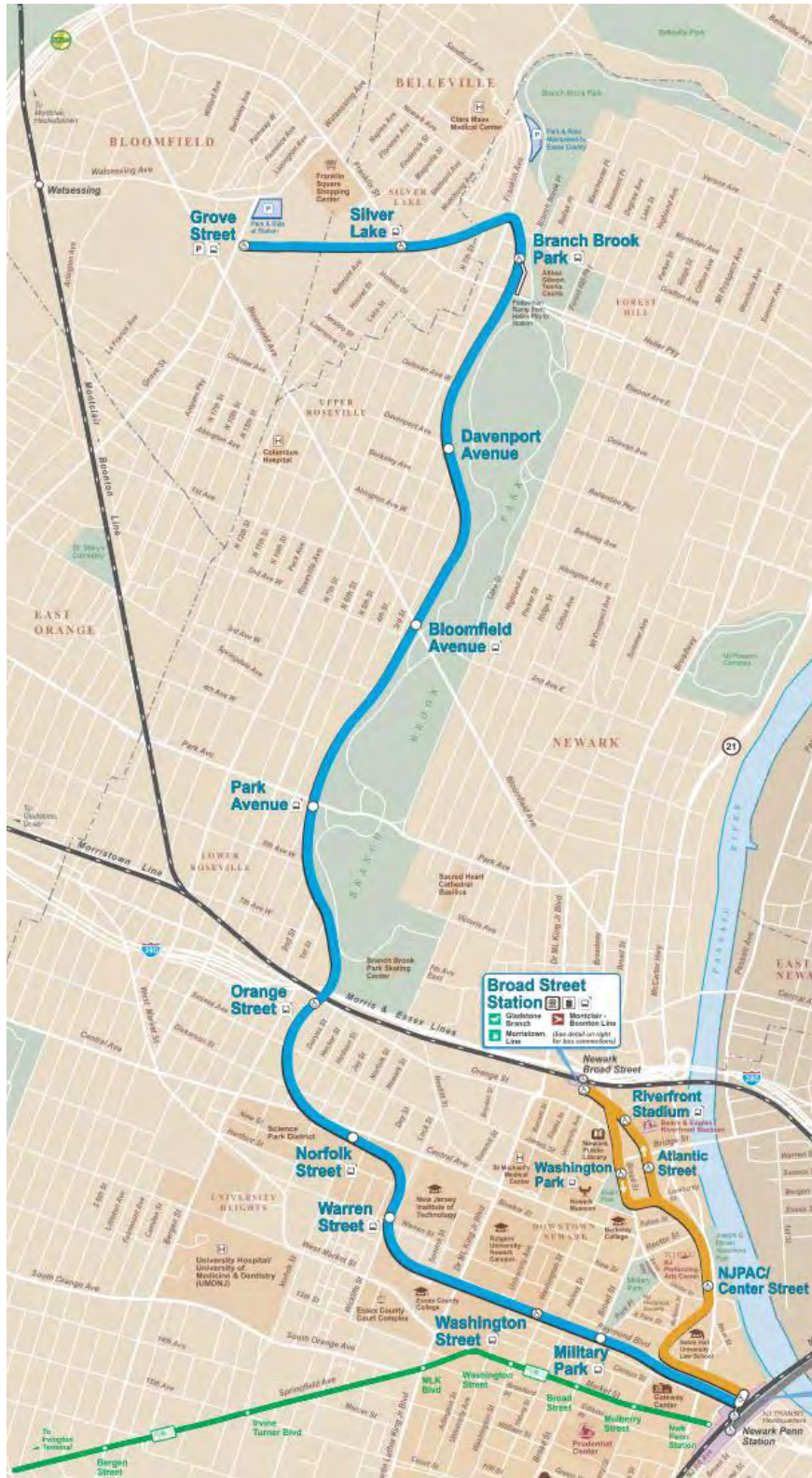

FIGURE 1 Newark City Subway map.

This terminal, long since demolished, was served in the early 1940s by several street car routes, including the 43 Jersey City that operated through the terminal located north of Raymond Boulevard and the now-abandoned Cedar Street Subway. The existence of this junction was a key factor in the constructability of the Broad Street Extension. Without it, service on the pre-existing city subway routes to Branch Brook Park and Grove Street would have been severely impacted, likely requiring the substitution of bus service on city streets in lieu of light rail for an extended construction period.

The extension project did require construction of a new tunnel that connects to the original branch tunnel described above. Shown in Figure 2, the new tunnel runs beneath (new) Mulberry Street, and then beneath and in the right-of-way of an abandoned segment of old Mulberry Street, Mulberry Street having been realigned by the city of Newark as part of the project to construct the New Jersey Performing Arts Center (NJPAC) in the 1990s. The tracks of the Broad Street Extension then ascend to grade to emerge from a portal located in the southwest quadrant of the intersection of McCarter Highway (NJ Route 21) and Center Street.

Immediately north of Center Street is a side platform station serving NJPAC to the west and a new waterfront park and FBI building to the east, across McCarter Highway. Because of the proximity of the NJPAC, the station and track were constructed on a special, “floating” slab as a vibration-reduction measure. Continuing north, the alignment parallels a recently widened and realigned (*I*) segment of McCarter Highway, traverses a signalized NJPAC service driveway and a signalized crossing of Rector Street. North of Rector Street, the tracks are situated between the highway and a new street created to connect Rector and Fulton Streets, then continue diagonally across a vacant lot (formerly an on-grade parking lot) to reach Lombardy Street. A “scissors” crossover was provided in this segment to permit reverse running should the need arise in the future. (A scissors crossover is a group of four turnouts and a diamond crossing that allows trains to be routed from one track to the other of a two-track system, irrespective of the direction of travel. The Newark City Subway normally operates with right-hand running. However, it is sometimes necessary to “reverse run” on the opposite track.)

At Lombardy Street the two-track system divides, with the northbound track proceeding across Lombardy Street to reach a transitway on the east side of Atlantic Street. North of Lombardy Street, the nominal northbound track is separated from southbound Atlantic Street by a nonmountable curb until its intersection with a driveway to—from a multilevel parking structure and a crosswalk serving the garage and the Atlantic Street Station. The station is located on a raised sidewalk, immediately beyond this crosswalk.

Proceeding north from the Atlantic Street Station, the trackway continues to a signalized crossing of Bridge Street, an important connection between McCarter Highway and Broad Street. Beyond Bridge Street to the Ball Park Station, the trackway is east of, and separated from, a new, one-way northbound extension of Atlantic Street that serves primarily as a “jug handle” to accommodate traffic that previously made left turns from northbound Broad Street to westbound Orange Street. (Such left-turn movements were prohibited as part of the Extension project design to reduce the number of conflicting movements at the Broad Street–Orange Street intersection. To accommodate such turns, the project created the Atlantic Street Extension.)

Immediately north of the Ball Park Station is a crosswalk that serves as an important pedestrian route to—from Bears and Eagles Stadium. Typical of the other pedestrian-only crossings on the Broad Street Extension, this crosswalk “rests-in-walk” until interrupted by an approaching train. Continuing towards the Broad Street Station, the alignment cuts diagonally across the intersection of Broad Street with Division Street–Lackawanna Avenue, passes through

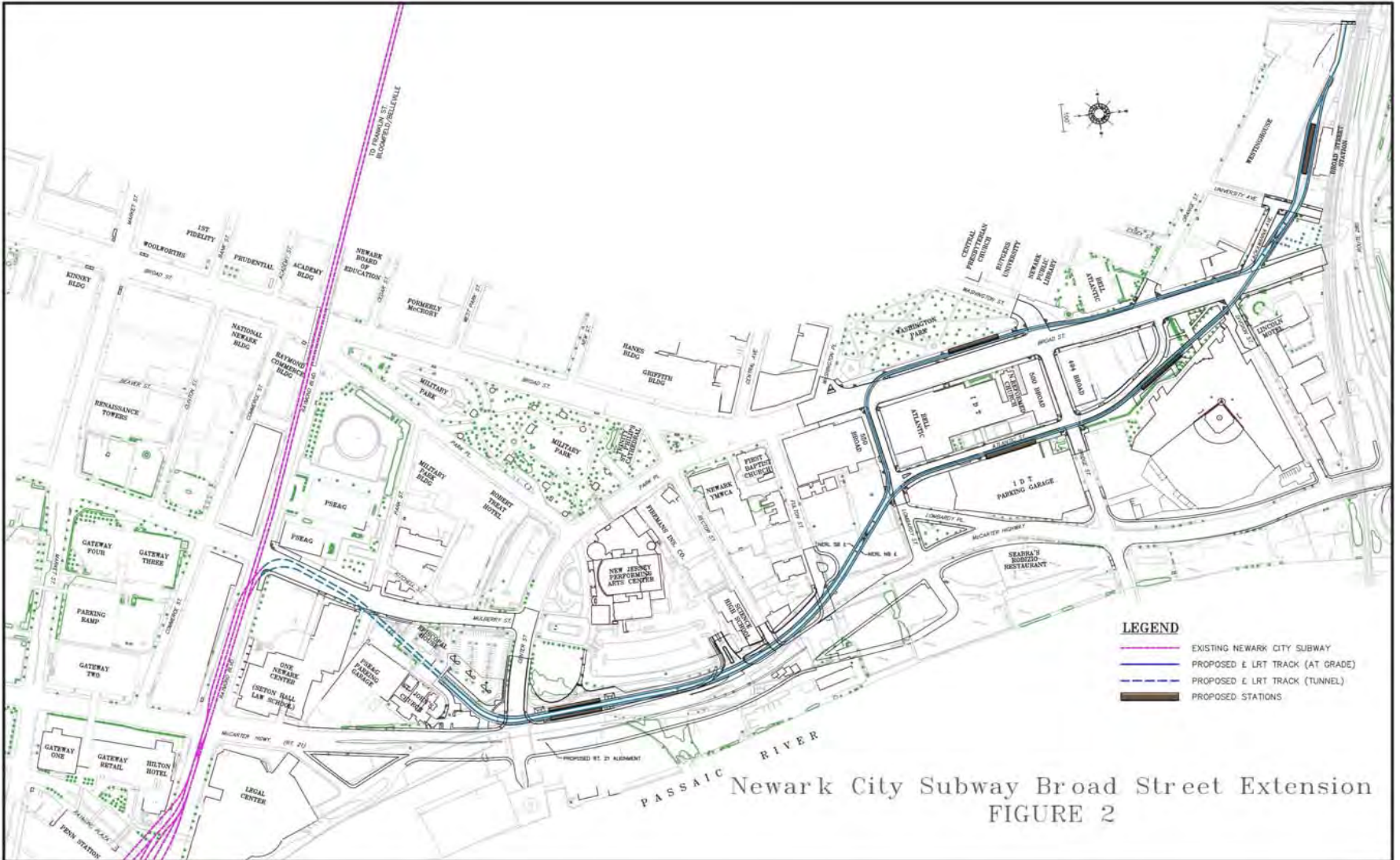

FIGURE 2 Newark City Subway Broad Street Extension.

another scissors crossover, and finally crosses University Avenue to reach the northern terminus of the Extension at the Broad Street Station. The traffic and train control issues in this segment are relatively complex, and are addressed in greater detail later in this paper.

The alignment of the southbound track leaving the Broad Street Station is the reverse of the route described above from the Station to Broad Street. There, the southbound route turns right and runs in a single track transitway along the western curb of Broad Street (2). The trackway continues between the west curb of southbound Broad Street and the western sidewalk through the signalized intersection of Orange Street, where southbound right turns and northbound left turns are prohibited, allowing the LRT to proceed concurrent with north–south Broad Street traffic flow. Continuing in the curb transitway, the tracks cross the signalized intersection with Washington Street (one way, eastbound) before entering the Washington Park Station.

South of this station, the trackway remains in the curb transitway until the intersection of Broad Street with Lombardy Street, where the alignment curves 90 degrees to the left as the tracks cross Broad Street to reach a similar transitway along the south side of Lombardy Street, and eventually connect with the two-track segment at Atlantic Street.

TRAFFIC–LRT INTERFACE CONTROL ISSUES

The type, or mode, of interface control strategy employed on the project varied to suite the needs and issues, depending on location. At locations where progression of traffic was deemed to be a significant issue, maintenance of arterial signal progression via fixed signal off-set was the control strategy selected. At nonarterial locations, a preemption strategy was implemented. Other important interface control issues were

- The city’s requirement for 2070-type (ATC Lite) traffic signal controllers;
- Selection of controller firmware that would be compatible with the city’s plans for a future central traffic control system, while also providing the flexibility needed to meet atypical phasing requirements at several interface locations (3); and
- Stand-alone capability in the event of a communication failure.

Table 1 provides a summary of the traffic control issues encountered at each of the LRT–street–pedestrian interface locations. A discussion of selected locations and issues follows. (otherwise, they would conflict with pedestrians in the crosswalk on the west Center Street approach). Right-turn-on-green-arrow only signs are used to remind drivers that turns are prohibited by a red arrow indication.

Standard preemption is the transit priority strategy used at Center Street. Northbound LRVs activate a track circuit while still in the Mulberry Street Tunnel. The circuit causes a call for preemption to be placed in the controller, and the controller clears to the preemptive state. The time-to-clear varies, depending on the currently active signal phase, so some LRVs must stop before entering the intersection. The call for preempt is held in the traffic controller until the LRV reaches the far side of the intersection, where a train-to-wayside communications (TWC) device releases the preemption hold.

Southbound, the call for preemption is placed by a TWC which is activated by the front of an LRV as it stops at the Center Street (NJ PAC) Station. The preemptive state is held until the LRV enters a track circuit on the far side of the intersection.

TABLE 1 Summary of LRT Control Strategies and Issues

Interface Location Name	Type of Transit Priority	Number of Signal Phases	Special Considerations
McCarter Highway at Center Street	LRT preemption	4	
NJPAC driveway	LRT preemption	2	
Rector Street	LRT preemption	2	
Fulton Street pedestrian crossing	LRT preemption	2	
Lombardy Street at Atlantic Street	LRT preemption	3	Crossover located immediately south of the intersection
Atlantic Street at pedestrian crossing—garage entrance and exit	LRT phase priority	3	Garage exiting traffic crosses track; poor visibility
Bridge Street at Atlantic Street	LRT phase priority	3	Traffic and pedestrians from new parking garage
Ball Park pedestrian crossing	LRT preemption	2	Infrequent heavy use of station
Broad Street at Division Street—Lackawanna Avenue	Await LRT phase	4	Maintain progression on Broad Street—Crossover located immediately west of intersection
Lackawanna Avenue at University Avenue	LRT preemption	2	Prevention of premature preemption
Broad Street at Orange Street	LRT phase priority	2	Maintain progression on Broad Street
Broad Street at Washington Street—Bridge Street	LRT phase priority	3	Maintain progression on Broad Street
Broad Street pedestrian crossing	LRT preemption	2	Maintain progression on Broad Street
Broad Street at Lombardy Street	LRT phase priority	3	Maintain progression on Broad Street
Service driveway on Lombardy Street	Blank-out sign by approaching LRV		Infrequent use, controlled by blank-out sign.

McCarter Highway at Center Street

Traffic and LRT movements at this intersection are controlled by a four-phase traffic signal owned, operated and maintained by the city of Newark (4). LRTs proceed across Center Street concurrent with the north–south traffic movements on McCarter Highway. The north-to-west left turn is served via a protected, lead left-turn phase, so the south-to-west right turn constitutes the remaining possible conflicting move. These turns are controlled by a right turn signal consisting of all arrow indications, and are permitted only during the eastbound, Center Street phase

Rector Street at McCarter Highway and Fulton Street Pedestrian Crossing

Rector Street operates as a one-way, westbound street away from McCarter Highway, so the only conflicting traffic movement is the southbound right turn from McCarter Highway. Fulton Street was terminated west of the light rail tracks, and a new roadway connection to Rector Street was provided. Thus, only pedestrian movements must be accommodated at this crossing. Both crossings use preemption, initiated sufficiently far in advance, to terminate conflicting movements prior to train arrival. As at many of the system's grade crossings, settable delay timers are employed to allow adjustment in the placing of the call for preemption relative to train position.

Atlantic Street at Station Crosswalk–Parking Garage Entrance–Exit

The sidewalk separating the transitway from the parking garage at this location is relatively narrow, and special provisions were employed to control the movement of pedestrians and vehicles exiting the garage. Pedestrians, exiting from a door removed from the vehicular exit, are prevented from entering directly into the transitway by a simple railing erected on the curb side of the sidewalk, forcing them to walk to the signalized crosswalk. The vehicular exit is controlled by traffic signals placed outside the garage (two signal heads on the opposite side of the street, but well within the cone of visibility; and one on the near left of the exit, on the sidewalk). Additional warning signs, including one that is activated by an approaching LRV, were placed inside the garage. Aside from this issue, the traffic controller operates in three phases: LRT when called; southbound Atlantic Street traffic including left turns into the garage across the tracks; and left turns across the sidewalk and tracks by vehicles exiting the garage together with pedestrian movements across Atlantic Street and trackway.

Ball Park Pedestrian Crossing

Upon arrival at the platform, the LRV places a preemption call of the pedestrian signals, which normally rest in the walk indication. It simultaneously places a call for the LRV phase at the Broad Street at Lackawanna intersection. This call is on an adjustable delay timer to account for anticipated dwell times at the platform.

Broad Street at Lackawanna Avenue–Division Street

This intersection is where the inbound and outbound LRT tracks converge (Figure 3). The system's northern terminus is adjacent to NJT's Newark Broad Street commuter rail station at University Avenue. Between University Avenue and Broad Street is a scissors crossover, which allows departures and arrivals at the Broad Street station to be made from either side of the center platform. (The terminal also is equipped with a tail track, permitting LRVs to enter the station on one track, reverse direction on the tail track, and platform on the other track for the departing trip when necessary.) From Broad Street station, southbound (inbound) trains turn across Lackawanna Avenue and continue along the west side of Broad Street in its exclusive right-of-way. The northbound track approaches Broad Street from the east, crossing both Broad Street and Division Street.

The signal cycle without LRT is basically a three-phase operation: a northbound lead phase which better serves left turns into Lackawanna Avenue followed by a concurrent northbound and

southbound Broad Street phase; followed by a phase serving pedestrians crossing Broad Street and the lightly traveled Division Street.

Broad Street is a coordinated traffic signal corridor consisting of three northbound and three southbound general purpose travel lanes, plus the southbound transitway. Preemption by northbound LRVs was not an option acceptable to the city of Newark due to concerns about potential negative impacts on Broad Street traffic progression. While southbound Broad Street traffic can be served concurrently with southbound LRVs, preemption for southbound train movements also could result in disruption to the progression of roadway traffic-- including scores of bus movements that traverse the intersection during peak periods. Instead, Light Rail movements are served in phases contained within the normal signal cycle, which varies over the course of a day from a minimum of 90 seconds to a maximum duration of 120 seconds. Since crossover moves in and out of Broad Street Station are possible, it is necessary that the two LRV travel directions be served during separate signal phases. Due to travel speeds, the length of these LRT phases are relatively long, especially in the southbound direction, where the curved track alignment through the intersection results in slow LRV speed. Additionally, the crosswalk across Broad Street and the southbound transitway is about 80 feet (24.4 m) in length, requiring the allocation of a pedestrian clearance interval of 17 seconds. These phases are sufficiently long that only in a 120-s cycle can they be served in the same cycle, with the added provision that the Division Street phase be skipped for one cycle. For shorter cycle lengths, which are in effect during most of the day, the LRT phases can only be served in alternate cycles.

NJT is in the process of exploring alternative control strategies at this intersection, with the objective of reducing LRV trip times by decreasing the time that LRVs wait for a proceed signal. Preemption is likely a strategy to be re-examined.

Broad Street at Lombardy Street

This intersection is where the LRV departs the Broad Street corridor, and returns toward the dual track, exclusive right-of-way section south of Lombardy Street. Lombardy Street is a two-way street, forming the stem of a T intersection by intersecting Broad Street from the east. A second T intersection, Broad Street at Washington Place, is located to the immediate south of the Lombardy Street intersection. These two intersections are essentially one, and are controlled by a single traffic signal controller.

The normal traffic signal cycle without LRV movement is three-phase: Broad Street, followed by separate phases for Washington Place and Lombardy Street. Because of the close spacing of the two side street approaches, internal clearance phases are provided at the end of each side street phase to prevent queuing between the two side streets. Pedestrian crossings of Broad Street are accommodated concurrently with the Washington Place phase.

The LRV must cross from the west side of Broad Street to the south side of Lombardy Street. The curved alignment places a 12 mph (19 km/h) restriction on the LRV through the curve. Plus, project design criteria mandated ample time be provided to clear a two-car consist, or a 180-ft (55-m) long train, through the intersection within its phase. The clearance requirements were 21 s. With a 10-s proceed indication included, the entire LRT phase requires 31 s. A new phase of this length could not be added to the traffic signal cycle, even during times when the maximum cycle length of 120 swas in service. However, it is conveniently equal to the time required to serve the Broad Street pedestrian crossings. The LRV could be served during the normal Washington Place phase while preempting the low-volume Washington Place vehicular movement.

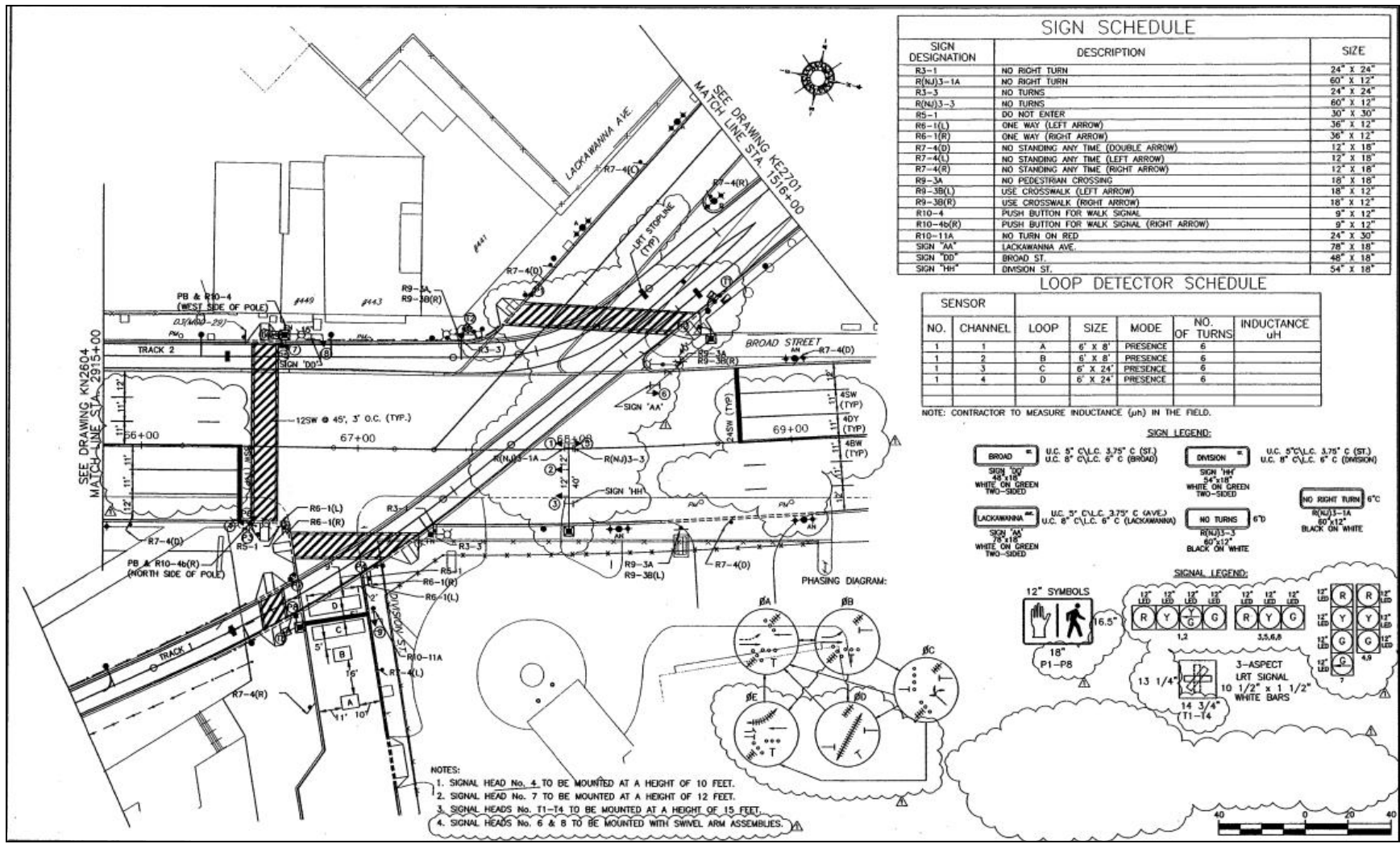

FIGURE 3 Traffic plan at intersection of Broad Street-Lackawanna Avenue-Division Street.

A short distance upstream of Lombardy Street is the Washington Park Station. Immediately south of the station platform is a pedestrian crossing of the track and Broad Street. These pedestrian crossings are offset slightly and operate completely independent of each other.

The call for the LRT phase at Lombardy Street is provided when the LRV hits an insulated joint between the platform and the pedestrian track crossing. The original intent was not to call the LRT phase at Lombardy Street until the train had departed the station, and the train would advance to the Lombardy Street intersection to wait for its phase. Because of the narrow window available (10 s) for the train to enter the intersection, the LRV ideally would be at the stop line at Lombardy Street when the LRT phase begins. However, this often did not happen in practice.

The LRT phase could only be provided within a fixed window during the coordinated traffic signal cycle. However, there is randomness in the LRV arrival as it is subject to widely variable dwell times at the Washington Park Station. Oftentimes, the LRV would leave the station and place the call for phase in the early portions of the normal preceding Broad Street phase. As a result, the LRT phase would have to stop and wait for its phase. Many operators perceived this as a delay and believed they weren't getting their signal early enough. Realizing that it was contacting the insulated joint beyond the platform that placed the call for LRT phase, the operators would make the station stop with the front wheels beyond the joint. This usually caused the LRT phase to begin before the train was at the intersection ready to use it, and the result was either there wasn't enough time to clear the train before the phase ended, or the train would have to stop before it entered the intersection and wait a full cycle for another LRT phase.

The operations at the Lombardy Street intersection also impacted operations at the downstream Lombardy Street at Atlantic Street intersection. Because of the short distance between the two intersections, just little more than the length of a two-car consist, the call for LRT phase at Atlantic Street was placed by the controller at Broad Street as it began to time the Broad Street LRT phase. Assuming the LRV would depart Broad Street at the beginning of its proceed signal, the Atlantic Street intersection, in most cases, would be able to clear all conflicting movements and provide the LRT phase prior to its arrival. The Atlantic Street intersection was an LRT preemption operation, not a phase within a fixed cycle length. It would be provided immediately upon LRV detection and proper clearance of conflicting vehicular and pedestrian phases, and held until the LRT had completely cleared the Atlantic Street intersection, or checked out. Whenever an LRV failed to utilize its LRV phase at Broad Street, Atlantic Street traffic would be unnecessarily delayed for long periods as the LRV would never check out.

Several improvements were devised and implemented to treat these operational deficiencies. First, the method of calling for the Broad Street LRT phase was changed from the insulated joint just south of the Washington Park Station to another joint just beyond the pedestrian track crosswalk at Washington Park. No longer would an LRV stopped at the station place the call for the LRT phase at Lombardy Street. Instead, it would come when the LRV has indeed departed the station on its way toward Lombardy Street. In most cases, the LRV would have to wait at Lombardy Street to cross Broad Street; only in a very narrow window would the proceed signal be displayed just as the LRT arrived or shortly before its arrival. But more often than not, the LRV would be at the intersection ready to use its phase when provided.

For those rare instances where the LRV could not use the phase, a call for phase would be repeated. One feature of the VS+ software is the ability to hold detection calls for a programmable number of repeated cycles. Our recommendation was to repeat the LRT phase call for two additional cycles, and removed once the LRT was determined to check out of the Broad

Street at Lombardy Street intersection.

With these improvements, operations at the Atlantic Street intersection were improved as well, as the LRV was more reliably able to use its phase at Broad Street nearly eliminating lengthy preemptions of the Atlantic Street intersection.

Even with these improvements, there still was the possibility for the train to stop to wait for its signal at Atlantic Street. This would occur when the call for preemption would come during walk indications, requiring the maximum clearance time before the LRT phase could be provided. This call for preemption was placed at the beginning of the LRT phase at Broad Street. If it were possible to provide this call earlier, the delays at Atlantic Street could be reduced or possibly eliminated.

When a controller exits the current phase, it knows which phase it will serve next as it begins the yellow clear of the current phase. So, rather than waiting until the beginning of the LRT phase, if the controller knew it was going to next serve the LRT phase would it be possible to provide the call to preempt Atlantic Street at the beginning of the yellow clearance interval at Broad Street? With the VS+ software, this was possible. The controller was reprogrammed to place the call for preemption at the Atlantic Street intersection at the beginning of the yellow clearance, 6 s earlier than previously provided. After implementing this improvement, stopping delays at the Atlantic Street intersection were eliminated.

Although southbound delays at the Atlantic Street intersection were greatly improved, LRV operations at Broad Street–Lombardy Street continue to be irregular, due mainly to the fact that a southbound LRV may arrive at any point in the traffic signal cycle. As at Lackawanna Avenue–Division Street, NJT is interested in re-examining the potential for LRV preemption at Lombardy Street with the objective of convincing the city that the benefits to transit outweigh any impacts to roadway traffic.

TESTING

It was a prime design consideration that the controller assemblies be ready to be placed into immediate operation once energized in the field. Rigorous field testing was to be avoided at all costs due to the many safety implications should something with the controllers prove faulty. A testing program was developed to put the controller assemblies through their paces in the shop, where material defects or programming deficiencies could be found and corrected before installation in the field.

A testing form was prepared which contained numerous tests to be performed. The tests were for several areas, such as normal signal operation, detection, and LRT priority or preemption operations. The specific tests included were designed to test nearly every conceivable situation to be encountered on the project. In many cases, several of the tests would not apply to an individual controller assembly. However, the testing procedure was not limited to the printed tests; new tests could, and were, devised as determined necessary.

The 2070 ATC Lite controller assemblies were produced by General Highway Products, Inc. (GHP), of Broomall, Pennsylvania. The signal timing plans were provided for each controller, so GHP could assure that all necessary components (controller, detector amplifiers, load switches, flash units, etc.) were included, to provide the required signal operation.

The VS+ software was installed on each controller unit. Referring to the timing plans and the traffic signal phasing diagram, the various timing parameters (minimum and maximum green

times, pedestrian and vehicular clearance times, phase extensions, force offs, and preemptions, etc.) were placed into a data file on a laptop computer. Separate data files were constructed for each individual controller. This allows easy downloading of timing programs via a serial port on the front face of the controller unit.

When the controller assemblies were constructed and ready for testing, a team consisting of representatives from NJT, the design consultant, construction manager, and construction contractor met at the GHP shops to test the units. The controller outputs were wired to a light board, consisting of rows of red, yellow, and green lamps, each set of lamps associated with a particular vehicular, pedestrian, or LRT phase.

The controllers were turned on, and the light board observed to confirm desired operation. The individual phase and point in the signal cycle could also be confirmed via the display on the controller face. Using the test form as a guide, the controllers were put through their paces. Normal operations were observed; detection calls were placed and reactions observed and noted. Numerous scenarios were simulated; such as “what happens if an LRT is detected in the early point of a phase; or late in a phase?”; “what happens if a second LRT is detected while a first LRT is being served?” If the controller performed satisfactorily, that particular test was checked OK on the test form; if not, changes were made in the software until the test results were satisfactory.

Once all the tests were satisfactorily performed on the controller assembly, the test form was signed by observers from PB, NJT, and GHP. These test forms eventually were included in the submission to New Jersey Department of Transportation (NJDOT) to have the signal installations certified.

This bench testing assured that the controller assemblies were in satisfactory order, and should provide safe operation immediately upon turn-on. The only unknown was that the hard wiring to the traffic signals, detectors and rail detection circuits. This required another round of testing in the field, prior to turn-on: first with artificially input LRT detections and finally real LRT operations.

CONCLUSIONS

The Newark City Subway Broad Street Extension project was typical of light rail projects in that it required continued coordination among several government entities, including NJT, NJDOT, the city of Newark and Essex County. In this case, however, the project was often confronted by changes in existing physical conditions within or adjacent to the LRT trackway. Principal examples of such changes that affected traffic control include

- Modifications to NJDOT’s design for Route 21 (McCarter Highway), which parallels the middle segment of the subway extension, specifically, changes to the design of the traffic signal layout and signal phasing at the Route 21–Center Street intersection required NJT to revise the design for control of the LRT–roadway interface at this location; and
- For 20 or more years, the stretch of Broad Street in the project area was operated with the center two traffic lanes serving as reversible lanes. In the morning peak, the roadway operated with four southbound and two northbound lanes. In the p.m. peak, the roadway featured four northbound and two southbound lanes. The preliminary design for control of the transit–traffic interface along Broad Street was compatible with this reversible lane operation.

Subsequent to the start of final design, the city decided to do away with reversible lane operation in favor of three northbound and three southbound travel lanes. This change required last-minute revisions to the design of traffic signal heads and pavement markings within a 5-block segment of Broad Street and resubmittal of the designs to NJDOT for authorization to install the revised traffic signals.

These and other changes required modifications to the project's design for placement and operation of traffic control devices. The choice of controller firmware and traffic signal communications system presented a different set of issues. Previously, the city of Newark had purchased a supervisory traffic control system that it intended to install in the CBD, and later expand to encompass a larger area. The city also had designed a fiber optic traffic signal communications system to enable traffic system supervision from the city's traffic control center and from a secondary control center located in city hall. Financial and contracting issues, however, slowed the installation of the communications system, leaving the intersections that were part of the Broad Street Extension project without connections to the control center. Moreover, the city and NJDOT had selected a traffic control system for the Route 21 project that was not suitable for the transit project. (A major issue was that most firmware would not allow the combination of pedestrian intervals and transit intervals required at the more complex intersections.) As a result, selection of the firmware that would run in the traffic controllers to be provided to the city by the Broad Street Extension project was rendered quite problematic. One firmware might satisfy the city's needs, but not the needs of the LRT project. Another might accommodate the needs of the LRT, but not be compatible with the city's plan for supervisory control of all its traffic signals by a single, citywide, system. After numerous meetings with the city and discussions with controller manufactures and vendors, a solution emerged: use of VS⁺ in a generic, 2070 Lite controller. This solution was satisfactory to the city since the firmware could run the controllers used at the intersections where light rail would operate and it was compatible with several proprietary supervisory control systems, including the one that the city had purchased but not yet installed. Moreover, the local controllers selected could, when outfitted with modems, communicate with central control by way of communications hubs installed by the transit project. In the short term, communications would be via leased phone lines; with conversion to a fiber-based system when installed by the city in the future.

The overall conclusion, then, is that virtually every traffic control issue was unique, requiring specific and individual treatment. The type of transit priority to be granted at each location; the type of (transit) detectors to be employed; the traffic signal phasing and timing at each location; and the type of traffic control firmware to be utilized. Although several of these issues were decided in preliminary, ultimately, other factors required that each be revisited and reconfirmed or modified as the project advanced through final design and construction.

NOTES

1. Creation of the right-of-way needed for this segment of the Newark City Subway Broad Street Extension project was contingent on the relocation of this segment of McCarter Highway. The planning and design of both projects was closely coordinated between their respective sponsors, NJT and NJDOT.
2. Note that Broad Street, from Lackawanna Avenue south to Lombardy Street, was widened by several feet as part of the LRT project to provide the additional width needed to accommodate the LRT trackway while retaining six vehicular travel lanes. Fortunately, the preexisting sidewalks on both

sides of Broad Street were sufficiently wide (approximately 20 ft or 6 m) to permit the roadway widening. Introduction of the LRT trackway did, however, require the elimination of a curb bus lane that had been in place for a number of years.

3. During the course of the NERL project design, but independent thereof, the city of Newark was in the process of selecting an areawide traffic control system. Ultimately, it was mutually agreed between the city and NJT that the NERL traffic controllers would be of the 2070 type, which, when equipped with the proper firmware, can operate with most areawide control systems. Discussions with several firmware suppliers led to the selection of VS+ as the firmware of choice, as this firmware can communicate with upstream and downstream controllers to maintain close coordination, or implement special operations.
4. All traffic signal controllers, traffic signal poles, signal heads, loop detectors and other equipment used to control traffic was provided by NJT as part of the NERL project. Following turn-on and acceptance, this equipment became the property of the city, which operates and maintains same. Track circuits and TWCs used to detect approaching LRVs are the property of NJT.

BRT and LRT
What Is the Role for Each Mode?

BRT AND LRT: WHAT IS THE ROLE FOR EACH MODE?

Bus Rapid Transit as a Precursor of Light Rail Transit?**LYNDON HENRY***Capital Metropolitan Transportation Authority***DAVID DOBBS***Publisher*

Can high-quality bus services—often described as bus rapid transit (BRT)—effectively function as a precursor of a subsequent electric light rail transit (LRT) system? This issue is frequently raised in at least two planning situations: (a) the alignment is envisioned ultimately for LRT, but a low-capital-cost BRT-type service is undertaken until ridership demand in the given corridor grows to justify a heavier rail investment; and (b) installation of a new LRT system or line is under way, and a BRT-type service is implemented to help build interim ridership in anticipation of the new electric rail service.

Several notable cases in North America where a BRT-type service has functioned in such a capacity include the following examples:

- Guadalajara, Mexico: Guadalajara’s LRT (Sistema de Tren Eléctrico Urbano, or SITEUR) opened to the public in 1989, utilizing a 5.3-km (3.3-mi), seven-station tunnel constructed in 1974 and operated with electric trolleybuses until 1988. Thus, the electric trolleybus line (including the subway) served as a precursor to LRT (1);
- Dallas, Texas: Dallas Area Rapid Transit (DART) operated BRT-like express bus service on North Central Expressway (a freeway parallel to DART’s LRT line) that served as a precursor to DART’s LRT extension to Plano, which opened in 2002. By early 2003, a study found that ridership on the new LRT service had nearly tripled compared to BRT. The transition from BRT to LRT was relatively easy, because the BRT operated on the freeway whereas LRT used available exclusive right-of-way (ROW) (mainly abandoned railway ROW) (2);
- Miami, Florida: The Miami–Dade Busway, operating on an abandoned Florida East Coast railroad alignment, has been serving as a precursor to an extension of the MetroRail rapid transit line. However, MetroRail is typically constructed as an elevated line over the surface alignment; conversion to a surface rail transit line, such as LRT, in this alignment might present difficulties in terms of disrupting the BRT service;
- Seattle, Washington: The Downtown Seattle Transit Tunnel (DSTT) with buses has basically represented a BRT-type service that has functioned to build ridership and demonstrate the need for rail. Now, conversion to LRT (intended to operate jointly with buses) is underway (further discussion below); and
- Los Angeles, California: The Wilshire Boulevard MetroRapid BRT service, operated by Los Angeles County Metropolitan Transportation Authority (LACMTA), has demonstrated huge ridership demand in this corridor, thus bolstering enthusiasm for an extension of LACMTA’s rail rapid transit metro system in the corridor. Planning for such a project is now under way.

It should be noted that the term BRT can have very wide application, as established by important public agencies such as the FTA and General Accounting Office, and various promoters of the BRT concept. Thus, BRT-type services that function as precursors to rail transit can span a very broad range, from express bus services preceding LRT (e.g., Dallas, San Diego, Sacramento, Portland) or rail rapid transit (AC Transit express buses preceding BART in the San Francisco Bay Area) to exclusive busway installations such as the LACMTA or the Ottawa Transitway, where ROW and stations themselves could be reused for rail service.

DESIGN ISSUES

It is worthwhile to consider design features that can facilitate a transition from BRT to LRT, as well as challenges and drawbacks. These are discussed in this section.

In general, the capital cost of a BRT-type operation often can be incrementally or significantly lower than that of LRT. For example, the BRT facility (whether operating in mixed traffic, in special lanes, or on a specially constructed busway) does not require rails (although special pavement treatments may be needed), nor does it require track switches, crossovers, and other types of special rail work. Motor buses do not need electric power distribution, and bus running facilities are not usually installed with much in the way of signalization (although there is debate over the adequacy of safety features).

This last issue relates to the familiar assertion by BRT proponents that “BRT is just like light rail, but cheaper.” However, the lack of comparable signal protection on BRT comparable to that found on LRT systems would seem to be a relevant concern in any effort to fashion BRT to be “just as good as LRT.” Presumably, such signalization for BRT could be provided at additional cost, but if it were, it would seem to represent an additional sunk cost. Furthermore, depending on the compatibility of the signal technology, it is possible that substantial elements of such a BRT-based signalization system might have to be sacrificed upon conversion to rail.

Another advantage of an initial BRT preceding rail is that bus rolling stock can often use existing maintenance facilities, although these may need incremental expansion.

On the other hand, rail facilities tend to have significantly longer life and greater salvage value; LRT tends to attract more ridership; trip-lengths tend to be longer (for equivalent station spacings); and the unit operating and maintenance (O&M) cost per passenger mile for LRT tends to be less. [According to APTA data, average trip length in 2005 on LRT was 4.5 mi versus 3.7 mi on bus (4); and for the superior ridership and cost per passenger mile operating performance of LRT versus bus, see L. Henry, Comparative Performance of Public Transport in U.S. New Start Rail Cities versus Bus-Only Cities, *Joint International Light Rail Conference: A World of Applications and Opportunities*, St. Louis, Missouri, April 9–11, 2006.] Added to this are possible extra benefits such as attracting and stabilizing adjacent development and reinforcing community development or redevelopment plans—effects that may also have some force even in countries with fairly strong government land use powers.

Another major factor to consider is that BRT facilities—particularly a busway—tend to represent a major investment of resources and possibly a physical impediment to LRT implementation. Even if the BRT facility can be initially designed for smooth conversion (certainly not always the case), the implementing agency has undertaken a major investment to install a significant mass of expensive infrastructure, with a nominal 30-year life (at least), and it tends to make sense to get most of the economic use out of the life of such a project.

Arterial and Street Alignments

For alignments in urban arterials and streets, there are additional issues. Often the right (in North America) curbside lane tends to be a less desirable location for a reserved guideway, mainly because of the possibility of conflicts with driveways, curbside parking, right-turn traffic movements, and pedestrian traffic. While this may be workable for slower-moving streetcars, such an alignment usually presents problems for faster interurban or semimetro-type LRT, which tends to perform better (faster and more safely) when routed mainly in the center of streets (mostly) to minimize these conflicts.

However, right-hand curbside alignments are often preferred for BRT-type operations for the same reason as for streetcar projects: to permit the use of sidewalks for passenger access and less expensive station locations. Stations can be installed as “temporary” and theoretically movable, but there is nevertheless an expense involved in any such relocations, especially on a large scale with numerous stations. In addition, there can be other significant expense issues, such as the relocation of buried communications lines, electrical connections, etc. In any case, BRT-specific infrastructure (including stations) should be designed to be very low cost so the sunk cost for BRT is not an impediment to eventual conversion to LRT.

Despite these design challenges, there are major advantages to deploying BRT services as precursors to LRT. For example

- A limited-stop BRT-type service, especially with traffic signal priority, could help build ridership in the corridor, and this in turn could help bolster the case for conversion to LRT;
- Some important infrastructure elements, such as the signal priority and communications system [e.g., NextBus Passenger Information (PID) system] can represent a sunk infrastructure costs that will benefit the LRT project;
- Some sidewalk and other urban renovation improvements associated with the BRT project could also accrue to the benefit of future LRT; and
- Stations could be designed to be easily and cheaply moveable to more substantial, median platforms, thus also representing a reusable asset for the LRT system.

Busways

One of the most exhaustive studies of the issues involved in conversions from major BRT facilities, such as busways, to LRT was performed under the direction of Seattle’s Sound Transit agency in 2005 by Parsons Brinckerhoff Quade & Douglas, Inc. (4). This study includes an excellent summation of many of these issues.

Conversion from BRT to LRT is a subject that has been studied and debated in cities across North America and Australia. Proponents of conversion point to the higher maximum carrying capacity offered by the larger LRT vehicles that can travel in trains of multiple cars, as well as the resulting lower operating costs due to the need for fewer vehicles and drivers. Detractors of converting to LRT assert that the capital costs associated with the conversion process outweigh any savings derived from lower operating costs, and that demand must be extremely high in order to reap those operating cost savings. Additional considerations include

integration with the larger regional transit system, the ease with which transfers can be made between different modes, and the effect of different modes on land development. As of the writing of this paper, no known conversions have been made from BRT to LRT, other than the current project to convert the LACMTA to joint bus and LRT use. Following are some of the key findings that were derived from a review of selected existing BRT systems:

- The majority of the BRT projects reviewed for this study include some provisions for future conversion to LRT. However, other than the current project to convert the Downtown Seattle Transit Tunnel, there are no known conversions from BRT to LRT.
- The arrangement of BRT cross sections varies considerably, and total width can vary from 20 to 54 ft. Lane widths range from 9.5 to 13 ft, with shoulders ranging from 2 to 10 ft. Typical busway configurations include one lane in each direction with no physical barrier or separation between lanes. The total width required for two-track LRT is generally between 30 and 35 ft.
- The critical elements that must be considered for future conversion to LRT include the horizontal and vertical geometric constraints and the vehicle envelopes of both the BRT and LRT vehicles. LRT design constraints would generally control the design of a BRT project if future modal flexibility choices are to be accommodated.
- Issues to consider when deciding whether or not to convert a BRT facility to LRT include the relative capacity of the two modes compared with the existing and forecasted corridor demand, the need for larger terminal stations, the potential for lower operating costs with LRT, and the capital costs associated with conversion. The construction activities required for conversion vary depending on whether or not the BRT system was designed and constructed to include provisions for LRT. Such activities can include modification to both the mainline and to stations. If no provisions for LRT were included in the busway design and construction, the cost of conversion can be significantly higher due to the need for more extreme modification or total reconstruction of structures and other facilities.

CASE EXAMPLES

It is useful to examine several specific examples where the issue of converting or transitioning from BRT-type operations to LRT has been raised.

Seattle: Downtown Seattle Transit Tunnel

The DSTT was originally opened in 1990, after nearly 4 years of construction at a cost of \$466 million. Run by King County Metro, the tunnel is 1.3 mi long and has five stations, all of which have elevators and are fully Americans with Disabilities Act-compliant. [Figure 1](#) shows a bus operating in the tunnel.

As originally constructed, the DSTT was intended to be readily convertible to use by LRT, and tracks were laid in the busway pavement. Unfortunately, to reduce cost, the rails were insufficiently insulated against stray current leakage (which can cause electrolysis problems) and insufficiently cushioned for noise control. In addition, station platforms were too low to permit level boarding of low-floor LRT rolling stock (and raising the platforms would have incurred conflicts with the elevators) (5, 6).

These problems were solved by removing the rails and existing pavement and lowering the running way—although at considerable extra expense (reportedly about \$45 million). The Seattle DSTT case thus represents a valuable object lesson on the pitfalls of trying to design for BRT-to-LRT conversion.

The DSTT was reopened for bus services in late 2007, and LRT operation is currently being tested. LRT service is scheduled to begin in 2009. Figure 2 shows a test train operating in the DSTT.

Seattle: I-90 Transit–HOV Project and East Link Light Rail

According to an agency fact sheet (7), Sound Transit’s I-90 Two-Way Transit and HOV (high-occupancy vehicle) Operations Project is intended to address traffic bottlenecks “caused by the existing reversible HOV express lanes in the center of I-90 operating only westbound in the morning and eastbound at night.” New HOV lanes will be added to the I-90 outer roadways to offer 24-h HOV capacity in both directions.

In addition, the project has been explicitly designed for convertibility to high-capacity transit, as the Sound Transit fact sheet points out:

Planning to provide for high capacity transit (HCT) in the center roadway of I-90 began 30 years ago as a result of a mutual agreement between King County, WSDOT, Cities of Mercer Island, Bellevue, Seattle, and King County Metro. This



FIGURE 1 Bus in DSTT.



FIGURE 2 LRT train in DSTT.

agreement stated that I-90 was to be designed and constructed so that future conversion of the center lanes to HCT would be possible. Later, an amendment to the original plan called for the construction of HOV lanes on the outer roadway and the conversion of the center roadway to HCT as soon as possible.

Thus, installation of the new HOV lanes in this corridor will also make way for building the long-awaited light rail connection between Seattle and the Eastside in the I-90 center lanes. The fact sheet proceeds to underscore that

The proposed East Link light rail extension will add much-needed people-moving capacity across Lake Washington. Fast and reliable light rail service would run 20 hours a day and every few minutes during peak times, connecting the Eastside to a 60-mi regional system.

Figure 3 provides a simulation of future LRT operation in this corridor.

Project planners emphasize that key infrastructure elements, such as access ramps, are being explicitly designed to accommodate future LRT. Figure 4 shows a diagram of the proposed design for conversion of median HOV lanes to LRT.

Seattle: SR-99 RapidRide

Also in the Seattle area, King County Metro Transit (Metro) is planning a new BRT-type service called RapidRide for Pacific Highway South–International Boulevard (State Route 99),



FIGURE 3 Simulation of Eastside Link LRT in I-90 corridor.

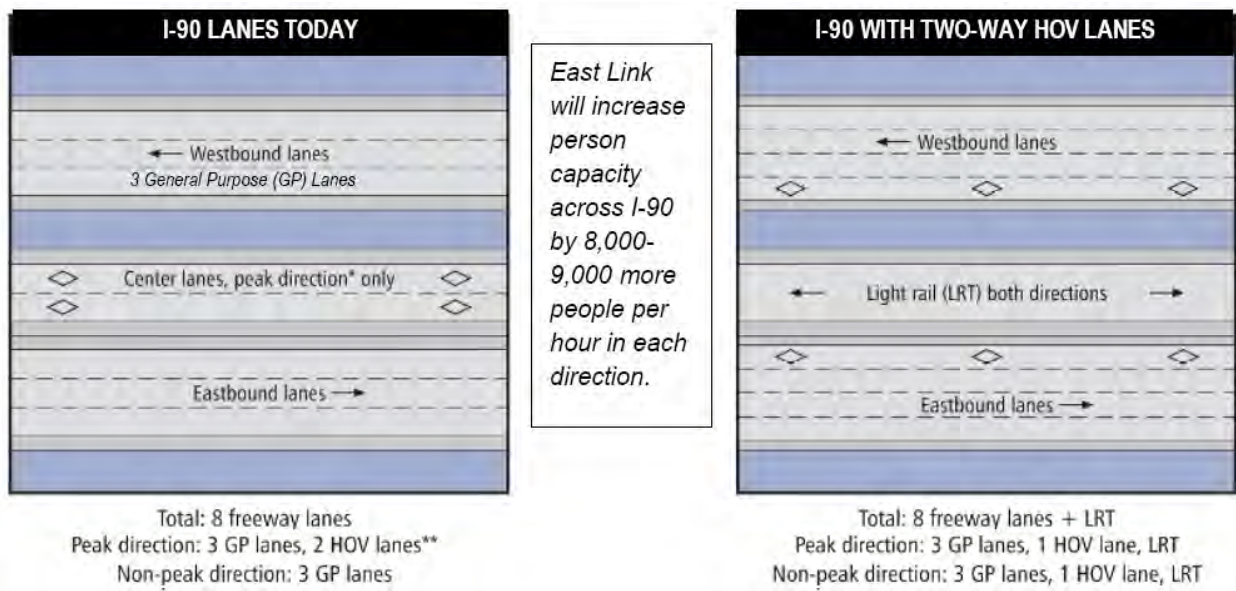

FIGURE 4 Diagram of I-90 HOV to LRT conversion design.

scheduled to open in February 2010, and replacing Metro's Route 174 in the same general corridor. The new service, intended to build transit ridership for eventual rail extensions, will offer improved access to destinations along the route and to places where travelers can transfer to other buses and light rail. Along the RapidRide corridor there will be a total of 13 major stations plus intermediate stops (8). **Figure 5** provides a map of the RapidRide project.

At the south end of the route, the Federal Way Transit Center will give riders connections to buses serving Tacoma, Pierce County, and Auburn, including Green River Community College. Sound Transit's Link Light Rail Tukwila International Boulevard Station, opening in 2009, will be located at the north end, enabling RapidRide passengers to transfer to and from Link Light Rail, which is expected to make 31-min trips between Tukwila and Seattle's Westlake Center frequently throughout the day. RapidRide passengers will also be able to connect to buses that serve Burien, Tukwila, the city of SeaTac, the Duwamish area, and downtown Seattle. A station near Highline Community College will provide connections to buses serving Kent, Des Moines, and Burien. A station near Sea-Tac International Airport (S. 176th Street) and the Link Light Rail airport station will provide bus connections to Pierce County, Auburn, Kent, and Burien. RapidRide will serve Sea-Tac Airport by connecting with the Link Light Rail station at S. 176th Street, without entering crowded airport roads.

RapidRide service is planned to significantly improve headways, with buses scheduled to arrive every 10 min during the busiest morning and evening travel hours. At other times between



FIGURE 5 Seattle RapidRide project.

05:00 and 22:00 (5 a.m. and 10 p.m.), buses will come every 15 min. Boarding will also be expedited, since RapidRide buses will have low floors and three doors, so passengers can board and disembark quickly. In addition, a new, trial fare payment system will allow riders with passes to pay as they enter any door. The inside of the RapidRide buses will be designed to make it easier for passengers to move to seats and exits. RapidRide trips will be faster, particularly as buses will use new HOV lanes installed on Pacific Highway South–International Boulevard. In addition, a signal prioritization system will expedite travel through intersections. RapidRide buses will be more recognizable with RapidRide branding and color schemes, and passengers will benefit from new high-capacity, low-emission hybrid vehicles designed especially for RapidRide.

Stations, located about every mile along the route, will be fitted with amenities, including lighting, increased space, shelters, benches, and trash receptacles. Shelters and signs will have a special RapidRide style and color scheme. Waiting areas will be well-lit, increasing security, and electronic real-time PIDs provide next bus arrival information.

Between the major stations, RapidRide bus stops also will have signs and other features to give them the distinctive RapidRide look. In some cases shelters and benches may be added or improved. Stop-request signals, which people can use to alert the bus driver when they are waiting for a bus at night, may be provided at these stops.

In terms of eventual conversion to LRT, the minimalist approach of the RapidRide design, including mixed-traffic operation and the lack of heavy infrastructure, may make such a conversion more feasible.

Ottawa: Transitway

Opened in 1983, Ottawa's "Transitway" (busway) has become a preeminent North American example of BRT, consisting of 16.0 mi of dedicated transitways (busways), with 26 stations; 1.2 route-miles of central business district (CBD) reserved lanes (on two parallel streets); 2.0 mi of mixed-traffic running (on the Ottawa River Parkway); and 6.6 mi of freeway shoulder lanes—totaling 25.8 route-miles. However, in recent years, severe CBD bus crowding, and the success of the O-Train light railway (on a different alignment), have stimulated interest in conversion of the BRT Transitway to LRT. [Figure 6](#) provides a view of the Transitway.

However, problems with this option were revealed in a 2003 city of Ottawa study titled *Rapid Transit Expansion Study* (9); of particular interest is the section Comparing Bus and Rail Technologies. First, Ottawa planners note some general comparative features between LRT and BRT:

- Based on review of existing transit operating systems, it is generally accepted within the rapid transit industry that the relative capacities of BRT and LRT are comparable, with LRT having a greater capacity (up to 30%);
- The right-of-way requirements for BRT and LRT are comparable; and
- The capital costs for LRT are generally greater than that for BRT. However, depending upon the extent and nature of the rapid transit rail service, operating costs for LRT can be lower when the vehicles are used to capacity, resulting in lower life-cycle costs and lower costs per passenger kilometer. Comparative capital and operating costs were acquired from Toronto, Calgary, Detroit, Dallas, Denver, Los Angeles, Pittsburgh, San Diego, and San Jose.



FIGURE 6 Ottawa Transitway.

We note that we find several assertions in this study to be somewhat questionable. For example, the statement that “it is generally accepted within the rapid transit industry that the relative capacities of BRT and LRT are comparable, with LRT having a greater capacity (up to 30%)” seems inherently contradictory, and, given vigorous ongoing discussion of this issue, such a conclusion seems far from generally accepted. Similarly, the report’s assertion that “The right-of-way requirements for BRT and LRT are comparable” is open to question, especially since ROW at busway stations typically is significantly wider, as the image of the Ottawa station provided above demonstrates.

Finally, the statement that “capital costs for LRT are generally greater than that for BRT” may be far too broad, especially when total life-cycle costs and fleet requirements are considered. For example, if the typical 30-year life of an installation is taken into consideration, any capital cost analysis would need to account for the cost of a second fleet of buses—i.e., 30 years of bus life, not the 15 years generally assumed for bus economic life.

The report also suggests that, despite over two decades of BRT operation, public sentiment seems to favor LRT technology, summarizing “public comments comparing LRT and BRT” and noting “a strongly stated preference by the public attendees of the open houses and stakeholder participants in the study for the train over the bus.”

A major reason given for this public preference is “a view that LRT will be more effective in achieving the smart growth objectives of intensification and redevelopment due to its sense of permanency and service reliability.”

For urban railway service in Ottawa, planners clearly envision an electrically powered LRT system, recommending the following characteristics:

- Low floors for easy entry and less obtrusive platforms;
- Electrical power for quieter, cleaner operation;
- Smoother, more comfortable ride;
- Vehicles can be connected into longer train sets with single operators; and
- Capable of efficiently climbing steeper grades and smaller turning radius.

Of particular interest for this analysis is the Ottawa document's discussion of the problems involved with conversion of the Transitway to LRT. As has been discussed above, transit agencies understandably aim to extract as much use and value as possible from their investment in bus-specific facilities, which may have economic lives ranging between 30 and 50 years. Furthermore, a conversion project in some cases could interrupt or disrupt existing BRT services—and operators are reluctant to disrupt what may be one of their most heavily used transit services. These considerations are definitely relevant to the Ottawa Transitway case, since much of the facility was constructed in an abandoned railway alignment, and providing parallel service during conversion would be virtually impossible.

Thus, the document notes that while “the transitway has been designed to be convertible to LRT,” and despite the advantages and public support expressed on behalf of LRT, planners have concluded that conversion of the BRT Transitway to LRT would not be justifiable, noting that “conversion of the Transitway to LRT would be expensive” for several reasons:

1. There will be service disruption during conversion. Rapid transit service would, in essence, cease while rail construction takes place.
2. Value for money is not sufficient to justify conversion. Conversion of the Transitway from Orleans to Kanata would cost about \$1 billion and provide unnecessary underutilized capacity.

As a result,

The study concludes that with limited financial resources, it is better to invest in new rapid transit corridors than to replace an existing one. It is not considered cost-effective to convert the Transitway to LRT at this time.

With further upgrades and extensions, the existing Transitway will continue to play an essential role in the recommended Rapid Transit Network. The network is one in which BRT and LRT are effectively blended to complement each other.

As an article on the Light Rail Now! website (10) points out,

The issue of whether BRT (i.e., busway) was, in hindsight, the most cost-effective choice for the Transitway corridor (which involved the widening and paving of an existing, abandoned railway right-of-way) is not addressed. Nevertheless, the report seems to state conclusively that, once a busway investment is in place, there are serious obstacles to converting it to LRT. This consequence should weigh heavily in the deliberations of planners and decision makers in other areas where LRT and BRT are being compared as potential project alternatives for New Start investments.

Austin: Capital MetroRapid

In Austin, Capital Metropolitan Transportation Authority (Capital Metro) is proceeding to implement a BRT-type project called Capital MetroRapid, which will feature enhanced transit service that makes use of high-quality, high-tech buses, special traffic signal priority technology, limited stops, upgraded station-stops with better passenger amenities such as real-time arrival PIDs, and other features that are intended to render improved service on high-ridership corridors. Operating in mixed traffic, Capital MetroRapid is projected to offer 10-min headways during peak and 15 min during off-peak service and to provide trip times that are 15% to 20% faster than existing service (11).

Initially, Capital MetroRapid service will involve two routes: North Lamar–South Congress (previously designated for LRT, but narrowly rejected by voters in 2000) and Burnet–South Lamar. There will be 43 stops in both directions along the North Lamar–South Congress route and 36 stops along the Burnet–South Lamar route. (See map, [Figure 7](#), which shows the Capital MetroRapid routes in green.) MetroRapid stops will be in proximity to local bus service and two MetroRail stations.

Capital Metro expects to begin service on the North Lamar–South Congress line by 2010 and 2011 for the Burnet–South Lamar line. Depending upon the type of vehicle, the investment cost is projected to range between \$28 and \$38 million.

As much as possible, the project is being designed to minimize infrastructure investment and capital cost, and to facilitate eventual conversion to LRT (interurban or streetcar) should that opportunity arise. For example, the PID communications system could be retrofitted for LRT, and the signal prioritization system would also be transferable. Corridor renovations, such as sidewalk upgrades and other pedestrian improvements, could also bolster future LRT installation. Sidewalk BRT stations will be designed to be easily relocated to more permanent, median LRT platforms in the future.

CONCLUSIONS

This analysis has identified certain factors that may optimize the capability of BRT to function effectively as a precursor of a LRT system. However, it is important for planners to keep in mind that initial system design, to permit a transition, is critical, and major challenges and drawbacks must be addressed and overcome. A major consideration is that the BRT facilities should not represent an obstacle to the subsequent LRT project. As noted, BRT-specific infrastructure (including stations) should ideally be designed to be very low in cost so the sunk cost for BRT is not an impediment to eventual conversion to LRT.

The examples of actual or prospective BRT-to-LRT conversion in both Seattle and Ottawa (and in fact Guadalajara as well) involve some degree of transit service shutdown or disruption on the BRT facility during the conversion process in these types of high-end exclusive facilities. In contrast, a lower-end express-bus type of BRT service can probably more readily continue a parallel service on adjacent highway or arterial lanes (if they are available) during the conversion period—although generally without stations and intermediate interchange of



FIGURE 7 Capital MetroRail and MetroRapid system map.

transferring passengers (an essential characteristic of LRT which planners should seek in BRT if the BRT service is intended to offer really the same kind of service as LRT).

In addition, the staging and logistics of conversion must be considered, particularly to avoid or minimize disruption of the existing BRT-type service while the LRT installation project is under way. In this regard, alignments in or alongside existing arterials provide at least some opportunity for maintaining a parallel BRT or bus-substitute service; on the other hand, alignments that have appropriated railway ROW for BRT (such as the Ottawa Transitway) make it virtually impossible to maintain a true parallel bus service—thus representing a serious obstacle facing conversion to LRT.

On the whole, the case studies cited suggest that actual experience is still inconclusive as to full cost effectiveness of some forms of BRT service functioning as precursors to LRT and other type of rail transit. However, several examples approaching implementation in the near future appear to show promise. As these planned BRT-to-LRT conversions become operational, an updated assessment should be carried out.

REFERENCES

1. Guadalajara LRT. *Rail Transit OnLine*, September 2005, Subways.net. www.subways.net/mexico/guadalajara.htm. Accessed December 23, 2005.
2. Dallas: DART's New LRT Service Nearly Triples BRT Ridership at Three Stations. *Light Rail Progress*, www.lightrailnow.org/features/f_dal016.htm. Accessed March 2003.
3. *Public Transportation Fact Book, 2005*. American Public Transportation Association, 2006. www.apta.com/research/stats/factbook/documents/section_06_passengers_pages_11_to_14.pdf.
4. Parsons Brinckerhoff Quade & Douglas, Inc. *Sound Transit Long-Range Plan Update Issue Paper N.5: Convertibility of BRT to Light Rail*. Prepared for Sound Transit, March 2005.
5. Schlien, P. The Metro Tunnel. <http://world.nycsubway.org/us/seattle/tunnel.html>. Accessed September 2005.
6. Pryne, E. Bus-Tunnel Error Years Ago is Costly in Shutdown Today. *Seattle Times*, October 13, 2005. http://seattletimes.nwsourc.com/html/localnews/2002557741_tunnel13m.html.
7. I-90 Two-Way Transit and HOV Project: Setting the Stage for East Link Light Rail. Sound Transit, April 4, 2007. www.soundtransit.org/Documents/pdf/projects/bus/i90/FLY_R_8A.pdf.
8. S 99 RapidRide service will build transit ridership for eventual rail extensions. Envision Midway 1. King County Metro Transit, May 21, 2008. www.envisionmidway.com/Documents/King%20County%20METRO%20Proposal.pdf.
9. City of Ottawa. Rapid Transit Expansion Study, February 2003.
10. Ottawa: New light rail system recommended...But "BRT" conversion presents obstacles. *Light Rail Now! NewsLog*, February 1, 2005. www.lightrailnow.org/news/n_newslog002.htm#OTW_20050201.
11. Capital MetroRapid, Capital Metropolitan Transportation Authority, 2008. <http://allsystems.go.capmetro.org/capital-metrorapid.shtml>.

BRT AND LRT: WHAT IS THE ROLE FOR EACH MODE?

Comparative Performance of Los Angeles' Transit Modes**RICHARD STANGER***Consultant*

Over the past 25 years Los Angeles, California's Metro transit network has evolved from an all-bus system to a network of many transit services and modes. As of spring 2008, this network included a rapid transit line, three light rail lines, three busways, 19 enhanced bus routes, and 95 local bus routes. Twelve other transit operators run municipal bus services and Metrolink operates the region's commuter rail system. This paper deals only with services operated directly by Metro, by far the dominant service provider. With Metro, we have the unique opportunity to compare a variety of transit modes all operated by the same agency within the same urbanized area. This eliminates external factors that cloud modal comparisons, such as differences in labor costs between urban areas, in operating and management practices, in efficiencies of scale, and in time and methods of data collection.

The purpose of this paper is to compare the travel speeds, trip lengths, capacities, operating costs, and capital costs of four bus modes and two rail modes all operated by one American transit agency. These measurements were selected because they are straight forward to obtain and are central to any debate comparing transit modes.

PAST STUDIES

Past studies comparing transit modes generally fall into two categories. The first compares modes which are being planned or hypothesized, that is, not in operation. These types of studies are needed, of course, when doing major planning work, but they must use projections of ridership and costs rather than actual ridership and costs. The alignments and operational assumptions made for each alternative may have to be different or may not, in the end, be possible. For example, Sislak (1) compared a busway and light rail alternative, each having a different alignment, for a planned Cleveland corridor. Stutsman (2) in another busway versus light rail comparison study for the Exposition corridor in Los Angeles, acknowledge that the assumption of full signal pre-emption for the busway mode was problematic.

The second category of studies compares operating modes among two or more cities. Until fairly recently, the only bus mode in the United States that could be compared with light rail was the busway within a freeway. Recent studies have had more bus services with which to compare. Two studies are worth noting in this regard. In 2002, a study by Kühn (3) compared various enhanced bus services with light rail using existing operations culled from cities worldwide. Although Kühn lumps the various bus services under the catch-all term bus rapid transit (BRT), he does recognize the useful range of bus modes that are available. It is a good study with useful conclusions, but each system included operates in a different cultural, economic, and operational context. Moreover, how well do transit systems serving diverse cities around the world translate to America? Helping to fill that gap is a 2005 study by Hess, Taylor and Yoh (4) that looks at various bus modes within U.S. cities and compares them with light rail.

Part of this study's value is in separating the term BRT into its three main components: enhanced bus services on arterial streets, busways within freeways, and at-grade busways within their own rights-of-way. The study's weakness—though no fault of its own—is that most of the projects cited were still in the planning and construction when its data were collected. The study does note the difficulty of comparing projects in different cities each using their own ways of cost estimating and operating.

What is needed is a study of transit modes based on actual operating experience, preferable one in which as many externalities as possible are removed. Los Angeles provides a unique opportunity to do just that.

OVERVIEW

In early 2008 Metro operated the following fixed-route services:

- **Red–Purple Line:** A rapid transit line in subway, the first segment of which opened in 1992, its last extension in 2000. It includes a 17-mi Red Line service and a 5-mi Purple Line service. Peak-period headways in each branch are 10 min with a combined frequency of 5 min in the common 4-mi downtown L.A. segment;
 - **Green Line:** A fully grade-separated light rail line opened in 1994 in the median of a freeway. Because of this and long station spacing, its average speed is the highest of all Metro transit lines. It operates with peak period headways of 7½ min;
 - **Blue Line:** A light rail line opened in 1990 with 75% of its length in an exclusive and/or grade-separated right-of-way. It operates peak period headways averaging 5½ min;
 - **Gold Line:** A light rail line opened in 2002 with 100% of its length within an exclusive and/or grade-separated right-of-way. It operates peak period headways of 7½ min;
 - **Orange Line Transitway:** A busway opened in 2004 with 90% of its length in an exclusive right-of-way. It has the same 1-mi station spacing as the light rail lines. It is served by one bus route which is given signal priority, uses high-capacity buses, and has peak-period headways averaging 4¼ min;
 - **El Monte Transitway:** A busway opened in 1972 on an exclusive roadway within a freeway right-of-way. For many years this facility was used only by buses, the busway is now shared with 3+ person carpools. Buses leave the busway to distribute passengers in downtown L.A. on surface streets in mixed traffic. Five MTA and seven Foothill Transit routes use this busway, coming together in the 11.5-mi freeway segment. Each bus route has its own frequency;
 - **Harbor Transitway:** Opened in 1996, this is special busway–high occupancy vehicle (HOV) facility on a separate roadway within a freeway right-of-way. It was designed for joint use by buses and car pools (3+ occupants) and has two lanes in each direction. Eight MTA bus routes (along with seven other bus routes) use the busway, coming together in the 12-mi freeway segment. Buses distribute passengers within downtown Los Angeles on surface streets in mixed traffic. Each bus route has its own frequency;
 - **Wilshire Rapid Express:** A mainly peak-period express bus service with very limited stops, signal priority, and articulated buses. It has a peak-period headway of 15 min. This type of service is now just on Wilshire Boulevard;
 - **Metro Rapid Bus:** Rapid bus routes operate in mixed traffic on existing streets.
- Almost all rapid bus services operate on the same route as the still-operating local bus route, but

have fewer stops, signal priority, usually a truncated length, and no late evening service. There are 19 rapid bus routes; and

- **Local Bus:** The 95 MTA bus routes not in the above categories. Included are conventional bus routes, some shuttle bus routes and a few peak hour, limited-stop bus routes.

METRO'S BUS RAPID TRANSIT LINES

Metro operates three types of bus services that fall under the FTA's broad definition of BRT (5). This paper will not use the term BRT because it is too general. It will use the term rapid bus for Metro's rapid bus routes and the Wilshire Rapid Express. It will use the term busway for the El Monte and Harbor Freeway bus-HOV transit services. The Orange Line, which operates quite differently from the other two busways, will be referred to by its name. All three services use articulated buses with a distinctive red color scheme. Metro has clearly tried to brand them as different from its local bus fleet, which is painted orange.

CHARACTERISTICS OF MODES WITHIN THE METRO SYSTEM

In this section travel times, trip lengths, capacities, and operating costs of the Metro transit modes are compared. Unless otherwise noted, the data used in calculating the values shown in the figures came either from Metro's unpublished Third Quarter FY2008 (January-March, 2008) bus operating statistics or from Metro's unpublished April, 2008 rail operating statistics.

Distribution of Transit Use by Mode

Metro operates a total of about 5,200 mi of transit routes. The four rail lines account for 1.3% of that mileage, rapid bus routes and busways another 11%. As [Figure 1](#) shows, local bus routes comprise the vast majority of Metro route miles. However, the rail system carries almost one-fifth of the system's ridership, rapid buses, and busways slightly less. The importance of the higher-speed, higher-capacity modes becomes even more pronounced when considering passenger miles carried. The four rail lines already carry over a quarter of Metro's total passenger miles of travel, rapid buses and busway buses another quarter. In short, one-eighth of Metro's transit miles carries over one-half of its total passenger miles of travel.

Average Peak Period Speed

Metro keeps annual revenue service miles and hours for each route, and from them it calculates the route's annual revenue speed. This information combines off-peak, peak and weekend speeds and includes layover and rest times. It does not reflect what passengers experience during the important peak periods. For this analysis, average peak-period travel speeds were estimated using travel times in Metro's printed timetables and route distances measured with tools in Google Earth.

Ideally, average peak period travel speeds would be calculated for each trip in each peak period in both peak-period directions, and these dozens of speeds averaged to obtain the peak-period speed for each route. This was not practical. Instead, at least four randomly selected peak-

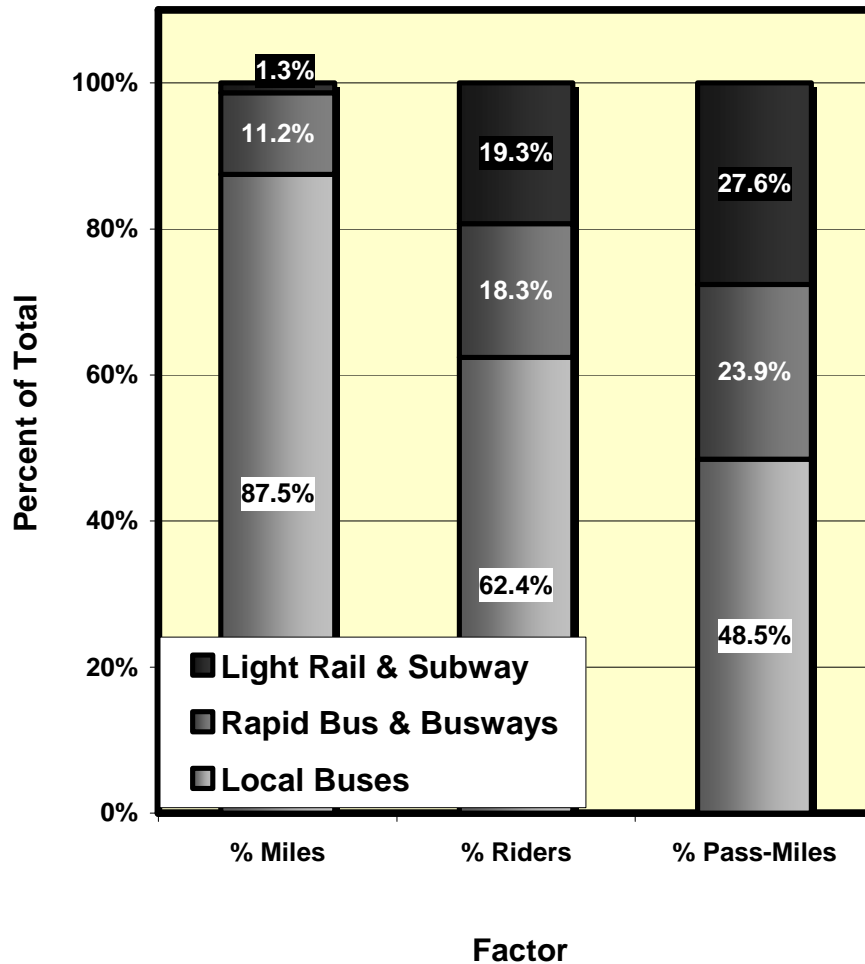

FIGURE 1 Transit distribution by mode.

period travel times for each route were used to derive the average speed of that route. The average speed shown for each mode is the combined speeds of all routes within that service type. (Checks using 16 data points per route resulted in average peak hour speeds per mode that were at most a fraction of a mile-per-hour different than an average derived from four data.)

The average scheduled speed for the 95 local bus routes came from the calculated average speeds of a random selection of 19 local routes (every fifth route). Peak-period speeds were calculated the same way for each rail line and bus route.

Figure 2 shows the resulting average peak-period speeds of the various modes operated by Metro. The Green Line in combined with the Red Line for this figure only because both these lines are fully grade separated. All other figures include the Green Line statistics with the other two light rail lines.

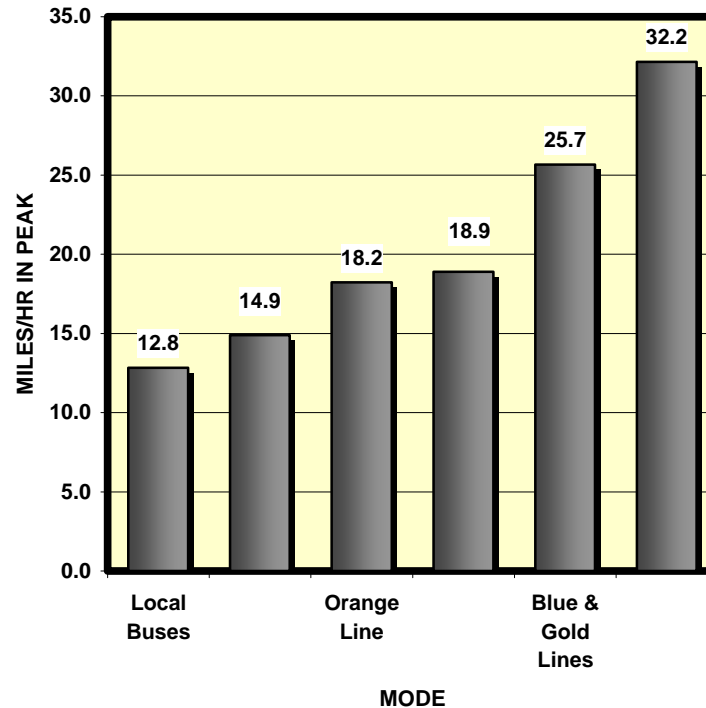

FIGURE 2 Average peak hour speeds by mode.

Rapid Bus Routes

To speed up service on its more important bus routes, Metro has implemented rapid bus service on 19 routes and is adding more. The major difference between this type of service and local bus services on the same streets is the longer stop spacing. Secondly, rapid buses get signal priority within the city of Los Angeles and some other jurisdictions.

The average peak-period speed for the rapid bus routes is 16% faster than the average local bus route. However, as shown [Figure 3](#), rapid bus routes are 25% faster than local buses on the same routes. This chart also shows the average speeds of the three Wilshire Boulevard bus services—local Route #20, Rapid Bus Route #720, and Express Route #920—in their common, 8-mi segment (between Westwood Boulevard and Western Avenue).

Orange Line and Busways

The Orange Line, with its exclusive right-of-way, 1-mi station spacing, and off-vehicle fare collection, could be expected to achieve a speed comparable to a light rail line in the same alignment. However, its buses slow at each crossing to make sure the crossing is safe (any collision at higher speeds is far more serious for bus riders than light rail riders). It has limited

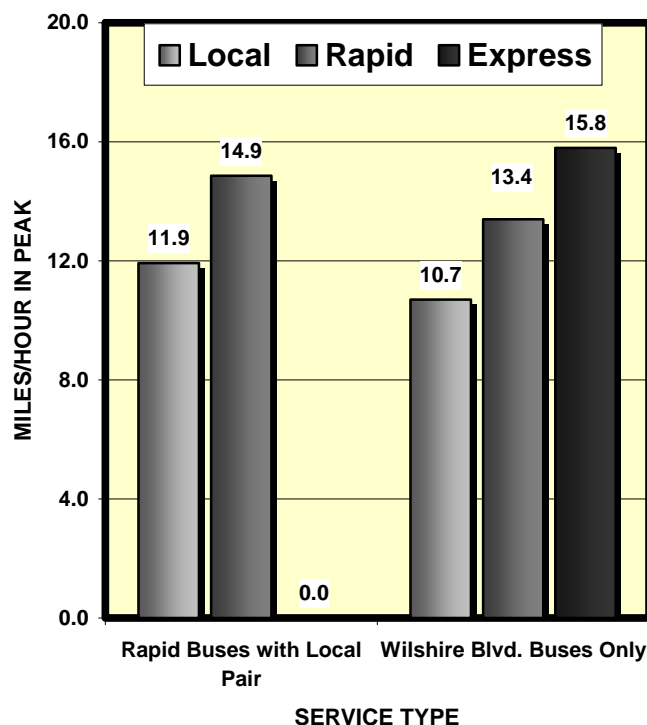

FIGURE 3 Average speeds of 19 rapid bus and local bus pairs.

signal priority and it is very doubtful that its buses will ever get full signal pre-emption because as more buses are added to meet growing demand they would pre-empt more and more of the available green time and unacceptably disrupt vehicle flows across the busway (6).

Figure 4 shows speeds by route segment in the two busways within freeway rights-of-way: the El Monte and Harbor Busways. The bus routes on these two facilities have an average speed of 21.3 mph on the Harbor Transitway and 16.6 mph on the El Monte Transitway, for a combined average of 18.9 mph. As the figure shows, however, the high speed achieved on the busway section is reduced substantially in the street segments at both ends of the routes, which include congested downtown Los Angeles streets.

Light Rail and Rapid Transit

The Blue and Gold Line’s travel speeds reflect their predominantly exclusive rights-of-way and full signal pre-emption. The Blue and Gold Line’s average travel speed is 40% greater than the Orange Line’s speed, 36% greater than the busway speeds. The Red and Green lines, with their full grade separation, achieve a 25% higher speed than the Blue and Gold light rail lines, and a 70% higher speed than that of the busways.

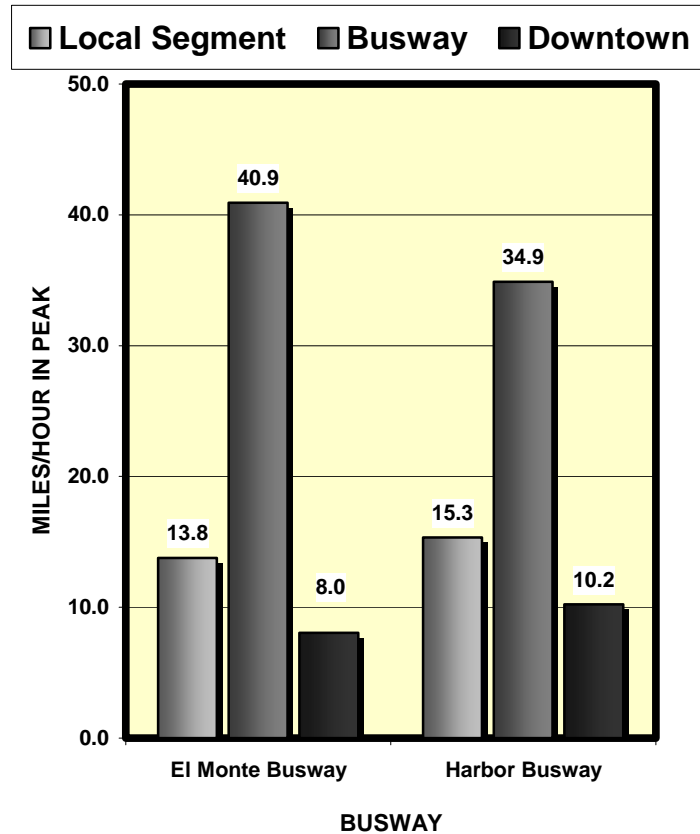

FIGURE 4 Average busway speeds by segment.

Average Trip Length

Figure 5 shows the average (unlinked) passenger trip lengths for each mode. It shows that trip length generally increases with the faster modes. The average trips on freeway busway routes are the longest, probably because they are predominantly made by commuters. The average trip length on the Red Line is relatively short. This reflects what has become one of its major functions: to distribute Metrolink, Blue Line, and Gold Line riders (among other services) through downtown Los Angeles.

Capacity

There are innumerable discussions of the capacities of various transit modes in the literature (7). Theoretical capacities can be high, but may not be achievable. This section will compare the possible capacities of Metro’s various modes based on its own operating experience. The results are shown in Figure 6.

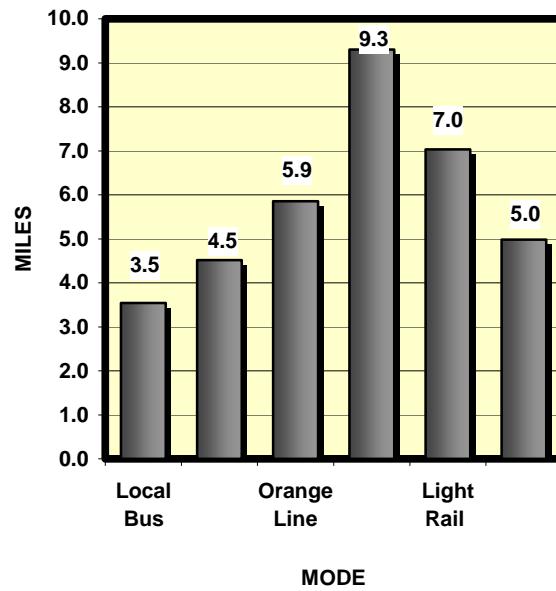

FIGURE 5 Average trip length by mode.

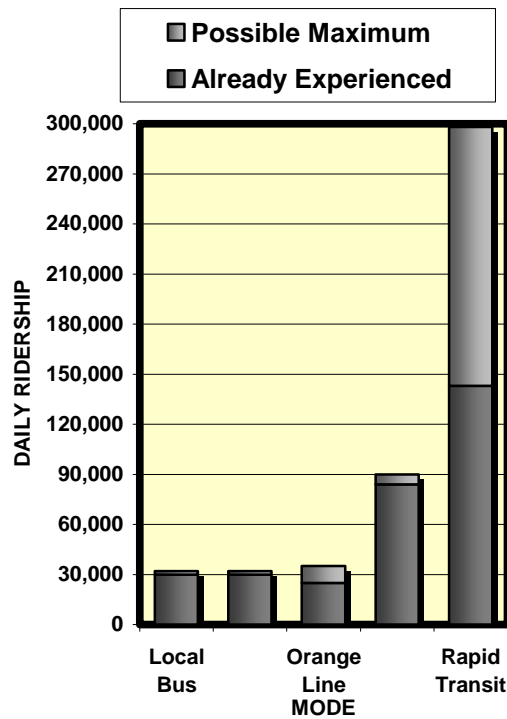

FIGURE 6 Daily ridership by mode.

Local and Rapid Bus Routes

Several Metro local bus routes carry almost 30,000 passengers per day, but only one surpasses that number (#204 Vermont Avenue at 30,385). This route is fairly long with high turnover (2.5 mi average trip length) and steady all-day demand. Only one rapid bus route carries more than 30,000 daily riders (#720 Santa Monica–Commerce). However, this route is really two routes interlined through downtown, and neither half carries 30,000 riders. Only four rapid bus routes together with their local bus route pairs have daily ridership levels above 30,000. However, the combined 54,000 daily riders on the Vermont Avenue routes approach twice the daily “capacity” shown for each mode in [Figure 7](#).

Orange Line

The Orange Line has carried an average of 25,400 weekday daily riders (April 2008) on crowded 60-ft articulated buses, and there is still limited unused capacity. The probable maximum ridership of the Orange Line Transitway is 35,000 riders per day. This is because the Orange Line traverses east–west across at least 20 heavily traveled north–south arterials. As a result, the Los Angeles Department of Transportation does not give Orange Line buses signal preemption and their headways are limited to a minimum of about 4 min. Using double-articulated buses or operating existing buses in platoons may add another 25% in capacity, which might allow the service to carry 35,000 riders per day.

Light Rail and Rapid Transit

The Blue Line has already carried 84,000 daily riders, albeit under very crowded conditions, and it is unlikely that it can carry many more daily riders than that under present conditions (three-car trains and 5-min headways). For this reason, the possible maximum daily ridership for Metro’s three light rail lines is 90,000. With its capability to run longer trains and its full grade separation, the Red Line has carried 143,000 average daily riders (April 2008) and should be able to carry 300,000 daily riders.

Operating Cost

Figure 7 depicts the operating cost per passenger mile by mode. Passenger miles are used because trip length varies by mode. Comparing the operating cost per trip between modes providing service for different length trips is inconclusive.

Rapid Bus Routes and Busways

The operating cost per passenger mile of these bus services is lower than local bus services because their speeds are faster and because rapid bus routes often serve higher-demand corridors. Also, local bus routes are at a relative disadvantage, having to operate during low-demand, late-evening periods. The cost per passenger mile of buses in the El Monte and Harbor Transitway is even lower than for rapid buses, as they are primarily tailored to peak hour commuters with less or no midday and evening services.

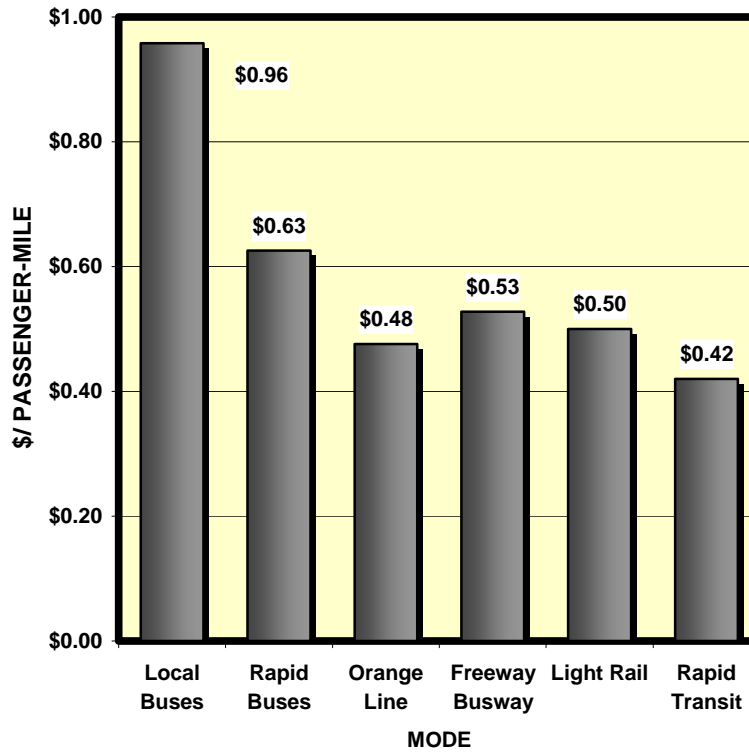

FIGURE 7 Operating cost per passenger mile by mode.

Orange Line

This is the most efficient of Metro’s bus services because of its high ridership throughout the day. This is quite significant considering that the Orange Line’s cost per revenue hour is almost double that of Metro’s other busway services (\$222/RevHr vs. \$121/RevHr) due to the maintenance expenses associated with the guideway.

Light Rail and Rapid Transit

The three light rail lines achieve a low average cost per passenger mile. This reflects the faster speed and the higher capacity of LRT trains. The LRT lines are more expensive to run, given the need to maintain the track, signals, traction power equipment and vehicles. But these greater costs are spread over a larger ridership. The Red Line has the lowest cost per passenger mile of all modes despite the high maintenance of its subway. This can be attributed in part to its high speed, its secondary distribution function, and its resulting high ridership.

Operating Subsidy

Average trip length must again be taken into account to compare levels of subsidy needed by mode. In early 2008 the average fare for the Metro system was \$0.67. Metro estimates fare revenues by mode by multiplying this average fare by the number of boarding passengers. The resulting revenues are subtracted from corresponding operating costs to determine the subsidy.

Figure 8 shows the average subsidy per passenger mile by mode. The pattern follows the same pattern as cost per passenger mile above: highest for local buses and lowest for rapid transit. However, if taken as a percentage of the operating cost, the range is less, from a high of 86% (busways) to 69% (rapid transit).

Capital Costs

Even within one urbanized area, capital costs reflect the construction climate during the years the project was constructed. It is even questionable trying to compare construction costs of the Blue Line built between 1985 and 1990 with the costs of the Gold Line built between 1999 and 2003. However, Metro completed several projects in 2000 and 2005 and this may allow a useful comparison of the relative costs of constructing each mode under similar conditions. It should be noted that the Red Line's MOS-3 segment has only three stations in its 6.3-mi length, and therefore its cost per mile should be considered relatively low.

Table 1 arrays the cost per mile for four Metro projects. The capital costs came from Metro statistics or from the sources noted in the table. Obviously, capital costs escalate rapidly as bus and rail projects are increasingly separated from urban traffic. Tellingly, the increase in cost by mode generally mirrors the increases in speed shown in Figure 2 and the increases in capacity shown in Figure 6.

CONCLUSIONS

The above analysis shows that Metro has derived clear benefits in improved performance, capacity, and efficiency by investing in faster, higher-capacity bus and rail modes. Below are conclusions that may be derived from Metro's experience.

Find Ways to Increase Bus Speeds

Faster bus travel times generally mean lower operating costs and subsidies. The instant success Metro experienced with its first rapid bus line on Wilshire Boulevard dramatically demonstrated that the public was ready for a new type of bus service with higher speed through longer stop spacing and signal priority. Wisely, Metro continues to expand its rapid bus program.

Transit operators need to reexamine policies that were established long ago and may be obsolete today, such as a bus stop every block or two. In most cities, such policies may belong to a different era. Faster travel may well lead to more gains in riders than losses. Some operators, while adding limited-stop services, have retained nominal local bus service to serve destinations

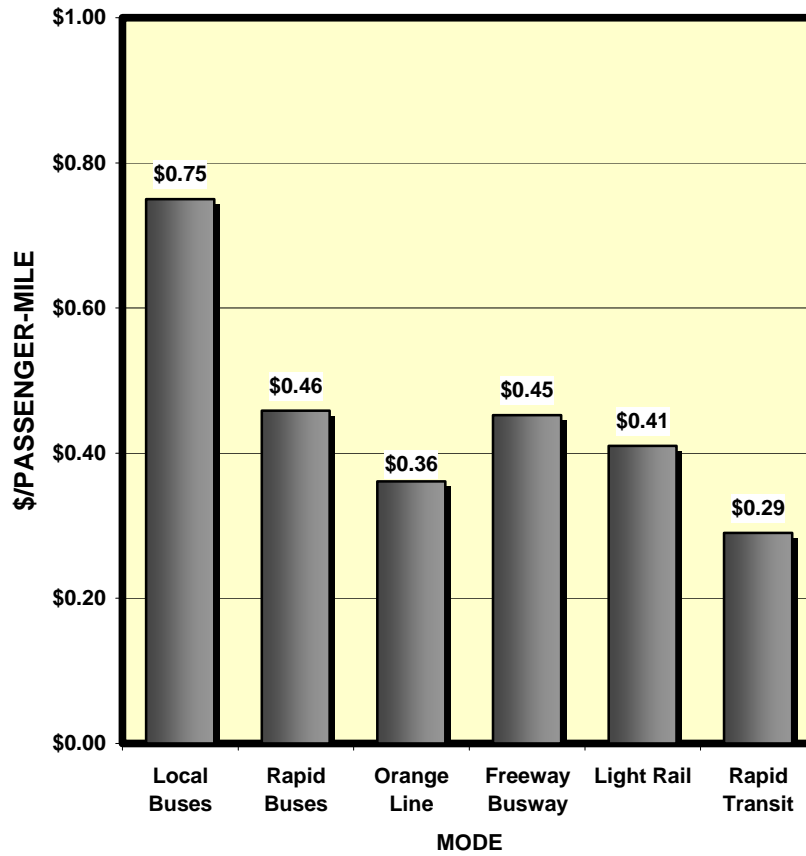

FIGURE 8 Subsidy per passenger mile by mode.

TABLE 1 Capital Cost of Select Metro Projects

Project	Mode	Year Opened	Length (miles)	Cost (millions)	Cost/Mile (millions)
Wilshire Rapid Bus	Rapid bus	2000	16.7	3.25	0.195 (4)
Orange Line	At-grade busway	2005	14.2	390 (6)	27.5
Gold Line	Light rail	2003	13.7	859	63
Red Line, MOS-3	Rapid transit	2000	6.3	1,313 (8)	208

between longer-spaced stops. This may be desirable as long as the schedule of the parallel local bus service does not overlap the limited-stop bus service. In addition, the limited-stop bus service should not be compromised by allowing passengers to disembark at any requested local stop. Transit agencies should also work closely and aggressively with local traffic engineers to achieve signal priority for important bus routes.

Understand the Limitations of Busways

Busways like the Orange Line Transitway (and the South Miami Busway) are inherently far slower than light rail transit. Their buses do not have signal pre-emption and, even with limited signal priority, they catch some red lights. Their buses are also required to slow at all grade-crossings to avoid high-speed accidents.

At-grade busways also have significantly less capacity than light rail. That may not be a factor for most cities in the United States, but it matters significantly in our largest cities. For these reasons, the planning and design of at-grade busways need to be closely coordinated with the city's traffic engineers to assure that realistic assumptions are made in the planning phases of project development. Assuming too high a speed for buses raises projected ridership and makes the busway appear as attractive as light rail, when in reality a rapid bus route might well serve the future requirements.

Design and Build to Emphasize Rail's Strengths

Light rail is too costly build to allow its speed and capacity to be compromised, yet too often they are. Its exclusive rights-of-way must be used whenever available and protected from encroachment, its full signal pre-emption must be a prerequisite for construction, its curves must be as few and as gradual as possible to assure high operating speeds, and its stations should be adequately spaced.

Build What Works for the Given Requirements

The best hope for better transit in general is to improve bus service through longer stop spacing, signal priority, and special bus lanes. Most transit riders will continue to use buses on existing roadways. Although the speed of buses in streets cannot match that of rail, in most corridors enhanced, rapid bus services will most benefit the public. Given the extreme sprawl in many cities in the United States, it is unlikely that these urban areas could ever afford or be well served by higher-speed rail lines or even busways.

ACKNOWLEDGMENTS

The author thanks Manuel Padron, who reviewed the draft of this paper and provided valuable comments, and Carolyn Flowers of the MTA and her staff for helping with data collection.

REFERENCES

1. Sislak, K. G. Bus Rapid Transit as a Substitute for Light Rail Transit: A Tale of Two Cities (CD-ROM). Presented at the 8th Joint Conference on Light Rail Transit, Dallas, Texas, 2000.
2. Stutsman, J. Bus Rapid Transit or Light Rail Transit—How to Decide? Los Angeles Case Study. In *Transportation Research Record: Journal of the Transportation Research Board*, No. 1973, Transportation Research Board of the National Academies, Washington, D.C., 2002, pp. 55–61.
3. Kühn, F. *Urban Mobility for All—La Mobilité Urbaine pour Tous* (Godard and Fatorzoun, eds.), Swets & Zeitlinger, Lisse, 2002, pp 357–365.
4. Hess, D., B. Taylor, and A. Yoh. Light Rail Lite or Cost-Effective Improvements to Bus Service? Evaluating Costs of Implementing Bus Rapid Transit. In *Transportation Research Record: Journal of the Transportation Research Board*, No. 1927, Transportation Research Board of the National Academies, Washington, D.C., 2005, pp. 22–30.
5. Booz-Allen and Hamilton. *Proc., Bus Rapid Transit Deployment Strategy Workshop*, Federal Transit Administration, U.S. Department of Transportation, 2001.
6. Stanger, R. An Evaluation of Los Angeles' Orange Line Busway. In *Journal of Public Transportation*, Vol. 10, No. 1, 2007, pp. 103–119.
7. Vuchic, V. Table 2.4: Maximum offered line capacities of transit modes. In *Urban Transit: Operations, Planning, and Economics*, John Wiley & Sons, 2005, p. 94.
8. Predicted and Actual Impacts of New Start Projects. Federal Transit Administration, U.S. Department of Transportation, 2003, pp. 103–108. www.fta.dot.gov/documents/CPAR_Final_Report_-_2007.pdf. Accessed January 27, 2009.

Stations, Stops, and Arts in Transit

STATIONS, STOPS, AND ARTS IN TRANSIT

Transportation Overlay District in the Valley of the Sun**RICHARD SIMONETTA****BENJAMIN LIMMER***Valley Metro Rail, Inc.*

The purpose of this research project was to develop an understanding of what makes the Phoenix, Arizona region successful with regard to transit-oriented developments within close proximity to the new light rail transit (LRT) alignment. This research focused on the amount of public and private sector commitments that have been realized, as well as what additional factors might make the Phoenix region unique to other similar LRT cities.

METRO LIGHT RAIL

METRO is the brand name for Valley Metro Rail, Inc., a nonprofit, public corporation charged with the design, construction and operation of the region's light rail system. The cities that participate in the light rail system each have a representative on the METRO Board of Directors. Currently, this consists of Phoenix, Tempe, Mesa, Glendale, Chandler, Peoria, and Scottsdale.

Central Phoenix–East Valley Light Rail Project

The Central Phoenix–East Valley light rail starter line is the newest element of the region's transit system. In 2005, construction began on the \$1.4 billion (2008 U.S. dollars), 20-mi (32.2-km) light rail segment connecting the cities of Phoenix, Tempe, and Mesa. The LRT starter line as shown in [Figure 1](#) opened on time and on budget on December 27, 2008. The at-grade light rail system has 28 stations, eight park-and-ride facilities and 50 vehicles. Ridership over the first 6 months was over 33,000 per day, 30% higher than projections (1).

Light rail trains run 20 h per day, every day of the week, stopping at stations about every 10 min from morning through the evening peak hours ([Figure 2](#)). The stations utilized a cool screen design method by being constructed with materials and landscaping specifically designed for exposure to extreme temperatures. In addition, the stations have overhead shading structures for midday sun and rain protection, as well as vertical shading structures for protection from the early morning and late afternoon sun.

Future Extensions

The Regional Transportation Plan, adopted by the Maricopa Association of Governments identifies 57 mi (91.7 km) of high-capacity LRT corridors to be implemented by 2026 as shown in [Figure 3](#) (2).



FIGURE 1 Central Phoenix–East Valley light rail starter line.



FIGURE 2 LRT vehicle at station.

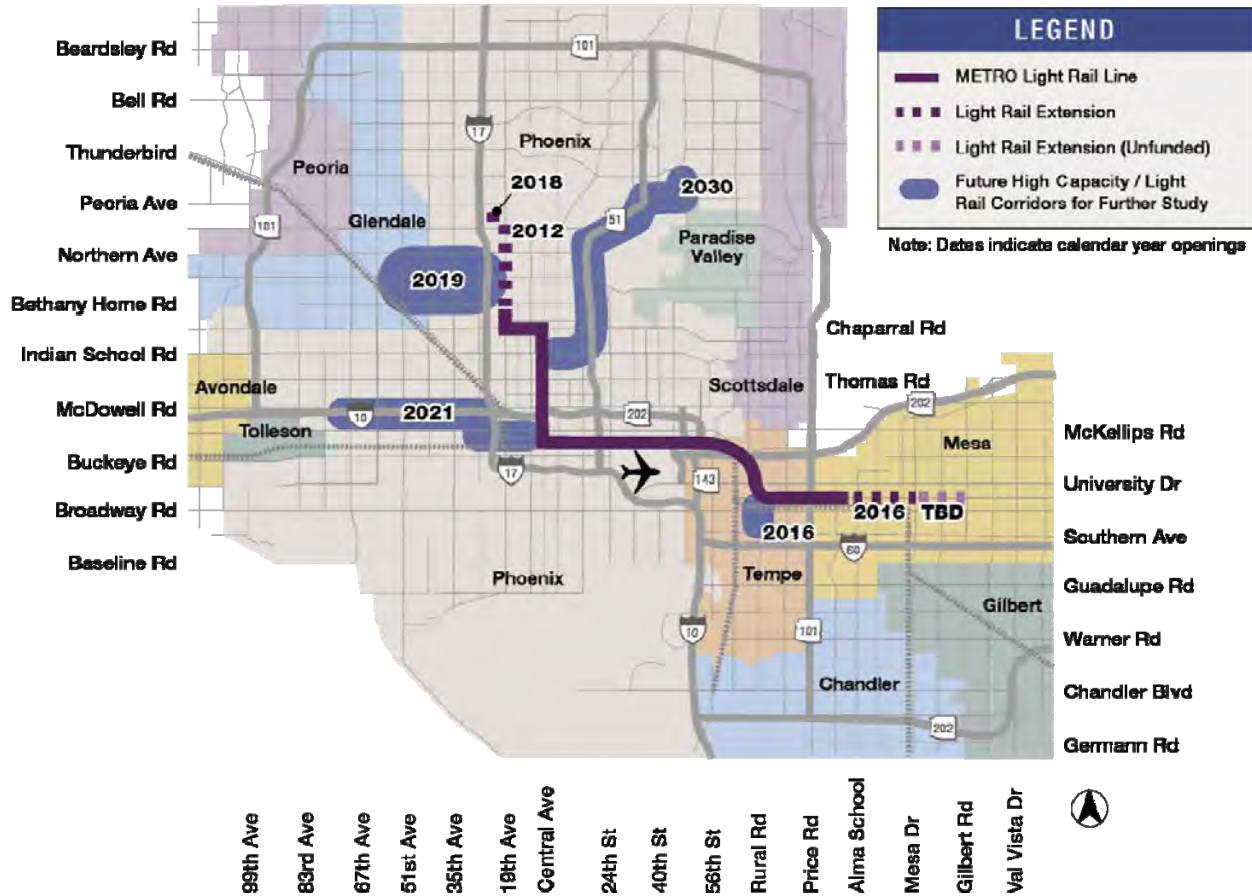

FIGURE 3 High-capacity–LRT system.

The high-capacity–LRT corridors serve the most densely populated areas of the Phoenix metropolitan area and are planned to add capacity in heavily traveled commuter corridors. The Phoenix metropolitan area experienced significant population growth between 1990 and 2000 according to the 2000 U.S. census with a 45.3% increase since 1990 to 2.8 million people. Phoenix continues to experience phenomenal growth with nearly 700,000 new residents, a 31% increase and approximately 500,000 new jobs, in less than 8 years. Projections indicate that by 2020 the region’s population will increase to 5.2 million people and to 7.3 million by 2040 (3).

EXISTING LAND USE AND METRO LIGHT RAIL

The 20-mi (32.2-km) initial light rail transit corridor and station areas are comprised of a diverse mix of land uses and activity centers. The LRT stations serve several of the largest employment centers in the region, as well as the area of highest residential density in the state of Arizona (3). The four largest employment centers in the region include

- North Central Avenue (75,000 employees);
- Downtown Phoenix (32,000 employees);
- Sky Harbor International Airport (24,000 employees); and
- Downtown Tempe (23,000 employees).

The Phoenix central core is maintaining its vitality with 32% of the regions' employment located in 4% of the land area (in downtown Phoenix and along Central Avenue). High-density residential is following suit. Over the last 5 years, 15% of all multifamily development in the Phoenix Metropolitan area has occurred within 1-mi (1.6-km) of the LRT corridor. Ten-year population growth of more than a million and employment growth of 500,000 has increased the density of the city despite popular misperception (3, 4) (Figure 4).

Phoenix is one of only eight large urbanized areas that demonstrated a density increase over 30 years and recently became the fifth largest city in America. In addition to the significant growth and densification of the central core, the adjacent suburbs are exhibiting similar economic vitality that provides a balanced development pattern throughout the LRT alignment and future high-capacity-LRT corridors (3,4).

The LRT stations also serve several prominent trip generators including U.S. Airways Arena, Phoenix Civic Plaza (convention center), Chase Field, Sky Harbor International Airport, Gateway Community College, Sun Devil Stadium, Arizona State University, Mill Avenue in Downtown Tempe, high-density residential along Apache Boulevard in Tempe, and west Mesa.

These prominent trip generators are estimated to add an additional 683,000 annual riders to the LRT system. These estimated riders are derived from conservative mode share percentages (ranging from 8.8% to 14 %) that are based on peer city experience (3,4).



FIGURE 4 Downtown Phoenix, 2008.

TRANSIT-ORIENTED DEVELOPMENT PROGRAMS AND POLICIES

The areas served by the LRT system are primarily located within urban infill districts. The affected cities have worked diligently to create land use policies and regulations to promote new transit-oriented development and revitalization of older suburban centers and low-density development within these areas. Each of the member cities recognize the opportunities that their downtowns have by linking together with a high capacity regional transit system. As such, each city has developed strategies to further increase economic and functional vitality to support transit use. Efforts vary widely by jurisdiction and include

- Attracting mixed-use developments with significant residential and employment components;
- Supporting residential home ownership in the corridor;
- Supporting new residential development of historic buildings;
- Implementing downtown marketing strategies; and
- Providing streetscape improvements and developing amenities such as parks and lakes in coordination with adjacent redevelopment areas.

Each of the cities is in different stages of creating land use regulations to support new transit-oriented development. A brief description of METRO's role and each city's program is provided.

METRO

METRO has a primary role as the steward of a large-scale public investment, a regional light rail system. The success of this system is directly related to easy access by riders and the proximity of land uses that generate transit ridership. METRO's staff worked with member cities to define its roles with regard to Transportation Overlay District (TOD) and to determine the appropriate role for METRO. City staffs requested a variety of areas in which support from METRO is desired and needed. In response, METRO has developed a TOD program to address many of these items. Some member cities, with METRO assistance, have established land use policies in support of new TOD around light rail stations. It was also agreed that METRO should continue to serve primarily as a resource, a support function and community educator.

By assisting in promoting high-quality, more-intensive development on and near properties adjacent to light rail, METRO can directly benefit by increasing ridership. METRO's TOD assistance consists of establishing model pedestrian-oriented development guidelines, urban design guidelines, a model TOD overlay zoning ordinance, station area planning assistance, market studies, marketing, and a TOD point person. In addition, recent TOD-related requests from member cities includes peer city research, guidance on joint development as it pertains to transit projects and TOD marketing support and materials.

City of Phoenix

The city of Phoenix has adopted a comprehensive "Strategic View of Growth" that encourages the containment of sprawl through policies that adhere to the following philosophies.

- Encourage short-term infill of inner city areas;
 - Protect Phoenix's unique desert environment;
 - Target "Growth Area" infill;
 - Link economic development efforts closely with community needs and growth goals;
- and
- Manage long-term employment and residential growth.

The city of Phoenix developed a comprehensive program of policies and regulations to link land use and transportation along the METRO Light Rail corridor. The program demonstrates the commitment to encourage mixed-use development, create compatible land use policies, and emphasize the transit-land use interrelationship. Under METRO's lead, this program was awarded the 2004 Transportation Excellence Award from the FHWA and the FTA. The award was given to communities who demonstrated outstanding initiatives to develop, plan, and implement innovative transportation planning practices

The components of the program include transit-oriented development goals and policies in the land use and circulation elements of the Phoenix General Plan, adoption and mapping of a Transit Overlay Zoning District (TOD-1 and TOD-2) as shown in the Appendix, initiation of a station-area planning program, amendment to the city's building code to increase accessible housing near light rail stations, establishment of a city team at Valley Metro Rail, and creation of marketing tools and development strategies to stimulate and attract transit-oriented development interest in station-area real estate.

These programs all promote mixed land uses, compact building design, walkable neighborhoods, and new housing opportunities for all members of the community. In addition the program is creating development opportunities within close proximity to transportation corridors, encouraging community and stakeholder collaboration, providing a range of transportation and mobility choices, and creating predictable development decision-making conditions by establishing the ground rules for new development.

City of Tempe

The city of Tempe has also developed a comprehensive program of policies and regulations to link land use and transportation along the METRO Light Rail corridor. The city of Tempe amended its zoning and development code in November 2005 to include TODs near the METRO Light Rail. The station area includes parcels within 400 ft (121.9 m) of a station platform, while the overlay district includes parcels within 1,950 ft (585 m) of a station platform or 800 ft (243.8 m) of the right-of-way.

The purpose of the Tempe TOD is to encourage appropriate land development and redevelopment that is consistent with and complementary to the community's focused investment in transit, bicycle, and pedestrian infrastructure in certain geographic areas of the city. Tempe is developing a multimodal transportation system intended to balance the choices people have to move throughout the city, meet the mobility needs of its citizens, and mitigate the impacts of congestion and pollution. This overlay district regulates land uses and establishes development standards in order to prevent developments which would interrupt the transit, bicycle and pedestrian experience. The specific objectives of this district are to

- Promote and develop livable and sustainable neighborhoods;
- Promote and increase the use of alternative modes of transportation such as walking, bicycling, car pooling, and riding the bus or light rail;
- Encourage a mix of uses and balance of densities and intensities within identified activity areas accessible to alternative modes of transportation;
- Provide a quality of urban design that attracts and encourages pedestrian activity;
- Reinforce public investments and private development to achieve a compact form of development conducive to walking, bicycling, and transit use; and
- Provide facilities that create a safe, accessible, comfortable, and pleasant environment for people and maintain safe access for automobiles and minimize conflicts between vehicles and pedestrians.

City of Mesa

The city of Mesa has recently developed the West Main Street Area Plan. This plan is an effort to identify and pro-actively guide the emerging forces of change in the study area. Those changes include, but are not limited to, new development, the arrival of LRT and bus rapid transit in December 2008, the departure of automotive and boat dealerships, as well as turnover of big box users. As a part of this area plan, the city developed a TOD to encourage a rich mix of uses and densities that support the light rail investment and improve the pedestrian nature of the area.

This planning effort resulted in recommendations that reflect the community's vision while guiding the physical development of the area. The plan recommendations identify measures to direct future land uses, infrastructure planning, and community facilities towards the community's shared vision. The plan was adopted by the Mesa City Council in 2007. The Mesa General Plan Goals and Objectives supporting this effort include the following:

- Develop and implement TOD for development and redevelopment along transit routes;
- Provide for a mixture of activities and increased densities within ¼ mi of existing and planned major transit routes and facilities;
- Encourage development along transit routes to relate to the transit line and pedestrians and to provide on-site pedestrian connections; and
- Develop guidelines to encourage pedestrian and transit-oriented development and revitalization.

ECONOMIC DEVELOPMENT OUTCOMES

By assisting in promoting high-quality, more-intensive development on and near properties adjacent to light rail, METRO and its member cities have been directly benefiting from increased economic development via urban infill projects, which will in turn promote new transit ridership. Success is measured by calculating the amount of development adjacent to the light rail. Since 2004, properties within ½ mi (0.8 km) adjacent to LRT have witnessed nearly \$7.4 billion in total investment either recently completed, under construction, or well into the design phase as shown in [Table 1](#). This figure includes \$5.9 billion in private investment and \$1.5 billion in public investment.

**TABLE 1 Summary of Adjacent Development Activity
METRO Light Rail: Phoenix, Tempe, and Mesa, 2009**

Number of projects	180
Public-sector development	\$1,523,550,000
Private-sector development	\$5,863,540,713
Total investment (2009, US\$)	7,387,090,713
Square feet (square meters) commercial	9,205,465 (855,216)
Square feet (square meters) government	148,194 (13,768)
Square feet (square meters) education	671,986 (62,430)
Square feet (square meters) residential	10,511,080 (976,511)
Number of residential units	17,886
Number of hotel rooms	3,260

Public-Sector Development

To compliment the \$1.5 billion public investment into to the light rail starter line, there is a significant amount of investment in a variety of other public sector projects. These projects total well over \$1.5 billion of investment and consist of a biomedical campus, a downtown university campus, and convention center and accompanying hotel, as well as a significant expansion of a community college. These projects are discussed below and shown in [Figure 5](#).

Phoenix Biomedical Campus

Located in downtown Phoenix, a cornerstone development of the Phoenix Biomedical Campus (PBC) is the expansion of the University of Arizona College of Medicine in collaboration with Arizona State University (ASU) Nursing and Biomedical Informatics programs. The next steps for the PBC will include development of a Health Science Education Building of approximately 310,000 ft² (28,799 m²) and a 400,000 ft² (37,160 m²) Arizona Biomedical Collaborative (ABC II) facility. The estimated construction budget for the two buildings is \$470 million. The two facilities represent the future growth of PBC which is estimated to be built out more that 6 million ft² (557,400 m²) of research and academic development including a clinical component.

Translational Genomics Research Institute (TGen)

Since TGen began its operations, numerous achievements and milestones have been reached. In January 2005, TGen staff moved into the six-story, \$52 million facility that set the foundation for continued development of bioscience and medical research in downtown Phoenix ([Figure 6](#)).

Through the years, TGen has collaborated and formed numerous strategic alliances and partnerships which have generated national and international recognition of TGen as a leader in the bioscience industry.

To date, TGen employs approximately 250 staff members, including top scientists and researchers who have been recruited from around the world. In an effort to prepare Arizona students to develop foundational skills as they pursue careers in science or medical-related fields,



FIGURE 5 Economic development outcomes: public and private sector examples.



FIGURE 6 TGen.

TGen launched a summer internship program in 2004 which became funded in 2006 through a partnership with the Helios Education Foundation (HEF). In January 2008, HEF made a \$6.5 million endowment to TGen that will provide funding for the Helios Scholars Program to support the summer internship for the next 25 years.

ASU at the Downtown Phoenix Campus

City of Phoenix and ASU leadership shared a vision of a new Downtown Phoenix campus that would bring higher education, jobs, revenue, and vitality to the urban core. In March 2006 Phoenix voters approved \$223 million in bonds to develop the first two phases of the campus. By August 2006, Phase I opened to a total enrollment of 6,229 students from the College of Public Programs, College of Nursing and Healthcare Innovation and University College.

Fall 2008 marked the opening of Phase II. Enrollment exceeds 7,500 students joined by over 1,200 faculty and staff in approximately 750,000 ft² (69,675 m²) of development. This includes the Walter Cronkite School of Journalism and Mass Communication, KAET Channel Eight, and a privately developed student housing complex that will house up to 1,300 students. At build-out, the campus will accommodate 15,000 students, 1,800 faculty and staff, and 4,000 beds in 1.5 million ft² (139,350 m²) in the heart of downtown Phoenix.

Phoenix Convention Center

In conjunction with LRT completion in December, the convention center recently completed a \$600 million expansion to expand the existing convention center adding 1.7 million ft² (157,930 m²) of new space. With the expansion, the facility can now accommodate 375,000 convention delegates, up from 135,000. Increased populations of convention visitors to the downtown will provide the LRT a large national exposure and ridership.

Sheraton Phoenix Downtown

To compliment the public investment in the Phoenix Convention Center, the Sheraton Phoenix Downtown was completed in October 2008 to become the first new hotel in downtown Phoenix in over 30 years (Figure 7). The Sheraton is a \$350 million high-rise convention hotel, located at the northeast corner of Van Buren Street and Third Street in Downtown Phoenix, adjacent to the Phoenix Convention Center and the Arizona Center office–retail complex. At 31 floors it has surpassed the Hyatt Regency Phoenix, at 24 floors, as the tallest hotel tower in Phoenix .

The hotel consists of 1,000 rooms, a 6,500-ft² (604-m²) fitness center, a 2,000-ft² (186-m²) outdoor pool and sundeck, 80,000 ft² (7,432 m²) of flexible, state-of-the-art meeting space including a 29,000-ft² (2,694-m²) ballroom and a 15,000-ft² (1,394-m²) junior ballroom. In addition, there are 16 meeting rooms, two boardrooms, and a terrace for outdoor events.

GateWay Community College

Located east of downtown along the city of Phoenix's "Opportunity Corridor," there is also significant public investment occurring at the GateWay Community College (GWCC). The campus master plan calls for the creation of a 65,000-ft² (6,039-m²) conference center, a new student services center, new classrooms, library, lab space, and computer commons, as well as a new wellness center.

An agreement has been reached between the city of Phoenix and GWCC on the business terms for the development of a minimum of 5,000 ft² (465 m²) of Wet Lab on its campus. GWCC commits to design and construct the Wet Lab and will lease the Wet Lab Space at below-market rates as validated by the Greater Phoenix Economic Council.



FIGURE 7 Phoenix Convention Center (foreground) and Sheraton Phoenix Downtown (background, left).

Private-Sector Development

In addition to the significant public-sector investment, there has been a tremendous amount of private-sector investment along the LRT corridor. As mentioned, the private-sector developments include nearly 16,000 residential units and over 10 million ft² (929,030 m²) of commercial space. The types of developments range from small scale low-rise developments to high-rise projects, office conversions to historic renovations, and downtown to urban redevelopment projects. Just a few of these projects are outlined below and shown in Figure 5.

Metro Manor

Located near the Montebello end-of-the-line LRT station in northwest Phoenix at 19th Avenue and Missouri, this development consisted of 26, two-story, 1,850-ft² (172-m²) condominium units. This project is the first of its kind in an area of the alignment that is ripe for redevelopment and adjacent to the recently renovated Phoenix Spectrum Mall. This project was completed in the summer of 2007.

Century Plaza

Located in Central Phoenix at Central Avenue and Osborn, this development consisted of a conversion of mid-rise office space to residential condominiums ranging in size from livable 650

to 5,000 ft² (60 to 465 m²), with a total 150 ownership condominium units. This project was completed in spring 2008.

Tapestry on Central

Located adjacent to the Willow Historic District of Phoenix, this three-building, seven-story, 280-unit community high-rise is on the northwest corner of Central Avenue and Encanto Boulevard. Tapestry on Central offers two-story units, in a variety of one- and two-bedroom floor plans, ranging from approximately 837 to 2,500 ft² (78 to 232 m²). This project was completed in 2007 (Figure 8).

Portland Place

Located at Central Avenue and Portland Street, Portland Place is a three-phase residential development with over 250 condominium units. The first phase, which opened in 2007, consists of 54 ownership condominium units ranging in size from 1,500 to 3,200 livable ft² (139 to 297 m²), with over 8,500 ft² (790 m²) of commercial space. Phase II and III will be completed by 2011.

44 Monroe

44 Monroe is a 34-story, 202-unit, high-rise condominium tower just off the heart of Downtown Phoenix. It is located at the corner of 1st Avenue and Monroe with the south bound light rail line running right outside its front door. Floor plans start at 993 ft² (92 m²) and expand to 4,406 ft²



FIGURE 8 Tapestry on Central (right).

(409 m²). The ground floor of 44 Monroe is reserved for a gourmet market for groceries, wine and other necessities. Construction began November 2005 and the first condo owners began taking possession of their homes at the end of 2008.

CityScape

CityScape is a mixed-use, multidimensional development that combines residential, retail, hotel, office, public park space, and more into one central and cohesive project. The project encompasses two lineal blocks in downtown Phoenix. The boundaries are: 1st Avenue to the west, 1st Street to the east, Washington Street to the north, and Jefferson Street to the south. The project is adjacent to the U.S. Airways Center and within two blocks of Chase Field. The LRT runs on three sides of the project with two nearby rail stations providing convenient access. Construction on CityScape began in October 2007 with the first phase slated to open late 2009. The project will be built out over several years based on market demand, with most construction planned to be completed by 2012 (Figure 9).



FIGURE 9 CityScape.

Papago Gateway Corporate Center

Papago Gateway Center is a 260,000-ft² Class A development that will be a key contributor to the economic growth of Tempe, Arizona, by bringing the city its first commercial biotechnology–laboratory and LEED certified corporate office facility.

This project was completed in January 2008. The building was designed to capture the amazing views of Tempe Town Lake to the south and the Papago Park Buttes to the north and to take advantage of its proximity to light rail. The campus is being built on the prominent 5-acre site at the northwest corner of Mill Avenue and Washington Street, a gateway to the city of Tempe, Papago Park Center, and Arizona State University.

Hayden Ferry Lakeside

Hayden Ferry Lakeside is a master-planned mixed-use project on a 43-acre waterfront site in downtown Tempe, Arizona—at the geographic center of Metropolitan Phoenix. The mixed-use components include condominium and apartment residential, Class A office space, and numerous commercial development space including a plaza-level restaurants and retail space in three mid-rise towers, a full-service hotel, and luxury residential condominiums totaling 380 units. Now, the planned Bridge to Bridge expansion will increase the scope of the project to more than 40 acres (161,864 m²), spanning the entire shoreline between the crossings at Mill Avenue and Rural Road. With new development scheduled to continue into 2009 and 2010, Hayden Ferry Lakeside is destined to be a focal point of office, residential, and commercial activity for years to come.

Grigio METRO

The first traditional public–private partnership along the LRT, Grigio is a planned mixed-use project consisting of approximately 408 high-end multifamily residential apartment homes, approximately 16,000 ft² (1,486 m²) of specialty retail space and a parking structure containing approximately 956 spaces, including 300 designated to the LRT system (Figure 10). Grigio will have a mix of one-, two-, and three-bedroom apartment homes.

SECRETS TO SUCCESS

This level of investment within close proximity to the light rail alignment was made possible through a variety of means. These include a common development vision between the public policy makers and the private developers. The amount of investment would not have been realized without the public policies and programs mentioned earlier, as well as significant interest by the private sector. The cooperation and vision by both entities was instrumental in gaining this much investment in the urban core.

Additionally, the Phoenix metropolitan region historically grew outwards from the urban core in a low-density pattern into the vast desert. This development pattern resulted in an abundance of single-family residential homes served by low-density strip retail centers. Over time as the region grew in population, an incredibly high market demand developed for alternative development prototypes. This unmet demand was fueled by a desire for urban living at or near the new LRT line.



FIGURE 10 Grigio METRO.

Another major advantage was the physical viability and size of the properties in close proximity to the light rail. The region's history of low density development patterns also led to many large underutilized properties within the urban core, often under single ownership. These parcels were even available in downtown Phoenix and north along Central Avenue. One of the primary issues with developing transit-oriented projects is finding physically viable parcels of land.

Lastly, the LRT alignment joins together the Phoenix downtown and midtown areas, as well as ASU and Mill Avenue district in Tempe, which have a significant amount of density and intensity within close proximity to the alignment. Within these dense areas of the region, the majority of the economic development outcomes are also concentrated in these areas. Over 80% of the \$7.4 billion of development activity adjacent to the light rail alignment is located in these areas.

RECOMMENDATION

One of the most important reasons for a transit agency to play a proactive role is the connection between promoting transit supportive land uses is the recognition that those land uses result in additional transit ridership. Section 5309(d) of federal transportation statutes, more commonly known as the New Starts Program, is a highly competitive system for allocating major capital project grants. As part of the New Starts evaluation process, the FTA recognizes transit-supportive land uses as a significant contributor to successful transit systems. METRO's role as a transit agency was to play an integrated role and assist the three land use authorities in establishing transit supportive land use policies and programs early on in the FTA New Starts project development phase. A transit agency playing a proactive role is key in bringing additional riders to the new system.

WHAT'S NEXT AND CONCLUSIONS

This paper focused on the METRO light rail starter line, the policies and programs the cities in the region enacted to encourage development adjacent to LRT, and a snapshot of developments that are occurring. After LRT operations begin, on-going analysis of the transit-oriented development investments will be conducted as the system matures.

Specifically, as the system matures over the first 2 years, the following research questions will be addressed in order to get a better understanding of the impact LRT has on private investment:

- Compare increases in valuation of property within a ¼- to ½-mi (0.4- to 0.8-km) adjacent to LRT stations as compared to properties not adjacent to LRT (control group) since 2000.
- Were there changes in occupancy and lease rates for properties adjacent to LRT stations compared to control group properties?
 - Were there development projects or portions of the new projects adjacent to LRT stations that can be attributed to LRT?
 - What portion of increases in sales and/or excise tax revenues may be attributed to LRT?
 - How did developers include the location of LRT in their decision to develop the project (interviews)?
 - How did business tenants include the location of LRT in their decision to lease space (interviews)?
 - What was the experience in other metropolitan areas with light rail systems?

This data will give METRO and its member cities an accurate measure of light rail's effect on various economic development measures critical to the region over the long term and help further promote development along the LRT system.

REFERENCES

1. Valley Metro Rail, Inc. *Final Environmental Impact Statement and Section 4(f) Evaluation, Volume 1 of 3*. Central Phoenix–East Valley Light Rail Project, 2002, pp. S-15–S-16.
2. Maricopa Association of Governments. *Regional Transportation Plan, 2007 Update*. 2007, pp. 10-7–10-9.
3. Valley Metro Rail, Inc. *Making the Case Document*. Central Phoenix–East Valley Light Rail Project, 2003, pp. 1–7.
4. Valley Metro Rail, Inc. *FY2005 Section 5309 Annual Report on New Starts, 20-Mile Minimum Operable Segment*. Central Phoenix–East Valley Light Rail Project, 2003, pp. ES-1–ES-3.

STATIONS, STOPS AND ARTS IN TRANSIT

Los Angeles County Metropolitan Transportation Authority
Eastside Extension Light Rail Transit Project
Cultural Influence in Station Site Selection for the
Boyle Heights–Mariachi Plaza Station

KRISHNIAH MURTHY
DENNIS S. MORI

Los Angeles County Metropolitan Transportation Authority

The \$898.8 million Metro Gold Line Eastside Extension Light Rail Project is a 6-mi light rail line running mostly at grade from Union Station in downtown Los Angeles to East Los Angeles, California. It will connect directly with the Pasadena Metro Gold Line at Union Station and will serve the ethnically diverse and culturally rich communities along the route, including the Little Tokyo–Arts District, Boyle Heights, and East Los Angeles. There are six at-grade stations and two subway stations, where the at-grade alignment proceeds underground beneath Boyle Heights for 1.7 mi of tunnel alignment. The 6-mi Metro Gold Line Eastside Extension Light Rail has an estimated one-way trip time of approximately 20 min from Union Station to Atlantic Station and vice versa (Figure 1). Construction began in July 2004 and revenue operations are scheduled for the end of 2009.



FIGURE 1 Map of Metro Gold Line Eastside Extension Light Rail Transit Project.

After many traffic surveys, community input, right-of-way consideration, linkages to other parts of the neighborhood, and potential for transit-oriented development, each station location was chosen. Special attention was given to the design of each station location, taking into account the history and culture of its respective neighborhood. East Los Angeles has gone through many cultural shifts, beginning with the influx of Chinese immigrants, then Jewish immigrants, and most recently, Hispanic immigrants, who now make up the majority of the population residing in the area. The East Side Light Rail from Union Station to Atlantic Station takes its riders through a historical tour of Los Angeles. It begins at Union Station, the last in a series of grand gilded train stations that were built in America before World War II, traveling through Little Tokyo, a reflection of the culture and the roots of the Japanese living in the Los Angeles area, and then goes over the historic First Street Bridge, built over the rail road tracks and the Los Angeles river, and finally lands in Boyle Heights, a predominantly Hispanic neighborhood.

In 2000, the Los Angeles County Metropolitan Transportation Authority (Metro) designated Mariachi Plaza as the site to construct one of two underground stations in Boyle Heights for the Metro Gold Line Eastside Extension Light Rail Project. A key station along the alignment, the Boyle Heights Mariachi Plaza station is part of the project's subway portion that was designed to preserve the narrow, curving roads in Boyle Heights. It is located at the intersection of 1st Street and Boyle Avenue at the site of the Mariachi Plaza de Los Angeles Avenue (Figure 2).

The design of the plaza incorporates elements of the surrounding urban environment and culture and provides the community with added accessibility to existing businesses, residences, and institutional buildings that are within immediate walking distances from the entrance plaza. To construct this station, the public street right-of-way needed to be closed and the redesignation of Mariachi Plaza De Los Angeles Avenue (previously known as Pleasant Avenue) to a pedestrian mall was necessary. The closure allowed Metro to extend the Mariachi Plaza station entrance into this area in order to provide a station portal containing two electric escalators, a staircase, and an elevator.



FIGURE 2 Aerial view of Boyle Heights–Mariachi Plaza Station at 1st Street and Boyle Avenue.

BOYLE HEIGHTS–MARIACHI PLAZA

Mariachi Plaza is a dedicated cultural center built in 1998 through the efforts of the office of Los Angeles City Council District 14, the Department of Cultural Affairs of the City of Los Angeles, the Department of Public Works of the City of Los Angeles, and Metro. The construction of Mariachi Plaza was based on the donation of a kiosk by the state of Jalisco, Mexico. The donation of this kiosk was to honor and encourage mariachi music and Mexican folklore in the city of Los Angeles.

Today, Mariachi Plaza is used by mariachi musicians as a place to find work and by the city of Los Angeles to host the Mariachi Festival held every year in the month of November. This is an annual community festival coordinated by the Office of Los Angeles Council District 14 and the Department of Cultural affairs. The festival features mariachi music and provides information on the city of Los Angeles and other public services.

BOYLE HEIGHTS–MARIACHI PLAZA STATION: URBAN DESIGN AND COMMUNITY LINKAGES

The design of the Boyle Heights–Mariachi Plaza station draws from the significance of the cultural landmark within this densely populated Hispanic community. In 1995, Metro conducted a cultural needs assessment in response to the message that emerged through public hearings and meetings with local residents and their elected representatives. The common understanding and consensus was that the eastside extension could not just be assessed as another mass rail transportation project, but rather, as the most crucial East Los Angeles transportation infrastructure to date. As such, a careful and comprehensive planning and community participation program had to be established.

The Transportation Community Linkages Program was created and simultaneously launched as the environmental planning and preliminary engineering began. The program included a number of objectives to expand the linkages to the local community. One of the objectives was to ensure that the station and public spaces were designed and built with creative and community sensitive architectural and art elements. The cultural needs assessment became a planning document to assist the architects and artists in the design of the station interior, portal, and public spaces around the station.

STATION ARCHITECTURE AND ARTWORK: CONCEPTUAL DESIGN AND PRELIMINARY ENGINEERING

The cultural needs assessment highlighted the rich and diverse history and demographics of East Los Angeles and its role as the gateway and a first home for many people. In the manner that East Los Angeles became a portal for people who were new to the area, the station entrance portals needed to be designed to fit within the community in a way that invited riders to visit and discover cultural landmarks and businesses. In working towards this goal, Metro, through its Planning and Art Program, selected the station architects and artists to work together in a collaborative effort to join their creative forces from the beginning of the station design process.

Lead architect Frank Villalobos, FAIA (Barrio Planners, Inc.) and artist Alejandro De La Loza were selected for the conceptual design and preliminary engineering for the Boyle Heights–Mariachi Plaza station. Both the architect and the artist grew up in the Boyle Heights and East Los Angeles area and are highly regarded for their other past and current projects within the community.

Architectural Influences from Historic and Cultural Landmarks

The historic landmarks at the 1st Street and Boyle Avenue Intersection are a testament to the deep-rooted history of Boyle Heights. Located across the street from the station entrance plaza is the Cummings Building, which was erected in 1895. This intersection at 1st Street and Boyle Avenue, named after the musicians who frequent the plaza, was a crossroads when Boyle Heights first began to prosper in the late 1880s. On the weekends, music can often still be heard from the plaza’s traditional kiosk. The station’s plaza area incorporates the Mariachi Plaza, a location that has been an informal gathering place for Mexican mariachis and trios for decades. In keeping with this tradition, a large open ornate plaza will incorporate the existing kiosk or “kiosko,” donated in 1998 by the city of Guadalajara, Jalisco, Mexico, to continue featuring mariachi groups and other performers.

Integrated Architecture and Artwork Station Design

Passengers will enter the station at the northwest corner of 1st and Bailey Streets. It is here that the station embraces the flavor of Mexico represented by the Mariachi Plaza kiosk. The urban design of the Mariachi Plaza station complements the existing Mariachi Plaza kiosk by introducing visual designs expressive of Mexican and mariachi culture in the paving, canopy over the portal, and the elevator shaft. The station entrance and canopy, plaza elevators, and plaza paving also include colorful icons, symbols, and finishes representative of Mexican or Mariachi culture. The shape of the main canopy draws inspiration from the fan used by Mexican folkloric dancers. The main support is designed to represent the string bridge of the violin; the main Mariachi musical instrument. The station plaza can serve as a gathering place for the community and for Mariachi performances (Figure 3).



FIGURE 3 Artist’s rendering of Mariachi Plaza Station.

The plaza has been conceived as an urban garden, with trees and benches where people can stroll and gather. A tree-lined walkway connects the kiosk to the Mariachi monument: an obelisk with bronze sculptural reliefs. Inspired by the famous Mexican song “El Nino Perdido” (the Lost Child), the bronze echoes the song’s call for the lost child, his answer, and the happy reunion. The design of the paving pattern symbolizes the flow of the dress created by the dance movements of Mexican folk dancers.

The thematic elements continue from the roof of the plaza elevator enclosure that is designed to represent a “zarape,” a colorful Mexican blanket floating over the steel frame and tempered laminated glass enclosure with pre-cast concrete columns and sandstone finishes at all four corners. From the plaza to the mezzanine of the underground station, a skylight illuminates the bottom of the stairs, and passengers descending into the station are greeted with warm tones and dramatic lighting. The design of the floor is a continuation of the festive and energetic concept of the plaza level. The colorful floor pattern is inspired by typical decorations at Mexican festivals and mariachi musician clothing ornamentation.

CONCEPTUAL AND PRELIMINARY DESIGN BECOME DESIGN-BUILD

Project development for Metro’s major capital projects involves joint management by two departments and a hand-off between planning–environmental–preliminary engineering and the final design–construction phases of the project. Project management responsibilities are transferred from the Metro Countywide and Regional Planning Division to the Construction Capital Management Division after the Metro board of directors adopts the locally preferred alignment and the environmental certification for the project is completed. To ensure continuity, a general engineering consultant was retained for conceptual, preliminary, and final design and the development of the solicitation documents for the construction phase.

In 2002, Metro awarded a consultant contract to Eastside LRT Partners, a joint venture of Parsons Brinckerhoff, Quade & Douglas, Jenkins, Gales and Martinez, and Barrio Planners, Inc., to complete conceptual engineering, preliminary design and to prepare design-build solicitation documents for the Metro Gold Line Eastside Extension Project. During the preliminary design phase, the Barrio Planners, Inc., station design team led by Frank Villalobos and station architect William Villalobos developed a theme for the station, which became a tribute to the Mariachi musician and its associative culture. The architect presented several design concepts that complemented the cultural theme of the surrounding neighborhood and met the approval of the Eastside community. These concepts, which include recommended finish materials, plaza landscape, and street furniture, were specified in the design–build contract in the form of scope drawings and project specific requirements.

Similarly, the artist, Alejandro De la Loza, was commissioned during the preliminary engineering phase, in advance of the design–build contract. The artist was selected as part of Metro’s Art Community Advisory Group Program. The artist and the architect collaborated on art opportunities and concepts which were consistent with architectural or community themes and could be implemented during the design–build phase. In the case of Mariachi Station, aesthetic locations were identified in the scope drawings for the placement of several artist-furnished bronze and granite sculptures and floor medallions that were representative of those themes.

On the Metro Gold Line Eastside Extension Project, a hybrid contract delivery method was utilized in which design–bid–build was used for the tunnels and underground station excavations and design–build for the stations, civil, systems, and track work. This decision was based on a risk assessment and the project schedule requirements. Under the hybrid contract delivery method, careful consideration was given to the level of mandatory and prescriptive requirements so as not to inhibit the designer–builder’s innovation, yet maintain a balance to ensure that the quality and sensitivity of the station design elements were met.

In June 2004, a contract was awarded to the Eastside LRT Constructors (ELRTC), a joint venture of Washington Group International, Obayashi Corporation, and Shimmick Construction. Under the design–build contract, ELRTC retained DMJM Frederick Harris as the final design subconsultant, who began the final design of the eight stations in 2005. The design–build contract called for the designer–builder to finalize the design, including the Mariachi architectural themes and art concepts above, in several different phases—schematic design, 85% design, and 100% design.

As a part of this design–build process, there were contractual requirements for continued collaboration between the architect and the artist from the preliminary engineering phase. In addition, the contract called for making a final design presentation to the Review Advisory Committee (RAC), which allowed for any final input or approval from the community. Once the 100% design was completed, issued for construction (IFC) drawings were issued for erection in the field and for the development of shop drawings and product data. ELRTC began the schematic design for Mariachi Station and by June 2006, the 100% design was complete, which also included RAC approval. The IFC drawings were issued in October 2006. The architect from the preliminary engineering phase continues to be engaged in the project in the review of shop drawings and product data for architectural finishes, such as the precast concrete wall elements that will match the existing kiosk (Figure 4). The artist also continues to be involved with the coordination of the sculpture installations and their connection to the station structure.

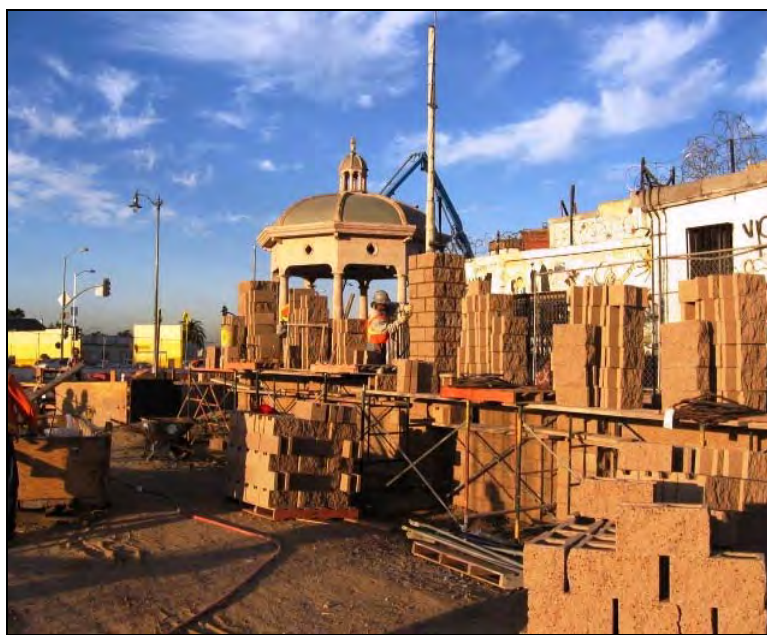

FIGURE 4 Mariachi Plaza Station during construction.

As part of the review and approval process, Metro continues to make presentations at the monthly community RAC meetings to provide construction updates and receive community feedback and provide detailed information the various station designs. Currently, all eight stations are in construction and will be substantially completed by spring of 2009. The Metro Gold Line Eastside Extension Project will open for service before the end of 2009.

Operations Planning *Coping with Change*

OPERATIONS PLANNING: COPING WITH CHANGE

Route 100

The Future in Motion

JOHN F. CALNAN

Southeastern Pennsylvania Transportation

The Philadelphia and Western Railway Company (P&W) commenced passenger service in 1907 linking the Pennsylvania communities of Upper Darby and Strafford. This standard gauge, grade-separated railroad was constructed to extraordinary standards for its day with moderate grades and curvature. Electric traction power was and still is drawn from a third rail. The P&W was conceived as a small link of a larger failed dream of creating a transcontinental railroad. In 1912, a branch line was built from Villanova to Norristown, which in time became the “main line.” Concurrently, Lehigh Valley Transit (LVT) also operated revenue service between Allentown, Norristown, and Upper Darby via the P&W line, making limited stops. For the next 37 years both P&W and LVT operated high-speed interurban service. Except for Norristown, all P&W stations were constructed as high-level platforms, and the on-street stop in Norristown was replaced by a modern elevated terminal in 1931. In 1949, LVT discontinued service between Norristown and 69th Street Terminal, and all rail operations ceased in September 1951. The Philadelphia Suburban Transportation Company, better known as the Red Arrow Lines, acquired P&W in 1954. Service to Strafford was discontinued in 1956. Since 1970, the operation under SEPTA continues to move people quickly and efficiently through Delaware and Montgomery Counties, as highlighted in [Figures 1, 2, and 3](#).

Beginning at 69th Street Terminal, just beyond Philadelphia’s western border, the railroad is double-tracked for nearly 13 mi (21 km) where a $\frac{3}{4}$ -mi (1.2 km) single-track bridge crossing of the Schuylkill River leads the line to its northern terminus in downtown Norristown. Schedule makers had a great deal of flexibility, as the railroad was mostly doubled-tracked with strategically placed crossovers, along with two island-style turnback tracks. What made the flexibility achievable was the fact that the railroad was designed and constructed to extremely high standards, and most importantly, the equipment operated on the railroad regularly achieved speeds of 70 mph (113 km/h). The operating equipment was known as Bullet and Strafford cars, and were the products of the J.G. Brill Car Company built between 1926 and 1931 (see [Figure 4](#)). [Figure 5](#) depicts a service map of the Norristown High-Speed Line.

Between 1950 and the 1980s, a multitiered rush hour schedule was operated consisting of a series of limited, express, and local service. However, despite superior headways and the introduction of first-class Liberty Liner service in 1964, the Norristown High-Speed Line was having difficulty competing with sprawling land development and the resulting environment designed strictly around the automobile. The rapid construction of suburban residential communities beyond the first ring suburbs, along with shopping malls, office parks, and other commercial ventures, resulted in a slow, downward spiral in ridership. Also worth noting is that suburban developments affected Philadelphia’s demographics as the region concurrently shifted from manufacturing to service sector-based employment. Philadelphia had begun to lose its influence as a primary working destination for suburban commuters. Transit strikes under Red



FIGURE 1 SEPTA service territory showing Route 100.

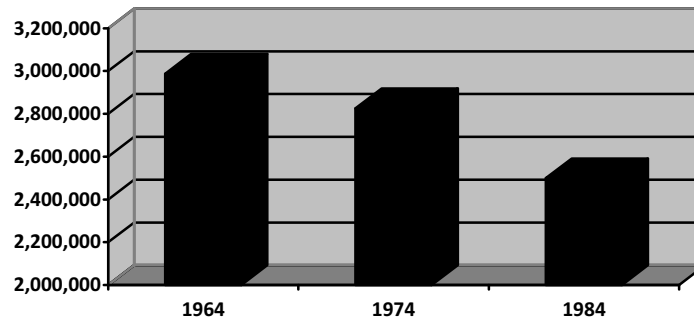

FIGURE 2 Route 100 annual ridership.

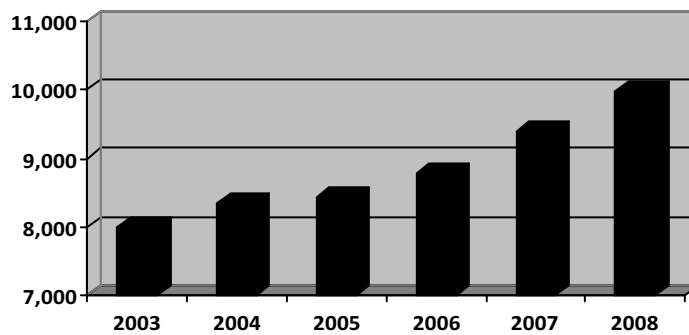

FIGURE 3 Route 100 average weekday ridership from 2003–2008.

Arrow Lines management in 1963, and under Southeastern Pennsylvania Transportation Authority (SEPTA) in 1975, 1977, 1981, and 1986, along with several fare hikes did not create a stable comfort level for riding SEPTA which further affected patronage, thus translating into gradual service reductions. Liberty Liner service was discontinued in 1975 and Limited service to–from Norristown faded away by 1980. Between 1964 and 1984, Route 100 lost 488,000 annual passenger trips, and in 1986, weekday ridership averaged 9,300 passenger trips.

When service commenced in 1907, the predominant direction of travel during rush hours was the traditional peak-direction commute to 69th Street Terminal, with a transfer to downtown Philadelphia via the Market Street Subway Elevated (El) Line in the morning, and reversing the pattern in the afternoon. Beginning in the 1970s and continuing in the mid-1980s the passenger flow gradually shifted to become principally reverse commuting. The reverse commute phenomenon initially reflected intense office development near Radnor Station, but also service sector employment at Bryn Mawr Hospital. Extensive land developments in the municipalities of Upper Merion, Tredyffrin, and Norristown attributed to new work and shopping trips. Passengers made transfers to connecting bus routes at Gulph Mills, King Manor, and Norristown.

When SEPTA took over the Red Arrow Lines in February 1970, the Authority inherited a high-speed railroad whose infrastructure would require serious capital outlay to bring it to a state of good repair and remain viable. Complicating matters was that when SEPTA was created by the Commonwealth of Pennsylvania in 1964, the Authority did not receive predictable, dedicated funding. In time, overall budget tightening strategies adopted during the 1970's and 1980s in order to strictly survive, combined with attention focusing on other urgent capital needs, would eventually affect all aspects of Route 100.

The perfect storm culminated during the 1980s as an unfortunate series of mechanical woes and vehicular collisions began to take its toll on Route 100. The most serious incident occurred in November 1986, as a vehicle crashed into the terminal building at 69th Street. This accident caused the temporary cessation of rail service, which was replaced with shuttle buses. This accident hastened the doom for the aging fleet of Depression-era trains.



FIGURE 4 SEPTA “Bullet” car (1931–1990).



FIGURE 5 Route 100 (Norristown High-Speed Line) map.

When service resumed, a transitory weekday peak hour schedule was developed that operated a combination of rail and substitute bus service. Service levels needed to be reduced because there was not enough equipment to operate full rail service. Rail service operated express between 69th Street Terminal and Rosemont then continued in local service to Norristown, while buses operated local service between 69th Street Terminal and Garrett Hill. All off-peak service continued to be operated by rail. When full rail service was restored in mid-1987 the multi-faceted, frequently-scheduled peak hour service to several outlying destinations using a combination of express and local service was reduced to a simplistic system of Norristown Express and Bryn Mawr Local trips. After the accident and subsequent resumption of service, weekday ridership fell to 6,500 trips per day. SEPTA purchased 1950s vintage Chicago Transit Authority (CTA) President's Conference Committee-type "L" cars to supplement the aging fleet. The CTA cars provided the ability to schedule express service; however, their operating speeds were far slower than their "senior" counterparts as the top speed of these cars was 45 mph (72 km/h). A one-way trip to Norristown with CTA cars required 7 to 10 min of additional travel time.

By June 1990, the last of the venerable Bullet and Stafford cars were retired after 60 years of service. Schedules were subsequently modified to operate an all-local operation, as there were not enough CTA cars to provide local and express service. Fortunately, this car shortage issue was resolved by January 1991 as surplus cars were borrowed from Route 100's main feeder, the Market–Frankford Line. Five vintage single-unit cars built by the Budd Company in 1960 were acquired for the primary purpose of providing Bryn Mawr local and midday service to Norristown. These broad-gauged subway cars were converted to standard gauge, as SEPTA purchased surplus trucks from the Port Authority Trans Hudson. By April 1995, 26 modern N5 cars built by Asea Brown Boveri were delivered and placed in revenue service.

TRANSFORMATION OF A RAILROAD

The N5 cars were a vast improvement in both passenger comfort and operating speeds versus the CTA and elevated equipment. The seating capacity can accommodate 60 passengers and 40 standees, an increase of 25%. The seats are wider and plush. An improved climate control system provides uniform heating and air conditioning. Operating speeds improved from 45 to 70 mph. In terms of safety, each car is equipped with full cab signaling and automatic train control. The equipment and the operation in general can be classified as light rail rapid transit, as Route 100 is characterized by fully exclusive right-of-way, complex train control systems, short headway capabilities and floor-level boarding (Figure 6).

In tandem with the acquisition of the N5 cars, a major capital improvement program was underway for Route 100. New track, ties, third rail, interlockings, communications system, reconstruction of the maintenance shops, renewal of the substations, the upgrade or replacement of several pedestrian and highway bridges, and renovation of the viaduct connecting Bridgeport with Norristown, were all part of a \$160-million infrastructure package. The 1930s terminus in Norristown, located at the intersection of Main and Swede Streets, was replaced by a multimodal Transportation Center facility linking seven bus routes and two rail lines. The Route 100 rail terminal contains two tracks that allow car storage and the ability to operate tighter headways.

The replacement of the automatic block signals with cab signals was a key component in the rebuilding of the railroad. The development of the cab signal system was predicated on the



FIGURE 6 SEPTA “N5” car.

operating schedules effective in the early 1990s where rush hour service consisted of 15-min service to Norristown and 15-min service to Bryn Mawr, and it was designed to safely space cars apart in order to prevent collisions in revenue service. Eight blocks per hour were scheduled between 69th Street and Bryn Mawr and four blocks per hour between Bryn Mawr and Norristown Transportation Center (TC). The spacing of the impedance bonds were placed 2,400-ft apart, except at the following interlockings: 69th Street, Bryn Mawr, Radnor, and Bridgeport. Implementation of the cab signal system was gradually phased into service. During each cut-over period operators had the ability to engage or bypass cab signal operations when cars ingressed or egressed into automatic block signal territory. Presently, operators do not have the authority to cut out the cab signal unless instructed by the control center.

By 1995, patronage slowly inched its way upward to 7,000 weekday trips, mostly due to reverse commuters. Riders from Philadelphia had become a dominant force in the line's slow rebound. While Route 100 offered quick and frequent service, the scheduled span of service made the line attractive for individuals working service-sector jobs in Delaware and Montgomery Counties, particularly second and third shifts.

During the modernization of Route 100, plans were formulated to transform Radnor Station into a three-track station similar to Bryn Mawr. Concurrently, a new operating schedule was formulated to operate four classes of service (Norristown Express, Radnor Express and Local, Bryn Mawr and Wynnewood Road Locals). While the cab signals were designed with the ability to accommodate the third track, the capital funds were unavailable to widen the right-of-way in order to reconstruct the station, thus the service plan was never executed.

POST N5 SCHEDULE ADJUSTMENTS

A series of peak hour schedule experiments were undertaken beginning in April 1995, taking advantage of the increased speed of the new cars versus the venerable rapid transit equipment previously used. Some trips were scheduled to terminate at Radnor to address overcrowded Norristown Express trips. While these Radnor trips helped to alleviate crowding in the northbound direction, the schedule in the southbound direction was negatively impacted when trains crossed over. The new cab signal system caused southbound trains in motion between Hughes Park and Radnor to severely reduce speed, or the cars automatically performed

emergency braking applications. One controller was assigned to oversee the operations, and during rush hours this individual was busy resolving issues and trying to restore order from chaos. Additionally, the lone controller also had the responsibility of monitoring trolley operations on Routes 101 and 102. Further schedule experimentation of the Radnor trips, along with sending trips to Bridgeport, proved futile as cab signal and control center issues were still commonplace.

When the cab signals were activated in 69th Street Terminal a southbound car could enter any track and either pull into berth B or berth A (Figure 7). The operational mode was set as automatic instead of manual. If a car is stationed at berth B another train has the ability to stop at berth A. However, this feature has a serious drawback, in that if a car is positioned at berth B, a two-car train can receive a clear signal to enter the occupied track thus creating an operational nightmare that could foul the terminal. The cab signal system cannot distinguish between a single car and a multiple-unit train. To settle any possible issues, operators had orders to contact the control center before moving from berth B to berth A. Yet in time, the control center staff did not desire to be contacted each time a car was ready to depart from the berth, and so the use of berth B was nixed on a full-time basis. Changing the cab signal system mode to manual operation was not given consideration. Consequently, the design specifications of the signal system under operating conditions appeared to more automatic than automated in nature.

October 1996 marked the resumption of operating the pre-1995 peak hour service patterns of Norristown Express and Bryn Mawr Local. Unfortunately, the cab signal system was not designed for any type of schedule flexibility for turning trains other than Bryn Mawr and Norristown. Innovative operational practices to expedite train movements were not successful. Weekday peak service to Norristown was adjusted to every 12 min, from every 15 min, in an attempt to accommodate the ever-increasing reverse peak crowds. Two-car trains were scheduled on many of the Norristown trips.

The Norristown High-Speed Line once prided itself on speed and efficiency using primitive communication systems, automatic block signals, hand-thrown turnouts, and utilized an operating schedule that had a Neapolitan flavor. The schedule that once gave the route pizzazz was now replaced with a plain vanilla flavor.

GRADUAL GROWTH

Between 1995 and 2003, average weekday ridership gradually increased, mostly due to rapid land use developments of office parks and shopping centers in municipalities located along or within close proximity to Route 100 stations, attracting more reverse commuters to the line. In 1997 weekday ridership averaged 7,300 and by 2000, weekday patronage reached 7,700. Peak direction patronage, mostly boarding at stations south of Ardmore Junction, had begun to return to the line although the percentage of reverse commuters still dominated. Weekday ridership surpassed 8,000 passenger trips by 2003 as gasoline prices consistently averaged over \$2 per gallon throughout southeastern Pennsylvania. Weekday scheduled rush hour service was operated with two-car trains in express service to Norristown with single-car local trains to Bryn Mawr. This pattern and equipment assignment had been the status quo since 1996. The express service was the traditional non-stop service to Bryn Mawr with a stop midway at Ardmore Junction.

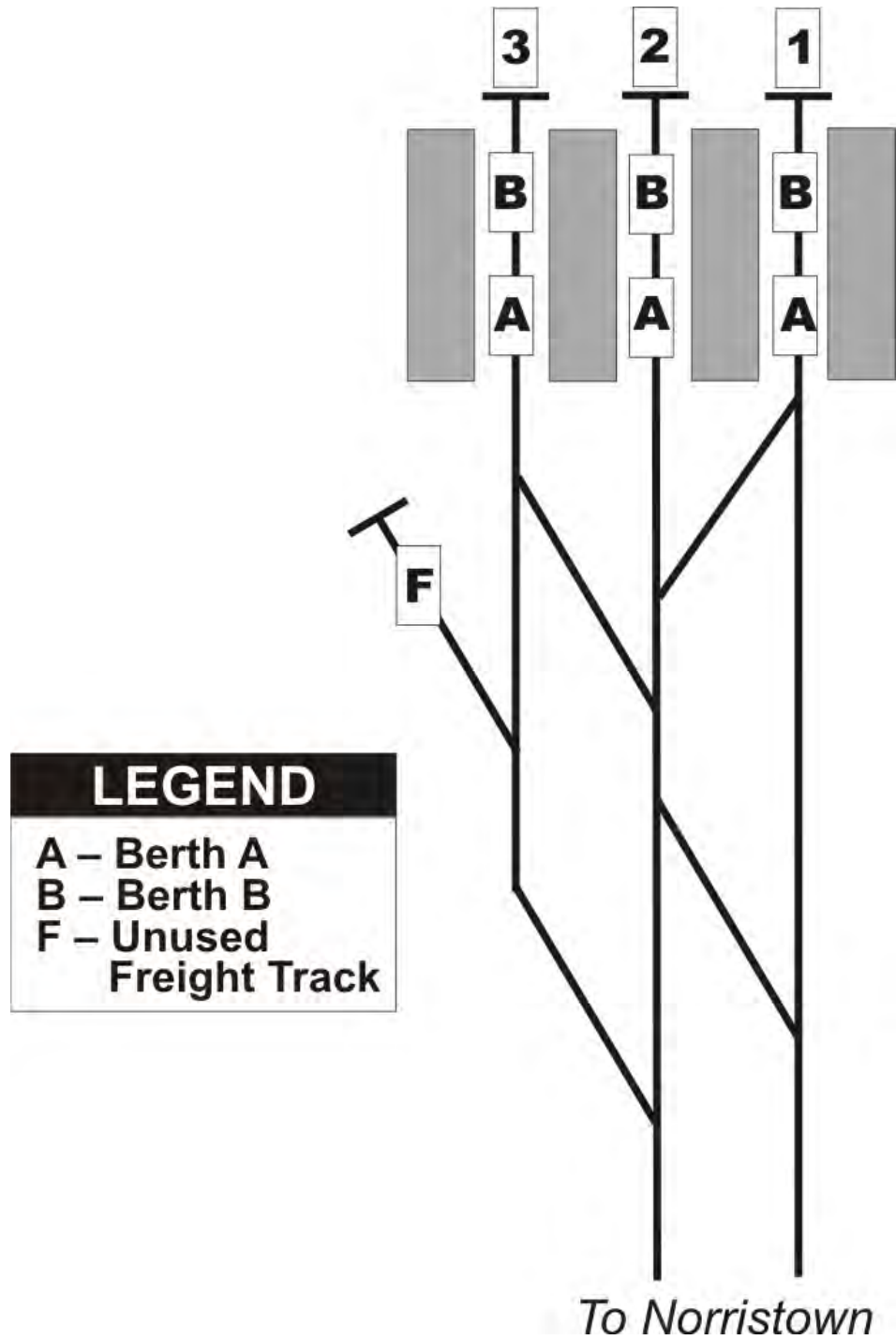

FIGURE 7 Track diagram of 69th Street Terminal.

From a casual glance, the operation had the appearance of a well-oiled machine, yet when examining the entire operation under a microscope there were serious issues that were bubbling to the surface. The two-car train operation alleviated some crowded conditions, but passenger loads on these trains beyond the maximum load point dropped off rather quickly, and the second car was either underutilized or ran empty for much of the trip. Also, two-car train operation on Route 100 requires two operators due to the design of the cars. Most importantly, compounding these operational issues was that Route 100 consistently operated over budget. An inverse relationship revealed that despite the increase in passenger revenues the operating ratio declined. Operating expenses zoomed upward due to the combination of scheduled and platform manpower requirements, escalating wages and fringes, and the cumulative high cost of operating two-car trains.

FISCAL AND OPERATIONAL REVIEW

An austere, temporary schedule commenced in summer 2004 in order to reduce operating expenses. The new weekday peak hour schedule replaced most Express trips with all-Local service on 15-min headways for both Norristown and Bryn Mawr trips. Strangely enough, the draconian weekday schedules accommodated all peak and reverse-peak riders. While no passengers were lost to the system, several customer complaints were logged primarily due to the additional travel time of the all-local service, perceived crowded conditions, and the pleading for the return of the traditional express service. Throughout this period, plans were being formulated to significantly improve and enhance service to pre-1986 levels, while building a schedule that stayed within the line's operating budget. However, several hurdles had to be addressed before the dream became reality.

PLANNING AND DEVELOPMENT

A detailed evaluation of Route 100 ridership and schedules was undertaken. The goals were to justify the elimination of the underutilized two-car trains, seek solutions to move passengers quickly and efficiently, identify operational limitations, and stay within budget. Complete ridership counts by trip and station were conducted in 2004 and compared to 2003 data. The analysis concluded that several stations had noticeable ridership gains in both peak and reverse peak directions. The prior express-local schedule that had been firmly entrenched since 1986 did not match the ridership trends. The entire character of the line had changed over what had been traditionally scheduled.

The examination of the maximum loads by trip determined that the establishment of another rush hour turnback point at Hughes Park would relieve potential overcrowding situations, especially for long-distance riders. It would also offer additional seats for present passengers, allowing for future growth and minimizing the scheduling of two-car trains and two-man crews. Additionally, turning trains at Hughes Park offered more benefits. These include scheduling and operational flexibility and better service to reverse peak customers, in particular at Gulph Mills, and Radnor to a lesser extent. The facilities department modified the cab signal software at Hughes Park interlocking by installing a vetag loop that allowed a southbound

crossing movement after changing ends. This improvement provided automation in an automatic cab signal environment.

Service planning staff developed a revamped Route 100 weekday peak hour schedule that offered the following benefits: (a) provide three classes of service: Limited, Express, and Local; (b) reduce daily mileage over the summer and fall 2004 schedules; and (b) virtually require the same number of runs and work hours as was operated with the spring 2004 schedule. Service commenced on November 22, 2004.

During the peak of the peak 12 blocks per hour were now scheduled between 69th Street and Bryn Mawr, eight blocks between Bryn Mawr and Hughes Park, and four between Hughes Park and Norristown TC. These schedule changes represented a 33% increase of service.

The new multitiered schedule operated fewer vehicles resulting in fewer man hours and car miles, versus the two-car train express service that previously was scheduled. The service now offered more trip opportunities for passengers destined to Penfield, Radnor, Gulph Mills, and Hughes Park stations. Most two-car trains were discontinued except when dealing with consistent maximum loads exceeding 90 passengers. Turning trains at Hughes Park would allow the first schedule in nearly 20 years to transport passengers, terminate, and cross over at a location other than Bryn Mawr and Norristown on a consistent basis. Fortunately, the new schedules allowed flexibility if corrective measures were necessary. The schedule concentrated on past ridership increases, added seating capacity for present and future growth, quicker travel time, addressing customer service complaints, satisfying the needs of passengers and operators, and reducing operating expenses.

IMPLEMENTATION AND AFTERMATH

Prior to implementation, service planning staff briefed the operations staff and the United Transportation Union membership on the dynamics of the schedule. Passenger notices were issued to riders alerting them of the upcoming schedule changes.

New line maps were created and installed on each N5 vehicle, at each station and on the SEPTA website identifying each service pattern and the corresponding stations to be served. New destination sign curtains were produced featuring larger-type signs for easier reading and were color coded to help riders distinguish between local, express, and limited service patterns. Yet, even with the advance informational blitzes to customers and training for SEPTA employees, the new schedule still required a learning curve for passengers, operators, and front-line supervisors.

Despite the initial teething pain the new multitiered schedule was deemed successful. Passengers were glad to see the return of Express service, in addition to the fast Limited service. The new schedule offered greater flexibility in regards to more stops at well-patronized stations and additional trip opportunities.

Daily passenger complaints that seemed commonplace during the “draconian” reduced-service period of 5 months prior had virtually disappeared. Many operators were skeptical at first, but gradually mellowed their attitude as they and the passengers adapted to the new schedule. Initially, some passenger confusion occurred at 69th Street Terminal. Even with the new destination signs, updated maps, rider leaflets, and SEPTA personnel directing traffic, some riders were not sure what train to board. Yet, regular riders quickly learned to distinguish the proper train to board so as to reach their destination.

The operational issue that generated the greatest concern were the bottlenecks generated at signal 6S, located before the interlocking complex at 69th Street Terminal. These incidents occurred during the peak of the peak, when four or five southbound single-unit cars attempted to enter a three-track terminal with operators having been instructed to use only berth A, instead of utilizing both berths A and B (refer to Figure 5).

The operating personnel and control center staff were not accustomed to fully utilizing the berths at the Terminal with the configuration of the cab signal system. Trains had to wait at signal 6S until a track slot opened up at the Terminal when a northbound car departed. This delay increased passenger travel times between 2 and 4 min. Since April 2005, several schedule solutions were incorporated into the weekday schedule, minimizing most of these operational delays for customers arriving at 69th Street Terminal where severe conditions were identified. Adjustments included a series of schedule tweaks to reduce long layovers wherever possible. Another important measure improving train flow was to reinstruct operators to pull forward and utilize berth B for loading and unloading. This action now brought the control center into the picture requiring a manual operation within the terminal complex instead of running on automatic.

Unfortunately, the inflexibility of the cab signal system was predicated on safety. The ability to accommodate future ridership growth or additional scheduled service was not engineered.

Route 100's convenient rush hour schedule has translated into ridership growth, requiring additional trips to alleviate severe overcrowding. In time, several Norristown Express trips were converted to Limited operation. Hughes Park local trips were turned in Express trips. Bryn Mawr local trips were extended to Hughes Park. And new Bryn Mawr local trips were scheduled. Additional trips operating with two-car trains were created. Service was also added on the fringes of the morning and afternoon rush hours to accommodate reverse-commuters.

As shown in Figures 2 and 3, ridership increased by 19% between November 2004 and November 2008. Weekday ridership is expected to consistently break through the 10,000 passenger trip mark during 2009. This has not been experienced since the late 1970s.

Addressing crowded situations with additional weekday service during peak and off-peak hours has created some unforeseen headaches. Presently, bunching of trains outside of 69th Street Terminal occurs more frequently. Schedule adjustments at this juncture are unable to resolve this issue. Schedule making is not an exact science, and tweaking will continue to be part of the business to perfect a product under imperfect conditions. Other issues compounding the bunching are operational in nature and some actions necessitate capital-intensive solutions.

THE NEXT DECADE

The future focus should be on implementing short and long-range infrastructure solutions so that the Route 100 can operate with minimal delays while ensuring operational and schedule flexibility. Clearly the objective is twofold. First, resolve short-term issues that require minimal investment, and second, speed the ride and improve the convenience for our riders. Long-term capital investments should be addressed, such as station modernization, upgrading the cab signal system and advancing the long-discussed extension to King of Prussia.

Short-Range Plans

Test weekday peak hour schedules have been developed to operate at maximum capacity without causing severe operational issues at 69th Street Terminal, Norristown TC, and the two short-turn locations of Bryn Mawr and Hughes Park. Presently, 254 weekday trips are scheduled and the proposed schedule would increase to 278 (Figure 8). Exceeding 278 trips would cause extensive delays and slow the ride for all passengers. Vehicle bunching would occur not just at 69th Street Terminal, but also at the outer ends of the line and at Hughes Park.

For decades wooden shelters and platforms were the norm for Route 100 stations. Under Red Arrow, and later SEPTA, many stations were reconstructed with concrete platforms and brick shelters. Gulph Mills Station has undergone a \$5.6 million station modernization project. As shown in Figure 9, the simplistic station has been transformed into a modern facility that has Americans with Disabilities Act (ADA) -accessible platforms and ramps, platforms lengthened to accommodate two-car trains, along with new shelters, lighting, next train schedule information, smart station technology, updated signage, and improved facilities for intermodal transfers (Figure 10). Improvements are slated for Ardmore Junction Station, while Ardmore Avenue Station is programmed to be reconstructed in time for the 2011 U.S. Open Golf Championship located nearby. The platforms at 69th Street Terminal are also planned to be renovated. Fiber optics and electronic message board signs are proposed as part of the Obama administration's economic stimulus package.

Long-Range Plans

The cab signals engineered at 69th Street Terminal were primarily designed to hold a maximum of three single cars on three tracks or three two-car trains on three tracks. This engineering was based on scheduled service from the early 1990s consisting of Norristown Express and Bryn Mawr Local trips, both operating every 15 min under an automatic block signal operation. When the transition was made to cab signal operations the scheduled service was adequate for the amount of riders the line carried, which was approximately 7,000 weekday passenger trips. Today, Route 100 carries nearly 10,000 weekday passenger trips. An evaluation of the cab signal system within the terminal complex and the 2,400-ft block spacing along the line should be reassessed to improve train flow as well as dealing with future ridership growth potential. Another concept to increase capacity at 69th Street Terminal is to convert the unused freight track (noted as "F" in Figure 5 and shown in Figure 11) into a fourth terminal track that would provide the following benefits:

- Creating two additional berthing locations to handle increased ridership as 90% of the ridership board and depart at 69th Street Terminal;
- Providing the ability to schedule additional service, including more two-car trains;
- Improving operational flexibility entering and departing 69th Street Terminal;
- Minimizing or potentially eliminating inbound stacking and slower operations between West Overbrook and the Car barn;
- Speeding the ride and improving convenience for customers; and
- Allowing storage of additional equipment at 69th Street for the evening rush hour, thus reducing operating expenses and conflicting movements from the Car barn.



FIGURE 8 New service patterns effective November 22, 2004.



FIGURE 9 CTA “L” car at Gulph Mills Station.



FIGURE 10 N5 car at Gulph Mills Station.

The platform for the 4th terminal track would tie into the present platform on track 3. This initiative would be a significant capital investment with the construction of a retaining wall, filling in the freight track and building new platforms, along with modifying the cab signal circuits. Yet, building the 4th terminal track would greatly assist in the programmed reconstruction of the present 69th Street Terminal passenger platforms, in that three tracks would always remain open for rail traffic which would allow the closure of one track. It is anticipated that this initiative would be in concert with the proposed extension of Route 100 to King of Prussia.

In 1964, Red Arrow Lines proposed a significant expansion of high-speed rail service into Montgomery and Chester Counties, terminating in Downingtown. Red Arrow considered purchasing the Chester Valley Branch line from the Reading Railroad where a junction would have been constructed near Hughes Park. However, the short-lived idea for expanded rail service quietly faded. Under SEPTA, the idea was resurrected in the late 1980s to construct a short extension to the King of Prussia shopping, office, hotel, and industrial complex via the Pennsylvania Turnpike alignment (I-276). Presently, Route 100 runs tangential to the employment and retail centers at King of Prussia, but provides no direct service. The King of Prussia Plaza and Court employs over 12,500 people and beyond the periphery of the shopping complex the office, hotel, and industrial sectors employ over 12,600. Transit trips to and from the King of Prussia area involve intermodal transfers between Route 100 and bus routes serving the King of Prussia area from either Gulph Mills, King Manor, or the Norristown TC stations.

Over the past 10 years two concepts were developed for a proposed extension of Route 100 to King of Prussia. First, an Alternatives Analysis Study was completed in November 2003 which proposed a two-phased project. An initial phase would be 2.5-mi (4.1-km) long and would extend from a point north of Hughes Park station to King of Prussia Plaza (see Extension Option A in Figure 12). A viaduct would be built taking the line over Yerkes and Church Roads and Norfolk Southern's (NS) Morrisville Line. A second viaduct would be constructed spanning the US-202–Gulph Road interchange to connect with a new transportation center at King of Prussia Plaza. The extension would be mostly single tracked, except for the junction at Hughes Park and at King of Prussia Plaza. Two stations would be built: King of Prussia Park–Ride, located over King of Prussia Road south of US-202, and the King of Prussia Transportation Center located adjacent to the Plaza–Court behind the former Macy's parking garage at the mall. Phase two would be a 2.4-mi (4-km) aerial extension linking King of Prussia Plaza with the King of Prussia Industrial Park and ultimately terminating at a potential brownfield redevelopment site at Port Kennedy (see Industrial Park Extension in Figure 10). Valley Forge. Portions of the right-of-way would utilize the abandoned NS Abrams Industrial Track alignment. A station would be constructed at First Avenue. The terminus would be a multimodal station intersecting with NS Harrisburg Line where a proposed extension of the Route R6 commuter rail line would be built to Reading.

Scheduled service would operate from 69th Street Terminal to King of Prussia and Port Kennedy, along with service to–from Norristown every 15 min during peak hours and every 20 min off-peak. Between 69th Street Terminal and Hughes Park peak hour service would operate roughly every 7½ min, and 10 min off-peak. An optional shuttle service could operate from Norristown to King of Prussia, however, trains would be required to reverse direction at Hughes Park as a direct connection in the southbound direction would be intricate, if not impossible to engineer. Furthermore, integrating a shuttle service may prove difficult to execute as a speedy ride would be sacrificed as trains operating from 69th Street Terminal, Norristown, or King of

Prussia would, depending on location, experience a downgrade in cab signal speed or come to a stop until conditions dictate resumption of normal conditions. Bus routes operating in the greater King of Prussia area, along with bus route 123 from 69th Street Terminal and direct routes from Philadelphia (124 and 125) to King of Prussia Plaza would be restructured to feed the extended rail line and the operating resources would be reallocated to provide the frequent rail service.

The second concept had taken a unique approach whereby direct service to King of Prussia could operate from either 69th Street Terminal or Norristown TC. The extension would branch off north of the Pennsylvania Turnpike (I-276) and follow at grade the Philadelphia Electric Company power line right-of-way to a point where it intersects with the Pennsylvania Turnpike. From there an aerial structure nearly 1 mi (1.6 km) in length would be built to King of Prussia Plaza (see Extension Option B in Figure 10). This extension would be double-tracked in its entirety. Two stations are proposed: Valley View Park–Ride located adjacent to DeKalb Pike

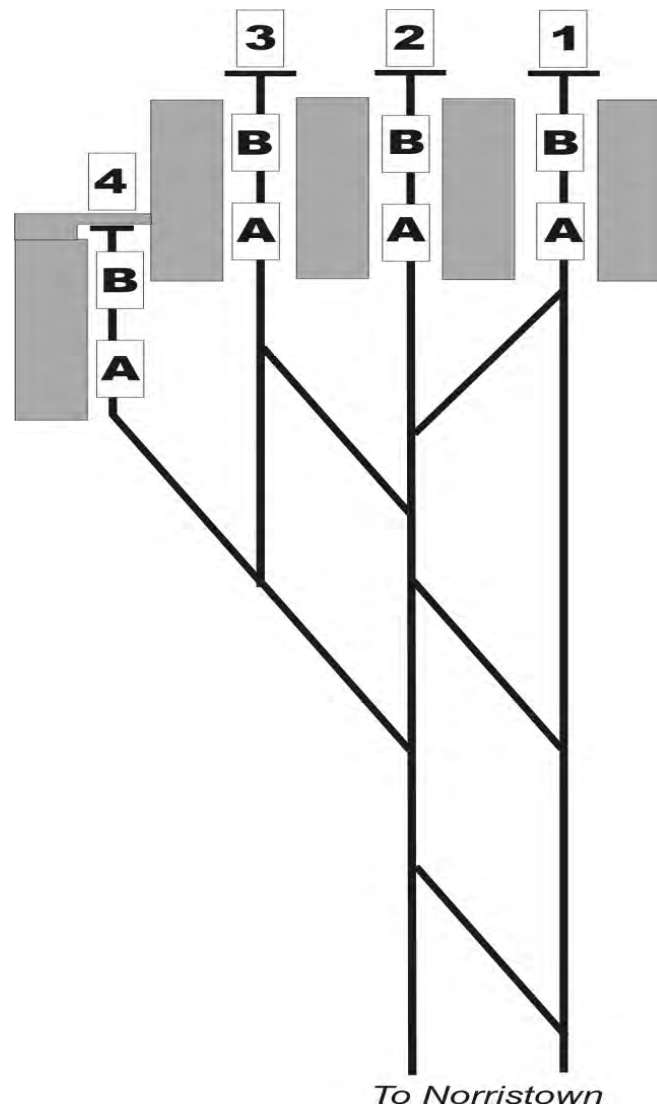

FIGURE 11 Concept for improving operational flexibility.

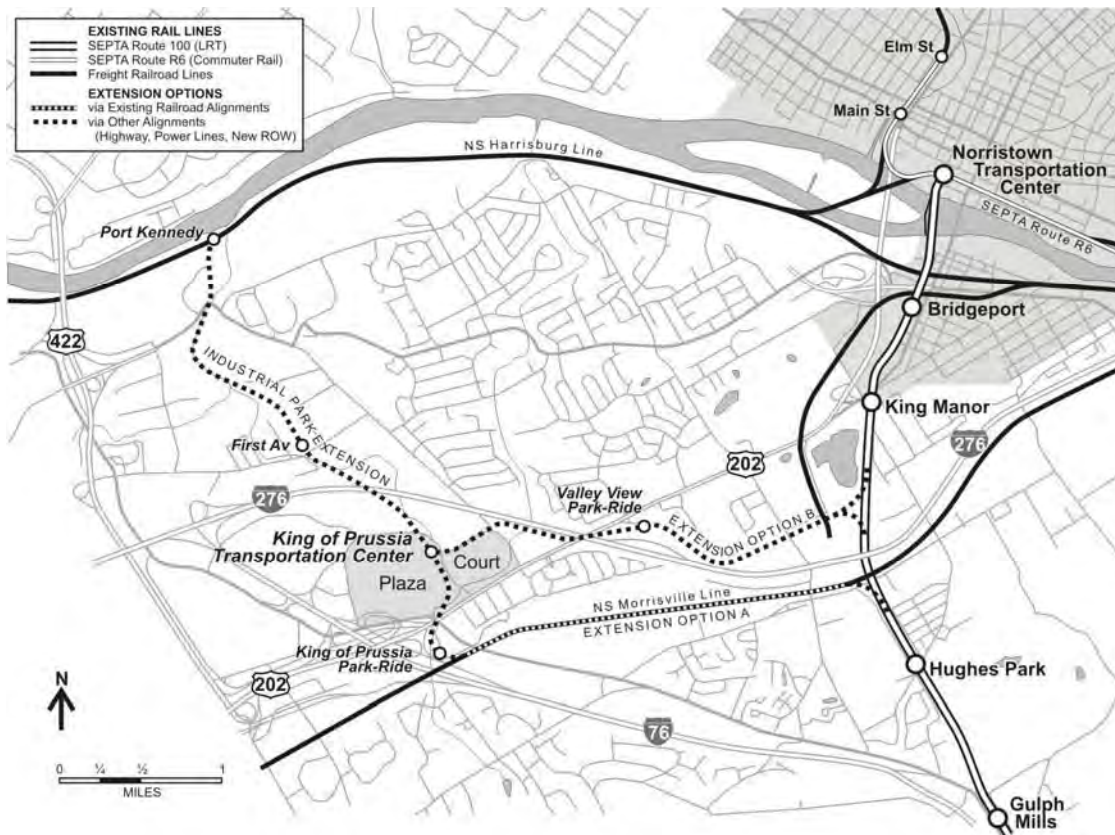

FIGURE 12 Route 100 extension proposals.

(US-202) and an apartment complex and the aforementioned King of Prussia TC. If desired, this option could also be extended at a later date to Port Kennedy to provide R6 passengers from the west connecting rail service to King of Prussia.

Like Option A, scheduled service would operate from 69th Street Terminal to King of Prussia, along with service to/from Norristown every 15 minutes during peak hours and every 20 min off-peak. Between 69th Street Terminal and Hughes Park peak hour service would operate roughly every 7½ min, and 10 min off-peak. Shuttle service would have the ability to operate directly between Norristown and King of Prussia at the same frequency as between 69th Street Terminal and King of Prussia as the junction with the existing Route 100 line would be double tracked and reversing movements would be unnecessary. Several bus routes operating in the greater King of Prussia area, along with bus Routes 123, 124, and 125 would undergo a major route restructuring as the King of Prussia Transit Center would become a key intermodal station. The 26 N5 cars could satisfactorily provide service and the reallocation of operational resources from the bus routes would provide the necessary rail operators.

The original 2003 ridership projections estimated for 2020 stated that 4,510 new passenger trips would be carried to/from King of Prussia from 69th Street Terminal, with an additional 1,700 on the Norristown shuttle. Some of these riders would shift from other bus routes, but the extension was projected to generate over 3,000 new trips using public transportation.

In 2006, the capital cost for building Option A from Hughes Park to King of Prussia Plaza was estimated at \$143 million (comparable costs for Option B have not been calculated). The Industrial Park Extension was projected at \$133 million. The annual operational cost was anticipated to cost \$1.4 million in 2006 dollars and includes resource reallocation from the restructured bus routes.

The Original Alternatives Analysis study for Option A was completed in November 2003. The conclusion of the study was that the project would not be eligible for FTA Small Starts–New Starts funding based on current cost-effectiveness criteria. Presently, the project is on hold, but is included in the regional long-range plan, and appears in SEPTA’s Capital Program (2013–2020). In July 2008, the FTA approved the use of funds previously earmarked for the Route R6 extension to update the 2003 Alternatives Analysis. Additional tasks will also include choosing the most cost-effective alignment, preparation of a financial plan, public outreach efforts, and initial National Environmental Policy Act of 1969 environmental scoping.

SEPTA and the Delaware Valley Regional Planning Commission (DVRPC) embarked on a transit study (Alternatives to Buses on I-76: SEPTA Rail Feeder Bus Study) that examined the feasibility of restructuring bus routes off the Schuylkill Expressway (I-76) and create new bus routes feeding Regional Rail and Route 100 stations. One proposal would restructure bus Route 123 presently operating from 69th Street Terminal to King of Prussia and considerably shorten the 17.50-mi (28.1-km) route to begin at Gulph Mills and terminate at King of Prussia Plaza. This new dedicated intermodal feeder route would be timed to connect with Route 100 trains in both directions. Route 123 ridership in 2008 averaged 1,400 weekday, 1,725 Saturday, and 1,000 Sunday passenger trips. The study projects that 85% of these passengers would be shifted to Route 100 and the connecting feeder bus route at Gulph Mills. Although a two-seat ride would be created, the restructured route would result in an overall travel time savings between 69th Street and King of Prussia and would offer more travel opportunities for Route 100 customers boarding between Parkview and Matsonford Stations. Operating expenses from Route 123 would be reallocated to provide additional feeder bus and rail trips.

As part of the FY 2009 Capital Budget, SEPTA is pursuing an upgrade to the present fare collection system across all modes, including Route 100. Modern fareboxes will accept electronic fare media such as contactless cards along with emerging media forms. New full service vending machines at key stations will improve customer convenience of fare instrument purchases. Electronic fare media used in conjunction with modern fare collection devices will allow customers to move seamlessly through the transit network and potentially reduce travel time on Route 100. Another element of the capital budget will be the major overhaul program to extend the useful life of the 26 N5 vehicles.

CONCLUSION

The capital improvements made during the 1990s, such as the acquisition of the N5 cars, improving track, consolidating interlocking locations, and upgrading the signal system from automatic block to cab signal–automatic train operation made Route 100 a safer rail operation. Regrettably, these necessary improvements inadvertently created a slower operation and diminished the number of trains that can be scheduled per hour. At this juncture there are no plans to upgrade the present cab signal system, although service planning continues to

collaborate with SEPTA staff to mitigate and minimize these issues so as to balance safety and to maximize scheduling potential.

Fortunately, in this decade Route 100's ridership has made a tremendous comeback, which can be attributed to several factors including the implementation of the multitiered Limited and Express schedules in November 2004, and demographic and economic shifts that favor the use of public transit. The traditional Norristown Express–Bryn Mawr Local rush hour paradigms were eliminated in favor of maximizing service to stations where ridership had markedly swelled. The high level of service offers sufficient seating capacity, and, where overcrowding exists, operating two-car trains provide adequate capacity. Today, more trips are scheduled per hour than what had been offered 20 years ago. On the fiscal side, the line operates within budget and opportunities exist for schedule flexibility if the need arises.

Since November 2004 the subsequent weekday schedule revisions addressed decreasing travel time, minimizing passenger inconvenience and increasing the scheduled number of trains per hour. Today a maximum of 13 trains per hour depart 69th Street Terminal during the peak of the peak. In a historical comparison, the P&W in 1951 introduced a weekday rush hour schedule where five classes of trains (Local, Express, and Limited) departed 69th Street Terminal every 15 min, totaling 23 trains per hour in both directions. Unfortunately, duplicating this level of service today would be impossible to operate, as the cab signal system, combined with the track configuration at 69th Street Terminal, could not support such a service.

In the 2010 decade, the potential exists for schedule and system expansion. As ridership is expected to exceed 10,000 weekday passenger trips schedules have been drafted that would operate 12 to 13 trips per hour during most of the weekday rush hours creating additional seats and trip opportunities. The implementation of the drafted DVRPC I-76 Alternatives to Buses study would add over 1,000 daily passenger trips on Route 100 connecting to a revised bus Route 123 at Gulph Mills creating an improved intermodal transfer and rubber-tired extension to reach King of Prussia. Construction of the long-awaited rail extension to King of Prussia and eventually to Valley Forge would create a much faster link to this exurban employment and shopping mecca from many Philadelphia and other suburban locations. Building the fourth terminal track at 69th Street would provide additional passenger capacity along with operational flexibility. A reengineering of the cab signal system would be studied concurrent with the proposed rail extension. Modernization of outlying stations to accommodate all customers is being engineered. Route 100's future is in motion and headed in the right direction.

ACKNOWLEDGMENTS

This paper is dedicated to the memories of Ronald H. DeGraw and John F. Tucker III. Both had long professional careers in public transportation and were great mentors and leaders, not only to their friends, but also to countless SEPTA employees and transportation professionals. Their legacies will long be remembered, but their presence will be missed.

Many thanks are extended to the following SEPTA staff whose guidance and resources proved valuable in the preparation of this paper: Mark Cassel, Alex Flemming, Thomas Hickey, Jeffrey Knueppel, Denver Pence, Tanya Rothe, Robert Selzer, and Charles Webb.

REFERENCES

1. Vigrass, J. W., and R. S. Patel. The Modernization of the Norristown High Speed Line, June 1989.
2. DeGraw, R. As Fast As a Speeding “Bullet”—Rebuilding the Norristown High-Speed Line, May 1992.
3. Fazio, A. E., and T. R. Hickey. Designing New Light Rail—Taking Engineering Beyond Vanilla, November 2003.
4. DeGraw, R. Every 2½ Minutes, *Classic Trains*, December 2003.
5. DeGraw, R. *The Red Arrow*, Haverford Press, 1972.
6. Projected Car Requirements for the Norristown High-Speed Line, SEPTA, March 1986.
7. FY 2009 Capital Budget and FY 2009–2020 Capital Program, SEPTA, May 2008.
8. Alternatives to Buses on I-76: SEPTA Rail Feeder Bus Study, DVRPC/SEPTA, October 2008 (Draft).
9. Revised New Transit Capacity Projects, SEPTA, November 2008.

Regulations and Standards

REGULATIONS AND STANDARDS

Track Geometry for Light Rail Systems**MARGARITA NOVALES****ALFONSO ORRO****MIGUEL R. BUGARÍN***La Coruña University*

Lately, light rail transit (LRT) systems are becoming increasingly important as a solution to the problem of metropolitan public transport in medium-sized cities, and as feeders for high-capacity modes in bigger ones. This fact is due to their great flexibility for running over different types of streets and layouts as they can adapt to very strict conditions.

Light rail systems are characterized by their type of right-of-way (B), which suppose that they are longitudinally separated from other traffic by curbs, barriers, grade separation, and other physical means, but with grade crossings for vehicles and pedestrians, including regular street intersections (I). These grade crossings in intersections are necessary for maintaining the permeability of the city to the rest of street flows, given that light rail system runs generally on the surface, with a very good accessibility for users. This kind of design is usually known as reserved (or semi-exclusive) right-of-way. In any case, light rail systems can combine different rights of way in a single line, with some zones in exclusive right-of-way without any kind of interference with the rest of the city flows (as tunnels), other ones with reserved right-of-way with intersections in some points, and finally, other areas with street running without any separation from other types of street traffic.

The good accessibility mentioned above is a result of the following:

- Light rail vehicles (LRVs) run at street level in most part (or in the whole) of their trip, which leads to a very easy access for users. They take the public transportation system in the street, rising to the platform, which is, in general, a little higher than the curb. In this way, ascents and descents, typical of subway systems, are avoided and
- Distances between stations for light rail systems are usually (in Europe) around 350 to 800 m. This distance is smaller than that for commuter rails (2,000 to 10,000 m) or for subways (1,000 to 2,000 m). So, access distances to stations are shorter than in other transportation modes, and users can cover them by walking in a reasonable time (5 to 10 min). This fact makes the system very convenient, even for short-distance travelers.

Nevertheless, the fact that the vehicle runs at street level (which is, as exposed previously, very beneficial for accessibility), leads to the necessity of adapting the track geometry to the one existing in the streets, which sometimes gives rise to great challenges: strong vertical grades (rising or falling), horizontal circular curves with very small radius without superelevation and transition curves, vertical curves with very small minimum radius, etc.

Obviously, track geometry conditions are closely related to tractive and braking efforts to be required to vehicles, to their dimensions, to their structural behavior and the efforts that they will have to support, as well as to the efforts that the vehicle itself will transmit to the track (and, therefore, with maintenance work). So, a combined teamwork must be made between vehicle

manufacturers and civil engineers to guarantee that the chosen LRV will be able to run over the track geometry of each installation. It is desirable that the vehicle requirements are not very severe, in such a way that a standard vehicle design can be used, instead of a customized model which will lead to higher costs.

Additionally, track geometry will determine, to a large extent, operational costs of light rail systems. This fact is a very good reason for limiting track geometry parameters as far as possible.

TRACK GEOMETRY

Main track geometry parameters will be specified in this section, highlighting values identified by TCRP Report 57 and International Union of Public Transport (UITP), and why each parameter must be limited. In the section on track geometry parameters, the stricter values of main parameters for several existing networks will be shown, to point to the fact that values are not always observed.

Track Gauge

Track gauge is one of the most important geometric parameters of track geometry. There are a lot of other parameters that are conditioned by track gauge (for example, minimum curve radius that the vehicles will be able to negotiate).

The most common value of track gauge for railroad systems is 1,435 mm, established as standard gauge in Bern Conference, in 1907. This value is compatible with International Union of Railways heavy rail gauge, and it is track gauge stated by American Railway Engineering Maintenance of Way Association as American standard gauge. This compatibility is a good reason to use this value in light rail tracks, mainly because the procurement of track materials and track maintenance will be easier, and also because it can allow the use of those railroads in the future in track sharing, if this is a good solution for mobility problems.

So, this track gauge is the one used for most of new light rail systems, although 1,000 mm is a very common value too.

In relation to early tramway systems, there is a large variety of values for track gauge. Examples are: Rome, Italy, 950 mm; Lisbon, Portugal, old network, 900 mm; Linz, Austria, network, 900 mm; Braunschweig, Germany, 1,100 mm; Okayama, Enoshima, Fukui, and Kochi, Japan, 1,067 mm; Moscow, Volgograd, Saint Petersburg, Omsk, and a large number of Russian tramway or light rail systems with 1,524 mm (2).

The choice of gauge for a new light rail system can be more complicated if the local existing heavy rail system is of nonstandard gauge, and either significant lengths of such existing tracks will be taken over for light rail, or heavy and light rail track sharing could be made even in the longer term.

In such situations, UITP (3) recommends seriously to consider the use of the existing nonstandard gauge, unless it were so narrow (e.g. less than 1,000 mm) as to constrain the vehicle design unacceptably.

Track Horizontal Alignment

Geometric parameters of horizontal alignment are: radii and length of curves, which will affect passenger comfort, as well as track–vehicle efforts, and therefore, their maintenance (for example by rail and wheel wear); superelevation, which will be related to passenger comfort according to operating speed, as well as to vehicle stability; transition curve length (in the case that they exist), which is related to superelevation gradient, and, finally, minimum straight track length between two curves, both conditioning passenger comfort and vehicle–track efforts.

Circular Curve Radius

Obviously, when a light rail system runs over a new created branch of the track, in a nonurbanized area, curve radii and superelevation will be settled in such a way that the maximum project speed can be achieved considering noncompensated centrifugal acceleration which can be withstood by travelers. This project speed will be limited by maximum operating velocity of the vehicle, which is usually not higher than 90 km/h.

When a light rail system runs over the streets, the layout will have to be adapted to them, and vehicle speed will be limited in the same way that it is for road vehicles (50 km/h in general, and 10 km/h in pedestrian streets, for Spain; this last value is usually raised to 25 km/h for light rail systems to avoid excessive influence in operation speed).

Minimum circular curve radius that can be negotiated in plan will specifically depend on physical characteristics of vehicle that will be used: distance between truck centers, distance between axles in the truck, the use of steering axles, the existence of physical axle between the two wheels of a wheelset, the number of articulations and their position, etc.

Even though a modified vehicle design would be able to negotiate almost any curve radius (as an example, in Lisbon old network minimum curve radius is 11 m), recommended limit values are established to avoid conditioning system operation excessively. These values are detailed in Table 1. As it can be seen, in general, TCRP Report 57 is a little more restrictive in horizontal curve radius, although differences are not very important. This fact is probably due to stricter restraints in street layout and space for European cities.

Real values of curve radius of light rail systems in operation nowadays can be seen in the last section of this paper. It is interesting to point the values of two modern systems as Lisbon new network, with 14.5 m, and Nottingham, United Kingdom, with 18 m (5).

TABLE 1 Minimum Values of Circular Curve Radius (m)

Situation	TCRP Report 57, 2000 (4)		UITP, 2004 (3)
	Desired R_{min}	Absolute R_{min}	
Main line (exclusive right-of-way)	150	90	100
Main line in tunnel or aerial structures (exclusive right-of-way)	—	150	
Main line with embedded track (mixed traffic or reserved right-of-way)	35	25	25–20
Yard and nonrevenue tracks	35	25	—

On the other hand, in a study developed by TRB about applicability of low-floor LRVs in North America (6), it is stated that curve radius below 18 m may restrict the use of category 2 vehicles (i.e., those which use conventional motor trucks at each end and innovative trailer trucks in between them, with generally 50% to 75% uninterrupted low-floor area between the motor trucks); and curve radius below 20 m may restrict the use of category 3 vehicles (i.e., those which use conventional motor and trailer trucks throughout and generally have 9% to 15% low-floor area but may have up to 48%).

Minimum Length of Circular Curves

According to TRB (4), minimum length of circular curves due to comfort will be:

$$L = 0.57 \cdot V \quad (1)$$

Where V is the vehicle speed in kilometers per hour and L is the circular curve length in meters. With this equation, running over the curve will last 2 s at least. If there is superelevation in the curve, the absolute minimum value of circular curve length will be 15 m.

As an example of strict layout in relation to this parameter, Nottingham case can be pointed, with only 6 m of circular curve minimum length (7).

Minimum Length of Transition Curves

The establishment of transition curves in the start and the end of circular curves is very advisable, even when they are in urban zone and they do not have superelevation. In this way, the curvature change will be gradual, and this fact will lead to improvements in comfort and reduction of wheel and rail wear. This is due to the fact that the angle of attack of the wheel when entering the curve will be lower with transition curves than without them, and so, the change of direction will be softer and the impact between wheel and rail will be attenuated. The clothoid is the most common transition curve. If there is superelevation in the curve, its length will be obtained according to maximum rate of change in superelevation that is allowed (see next sections), always accounting for the change in uncompensated centrifugal acceleration, which will affect passenger comfort. In other case, minimum recommended value is 20 m, and minimum absolute value is 10 m. This minimum absolute value is the one used in Nottingham light rail (7) and in Seville (Spain) light rail (8). In Tenerife (Spain) system the minimum length of transition curves is 12 m (9).

Superelevation

Superelevation is used for compensating part of the centrifugal acceleration which occurs in curves. This compensation is due to the component of vehicle weight in track plan when it is inclined (i.e., when the outer rail is elevated). In this way, the passenger suffers less transversal acceleration for a given speed, or the speed can be increased keeping the value of lateral acceleration to be experienced by the passenger.

For light rail systems, UITP (3) recommends that the passenger does not suffer a transversal acceleration greater than 1 m/s^2 , i.e., $0.10 \cdot g$ (where g is the gravity acceleration), the same value TCRP Report 57 identifies (4).

On the other hand, UITP recommends, for exclusive right-of-way, 120 mm as maximum superelevation value for track gauge of 1,435 mm (3), and 165 mm as absolute maximum value, while TRB identified and absolute values of 100 and 150 mm, respectively. This superelevation limit (165 mm) is set due to the problem for maintaining ballast bed if superelevation is greater, while lower values (150 or 120 mm) are imposed by passenger comfort (3). In case of reserved or mixed right-of-way, the limit will be given by layout compatibility with street alignments.

So, as it can be seen, TCRP Report 57 may be a little more restrictive than UITP in relation to superelevation, although differences are not big. This is probably due to stricter restraints in space for introducing a new light rail system with independent right-of-way in European countries, where there is a more intensive use of land. In such a situation, curve radii will often be lower, which leads to allow greater values of superelevation for keeping passenger comfort.

When running over a curve, maximum speed will be given by the following expression:

$$v = \sqrt{\left(a + \frac{g \cdot h}{1500}\right)} \cdot R \quad (2)$$

Where v is maximum operating speed (m/s); h is superelevation (in mm); a is maximum lateral passenger acceleration value (m/s²); and R is curve radius (in m). This expression is valid for international track gauge (with a distance between rail axis of around 1,500 mm), and without accounting for suspension flexibility or track irregularities.

If maximum values of a and h are considered, the relation between speed (V , in km/h) and curve radius (in m), will be:

$$V = 5.2 \cdot \sqrt{R} \quad (3)$$

When the track is in urban zone, it is not common to establish superelevation in curves, because it is necessary to maintain a regular surface in such a way that road vehicles are able to run over it. Even where the right-of-way is reserved, there will be grade crossings and intersections with road traffic, in which it is compulsory to carry out this condition. This fact leads to stricter speed limitations to keep passenger comfort. Indeed, the relation between V and R in these cases will be:

$$V = 3.6 \cdot \sqrt{R} \quad (4)$$

Using these expressions, the speed limitation for a curved track with 25-m radius running over urban zone without superelevation would be 18 km/h, i.e., 15 km/h since speed limitation signals are in steps of 5 km/h. On the other hand, for a curve radius of 100 m, in exclusive right-of-way and with maximum superelevation, speed limit would be 52 km/h (i.e., 50 km/h).

Superelevation, if used, will increase and decrease linearly in transition curves in the start and the end of circular curves, raising and lowering, respectively, the outer rail height. Allowed maximum rate of change of superelevation should be 4 mm/m in modern light rail systems, according to UITP (3). In accordance with TCRP Report 57 (4), it should be such that superelevation differential between truck centers do not exceed 25 mm (for a vehicle with 7 m of distance between trucks, this will lead to maximum superelevation rate of change of 3.57 mm/m). In this way, an improvement in passenger comfort is achieved and vehicle frame twist is

limited to avoid overstressing. In Nottingham light rail, maximum superelevation grade is 1 in 300, i.e. 3.33 mm/m (7). The same value is stated as absolute maximum for Genève (Switzerland), where recommended maximum is 2 mm/m (10).

These values will determine, for each case, minimum transition curve length if superelevation exists. Nevertheless, sometimes these limits are exceeded, specifically over alignments with reverse circular curves.

Minimum Tangent Length Between Reverse Curves

Generally, in railway track, minimum straight track length between two curves is set to be at least equal to that of the longest car in the trains that are going to use the track. This usually means that minimum length is around 30 m. Sometimes, distance between truck centers or between front and rear axle of the car are used, instead of longer car length.

However, it is usual to establish a comfort criterion, which sets that minimum straight track length should be such that the vehicle takes at least 2 s for running over it (4), in the same way that for circular curves. There are some administrations which establish smaller running times. This is the case of Geneva Public Transportation (*Transports Publics Genèvevoises*, 10), that sets a running time over tangent stretch of between 0.7 and 1.5 s.

The value that must be used is the greatest one between those from comfort and vehicle length criteria. Nevertheless, there are many situations in which these values can not be achieved, due to street layout restraints. In these cases, absolute minimum value of tangent track between curves will be given by the maximum angle which can be stood by the vehicle articulations. This can only be applied if operating speeds are below 32 km/h and no track superelevation is used in either curve (4).

In Nottingham light rail, minimum tangent length between reverse curves must be, at least, of 6 m, and if this is not possible, transitions of opposite hand curves shall meet at point of infinite radius (7).

Track Vertical Alignment

Geometric parameters related to vertical alignment are, mainly: vertical grades and their lengths, which will have an influence in vehicle tractive and braking performance demanded to vehicles, as well as in passenger comfort; and minimum vertical curve radii, which will determine passenger comfort, as well as efforts that must be withstood by vehicle frame.

Vertical Grades and Their Lengths

According to TCRP Report 57 (4), recommended limit value for vertical grades of unlimited length is 4.0%; for sustained vertical grades with up to 750 m between points of vertical intersection of vertical curves is 6.0%; while for short sustained grade with no more than 150 m between points of vertical intersection of vertical curves is 7.0%.

On the other hand, UITP (3) establishes that common limitations in modern light rail systems are 4.0%, 5.0%, or 7.0% (approximately the same values as TCRP Report 57), although if fully motorized vehicles are used, they will be able to overcome vertical grades up to 10.0%. However, in planning stages it is recommended not to consider values over 4.0%, because they will lead to greater operation and construction costs.

Tenerife light rail can be cited as an unusual example in modern light rail systems. In this case, the difference in height between Santa Cruz Centre and La Laguna (the two ends of the line) has forced to use fully motorized vehicles to overcome maximum vertical grade of 8.5% in no more than 250 m, and maximum sustained grade of 7.5%. In Figure 1 the longitudinal section of Tenerife light rail line is shown to point its escarpment. In some parts of the layout it has been necessary to adopt inventive solutions, as the one which is shown in Figure 2, in which the light rail alignment has been raised in relation to the street one to avoid excessive vertical grade (14.5%).

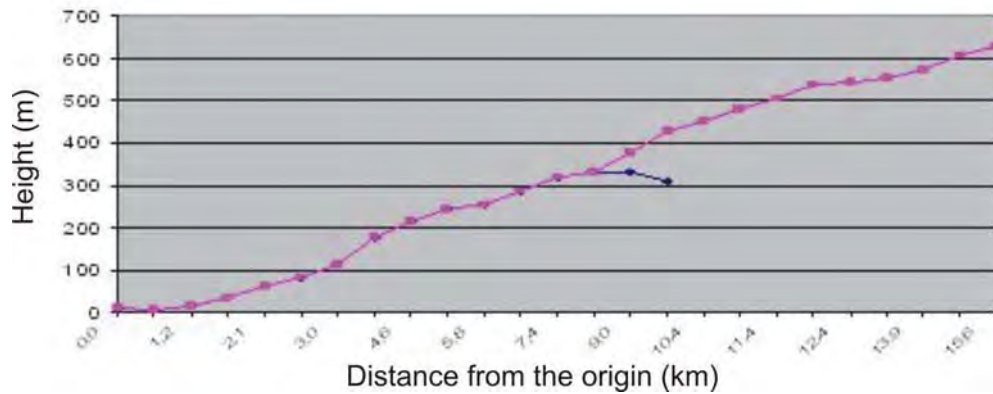

FIGURE 1 Longitudinal section, Tenerife light rail (II).



FIGURE 2 Light rail alignment raised from street one, Tenerife light rail.

In relation to minimum grade for drainage, TCRP Report 57 (4) identifies 0.2% for direct fixation track. There are other administrations that demand values of 1.0% to 1.5%, and exceptionally, 0.5%. Sometimes a minimum grade of 0.25% is required in tunnels for removing water by a central drain.

Additionally, TCRP Report 57 (4) notes a minimum length for vertical grades of 30 m or $0.57 \cdot V$ (running time 2 s, in the same way of previous sections), with an absolute minimum of 12 m. However, this can be waived if street layout imposes smaller values.

Vertical Curves

Vertical curves are circular or parabolic curves located between vertical grades, which are characterized by their minimum circular radius. Minimum value of that radius must be limited due to the following two subjects:

- The requirement of keeping minimum distances from lower part of the vehicle to higher part of the track under dynamic loads or in failure conditions. These distances must be kept whether for crests or for sag vertical curves (see Figure 3). For checking this subject, the value of maximum angle which can be stood by the vertical articulation must be considered. Sag vertical curves are usually conditional on this topic.
- For restricting vertical inertial accelerations which influence passengers comfort. Crest vertical curves are usually conditional on this topic. In this sense, vertical acceleration experienced by passengers should not exceed the value of $0.2 - 0.3 \text{ m/s}^2$. Equation 5 expresses the relation between v (operating speed in m/s) or V (operating speed in km/h), with minimum vertical curve radius (R_v , in m), and vertical acceleration suffered by passengers (a_v). With this equation, the minimum radius of the vertical curve may be obtained in a simple way.

$$a_v = \frac{v^2}{R_v} = \frac{\left(\frac{V}{3.6}\right)^2}{R_v} \rightarrow R_v = \frac{\left(\frac{V}{3.6}\right)^2}{0.2} \approx 0.4 \cdot V^2 \quad (5)$$

With equation 5, vertical curve radius for a speed of 50 km/h would be 1000 m, and for 25 km/h it would descend to 250 m.

UITP (3) establishes that the absolute minimum curve radius value for sag vertical curves is 350 m and not lower than 700 m for crest vertical curves. According to German regulations, minimum parameter for vertical curves must not be below 625 m for crests and below 350 m for sags.

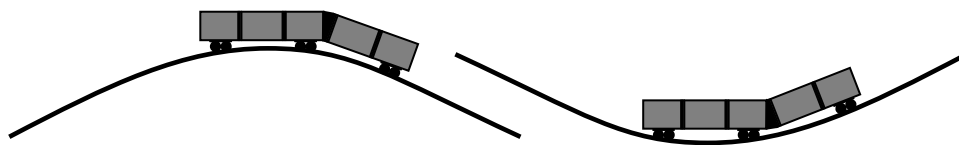

FIGURE 3 Effects of vertical curves over vehicle geometry.

On the other hand, TCRP Report 57 (4) identifies a minimum vertical curve radius 250 m for sags and 350 m for crests, values that are quite a lot smaller than those of the UITP. In the case of crests, this must be due to greater values of allowed vertical acceleration to be experienced by passengers, or to stricter speed limitations for American systems, although this last reason does not seem very solid. For sags, the difference could be due to differences in typical vehicle design between European and American light rails.

If there are unusual restrictions which make necessary a very tight layout, smaller values can be achieved, although this can compromise vehicle design in a considerable way. This is the case of Amsterdam, Netherlands, with vertical radius up to 150 m.

TRACK GEOMETRY AT STATIONS

Track Horizontal Alignment

Both TCRP Report 57 (4) and UITP (3) observe that stations have tangent alignment. In this way, excessive distances between platform and vehicle will be avoided and access to the vehicle will be easier. On the other hand, curves at stations lead to low visibility of doors by the driver, who has difficulties to control if there are passengers getting in or out, although this can be overcome by means of mirrors.

The effect of the curve at stations can be seen in [Figure 4](#). Tangent stretch must be extended to both sides of the platform, in a minimum recommended length of 25 m, with a minimum absolute value of 15 m. Sometimes it is not possible to comply with this recommendation, and it is waived (see [Figure 5](#) as an example).

If it is not possible to get a tangent alignment at any particular location, UITP (3) establishes that the radius should not be smaller than 300 m.

Track Vertical Alignment

Stations must be located in places with constant vertical grade (3–4). This constant vertical grade stretch should be extended to both sides of the platform in a minimum length of 12 m. Recommended vertical grade at stations is 0.0%, and absolute maximum is 2.0% or 4.0%. Again, these two conditions are waived if it is necessary (see [Figure 6](#) and [7](#) as examples).

TRACK GEOMETRY PARAMETERS OF SOME LIGHT RAILS SYSTEMS IN OPERATION TODAY

Extreme values of track geometry parameters of some light rail systems in operation today can be seen in [Table 2](#). Despite the recommended limitations that have been referenced along this paper, it can be seen in the table that light rail systems are able to operate in extremely tight alignment conditions. This fact makes that these systems are very flexible for introducing them over the central business district along almost every kind of street.



FIGURE 4 Effects of horizontal curves at stations, Zurich, Switzerland, light rail.



FIGURE 5 Station in which tangent tract is not extended to both sides of the platform, Tenerife light rail.



FIGURE 6 Vertical grade of 7.5% at Tenerife light rail station. See the detail of staggered seats in the shelter.



FIGURE 7 Station located in a sag vertical curve, Tenerife light rail (12).

TABLE 2 Extreme Values of Track Geometry Parameters of Some Light Rail Systems in Operation Today

System	Minimum Radius (m)		Maximum Superelevation (mm)		Maximum Vertical Grade (%)		Minimum Radius in Vertical Curves (m)	
	Rec.	Abs.	Rec.	Abs.	Rec.	Abs.	Rec.	Abs.
Denver (United States)	152	25	101	152	3.5	6.0	—	
Lisbon, old network (Portugal)	11		—		14.5		—	
Lisbon, new network (Portugal)	14.5		45		6.0	7.5	—	
Barcelona (Spain)	25		0		7.5		500	
Tenerife (Spain)	26		100		7.5	8.5 ^a	700 ^b	500 ^b
Seville (Spain)	25		-		1.56		1,000 ^c	700 ^c
Rouen (France)	30		160		7.0	8.0 ^a	350 ^b	700 ^c
Dusseldorf (Germany)	25		165		4.0		500	
Dublin (Ireland)	25		120		6.0	8.0 ^a	350 ^b	700 ^c
Nottingham (United Kingdom)	18		36 ^d	143 ^e	6.7 ^f	8.5 ^g	300 ^b	500 ^c
Genève (Switzerland)	150 ^h	80 ^h	70		3.0	6.0 ^k	1,000 ^b	300 ^b
	50 ⁱ	20 ^j					1,500 ^c	300 ^c
Sheffield (United Kingdom)	25		150		10.0		—	
Croydon, London (United Kingdom)	25		15 ^l	150 ^m	9.0		1,000	
Docklands, London (United Kingdom)	40		150		6.0		—	
Manchester (United Kingdom)	25		35 ⁿ	150 ^o	5.56		—	

NOTE: ^aLength smaller than 250 m; ^bsag vertical curves; ^ccrest vertical curves; ^dshared right-of-way; ^esegregated right-of-way; ^fmaximum grade at platforms; ^gmaximum grade elsewhere; ^hmain line; ⁱat stations; ^jat stations, with right hand curve, for visibility in right hand doors; ^kmaximum length 80 m; ^lsegregated right-of-way; to allow track to conform to the highway camber; ^mindependent right-of-way, plain ballasted track; ⁿgrooved track; ^oballasted track.

CONCLUSIONS

Along this paper, common limit values for track geometry parameters of light rail systems have been summarized according to different recommendations. Nevertheless, due to the necessity of light rail systems for running over existing streets which have been conceived with stricter parameters, it has been shown that there are many occasions in which these recommendations are not satisfied.

If existing systems are taken into account, specially the old ones, the conclusion that light rail systems are able to operate over practically any alignment (horizontal curve radius of 11 m, vertical grades of 11.5%, etc.) can be reached. In this sense, this paper has stated the great flexibility of this kind of systems, which are able to run over really strict layouts in the event of necessity. Nevertheless, these tighter values must be avoided in new networks insofar as possible, in such a way that the following advantages are achieved:

- Increase in passenger comfort, and in service attractiveness;
- Reduction of investment and operation costs;
- Minimization of severe speed restrictions, improving in this way the commercial speed of the system; and
- Possibility of using standard vehicles of current production in the market, without exceptional requirements which should have an effect on their acquisition costs, as well as on maintenance expenses and complexity.

If a comparison is made between limitations to track geometry parameters discussed by TCRP Report 57 and UITP, the conclusion achieved is that the parameters are quite similar, except for vertical curve minimum radii, in which TCRP Report 57 is more permissive than UITP, for the reasons stated above.

In relation to real values, it is possible that extreme values are achieved more frequently by European systems than by United States ones for new networks, due to stricter restraints in street layout and space for European cities.

ACKNOWLEDGMENTS

The authors thank Metropolitano de Tenerife, S.A., and Autoritat del Transport Metropolità de Barcelona for their contribution to this work in providing data about light rail systems of both cities.

REFERENCES

1. Vuchic, V. R. *Urban Transit Systems and Technology*. John Wiley & Sons Inc., New York, 2007.
2. Taplin, M. *A World of Trams and Urban Transit. A Complete Listing of Light Rail, Light Railway, Tramway and Metro Systems throughout the World*. Light Rail Transit Association, January 2006. <http://www.lrta.org/world/worldind.html>. Accessed September 30, 2008.
3. *Guidelines for Selecting and Planning a New Light Rail System. Level 1, 2, and 3 (CD-ROM)*. Union International des Transports Publics, Brussels, 2004.
4. Parsons Brinckerhoff Quade & Douglas, Inc. *TCRP Report 57: Track Design Handbook for Light*

- Rail Transit*. Transportation Research Board of the National Academies, Washington D.C., 2000.
5. Hollis, J. A Survey of U.K. Tram and Light Railway Systems relating to the Wheel/Rail Interface. Report FE-04-14b. Health and Safety Laboratory, Her Majesty Railway Inspectorate, London, 2006.
 6. Parsons Brickerhoff Quade & Douglas, Inc. *TCRP Report 2: Applicability of Low-Floor Light Rail Vehicles in North America*. Transportation Research Board of the National Academies, Washington D.C., 1995.
 7. Leyghon, K., M. Gillespy. Nottingham Express Transit Line I: Geometrical Aspects. Proc., Institution of Civil Engineers, Transport, London, 159, Issue TR2, , 2006, pp. 63–68.
 8. Martínez, F. El Casco Antiguo de Sevilla: Un Reto de Futuro para la Movilidad Sostenible. Implantación, Gestión y Explotación de Metro Ligero (CD-ROM). Institute for International Research, Madrid, 2006.
 9. Manjón, O., Línea 1 de metro ligero en Tenerife. Seminario sobre tranvías y metros ligeros. CD-ROM. Foro del Ferrocarril y del Transporte, Madrid, 2004.
 10. Transports Publics Genevois. Directives Techniques pour Tramway. Departement des Constructions et des Technologies de l'Information. Genève, 2006
 11. Muñoz de Dios, A. La experiencia de la construcción y puesta en marcha con éxito de un sistema de metro ligero. VIII Congreso de Ingeniería del Transporte. Ed: Miguel R. Bugarín, Alfonso Orro & Margarita Novales. A Coruña (Spain), 2008.
 12. Oromí, P. El Tranvía Vuelve a Tenerife. Cimbra: Revista del Colegio de Ingenieros Técnicos de Obras Públicas, nº 378, 2007, pp. 20-31.

REGULATIONS AND STANDARDS

Adapting Established Safety Outreach to Light and Commuter Rail Systems

IYON ROSARIO

Federal Transit Administration

ISABEL KALDENBACH

Operation Lifesaver, Inc.

In 2002, FTA officials became concerned by an emerging trend of pedestrian and driver casualties around new light rail systems, and realized that with additional light rail systems in the pipeline, the problems could multiply. It selected Operation Lifesaver, Inc. (OLI), based on their almost four-decade history of effective safety training and outreach, to develop and implement a toolkit that could be implemented as is or customized by individual transit agencies, notwithstanding the geographic diversity and variety in equipment, alignment, size, and operating characteristics of each light rail system. While initially focused on light rail, the FTA wanted the toolkit to be adaptable to and usable by other modes—including commuter rail and bus.

OLI approached the project by canvassing existing and new-start light rail systems, as well as established commuter and intercity passenger rail systems, to identify challenges, approaches, and potential pitfalls. Then OLI convened a working group of representatives from 23 transit agencies and utilizing conference calls, meetings during association events (i.e., APTA conferences, TRB), a website and e-mail communications, developed a character, messages, and collateral materials.

The mascot selected was Earl P. Nutt, a North American Red Tail Squirrel with a desire to see America, whose family has a tragic tradition of ending up as road kill. Undaunted, Earl P. Nutt studies the safety rules before he embarks on his tour of America. Earl is funny, savvy, and smart, and he interacts with a variety of characters (including, potentially, other transit agency mascots) in his travels. The children's educational safety program includes posters and other artwork depicting Earl in various situations, an 8-min cartoon in English and Spanish that spotlights his travels around one unnamed city, and dozens of interactive activities grouped by age that pivot off his name, his character, and a mnemonic for five basic rules about light rail safety (ACORN). The mnemonic stands for: Always look both ways, Cross only at crosswalks, Obey all signs and signals, Railroad tracks are for trains only, and Never try to outrun a train (Figure 1).

The initial materials were focus group tested at three locations: Seattle/Tacoma, Washington; Houston, Texas; and Camden, New Jersey. The focus groups, which tested three groups of children in three age groups and featured a variety of different types of presenters, revealed some modifications that could improve the print materials, activities and cartoons, and unexpectedly revealed the critical importance of having information presented by presenters knowledgeable both about trains in general and about the immediate locality—we say unexpected because this was not a variable we set out specifically to test.

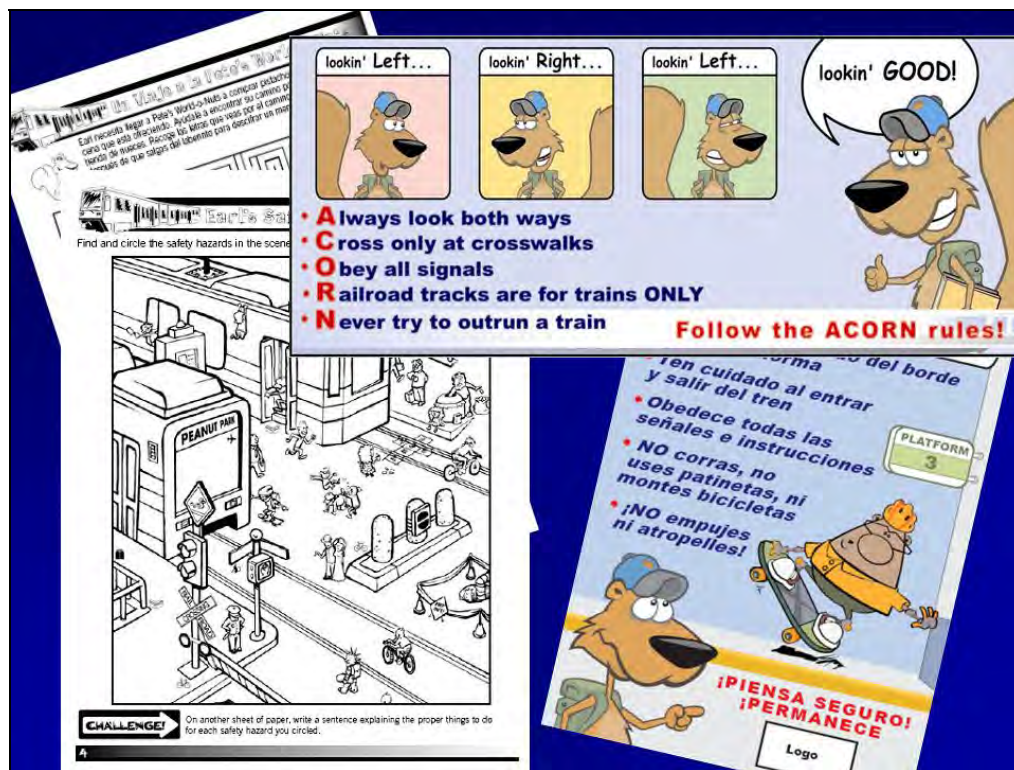

FIGURE 1 The intensified outreach pilot program.

Focus groups began by quizzing children about their general knowledge of train safety, then presenting them with a short presentation from the toolkit of materials, then quizzing them to gauge retention of information and allowing them to fill out a report card on both the presenter and the presentation. Three weeks later, a short follow-up call gauged their longer-term retention of safety messages.

Aside from suggestions about the materials (wordsmithing, artwork changes, the need for a longer cartoon with more closure to the story), the participants in the focus groups spent a great deal of time critiquing the presenter's ability to answer questions. Purely by chance, Houston's presenter was a long-time OLI presenter who was also a police officer and had been working with the Metro since its inception; Camden's was a resident of a nearby state but not a resident of Camden, who had great familiarity with rail safety and passing familiarity with NJTRANSIT operations; and Seattle's presenter was an out-of-stater who knew nothing about Sound Transit and had not been trained in rail safety, but was involved in education in general. Retention rates by students and scores for presenters tracked the presenters directly by their familiarity with the area and with trains. Criticisms of the Seattle presenter included an inability to answer follow up questions or to answer questions about the train service; kudos for the Houston presenter included raves for his ability to answer detailed questions about Houston Metro's operations (does the train go to X?) as well as train safety questions in general (why is the railing this high at a platform?).

Materials were modified as needed and distributed to interested transit agencies around the country. Two years later, adult education materials were developed and distributed. These materials include posters and artwork, a template PowerPoint speech, fact sheets, and an

informational brochure. Both youth and adult education materials were provided in hard copy as well as electronic format, and many elements were bilingual (English–Spanish).

Materials were made available at industry conferences and letters. In response to requests from calls, in-person contact, OLI state coordinator outreach, and e-mails from the website, 47 transit agencies, police departments, state departments of transportation, and school bus driver departments received copies of the materials. In addition, in the summer of 2007, letters introducing the effort were sent directly from OLI's President Helen Sramek to the general managers and safety heads of rail transit agencies that were not already participating in the program.

In June 2007, OLI began an intensive agency-by-agency effort that paired light rail agencies with OLI state coordinators and provided material and financial support to projects developed by this partnership. The idea behind the pairing was to build off of the template materials and adapt them to specific needs, providing transit agencies with not only the free toolkit but with free assistance to adapt and implement the materials each agency individually identified.

Light rail systems are invited to pair with OLI state coordinators. The agencies selected are chosen because they (a) have previously expressed a need for assistance that went beyond what was in the toolkit, (b) represent a diversity in geography, size, alignment, and operating characteristics, and (c) represent a variety in age, from systems still in the planning stage to those that have operated for decades. An initial six programs grew to 11 as additional funding was made available.

As the program expanded to 11 sites, a secondary benefit came into play. Conference calls, group e-mails and meetings among the agencies and state coordinators became a forum to share "best practices" as well as potential pitfalls among the various transit agencies, helping the participating agencies replicate and build on success as well as identify and address challenges.

The variety of systems participating in the program has provided an interesting set of approaches.

- In some cases, toolkit materials are used "as is." St. Louis, Missouri, for example, took the posters and, with minor modifications and the addition of a logo, placed them on their transit buses. Houston Metro ran the cartoons in continuous loops at electronics stores situated near light rail stations, developing a partnership with these stores to utilize new video technologies on sale at the stores to help spread safety messages;

- In other cases, materials are freely adapted. Austin Capital Metro (Texas) used the Earl P. Nutt cartoon character's image but placed him in its own artwork and settings, and translated the materials into language more in keeping with local dialect. Charlotte, North Carolina's Area Transit Authority (CATS) used many of the slogans but used its own images in public safety announcements and collateral materials handed out at sporting events;

- In still other cases, materials are used as is but implemented through new outreach techniques. CATS engaged local professional sports teams in new public safety announcements and game day events in an effort to reach teenage and early-20s aged males. North County Transit District (NCTD) developed cable-access programs incorporating the slogans, artwork, and materials from the program while adding its own content and images. Austin Metro offered lawn signs based on program slogans to property owners along the rail alignments; and

- Several light rail systems are using the partnerships as a springboard to develop entirely new materials. San Francisco, California's Muni translated materials into Chinese, with

bilingual stickers, flyers, and community outreach designed to penetrate a new community. Working in conjunction with its local boy and girl scouts, Austin Metro developed a railroad safety badge focused narrowly on Austin's own new system. NCTD created its own 30-min program for use by local television. Utah Transit Authority's TRAX developed a strikingly effective, yet simple, billboard.

Details about the sites selected, tactics and approaches employed, and results at each of the 11 sites follow.

MUNI (SAN FRANCISCO)

One of America's oldest transit agencies, and the seventh-largest in the country, Muni operates historic streetcars and city-defining cable cars, as well as electric trolleys, buses, and hybrid vehicles. The entire transit system (bus, rail, and paratransit) carries more than 200 million passengers annually. There are seven traditional light rail lines, as well nontraditional light rail systems made up of three cable car lines and one heritage electric trolley line.

California's OLI coordinator worked with Muni's safety department and local FRA officials to develop a localized PowerPoint that meshes OLI's nationwide messages with photographs of actual situations the challenges of maneuvering around, walking around, and parking near light rail lines, all with the goal of educating adult drivers and pedestrians. Relying on the city's expertise as well as OLI's proven messaging expertise, the PowerPoint showed dangers and explained in short and easy-to-remember messages how to avoid these dangers, without scaring passengers and potential passengers away from using the service.

Responding to incidents of injury in Chinatown among non-English-speaking populations, Muni also reached out to its Chinese constituency and together with OLI developed graphically appealing ethnically sensitive artwork and a Chinese language tagline to educate people in one quick statement about the dangers of not being alert around cable cars (Figure 2). The stickers and pencils were handed out at major Chinese street festivals, as well as at citywide safety and transportation events. Results are pending.

NCTD SPRINTER

Twenty-two miles of brand-new light rail service between Escondido and Oceanside, California, began serving 15 stations on March 9, 2008.

California OLI and NCTD worked closely to develop materials and outreach strategies well before the new line started running, training 17 of 33 NCTD OLI presenters within the last 2 years. The team developed a 30-min program that will be completed on October 31 and aired some time after that. The video featured visuals of actual crossings and alignments and, much like Muni's efforts, localized proven safety messages and provided a set of recognizable images that could grab and hold the interest of local residents. Similar to Muni, a presentation for adults that featured local sites in its visuals was developed that helped draw the attention of residents.

OLI presentations were made prior to implementation of Sprinter service, at schools, community organizations, employer, and professional driver groups. Rail safety educational materials were distributed in public schools throughout North County (just one effort included



FIGURE 2 Examples of outreach materials.

distribution of 120,000 flyers to parents), and to citizens via inserts in residential waste and waste management bills (approximately 100,000 mailings). Rail safety teams were formed in every city served by Sprinter and they distributed safety information at police departments, fire departments, public libraries, city halls, churches, and senior centers. OLI volunteers set up booths at numerous county fairs and events. Results: more than 300,000 people were reached in the efforts.

METRO–METROLINK (ST. LOUIS)

Begun in 1993, Metrolink light rail now stretches 46 mi in two states (Illinois and Missouri) and serves 37 stations. Metrolink light rail is the fastest growing component of the Metro system, with a ridership increase of more than one-third last year and a total ridership of 21.8 million in 2007.

Missouri OLI and Metrolink initiated a program to reach out to transit bus drivers, not only because they had received minimal rail safety training (since like most transit agencies, bus and rail were distinctly separated programmatically), but because bus drivers often flow from one bus system to another and into the general commercial drivers' license world. By training this population, rail safety knowledge could ripple among commercial drivers of all sorts. The bus drivers selected for training were also those who had significant civic and social connections in their own residential communities. By training them as OLI presenters, the hope is that they would make presentations to the groups with which they volunteered outside of Metro, expanding safety education to new audiences otherwise probably unreached by the conventional rail safety community (those who work or live around train tracks). Missouri OLI sweetened the training by offering prize incentives to the new presenters who made a high number of presentations, thereby encouraging creative thinking among these presenters about how to spread the safety message.

Within the first month, OL had trained six new presenters, who in their first few weeks had made presentations reaching nearly 300 people. A newly retired presenter on his own began reaching out to schools and groups on behalf of these new presenters.

Metrolink also availed itself of the materials offered in the program, tailoring one of the billboard images provided in the toolkit and creating a banner for the sides of Metro buses that featured the OL image and statement (Figure 3). These ran across the St. Louis metropolitan area on 411 buses and 87 light rail vehicles in fiscal years 2008 and 2009. Results: 53,000 persons reached through this pilot program.

CATS

CATS began its 10-mi, 15-station LYNX service in November 2007, but an extension is already planned for south of the city. North Carolina OLI worked closely with CATS well before the light rail system came online, and well before testing began. By the time the system opened, bilingual flyers (Spanish–English) had been distributed to the public; public service announcements (PSAs) produced in conjunction with local professional sports teams were playing online, on television, and at games; a website on safety was up and running; and the professional basketball team (Charlotte Bobcats) joined with CATS and OL to distribute giveaway mugs with rail safety messages at 25 of its home games. Charlotte police conducted three separate safety blitzes in conjunction with North Carolina OLI.

Results: The efforts reached at least 400,000 people through sports game exposure. Moreover, 6,000 people have seen in-person OLI presentations (including 5,000 students in the Charlotte–Mecklenburg school system), and presentations have been made to all medics and first responders in the Charlotte–Mecklenburg area and, via internet training, to all Charlotte–Mecklenburg Police officers. There has been only one train–automobile collision (in that case, the automobile operator was arrested and charged)—a success record that reflects well



FIGURE 3 Metro St. Louis is using a version of these posters to create banners.

on the extensive advance safety outreach and planning by CATS. While as above full credit can not be claimed by any one effort, the aggressive public safety outreach was integral to the overall safety efforts made by CATS. One ongoing issue is that more than 60 automobiles have come into contact with crossing gates, causing a varying level of damage to the gates. This issue indicates more education is needed at the crossings in the future.

CAPITAL METRO (AUSTIN)

Slated to begin service in March 2009, Metrorail will run 32 mi between Leander and Downtown Austin, serving nine stations during morning and evening rush hours.

Austin has been one of the poster children for the pilot outreach program, moving within six months from an agency that had yet to develop its safety outreach efforts to one that is leading the way in innovative, effective, and cost-efficient outreach (see [Figures 2 and 4](#)). It is no exaggeration to say that without the close working relationship between Texas OL and Capital Metro, it is unlikely that the groundbreaking new materials and outreach strategies would have come to be.

Just a few of the efforts include the following:

- A badge for Girl and Boy Scouts, and a magazine ad for a Girl Scouts publication distributed throughout Central Texas;
- A website, posters, flyers and activity book, as well as lawn signs for houses and properties adjacent to the tracks and web pages on Capital Metro's site, Facebook, MySpace, and a dedicated site (www.stayoffthetracks.com);
- A bilingual PSA featuring the Austin Chief of Police and Austin Sheriff; more PSAs are in development featuring local Austin celebrities;
- A film contest with monetary prizes and scholarship opportunities based on the theme of rail safety, being administered by Capital Metro and utilizing the expertise of a local film school;
- "Bus radio" announcements on all yellow school buses, carrying key safety tips about railroad crossings;
- A focus on outreach to schools throughout Austin, both directly and through PTAs, as well as through a tagline at the bottom of report cards (so the message got directly into the hands of parents) and a project the sheriff's office. The sheriff's office conducted a safety blitz with graphic T-shirts that warned about the dangers of irresponsible behavior around train tracks. Widely praised as "cool" by the students, the stock of 100 black T-shirts were depleted within 2 h; and
- One hundred lawn signs in English and Spanish—similar to political candidates' lawn signs—were distributed along the rail alignment, informing the public by that trains will soon be running and that they should be alert. Two hundred more have been ordered.

Results: To date, almost 30,000 students and an estimated additional 15,000 Austin residents have been reached directly through the variety of tools described above, and the efforts have garnered widespread media attention that has expanded that audience exponentially.

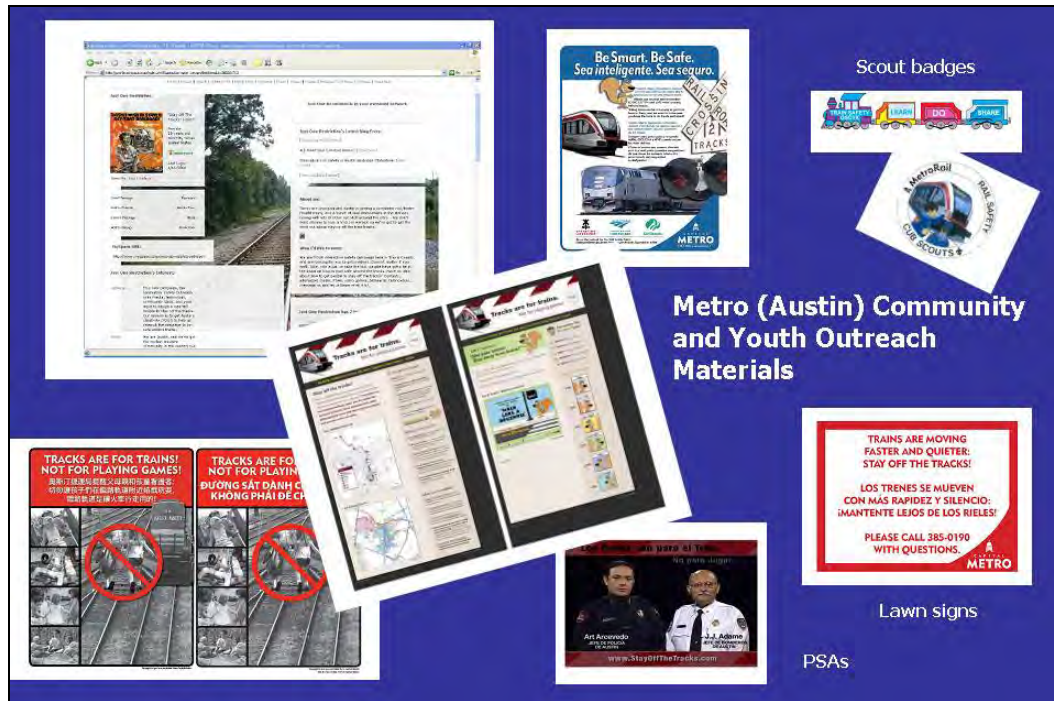

FIGURE 4 Capital Metro, Austin, Texas.

METRO (HOUSTON)

Begun in January 2004, the 7.5-mi Metrorail serves 16 stations and 45,000 riders per day. Its initial days were marked by challenges involving drivers unfamiliar with light rail trains operating along streets, particularly in left turn situations, spurring extensive efforts to educate and engineer solutions.

Houston Metro took an innovative approach to the materials provided when it negotiated with a local electronics retailer to have the retailer play OLI cartoons on the big screen televisions in the windows of the stores it operates near rail stations.

Results: pending.

UTAH TRANSIT AUTHORITY TRAX (SALT LAKE CITY TO SANDY) AND FRONTRUNNER (SALT LAKE CITY TO PLEASANT VIEW)

Established in 1970, Utah Transit Authority (UTA) has become a multimodal transportation authority that prides itself on being 100% accessible. The system operates light rail, commuter rail, and bus service. Its light rail system (TRAX) currently averages more than 51,849 riders a day along its 15-mi Salt Lake-Sandy line and the 4-mi University Line. UTA has five planned extensions of its light rail system. UTA has constructed a 44-mi commuter rail line from Salt Lake City to Pleasant View called FrontRunner, which has eight stations and is averaging 8,250 daily riders. UTA has already started construction on FrontRunner south to Provo—a 44-mi, eight station commuter rail line to be completed in 2012.

Joint UTA and OLI Utah activities through the pilot program focused on that imminent start up of FrontRunner commuter rail service and included partnering on a billboard on Interstate 15 about commuter rail trains (Figure 5). That portion of I-15 has a traffic volume of more than 50,000 vehicles per day on southbound lanes. The billboard ran for 3 months and has a value of \$32,000 (what UTA paid for the billboard).



FIGURE 5 UTA–TRAX billboard and bus ad.

UTA and OLI Utah also partnered with UTA to place posters on the outside of 10 city buses, which crisscrossed a variety of city routes from Salt Lake City to Ogden and reached both drivers and pedestrians throughout the day and night for 5 months. In reality, because some of the space remained unsold after the scheduled ended, some of the buses carried the message longer than 5 months.

UTA and OLI Utah also partnered to give presentations and assemblies to 28 public schools along the entire FrontRunner commuter rail corridor from Ogden to Salt Lake City.

Results: More than 125,000 people were reached by these efforts. While the FTA–OLI program can in no way take entire credit for the system’s safety record, only two incidents have been recorded since FrontRunner’s April 26, 2008, start-up.

VALLEY METRO (PHOENIX, ARIZONA)

Slated to open in December 2008, Valley Metro light rail is expected initially to carry 20,000 people daily, operating at 10-min intervals over 20 h each day (ridership is projected to double when the system is fully up and running). Trains will operate on street-level tracks that are in dedicated lanes and physically separated from automobile traffic. The initial 20-mi alignment will be supplemented by 37 additional miles of track planned to open in 2012.

Arizona OLI and Valley Metro have focused on training Valley Metro employees, Phoenix area driver’s education classes, and truck drivers at a large commercial trucking firm. To date 30 presenters have been trained, who within weeks of completing training had made 43 presentations to driver’s education classes, school bus driver training programs, bicyclists organizations, and transit agency personnel.

Most encouragingly, the pilot program has resulted in refocusing transit agency priorities to increase efforts in the realm of public safety outreach. Where previously it seemed that little advance work had been invested in this, now there is a renewed focus and the agency is developing materials to specifically address outreach to the general public, including a PowerPoint with OLI-tested messages but (as with systems above) local visuals that can appeal to and grab the interest of residents. “Metro light rail has been a pleasure to work with as well as very competent,” says OLI Arizona State Coordinator Doug Farler. “We are excited to continue partnering with Metro for the long run.”

Results: Other than the training numbers and recent presentation schedule above, there are no results to report—the system is not yet operational.

SOUND TRANSIT (SEATTLE, WASHINGTON)

Sound Transit operates bus, commuter rail and since 2003, light rail services in the Puget Sound Area. Light rail began operations in downtown Tacoma in 2003, and a 16-mi line linking Tacoma to Sea-Tac airport is in construction and slated to open next year. In the meantime, ground breaking for a new light rail line to the University of Washington in 2008 will usher in service by 2016. Sound Transit also operates 74 mi of commuter rail between Everett, Tacoma, and Seattle, with a new station opening in Seattle in 2008. Extensions of the commuter line are in development.

Sound Transit has long been a partner with Washington OLI and with the FTA–OLI light rail program. In 2004, Sound Transit hosted light rail materials focus group tests. In the spring of 2008, Sound Transit joined the intensified outreach pilot program, focusing its efforts on intensifying training of presenters and outreach to small local community events. Twelve presenters have been trained specifically on light rail and have spoken to almost a dozen community events ranging in size from 50 to 225 people. “Since we started training Sound Transit employees as presenters,” says OLI Washington State Coordinator Bob Boston, “they have educated more than 2,100 people at presentations and special events. We have also asked our other presenters in the Seattle–Tacoma area to include light rail and commuter operations into their presentations. This adds another 5,213 to the audience.”

Results: OLI’s efforts have helped contribute to a tremendous safety record. Tacoma Link light rail and Sound Transit rail operations have not been involved in any fatal incidents since their inception—particularly notable given the longevity of both operations and given that the Sounder commuter train operates over the same tracks as BNSF, Amtrak, and UPRR. As noted by the Tacoma News Tribune: “Sound Transit trains have never had a fatality accident since Sounder commuter rail service started in 2000....The multicounty transit authority has one of the best safety records of any passenger rail system in the country” (October 27, 2008). State Coordinator Boston notes that the pilot program has helped bolster the proactive efforts of Sound Transit Light Rail’s Carol Doering, who has worked to educate the public well in advance of the actual start of operations.

NJ TRANSIT

NJ TRANSIT is the nation’s third largest transit agency, linking major points throughout the entire state with each other and with New York City and Philadelphia—a coverage area of 5,325 mi². The system operates buses, commuter trains and light rail vehicles, providing nearly 223 million passenger trips each year. NJ TRANSIT has long partnered with OLI in various efforts, and hosted light rail materials focus groups in Camden in 2004.

This long-standing partnership enabled the transit agency to “hit the ground running” when it joined the intensified outreach pilot program. Within a few weeks, OLI and NJ TRANSIT cobranded a high school Driver Education Training Program for use across the state (Figure 6). The program pairs the new OLI teen driving video, *Look to Live*, with a PowerPoint training program developed by NJ TRANSIT and an online interactive quiz. The kit will be distributed to 2,000 driver education instructors across the state. Moreover, the ability to splice a light rail element quickly onto traditional OLI presentations enabled the transit agency to get the word out for safety very early.

One unusual characteristic of the system in southern New Jersey is that its light rail system is a shared use track, light rail in the daylight/evening hours and freight rail in the overnight hours. So the rail line sees train traffic 24 h per day—a particular challenge for any safety effort.

Results: too soon to report.

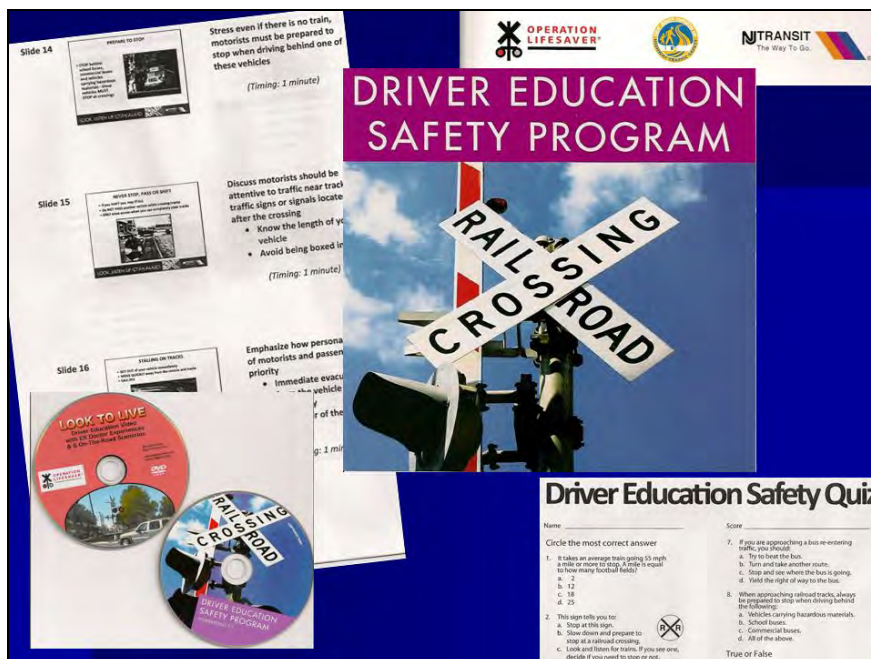

FIGURE 6 Materials from NJ TRANSIT’s high school driver education program.

SOUTHEASTERN PENNSYLVANIA TRANSPORTATION AUTHORITY (SEPTA) (PHILADELPHIA)

Serving 301 million people per year, SEPTA operates bus, subway, high speed rail, light rail, streetcars, trackless trolley, Regional Rail, and Paratransit vehicles that link the city of Philadelphia with points in five counties as well as the states of Delaware and New Jersey. Commuter rail trains alone serve 153 stations; light rail trains serve 53 stops.

As the newest addition to the pilot outreach program, SEPTA and Pennsylvania OLI have yet to meet to begin mapping out strategies.

CONCLUSION

What began as a joint partnership between the FTA and OLI has evolved into a thriving, innovative public safety education outreach program that works in tandem with transit agencies and the communities where their systems operate. Without the commitment of the individual transit agencies, OLI would not have been able to develop strategically focused community-based materials and outreach strategies. Without OLI’s four decades of experience, transit agencies would have found themselves reinventing the wheel, wasting resources to develop their public safety outreach efforts from the ground-up. The experiences gained at 11 separate sites and the best practices reviews afforded by sharing information, further enhanced the outcomes from this comprehensive effort.

And, most importantly, this partnership has helped achieve the objectives of all participants by reducing injuries and deaths along passenger rail alignments.

REGULATIONS AND STANDARDS

Development and Application of Structural Design Standards for Safety of Light Rail Cars and Streetcars

PHILIP STRONG

P S Consulting

STEVEN KIRKPATRICK

Applied Research Associates

Accidents that result in car body damage, although infrequent, carry the risk of occupant casualty. Such accidents continue to occur on commuter and intercity rail, heavy rail, and light rail operations (i.e., recently in Los Angeles, California and Boston, Massachusetts). Also, light rail operations in street traffic have resulted in casualties to occupants of automobiles, as detailed later in this paper.

Car body structural design regulations have been developed by FRA for commuter and intercity vehicles. APTA has supplemented these regulations with standards for pertinent aspects of car body and interior design.

Therefore, it was decided that it would be worthwhile to develop similar standards for heavy and light rail vehicles (LRVs), with leading end design for mitigation of automobile occupant casualties in collisions with LRVs' included in the light rail car body standard.

DEVELOPMENT OF STANDARD

Following the approach set by the FRA in their safety regulations for commuter and intercity cars (1) issued about 8 years ago, guidelines for car body static strength were included in the RT-1 standard in the first and subsequent drafts. (Note that LRVs are not directly under the jurisdiction of FRA, although FRA does have responsibility for overseeing shared use operations.) The APTA formed a Passenger Rail Equipment Safety Standards (PRESS) committee in the late 1990s to work with FRA to develop the above referenced safety regulations for passenger equipment under the jurisdiction of FRA (2). PRESS has issued standards that compliment the FRA regulations (1). One of these standards, (3), includes crash energy management (CEM) as an optional approach for design; see definition in [Appendix 1](#). The committee decided to include CEM as part of the current ASME standard RT-1 for LRV and streetcar structural requirements.

Early drafts of RT-1 included static strength criteria, criteria for limiting fatigue damage, and crashworthiness criteria. The latter focused on the crash energy management approach. (Crashworthiness and crash energy management are defined in [Appendix 1](#).) It was decided several years ago to not cover design for fatigue resistance in the standard. Risk assessment was also included in early drafts but not included in the final version.

A major division within the committee was over what value to use for the not-to-exceed car body end sill compression load without permanent deformation (the buff strength). Many North American light rail cars have been designed for a 2g buff strength (2g is shorthand for a

buff strength equal to two times the LRV empty weight). Most, if not all, European cars have been designed to a buff strength of 1g or less. This dispute was resolved in favor of specifying a buff strength close to the 1g value. The resolution was reached by recognizing that in collisions severe enough to deform the car body the buff strength by itself was not a major parameter in determining the degree of car body collapse and loss of occupied volume. This was clearly brought into focus in the report on the TCRP Project C-17 (4). The objective of Project C-17 was to investigate the collision behavior of current North American LRVs' to support the development of LRV CEM requirements. The force–crush characteristics for various LRV designs were determined for four different 2g LRV designs in 15- and 25-mph collisions in Figures 1 and 2, respectively. The crush strength was shown to have little correlation to the buff strength and the collision behavior and crash energy dissipation were better controlled by CEM requirements than by the buff load requirement.

Load cases not included in the European standards (5, 6) but included in the RT-1 standard are: car body side strength, specific anticlimber strength guidelines, roof strength, truck-to-car body attachment strength, coupling system strength, low-speed collision scenario and protection to road vehicle in collision with LRV or streetcar.

The decision to include consideration of protection to automobiles in collisions with LRVs was based on review of accident statistics. The committee determined that the vast majority of significant collisions are between LRVs and road vehicles and that these collisions produced most of the casualties in LRV collisions. These conclusions are supported by the transit accident data collected in the United States (7-11). Statistics for transit mode fatalities per 100 million passenger miles (in 1997–2001), from the U.S. Bureau of Transportation Statistics (BTS), is shown in Figure 3a (11). However, the majority of reported light rail fatalities are those of the occupants of automobiles or pedestrians that are struck by LRVs. As can be seen by

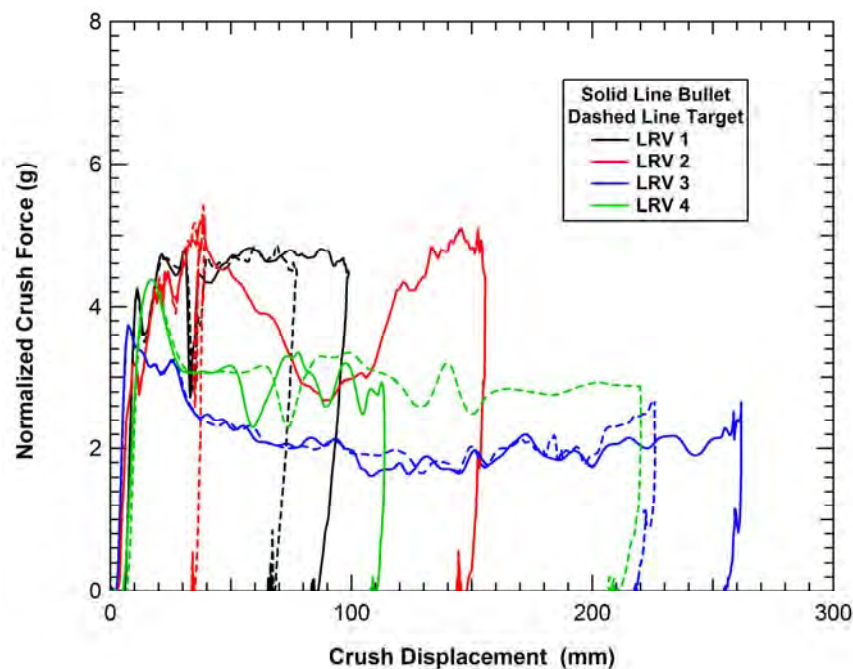

FIGURE 1 Force–crush plots for all the LRVs in the 15-mph compatible collisions.

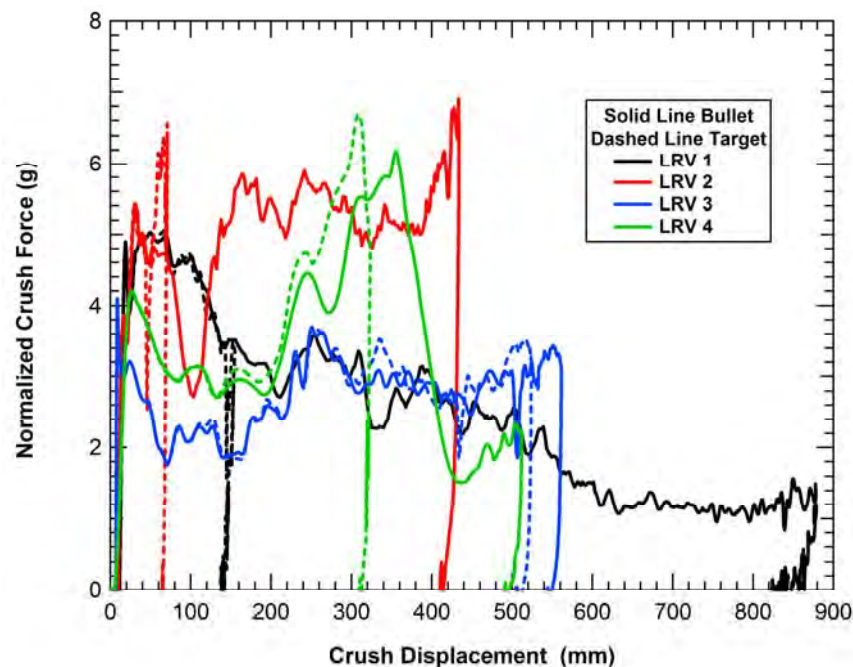

FIGURE 2 Force–crush plots for all the LRVs in the 25-mph compatible collisions.

comparing the results of Figure 3*b* with those of Figure 3*a*, LRV operations compare much more favorably to those of other modes for fatalities to the occupants of the transit vehicles than for overall fatalities for the transit modes. Thus the transit system safety record does not reflect the safety record for travel on LRVs.

A closer investigation of the accident data allows us to separate out the fatalities for LRV passengers versus those for pedestrians and automobiles (10). The corresponding distribution of injuries and fatalities is shown in Figure 4. This shows that the majority of the fatalities in LRV collisions are to pedestrians and motorists that collide with the LRV.

Clearly, the collision between an LRV and an automobile should be considered as part of the overall collision safety. Many of these collisions may be the fault of the automobile driver; however, the associated injuries and fatalities are counted against the safety record of the light rail system. Application of crashworthiness design technology should help reduce the severity of accidents involving road vehicles. For example, in collisions where the LRV strikes the side of an automobile, a compatible LRV cab-end can potentially result in significantly less structural intrusion into the street vehicle leading to a reduction in injury or fatality rates. This will contribute to a better overall safety record and a more positive view of LRV operations. Therefore, it was agreed to include appropriate LRV and streetcar leading end design criteria in the standard.

Simulations of collisions between automobiles and LRVs in Project C-17 were used to help identify appropriate crash safety requirements for RT-1. One of the primary requirements identified was to include a bumper or similar enclosure on the front of the LRV (12). The analyses used to investigate this requirement included a 20-mph collision between a small car (Dodge Neon) and an LRV both with and without a bumper enclosure as shown in Figure 5. By examination of the impact geometry, it is easy to see that there is a large variation between the

two vehicles in the size, weight, and height that result in a large degree of crash incompatibility. However, the addition of the bumper enclosure results in a significant improvement of the geometric compatibility. The enclosures applied the collision loads more evenly and lower on the automobile structure where the collision energy would be more efficiently dissipated.

The corresponding crush intrusions in the Dodge Neon for the 20 mph collisions without and with the bumper enclosure are shown in Figure 6. The comparison of the crush intrusions is significant. The maximum crush displacement without the bumper enclosure was approximately 67 cm and located relatively high on the occupant compartment of the car. With the bumper enclosure, the crush intrusions in the occupant compartment were reduced to approximately 43 cm and were more uniform over the center portion of the door.

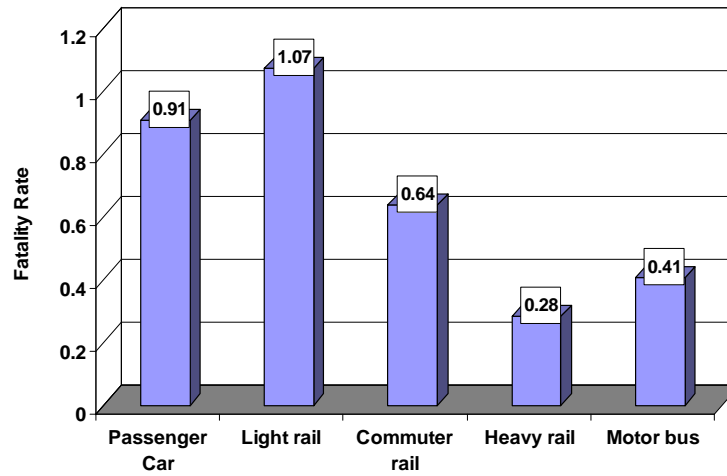

(a)

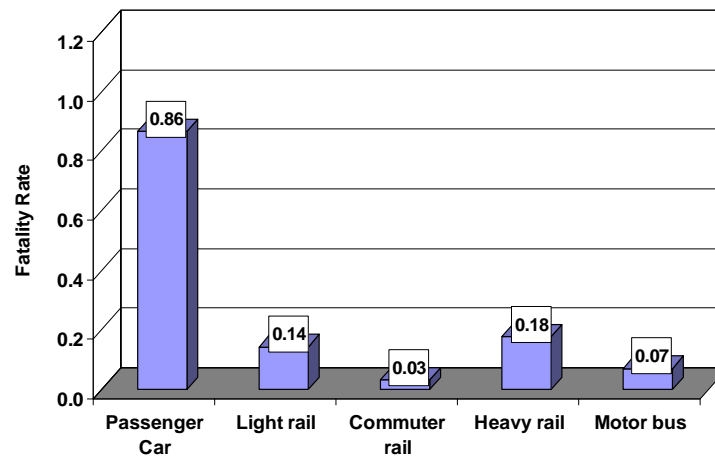

(b)

FIGURE 3 Transit mode fatality rates per 100 million passenger miles (1997–2001) (9–11): (a) transit mode fatalities and (b) transit occupant fatalities.

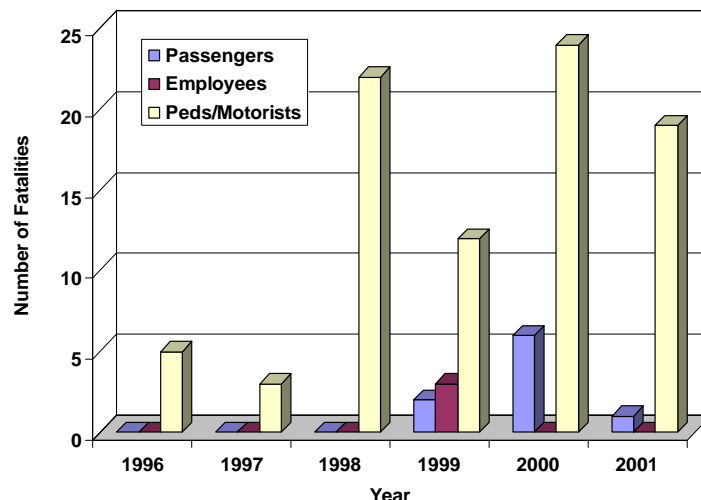

FIGURE 4 Distribution of fatalities for LRV accidents (9).

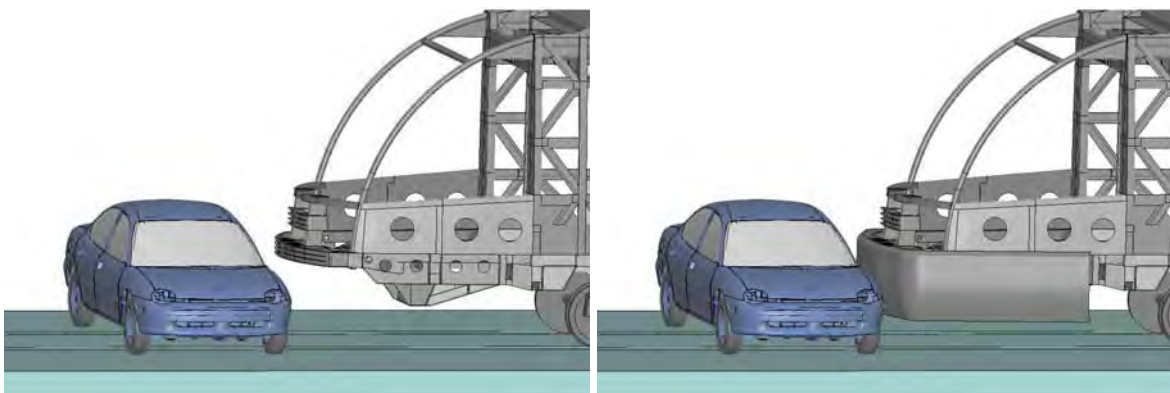

FIGURE 5 Geometric compatibility with and without bumper.

The reduction in automobile injury potential resulting from inclusion of the bumper enclosure can be estimated from research results on side impact safety of automobiles provided by the National Automotive Sampling System (NASS), which reports statistics of injury. These results were used to estimate the effect of broadening the load distribution across the automobile and directing the principal contact point lower on the automobile structure. Data from NASS shows that injury can be contributed by two effects, namely the sudden change in velocity when struck, and the physical intrusion into the vehicle. From the simulations described above it was shown that by including a bumper the probability of a fatal injury was reduced from approximately 75% without the bumper enclosure down to approximately 35% with the enclosure, as seen from data taken from the NASS plot of intrusion versus probability of injury or fatality shown in [Figure 7](#). The curves in the figure are parameterized by the number of injuries and fatalities. The RT-1 standard includes a requirement for a leading end bumper or similar design.

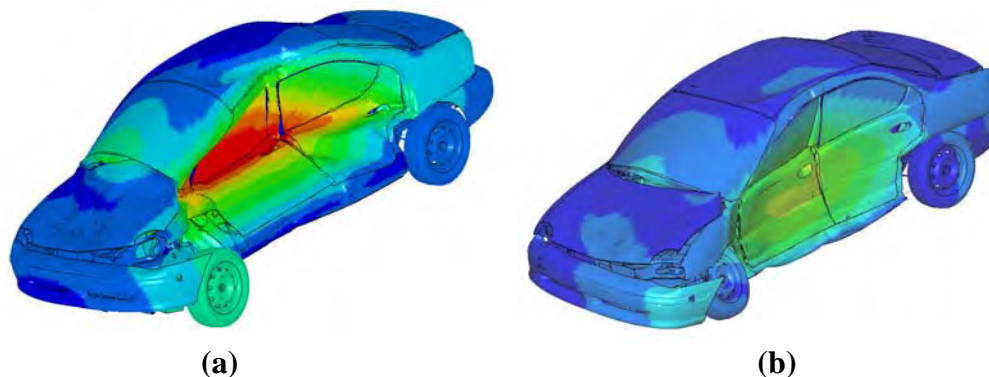

FIGURE 6 Fringe displacement patterns for Dodge Neon without and with LRV bumper: (a) without bumper (maximum crush 67 cm) and (b) with bumper (maximum crush 43 cm).

The European community had been developing both static strength and crashworthiness standards during the time period that the ASME effort (13–14) was in progress. These works in progress, now finalized (5–6), were reviewed and some of their requirements were incorporated in the RT-1 standard, whereas others were not incorporated directly but were included in another way. For example, the current practice in North America of specifying static strength in the end frame above the anticlimber was retained, as opposed to the European approach of specifying a collision scenario with a “large deformable obstacle.”

The role of the coupler in allowing engagement of colliding cars and subsequent energy absorption by deforming material was recognized at the beginning of the ASME effort as a significant feature of LRVs and is covered in the ASME standard by requiring a shearback coupler, except for streetcars that utilize rigid drawbars for towing. Both the European standard (6) and RT-1 recognize the importance of an anticlimber or equivalent in mitigating the risk of override in the event of a collision. RT-1 specifies structural strength requirements for anticlimbers. This should result in a more universal design for override protection than that arrived at using the performance approach specified in (6).

The traditional approach in North America for protection of the operator and passenger occupied volumes in the event of collision with an object above the anticlimber is to use either vertical posts or a structural wall. This approach is embodied in RT-1 by specifying specific strength requirements for the posts (collision and corner posts) or an equivalent wall, whereas in the European standard (6) it is specified by simulating impact with a defined large obstacle and demonstrating not exceeding acceptable loss of occupant volume and mean deceleration less than 7.5 g. The RT-1 design specific approach should result in a more universal design for end structure above the end sill than that arrived at using the performance approach specified in (6).

The more universal design achieved by use of RT-1 for design of the anticlimber and the end structure above the anticlimber, as contrasted with the designs resulting from the approach embodied in the European standard (6), would be expected to promote better interoperability between fleets.

Car body acceleration or deceleration in a collision is limited in the European standard (6). This influences both the risk of occupant slips, trips, and falls, and sometimes the secondary impact velocity with which occupants would strike objects within the car during a collision. A

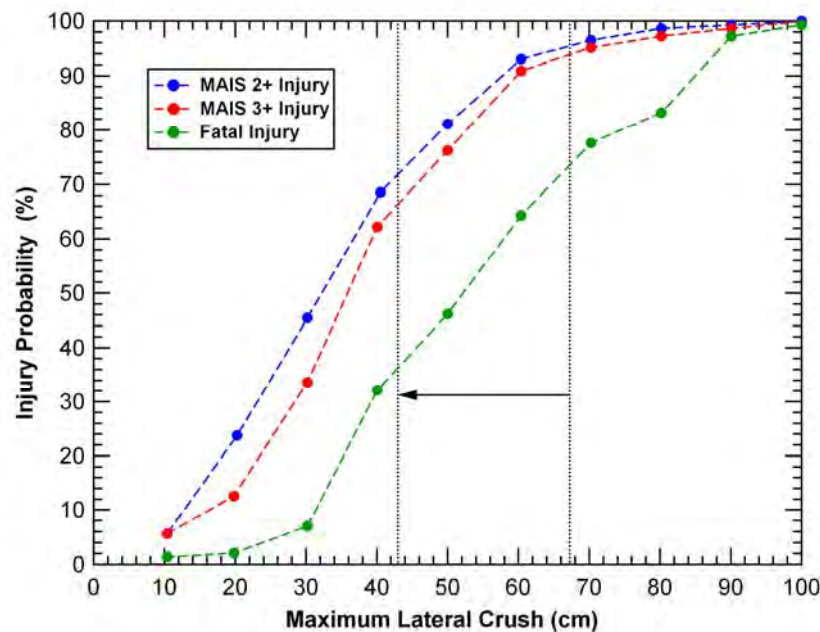

FIGURE 7 NASS injury and fatality probability versus lateral crush displacement.

relatively low crush force, while resulting in relatively low acceleration, could result in relatively large crush displacement. The limits used for average acceleration in (6) were used for collisions at 15-mph closing speed in the RT-1 standard. A higher limiting average acceleration was used for collisions at 25-mph closing speeds in RT-1. Although the European standard (6) does not specifically address collision at a 25-mph closing speed, the committee felt this was important, especially for LRVs, in order to ensure controlled deformation at more severe collisions than at 15 mph closing speed. The European standard (7) addresses this indirectly by the statement “absorb collision energy in a controlled manner.”

CONTENTS OF THE STANDARD

The table of contents for the RT-1 standard is included in [Appendix 3](#). The various sections of the standard provide the information on the design requirements and their intended application to LRV and streetcar structures. However, most of the critical requirements in the standard are captured within the tables of load requirements. These load requirements are summarized here. The structural design requirements in the RT-1 standard can be divided into four categories of loads that the car body may encounter. The first category of loads is the upper limit loads that could be seen in normal service. These design load requirements include the maximum vertical passenger load, end sill compression (buff load), coupling impact load, coupler anchor compression and tension loads, and roof loads. At these limiting design loads all of the acceptance criteria are that no permanent deformation is allowed. The maximum stress at maximum vertical load includes a safety margin below yield stress to protect against fatigue damage from dynamic loads.

The second category of loads are anticlimber loads that are specified at a level sufficient to prevent override in car to car collisions, and to protect occupied volume in collisions that occur with objects that impact on the area between the anticlimber and the structural shelf at the end of the car. These load requirements include longitudinal loads on the collision posts and corner posts and transverse loads on the corner posts both at the bottom and at 15 in. above the top of the end sill, longitudinal loads on the structural shelf, and combined longitudinal and vertical loads on the anticlimber. The acceptance criteria established for these load requirements are that no permanent deformation is allowed, except for loads at the bottom of the collision and corner posts for which ultimate strength is not to be exceeded. A collision wall is allowed as an alternate to collision posts.

The third category of loads are overloads that can result from side collisions with road vehicles, and with truck to car body attachment and equipment attachments developed in severe collisions. These loads include side loads on the side sill and belt rail to protect the occupant compartment in the case of a side impact by a highway vehicle and loads on equipment attachments and truck attachment to ensure that separation does not occur even when subjected to crash accelerations.

The final category of loads is those that are typically associated with the CEM or crashworthiness of colliding vehicles. Crush displacement limits and requirements for retention of survivable volume are specified. These collision scenarios are summarized in Table I. They include low-, moderate-, and high-severity collisions between vehicles at 5-, 15-, and 25-mph closing speed (streetcars are not required to consider the 25-mph collision). The acceptance criterion for the 5-mph collision is that no damage occurs to either vehicle. In the 15 mph moderate collision scenario the damage must be limited to 12 in. of crush in a zone in the front of the LRV. This maximum crush limitation assures that the average crush strength will be a minimum of approximately 2 g. All of the LRV designs analyzed in the Project C-17 would be able to meet this requirement (Table 1). The acceptance criteria for the highest severity 25-mph collision scenario were included to ensure a controlled stable crush response and protection of the passenger volume.

ACKNOWLEDGMENTS

The final standard is the result of dedicated effort by committee members, who are listed in Appendix 2. Special credit goes to Stan Canjea, recently retired from New Jersey Transit and the

TABLE 1 Crash Energy Management Requirements

RT-1 Item No.	Collision Scenario	Specified Load
17	Collision Zone 1: low severity impact	Closing speed between two like LRVs of 8 km/h (5 mph).
18	Collision Zone 2: moderate severity impact	Closing speed between two like LRVs of 24 km/h (15 mph).
19	Collision Zone 3: high severity impact	Closing speed between two like LRVs of 40 km/h (25 mph).
20	Collision between LRV and road vehicle	Smooth leading end, adequate strength (LRV only).

original chair of the committee, for his persistence in the face of concern over the reduction in buff strength below the 2g level. Martin Schroeder, committee chair, was instrumental in obtaining FTA funding for a project to investigate the collision behavior of current North American LRVs. This investigation was conducted by Steven Kirkpatrick of ARA and a member of the ASME committee. The results of the investigation renewed confidence that crash energy management parameters used in the standard were appropriate. Keith Falk, former chair of the committee, brought focus to the group's consideration of collisions between LRVs and road vehicles by leading discussion on accident statistics indicating that most casualties in LRV collisions in the United States were to occupants of road vehicles. This consideration is included in the standard.

REFERENCES

1. United States Code of Federal Regulations, Title 49: Transportation, PART 238—Passenger Equipment Safety Standards (49 C.F.R. PART 238).
2. Safety Management Information Statistics. 1997 Annual Report, U.S. Department of Transportation, Report No. FTA-MA-26-5002-99-01, DOT-VNTSC-FTA-99-3, March 1999.
3. RT-1: Safety Standard for Structural Requirements for Light Rail Vehicles, ASME Standards Committee on Rail Transit Vehicles, Draft 12, February 2009.
4. Kirkpatrick, S. W. *Development of Crash Energy Management Performance Requirements for Light-Rail Vehicles*. ARA Final Technical Report, TCRP Web-Only Document 40, Final Report for TCRP Project C-17, April 2008.
5. EN 15227. Railway Applications—Crashworthiness Requirements for Railway Vehicle Bodies. European Committee for Standardization, January 2008.
6. Passenger Rail Equipment Safety Standards, APTA.
7. *TCRP Report 69: Light Rail Service: Pedestrian and Vehicular Safety*, Transportation Research Board of the National Academies, Washington, D.C., 2001.
8. National Transit Database Data, <http://www.ntdprogram.com/>, Annual Data Tables.
9. Federal Transit Administration State Safety Oversight Program, *2003 Annual Report*. <http://www.transit-safety.volpe.dot.gov>.
10. Bureau of Transportation Statistics, National Transportation Statistics, 2005. http://www.bts.gov/publications/national_transportation_statistics/2005/.
11. Light Rail Collisions, 2005. http://cfapp.rockmountainnews.com/news/light_rail.html.
12. Bureau of Transportation Statistics, National Transportation Statistics, 2005. http://www.bts.gov/publications/national_transportation_statistics/2005/.
13. RT-2: Safety Standard for Structural Requirements for Heavy Rail Transit Vehicles. ASME Publications, 2008.
14. EN 12663: Railway Applications—Structural Requirements of Railway Vehicle Bodies. European Committee for Standardization, July 2000.

RESOURCE

- R. A. Arbelaez, B. C. Baker, and J. M. Nolan. *Delta Vs for IIHS Side Impact Crash Tests and Their Relationship to Real-World Crash Severity*. Paper Number 05-0049, Insurance Institute for Highway Safety, Arlington, Va., 2005.

APPENDIX 1: DEFINITIONS

- Anticlimber:** A structural member located at each end of the vehicle, used to engage the anticlimber of an opposing or other coupled vehicle to resist relative vertical travel between the two car bodies during a collision.
- Average Acceleration:** The average computed longitudinal acceleration at the vehicle center of gravity predicted by finite element modeling of a collision. The average computed acceleration is defined over a period of time from first contact between vehicles to a time when the contact force between vehicles first reaches a magnitude of zero.
- Closing Speed:** The relative speed of a vehicle to another object or vehicle at the time of initial impact.
- Collision Posts:** A set of two structural posts located at each end of the car body, extending from the bottom of the end underframe structure up to the structural shelf. They are located at the approximate one third points across the width of the vehicle, and are forward of the seating position of any passenger or crew person. An alternative to a collision post is the use of a collision wall.
- Collision Wall:** A structure at the leading end of the vehicle spanning the area between the structural shelf, corner posts and top of the underframe.
- Corner Posts:** A set of two full-height structural posts located at the outside corners of the passenger compartment or near the extreme corner of the car body, extending from the bottom of the underframe structure up to the roof at the top of the side frame at its intersection with the roof.
- Crash Energy Management (CEM):** A method of design and manufacture of vehicle structures that enhances crashworthiness by assigning certain sections of the car body the task of absorbing a portion of the energy of collision by crushing in a controlled manner (see structural energy absorption zone) in order to preserve occupant volume and minimize the consequences of occupant impacts with the vehicle interior. The controlled crushing and energy absorption functions are typically assigned to special car body structural members in the structural energy absorption zone that are designed to crush in a predictable and stable manner over a distance that depends on the design of the member, and the desired amount of energy absorption. The use of supplementary energy absorbing element(s) may be specified.
- Crashworthiness:** The ability of a car body to manage the energy of a collision while maintaining structural integrity, so as to minimize casualties to occupants, other vehicles and pedestrians.
- End Frame:** At the coupler ends, the end frame consists of structure inboard of and supporting the anticlimber, corner posts at the juncture of the front end and side frames, collision posts located at the approximate one third points of the end frame width, the end structural shelf or transverse beam, and sheathing connected to the structural framing members.
- End Sill Compression Load (Buff Load):** Compressive (longitudinal) force applied at the ends of the vehicle, usually at the anticlimber.
- Light Rail Vehicle:** light rail vehicles (LRVs) operate on a light rail transit system, and are not part of main line railroads. LRVs are capable of boarding and discharging passengers at track/street level or elevated platforms. The LRV provides a mode of rail transit characterized by its ability to operate on exclusive rights-of-way, shared street running, and through roadway grade crossings. Vehicle designs are typically smaller and/or narrower than heavy rail vehicles.

Streetcar: Streetcar is a category of LRV that operates mainly at street level (with some sections in tunnels or on rights-of-way) in consists of normally single or two units per train and at a maximum speed of 70 km/h (44 mph). Vehicles are typically smaller, lighter and narrower in width than LRVs.

Shearback Coupler: Coupler including release mechanism to allow the coupler not to impede engagement of anticlimbers and crushing of colliding car. The coupler may include an energy absorbing feature.

Structural Shelf: The structural member in the end frame that spans the full width of the car body and is attached to the tops of the collision posts and to the corner posts, and designed to transmit the collision post top reaction loads to the car body sides.

APPENDIX 2: MEMBERS OF ASME RTV COMMITTEE

M. Schroeder, Chair	C. Thomas	C. Woodbury
P. Strong, Vice-Chair	P. Jamieson	N. Zeolla
K. Hyam, Current Secretary	M. Burshtin	G. Gough
G. Burdeshaw, Past Secretary	W. Keevil	S. Canjea
F. Cihak	J. Kenas	C. Thornes
K. Falk	T. McGean	
S. Kirkpatrick	T. Tarantino	

APPENDIX 3: TABLE OF CONTENTS FOR THE RT-1 STANDARD

Foreword	
Introduction	
1	Scope
2	Definitions
3	Interoperability
4	Structural Requirements
5	Design Load Requirements
	Table 1 Streetcar: Table of Load Requirements
	Table 2 LRVs: Table of Load Requirements
6	Coupler System
7	Material
8	Crash Energy Management (CEM)
9	Analysis
10	Tests

REGULATIONS AND STANDARDS

Modifications to Light Rail Vehicles for Improved Compatibility in Collisions with Automobiles

STEVEN W. KIRKPATRICK

ROBERT T. BOCCHIERI

CLAUDIA NAVARRO-NORTHRUP

ROBERT A. MACNEILL

BRIAN D. PETERSON

Applied Research Associates, Inc.

The vast majority of light rail vehicle (LRV) accidents occur with motor vehicles and cyclists–pedestrians. Collisions where the LRV overrides an automobile are all too common, as seen in [Figure 1](#), which can lead to negative consequences (1). First, the override behavior results in significantly greater crush intrusions into the automobile and greater injuries to the automobile occupants. Second, the override collision has the potential to produce much more extensive damage to the LRV and greatly increase the repair costs and time before the vehicle is placed back in service. Finally, the override collision has a much higher potential to derail the LRV or create higher crash decelerations that can result in higher injury potential to the LRV occupants. Therefore, there has been a recognized need to investigate methods for improving the safety of passengers in motor vehicles as a consequence of a LRV collision.

The American Society of Mechanical Engineers (ASME) has had an ongoing committee with the objective of preparing safety standards for structural design requirements of heavy rail, light rail, and streetcar car bodies. The standard for light rail and streetcar car bodies (referred to as RT-1) was approved by the committee at the end of 2008 (2), and is currently in release for public comment. This ASME RT-1 committee recognized the need to include appropriate LRV and streetcar leading end design criteria in the standard to protect the motor vehicle occupants.



FIGURE 1 Example of a collision between an LRV and an automobile.

The determination of LRV front-end safety requirements to reduce injuries was difficult within the ASME RT-1 effort due to the lack of research and data regarding these accidents. The Crash Energy Management Subcommittee of the ASME, with responsibility for planning a way forward in this regard, succeeded in obtaining TCRP funding for a research project (C-17) with the aim of establishing a foundation and rationale for structural specifications of LRVs that would guide development of a standard (3).

TCRP PROJECT C-17 RESULTS

The TCRP Project C-17 analyzed a range of collisions between automobiles and LRVs that were used to develop the corresponding crash safety requirements for RT-1. Primary modifications that can be made to improve compatibility in collisions with automobiles are to eliminate features in the LRV front end geometry that make it aggressive. These measures include (a) adopting retractable or fold-away couplers at the ends of the LRV, (b) enclosing the front end of the vehicle and having a sufficiently low nose to prevent override of cars, and (c) including energy absorbing elements in the front-end designs of LRVs.

Collision simulations between LRVs and automobiles were performed in Project C-17 to quantify the potential safety improvements that can be obtained by adding appropriate crash safety features to the LRV. The simulations were performed using the LS-DYNA finite element code (4). Two different highway vehicles were used in the collision analyses as shown in [Figure 2](#). These models were developed under FHWA and/or NHTSA sponsorship and are maintained at the FHWA–NHTSA National Crash Analysis Center at the George Washington University (5). Highway Vehicle 1 (HV 1) is the Dodge Neon, selected to be representative of a small passenger vehicle with greater height and weight differences in a collision with an LRV. Highway Vehicle 2 (HV 2) is the Ford Explorer, selected to be representative of the light truck and SUV class of passenger vehicles which are very common in the highway vehicle fleet.

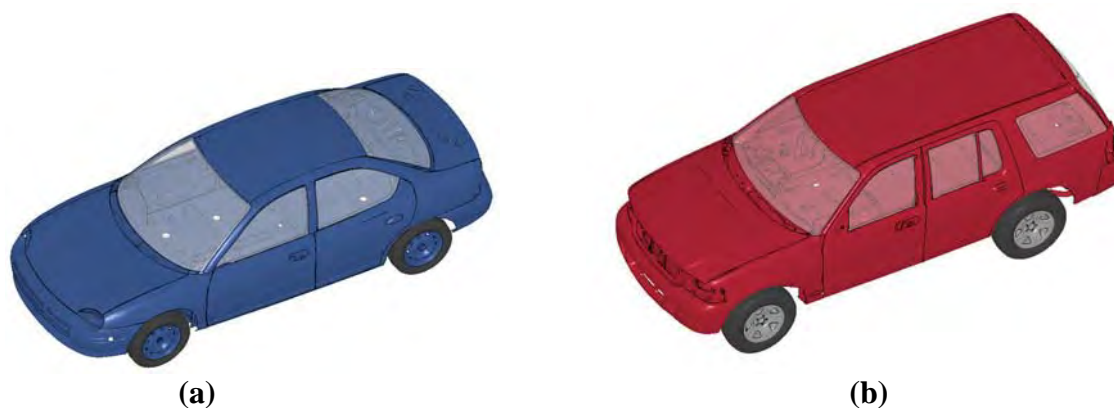

FIGURE 2 Finite element models for the highway vehicles used in the crash analyses: (a) HV 1—Dodge Neon and (b) HV 2—Ford Explorer.

The collisions were performed at a range of speeds between 10 mph and 30 mph with the majority of analyses at 20 mph. Two different impact orientations were used as shown in [Figure 3](#). The first is a normal (90-degree) impact of the LRV into the side of the highway vehicle passenger compartment and the second is an oblique impact of the corner of the LRV into the highway vehicles at a 45-degree angle relative to the LRV axis.

A side view of the impact interface between HV 1 and the LRV with different front end geometries is shown in [Figure 4](#). The impact geometry clearly illustrates the potential geometric incompatibility of the two vehicles that introduces a significant injury risk to the occupants of the highway vehicle. The impact point of the head girder is close to the bottom of the side window of the automobile. Such an impact would result in large intrusions close to the upper thorax of an occupant, leading to a high potential of a head impact against the LRV front-end structures. The safety feature illustrated in [Figure 4 \(b\)](#) is a rigid bumper enclosure that provides a larger smooth impact patch on the highway vehicle. The bumper enclosure extends in height from approximately 300 mm to slightly over a meter above top of rail.

The calculated 20-mph crash behavior of the LRV without the front-end safety feature into the side of HV 1 (90 degree) is shown in [Figure 5](#). The head girder overrides much of the HV 1 side-protective structures and intrudes significantly into the occupant volume. The high location of the impact also rotates the struck HV 1, lifting the wheels on the impact side off the ground. The response illustrates the significant incompatibility of the two vehicles in the collision and the potential for the LRV to override the highway vehicle and cause significant injuries to the occupants.

The calculated 20-mph crash behavior of the LRV with a bumper enclosure into the side of HV 1 (90 degree) is shown in [Figure 6](#). The bumper engages much of the HV 1 side protective structures and the crash response is significantly modified. The lower height of the impact loads pushes HV 1 laterally in the direction of the LRV movement. The motion is primarily a translation without the large roll of HV 1 seen when impacted without the bumper. The bumper also significantly reduces the crush intrusions of the LRV into HV 1.

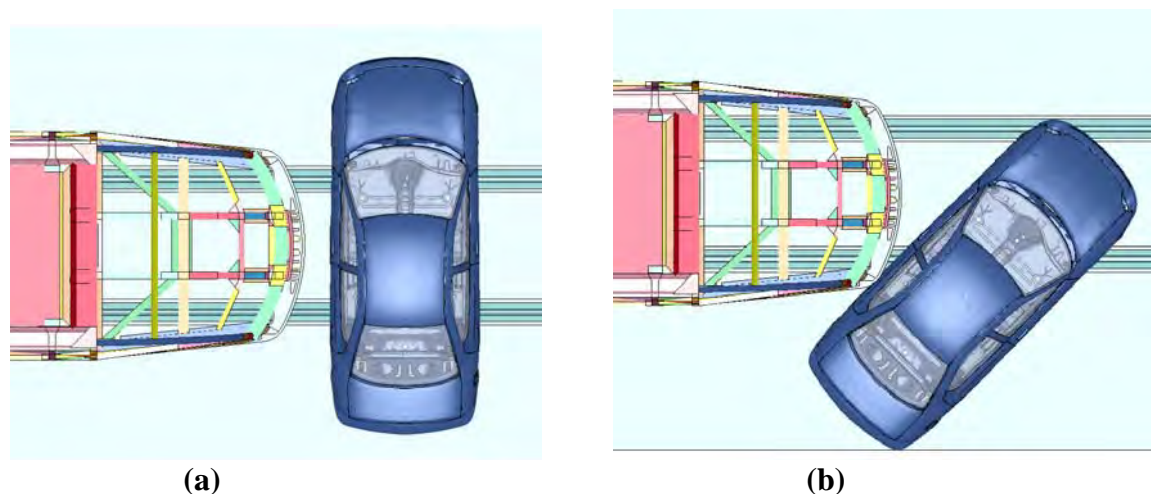

FIGURE 3 Collision interface conditions for LRV 2 and HV 1:
(a) 90-degree collision interface and (b) 45-degree collision interface.

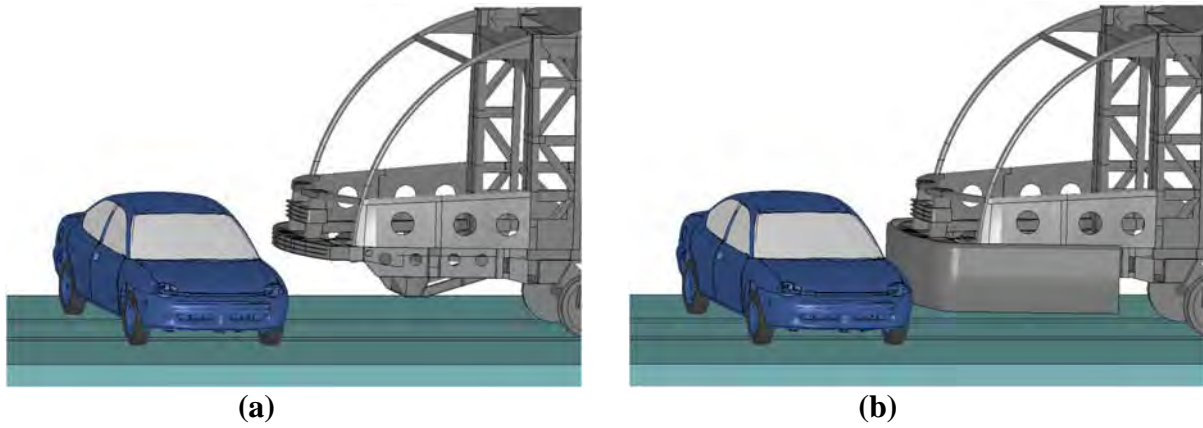

FIGURE 4 Collision interface with different LRV front-end features: (a) LRV without any safety features and (b) LRV with enclosed rigid bumper.

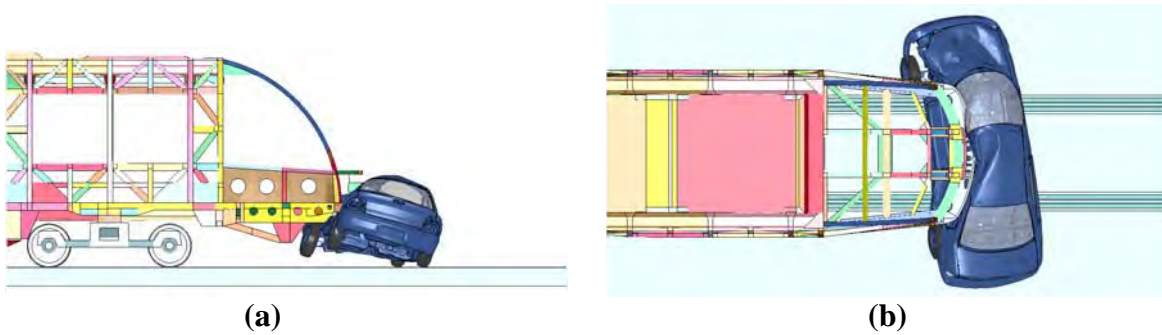

FIGURE 5 Simulation of the 90-degree, 20-mph collision with HV 1 (LRV without a bumper): (a) side view and (b) top view.

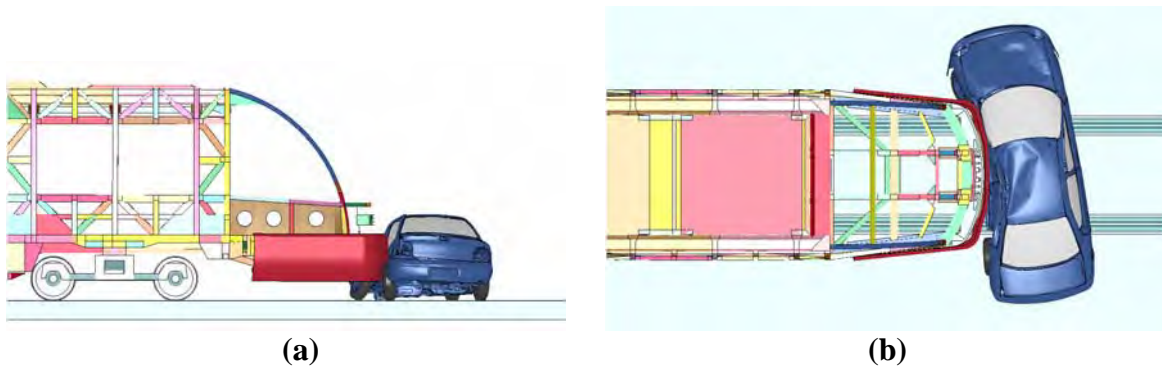

FIGURE 6 Simulation of the 90-degree, 20-mph collision with HV 1 (LRV fitted with a bumper): (a) side view and (b) top view.

The corresponding crush intrusions in the Dodge Neon for the 20-mph collisions are shown in [Figure 7](#). The bumper enclosure produces significant differences in the crush intrusions. The maximum crush without the bumper enclosure was approximately 67 cm and located relatively high on the occupant compartment of the car. With the bumper enclosure, the maximum crush in the occupant compartment was reduced to approximately 43 cm and is more uniform over the center portion of the door. Thus, the bumper produces significant improvements in both the magnitude and location of crush intrusions in the highway vehicle.

The level of automobile injury potential resulting from inclusion of the bumper enclosure can be estimated from research on side impact safety of automobiles provided by the National Automotive Sampling System (NASS), which reports statistics of injury. These data are used to estimate the effect of broadening the load distribution across the automobile and directing the principal contact point lower on the automobile structure. Data from NASS show that injury can be correlated with two effects, namely the sudden change in velocity when struck, and the physical intrusion into the vehicle. From the simulations recently conducted it can be shown how bumpers can affect the intrusion side of the equation (6). As a result of adding bumpers, the probability of a fatal injury is reduced from approximately 75% without the bumper enclosure down to approximately 35% with the enclosure, as seen from data taken from the NASS plot of intrusion versus probability of injury or fatality shown in [Figure 8](#). These reductions in injury potential lead to the front end safety specifications included in the ASME RT-1 standard.

Collision analyses with the Ford Explorer model (HV 2) found very similar trends. The calculated 20-mph crash behavior of the LRV without any front-end safety features into the side of HV 2 (90 degree) is shown in [Figure 9](#). The head girder overrides much of the HV 2 side protective structures and intrudes significantly into the occupant volume. The high location of the impact also rotates the HV 2 lifting the wheels on the impact side off the ground. When the bumper is added to the LRV, the collision engages much of the HV 2 side protective structures and the crash response is significantly modified. The bumper significantly reduces the crush intrusions of the LRV into HV 2. In addition, the motion is primarily a translation without the large roll seen when impacted without the bumper.

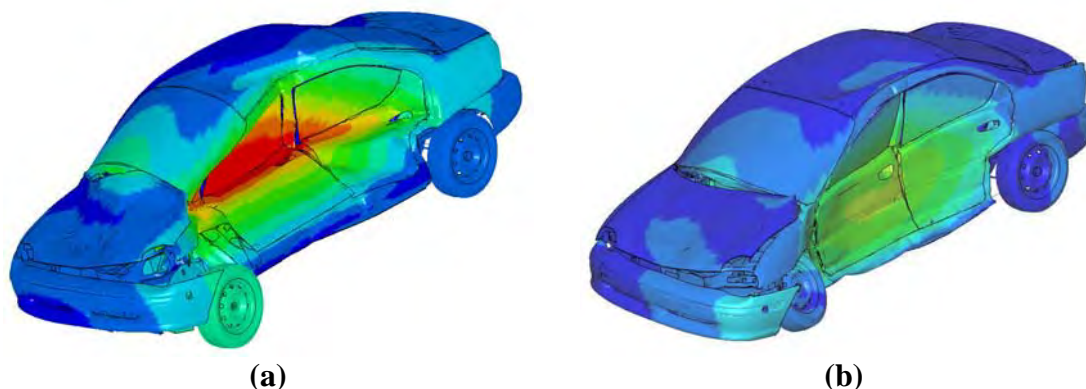

FIGURE 7 Calculated crush for HV 1 in the 90-degree, 20-mph collisions: (a) without bumper (maximum crush 67 cm) and (b) with bumper (maximum crush 43 cm).

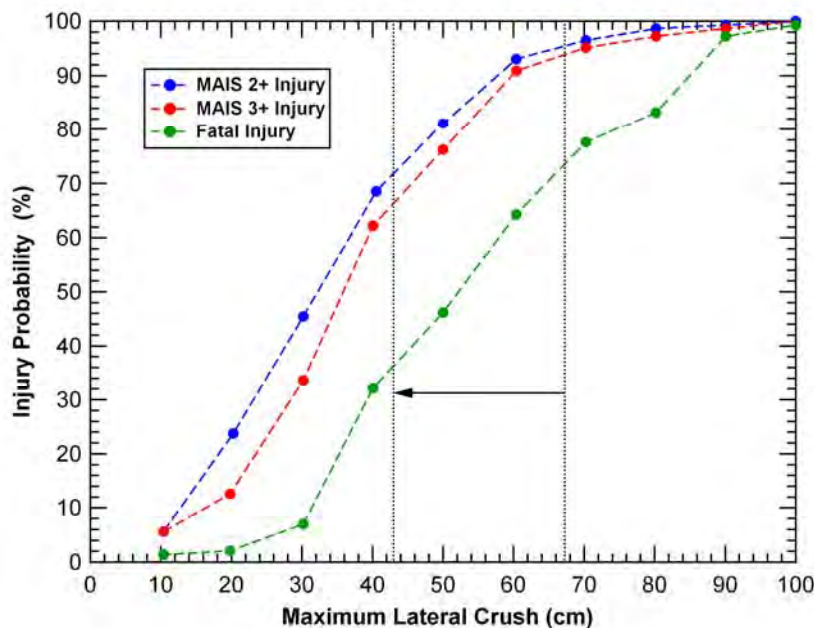

FIGURE 8 NASS injury and fatality probability versus lateral crush displacement.

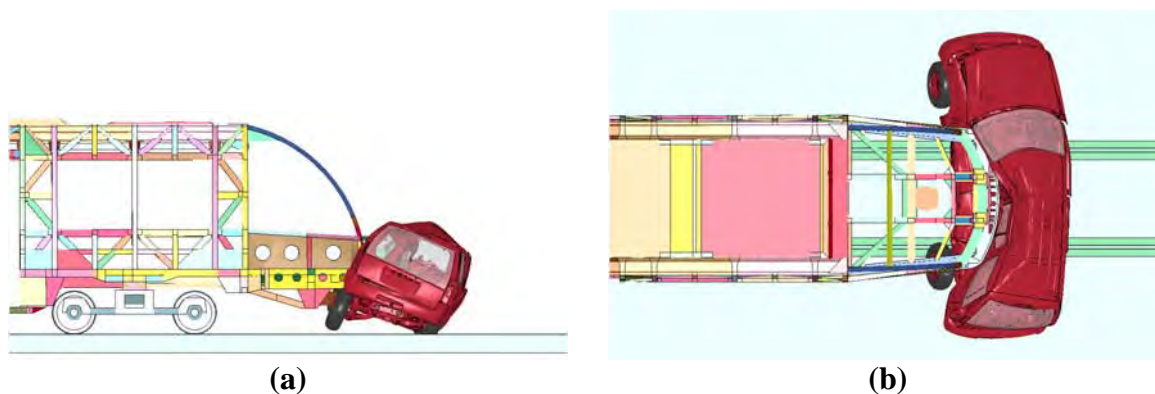

FIGURE 9 Simulation of the 90-degree, 20-mph collision with HV 2 (LRV without a bumper): (a) side view and (b) top view.

An important result of the analyses of collisions between LRVs and highway vehicles is the assessment of the side force crush characteristics of the highway vehicles. This information can be used to determine effective bumper energy absorbing characteristics to protect occupants of automobiles struck by an LRV. The force–crush characteristics for both HV 1 and HV 2 impacted at 20 mph by the LRV with the rigid bumper system at 90-degree and 45-degree orientations are shown in Figure 10. For the 90-degree collisions, the crush forces remain below approximately 100 kN until a crush intrusion of 300 to 400 mm. The forces then increase to a maximum of 150 kN for HV1 and 220 kN for HV 2 at crush intrusions between 400 and 500 mm.

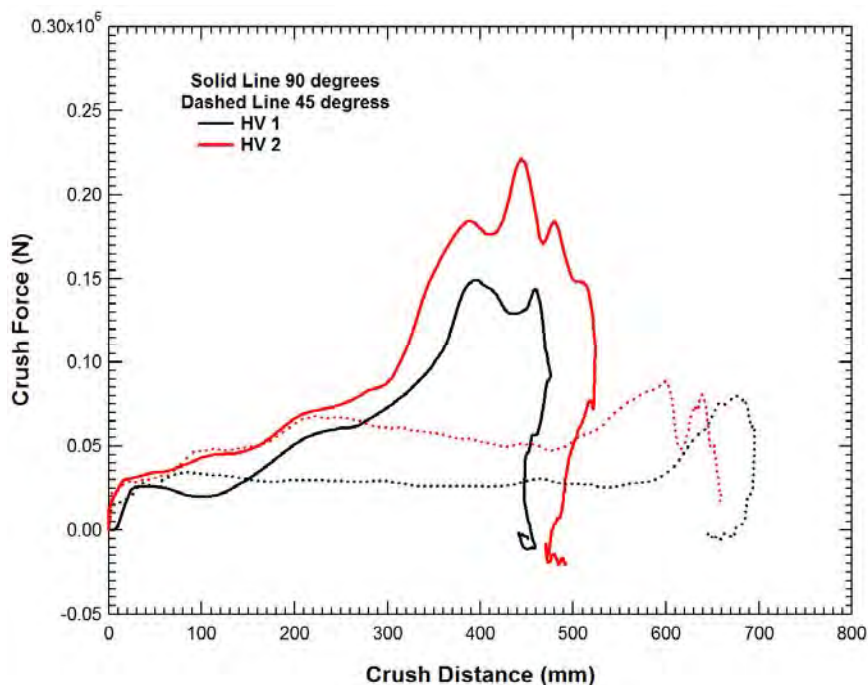

FIGURE 10 Force-crush profiles for the 45- and 90-degree, 20-mph collisions (LRV fitted with bumper).

For the 45-degree collisions, the crush forces remain below approximately 40 kN for HV 1 and 75 kN for HV 2 until a crush intrusion of greater than 500 mm. The peak crush force for either vehicle in the 45-degree collisions remains below 100 kN.

The comparison of the highway vehicle force–crush behaviors illustrates the difficulty of defining an energy-absorbing bumper for LRVs that reduces injury to automobile occupants and is still effective for LRV operations. Unless the force required to activate the bumper energy absorbers is significantly below 100 kN, the energy absorption mechanisms will not be activated in oblique impacts. If the system has 200 mm of travel at an average force of 50 kN, the energy absorbed would be 10 kJ. In the 90-degree impacts at 20 mph, this would reduce the crush by approximately 15%. By comparison, the addition of the rigid bumper enclosure reduced the crush by approximately 35% in HV 1 and nearly 50% in HV 2.

In addition, the 10 kJ of energy dissipation in the bumper is only about one third of the energy dissipation needed for the 5-mph collision between two similar LRVs. As a result, it is difficult to develop a bumper system that will both dissipate a significant amount of energy in collisions with automobiles but still be suitable for preventing damage in the 5-mph collision between two identical LRVs.

Some specific findings in Project C-17 from the collision analyses between LRVs and highway vehicles included that the addition of a bumper enclosure, resulting in a smooth LRV front-end profile and lower contact zone between the LRV and the automobile, has a significant potential for reducing injuries and fatalities in side collisions. In addition, an energy-absorbing bumper system that protects against a 5-mph LRV collision does not appear to offer much advantage in collisions with automobiles over the performance of a rigid bumper enclosure. The side crush strengths of automobiles, particularly for the oblique impact conditions, are

sufficiently low that the energy absorbers would not be activated. Designing an energy-absorbing bumper to protect the automobile would require low force levels and a large stroke length for significant safety improvements.

As a result of these findings, a requirement was included in the ASME RT-1 Safety Standard that the leading end design shall take into account collision compatibility with automotive construction. Specifically, LRVs and streetcars operating in urban environments shall incorporate a contoured geometry shape extending across the width of the vehicle, enclosing open area spaces to encourage deflection of struck objects from the path of the LRV–streetcar and to minimize entrapment, override and penetration of automobiles and light trucks. Sharp corners and protruding shapes of the contoured geometry design shall be minimized. A bumper, coupler enclosure, pilot beam, skirting, and/or alternative structures may be used to achieve these objectives. In addition, the bottom of the car end structures shall not be greater than either 250 mm (10 in.) above the top of rail or the minimum allowable by the dynamic operating envelope.

DEVELOPMENT OF ADVANCED LRV FRONT-END SAFETY FEATURES

More recently, a study has been initiated by the FTA to develop LRV front-end features that further improve the crash compatibility with automobiles. The approach depends on results from computer simulation modeling of vehicle collisions across a wide variety of LRV bumper designs some with and some without energy absorbers. The methodology and preliminary results of this effort are presented in this section.

One significant difference between the C-17 and the FTA studies is the use of improved injury assessment. In the TCRP Project C-17 the injury was estimated from the maximum crush intrusions as shown in FIGURE . However, the data used to generate the injury probability in Figure 8 were from motor vehicle accidents and therefore assumes that the impacting object is another highway vehicle. LRVs are larger, stiffer, and heavier than highway vehicles. These differences would potentially influence the correlations of crush intrusion and injury probability.

In the FTA study an unbelted side impact dummy (SID) model (7, 8) was included inside all of the struck vehicles in the simulations. The SID response measures are used to calculate injury probability. The SID model and an example of the SID positioning inside the Ford Explorer are shown in Figure 11. Explicit modeling of the SID allows for an improved assessment of the driver pelvis, thorax, and head injury potential from the various collision scenarios.

The FTA study also includes simulations with a wider range of vehicles to assess the crash responses and injury potential. In addition to the Neon and Explorer models shown previously in Figure 2, the FTA study uses models for the Toyota RAV4 (5) as Highway Vehicle 3 (HV 3), and the Ford Crown Victoria (9, 10) as Highway Vehicle 4 (HV 4), shown in Figure 12. By using a wider range of vehicle types, that represent different segments of the vehicle fleet, the statistical assessments of injury potential will be more accurate.

The first task in the FTA study is to evaluate the geometric characteristics of the bumper enclosure on injury potential. The TCRP Project C-17 had demonstrated that the enclosed bumper can reduce injuries but used primarily one existing bumper profile in the development of these results. A set of potential geometric designs for the bumper were developed that used appropriate bounds established from vehicle operational requirements, as shown in Figure 13. The bumper Profile 6 in Figure 13 is the design previously evaluated in Project C-17.

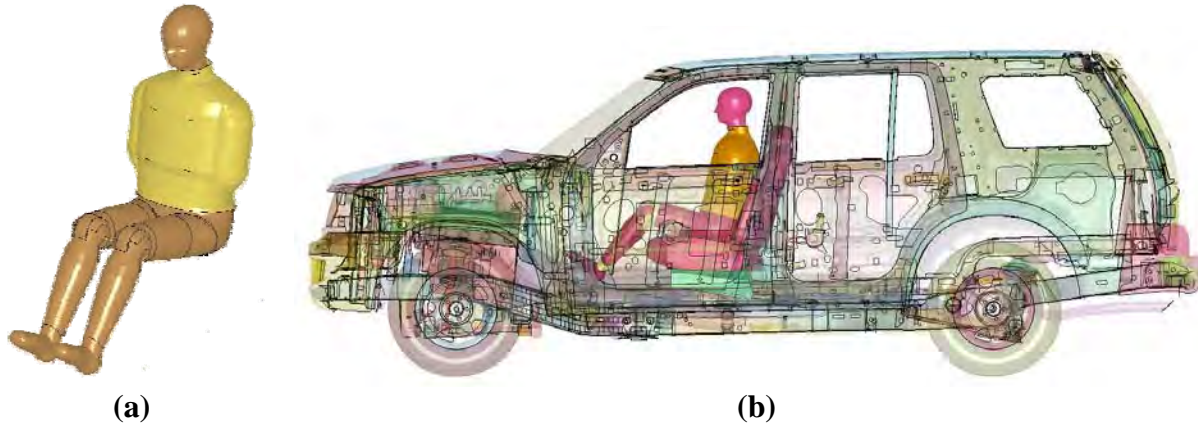

FIGURE 11 Cutaway views illustrating positioning of the SID inside the Ford Explorer model: (a) SID model and (b) SID positioned in the Ford Explorer.



FIGURE 12 Finite element models for the additional highway vehicles used in the crash analyses: (a) HV 3, Toyota RAV4; and (b) HV 4, Ford Crown Victoria.

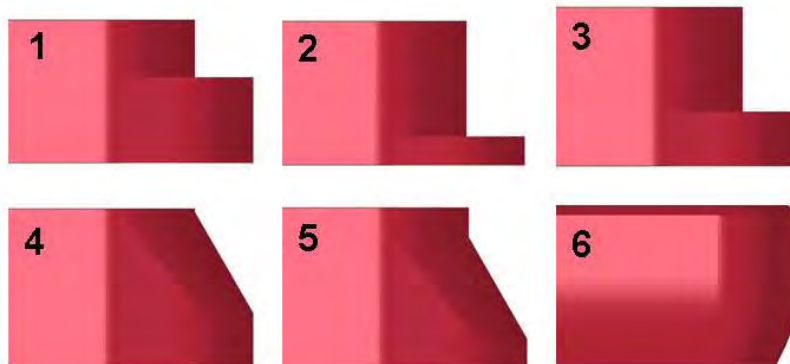

FIGURE 13 Profile of bumper geometries considered.

Preliminary impact analyses were performed at 15-, 20-, and 25-mph impact speeds for 90-degree impacts with the Dodge Neon and Ford Explorer to establish a design impact speed. An impact speed of 20 mph was selected to refine the bumper design. It is at this speed that there are significant probabilities that serious to severe injuries can occur to the vehicle occupants [corresponding to maximum abbreviated injury scale (MAIS) 3+ and MAIS 4+].

The six bumper profiles shown in Figure 13 were evaluated at the 20-mph impact speed and compared to impacts from an S70 LRV with no bumper. Three measures of injury were evaluated from the response of the SID; thoracic, pelvis, and head injury. Detailed results from the SID response were correlated with probability of injuries to the head and thorax. Pelvic injury is not typically evaluated in this way, but rather uses a criterion of 130 g for pelvic fracture.

The full evaluations of the various bumper profiles are not complete. However, in the 90-degree impact simulations with the Neon and Explorer, the bumper profile 5 provided the best performance. This bumper profile is shown on the front of the S70 LRV in Figure 14, as well as the geometric compatibility with the Neon. The figure shows that the bumper engages low on the vehicle with the initial crush occurring at a level approximately aligned with the rocker panel.

Vehicle and SID responses from the HV 1 impacts with the S70 LRV without a bumper and with bumper are shown in Figure 15 and Figure 16, respectively. Note that vehicle override is significantly reduced with the addition of Bumper 5. The probability of severe thoracic injury to an occupant in the Neon is reduced by approximately 50% and in the Explorer by approximately 90% with the Bumper 5 geometry. Probability of serious head injury improved in the Neon and only went up slightly in the Explorer, while pelvic accelerations are well below the level for pelvic fracture.

The vehicle kinematics for both the Neon and Explorer impacted by the S70 LRV without a bumper and by bumper Profiles 5 and 6 are all shown in Figure 17. Clearly, without a bumper, the high impact of the LRV head girder tends to drive the struck vehicles downward and would increase the potential for override and potential derailment of the LRV. Bumper 5 has the opposite trend where the low center of impact can actually lift the struck vehicle. Longer duration analyses showed that this lift behavior did not produce a rollover risk and the struck vehicle is eventually pushed out of the path of the LRV. Bumper 6 produces a response where the impact kinematics of the struck vehicle are dominated primarily by a lateral translation without vertical or roll motions.

Remaining activities in this task include impact analyses of the bumper designs with the full set of target vehicles and evaluating the performance for corner (45-degree) impacts.

ENERGY-ABSORBING BUMPER CONCEPT DEVELOPMENT

In addition to optimizing the bumper enclosure profile, a secondary objective of the FTA project is to develop an energy-absorbing bumper design to further protect the occupants of road vehicles in collisions with LRVs. The most common collision is the motor vehicle turning left in front of the LRV resulting in an oblique collision with the right front corner of the LRV. The TCRP project C-17 found previously that the vehicle side crush forces are low for this collision scenario and implementation of energy absorption designed for this collision is incompatible with protection for a 5 mph LRV-LRV collision.

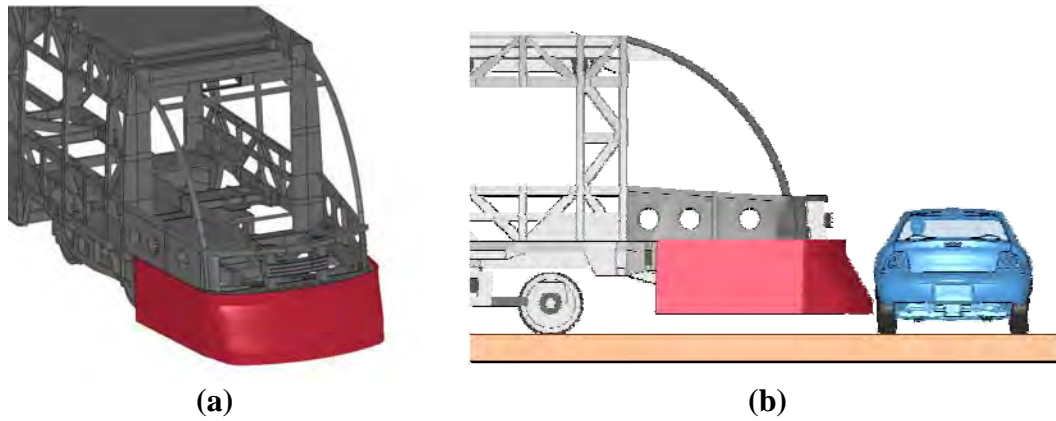

FIGURE 14 Bumper 5 geometry shown on the S70 LRV: (a) oblique view and (b) side view with HV 1.

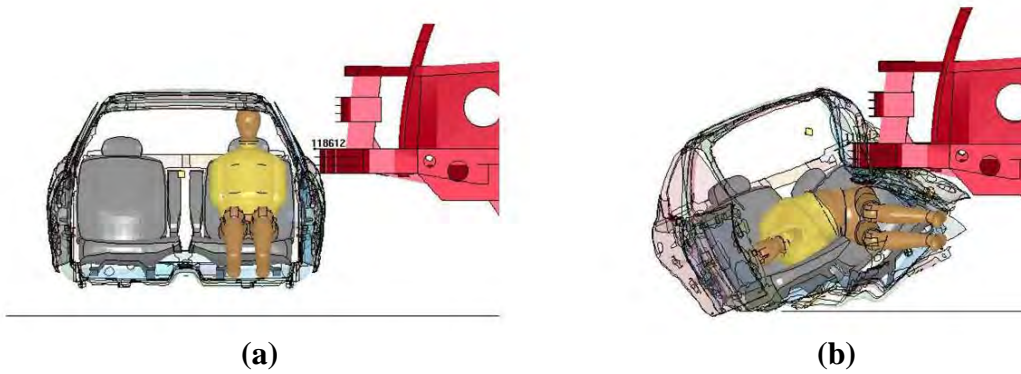

FIGURE 15 Vehicle and SID response to HV 1 with no bumper enclosure: (a) initial position and (b) calculated response.



FIGURE 16 Vehicle and SID response at the time of peak injury: (a) initial position and (b) calculated response.

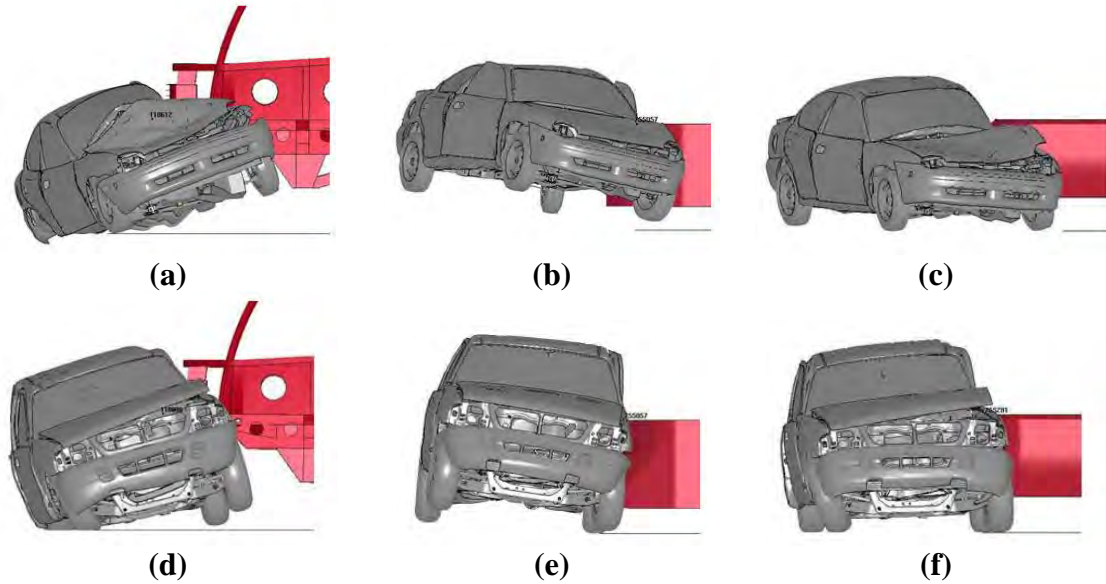

FIGURE 17 Calculated vehicle impact responses at late time: (a) HV 1, no bumper; (b) HV 1, Bumper 5; (c) HV 1, Bumper 6; (d) HV 2, no bumper; (e) HV 2, Bumper 5; and (f) HV 2 - Bumper 6.

The proposed energy-absorbing bumper retrofit design is shown in Figure 18. The design consists of a stiff segmented bumper attached by joints where the side segments are free to rotate independently. These side segments are attached to their own hydraulic energy absorbers that are designed to be activated in an oblique corner collision. A flexible bumper cover can be included that encompasses these internal structures.

The central energy absorbers can be designed to either protect against the normal (90-degree) impact with a road vehicle or to protect against the 5-mph LRV collision which is a common CEM requirement for energy absorbing front end structures. A potential design is to use coupler system energy absorbers in place of the central energy absorbers. The corner energy absorbers are designed to be compatible with the relatively low side crush force levels in an oblique side impact with an automobile.

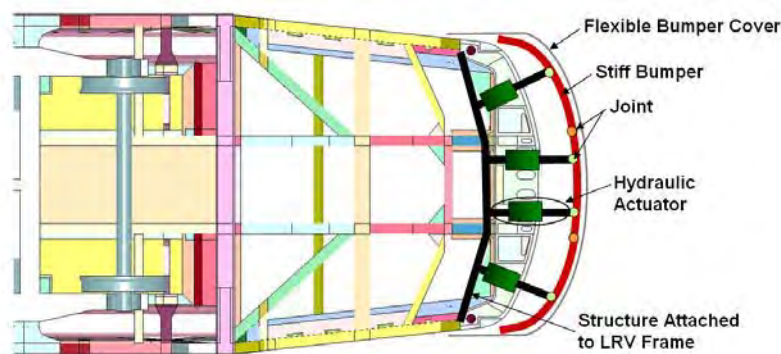

FIGURE 18 Proposed segmented bumper retrofit on the front end of a Siemens S70 LRV.

This is a significant innovation in bumper design with the segmented bumper and hydraulic energy absorbers that can be tailored to a lower force for corner collisions with automobiles. The corner impact is the most common type of accident and results in many of the serious injuries and fatalities of LRV operations. By allowing the corner segment to move independently, it also allows the bumper to engage a greater area on the vehicle.

A preliminary calculation of the response of this segmented bumper concept is shown in [Figure 19](#) for a collision with a Ford Explorer. As the bumper engages the Explorer, the corner segment rotates and develops a larger contact patch that distributes the impact loads. The increased contact patch on the struck vehicle should further reduce the crush intrusions and injury risk. As the impact progresses, the rotation of the side bumper segment modifies the corner profile of the LRV and more effectively deflects the struck automobile out of the path of the LRV. This can be seen by the rotation and lateral deflection of the Explorer in [Figure 19c](#). This preliminary analysis with the proposed bumper concept demonstrates the potential for significant improvements in the collision compatibility between LRVs and road vehicles.

CONCLUSIONS

There has been an increasing recognition in the LRV safety community of the need to improve the collision safety between LRVs and road vehicles. As a result, the ASME RT-1 safety standards committee has proposed initial crash safety requirements for LRVs that require an enclosed front-end geometry to allow for improved geometric compatibility with road vehicles in collisions. This was based in part on the findings of the TCRP Project C-17 that the addition of a bumper enclosure, resulting in a smooth LRV front-end profile and lower contact zone between the LRV and the automobile, has a significant potential for reducing injuries and fatalities in side collisions.

The development of energy absorption systems to protect the occupants of road vehicles is ongoing. Energy-absorbing bumper system that protects against a 5-mph LRV–LRV collision does not appear to offer much advantage in collisions with automobiles over the performance of a rigid bumper enclosure. The side crush strengths of automobiles, particularly for the oblique impact conditions, are sufficiently low that the energy absorbers would not be activated.

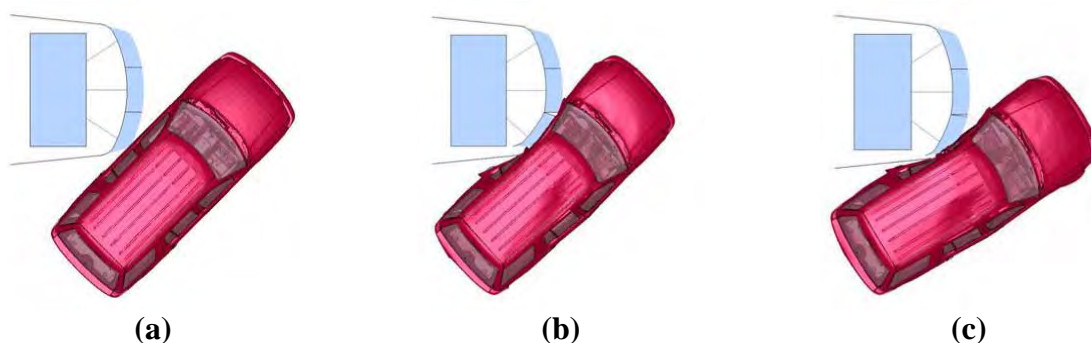

FIGURE 19 Segmented bumper functionality during a 45-degree impact with HV 2: (a) impact configuration; (b) bumper activation; and (c) postcollision.

Designing an energy-absorbing bumper to protect the automobile would require low force levels and a large stroke length for significant safety improvements.

An ongoing research project sponsored by the FTA is addressing the outstanding issues for improved safety of LRVs in collisions with road vehicles. This includes analyses to optimize the geometry of the bumper and development of bumper concepts to introduce energy absorbers compatible with road vehicle side crush strengths by segmenting the bumper. Preliminary results from this program indicate potential for significant improvements in LRV crash safety.

ACKNOWLEDGMENTS

The authors appreciate the support of the American Society of Mechanical Engineers and the ASME Rail Transit Vehicle Standards Committee. The authors also thank the Transportation Research Board for their support of the C-17 Project of the Transit Cooperative Research Program and the FTA for their support of the LRV collision safety improvement project that have made the computer simulations described herein possible. Finally the authors would like to thank Siemens Transportation for their commitment to improved safety and contributing their LRV models for use in these studies.

REFERENCES

1. Swanson, J. D. Establishing the Needs—What Must We Design For? Presented at RT-1 CEM Subcommittee Meeting, Colorado Springs, Colo., September 30–October 2, 2003.
2. RT-1: Safety Standard for Structural Requirements for Light Rail Vehicles, ASME Standards Committee on Rail Transit Vehicles. Draft 12, February 2009.
3. Kirkpatrick, S. W. *Development of Crash Energy Management Performance Requirements for Light-Rail Vehicles*. ARA Final Technical Report, TCRP Web-Only Document 40, Final Report for TCRP Project C-17, April 2008.
4. *LS-DYNA Keyword User's Manual*. Livermore Software Technology Corporation, Version 970, April 2003.
5. NCAC Finite Element Model Archive, <http://www.ncac.gwu.edu/vml/models.html>.
6. Arbelaez, R. A., B. C. Baker, and J. M. Nolan. *Delta Vs for IIHS Side Impact Crash Tests and Their Relationship to Real-World Crash Severity*. Paper Number 05-0049. Insurance Institute for Highway Safety, Arlington, Va., 2005.
7. Kirkpatrick, S. W., B. S. Holmes, T. C. Hollowell, C. Gabler, and T. Trella. Finite Element Modeling of the Side Impact Dummy. *Human Surrogates: Design, Development, and Side Impact Protection*. SAE Publications, SP-945, pp. 75–86, Presented at the 1993 International Congress and Exposition, March, 1993, SAE Paper No. 930104, 1993.
8. Ray, M. H., K. Hiranmayee, and S. W. Kirkpatrick. Performance Validation of Two Finite Element Models of a Side Impact Dummy. *International Journal of Crashworthiness*, Vol. 4, No. 3, 1999, pp. 287–303.
9. Kirkpatrick, S.W. *Development and Validation of High Fidelity Vehicle Crash Simulation Models*. Computer Applications for Crash, Optimization, and Simulation Research, SAE Publications SP-1496. Proc., 2000 International Congress and Exposition, March 6–9, 2000, SAE Paper No. 2000-01-0627.
10. Kirkpatrick, S. W., J. W. Simons, and T. H. Antoun. Development and Validation of High Fidelity Vehicle Crash Simulation Models. *International Journal of Crashworthiness*, Vol. 4, No. 4, 1999, pp. 395–405.

Infrastructure Maintenance
Renewal and Refurbishment

INFRASTRUCTURE MAINTENANCE: RENEWAL AND REFURBISHMENT

NJT–NLR Broad Street Extension
*Experiences and Lessons Learned from NJT–NLR Rehabilitation of the
 Penn Station Loop Track and Main Line Special Track Work*

JOSEPH A. BONSIGNORE
Systra Consulting, Inc.

STELIAN (STAN) CANJEA
NJ Transit

The Newark Light Rail (NLR) is a vital link in the region’s transportation network, and brings residents in north Newark and Newark’s outer suburbs to educational and cultural destinations in New Jersey’s largest city. This system introduced a new fleet of light rail vehicles (LRVs) and new stations in Belleville and Bloomfield in 2001. In 2006, new stations were opened in the downtown as part of a service connection between Newark Penn Station, the major transportation terminal in the state, and Broad Street Commuter Rail Station. The system connects with NJ Transit (NJT) bus and rail service as well as AMTRAK trains and Port Authority Trans-Hudson (PATH) (Figure 1).

The line is a subway–surface light rail line which originally opened in 1935 along the old Morris Canal right-of-way and was originally operated by the Public Service Corporation as its #7 line. NJT took over the line in 1980 and operated it from Penn Station to Franklin Avenue Station, a closed-loop system that was approximately 4 mi long. Since the 1950s single-unit Presidents Committee Car (PCC) cars, built in the 1940s, were running on the line until 2001, when NJT purchased 21 new articulated LRVs from Kinki Sharyo of Japan. The PCC cars have since been retired. In 2002, NJT extended the line approximately 1 mi (1.61 km) to Grove Street Station in Bloomfield, New Jersey, where a new yard and shop was built to service the new fleet of LRVs. In 2006, NJT opened the 1-mi-long (1.61-km) Broad Street Extension (BSE) from Penn Station to Broad Street Station in Newark. The system operates today with 21 LRVs over 9.9 route miles (15.9 km).

The introduction of the LRVs and extensions to the system presented a variety of track work and vehicular engineering challenges in providing a renewal or refurbishment to a system that was built many years prior. The new LRVs were provided with a specific wheel back-to-back dimension and wheel profile similar to PCC cars in order to properly interface with the system specific track work that accommodated the PCC operation.

This paper explains the challenges in the modernization of the system. Other transit authorities which may consider extending or rehabilitating their systems under similar conditions may benefit from the lessons learned.

The following specific project elements, in support of the BSE Project and modernization–refurbishment of the system, are presented in this report:

- Penn Station Loop(s) rehabilitation;
- Fully guarded switches;
- Tunnel track direct fixation;



FIGURE 1 NLR system map: NJT BSE project.

- BSE-embedded track on floating slab;
- BSE-embedded special track work;
- Tunnel trackside lubrication; and
- Onboard LRV lubricator for BSE-embedded track.

It must be mentioned that why it may have been considered a routine design and construction—the track replacement and special trackwork selected from AREMA (and former AREA) manuals and standard plans—the BSE project turned out to be very specific since all the AREMA standard plans do not cover the light rail’s specific features such as: restraining rail design, flange bearing frogs, housetops and fully guarded switches, tongue and mate and double tongue turnouts, girder rail, specific wheel back-to-back dimension and profile, and light rail track maintenance standards. For more on this topic reference TCRP Project D-7 March 2004, “Interpretation of the AREMA Track Standards for Transit Agencies.”

Our observations, comments, and conclusions are indicated within each section of this paper.

BSE TRACK AND SPECIAL TRACK WORK PROJECTS

Background

Specific conditions related to this project required innovative solutions for the tunnel and street running track and for the special track work for optimum interface with the rail vehicle’s running gear as depicted in [Figure 2](#) and [Figure 3](#).

The NLR back-to-back wheel gauge is 54 1/8 +/- 1/16 in. (1374.77 mm +/- 1.58 mm). The AAR standard back-to-back wheel gauge is 53 3/8 in. (1355.72 mm).

The NLR wheel is a 4-in. (101.6-mm) tread, ORE type (European Organization of Railroads). The AAR 1B wheel is a 5 1/4-in. (133.35-mm) tread.

Other restrictions were related to the track location in the proximity of the city buildings and in front of the Newark Performing Arts Center. NJT commissioned several studies to define solutions aimed to reduce the running noise and vibration caused by the rail vehicles. Wilson, Ihrig and Associates studied the ground-borne vibrations in conjunction with the rail vehicle low unsprung masses (achieved with a fully suspended traction motor/hollow shaft gear box unit and B84 resilient wheels) and recommended the track floating slab.

Penn Station Loop Tracks

The lower level of Penn Station contains the inbound and outbound platform areas of the NLR that are connected by two adjacent tight radius tracks that form a loop track configuration. They are commonly known as the Inner Loop Track and Outer Loop Track. The loop tracks were originally configured so that the PCC cars can be turned in Newark, since some of them could only be operated from one end. The other end of the original line also contained a loop, the Franklin Loop, which was demolished in 2001 to allow for the construction of the Branch Brook Park extension.

NJT was experiencing a high rate of wear on the running rails, excessive noise (wheel squeal) and broken restraining rail brackets on the Outer Loop Track stemming from a retrofit

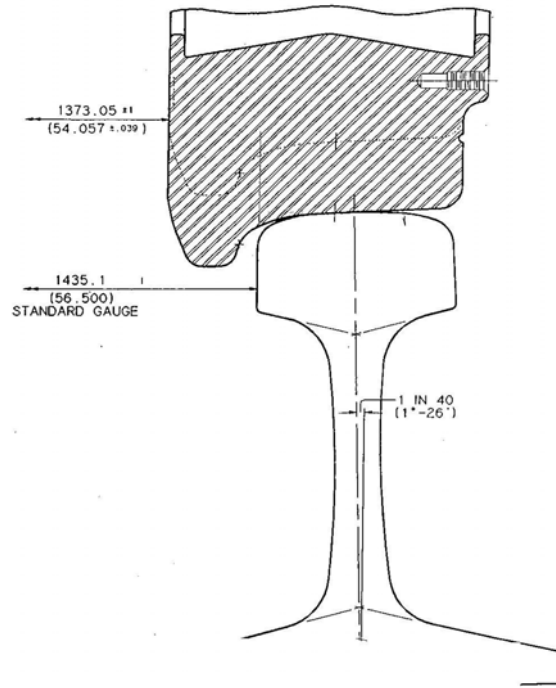

FIGURE 2 NLR wheel-rail interface: Penn machine drawing 9733.

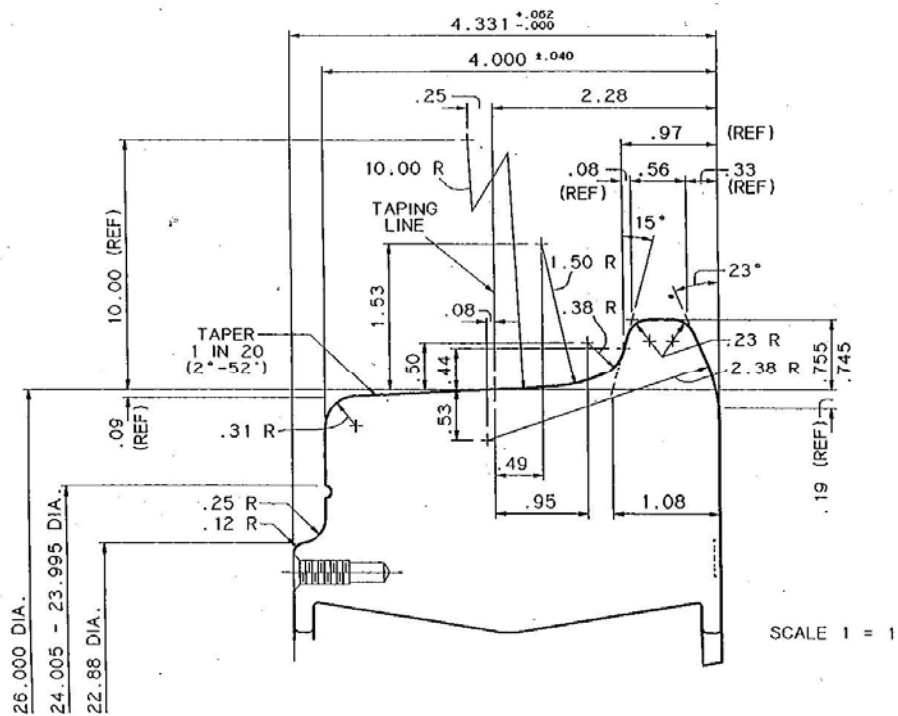

FIGURE 3 NLR wheel profile: Penn machine drawing 9733.

that was performed in 1993. SYSTRA Consulting, Inc. was contracted with NJT in 2002 to evaluate the existing track conditions of both the Inner and Outer Loop tracks and provide a design to better accommodate the operation of the new LRVs and phase-out of the old PCC cars. The design was to maintain the existing track alignment and re-use of the embedded timber tie blocks. Even though the new LRVs have the ability to be operated from both ends, it was decided that the operation at Penn Station would continue to use the loop track configuration.

Inner Loop Track

The Inner Loop Track was previously used for some PCC car maintenance, in an emergency to bypass a defective car blocking the outer loop, and for overnight storage. The track geometry consists of a 125-ft (38-m) centerline radius that transitions to a 61-ft (18-m) centerline radius then to a 63.35-ft (19.32-m) transition curve back to tangent track. The rails consisted of 100RB manganese rails with a bolted restraining rail and separator block design adjacent to the inner or low rail. Gauge was 4 ft, 8 ½ in. (1237.19 mm) and the flangeway was 1-9/16 in. (39.68 mm). The timber ties are embedded in concrete. This trackwork was part of the original 1935 construction of the facility and saw minimal wear over time since the track was only used for overnight maintenance and storage. Once the Grove Street Extension project was completed the storage and maintenance activities were moved to the vehicle maintenance facility located at Grove Street. With the addition of the LRVs and operations to BSE, the Inner Loop Track became a revenue service track to facilitate the new operation and support of an increased number of cars operating on the system. Design and construction needed to be completed before the opening of the BSE Project.

Outer Loop Track

The Outer Loop Track ([Figure 4](#)) was utilized during the normal operation as a nonrevenue operation after dropping off inbound passengers in Newark and picking up new passengers for the return outbound trip. As part of the proposed change in operation associated with the BSE Project the Outer Loop track would continue to be used by all main line service trains but would become a revenue service track. The track geometry consists of a 125-ft (38-m) centerline radius that transitions to an 80-ft (24-m) centerline radius, back to a 125-ft (38-m) centerline radius and into tangent track. The Outer Loop Track was rehabilitated in 1993 with new timber tie blocks, 115RE rail, and U-69 guard rail adjacent to the inner or low rail. Gauge was set at 4 ft, 8 5/8 in. (1237.45 mm) and the flangeway was set at 1-5/8 in. (41.27 mm).

Loop Track Design Approach and Process

Given the high amount of usage of the tracks, the new design needed to yield something that would reduce maintenance, increase the life cycle of the rails, and reduce noise. A study was undertaken to evaluate different configurations/combinations of gauge and flangeway width on the 61 ft (18 m) and 80 ft (24 m) radius curves using the LRV's specific wheel profile and wheel back-to-back dimension. All configurations had to be consistent with the existing embedded tie blocks (with superelevation) which were to be re-used. The final design was based on SYSTRA's preparation of Nytram and Wharton Plots Analysis ([Figure 5](#)). The analysis examined the position of both the inside and outside wheels relative to the gauge line and edge of



FIGURE 4 Outer Loop track.

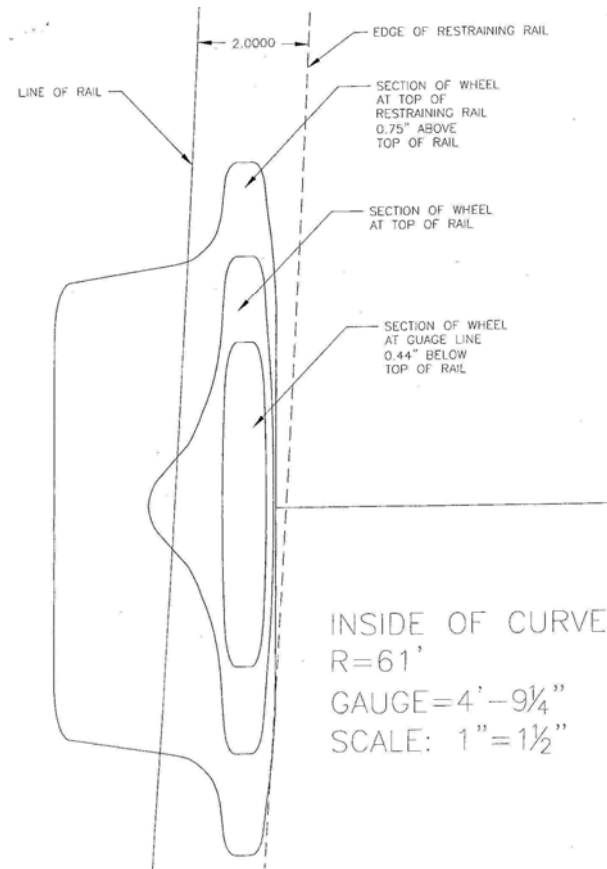

FIGURE 5 Wharton Plot: SYSTRA study for wheel-rail interface.

restraining rail. Each plot displays the section of the wheel, in elevation, at the gauge line, the top of rail and at the top of restraining rail to show what part of the wheel is making contact with either the running rail or restraining rail. It was determined that a 4-ft, 9 in. (1.44-m) gauge combined with a 2-in. (50.8-mm) wide flangeway on both the inner and outer rails was the optimum interface between the wheels and the track.

NJT-SYSTRA selected the Nortrak Boltless Vanguard U-69 Plate (Figure 6) for the double restraining rail installation. This patented design proved to be the best solution for the U-69 installation compared with two or three other designs used before on the line where U-69 replaced old types of restraining rails.

In the boltless Vanguard Plate the U-69 is easy to install and has an adjustable flangeway. Nortrak designers confirmed that there is a 2200 lb force (9790 N) of the hook holding the U-69 rail. The plates were designed to fit on existing timber tie blocks which varied in length between those under the inner and outer rails as well as between the Inner and Outer Loop tracks. The timber tie block hold down bolts had to be removed and recessed to allow for the installation of the wider restraining rail plates. Old spike holes were plugged.

Both loops were completely refurbished with new pre-curved 115RE head hardened running rails, pre-curved double restraining rails with adjustable 2-in. (50.8-mm) flangeways, and insulating pads and bushings. Given the past experiences with rapid rail wear, a harder rail with 410 Brinell, otherwise known as HP410 head hardened rail, as delivered by Rocky Mountain Steel Industries, was used and has been holding up well. Screw lags and standard Pandrol clips were also used in the assembly.

NJT contracted with the L.B. Foster Company and all materials for the loops including running rails, restraining rails and plates were delivered in time and there were no installation problems. The refurbishment was completed in 2005 and is performing better than expected. There was a noticeable reduction in the noise levels upon the completion of the work which was also enhanced by the addition of the automatic lubricators described below.

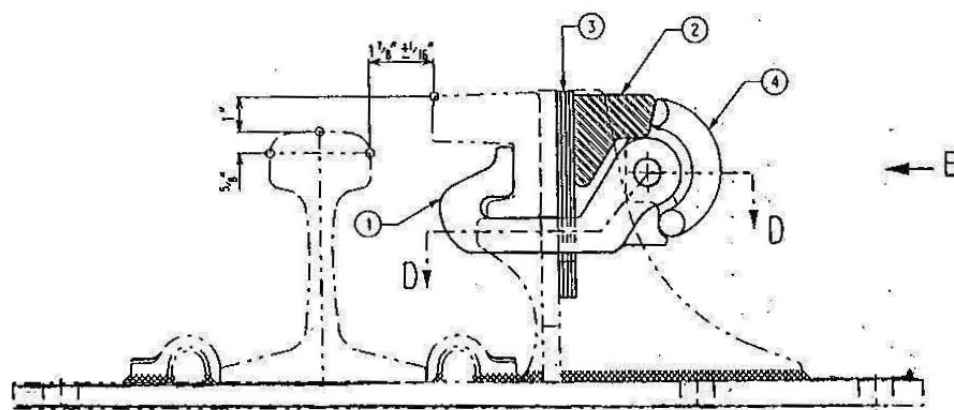

FIGURE 6 U-69 Vanguard plate: Nortrak design for NLR U-69 plate.

In addition to the track improvements, the 5 mph (8 km/h) maximum authorized speed (MAS) enforcement of the LRVs around the loop tracks has also contributed to less wear; where as in the past a 10 mph (16 km/h) speed was a contributing factor to more wear and more frequent maintenance.

In summary the combination of utilizing optimum gauge and flangeway dimensions, dual guarding with adjustability, harder rail, lubrication and slower speeds has yielded less noise, less wear and tear, and less track maintenance.

Fully Guarded Switches

Previous special track work retrofits on the NLR system in the 1980s utilized, for the most part, standard AREMA layouts with unguarded switches and RBM flange bearing frogs (Figure 7). The turnouts were generally No. 6s with some No. 8 or other custom angles in a few locations. The problem was that “heavy” rail designers were involved designing retrofits on a light rail system, which eventually lead to common recurring problems over the years. NJT therefore asked SYSTRA to provide special track work retrofits at several key locations throughout the system. The retrofits included developing details to provide full guarding in special track work where applicable, and switch point guarding in areas where full guarding was not practical, without having to do a significant change out or full replacement of a turnout.

The goal of the housetop switch point guarding was to come up with a design that could be used as a new standard throughout the system, could be installed on the existing timber headblock spacing, utilized U-69 guarding, and did not protrude above top of rail (TOR) by more than 1 in. The LRV’s center truck “crank” axle was designed to allow the center section to be the same floor height from TOR of 13 ¾ in. (349.2 mm) as the LRV sections A and B. The clearance under the center truck axle is as low as 1-3/8 in. (34.9 mm) above TOR when the wheels are worn at the condemning limit. The design of any component of special track work had to comply with the worn-out wheel condition, and the maximum 1 in. (25.4 mm) protrusion above TOR.



FIGURE 7 Fully guarded switch.

SYSTRA's design was a spin-off of what was being used on the Pittsburgh light rail transit (LRT) system except modified for the NLR system flangeway and utilizing U-69 guarding ahead of the point of switch, instead of strap guard. The design included a "no-hand" (could be used on a left-hand or right-hand switch) manganese housetop plate on welded steel chairs on new switch type plates. At locations where gage plates existed (typically 2 or 3 gage plates existed) in the switch area, the chairs were designed to be welded in the field directly to the gage plates. This made for an easy field installation where the switch could remain in operation. The holes in the top plate were recessed and half-height bolt heads were used to obtain the height requirements. The U-69 guarding extended 10 ft (3 m) in front of the first chair ahead of the point of switch so that one full truck would be guided into the approach to the switch point. Housetops were installed opposite the curved switch point, except at one location where housetop guarding was installed on both sides, as it once existed in the 1935 construction.

In areas where full guarding was achievable, the housetop guards were installed in addition to a new undercut stock rail, "double-point" switch rail, and continuous tee rail guarding from the switch point to the heel of the frog on the diverging side of the turnouts. This type of retrofit was only achievable in locations where the existing heel spread was wide enough to accept the additional guard rail. In a few locations, there existed an 11-13/16 in. (284.16 mm) heel spread as opposed to the standard 6-1/4-in. (158.75-mm) heel spread on a 13-ft (3.9-m) switch. The tee rail guarding consisted of 132RE guarding with bolted separator blocks and associated guard rail plates. A new welded switch heel block was installed with shoulder bolts and the standard NLR flangeway width of 1-9/16 in. (39.68 mm).

The new connections of the BSE outbound and inbound with the main line NLR tracks were achieved with new fully guarded turnouts. The design selected for these turnouts is similar to New York City Subway's models. On the NLR outbound track the original concept of using a No. 6 turnout to connect with the BSE extension was changed to No. 8. The installation of a No. 8 required a thorough verification of the foot-by-foot vehicle-tunnel clearance to provide the optimum track center line profile within the boundaries of the tunnel walls and adjacent track, however, the selection of the No. 8 allowed the use of a MAS of 15 mph (24 km/h) speed instead of 10 mph (16 km/h).

The guarding has proved to offer the best protection against derailment and has become the new standard for the NLR for any mainline turnout procurements. Guarding of all high-use or critical mainline turnouts is recommended and is critical to maintaining operations.

Tunnel Track Direct Fixation

In the BSE tunnel sections, the rail direct fixation is provided with the Advanced Track Products (ATP) Egg Type DF Plate (Figure 8). The Egg track fastener was recommended by NJT's consultants as the special, vibration attenuating fastener appropriate for the use in the tunnels and aerial structures. It was advertised by ATP as "having superior acoustical performance and an excellent maintenance record. Vertical forces are cushioned, as rubber is placed largely in shear and partially in compression when the Egg deflects under load from passing trains. The Egg was specifically designed to reduce ground-borne vibration which is the cause of secondary noise in building neighboring transit tracks."

These plates had been previously used by SEPTA and NJT was able to obtain them in time by piggybacking onto one of SEPTA's orders.



FIGURE 8 Egg type DF plate.

After 2 years of operations it appears that the other major advertised advantage, “the fail safe maintenance of the track gauge by creating the vital combination of lateral integrity and vertical softness” was confirmed by several track measurements which did not reveal any out-of-tolerance track geometry.

Due to the angle elastomeric contact between the top plate and the containment lower frame, in the unlikely event of elastomeric failure, the top plate sinks further and further in the nest provided by the frame. As it does, the lateral stability is not only maintained but is increased, and this represents a significant safety benefit particularly in curves.

The tunnel direct fixation reduced maintenance requirements and was all the more important since the tunnel track has a particularly difficult profile (some mentioning its similarity to a “roller coaster”) due to the reverse and compound curves up to the geometry limits imposed by the vehicle specification. On the south-inbound track there is an 82-ft (25-m) curve radius followed by a 7% down slope connected to an almost minimally acceptable vertical curve sag radius, to another curve and to a vertical curve crest radius before reaching the main track to Penn Station.

For the same reason, track profile testing related to a defective train rescue and towing up and down the inbound track were conducted.

BSE-Embedded Track on Floating Slab

Immediately outside the BSE tunnel and located in the proximity of the Newark Performing Arts Center the track is embedded in a floating slab.

A typical section of the track depicts the Ri59 girder rail embedded in the “Rubber Extrusion Rail Boot” as manufactured by Iron Horse Engineering Company (Figures 9 and 10). Double tee rail was installed at five locations with track curve radius under 200 ft which basically covered all other tight curves on the system. NJT found this solution safer against derailment, easier to replace, and, with reasonable lubrication, is better than simply girder rail.

The direct fixation is achieved with Pandrol e-2055 clips and the contact with the booted rail base is protected with a Pandrol HD-8X insulator. The anchor plate is a 6 in. (152.4 mm)

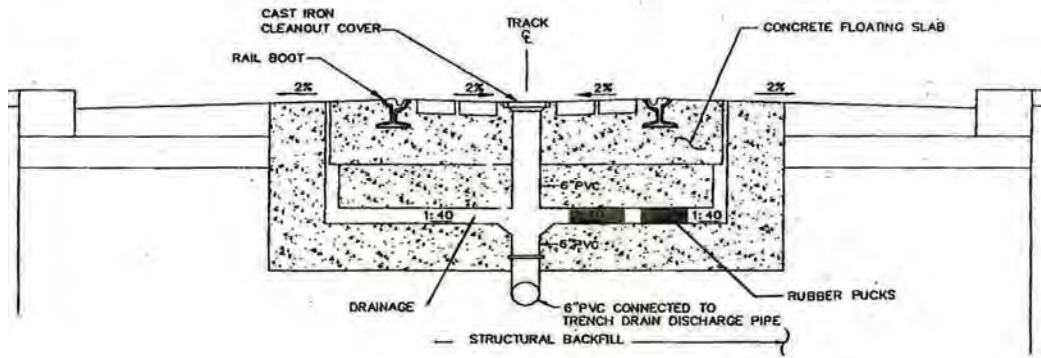

FIGURE 9 Floating slab: BSE project drawing.

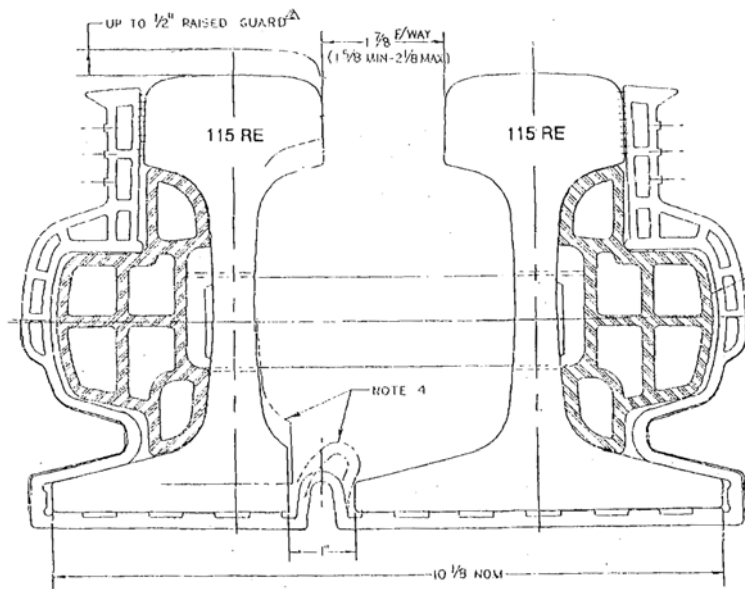

FIGURE 10 Rubber extrusion rail boot: BSE project drawing.

steel shoulder casting also supplied by Iron Horse. A protective metal cap covers the direct fixation clips and allows access to the clips. Each rail is embedded in a cast-in-place (CIP) track slab isolated laterally on both sides from the tub by 1.00 inch (25.4 mm) of sealant. The two-rail CIP is installed on the precast concrete track slab forming the “floating slab.”

The floating slab is isolated from the concrete tub with vibration absorbers consisting of a number of 12-in. (304.8-mm) diameter Rubber Pucks and is also provided with 6- and 8-in. (152.4- and 203.2-mm) diameter PVC drainage pipes connected to the trench drain discharge pipe.

The floating slab’s complex and costly design and construction confirmed the prediction that the ground-borne vibrations and noise generated by the rolling stock operation would be reduced to low level. To date, not a single complaint has been received from the adjacent building occupants.

BSE-Embedded Special Track Work

The special track work consists of two double crossovers and a pocket track at the end of the line at Broad Street Station with a total of nine double-tongue embedded turnouts. The turnouts, originally proposed as a tongue and mate type were later, after the first design review, replaced as requested by NJT with a double-tongue switch (DTS).

SEPTA and Buffalo LRT went through the same process of replacing the tongue and mate with double tongue switches which are more appropriate for main line operations with frequent moves.

The DTS’s were manufactured by the Rail Products & Fabricators (now NORTRAK) in Seattle. During the design review phase, it was obvious that the AREMA standard frog dimensions may not match the LRV’s wheel back to back dimension and the wheel profile.

NJT conducted some running tests over similar switches at NJT’s Elizabeth Yard using the NLR dolly which dimensionally simulates the LRV center truck. The dolly derailed consistently at the frogs. The same dolly was then used by the manufacturer during the first article inspection of the prototype and the final dimensions were established (Figure 11). The 57-in. (1447.8-mm) corrected gauge at the frog was later confirmed by the perfect pattern of the top of the wheel flange yielded by the flange bearing frogs during normal operations.

However, the operations of the double crossover during the start-up were not without problems. The first major glitch was caused by the drainage under the switch machine and adjacent area. The drainage pipe located just in front of the switch machine was supposed to be easily accessible for cleaning and checking. After the machines were installed and connected, the switch operation was acceptable until a heavy rain flooded the machines and the wiring connection boxes.

The contractor, who originally installed the turnouts, was requested to remove the switch machines and create a new path for drainage, this time to be accessible with only the switch cover removal.

After the drainage retrofit was completed NLR hired a vacuuming truck to clean the turnout’s sides and the drains. The NLR technicians reconnected and waterproofed the wiring in the previously flooded junction boxes.

Several months after the BSE system start-up, an LRV derailed at one of the DTS’s. The investigation revealed that the tongues were not provided with a shunt and were isolated from the casting by the plastic pads installed under the tongues to reduce the friction. Lack of shunting



FIGURE 11 Dolly inspection.

was a contributing factor to the derailment. As a temporary correction item, NLR installed an exterior shunt at the tongue pivot where there is a minimum relative movement between the tongue and the housing.

Just before the winter season the switches were provided with heaters but the temperature control sensors were not installed and adjusted properly. Due to the relatively small section of the 11-ft (3.3-m) tongue, the thermal expansion and contraction caused frequent blocking of the point detector and the switch position signal was lost. The temperature sensors activation of the heaters at the optimum temperature is still in a trial and error phase. Obviously, the heaters must prevent switch icing and preclude the distortion of the tongues, due to thermal expansion at higher than necessary temperature. To increase the stiffness of the tongues and to further improve the switch operation, NLR decided to replace, in the near future, the tongues originally provided with insulation–low-friction pads, with a reinforced tongue. By eliminating the pads and the plate welded on the tongues, the tongue section increases in width by $\frac{1}{2}$ in.

Tunnel Trackside Lubrication

NLR installed trackside lubricators to attenuate the noise and vibration caused by the vehicle wheel–rail contact at critical locations even before the BSE project started. In 2003, NLR installed 10 PORTEC lubricators consisting of a gauge side of rail, back of the wheel/U-69 grease applicators, and TOR friction modifiers (FM). At the Penn Station Loops, two PORTEC IVs were installed, one for the outer loop of 80 ft (24 m) radius curve and the other for the inner loop 61-ft (18-m) curve radius.

At the Vehicle Base Facility six PORTEC–IIIs were installed at the west and east side of the yard for the 100-ft (30-m) radius curves.

At the Franklin Avenue grade crossing, located in the vicinity of a large apartment building requiring noise and vibration control, two PORTEC III, TOR FMs were installed.

For the BSE project, NJT commissioned with ENSCO and with help from AMTRAK and their tribometer, an investigation of the effectiveness of the TOR FM was conducted. The conclusion of the study was

- The TOR FM provides an optimum friction coefficient of 0.3 along the curves;
 - The effect of the FM appears to die out about 150 ft (45 m) after the end of the curve;
- and
- Outside the 150-ft (45-m) range, the lack of FM raised the friction coefficient to over 0.5.

Based on the experience achieved with the first ten PORTEC wayside lubricators, NJT decided to purchase, for the BSE, an additional 12 units which were installed in the curves provided with U-69 restraining rails.

NJT's overall evaluation of the wayside PORTEC III and IV lubricators is summarized as follows (Figure 12).

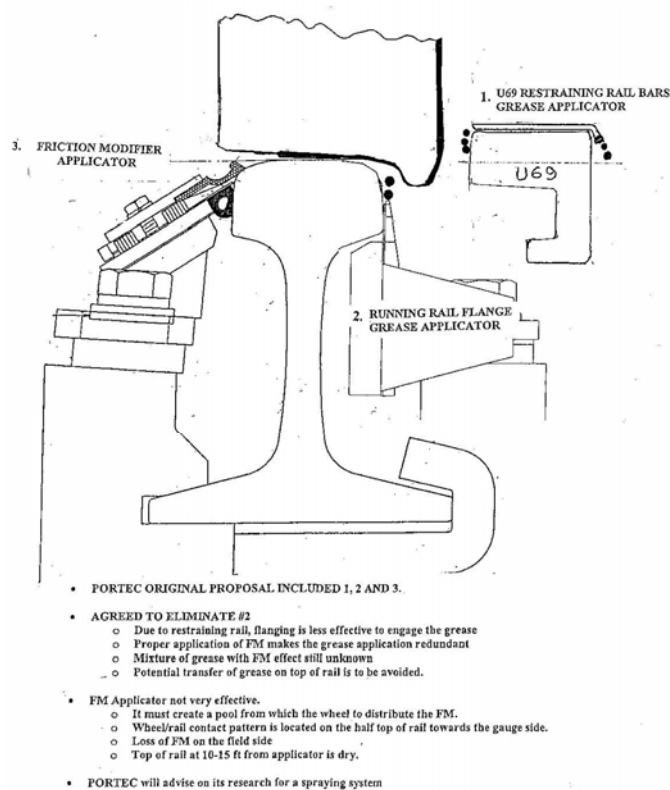

FIGURE 12 PORTEC lubricators: author's evaluation of PORTEC lubricators.

- The best result is obtained with the grease applied by the pump to the U-69 restraining rail and transferred to the back of the wheel during the car curving;
- The running rail lubrication with grease applied by the pump at the gage side just under the area of contact with the wheel flange was not effective and was eliminated from the order;
- The TOR FM applied by the pump with applicators installed on the field side of the running rail was not effective. The pump was intended to create a pool on top of the rail from which the wheel would catch the FM and distribute along the TOR. However, most FM is falling back due to gravity and just a small amount reached the area of the wheel–rail contact; and
- FM lost on the field side of the rail is creating cleaning and drainage problems.

NJT requested PORTEC to investigate a spray system for the FM application similar to the system successfully operated at the NLR by an onboard wheel flange lubricator. A spraying system would apply a constant and controlled amount of FM at the right (and easily adjustable) location, eliminating the current unit's lack of efficiency and the need for extensive maintenance, cleaning and adjustments.

Onboard LRV Lubricators for BSE-Embedded Track

NLR–BSE street running operation is not provided with wayside wheel flange–rail contact lubrication as in the main line ballasted track and tunnel operation. The BSE system has five tight curves under 200-ft (61-m) radius of embedded track and the rail replacement due to rail wear would be very costly.

Elsewhere on NJT, the need for lubrication was perfectly demonstrated by the case of the Hudson Bergen Essex Street 100-ft (30-m) curved track which had to be replaced after only 6 years, due to extensive running and restraining rail wear.

For BSE, a temporary solution being currently used consists of an onboard wheel flange lubrication system. It was installed on only one LRV, #117, as a prototype 5 years ago and has been in service on and off ever since.

The installation of the relatively simple and low cost per car system was performed by NLR technicians with components delivered by REBS–InterTran Company. Each leading axle wheel(s) are provided with two adjustable nozzles (Figure 13) one for the gauge side of the



FIGURE 13 Onboard lubricator: flange lubricator on LRV117.

flange and the other for the back of the wheel. The biodegradable friction modifier (all-rail FM, fabricated in New Jersey) is sprayed by the nozzles based on the signal received from the controller, which is interfaced with the no-motion circuit to preclude spraying when the car is not moving. The controller can be manually programmed for the frequency of applications on a time basis. The sprayed quantity, a silver dollar size, is constant and there are no losses. The system is very reliable providing minor maintenance is performed to check the nozzles and fill the tank every 6 months.

It was recommended that the number of cars equipped with on board flange lubrication system be increased to half the fleet of the 21 LRVs now operating the BSE. A similar approach was recommended for NJT's Hudson Bergen fleet of 52 cars. To date no decision was made as yet on this matter. At other transit authorities, such as in Phoenix, Arizona, the entire fleet is equipped with the REBS systems.

INFRASTRUCTURE MAINTENANCE: RENEWAL AND REFURBISHMENT

Noncontact Ultrasonic Guided-Wave Detection of Rail Defects**STEFANO COCCIA****IVAN BARTOLI****SALVATORE SALAMONE****ROBERT PHILLIPS****FRANCESCO LANZA DI SCALEA***University of California***MAHMOOD FATEH****GARY CARR***Federal Railroad Administration*

Safety statistics data from the FRA (1) indicate that train accidents caused by track failures including rail, joint bars and anchoring resulted in 3,386 derailments and \$685 million in reportable direct costs during the decade 1998-2008. The associated indirect costs due to disruption of service are considered to be at least equally significant. The leading cause of these accidents was the Transverse/Compound Fissure (reportedly responsible for \$158 million in direct damage cost and 808 derailments during 1998–2008), followed by the Detail Fracture (responsible for \$136 million in direct cost and 424 derailments during the same period). Transverse Fissures–TFs (initiating at a location internal to the rail head) and Detail Fractures–DFs (initiating at the head surface as Rolling Contact Fatigue-RCF defects) are cracks primarily growing in a plane perpendicular to the rail running direction (Transverse Defects–TDs).

Conventional ultrasonic rail inspection uses piezoelectric transducers that are coupled to the top of the rail with ultrasonic wheels or sleds filled with water or other fluids. The transducers are typically operated at 2.25 MHz in a pulse-echo mode with two orientations, namely normal incidence for detecting horizontal cracks and 70° angle of incidence for detecting transverse cracks (2). The most disconcerting drawback of ultrasonic wheels is the fact that horizontal shallow cracks (shelling) can mask the internal transverse defects. This limitation was the cause of the derailment of fourteen freight cars in Superior, WI in 1992, where hazardous material spillage caused the evacuation of more than 40,000 people. Following the Superior, WI accident, the National Transportation Safety Board issued a safety recommendation (3) to improve the detection of defects internal to the rail, particularly in the presence of shelling. Another undetected TD was responsible for the derailment in Hatfield, U.K. in 2000, that caused four deaths and over 30 injuries.

A second limitation of ultrasonic wheel inspection is its limited coverage, since the inspection is carried out at each cross-section of the rail at a time. Hence the inspection speed is limited by this fundamental constraint in coverage. A third problem with this technique is that the high frequencies used (typically 2.25 MHz) cannot penetrate alumino-thermic welds because of excessive attenuation when propagating through the weld's coarse microstructure, thus degrading its potential to detect weld cracks or separations.

In an effort to overcome some of the issues associated with ultrasonic wheel inspections, some research groups, including UCSD, are investigating ultrasonic guided waves for rail

inspections (4–14). There are several reasons for this. First, guided waves propagate along, rather than across the rail, and are thus ideal for detecting the critical TDs. Second, guided waves increase the inspection coverage (length of rail inspected at once) thereby relaxing limits on the achievable speed. Third, since guided waves penetrate a finite depth of the rail surface, they can travel underneath shelling and still interact with internal defects allowing for their detection. Fourth, since guided waves travel in the mid-frequency range, between 20 kHz and 1 MHz, they can penetrate alumino-thermic welds, hence potentially targeting weld cracks/discontinuities.

The advantages of guided waves come with the difficulty in managing their complicated propagation behavior. The main issue is the guided wave multimode character (many modes can propagate simultaneously) and dispersive character (the propagation velocity depends on the frequency). Consequently, only when guided modes are properly “managed” can guided waves become an effective tool for rail defect detection. Such “management” requires knowledge of the guided wave propagation in rails. Unfortunately, this cannot be readily studied by either closed-form solutions (Timoshenko beam theories of rails are limited to less than 6 kHz), or conventional Finite Element Analysis-FEA (too many degrees of freedoms required for high-frequencies). Hence, UCSD has utilized a semianalytical finite element (SAFE) method that combines theoretical and numerical formulations to allow the study of high-frequency guided waves in rails in a computationally efficient manner. These studies have allowed an optimized design of the rail defect detection prototype.

The UCSD/FRA prototype uses non-contact means of generating and detecting the guided waves in the rail. The solution of choice is a combination of laser and air-coupled sensors, which were first proposed in 2000 for noncontact rail probing (15). The prototype also uses a statistical pattern recognition algorithm for detecting and classifying defects. The uniqueness of this algorithm is that it does not require previous knowledge of defects (i.e. it does not require a “training” phase as in neural network-based classifiers), and it is hence very practical. This algorithm was successfully tested in the field with excellent results.

This paper describes first SAFE models of guided waves in rails. It then discusses the status of the UCSD/FRA rail defect detection prototype including the results of the last field tests performed in March 2008.

SEMIANALYTICAL FINITE ELEMENT METHOD FOR MODELING HIGH-FREQUENCY WAVES IN RAILS

Semianalytical finite element (SAFE) methods have emerged for modeling high-frequency wave propagation in waveguides of arbitrary geometries, where theoretical solutions are non-existent or 3-D FEA becomes computationally too intensive (8, 12, 16, 17). The general SAFE approach for extracting the wave solutions (velocity, attenuation, mode shapes) uses an FE discretization of the cross-section of the waveguide alone. The displacements along the wave propagation direction are described theoretically as harmonic exponential functions. Thus only a 2-D FE cross-sectional discretization is needed, with considerable computational savings compared to a full 3-D FEA of the entire waveguide. In addition, since polynomial approximation of the displacement field along the waveguide is avoided, the method is applicable to predict waves with very short wavelengths, where a traditional 3-D approximation may fail.

The displacement field is assumed harmonic along the propagation direction, x , and spatial functions are used to describe its amplitude in the cross-sectional plane of the rail ($y - z$) (Figure 1):

$$\mathbf{u}(x, y, z, t) = \begin{bmatrix} u_x(x, y, z, t) \\ u_y(x, y, z, t) \\ u_z(x, y, z, t) \end{bmatrix} = \begin{bmatrix} u_x(y, z) \\ u_y(y, z) \\ u_z(y, z) \end{bmatrix} e^{i(\xi x - \omega t)} \quad (1)$$

where i is the imaginary unit. The discretized version of the displacement over each cross-sectional element can be written in terms of the shape functions, $N_k(y, z)$, and the nodal unknown displacements, (U_{xk} , U_{yk} , U_{zk}):

$$\mathbf{u}^{(e)}(x, y, z, t) = \begin{bmatrix} \sum_{k=1}^n N_k(y, z) U_{xk} \\ \sum_{k=1}^n N_k(y, z) U_{yk} \\ \sum_{k=1}^n N_k(y, z) U_{zk} \end{bmatrix} e^{i(\xi x - \omega t)} = \mathbf{N}(y, z) \mathbf{U}^{(e)} e^{i(\xi x - \omega t)} \quad (2)$$

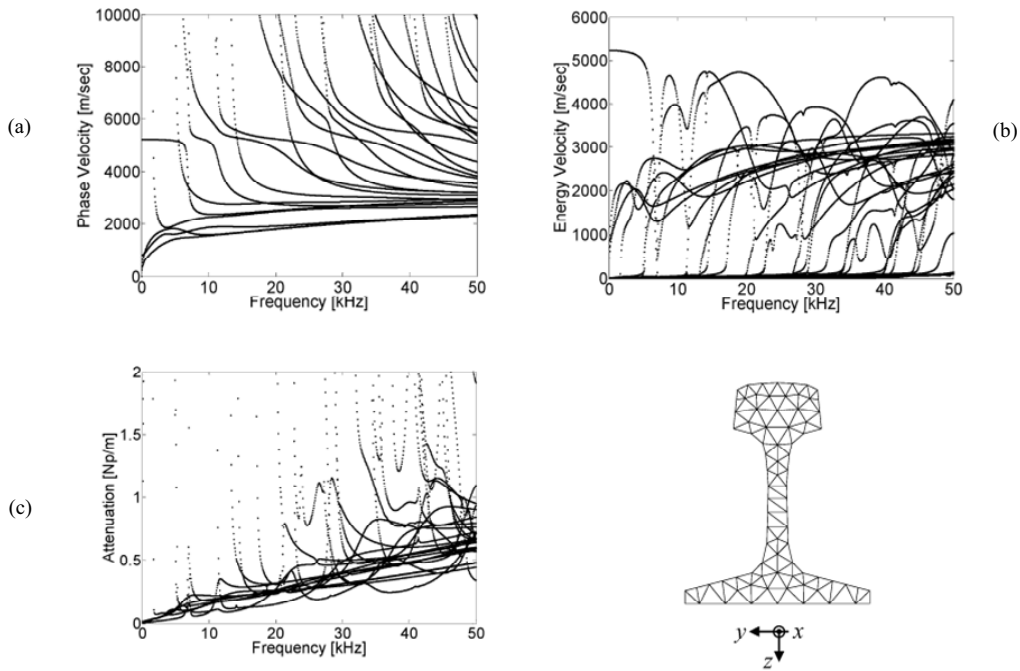

FIGURE 1 SAFE dispersion results for high-frequency guided waves propagating in a 115-lb AREMA viscoelastic rail: (a) phase velocity, (b) energy velocity, and (c) attenuation.

Applying Hamilton's theorem and standard finite element assembling procedures yields the following wave equation (8, 17):

$$\left[\mathbf{K}_1 + i\xi\mathbf{K}_2 + \xi^2\mathbf{K}_3 - \omega^2\mathbf{M} \right]_M \mathbf{U} = \mathbf{p} \quad (3)$$

where the subscript M is the number of total degrees of freedom of the system, \mathbf{U} is the nodal displacement of the rail cross-section and \mathbf{p} is the nodal force. For unloaded rail ($\mathbf{p} = 0$), nontrivial solutions can be found by solving a twin-parameter generalized eigenproblem in ξ and ω . The frequency ω is a real positive quantity. The wavenumber ξ can be either real or complex and can have both positive and negative signs. A classic technique to solve the eigenvalue problem $\xi(\omega)$ consists of recasting eq. (3) to a first-order eigensystem by doubling its algebraic size:

$$\left[\mathbf{A} - \xi\mathbf{B} \right]_{2M} \mathbf{U} = \mathbf{0} \quad (4)$$

where \mathbf{A} and \mathbf{B} are related to the dynamic stiffness and mass matrices of the rail.

Solving eq. (4) at each frequency ω , $2M$ eigenvalues ξ_m and, consequently, $2M$ eigenvectors are obtained. The eigenvectors are the M forward and the corresponding M backward modes. In general the eigenvalues are pairs of complex conjugate numbers ($\pm \xi_{\text{Re}} \pm i\xi_{\text{Im}}$), representing propagating and evanescent waves along the $\pm x$ -directions. The wave phase velocity can be evaluated by $cp = \omega/\xi_{\text{Re}}$ and the attenuation, in Nepers per meter, by ξ_{Im} .

Figure 1 shows the SAFE results for guided waves up to 50 kHz propagating in a 115-lb AREMA rail. Material properties are: density $\rho = 7932 \text{ kg/m}^3$, bulk longitudinal velocity $c_L = 5960 \text{ m/s}$, bulk shear velocity $c_T = 3,260 \text{ m/s}$, longitudinal attenuation $\kappa_L = 0.003 \text{ Np/wavelength}$, shear attenuation $\kappa_T = 0.043 \text{ Np/wavelength}$. The mesh of the rail cross-section, also shown in Figure 1, used 81 nodes for 106 triangular elements with linear interpolation displacement functions. Notice the complexity of the modes. For example, at least 25 guided modes exist at 50 kHz. Phase velocity, energy velocity and attenuation values are shown for all modes. The velocity curves allow mode identification. The attenuation curves allow selecting mode-frequency combinations propagating with minimum attenuation losses thereby maximizing the inspection coverage.

Figure 2 shows SAFE results obtained at a higher frequency of 200 kHz. The mesh in this case used 1,118 triangular elements with a total number of degrees of freedom of 1,815 (see figure). Results are shown for the fundamental symmetric mode (S_0) and the 1st order antisymmetric mode (A_1). The plots show the displacement mode shapes (x -component) and the cross-sectional strain energy associated with the two modes at 200 kHz. The symmetry of the mode is usually referred to the displacement ux relative to the vertical axis of symmetry (z) of the rail section. Accordingly, the mode shapes in Figure 2 show a symmetric ux for S_0 and an antisymmetric ux for A_1 . This behavior is therefore equivalent to an axial-type motion for S_0 and a horizontal flexural-type motion for A_1 . The strain energy plots indicate where the energy of the mode is focused across the rail section. It can be seen that while S_0 concentrates the energy at the center top of the rail head, A_1 primarily excites the flanges of the rail head. To some extent, this behavior can be generalized to all S_i and A_i modes. Therefore, in a defect detection context, symmetric-type modes are more effective to detect cracks located in the center of the rail head (such as a TF), whereas antisymmetric-type modes are more effective for targeting defects in the sides of the head (such as gage-side RCF cracks).

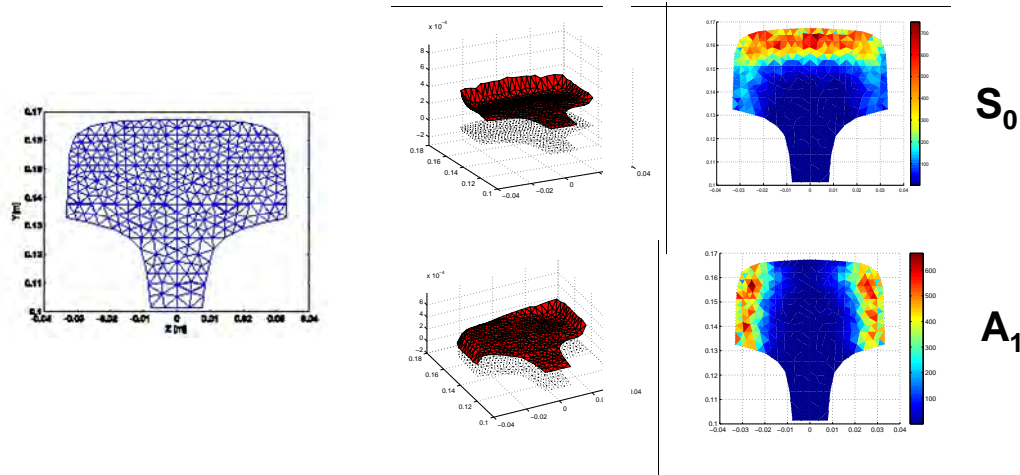

FIGURE 2 SAFE results for guided waves in a 115-lb AREMA rail at high frequency: mesh.

The rail response at a generic location $x = x_U$ due to an external harmonic force p applied at $x = x_F$ can be obtained in terms of the displacements \mathbf{U} as a linear combination of the eigensolutions ($\xi_m - \mathbf{U}_m$) for the m th mode (8):

$$\mathbf{U} = \sum_{m=1}^M \left(-\frac{\mathbf{U}_m^L \mathbf{p}}{B_m} \right) \mathbf{U}_m^{Rup} \exp[i\xi_m (x_U - x_F)] \tag{5}$$

where $B_m = \mathbf{U}_m^L \mathbf{B} \mathbf{U}_m^R$, and \mathbf{U}_m^L and \mathbf{U}_m^R represent the left and right eigenvectors, and \mathbf{U}_m^{Rup} represents the upper part of the right eigenvector. The response to a force of any frequency content can be then obtained by combining the different harmonic responses in the spatial frequency domain by Fourier Transform processing.

The forced response of the rail was studied for the case of a broadband excitation applied to the top of the rail head. The excitation simulated the laser pulse which is used in the defect detection prototype (see next section). Figure 3 shows the rail response to a symmetric (left) and to a nonsymmetric (right) laser excitation, at a distance of 4 in. (0.1 m) from the irradiation point. The response is shown in terms of strain energy for all excited guided wave modes. It is shown that while the symmetric excitation predominantly vibrates the center of the head, the nonsymmetric excitation favors one side of the rail head. Therefore, similar to what is concluded for the unforced modes in the previous figure, a symmetric (or nonsymmetric) laser excitation should be used to focus the inspection to the center (or the gage-side) of the rail head.

RAIL DEFECT DETECTION PROTOTYPE

The UCSD/FRA rail defect detection prototype is based on ultrasonic guided waves and non-contact probing. Certain wave frequencies are chosen, which penetrate the entire rail head, and can hence interact with surface or internal head cracks, located either at the center or at the gage-side of the head. While guided waves are preferentially sensitive to transverse-type cracks (TF

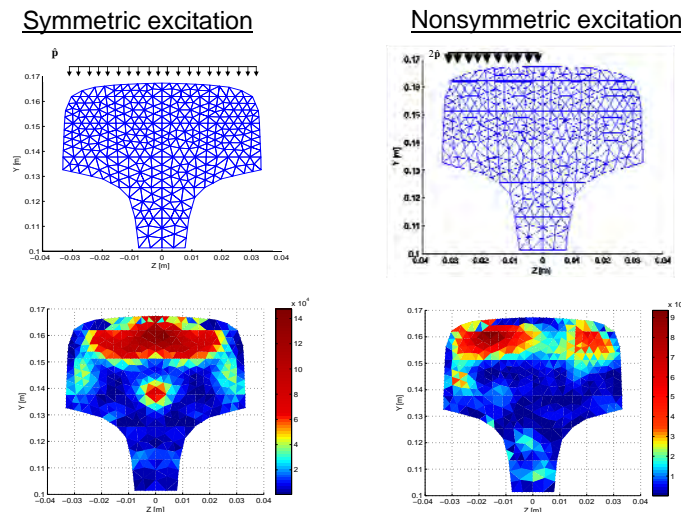

FIGURE 3 SAFE results for guided waves in a 115-lb AREMA rail excited by a broadband force: mesh, wave strain energy for a symmetric excitation, and wave strain energy for a nonsymmetric excitation.

and DF), the used wave paths are also sensitive to longitudinal cracks and mixed-mode cracks such as vertical split heads and compound fractures, respectively. The current system targets exclusively the rail head, hence no coverage is provided for the web and base.

The guided waves are excited and detected in a non-contact manner. An Nd:YAG pulsed laser is used for wave generation. An array of air-coupled sensors is used for wave detection. The sensors stay 2 in. (50.8 mm) above the rail head.

The ultrasonic excitation, detection and processing are performed in light of the SAFE model predictions to maximize the sensitivity to (a) the presence of head cracks and (b) the type of head cracks (surface vs. internal). A statistical pattern recognition algorithm, proprietarily developed by UCSD, has been added to provide real-time indication of defects in a statistically robust manner. The algorithm does not require any learning cycle on known defects, which would be impractical to obtain given the large variety of defect cases possible. The algorithm outputs two levels of classification. The first classification level identifies “discontinuities” in the track (including defects and joints). The second classification level flags each discontinuity as “joint,” “surface defect,” “internal defect,” or “unclassified defect.” The two-level classification was implemented to minimize the chances of missing a defect (i.e., minimizing false negatives) and, at the same time, to provide the defect classification (“surface defect” versus “internal defect”) whenever possible. Defects are flagged in real-time along with their position. The classification analyzes “damage indexes” that are calculated from the signals acquired by the air-coupled sensors.

A plot of a damage index is shown in Figure 4. This result is from a run conducted at 10 mph at the Gettysburg, Pennsylvania, test site (see next section). The largest peaks are joints, and the smaller peaks are defects. Notice that the signal-to-noise ratio (SNR) of the data is extremely high. The discontinuity-free portions of the rail show an almost identically zero damage index. This level of SNR could not be achieved with deterministic information such as the typical threshold-crossing of a single ultrasonic measurement.

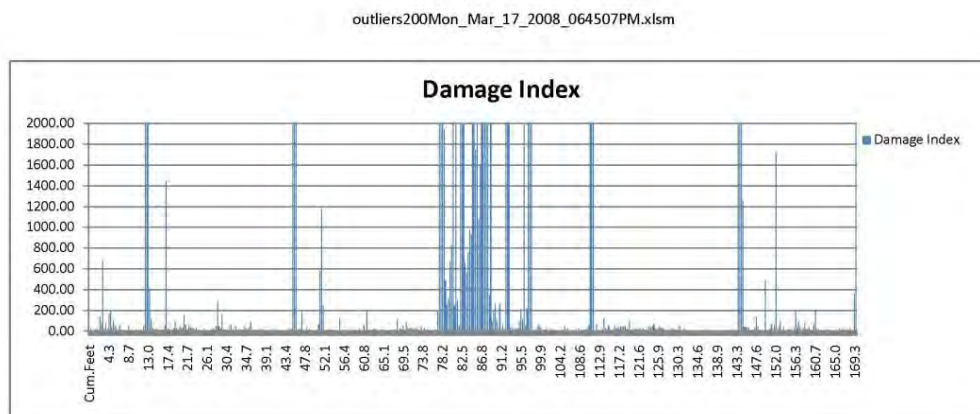

FIGURE 4 Typical run during March 2008 Gettysburg, Pennsylvania, field test, showing effectiveness of statistical analysis in detecting joints (largest peaks) and defects (smaller peaks).

Figure 5 shows a defect classification result from another run at the Gettysburg site. Notice that the plots are zoomed between locations 70 ft and 120 ft. The software shows two plots, namely the “discontinuities” plot which includes both joints and defects, and the “classification” plot which color codes the discontinuities according to the classes “joint,” “internal defect,” “surface defect,” and “unclassified defect.”

The software also generates a tabular report which includes the position of the detected discontinuities, as well as the discontinuity type among the classes indicated above.

FIELD TEST RESULTS

The most recent field test of the prototype was conducted in Gettysburg in March 2008. This test was preceded by two other tests at the same site (March 2006 and April 2007). ENSCO, Inc. provided technical support throughout the field tests, including design/build of cart for the prototype, and operation of the FRA hy-railer which was used to tow the cart.

Figure 6 shows pictures of the prototype mounted on the cart at the site, with UCSD, FRA and ENSCO personnel involved. The test site, Figure 7, is located near Gettysburg, PA, and consisted of a segment of railway siding, 160 ft (49 m) in length, containing known defects. Several joints were present along the test section. Three, 1.8-m-long (6 ft), 136-lb A.R.E.M.A. sections with known internal defects in the head were inserted, and secured with joint bars, in the test section. From ultrasonic hand mapping, three internal defects were located and sized, with 3.5% head area (HA), 35% HA, and 12% HA, respectively. The hand mapping also indicated that all internal defects were primarily transverse, with two located in the gage side and one located in the head-center. In addition, two surface cuts were machined perpendicularly to the rail running direction, with sizes of 5% and 2% HA, respectively. Two oblique surface cuts (45-degree inclination from the running direction) were also added at the top of the head, both about 3.5% HA.

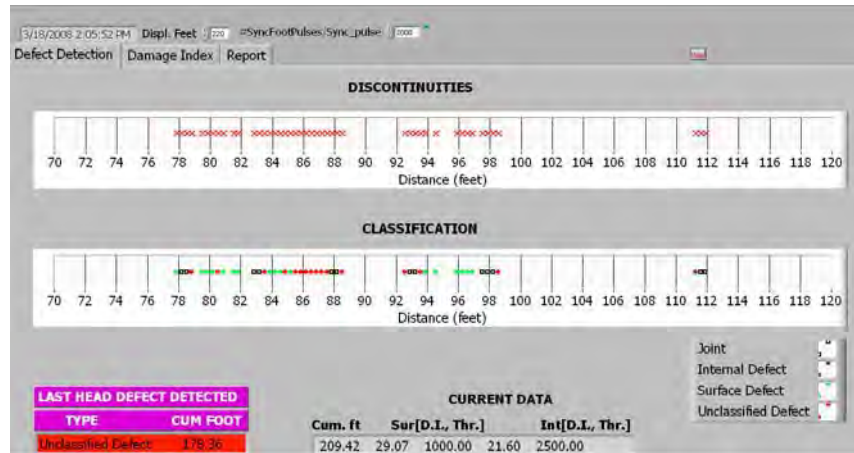

FIGURE 5 The “Defect Detection” window of the user’s interface showing the real-time classification of joints and defects as color-coded points.



FIGURE 6 Prototype mounted on cart, and UCSD, FRA, and ENSCO personnel at the Gettysburg test site, March 2008.

Various runs were made during 4 days of testing. Twenty-four of these runs were used to collect damage index data for estimating the probability of detection (POD) for the present defects. The other runs were performed to collect raw data for further analysis. To assess the robustness of the system, the tests were performed under various conditions including calm versus windy, dry versus wet rail, 5 mph versus 10 mph, and using two different powers of laser excitation.



FIGURE 7 Test site near Gettysburg.

The performance of the prototype, evaluated in terms of POD, is summarized in [Table 1](#). The results are shown separately for the 5-mph and the 10-mph testing speeds. The “cumulative” POD, obtained by considering all tests regardless of testing speed, is also shown. The POD was calculated as the ratio between the number of runs where a given defect was detected, over the total number of usable runs. A defect was considered detected when at least one of the statistical damage indices was activated. A statistical damage index was called “activated” when the corresponding value was above a fixed threshold level. Table 1 shows an excellent performance in detecting all present defects. Particularly noteworthy is the high POD obtained for the three internal defects. The reliability of detection for the surface and the oblique cuts was also high. It is not clear why the POD of the 35% H.A. internal defect was smaller than that of the other two internal defects at 5 mph. It is possible that the 35% H.A. defect has a curvature that makes the ultrasonic detection more challenging. The fact that this effect was not seen at 10 mph could be due to the favorable position of the air-coupled sensors relative to the defect in the faster runs. Hence, for some of the defects, there seems to be a dependence of reliability of detection on the position of the sensors. This is not surprising, because the defect “ultrasonic shadow” footprint will change with position along the rail.

It can also be noticed that, except for one of the oblique cuts, the performance did not degrade with switching from the 5-mph speed to the 10-mph speed. The low false positive indications (last column of Table 1) are also reassuring since false positives would require an inspector to manually verify the indication in the “stop and confirm” mode. The false positives were calculated as the percentage ratio between the sum of false positive detections over all the runs and the total number of the readings, excluding the ones related to the discontinuities (joints and defects). Finally, it should be noted that the POD was maintained high within the large range of environmental conditions encountered, including rain and wind.

TABLE 1 Defect Detection Reliability During March 2008 Field Test at Gettysburg

Defect	Surface cut (5% H.A.)	Surface cut (2% H.A.)	Internal defect (gage side, 3.6% H.A.)	Internal defect (gage side, 35% H.A.)	Oblique cut (3.5% H.A.)	Internal defect (center head, 12% H.A.)	Oblique cut (3.5% H.A.)	False positive %
POSITION FROM START	81'_7"	82'_7.5"	86'_4"	91'_3.5"	95'_1"	96'_4"	97'_8"	
POD (5 MPH)	100.0	97.7	100.0	81.8	95.5	84.1	100.0	0.8
POD (10 MPH)	100.0	100.0	100.0	100.0	75.0	87.5	100.0	2.9
POD (Cumulative)	100.0	98.1	100.0	84.6	92.3	84.6	100.0	1.1

CONCLUSIONS

This paper has presented the status of the rail defect detection prototype being developed at UCSD under FRA sponsorship. The prototype uses ultrasonic guided waves, rather than bulk waves used by conventional ultrasonic wheel inspections. Guided waves, propagating along the rail running direction, offer several advantages compared to wheel-based inspections. These include, a preferential sensitivity to transverse-type defects, a better ability to overcome the problem of “defect masking” in the presence of surface shelling, and a larger inspection range which can in turn increase inspection speed.

However, guided waves in rails are complicated because of their multimode and dispersive character. The first part of the paper therefore presents a semianalytical finite element (SAFE) method to model guided waves in rails at frequencies as high as 1 MHz, which would be impossible to model with conventional finite element analysis using off-the-shelf computing resources. The SAFE analysis was used to predict wave velocity and attenuation curves, as well as wave patterns in the rail due to different excitations.

These models allowed for the selection of the appropriate mode and frequency combinations in the prototype under development, for the detection and classification of head defects. Although the prototype was initially designed to target TDs, wave paths are used which can theoretically also detect vertical split heads and compound fractures. This is because the wave propagation direction is oblique with respect to the rail running direction.

The prototype excites and detects guided waves in the rail in a non-contact manner, using a combination of laser and air-coupled sensors. The software analyzes the sensor indications in real time using a statistical pattern recognition algorithm which greatly increases defect detectability compared to deterministic analysis. The algorithm also provides a classification of the detected discontinuities, among the classes of “joint,” “internal defect,” “surface defect,” and “unclassified defect.”

The prototype was field tested in March 2008 at speeds of up to 10 mph. The test track included three different sizes of internal head defects (3.5%, 35% and 12% H.A.), two sizes of transverse surface head cuts (2% and 5% H.A.), and one size of oblique surface dead cut (3.5% H.A.). The results of the tests indicated a high probability of detection for all defects present, ranging from 75% to 100% success rate over twenty-four runs conducted with varying environmental conditions including wind and rain. Unfortunately it was not possible to compare the proposed technology with existing rail inspection technologies. It is hoped that this

comparison can be done in the near future. Further improvements are planned, including a new higher frequency laser to increase inspection speed up to 40 mph, better operational controls, and repackaging for the harsh railroad environment, as well as and installation in an FRA Research Car for technology demonstration.

ACKNOWLEDGMENTS

This work, initially supported by the U.S. National Science Foundation, is currently being funded by the U.S. Federal Railroad Administration. The support of ENSCO, Inc., during the field tests is acknowledged and much appreciated.

REFERENCES

1. Federal Railroad Administration. Safety Statistics Data. Train Accident by Cause: 1998–2008. FRA, U.S. Department of Transportation, 2008
2. Lanza di Scalea, F. Ultrasonic Testing Applications in the Railroad Industry. In Chapter 15: Special Applications of Ultrasonic Testing, *Nondestructive Testing Handbook*, 3rd edition, P.O. Moore, ed., American Society for Nondestructive Testing, 2007, pp. 535–540.
3. National Transportation Safety Board. Safety Recommendation I-94-2. Washington, D.C., 1994.
4. Wilcox, P., M. Evans, B. Pavlakovic, D. Alleyne, K. Vine, P. Cawley, and M. J. S. Lowe. Guided Wave Testing of Rail. *Insight-NDT and Condition Monitoring*, Vol. 45, 2003, pp. 413–420.
5. Cawley, P., M. J. S. Lowe, D. Alleyne, B. Pavlakovic, and P. Wilcox. Practical Long Range Guided Wave Testing: Applications to Pipes and Rail. *Materials Evaluation*, Vol. 61, 2003, pp. 66–74.
6. Rose, J. L., M. J. Avioli, and W. J. Song. Application and Potential of Guided Wave Rail Inspection. *Insight-NDT and Condition Monitoring*, Vol. 44, 2002, pp. 353–358.
7. Rose, J. L., M. J. Avioli, P. Mudge, and R. Sanderson. Guided Wave Inspection Potential of Defects in Rail. *NDT&E International*, Vol. 37, 2004, pp. 153–161.
8. Hayashi, T., W. J. Song, and J. L. Rose. Guided Wave Dispersion Curves for a Bar with an Arbitrary Cross-section, a Rod and Rail Example. *Ultrasonics*, Vol. 41, 2003, pp. 175–183.
9. McNamara, J., F. Lanza di Scalea, and M. Fateh. Automatic Defect Classification in Long-Range Ultrasonic Rail Inspection Using a Support Vector Machine-based Smart System. *Insight-NDT and Condition Monitoring*, Vol. 46, 2004, pp. 331–337.
10. Bartoli, I., F. Lanza di Scalea, M. Fateh, and E. Viola. Modeling Guided Wave Propagation with Application to the Long-Range Defect Detection in Railroad Tracks. *NDT&E International*, Vol. 38, 2005, pp. 325–334.
11. Lanza di Scalea, F., P. Rizzo, S. Coccia, I. Bartoli, and M. Fateh. Laser/air-coupled Hybrid Non-contact System for Defect Detection in Rail Tracks: Status of FRA Prototype Development at UC San Diego. In *Transportation Research Record: Journal of the Transportation Research Board*, No. 1943, Transportation Research Board of the National Academies, Washington, D.C., 2006, pp. 57–64.
12. Coccia, S. Ultrasonic Guided Waves for Structural Health Monitoring and Application to Rail Inspection Prototype for the Federal Railroad Administration. Ph.D. Dissertation, University of California, San Diego, 2007.
13. Hesse, D., and P. Cawley. Surface Wave Modes in Rails. *Journal of the Acoustical Society of America*, Vol. 120, 2006, pp. 733–740.
14. Dixon, S., R. S. Edwards, and X. Jian. Inspection of Rail Track Head Surfaces Using Electromagnetic Transducers (EMATs). *Insight-NDT and Condition Monitoring*, Vol. 46, 2004, pp. 326–330.

15. Lanza di Scalea, F., S. Kenderian, and R. E. Green, Jr. Non-contact Ultrasonic Inspection of Rail Tracks. *Proceedings of the 45th International SAMPE Symposium and Exhibition, Long Beach, California, 2000*, pp. 1,762–1,769 (also Lanza di Scalea, F. Advances in Non-contact Ultrasonic Inspection of Railroad Tracks. *Experimental Techniques*, Vol. 24, 2000, pp. 23–26).
16. Bartoli, I. Ultrasonic Guided Wave Models for Structural Health Monitoring. Ph.D. Dissertation, University of California, San Diego, 2007.
17. Bartoli, I., A. Marzani, F. Lanza di Scalea, and E. Viola. Modeling Wave Propagation in Damped Waveguides of Arbitrary Cross-section. *Journal of Sound and Vibration*, Vol. 295, 2006, pp. 685–707.

Streetcar Circulators and the New Urbanism

STREETCAR CIRCULATORS AND THE NEW URBANISM

The Santa Ana and Garden Grove Streetcar Project Concept

Assessing the Viability, Exploring the Potential, and Evaluating the Feasibility

TONI BOTTE BATES

MELISSA ESTRADA

PATRICK BLANKENSHIP

Parsons Brinckerhoff

The United States is experiencing a streetcar renaissance. Since 2000, at least six cities have opened new streetcar systems, with several of these having already extended their initial lines. New streetcar systems are built for a variety of reasons, but many reasons are only peripherally related to regional transit system mobility and expansion. In fact, most new streetcar systems are initiated by cities, not transit agencies, to promote tourism, spawn economic development and redevelopment, and to facilitate localized circulation by acting as “pedestrian enhancers” for short trips. Generally, the idea behind the streetcar is not to move masses of people, but to revitalize urban areas by offering visible, permanent, and easily-accessible transportation at a human pace and scale.

The success of new streetcar systems in achieving a wide range of goals has garnered the interest of dozens of other U.S. cities, including the neighboring cities of Santa Ana and Garden Grove, California. But unlike most other locales, regional transit system mobility and the regional transit agency—the Orange County Transportation Authority (OCTA)—were the catalysts for local consideration of a streetcar system in Santa Ana and Garden Grove.

REGIONAL CATALYST–LOCAL INSPIRATION

Measure M, the Orange County transportation sales tax measure, approved in 1990 and subsequently renewed in 2006, provides a long-term funding source to address transportation deficiencies and improvements throughout Orange County, including within the cities of Santa Ana and Garden Grove. Through the use of Measure M funds, OCTA is implementing a capital and operating program to increase service on the existing Metrolink commuter rail line in Orange County, between the Laguna Niguel/Mission Viejo and Fullerton Stations. To extend the reach of Metrolink, while supporting expanded service and promoting ridership, OCTA developed the Go Local program, encouraging all 34 county cities to develop local concepts to improve access to Metrolink stations. OCTA supported local concepts by providing each city with \$100,000 in initial concept planning funding, and will provide subsequent funding for the design and implementation of selected projects.

Santa Ana is home to one of the busiest Metrolink stations in Orange County—the Santa Ana Regional Transportation Center (SARTC). In 2007, over half a million people boarded and alighted approximately 32 daily Metrolink trains and 22 daily Pacific Surfliner (Amtrak) trains at the SARTC. By 2030, more than 1 million annual passengers are expected to use the SARTC as a result of Measure M-funded increases in Metrolink service which will be expanded to 30 min

all day. Garden Grove, Santa Ana's neighbor to the west, is not directly served by a Metrolink station, but lies within 5 mi of the SARTC (Figure 1). Due to their shared focus on the SARTC, Santa Ana and Garden Grove entered into a partnership to develop a joint concept to connect to Metrolink, as part of OCTA's Go Local Program.

From OCTA's perspective, Santa Ana and Garden Grove's local transit concept needed to successfully address the following criteria to achieve regional transit goals:

- Local jurisdiction funding commitments;
- Proven ability to attract other financial partners;
- Proximity to job and population centers;
- Regional benefits;
- Ease and simplicity of connections;
- Cost-effectiveness;
- Traffic congestion relief;
- Right-of-way availability;
- Sound long-term operating plan;
- Compatibility and approved land use;
- Project readiness; and,
- Safe and modern technologies.

However, Santa Ana and Garden Grove envisioned a dual role for their Metrolink connection concept that would support local as well as regional goals. Local goals centered on:

- Connecting population, employment, and activity centers internally, as well as to Metrolink;
- Creating transit gateways into both Santa Ana and Garden Grove; and,
- Supporting and promoting economic development and redevelopment.

Santa Ana and Garden Grove undertook the OCTA Go Local study to assess the viability, explore the potential, and evaluate the feasibility of a local transit connection to meet regional and local goals.

ASSESSING THE VIABILITY

To assess the viability of a transit connection to Metrolink, from both a regional and local perspective, Santa Ana and Garden Grove looked at factors that traditionally influence transit ridership and performance, such as population demographics and travel patterns, as well as factors that relate to localized transit/land use integration and ease of implementation. The viability assessment, summarized below, indicates that Santa Ana and Garden Grove are strong candidates for a successful transit connection that would support Metrolink expansion and local land use and mobility goals.

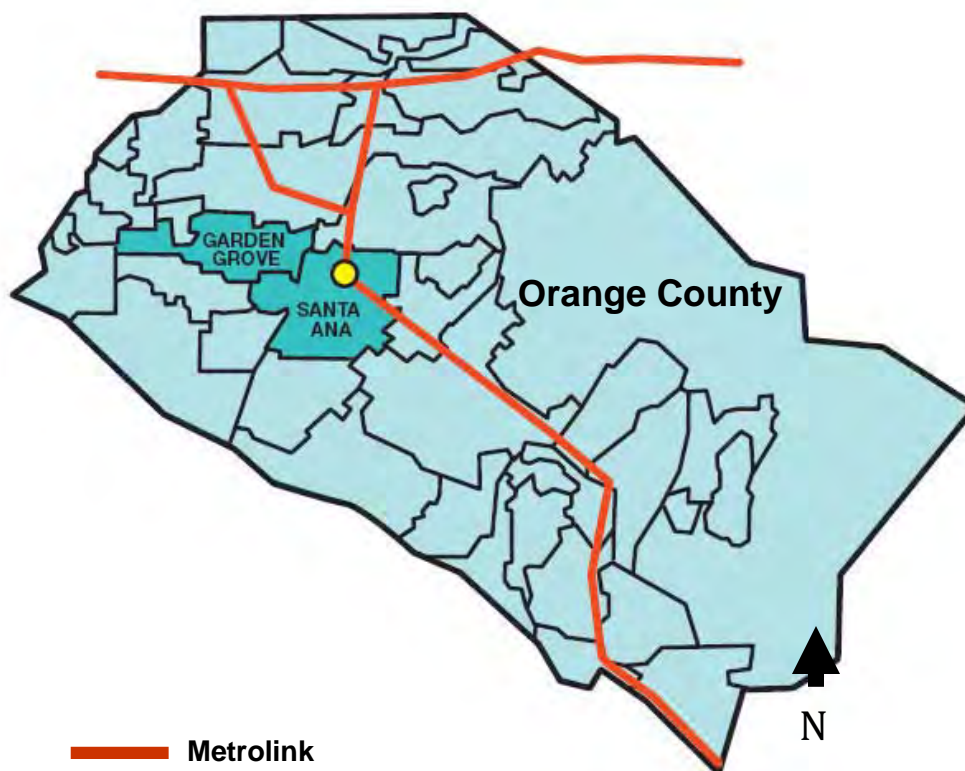

FIGURE 1 Orange County.

Population and Employment

Santa Ana is the largest of Orange County's 34 cities, with a 2007 population of over 350,000 (1), and is the most dense. According to the 2000 U.S. Census, this 27 mi² city has a density of 12,452 people per square mile, making it the eighth most densely populated city in the United States (2). Central Santa Ana, located within a few miles of the SARTC, has the highest residential concentration and is among the three highest employment concentrations.

As the seat of county government and home to two major retail centers and a large community college, Santa Ana also attracts a large number of employees on a daily basis—170,000 in 2005 (3). In addition to its government civic center, Santa Ana has a small but vibrant traditional downtown.

Garden Grove has over 170,000 residents, concentrated at densities of 9,200 people per square mile, making it Orange County's third most dense city (4). Although smaller and more residential than Santa Ana, Garden Grove has a significant employment base, with 53,000 jobs in 2005 (5).

In addition to strong and growing Metrolink ridership at the SARTC, both cities have high levels of existing local transit ridership. In 2006–2007, over 25 million people boarded OCTA buses in Santa Ana and Garden Grove, almost 40% of total OCTA boardings (6).

Activity Centers

Santa Ana boasts a number of major activity centers in and adjacent to the city that attract employees, shoppers, students, and visitors. The Santa Ana Civic Center includes city hall, county courthouses, state and federal buildings, and supporting offices and businesses. South Coast Plaza and Main Place shopping malls together comprise almost 4 million square feet of retail shopping (7). Santa Ana College has over 25,000 students and staff (8). Downtown Santa Ana, Bowers Museum, and the Discovery Center offer regional visitor attractions. Additionally, a variety of new mixed-use developments, including City Place and Metro East, are focusing concentrations of activity in the city. Garden Grove activity centers include its civic center and the International West Resort Corridor, a growing high-density area of hotels and tourist infrastructure, along Harbor Boulevard, designed to support the resort area anchored by Disneyland in neighboring Anaheim.

Travel Demand

An assessment of regional travel demand, using the Orange County Transportation Analysis Model (OCTAM 3.2), reveals that Santa Ana is a strong regional trip attractor, due to its civic center, shopping malls, and educational and visitor institutions, with over 2.3 million trips to, from, and within the city each day. Moreover, across the five-county region, consisting of Los Angeles, San Bernardino, Riverside, Ventura, and Orange counties, trips from south Orange County will comprise the largest proportion of trips to Santa Ana by 2030 (35% of all trips and almost 30% of work trips). These trips occur precisely along the Metrolink corridor slated for service enhancements by OCTA. However, arrival on Metrolink at the SARTC would leave these travelers short of their final destinations, indicating a strong need for the missing transit link to complete trips.

Right-of-Way

Available public right-of-way in Santa Ana and Garden Grove includes existing city streets and the abandoned Pacific Electric (PE) streetcar right-of-way. The OCTA-owned PE right-of-way diagonally traverses the two cities from southeast to northwest and offers multiple opportunities for re-use as a transportation corridor.

Economic Development

In addition to existing activity centers, Santa Ana and Garden Grove have a number of planned development and redevelopment areas, to support the integration of transit and land use, as shown in [Figure 2](#) and described below.

- **Renaissance-Specific Plan (RSP) Area:** Santa Ana's RSP area encompasses 421 acres in the city's core area, between the SARTC and the civic center—downtown. The RSP is intended to rehabilitate and redevelop properties in several neighborhoods and districts. Goals include: making the city's core regionally competitive, stabilizing neighborhoods, capitalizing on transit opportunities, and transforming the city's core into Orange County's downtown. Planned development will include both residential and commercial development that is transit oriented in

nature. A key feature of the plan is the existing SARTC, which will serve as the eastern node of the RSP area, providing a gateway to the city for travelers emerging from the rail station, and a focal point for new transit-oriented mixed-use development;

- **Bristol Street Corridor:** Santa Ana has commenced a \$125 million project to widen and beautify Bristol Street. The project includes infrastructure and landscaping that the city hopes will spark re-investment in the aging and blighted corridor;
- **Willowick Golf Course:** Santa Ana and Garden Grove are jointly pursuing development of the Willowick Golf Course, an 18-hole municipal golf course located along the PE right-of-way. This site, within the city of Santa Ana but owned by the city of Garden Grove, provides a unique opportunity for the two cities to collaborate on both access and economic development;
- **International West Resort Corridor:** This 520-acre corridor, centered on Harbor Boulevard in Garden Grove, aims to capture some of Orange County’s strong tourism sector. The corridor begins near the Disney Anaheim Resort and continues approximately 4 mi south to Santa Ana. Already, nine hotels, with more than 2,700 rooms and five restaurants, have been developed and Garden Grove is offering developers a variety of economic incentives to facilitate further appropriate development. Garden Grove sees a viable transit link to the SARTC as contributing to those incentives; and
- **Amusement Park:** Expanding on the resort corridor, Garden Grove also has plans to create a new amusement park or entertainment-themed project at the south end of the corridor, where the PE right-of-way meets Harbor Boulevard.

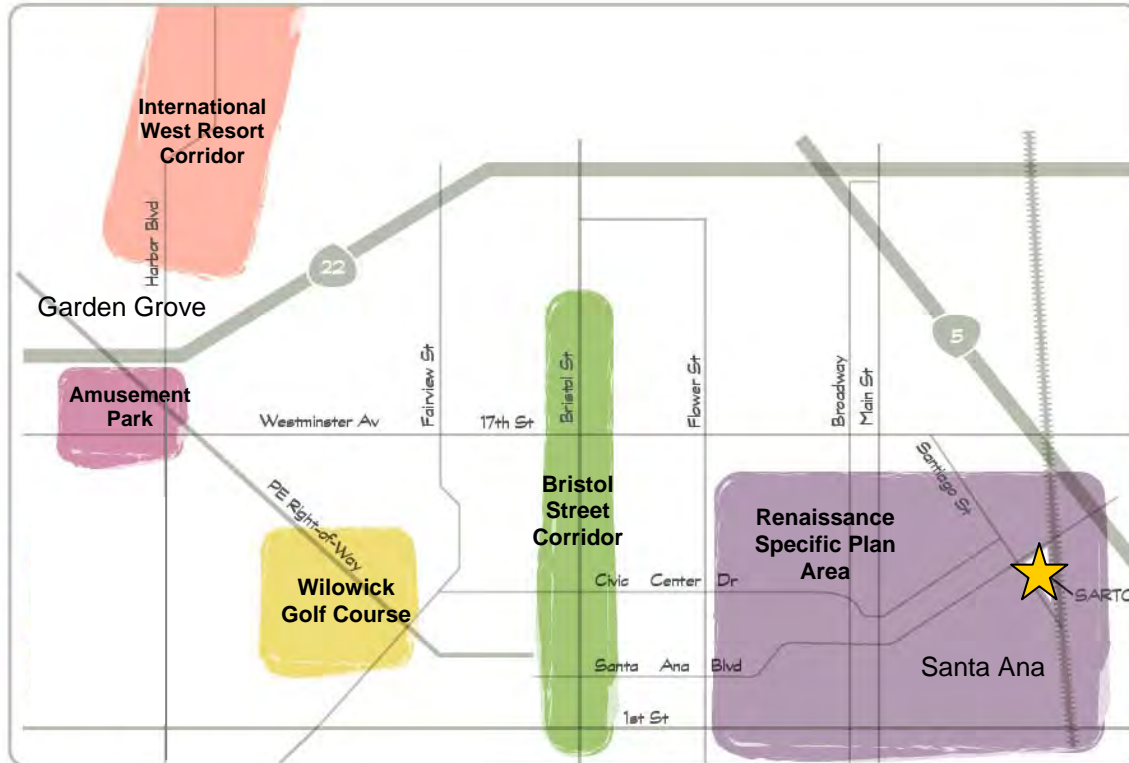

FIGURE 2 Santa Ana and Garden Grove economic development opportunities.

EXPLORING THE POTENTIAL

The Concept

Upon concluding that population, employment, activity centers, travel patterns, and development—redevelopment characteristics combine to create a strong case for a viable transit connection from Metrolink at the SARTC into Santa Ana and Garden Grove, the two cities created a concept for the transit connection, taking advantage of the identified opportunities and reinforcing regional and local goals. The concept provides for visible, attractive, convenient, and integrated transit facilities and services along a 5.9-mi corridor, from the SARTC to Harbor Boulevard, linking the RSP area, Downtown Santa Ana, the Santa Ana Civic Center, the Bristol Street Corridor, the Willowick Golf Course, and the International West Resort Corridor. As shown in [Figure 3](#), between the SARTC and the Santa Ana Civic Center, in the eastern segment, the transit concept would travel on city streets. In the western segment, the concept would take advantage of the abandoned PE right-of-way.

Transit Mode Considerations

To complete their project concept, Santa Ana and Garden Grove considered a variety of transit technologies, including: light rail transit (LRT), feeder buses, rubber-tired shuttles, and other fixed-guideway transit. The cities sought a mode that would best address the criteria set by OCTA, while complementing and supporting local goals. After reviewing transit mode options, Santa Ana and Garden Grove concluded the following:

- LRT is impractical because its capacity and infrastructure is better suited for regional transit applications, it would have significant public and private right-of-way impacts, and it would disrupt local traffic capacity and circulation. Furthermore, OCTA had previously advanced the Centerline, a regional LRT project that would have served Santa Ana and the SARTC, through the environmental and preliminary engineering phases of project development, but the project was subsequently abandoned as a feasible regional transit investment.
- Feeder buses lack the permanence and visibility desired of a new transit connection to the SARTC, which is necessary to promote ridership and economic development. Although feeder bus service is currently provided between the SARTC and several Santa Ana and Garden Grove activity and employment centers, it fails to attract ridership or promote economic development to the extent that both OCTA and the cities would prefer.
- Rubber-tired shuttles may provide some visibility for a transit connection to the SARTC, through the use of unique vehicles and paint schemes, but also suffer from a lack of permanence. Shuttles also have limited capacity to serve the anticipated travel demand, particularly between the SARTC and the Santa Ana Civic Center.
- Other fixed-guideway technology holds the most promise for providing the desired permanence and visibility, while at the same time addressing capacity needs and right-of-way constraints, and minimizing traffic and land use impacts. Of the fixed-guideway technologies considered, the use of a modern streetcar was determined to be the most desirable technology for meeting regional and local goals. This determination was made based upon case study research of existing streetcar systems.



FIGURE 3 Santa Ana and Garden Grove streetcar concept.

Case Study Research

To understand the potential application of streetcars in Santa Ana and Garden Grove, extensive case study research was undertaken on six existing streetcar systems, including:

- Portland (Oregon) Streetcar,
- Tacoma (Washington) Link,
- Seattle (Washington) South Lake Union Streetcar,
- Kenosha (Wisconsin) Transit Electric Streetcar,
- Tampa (Florida) Teco Line, and
- Little Rock (Arkansas) River Rail Streetcar.

All of the case study systems are relatively new, with the Portland Streetcar being the first to open in 2001. The case study research focused on streetcar planning purposes, design, performance, costs, and funding. The case study research is discussed below, with highlights included in [Table 1](#).

Planning Purpose

In general, the case study streetcar systems were implemented to:

- Promote tourism (Little Rock, Kenosha, and Tampa);
- Facilitate local circulation and connections (Portland, Tacoma, Seattle, Kenosha, Tampa, and Little Rock); and
- Stimulate economic development (Portland, Tacoma, Seattle, Kenosha, Tampa, and Little Rock).

TABLE 1 Streetcar Case Study Findings

System	Funding	Development Impacts	Operations			Capital Costs per Track Mile (millions)*	Annual Unlinked Boardings
			Frequency (min.)	Weekday Operating Hours	Operating Costs per Revenue Hour		
Portland Streetcar	<ul style="list-style-type: none"> • Bonds • Tax increment financing • Local improvement district • Regional transportation funds • City funds • Transportation land sales • Development commission funds • Other sources 	<ul style="list-style-type: none"> • \$3.5 billion local investment • 7,248 new housing units • 4.6 million sq. ft. commercial space • Majority of new downtown development is occurring near the streetcar • Residential units near the streetcar have highest densities and lowest parking ratio 	13	18	\$140	\$12.8	4,000,000
Tacoma Link	<ul style="list-style-type: none"> • No federal funds 	<ul style="list-style-type: none"> • 2,000 new housing units • 30% Increase in business activity 	10	15	\$292	\$25.1	885,000
Seattle South Lake Union Streetcar	<ul style="list-style-type: none"> • Local improvement district • State funds • Federal funds 	<ul style="list-style-type: none"> • 6,000 new housing units • 3.3 million sq. ft. commercial space • 15,000 to 23,000 new jobs expected • 8,000 to 10,000 new housing units expected 	15	15	N/A	N/A	300,000
Kenosha Transit Electric Streetcar	<ul style="list-style-type: none"> • All federal funds 	<ul style="list-style-type: none"> • 400 new housing units • Four high-density projects • One new museum • New commercial and community spaces planned 	15	4 or 8	\$100	\$3.9	53,000
Tampa TECO Line Streetcar System	<ul style="list-style-type: none"> • Federal funds • City funds • Florida DOT funds • Assessment district 	<ul style="list-style-type: none"> • \$1 billion local investment 	15	12	\$95	\$22.1	520,000
Little Rock River Rail Streetcar	<ul style="list-style-type: none"> • Federal funds • Local government funds 	<ul style="list-style-type: none"> • \$200 million planned/built development • \$28 million planned baseball stadium • Existing high-density redevelopment • Business activity increases 	25	12	\$68	\$8.3	154,000

NOTE: Development impact, operations, and annual unlinked boarding data based on 2006 and 2008 data.

* Capital costs include vehicles and supporting infrastructure.

Although promoting tourism and enhancing local circulation were among the specified goals, achieving economic development was the overarching goal of streetcar implementation in all six case study cities, encompassing tourism, circulation, and community revitalization. The case study systems have helped to catalyze development along streetcar lines, providing a permanent public investment in the community, conveying a positive image or “moving landmark” for the city, and creating a sense of place.

In all systems, tremendous amounts of growth either anticipated or followed streetcar implementation. In Portland, over \$3.5 billion in local investment, occurring in the downtown Pearl District, is attributed to the streetcar. In Tampa, over \$1 billion in investment has occurred; in Little Rock, \$200 million in development has been built or planned; and a new \$28 million minor-league baseball stadium is planned along the streetcar line. In Seattle, up to 10,000 new housing units are expected to be built near the streetcar line, along with 15,000 to 23,000 new jobs. Kenosha saw 400 new townhomes built along the streetcar line. Additionally, most new development has been transit-oriented development, supporting the higher densities and mix of land uses necessary to revitalize areas (9). The case studies demonstrate that the initial reasons for, and the successful results of, streetcar implementation are consistent with the goals of Santa Ana and Garden Grove, related to economic development, local connections to regional transit and activity centers, and tourism.

Design

All case study systems featured simple design characteristics, making streetcars a relatively inexpensive and cost-effective form of fixed-guideway transit. Many systems operate streetcars in mixed traffic (in shared lanes with automobiles) on existing streets, and stations are simple curbside designs, eliminating or reducing the need to acquire additional right-of-way. This not only reduces traffic and land use impacts, but allows for quick project implementation, often within 5 years of initial planning. All streetcar systems use single-car vehicles, making them compatible with both the automobile and community environments in which they operate. Frequent single-vehicle operation accommodates capacity needs. The simple design of the case study systems led Santa Ana and Garden Grove to conclude that streetcars can be reasonably integrated into their cities' street network and neighborhoods.

Ridership

While ridership levels range widely among case study streetcar systems, based on the length of the system, hours of operation, size of the city, and maturity of the system, ridership has been consistently above projected first-year levels, regardless of destinations served or fares charged. Current ridership in Kenosha is about 53,000 boardings a year, while the Portland Streetcar carries 4 million annual riders. Santa Ana and Garden Grove found ridership levels (even in the smaller case study cities) promising, particularly given the projected growth in Metrolink ridership, strong existing transit ridership, population and employment densities, and development plans in Santa Ana and Garden Grove.

Cost

The case study research found that capital costs ranged greatly from approximately \$4 million per track mile to over \$25 million per track mile, with Kenosha and Little Rock on the low end and Tacoma and Tampa on the high end. Given that some systems are single track, some are double track, and some have segments of both, the corridor mile capital costs ranged from a \$4 million low in Kenosha (all single track) to a \$50 million high in Tacoma (mostly double track), per corridor mile. Santa Ana and Garden Grove considered these capital costs within a reasonable range for implementation in their cities, particularly in comparison to other fixed-guideway mode options.

Operating costs among the case study systems range from about \$70 to \$140 per revenue hour, with the exception of Tacoma which has a significantly higher operating cost comparable to LRT. Again, these costs were deemed feasible relative to other fixed-guideway options.

Funding

The case study streetcar systems were implemented using a range of funding sources and most included multiple public and private funding sources. Public funding was often complemented with bonds, tax increment financing, local improvement districts, sponsorships, and a number of other private sector sources. The use of local and private funding sources, as demonstrated by the case studies, illustrates the willingness of communities to tax themselves to obtain the anticipated benefits of the streetcar. Santa Ana and Garden Grove will contemplate a number of local and private mechanisms to help fund their concept, viewing the case study cities as feasible models for a successful financing strategy.

Selection of the Modern Streetcar Concept

After a thorough review of the six-case study streetcar systems, and an exploration of their local potential and applicability, Santa Ana and Garden Grove determined that a modern streetcar holds the most promise for addressing regional and local goals. The cities then embarked on a locally focused evaluation of the feasibility of a streetcar project concept to better identify routes, operating plans, ridership potential, capital and operating costs, and funding options.

EVALUATING THE FEASIBILITY

Concept Routes and Operating Plans

To evaluate the feasibility of a modern streetcar, which would serve both cities, Santa Ana and Garden Grove developed five concept route options and two operating plan scenarios. The route options ranged from a small 2.2-mi single track loop, between the SARTC and the Santa Ana Civic Center, to a 5.9-mi corridor route, between the SARTC and Garden Grove (serving the Santa Ana Civic Center), including both single and double-track segments (Figure 4). Operating

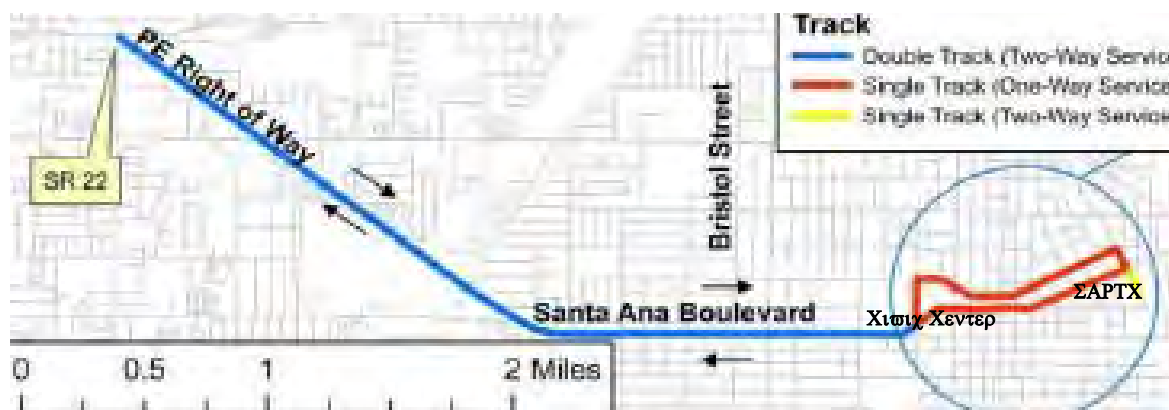

FIGURE 4 Santa Ana–Garden Grove 5.9-mi streetcar route concept.

plans included a 10-min all-day scenario and a 10-min peak–15-min off-peak scenario, both with an 18-h daily span of service. Operating and maintenance (O&M) costs, capital costs, and ridership estimates were developed for all combinations of route options and operating plan scenarios.

Concept-Level Operating Cost Estimates

The routes and operating plans provided the basic route distance, service frequency, and hours of operation required to estimate O&M costs. Assumptions for travel speeds (12 mph adjusted by a factor of 1.2 for congested peak periods and 0.9 for off-peak periods) and recovery time at terminals allowed for trip run time calculations. Run time and service frequency then determined vehicle requirements, which in turn, led to total revenue service hours for each route–operating plan combination. An average \$121.48 service hour operating cost, from three of the case study systems (Portland, Kenosha, and Tampa), adjusted for regional cost factors, was then used to estimate O&M costs for the Santa Ana and Garden Grove project concept. (Only three case study cities were used to estimate O&M costs. Tacoma, the high cost city, and Little Rock, the low city, were excluded to normalize the case study operating cost average. Seattle was also excluded because it had not yet opened). Since the maintenance facility is assumed to be located at the SARTC, no nonservice hours were included. Depending upon the route option and operating plan scenario combination, the estimated gross concept-level operating costs for the Santa Ana and Garden Grove streetcar concept range from \$1.2 million to \$4.7 million a year. The operating cost and fleet requirement estimate methodology used for the Santa Ana and Garden Grove streetcar project concept is shown in [Figure 5](#).

Concept-Level Capital Cost Estimates

Concept-level capital cost estimates were developed based on route length and general characteristics assumed for the system, including track, traction power systems, stations, vehicles, and the maintenance facility. Conceptual capital cost estimates were derived using actual single and double track capital costs per mile from each of the six case study systems. Costs from these systems were adjusted to 2007 dollars using the Engineering News Record Construction Cost

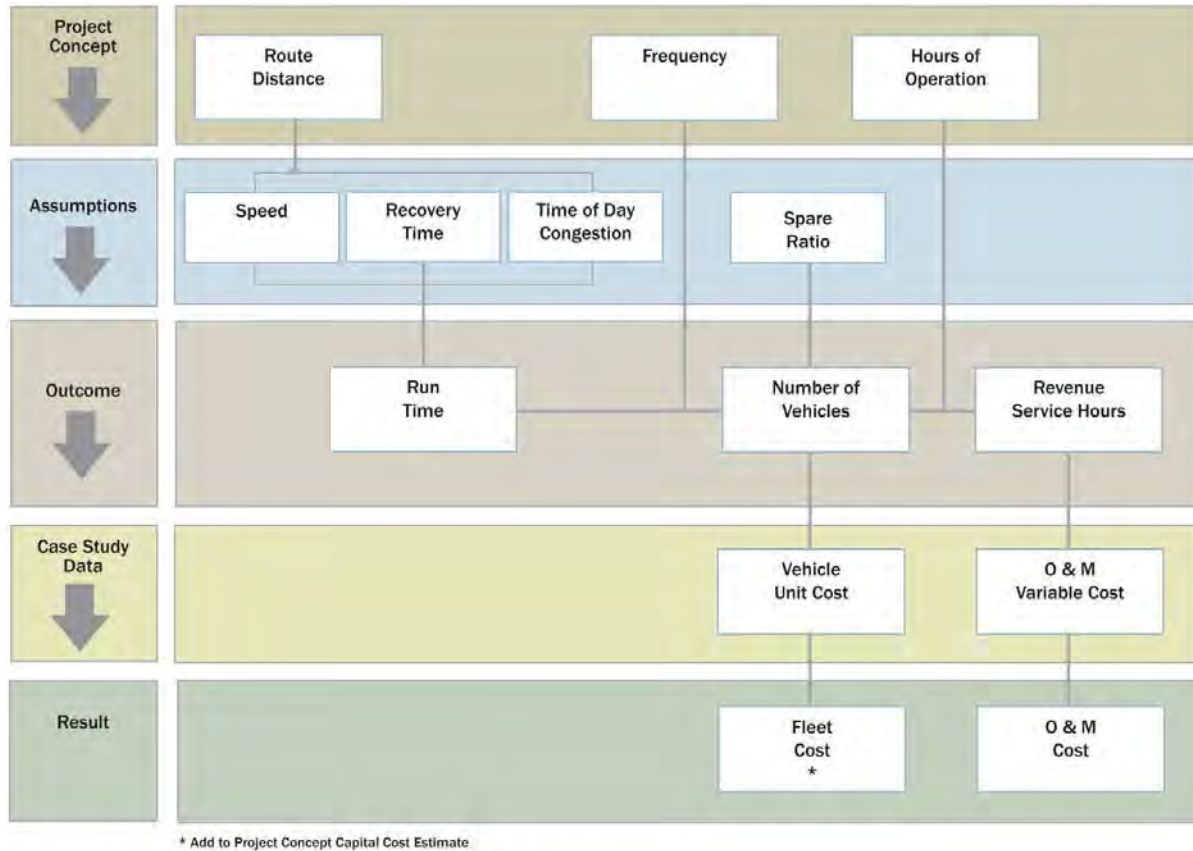

FIGURE 5 Operating cost and fleet requirement estimate methodology.

Index (CCI). Inflation was included using a variable rate (the actual inflation rate for each year) in place of an average fixed rate for all years. The costs were regionally adjusted to reflect geographic differences in construction costs using the fourth-quarter 2007 RS Means CCI. Fleet costs were subtracted from the total capital costs to obtain capital costs without vehicles. Capital costs without vehicles were divided by track miles to obtain capital costs per track mile without vehicles. Table 2 illustrates total (and per track mile) capital costs without vehicles for each of the case study streetcar systems. Double-track costs per mile were assumed to be less than twice the cost of single track per mile, reflecting an assumption of economies of scale attributable to redundancies in construction costs, such as utility relocations and power substations. Based on research by M. Kraus, a cost factor of 1.8 was used to estimate double-track costs from single-track (10). The 65th percentile of average case study system capital costs per track mile was used to provide a conservative measure of capital costs. A 30% contingency was added to the estimates to account for unknown elements inherent in cost estimates at the conceptual level.

Vehicle costs were assumed to be \$3.8 million per vehicle based on the Portland, Tacoma, and Seattle purchase price of approximately \$3 million per vehicle (for Skoda Inekon Astra 10T and Inekon Trio vehicles) and an \$800,000 per vehicle contingency for inflation, possible lower economies of scale with a smaller vehicle order, and other unforeseen costs.

**TABLE 2 Case Study and Estimated Capital Costs,
Excluding Vehicles (Regionally Adjusted)**

System	Completion Date	System Capital Cost Excluding Vehicles (\$2007)	Cost per Single-Track Mile (\$2007)	Cost per Double-Track Mile (\$2007)*
Portland Streetcar	2003	90.7 million	11.3 million	20.4 million
Tacoma Link	2003	89.6 million	28.0 million	50.4 million
Seattle South Lake Union Streetcar	2007	43.0 million	16.5 million	29.8 million
Kenosha Transit Electric Streetcar	2000	8.6 million	5.1 million	9.1 million
Tampa Teco Line Streetcar System	2002	70.1 million	29.2 million	52.6 million
Little Rock River Rail Streetcar	2004	33.8 million	10.0 million	17.9 million
Average			16.7 million	30.0 million
65th percentile			19.4 million	34.9 million
With 30% contingency			25.2 million	45.4 million

*Estimated value: cost per double-track mile = 1.8 × cost per single-track mile.

The project concept also includes a streetcar maintenance facility and storage yard presumably located at the SARTC. The maintenance facility capital cost was assumed to be \$5 million (based on a recently constructed two-vehicle maintenance facility cost for the Seattle South Lake Union Streetcar) plus a 30% contingency, totaling \$6.5 million.

To develop the capital cost estimates for the Santa Ana and Garden Grove streetcar, the methodology's resulting single and double track mile costs (\$25.2 million and \$45.4 million, respectively) were applied to the route length and configuration (single or double track), for each of the route concept options. Vehicles and maintenance facility costs were then added to the total trackway costs. Finally, 17% was added to the total for project design (10%) and construction management (7%), completing the estimates. Conceptual-level capital cost estimates for the Santa Ana and Garden Grove streetcar project range from \$35 million to \$51 million a corridor mile (\$35 million to \$37 million a track mile) depending on the route option. Total capital costs range from \$83 million for the small 2.2-mi one-way loop to \$300 million for the 5.9-mile mostly double-tracked option. [Figure 6](#) displays the conceptual-level capital cost estimate methodology used for the Santa Ana and Garden Grove streetcar project concept.

Concept-Level Ridership Estimate

High population and employment densities, strong employment and activity centers, strong travel patterns, existing and planned transit-friendly land uses, high levels of planned development and growth, and high existing transit ridership, point to a strong rider base for a streetcar in Santa Ana and Garden Grove. Going beyond these ridership indicators at the

conceptual planning phase to estimate project ridership is more an art than a science. The conceptual level ridership estimates were not derived from modeled forecasts, but were developed using a baseline ridership reflecting experience of the case study cities and building up from the baseline through a number of assumptions specific to Santa Ana and Garden Grove. The concept-level ridership estimation methodology is described below and shown in Figure 7.

- Riders per service hour baseline. Average riders per service hour from Portland and Tacoma (105 and 89 respectively) were applied to the Santa Ana and Garden Grove streetcar concept using service hours developed from the operating plan scenarios;
- Projected growth in Metrolink ridership. Application of existing transfer ratios to projected ridership growth on Metrolink at the SARTC resulting from increases in service frequency planned by OCTA were added to the baseline ridership;
- Influence of planned bus rapid transit connections. Additions to the baseline were assumed as a result of transfers between the streetcar and OCTA planned bus rapid transit (BRT) services on Harbor Boulevard, Bristol Street, and the Westminster–17th Street BRT; and
- Projected growth from changes in land use and economic development. Ridership augmentations were applied based on projected higher trip generation and transit mode share expected from planned higher density, TOD in Santa Ana and Garden Grove.

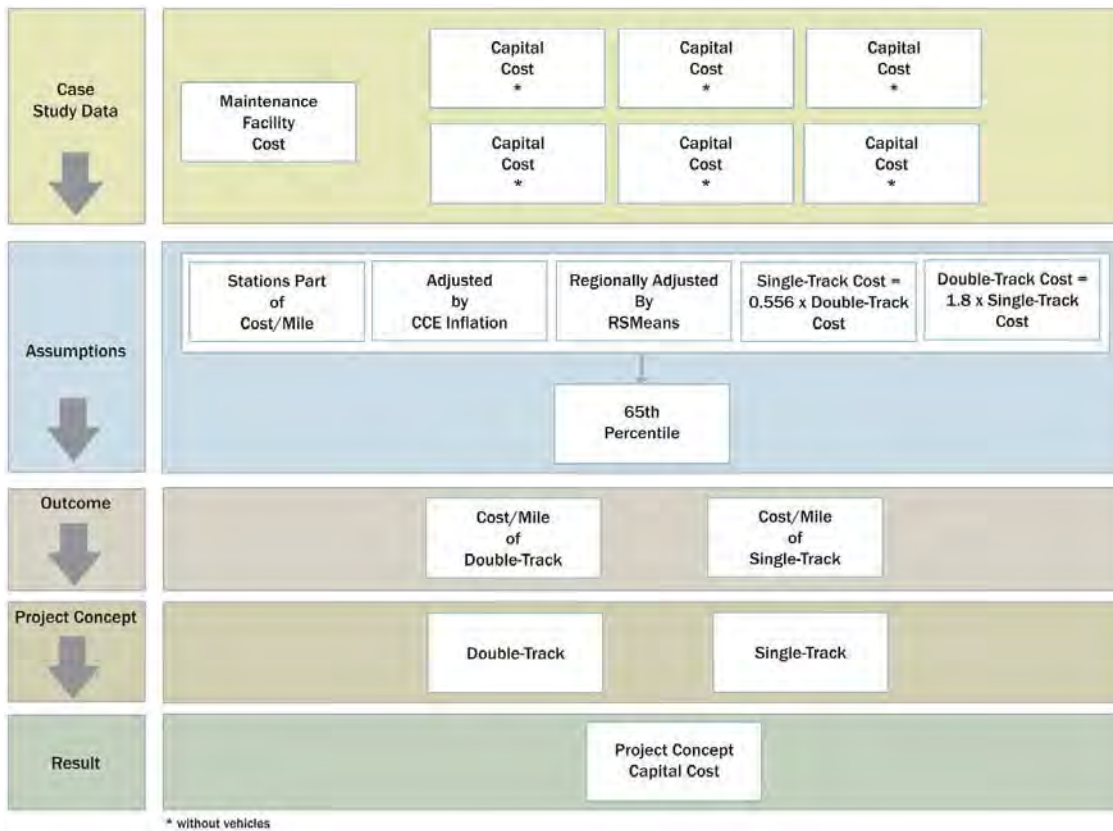

FIGURE 6 Capital cost estimate methodology.

The baseline ridership projections plus the build-up assumptions resulted in concept-level ridership estimates for the Santa Ana and Garden Grove streetcar of 4,000 to 5,000 daily riders for an initial segment between the SARTC and Civic Center within 5 years, and 12,000 to 14,000 daily (approximately \$4 million annually) by 2030 for the 5.9 mi project. These concept-level ridership projections indicate that there is a strong ridership potential that would help make the Santa Ana and Garden Grove streetcar a cost-effective project.

Funding Feasibility

A large proportion of operating and capital funding for the Santa Ana and Garden Grove streetcar is anticipated to come from Measure M, administered by OCTA. Some federal sources could also be considered. However, OCTA will require local contributions toward system capital and operating costs. Santa Ana and Garden Grove are in a strong position to develop local funding sources given the redevelopment and economic development plans within their cities. Potential local funding sources include the following:

- Municipal parking fee increases/bonds backed by parking fees;
- Local improvement districts/business improvement districts;
- Special assessment districts;
- Empowerment zones;
- Tax increment financing (RSP redevelopment area);
- Developer fees, agreements, and exactions (in the RSP–Civic Center areas);
- Public–private partnerships;
- Joint development (at the SARTC and the Willowick Golf Course); and
- Sponsorships.

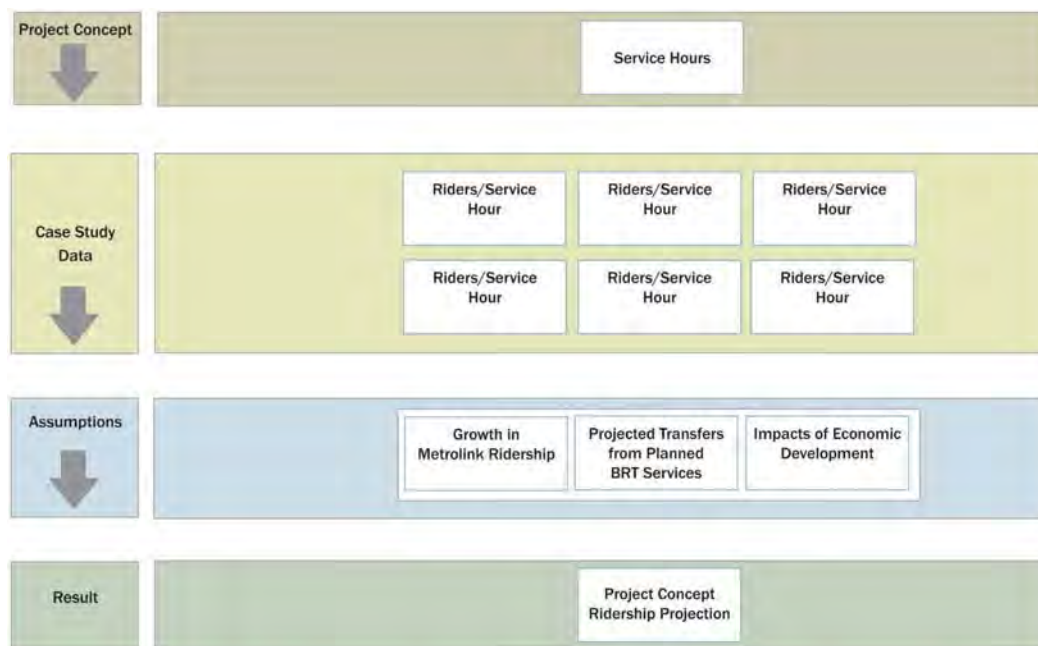

FIGURE 7 Concept-level ridership estimate methodology.

CONCLUSION

Based on the concept-level analysis of the viability, potential, and feasibility of a streetcar project for Santa Ana and Garden Grove, the partner cities are confident that a modern streetcar will fulfill both regional and local goals, and have determined that a streetcar is a promising investment because

- Growing Metrolink commuter rail ridership, strong travel patterns to and from Santa Ana, high population and employment densities, and high levels of existing transit ridership provide a solid ridership base for a streetcar;
- A streetcar can provide the missing transit link from regional Metrolink and bus rapid transit services, as well as local circulation, to key activity and employment centers;
- A streetcar fits within the existing public right-of-way, on both city streets and the abandoned PE right-of-way, making it relative easy to implement since little or no private right-of-way will be required;
- Case study research provides strong evidence that a streetcar will support local goals for economic development, TOD, and tourism, particularly in the RSP area, along Bristol Street, at the Willowick Golf Course, and along the International West Resort Corridor; and
- The capital and operating costs projected for the streetcar are within reason for a cost-effective project, and Santa Ana and Garden Grove are well positioned to develop local public and private funding sources to support the streetcar.

NEXT STEPS

In May 2008, OCTA approved \$5.9 million to advance the Santa Ana and Garden Grove modern streetcar project concept into detailed planning, conceptual engineering, environmental analysis, and financing strategy development.

RESOURCES

1. California Department of Finance, January 2007.
2. Southern California Association of Governments Growth Forecasts, 2004.
3. Southern California Association of Governments Growth Forecasts, 2004.
4. California Department of Finance, January 2007.
5. Southern California Association of Governments Growth Forecasts, 2004.
6. OCTA Directly Operated Fixed Route Statistics by City for Fiscal Year 2006–2007.
7. <http://www.seeing-stars.com/Shop/SouthCoastPlaza.shtml> and http://travel.yahoo.com/p-travelguide-2812257-main_place_mall_los_angeles-i.
8. [http://www.sac.edu/homex.asp/Santa Ana College](http://www.sac.edu/homex.asp/Santa%20Ana%20College).
9. Street Smart Streetcars and Cities in the 21st Century, Reconnecting America. www.portlandstreetcar.org; www.seattle.gov; www.soundtransit.org; www.railwaypreservation.com; www.lightrailnow.org.
10. Kraus, M. Scale Economies Analysis for Urban Highway Networks. *Journal of Urban Economics*, Vol. 9, 1981, pp. 1–22.

STREETCAR CIRCULATORS AND THE NEW URBANISM

Best Practices for the Effective Integration of Historic Trolley and Modern Urban Rail Transit Systems

BRETT WALLACE
HDR Engineering, Inc.

BACKGROUND AND PURPOSE

What Are “Heritage” and “Modern” Rail Transit Systems?

As stated by the APTA’s Heritage Trolley and Streetcar Subcommittee, the term “heritage trolley” describes the modern use of trolleys of a design dating from roughly 1900 to 1950. The term can be used to refer either to a replica car that more or less accurately reproduces a trolley from the first half of the 20th century, or to an original preserved (vintage) car restored to accurate or nearly accurate standards (1). For purposes of this discussion, the term heritage trolleys include both vintage and replica cars.

Modern rail transit systems include light rail, which is characterized as “a metropolitan electric railway system characterized by its ability to operate single cars or short trains along exclusive rights-of-way at ground level, on aerial structures, in subways, or occasionally, in streets, and to board and discharge passengers at track or car floor level” (2). Light rail typically has a much lower capacity than heavy rail (e.g., subway) systems. An emerging subset of light rail is the modern streetcar, which operates as a fixed-guideway system using modern rail vehicles similar to light rail cars, but usually within a shared right-of-way with automobile traffic.

Like modern light rail and streetcar systems, heritage trolleys are an important part of the urban fabric in cities across the United States. Heritage trolleys operate in cities large and small, and range from small, volunteer-driven operations to large urban transit applications. Some cities in which heritage trolleys operate have also implemented modern light rail and streetcar service, and others are in the planning stages.

Key Similarities and Differences Between Heritage and Modern Systems

Although heritage and modern systems share many similar characteristics, their missions and goals often differ. Modern systems are essentially a more evolved version of historic trolley lines, and employ advanced designs to move people between points quickly. Key design features of modern light rail systems include the use of exclusive right-of-way where possible, larger cars operating in trains, greater spacing between stations, and level boarding platforms to speed passenger entry and exit.

Modern streetcar systems are more akin functionally to the early streetcar lines, and serve more of a local circulation role than a regional mobility function. Modern streetcars are defined by smaller cars than light rail vehicles, operation in mixed traffic lanes, simple station stops, and relatively close spacing of stops. Heritage systems in operation today provide transportation

connections much like modern streetcars, but also have a primary role as an attraction in and of themselves.

The heritage systems (using vintage or replica vehicles) attract families, tourists, rail enthusiasts, and others who are looking for a more unique experience than that provided by a modern light rail system that is designed primarily to transport passengers from origin to destination as quickly as possible. Heritage systems may include conductors or docents who are well-versed in the history of the area served, museums depicting the history or rail transportation in the region, and other features that establish a more complete experience than the utilitarian nature of modern systems.

Rationale for Desired Integration of Heritage and Modern Systems

Heritage and modern systems clearly have distinct purposes, but as cities grow, more of them are realizing a desire for both types of systems. Smaller cities with a heritage trolley operation are growing to the point where modern light rail transit is also viable, and larger cities with modern systems recognize the tourism benefits of a heritage trolley system. Despite the recognized differences, it is desirable in many cases to consider how these two distinct types of passenger rail operations can work together to meet the unique goals of each system while making efficient use of available rail infrastructure. Joint use of rail track, stations, and other infrastructure potentially could enable a significant cost savings over having completely independent heritage and modern systems.

However, the differences in heritage and modern operations go well beyond whether the vehicle looks “old” or “new.” There are numerous challenges that must be overcome to ensure the compatibility of heritage and modern equipment, including safety assurances, vehicle design considerations, station and track design challenges, operational issues, systems and communications concerns, maintenance facility considerations, and institutional and administrative issues. These challenges are exacerbated as modern light rail systems continue to grow, as a higher level of service often means reduced opportunities for joint track usage by heritage vehicles.

Recognizing the unique nature of heritage trolley equipment as compared to modern light rail vehicles, the APTA’s Streetcar and Heritage Trolley Subcommittee developed a *Standard for Vintage/Heritage Trolley Equipment*. This standard describes appropriate characteristics of operating heritage trolley equipment in an urban transit environment. Safety assurance for any potential service integration concepts is of utmost importance, and this standard sets the stage for a broader discussion concerning related issues related to the integration of heritage and modern vehicles.

OVERVIEW OF CITIES WITH INTEGRATED OPERATIONS

Cities with Heritage and Modern Systems Currently in Operation

Several cities across the United States have heritage and modern rail transit systems that share common rail infrastructure. Heritage trolleys and modern light rail vehicles (LRVs) share tracks in regular service in San Francisco, California; Charlotte, North Carolina; and Portland, Oregon. To a lesser extent, vintage trolleys operate during special events on light rail tracks in San Jose,

California. Tucson, Arizona is currently studying ways to integrate a heritage trolley system with a proposed modern streetcar alignment; San Francisco, California is working to ensure that heritage and modern vehicles can share trackage along the planned E Embarcadero Line; and Memphis, Tennessee has incorporated design considerations into its heritage trolley alignment to accommodate future light rail service. Undoubtedly, as more cities embrace light rail, modern streetcars, and heritage trolleys, the effective integration of these services will become increasingly important. To highlight these issues, this paper focuses on six cities operating or preparing to operate light rail transit (LRT), modern streetcars, and heritage trolleys on a shared infrastructure.

San Francisco, California

The heritage streetcars on San Francisco's F Line operate to and from the Geneva Yard maintenance facility using J Line track that is served by modern LRVs. The heritage streetcars are officially in revenue service over the J Line track segments, although these early morning and late night trips typically have light ridership. The official F Line route map does not include the portion of the route that traverses J Line track, although the runs are included in the published schedule.

Charlotte, North Carolina

The Charlotte Trolley, a heritage system, operates on a 2-mi alignment that is shared with modern light rail operations. The exclusive track traverses a rapidly developing former "streetcar suburb," connecting with the central business district. Trolley operations resumed in April 2008 after being suspended for 2 years to enable light rail construction. Light rail service began in the corridor in November 2007, and following a trial period to gain experience with light rail operations, joint use of the line was instituted. Trolleys operate only on a portion of the light rail alignment, using shared stations as well as three additional stations that are served only by trolley vehicles.

Before light rail construction, three vintage trolley vehicles formerly operated on weekends only, stopping at the fringe of the "uptown" central business district because a necessary track connection had not been constructed through the convention center. The connection through the convention center was completed in 2004, and expanded trolley service to include daily operations was set to begin. However, it was decided that the three vintage vehicles could not handle the rigors of daily service. The recommendation of the transit system was to provide trolley service only on weekends and at lunchtime during the week, but the community did not respond well to the proposed reduced level of service. Therefore, three replica trolleys (manufactured by Gomaco Trolley Company) were purchased to provide daily service. These vehicles were placed into service in 2004, and operated until the suspension of trolley service in 2005 (for light rail construction). The three replicas are now operating again on weekends, sharing tracks with LRVs.

These vehicles underwent several modifications to enable them to be compatible with light rail operations, including the addition of a pantograph (the trolleys were initially placed in service using a trolley pole). A vintage car was also extensively refurbished with the intention of operating it along the light rail alignment shared with modern light rail equipment, but despite

extensive upgrades, it is not allowed to operate in regular service due to safety concerns regarding crashworthiness.

The Charlotte Area Transit System (CATS) owns, operates, and maintains the replica trolley vehicles. Charlotte Trolley, Inc. (CTI) is a nonprofit organization that promotes the history and role of vintage trolleys in shaping Charlotte's neighborhoods. CTI volunteers serve as docents on trolley runs, but do not operate the vehicles.

Portland, Oregon

In Portland, replica trolleys operate along a portion of the MAX light rail line in the downtown area. Trolleys serve the MAX stations between Lloyd Center and SW 11th Avenue (the trolley has its own station at Lloyd Center). There is no fare for the service, although donations are accepted. This service is completely independent of Portland's modern streetcar system. Replica trolleys formerly operated along the modern streetcar tracks, but no longer do so due to operational and accessibility constraints.

Replica trolleys operate on Sundays only from March through December, between noon and 6:30 p.m. The trolleys currently run every 45 min. The trolleys formerly operated 7 days per week, but service was scaled back as additional light rail lines opened and added traffic to the corridor.

The Portland system utilizes four replica trolleys manufactured by the Gomaco Trolley Company in 1991. These vehicles are replicas of the historic Council Crest streetcars that ran in Portland between 1904 and 1950. These vehicles were designed for operation in the light rail environment, featuring a robust steel car body structure and rapid acceleration and braking. The trolleys are also equipped with the signal and communications systems used by LRVs on the line. The vehicles will accommodate wheelchairs, though the only platforms that have provisions for wheelchair boarding onto these vehicles are the Lloyd Center trolley station and the Yamhill District (1st and Yamhill) MAX station.

San Jose, California

The California Trolley and Railroad Corporation (CTRC) was founded in 1982 to promote a historical rail component alongside the emerging light rail project in San Jose. The nonprofit organization constructed a replica trolley barn and over a mile of track on the grounds of the San Jose Historical Museum, and obtained a number of vintage trolley cars to be restored.

The trolley barn is an attraction in itself at the museum, and visitors are welcome to observe ongoing trolley restoration activities. On weekends, the vintage cars that have been restored shuttle visitors around the museum grounds. Several hundred volunteers have contributed time and materials to the restoration effort, and continue to restore additional trolleys and serve as docents at the museum.

On a limited basis, the restored vintage cars operate along the downtown light rail alignment in San Jose, sharing tracks with LRVs.

Four restored vintage trolleys are maintained by the Santa Clara Valley Transportation Authority (VTA), the regional transit provider. These four vehicles, built between 1903 and 1928, were restored using volunteer labor by the CTRC. These four vehicles are leased to VTA. Several additional vehicles are housed at the trolley barn, where additional restoration activities continue.

VTA operates the limited seasonal service on light rail tracks, using paid operators. The nonprofit CTCRC operates the year-round trolley service on the grounds of the San Jose Historical Museum, using volunteers.

Cities with Planned Integration of Heritage and Modern Systems

Tucson, Arizona

The City of Tucson Department of Transportation is planning to implement modern streetcar service in the Tucson Urban Corridor, which includes many of the city's major activity centers, including downtown Tucson, the University of Arizona, and the Arizona Health Sciences Center. A vintage trolley operation, the Old Pueblo Trolley (OPT), currently operates along a portion of this corridor between the 4th Avenue and the Main Gate business districts. In recognition of the unique characteristics and goals of these two rail transit operations that share a common alignment, the city is conducting a planning study to define the future roles of these services in relation to each other.

OPT began trolley operations in April 1993, with service provided on Friday nights, Saturdays, and Sundays. Volunteer labor was used to restore two vintage trolleys and to construct the rail infrastructure. Ongoing administration and maintenance duties continue to be provided by volunteers. OPT has since expanded its scope to include bus restoration and the operation of the Southern Arizona Transportation Museum.

San Francisco, California

The planned E Embarcadero Line will use existing track currently used by the F Line (heritage streetcars) and the N Judah and T Third Street (modern light rail) lines. The stations include both high-level platforms (for modern LRVs) and low-level boarding areas (for heritage streetcars). Heritage streetcars have already successfully operated in demonstration service over the modern portions of the alignment, illustrating the technical compatibility of the two types of equipment.

Memphis, Tennessee

The Memphis trolley network consists of three lines in the downtown area using heritage vehicles:

- The 2.5-mi Main Street Trolley serves the Main Street transit—pedestrian mall. A portion of the route operated along the exclusive transit—pedestrian mall, while the remainder operates in mixed traffic. Service on this two-way line was initiated in 1993.
- The 2.2-mi Riverfront Loop connects the two ends of the Main Street Trolley line. The majority of this alignment uses an abandoned track purchased from the Canadian National–Illinois Central Railroad in a railroad reservation adjacent to an existing Amtrak line. The Riverfront Loop, which operates in the southbound direction only, began service in 1997.
- A 2-mi line operating along Madison Avenue opened in 2004. This alignment connects downtown with the Medical Center area, linking the two largest employment centers in the city. The street-running alignment operates in both directions, and is envisioned as the initial segment of a regional light rail line.

The Memphis trolley fleet consists of a fleet of 18 rehabilitated vehicles that were previously in service elsewhere, and two replica trolleys manufactured by Gomaco Trolley Company. A variety of trolley models currently operate, and all are wheelchair accessible. Some of the vehicles required substantial rebuilds to provide sufficient space for wheelchairs. Stations have high-block platforms accessed by ramps, along with bridge plates, to enable wheelchair boarding.

The Madison Avenue trolley line is planned to serve as the first leg of the future light rail system, and some considerations for light rail were made in the design of the trolley line. The Madison Avenue trolley line has stations that are long enough to accommodate a single LRV, although multiple-car trains would require longer platforms. The platform height was set for low-floor LRVs, and the station spacing is greater than on the Main Street line (and thus more appropriate for light rail use). In addition, larger traction power substations were installed, and a traffic signal prioritization system is in place (although not currently operational).

COMPATIBILITY CONSIDERATIONS FOR OPERATIONAL INTEGRATION

A wide variety of challenges are associated with the successful integration of heritage trolleys into a modern light rail–streetcar environment. Compatibility issues must be overcome in many areas, including the following:

- Design considerations (including vehicle design, station design, track design, and maintenance facility design);
 - Operational considerations (including how to fit heritage vehicles in the operational scheme for modern vehicles);
 - Systems considerations (including the overhead contact system and communications elements);
 - Administrative considerations (including the organizational structure and staffing requirements);
 - Regulatory considerations (including applicable federal, state, and local guidance);
- and
- Safety considerations (including crashworthiness, speed differentials, and consideration of stopping distances).

Design Considerations

Vehicles

Where an agreement for joint use of track is being sought, the design of the heritage vehicles used on the modern line must be compatible with the vehicle design requirements of the modern system. This requirement may affect the design of the carbody (see the section following on Crashworthiness), propulsion, braking, communications, and other ancillary systems on the cars.

Accessibility Vintage trolleys typically are not equipped with wheelchair lifts. To function on a modern light rail–streetcar alignment, provisions must be made to accommodate access for disabled patrons in accordance with the Americans with Disabilities Act (ADA). The

requirements to meet this provision are stringent, but are likely to vary depending on the operating scheme. For example, if vintage trolleys were interspersed among modern vehicles on a regular basis, a case could be made that accessibility requirements are met through the wheelchair access provided by the modern cars (thus requiring no accessibility retrofits to the vintage fleet). The vintage trolley operation in Portland reached a similar agreement with the local accessibility committee to utilize the modern cars to meet access requirements.

However, if vintage trolleys operated on the line independently (on a time-separated basis), there would be no intermingled modern cars to fulfill this requirement. In this case, either the vintage vehicles would have to be retrofitted to enable access, or complementary paratransit service would have to be provided. The vintage vehicles operated by the McKinney Avenue Trolley in Dallas, Texas are not wheelchair-accessible, but the system uses paratransit service provided by Dallas Area Rapid Transit to meet this ADA requirement.

Newly-built replica trolleys like those currently operating in Charlotte typically are lift-equipped for wheelchair access.

Single-Ended Versus Double-Ended Cars The need for operational flexibility for heritage vehicles functioning on a modern rail alignment may require double-ended cars, depending on how end-of-line directional changes are accommodated. Many vintage cars are single-ended cars, and would require a turnaround loop or turning wye to change direction (double-ended cars could reverse direction at an end-of-line stub track). Therefore, if turnaround loops or wyes are not available in the modern alignment, a double-ended car will be required. Typically, replica vehicles are constructed as double-ended cars.

Clearance Envelope Modern streetcar and light rail projects are designed to accommodate vehicles within a specific clearance envelope. Particularly at station stops, where level boarding with a minimal gap between the vehicle and platform typically is included in modern system designs, vehicles that vary in dimensions (particularly width) may not be compatible. Vintage vehicles that are wider than the modern vehicles would hit the platform, unless the bottom step is higher than the platform. Likewise, vintage vehicles that are narrower than the modern vehicle may have a significant gap between the vehicle floor and the platform, which would require a bridge plate at every doorway for safe boarding. Replica vehicles must consider clearance requirements in vehicle design as well.

Stations

Station stop design characteristics must be considered with regard to the interface between the platform and the heritage vehicles.

Platform Height and Gap As mentioned above, the level boarding provisions of modern light rail–streetcar design require a precise interface between the vehicle and the platform. Vintage vehicles that vary in width or floor height from this specification may have difficulty using the raised platforms. Vehicles that are too narrow would require bridge plates, whereas vehicles that are too wide may hit the platform. Furthermore, the floor height of the vehicles may not be compatible with the modern rail vehicle platform height, resulting in a tripping hazard for passengers. This situation is exacerbated for some heritage systems due to the varying dimensions of the vintage cars themselves. Without consistency in the design of the vintage cars,

it is even more difficult to design a platform that can accommodate modern streetcars or light rail vehicles as well as various vintage vehicles.

A similar situation arose in Portland, where the replica trolleys were too wide to operate along the light rail alignment. To remedy this problem, the step height was increased in the vintage vehicles, enabling the steps to pass over the platform height that was set to enable level boarding for the light rail trains.

Newly constructed replica vehicles likely could be designed to adhere to the level boarding provisions of the modern system.

Charlotte addressed this issue by incorporating separate light rail and trolley platforms at each station that is shared by the two services. The light rail portion of the platform was set to enable level boarding, whereas the adjacent area for trolley boarding is set at the height of the tracks to enable a step up onto the trolley vehicle (Figure 1). The replica trolleys fit within the envelope of the light rail platform, but the platform height would have required a step down and then a step up to board the trolleys, and CATS felt that this would be a significant safety concern and tripping hazard.



FIGURE 1 Light rail and replica trolleys have separate but adjacent platforms in Charlotte. The trolley boarding area is at the front of the above picture, and the raised light rail platform is in the rear.

Although the designation of separate platforms is better for passenger safety, CATS reports that the major disadvantage to this treatment is that there has been some passenger confusion regarding where to board the trolleys. Furthermore, a similar design would be difficult in a street-running environment due to the resulting excessive length of the platforms.

The platform height and gap issue is a concern primarily in newer light rail systems that use raised platforms for level boarding. In older systems where a low-level platform is used and passengers step up onto the vehicle, there is a much lower likelihood of experiencing significant design challenges. The heritage vehicles using the “modern” J Line alignment in San Francisco do not experience this problem due to the low-level stops (at sidewalk level) along the line.

Curbside Versus Median Platforms Modern streetcar–LRVs have doors on both sides, enabling them to serve both curbside and median platforms (in a street-running situation), or side and center platforms (in an exclusive alignment). Regardless of whether the system is street-running or in an exclusive right-of-way, both platform orientations are typically found in a modern rail transit project. If a joint use of these platforms is desired, the heritage vehicle (vintage or replica) must also have doors on both sides of the vehicles to access both types of platforms.

Track

Simply having track in place is not enough to ensure that heritage vehicles will be able to operate on a modern light rail–streetcar alignment. Turnaround provisions must be available, and the heritage vehicles must be able to handle the design characteristics of the modern track.

Turnaround Loops–Wyes As discussed earlier, turnaround loops or wye tracks would be needed to enable single-ended heritage vehicles to operate along a portion of a modern streetcar or light rail alignment. A loop or wye would be required for single-ended cars, but double-ended heritage cars would not experience this issue.

Curvature–Grade Heritage cars must be tested to ensure that they can successfully navigate significant curves and grades along a modern rail transit alignment, particularly in a street-running environment. Replica vehicles generally are constructed to similar performance specifications as modern streetcars, and vintage vehicles in many cases can handle higher grades and tighter curvature than modern vehicles. However, in a street-running alignment, the power and braking capabilities of vintage vehicles must be sufficient to safely intermingle with vehicular traffic, with particular attention paid to segments with steep grades or sharp curves.

Portland formerly operated its replica streetcars on its modern streetcar alignment, but discontinued this operation due to the steep grades (up to 9%) on extensions of the line. There was concern over the ability of the replica cars to stop on these high grades in a street-running environment. Portland now operates these cars on a portion of the light rail alignment, and planned to transition the replica streetcar service to the new Transit Mall when it opened in September 2009.

Furthermore, modern streetcars can navigate curves with a radius as small as 60 ft. Vintage and some replica streetcars traditionally have been able to traverse smaller radius curves, but the ability of heritage vehicles to negotiate curves associated with the modern alignment

needs to be confirmed. Issues related to the grade and curvatures of the alignment are less pronounced in an exclusive alignment, where rail vehicles do not mix with vehicular traffic.

Wheel–Rail Interface The wheel–rail interface between heritage vehicles and the modern track must be carefully considered. Modern projects usually are constructed with a combination of 115 RE T-rail or girder rail. The wheels of the heritage vehicles must have a secure fit with the rail types that have been installed locally on a modern alignment, which may require extensive modifications to the existing wheel profiles (and possibly trucks) of the heritage vehicles. Wheel–rail interface issues are specific to each project, based on the profiles of the track as well as the wheels of the vehicles that are desired for use.

Maintenance Facility

It is appropriate to consider shared usage of a maintenance facility for both modern and vintage vehicles.

Unfortunately, modern rail vehicles do not mix well in facilities designed strictly for vintage cars. Simple things such as the location of the propulsion and braking system components on the car present major conflicts in space allocation within the facility. For example, these components on vintage cars are located under the floor of the car, reachable from the facility ground floor or from a maintenance pit in the floor. Modern streetcars locate most components on the roof of the car; thus allowing a lower car floor configuration, which aides in passenger accessibility.

A modern streetcar shop will have extensive elevated platforms and mezzanines for roof top component repair activities. A crane is necessary since the modern streetcar has roof top components weighing between 500 and 1,200 lbs; physically too large to be manhandled by maintenance personnel. Modern streetcars also require dedicated space for electronic repair and significantly enhanced storage space for spare parts.

Although modern vehicles can not be accommodated in most vintage car facilities, vintage and replica cars can be accommodated in modern streetcar facilities. Portland's replica cars are housed in a separate facility, but the facility has limited provisions for maintenance and serves primarily as a storage facility. Most maintenance activities are conducted at the light rail maintenance facility, which is connected by track to the replica trolley facility. Charlotte's replica trolleys are stored and maintained at its light rail maintenance facility.

Operational Considerations

Even if all the design-related issues can be solved, the operating scheme of the heritage vehicles on the modern streetcar–light rail alignment must be fully considered. If intermingling of the heritage and modern vehicles is desired, there must be a sufficient operating window to enable this type of operation to occur. Particular with regard to vintage vehicles, the distinct differences in the operating capabilities of the heritage vehicles as compared to the modern vehicles (e.g., slower speed, less responsive acceleration and braking) will result in a running time of the modern vehicles that is shorter than that of the vintage vehicles. Therefore, it is entirely possible that a trailing modern vehicle could catch up to the historic vehicle in front of it. Such a situation can not be allowed to occur, because it would increase the travel time for passengers and

diminish the attractiveness of the system as a transit option. The intermingling of vehicles would only be possible if the headways are high enough to avoid system slowdowns.

Charlotte and Portland have both addressed this situation by allowing their historic vehicles to intermingle with modern vehicles only during off-peak times when headways are greater, and mixing the vehicles only on a relatively short section of track. In Portland, replica cars do intermingle with modern LRVs, but only on Sunday afternoons.

In Charlotte, replica vehicles operate along with light rail vehicles on weekends only, when the light rail headways are greater. A very specific operational scheme is necessary for this operation to be possible. Replica vehicles begin their trip on a siding, and immediately follow a passing LRV and enter the mainline. The trolleys follow the LRV for a distance of 2 mi to the uptown end of line. The higher-speed LRV traverses the line more quickly than the trolley, but there is sufficient time to enable the trolley to reach the end of line before the subsequent LRV arrives. Furthermore, whereas the LRV makes all stops, the trolleys will only stop at intermediate stations upon request. The same pattern is followed for the return trip. However, there is insufficient time to accommodate both types of vehicles during peak periods when more frequent light rail service is provided.

There may be more flexibility with a joint operations plan for modern streetcars and heritage vehicles, because the street-running modern streetcar will operate at a slower average speed than an exclusive light rail line. However, a detailed operational plan will need to be developed to determine whether intermingled operation is possible from this perspective.

Systems Considerations

A variety of systems elements must be considered in evaluating compatibility between heritage vehicles (particularly vintage cars) and modern vehicles, with many related to the overhead contact system (OCS).

Overhead Contact System

The overhead contact system (OCS) is the component of the overall traction electrification system that makes direct contact with the vehicles to supply power necessary for safe, efficient, and continuous operations. Although the first modern light rail systems in North America (Edmonton, Calgary, and San Diego) were built to operate at 600 volts DC, newer modern streetcar and light rail systems (as well as replica vehicles) are typically designed to operate at 750 volts DC. However, vintage vehicles typically operate at 600 volts DC. Systems designers must consider potential users of new alignments to determine an appropriate electrification system. Recognizing that most modern vehicle manufacturers design their vehicles to operate at 750 volts DC, it may be more appropriate to focus on modifying vintage vehicles to enable them to operate at 750 volts DC in cases where vintage vehicles provide only a small amount of the total service on the line. It is possible to accommodate both voltage levels in a single OCS; San Francisco has developed such a system. However, this type of systems design may be cost-prohibitive for smaller operations.

A related issue is the current collection device. Many vintage vehicles use a trolley pole to receive power from the OCS, whereas modern streetcars utilize a more flexible pantograph. It is possible to design an OCS system to accommodate both types of devices, but it would be more expensive to design, construct, and maintain. There is also some risk that such a system would

cause premature failure of the pantograph carbons, unless a staggered contact wire system is designed with provisions for trolley pole-equipped cars to have swiveling connections between the contact shoe and the trolley, as opposed to more rigid trolley wire systems.

Charlotte's replica trolleys were retrofitted for the installation of a pantograph (Figure 2). Another important consideration for the vintage vehicles is that the structure of the vehicle must be able to support the weight of the pantograph.

Communications

Regardless of the specific operating scheme, if historic and modern vehicles share track, all vehicles must be connected to the same communications system. Heritage vehicles would need to be retrofitted to include the same communications equipment that is included for the modern equipment, including communications with central dispatchers as well as signal preemption and any other types of communications equipment.

Administrative Considerations

Staffing Requirements

As heritage and modern systems contemplate shared use of rail infrastructure, the administrative and organizational functions of the system must be considered. Modern systems are typically



FIGURE 2 Pantographs were installed on Charlotte's replica trolleys to enable them to share track with modern LRVs.

operated by a large transit agency, whereas heritage systems are operated using a small (often volunteer) staff. While this organizational structure may well be appropriate for a small heritage system, the intermingling of vehicles produces a number of challenges that may not be able to be addressed appropriately by a small volunteer staff.

Operations such as the McKinney Avenue Trolley in Dallas have had to supplement their volunteer staff with paid staff. In Charlotte and Portland, where historic trolleys share track with modern vehicles, the transit authority has assumed many of the operational duties, with volunteers now serving as docents. San Francisco, with a large heritage fleet, has a separate maintenance group that handles the specialized maintenance needs of the fleet, and all streetcars are operated by the transit authority. [Table 1](#) below highlights the organizational characteristics of three cities in which heritage operations share track with modern LRT.

Collective Bargaining

The FTA has strong fair labor regulations, and collective bargaining concerns will be critical particularly in areas with a strong union presence. For example, there may be strong union resistance to volunteers operating heritage vehicles on a modern streetcar or light rail line.

In Portland, transit union members are assigned as vehicle operators, but volunteers from the nonprofit Vintage Trolley, Inc., organization serve as docents. The nonprofit organization also agreed to recruit retirees from the transit union to serve as docents. Also, the union required that all maintenance work on the historic vehicles be done by union members, noting the stringent maintenance requirements of the trolleys. Vintage Trolley, Inc., proposed to allow volunteers to do minor repair and painting work, leaving mechanical issues to the union. The union rejected this proposal, but the nonprofit organization reports that it will keep trying to secure an increased role for volunteers.

TABLE 1 Organizational Characteristics of Systems Sharing Trackage

	Charlotte	Portland	San Jose
Organizational roles	Public transit provider owns, operates, and maintains replica vehicles. Nonprofit organization promotes heritage trolleys and conducts educational activities.	Public transit provider owns, operates, and maintains vehicles. Nonprofit organization provides policy direction and coordinates funding support.	Public transit provider maintains some vehicles (leased from nonprofit organization), with operates them on a limited basis. Nonprofit organization operates other vehicles on museum track, conducts restoration activities, and promotes heritage trolleys.
Use of volunteers	Volunteers from nonprofit organization serve as docents on board the vehicles, but do not operate them.	Volunteers from nonprofit organization serve as docents on board the vehicles, but do not operate them.	Volunteers operate service on museum track, restore vehicles, and conduct educational activities.

Regulatory Considerations

A variety of regulatory considerations may be applicable to the potential operation of heritage vehicles on a modern streetcar–light rail alignment. The ultimate applicability of these regulations is dependent to some extent on the sources of funding for the modern rail line. Any federal participation in funding will trigger a host of regulations, the most critical of which is the development of and adherence to a system safety program plan. A system safety program plan must be in place even if the alignment is built entirely with state or local funds but the system will receive federal formula funds for operations. Furthermore, even if a heritage system continues to operate their historic cars, they will be subject to these regulations if they use the tracks of a federally funded system.

System Safety Program Plan and Security Plan

In 1995, the FTA mandated the creation of a state-managed oversight program for rail transit safety and security. The designated state oversight agency is responsible for the development of specific system safety program standards as well as requiring, reviewing, approving, and monitoring a system safety program plan and security plan at each rail transit agency. For shared use of track, the heritage system would be responsible for submitting and gaining approval for their safety plans, and would be charged with ensuring compliance to the plan at all times.

Ultimately, the state oversight agency and FTA must certify the system as safe before any passenger operations are initiated, and if the system is not compliant with these standards, service will not be allowed to begin. Charlotte invested approximately \$200,000 in upgrading a vintage car by adding a modernized propulsion control system, automatic train protection equipment, and rewiring to change the operating voltage from 600 volts DC to 750 volts DC. However, during a safety and security readiness review, FTA recommended that this car not be used in passenger service intermingled with LRVs. Despite the electrical and mechanical improvements, FTA felt that the car did not have the strength to withstand a collision with a larger, heavier LRV. Now, this car is used only rarely for special events.

Safety Considerations

Safety is the most critical consideration in the intermingling of historic and modern streetcar vehicles. Without an assurance of safe operations, the mixing of the two types of vehicles will be impossible, and even time-separated usage of vintage vehicles on a modern alignment will be difficult to achieve.

Crashworthiness

The frame of the heritage vehicles must be able to withstand collisions with modern streetcars without compromising the structural integrity of the trolley. Most vintage cars are deficient in terms of buff strength, but detailed engineering analyses would be needed to determine existing car body conditions and buffing load strength of vintage cars. Replica vehicles can be designed for a higher level of structural integrity, although additional safety enhancements may be needed if the cars will intermingle with modern vehicles. In Charlotte, the replica vehicles were also outfitted with anticlimbers as an added safety feature. Portland's replica trolleys consist of an authentic-

looking (mostly wood) outer skin and interior walls that surround a robust steel frame designed to withstand collisions with modern LRVs.

Acceleration–Braking

Acceleration and braking performance, along with speed capabilities, are important considerations in a mixed traffic environment, as would be experienced on a shared modern streetcar alignment. The replica vehicles operating in Charlotte and Portland were designed specifically with acceleration and braking provisions that are more akin to modern transit operations than the older vintage vehicles.

SUMMARY

Although there are significant design challenges associated with the integration of modern and historic rail vehicles, these hurdles can be overcome. There is no single solution for addressing these issues, because every situation is unique. Therefore, it is difficult to identify specific “best practices” for detailed design issues. This paper identifies a number of specific design considerations to be addressed, but perhaps the most important “best practice” is the recognition that the development of viable design solutions requires close coordination between the heritage and modern systems, as well as vehicle manufacturers, designers, and appropriate oversight agencies.

The successful integration of heritage and modern systems in Charlotte and Portland (and to a more limited extent in San Jose) provides a framework for utilizing existing rail infrastructure to meet the diverse goals of each of these types of systems.

ACKNOWLEDGMENT

The author gratefully acknowledges the contributions of Michael Hall, Sabro Takeda, and Werner Uttinger of LTK Engineering Services, who provided significant technical insight with regard to issues related to the maintenance facility and vehicle design considerations.

REFERENCES

1. APTA Heritage Trolley and Streetcar Subcommittee. www.heritagetrolley.org/defHeritage.htm. Accessed November 11, 2008.
2. *Urban Public Transportation Glossary*. Transportation Research Board, National Academy of Sciences, Washington, D.C., 1989.
3. APTA Heritage Trolley and Streetcar Subcommittee. www.heritagetrolley.org/defLightRail.htm. Accessed November 11, 2008.
4. APTA Heritage Trolley and Streetcar Subcommittee. *APTA Standard for Vintage/Heritage Trolley Vehicle Equipment (APTA SS-HT-001-05)*, June 20, 2005.
5. San Francisco MTA Transit Effectiveness Project Data. www.sfmta.com/cms/rtep/documents/BinderF.pdf. Accessed February 2, 2009.
6. Muni F Line Schedule. <http://transit.511.org>. Accessed February 2, 2009.

Operations, Supervision, and Service Quality

OPERATIONS, SUPERVISION, AND SERVICE QUALITY

Toward an Operating Doctrine for Shared-Use Railways**ALFRED E. FAZIO***River LINE***J. NORTH***New Jersey Transit Light Rail Operations***ROB TROUP***SYSTRA Engineering*

Operating Doctrine (OD) has been defined as technology and its use. This term is borrowed from Naval and Military Service, where it is formally applied to the means and methods of accomplishing an objective and their relationship to existing and evolving technologies. While not formally used in the railway industry, its application has been implied since the industry's early days and continues today with manifestations as diverse as run-through unit trains or the Northeast Corridor's High-Speed Rail. Currently a new challenge faces the railway industry; this is the development of technology which is suitable to permit some level of operation of passenger rolling stock which does not fully comply with all of the FRA standards for rail vehicles (specifically for buff strength) operating on FRA-regulated railroads. Many of these vehicles which do not fully achieve the FRA-mandated minimum buff strength come reasonably close and some also offer a high degree of crash energy management. Such vehicles are termed as near compliant, and to a great extent, reflect the old Interurbans. A railway which combines compliant with near-compliant vehicles requires an operating waiver from the FRA; such an operation is commonly (but not with complete accuracy) referred to as a shared-use railway. The challenges associated with this potential opportunity for rail industry growth include the development of appropriate mission statements (e.g., capacity requirements), business cases (which will clearly be railroad and location specific), and the formulation of suitable OD (which, due to uniformity in FRA regulations and the great commonality in railroad operating practices, is not likely to be as location specific as the business case.) This paper advocates the adoption of a more formal statement and approach to the development of railway OD in evaluating opportunities and requirements associated with the anticipated growth of shared-use railways.

SHARED-USE RAILWAYS

Shared-use railways—railroads that operate passenger and freight trains on common trackage—are not a new concept. Private railroads once ran it all: drag freight, mail trains, and multiple classes of passenger trains. Each railroad had its own OD based on its geography, business requirements, and resources.

There are two factors that have caused the current climate to be different. These are

1. The corporate divisions that presently exist between companies which operate passenger service and those that operate freight. This division creates the potential for conflicting business interests, at times causing the passenger and freight carriers to view shared operations as a zero sum game. It also has drastically altered training and development opportunities and career paths for railway operating officers, with a resultant impact on their capability for horizontal thinking as they achieve positions of greater responsibility and authority and
2. The introduction of so-called near-compliant passenger rolling stock. This near-compliant passenger equipment may be electric or diesel, and while larger, faster, heavier, and stronger than light rail vehicles (LRVs), they are fully not compliant with the FRA's buff strength standards. Because of their high performance and generous construction, they are capable of providing interurban style service on lines which also operate freight (or commuter rail) and which are therefore FRA regulated. For purposes of this paper, shared-use railways refers to railroads that operate compliant and near-compliant trains (either passenger or freight) on common trackage, under some special arrangement (e.g., temporal separation, extended temporal separation, or particular rules) with the FRA.

Arguably, operational and safety issues involving joint operations were more easily addressed when they rolled up to a single general manager. The photo of the Shore Fast Line Interurban, a Pennsylvania Railroad (PRR)-owned Interurban which once operated between Atlantic City and Ocean City, New Jersey, provides an insight ([Figure 1](#)). These trains entered Atlantic City over the PRR–Pennsylvania-Reading Seashore Lines mainline, the photo shows a Shore Fast Line Interurban operating under a PRR position light signal on the mainline outside Atlantic City.

Today, environmental, energy, land use and energy considerations conspire with the high cost of building completely new light rail ways to rekindle interest in Interurban style, or so-called shared-use railways. Current examples include San Diego (California) Trolley, New Jersey Transit's River LINE, and Austin's (Texas) Capital Metro, each of which operates (or proposes to operate) under a specific FRA waiver. The safety and viability of such operations require a clear understanding of OD. Likewise the efficiency and cost effectiveness of future, similar shared-use operations warrants the clear articulation and promulgation of some of the baseline requirements of the OD of shared-use railways.

THE MEANING OF OPERATING DOCTRINE

A brief discussion of what is meant by OD is worthwhile.

One definition of OD is technology and its use, another refers to the combined use of technology and practices to achieve an operational goal (*1*). The term essentially refers to technology (i.e., a system, subsystem, or equipment) and the method by which that technology is employed to accomplish a mission. OD also considers how technology evolves in support of a mission, i.e., technology is not static and should continue to be developed and refined as the mission evolves. A classic book on the evolution of aircraft carrier design and associated flight operations describes this concept well (*2*). While the specific subject of that book relates to naval



FIGURE 1 A Shore Fast Line Interurban passes under a PRR position light signal on its way into Atlantic City. Once in Atlantic City, this train will leave the main track and operate over streetcar tracks to the boardwalk. An example of simple technology and sound OD in the days before we needed to rely on Maglevs, monorails, and other advanced concepts to get to the boardwalk.

science, the concept of the concurrent and iterative development of technology and practice is certainly applicable to railway science. Another example of the development of doctrine is the evolution of Anti-Submarine Warfare (ASW) during World War II. The Battle of the North Atlantic began with heated debates over whether independent hunter-killer (i.e., attack) groups, or convoy escort constituted the optimal use of available ASW assets; the technology was the same, the results were vastly different. Paradoxically, during the early Cold War, advances in technology (helicopters, anti-submarine rocket, and advanced sonar, pitted against nuclear submarines with high submerged speed) caused a revisit of the hunter-killer concept (i.e., a further change to OD).

Although the term OD is not commonly used within the railroad industry, the associated concepts are widely practiced (albeit not formally defined). Consider the former New Haven Railroad. Its OD was largely shaped by its high-speed mainlines (due to the passenger traffic), the short haul for freight traffic, the intense competition it faced from trucks, and the type of commodities hauled. As a result it employed a doctrine which emphasized scheduled fast freights [e.g., the Speed Witch from Boston, Massachusetts to Bay Ridge, New York (3)].

Amtrak's experience in evolving high-speed operations on the Northeast Corridor (NEC) provides a more current example of OD applied to all facets of railway operations (e.g., train operations, maintenance of way, employee safety). From the standardized Metroliner (they were occasionally referred to as the Red, White, and Blue hourly subway to Washington, D.C.) and ACELA train sets, to the development of the new high-speed track safety standards in 1997 (as a replacement to many years of operation with a waiver allowing 125 mph on the NEC as so-called class 6X). This waiver for class 6X operations provides an example of refining the use of technology. During the late 1970s the principal author of this paper, while employed by a large eastern freight railroad, led a joint railroad-FRA project to apply track geometry car data to maintenance of way planning and resource allocation. While only marginal success was achieved in defining critical TQIs (Track Quality Indices) and relating these to track production planning, the FRA's Office of High-Speed Rail utilized the results of this project to determine that monthly operation of a high-speed track geometry car would be an essential aspect of a class 6X waiver. Concurrent with this, OD developed for AMTRAK's Employee Protection Against Trains program, which has since evolved into the FRA mandated Roadway Worker Protection (RWP) program, as well as for high-performance surfacing equipment which was ultimately approved, under certain circumstances, for traveling on signal indication. The NEC OD developed in a stepwise manner, with iterative changes in technology, then practice, and then technology again.

TOWARD A DOCTRINE FOR SHARED-USE RAILWAYS

A thoughtful and stepwise approach similar to that followed by AMTRAK and the FRA during the early 1990s for the evolution of high-speed rail is essential for development of operational doctrine of near-compliant passenger equipment in joint service with compliant passenger or freight equipment. The technology and operating practices of the next generation of joint use railways are not really those of light rail; neither are they the OD of commuter rail, hence the reuse of an old term is appropriate; these operations may be considered to be those of a modern Interurban.

The Interurbans were hybrids—larger and faster than suburban streetcars; the suburban car was, in turn, larger (and usually faster) than city streetcars and they often operated on common trackage with interchange freight (Figures 2 and 3). Some Interurbans directly competed with steam railroads, while others, such as the Bay Area's Interurban Electric Railroad (IER) were extensions and feeders to mainline railroads; in the case of the IER, to its owner, the Southern Pacific Railroad.

The Interurban concept is useful and appropriate today. Demand exists for installation of medium to light-density passenger service on light density freight lines—mainly on short lines and regionals. This demand is based on environmental, land use, and energy considerations as much as upon purely transportation considerations. A major opportunity for the modern Interurban, as seen by these writers, is for reasonable cost capital investments in existing light-density freight lines in order to enable the operation of a medium-to-low density (or medium-to-low capacity) passenger service. Another strong possibility is for the mixing of near compliant with fully compliant passenger trains on commuter-oriented passenger railways; in such case the near compliant (i.e., waiver) trains may provide feeder or fill-in local service to line haul trains. Table 1 indicates some existing or planned shared-use railways.



FIGURE 2 The Interurban car designated for use on Capital Metro–Austin. At 130 ft in length, and with operator crash protection, it is completely different in concept from the Media–Sharon Hill Line LRVs.



FIGURE 3 A River LINE Interurban destined for Trenton parallels Norfolk Southern rail freight.

TABLE 1 Sample List of Current and Near-Term Shared-Use Operations

Line	Passenger Car	Method of Separation	Freight Intensity	Signal System
River LINE (IR) Trenton to Camden	100 ft × 10 ft 55 tons	Train stops and derails	Four to five trains/day 1 MGT/year	Wayside signals w/transponders NORAC Rule 261
Sprinter (IR) Oceanside to Escondito	137 ft × 11 ft		Three trains/week	Wayside ABS
Capital Metro (IR) Austin	130 ft × 10 ft Near compliant	Derails	Varies 1 to 2 MGT/year	Wayside ABS, GCOR
Denton County (IR) Dallas, Texas	Not known	Not defined	Three trains/week local switching only	ABS, possible cab signals
Newark City Subway (a light rail operating with ETS)	90 ft × 9 ft LRT	Cab signals with positive stop for LRVs and derails for freight	Twice weekly local	Audio frequency cab signals with home signal only (no waysides)
San Diego (LRT)	48 ft long × 8 ft 6 in. wide × 13 ft 6 in. high	Train order	Nightly	Wayside ABS
Lackawanna County (IR) Scranton	Historic interurban	Manual locking of turnouts, train order operation	One daily local	Dark territory
NICTD (former C,S,S & SB) Commuter	Compliant EMUs	Wayside signals, no positive stop	Heavy mainline and local switching	Wayside only, enforce train separation, mode separation of modes is not required
Bergen–Passaic (IR) New Jersey	Possibly compliant, thus mode separation may not be required.	Signals, possibly derail	Heavy mainline and local switching	Power frequency cab signals

NOTE: LRT = light rail transit; IR = interurban railway; MGT = million gross tons; NORAC = Northeast Operating Rules Advisory Committee; ABS = automatic block signal; GCOR = General Code of Operating Rules.

A joint policy statement for shared-use operations was issued by the FRA and FTA in July 2000. This top level policy must be the basis for a logic development of an OD for shared use. The technology and its use (i.e., OD) must now be more fully developed jointly by all interested parties in a manner which conform to this policy. Some of the important aspects of this policy include the following (4):

- FRA regulations apply unless specifically waived;
- Separation of modes (i.e., compliant and other rolling stock) must be positive, reliable, and fail safe;
- The waiver may be granted (only) ...if the waiver is in the public interest and consistent with railroad safety (author's underscore);
 - In the event that petitioners seek approval of simultaneous joint use, the petitioners will face a steep burden of demonstrating that extraordinary safety measures will be taken; and
 - An active state safety oversight program, as required by the FTA, is required as a means of assuring the safety of waived regulations, as well as for systemwide safety assurance.

THE TECHNOLOGY OF THE NEW INTERURBAN

In shaping the picture of the New Interurban (or whatever term will ultimately apply) it is instructive to begin with a discussion of this submode's close relative, light rail. The defining technological element of light rail is the wide varieties of right-of-way (ROW) that may be employed, even over a single route. As a direct consequence of this requirement to comfortably operate over mixed ROWs, designs of the vehicle and of the train control systems are affected. Each of these technological systems is briefly reviewed.

Right-of-Way

A review of light rail–Interurban technology is worthwhile. An expert on light rail notes that the defining element of that mode is its ability to operate at maximum performance levels on a variety of right-of-ways (ROW) (5). Likewise an early, and highly definitive report on the resurgence of light rail in North America written in 1976, defines light rail by its ability to operate in mixed-use ROW (6). Note that the evolving Interurban technology maps onto the LRT category quite well, however, with some important differentiators. [Figure 4](#) provides a family tree of fixed-guideway modes of transportation. The primary but not sole differentiation of modes is the ROW. The operation in mixed ROWs causes the technology of two other systems to be applied differently; these other systems are the vehicle and the train control (railway signal) system.

The Vehicle

A LRV is generally larger and faster than a streetcar, and is more likely to operate in trains, i.e., multiple units. Vuchic (5) notes that a streetcar operating on exclusive ROW does not meet LRT performance parameters and should not be considered as LRT. Portland, Oregon, makes this

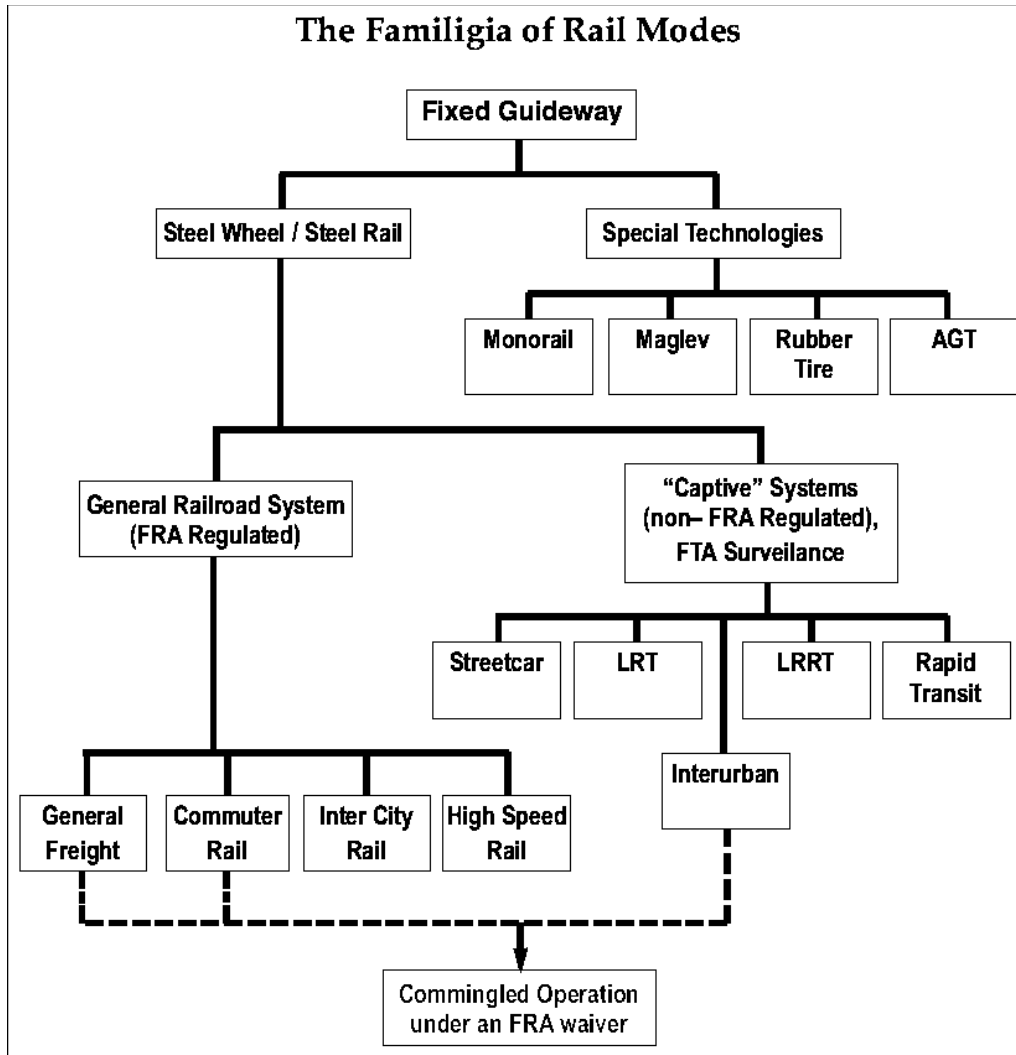

FIGURE 4 LRT and light rail rapid transit are captive systems; Interurbans are not.

distinction most clearly in differentiating between the LRT system Metropolitan Area Express (or MAX) and the Portland Streetcar System. The Interurban is likely to be larger and capable of higher speeds (and hence involve more kinetic energy) than the LRV. Consider, for example, that a two-car interurban at 55 tons/car operating at 65 mph has roughly double the kinetic energy of a two car Hudson–Bergen LRV (say a 45-ton car) operating at 50 mph and five times the kinetic energy of a 40-ton streetcar operating at 40 mph. While line of sight operation for the streetcar is routine, and may even be acceptable in some conditions for the light rail train, it is not adequate for the Interurban, except when the Interurban is operating at low speed in mixed-traffic territory.

A key element of vehicle design is that both the LRV and Interurban are street capable; however, the LRV is more street friendly due to such items as size (length and width), operator visibility, turning radius. By way of example, a typical LRV turn radius is approximately 90 ft while the River LINE Interurban requires a 133-ft radius and the new car which has been

deployed in Austin needs even more room to turn. Likewise, the street-friendly Hudson–Bergen LRV is 90 ft long, has a step height of 14 in., and is a nominal 9 ft in width, while the River LINE car is 10 ft wide, 100 ft long, and has a step height of 21 in. The Hudson–Bergen Light Rail (HBLR) car operates at a maximum speed of 55 to 60 mph, while the River LINE car is capable of speeds of up to 70 mph, and the Austin Interurban (most recently Capital Metro is referring to their new railway as Regional Rail) is reportedly capable of 75 mph. The Austin car, clearly an Interurban, includes crash protection for the operator, but trades off the operator's horizontal and looking down vision to do so. As a consequence, this vehicle requires forward facing cameras below the anti-climber to enhance operator visibility over the front. Such a requirement hardly fits the character of a street friendly LRV.

Signal Design Practice

Train control (or railway signaling) constitute the other major engineering system requiring specialized applications design for LRT–Interurban. A wide variety of signal design practices and signal systems exist throughout the country for both LRV and for Interurbans. The primary functions of signalization may be stated as providing for

- Train separation,
- Train routing, and
- Civil speed enforcements.

Other secondary functions, e.g., broken rail protection, may be considered once the protocols for accomplishing the primary functions in designing for shared use are better defined. Applications engineering (i.e., the type and configuration) for the signal system must be based upon stated OD. Operational experience is essential in determining how functionalities for the train control system may best be accomplished for the Interurban mode.

At this point it is also critical to note that in shared-use operations the signal system is also required to enforce the positive separation of modes; this requirement is over and above the fundamental functionality of train separation. This is an important additional functionality; thus vital technology is required to delineate and enforce modal barriers between near compliant and compliant trains, and this functionality must include a vital positive stop capability. Defining the signal design for Interurban applications is not a case of reinventing the H circuit, rather it requires focus on developing applications engineering suitable to the Interurban, which translate into an accurate incorporation of the Interurban railway's operating practices, that is, the means of employing this technology. Thus, the operating practices of the new Interurban do not follow from the signal design; they lead it, or at worst, are developed concurrently with the design concept.

A wide variety of signal technology and design practices currently exist in LRT–Interurban, many of which fail to appropriately reflect the operational environment or operating practices of these modes. In an extreme case, one light rail property considered the feasibility of designing track circuits that would function in highway pavement in order to place cab signals with continuous automatic train control (ATC) in mixed-traffic (street) operation. While this may (or may not) be feasible from a purely technical perspective, it is clearly not practical—more importantly, from the perspective of system safety (and potential liability for the operating company) what would these signals mean to a train operator running in mixed traffic? Consider

the meaning of a clear cab displayed to a train operator in street territory; how would a rules committee write an indication and rule for a situation that could explain how an absolute and vital clear signal might be displayed into the rear of a school bus?

Also consider the use of positive stop; most transit (i.e., not railroads) systems with cab signals and ATC assign a zero speed to a zero code situation (in some recent installations, provisions are made for electronic key by for following moves) while traditional railroad practice is to permit restricted speed for zero code. One railroad's (AMTRAK) recent positive stop provisions at home signals have been accomplished by the installation of a supplemental system of transducers which overlap the basic cab signal system. Conversely the design for train separation (following movements) on HBLR mimics a trip stop design (e.g., used New York City Transit Authority) and is illustrated in [Figure 5](#). The use of a buffer block of zero speed to the rear of an unoccupied block is highly inefficient and not appropriate to a railway whose very essence is a qualified train operator. (Or else how could street operation be certified as safe?) It is at the extreme opposite end of the applications spectrum to the block layout protocol employed on railroads and more closely replicates designs used on ATO-based rapid transit systems. This illogical basis for block layout (i.e., two zero-speed blocks) is prima facie evidence of a failure in thinking through that railway's OD. The operator's training and qualification and the rules (among other factors) were discounted during the applications design of the signal technology.

The difference in braking between freight and passenger trains has long been a challenge to signal engineers in performing block layout. The River LINE uses LRT signs (of note is that the FRA is absolute in its judgment: these are not considered to be fixed signals, they are signs) that are placed to accommodate the more efficient safe braking characteristics of the LRT. With block lengths of 5,000 for freight braking, the trip times for the LRV would increase dramatically (particularly when associated with passing sidings) if the LRV began its brake application at an approach signal, by placing an LRT sign at safe reduction—stopping distance from the home signal, the LRV performance is maximized. The LRT sign is not considered to be a signal by the FRA because it does not convey train ahead information, but rather, supplements the information conveyed by the previous signal. The operator's required action at the sign depends strictly on the aspect displayed on the wayside passenger 2 or 3 min before (i.e., the aspect observed on signal to the rear of the sign). This creates other operating issues, including a higher (but still quite low) probability of stop signal violations.

The use of signaling technology to enforce civil speeds warrants a thorough discussion on an Interurban Railway. As technology evolves the philosophy pertaining to enforcement of civil speeds has changed. Traditionally, railroads would not utilize a signal system to enforce civil speeds and would rely solely on operator compliance to the timetable (physical characteristics qualifications). In rare instances, where overturning speeds on curves located within in long sections of high-speed territory require special enforcement, cab signals would reduce to safe (not comfort) speed or, at least, enforce acknowledgement. With advancements in technology, e.g., Amtrak's ACSES and communications-based train control, the enforcement of civil speeds is being instituted on a number of FRA railroads. Conversely transit (LRT) signalization would historically enforce civil restrictions through the use of ATC devices such as cab signals, grade timers, and transponders.

The FRA considers the reliable, fail safe, and positive separation of modes (as distinguished from train separation) to be essential to shared-use operations. The conclusion to

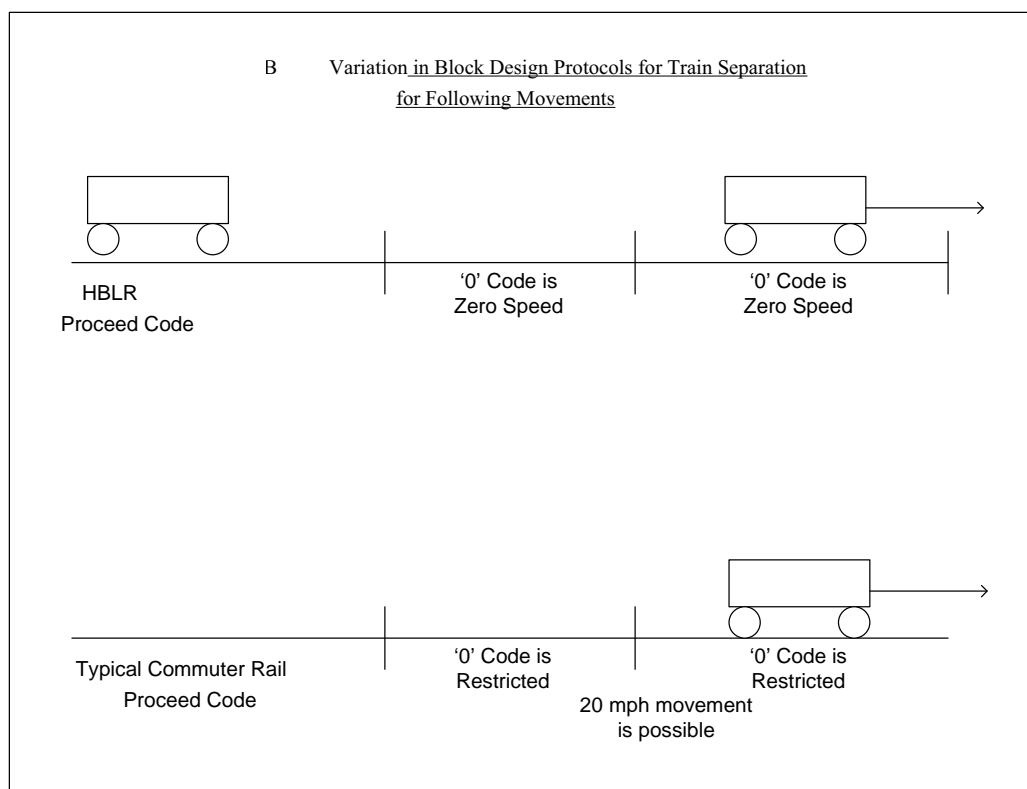

FIGURE 5 Variation in block design protocols for train separation for following movements.

be drawn is that proposed shared-use operations be planned to fully comply with FRA and Association of American Railroads (AAR) signal practice. The potential for loss of shunt is a separate issue which must be addressed in the safety case. Signal design practices have evolved which utilize available, standard vital design to implement and enforce separation of modes, such as that used on River LINE's extended temporal separation (ETS). The River LINE's ETS is described elsewhere in great detail (7). Of importance here is that

1. Boundaries between modes are enforced by vital, yet intermittent forms of train control, i.e., trip stop and derails;
2. Cab signals—continuous ATC were not required by FRA as a condition of the waiver;
3. Modes remain temporally separated over the roughly 2 mi and three interlockings involved, however the time scale of separation is on the order of 5 min, not 8 h (this is due to the technology utilized);
4. Use of basic railroad operating practices, that is the use of the technology, was a major factor in the FRA's favorable decision, including
 - The existence of a railroad style movement office—dispatch center on River LINE,
 - Control of all movements over the ETS territory by the River LINE's train controller, and
 - Close coordination between River LINE train controllers, Conrail train dispatchers, and Conrail crews, which includes coordination of radio communication.

The River LINE ETS, including the associated operating practice provide a basis of design or a design template for future shared-use (Interurban) properties.

Admittedly, the existing ETS is very basic; an improvement to ETS would include the introduction of cab signals. River LINE has completed a concept of operations and conceptual design for cab signals—continuous ATC which is summarized in [Figure 6](#) and includes

- Zero-code permits 20-mph movement;
- Two MAS aspects, one of which will indicate an impending cab drop at the LRT sign;
- Retention of trip stops at stop signals;
- Separation of modes using the existing trip stops (for passenger) and, in addition, derrails for locations where positive stop of freight trains is required; and
- Retention of existing wayside signals for governance of freight and work trains (under this concept, freight and work trains would not be equipped).

The concepts all address the application of standard railroad signaling technology to the next increment of Interurban railroading. The concept of operations and preliminary design, constitute an evolution in the OD of Interurbans and will require FRA review and approval prior to final design. FRA has repeatedly stated that use of cab signals, with continuous automatic train protection would be viewed in a highly favorable manner where waivers are requested for use of near-compliant rolling stock on railroad lines. Much of the passenger transport industry has failed to properly consider this in system design.

Figure 6 shows a conceptual arrangement for cab signals in shared-use territory. Note the use of a 270 code which enforces the LRV to a 60-mph speed and provides the theoretical clear approach aspect in the cab. The intent is for an operator acknowledgment and a minimal reduction in speed. However, the safe braking is enforced from the cabs in relation to the profile of the LRV, which is similar to the aforementioned LRT signs. Cab equipped freights would receive a zero cab after passing the approach signal and enforcement applied to run restricting through the block.

The FRA's stated requirement that if cab signals are installed on a railway all trains must be equipped requires consideration. The intent of this requirement is clear, to raise the level of operating safety; In practice, this stipulation must be reconsidered during the waiver process as it may in fact discourage the installation of cab signals over some shared-use railways. Other considerations in signal design include the development of rational and efficient safe braking models (ones which are not ATO based) and which recognize the role of the operator. The synthesis of the operator's actions with the intended use of the signaling and other technology leads directly to the other aspect of OD, operating practices.

OPERATING PRACTICES

The other component of OD is the means and methods, which for a railway may be summarized as operating practices. Some of these practices are based in FRA (or other) regulations, others are based on industry standards or tradition, while yet others are based upon railroad-specific practices. For example:

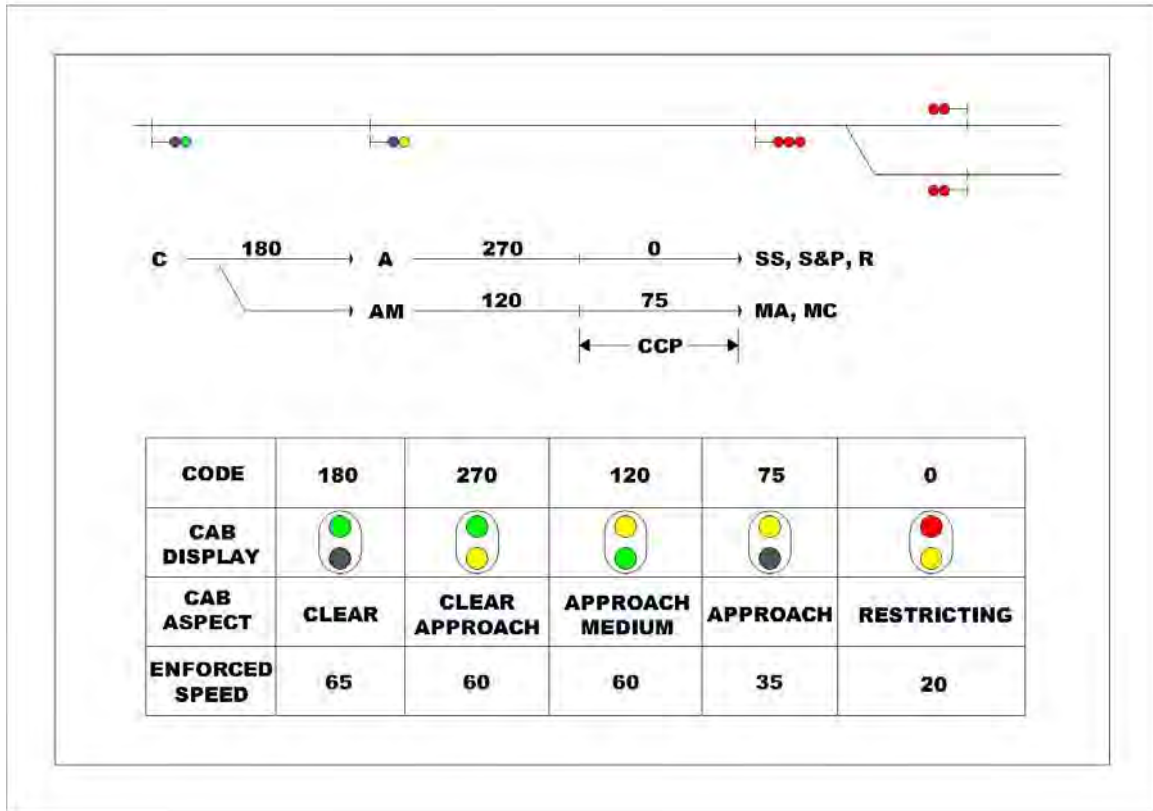

FIGURE 6 Route and aspect chart: cab signal installation. (Note: POSITIVE STOP is enforced by an intermittent inductive trip stop system, thereby permitting a zero code to be enforced at a nominal 20-mph speed. Trip stops are located at home signals and selective other signals.)

- Regulation-based practices include training and licensing for locomotive engineers, requirements for inspection and maintenance of signals or track, locomotive inspection requirements and RWP, and hours of service requirements;
- Industry association practices include use of common rule books (GCOR, NORAC); these are reflective of the signal technology employed on any specific territory. In maintenance of way they also include practices for bridge inspection and heat counter measures. (The FRA regulations allow industry practices to govern.); and
- Traditional and railroad specific practices include such items as preventive maintenance practices, depth of knowledge required to achieve physical characteristics or rules qualifications, and train blocking and dispatching practices. Railroad specific practice also includes storm and emergency response and coordination protocols.

A simple but pointed example of railroad location-specific OD once existed on Amtrak’s New York Division. The NEC’s highest density territory is Union Interlocking in Rahway, New Jersey to Pennsylvania Station, approximately 20 mi. Amtrak long ago developed a revised doctrine for superiority of trains. In this locally applied doctrine any train operating in its slot is

considered superior to any train operating out of slot; thus an on-time commuter local would not be delayed in order to improve performance of a late Metroliner. Such a practice was necessary due to the great mix of train types (Metroliners, regionals, long hauls, commuter expresses, locals) operating at what is essentially minimum practical headways.

A more current example, in which operating practice drove design, is on HBLR, where certain routes were specifically designed for express train operations (zone, or in one case, overtake) under the mandate that the base (local) service not be delayed or obstructed by express trains (Figure 7).

Consider the evolution of OD on the River LINE. The original statement of operations was it is a bus on rails—that is a succinct summary of doctrine; it is one which is not atypical for new start LRT systems and it formed the basis for much of the design and technology selection. Unfortunately this was an unacceptable doctrine for the River LINE with regard to the length of the line and the speeds required, and in particular with regard to the shared-use operation and the requirements, both expressed and implied, in the FRA waiver. Because the original OD was flawed, significant rework was required of system and in practices.

Since its opening the River LINE has evolved into an operation which is completely based in railroad practices and standard technology and designs, using a near-compliant passenger vehicle. Railroad operating practices include a NORAC-based rulebook, and requirement for all train operators to qualify on physical characteristics. (This is not a transit industry practice.). Also, track, signals and bridges are inspected and maintained in strict compliance with FRA regulations. The OD also includes the use of RWP and efficiency checks



FIGURE 7 The Susquehanna Railroad's Motorailer operated in Bergen and Passaic Counties in New Jersey. Interurbans may be restored to a portion of this line in the near future.

during the period or in the territory where only passenger trains are operating. The loss of shunt issue previously mentioned is partially mitigated by operating practices (and partially by engineered solutions).

Further evolution of the OD on River LINE is illustrated by the following:

- Extended temporal separation, which was described in the 2007 Railway Age C&S Annual (7). A proposal for a major expansion of this concept has been developed and has received FTA funding for final engineering;
- Qualification of elected River LINE staff as locomotive engineers for use in operation of work and special trains. This qualification is in full compliance with FRA regulation;
- Operation of work trains and work equipment, which River LINE follows mainline railroad practice; operation of work trains is permitted only with a licensed locomotive engineer and qualified conductor; and
- Terms have meaning—they imply operating practices, lead to doctrine, and ultimately define an approach to safety regulation. The current FRA view is dynamic, as well it should be, as the OD for Interurbans continues to evolve.

A BASELINE FOR OPERATIONS ON THE NEW INTERURBANS

There are a number of knowns for rail properties interested in progressing in shared-use operations:

1. Recognize the role, immediate actions, property specific, and right of the FRA to regulate the operation;
2. Take a systems engineering approach, extend the focus of study of shared-use operations beyond the vehicle. Current attention is focused on the debate over crash energy management versus buff strength. A shared-use OD must go well beyond this and must include a review of track, train control, and supervisory control. The OD must also consider operating practices and training and qualification of operating employees;
3. Define a concept of operations which includes precise usage of terms (e.g., Interurban, light rail, commuter rail), which includes a comprehensive safety case, and which minimizes requests for CFR waived items; and
4. Consider that shared use may well apply to the operation of compliant and near-compliant passenger trains on the same railway; consider, for example, New Jersey Transit's Atlantic City Line, where Interurban trains would be capable of providing a highly cost-effective fill-in or short-haul commute service over portions of the line.

In general an Interurban (shared-use) operation should be based on a railroad tradition but not necessarily on railroad work rules or job classifications. On River LINE, for example, a track technician and general manager comprise two of the currently six licensed locomotive engineers. The others are passenger train operators who have also received a locomotive engineer's license. Waiver requests are limited to only those items which are essential, and where waivers are granted, an alternate and equivalent practice defined. A safety case, one which is consistent with the requirements of System Safety Standard 882 must be developed for the equivalent design or operating practice.

Conversely it is reasonable, but not necessarily part of existing OD that nonwaived regulations will apply as written and understood across the railroad industry; Track speeds as delineated in the code of Federal Regulations Section 213 (pertaining to track standards) for example. This has, unfortunately not necessarily been the case. Lurking in the shadows, for example, are theories about high-speed light rail presumably this will somehow mimic the track and other standards for high speed rail (i.e., greater than 90 mph.). The associated special requirements of so-called high-speed light rail as well as the delineation of the magical threshold speed should reasonably be the subject of open and frank industrywide discussion.

Finally, creative use of existing signal technology provides for greater opportunity for expanding such concepts as ETS, but only within the concept of common OD between both of the modes involved.

WHAT NEXT?

From an industrywide perspective, the following actions should be considered:

1. State and federal governmental units and rail operators should recognize the need and the trend for expansion of moderate density passenger service on light density freights. Recognize that such expansion, if done safely, will be to the public benefit;
2. Industry groups need to collectively work with the FRA and FTA toward development of a menu of waiveable and nonwaiveable CFR requirements; and
3. FRA should consider the establishment an RSAC to further develop OD, i.e., operating practices and technology requirements and the technology discussion should go well beyond current discussions of vehicle crashworthiness. The transit industry needs to get beyond this issue and engage the FRA on a full discussion of OD. Such an effort could use, as its template, the evolution of OD for high-speed rail on the NEC. The bus-on-rails concept is flawed because it relates to shared-use operations on a railroad.

REFERENCES

1. Home, T. C., N. Friedman, and M. Mandela. *American and British Aircraft Carrier Development*. United State Naval Institute Press, Annapolis, Md., 1999.
2. Smith, D. V. *The Carrier War*. United State Naval Institute Press, 1982.
3. The New Haven Railroad: A Fond Look Back.
4. Joint Policy Statement by FRA and FTA on Shared Use, CFR, July 2000.
5. Vuchic, V. *Urban Transportation, Technology and Systems*. Prentice Hall, Englewood Cliffs, N. J. 1982.
6. DeLeuw, C. *Light Rail Transit, State of the Art*. U.S. Government Printing Office, 1976.
7. Signaling for Shared Use. In *Railway Age C&S Buyers Guide*, November 2008.
8. Fazio, A. E. Hudson–Bergen Light Rail, 5th Anniversary Edition. *Railpace*, Piscataway, N. J., 2003.

The Next Generation Vehicle

THE NEXT GENERATION VEHICLE

**New Los Angeles Metropolitan Transportation
Authority P2550 LRV
*Energy-Saving Techniques***

LUIGI ACCARDO

CIRO NAPPO

AnsaldoBreda S.p.A. Naples

DAVID TURNER

Turner Engineering Corporation

AnsaldoBreda S.p.A. (AB) has designed and built new light rail vehicles (LRVs) for the Los Angeles Metropolitan Transportation Authority (LACMTA) Metro Gold Line. AB and LACMTA worked with LTK Engineering Services (LTK), and Turner Engineering Corporation (Tenco) to introduce new control techniques to save energy and reduce conductive harmonic emissions. This paper describes energy savings techniques which have been developed on the P2550 vehicles that are running in revenue service today on the LACMTA Metro Gold Line.

The P2550 is a new LRV built by AB with insulated gate bipolar transistor (IGBT) propulsion system; it is the first LRV using the IEC standard 61375 for Multifunction Vehicle Bus communication in the U.S. market. This paper describes the vehicle propulsion architecture and the control techniques implemented to reduce the harmonic content in the line current and save energy. These algorithms used in the P2550 project are the first practical application of research and development performed by AB in two different European Community research projects: ModUrban and RailEnergy. Both these projects are described below, and the application of these energy savings techniques in the P2550 project is shown.

To qualify the proposed solutions, LACMTA, AB, LTK, and Tenco performed several tests during 2008 on the Los Angeles (California) Metro Gold Line. A straight section of track long enough to permit the vehicle to be accelerated from a standstill to approximately 65 mph and then safely brake to a stop was required. The Gold line track between Allen Station and Sierra Madre Villa Station was used for this test site. The test point was identified as the substation feed point coming from the Craig substation at milepost 12.2. The test section was isolated from all other power substations during testing.

P2550 DESCRIPTION

The P2550 LRV is composed of two LRV bodies and three boogies. Each end boogie has two induction motors fed by a propulsion inverter and a friction brake system. The middle trailer boogie has friction brakes only. The two propulsion systems are completely independent from each other and are controlled by independent traction control units, TCU_A and TCU_B. **Figure 1** shows the vehicle architecture, and **Table 1** lists the main P2550 LRV parameters.

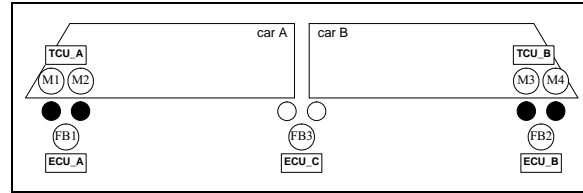

FIGURE 1 P2550 architecture.

The propulsion system consists of two forced-air cooled IGBT variable-voltage, variable-frequency inverters, installed under the LRV floor near their respective trucks. The drive unit for each truck performs its functions, including propulsion, dynamic braking, and wheel spin–slide correction, even if the other truck’s drive unit is not functioning. The two propulsion systems derive power from the pantograph and are protected by a high-speed circuit breaker (HSCB) located on the vehicle roof.

Each propulsion system consists of

- One propulsion inverter,
- One line reactor, and
- One braking resistor.

TABLE 1 P2550 Parameters

Parameter	Value
Line voltage	950 VDC (max.) 750 VDC (nom.) 525 VDC (min.)
Battery voltage	42 VDC (max.) 37.5 VDC (nom.) 25 VDC (min.)
Wheel diameter	711 mm (new) 660 mm (fully worn)
Number of LRVs per train	Minimum = 1 Maximum = 4
Total railcar mass	AW0 = 46,840 Kg AW2 = 58,740 Kg AW4 = 65,320 Kg
Total mass including rotating mass	AW0 = 51,524 Kg AW2 = 63,424 Kg AW4 = 70,004 Kg
Ambient air temperature	-7°C (min.) 46°C (max.)

An external line inductor for each propulsion unit forms a single cell L-C input filter. The line inductor is connected between the HSCB and the power inverter (one filter for each inverter). The input filter prevents damage to solid-state equipment from large voltage transients on the line caused by interruption of fault currents by vehicles, by wayside breakers, or by lightning strikes. The input filter also plays a critical role in controlling conductive harmonic emissions in the line current.

The line filter has the following parameters: $L = 4 \text{ mH}$ and $C = 5.8 \text{ mF}$. Figure 2 shows the high voltage and medium voltage schematic drawing of a propulsion system.

In December 2008, there were 12 P2550 LRVs in revenue service. Figure 3 shows a train of P2550 LRVs during night testing.

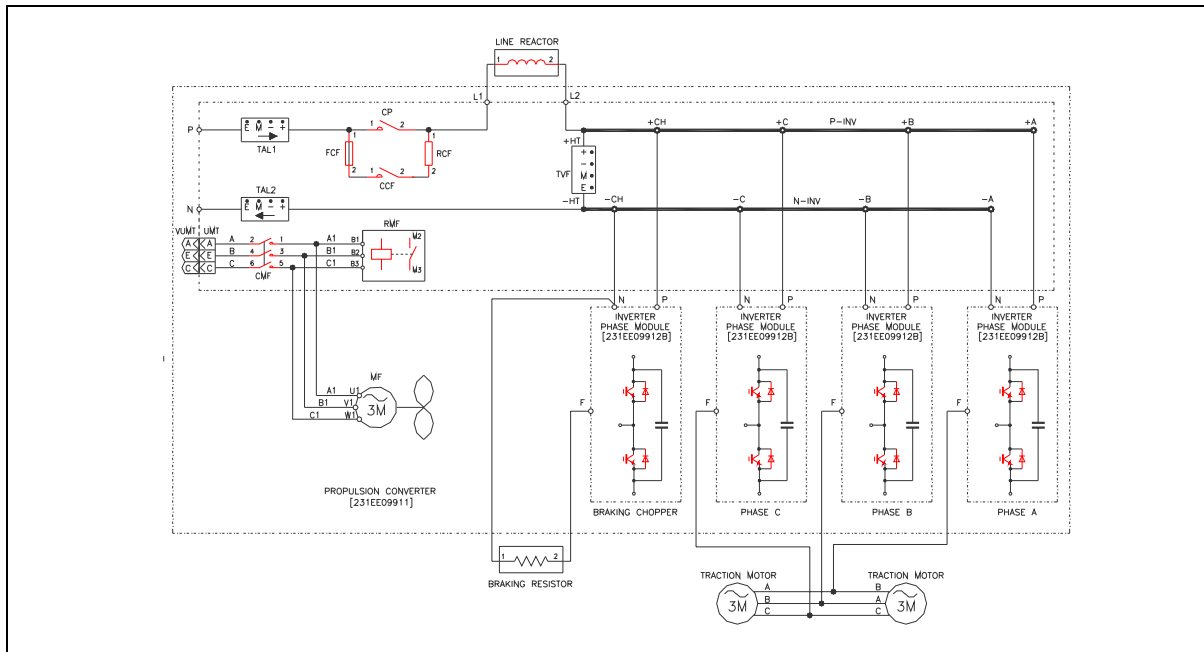

FIGURE 2 Propulsion inverter schematic.



FIGURE 3 Night testing of P2550 LRV.

EUROPEAN RESEARCH PROJECTS

AB participates in important research projects in Europe. The European Commission (EC) finances research projects in railway system to address two main topics:

- Railway standardization and
- Energy savings.

Two important EC projects AB is working in are ModUrban and RailEnergy. These two projects share common goals: to research new or optimized solutions to reduce the power demand of rail transportation systems.

ModUrban

The Modular Urban Guided Rail System project (ModUrban) is a 50% European Union-funded Integrated Project. It is the first of its kind on a truly European level in the area of joint, pre-competitive research. It brings together all major rail industry suppliers and all major European rail operators. The project started in January 2005 and will last 4 years, through the end of 2009. See www.modurban.org.

The main target of the ModUrban project is to design, develop, and test innovative and open common core system architecture and its key interfaces for urban transit. This covers command control, energy saving, and access subsystems.

AB is participating in the ModEnergy subproject whose focus is the reduction of urban rail transport energy consumption by using storage and by reusing braking energy. The subproject is evaluating flywheel energy storage systems, supercap–ultracap technology, and conventional batteries for key characteristics including energy content, mass, volume, and lifetime.

The subproject is also examining integration methods for storage systems into existing propulsion concepts and structures. Typical drive cycles and types of vehicles have been considered. The control strategy which influences the power flow between the components is an important aspect needed to guarantee the success of an application. An appropriate combination of these characteristics will result in a specification that can have the highest benefit to the transit operating agency.

RailEnergy

The objective of RailEnergy is to cut European railway system energy consumption, thus reducing life-cycle costs of railway operation and CO₂ emission per seat kilometer or ton-kilometer. The project target is to achieve a 6% reduction of the specific energy consumption of the rail system by 2020. This entails addressing the systems, subsystems, and components of railways in an integrated way. See www.railenergy.org.

AB is the Subproject 6 leader in RailEnergy. Subproject 6 focuses on the optimization of electrical equipment topologies and system designs. The optimization of the energy consumption is achieved, in general, not only through the application of new hardware technologies, but also

- Studying, in an integrated way, the operating conditions and the mutual links among the equipment;
- Discovering and testing new architecture;
- Evaluating efficiency improvements derived from processing energy flows in new ways; and
- Applying new control techniques, starting from a deep knowledge of hardware characteristics and allowing the most efficient equipment operating conditions.

The expected benefits are

- Energy saving,
- General design optimization, and
- Weight and dimension reduction.

A key emphasis is to achieve energy savings by optimizing control algorithms and regulation mechanisms, or developing new ones, related to propulsion system functionality and characteristics. The overall efficiency of propulsion system could be improved with optimized control algorithms developed for

1. Reducing converter commutation losses using or developing new modulation techniques,
2. Reducing energy losses in rheostatic braking mode by improving coordination between other vehicle loads and line voltage and regeneration,
3. Reducing input passive filter (reactors) losses by improving converter filtering capability and harmonics reduction, and
4. Reducing converter losses by optimizing converter mode in response to ambient temperature.

These main topics are discussed in the next paragraphs.

Input Voltage Management

In a two-stage DC propulsion inverter configuration, the three-level chopper could be used to vary the input voltage of the inverter to reduce inverter losses.

The two-stage converter is typically used in multimode locomotives, where the available components (already used for AC operation) are also used for DC operation.

In AC application, the four-quadrant line converter could be used to vary the input voltage of the traction inverter to reduce inverter losses.

Use of Braking Energy

Regenerative braking energy saving can be improved by coordinating with other vehicle loads (such as air compressor) or modulating the braking to feed auxiliary converters.

Auxiliaries such as air conditioners could also act as energy storage systems, converting braking energy into thermal energy for heating or cooling.

Reduction of Input Passive Filter Losses

Reduction of losses in filter reactors will result in weight and volume reduction.

The use of the traction inverter, the first-stage converter or the auxiliary converter as active filters and also dedicated algorithms for harmonic reduction will be investigated, for AC and DC configurations.

Figure 4 shows a simplified scheme of the algorithm used for harmonics reduction. To obtain the expected harmonic reduction, it will be possible to act on the inverter control algorithm or directly on the PWM modulator.

For DC traction supply, the inverter control can be used to filter harmonic currents at low frequency, e.g., signaling frequencies, such as 50, 60, or 100 Hz.

The use of the auxiliary converter (with lower power than the traction inverter, but higher switching frequency) as active filter will be investigated.

In a double-stage configuration, the first three-level chopper stage can also be used to filter low-frequency harmonics. In this case there is a further degree of freedom with respect to the single-stage configuration.

In a 50 Hz AC traction power configuration, the four-quadrant converters and the traction inverter could compensate the 100 Hz harmonics coming from the AC-to-DC conversion so that the reactor of the tuned filter can be eliminated or downsized, reducing weight and losses.

Optimizing Converter Mode in Response to Ambient Temperature

Semiconductor losses increase with the component junction temperature. On the other hand the energy spent to cool the converter heat sinks decrease with the junction temperature. This indicates that lowering the junction temperature requires more cooling energy.

It could be possible to develop a control law that minimizes the total converter energy loss according to the ambient temperature and the maximum allowable device junction temperature (Figure 5).

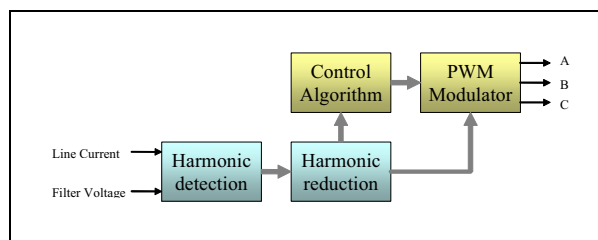

FIGURE 4 Filter losses reduction algorithm.

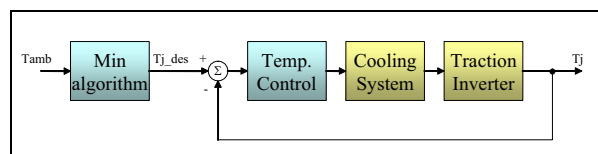

FIGURE 5 Regulation of junction temperature.

Using information on the ambient temperature and the junction temperature, the inverter control will act on the cooling system to regulate the junction temperature.

The converter motor blower is chosen to properly cool the power modules at the maximum ambient temperature (worst case). Using a dedicated inverter, the blower can be fed at variable voltage and frequency so that its speed, and its power, can be changed according to the temperature. In some conditions, it can be turned off. Figure 6 shows a comparison of the components losses and the cooling power request for the AB locomotive type E403. The figure shows there is a minimum around 90°C.

P2550 ENERGY-SAVING TECHNIQUES

Input Voltage Management

To minimize the energy losses during regeneration, the reference filter voltage limit has been set to 920 VDC. This increases regenerative braking performance and reduces rheostatic braking energy losses. The level of 920 VDC was chosen to coordinate with the high voltage alarm detection threshold, which is set to 950 VDC.

Figure 7 shows the chopper control block diagram.

During the electric brake mode the chopper duty cycle $dutyCH$ is calculated as the sum of two contributions:

$$dutyCH = dutyFF + dutyVF$$

where $dutyFF$ is the “feed forward” value calculated starting from the input inverter power:

$$dutyFF = (invPower \times R) / (vF \times vF)$$

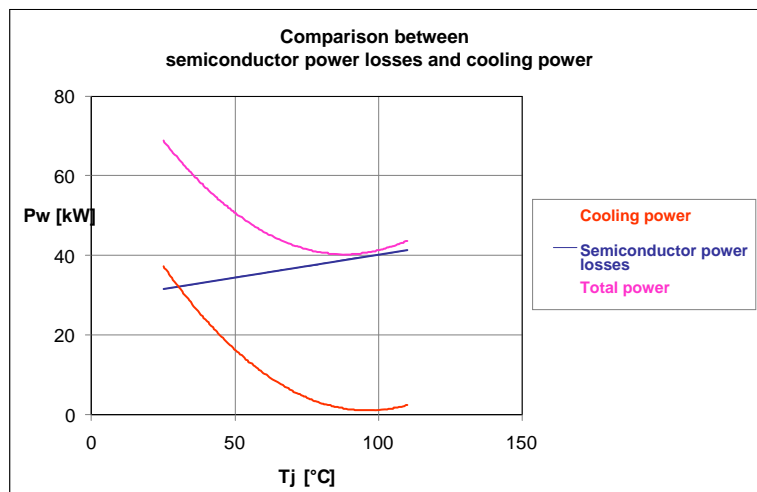

FIGURE 6 Power losses versus junction temperature.

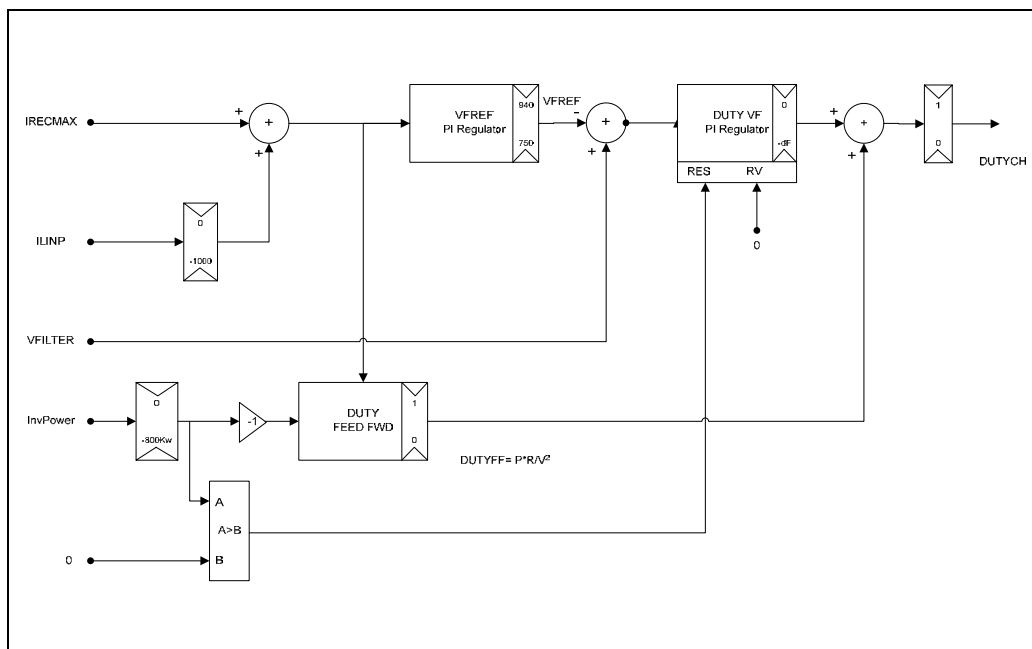

FIGURE 7 Chopper control block diagram.

This feed forward value is the duty cycle to be used for 100% rheostatic braking. At the start of a braking event, the propulsion control starts to dissipate all the power coming from the inverter on the braking resistor. Then the propulsion control tries to regenerate the power using the *dutyVF* parameter, up to 100% regenerative braking, while regulating the filter voltage level below the maximum.

dutyVF is the contribution to the brake chopper duty cycle based on the filter voltage reference value VFREF. The propulsion software calculates *dutyVF* using a proportional–integral (PI) regulator which looks at the instantaneous error $vF - VFREF$, as well as the actual state of the regulator. The maximum value is 0, while the minimum is $-dutyFF$. If *dutyVF* is 0, braking is completely rheostatic; if it is $-dutyFF$, the brake is completely regenerative. In between the limit values, the braking mode is mixed. In addition to this, the *dutyVF* value is kept at 0 until the inverter power is greater than 0, because that means the railcar operating mode is not power or coast.

The filter voltage reference value VFREF is 920 VDC; however this value can be adjusted if the railcar might otherwise regenerate too much current. For this reason the VFREF value is the output of a PI regulator which receives in input the actual line current and the maximum value of the regenerative current IRECMAX, which is 600A.

A complementary control technique handles power demand when the line voltage is lower than 650 VDC. This enables the P2550 LRVs to reduce traction power losses and regulate line voltage to avoid low voltage alarms. The nominal maximum current *nomILinMax* is set at 600 A. If line voltage is lower than 650 VDC, the control reduces the maximum allowed current:

$$iLinMax = nomILinMax - kLim \times nomILinMax \times \left(1 - \frac{vF}{650}\right)^2$$

Figure 8 shows the current limitation in function of the actual line voltage with $kLim$ set to 5.0.

Input Voltage Management Results

Figure 9 shows the energy consumption and the energy fed back to the line for one propulsion system, with one-car consist train on the LACMTA Gold Line, traveling from Sierra Madre to Union Station.

The first diagram shows the voltage across the propulsion filter capacitor (vC), the current flowing in the propulsion filter inductor (iL), and the vehicle speed ($speed$) amplified by a factor 10.

The second diagram shows the driving power ($potAbs$) and the power fed back to the line in braking mode ($potRec$).

The third diagram shows the driving energy ($enerAbs$) and the braking energy feedback ($enerRec$). This diagram also shows the percentage of driving energy fed-back to the line ($enerRec\%$).

Figure 10 shows the energy flow diagram and how average energy consumption is distributed in a typical light rail vehicle.

The typical amount of braking energy feedback is 27% of the total energy absorption, and about 31% compared to the driving energy. The real energy amount fed back to the line depends mainly on the receptivity of the line.

At the end of the trip shown in Figure 9, the total driving energy is 33.9kW for one propulsion system, and the total braking energy feedback is 16.3 kW. So the braking feedback energy is about 48.1% of the driving energy. The percentage of energy feedback varies along the trip and depends on the receptivity of the line. The measured maximum along the trip was 52%.

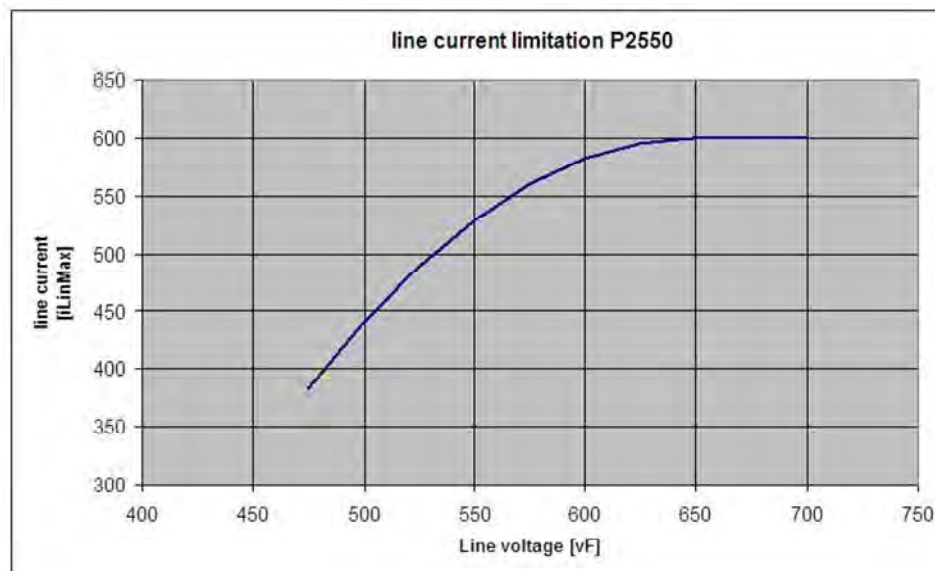

FIGURE 8 Line current limitation.



FIGURE 9 Energy consumption for one propulsion system.

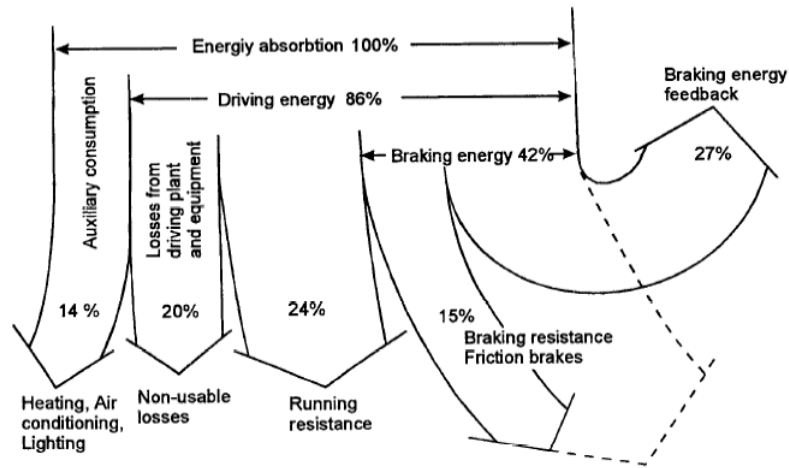

FIGURE 10 Division of rolling stock energy consumption (source: UITP).

Active Filtering

For the P2550 LRV, the LACMTA EMI limits required special attention by AB. To meet the limits at 60 Hz, AB decided to implement active filtering as investigated during the RailEnergy project, rather than to increase the rating, size, and weight of the line inductor and filter capacitor.

The top of Figure 11 shows how the baseline configuration inverter control manages the filter voltage to calculate the modulation index.

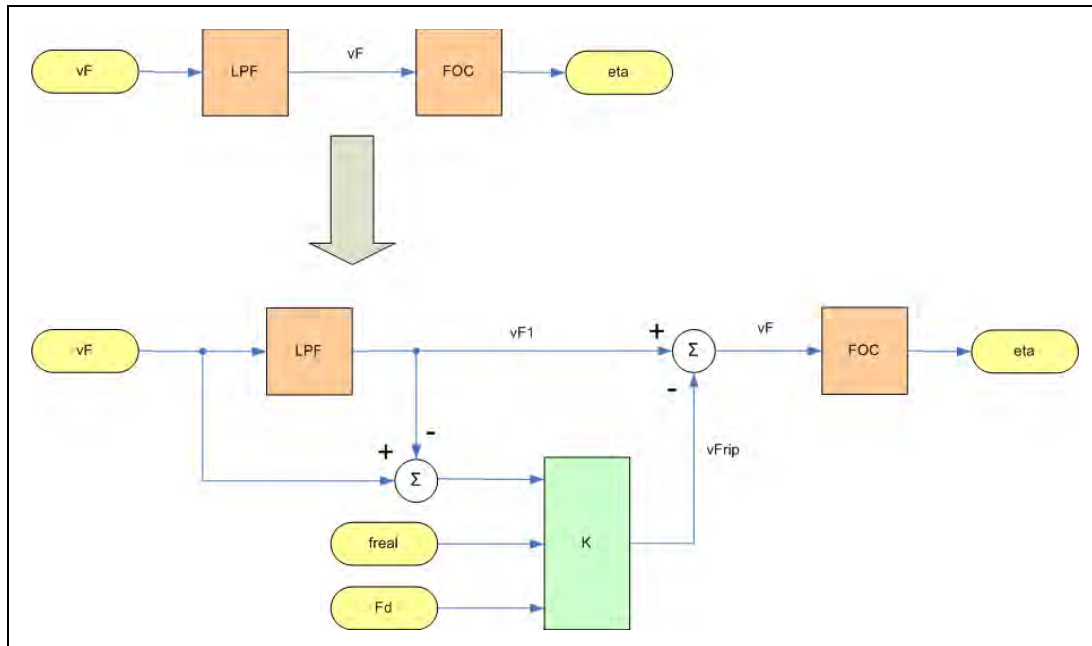

FIGURE 11 Active filtering inverter control of modulation index.

The measured filter capacitor voltage (vFIL) is filtered by means of a low-pass filter LPF (vF) and then used to calculate the modulation index (η) by means of the flux-oriented control algorithm. The second harmonic of the fundamental is present on the acquired voltage filter but not on the output of the LPF. To reduce the second harmonic, the input voltage ripple (vFrip) is added in opposite phase to the output of the LPF filter. The variable (vF) is then used by the FOC block to calculate the modulation index.

The lower half of Figure 11 shows the modified block diagram which provides active filtering. The added block Kdamp is a coefficient which depends on the fundamental output frequency (freal) and the rotor flux (Fd).

The damping techniques acts mainly in the frequency range 25 Hz to 35 Hz of the fundamental frequency, and it reduces harmonic content in the range 50 Hz to 70 Hz. To smooth this corrective action, two ramp controlled transitions are used.

Figure 12 shows the value of Kdamp in the frequency range of interest:

- Kdamp = 0 for frequency lower than 20Hz and higher than 40Hz, so that in such ranges the damping does not work;
- Kdamp = Kmax (2.0 in figure) for frequency in the range 25Hz/35Hz, where the damping has to work more effectively;
- Kdamp from 0 to Kmax in the range 20Hz/25Hz; and
- Kdamp from Kmax to 0 in the range 35Hz/40Hz.

Kdamp can be described as a function of the rotor flux. Since the rotor flux is also function of the rate reference, Kdamp can also be considered as function of the rate reference (i.e. the position of the master controller).

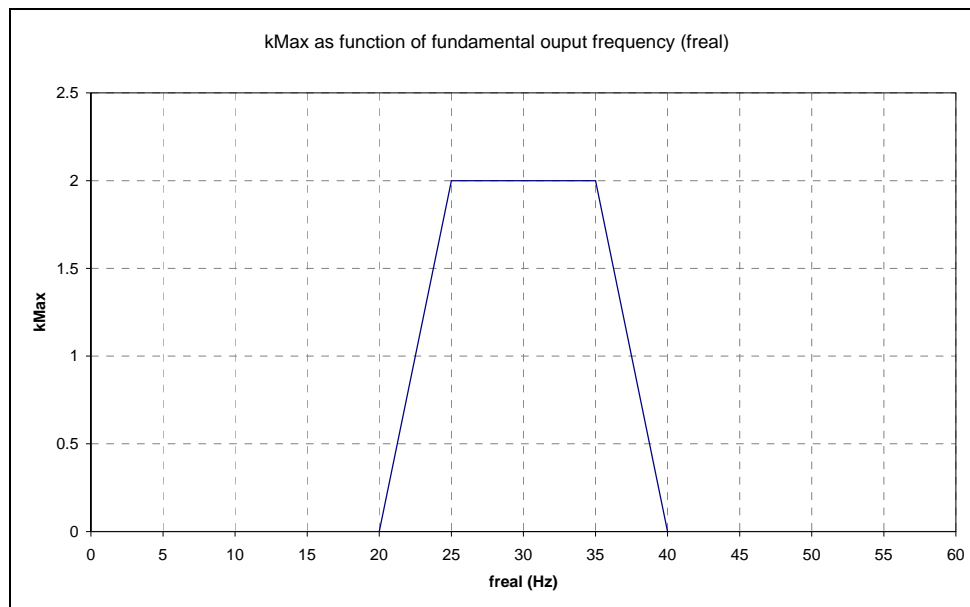

FIGURE 12 Control of Kdamp.

Active Filter Results

On the P2550 LRV operating on the LACMTA Gold Line, AB measured the 60 Hz emissions, with the LRV in different operating modes. The onboard Conducted EMI Protection System (CEMIPS) was used to measure the 60 Hz levels.

For the original configuration, over-limit events at 60 Hz were observed in traction mode, at medium power from 0 to 15 mph. In these tests, the vehicle started from rest and reached the substation feeder at about 15 mph. **Figure 13** shows the 60 Hz harmonic content versus time, measured by CEMIPS. The peak level is about 2.4 A, and the event has emissions of greater than 1.0 A for about 3 s.

For the modified active filter configuration, the over-limit events at 60 Hz are dramatically reduced in amplitude and duration, for the identical test runs. **Figure 14** shows the 60 Hz harmonic content versus time for the modified propulsion system, measured by CEMIPS. The peak level is less than 0.7 A, and the duration is less than 1 s.

This active filter technique has the advantage to reduce the power losses, too. The alternative solution to the problem was to double the actual line reactor for each propulsion system.

The line reactor on the P2550 has a resistance value $RL = 55 \text{ m}\Omega$ and the average current for each propulsion system is 360 A. It means with the new control technique, the total saved power can be estimated according to the next formula:

$$powerSaved = numberofinverter \times RL \times Iavg^2 = 2 \times 0.055 \times 360^2 = 14.26 \text{ kW}$$

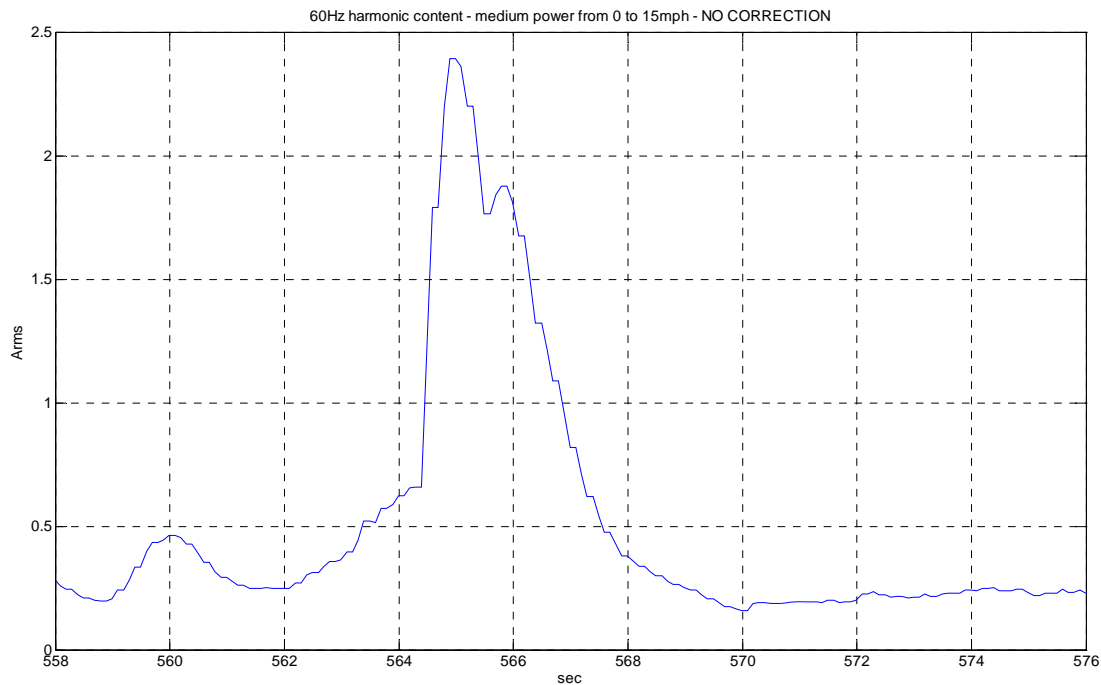

FIGURE 13 60-Hz emission level versus time for base propulsion system configuration.

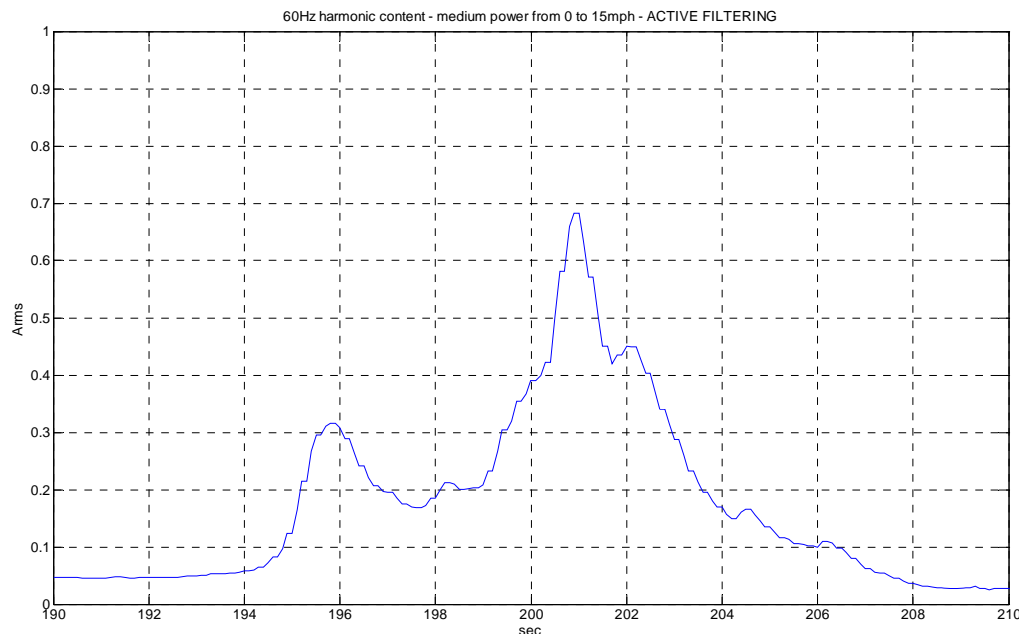

FIGURE 14 60-Hz emission level versus time for active filter propulsion system configuration.

CONCLUSION

The P2550 LRV team used techniques which AB derived from EC advanced development projects to solve real-world energy and electromagnetic compatibility problems for LRVs operating on the LACMTA Gold Line. The LRV performance and technical characteristics of the LRVs incorporating these new technologies comply with LACMTA's technical specifications, satisfying important technical and operating constraints. The advantage of the selected design techniques is that they allowed AB to avoid making hardware changes which would have required introducing a new inductor; increasing material cost, weight, and energy usage, and slowing completion of the project. Over the 30-year life of the car, this software-based solution allowed significant financial and carbon emission savings.

ACKNOWLEDGMENTS

The authors acknowledge the determined and focused efforts of the many members of the P2550 LRV team, whose effort brought the LRVs into service on the Gold Line. These include many dedicated staff in LACMTA management, rail transit engineering, rail transit operations, and vehicle maintenance, who have guided the project from conception through the procurement and into service. The authors recognize the efforts of the Italian and U.S. staff of AB who designed, built, integrated, tested, and delivered the railcars. Finally, the authors acknowledge the contributions of the transit equipment engineering and management specialists at LTK Engineering Services and at Turner Engineering Corporation, who helped identify challenges and solutions at each stage of the project.

Appendices

APPENDIX A

**Transportation Research Board
2010 Executive Committee***

Chair: Michael R. Morris, Director of Transportation, North Central Texas Council of Governments, Arlington

Vice Chair: Neil J. Pedersen, Administrator, Maryland State Highway Administration, Baltimore

Executive Director: Robert E. Skinner, Jr., Transportation Research Board

J. Barry Barker, Executive Director, Transit Authority of River City, Louisville, Kentucky

Allen D. Biehler, Secretary, Pennsylvania Department of Transportation, Harrisburg

Larry L. Brown, Sr., Executive Director, Mississippi Department of Transportation, Jackson

Deborah H. Butler, Executive Vice President, Planning, and CIO, Norfolk Southern Corporation, Norfolk, Virginia

William A. V. Clark, Professor, Department of Geography, University of California, Los Angeles

Eugene A. Conti, Jr., Secretary of Transportation, North Carolina Department of Transportation, Raleigh

Nicholas J. Garber, Henry L. Kinnier Professor, Department of Civil Engineering, and Director, Center for Transportation Studies, University of Virginia, Charlottesville

Jeffrey W. Hamiel, Executive Director, Metropolitan Airports Commission, Minneapolis, Minnesota

Paula J. Hammond, Secretary, Washington State Department of Transportation, Olympia

Edward A. (Ned) Helme, President, Center for Clean Air Policy, Washington, D.C.

Adib K. Kanafani, Cahill Professor of Civil Engineering, University of California, Berkeley (Past Chair, 2009)

Susan Martinovich, Director, Nevada Department of Transportation, Carson City

Debra L. Miller, Secretary, Kansas Department of Transportation, Topeka (Past Chair, 2008)

Sandra Rosenbloom, Professor of Planning, University of Arizona, Tucson

Tracy L. Rosser, Vice President, Corporate Traffic, Wal-Mart Stores, Inc., Mandeville, Louisiana

Steven T. Scalzo, Chief Operating Officer, Marine Resources Group, Seattle, Washington

Henry G. (Gerry) Schwartz, Jr., Chairman (retired), Jacobs/Sverdrup Civil, Inc., St. Louis, Missouri

Beverly A. Scott, General Manager and Chief Executive Officer, Metropolitan Atlanta Rapid Transit Authority, Atlanta, Georgia

David Seltzer, Principal, Mercator Advisors LLC, Philadelphia, Pennsylvania

Daniel Sperling, Professor of Civil Engineering and Environmental Science and Policy; Director, Institute of Transportation Studies; and Interim Director, Energy Efficiency Center, University of California, Davis

Kirk T. Steudle, Director, Michigan Department of Transportation, Lansing

- Douglas W. Stotlar**, President and Chief Executive Officer, Con-Way, Inc., Ann Arbor, Michigan
- C. Michael Walton**, Ernest H. Cockrell Centennial Chair in Engineering, University of Texas, Austin (Past Chair, 1991)
- Peter H. Appel**, Administrator, Research and Innovative Technology Administration, U.S. Department of Transportation (ex officio)
- J. Randolph Babbitt**, Administrator, Federal Aviation Administration, U.S. Department of Transportation (ex officio)
- Rebecca M. Brewster**, President and COO, American Transportation Research Institute, Smyrna, Georgia (ex officio)
- George Bugliarello**, President Emeritus and University Professor, Polytechnic Institute of New York University, Brooklyn; Foreign Secretary, National Academy of Engineering, Washington, D.C. (ex officio)
- Anne S. Ferro**, Administrator, Federal Motor Carrier Safety Administration, U.S. Department of Transportation (ex officio)
- LeRoy Gishi**, Chief, Division of Transportation, Bureau of Indian Affairs, U.S. Department of the Interior, Washington, D.C. (ex officio)
- Edward R. Hamberger**, President and CEO, Association of American Railroads, Washington, D.C. (ex officio)
- John C. Horsley**, Executive Director, American Association of State Highway and Transportation Officials, Washington, D.C. (ex officio)
- David T. Matsuda**, Deputy Administrator, Maritime Administration, U.S. Department of Transportation (ex officio)
- Victor M. Mendez**, Administrator, Federal Highway Administration, U.S. Department of Transportation (ex officio)
- William W. Millar**, President, American Public Transportation Association, Washington, D.C. (ex officio) (Past Chair, 1992)
- Robert J. Papp** (Adm., U.S. Coast Guard), Commandant, U.S. Coast Guard, U.S. Department of Homeland Security (ex officio)
- Cynthia L. Quarterman**, Administrator, Pipeline and Hazardous Materials Safety Administration, U.S. Department of Transportation (ex officio)
- Peter M. Rogoff**, Administrator, Federal Transit Administration, U.S. Department of Transportation (ex officio)
- David L. Strickland**, Administrator, National Highway Traffic Safety Administration, U.S. Department of Transportation (ex officio)
- Joseph C. Szabo**, Administrator, Federal Railroad Administration, U.S. Department of Transportation (ex officio)
- Polly Trottenberg**, Assistant Secretary for Transportation Policy, U.S. Department of Transportation (ex officio)
- Robert L. Van Antwerp** (Lt. General, U.S. Army), Chief of Engineers and Commanding General, U.S. Army Corps of Engineers, Washington, D.C. (ex officio)

*Membership as of June 2010.

APPENDIX B

American Public Transportation Association Board of Directors

EXECUTIVE COMMITTEE

President: William W. Millar

Vice President—Member Services: Kathy Waters

Officers

Chair: Mattie P. Carter, Commissioner, Memphis Area Transit Authority

First Vice Chair: Michael J. Scanlon, General Manager/Chief Executive Officer, San Mateo County Transit District and Peninsula Corridor Joint Powers Board

Secretary/Treasurer: Nathaniel P. Ford, Sr., Executive Director/CEO, San Francisco Municipal Transportation Agency

Immediate Past Chair: Beverly A. Scott, Ph.D., General Manager/CEO, Metropolitan Atlanta Rapid Transit Authority

Vice Chairs

Business Members: Sharon Greene, Principal, Sharon Greene and Associates

Business Member-at-Large: Delon Hampton, Ph.D., P.E., Chairman of the Board, Delon Hampton & Associates, Chartered

Bus and Paratransit Operations: Joyce Eleanor, Chief Executive Officer, Snohomish County Public Transportation Benefit Area Corporation (dba Community Transit)

Canadian Members: Angela Iannuzziello, P.Eng., President, ENTRA Consultants

Commuter and Intercity Rail: Joseph J. Giulietti, Executive Director, South Florida Regional Transportation Authority/Tri-Rail

Government Affairs: J. Barry Barker, Executive Director, Transit Authority of River City (TARC)

Human Resources: Doran J. Barnes, Executive Director, Foothill Transit

Management and Finance: Christopher P. Boylan, Deputy Executive Director, Corporate Affairs and Communications, Metropolitan Transportation Authority

Marketing and Communications: Alice Wiggins-Tolbert, Director, Project Development, Parsons Brinckerhoff

Rail Transit: Gary C. Thomas, President/Executive Director, Dallas Area Rapid Transit

Research and Technology: Linda J. Bohlinger, Vice President, National Director of Management Consulting, HNTB Corporation

Small Operations: Peter J. Varga, Chief Executive Officer, Interurban Transit Partnership (The Rapid)

State Affairs: Michael A. Sanders, Transit Administrator, Transit & Ridesharing, Connecticut
Department of Transportation

Transit Board Members: Flora M. Castillo, CHIE, Board Member, New Jersey Transit
Corporation (NJ TRANSIT)

THE NATIONAL ACADEMIES

Advisers to the Nation on Science, Engineering, and Medicine

The **National Academy of Sciences** is a private, nonprofit, self-perpetuating society of distinguished scholars engaged in scientific and engineering research, dedicated to the furtherance of science and technology and to their use for the general welfare. On the authority of the charter granted to it by the Congress in 1863, the Academy has a mandate that requires it to advise the federal government on scientific and technical matters.

Dr. Ralph J. Cicerone is president of the National Academy of Sciences.

The **National Academy of Engineering** was established in 1964, under the charter of the National Academy of Sciences, as a parallel organization of outstanding engineers. It is autonomous in its administration and in the selection of its members, sharing with the National Academy of Sciences the responsibility for advising the federal government. The National Academy of Engineering also sponsors engineering programs aimed at meeting national needs, encourages education and research, and recognizes the superior achievements of engineers. Dr. Charles M. Vest is president of the National Academy of Engineering.

The **Institute of Medicine** was established in 1970 by the National Academy of Sciences to secure the services of eminent members of appropriate professions in the examination of policy matters pertaining to the health of the public. The Institute acts under the responsibility given to the National Academy of Sciences by its congressional charter to be an adviser to the federal government and, on its own initiative, to identify issues of medical care, research, and education. Dr. Harvey V. Fineberg is president of the Institute of Medicine.

The **National Research Council** was organized by the National Academy of Sciences in 1916 to associate the broad community of science and technology with the Academy's purposes of furthering knowledge and advising the federal government. Functioning in accordance with general policies determined by the Academy, the Council has become the principal operating agency of both the National Academy of Sciences and the National Academy of Engineering in providing services to the government, the public, and the scientific and engineering communities. The Council is administered jointly by both the Academies and the Institute of Medicine. Dr. Ralph J. Cicerone and Dr. Charles M. Vest are chair and vice chair, respectively, of the National Research Council.

The **Transportation Research Board** is one of six major divisions of the National Research Council. The mission of the Transportation Research Board is to provide leadership in transportation innovation and progress through research and information exchange, conducted within a setting that is objective, interdisciplinary, and multimodal. The Board's varied activities annually engage about 7,000 engineers, scientists, and other transportation researchers and practitioners from the public and private sectors and academia, all of whom contribute their expertise in the public interest. The program is supported by state transportation departments, federal agencies including the component administrations of the U.S. Department of Transportation, and other organizations and individuals interested in the development of transportation. www.TRB.org

www.national-academies.org



TRANSPORTATION RESEARCH BOARD

500 Fifth Street, NW
Washington, DC 20001

THE NATIONAL ACADEMIES™

Advisers to the Nation on Science, Engineering, and Medicine

The nation turns to the National Academies—National Academy of Sciences, National Academy of Engineering, Institute of Medicine, and National Research Council—for independent, objective advice on issues that affect people's lives worldwide.

www.national-academies.org