

## Winter Maintenance and Surface Transportation Weather

### DETAILS

---

0 pages | 8.5 x 11 | PAPERBACK

ISBN 978-0-309-43103-3 | DOI 10.17226/17650

### AUTHORS

---

Winter Maintenance Committee and Surface Transportation Weather Committee

BUY THIS BOOK

FIND RELATED TITLES

### Visit the National Academies Press at [NAP.edu](http://NAP.edu) and login or register to get:

---

- Access to free PDF downloads of thousands of scientific reports
- 10% off the price of print titles
- Email or social media notifications of new titles related to your interests
- Special offers and discounts



Distribution, posting, or copying of this PDF is strictly prohibited without written permission of the National Academies Press. (Request Permission) Unless otherwise indicated, all materials in this PDF are copyrighted by the National Academy of Sciences.

TRANSPORTATION RESEARCH  
**CIRCULAR**

Number E-C162

April 2012

**Winter  
Maintenance  
and Surface  
Transportation  
Weather**

**International Conference on  
Winter Maintenance and Surface  
Transportation Weather**

**April 30–May 3, 2012**



**TRANSPORTATION RESEARCH BOARD  
OF THE NATIONAL ACADEMIES**

## TRANSPORTATION RESEARCH BOARD 2012 EXECUTIVE COMMITTEE OFFICERS

**Chair: Sandra Rosenbloom**, Professor of Planning, University of Arizona, Tucson

**Vice Chair: Deborah H. Butler**, Executive Vice President, Planning, and CIO, Norfolk Southern Corporation, Norfolk, Virginia

**Division Chair for NRC Oversight: C. Michael Walton**, Ernest H. Cockrell Centennial Chair in Engineering, University of Texas, Austin

**Executive Director: Robert E. Skinner, Jr.**, Transportation Research Board

## TRANSPORTATION RESEARCH BOARD 2012–2013 TECHNICAL ACTIVITIES COUNCIL

**Chair: Katherine F. Turnbull**, Executive Associate Director, Texas Transportation Institute, Texas A&M University, College Station

**Technical Activities Director: Mark R. Norman**, Transportation Research Board

**Paul Carlson**, Research Engineer, Texas Transportation Institute, Texas A&M University, College Station, *Operations and Maintenance Group Chair*

**Thomas J. Kazmierowski**, Manager, Materials Engineering and Research Office, Ontario Ministry of Transportation, Toronto, Canada, *Design and Construction Group Chair*

**Ronald R. Knipling**, Principal, safetyforthelonghaul.com, Arlington, Virginia, *System Users Group Chair*

**Mark S. Kross**, Consultant, Jefferson City, Missouri, *Planning and Environment Group Chair*

**Peter B. Mandle**, Director, LeighFisher, Inc., Burlingame, California, *Aviation Group Chair*

**Harold R. (Skip) Paul**, Director, Louisiana Transportation Research Center, Louisiana Department of Transportation and Development, Baton Rouge, *State DOT Representative*

**Anthony D. Perl**, Professor of Political Science and Urban Studies and Director, Urban Studies Program, Simon Fraser University, Vancouver, British Columbia, Canada, *Rail Group Chair*

**Steven Silkunas**, Director of Business Development, Southeastern Pennsylvania Transportation Authority, Philadelphia, Pennsylvania, *Public Transportation Group Chair*

**Peter F. Swan**, Assistant Professor of Logistics and Operations Management, Pennsylvania State, Harrisburg, Middletown, Pennsylvania, *Freight Systems Group Chair*

**James S. Thiel**, General Counsel, Wisconsin Department of Transportation, *Legal Resources Group Chair*

**Thomas H. Wakeman**, Research Professor, Stevens Institute of Technology, Hoboken, New Jersey, *Marine Group Chair*

**Johanna P. Zmud**, Director, Transportation, Space, and Technology Program, RAND Corporation, Arlington, Virginia, *Policy and Organization Group Chair*

TRANSPORTATION RESEARCH CIRCULAR E-C162

# Winter Maintenance and Surface Transportation Weather

**International Conference on  
Winter Maintenance and  
Surface Transportation Weather**

**April 30–May 3, 2012**

**Coralville, Iowa**

*Sponsored by*  
Transportation Research Board of the National Academies

*In Cooperation with*  
Iowa Department of Transportation  
American Association of State Highway and Transportation Officials  
Federal Highway Administration

April 2012

**Transportation Research Board  
500 Fifth Street, NW  
Washington, DC 20001  
[www.TRB.org](http://www.TRB.org)**

TRANSPORTATION RESEARCH CIRCULAR E-C162  
ISSN 0097-8515

The **Transportation Research Board** is one of six major divisions of the National Research Council, which serves as an independent adviser to the federal government and others on scientific and technical questions of national importance. The National Research Council is jointly administered by the National Academy of Sciences, the National Academy of Engineering, and the Institute of Medicine. The mission of the Transportation Research Board is to provide leadership in transportation innovation and progress through research and information exchange, conducted within a setting that is objective, interdisciplinary, and multimodal.

The **Transportation Research Board** is distributing this Circular to make the information contained herein available for use by individual practitioners in state and local transportation agencies, researchers in academic institutions, and other members of the transportation research community. The information in this Circular was taken directly from the submission of the authors. This document is not a report of the National Research Council or of the National Academy of Sciences.

**Operations and Preservation Group**

Paul J. Carlson, *Chair*

**Maintenance and Preservation Section**

John P. Burkhardt, *Chair*

**Winter Maintenance Committee**

Max Samuel Perchanok, *Chair<sup>a</sup>*

Joseph Brett Althouse  
Roya Amjadi  
Lisa Ballard  
Dennis W. Belter  
David L. Bergner  
John P. Burkhardt  
Madhav V. Chitturi  
Peter F. Costello  
Tim J. Croze  
Rand Decker  
Charles C. Goodhart

Srikanth Kidambi  
Robert Scott Koefod  
David A. Kuemmel  
Chanyoung Lee  
Michael J. Loftus  
Masaru Matsuzawa<sup>b</sup>  
L. David Minsk  
Tony A. Myhra  
Richard J. Nelson

Jan Å Ölander<sup>b</sup>  
Raqib Omer  
Paul A. Pisano  
Morton Satin  
Noriyuki Sato  
Xianming Shi  
Leland D. Smithson  
Torgeir Vaa  
Yetkin Yildirim  
Jamie Yount  
Dukgeun Yun

**Surface Transportation Weather Committee**

Wilfrid A. Nixon, *Chair<sup>a</sup>*

Kathy M. Ahlenius  
Roemer M. Alfel<sup>b</sup>  
Christopher Cluett  
Nour-Eddin El Faouzi  
Tina M. Greenfield  
Arthur L. Handman<sup>b</sup>  
Gao Jianping

Richard J. Nelson  
James M. O'Sullivan  
Jan Å Ölander  
Leon F. Osborne, Jr.<sup>b</sup>  
Curt V. Pape

Max Samuel Perchanok  
Lin W. Qiu  
Adel W. Sadek  
Joshua Lawrence Seeherman  
Leland D. Smithson<sup>b</sup>  
Zhirui Ye  
Robert A. Younie

<sup>a</sup> Cochairs of Conference Program Committee

<sup>b</sup> Members of Conference Program Committee

Frank N. Lisle, *TRB Staff Representative*  
Rosa Allen, *Administration Coordinator*

**Transportation Research Board**

500 Fifth Street, NW  
Washington, DC 20001  
[www.TRB.org](http://www.TRB.org)

Glenda J. Beal, Production Editor; Jennifer Corro, Proofreader and Layout

## Preface

The 2012 International Conference on Winter Maintenance and Surface Transportation Weather was held April 30–May 3, 2012 in Coralville, Iowa. The conference was conducted by the TRB Committees on Winter Maintenance and Surface Transportation Weather in cooperation with Iowa Department of Transportation, AASHTO, and FHWA. This conference included papers and presentations on Environmental Stewardship and Sustainability, Road Safety Under Winter Conditions, Decision Support Systems, Winter Surface Friction, Blowing and Drifting Snow, Winter Mobility and Maintenance Performance, Road Weather Data Management, Climate Trends, Large-Volume Snow Control, Winter Maintenance Policy and Management, Data Networks and Quality, Delivery Approaches and Performance Measures, Optimizing Winter Maintenance Materials, Measuring and Forecasting Pavement Surface and Subsurface Conditions, Innovations in Winter Maintenance Equipment, and Weather Information to Improve Driver Decisions. Maintenance managers, engineers, and researchers from the following countries presented their papers: Canada, China, Japan, Korea, Norway, Sweden, and the United States. The papers were not subjected to the TRB peer review process.



## Contents

### ENVIRONMENTAL STEWARDSHIP AND SUSTAINABILITY

**Impact of Climate Change on the Use of Anti-Icing and Deicing Salt in Sweden** (WM-STW12-167) .....3  
 Anna K. Arvidsson, Göran Blomqvist, and Gudrun Öberg

**Sustainable Winter Maintenance and a 22-in. Blizzard: Case Study** (WM-STW12-139) .....11  
 Wilfrid Nixon and R. Mark DeVries,

**Identification of Salt-Vulnerable Areas: A Critical Step in Road Salt Management** (WM-STW12-163A) .....20  
 Andrew Betts, Nandana Perera, and Bahram Gharabaghi

**Measuring Sustainability in Winter Operations** (WM-STW12-155).....21  
 Wilfrid A. Nixon

### ROAD SAFETY UNDER WINTER CONDITIONS

**Application of Collision Prediction Models for Quantifying the Safety Benefit of Winter Road Maintenance** (WM-STW12-101) .....29  
 Taimur Usman, Liping Fu, Luis F. Miranda-Moreno, and Max S. Perchanok

**Registration of Road Vehicle Rescue Actions as a Basis for Traffic Safety Measures** (WM-STW12-111) .....43  
 Torgeir Vaa and Per Brandli

**Diagnosing Hazardous Road Surface Conditions Through Probe Vehicle as Mobile Sensing Platform** (WM-STW12-127) .....54  
 Jinhwan Jang and Namchul Baik

**Safety Impacts of Winter Weather on Iowa’s Rural Primary Highways** (WM-STW12-113A) .....62  
 Zachary Hans, Neal Hawkins, Inya Nlenanya, and Steve Lavrenz

### DECISION SUPPORT SYSTEMS

**Intelligent Transportation Solutions and Support System for Winter Road Maintenance** (WM-STW12-104) .....65  
 Jörgen Bogren and Torbjörn Gustavsson

**Geospatial Weather Decision Support for Transportation Applications** (WM-STW12-112) .....72  
 Jeremy Duensing

**Present and Future of Practical Road Weather Decision Support Research** (WM-STW12-164) .....88  
 Michael B. Chapman and Sheldon Drobot

**Decision Support Technologies: Beyond Winter Operations** (WM-STW12-116A) .....104  
 Benjamin W. Hershey, Anthony K. McClellan, and John J. Mewes



## WINTER SURFACE FRICTION

<b>Side Friction as a Parameter in Optimizing Winter Road Operations</b> (WM-STW12-110) .....	107
Torgeir Vaa and Ivar Hol	
<b>Potential of Using Warm Wetted Sand for Skid Control on Walkways and Bike Paths</b> (WM-STW12-108).....	117
Anna Niska	
<b>Trafficability of Heavy Vehicles on Inclines</b> (WM-STW12-109).....	125
Torgeir Vaa and Ivar Hol	
<b>Friction and Side Friction: Comparing Measuring Equipment with Passenger Cars</b> (WM-STW12-146A).....	139
Dagfin Gryteselv, Terje Giæver, and Torgeir Vaa	

## BLOWING AND DRIFTING SNOW

<b>Revision of <i>Highway Snowstorm Countermeasure Manual: Focus on Snowbreak Woods</i></b> (WM-STW12-131) .....	143
Manabu Kaneko, Takashi Watanabe, Masaru Matsuzawa, and Yasuhiko Ito	
<b>Snow Transport and Mitigation Modeling System for Managing Snow Drifting Along Highways</b> (WM-STW12-120).....	154
Patrick Grover, Neil Hellas, and Steven McArdle	
<b>Operational Blowing Snow Modeling: Benefits for the End User</b> (WM-STW12-114A).....	169
Leon F. Osborne, Jr., Benjamin W. Hershey, and John J. Mewes	

## WINTER MOBILITY AND MAINTENANCE PERFORMANCE

<b>Quantifying the Mobility Effects of Winter Snow Events and the Benefits of Winter Road Maintenance</b> (WM-STW12-165).....	173
Garrett Donaher, Liping Fu, Taimur Usman, and Max S. Perchanok	
<b>Winter Performance Measurement Using Traffic Speed Modeling</b> (WM-STW12-161) .....	187
Tina Greenfield, Matt Haubrich, Mark Kaiser, Zhengyuan Zhu, Daniel Fortin, and Jing Li	
<b>Weather and Friction Data Collection for Winter Road Performance Evaluation</b> (WM-STW12-128).....	198
Roberto A. Tokunaga, Makoto Kiriishi, Tetsuya Takada, Naoto Takahashi, and Tatsuya Yamazaki	
<b>Simulating Winter Maintenance for Performance Measurement</b> (WM-STW12-118) .....	208
John J. Mewes, Jeffrey Kuntz, and Benjamin W. Hershey	

## ROAD WEATHER DATA MANAGEMENT

<b>Using <i>Clarus</i> Data for Disseminating Winter Road Weather Advisories and Other Weather-Related Alerts</b> (WM-STW12-152).....	223
Roemer M. Alfelor, Paul A. Pisano, Doug Galarus, and David Yohanan	

<b>Clarus System</b> (WM-STW12-168A) .....	237
Brenda Boyce	
<b>Clarus Multistate Regional Demonstrations: Summary of Evaluation Results and Lessons Learned</b> (WM-STW12-123) .....	238
Deepak Gopalakrishna, Chris Cluett, Kevin Balke, and Paul A. Pisano	
<b>Evaluating Quality and Value of Road Weather Information</b> (WM-STW12-142) .....	253
Roemer M. Alfelor, Paul A. Pisano, Leon F. Osborne, Jr., and Robert D. Hart	

## CLIMATE TRENDS AND LARGE-VOLUME SNOW CONTROL

<b>Measures Against Avalanches Where Snow Slides Through Supporting Surfaces of Snow Bridges</b> (WM-STW12-130) .....	267
Hiroki Matsushita, Masaru Matsuzawa, Osamu Sakase, and Hiroshi Nakamura	
<b>Implementing Winter Climate Studies for Transportation Projects in Ontario, Canada</b> (WM-STW12-121) .....	279
Steven McArdle, Patrick Grover, and Neil Hellas	
<b>Recent Trends in Changes in Snowfall and Snow Depth in Japan and Their Impact on Snow-Control Measures</b> (WM-STW12-107) .....	292
Masaru Matsuzawa, Yusuke Harada, Masayo Ueda, Hiroki Matsushita, and Yasuhiko Ito	

## WINTER MAINTENANCE POLICY AND MANAGEMENT

<b>Weather or Not? State Liability and Road Weather Information Systems</b> (WM-STW12-151) .....	305
Jaime Rall	
<b>Implementing the Pennsylvania Department of Transportation’s Winter Services Strategic Plan</b> (WM-STW12-158) .....	315
Charles C. Goodhart, Bonnie J. Fields, Robert J. Vance, Michael S. Renz, Mary W. Treisbach, and Barbara T. Harder	
<b>Winter Storm Responses: Adverse Conditions Communication–Coordination Plan 2008</b> (WM-STW12-150A) .....	331
Paul Keltner	
<b>Importance of a Comprehensive Winter Operations Plan and Manual</b> (WM-STW12-141) .....	332
David L. Bergner	

## DATA NETWORKS AND QUALITY

<b>New Methods to Quality Check Road and Weather Observations for Vehicle Data</b> (WM-STW12-117) .....	349
Daniel Koller, Benjamin W. Hershey, John J. Mewes, and Anthony K. McClellan	
<b>National Mobile Environmental Observation Network: Increasing Insight to Road Weather and Surface Conditions</b> (WM-STW12-124) .....	363
Brian Bell and Paul Heppner	

**Multistate, Multisensor, and Predictive Road Condition Information** (WM-STW12-119A).....373  
 John J. Mewes, Gregory M. Ostermeier and Julie L. Theisen  
**Assessment and Evaluation of Maintenance Decision Support System Recommendations** (WM-STW12-115).....374  
 Anthony K. McClellan, Benjamin W. Hershey, Robert D. Hart, and John J. Mewes

**DELIVERY APPROACHES AND PERFORMANCE MEASURES**

**Evaluation of Three Methods for Delivery of Winter Operations Contracting** (WM-STW12-153).....391  
 Amy Burlarley-Hyland  
**Research Programs for Winter Road Maintenance in Third Medium-Term Plan of the Public Works Research Institute of Japan** (WM-STW12-129) .....401  
 Motoki Asano, Masayoshi Watanabe, Masaru Matsuzawa, Masayuki Kumagai, and Yuyi Yanagisawa  
**Performance Measures and Prediction Models Applied to Management of Henan, China, Provincial Highways** (WM-STW12-160) .....413  
 Li Ningyuan and Wei Wang

**OPTIMIZING WINTER MAINTENANCE MATERIALS**

**Combined Use of Chemicals for Deicing and Dust Binding of Paved Roads: Possibilities and Problems** (WM-STW12-137) .....425  
 Mats Gustafsson, Göran Blomqvist, and Wolfgang Hafner  
**Alternative Approaches to Measuring Deicer Ice-Melting Capacity: Optimization of Test Accuracy and Precision** (WM-STW12-145).....432  
 Scott Koefod, Jessica Adkins, and Michelle R. Akin  
**Residual Salt and Road Surface Wetness: Comparison of Field Techniques** (WM-STW12-140) .....443  
 Göran Blomqvist and Mats Gustafsson

**MEASURING AND FORECASTING PAVEMENT SURFACE AND SUBSURFACE CONDITIONS**

**Model to Forecast Short- and Long-Term Prediction of Road Surface Temperature in South Korea** (WM-STW12-102).....453  
 ChoongHeon Yang, Duk-Geun Yun, and Jung Gon Sung  
**Measuring and Predicting Soil Temperature and Moisture Content Beneath Highways in Nova Scotia, Canada: One Year of Observations and Forecasts** (WM-STW12-122) .....465  
 Benoit Pouliot, Paul Delannoy, Phil Woodhams, Shawn Allan, and Olga Kidson

**Evaluation of a Simulation of Subpavement Conditions as They Affect the Implementation and Removal of Seasonal Load Restrictions (WM-STW12-136)..... 478**  
 Robert D. Hart, Leon F. Osborne, Jr., John J. Mewes,  
 Mark A. Askelson, and Jennifer L. Hershey

**INNOVATIONS IN WINTER MAINTENANCE EQUIPMENT**

**Potential Impacts of a Multipurpose Snow Removal Instrument on Snow Removal (WM-STW12-103)..... 493**  
 Woo Hoon Jeon, Choong Heon Yang, In Su Kim, and Jun-Seok Oh

**Factors for Consideration in Selecting Snowplow Cutting Edges (WM-STW12-143) ..... 502**  
 Wilfrid A. Nixon

**Synthesis and Best Practices for Performance Evaluation of Snow and Ice Plows (WM-STW12-156A)..... 510**  
 Souhail Elhouar and Enad Mahmoud

**Benefits of Implementing Automatic Vehicle Location Technologies in Wisconsin for Winter Maintenance Operations (WM-STW12-157) ..... 511**  
 Kelvin R. Santiago-Chaparro, Madhav Chitturi, Todd Szymkowski, and David A. Noyce

**WEATHER INFORMATION TO IMPROVE DRIVER DECISIONS**

**Subjective and Objective Assessment of Winter Driving Environment (WM-STW12-126)..... 521**  
 Naoto Takahashi, Tetsuya Takada, Makoto Kiriishi,  
 Roberto A. Tokunaga, and Shigeru Kamiyama

**Condition Acquisition and Reporting System—Common Alerting Protocol Automated Weather Reporting (WM-STW12-125)..... 535**  
 Peter Davies, Kristin Virshbo, and Dane Unruh

**Study on Provision of Winter Road Snowstorm Information to Road Users (WM-STW12-132) ..... 543**  
 Hirotaka Takechi, Masaru Matsuzawa, Toshiro Kawanaka,  
 Hiroshi Nakamura, and Manabu Kaneko

**Tomorrow’s Forecast: Informed Drivers (WM-STW12-105)..... 560**  
 Sheldon Drobot, Michael B. Chapman, Amanda Anderson, Brice Lambi,  
 Paul A. Pisano, and Gabriel Guevara

**APPENDIX: Author Contact Information ..... 573**



# Environmental Stewardship and Sustainability



## ENVIRONMENTAL STEWARDSHIP AND SUSTAINABILITY

## Impact of Climate Change on Use of Anti-Icing and Deicing Salt in Sweden

ANNA K. ARVIDSSON

GÖRAN BLOMQVIST

GUDRUN ÖBERG

*Swedish National Road and Transport Research Institute*

The future needs for winter maintenance will probably be influenced by the climate change in different ways in different parts of the world. As Sweden is a country with several climate zones, the influence of climate change on winter maintenance will therefore differ between regions within the country. To understand the influence of climate change on the future needs of salt consumption in winter maintenance, modeled road weather data were calculated in the IRWIN project (a joint research project through ERA-NET ROAD funded by the 6th Framework Program of the European Commission), where climate change scenarios from ECHAM5 (the fifth generation of the European Centre Hamburg Model general circulation model from the Max-Planck Institute for Meteorology) were combined with field data from the road weather information system in Sweden. These modeled road weather data were used in project KLIVIN (the study presented here) in three Swedish regions (Gothenburg, Stockholm, and Sundsvall) and was combined with the Swedish winter severity index in order to calculate the trends of future salt needs. In this study the needs of salt for each of the three investigated regions were calculated in 30-year periods between 1970 and 2100. The results show that salt use related to snowfall will decrease in all three regions, while the salt use related to temperature will increase in the northernmost region (Sundsvall) and show a small decrease in the two other regions (Gothenburg and Stockholm).

This study has its focus on the future needs of salt for winter road maintenance in Sweden. There is not much research done in the area of climate change and winter road maintenance, and even less on the future needs of salt for anti-icing and deicing (1).

In the winter of 1993–1994 salt consumption in Sweden was 420,000 tonnes (413,400 long ton), which has been reduced, and in the winter of 2007–2008 just 184,000 tonnes (181,100 long ton) were used (2, 3). By comparison, the United Kingdom uses 2 million tonnes (1,968,000 long ton) of rock salt in an average winter (4).

In Iowa approximately \$6,500,000 are spent on salt use (5). A little over one-half of the salt use is directed toward anti-icing activities.

The Swedish west coast city of Gothenburg had an average daily minimum temperature of 0°C or below for 118 days (modeled) of the winter months November to March for the years 1970 to 2000. With the current climate change scenarios the amount of such days will be reduced by 22% by the end of the 21st century (2070 to 2100) (1). The amount of salt needed in winter road maintenance could be expected to decrease by at least 15% by the end of the 21st century if the maintenance is performed in the same way as it is today (1).

Experts have agreed that salt usage in southern and western Ontario, Canada, would be unchanged by global warming, but that salt usage would increase in northern and eastern parts of the province (6).



A study that compared three winter indices to salting activity, found that the indices differed substantially depending on what parameters were used in their formulation. In addition, they found that all three did not give a total correspondence with maintenance activity (7). Likewise, in Scotland, United Kingdom, the relationship between one index—the modified Hulme index—and maintenance expenditures investigated, found a complicated relationship between regional expenses and changes in winter severity on regional scales (8).

Climate change will affect transportation primarily through increases in several types of weather and climate extremes, such as very hot days; intense precipitation events; intense hurricanes; drought; and rising sea levels, coupled with storm surges and land subsidence (9). Climate change impacts on transportation will vary around the world, however, impacts on transportation will be widespread and costly. This will require a significant change in planning and maintenance.

## METHODS

### Climate Scenario Data

IRWIN was the acronym for the ERA-NET ROAD project “Improved local winter index to assess maintenance needs and adaptation costs in climate change scenarios” in 2008. For further description see the final report in the IRWIN project (10).

The main objective of IRWIN was to develop an improved winter road index capable of assessing the implications of climate change in various weather parameters and the related costs and benefits of winter road maintenance actions. Climate change scenarios are usually calculated from meteorological data with large limitations with respect to resolution. The idea of IRWIN was to combine the best traditionally made climate scenarios with the more accurate spatial data observed by field stations in the road weather information system (RWIS).

To make the climate change predictions, IRWIN uses the analogue model for statistical downscaling to combine the historical RWIS outstation weather data and global climate model change scenarios. To obtain road surface temperatures, the model takes the weather data in the scenario and compares it to historical data. The model is built on the atmospheric general circulation model ECHAM5 and also Intergovernmental Panel on Climate Change emission scenario A1B, which is defined by a rapidly growing economy and a global population that peaks in the middle of the century and then declines. The scenario assumes that new and more efficient technologies are rapidly introduced (11).

The modeled data is divided into four time slices in this study, November to March for baseline 1970–2000, 2020s (2010–2040), 2050s (2040–2070), and 2080s (2070–2100), and is calculated for each RWIS outstation.

From the total number of about 770 RWIS stations in Sweden, 50 were selected for the IRWIN analysis from three areas in Sweden: southwestern region with 24 stations in the area of Gothenburg, 12 stations in the east around Stockholm, and 14 stations in northeast around Sundsvall (Figure 1).

These three areas represent three types of climate in Sweden. The southwestern region was the test area for the IRWIN project, and these stations were used to establish methods to be used, and to develop routines for quality assurance. The data used for the project include: precipitation type and amount, surface and air temperature, wind speed and direction, and dew



**FIGURE 1** The three Swedish regions, Gothenburg, Stockholm, and Sundsvall with RWIS outstations. Sweden is divided into four climate zones.

point (calculated from humidity), for the winter period (November to March), 1998 to 2008 (10).

### Combining Climate Data with Winter Index

The modeled road weather data from the IRWIN project has been used in project KLIVIN. The criteria for a slippery condition used in this study are the same that the Swedish Transport Administration uses to calculate the needs for winter maintenance: four types of slipperiness (HR1, HR2, HT, and HN) and four types of actions related to snow (HS, Snow 0.31–1.00, Snow 1.01–2.50, and Snow  $\geq 2.51$ ) (Table 1).

The needed amounts of road salt were calculated for the winter seasons between 1970 and 2100 based on the number of needed actions for anti-icing and deicing.

The climate in Sweden will change during this century. Temperatures will rise somewhere between 2.5 and 4.5 degrees for the period 2071–2100 compared to baseline period (1961–1990). Changes will mostly be during the winter months due to the snow and ice conditions. The total amount of precipitation will increase in Sweden, due to more days with rain during the autumn, winter, and spring, but also heavier rain will occur (12, 13).

The maps presenting the modeled results in Figure 5 are created using the software Surfer 10 (Golden Software Inc.). The interpolation method used is omnidirectional kriging with a linear variogram.

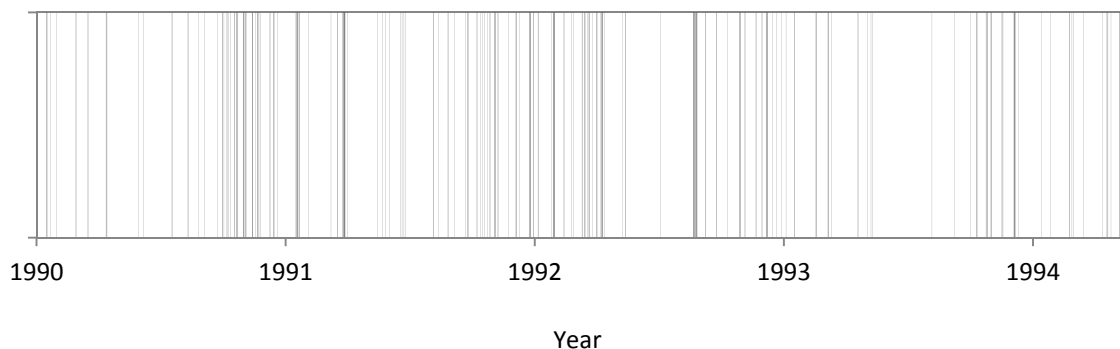
**TABLE 1 Acronyms and Definitions of Slippery Conditions**

HR1	Slippery conditions due to moderate hoarfrost. Road surface temperature below 1°C (33.8°F) and 0.5°C–2.0°C (32.9°F–35.6°F) lower than dewpoint temperature.
HR2	Slippery conditions due to severe hoarfrost. Road surface temperature below 1°C (33.8°F) and at least 2.0°C lower than dewpoint temperature.
HT	Slippery conditions due to road icing. Moist road surface freezing when road surface temperature falls below 1°C (33.8°F).
HN	Slippery conditions due to rain or sleet on a cold road. Road surface temperature below 1°C (33.8°F) and precipitation.
HS	Slippery conditions due to a small snowfall <0.30 cm (0.118 in.).
Snow 0.31–1.00	Snowfall with snow amount 0.31–1.00 cm (0.122–0.394 in.).
Snow 1.01–2.50	Snowfall with snow amount 1.01–2.50 cm (0.397–0.984 in.).
Snow ≥2.51	Snowfall with snow amount ≥2.51 cm (≥0.988 in.).

## RESULTS

The amount of winter road maintenance that is needed during a winter season differs between winter seasons. To get an idea about the variation, see the number of needed actions for the calculated slipperiness type HR1 (slippery conditions due to moderate hoarfrost) at one RWIS outstation plotted in Figure 2 for a 10-year period, 1990 to 2000. It clearly shows the differences between the winters. Because of this variance, an average of 30 winters will be used in this paper.

The IRWIN project had modeled 50 RWIS outstations every half hour between 1970 and 2100. From this set of data, eight types of slippery situations were calculated and every winter season in each region were summed and multiplied with the recommended amount of salt ( $\text{g}/\text{m}^2$ ) for each action of anti-icing or deicing. The amount of salt was then made into yearly average values for a winter (November to March) for each 30-year period, a baseline period 1980s, 2020s, 2050s, and 2080s.



**FIGURE 2 Occurrences of half hours with HR1. RWIS outstation 0601. Years 1990–2000 (modeled) and in 4-h intervals. Darker means more HR1.**

The average need for road salt in one of the outstations for the eight types of slipperiness that were specified in Table 1 is shown in Table 2. This RWIS outstation is in the southwestern part of Sweden. The two types HS and Snow  $\geq 2.51$  will almost be divided in half. They will decrease by 42%. This is a consequence of the rising temperatures, and thereby more rain than snow.

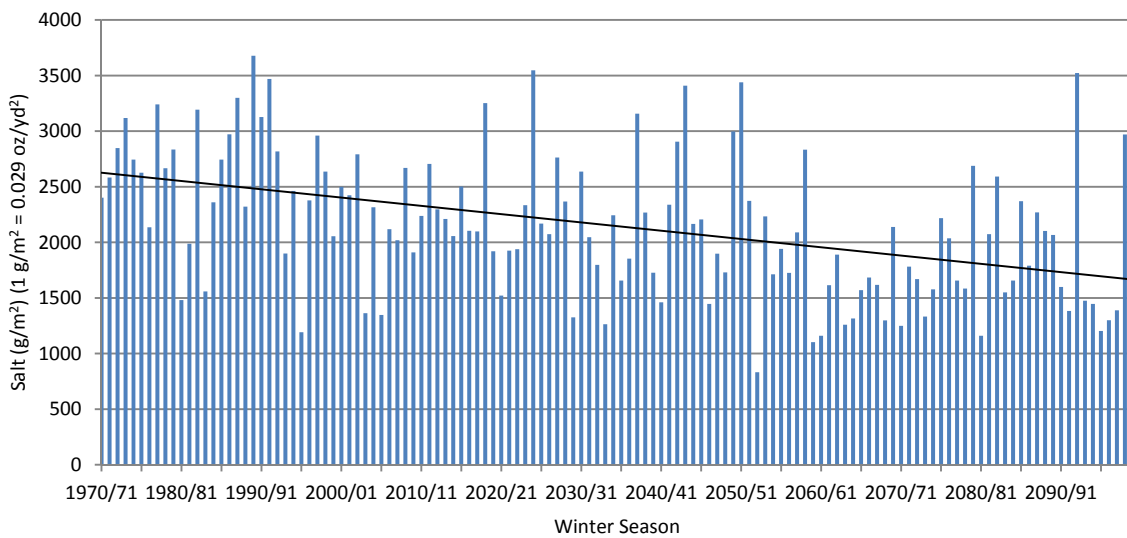
Salt use over time in Gothenburg (Figure 3) and Stockholm show a similar pattern with decreasing use of salt for both areas. In the area of Sundsvall further to the north are the scenarios for salt use increasing as much as 75% for the four slipperiness types that are related to temperature compared with the baseline period for the type HT.

For the winter road maintenance related to snow, the trends are the same for the three areas with decreasing amounts. The decreasing percentage is slightly larger in Gothenburg with an average decrease of 38% compared to 41% for Stockholm. In Sundsvall there is a decrease in salt use for the snow related maintenance (Figure 4).

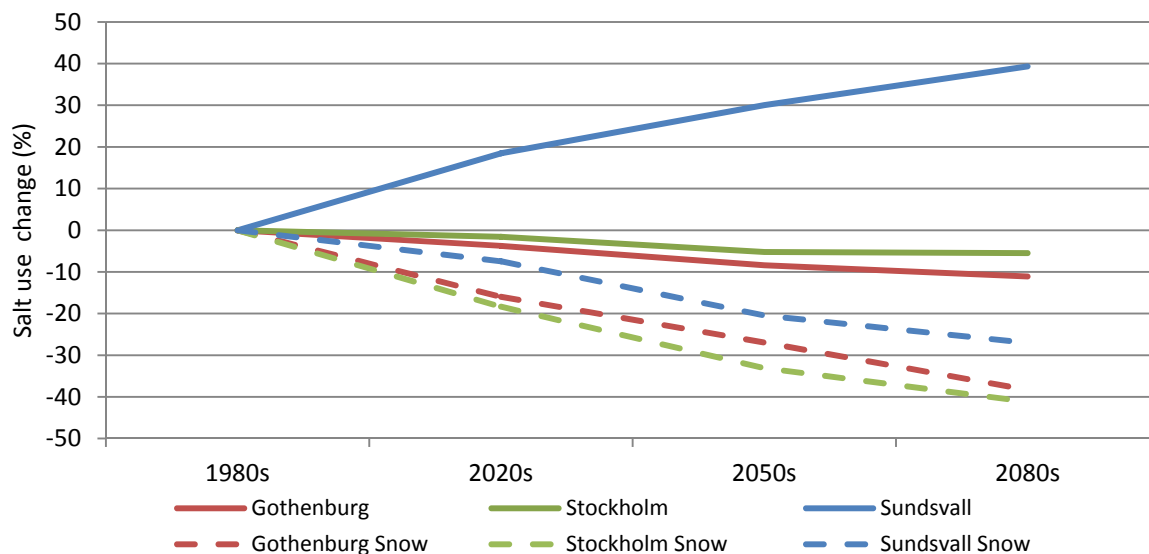
The yearly amount of salt (averaged for 30-year periods) used for winter road maintenance related to snowfall can be seen plotted in the map at the top of Figure 5 and in the bottom of the figure the salt consumption related to temperature (e.g., hoarfrost) can be seen.

**TABLE 2 Average Use of Road Salt ( $\text{g/m}^2$ ) at RWIS Outstation 0601 for the Eight Types of Slipperiness ( $1 \text{ g/m}^2 = 0.029 \text{ oz/yd}^2$ )**

	HR1	HR2	HT	HN	HS	Snow 0.31–1.00	Snow 1.01–2.50	Snow $\geq 2.51$
1980s	166	35	226	446	84	388	691	556
2020s	159	34	238	438	62	314	546	410
2050s	153	33	209	411	53	256	469	362
2080s	150	29	212	408	49	228	444	323



**FIGURE 3 Salt use per winter season in RWIS outstation 0601 in the Gothenburg area. A decreasing trend of  $7.5 \text{ g/m}^2$  ( $0.22 \text{ oz/yd}^2$ ) per year ( $1 \text{ g/m}^2 = 0.029 \text{ oz/yd}^2$ ).**



**FIGURE 4 Salt use change in Gothenburg, Stockholm, and Sundsvall in 21st century. Temperature-related maintenance is marked by solid lines, and snow-related maintenance is marked by dashed lines.**

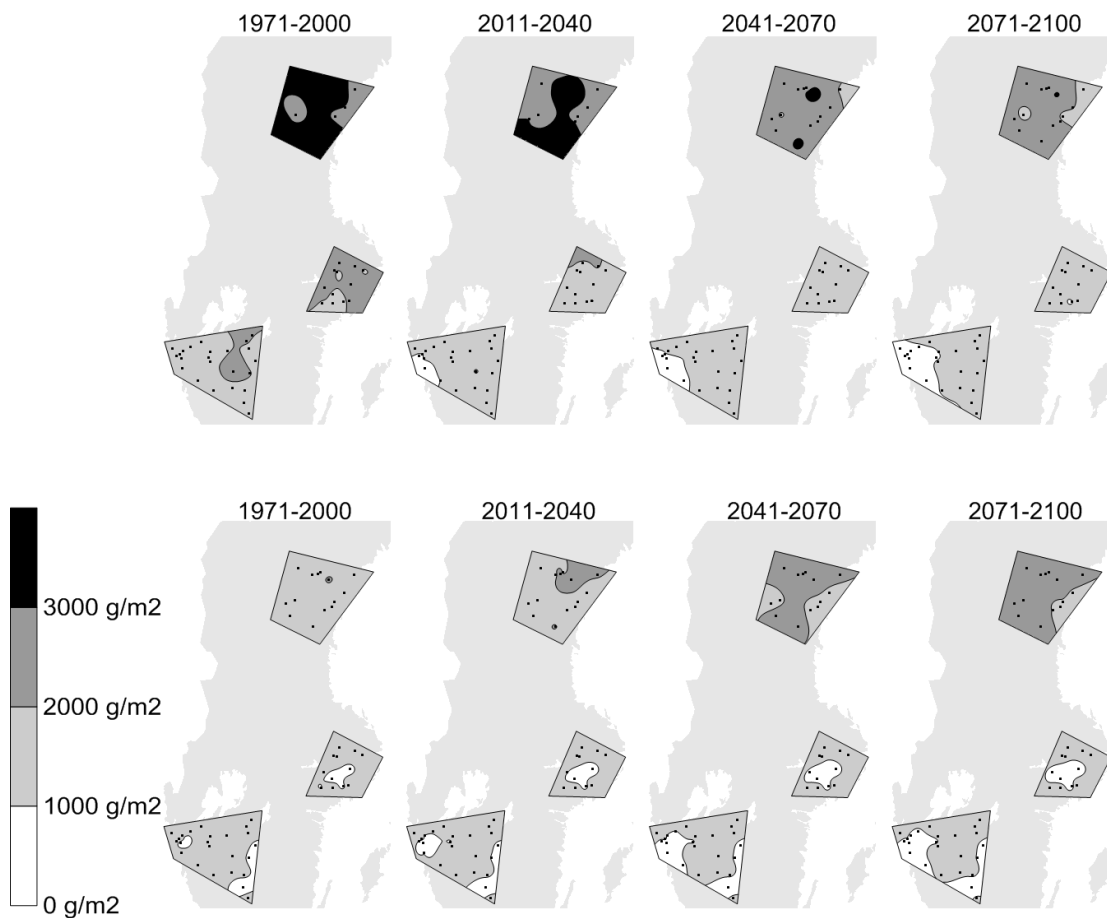
When each station's salt consumption is linked together the geographical differences appear clearly. One example is in the northern area where the rising temperature will have a great effect with more marginal nights and this area might need over 100 more salting actions per winter season compared with today. This pattern is clearly visible as the darker area takes over more and more in Figure 4.

## DISCUSSION AND CONCLUSION

The Swedish Transport Administration and the Swedish Government are aiming to lower the use of salt for winter road maintenance without compromising road safety or accessibility. This study has shown that, given the same rules and methods used in winter maintenance in the future as used today, the total amount of salt will decrease due to climate change.

Today the criteria for winter road maintenance on the major highways is that the lanes should be free from ice and snow if the temperature is above  $-6^{\circ}\text{C}$  ( $21.2^{\circ}\text{F}$ ). If it is colder, the criteria of the road standard is lowered. There are no salting activities if the temperature is below  $-12^{\circ}\text{C}$  ( $10.4^{\circ}\text{F}$ ), unless the weather forecast is indicating rising temperatures. This is one reason for the increase of salt consumption in the northern parts of the country. Sundsvall city has an average of  $-7.5^{\circ}\text{C}$  ( $18.5^{\circ}\text{F}$ ) for January (1961 to 1990) and Sundsvall airport has an average January temperature of  $-9^{\circ}\text{C}$  ( $15.8^{\circ}\text{F}$ ) (14), so an increase in temperature will have effects. Gothenburg and Stockholm have average temperatures of  $-0.9^{\circ}\text{C}$  ( $30.4^{\circ}\text{F}$ ) and  $-2.8^{\circ}\text{C}$  ( $27.0^{\circ}\text{F}$ ), respectively (14).

Overall, the use of road salt will decrease in Sweden. This study has covered a small part of the country, and it would be interesting to see a more complete pattern for Sweden or the Nordic countries, perhaps with the emphasis on the impacts on the environment.



**FIGURE 5** Development in yearly salt consumption ( $\text{g/m}^2$ ) ( $1 \text{ g/m}^2 = 0.029 \text{ oz/yd}^2$ ) for snow-related maintenance (top) and temperature-related maintenance (bottom).

## REFERENCES

1. Andersson, A. K. Winter Road Conditions and Traffic Accidents in Sweden and UK: Present and Future Climate Scenarios. PhD thesis. University of Gothenburg, 2010.
2. Årsredovisning. Publication 1999:33. The Swedish Transport Administration, Borlänge, 1999 (in Swedish).
3. Annual Report 2008. Publication 2009:32. The Swedish Transport Administration, Borlänge, 2009.
4. Salt Union Ltd. Salt Union: 2011. Available from <http://www.saltunion.com>. Accessed October 18, 2011.
5. Burkheimer, D. A Winter Weather Index for Estimating Winter Roadway Maintenance Costs. *Journal of Applied Meteorology*, Vol. 43, 2004, pp. 1783–1790.
6. Lemmen, D. S., F. J. Warren, E. Barrow, R. Schwartz, J. Andrey, and B. Mills, et al. Climate Change Impacts and Adaptation: A Canadian Perspective. Climate Change Impacts and Adaptation Directorate, Natural Resources Canada, Ottawa, Ontario, 2004.
7. Gustavsson, T. Test of Indices for Classification of Winter Climate. *Meteorological Applications*, Vol. 3, 1996, pp. 215–222.
8. Cornford, D., and J. E. Thornes. A Comparison Between Spatial Winter Indices and Expenditure on Winter Road Maintenance in Scotland. *International Journal of Climatology*, Vol. 16, 1996, pp. 339–357.

9. *Special Report 290: Potential Impacts of Climate Change on U.S. Transportation*. Transportation Research Board of the National Academies, Washington, D.C., 2008.
10. Saarikivi, P., T. Gustavsson, and D. Rayner. Improved Local Winter Index to Assess Maintenance Needs and Adaptation Costs in Climate Change Scenarios. IRWIN Final Report. ERA-NET ROAD, 2009.
11. Summary for Policy Makers, Emissions Scenarios. Intergovernmental Panel on Climate Change, Working Group III, 2000, p. 27.
12. Solomon, S., D. Qin, M. Manning, Z. Chen, M. Marquis, and K. B. Averyt. IPCC 2007: Climate Change 2007: The Physical Science Basis. Contribution of Working Group I to the Fourth Assessment Report of the Intergovernmental Panel on Climate Change. Cambridge University Press, United Kingdom and New York, 2007, p. 996.
13. SMHI/Rosby Centre. Scenariokartor/Scenario Maps: 2011. Available at <http://www.smhi.se/klimatdata/klimatscenarier/scenariokartor>. Accessed 6 October 2011.
14. SMHI. Dataserier med normalvärden för perioden 1961–1990 (in Swedish). Available at <http://www.smhi.se>. Accessed October 25, 2011.

## ENVIRONMENTAL STEWARDSHIP AND SUSTAINABILITY

**Sustainable Winter Maintenance and a 22-in. Blizzard**  
*Case Study***WILFRID A. NIXON***University of Iowa***R. MARK DEVRIES***McHenry County Department of Transportation*

On February 1 and 2, 2011, a particularly severe winter storm occurred across a broad swath of the United States. The storm hit the Midwest particularly hard, and areas around Chicago, Illinois, received close to 2 ft of new snow. Additionally, winds during the storm were very high, with wind speeds in excess of 50 mph not uncommon. Snowfall began on Tuesday, February 1 and for the most part had ended in the Chicago area by 9:00 a.m. on Wednesday, February 2. Many roads in the area were blocked with abandoned cars and other vehicles, and drifts in excess of 6 ft in height were not uncommon. For example, as shown in many news reports (See <http://latimesblogs.latimes.com/chatter/2011/02/lake-shore-drive.html>, <http://www.examiner.com/community-life-in-chicago/lake-shore-drive-chicago-reopened-after-blizzard-car-claim-info>, and [http://www.huffingtonpost.com/2011/02/04/chicago-blizzard-stranded\\_0\\_n\\_818577.html](http://www.huffingtonpost.com/2011/02/04/chicago-blizzard-stranded_0_n_818577.html) as examples), several hundred vehicles were caught in deep drifts on Lakeshore Drive in Chicago. McHenry County, Illinois, is located about 50 mi north of Chicago and received 22 in. of new snow in this storm. The County Division of Transportation has been implementing sustainable winter maintenance practices over the past several years, with a particular (although not exclusive) emphasis on limiting chemical usage. This paper reports on how McHenry County handled this storm, emphasizing how planning guided the storm response, and the end results of the activities. By 6:00 p.m. on Wednesday, February 2, all county roads were passable, and more than 70% of the lane miles were in a bare and wet condition. This makes clear that application of the principles of sustainability does not have to mean a reduced level of service for road users in winter conditions.

On February 1 and 2, 2011, a particularly severe winter storm occurred across a broad swath of the United States. The storm hit the Midwest particularly hard, and areas around Chicago received close to 2 ft of new snow. Additionally, winds during the storm were very high, with wind speeds in excess of 50 mph not uncommon. The blizzard began on Tuesday, February 1 and for the most part had ended in the Chicago area by 9:00 a.m. on Wednesday, February 2. Many roads in the area were blocked with abandoned cars and other vehicles, and drifts in excess of 6 ft in height were not uncommon.

This paper reviews how the department of transportation (DOT) in McHenry County handles winter storms. The results of the efforts of the McHenry County DOT are presented, and certain special actions taken during the storm are discussed.



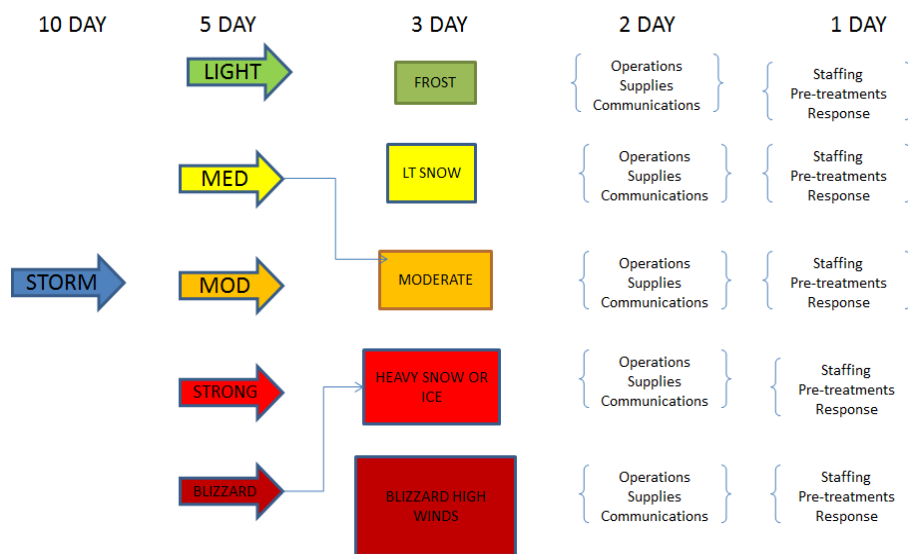
## DESCRIPTION OF McHENRY COUNTY

McHenry County is located north of Chicago, Illinois. About 300,000 people live within the county. The county has 455 lane miles of road to maintain, and these are maintained at three levels of service. A given road or road segment is assigned a level of service based primarily upon average annual daily traffic (AADT).

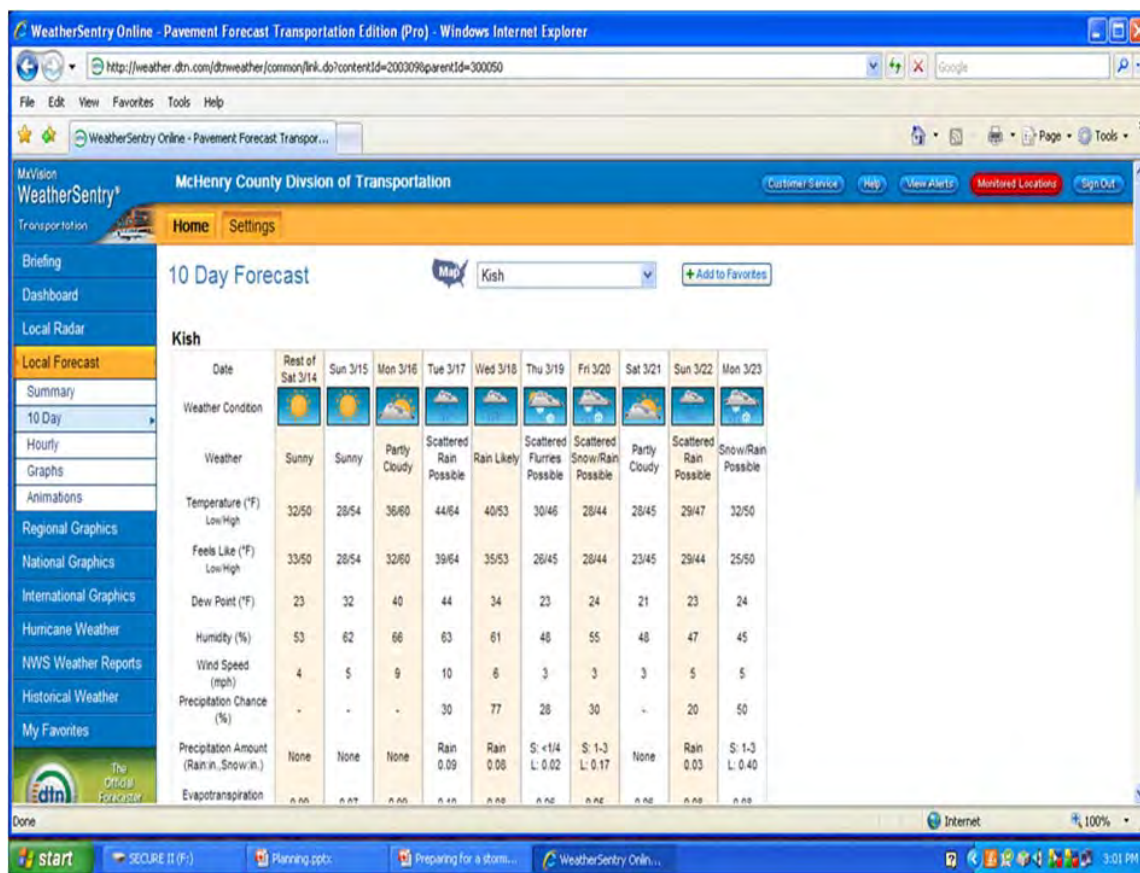
## THE 10-DAY PROCESS

Planning for storms in McHenry County operates on a 10-day process. There are two reasons for this. First, most forecasts will not go beyond 10 days. Indeed, beyond 3 days, forecasts become significantly less reliable due to the chaotic dynamic nature of weather systems. Second, 10 days provides a reasonable timeframe for all steps that need to be taken to happen. For the county, there are a series of decision and action points within the 10 day timeframe. Specifically, actions occur at 10 days, 5 days, 3 days, 2 days, and 1 day prior to the storm. Figure 1 demonstrates this planning process schematically.

Ten-day forecasts, even though often highly uncertain, are part of many weather products used by winter maintenance agencies within North America (and no doubt elsewhere). Figure 2 shows an example for McHenry County’s forecast provider from the 2010–2011 winter season. As can be seen, in this 10-day forecast, precipitation is shown as possible for 6 of the 10 days. It is unclear from the forecast whether the 6 days represent six different events, or whether some of those represent one single long event; for example, days 4, 5, 6, and 7 all show possible precipitation. In order to clarify this, it is standard practice for McHenry County personnel to contact their forecasting service to ask for clarification on any possible precipitation event. Thus, upon receiving the forecast shown in Figure 2, they would contact their forecaster to ask whether the snow–rain possible on day 10 is the same precipitation event as the scattered rain possible shown on day 9.



**FIGURE 1 Schematic representation of 10-day winter storm planning process.**



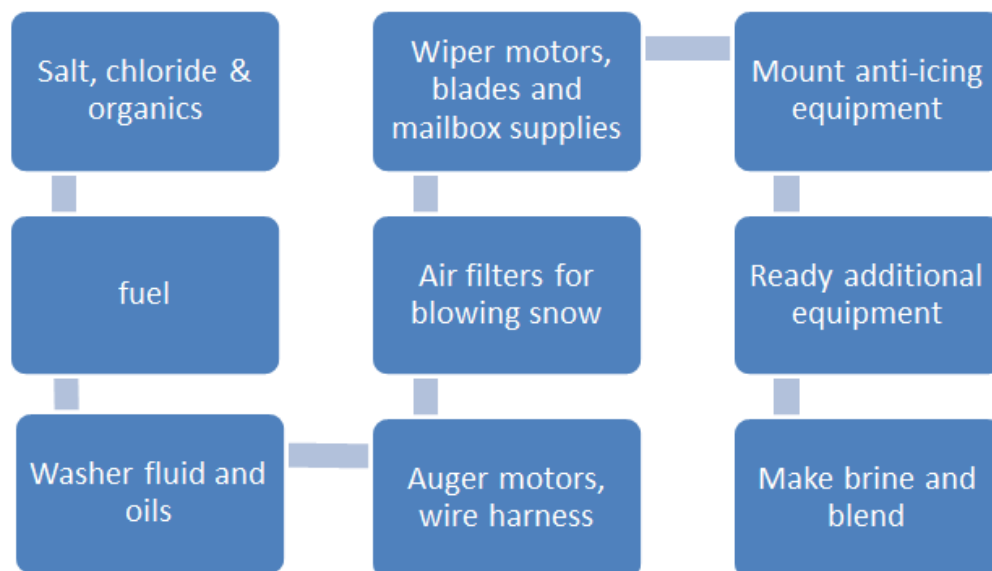
**FIGURE 2** Ten-day forecast for McHenry County during 2010–2011 winter season.

### Day 10 Actions

Because of the high degree of uncertainty of the forecast 10 days out, relatively few actions are taken between the 10-day and the 5-day action points. Primarily, staff is informed that an event may be occurring on that day, and what the nature of that event is predicted to be. The event type and likelihood are updated daily for the staff so that they can be prepared for future action. A key factor at this time is what type of storm is expected. As shown in Figure 1, McHenry County classifies winter events in one of five ways: frost, light snow, moderate snow, heavy snow or ice storm, and blizzard (heavy snow with high winds).

### Day 5 Actions

Even though there is still a significant level of uncertainty in the storm forecast 5 days before the event, planning in McHenry County begins for the different possible storm types at the 5-day mark. Particularly important at this time is ensuring that materials, fuels, and parts are available (some parts, for example, take 5 days for ordering and delivery). Since McHenry County uses a blended brine, they will start to make and blend brine at this point in time, if they do not already have full stocks. Figure 3 shows a schematic of the steps taken 5 days out.



**FIGURE 3** Schematic of actions taken by McHenry County at 5 days.

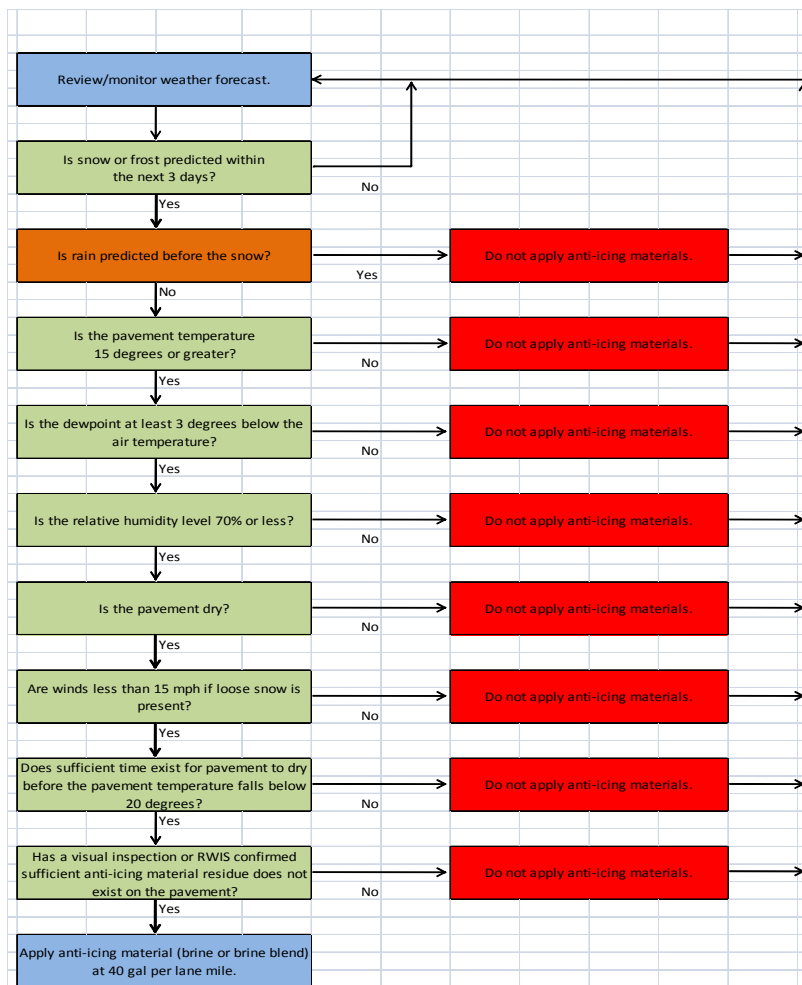
### Day 3 Actions

At this point, the reliability of the forecast begins to improve dramatically. While there may still be some uncertainty about the exact start and end times of the storm, the general nature of the storm will be increasingly clear at this point. McHenry County uses proactive winter maintenance, and applies liquid ice control chemicals (primarily a blended brine) prior to storms when conditions are appropriate. In order to determine whether or not application is appropriate, they use the decision tree shown in [Figure 4](#).

Not all of the information needed to make a go–no-go anti-icing decision will be available 3 days out, but by going to the chart at this stage, staff will have a good idea as to whether or not anti-icing is likely to be used. If it is, then they can start preparing equipment to go out, with sufficient time available to allow all anti-icing applications to be completed prior to the storm. The goal of the anti-icing is to prevent the formation of a bond between the snow (or ice) and the pavement itself, so that the snow can be easily plowed off the pavement.

In addition to determining whether anti-icing should be used, four other major activities take place at the 3-day action point. A prestorm meeting with supervisors is held. Items on the agenda include whether anti-icing is likely to be required, as well as a discussion of the form the storm is likely to take. This latter includes start and end time, precipitation type ([Figure 1](#)) and matters relating to equipment, contractors, vendors, and all other personnel. The second activity derives directly from the first, and is the formation of a response, or a specific tactical plan, for the storm. Of course, the storm is still only a forecast at this point, so the plan may well change, but having a plan allows a starting point from which adjustments can be made. The third and fourth activities are contacting and informing all people who will be directly involved in the storm, and checking that all equipment and resources are available and on hand.

In the case of a very severe event being forecasted, a number of additional steps are also taken. These include booking hotel rooms for personnel: a plow driver who is stuck at home by severe weather cannot be out driving their plow, so ensuring that personnel are where they are



**FIGURE 4 Anti-icing application decision flowchart.**

needed is critical. Depending on the nature of the severe event, contractors who deal with snow removal and downed tree limb removal are also contacted. While the damage that an ice storm does in the way of tree destruction is perhaps inevitable, preparation before the storm can make clean up go much more smoothly.

**Day 2 Actions**

At this point, the forecast is becoming much more reliable. Information about the start and end times of the storm become clearer, and the precipitation type will also be clarified. For McHenry County, anti-icing has to start at this point in time, since it takes nearly 2 days of effort to anti-ice their whole system, so the decision made the day prior (see above) is now implemented, or adjusted if changes have occurred and then implemented.

It is at this time that pavement conditions (primarily pavement temperature) come into the picture operationally. Application rates are (for McHenry County) a function of pavement temperature (among other factors, which include the type of storm and the cycle time for a given

route). Given this, monitoring of pavement temperature and use of that temperature in application rate decisions is critical.

In addition to a new focus on pavement temperature, the prestorm meeting for supervisors is reconvened. If there have been changes in the storm forecast, the tactical plan for the storm is revised accordingly. The progress of anti-icing applications is reviewed, and resources are reallocated if needed to allow the pretreatment to be completed in a timely manner. Additionally, the road system is reviewed for any hazards that may have arisen (e.g. fallen trees or blocked drains) so these can be dealt with prior to the start of the storm. Finally, steps are taken to inform the media about the upcoming storm, and to establish (or more accurately, reestablish) communication links for storm updates.

## **Day 1 Actions**

The day immediately prior to the forecast storm start requires even greater attention to the forecast, and to tracking the storm as it approaches McHenry County. This is when consulting with the forecast provider is perhaps most important.

Depending on the length of the storm or on the storm severity, a decision is made to either run one single shift or to split shifts. If the storm is severe (heavy snow, ice, or blizzard) or if the storm duration is expected to exceed 16 h, then shifts are split. When a single shift operates, there are 22 trucks assigned to 19 routes. When shifts are split, there are 12 trucks on 12 routes. In total, 28 personnel are available for truck operations.

In addition to the decision on splitting shifts, a number of other events occur during the day. The forecast is posted, and all staff are informed of the tactical plan. This includes informing staff of the expected application rate for chemicals during the storm. This has been a most useful step in terms of ensuring that salt is not used excessively, since in the poststorm review, all operators have to discuss their actual salt usage during the storm in comparison with the forecasted application rates. Also, the whole staff of the McHenry County DOT, not just the plow operators and their supervisors, is informed via e-mail of the storm forecast and the expected response.

During this final preparation day, trucks are prefilled with both rock salt, and with liquid brine mixtures, the latter being used to prewet the salt on application. Depending on the expected storm type, the start time may be predetermined, or staff may be informed that they will be called when they have to report. For severe events, hotel room bookings are finalized and rooms are assigned to personnel. The county sheriff and the county management team are informed of the expected storm and the planned response, and are provided with appropriate briefing materials. Nonsnow staff (e.g., the engineering staff) are informed of their roles for severe events, in tasks such as fuel runs, and any specialized heavy equipment (e.g., if tree clearing is expected to be a requirement) is repositioned.

With severe events, extra tasks are undertaken to provide the best possible information to the public. To the greatest extent possible during such events, people should stay home unless absolutely necessary, as this both makes snow plowing easier and safer, and reduces the need for trucks to be diverted to rescue stranded motorists. There are a series of meetings planned in such circumstances with schools, courts, area municipalities, and the media, and rather than simply informing the management team by e-mail, they are given an in-person briefing of the upcoming event. Notices of building closures and cancellations are sent out by a variety of channels, such

as the county website, press releases, the county Facebook account, and the county Twitter account. Finally, and again for severe events, the Emergency Operations Center may be opened.

Clearly, the set of Day 1 actions is extensive and somewhat complex. One benefit of having a well described, defined, and detailed plan in place is that this reduces the chance of a step being overlooked. Enough things will go wrong during a winter storm anyway that taking steps to reduce problems before they happen is well worthwhile.

## THE BLIZZARD EVENT

The blizzard started in McHenry County at about 8:00 p.m. on Tuesday, February 1, 2011. Only 3 days prior, the forecast had been indicating a storm of about 6 in. total snow, but over the weekend, it became clear that a significant amount of snow was going to fall, with calls for 18 in. of snow being forecast for Sunday. In actuality, 22 in. of snow fell on McHenry County during this event. Wind speeds were very high from the start of the storm until the end, with gusts over 50 mph not uncommon and sustained wind speeds in the 20- to 30-mph range throughout the storm. The air temperature and pavement temperature were both relatively warm, which is to be expected in general with such high precipitation levels, and were in the lower 20s (degrees Fahrenheit) throughout the storm. The snow was a wet heavy snow, which in lighter winds would not have drifted, but in this case, because of the very high wind speeds, drifted easily and often. [Figure 5](#) gives some indication of the degree of drifting.

In actuality, it had started to snow by 4:00 p.m. on January 31. That night and into the following day about 3 in. of snow fell, and it never really stopped snowing before the blizzard began. The winds began to pick up on the morning of February 1, and by 10:00 a.m. wind speeds were 21 mph. Reports of stranded vehicles began to accumulate at about 4:00 p.m. on the afternoon of February 1, even though the snow was still light at that time. By 9:30 p.m. a number of plow trucks had to stop plowing because visibility was so poor that continuing plowing was unsafe. Anti-icing was not performed prior to the storm because of the ongoing light snowfall for the preceding hours. All trucks were preloaded with salt (and prewetting liquid) but the major emphasis during the storm was plowing rather than plowing and chemical application. This was because the snow was falling at 2 to 3 in. per hour, and the major goal was to keep roads open,



**FIGURE 5** Drifting during the blizzard.

rather than trying to achieve bare and wet pavement after a plowing pass. However, salt was applied during the light snow on the day prior to the blizzard, and this application really paid dividends at the end of the storm, because it had stopped the snow from freezing to the pavement, and thus final clean-up was much easier, with the snow “peeling off” the road with little effort. Of course, some salt was applied at particular locations (e.g. intersections) during the storm but the total salt usage during the blizzard was significantly less than the county would use during a 2- to 6-in. snowstorm.

During the storm itself, the goal was to keep the depth of snow on the roads to a level that was passable with care. In particular, in such circumstances, the ability of emergency vehicles to get through was critical. Two factors complicated the storm fighting (beyond the very heavy snow and high winds). First, snowplow trucks were used fairly often during the night to assist the sheriff’s office with rescue of stranded motorists. Obviously, such actions are necessary, but equally, they mean that a plow is not working on its assigned route. The second factor complicating the McHenry County response to the storm was that conditions became so bad during the storm that some of their plow operators became stuck themselves. The problem was not only deep snow but also extremely limited visibility due to blowing snow. Again, a stuck truck is not plowing snow but fortunately, because nearby hotel accommodations had been obtained, additional personnel were available to use extra plows (a split shift was in effect, so there were plows available in the shop at all times).

The snow ended at about 9:00 a.m. on Wednesday, February 2, although there were still high winds present, which caused additional drifting. The challenge at that point became one of clean up. A 22-in. snowfall leaves a lot of snow to be moved off the road, and also many cars had been abandoned and created, if not hazards for the plow operators, then certainly, additional difficulties. As [Figure 6](#) shows, not all the vehicles that were trapped by the snow were personal vehicles.

Also evident in [Figure 6](#) is the road condition that was fairly rapidly attainable soon after the end of the blizzard. This was due to the use of anti-icing prior to the storm which, as noted above, prevented snow from bonding to the pavement and thus made subsequent clean-up much easier. By 6:00 p.m. on February 2, all of the roads in the McHenry County DOT jurisdiction were passable, and more than 70% of the lane miles were essentially bare pavement. A typical road condition by that 6:00 p.m. time is shown in [Figure 7](#).



**FIGURE 6** Trapped vehicles being rescued after the blizzard.



**FIGURE 7** Typical road condition by 6:00 p.m. on February 2, 2011.

## CONCLUSIONS

Without a doubt, the blizzard of February 1 and 2, 2011, hit the Midwest United States hard, and caused many transportation problems. However, by using a well described, defined, and detailed planning system, that begins 10 days prior to any storm, and has clear steps for all contingencies, McHenry County DOT was able to provide their customers with an excellent storm response. Furthermore, they were able to do so without using excessive quantities of chemicals. In fact, their chemical usage for this blizzard event was less than they would typically use for a 2- to 6-in. snowstorm.

## NOTE

1. See <http://latimesblogs.latimes.com/chatter/2011/02/lake-shore-drive.html>, <http://www.examiner.com/community-life-in-chicago/lake-shore-drive-chicago-reopened-after-blizzard-car-claim-info>, and [http://www.huffingtonpost.com/2011/02/04/chicago-blizzard-stranded\\_0\\_n\\_818577.html](http://www.huffingtonpost.com/2011/02/04/chicago-blizzard-stranded_0_n_818577.html) as examples.



## ENVIRONMENTAL STEWARDSHIP AND SUSTAINABILITY

**Identification of Salt-Vulnerable Areas**  
*A Critical Step in Road Salt Management*

**ANDREW BETTS**  
**NANDANA PERERA**  
**BAHRAM GHARABAGHI**  
*University of Guelph*

Northern communities repeatedly encounter snow and ice conditions forming hazardous environments on road networks during winter months. Millions of tons of road salts are applied in urban watersheds in North America for winter deicing operations. Although chlorides are nontoxic to humans, it has been shown to create toxic environments in aquatic habitats. Increasing numbers of agencies involved with winter road maintenance are working proactively to develop salt management plans that minimize the adverse environmental effects of deicing chemicals. However, the attention that has been given to another important aspect of developing a salt management plan, the identification of salt-vulnerable areas, seems to be lacking. Too few agencies attempt to identify areas vulnerable to road salts within their jurisdictions for better use of best management practices (BMPs). The low rate of participation of road agencies' work on salt-vulnerable areas seems to be due to lack of clear guidelines, proper understanding of the process, and the perception that the process may require expensive and advanced data collection and analysis. Because the effectiveness of salt management practices is highly visible in salt-vulnerable areas, it is prudent to put more effort into identification of the vulnerable areas and take action to reduce the risks. This paper presents a risk-based approach for identification of salt-vulnerable areas considering salt application rates at varying land use types, transport pathways, and exposure to receptors. A fuzzy set methodology will be used to estimate the risk associated with the exposed receptors. Transport pathways include both surface and subsurface conveyance of chlorides. This paper also highlights the significance of the contribution by private contractors on salt loadings in urban areas. This risk-based approach would help provide the opportunity to prioritize implementation of management practices in the salt-vulnerable areas. The approach presented is based on research work at Highland Creek Watershed in Toronto, Canada, and Hanlon Creek Watershed in Guelph, Canada. Part of the research work done at Highland Creek and Hanlon Creek Watersheds was monitoring at different land use types by contractors with varying winter maintenance practices. Currently there are no guidelines with respect to salt application rates in parking lots, and as a result the quantity of applied salts tends to vary based on land use and contractor. For example, a contractor who is responsible for a commercial parking lot may apply more road salts than a contractor who is responsible for an industrial parking lot. The different perceived risks associated with the varying land use typically plays a major role in the amount of salt applied in an area, and this concept must be accounted for when identifying salt-vulnerable areas. In addition to the evaluation of the potential for reducing and optimizing salt application rates, other BMPs are identified and assessed. Lining the vegetated roadside ditches to minimize groundwater contamination and the use of capture and controlled release of chloride-laden snowmelt in storm water ponds to reduce chloride peaks in stream water are presented as possible BMPs.

## ENVIRONMENTAL STEWARDSHIP AND SUSTAINABILITY

**Measuring Sustainability in Winter Operations****WILFRID A. NIXON***University of Iowa*

Prior work has indicated that a useful way to consider how to make winter operations sustainable is to consider the interaction of three driving considerations: societal, environmental, and economic. Sustainable practice will be found in the region where all three considerations intersect. This approach is valuable in that it allows an agency to determine whether a given approach or operational pattern is sustainable. However, it does not readily allow for comparison between two approaches, each of which is sustainable. In other words, it does not provide a measure of the degree of sustainability for any given action. The purpose of this paper is to describe a method where sustainability of certain winter maintenance actions can be measured, specifically in context of the three considerations (societal, environmental, and economic). By way of case studies, the use of this method is demonstrated, and areas of further work are indicated.

Two recent events underscored the importance of developing a clear picture of sustainable winter maintenance. In 2010, a 1½-day workshop was held to determine the “grand challenges” in winter maintenance (1), and in 2011, the third winter maintenance peer exchange meeting took place (2). At both meetings, the issue of sustainability was very much central to discussion. The issue ties in with international efforts through the Permanent International Association of Road Congresses Committee on Winter Service that in 2009 conducted a workshop on sustainability in winter maintenance (3).

A theme at the two North American meetings referenced above was that nobody seemed to know how to implement sustainable practices in winter maintenance. The traditional definition of sustainability, while inspirational, is not of much operational help:

“Sustainable development meets the needs of the present without compromising the ability of future generations to meet their own needs” (4).

A recent paper provided the following definition of sustainability in winter maintenance:

Sustainable winter operations are utilizing the most appropriate snow and ice control equipment, processes and materials for the unique objectives and conditions that each agency encounters in a manner that does not compromise the ability of future generations to do likewise (5).

While more specific to the field in question, and as noted in the paper where the definition was provided, this still does not provide any guidance on how the sustainability of a given winter maintenance operation can be determined. However, in that paper a detailed checklist was presented that looked at six areas of winter maintenance (Table 1) and posed evaluative questions in each of the areas (see Table 2 for an example of the questions for one of the six areas identified in Table 1).

But again, as noted by Nixon (5), the checklist is more a measure of best practices than a measure of sustainability per se. There is nothing wrong with measuring best practices. Indeed, it would be of great benefit if all agencies in the United States conducted their winter maintenance in keeping with best practices, but best practices are intended to be somewhat universal while sustainable solutions are intended to include local factors centrally and fundamentally.

The purpose of this paper is to examine how local issues should be incorporated into sustainability considerations of winter maintenance, and to suggest a method in which this incorporation could be quantified (albeit in a subjective rather than objective manner).

**SUSTAINABILITY AND LOCALITY**

One of the more useful expositions of the standard definition of sustainability given above is often referred to as the “triple bottom line” (6). In this concept, sustainability is seen as the area where fiscal, social, and environmental interests overlap. All three of these interests will have local aspects, and by careful consideration of these three areas, the local can be incorporated effectively into the sustainability framework. Indeed, it is fair to say that if local aspects are not incorporated into the sustainability framework, then the solutions obtained are

**TABLE 1 Areas of Winter Maintenance Operations Identified in the Checklist (5)**

Levels of service
Materials usage
Equipment selection and operations
Performance measurement and continuous improvement
Strategic (annual) operations
Tactical (per storm) operations

**TABLE 2 Checklist Questions in the Tactical (per Storm) Operations Area (5)**

Questions	Response Type
Do you use some sort of value-added meteorological service to provide forecasts for your winter storms?	Yes/no
Are these forecasts site specific (i.e., they provide different forecasts for different road segments)?	Yes/no
Do these forecasts provide pavement temperature forecasts?	Yes/no
Do you adapt your storm strategies depending on the time of day at which the storm starts or ends, to take account of variations in traffic levels?	Yes/no
Do you have systems in place to deal with disruptions that can occur during winter storms (e.g., equipment failure, traffic congestion, crashes)?	Yes/no
Do you use methods to dry out the road at the end of the storm for those cases where temperatures are expected to drop and wind speeds to rise?	Yes/no
Do you have systems in place that allow for easy communication with emergency services in your area?	Yes/no

fundamentally unsustainable, insofar as they do not fully reflect the three interests indicated above.

An example may help to elucidate this issue. Many agencies strive to achieve bare pavements in a certain time after the end of a storm. Some might term achieving bare pavement the state of the art of the state of the practice of winter maintenance, but that is not completely true. Bare pavement cannot in general be attained without the use of ice-control chemicals to break (or prevent) the bond between snow and pavement. Gravel roads, for example, should not be treated with ice-control chemicals as their use may destabilize the whole road. In Scandinavia (7), some low-volume roads, even though paved, are not treated to achieve bare pavement, but rather to achieve a lasting layer of abrasives on top of a groomed snow surface. We can therefore see that in certain locations the goal that is in general considered optimal (bare pavements) is not a suitable goal or level of service.

Reasons for this selection of what some may term a “lower” level of service will vary. The Scandinavian example arises from the need to treat many miles of low-volume roads. The expectation among the public is not for bare pavements but rather for a well-groomed snow surface. Similar situations occur in the United States. For example, in Kittitas County in Washington State, many of the county roads are treated in the winter to achieve a groomed snow surface rather than a bare pavement. This level of service is appropriate for a number of reasons. First, the county is rural and most county inhabitants are used to driving on snow-covered roads. Not all roads are left snow covered, so in most cases visitors to the county would not expect to travel far or at all on the snow-covered roads. Second, the county depends strongly on its agricultural activities, and in many cases irrigation ditches run alongside the roads (often less than 3 ft from the paved surface). To use ice-control chemicals on such roads would pose the risk of contaminating the irrigation water supply, whether temporarily or permanently, and so the county has decided not to use chemicals on those roads. While the end result here is a level of service that some might judge to be suboptimal, in the sustainability context it would be described as a level of service that is optimal for local conditions, which is a suitably sustainable outcome.

A number of questions arise from this example and from the more general point. First, how do we know that the level of service being used in a given agency has been determined in a sustainability-based manner? Second, what range of levels of service is appropriate? Third, does this issue of level of service say anything about how a given level of service is achieved? Fourth, level of service is only one aspect of winter maintenance, so how does this approach get broadened into other areas and what should those areas be? In answering these questions, a method can be developed to incorporate local issues into sustainability considerations of winter maintenance.

## **METHOD DEVELOPMENT**

The goal in this section of the paper is to develop a series of questions that would indicate whether an agency, in developing their winter maintenance levels of service, has appropriately considered local factors. To achieve this, the first three questions identified above will be considered in greater detail.

## Question 1: How Is Level of Service Determined?

Ideally, the level of service should result from a discussion with stakeholders. In many cases, the reality is that levels of service have developed over time, and if they receive any explicit review by stakeholders, this may amount to a discussion and vote by a board of supervisors (for example). In the worst case, levels of service are not explicitly stated but are rather an implicit, and noncommunicated, expectation within the agency.

From the viewpoint of sustainable practice, levels of service should not only be explicitly stated but also subject to some form of review and approval by stakeholders. In terms of review, some form of public forum (which could be virtual if enough stakeholders are sufficiently “connected” to be informed and to take part if they desire) is a suitable method, although others may also be considered. Approval of a level of service policy is properly the task of elected officials, and so should be undertaken by entities such as boards of supervisors or their equivalent.

However, a review of levels of service by stakeholders is difficult if the levels of service are not clearly expressed, and if the conditions which place a road segment in a given level of service is not readily apparent. [Figure 1](#) shows a road sign from Larimer County, Colorado, that eloquently expresses the six levels of service for county roads and is eminently accessible to the general public.

Thus, in a manner similar to that shown in [Table 2](#), a series of statements could be added to a winter maintenance sustainability checklist along the lines of those shown in [Table 3](#).



**FIGURE 1** Levels of service on Larimer County roads.

**TABLE 3 Inclusion of Local Factors in Sustainable Winter Maintenance**

<b>Inclusion of Local Factors</b>	<b>Response Type</b>
Are levels of service clearly expressed and easily available to the general public?	Yes/no
Is the general public regularly engaged in discussion about the levels of service?	Yes/no
Are the levels of service approved by an elected or representative body?	Yes/no

### **Question 2: What Range of Levels of Service Is Appropriate?**

Clearly an agency may choose a level of service that goes all the way from no action (see level 6 roads in Figure 1) to aiming to achieve bare pavement soon after the end of a storm. The appropriate level of service for any given road within an agency's area of responsibility will be a factor of many things, such as annual average daily traffic, emergency routes, bus routes, mail routes, major commercial routes, and so forth. In the United States there are no national levels of service, which is appropriate since level of service is very much a local choice. Accordingly, the range of level of service for an agency is properly determined by the local road users, and would be included in the questions measured in Table 3. No separate measure of the range of levels of service is required.

### **Question 3: How Is the Level of Service Achieved?**

In general the answer to this question should be "by using best practices," with the caveat that due to certain local conditions, best practices may not be possible. The sort of local conditions that might impact the use of certain winter maintenance tools could include roads close to rivers that are spawning areas for fish (abrasives should not be used because they may damage the river habitat and thus reduce fish spawning) or wetlands that are particularly sensitive to salts (none of the typical chloride deicers could be used in such locations). However, these issues are already covered in the recent checklist paper (5) with questions such as

- Do you track the total loading of materials placed on the road network each winter?
- Is this tracking for your whole network, or is it more location specific?
- Do you have a system in place to designate certain road segments as being environmentally sensitive?
- Do you use this system annually to evaluate all the road segments in your district?

Accordingly, no additional questions would be required to address this issue.

## **EXTENSION OF THE METHOD**

How might this issue of local effects be incorporated into other aspects of winter maintenance beyond levels of service? Clearly, there are a host of local factors that can impact winter maintenance. For example, some areas, especially in mountainous or hilly terrain, have many microclimates. In such cases, weather conditions and thus road conditions may change in a mile or less distance down a road. Certainly different agencies face both different fiscal or budgetary

conditions and different expectations from their customers. And as noted above, environmental concerns can vary significantly as a function of location. If the “triple bottom line” of sustainability is to mean anything in winter maintenance, then these location-specific factors (and no doubt many others) need to be addressed.

No doubt additional work is needed in this regard, and one of the goals of this work on checklist development is to publish a tool that is sufficiently developed to be tested and have its shortcomings determined. Future work in this area will provide answers to many of these issues, but for the present it is sufficient that the winter maintenance community is aware of the need to include these factors, somehow, into their deliberations on sustainable winter maintenance.

## CONCLUSIONS

Sustainability in winter maintenance is an important topic, and one about which the winter maintenance industry is greatly concerned. While a checklist approach provides certain insights into how sustainable a given winter maintenance approach is, it does not fully capture the “triple bottom line” nature of sustainability, and in particular it has difficulty in fully mirroring the inevitable local concerns that sustainability must address.

In this paper a method has been presented that goes some way toward solving the locality issue in sustainable winter maintenance. While this method remains to be fully tested, preliminary (albeit very limited) work suggests it is a good starting point from which further refinements may grow.

## REFERENCES

1. Nixon, W. A. Grand Challenges: A Research Plan for Winter Maintenance. Final Report of NCHRP 20-07 Task 287. December 2010.
2. <http://www.westerntransportationinstitute.org/professionaldevelopment/peer-exchange/default.aspx>. Accessed August 1, 2011.
3. Proc., PIARC International Seminar on Sustainable Winter Service. Czech Republic, October 7–9, 2009. [http://publications.piarc.org/en/seminars/seminars\\_09/hradeckralove\\_October09.htm](http://publications.piarc.org/en/seminars/seminars_09/hradeckralove_October09.htm). Accessed August 1, 2011.
4. United Nations General Assembly. Report of the World Commission on Environment and Development: Our Common Future. Transmitted to the General Assembly as an Annex to Document A/42/427: Development and International Co-operation: Environment, 1987. Accessed August 1, 2011.
5. Nixon, W. A., R. Nelson, R. M. DeVries, and L. Smithson. Sustainability in Winter Maintenance Operations: A Checklist. Presented at 91st Annual Meeting of the Transportation Research Board, Washington, D.C., 2012.
6. Cocu, X., and M. Marchetti. Provide Sustainable Winter Maintenance. Proc., the PIARC International Seminar on Sustainable Winter Service, Czech Republic, October 7–9, 2009.
7. Vaa, T. Implementation of New Sanding Method in Norway. Proc., *Sixth International Symposium on Snow Removal and Ice Control Technology*, Spokane, Wash., June 7–9, 2004.

# Road Safety Under Winter Conditions





## ROAD SAFETY UNDER WINTER CONDITIONS

**Application of Collision Prediction Models for  
Quantifying the Safety Benefit of Winter Road Maintenance****TAIMUR USMAN****LIPING FU***University of Waterloo***LUIS F. MIRANDA-MORENO***McGill University***MAX S. PERCHANOK***Ontario Ministry of Transportation*

**Winter road maintenance activities are intuitively beneficial due to their critical roles in maintaining the safety and mobility of highway networks in winter seasons. There is, however, no robust methodology currently available for quantifying these benefits. This paper introduces a set of collision risk models that have the potential to address this knowledge gap. The models were developed using a unique data set containing detailed hourly records of road weather and surface conditions, traffic counts, and collisions over 31 maintenance routes from Ontario, Canada, from 2000 to 2006. The developed models were used in several case studies to show their application for evaluating alternative winter maintenance policies and operations, such as shortening bare pavement recovery time, changing maintenance operation deployment time, and raising LOS standards.**

**I**n countries with severe winters such as Canada, winter road safety is a source of concern for transportation officials. Winter road safety is of particular concern because driving conditions in winter vary dramatically and deteriorate quickly due to snowfall and ice formation. This can cause a significant reduction in pavement friction and increase the risk of accidents (1–8). Weather-related crash costs including both injury and property damage crashes are estimated to be in the range of \$1 billion per year in Canada (2). Litwin and Turriffin (9) showed that the total accident cost in the province of Ontario was \$567.1 million (\$125.4 million in direct costs and \$441.7 million in indirect costs) for the year 1996. A report by Transport Canada (10) estimated accident-related costs in Ontario to be \$18 billion for the year 2004.

Winter road maintenance (WRM) activities such as plowing and salting play an indispensable role in maintaining good road surface conditions (RSC) and keeping roads safe (11–17). While essential for keeping roads safe, WRM operations also incur significant monetary costs and negative environmental effects. For example, the direct cost of winter maintenance programs in Ontario is estimated to exceed \$100 million annually (18). This represents 50% of its total annual highway maintenance budget (19). The total WRM cost is estimated to be \$1 billion in Canada, and over \$2 billion in the United States (20, 21). These estimates do not include significant indirect costs such as the damage caused to the environment, roadside infrastructure, and vehicles due to salt use (18, 22). A recent study by Environment Canada has concluded that road salts at high levels of concentration pose

a risk to plants, animals, and the aquatic environment (23). A risk management strategy for road salts was subsequently developed to provide measures to manage the risks associated with road salts (24).

The substantial direct and indirect costs associated with WRM have stimulated significant interest in quantifying the safety and mobility benefits of WRM, such that systematic cost–benefit assessment can be performed. A number of studies have been initiated in the past decade to identify the links between winter road safety and factors related to weather, road, and maintenance operations. However, most of these studies have focused on the effects of adverse weather on road safety (2, 6, 25–27). Limited efforts have been devoted to the problem of quantifying the safety benefits of WRM under specific weather conditions. Furthermore, most existing studies have taken an aggregate analysis approach, considering roads of all classes and locations together and assuming uniform road weather conditions over the entire day. This aggregate approach may average out some important environmental and operating factors that affect road safety at a micro level (e.g., a roadway section). Therefore, results may not be applicable for assessing decisions at an operational level with an analysis scope of a maintenance yard. Moreover, past studies usually do not control for the effects of traffic and RSC simultaneously. The joint interactions between road driving conditions, traffic and maintenance, and their impact on traffic safety have rarely been studied. In particular, few studies have investigated the link between road safety and RSC resulting from the mixed effects of weather, traffic, and road maintenance during snowstorms.

This paper describes a new effort that is particularly aimed at addressing the challenge of quantifying the safety effects of WRM. The paper first provides a review of literature on the topic of winter road safety, followed by an introduction of the winter collision frequency and severity models that were developed for the evaluation of the safety effects of alternative WRM. The paper then focuses on illustrating the applications of these models in answering some interesting policy questions.

## **SAFETY EFFECT OF WRM: LITERATURE REVIEW**

Significant past efforts have been directed toward road safety problems in general and winter road safety in particular. This section provides a review of studies that focused specifically on the effect of WRM on road safety. For other general winter road safety issues and research, readers are referred to Andrey et al. (2), Qiu and Nixon (7), Khattak and Knapp (28), Hermans et al. (29), Qin et al. (30), Andrey (31), and Strong et al. (32).

One of the first documented studies in the literature on the effect of WRM on road safety is provided by Hanbali (11). Hanbali conducted a before-and-after analysis to identify the effectiveness of salting on 570 mi of randomly selected divided and undivided roads in New York, Minnesota, and Wisconsin. Hanbali's analysis concluded that significant reductions in accidents were observed after salting operations. The average reduction in accident rates was 87% and 78% for two-lane undivided highways and freeways, respectively. While simple and easy to understand, the before and after analysis technique is commonly considered to be suitable mainly for experimental studies in a controlled environment (e.g., varying one factor at a time). For an observational study, before and after analysis has several significant limitations, including the inability to remove confounding effects, differentiate the effect of combined operations (e.g., plowing and salting), and estimate the effect of new snow and ice control strategies such as anti-icing.

A study in Finland (33) found that reduction of salt (from 6 to 7 T/road-km to 1.8 T/road-km) was associated with an approximate 5% increase in the number of injury accidents for highways with

traffic greater than 6,000 vehicles per day and 20% for low-volume highways (salt reduced from 6 to 7 T/road-km to 1 T/road-km).

Norrman et al. (12), was among the first to attempt to quantify the relationship between road safety and RSC. In their study, they classified RSC into 10 types based on slipperiness, and then compared the crash rates associated with the different road surface types. As a next step, they defined accident risk for a specific RSC type,  $A_t$ , defined as the ratio of the accident rate ( $A_{t,m}/h_{t,m}$ ) to the expected number of accidents for each month ( $A_m/h_m$ ) divided by the number of months  $N$ , 18 in this study ( $A_{t,m}$  is the number of accidents that had occurred under RSC  $T$  in month  $m$ , and  $h_{t,m}$  is the corresponding number of hours, whereas  $A_m$  represents all accidents during a month, and  $h_m$  the number of hours in that month). The accident risk computed was then compared to the percentage of maintenance activities performed. Norrman et al. (12) concluded that, in general, increasing maintenance reduces the number of accidents. However, the approach taken by Norrman et al. (12) has several limitations. First, it is an aggregate analysis in nature, considering roads of all classes and locations together. This approach may mask some important factors that affect road safety, such as road class and geometrical features, traffic, and local weather conditions. The resulting models may not be applicable for assessing safety effects of different maintenance policies and decisions at the level of maintenance yards. Second, the simple categorical method of determining crash rates may introduce significant biases if confounding factors exist, which is likely to be the case for a system as complex as highway traffic. Furthermore, the procedure cannot be used to compare the effect of different maintenance operations.

Fu et al. (13) investigated the relationship between road safety and various weather and maintenance factors, including air temperature, total precipitation, and type and amount of maintenance operations. Two sections of Highway 401 were considered. Fu et al. (13) used the generalized linear regression model (Poisson distribution) to analyze the effects of different factors on safety. They concluded that anti-icing, prewet salting with plowing, and sanding have statistically significant effects on reducing the number of accidents. Both temperature and precipitation were found to have a significant effect on the number of crashes. Their study also presents several limitations. First, the data used in their study were aggregated on a daily basis, assuming uniform road weather conditions over entire day for each day (record). Second, their study did not account for some important factors due to data problems, such as traffic exposure and RSC. Furthermore, the data available for their analysis covered only nine winter months, and thus the power of the resulting model needs to be further validated. One of the implications of these limitations is that their results are not directly applicable for quantifying the safety benefit of WRM of other highways or maintenance routes.

Qiu (34) and Qiu and Nixon (35) used multiple classification analysis for the effects of weather and maintenance on safety. Occurrence of collision within an hour was coded as a binary variable. Separate models were developed for accident frequency and severity. A stepwise modeling approach was utilized and three models were developed. To Model 1 independent variables such as road attributes [road classification, speed limit, urban or rural setting, annual average daily traffic (AADT)], weather (different stages of winter precipitation before, during or after snowstorm, wind speed, road surface temperature, and visibility) and maintenance factors [winter maintenance level of service (LOS)], whether maintenance has been performed, plowing, sanding, and chemical application) were added. For Model 2, RSC were added to the variables in Model 1 and for Model 3, traffic volume and speed variance were further added to Model 2. Effects of a variable (e.g., RSC) were calculated as the difference between the two models with and without that variable (Model 1 and Model 2). RSC was found significant in both frequency and severity models. With snow-covered

roads the probability of injury and property damage-only (PDO) crashes were 76% and 98% above the average, respectively. Snowstorms were found to increase the probability of injury and PDO crashes by 95% and 33% above the average, respectively. Wind speed in the range of 12 to 15 mph was found to have the most effect, increasing the probability of injury and PDO crashes by 160% and 30%, respectively, above the average. Inclusion of traffic volume and speed reduced the effect of RSC and precipitation by 7% and surface temperature by 8%.

Nordic countries have conducted extensive research on issues related to winter road safety and road maintenance. However, most of these studies were published in the form of project reports in the local language and few were published in academic journals. Wallman et al. (36) provided a comprehensive review on this body of work. In terms of research methodology, most of these studies relied on simple comparative analyses instead of rigorous statistical modeling. Nevertheless, the findings were in general consistent, showing that winter weather increases the risk of accidents by virtue of poor RSC and that maintenance lowers the crash risk by improving RSC.

## METHODOLOGY

### Collision Frequency Models

In road safety literature, the most commonly employed approach for modeling accident frequencies is the generalized linear regression analysis. In particular, the single level negative binomial (NB) model and its extensions have been found to be the most suitable distribution structures for road accident frequency (37–43).

In our recent effort, we have conducted an extensive study based on a large collision data set containing hourly observations of road weather and surface conditions, traffic volume, maintenance operations, and collisions over 31 sites for six winter seasons (2000 to 2006). Two types of models have been developed, namely, event-based models for explaining variation of collisions over individual snowstorms and hourly-based models for capturing both variations of collisions over event and individual hours within events (15–17). Different types of generalized linear regression models were evaluated, including generalized NB (GNB), NB, zero-inflated NB, and Poisson lognormal models. It was found that GNB models performed best, which are given in Equations 1 and 2, for event-based model (GNB\_E) and hourly-based model (GNB\_H), respectively.

$$\mu_{\text{GNB-E}} = \text{Exp}^{0.648} e^{-3.912-0.018T+0.009\text{WS}-0.044V+0.014\text{TP}-4.42\text{RSI}+M+S} \quad (1)$$

$$\mu_{\text{GNB-H}} = \text{Exp}^{0.235} e^{-1.249-0.011T+0.005\text{WS}-0.039V+0.097\text{HP}-2.594\text{RSI}+M+S+\text{FH}} \quad (2)$$

where

- $\mu$  = mean number of collisions;
- $T$  = temperature (°C);
- WS = wind speed (km/h);
- $V$  = visibility (km);
- TP = total precipitation (cm);
- HP = hourly precipitation (cm);
- RSI = road surface index representing RSC (15);

- Exp = exposure (equal to total traffic in an event—hour multiplied by length of the section for the event-based model and hourly-based model, respectively);  
*M* = indicator for month (Table 1);  
*S* = indicator for site (Table 1); and  
 FH = dummy variable for the effects of first hour (−0.302 if first hour, 0 otherwise).

**TABLE 1 Values for Month and Site Indicators for GNB\_E and GNB\_H Models**

Variable		GNB_E		GNB_H	
		B	Sig	B	Sig
<i>M</i>	October	0.000		0.000	
	November	−1.048	0.000	−1.029	0.000
	December	−1.229	0.000	−1.262	0.000
	January	−1.193	0.000	−1.308	0.000
	February	−1.537	0.000	−1.536	0.000
	March	−1.248	0.000	−1.278	0.000
	April	−1.049	0.000	−1.134	0.000
<i>S</i>	Site 1	−2.607	0.000	−4.027	0.000
	Site 2	−1.232	0.021	−3.522	0.000
	Site 3	−2.815	0.000	−4.011	0.000
	Site 4	−3.317	0.000	−3.875	0.000
	Site 5	−2.464	0.000	−4.010	0.000
	Site 6	−1.936	0.000	−3.399	0.000
	Site 7	−1.456	0.000	−2.853	0.000
	Site 8	−1.268	0.000	−2.370	0.000
	Site 9	−2.181	0.000	−3.090	0.000
	Site 10	−2.128	0.000	−3.001	0.000
	Site 11	−1.782	0.000	−2.483	0.000
	Site 12	−1.374	0.000	−2.518	0.000
	Site 13	−1.287	0.000	−2.388	0.000
	Site 14	−2.139	0.000	−2.788	0.000
	Site 15	−1.497	0.000	−2.196	0.000
	Site 16	−2.019	0.000	−2.595	0.000
	Site 17	−1.467	0.000	−1.727	0.000
	Site 18	−1.410	0.000	−1.580	0.000
	Site 19	−1.631	0.000	−1.995	0.000
	Site 20	−1.459	0.000	−1.709	0.000
	Site 21	−0.628	0.000	−0.732	0.000
	Site 22	−1.384	0.000	−1.747	0.000
	Site 23	−1.143	0.000	−1.297	0.000
	Site 24	−0.997	0.000	−1.315	0.000
	Site 25	−1.635	0.000	−1.605	0.000
	Site 26	−0.810	0.000	−0.969	0.000
	Site 27	−1.175	0.000	−1.038	0.000
	Site 28	−1.606	0.000	−1.298	0.000
	Site 29	−1.216	0.000	−1.074	0.000
	Site 30	−0.986	0.000	−0.710	0.000
	Site 31	0.000		0.000	

## Collision Severity Models

Logistic regression models are widely employed for collision severity analysis in literature. Three approaches can be used for collision severity analysis: (a) incorporating severity into the collision frequency models by modeling collisions classified by severity types (44–47); (b) modeling the conditional probability of experiencing each severity level for a given collision (48–52); and (c) establishing aggregate models for the ratios of individual severity levels based on data averaged over given spatial and temporal units (53).

Moreover, collision data are hierarchical in nature where individuals or occupants are nested within vehicles and vehicles are nested within collisions. Three datasets could thus be formed aggregated at different levels: collision-based records, one level including details on collisions but aggregated info about vehicles and occupants; vehicle-based records, two levels including details on both collision and vehicle details but aggregated info about occupants; and occupant-based records, three levels including details on collisions, vehicles, and occupants. Because of the hierarchical nature of the data, there could be possible correlation at the occupant or vehicle level. Ignoring such correlation (intraclass correlation) could result in under estimation of standard errors, thus causing some of the variables to appear falsely significant (54).

In recent research (55), the authors have calibrated and compared a variety of modeling options, including multilevel multinomial logit model (MML), multilevel sequential binary logistic model, and multilevel ordered logit model using six winter seasons of collision data from Ontario, Canada. It was concluded that the occupant-based MML model is the best, which is therefore used in case studies described in the following section. This model for a collision injury severity is shown as follows:

$$P(\text{Fatality} + \text{Major Injury}) = \frac{e^{V_1}}{1 + e^{V_1} + e^{V_2}}$$

$$P(\text{Minor Injury}) = \frac{e^{V_2}}{1 + e^{V_1} + e^{V_2}} \quad (3)$$

$$P(\text{PDO} + \text{Minimal Injury}) = \frac{1}{1 + e^{V_1} + e^{V_2}} \quad (4)$$

where

$$V_1 = 0.464 + RT - 0.15NOL + CL + 0.01DA + DC + SB - 0.38\text{Ln}(\text{Traffic});$$

$$V_2 = 0.378 + RT + 0.01SL - 0.07NOL - 0.27RSI + DS + VT + \text{Pos} + SB - 0.14\text{Ln}(\text{Traffic});$$

PDO = property damage only;

RT = road type (freeways = 0.055, multilane kings = -0.11 for Equation 3, freeways = 0.048, multilane kings = 0.082 for Equation 4, and two-lane kings is the base category = 0 for both equations);

SL = speed limit (km/h);

NOL = number of lanes;

RSI = road surface index;

CL = collision location (intersections = 0.862, bridges and underpasses = 2.162, and straight segment is the base case = 0);

DA = driver age (years);

DS = driver sex (male =  $-0.36$  versus female);

DC = driver condition (not drinking =  $-0.42$  versus drinking);

VT = vehicle type (vans =  $-0.21$ , large trucks =  $-0.84$  and car or station wagon is the base case = 0);

Pos = position in vehicle (front =  $0.213$  versus rear);

SB = seat belt used (used =  $-0.69$  for Equation 3 and  $-0.77$  for Equation 4 versus not used = 0 in both equations); and

Traffic = hourly traffic volume at the time of collision (vehicles per hour).

## MODEL APPLICATION

In this section, the authors apply the models that were described in the previous section for assessing the safety effects of three critical maintenance decision variables, including bare pavement (BP) recovery time, maintenance delivery timing, and networkwide LOS goal. The GNB\_E model is used for assessing the effects of different maintenance options on a seasonal basis whereas the GNB\_H model is for assessing the effects of individual maintenance operations within events.

### Safety Effect of BP Recovery Time

The amount of time that has passed before a highway resumes bare conditions after a storm ends, commonly known as BP recovery time, is a critical measure of the efficiency of the maintenance program being delivered. A shorter BP recovery time is representative of better maintenance service and means less effects of the snowstorm. As such, BP recovery time has been widely used by transportation agencies as a performance measure and LOS indicator. This section uses a simple case study to show how the benefit of shortening BP recovery time can be quantified.

Patrol 2, which is a 28-km section of Highway 401 from Morningside Avenue to Highway 404, is selected as study route for this analysis. The study route is one of our analysis sites located in the central region (Toronto) of Ontario.

It is assumed that a specific snow event has occurred on this highway site, which has the following attributes:

- Event duration = 8 h,
- Total precipitation = 3.91 cm,
- Temperature =  $-4.31^{\circ}\text{C}$ ,
- Wind speed = 15.75 km/h, and
- Visibility = 11.84 km.

The total traffic volume on this highway over the storm period is estimated to be 12,000 vehicles.

During the event, RSC could vary between completely snow covered and bare pavement. For a complete snow-covered condition, the corresponding RSI is assumed to be 0.2 (average condition within the snowstorm) while the bare pavement surface is assumed to have a RSI of 0.8. It is also assumed that before the start of the storm, road surface is dry with a RSI of 1.0.



Two scenarios are considered, which have different BP recovery times but same values for all other factors. First, the base scenario is considered by assuming a BP recovery time of 4 h. The resulting average RSI for this scenario is therefore 0.356 [= (1.0 + 7.0 x 0.2 + 0.8) / 9]. The mean number of collisions in this case is estimated using the GNB\_E model, which is equal to 1.439.

Second the alternative scenario of reducing the BP recovery time to 3 h is considered. This means reducing the storm duration to 7 h (4 h of precipitation and 3 h of BP recovery time). Under the same conditions, the new average RSI is 0.375 [= (1.0 + 6 x 0.2 + 0.8) / 8]. The mean number of collisions in this case is 1.214, which represents a 16% reduction. Note that this reduction in number of collisions represents the benefit of shortening BP recovery time by one h and can be easily converted into monetary value by using either a unit collision cost or the severity models and unit cost of collisions at each severity level, as shown in the last case study (section on Networkwide Safety Effect of Maintaining a Given LOS Goal).

### Safety Effect of Maintenance Operation Timing

Maintenance operations have a direct effect on the RSC and thus the safety of a highway. As a result, the timing of maintenance operations is expected to have a significant impact on the safety effect of snowstorms. This section shows how this effect can be quantified by applying the hourly based model (GNB\_H) described previously. The safety benefit of the maintenance operation is defined as the difference in the expected total number of collisions between the conditions of with and without WRM over the storm period.

The same patrol route and snowstorm as those applied in the previous case study are used. Furthermore, the following assumptions are made to represent the effects of the event and the maintenance operation on the RSC of this route:

- At the start of the event, the road surface is bare and dry with a RSI of 1.0 at the start of the first hour.
- At the end of the first hour, the road surface becomes “snow packed with icy” with an RSI value equal to 0.2.
- In the case that no maintenance operations are done, the road surface would remain in this condition (with RSI = 0.2) until the end of the event (i.e., 8 h).
- For the case with maintenance operations (e.g., a combination of plowing and salting operations), the RSC will be improved to a mixed state of wet and partial snow cover with an equivalent RSI of 0.8.
- It is assumed that the effect of salt would last for 5 h. The RSI of the RSC would decrease linearly from 0.8 to 0.2 (snow packed with icy) within the storm period.

Consider the scenario that the maintenance operations (plowing and salting) is deployed and completed at the start of the second hour. [Figure 1](#) shows the hourly collision frequency predicted using the GNB\_H model under the two alternative scenarios of with and without maintenance operations. The shaded area represents the total reduction in the number of collisions that is expected from the maintenance operation at the second hour of the storm event. The mean numbers of collisions over the storm period under the two scenarios are 6.058 (without maintenance) and 3.671 (with maintenance). The benefit of the maintenance operation is therefore a reduction of 2.387 collisions or 39.4%.

## Networkwide Safety Effect of Maintaining a Given LOS Goal

This section shows how the collision frequency and severity models can be applied to assess the safety implications of different maintenance LOS goals. The Ontario provincial road network maintained by the Ministry of Transportation Ontario is considered. The network covers approximately 46,000 lane kilometers. The LOS goals are modeled as the minimum average RSI that must be maintained over each storm. For example, if a minimum RSI of 0.6 is used as the LOS target, it means that all highways must be maintained in such a way that the average RSI over each storm during a season must be above 0.6.

To facilitate this analysis, the following assumptions are introduced:

- The 31 patrol routes used in our model calibration, which are about 18.6% of the whole network in terms of total lane kilometers, provide a reasonable representation of the whole Ontario network. As a result, the benefit result from these sample routes can be scaled up to the whole network in proportion. If the AADT is available for all highways, it would make more sense to estimate the networkwide benefit based on highway lengths weighted by AADT.
- The snowstorms experienced by the 31 sites over six winter seasons (2000–2006) are considered as the basis for analysis.
- The observed RSI for each site under each storm represents the base scenario while the assumed LOS goal, as represented by the minimum RSI to be maintained, represents the alternative scenario. The difference between the two scenarios represents the benefits that could be expected by achieving a target LOS or minimum RSI.
- For a given site under a given storm, if the existing RSI is above the target RSI, then the target LOS goal has no effect and thus no additional benefit is to be accounted for. However, the existing RSI is less than the target RSI, a new scenario with a RSI value equal to the target RSI is generated for benefit analysis. The expected number of collisions by each severity level is estimated using the GNB\_E and MML models for the base and new scenarios.

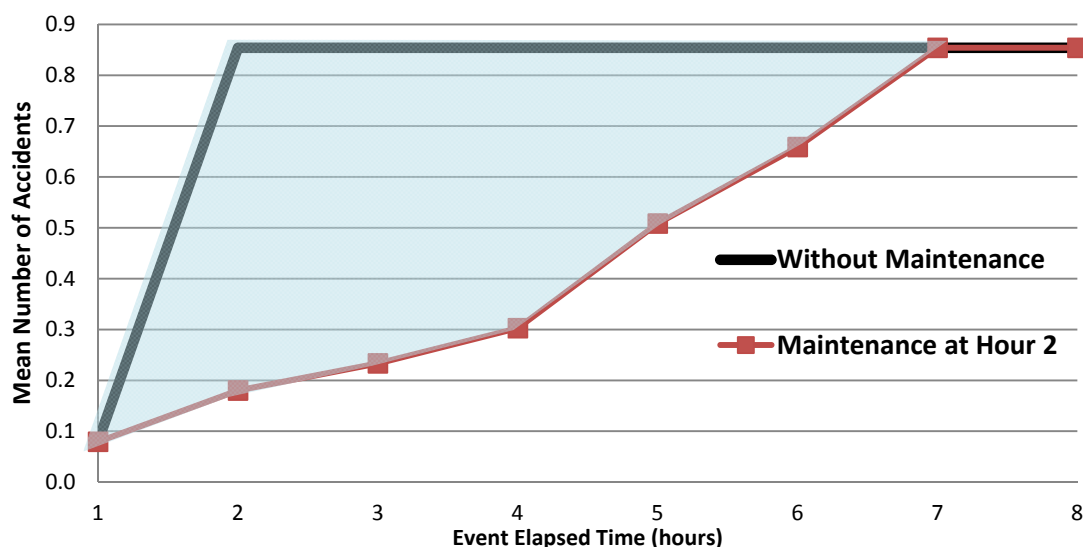


FIGURE 1 Safety benefit versus maintenance timing.

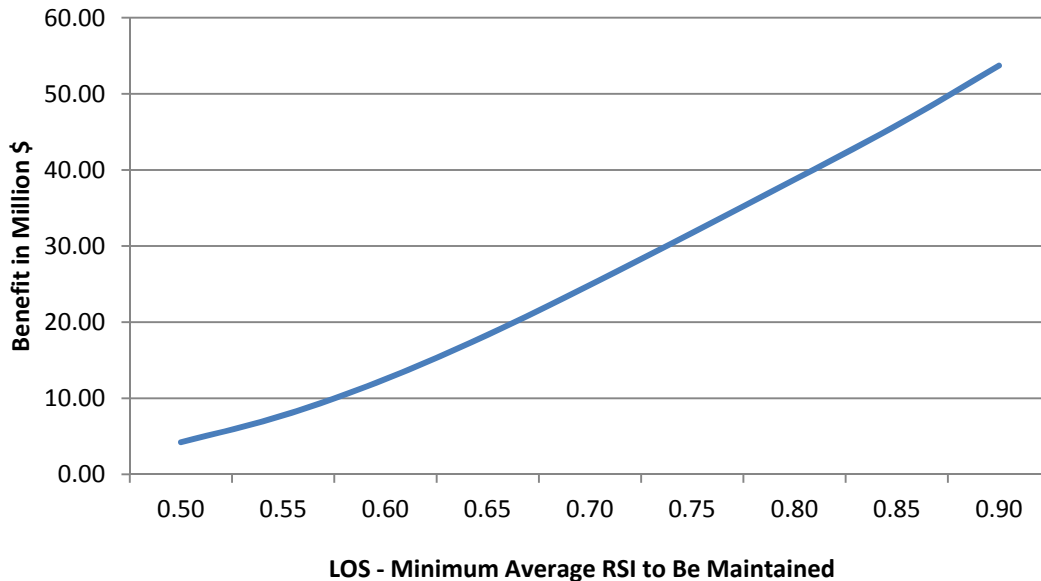
- The collision costs by individual severity levels can be estimated on the basis of the nominal unit collision costs provided in Table 2.
- The average benefit per season is estimated by dividing the difference of the two cost estimates by six (for the six winter seasons).

Table 2 shows the results of an example case calculation for a target RSI of 0.5. The total additional benefit for the 31 sites for achieving a target RSI of 0.5 for all storms is \$0.79 million per season whereas that for the whole Ontario network is \$4.22 million. Figure 2 shows the total networkwide benefit as a function of the LOS target (minimum RSI to be maintained). As expected, the total additional benefit is an increasing function of the minimum RSI to be maintained. A 0.10 increase in the minimum RSI (e.g., from 0.5 to 0.6) could result in \$8.29 million of additional savings in terms of collision reduction.

**TABLE 2 Benefit Calculation for Target RSI**

	<b>Under Existing Conditions</b>	<b>For Target RSI</b>	<b>Unit Cost of an Injury Level*</b>	<b>Associated Cost (base case)</b>	<b>Associated Cost (target RSI)</b>
Expected collision frequency	3,240	3,032			
Number of occupants	8,524	7,977			
PDO + minimal injury	7,178	6,713	249	1,787,395	1,671,596
Minor injury	1,296	1,216	4,674	6,059,265	5,684,603
Fatal + major injury	49	47	2,036,638	100,707,25	96,485,250
Total				108,553,91	103,841,450

\*Source: Transport Canada (56).



**FIGURE 2 Additional safety benefit for achieving a given LOS target.**

## CONCLUSIONS AND FUTURE WORK

This paper has introduced a methodology for quantifying the safety implications of WRM. The foundation of this methodology is a set of empirical models that can be used to predict collision frequencies and consequences based on road weather, traffic, and surface conditions. The RSC, as represented by a friction-like road surface index, is the primary mechanism to capture the direct effect of maintenance operations. Case studies are used to illustrate the potential applications of these collision prediction models for quantifying the safety benefits of WRM, including shortening of BP recovery time, changing of maintenance operation deployment time, and increasing in LOS standards. More importantly, the research has shown the feasibility of developing performance-based WRM standards.

## ACKNOWLEDGMENTS

The authors acknowledge the assistance of John Zajac, Marry Anne, Zoe Lam, and David Tsui from MTO in providing data for this research.

## REFERENCES

1. Brown, B., and K. Baass. Seasonal Variation in Frequencies and Rates of Highway Accidents as Function of Severity. In *Transportation Research Record 1581*, TRB, National Research Council, Washington, D.C., 1997, pp. 59–65.
2. Andrey, J., B. Mills, and J. Vandermolen. Weather Information and Road Safety. Paper Series No. 15. Institute for Catastrophic Loss Reduction, Toronto, Ontario, Canada, 2001.
3. Pisano, P., L. Goodwin, and A. Stern. Surface Transportation Safety and Operations: The Impacts of Weather within the Context of Climate Change. Presented at 83rd Annual Meeting of the Transportation Research Board, Washington, D.C., 2004.
4. Eisenberg, D., and K. E. Warner. Effects of Snowfalls on Motor Vehicle Collisions, Injuries, and Fatalities. *American Journal of Public Health*, Vol. 95, No. 1, 2005, p. 120.
5. Velavan, K. Developing Tools and Data Model for Managing and Analyzing Traffic Accident. MSc thesis. University of Texas, Dallas, 2006.
6. Knapp, K. K., D. L. Smithson, and A. J. Khattak. The Mobility and Safety Impacts of Winter Storm Events in a Freeway Environment. Presented at Mid-Continent Transportation Symposium, Iowa State University, Ames, May 15–16, 2000.
7. Qiu, L., and W. A. Nixon. Effects of Adverse Weather on Traffic Crashes Systematic Review and Meta-Analysis. In *Transportation Research Record: Journal of the Transportation Research Board*, No. 2055, Transportation Research Board of the National Academies, Washington, D.C., 2008, pp. 139–146.
8. HASTE Report. Human Machine Interface and Safety of Traffic in Europe. Project GRD1/2000/25361 S12.319626: Deliverable 1: Development of Experimental Protocol. 2002.
9. Litwin, N., and T. Turriffin. Spine and Brain Injuries from Vehicle Crashes: The Human and Economic Cost. Report 04-01. Transport 2000 Ontario, January 2004.
10. Transport Canada. Analysis and Estimation of the Social Cost of Motor Vehicle Collisions in Ontario. Final Report. TP 14800F. August 2007.
11. Hanbali, R. M. Influence of Winter Road Maintenance on Traffic Accident Rates. PhD dissertation. Marquette University, Milwaukee, Wisconsin, 1992.

12. Norrman, J., M. Eriksson, and S. Lindqvist. Relationships Between Road Slipperiness, Traffic Accident Risk and Winter Road Maintenance Activity. *Climate Research*, Vol. 15, 2000, pp. 185–193.
13. Fu, L., M. S. Perchanok, L. F. Miranda-Moreno, and Q. A. Shah. Effects of Winter Weather and Maintenance Treatments on Highway Safety. Presented at 85th Annual Meeting of the Transportation Research Board, Washington, D.C., 2006.
14. Usman, T., L. Fu, L. Miranda-Moreno, and M. Perchanok. A Multilevel Disaggregate Model for Quantifying the Safety Effect of Winter Road Maintenance. Presented at 13th Winter Road Congress Meeting, Quebec City, Canada, 2010.
15. Usman, T., L. Fu, and L. Miranda-Moreno. Accident Prediction Models for Quantifying Safety Benefit of Winter Road Maintenance. *Accident Analysis and Prevention*, Vol. 42, No. 6, 2010, pp. 1878–1887.
16. Usman, T., L. Fu, and L. Miranda-Moreno. Accident Prediction Models for Winter Road Safety: Does Temporal Aggregation of Data Matter? Presented at 90th Annual Meeting of the Transportation Research Board, Washington, D.C., 2011.
17. Usman, T., L. Fu, and L. Miranda-Moreno. Winter Road Safety: Effects of Weather, Maintenance Operations and Road Characteristics. *Proc., American Society of Civil Engineers Conference*, 2011, pp. 1152–1159.
18. Perchanok, M. S., D. G. Manning, and J. J. Armstrong. Highway Deicers: Standards, Practice, and Research in the Province of Ontario. Ministry of Transportation Ontario, 1991.
19. Buchanan, F., and S. E. Gwartz. Road Weather Information Systems at the Ministry of Transportation, Ontario. Presented at 2005 Annual Conference of the Transportation Association of Canada Calgary, Alberta, 2005.
20. Transport Association of Canada. Salt Smart Learning Guide, 2003.
21. *Where the Weather Meets the Road: A Research Agenda for Improving Road Weather Services*. National Academies Press, Washington, D.C., 2004.
22. Environment Canada. Winter Road Maintenance Activities and the Use of Road Salts in Canada: A Compendium of Costs and Benefits Indicators. 2002.
23. Transport Canada. Canadian Environmental Protection Act, 1999: Priority Substances List Assessment Report, Road Salts. December 2001.
24. Risk Management Strategy for Road Salts. Environment Canada, 2003.
25. Andreescu, M. P., and D. B. Frost. Weather and Traffic Accidents in Montreal, Canada. *Climate Research*, Vol. 9, 1998, pp. 225–230.
26. Handman, A. L. Weather Implications for Urban and Rural Public Transit. Presented at 84th AMS Annual Meeting, Seattle, Wash., 2002.
27. Kumar, M., and S. Wang. Impacts of Weather on Rural Highway Operations Showcase Evaluation No. 2. Research and Innovative Technology Administration, U.S. Department of Transportation, 2006.
28. Khattak, A. J., and K. K. Knapp. Interstate Highway Crash Injuries During Winter Snow and Nonsnow Events. In *Transportation Research Record: Journal of the Transportation Research Board*, No. 1746, TRB, National Research Council, Washington, D.C., 2001, pp. 30–36.
29. Hermans, E., T. Brijs, T. Stiers, and C. Offermans. Impact of Weather Conditions on Road Safety Investigated on Hourly Basis. Presented at the 85th Annual Meeting of the Transportation Research Board, Washington, D.C., 2006.
30. Qin, X., G. Khan, and D. A. Noyce. Spatial Statistical Approach to Identifying Snow Crash-Prone Locations. Presented at the 86th Annual Meeting of the Transportation Research Board, Washington, D.C., 2007.
31. Andrey, J. Long-Term Trends in Weather-Related Crash Risks. *Journal of Transport Geography*, Vol. 18, 2010, pp. 247–258.
32. Strong, C. K., Z. Ye, and X. Shi. Safety Effects of Winter Weather: The State of Knowledge and Remaining Challenges. *Transport Reviews*, 2010, pp. 1–23.

33. Leppänen, A. Final Results of Road Traffic in Winter Project: Socioeconomic Effects of Winter Maintenance and Studded Tires. In *Transportation Research Record 1533*, TRB, National Research Council, Washington, D.C., 1996, pp. 27–31.
34. Qiu, L. Performance Measurement for Highway Winter Maintenance Operations. PhD dissertation. University of Iowa, 2008.
35. Qiu, L., and W. Nixon. Performance Measurement for Highway Winter Maintenance Operations. Iowa Highway Research Board Project TR-491, 2009.
36. Wallman, C. G., P. Wretling, and G. Oberg. Effects of Winter Road Maintenance. VTI Rapport 423A. 1997.
37. Hauer, E. Overdispersion in Modeling Accidents on Road Sections and in Empirical Bayes Estimation. *Accident Analysis and Prevention*, Vol. 33, No. 6, 2001, pp. 799–808.
38. Shankar, V., F. Mannering, and W. Barfield. Effect of Roadway Geometrics and Environmental Factors on Rural Freeway Accident Frequencies. *Accident Analysis and Prevention*, Vol. 27, No. 3, 1995, pp. 371–389.
39. Miaou, S. P., and D. Lord. Modeling Traffic Crash-Flow Relationships for Intersections: Dispersion Parameter, Functional Form, and Bayes Versus Empirical Bayes. In *Transportation Research Record: Journal of the Transportation Research Board, No. 1840*, Transportation Research Board of the National Academies, Washington, D.C., 2003, pp. 31–40.
40. Miranda-Moreno, L. F. Statistical Models and Methods for Identifying Hazardous Locations for Safety Improvements. PhD thesis. University of Waterloo, 2006.
41. Sayed, T., and K. El-Basyouny. Comparison of Two Negative Binomial Regression Techniques in Developing Accident Prediction Models. In *Transportation Research Record: Journal of the Transportation Research Board, No. 1950*, Transportation Research Board of the National Academies, Washington, D.C., 2006, pp. 9–16.
42. Kim, H., D. Sun, and R. K. Tsutakawa. Lognormal vs. Gamma: Extra Variations. *Biometrical Journal*, Vol. 44, No. 3, 2002, pp. 305–323.
43. Winkelmann, R. *Econometric Analysis of Count Data*. Springer, Germany, 2003.
44. Bijleveld, F. D. The Covariance Between the Number of Accidents and the Number of Victims in Multivariate Analysis of Accident-Related Outcomes. *Accident Analysis and Prevention*, Vol. 37, No. 4, 2005, pp. 591–600.
45. Ma, J., and K. M. Kockelman. Bayesian Multivariate Poisson Regression for Models of Injury Count, by Severity. In *Transportation Research Record: Journal of the Transportation Research Board, No. 1950*, Transportation Research Board of the National Academies, Washington, D.C., 2006, pp. 24–34.
46. Park, E. S., and D. Lord. Multivariate Poisson-Lognormal Models for Jointly Modeling Crash Frequency by Severity. In *Transportation Research Record: Journal of the Transportation Research Board, No. 2019*, Transportation Research Board of the National Academies, Washington, D.C., 2007, pp. 1–6.
47. Ma, J., K. M. Kockelman, and P. Damien. A Multivariate Poisson-Lognormal Regression Model for Prediction of Crash Counts by Severity, Using Bayesian Methods. *Accident Analysis and Prevention*, Vol. 40, No. 3, 2008, pp. 964–975.
48. Shankar, V., and F. Mannering. An Exploratory Multinomial Logit Analysis of Single-Vehicle Motorcycle Accident Severity. *Journal of Safety Research*, Vol. 27, No. 3, 1996, pp. 183–194.
49. Dissanayake, S., and J. Lu. Analysis of Severity of Young Driver Crashes: Sequential Binary Logistic Regression Modeling. In *Transportation Research Record: Journal of the Transportation Research Board, No. 1784*, Transportation Research Board of the National Academies, Washington, D.C., 2002, pp. 108–114.
50. Yau, K. K. W. Risk Factors Affecting the Severity of Single Vehicle Traffic Accidents in Hong Kong. *Accident Analysis and Prevention*, Vol. 36, 2004, pp. 333–340.
51. Saccomanno, F. F., S. A. Nassar, and J. H. Shortreed. Reliability of Statistical Road Accident Injury Severity Models. In *Transportation Research Record 1542*, TRB, National Research Council, Washington, D.C., 1996, pp. 14–23.

52. Wong, J., and Y. Chung. Comparison of Methodology Approach to Identify Causal Factors of Accident Severity. In *Transportation Research Record: Journal of the Transportation Research Board, No. 2083*, Transportation Research Board of the National Academies, Washington, D.C., 2008, pp. 190–198.
53. Edwards, J. B. The Relationship Between Road Accident Severity and Recorded Weather. *Journal of Safety Research*, Vol. 29, No. 4, 1998, pp. 249–262
54. Lee, C., and M. Abdel-Aty. Two-Level Nested Logit Model to Identify Traffic Flow Parameters Affecting Crash Occurrence on Freeway Ramps. In *Transportation Research Record: Journal of the Transportation Research Board, No. 2083*, Transportation Research Board of the National Academies, Washington, D.C., 2008, pp. 145–152.
55. Usman, T., L. F. Miranda-Moreno, and L. Fu. Analysis of Injury Severity Outcomes of Highway Winter Crashes: A Multi-Level Modeling Approach. Presented at 91st Annual Meeting of the Transportation Research Board, Washington, D.C., 2012.
56. Transport Canada. Estimates of the Full Cost of Transportation in Canada. Synthesis report. August 2008.

## ROAD SAFETY UNDER WINTER CONDITIONS

## Registration of Road Vehicle Rescue Actions as a Basis for Traffic Safety Measures

**TORGEIR VAA**

**PER BRANDLI**

*Norwegian Public Roads Administration*

Traffic safety is one of the areas prioritized by the Norwegian Public Roads Administration, and efforts have been made to improve the basis for establishing which locations are generally hazardous or pose a heightened risk in winter. This is the reason for looking into the possibility of increasing the volume of data available for traffic safety analysis by systematically registering road vehicle rescues by means of a personal data assistant (smartphone). The main idea behind the Road Rescue Research and Development project is to develop a new method for electronic registration of towing operations. The system has been collaboratively developed by a number of parties with different objectives:

- Road rescue operators: to simplify their further processing of incidents;
- The insurance company: to simplify and speed up the process of obtaining documentation of conditions at the accident site; and
- The Public Roads Administration: to obtain an overview of accident locations on the road network with a view to implementing road repairs and strengthening road maintenance services. In winter, this can, for example, involve the improvement of winter road operations on routes that are especially prone to accidents.

All registrations are treated confidentially and only the above mentioned agencies can access the material obtained. Photos are taken on site to supplement the other records that are made.

### BACKGROUND

Traffic safety is one of the areas prioritized by the Norwegian Public Roads Administration and efforts have been made to improve the basis for establishing which locations are generally hazardous or pose a heightened risk in winter. This is the reason for looking into the possibility of increasing the volume of data available for traffic safety analysis by systematically registering road vehicle rescues by means of a personal data assistant (PDA).

The main idea behind the Road Rescue Research and Development (R&D) project is to develop a new method for electronic registration of towing operations. The system has been collaboratively developed by a number of parties with different objectives:

- Road rescue operators: to simplify their further processing of incidents;
- The insurance company: to simplify and speed up the process of obtaining documentation of conditions at the accident site; and
- The Public Roads Administration: to obtain an overview of accident locations on the road network with a view to implementing road repairs and strengthening road



maintenance services. In winter, this can, for example, involve the improvement of winter road operations on routes that are especially prone to accidents.

## PROJECT OBJECTIVES

The project benefits include the following:

- Better overview of accident hotspots. Personal injuries are fortunately rare and occur in scattered locations. Consequently, there is often insufficient data to prioritize implementation of traffic safety measures. Increasing the volume of available data by recording the great majority of incidents involving damage to property, will enable us to take action before a major accident occurs.
- Increased knowledge about the relationship between road conditions and accidents. Access to a greater data set will provide a reliable basis for budgeting and for making the right priorities in terms of remedial action and operational measures.
- Improved winter road operations on problem routes. This will also be useful for drawing up road maintenance contracts by being able to identify routes that have a disproportionate number of accidents in winter.
- Analysis of the relationship between types of vehicles and types of accidents to see if any vehicles are overrepresented.
- Provision of better road information through signage, etc.

## PROJECT DESCRIPTION

### Study Area

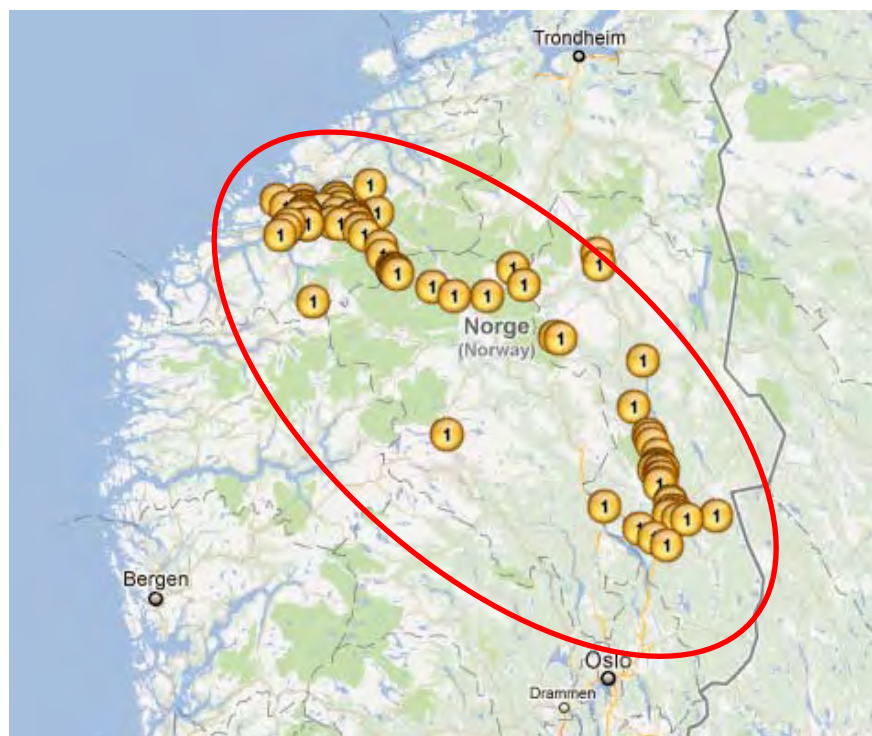
The registration of road vehicle rescues commenced on January 1, 2008, as part of the national Indre Romsdal R&D project (1). In the first year the study area covered the Romsdal Valley in Norway; in 2009 the project was expanded to include the North Gudbrandsdalen, Norway, area. On January 1, 2011, the project was considerably stepped up by including one of the major trunk roads in Norway, northbound from Oslo. The vehicle rescue registration project now has the status of an independent pilot project. This paper focuses on this extended pilot project.

The pilot project is a partnership between the Viking and Falck rescue companies, the If insurance company and the Public Roads Administration.

Figure 1 shows the study area. The yellow circles provide a rough idea of the road network covered by the pilot project. Both trunk roads and county roads are included in the study.

### Registration Method

The registration unit is a PDA or smartphone (Figure 2), with software customized specifically for this purpose.



**FIGURE 1 Study area.**

The pilot comprises a total of 15 local companies and 25 PDA units fitted with software specially developed for the project. The registration of an incident involves the following procedure:

- Before arriving at the accident site, the PDA unit is turned on.
- When stopping at the accident site, the Global Positioning System (GPS) signal is checked.
- The following type of information is then recorded:
  - Type of incident,
  - Type of vehicle,
  - Road surface and weather conditions,
  - Condition of tires, and
  - Nationality of the driver.

Then one to four pictures are taken. The photos are taken onsite to supplement the other records that are made.

The location is automatically identified based on its GPS coordinates, and every registration is time and date stamped as the rescuer arrives. Once the registration process has been completed, the data is transferred to a separate web portal via the Global System for Mobile Communications transmitter in the PDA unit. The data can be accessed as a web service on a portal set up for the pilot study.

The data include accidents involving personal injuries as well as damage to property.



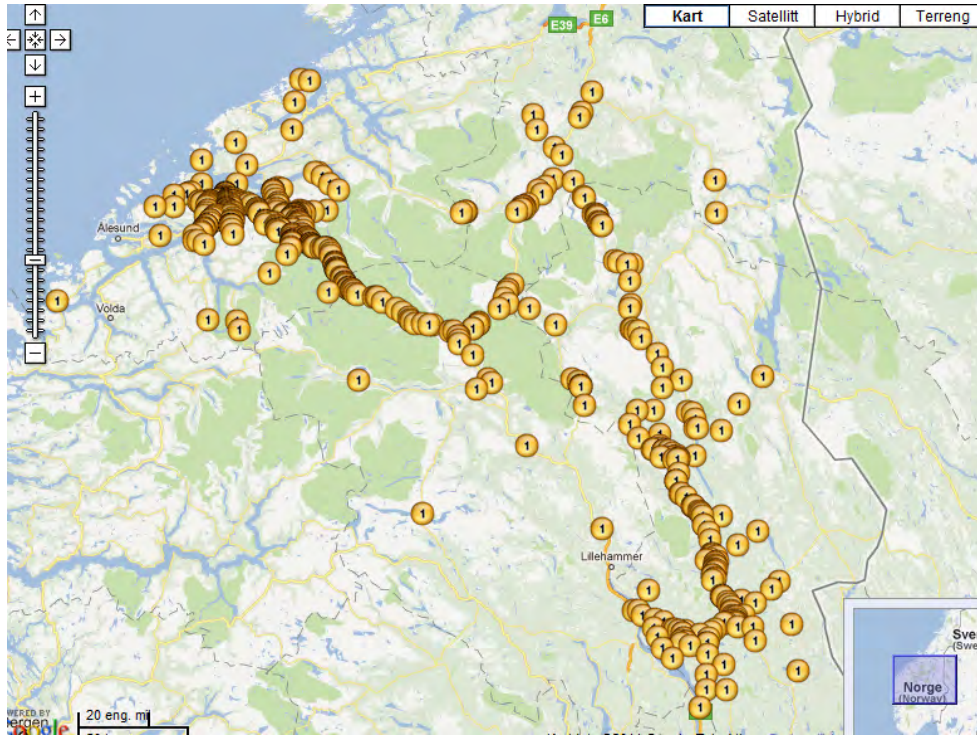
**FIGURE 2** Registration unit.

Some of the accidents, especially those involving heavy goods vehicles, are dramatic in their nature and very costly in terms of roadway clearance and insurance payouts. All registrations are treated confidentially.

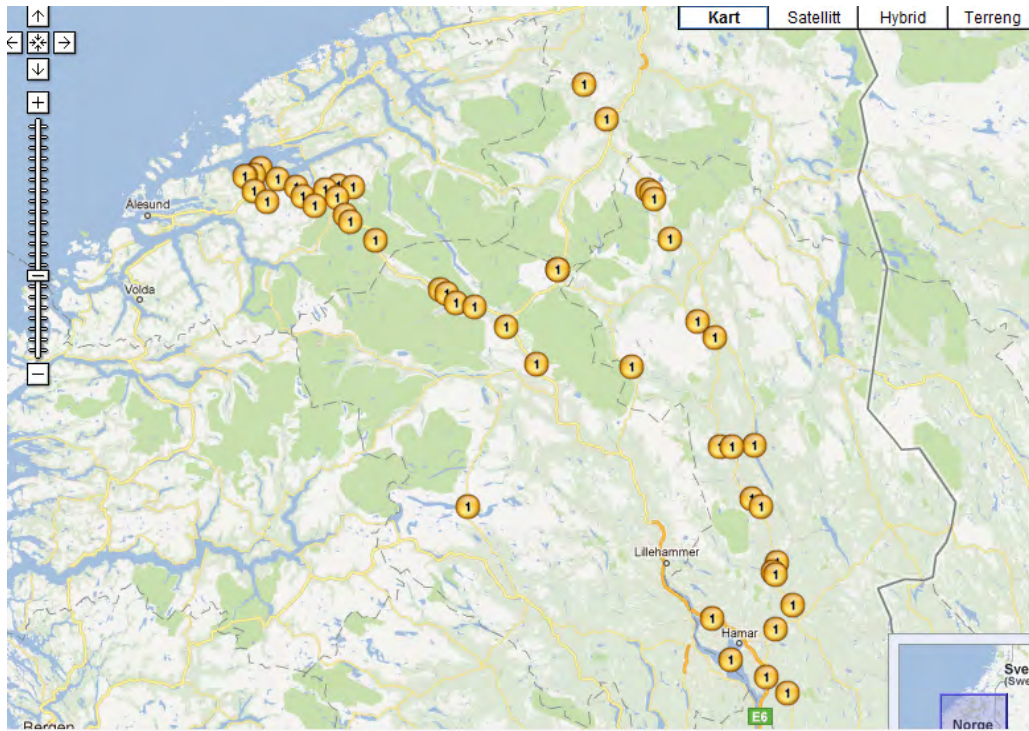
## RESULTS

Figure 3 shows a plot of all registered road vehicle rescues since January 2011. Figure 3 shows only rescue actions in which trucks were involved. Technical assistance is included in this overview.

The total number of incidents recorded in the database since January 1 involves 669 rescue actions. As can be seen from Figure 3 the rescues are geographically scattered, but there also seems to be a certain number of accident hotspots on the road network. If rollover and run-off-road incidents are filtered out (Figure 4), the result is only 54 rescues. The data available from only a single year of registrations consequently appear to be too meager for a more profound analysis.



**FIGURE 3** Road vehicle rescues in the period January–November 2011: all types of incidents.



**FIGURE 4** Road vehicle rescues in the period January–November 2011: Rollover and run-off-road incidents.

The map is interactive, so information about the incident can be viewed by clicking on the plotted circle. Figures 5 and 6 show an example involving an incident with a trailer (truck with fully loaded trailer) on the E6 trunk road on October 18, 2011. The trailer was torn loose from the tractor and the two parts landed on each side of the roadway. The cause of the accident has not been fully investigated, but one of the hypotheses is that the narrow shoulder can have triggered a noncontrollable maneuver if the outer pair of wheels on the trailer drove off the shoulder edge. Figure 7, showing a picture of the accident site, supports this theory.

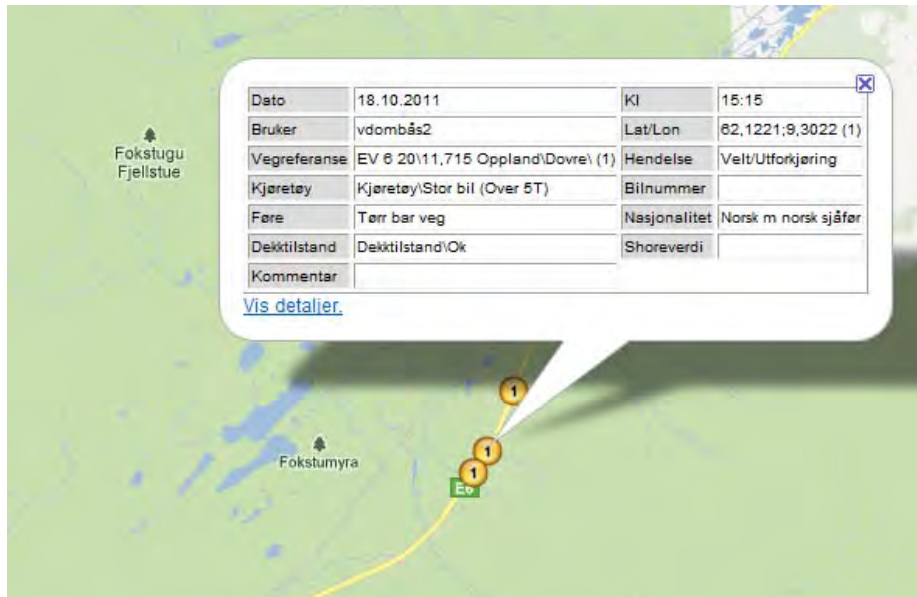


FIGURE 5 Example: incident on October 18, 2011.

Navn	Verdi	Endre
Dato	18.10.2011	[...]
Kl	15:15	[...]
Bruker	vdombås2	[...]
Hendelse	Velt/Utforkjøring	[...]
Kjøretøy	Kjøretøy\Stor bil (Over 5T)	[...]
Bilnummer		[...]
Føre	Torr bar veg	[...]
Nasjonalitet	Norsk m norsk sjåfør	[...]
Dekktilstand	Dekktilstand\Ok	[...]
Shoreverdi		[...]
Kommentar		[...]

Latitude	Longtude	Retning	Fart	Antall satellitter
62,12214	9,302157	0	0	8

Kommunenavn	Vej	Vej	Vegnum	HP	Meter	Gatenavn
Oppland\Dovre	E	V	6	20	11715	

Klikk på bilde under for full størrelse

FIGURE 6 Example: detailed data regarding the incident on October 18, 2011.

Fy05\_Ev006\_hp20\_f2\_m11703



**FIGURE 7 Example: incident on October 18, 2011, picture from the accident site.**

Below is a presentation of some statistical data from the registrations made in 2011. The following categories are used for types of incident:

- Rollover and run-off-road incidents,
- Collisions,
- Vehicles stranded on the roadway due to road conditions,
- Fire, and
- Collisions with animals.

Figure 8 shows the distribution between the different types of incidents. Fifty percent of the incidents were associated with road conditions. The other 50% were associated with technical problems with the vehicle. In the following, only the road-related incidents are included in the statistics.

The following categories are used for types of vehicle:

- Light vehicle (weight below 5 tons) and
- Heavy vehicle (weight above 5 tons).

Figure 9 shows the distribution between light and heavy vehicles. Sixty-six percent of the vehicles are passenger cars or light goods vehicles.

The following categories are used for types of road conditions:

- Dry and bare surface;
- Wet and bare surface;
- Slippery, around 0°C;
- Snow/ice cover and precipitation; and
- Snow/ice cover, no precipitation.

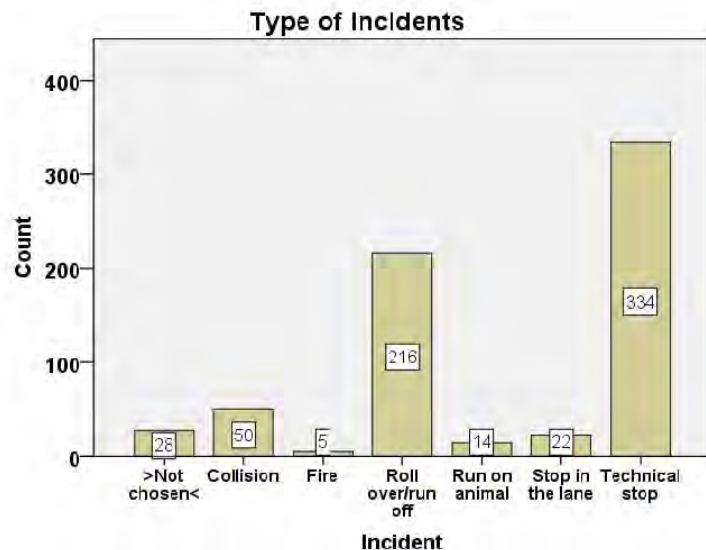


FIGURE 8 Registration period January–November 2011, types of incidents.

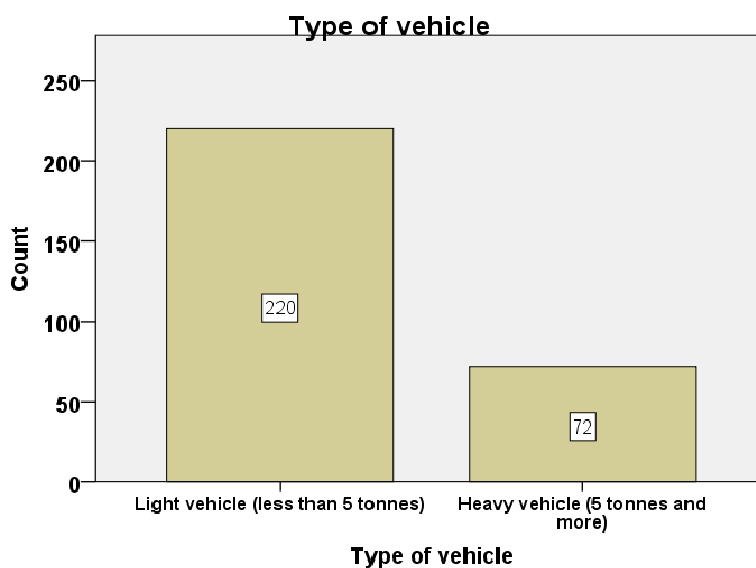
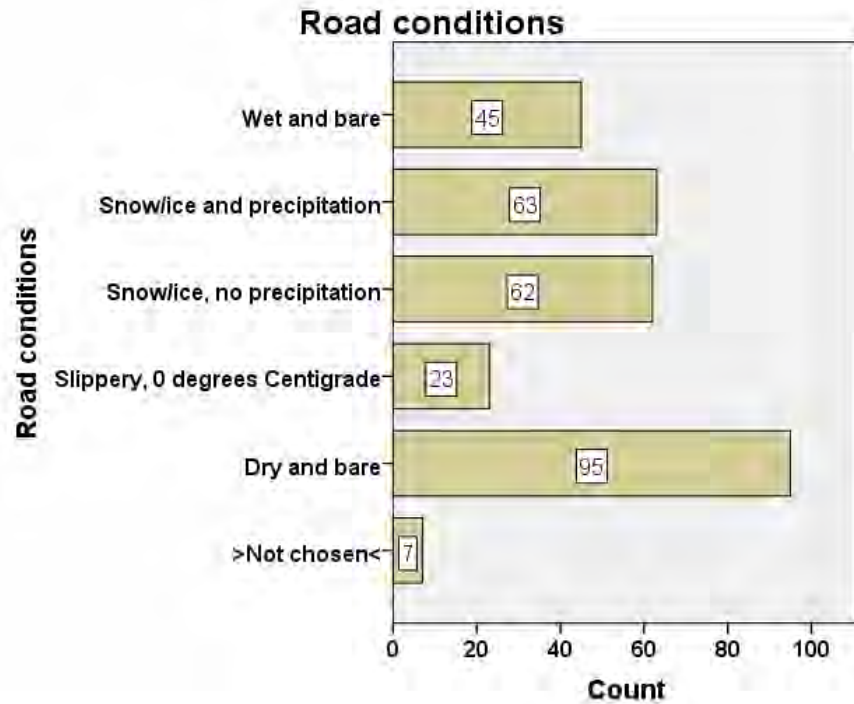


FIGURE 9 Registration period January–November 2011, types of vehicles.

Figure 10 shows the registered road and weather conditions on the accident site. Approximately 50% of the cases are associated with wintry road conditions. This is an overrepresentation.

The following categories are used for vehicle nationality:

- Norwegian with Norwegian driver,
- Norwegian with foreign driver,
- Scandinavian, and
- Other.



**FIGURE 10** Registration period January–November 2011, types of road conditions.

Figure 11 shows the nationalities recorded in the database for vehicles weighing 5 tons or more. Seventy-four percent of the vehicles were Norwegian while one in five drivers were foreign. This information is of interest in terms of trends in the haulage market, but is not really relevant to the main objectives of the pilot project. It has therefore been decided to exclude this type of information in the continuation of the project.

The following categories are used to record the condition of tires (Figure 12):

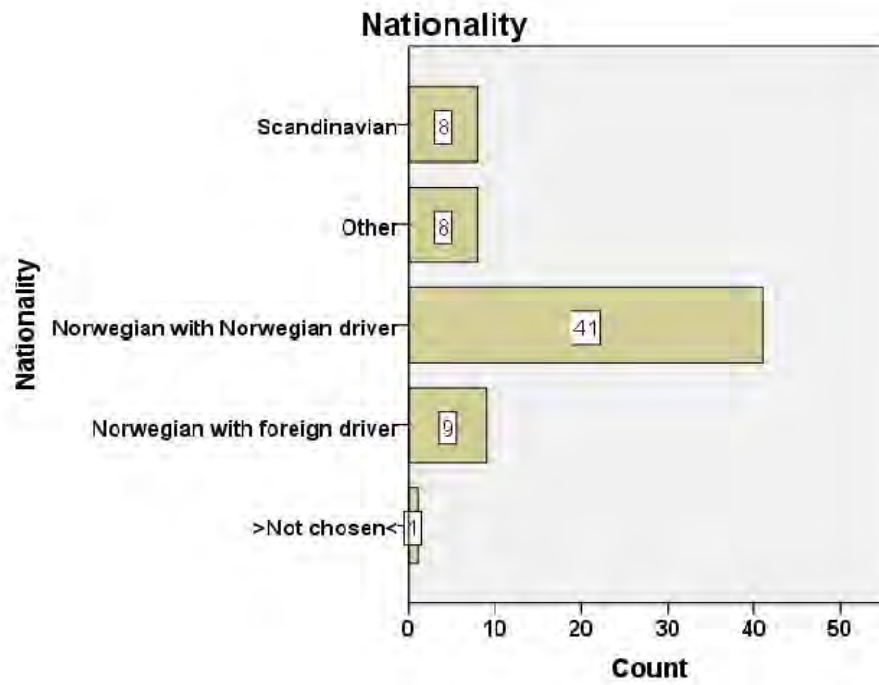
- Tires OK or
- Not rated.

Other subprojects under the Indre Romsdal R&D project have focused on the significance of tire quality. This is why this type of information is recorded under the vehicle rescue project. The category “tires not rated” indicates that the tires have been considered to be of nonsatisfactory standard, but this information is uncertain.

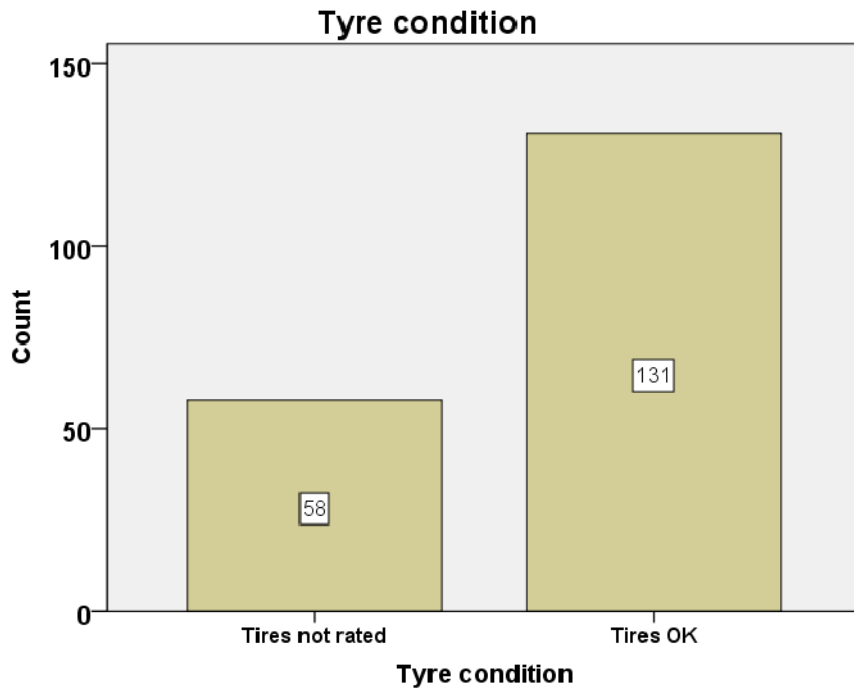
## FURTHER STUDIES

The results from the pilot project confirm that the potential for this type of data is great, but there are some challenges involved with the data registration process. It is estimated that only 10% of the total number of rescue actions in the study area were registered in the project database. One of the reasons for the underreporting is that this type of registration is new to the rescue personnel. The companies receive a small annual payment (2000 US\$) for each PDA unit





**FIGURE 11** Registration period January–November 2011, nationality, vehicles weighing 5 tons or more.



**FIGURE 12** Registration period January–November 2011, condition of tires.

in use, but some of them have requested payment per registration. This attitude can probably partly explain the underreporting.

The road vehicle rescue data can be processed in a number of ways. The data can be used for detailed studies of road sections with multiple accidents, and for traffic safety studies that aim to analyze the factors that contribute to the risk of accidents. There is a plan to combine the vehicle rescue records with other types of data, like road standards and winter maintenance standards, to see if the incidence of vehicle rescues can be explained by parameters such as carriageway width, shoulder width, alignment, and winter strategy (salting or sanding policy). Provided we obtain a substantially greater data set, we expect to acquire increased knowledge about the causative reasons for accidents.

It is also expected that the vehicle rescue data will trigger minor maintenance actions at problem spots on the road network.

The project is run as a pilot and covers four counties. The plan is for the project to go nationwide in the longer term, and there are great expectations that this will help improve road safety on the Norwegian road network and reduce the cost of insurance premiums. The potential for data access can be illustrated by pointing out that the two largest road rescue companies perform an approximate total of 350,000 towing operations annually. According to the road rescue companies, approximately 15% of this annual total may be road related.

It has been decided to continue the pilot for another year into 2012, and then to introduce the incentive of payment per registration of road-related incident. Hopefully this will significantly increase the number of registrations. It is expected that in a relatively short period of time, the PDA device will be made mandatory for vehicle rescue operators. In the meantime, it is considered important to continue the pilot project in order to gain experience with this type of data and to prepare for a nationwide system.

## REFERENCE

1. Torgeir, V. Follow-Up Study of Winter Standard the Seasons 2006/2007 and 2007/2008. SINTEF Report A11557. R&D Indre Romsdal, April 2009.

## ROAD SAFETY UNDER WINTER CONDITIONS

## Diagnosing Hazardous Road Surface Conditions Through Probe Vehicle as Mobile Sensing Platform

JINHWAN JANG

NAMCHUL BAIK

*Korea Institute of Construction Technology*

Harsh weather has adverse effects on traffic safety as well as on traffic flow. To mitigate the adverse effects, quick recognition of hazardous road surfaces caused by harsh weather is essential. Conventionally, Road Weather Information System (RWIS) has been used to collect road weather data. However, because RWIS can only collect spot data, not section data, the benefit could be limited, considering that road surface conditions vary dynamically even in a short roadway segment. Noting this limitation of the current RWIS, a new cost-effective approach to diagnosing hazardous road surfaces, using a probe vehicle as a mobile sensing platform was motivated in this research. The probe car equipped with a Global Positioning System receiver, a wheel speed (antilock braking system) sensor, and a G-sensor can diagnose slipperiness and roughness of a given road section. To detect slipperiness, a vehicle wheel slip ratio defined as the relative difference between vehicle body and wheel rotation speeds was used. To detect roughness, the vehicle vertical acceleration collected by the G-sensor was used. Experiments were performed under dry and wet road conditions. The slip ratios exhibited under the two conditions were significantly different. Also, it was found that the roughness caused by potholes on a rainy day can be determined on the basis of G-sensor outputs, especially when a probe car travels over a pothole.

Harsh weather conditions cause significant traffic problems. In Korea, approximately 1,500 fatalities occur annually during adverse weather, which amounts to nearly 25% of the country's total traffic fatalities. Considering that adverse weather occurs only 8% of the time, the fatality ratio is three times higher than the adverse weather ratio (1, 2). To mitigate this tragic statistic, it is vital to provide quick detection of hazardous roads. Quick detection would allow road agencies to take timely, proper, and efficient countermeasures, such as the application of anti-icing chemicals or dissemination of information about hazardous road conditions to road users.

Traditionally, roadway weather information system (RWIS) has been employed to collect road weather data such as temperature, humidity, and road icing. However, as RWIS can only collect spot data, not section data, the benefit is limited, considering that road surface conditions vary dynamically even in a short roadway segment especially under adverse weather conditions (3). Also, the high cost of RWIS has restricted its extensive deployment. Moreover, RWIS can only collect road weather conditions, such as snow, ice, and rain. Drivers want to know how slippery the road surface is. Because of this limitation of the RWIS, a new cost-effective approach to diagnosing hazardous road surfaces, using a probe vehicle as a mobile sensing platform, was developed in this research project.

Several previous researches have been conducted regarding road weather data collection using probe cars. Nakatsuji et al. (4–5) developed novel methodologies for tire–road friction coefficient identification using a genetic algorithm and the unscented Kalman filter combined with

tire models with probe vehicle data. The probe vehicles in their researches were equipped with a Global Positioning System (GPS) module and a motion sensor to gather vehicle body speed, wheel rotation speed, yaw rate, pitch, etc. Pilli-Sihvola (6) invented a probe-based road weather data gathering system in Finland. The system fitted with various devices [a friction tester, a GPS antenna, an infrared sensor, a combined air temperature and humidity sensor, video equipment, and a Global System for Mobile Communications (GSM) phone] transmitted different kinds of road weather-related data, including temperature, humidity, road surface friction, and video images along a given roadway section. Wang et al. (7) developed a real-time tire–road friction coefficient estimation system using probe vehicles equipped with a vehicle motion sensor and a differential GPS module. Wang insisted his system could be applicable while both accelerating and decelerating, and was capable of estimating the friction coefficient reliably for a wide range of slip ratios, an improvement over previous methods researched. Dong et al. (8) demonstrated a probe application for identification of road slipperiness and coarseness using vehicle body (collected by GPS) and wheel rotation speeds; this study was conducted in California. Petty et al. (9–10) examined the potential use of data gathered from vehicle infrastructure integration–enabled probe vehicle in weather-related applications and products for surface transportation. This study revealed probe vehicle data elements (wiper status, temperature, and pressure) had a good correlation with surrounding weather observations. Drobot et al. and Chapman et al. (11–12) conducted a probe-based weather-specific field study in Detroit, Michigan, during April 2009. They developed a vehicle data translator for paring, quality controlling, and combining the collected probe vehicle data (temperature and barometric pressure) with ancillary weather data. Koskinen (13) discussed a technique to estimate the maximum friction coefficient (or friction potential) while simultaneously identifying the road conditions. His technique was based on multisensor data (environmental sensors, vehicle motion sensors, and experimental tire sensors), and reliably estimated friction potentials for around 90% of the experiment’s driving time. He also analyzed how the estimated friction coefficients can be utilized for collision avoidance and collision mitigation systems using simulations.

The probe-based system developed in this research project detects dangerous road conditions, such as slippery road segments and potholes, caused by inclement weather. To detect slippery road conditions, the vehicle body speed obtained by a GPS receiver and the wheel rotation speed collected by antilock braking system (ABS) sensor were used. When braking or accelerating on slippery roads, some discrepancy arises between vehicle body speed and wheel rotation speed. If the discrepancy, called slip, exceeds a predefined threshold, the roadway section tested is considered to be slippery. Potholes created by rainy or snowy weather can cause flat tires and traffic accidents. To identify a pothole, the probe car accelerations in vertical axis were recorded. If the accelerations, gathered using a gravity (G) sensor mounted on the probe vehicle, exceeds the predefined threshold, the roadway point is regarded as a pothole. Detailed descriptions of the probe-based system and methodologies to discern dangerous road conditions are provided in the sections that follow.

## DATA COLLECTION

The probe-based data collection system consists of a GPS receiver, a front wheel speed (ABS) sensor, a G sensor, a control board, and a notebook computer (Figure 1). Using the GPS signal from the GPS receiver, the vehicle transitional speed was obtained; using the wheel pulse (three

times per one wheel rotation) data from the ABS sensor and the effective radius of the vehicle wheel, the wheel rotation speed was calculated. Subsequent comparison of the two speeds provided the slip. The G-sensor, a kind of accelerometer, collected vertical and horizontal vehicle accelerations. In this research project, the vertical component (or acceleration) of the G-sensor was used for diagnosing road surface roughness, such as potholes. All sensor signals were recorded every 0.1 s by the control board and notebook computer. For the purpose of data verification, video images from a web camera attached at the top of the control board were also recorded on the notebook.

Experiments were performed on an uninterrupted facility (see Figure 2), named as Jayuro, near Seoul, Korea, under heavy rain and clear weather conditions. As shown in Figure 2, the roadway section consists of four lanes with a 3.5-m lane width in each direction and has a 90 km/h speed limit. On the rainy day, several potholes were present on the road surface. To find out if any differences in the calculated slip exist between acceleration (or deceleration) and constant speed driving, the experiment car (Santa Fe, manufactured by Hyundai Co. Ltd.) was run through several decelerations followed by accelerations of the type a car would normally undergo at intersections.



**FIGURE 1** Data collection devices applied to a probe car.



**FIGURE 2** Data collection area.

## DATA ANALYSIS

### Diagnosing Slippery Roads

A slippery road is identified as one with a slip percentage above a certain value. The road's slip is defined as the relative difference between vehicle body speed and wheel rotation speed. As shown in Equation 1, the slip can be calculated using wheel circumferential speed and vehicle body speed. For this research project, the wheel circumferential speed was obtained from the wheel's angular speed and effective wheel radius, and vehicle body speed was directly obtained through a GPS receiver. However, due to the dynamic effective wheel radius, mainly caused by the changeable pneumatic pressure of a tire, the circumferential speed measurements could be biased. To minimize this effect, the wheel speeds were corrected with the vehicle body speeds. [Table 1](#) presents the relationships between the wheel and the body speeds under dry and wet road surface conditions. Despite the probable bias in wheel speed measurements, the two speeds were highly analogous to each other.

$$\text{Slip} = \begin{cases} \frac{\{(w_w r_w) \times 3.6\} - v_b}{(w_w r_w) \times 3.6}; & \text{when accelerating} \\ \frac{v_b - \{(w_w r_w) \times 3.6\}}{v_b}; & \text{when decelerating} \end{cases} \quad (1)$$

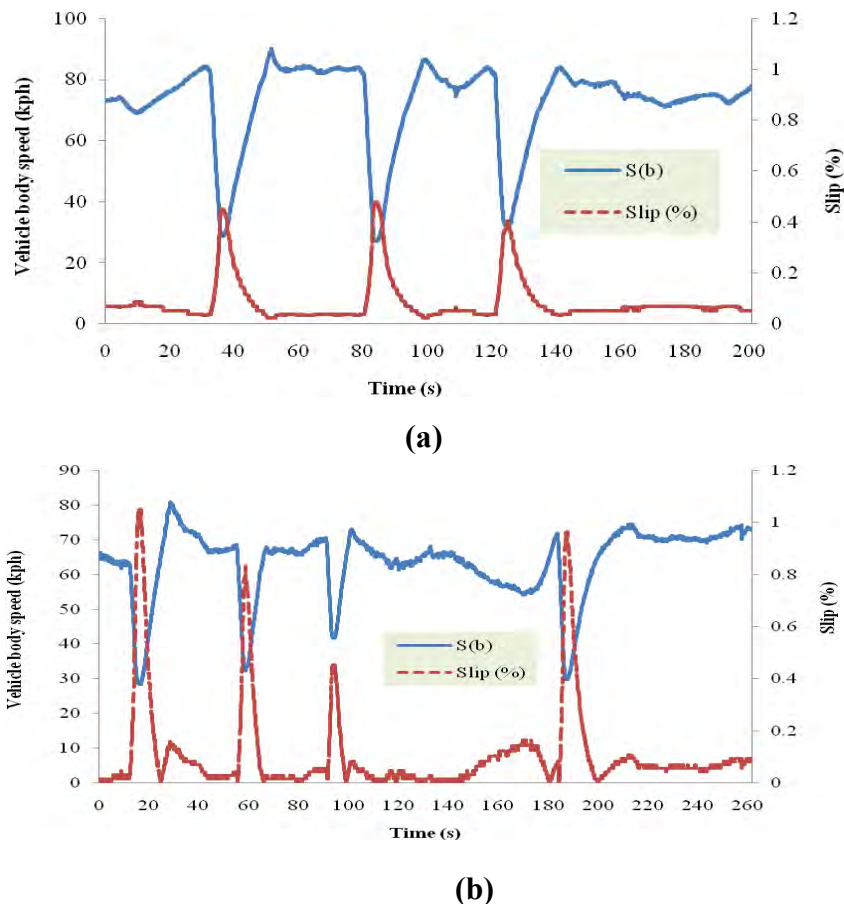
where

- $w_w$  = wheel's angular speed (rad/s),
- $r_w$  = effective wheel radius (m), and
- $v_b$  = vehicle body speed (km/h).

From the results of the experiment, it was identified that the slip recorded was considerably different under dry and wet road surface conditions, especially while accelerating or decelerating. This relationship is shown in [Figure 3](#). On the dry road surface, the slip was lower than 0.1% under normal driving conditions and the maximum slip that occurred during sudden acceleration (or deceleration) did not exceed 0.5%. In contrast, in tests on the wet road surface, the maximum slip was higher than 1%, more than twice that on the dry surface. However, the slip during normal driving showed no notable difference.

**TABLE 1 Regressions Between Vehicle and Wheel Speeds Under Dry and Wet Road Conditions**

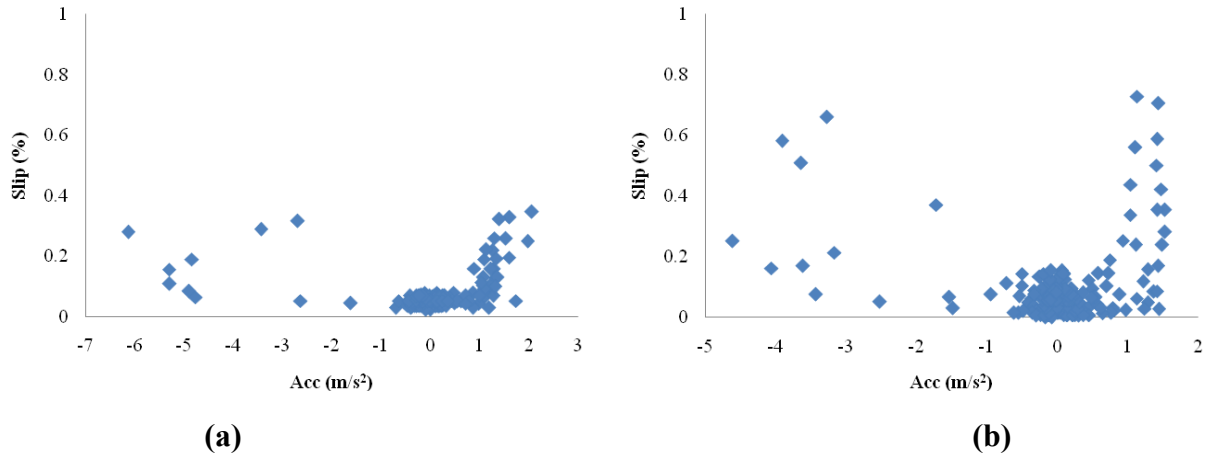
Condition	Determ. Coef. ( $R^2$ )	Slope	Y-intercept	Sample	Equation
Dry	0.978	0.998	0.185	2000	$Y = 0.998X + 0.185$
Wet	0.982	0.992	0.527	2600	$Y = 0.992X + 0.527$



**FIGURE 3** Difference in slip between dry and wet road surface conditions: (a) dry road surface condition and (b) wet road surface condition.

Figure 4 depicts the relationships between acceleration (or deceleration) and slip on dry and wet road surfaces, showing that there were clear differences in the slip for dry surfaces and the slip for wet surfaces. One notable observation is that the slip during acceleration shows dramatic changes even at relatively low accelerations, which is in agreement with the results reported in (3). This implies that, during acceleration, a vehicle's wheels tend to spin in place easily in slippery road conditions. This also indicates that a probe car can more easily detect slippery roads during acceleration than during deceleration. Though the slip differences between dry and wet road conditions are clear, the variations also tend to increase even in relatively low acceleration and deceleration states. Therefore, it was required that the differences be verified statistically.

One-tailed  $T$ -tests at 5% significance level were performed as a statistical test on the slip difference. The slip data was categorized into three subgroups, namely, acceleration (or deceleration), nonacceleration (or deceleration), and total. As shown in Table 2, the slip differences were proven to be significant statistically in the acceleration and total groups, presenting  $P$ -values that were considerably lower than the predefined significance level of .05. However, the slip difference during nonacceleration was not statistically significant, the  $P$ -value being slightly higher than the significance level. These results show that the



**FIGURE 4** Plot of slip versus vehicle acceleration: (a) dry road surface condition and (b) wet road surface condition.

**TABLE 2** *T*-tests for Means of Slips at 5% Significance Level

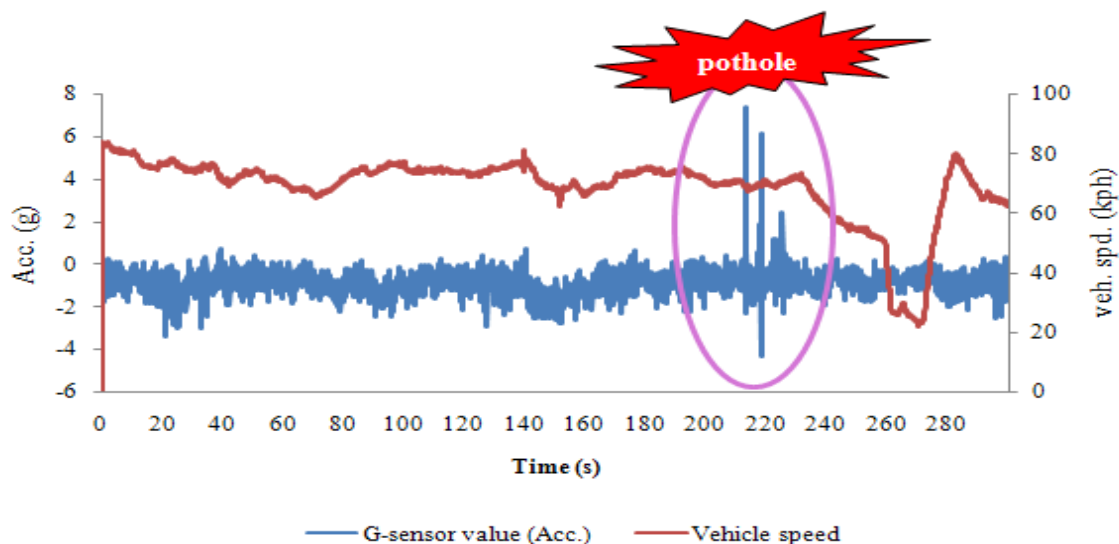
Category	Condition	Mean	Variance	Sample	<i>T</i> -value	<i>P</i> -value
Total	Clear	0.085	0.008	2000	5.99	1.2E-9 (one-tail)
	Rainy	0.109	0.032	2600		
Acceleration or deceleration	Clear	0.172	0.017	2000	12.98	1.5E-34 (one-tail)
	Rainy	0.366	0.091	2600		
Nonacceleration or deceleration	Clear	0.052	0.0002	2000	1.56	0.059 (one-tail)
	Rainy	0.053	0.0015	2600		

difference in the slip due to wet roads is much more obvious during acceleration (or deceleration) than during steady driving. This indicates that slippery road conditions can be better identified during accelerating or decelerating.

### Diagnosing Potholes

The G-sensor in the control board was used to identify potholes in the road. The G-sensor used in this study produced vertical and horizontal acceleration values in the units of the acceleration of gravity. As shown in Figure 5, if a probe car rattled over a pothole, the vertical acceleration value rose suddenly. From this sudden change, the existence of a pothole could be identified. If a threshold is set as a certain value (e.g., 4 G for this study), potholes can be detected at the point where the outputs of the G-sensor exceed the predefined threshold value. The reason for only using the vertical acceleration is that the vertical acceleration does not change with the vehicle speed, while horizontal acceleration does change.





**FIGURE 5 Pothole identification using G-sensor output.**

## CONCLUSIONS AND FUTURE STUDIES

This research project developed a probe-based road surface monitoring system and demonstrated its usefulness through field experiments. The probe vehicle, equipped with a GPS receiver, an ABS sensor, and an accelerometer (G-sensor), continuously collected the sensor outputs and calculated vehicle body and wheel rotation speeds. The difference between the two speeds, called slip, was employed to diagnose road surface slipperiness. The G-sensor output (vertical acceleration) was used to diagnose the existence of potholes in the road. When a vehicle rattles over a pothole, vertical acceleration surges significantly. Using this phenomenon, a pothole (or road surface roughness) could be distinguished. Experiments were conducted on an uninterrupted facility under clear and rainy weather conditions.

Analyses of the collected data indicate that the slip was significantly different for the different road surface conditions, especially during accelerating and decelerating. Also, slip changed more dramatically in acceleration in comparison with deceleration, indicating that a vehicle's wheels tend to spin in place more easily while accelerating than while decelerating. The slip difference in acceleration (or deceleration) was proven to be statistically significant on conducting *T*-tests, though the slip difference at constant speed driving was not.

The work reported in this paper is yet in its preliminary stages. The complete research project, consisting of five steps, will continue over the next four years (until 2015). The final goal is to estimate tire-road friction on a real time basis under various road surface conditions, and disseminate the friction information to road users and drivers to enhance road safety efficiently. To do so, more advanced tire-road friction collection devices will be invented and be tested in extensive field experiments under different weather conditions. Also, accuracy tests on the sensors employed will be conducted. The accuracy tests were not performed for this study due to the absence of reference standards for the tests.

## REFERENCES

1. National Police Agency of Korea. Traffic Accident Statistics for the Year 2010, 2011.
2. w365.com website. <http://www.w365.com/korea/>. Accessed August 27, 2011.
3. Nakatsuji, T., and A. Kawamura. Relationship Between Winter Road Surface Conditions and Vehicular Motion: Measurements by Probe Vehicles Equipped with Global Positioning System. In *Transportation Research Record: Journal of Transportation Research Board, No. 1824*, Transportation Research Board of the National Academies, Washington, D.C., 2003, pp. 106–114.
4. Nakatsuji, T., Hayashi, I., Kawamura, A., and Shirakawa, T. Inverse Estimation of Friction Coefficients of Winter Road Surfaces: New Considerations of Lateral Movements and Angular Movements. In *Transportation Research Record: Journal of Transportation Research Board, No. 1911*, Transportation Research Board of the National Academies, Washington, D.C., 2005, pp. 149–159.
5. Nakatsuji T., Hayashi, I., Ranjitkar, P., Shirakawa T., and Kawamura, A. Online Estimation of Friction Coefficients of Winter Road Surfaces Using the Unscented Kalman Filter. In *Transportation Research Record: Journal of Transportation Research Board, No. 2015*, Transportation Research Board of the National Academies, Washington, D.C., 2007.
6. Pilli-Sihvola, Y. Floating Car Road Weather Information Monitoring System. In *Transportation Research Record: Journal of Transportation Research Board, No. 1741*, TRB, National Research Council, Washington, D.C., 2001, pp. 3–5.
7. Wang, J., L. Alexander, and R. Rajamani. GPS-Based Real-Time Tire–Road Friction Coefficient Identification. University of Minnesota, 2004.
8. Dong, X., K. Li, J. Misener, P. Variyia, and W. Zhang. Expediting Vehicle Infrastructure Integration (EVII). California PATH Research Report, Institute of Transportation Studies, University of California, Berkeley, 2006.
9. Petty, K. R., and W. P. Mahoney, III. Weather Applications and Products Enabled Through Vehicle Infrastructure Integration (VII). FHWA, U.S. Department of Transportation, 2007.
10. Petty, K. R., and W. P. Mahoney, III. Enhancing Road Weather Information Through Vehicle Infrastructure Integration. In *Transportation Research Record: Journal of Transportation Research Board, No. 2015*, Transportation Research Board of the National Academies, Washington, D.C., 2007, pp. 132–140.
11. Drobot, S., M. Chapman, E. Schuler, G. Wiener, W. Mahoney, III, P. Pisano, and B. McKeever. Improving Road Weather Hazard Products with Vehicle Probe Data: Vehicle Data Translator Quality-Checking Procedures. In *Transportation Research Record: Journal of Transportation Research Board, No. 2169*, Transportation Research Board of the National Academies, Washington, D.C., 2010, pp. 128–140.
12. Chapman, M., S. Drobot, T. Jensen, C. Johansen, W. Mahoney, III, P. Pisano, and B. McKeever. Diagnosing Road Weather Conditions with Vehicle Probe Data: Results from Detroit IntelliDrive Field Study. In *Transportation Research Record: Journal of Transportation Research Board, No. 2169*, Transportation Research Board of the National Academies, Washington, D.C., 2010, pp. 116–127.
13. Koskinen, S. Sensor Data Fusion Based Estimation of Tyre-Road Friction to Enhance Collision Avoidance. PhD. dissertation. The Tampere University of Technology, Finland, 2010.

## ROAD SAFETY UNDER WINTER CONDITIONS

**Safety Impacts of Winter Weather on  
Iowa's Rural Primary Highways****ZACHARY HANS****NEAL HAWKINS****INYA NLENANYA****STEVE LAVRENZ***Iowa State University*

**Each winter, hundreds of drivers are injured on Iowa's highways due to weather-related crashes. Transportation agencies spend millions of dollars on proactive and reactive maintenance and roadway-roadside improvement strategies to ensure the best possible pavement and visibility conditions for traveling motorists. However, there does not currently exist a way to easily measure the impacts of these activities on winter weather-related safety and mobility. Furthermore, there is no systematic method to identify potentially problematic weather-related crash locations. Using historic crash data, techniques were developed to systematically evaluate the safety of the state-maintained rural highway system in Iowa during winter weather conditions and identify locations potentially in the greatest need for crash mitigation resources. Three evaluation metrics were developed (winter weather-related crash density, crash proportion, and crash severity) and applied over multiple analysis periods and roadway types. The results of these analyses were then presented within the Google maps and Earth environments. The impact of different analysis periods was evaluated and preliminary site specific analysis demonstrated. A preliminary work plan was also developed outlining procedures for identification and evaluation of candidate improvement sites and selection of potential mitigation strategies.**

# Decision Support Systems



## DECISION SUPPORT SYSTEMS

## Intelligent Transportation Systems and Support System for Winter Road Maintenance

JÖRGEN BOGREN  
TORBJÖRN GUSTAVSSON  
*Göteborg University, Sweden*

Using the information available within modern cars and data from road weather information systems (RWIS) makes it possible to find solutions for detection of different kinds of maintenance needs. Three models are presented: slippery road information system (SRIS), bearing information through vehicle intelligence (BiFi), and support system for winter maintenance (SSWM). The SRIS integrates information from a weather model and car data to give a view of the current condition of the road, and has shown very promising results. During the trial period, 100 cars were connected to deliver online data. The model can be used to give information to different kinds of road users, such as winter maintenance personnel and private drivers, about where there are slippery conditions as well as when it is time to lower speed limits or to perform maintenance activities. The BiFi is a model for detection of quality of the road coating and detection of bearing strength during thaw–freeze periods. The BiFi is used as a tool for judging the load-bearing capacity of the road network in a detailed and dynamic way. Tests have been successful and are a basis for further product implementation. SSWM combines information from sources such as RWIS, salt trucks, and weather forecast models, resulting in a powerful tool for winter road maintenance. The SSWM includes models for calculation of

- Road surface temperature and road conditions,
  - The spatial variation of slipperiness,
  - The severity of a specific weather situation with respect to risk for road slipperiness,
- and
- Need for maintenance activity.

People in today's society have come to rely on roads to be in perfect condition to get them where they are supposed to be on time. Real-time reports about the prevailing road conditions are important to be able to make correct decisions about maintenance activities, lowered speed limits, or closure of roads. If such information is reached by all road users, they can act and make proper decisions accordingly.

To have information about road conditions and traffic data for road stretches, it is necessary to have access to comprehensive and reliable data that are frequently updated. In many areas road weather information systems (RWIS) are established to give information about the prevailing weather conditions at certain locations along the roads. However, this system is limited to certain spots along the road network meaning that there is insufficient coverage of the road network. For this reason, road traffic engineers are making increasing use of intelligent vehicles as mobile sensors, so-called “floating cars,” to determine the actual condition that is prevailing. In modern vehicles, the data available include a wide variety of variables that can be acquired in digital form from the vehicle's databases. Using these data as a base, research and

developing work have been carried out to construct models that could be applied for maintenance use and information to the drivers. Three models are presented: slippery road information system (SRIS), bearing information through vehicle intelligence (BiFi), and support system for winter maintenance (SSWM).

Experiences from the project SRIS, where the information from the weather model and the car data are integrated to give a view of the current condition of the road, have shown promising results. During the trial period, 100 cars were connected to deliver online data. The model can be used to give information to road users as diverse as winter maintenance personnel and private drivers about where there are slippery conditions as well as when it is time to lower speed limits or to perform maintenance activities.

Using the information available within modern cars makes it possible to find solutions for detection of different kinds of maintenance needs. Detection of quality of the road coating and detection of bearing strength during thaw–freeze periods is achieved in the project BiFi. The BiFi is a tool for judging the load-bearing capacity of the road network in a detailed and dynamic way and would considerably help to change the current strategy and possibly save the industry significant funds. The aim of the present project is to develop a vehicle-based method for determining the load-bearing strength of the roads. These tests were shown to be successful and are a basis for further product implementation.

The SSWM combines information from sources such as RWIS, salt trucks, and weather forecast models resulting in a powerful tool for winter road maintenance. The SSWM includes models for calculation of

- Road surface temperature and road conditions along roads,
  - The spatial variation of slipperiness,
  - The severity of a specific weather situation in respect of risk for road slipperiness,
- and
- Road conditions and need for maintenance.

## **SLIPPERY ROAD INFORMATION SYSTEM**

### **In-Vehicle Technology Used with Infrastructure**

SRIS is an example of a project carried out in Sweden with the aim of doing research in traffic safety using existing in-vehicle technology together with infrastructure in a new and innovating way. In the SRIS, project data were collected from existing sensors in vehicles about the road condition [electronic stability program (ESP), antilock braking system] and other useful information (temperature, windshield wipers, etc.) and transmitted to a central database. The information was combined with weather information from a road weather model and data from road weather stations, and as a result, improved and increased information about the road condition were provided. One of the real benefits with SRIS is that it covers a spatially larger area compared with the fixed positions of the road weather stations and also gives a denser temporal resolution.

Approximately 90% of all new cars in Sweden have ESP. By using only existing sensors in vehicles, a greater coverage can be established. All vehicles in the SRIS field test had special equipment to transmit the signals from the vehicles to a central database. More important is that

many new cars have integrated telecommunication equipment, so the real task in the future is to integrate SRIS into the electrical architecture of the vehicle so the vehicles can send information without the extra equipment that has been used.

SRIS experienced a field test in the winter of 2007–2008 with 100 cars, and the results were successful showing that in most cases the information from the vehicles corresponds with the information from the road weather stations. But there were also situations where SRIS detected slipperiness without warnings from the road weather stations.

In a worldwide perspective, the idea is to increase SRIS to more countries, but it is a political challenge, even though, technically, many of the new vehicles are equipped with ESP and telephones.

The SRIS test in Sweden was performed by use of 100 cars, 90 of them located in the Gothenburg area with 10 cars in Stockholm. The car models used in the test were Volvo V70s and Saab 9-5s. The cars used were both company cars and taxis to get a high frequency of usage and driving distance of the cars.

The weather information was collected by 80 road weather stations and transmitted to a central database located in Borlänge, Sweden. At the same time, vehicles were reporting background data or events of slipperiness from the existing in-vehicle sensors to the same database.

### Relation Between Signals from Vehicles and Actual Road Conditions

Actual road weather was collected from road weather stations during the 2007–2008 season and sorted by an expert system to classify the types of slipperiness. The signals from the vehicles were sorted by type of slipperiness that was registered in relation to the closest road weather stations.

The performed field tests show that collected data were possible to combine in a useful way to get increased usability of the provided information. SRIS increases the possibilities to identify severe road conditions. The field test with 100 cars revealed that SRIS might be applied to more vehicles and for society's profit, both for drivers and road maintenance.

The result from the SRIS field test showed a good result in the test area. An external social economic report concluded that the system gives a high social economic outcome when compared with the cost for SRIS. The economic benefits would be for the road administration that pays for the road maintenance and insurance companies who can lower their costs. But most important is that SRIS has the potential to increase traffic safety which can save lives. SRIS also has the potential to benefit the environment by avoiding unnecessary road salting (1).

An important conclusion is that the weather has a major impact on how often vehicles report events of slipperiness. This means that it is possible to detect and determine the risk and level of slipperiness on the roads. (Note: During snowy conditions, the signals increased 14 times compared with nonslippery conditions.)

	<i>Not Slippery</i>	<i>Rain</i>	<i>Rain on Cold Road</i>	<i>Snow</i>	<i>Frost</i>
Probability of slipperiness	1	1,03	10	14	3



## BEARING INFORMATION THROUGH VEHICLE INTELLIGENCE

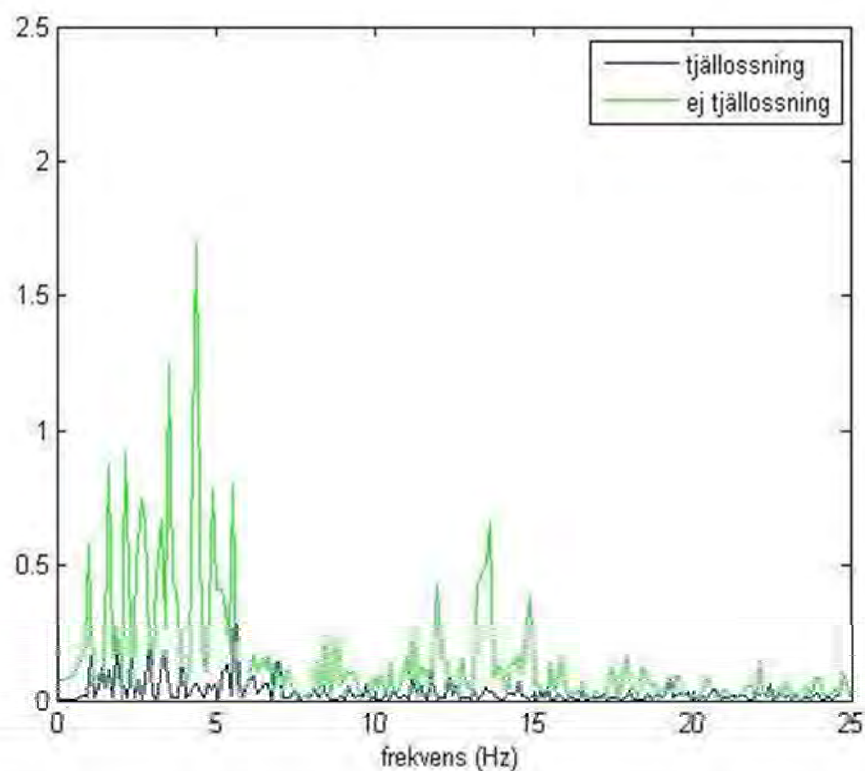
The BiFi project is an ongoing project in Sweden with the aim of studying whether it is possible to map the load-bearing strength of roads using a vehicle-based method. The basic idea is that by combining the vehicle data with weather observations and forecasted weather data, it is possible to model and forecast the road status according to bearing strength. The results from the project are based on field tests in a rough and real environment for determining the load-bearing strength of the roads.

Roads with a high capacity for load bearing are essential for harvesting natural resources and helping keep the countryside open and prosperous. During spring periods when the ground frost thaws, the load-bearing capacity of the forest roads is greatly reduced, leading to road closure. Subsequently it is not possible to use the roads for transporting heavy goods such as lumber. To decrease the costly consequences of road closure, the lumber industry needs to build up large stocks and to plan their transport in such a way that secondary stocks can be used. It has been calculated that these measures cost the Swedish industry an extra \$650 million a year. Therefore, a tool for judging the load-bearing capacity of the road network in a detailed and dynamic way would help to change the current strategy and possibly save the industry significant amounts.

Results from the BiFi project have been successful. The technology using vehicles to detect the bearing strength of gravel roads has been promising. In the first part of the BiFi project, an algorithm was developed based on collected real-time data from a vehicle's standard sensors (Figure 1). Through data analysis, a method of determining the load-bearing capacity of the roads that were driven on with cars was established. To test the algorithm and model, extensive field trials were carried out together with reference measurements. Using the well-proven method based on dynamic cone penetrometer, a comprehensive set of reference data was established. This method was also complemented by measurements using a falling weight deflectometer (FWD). It was concluded that the FWD is not a very useful method during the thawing period because high water content in the road bed gives rise to errors for the FWD. To ensure quality data from the cars, additional sensors were used by reference accelerometers that were fitted to the vehicle to give an indication of the quality of the vehicle's own accelerometer data. The BiFi system detects the bearing strength in a way that is in accordance with reference measurements (2).

## SUPPORT SYSTEM FOR WINTER MAINTENANCE

RWIS is used for helping maintenance personnel make the right decision regarding salting and plowing activities. Such systems have been in use for many years and have been shown to be helpful for maintenance personnel. However, the system was originally designed and built for a maintenance system consisting of small surveillance areas and well-trained personnel that also had local knowledge both of field station environments as well as the local road network. Today most national road administrations need to lower costs associated with winter maintenance and therefore small surveillance areas are lumped together, forming bigger ones. In the process, local knowledge of roads and field stations, among other things, are often lost and forgotten.



**FIGURE 1** Detection of lateral acceleration in vehicle reveals road conditions.

RWIS normally form a very good tool for making decisions regarding maintenance activities. But to be used in its full potential, it is important that users are well trained and experienced to interpret the data that are produced by the system. An interview study among maintenance personnel performed in Sweden (3) clearly showed that the personnel found their work to be very stressful and were often afraid to make the wrong decision because the consequences could be fatal. What the personnel asked for was some help to make better use of the system and also to help make the right decision regarding type and timing of activities.

To meet these demands, research and development regarding a decision support system was conducted at the University of Göteborg, Sweden. The aim of these studies was to develop the present RWIS into a system that gives information, not only data regarding the present and upcoming need for winter maintenance activities (4). The result of this is the SSWM, a tool for making the right decision regarding

- When to perform activity,
- Where to perform activity, and
- Type of activity.

Forecast of the upcoming weather and road conditions are an important part of a SSWM. Several forecast models have been developed during the past years (5, 6). In the present SSWM, the RoadCast model, developed by the authors, is used for road condition prediction. It differs from previous models because it includes a neural network component. This model also contains

a combination of an energy balance component and a statistical component that has been shown to be successful for producing good forecasts of both road surface temperatures and road conditions.

Another important tool for the potential to predict the variation in road slipperiness is a model that can calculate the variation in road surface temperature and road conditions along roads. A local climate model is used that makes it possible to calculate temperature and road condition variations based on input information from thermal mapping, road segmentation, and RWIS data (7, 8).

One development that has increased the performance of the SSWM is that input comes from the maintenance personnel, where their experiences and knowledge are taken into account for the actual area covered by the SSWM. Rules regarding when to perform activities in respect to road standards and “allowed” road conditions forms an important link between the processing unit and the output from the SSWM. Performed activities, such as salting and plowing, along with online feedback from thermal measurements by the trucks, makes the model dynamic and adjustable to prevailing conditions.

Trials and experiences from the Czech Republic that started during the 2007–2008 winter of the SSWM in full operation, including first and second class roads, have proven cost effective, delivering reliable results (9).

The SSWM is now available in three levels depending on the users’ needs: entry level forecasts road conditions that can be used for planning of maintenance activities; advanced level includes feedback about performed activities; and professional level includes dynamic segment using online thermal mapping (Figure 2).

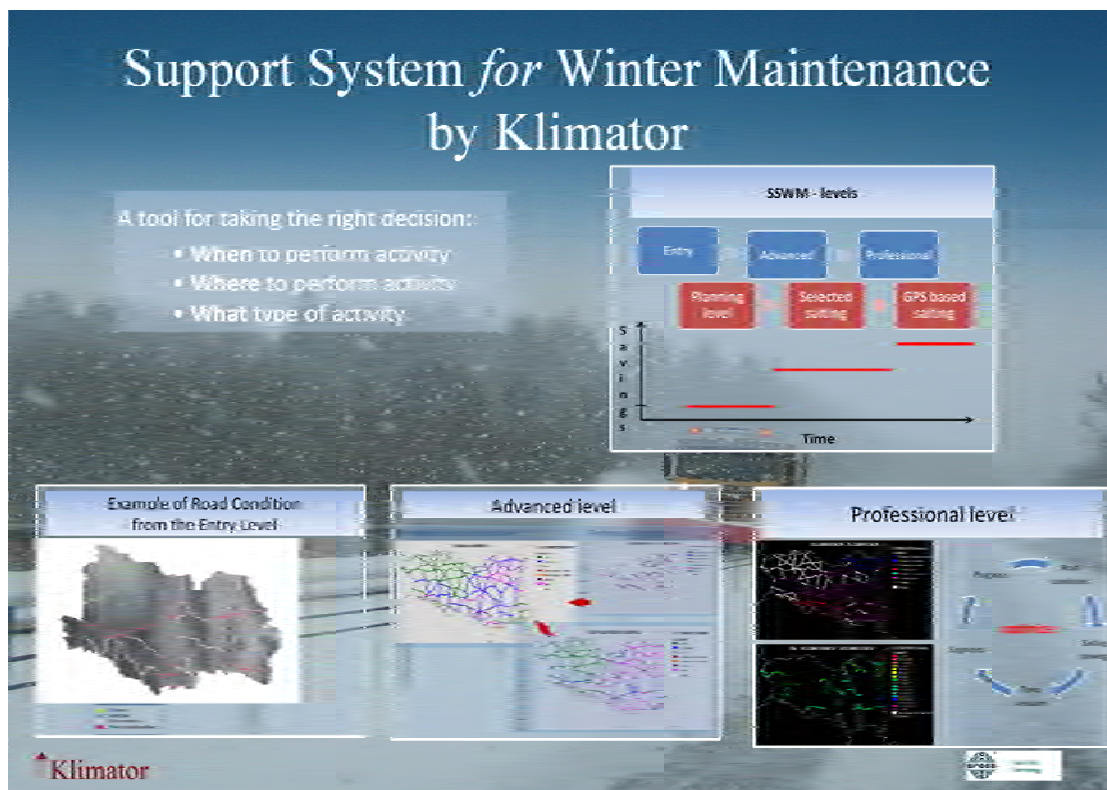


FIGURE 2 Available components in the SSWM.

**REFERENCES**

1. Website: [www.sris.nu](http://www.sris.nu).
2. Website: [www.bifi.nu](http://www.bifi.nu).
3. Ljungberg, M. Expert System for Preventive Salting Operations on Winter Roads. Research report TRITA-VT FR 02:03. KTH, 2002.
4. Website: [www.klimator.se](http://www.klimator.se).
5. Gustavsson, T., and J. Bogren. Automatic Speed Regulation on Highways by Use of Climate Data. Proceedings of the 10th SIRWEC, Davos, Switzerland, 2000.
6. Bogren, J., T. Gustavsson, and U. Postgård. Local Temperature Differences in Relation to Weather Parameters. *International Journal of Climatology*, Vol. 20, 2000, pp. 151–170.
7. Bogren, J., T. Gustavsson, and S. Lindqvist. A Description of a Local Climatological Model Used to Predict Temperature Variations Along Stretches of Roads. *Meteorological Magazine*, Vol. 121, 1992, pp. 157-164.
8. Gustavsson, T., and J. Bogren. Evaluation of a Local Climatological Model: Test Carried Out in the County of Halland, Sweden. *Meteorological Magazine*, Vol. 122, No. 1456, 1993, pp. 257–267.
9. Website: [www.cross.cz](http://www.cross.cz).

## DECISION SUPPORT SYSTEMS

## Geospatial Weather Decision Support for Transportation Applications

JEREMY DUENSING

*Telvent DTN*

Weather is a major factor in surface transportation: it impacts traffic flow and patterns, and is often a precursor to accidents, a significant portion of which cause injury or death. Integration of current and forecast weather information into intelligent transportation system (ITS) applications, including 511 systems, can provide transportation managers with the information they need to make better decisions and provide alerts that can reduce congestion while improving safety. Improved routing, logistics coordination, maintenance operations, and efficiencies for the transport of materials can also be gained through a better understanding of weather issues that affect the transportation network. The merge of weather information with geographic information system (GIS) technology provides new and exciting capabilities now being realized by the transportation industry to mitigate weather-related risks through operational decision support. Telvent DTN has developed unique capabilities to merge weather information with non-weather assets, both stationary and mobile, to provide unparalleled weather risk monitoring and location-based alerting. Weather parameters that are relevant to specific business requirements are continuously monitored and compared to customer asset locations. Automated alerts are generated when critical weather thresholds are exceeded at the identified asset locations. These real-time location-based alerts can provide dramatically enhanced public safety, improved logistics support, and provide a superior advantage in operating business efficiencies relating to weather conditions. This advanced capability provides effective, accurate, and precise weather decision support for varied transportation applications. Covered in this paper will be the methodology, data sets (both stationary and mobile,) and benefits behind this geospatial decision support for various transportation applications. Also included will be a demonstration of how this technology was utilized in conjunction with roadway weather information system (RWIS) information from Clarus in the 511NY traveler information system.

The merge of weather information with geospatial technology provides new and exciting capabilities now being realized by many different transportation organizations to mitigate weather-related risks through operational decision support. Telvent DTN, the world's leading commercial weather service provider, has adopted a geospatially enabled weather processing and display infrastructure for preparation and conversion, display and visualization, and active monitoring and alerting of weather data and events. The powerful spatial analysis capabilities inherent within geospatial weather information make possible an impressive array of capabilities that can help solve a variety of complex transportation problems and create new possibilities and solutions in transportation applications.

## GEOSPATIAL INFORMATION

Over the period of more than a decade, Telvent DTN has developed software that makes possible the operational merging of geospatial weather with non-weather data to solve complex transportation problems. Telvent DTN gathers both categories of information from various sources and each data type imparts valuable information with which to make operational decisions.

### Geospatial Weather Data

Weather information is ever changing and represents a very dynamic data set (i.e., some of the weather information updates as often as once every few seconds). The collection, management, quality control, and conversion of geospatial weather data into actionable information, in an operational environment, represent a set of formidable challenges. A data set that is delayed by decoding, processing, and quality control algorithms is of no use to the end user. Extremely timely but poor quality weather information is also of no use to the end user. Telvent strives to meet both issues by striking a balance between timeliness and quality through a combination of a robust and redundant back-end infrastructure combined with decoding and quality control algorithms based on many years of weather industry expertise. Below is a list of weather information and the input each can give a transportation user.

#### *Observations*

National meteorological organizations as well as smaller public and private entities have a vested interest in measuring and distributing routine observations. For example, the FAA takes routine atmospheric observations at most airports. Atmospheric observations of this type contain such valuable transportation-specific information such as wind speed and visibility (Figure 1). One drawback to transportation users of observations of this type is that these are typically located away from major highways and are centered on major airports.

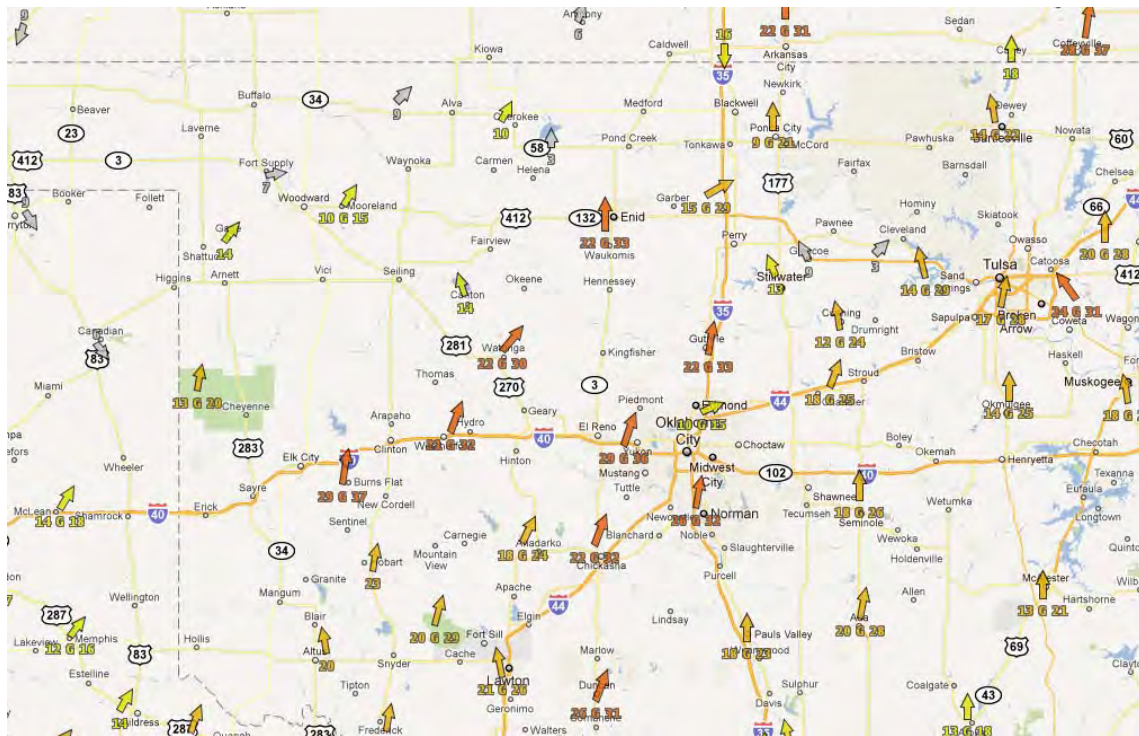
For this reason, many transportation agencies have also found value in installing surface-based observations along the roadside in the form of RWIS. Not only is this information taken along the roadway itself, as opposed to the nearest airport, it also contains valuable transportation-specific information such as pavement temperature, pavement condition, and even traffic speed.

#### *Radar*

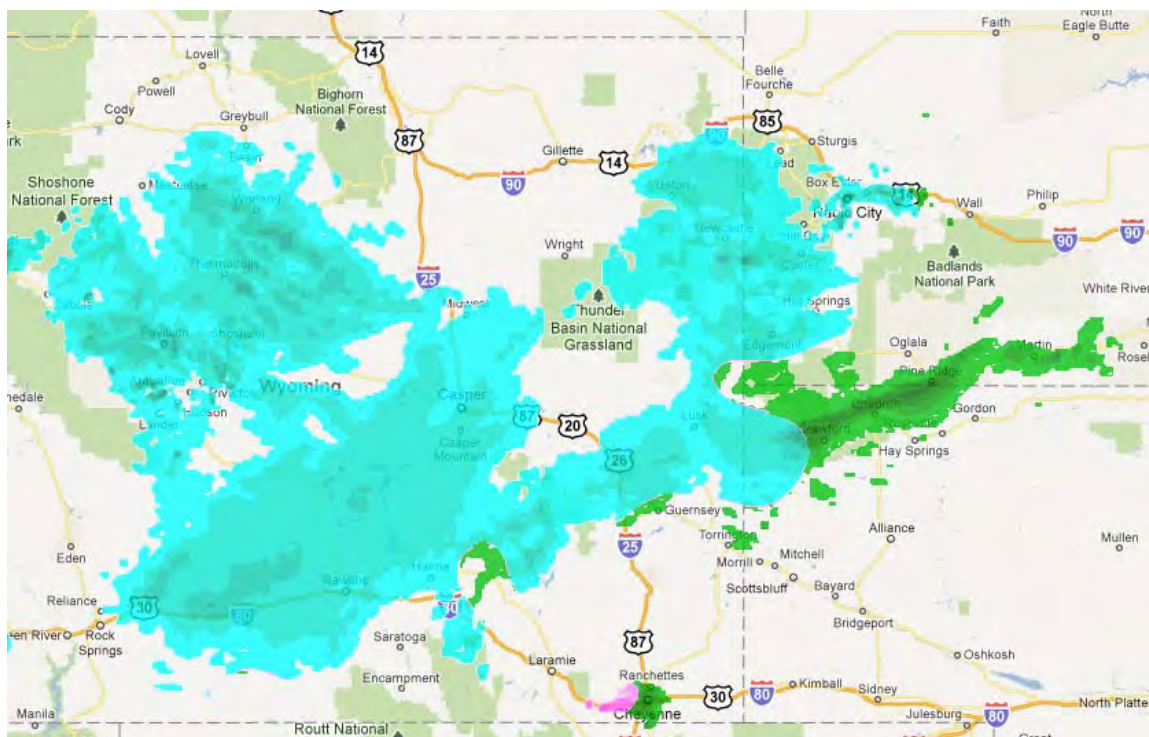
Radar information typically is generated and distributed by national meteorological organizations and is an indication of the geographical location and intensity (light, moderate, or heavy) of precipitation falling from the clouds (Figure 2). Further processing can also give an indication of the type of precipitation that is occurring (rain, snow, or mix).

#### *Weather Watches and Warnings*

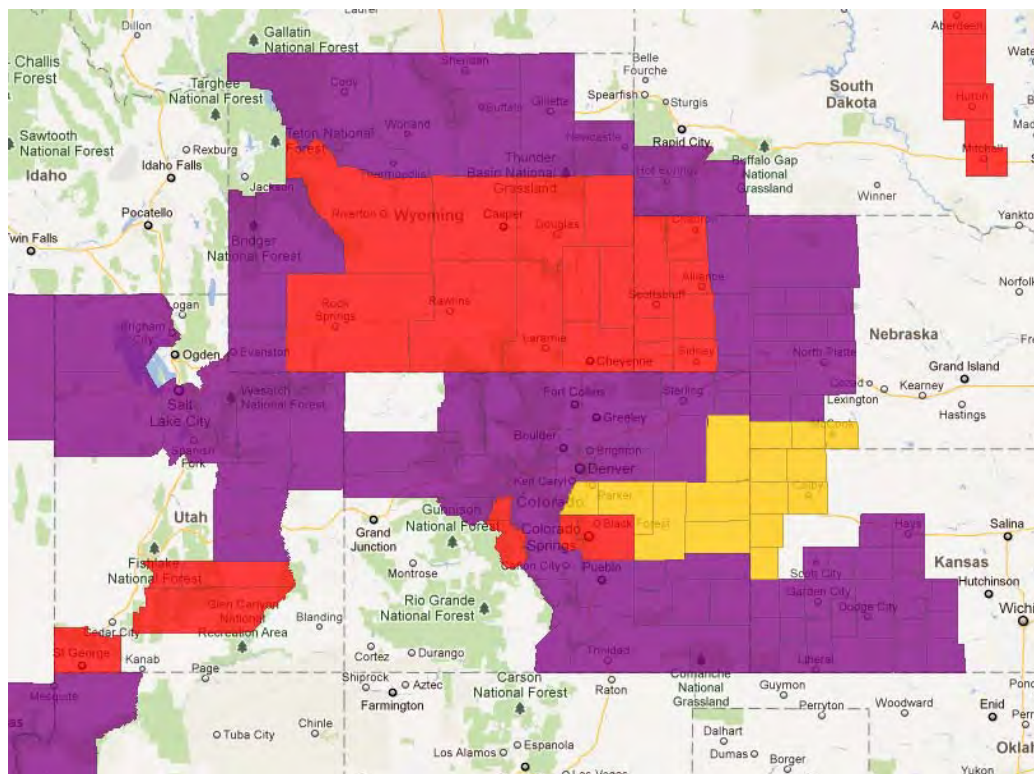
Both national meteorological organizations as well as private weather organizations such as Telvent create and distribute weather advisories for geographically specific areas (Figure 3). The time horizon for this information exists from 15 to 30 min out through several days in advance



**FIGURE 1** Display of wind observations across the state of Oklahoma.



**FIGURE 2** Radar data depicting precipitation type and intensity across Wyoming, South Dakota, and Nebraska.



**FIGURE 3 National Weather Service watches and warnings across Utah, Colorado, and Kansas.**

of a high-impact adverse weather event. Examples of this type of information include a winter storm watch issued several days in advance or a tornado warning issued a few minutes in advance of a tornadic thunderstorm.

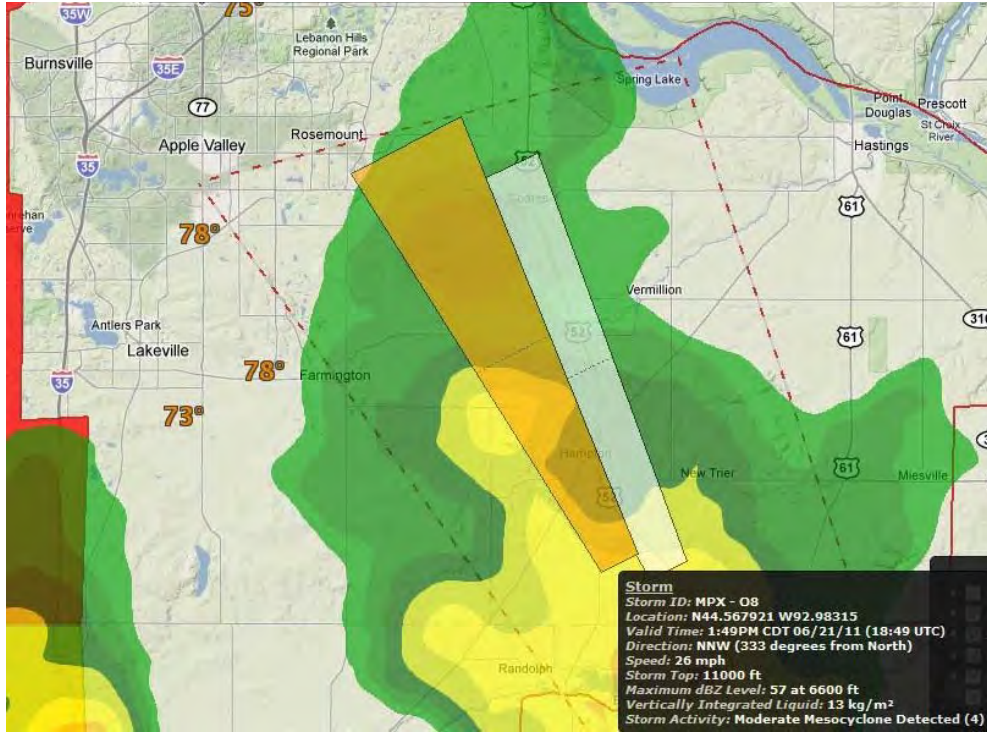
### *Storm Corridors*

In addition to the geographic location, intensity and type of precipitation falling from the clouds (as mentioned the section on weather watches and warnings), additional information called storm corridors are sometimes available from radar data received from national meteorological organizations. Storm corridors are essentially a “cat scan” of severe storm cells and can give a 15- to 30-min forecast of high-impact information such as possible storm rotation (tornados) and hail size potential (Figure 4).

### *Lightning*

Lightning is good example of rapidly updating geographically referenced weather information that goes beyond just radar information alone. While radar information typically updates on the order of minutes at a time, lightning updates typically occur on a subminute basis due to the frequency it occurs and safety impact lightning can have on decision making (Figure 5). Lighting can also be further broken down into cloud-to-cloud strikes and cloud-to-ground strikes indicating the specific location of any dangerous lightning to personnel or assets on the ground.





**FIGURE 4** Tornadoic storm corridor across southern Minnesota.



**FIGURE 5** Lightning strikes (blue and white bolts) across Iowa and Illinois.

## Geospatial Nonweather Data

There are many different types of nonweather information that are valuable to the transportation industry. These data sets vary widely and can include garage locations, roadway segments, or the location of a moving vehicle.

### *Fixed-Point Locations*

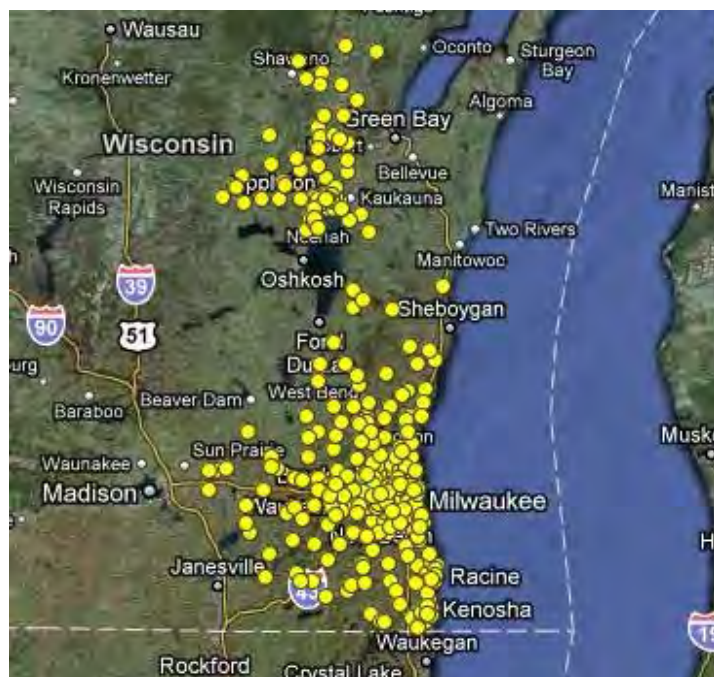
Locations of specific geographically referenced points of interest can take many forms, especially in the transportation industry (Figure 6). Examples of fixed points can include garage locations, traffic intersections, or locations of observations points such as RWIS.

### *Fixed-Line Segments*

From a transportation perspective, fixed-line segments typically take the form of the location and name of a roadway segment (Figure 7). These roadway segments are usually defined by mile markers, intersections, landmarks, or other similar information that make them identifiable to the end user. Other examples of fixed-line segments include railway lines, bus routes, or plow routes.

### *Fixed-Polygon Areas*

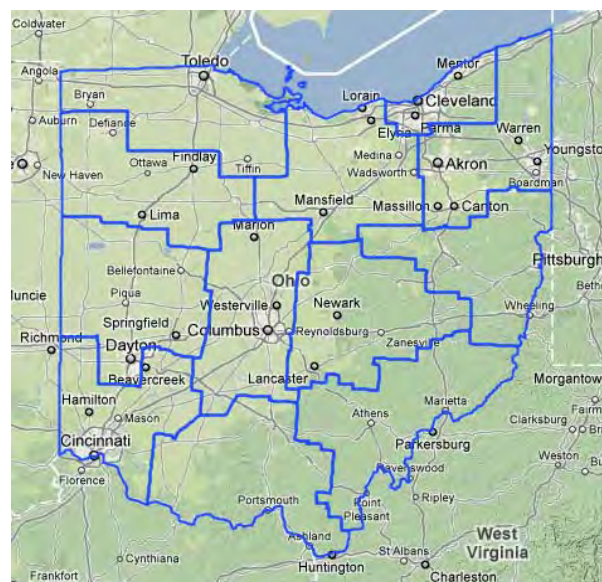
Polygon areas encompass any area that cannot be defined by a simple straight line. These areas can be straightforward shapes (squares, circles) or can be defined by irregular boundaries such as rivers or political areas (Figure 8). Examples of fixed-polygon areas include counties, district boundaries, or maintenance responsibility regions.



**FIGURE 6** Fixed-point locations across Wisconsin.



**FIGURE 7 Fixed-line segments in Minnesota.**

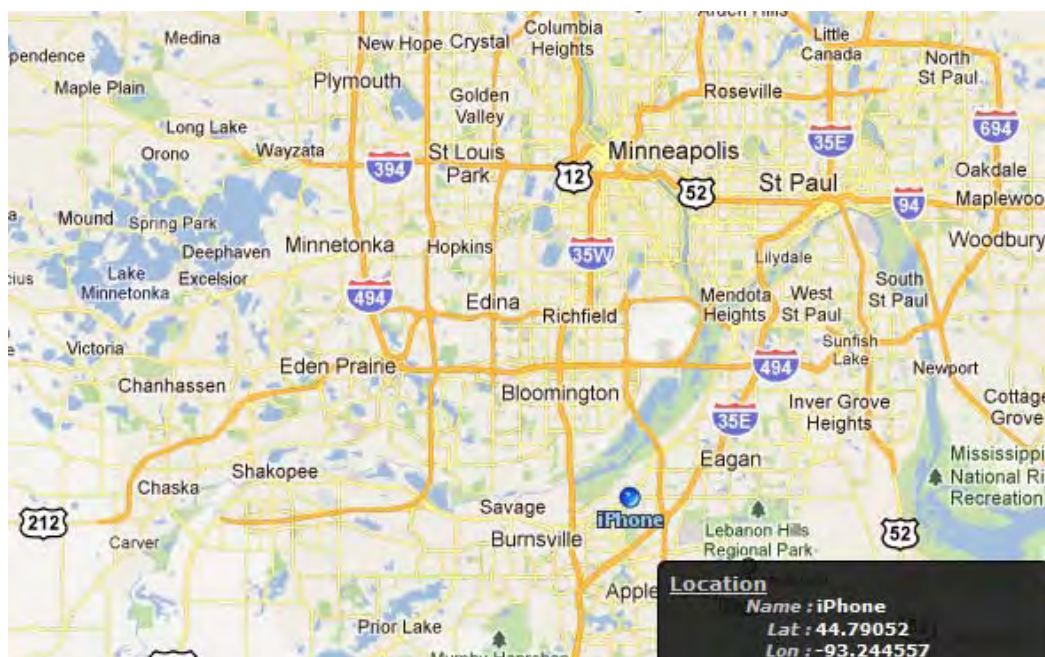


**FIGURE 8 Fixed-polygon segments in Ohio.**

### *Mobile-Point Locations*

Mobile information typically takes the form of routinely updating latitude and longitude data and can also include other ancillary information such as speed, heading, and even weather observations (Figure 9). The more traditional mechanism for gathering this information in the transportation space is use of automatic vehicle location (AVL) technology whereby hardware is installed on a fleet of vehicles such as plow trucks and utility vehicles.

With the explosion of smart phones in recent years, mobile phones that contain GPS functionality are also serving as sources of mobile point locations and provide information of the precise location of the smart phone itself rather than a specific vehicle.



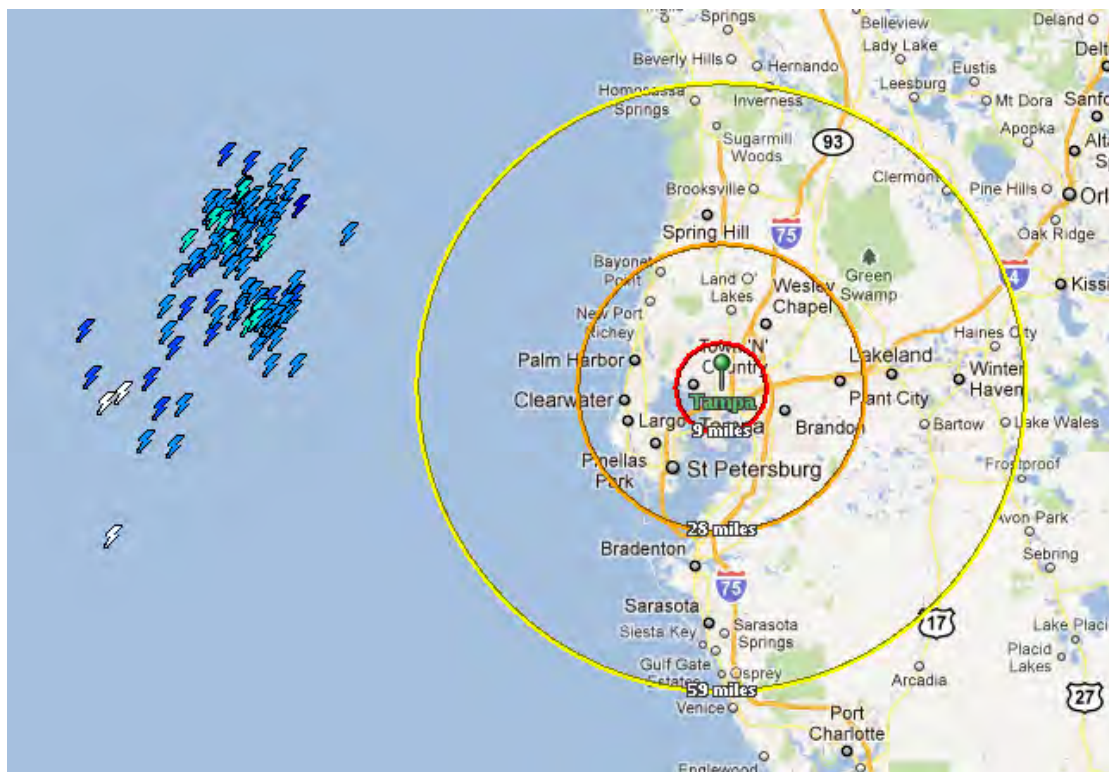
**FIGURE 9 Mobile-point location in Minnesota.**

## COMBINATION OF GEOSPATIAL WEATHER AND NONWEATHER INFORMATION

By combining weather information and other georeferenced information (discussed in the sections on Geospatial Weather Data and Geospatial Nonweather Data), Telvent DTN is able to facilitate the continuous monitoring of multiple weather parameters against geographical assets which automatically trigger active, location-specific alerts when critical weather thresholds are exceeded. This weather-enabled decision support system, which has been patented by Telvent DTN, can help transportation agencies monitor specific weather threats and manage their weather-related risks. The various use cases for these alerts are described below.

### Active Weather Alerts for Fixed-Point Locations

The continuous monitoring of multiple weather parameters relative to fixed transportation assets can be achieved within a GIS-based weather alert system (Figure 10). We identified a fixed-point location such as a traffic intersection in the section on Fixed-Point Locations. By combining this geographically referenced location with the rapidly updating weather data laid out in the section on Geospatial Weather Data, a continuous monitoring of transportation-specific weather parameters such as snowfall intensity or wind speed against intersection locations across a city can be provided. The system compares the actual conditions against intersection-specific weather tolerance thresholds that, if exceeded, generate a unique real-time alert message notification. If heavy snow is affecting an intersection, an alert would be generated and sent to the proper recipient. It is this type of flexible and configurable weather alert technology that can assist transportation agencies to more quickly respond to rapidly changing weather conditions that can substantially impact their operational decisions.



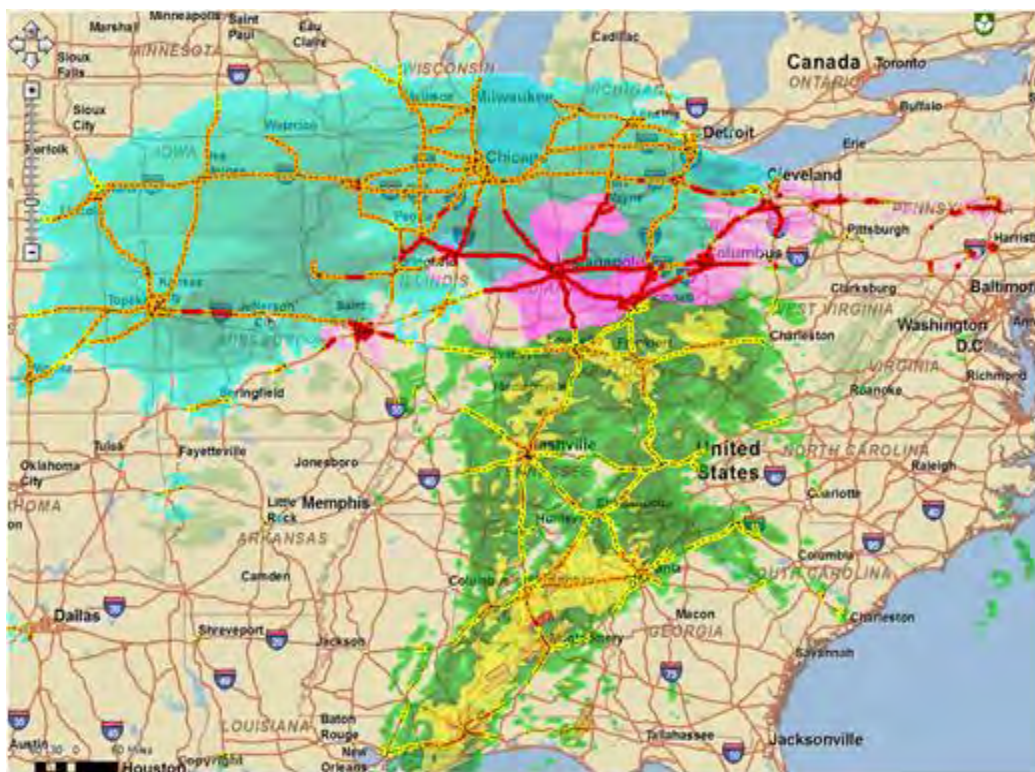
**FIGURE 10** Lightning alerts for a fixed point.

### Active Weather Alerts Along Line Segments

The proximity of specific weather relative to line segments, such as highways or railways as discussed in the section on fixed-line segments, can be monitored within Telvent DTN's GIS-based weather decision support system providing benefit to transportation management systems. One example is road segment-based weather alerting for 511 systems (Figure 11). Standard transportation road segments and landmarks can be monitored for high winds, dangerous storm corridors, heavy precipitation, or fog that will affect visibility, or winter weather conditions that can affect pavement condition and safety. Weather alerts for the road segments and landmarks can be delivered to a 511 phone system, website, and dynamic message signs along the roadway for dissemination to the public, preventing accidents, congestion, and delays.

### Active Weather Alerts for Geographical (Polygon) Areas

In addition to fixed-point locations and line segments, the Telvent DTN GIS-based decision support system also has the ability to objectively evaluate weather threats that may exist over larger geographic areas. One example of this capability is the intersection of potentially dangerous tornadic thunderstorms with a populous city center. This information can enable emergency managers to make better decisions on where to evacuate people, where to send first responders and where roadblocks may need to be set up. Use of this technology allows emergency response personnel to provide a faster, more intelligent and informed response to a crisis situation that can be affected by the weather.



**FIGURE 11** Precipitation type and intensity alerts for road segments.

### Active Weather Alerts for Mobile Points

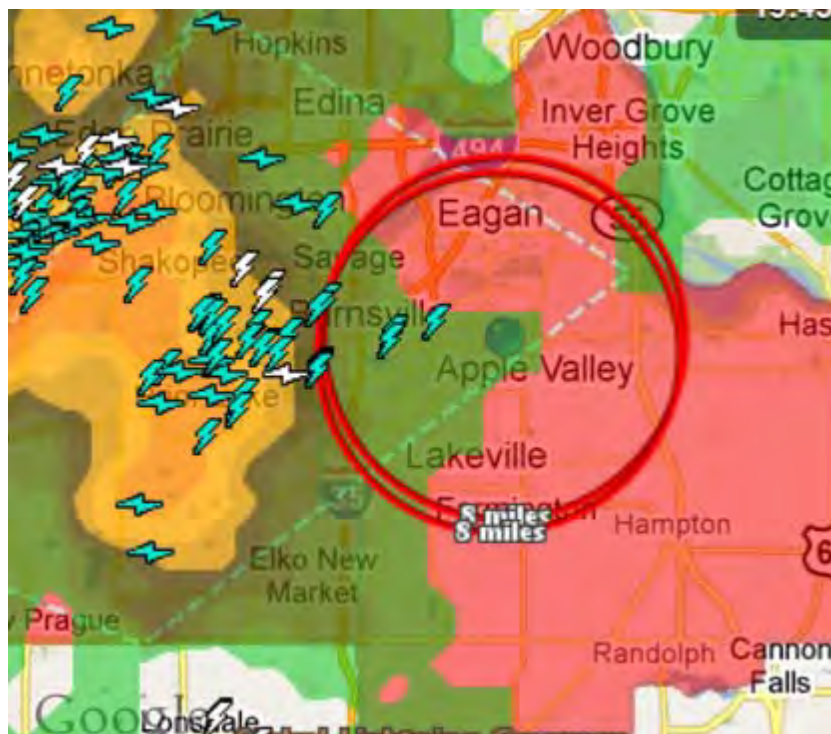
The most powerful capability yet realized occurs when not only does geospatial weather information update in real time but so does the location of the mobile asset itself (Figure 12). By continuously monitoring both types of geospatial information, alerts can be generated by taking into account whether a mobile asset is moving into or out of a high-impact weather situation.

Applications for these types of alerts include such scenarios as alerting a moving plow truck against the observation of high winds, making a mower aware of the presence of lightning in the area or an alert for a bus that it is in the path of a severe thunderstorm with large hail.

The concept of the connected vehicle plays a large role in this space and it is completely possible to alert against a moving vehicle that is driving into heavy snow, may be impacted by a blizzard warning or is in the path of a potentially tornadic thunderstorm.

### APPLICATIONS OF GEOSPATIAL WEATHER DATA

In taking a step back and looking at the big picture, numerous transportation applications exist where geospatial analysis of specific weather information against fixed or mobile assets can facilitate improved business decisions. Given that the alert format can take the form of an XML feed, for example, this information can be easily integrated into existing applications to take advantage of location-specific alerts on geospatial weather information.



**FIGURE 12 Mobile asset (blue dot in center of screen) versus lightning and severe thunderstorm warning.**

### **Advanced Traveler Information Systems**

Integration of current and forecast weather information into ITS applications, including 511 systems, can provide transportation managers and the general public with the information they need to make better decisions and provide alerts that can reduce congestion while improving safety. Improved routing, logistics coordination, maintenance operations, and efficiencies for the transport of materials can also be gained through a better understanding of weather issues that affect the transportation network.

### **Advanced Traffic Management Systems**

Given weather's direct impact on surface transportation and its impact on traffic flow and patterns, alerts for specific road segments being affected by weather can be used as input to traffic models to better predict where traffic issues will occur due to factors other than time of day or vehicle counts. Another advanced traffic management system (ATMS) application includes modifying signal timing based on the intersections that are or will be affected by events such as heavy snow. These types of alerts could be integrated in a traffic management center for use in the decision-making process concerning signal timing, variable messaging sign content, and variable speed limits.

## Connected Vehicle Initiative

By intersecting mobile assets with geospatial weather information, these alerts can play a large part in driver safety and route decision making. Vehicle-specific alerts can be generated by the presence of heavy snow, potential tornadoes, or blizzard warnings. These configurable alerts can be modified and grow as the connected vehicle initiative takes form and grows on both a state and federal level.

## Personnel Safety

Real-time location and movement of dangerous storm cells, geospatially analyzed against the precise location of transportation personnel (mowing, striping, spraying), produces location-based event notification of impending weather threats resulting in advanced warning time for safety preparation.

## Emergency Management

The forecast position and track of a tropical storm or a tornado, compared against population centers, allow an objective forward-looking analysis of damage potential as well as a more precise determination of optimal evacuation routes.

## ATMS CASE STUDY: 511NY

### Demonstration Project for Weather Alert Data

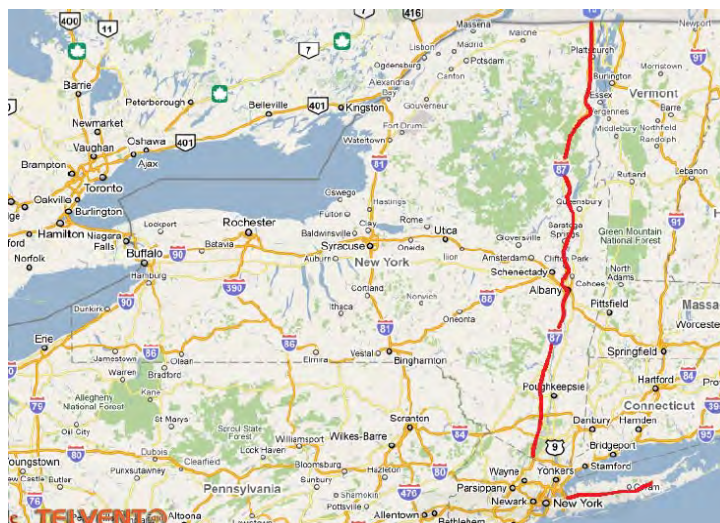
During the winter of 2010–2011, Telvent and New York State Department of Transportation (DOT) completed a demonstration project sponsored by the FHWA on innovative uses of *Clarus* information. This project involves the design, development, and implementation of an ITS that collects real-time *Clarus* RWIS data and other pertinent weather alert data from various sources on selected roadways in New York State and integrates the information for display to the end user through a modified 511NY traveler information website (Figure 13). The collected data can also be integrated into other traveler information systems such as the New York connected vehicle system currently under development.

The goal of this project is to demonstrate the feasibility of collecting, integrating, and disseminating various types of current and forecast location-specific weather alert data for use by traffic managers and motorists to help make better travel decisions, reduce congestion, and improve safety.

The *Clarus* system provides a location-specific data source for road weather information based on state RWIS sensors scattered across North America. There is concern that some sensors are not evenly distributed; some are within a few miles of each other while others are hundreds of miles apart. To address this problem, the weather information from *Clarus* can be supplemented with additional real-time, location-specific weather data sources to provide a continuous weather picture at various locations.

Through this project, the Telvent project team integrated *Clarus* data into the Telvent road segment alerting engine. This product, called SiteWatch, is a patented system that analyzes multiple weather factors against specific road segments along a transportation corridor. If weather conditions exist that can cause issues with the transportation system, an alert is generated for the individual road





**FIGURE 13** Telvent and New York State DOT project coverage area.

segments that are affected. These road segment alerts are integrated into the 511NY pre-production system to provide enhanced, detailed, localized road weather condition information, including information from *Clarus*. In addition, the road segment alerts are provided through a data feed for use by the New York connected vehicle system.

The coverage area for this project includes the New York transportation corridors of the Long Island Expressway (I-495) and I-87 west of the Hudson River to the Canadian border. Since the number and location of the RWIS sensors along the project corridors are limited, Telvent extended a radius of influence around the locations for 8 mi. This means that only road segments within this area will be candidates for *Clarus*-based road weather alerts.

To supplement the RWIS data received from *Clarus*, weather information from a number of other data sources was accessed and integrated into the resulting system, including National Weather Service surface observations, Doppler radar, storm corridors, and National Weather Service bulletins.

### Demonstration Weather Scenarios

Several weather scenarios were captured during this project to demonstrate the results of utilizing geospatial weather information against specific road segments in a 511 system.

#### *Winter Weather Scenario*

On the morning of March 7, 2011, an area of moderate to heavy snow was affecting I-87 from Albany, New York, north to the Canadian border (Figure 14).

The New York State DOT RWIS network was reporting wet road conditions with pavement temperatures below freezing through the *Clarus* system. Both the precipitation type and intensity information from radar was combined with observed RWIS information from *Clarus* and intersected with road segments as defined in the 511NY system. This intersection of geospatial weather and nonweather information generated an alert for I-87 north of Albany which was then depicted in the 511NY system (Figure 15).



FIGURE 14 Radar display showing moderate to heavy snow on I-87 north of Albany, N.Y.

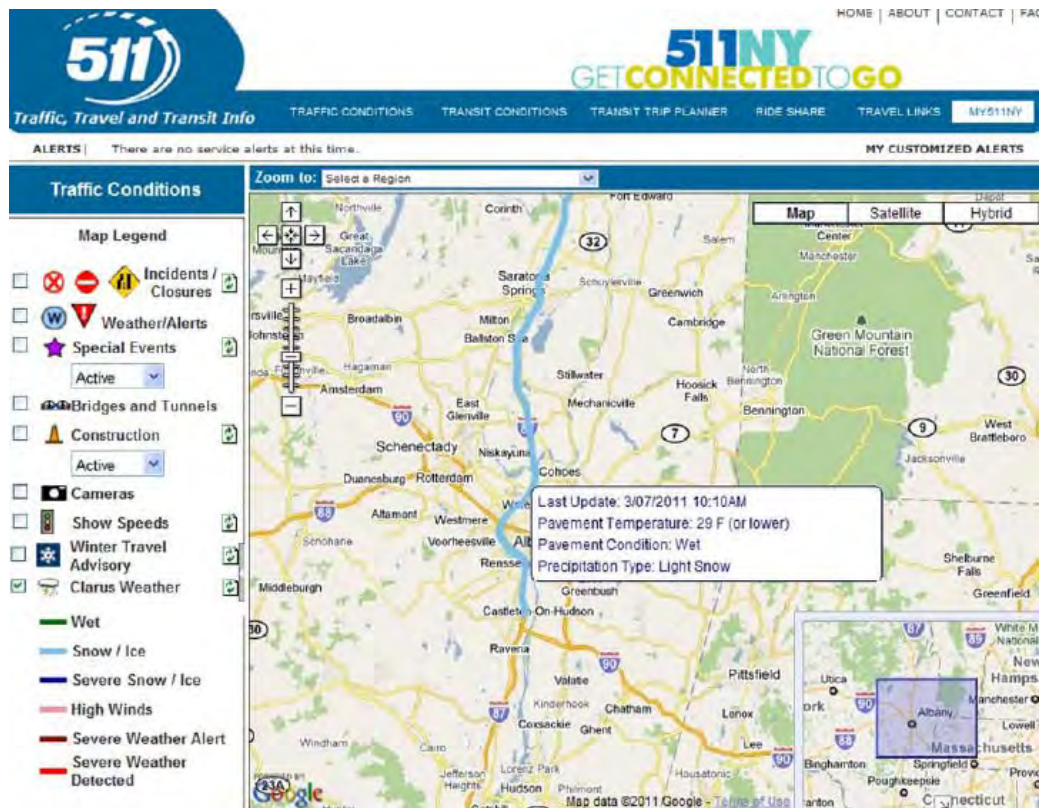


FIGURE 15 Road segment alert depicted in 511NY system by blue-shaded roadways north of Albany, N.Y.

Even though the 511NY system may have been showing good traffic speeds with no incidents, a driver equipped with this additional information about snowfall north of the Albany area may have made a different travel choice by delaying departure times or taking an alternate route.

### Summer Weather Scenario

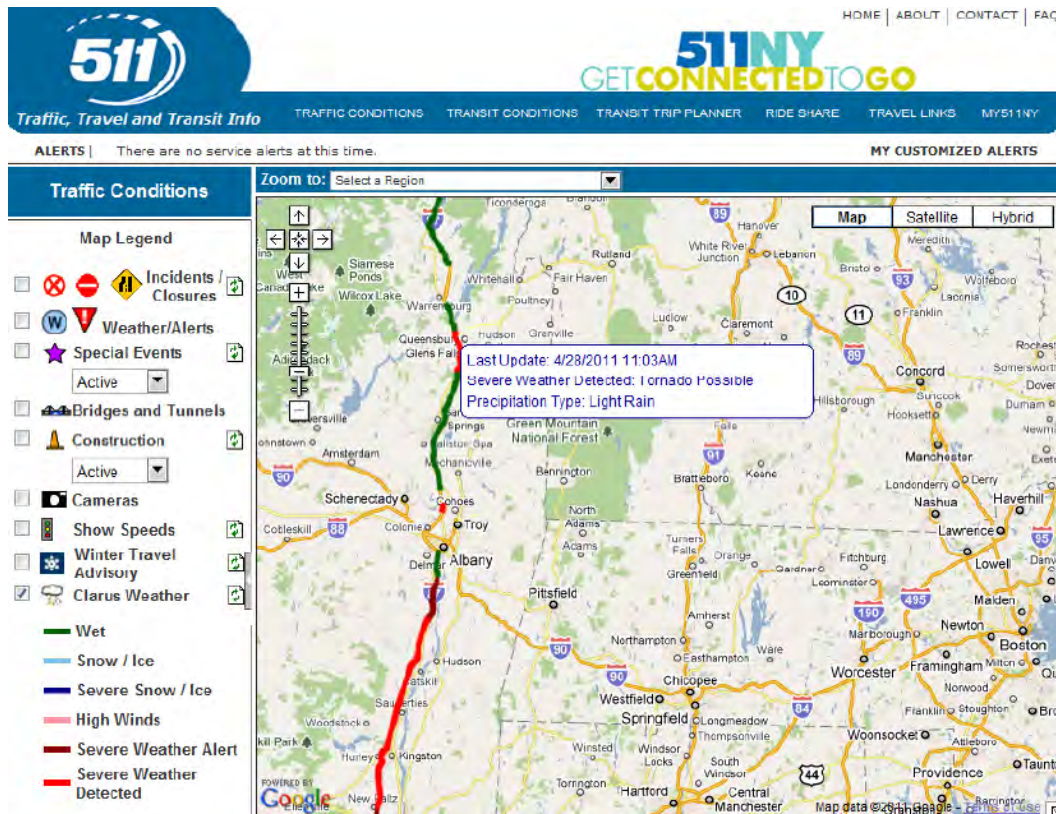
During the late morning of April 28, 2011, a line of strong to severe thunderstorms were moving across eastern New York causing many issuances of severe thunderstorm and tornado warnings across the region. Many of the storms showed strong signatures of severe hail and even tornadoes, especially in northeastern New York near Queensbury (Figure 16).

This storm corridor depicting a potential tornado was intersected with I-87 road segments and an alert was generated and displayed in the 511NY system using a red shaded road segment (Figure 17).

These two weather scenarios demonstrate that by utilizing geospatial weather information (radar, RWIS observations, and storm corridors) and nonweather information (511NY road segments), information can be presented to the general public that can be used to make better travel decisions using information beyond what is available today in 511 systems. The full and complete report for this project can be referenced under the name *Integrating Clarus with the 511 New York Traveler Information System* published in June 2011 under publication number FHWA-JPO-11-112.



**FIGURE 16** Storm corridors indicating a tornadic signature near Queensbury, N.Y., area (red cone in center of screen).



**FIGURE 17** Possible tornado indicated by red shading in upper portion of 511NY display.

## CONCLUSION

Telvent DTN has pioneered geospatial weather technology that has led to the development of weather-enabled decision support systems and alerts for transportation applications. This technology allows transportation agencies to seamlessly merge the locations of their assets (intersections, roadways, mobile vehicles) with up-to-the-minute localized weather information to provide improved operational decision support. GIS is used in these systems as an enabling technology that allows the effective merge of weather with transportation assets, sophisticated spatial and temporal analysis, and determination of the customized net effect of the present or impending weather event. Automated alerts are generated through a patented process when critical weather thresholds are exceeded.

The deployment of operational weather-enabled decision support systems continue to provide dramatically enhanced personal safety, improved logistics support, and superior advantage in operating transportation efficiencies relating to weather. Many years of research and development by Telvent DTN has led to the development of this advanced capability to centrally provide weather decision support aides. This synergy of technologies holds great promise for transportation agencies to use weather information to their advantage in the future.

## DECISION SUPPORT SYSTEMS

## Present and Future of Practical Road Weather Decision Support Research

MICHAEL B. CHAPMAN

SHELDON DROBOT

*National Center for Atmospheric Research*

Maintaining control of snow and ice buildup on roadway surfaces during winter storms is challenging for road maintenance entities. Some of the critical challenges include making effective and efficient decisions for treatment types and timing of treatments, and knowing the location of greatest impact to the roadway based on precipitation rates and types and other weather conditions. These decisions are critical because of the implications to roadway safety, as well as economic impacts to the agency and the environmental impacts of treatments. In order to mitigate the challenges associated with winter road maintenance, the FHWA under the United States Department of Transportation (DOT) initiated the development of the Maintenance Decision Support System (MDSS) in 1999. MDSS provides a single platform that blends existing road and weather data sources with numerical weather and road condition models in order to provide information on the diagnostic and prognostic state of the atmosphere and roadway (with emphasis on the 1- to 72-h lead time period) as well as a decision support tool for roadway maintenance treatment options. MDSS was engineered with a robust modular design. The flexibility of this design allows for smaller sections of the system to be modified without having to redesign the entire system. Porting MDSS to a decision support system for non-wintertime weather impacts (visibility, flooding, non-winter maintenance, etc.) to the roads is being considered as the next step for this system. Also, customizing modules for other non-DOT user groups (e.g., emergency medical services, school planning, and fleet trucking companies), which are also highly impacted by adverse road weather, is a future direction for this research. This paper gives an overview of the most recent advancements to the federal prototype MDSS system as well as a discussion on the future direction of road weather decision support for not only the road maintenance community but also different user groups that may benefit from better and more useful road weather decision support.

The National Center for Atmospheric Research (NCAR) Maintenance Decision Support System (MDSS) (1) is a decision support system designed to give winter road maintenance decision makers both tactical and strategic guidance for planning and executing different aspects of winter road maintenance. The original plan for the system was to combine weather data, road data, and winter road maintenance rules of practice into one system that could provide useful road weather-specific atmospheric information (e.g., weather observations, road surface observations, and forecasts) as well as recommendations (e.g., treatment recommendations) for actions to be taken with respect to physical maintenance of the roadways and bridges. While the treatment recommendations were built as a tactical tool for the maintenance managers, the overall use of the system was originally intended to be strategic (1 to 2 days).

As the system has matured and the requirements of the various types of users have changed, the need for a more accurate tactical component (0 to 6 h) to the weather and road forecast engines of MDSS has become apparent. This is especially important for the prediction

of precipitation over the short term. The federal prototype MDSS had recently been deployed over the Denver International Airport and a highway north of Madrid, Spain. Work is being done to improve the tactical capability of the system.

Additionally, the MDSS system was engineered in a robust manner, which allows for it to be ported to different weather phenomena that are also highly impactful to road safety, as well as user groups that may benefit from more practical and useful road weather-centric data and applications.

The purpose of this paper is to describe the MDSS system, show results from previous verification studies performed on the system, and discuss the future needs with respect to adding a non-wintertime weather impact to the roads capability as well the need to modify the system for other user groups.

## MDSS SYSTEM TECHNICAL OVERVIEW

The NCAR MDSS is a computer-based and customizable system that can be configured to provide route-specific weather–road observations and forecasts and road maintenance treatment recommendations. The MDSS system integrates state-of-the-art weather forecasting, data fusion, and optimization techniques with computerized winter road maintenance rules of practice (RoP) logic (1). Over the years MDSS has proven to be a vital strategic decision-making tool with benefits that are included as follows:

- Route-specific forecasts,
- Customizable treatment recommendations,
- Material (e.g. salt, sand) savings,
- Reduced impact on the environment, and
- Savings on manpower and fuel.

Figure 1 shows a high-level flow diagram for MDSS. The upper left box represents data received from the United States National Weather Service (NWS) National Centers for Environmental Prediction. These data include surface observations, statistical guidance products, daily weather summaries, and numerical weather prediction model output from national-scale numerical weather prediction models called the North American Model (NAM) and Global Forecast System (GFS). The NWS models are supplemented by a high-resolution model: the Rapid Update Cycle (RUC) (2) which is generated by the U.S. National Oceanic and Atmospheric Administration Global Systems Division.

The Road Weather Forecast System (RWFS) is tasked with ingesting reformatted meteorological data (observations, models, statistical data, climate data, etc.) and producing meteorological forecasts at user-defined forecast sites and forecast lead times. The forecast variables, generated by the RWFS, are used by the Road Condition and Treatment Module (RCTM) in order to calculate the road surface temperature as well as to calculate a recommended treatment plan. In order to achieve this goal, the RWFS generates independent forecasts from each of the data sources using a variety of forecasting techniques.

A single consensus forecast from the set of individual forecasts is provided for each user-defined forecast site or district (e.g., plow route and zone) based on a processing method that

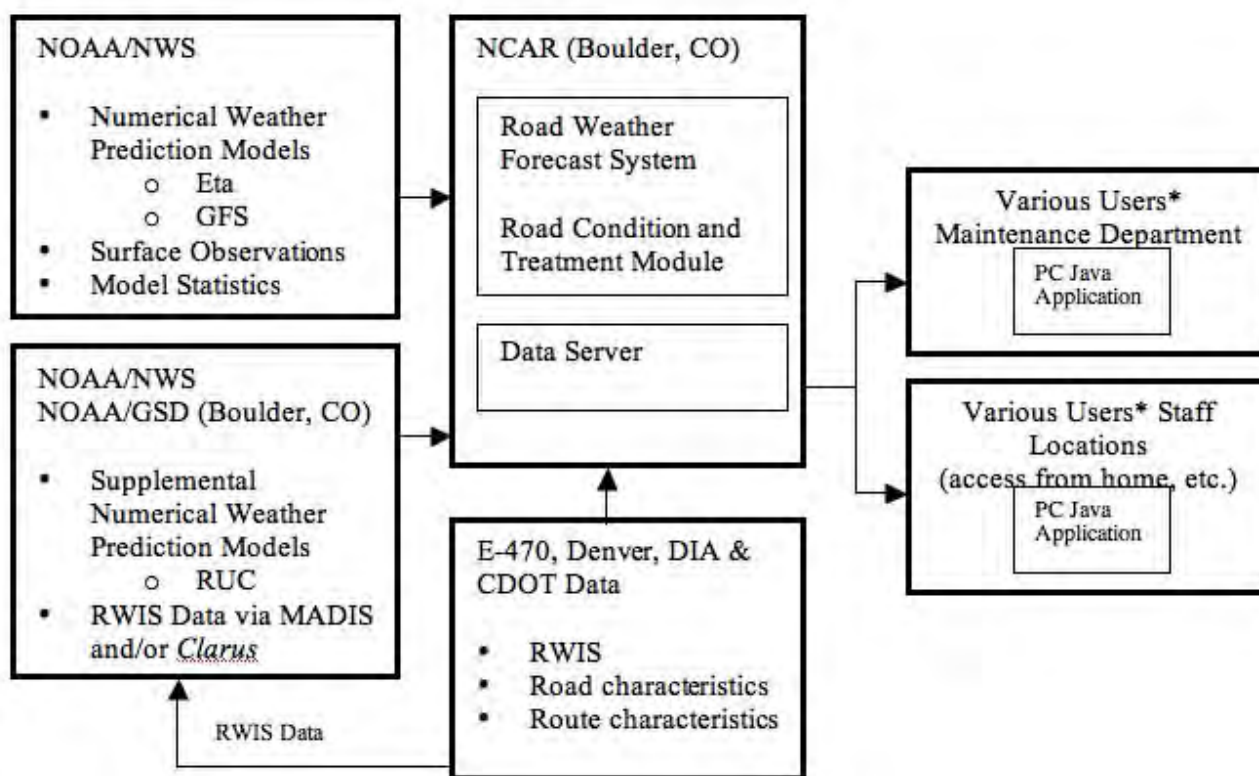


FIGURE 1 Flow diagram for Colorado MDSS.

takes into account the recent skill of each forecast module. This consensus forecast is nearly always more skillful than any one component forecast. The RWFS is designed to optimize itself using available site observations along or near the routes (e.g., RWIS, METARS). The forecast modules that perform the best are given more weight over time. In addition, Dynamic Model Output Statistics (DMOS) are calculated weekly using observations and model output. The DMOS process is used to remove model biases. The optimization period of the RWFS is approximately 90 to 100 days.

The final module in the system contains the RoP algorithms. The RoP are customized rules and techniques that are used at DOT maintenance garages for maintaining mobility during winter conditions. These rules tend to vary from state to state and in many cases are different for each garage. Hence, this module has the ability to customize many of its inputs so that it can be portable between garages. Treatment recommendations include the following information:

- Recommended treatment plan (e.g., plow only, chemical use, and abrasives);
- Recommended chemical amount (e.g., pounds per lane mile);
- Timing of initial and subsequent treatments; and
- Indication of the need to pretreat or posttreat the road.

An easy to use Java-based graphical user interface (GUI) (Figure 2) ties all of the pieces of MDSS together and helps to organize (graphically) the information for the user.

## VERIFICATION

### Methods

This section provides MDSS results from the winter 2007–2008 MDSS field demonstration in Colorado and the 2011 campaign in Spain. Objective analyses of the weather forecasts were performed as well as analyses of the road temperature model. Obtaining sufficient, high-quality verification data, especially precipitation information, is an ongoing challenge for this project.

Surface weather observation quality from standard road weather information systems was assessed in 2003 via coincident observations of state and road parameters (3). Differences apparent in the observations themselves set an acceptable threshold of deviation of the forecast from the observations, or a lower bound for the accuracy one can expect from the MDSS forecasts; in other words, if the observations can only be measured within a certain tolerance, then differences between such observations and the MDSS forecasts can be attributed to uncertainty in the observations themselves.

Objective verification is achieved via direct comparisons of MDSS forecasts to reliable observations from NWS and roadside environmental sensor stations. These results are presented through diagrams of root mean squared error (RMSE), median absolute error (MAE), bias for state parameter fields (e.g., air temperature, dew point, and wind speed), and road and bridge temperatures.

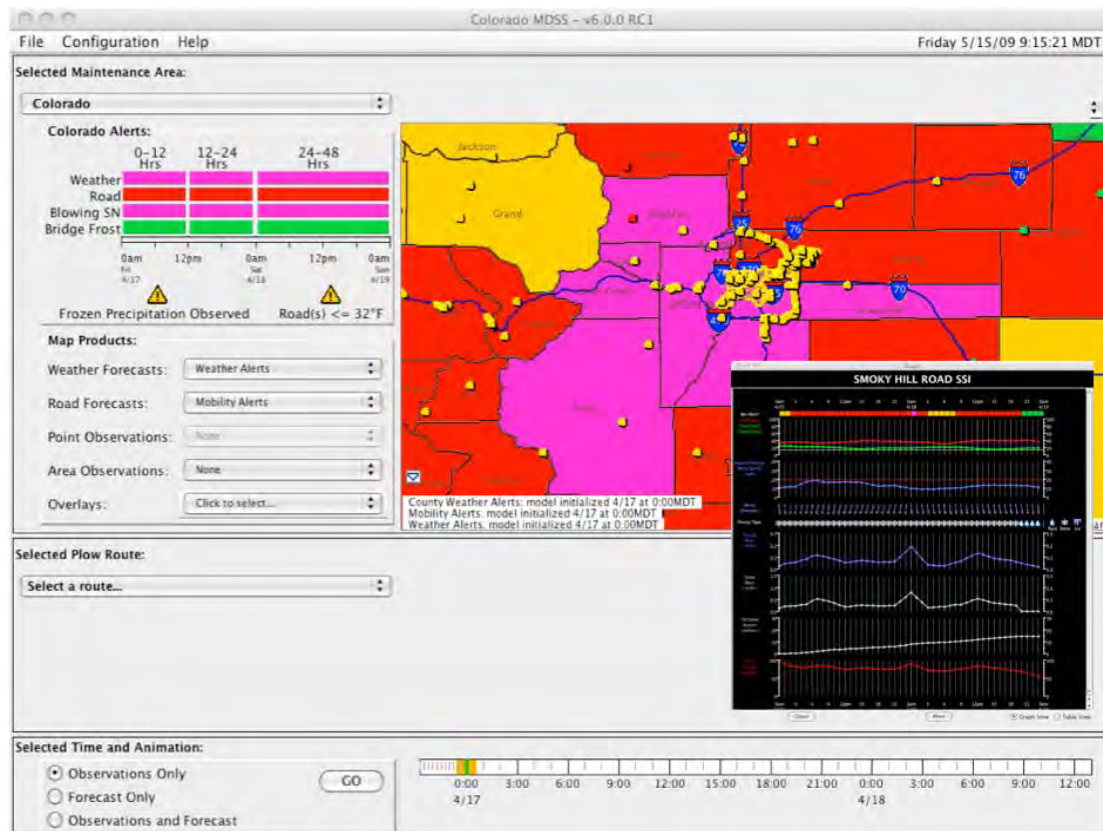


FIGURE 2 An example of the MDSS GUI.



The RWFS integration process independently optimized the forecasts based on recent skill at each prediction site for each parameter and forecast lead time, except for precipitation. Forecast modules with the most skill receive more weight in the RWFS integration process that generates the consensus forecast. Due to the lack of accurate winter precipitation measurements, the probability of precipitation and quantitative precipitation forecast consensus output were calculated using fixed weights.

The RWFS also applies a Forward Error Correction (FEC) scheme, which is used to ensure that the forecasts produced by the RWFS more accurately reflect the current conditions in the near term. The forecasts valid at the current time are forced to match the available observations. Then, in the first forecast hours, the forecast time series is forced to trend toward and blend seamlessly into the RWFS consensus forecast.

### **Data: Colorado Demonstration**

Linden and Petty (4) previously documented that the 2006–2007 season was comprised of several large storms with above average winter weather activity throughout much of the time period. The 2007–2008 season was less active and consisted of many smaller storms relative to the previous season. The demonstration for the 2007–2008 winter season officially began on October, 15, 2007, and ended on May 5, 2008. During this period there were several winter weather events, which resulted in a diverse season in terms of event snowfall amounts, duration, and large-scale characteristics. There were two major snowstorms during the 2006–2007 winter season, which resulted in more than 4 ft (combined) of snow across the Denver metropolitan area compared to zero major snow storms for the 2007–2008 season. In total, there were 15 snow events of 2 in. or greater within the Denver area during the demonstration period.

The following weather observation data sources were used for verification and analysis:

1. Colorado DOT and E-470 RWIS,
2. NWS Automated Surface Observing Systems (ASOS) and Automated Weather Observation System (AWOS),
3. Local observer surface data,
4. Weather satellite,
5. Weather radar,
6. NWS storm summaries,
7. GEONOR precipitation gauge (Denver International Airport), and
8. Denver Urban Drainage and Flood Control District precipitation observations.

Colorado DOT and E-470 road temperature sensors were used for verification and analysis.

The RWFS was configured to utilize and integrate four forecast modules for the winter 2007–2008 demonstration. Numerical models that were ingested into the RWFS included the NAM (the replacement for the Eta), GFS (formerly called the Aviation Model by the NWS) and RUC. Aviation Model Output Statistics (MAVMOS) were also used as input. DMOS were calculated within the RWFS for each of the model inputs. The four weather forecast modules that were used to predict the weather parameters for each MDSS forecast point were:

1. MAVMOS,

2. NAM DMOS,
3. GFS DMOS, and
4. RUC DMOS.

### **Data: Spain Demonstration**

The demonstration for the 2011 season in Spain officially began on January 15, 2011, and ended on March 31, 2011. With a late start to the demonstration, very few impactful winter weather events occurred. This study is an assessment of the quality of the general weather variables (excluding precipitation) that were forecast with a more robust evaluation planned after the 2012 winter season.

#### *Weather Observations*

The following weather observation data sources were used for verification and analysis:

- Alvac RWIS,
- Spanish RWIS,
- Spanish METAR,
- Weather satellite, and
- Weather radar.

#### *Data Sources: Weather Models*

The RWFS was configured to utilize and integrate two forecast modules for the winter 2011 demonstration. Numerical models that were ingested into the RWFS included the GFS (formerly called the Aviation Model by the NWS) and the Weather Research and Forecast (WRF) model from the University of Cantabria in Santander, Spain.

## **RESULTS**

In this section, performance results are described for the entire winter 2007–2008 Colorado field demonstration and for a portion of the 2011 demonstration in Spain for specific components of the MDSS. Bulk statistics based on the weighted average RMSE, MAE, and bias (forecast minus observation) are calculated. The statistics were calculated for 71 sites along the Colorado Front Range and 83 sites in Spain. The weighted average RMSE is calculated in the following manner: for each lead time, RMSE is calculated for each site and then weighted based on the total number of valid errors for that site. The RMSE values (for each site) are then summed over all sites and divided by the sum of the errors for each site.

### **Meteorological Variables: Colorado**

The RWFS consensus forecast was compared to the forecasts from the individual models included in the ensemble in order to discern whether the RWFS statistical post processing methods and techniques added value (e.g., increased skill).

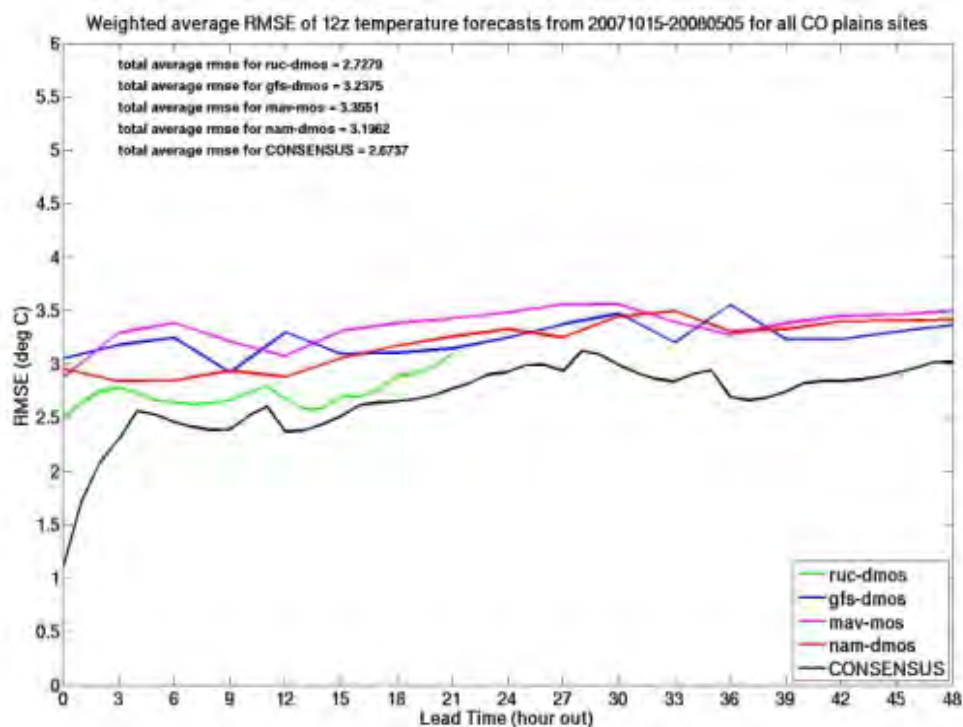
The results are based on average RMSE and bias per lead time (1 to 48 h) of forecasts initiated at 12 Universal Coordinated Time (UTC) for the entire season (October 15, 2007, to May 5, 2008).

For all three variables, the RWFS performed well with the consensus forecasts having lower RMSE values compared to the individual forecast module components for all lead times (Figures 3 through 5). FEC which is applied to all the verifiable variables (variables that have corresponding observations) reduces the RMSE within the first 3 h.

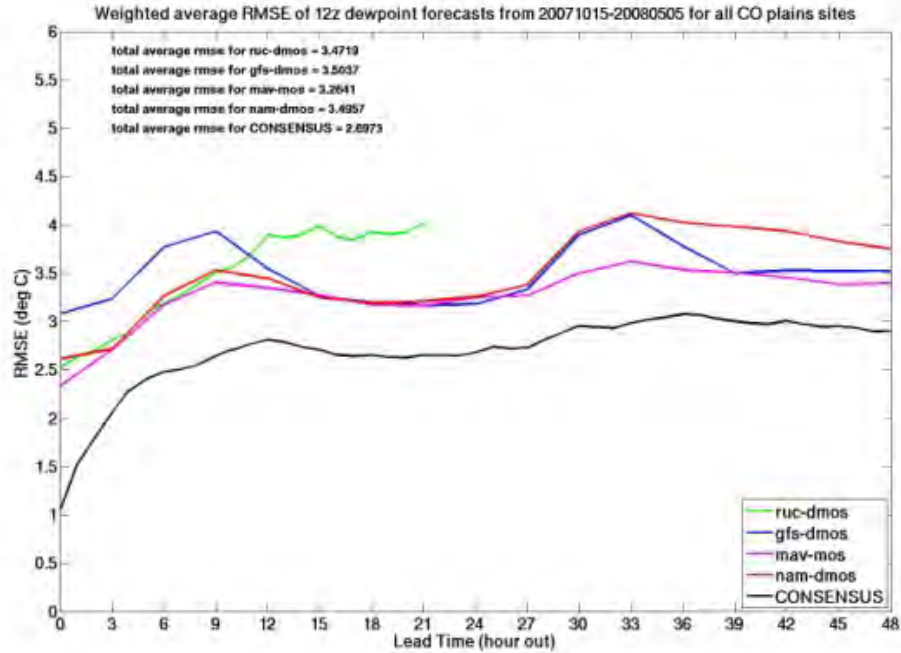
The reduction in overall error provided by the consensus forecast is most evident for air temperature and dew point temperature. In general, there is a more pronounced difference in skill (i.e., larger spread among the forecasts) between the final consensus forecast and its components for air temperature and dew point temperature (Figures 3 and 4) than for wind speed (Figure 5).

### Pavement Temperature: Colorado

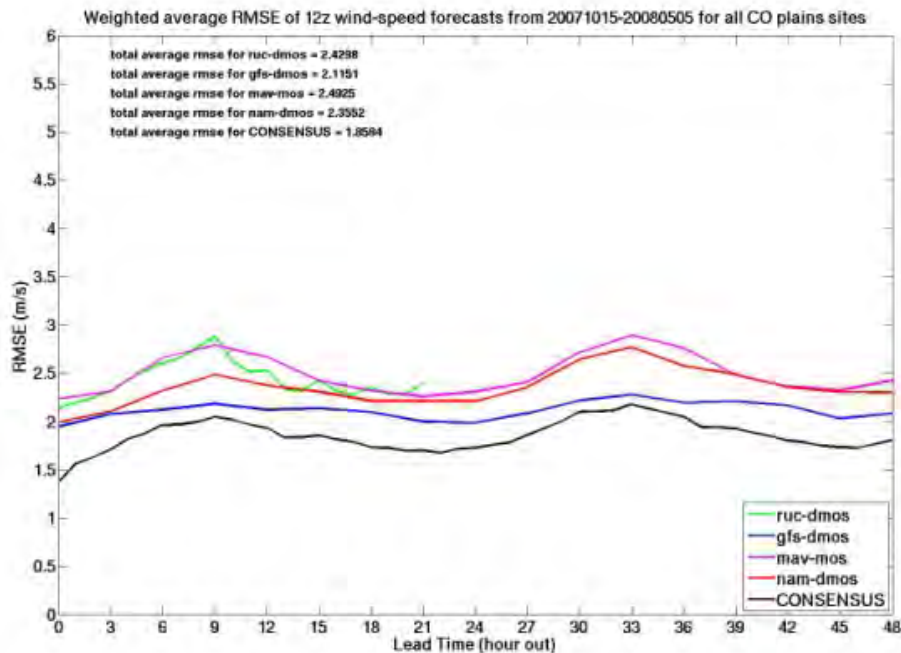
This section examines the road and bridge temperature forecasts using recommended treatments as determined within the MDSS RCTM. Measurement differences between the predictions and pavement sensors were used to calculate MAE and average bias (forecast minus observation) per lead time (e.g., 1 to 48 h) for 12 UTC forecasts generated over the entire season (October 15, 2007, to May 5, 2008). Statistics were calculated for nine road sites in the Denver area and two bridge sites along E-470.



**FIGURE 3** Weighted-average air temperature RMSE computed from the 12 UTC forecasts for the entire demonstration season (October 15, 2007, to May 5, 2008). The consensus forecast (black line) and the individual forecast module components for the Colorado plains sites are shown.



**FIGURE 4** Weighted-average dew point temperature RMSE computed from the 12 UTC forecasts for the entire demonstration season (October 15, 2007, to May 5, 2008). The consensus forecast (black line) and the individual forecast module components for the Colorado plains sites are shown.



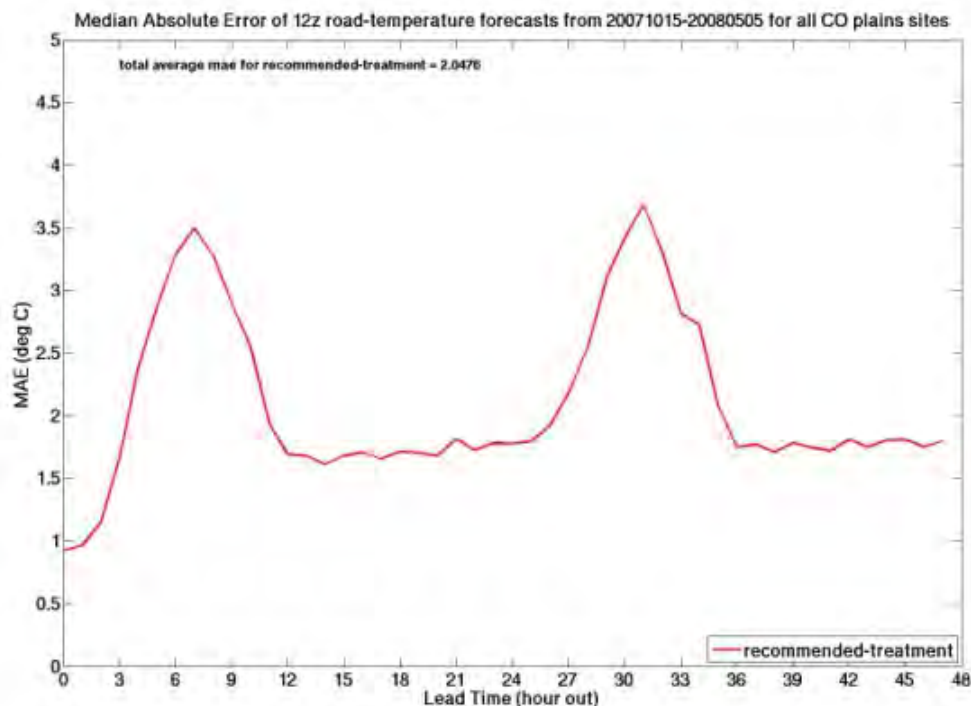
**FIGURE 5** Weighted-average wind speed RMSE computed from the 12 UTC forecasts for the entire demonstration season (October 15, 2007, to May 5, 2008). The consensus forecast (black line) and the individual forecast module components for the Colorado plains sites are shown.

The road temperature MAE (Figure 6) ranges from around 1.5°C to 2.0°C during the evening and overnight hours, but increases to a peak of about 3.5°C in the afternoon, which corresponds with the hours of maximum solar insolation. There is a cold bias evident in the late morning hours (lead times 0 to 6 and 24 to 30 h) turning to a warm bias during the afternoon (lead times 7 to 14 and 31 to 38 h) (Figure 7).

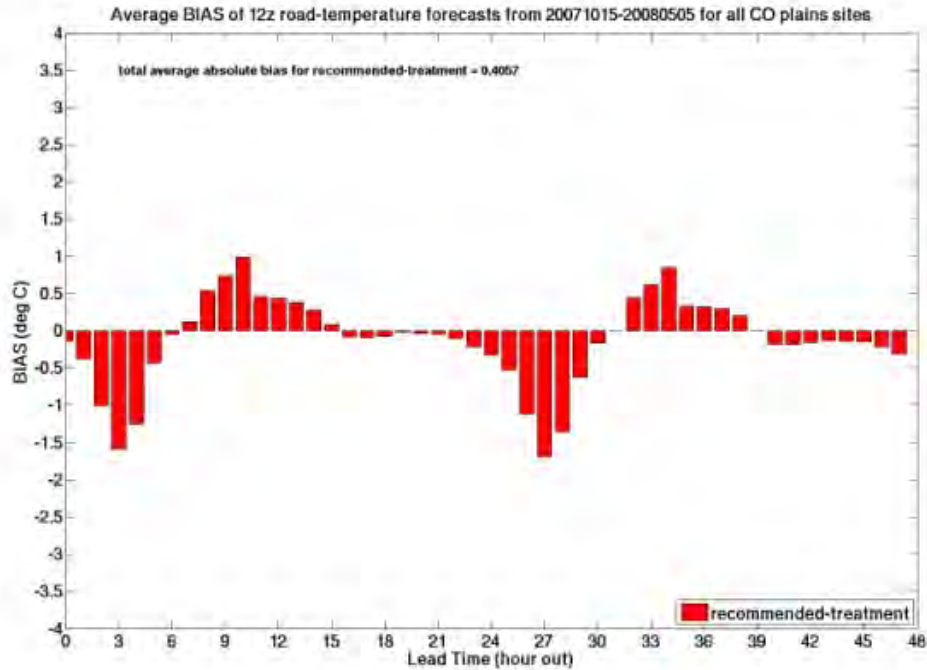
There is still some uncertainty as to whether part or all of the bias in the forecasted road temperatures is real or due to differences between the measurements made by the road temperature sensors (pucks), which have different thermal properties than the road surface, and the road temperature model, configured to predict the pavement skin temperature.

### Meteorological Variables: Spain

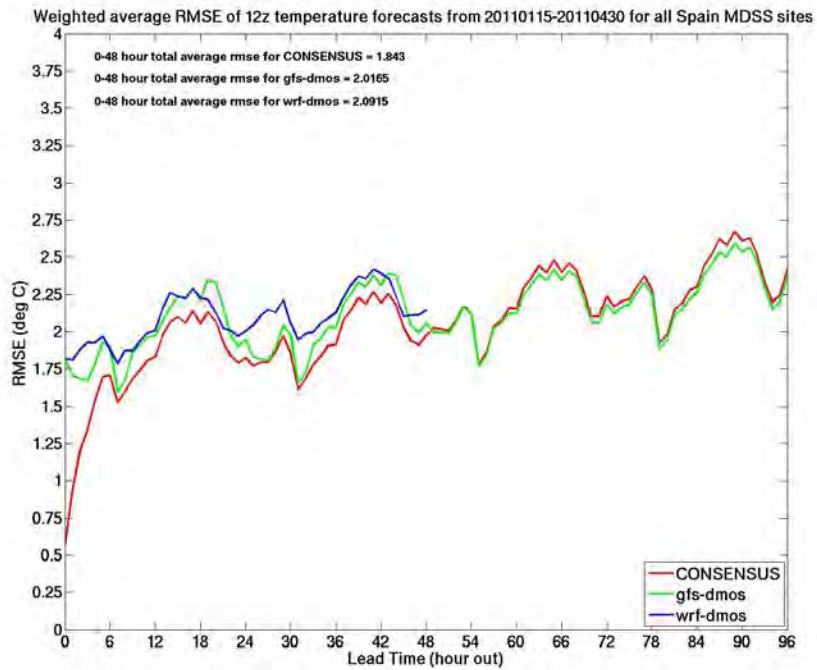
For all three variables, the RWFS performed well with the consensus forecasts having lower RMSE values compared to the individual forecast module components for all lead times (Figures 8 through 10). FEC which is applied to all the verifiable variables (variables that have corresponding observations) reduces the RMSE within the first 6 h. The statistical methods and techniques utilized by the RWFS do improve the predictions on average for all verifiable parameters. It is clear from the analyses that no single model performs better for all parameters; therefore, a blend of weather models will likely provide better results. It is also evident that the GFS model showed slightly better results than the WRF model over this time period but the error differences were small for all three variables.



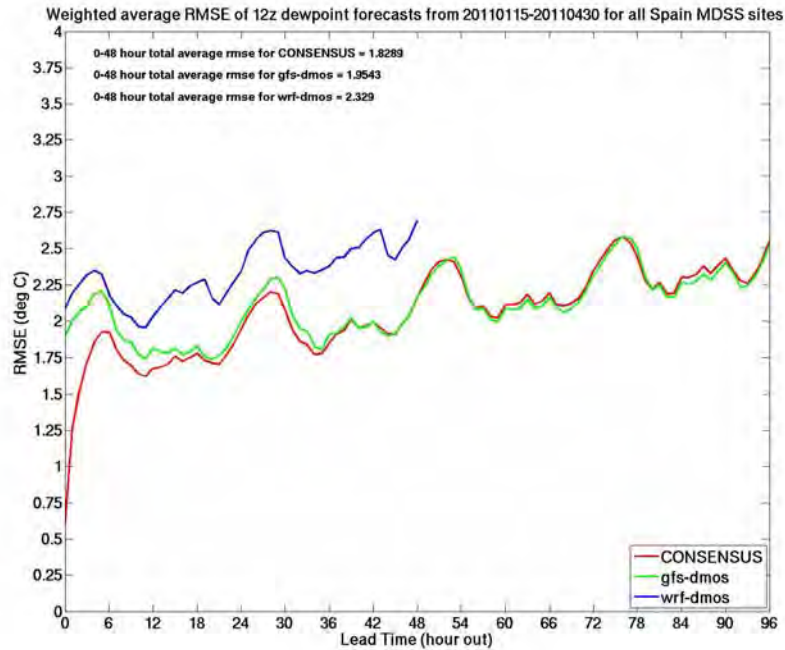
**FIGURE 6** Road temperature MAE, computed based on 12 UTC forecasts from October 15, 2007, to May 5, 2008, for the Colorado plains sites. Local noon is at hours 7 and 31.



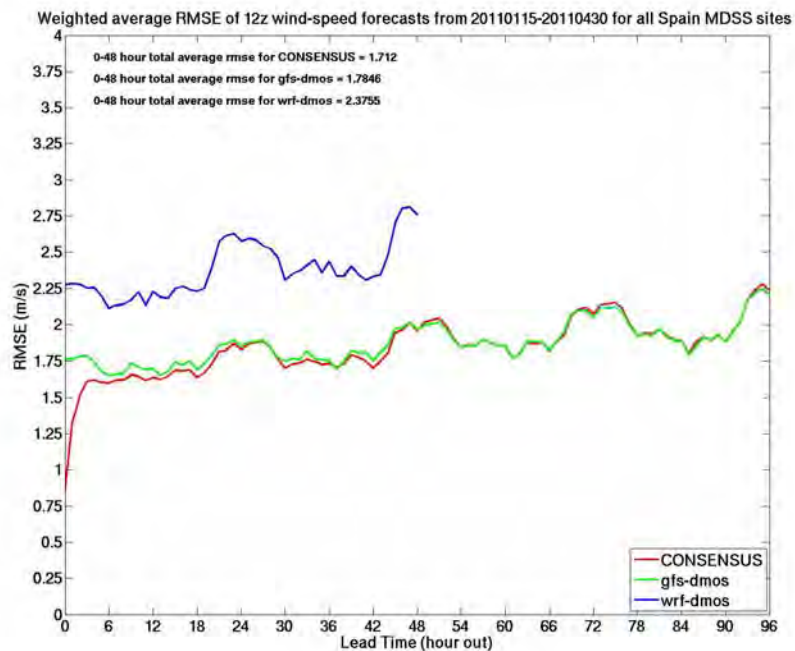
**FIGURE 7** Average road temperature bias from the 12 UTC forecasts for October 15, 2007, to May 5, 2008, for the Colorado plains sites. Local noon is at hours 7 and 31.



**FIGURE 8** Weighted-average air temperature RMSE computed from the 12 UTC forecasts for the entire demonstration season (January 15, 2011, to April 30, 2011). The consensus forecast (red line) and the individual forecast module components for the Spanish sites are shown.



**FIGURE 9** Weighted-average dew point temperature RMSE computed from the 12 UTC forecasts for the entire demonstration season (January 15, 2011, to April 30, 2011). The consensus forecast (red line) and the individual forecast module components for the Spanish sites are shown.

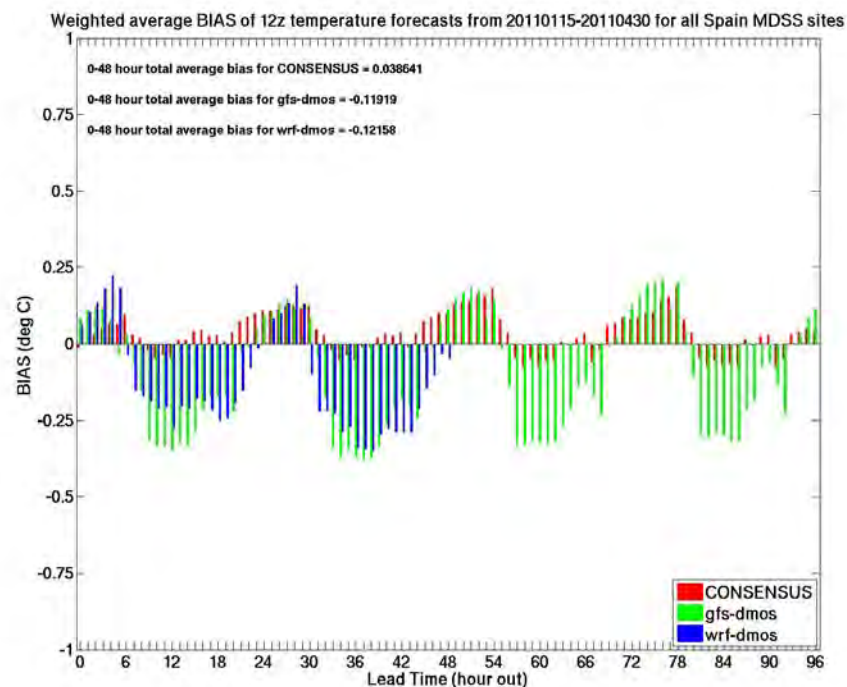


**FIGURE 10** Weighted-average wind speed RMSE computed from the 12 UTC forecasts for the entire demonstration season (January 15, 2011, to April 30, 2011). The consensus forecast (black line) and the individual forecast module components for the Spanish sites are shown.

Bias was examined separately for the each model component and consensus forecast over every lead time. Overall, the RWFS exhibits no significant bias for the three meteorological state variables examined (Figures 11 through 13). Overall, the two models showed a cold bias during the night and a smaller warm bias during the day but the consensus forecast showed very little bias during the time period analyzed. A small wet bias in the GFS and WRF was evident during the daytime hours in the dewpoint analysis. The GFS also showed a slight dry bias during the nighttime hours. Again, overall, the consensus forecast showed very little bias over this time period. For wind, the GFS results showed a tendency to under-forecast wind speed with opposite results for the WRF model. The consensus results showed a very slight over-forecast of wind speed over this time period.

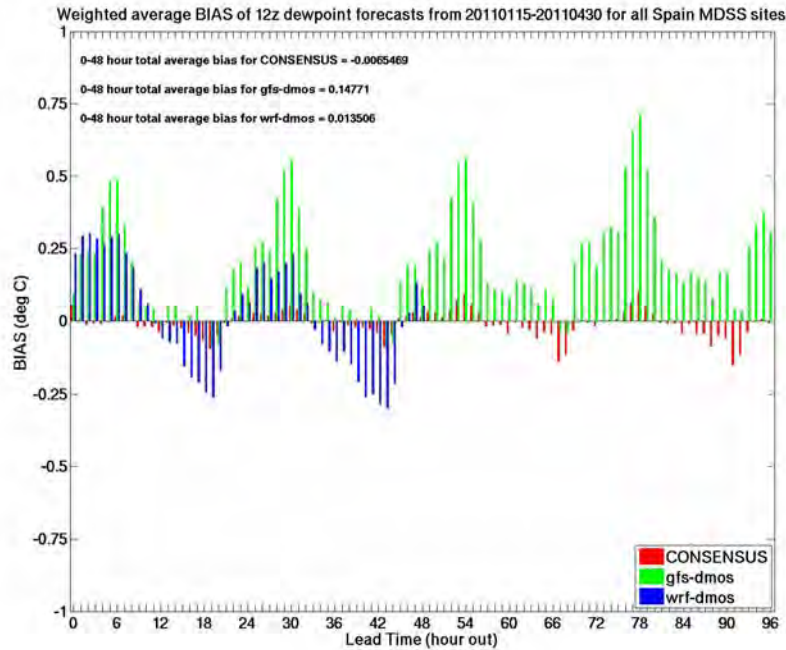
### Pavement Temperature: Spain

Due to a delay in the archival of pavement temperature observations from Spanish RWIS sites, the analysis of pavement temperature forecasts spanned April 1, 2011, to October 25, 2011. The pavement temperature model is tuned specifically for the winter season and the results of this analysis are not necessarily representative of the months where the greatest impact (in terms of winter weather) is felt in the demonstration area. In fact, analyses that have been performed in the past over non-winter months in the United States have shown issues with the model during the peak heating times of the day.

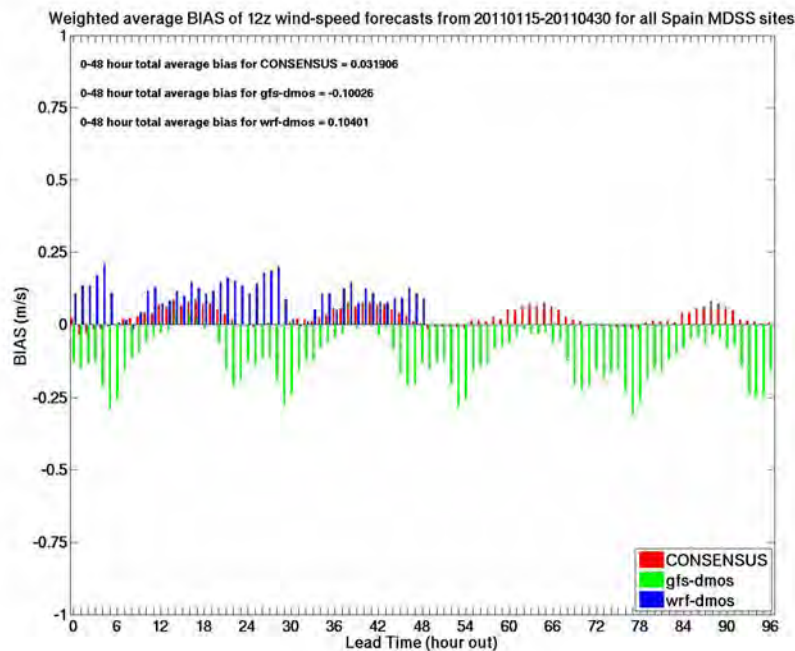


**FIGURE 11** Weighted-average air temperature bias computed from the 12 UTC RWFS output for the entire demonstration season (January 15, 2011, to April 30, 2011) for the Spanish sites.





**FIGURE 12** Weighted-average dew point temperature bias computed from the 12 UTC RWFS output for the entire demonstration season (January 15, 2011, to April 30, 2011) for the Spanish sites.



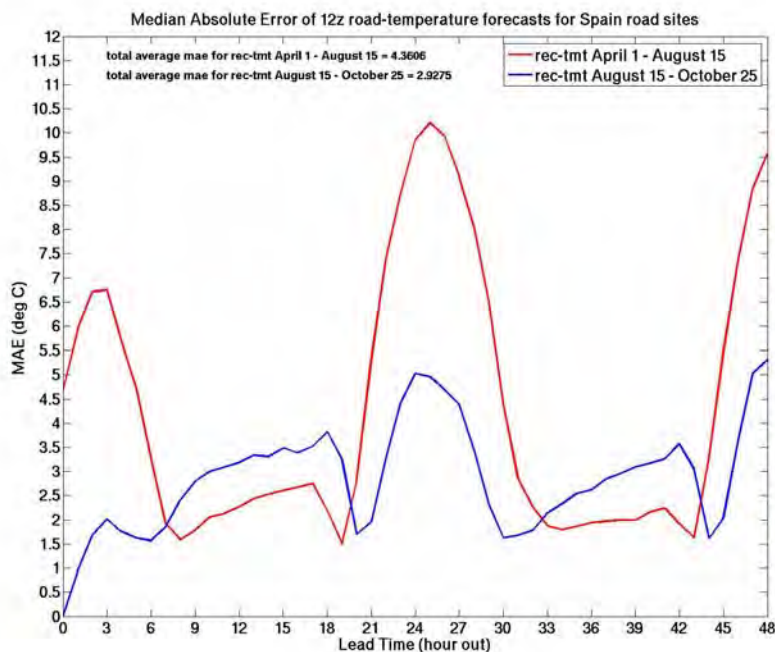
**FIGURE 13** Weighted-average wind speed bias computed from the 12 UTC RWFS output for the entire demonstration season (January 15, 2011, to April 30, 2011) for the Spanish sites.

Work was accomplished to solve this problem, but the results up to August 15, 2011, are from the model without any attempt to fix the warm weather problems. After the middle of August some modifications were made to the model in regard to the statistical assimilation of observations into the initial hours of the forecast. Also, as of August 15, 2011, FEC is now being performed on the pavement temperature variable much like was performed on air temperature, dewpoint temperature, and wind speed.

Figure 14 is a plot of MAE for the road temperature forecasts over four sites along Highway A-1. The analysis was broken down between the months prior to the FEC fix (April 1, 2011, to August 15, 2011) and several months after the change was made (August 15, 2011, to October 25, 2011). The results show a large decrease in the error during the peak heating times of the day. Also, the error during the first 6 h is also reduced significantly. There is a slight increase in error during the nighttime hours, which is being investigated. The change in error during the first 6 h will likely also be seen for the winter months because of the addition of FEC for this variable. The relative change in error during the daytime hours is likely less, because (as was previously discussed) the model has been tuned for the winter season and the results from past analyses in the United States show much lower error results during the winter months.

## DISCUSSION OF OTHER APPLICATIONS

Over the past decade MDSS has been tuned and applied to various user groups (e.g., state departments of transportation, cities, counties, and airports) in the United States for the purpose of providing a central platform that combines weather, road weather, and winter



**FIGURE 14** Average MAE for pavement temperature forecasts for April 1, 2011, to August 15, 2011, and August 15, 2011, to October 25, 2011.

maintenance RoP. The system has been customized (by various providers of the system) to fit the needs of the customers and users of the system. With the research and development of the federal prototype MDSS at a mature stage, emphasis on modifying the MDSS platform to provide information to maintenance managers regarding non-winter time road maintenance activities (e.g., chip repair, lane striping, weed spraying, and construction) is ongoing. Also being explored is customizing the system to suit the needs of other groups that are impacted by other non-wintertime weather phenomena on the roads. Possible modifications to the system include (but are not limited to) the following weather phenomena:

- Visibility—fog, blowing dust, and smoke;
- Flooding—flash floods and washouts;
- Thunderstorms—hail, tornadoes, and heavy rain; and
- High winds—truck and rail blowovers.

Modifications for other users groups are also being considered and include some of the following:

- Aviation impacts on the ground: runway maintenance and aircraft deicing;
- Emergency medical services: route planning and tactical alerts;
- Freight: route planning and parking ;
- Automotive racing: pavement temperature forecasting and tactical precipitation forecasting;
- Everyday driver: safety and mobility; and
- Environmental: smart routing and reduction of polluting emissions.

The range of roadway users is broad. The initial emphasis will (and should) be placed on improving road weather forecasts for the highest impacted groups.

## **FUTURE WORK**

The results from this study (as well as past studies) indicate that MDSS is a useful and fairly accurate tool that can aid in both strategic and tactical decision making for the winter road maintenance community. Up to this point the road maintenance community has used it to provide weather information essential for the strategic planning for labor, equipment, and material. With the robust manner in which MDSS has been designed and engineered, strides are being made to port the system to not only non-wintertime road maintenance activities but also to other situations where non-wintertime weather impacts users and maintainers of the roadways.

## **REFERENCES**

1. Mahoney, W. P., B. Bernstein, J. Wolff, S. Linden, and W. L. Myers. The Federal Highway Administration's Maintenance Decision Support System Project: Summary Results and Recommendations. Presented at the 84th Annual Meeting of the Transportation Research Board, Washington D.C., 2005.

2. Benjamin, S. G. From the 13 km RUC to the Rapid Refresh. Presented at 12th Conference on Aviation, Range, and Aerospace Meteorology, Atlanta, Ga., 2006.
3. Bernstein, B. C., J. K. Wolff, and S. Linden. Verification Report for the MDSS 2003 Demonstration at the Iowa Department of Transportation. 2003.
4. Linden, S., and K. Petty. Technical Performance Assessment Report, Colorado Field demonstration 2006–2007. National Center for Atmospheric Research Technical Report, 2007.

## DECISION SUPPORT SYSTEMS

**Decision Support Technologies**  
*Beyond Winter Operations***BENJAMIN W. HERSHEY****ANTHONY K. MCCLELLAN****JOHN J. MEWES***Meridian Environmental Technology, Inc.*

Since the late 1990s there has been a push to develop and deploy a system that can integrate maintenance and weather data for winter maintenance operation decision makers to conduct safe and effective maintenance strategies on the roadway. In 2002, a group of states joined together [Pooled Fund Study Maintenance Decision Support System (MDSS)] to develop a MDSS that could augment current winter operation techniques with weather information and provide a one-stop shop for decision makers regarding snow and ice. As states deployed MDSS technology into their maintenance operations, their benefits included actual dollars saved, improved internal communications, and a more consistent level of service on the roadway. A new question arose as these benefits were realized: Are there more benefits to be realized with this data, and could it be integrated with other weather-based type operations that occur throughout the year? As the understanding of MDSS technology has grown so has the realization of MDSS' utility beyond winter maintenance operations. One of the new uses of MDSS data is expanding the route-specific recommendations to non-wintertime operations performed by agencies. These operations include but are not limited to pavement repair, pavement preservation, lane and intersection marking, herbicide spraying, or any other highway operation that is dependent on the weather and road conditions. Each operation has specific weather thresholds that will restrict or not restrict that specific operation to occur. Accurate weather forecast information is critical because many non-wintertime operations projects can be completely ruined or ineffective if precipitation occurs or if temperatures or moisture levels fluctuate quicker than expected. The combination of improved weather forecasts with acceptable operating weather thresholds for non-winter maintenance activities provide agencies a larger cost benefit when deploying a fully operational MDSS within their agency. This paper and presentation will investigate and illustrate possible uses of MDSS data and current methods to communicate that data. Examples will be presented assessing the use of MDSS for non-wintertime operations decisions.

# Winter Surface Friction



## WINTER SURFACE FRICTION

**Side Friction as a Parameter in Optimizing Winter Road Operations****TORGEIR VAA****IVAR HOL***Norwegian Public Roads Administration*

When measuring the coefficient of friction, researchers normally focus on friction in the driving direction—in other words, the friction available for stopping a vehicle presuming that all the measured friction can be used for braking. However, this is not the case when the vehicle rounds a curve. With curves, a component of the friction will be used to counteract the centrifugal force. The size of this component will depend on the vehicle's speed, radius, and super elevation. The relationship between these parameters and the resulting friction available for braking is well known, but it has so far been impossible to measure directly the side friction component. This possibility now has become available to us through the friction device referred to as Traction Watcher One (TWO), which is a continuous measuring device. A new sensor has been developed that combines gyro and accelerometer. If researchers know the speed of the vehicle, the radius can be derived from these data, which form a basis for calculating critical speed. The new sensor went through extensive testing throughout the 2008–2009 winter season. The first studies showed promising results with regard to obtaining reliable data. Since the initial studies in 2008–2009, more road measurements have been conducted, as well as trials in closed test areas, to compare the calculated critical speed to the actual speed of passenger cars slipping on curves.

**BACKGROUND**

One of the main challenges from a traffic safety perspective is to keep the risk of skidding below a certain threshold value under varying driving conditions. The side friction factor at which skidding can happen depends on several other factors, among which the most important are the speed of the vehicle, the type and conditions of the tires, the type and conditions of the road surface, and the horizontal curvature.

When measuring the coefficient of friction researchers normally focus on friction in the driving direction—in other words, the friction available for stopping a vehicle presuming that all the measured friction can be used for braking. However, this is not the case when the vehicle is driving on a curve. With curves, a component of the friction will be used to counteract the centrifugal force. The size of this component will depend on speed, radius, and super elevation. There is a well-established relationship between these parameters and the resulting friction available for braking, but it has so far been impossible to measure directly this side friction component. A new continuous friction measuring device, Traction Watcher One (TWO), has changed this situation. A new sensor has been developed that combines both gyro and accelerometer. The sensor is placed horizontally in the measuring vehicle and registers side forces on the vehicle as well as the angular deflection. If researchers know the speed of the vehicle, the radius can be derived from these data, which in turn provide a basis for calculating critical speed.



The new sensor went through extensive testing throughout the winter of 2008–2009. So far, the results have been promising with regard to obtaining reliable data. Increased knowledge of how side forces influence the vehicle on curves is important information for drivers, but also feeds into the design and construction of roads as well as the introduction of measures to maintain a certain safety level to counteract the risk of exceeding a critical speed. The problem is that many drivers fail to adapt their speed to the prevailing driving conditions and therefore drive with a very low safety margin, especially on curves.

## PURPOSE

The new measuring principle will provide important new information about the available road grip. At locations where the critical speed is low when driving in wintry conditions, this can be compensated by the introduction of tougher demands for action and operational effort. Another option will be to inform motorists of where and when to be especially aware of low safety margins when driving above a certain speed.

One of the main objectives for registering critical speed is to provide support for a more satisfactory decision-making process, allowing winter maintenance services to meet standard requirements where side friction is included as a parameter.

With more-detailed data about the impact of the geometry it will be possible to link the level of road services to the actual safe speed. This can help to ensure more predictable road conditions for motorists, which may be achieved by taking the influence of the side forces into account when calculating the friction improvement required to maintain a certain safe margin. This will be especially valuable for roads where mainly sand is used for friction improvement.

There is a need to increase awareness of how driving on curves influences the safety margin in order to avoid skidding because the side forces exceed the available road grip. It is mainly a question of compensating for a higher level of friction changes on curves than on straight road sections.

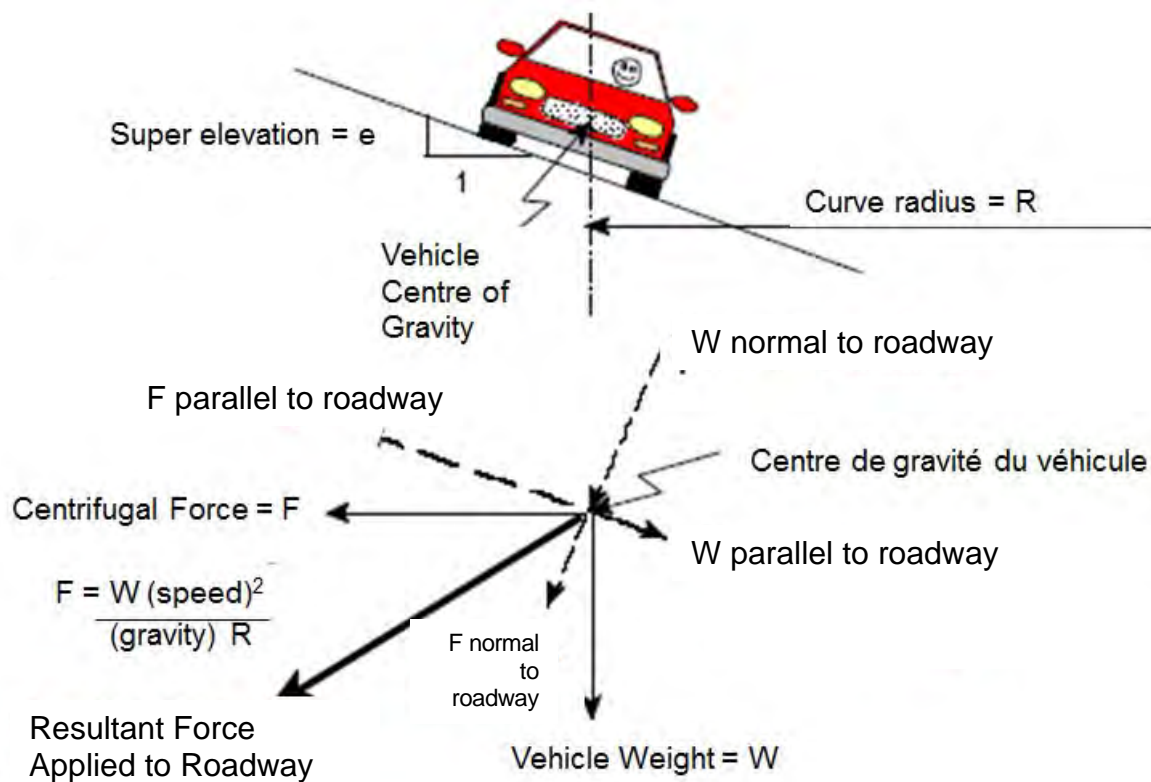
## FRICITION THEORY

The friction influences a vehicles' ability to stop (braking), to start moving (acceleration), and to maneuver (turning). Under low friction conditions, all three abilities are influenced, thus reducing safety.

When a vehicle rounds a curve, it experiences a lateral force known as centrifugal force. This lateral force pushes the vehicle and its occupants outward from the center of the circle. The lateral force is caused by the directional change of the vehicle (i.e., directional change of the velocity vector) called centripetal acceleration. This is similar to the acceleration forces from increasing vehicle speed, with the exception that acceleration works towards the center of the circle ( $I$ ) (Figure 1).

Super elevation is defined as the amount of cross slope provided on a horizontal curve to help counterbalance the outward pull of a vehicle traversing the curve.

Super elevation is the banking (camber) of a highway designed to counter some of the lateral force ( $I$ ). The banking causes a portion of the lateral acceleration to work as normal (perpendicularly) relative to the banked roadway. This is felt as a downward (with respect to the



**FIGURE 1** Forces acting on a vehicle traversing a horizontal curve (*I*).

vehicle) force by the vehicle's occupants. The remaining portion of the lateral force may work in one of three ways depending on the banking and the speed of the vehicle.

- If the speed is balanced for the banking, the lateral force acting outward on the vehicle will be countered by the forces pushing the vehicle down the slope of the banking. The vehicle and its occupants will experience a downward force (perpendicularly to the roadway) and the vehicle will travel around the curve with little steering input. This is a neutral or equilibrium condition.
- If the vehicle is travelling faster than the equilibrium speed, the resultant lateral force acts outward on the vehicle and its occupants. At excessive speeds, the vehicle will skid or roll off the road.
- If the speed is lower than the equilibrium speed, the vehicle and its occupants are forced inward. Extreme banking can cause top-heavy vehicles to roll over towards the inside of the curve. Additionally, icy conditions can cause the vehicle to slide down the banking, particularly when the tires are spinning to accelerate in stop-and-go traffic.

High levels of super elevation may cause slow-moving vehicles to slide down the banking on surfaces covered with snow and ice, so a maximum super elevation rate of 6% to 8% is normally imposed in areas that frequently experience snow and ice (*I*).

Friction allows cornering, braking, and acceleration forces to be transmitted from the tires to the roadway. Rather than using the coefficient of friction from dynamics, highway engineers

use a ratio of the lateral forces that the roadway can resist. This lateral ratio is most commonly referred to as the friction factor.

The friction factor required to counter centrifugal forces is reduced by the vehicle braking (decelerating) and accelerating. For example, when most of the friction is used for an emergency stop, there is little friction available for cornering. Antilock braking systems have greatly improved this situation.

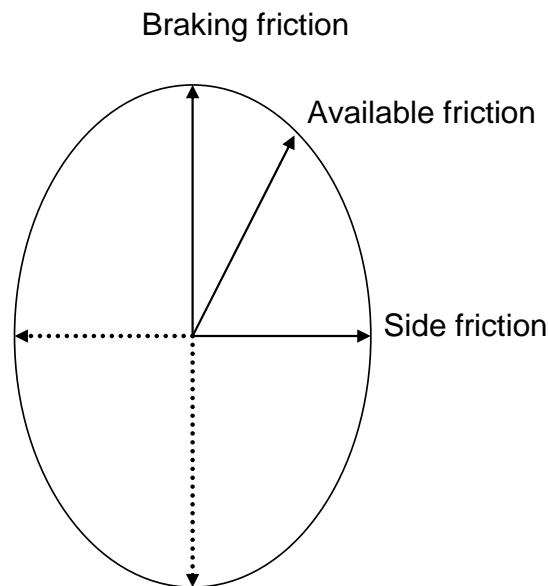
The friction factor also depends on numerous variables, including the vehicle speed, weight, suspension, tire condition (wear, tire pressure, tire temperature), tire design (tread, contact patch, rubber compound, sidewall stiffness), roadway, and any substance between the tire and roadway. Since the friction factor decreases as speed increases, numerous studies have been performed to develop friction factors for various speeds. Note that the friction factor diminishes substantially when the tires are spinning faster or slower than the vehicle speed (e.g., in a skid, spinning tires when attempting to accelerate or stop on ice, and during a “burn out” or “peel-out”) (1).

The simplest and most natural method for determining the friction number is to measure the braking distance to full stop for a vehicle with locked wheels during braking. The coefficient of friction is determined by Equation 1.

$$\mu = \frac{v^2}{2 \times g \times d} \quad (1)$$

where  $v$  is the vehicle brake application speed,  $g$  is the acceleration of gravity, and  $d$  is the stopping distance.

Traditionally, side friction has been included as a component in the design of roads—in other words, it is taken into account that the available friction on curves must be reduced to compensate for the fact that some of the road grip is used to counteract the side forces. This can be illustrated as shown in [Figure 2](#).



**FIGURE 2** The connection between side friction and braking friction.

**TABLE 1 Maximum Speed for Different Friction Numbers at a Curve Radius of 100 m**

Friction figure	0.05	0.10	0.125	0.15	0.175	0.20	0.225	0.25	0.30
Maximum speed (km/h)	25.2	35.7	39.9	43.7	47.2	50.4	53.5	56.4	61.8

According to Nordstrom (2) there is the following physical connection between utilized friction number and curve speed (see Equation 2):

$$v^2 = R \times \mu \times 9.81 \times 3.6^2 \quad (2)$$

where  $v$  is speed in km/h,  $R$  is curve radius, and  $\mu$  is the friction figure. Table 1 shows the connection between  $v$  and  $\mu$  for  $R = 100$  m.

The relationship between design speed and curvature, and also the relationship with superelevation and side friction, can be represented by Equation 3 according to the AASHTO Design Policy (3).

$$R_{\min} = \frac{V^P}{127 (f_{R,\text{perm}} + e_{\max})} \quad (3)$$

where

- $R_{\min}$  = Radius of horizontal curve (m);
- $V$  = speed (usually design speed) (km/h);
- $f_{R,\text{perm}}$  = permissible side friction factor; and
- $e_{\max}$  = maximum super elevation rate (%/100).

## CALCULATION OF CRITICAL SPEED

The TWO program calculates the critical speed in two different ways. This results in different sets of values, of which the lower determines the critical speed at any time.

The following formula is used to convert friction and braking distance to critical speed:

$$v = \sqrt{254.3 \times \mu \times Lb} \quad (4)$$

where  $\mu$  is friction and  $Lb$  is braking distance (m).

In the TWO program  $\mu$  is measured whereas  $Lb$  can be chosen by the user. Converting friction and curve radius to speed  $v$  (km/h):

$$v = 3.6 \times \sqrt{9.81 \times \mu \times r} \quad (5)$$

where  $r$  is curve radius calculated from measured acceleration (centrifugal force) and the speed of the vehicle, as shown in Equation 6.

$$r = \frac{\left(\frac{v}{3.6}\right)^2}{a} \quad (6)$$

By calculating the critical speed using Equation 4 and Equation 5 and then stating the lower value of those two, we arrive at the worst-case speeds.

One of the main reasons for including side friction forces in the friction measuring routines is that the information found may be important to road users as well as road owners and contractors. During slippery conditions this could be an important tool in assessing the need for actions to improve the friction on critical parts of the road network.

The procedure also will bring knowledge about the correlation between friction and critical speed for maintaining a certain level of safety when driving round curves. This type of knowledge can be used to set the design criteria for new roads. If the speed limit is set, it is possible to calculate the minimum safe curvature for the relevant range of road conditions.

## EXAMPLES OF MEASURING RESULTS

Measurements were made with the new sensor in the winter of 2008–2009, as part of the Indre Romsdal research and development project (4). The following shows some examples of the results obtained by using the new measuring principle (Figure 3).

This example is taken from road section 5 in a follow-up study to the winter standard on the E136 trunk road in Romsdal (4) (Figure 3). This road section has some sharp bends as shown in Figure 4.

Figure 5 shows the road conditions on February 9, 2009, at 4:46 p.m. There was a thin layer of snow and ice on the road, and the mean value of the coefficient of friction was 0.22 for the whole road section (Figure 6).

Figure 6 shows the critical speed calculated by using Equation 5. The speed limit is 80 km/h and there are several sections where the critical speed is calculated to be considerably lower than the speed limit. A few spots have a critical speed below 50 km/h (Table 2). The four spots in Table 2 all have a radius of less than 100 m according to the national road data bank. Even if the calculated radius from the sensor readings is largely congruent with the road data values, there are some discrepancies that should be investigated further.

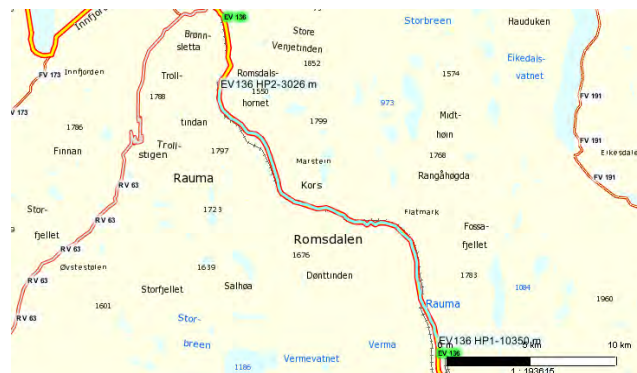
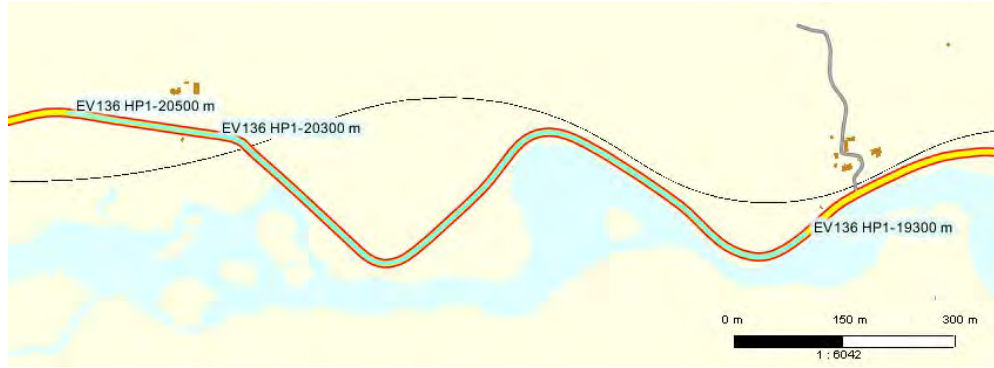
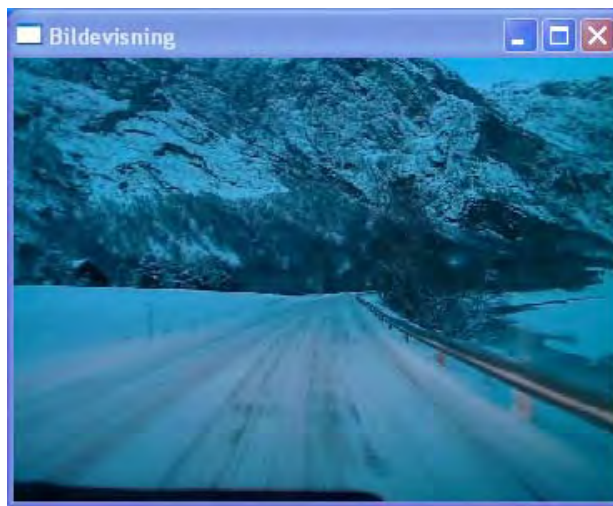


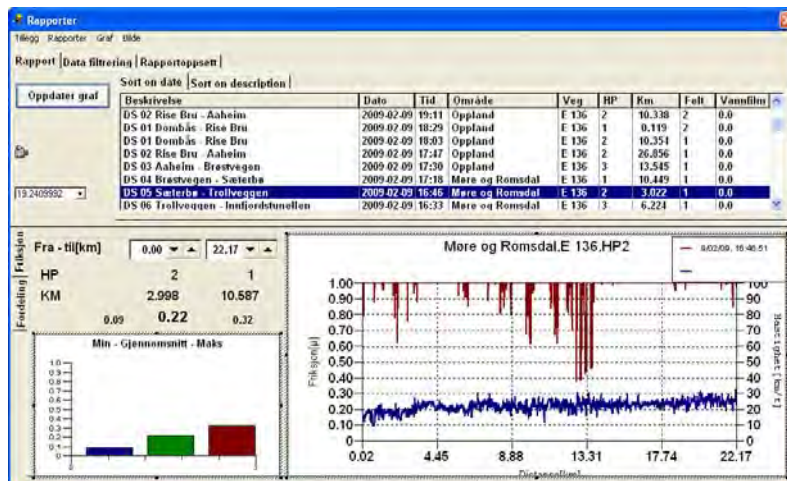
FIGURE 3 Road section 5, Sæterbø–Trollveggen.



**FIGURE 4** Road section with sharp bends.



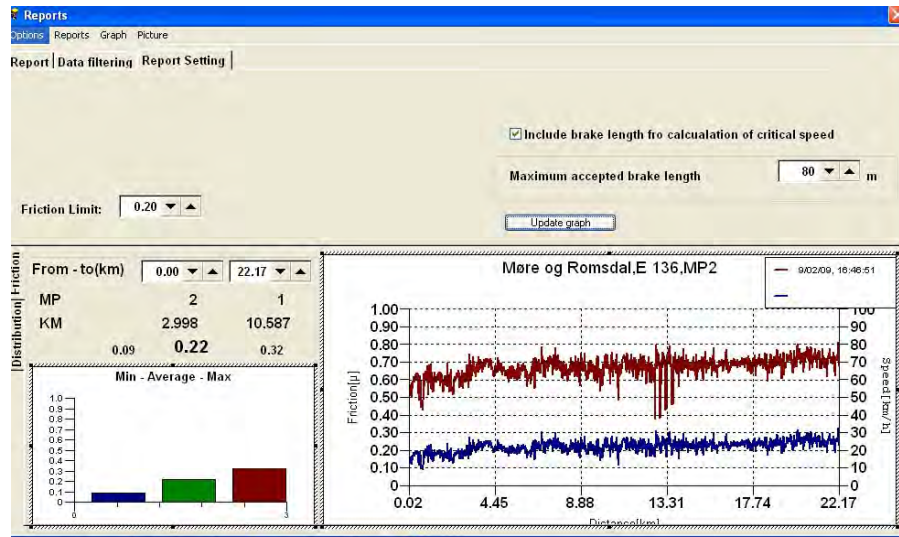
**FIGURE 5** Surface conditions, road section between Sæterbø and Trollveggen, February 9, 2009, at 4:46 p.m.



**FIGURE 6** Measured friction and calculated critical speed on the road section between Sæterbø and Trollveggen, February 9, 2009, at 4:46 p.m.

**TABLE 2 Comparison Between Calculated Curvature and Curvature According to National Road Data Bank**

Curve	Distance	Radius According to National Road Data Bank	Calculated Radius (m)	Coefficient of Friction (km/h)	Critical Speed
1	12.68	96	57	0.19	38
2	12.94	46	51	0.22	38
3	13.23	69	74	0.21	43
4	13.60	66	80	0.21	46



**FIGURE 7 Inclusion of braking distance in the calculation of critical speed on the road section between Sæterbø and Trollveggen, February 9, 2009, at 16:46 p.m.**

Figure 7 shows the same measurements as Figure 6 where the braking distance is included in the calculation of the critical speed.

The braking distance is set to 80 m in the example in Figure 6. The critical speed clearly varies throughout the road section.

## OPTIMIZING WINTER OPERATIONS

### Areas of Application

Information about the ways in which curvature influences road grip and the calculation of critical speed on curves will have numerous areas of application. This type of information is already being used as part of the design criteria for highways. New areas of application for this type of information will be

- Greater focus on how curvature influences driving in driver training,
- Information to road users about the actual road grip,

- Friction requirements adjusted for the side friction factor (i.e., the actual road grip can be reflected in the standard winter regulations), and
- Support to the contractors in their daily work.

One important aspect of a sharper focus on side friction is that the general level of awareness may increase, thus resulting in safer driving in winter. This also will be useful with respect to the training of new drivers.

However, the first step will be to concentrate on how the calculation of critical speed can be used to optimize winter road operations within a winter road strategy, for example, where sand is used to improve the friction.

## LEVEL OF SAFETY

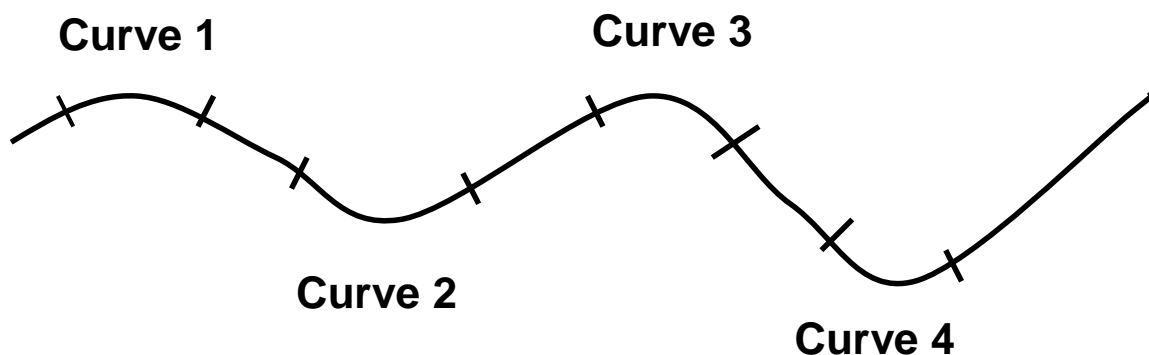
The main idea is for driving conditions to provide a predictable level of safety. In order to compensate for the influence of side forces, the friction level should be higher on curves than on straight sections even if the friction measured by the friction trailer is the same.

This will result in more flexible winter road operations, and may also be used as a guideline for selecting road sections where maintenance actions should be strengthened to keep a stable safety margin throughout a route. One way of doing this, and to ensure that fresh data is available, is to mount a friction device on the truck (e.g., a gritter). This will help ensure that contractor services match the friction requirements.

The system can be illustrated as shown in [Figure 8](#). Based on radius, friction, and super elevation, it is possible to calculate the required level of safety for each curve.

If it can be assumed that [Figure 8](#) illustrates the same curves as [Table 2](#) and that the coefficient of friction is as measured at the different spots, this will give the need for friction improvement as shown in [Table 3](#) if the level of safety is set to 10 km/h above the critical speed.

[Table 3](#) illustrates that the need for friction improvement will vary with the geometry and a friction improvement measure raising the friction up to 0.30 will not be sufficient on the sharpest curves of the example. If possible, additional friction improvement should be provided for these curves, or alternatively driver information strategies should be considered.



**FIGURE 8** Example of a bumpy road where side friction will influence the level of safety.



**TABLE 3 Friction Level Required to Maintain a Specific Level of Safety**

Curve	Distance	Calculated Radius	Coefficient of Friction	Critical Speed (km/h)	Safety Level (km/h)	Required Friction Level
1	12.68	57	0.19	38	48	0.33
2	12.94	51	0.22	38	48	0.36
3	13.23	74	0.21	43	53	0.30
4	13.60	80	0.21	46	56	0.31

## FURTHER STUDIES

So far the project has concentrated on developing the friction measuring device and its basic functions in the new sensor. The next steps will be to develop the measuring system further and to come up with recommendations for how information about side friction can be used in winter road operations.

Regarding the measuring system, there will be more comprehensive verification of the accuracy of the sensor readings forthcoming. The calculation of critical speed will be further elaborated by including the super elevation in the formula.

Standard Norwegian winter regulations include a rule requiring reinforced gritting on curves and hills. There is, however, no trigger criteria specified. On curves, this could be what is referred to as critical speed or level of safety. This will therefore naturally be one of the aspects that will be investigated more thoroughly in the continuation of the project.

Other areas of application, like dissemination of information to motorists and driver training, will be considered once the final project report has been completed after the 2010–2011 winter season.

## REFERENCES

1. New York State Department of Transportation. *Recommendations for AASHTO Superelevation Design*. Design Quality Assurance Bureau, 2003.
2. Nordstrom, O. The Friction on Smooth Ice for New and Used Winter Tyres: An Investigation Concerning the Influence of Age, Tread Depth, Tread Rubber Hardness, Stud Protrusion and Stud Force. *VTI meddelande*, Vol. 923, 2003.
3. AASHTO. *A Policy on Geometric Design of Highways and Streets*. Washington, D.C., 1990.
4. Vaa, T. *R&D Indre Romsdal: Follow-Up Study of Winter Standard the Seasons 2006–2007 and 2007–2008*. SINTEF Report A11557, April 2009.

## Additional Resource

Morall, J. F., and R. J. Talarico. *Side Friction Factors for Horizontal Curves and Guidelines for Flattening Horizontal Curves on Rural Two-Lane Highways*. 1994.

## WINTER SURFACE FRICTION

## Potential of Using Warm Wetted Sand for Skid Control on Walkways and Bike Paths

ANNA NISKA

*Swedish National Road and Transport Research Institute*

**In Sweden, the government's goal is to promote cycling even during winter, and one way to do that is by improving the winter maintenance service level of bike paths. In 2006 the municipality of Umeå invested in equipment for spreading warm wetted sand on bike paths and walkways. By mixing the sand material with hot water while spreading, it will adhere to a cold surface through a process of melting and freezing. The method has been used for skid control on roadways during several years, but Umeå has the only equipment available for use on bike paths and walkways. A research project was started at the Swedish National Road and Transport Institute in 2010 to evaluate the method and its applicability on bike paths and walkways. During the winter of 2010–2011 the method was evaluated through road condition observation and interviews with cyclists and pedestrians. However, the paper focuses on the practical experience using the method. From road weather data it can be concluded that the method has the potential to decrease the number of actions needed to maintain a sufficient friction level on bike paths and walkways. The best effect is on hard packed snow and thick ice. The most crucial problem to be solved is the freezing of the sand material in the hopper. The mixture of the sand material used needs to be adjusted and the operational routines must be improved.**

Cycling is an environmentally sound way of transportation that also provides individual health benefits. In Sweden, the governmental goal is to promote cycling even during the wintertime, and one way to do that is by improving the winter maintenance service level of bike paths.

In 2006 the municipality of Umeå invested in equipment for spreading warm wetted sand on bike paths and walkways. The purpose was to reduce the time with slippery surfaces by extending the duration of the skid control measures performed. The potential of the method is also a reduced number of actions and less sand consumption. According to Swedish accident data, approximately 40% of bicycle fall accidents (which represents more than 70% of all bicycle accidents) are maintenance related, slippery surfaces above all (1). During the wintertime, December to February, slipperiness due to snow and ice is a contributory cause in more than half of the single-bicycle accidents in Sweden. Loose grit (from winter maintenance) is also a frequent cause, and accounts for 19% of the single-bicycle accidents on bike paths in the month of April (1).

The method using warm wetted sand (also known as fixed sand) has been used for skid control on roadways during several years, especially in Norway (2, 3). The method is based on a Swedish prototype, first presented at the Permanent International Association of Road Congresses International Winter Road Congress, in Luleå in 1998. By mixing the sanding material with hot water while spreading, the sand will adhere to a cold surface through a process of melting and freezing. The method has proved to be very effective on snow and ice layers. In 2010 Swedish National Road and Transport Institute (VTI) got funding from the Swedish

Transport Administration to evaluate the method and its applicability on bike paths and walkways.

## METHOD

### Equipment Description

The equipment in Umeå is unique, since it is the only one available for spreading warm wetted sand on bike paths and walkways. The spreading equipment (manufactured by AEBI Schmidt Sweden) is comprised of a hopper for the abrasives (sand material), water tanks, a heating system, a mixing unit where the hot water is added to the abrasives, and a spinner. The maximum spreading width of the equipment is 3 m (9.8 ft). Normally, when using the method for skid control on walkways and bike paths the spreading width is 2 m (6.6 ft) depending on the snow cleared width of the path.

The spreading equipment is mounted on a small truck, a Mercedes-Benz 616 CDI from 2003 (Figure 1). The total length of the vehicle is 6.7 m (22 ft) and the total width 2.33 m (7.64 ft). The same equipment can also be used for traditional gritting just by turning off the water supply. In the summertime the spreading equipment can be demounted and the vehicle then can be equipped for park maintenance instead.

The service weight of the vehicle is 4,480 kg (9,880 lb) and the maximum loading capacity is 1,510 kg (3,330 lb). It is important that the total weight is kept low to avoid damaging the pavement structure; however, the loading capacity of the vehicle used is not really sufficient for a full load in the hopper and the water tanks. Another critical aspect of the carrying vehicle is the total height since it has to pass through many tunnels when attending bike paths and walkways. The height of the vehicle in Umeå is 2.4 m (7.9 ft), which is the maximum height possible.



**FIGURE 1** The equipment used for spreading warm wetted sand on walkways and bike paths in Umeå municipality, in Sweden.

## Evaluation Methods

To synthesize the practical experience using the method on walkways and bike paths, interviews with maintenance operators and the street operations manager in Umeå municipality were carried out at several occasions from 2008 to 2011. Questions were asked about operational routines in general, and specifically about the method, equipment, and material used for skid control with warm wetted sand on bike paths and walkways. A sieve analysis also was conducted to further evaluate the sand material used.

During the winter of 2010–2011 the method also was evaluated through road condition observations and initial interviews with cyclists and pedestrians. In addition, the theoretical potential of the method was assessed based on climate data from RWIS (road weather information system) stations in the vicinity of Umeå.

## RESULTS AND DISCUSSION

### Practical Experience

#### *Operational Routines*

In Umeå snow clearance starts at a snow depth of 2 to 4 cm (0.8 to 1.6 in.) on high-priority walkways and bike paths and at 5 to 8 cm (2.0 to 3.1 in.) on those with lower priority. To maintain a good friction even during winter, skid control is performed twice a week and at occasions with slippery conditions. The decision whether skid control is needed to combat slippery conditions is made by operation managers based on weather forecast reports, while routine gritting to maintain a good friction is based on the judgement of the maintenance operators. On certain stretches with high accident frequency, such as downhill slopes, daily gritting is applied.

For winter maintenance of bike paths and walkways, Umeå have their own maintenance personnel as well as contractors. The equipment for warm wetted sand is owned by the municipality, and it is mainly used for skid control on parts of the bicycle road network in the densely built-up area of Umeå. When first starting to use the method with warm wetted sand for skid control on bike paths and walkways, Umeå had  $-5^{\circ}\text{C}$  ( $23^{\circ}\text{F}$ ) as temperature criteria. At the time of the study, after the method had been used for a couple of years, the routine was to use warm wetted sand when the temperature was  $-2^{\circ}\text{C}$  ( $28.4^{\circ}\text{F}$ ) or below. When the temperature criterion is not fulfilled, the equipment is used for traditional sanding without water.

The normal dosage of sand spread in skid control with warm wetted sand is equivalent to  $150\text{ g/m}^2$  ( $0.492\text{ oz/ft}^2$ ), mixed with approximately 21% water (by volume). The water temperature should be as close to  $100^{\circ}\text{C}$  ( $212^{\circ}\text{F}$ ) as possible and is usually about  $96^{\circ}\text{C}$  ( $204.8^{\circ}\text{F}$ ) when spreading. The maximum vehicle velocity while spreading is 30 km/h (18.6 mph). However, the spinner velocity is independent of the driving velocity since the spreader is automatically adjusting to the driving velocity in order to maintain a constant dosage of sand. A full load of material and water lasts for about one hour of spreading. On a normal day requiring skid control, the maintenance operator needs to refill the hopper and the water tanks about four to five times.

### *Observations of Benefits and Drawbacks with the Method*

The maintenance operators have observed a very long duration of the skid control measures with warm wetted sand on walkways and bike paths. Their experience is that the effect is only reduced when plowing the surface after a snowfall or during mild weather with thawing. There seems to be no noticeable wearing of the sand from cyclists and pedestrians.

As mentioned before, the normal dosage of sand is equivalent to 150 g/m<sup>2</sup> (0.492 oz/ft<sup>2</sup>). According to the operations manager, it is important that the dosage is not too large since that can create an uneven surface that is uncomfortable for cyclists. Also when spreading on soft packed snow an uneven surface might occur, if the warm sand melts through the top layer of the snow surface. On hard packed snow and thick ice the sand stays at the top of the surface, which is as expected.

The maintenance operators' main objection towards the method is that the sand material freezes in the hopper and then has to be separated manually with a shovel. The material needs to be stirred now and then to prevent it from freezing and there is no automatic mixer in the hopper.

The sand material recommended by the manufacturer is crushed stone material in a fraction of 0 to 4 mm (0 to 0.16 in.) with 10% fine gradation less than 0.075 mm (0.0030 in.). The recommendation is based on studies performed in Norway (2–4). The sand material actually used by the maintenance operators varies and is usually a mixture of natural sand and crushed stone material. The maintenance operators perceive the crushed stone material to be the main cause of the freezing problem and prefer to use natural sand. Since starting to use the method with warm wetted sand, the maintenance operators have tried several different mixtures of sand materials and are still not satisfied with the mixture. To abate the freezing problem, the inside of the hopper has been painted before the next winter season, 2011–2012.

### **Sand Quality**

As mentioned before, different mixtures of sand materials have been used since starting to use the method with warm wetted sand on walkways and bike paths. To evaluate the sand material used during the winter of 2010–2011, a gradation curve was produced through a sieve analysis (Table 1). It showed that 25% of the material is more coarse grained than recommended, and also that the amount of fine-graded material is larger than suggested. The experience from the studies in Norway (3) is that there is an increased risk that a sand material with a high amount (>10%) of fine-graded particles (<0.075 mm) freezes, if the moisture content is high. The material then requires a certain design of the hopper and special attention when transported.

It should be noted that the results presented in the table is only an example, since the sand material used might vary from time to time. However the results indicate that the sand quality should be adjusted.

### **Road User Perspective: Interviews with Cyclists and Pedestrians**

Roadside interviews with three pedestrians and five cyclists were performed in March 2011. The main purpose of these interviews was to test the questionnaire before a more extended evaluation in the winter of 2011–2012. It was concluded that the maximum interview time was about 5 min and hence the questionnaire was shortened before the winter of 2011–2012.

**TABLE 1 Sieve Analysis of the Sand Material Used for Skid Control with Warm Wetted Sand on Bike Paths and Walkways**

Screen (mm) <sup>a</sup>	Pass (%)
11.2	100
8.0	99
5.6	86
4.0	75
2.0	55
1.0	42
0.5	34
0.25	27
0.125	19
0.063	12

<sup>a</sup> 1 mm = 0.039 in.

In general, the interviewees were satisfied with the municipal winter maintenance of walkways and bike paths. Among the eight persons interviewed, only two were aware that Umeå municipality used warm wetted sand for skid control on some walkways and bike paths. No one had noticed any difference, and the two persons who knew about the method had read about it in the local newspaper.

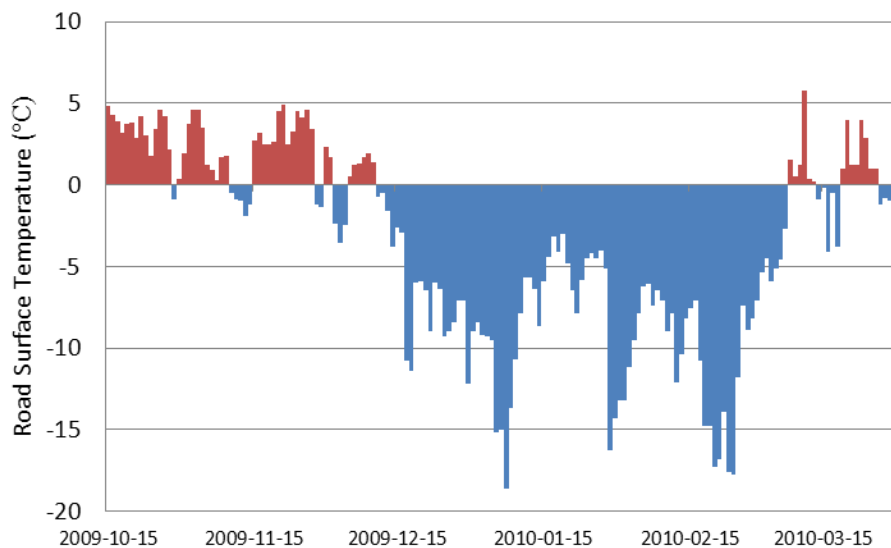
### Road Condition Observation

In accordance with the roadside interviews, road condition observations performed during the winter of 2010–2011 showed no visible difference between sections where warm wetted sand had been used for skid control, compared to sections attended with traditional gritting. Therefore, measurements of friction are needed to evaluate the effect of the method, and no such measurements were performed during the winter of 2010–2011.

### Theoretical Potential of the Method Based on Climate Data

One of the prerequisites for the method using warm wetted sand is a cold surface [i.e., the road surface temperature must be below 0°C (32°F)]. To picture the climate conditions in Umeå, weather data from RWIS stations in the vicinity of Umeå were analyzed for seven winters (2003–2004 to 2009–2010). The winter period is defined as the period from October 14 to March 31. Since 2003 data are available from two RWIS stations and since 2006 from three stations, within 15 km from Umeå. [Figure 2](#) gives an example of the daily variation of the maximum road surface temperature in Umeå.

As shown in [Figure 2](#), there is a period of at least three months during the winter in Umeå when the method using warm wetted sand is applicable. To be on the safe side, the routine in Umeå was to use the method when the air temperature was –2°C (28.4°F) or below. The operation managers in Umeå municipality are using weather forecast reports from the meteorological service rather than RWIS weather data when planning actions. Therefore, they have no information about the road surface temperature. However, the air temperature gives a



**FIGURE 2** The daily variation in the maximum road surface temperature during the winter of 2009–2010, according to an RWIS station near Umeå city.

good indication of when the method is applicable. According to analysis of the RWIS data, the road surface temperature is usually lower than the air temperature (in about 70% of the cases).

To estimate the number of actions needed with the warm wetted sand method, it is assumed that a skid control measure is needed after each separate snowfall. The RWIS weather data analyzed showed that Umeå has 72 separate snowfalls on average, each winter. A “separate snowfall” is defined as a recording of snowfall at least 6 h after the last snowfall was recorded. When combining snowfall data and a road surface temperature requirement of  $-2^{\circ}\text{C}$  ( $28.4^{\circ}\text{F}$ ) or below, the number of actions needed can be estimated. On average, skid control using warm wetted sand is needed 24 times each winter; however, there is a great variation between RWIS stations and years (Table 2).

**TABLE 2** Number of Times Skid Control with Warm Wetted Sand Is Needed When Considering Road Surface Temperature and Snowfall Recorded by RWIS Stations Near Umeå

Winter Season	RWIS Station		
	2416	2440	2451
2003–2004	27	22	—
2004–2005	32	30	—
2005–2006	28	27	—
2006–2007	24	24	21
2007–2008	22	25	14
2008–2009	19	24	20
2009–2010	24	28	24
Average	25	26	20

When using traditional gritting, skid control is performed at least twice a week on walkways and cycle paths in Umeå. For a whole winter it adds up to more than 48 skid control measures. This means that the method using warm wetted sand has a potential of reducing the number of actions needed by half. According to the manufacturer, the effect of the warm wetted sand might last even after as many as three to four plowing actions. In that case the number of actions needed might be reduced even further. However, this is only theoretical estimations and a calculation of the real savings has to be based on studies of the actual duration of the skid control measures, for example through measurements of friction. Such studies were conducted during the winter of 2011–2012.

## CONCLUSIONS

At this time, not all parameters are known in order to make an economical appraisal of the method. However, from road weather data it can be concluded that the method using warm wetted sand has a potential of decreasing the number of actions needed to maintain a sufficient friction level on bike paths and walkways. There seems to be no noticeable wearing of the sand from cyclists and pedestrians; the measures taken have a long duration, and the effect is only reduced when plowing the surface or during mild weather. The best effect of the method is on hard packed snow and thick ice. If the snow layer is too soft the method might create an uneven surface uncomfortable for cyclists.

The most crucial problem to be solved is the freezing of the sand material in the hopper. One solution might be adjusting the mixture of the sand material used. Another is to secure a warm and dry sand storage or to use the material right after crushing. Improvements must be made in logistics as well as in operational routines.

Road condition observations showed no visible difference between sections where warm wetted sand had been used for skid control, compared to sections attended with traditional gritting. Therefore, measurements of friction are needed to evaluate the effect of the method. To be able to further evaluate the method with roadside interviews, the research design of the field study has to be more stringent. For example, the areas where warm wetted sand will be used should be more clearly defined.

## NOTE

During the winter of 2011–2012 the method was further evaluated through measurements of friction and complementing interviews with cyclists and pedestrians. In the oral presentation at the conference, the results presented in the paper will be complemented with results from these further evaluations.

## ACKNOWLEDGMENT

The author offers her deepest gratitude to all of the Umeå municipality personnel with whom she has been in contact during this project, especially street operations manager Torbjörn Sandberg



and the maintenance operators Nina Rooth and Michael Niord, for their cooperation and valuable discussions.

The financial support by the Swedish Transport Administration (the former Swedish National Road Administration) and the valuable insights from its agent Pontus Gruhs is gratefully acknowledged.

## REFERENCES

1. Thulin, H., and A. Niska. *Injured Cyclists. Analysis Based on Hospital Registered Injury Information from STRADA* (in Swedish with English summary). VTI Rapport 644, Swedish Road and Transport Research Institute. Linköping, Sweden, 2009.
2. Dahlen, J., and T. Vaa. Winter Friction Project in Norway. In *Transportation Research Record: Journal of the Transportation Research Board*, No. 1741, TRB, National Research Council, Washington, D.C., 2001, pp. 34–41.
3. Vaa, T. *Winter Friction Project—Results from Studies of Different Applications of Abrasives in 1999/2000*. (In Norwegian, “Vinterfriksjonsprosjektet - resultater fra sandningsforsok sesongen 1999/2000”). SINTEF Rapport STF22 00566, SINTEF. Trondheim, Norway, 2000.
4. Vaa, T. *Results from Studies of Warm Wetted Sand Spreaders in 2007*. (In Norwegian with English summary, *Resultater fra tester av Fastsandspredere i uke 2/2007*). TEKNOLOGIRAPPORT No. 2517. Vegdirektoratet, Oslo, Norway, 2008.

## WINTER SURFACE FRICTION

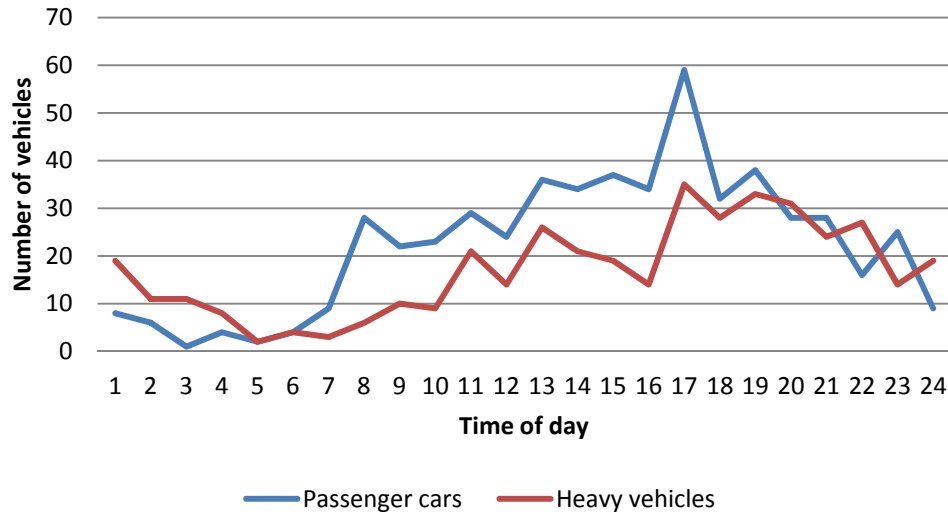
**Trafficability of Heavy Vehicles on Inclines****TORGEIR VAA****IVAR HOL***Norwegian Public Roads Administration*

**The trafficability of heavy vehicles on steep hills is a matter of great concern in Norway due to the nature of the topography with its many mountain passes and inclines. Vehicles stranded on the roadway constitute a big problem on many roads in winter, and this is why the Norwegian Public Roads Administration has carried out a project designed to establish what factors influence the ability of trucks to keep moving even in poor driving conditions in winter. Four vehicles with different axle configurations were used in the trials carried out in February 2009: (1) bogie truck with three-axle trailer; (2) semitrailer with bogie and three-axle trailer; (3) semitrailer without bogie and three-axle trailer; and (4) semitrailer with bogie and three-axle trailer. The trials included the following configurations for vehicles 1–3: vehicle and trailer without cargo, 10-tonne cargo, 20-tonne cargo, and with and without use of bogie (vehicles 1 and 2). The results show that the weight at the driving wheels is of key importance to whether the vehicle is able to reach the top of the gradient or not. The tests also clearly demonstrate the considerable advantage of a bogie. When the bogie is retracted, the weight on the driving wheels is significantly increased, and this makes it easier to maintain speed on an up-hill gradient. Also, it is often an advantage to increase the pressure of an axle beyond 10 tonnes, which is the legal limit on many Norwegian roads.**

**T**he trafficability of heavy vehicles on steep hills is a matter of great concern in Norway due to the nature of the topography with its many mountain passes and inclines. Vehicles stranded on the roadway constitute a big problem on many roads in winter, and this is why the Norwegian Public Roads Administration has carried out a project designed to establish what factors influence the ability of trucks to keep moving up hill even in poor driving conditions in winter.

The trafficability of heavy vehicles is a key issue to the Inner Romsdal research and development project (1), and the problem of heavy vehicles in mountain passes was one of the main reasons why the project was launched. This is also an important reason why the Nord Møre and Romsdal district authorities have taken the initiative to carry out trials with heavy vehicles on inclines, in order to study in detail the challenges associated with different vehicle configurations.

To illustrate the extent of the heavy vehicle traffic, [Figure 1](#) shows the traffic variation over a day at a traffic registration point on the E136 trunk road in Romsdalen by Horgheim. This Wednesday in February 2009, a total of 409 heavy vehicles traveling in both directions were recorded; this constitutes 44% of total daily traffic. Heavy vehicles are defined as vehicles with a length equal to or greater than 5.6 m, and are thus a group of vehicles that are not exclusively made up of trucks, lorries, and trailers.



**FIGURE 1** Traffic variation during the day at Horgheim, Wednesday, February 11, 2009.

## DESIGN OF THE STUDY

### Study Area

Trials have been conducted with heavy vehicles on a gradient near Vestnes in Møre og Romsdal County in mid-Norway. The aim of this subproject (2) was to study the traffic flow quality for heavy vehicles on winter roads with an uphill gradient. Four vehicles with different axle configurations were used in the trials carried out in February 2009:

1. Bogie truck with three-axle trailer;
2. Semitrailer with bogie and three-axle trailer;
3. Semitrailer without bogie, and three-axle trailer; and
4. Push truck with bogie and three-axle trailer.

The trials included the following configurations for vehicles 1–3:

- Vehicle and trailer without cargo,
- 10-tonne cargo,
- 20-tonne cargo, and
- With and without use of bogie (vehicles 1 and 2).

Vehicle 4 was tested only with 20 tonnes of cargo and without a bogie. The trials were mainly carried out on compacted snow, partially covered with some loose snow.

During a field test of this kind it is important to have appropriate testing conditions that maintain safety standards. The Heggelia hill by Vestnes was found to be a convenient place for carrying out the trials. Heggelia, which is the steepest road section between Oslo and Aalesund, closes in difficult periods over the winter. It is therefore easy to use this road section for controlled trials with trucks.

Figure 2 shows an overview of the test area with the diversion option via E39. Figure 3 shows an overview of the test section with its various subsections plotted. Between the 18,017-km point and the 18,604-km point, there is a height difference of 42 m. This represents a gradient of 7.2%. It is clear from the gradient profile in Figure 4 that the incline is rising fairly steadily, but that the first 150 m is a more level section (6.3%).

The starting point of the Heggelia hill is visible to the left in the image in Figure 5. The test section was closed to other traffic during the trials, and security was ensured through manual traffic control in addition to road signs.

Figure 6 shows the vehicles included in the trials, and Table 1 shows their load distribution when empty and when loaded with 10 and 20 tonnes, respectively.

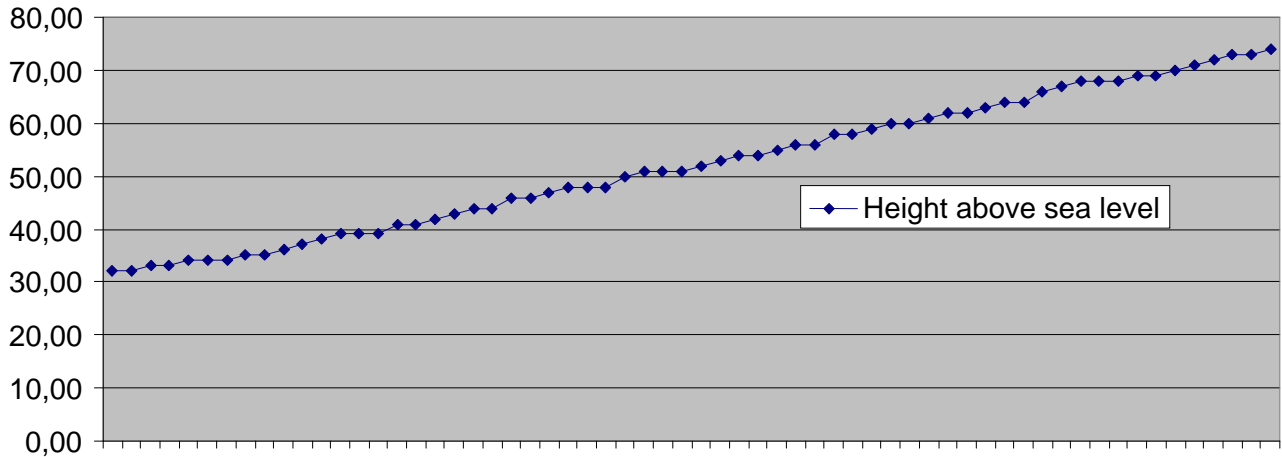
On the second day, the tires were changed on the drive wheels of Truck C. The original tires were fairly worn Norwegian winter tires with a shore value of 64 (Figure 7). The replacement tires were “foreign” block pattern tires with a shore value of 72 and with good tread depth, as seen on Figure 8.



**FIGURE 2** Test area.



**FIGURE 3** Overview of the test section at Heggelia.



**FIGURE 4 Gradient profile at Heggelia.**



**FIGURE 5 The starting point of the test road can be seen to the left.**

### Registration of the Speed Profile

All vehicles were equipped with a Global Positioning System (GPS) unit programmed to log positions every 0.5 s. The signals from the GPS device were transmitted wirelessly to a personal data assistant that acted as a data logger. The records provided a detailed speed profile for the test section.

## Weighing Procedures

All weighing was carried out by personnel from the Road Users and Vehicles Department (TK) using mobile scales. The setup for weighing with mobile scales is shown in Figure 9. This is a flexible weighing system that gives detailed weights for all axles on both the tractor and trailer.

## Friction Measurements

Traction Watcher One (TWO) -type measurements were used to establish the level of friction (see Figure 10). The friction measurements were taken simultaneously with two trailers of the same type every day.



**FIGURE 6** Vehicles included in the trials.

**TABLE 1 Load Distribution in Kilos, Without Cargo and With a 10-tonne and a 20-tonne Load**

Load, Use of Bogie, Truck A, 460 HP	Tractor			Trailer			Gross Weight		
	Axle Weight			Axle Weight			Load Distribution		
	In Front	At Rear 1	At Rear 2	Axle 1	Axle 2	Axle 3	Tractor	Trailer	Truck Train
<u>0 tonnes</u>									
Bogie down	6050	4750	2400	4600		4600	13050	9200	22250
Bogie up	5300	7750		4600		4600	13050	9200	22250
<u>10 tonnes</u>									
Bogie down	7600	6300	4050	7700		7000	17950	14700	32650
Bogie up	6400	10900		7700		7000	17950	14700	32650
<u>20 tonnes</u>									
Bogie down	8000	9500	6600	9600	4950	5150	24100	19700	43800
Bogie up	5900	17800		9600	4950	5150	24100	19700	43800
Load, Use of Bogie, Truck B, 550 HP	Tractor			Trailer			Gross weight		
	Axle weight			Axle weight			Load distribution		
	In Front	Be-hind 1	Be-hind 2	Axle 1	Axle 2	Axle 3	Tractor	Trailer	Truck Train
<u>0 tonnes</u>									
Bogie down	6500	5110	2200	2450	2450	2550	13810	7450	21260
Bogie up	5550	8100			3810	3800	13650	7610	21260
<u>10 tonnes</u>									
Bogie down	7000	7100	3800	4150	4050	4100	17900	12300	30200
Bogie up	5450	12250		4200	4100	4200	17700	12500	30200
<u>20 tonnes</u>									
Bogie down	7500	8100	4750	6300	6350	6450	20350	19100	39450
Bogie up	5450	14900		6300	6350	6450	20350	19100	39450
Bogie, partial	5450	16550			8700	8750	22000	17450	39450
Load, Use of Bogie, Truck C, 530 HP	Tractor			Trailer			Gross weight		
	Axle Weight			Axle Weight			Load Distribution		
	In Front	At Rear 1	At Rear 2	Axle 1	Axle 2	Axle 3	Tractor	Trailer	Truck Train
<u>0 tonnes</u>									
No bogie	6850	5350	—	—	—	—	12200	7850	20050
<u>10 tonnes</u>									
No bogie	7500	9000	—	—	—	—	16500	12850	29350
<u>20 tonnes</u>									
No bogie	8000	11700	—	6900	6850	6600	19700	20350	40050
Load, Use of Push Function, Truck D, 400 HP	Tractor			Trailer			Gross weight		
	Axle Weight			Axle Weight			Load Distribution		
	In Front	At Rear 1	At Rear 2	Axle 1	Axle 2	Axle 3	Tractor	Trailer	Truck Train
<u>20 tonnes</u>									
Pusher up	—	8000	—	6300	6350	6450	—	19100	—
Pusher down	—	11700	—	6300	6350	6450	—	19100	—



**FIGURE 7** Norwegian winter tire. Shore value: 64.



**FIGURE 8** "Foreign" block pattern tire. Shore value: 72.



## RESULTS

### Driving Conditions

Figure 11 shows what the situation looked like in the morning of February 11. There was a lot of loose snow, the consistency of which was clearly influenced by residual salt from the spreading that had been carried out before a major snowfall a few days earlier.



**FIGURE 9** Setup for weighing with mobile scales.

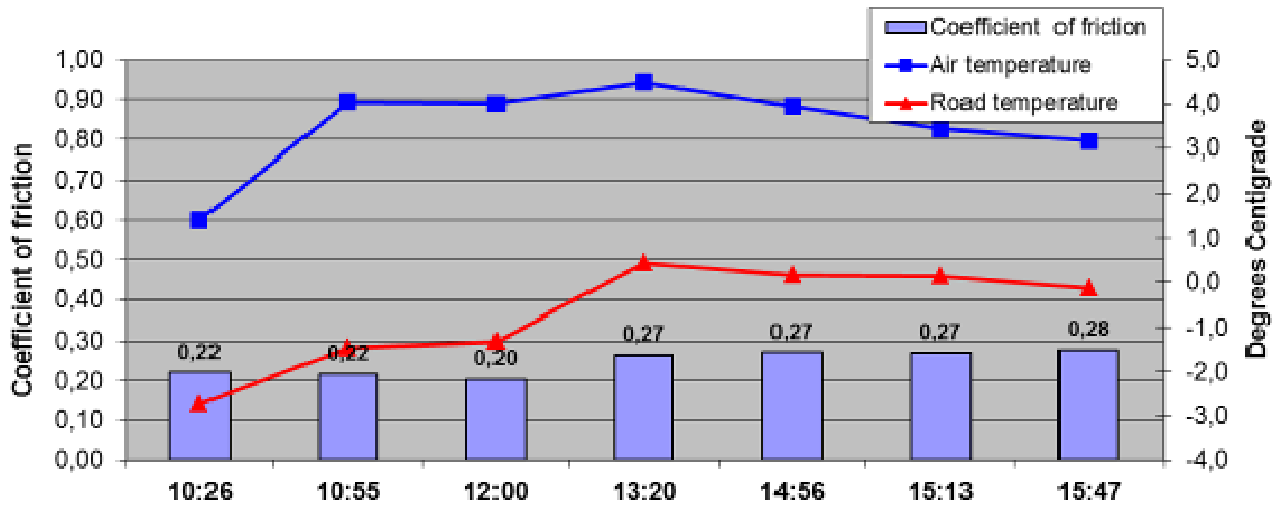


**FIGURE 10** Friction measurement with a TWO-type friction trailer.

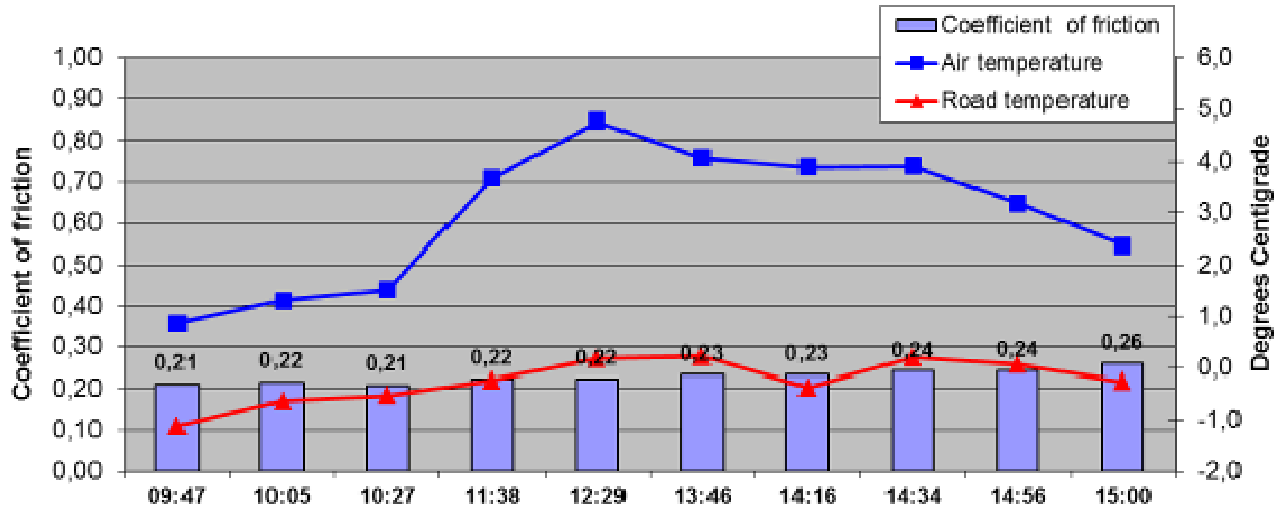


**FIGURE 11** Driving conditions on the morning of February 11, 2009.

Figures 12 and 13 show average friction readings from each of the measurements carried out on the two test days. The friction value is based on the average of measurements on a 600-m section from the start of the climb at the 18,000-km point and past the curve at 18,600-km point. The friction values presented are the average of the values from both friction trailers. Temperature data were obtained from one of the measuring vehicles.



**FIGURE 12** Mean value for the coefficient of friction on the test section, November 2, 2009.



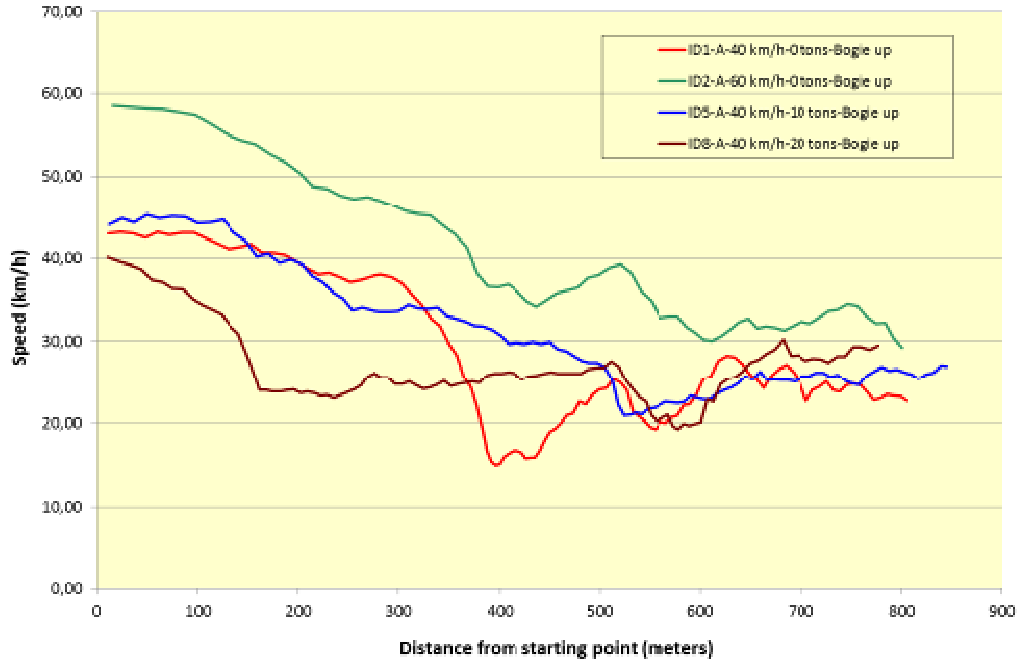
**FIGURE 13** Mean value for the coefficient of friction on the test section, December 2, 2009.

There was a marked change in friction levels between 12:00 p.m. and 1:20 p.m. on the first day of the trials; this appeared to have a clear connection with treatment (grading) of the snow cover to create a more compact surface. Also, the change in friction conditions on the second day of the trials can be explained by mechanical treatment of the snow and ice surface.

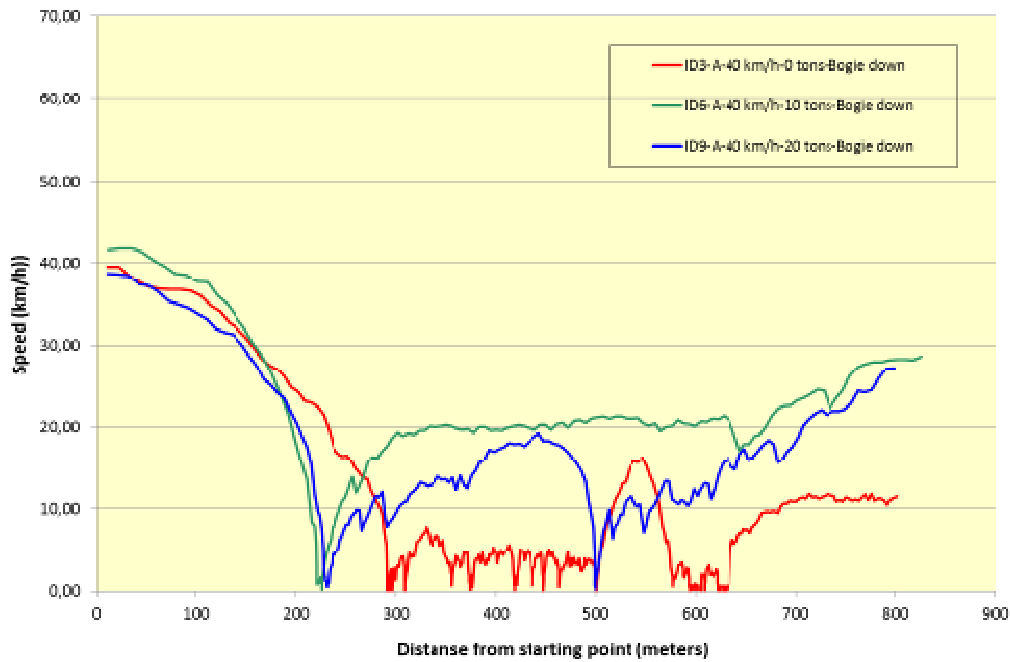
### Driving Tests, Both Days Combined

Figures 14 through 18 show a compilation of the results of the ordinary driving tests, without provoked stops, for the three main units that participated in the trials. The main results show that

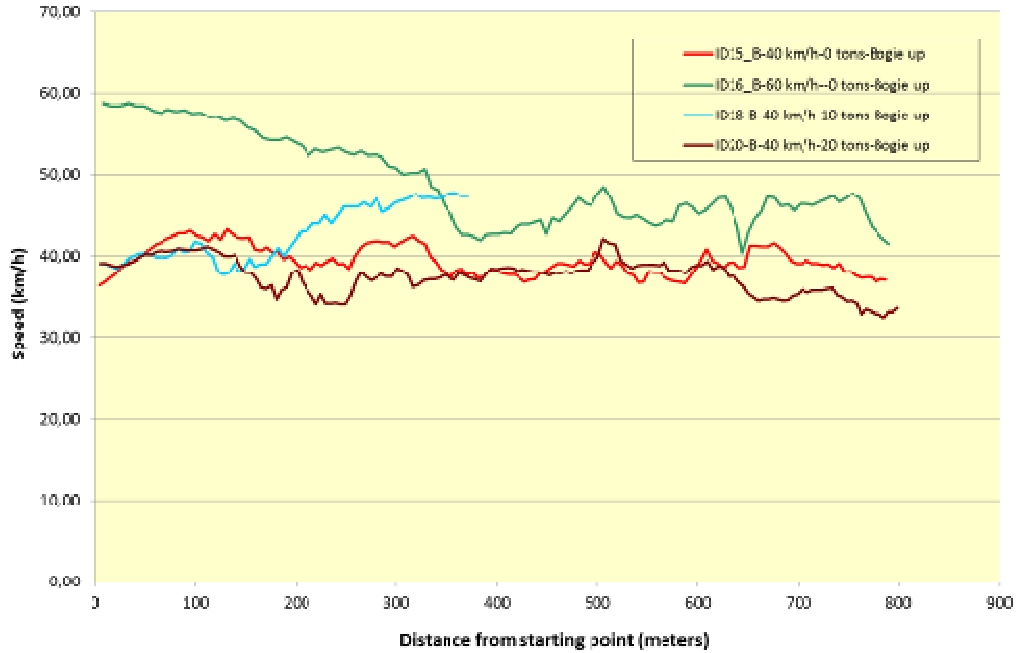
- Trucks with bogies:
  - With the bogie retracted, the vehicles experienced no significant problems in climbing the slope—they reached the summit without stopping; their loading had no significant impact on their trafficability.
  - With the bogie lowered, both vehicles stopped on the incline, regardless of whether they were loaded or not.
  - The vehicle with the lowest engine power found it more difficult to climb the hill than the truck with the highest engine power in that it would generally come to a stop at an earlier point on the incline.
  - When traveling without a load, raising the bogie had no impact and both trucks needed towing assistance to get up the incline.
  - When traveling with either 10 or 20 tonnes of cargo, it was sufficient for either vehicle to raise the bogie in order to start up after coming to a standstill.
- Semitrailer without a bogie
  - When traveling without a load and at an initial speed of 40 km/h, the truck without a bogie was unable to climb the hill without stopping. Raising the speed to 50 km/h was sufficient for the vehicle to climb the hill without stopping.
  - The truck without a bogie had no problems climbing the hill when loaded with either 10 or 20 tonnes of cargo.



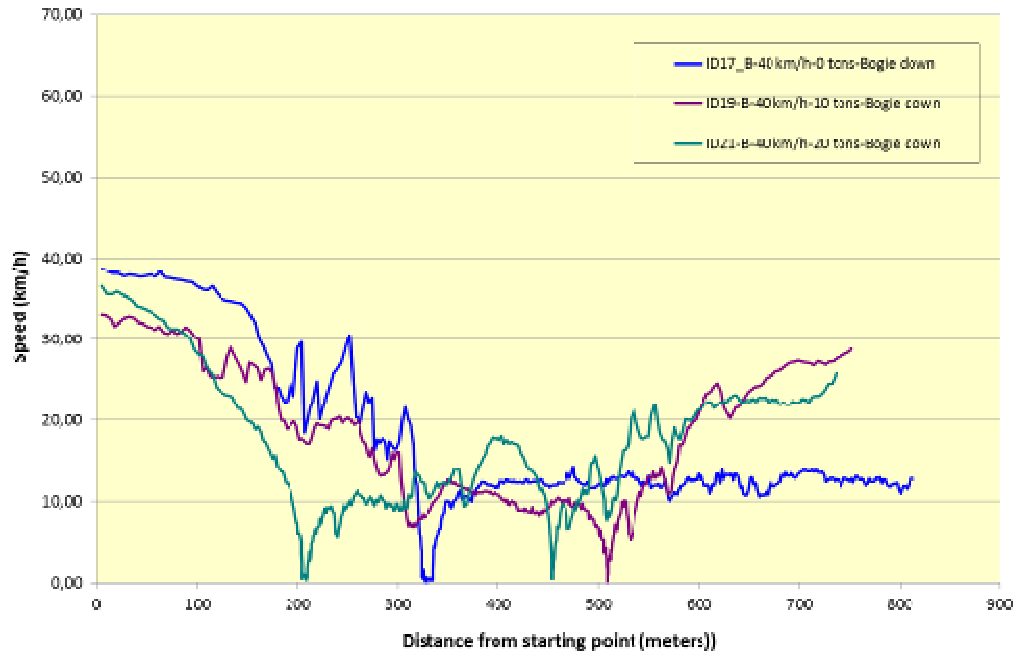
**FIGURE 14** Truck A: truck with a bogie and trailer with different loads, bogie raised.



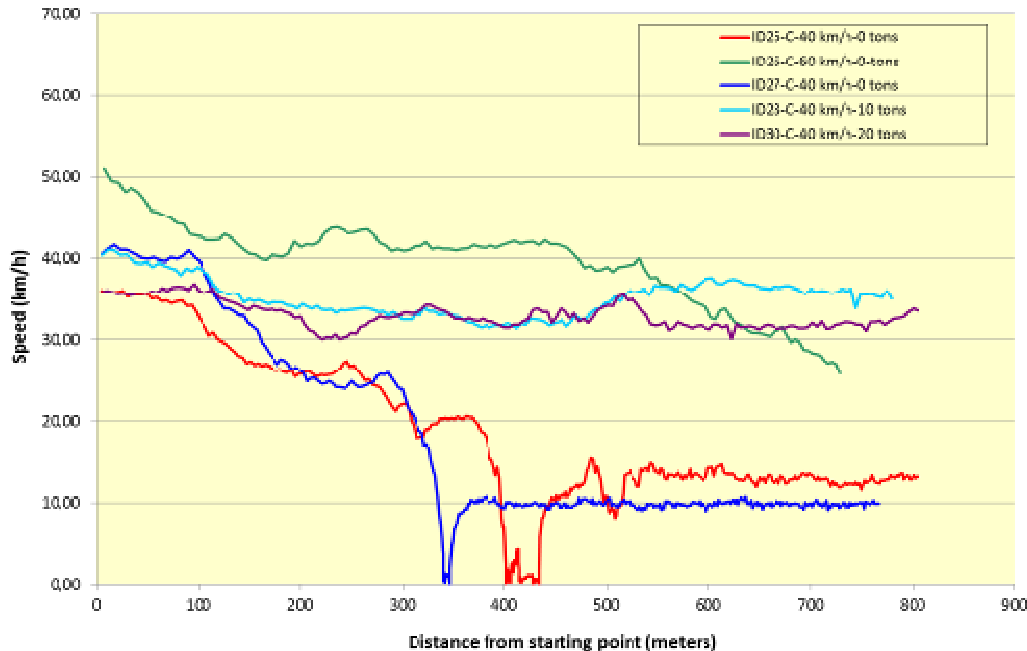
**FIGURE 15** Truck A: truck with a bogie and trailer with different loads, bogie lowered.



**FIGURE 16** Truck B: truck with a bogie and trailer with different loads, bogie raised.



**FIGURE 17** Truck B: truck with a bogie and trailer with different loads, bogie lowered.



**FIGURE 18 Truck C: semitrailer without a bogie and different loads.**

## CONCLUSIONS

The test results show that the weight on the driving wheels is of key importance to whether the vehicle is able to reach the summit or not. The tests also clearly demonstrate the substantial advantage of having a vehicle with a bogie. When the bogie is retracted, the weight on the driving wheels is significantly increased and this makes it easier to maintain speed uphill. It is often advantageous to increase the pressure of an axle beyond 10 tonnes, which is the legal limit on many Norwegian roads.

The trials show that tire properties are important. Hard rubber tires (high shore value) decrease the likelihood of maintaining speed uphill compared with ordinary tires.

As expected, the relationship between the power of the engine and the total weight of the vehicle may be important. Vehicles with a high engine power/total weight ratio maintain the highest speed uphill. However, if the weight on the driving wheels is relatively low, the power of the engine is of no or only limited significance.

Semitrailers without a bogie are commonplace among foreign trucks on Norwegian roads. With no or little cargo these vehicles often have problems on gradients during winter conditions. The problems are aggravated by their use of hard rubber tires.

The results of the study are not surprising, but they do provide documentation of how a variety of factors influence the trafficability of heavy vehicles on gradients in wintry conditions. To more widely illustrate the problems, it is required to carry out more trials under other road conditions, with other tire combinations and the use of snow chains.

The results of the trials show that the weight on the drive wheels has significant and decisive impact on the vehicles' ability to drive up a steep hill. The trials also demonstrate quite clearly that having a bogie on the tractor can be a great advantage. The bogie makes it possible to

increase substantially the weight on the drive wheels, thus achieving significantly better traction. Also, it will often be advantageous to increase the axle pressure beyond the legal 10-tonne limit.

The trials also demonstrate that the choice of tire may influence the vehicle's traction characteristics. Hard tires have poorer performance than regular tyres. Although the study involved only a few runs with hard tires, researchers found that tire choice had an impact on whether the vehicles managed to get going after the imposed stop on the incline. It also appears that a friction level of 0.25 is sufficient to reduce the traffic flow problems created by hard tires.

The tests at Heggelia confirm that the vehicle's configuration is of key importance to the truck trailer's trafficability on inclines. Single axle semitrailers, which are a common vehicle type among foreign trucks, depend on their loading in order to drive up an incline like the Heggelia hill. Empty vehicles of that type are unable to get going again after coming to a standstill. The problem is aggravated by the fact that these vehicles regularly are fitted with tires with a high shore value.

## FURTHER STUDIES TO BE CARRIED OUT

The test results are not surprising, but document how a variety of factors influence the trafficability of heavy vehicles on gradients in wintry conditions. In order to illustrate the problem more widely, further trials must be conducted under different road conditions, with a greater number of tire combinations and with the use of snow chains.

Trucks with bogies were found to be completely dependent on their ability to raise the suspension in order to climb the Heggelia hill. With loads over a certain weight and the suspension fully retracted, this entails a breach of the axle regulations. The trials at Heggelia suggest that it is not necessary to run at full speed on the suspension, but further investigation is required to establish by how much the pressure may be reduced without compromising trafficability.

It is also desirable to carry out further testing with a number of different tire combinations and to conduct a study of the effects of using chains.

The tires never ran hot during the tests at Heggelia, so there was no melting effect with the subsequent sliding that usually happens when a vehicle stops on snow covered ground on an incline. When repeating the study, it would be beneficial to include tests with warm tires.

## REFERENCES

1. Vaa, T. *R&D Indre Romsdal. Follow-up Study of Winter Standard the Seasons 2006/2007 and 2007/2008*. SINTEF Report A11557, April 2009.
2. Vaa, T., and T. Giæver. *R&D Indre Romsdal. Traffic Ability for Heavy Vehicles in an Incline*. SINTEF Report A11476, March 2009.

## WINTER SURFACE FRICTION

## Friction and Side Friction

### *Comparing Measuring Equipment with Passenger Cars*

**DAGFIN GRYTESELV***SINTEF Road and Railway Engineering, Norway***TERJE GLÆVER****TORGEIR VAA***Norwegian Public Roads Administration*

The coefficient of friction is one of the parameters measured to tell something about the maintenance and driving standard in winter condition. Normally it is assumed that all of the friction is used for braking. When driving in curves some of the friction is used to maintain a steady curve track, or the centripetal force. The continuous friction measuring device Traction Watcher One (TWO) has a relatively new sensor combining a gyro and an accelerometer, registering side forces and angular deflection. Adding the known vehicle speed, the driving radius can be calculated. Using the measured friction, the highest possible speed without skidding sideways can be estimated. This speed is denoted critical speed. By knowing the critical speed drivers can better adapt speed to current conditions. It is important to be aware of the critical spots, especially when friction changes along a road section and also as a parameter when considering locally increased maintenance efforts. To verify this critical speed measuring device two field experiments were conducted during winter 2010–2011. The TWO measuring device critical speed was compared with that of different passenger cars on a level icy prepared track with curve radiuses from 50 to 150 m. Passenger cars were of different sizes and weights and had somewhat different tires. The cars were driven with increasing speed through the curves until side skidding occurred. Actual speed and curve radius was monitored using a high-frequency Global Positioning System logger. Traditional breaking tests and breaking tests in curve also were conducted. Preliminary results indicate that TWO calculates somewhat lower critical speed in curves than observed by driving the passenger cars.





# Blowing and Drifting Snow



## BLOWING AND DRIFTING SNOW

## Revision of *Highway Snowstorm Countermeasure Manual* Focus on *Snowbreak Woods*

MANABU KANEKO  
TAKASHI WATANABE  
MASARU MATSUZAWA

*Civil Engineering Research Institute for Cold Region, Public Works Research Institute, Japan*

YASUHIKO ITO

*Snow Avalanche and Landslide Research Center, Public Works Research Institute, Japan*

Hokkaido is a cold, snowy region located in the northernmost part of Japan and depends heavily on automobiles for transportation in daily life and socioeconomic activity. Forty percent of recent road closures on national highways in Hokkaido have been caused by snowstorms, including large-scale phenomena in which significant numbers of vehicles were stranded for extended periods. Such incidents adversely affect socioeconomic activity in the region. The Hokkaido Regional Development Bureau, which manages national highways in Hokkaido, published the first edition of the *Highway Snowstorm Countermeasure Manual* in 1990 as a collection of technical criteria for facilities to control blowing snow. The publication was revised in 2003. However, over seven years have passed since the last revision, and user demand has grown for the manual to reflect new findings and blowing-snow control technologies. Against this backdrop, the Civil Engineering Research Institute for Cold Region (CERI) spent 3 years revising the publication from 2008 onward. This document provides an overview of the revised *Highway Snowstorm Countermeasure Manual*, with particular emphasis on snowbreak woods.

Hokkaido is a cold, snowy region located in the northernmost part of Japan and depends heavily upon automobiles for transportation in daily life and socioeconomic activity.

Forty percent of recent road closures on national highways in Hokkaido have been caused by snowstorms, including large-scale phenomena in which significant numbers of vehicles were stranded for extended periods.

As technical criteria for blowing-snow control facilities are necessary in the improvement and maintenance of facilities to combat traffic obstruction caused by snowstorms, the Hokkaido Regional Development Bureau published the first edition of the *Highway Snowstorm Countermeasure Manual* (draft) in two volumes (Snowbreak Woods and Snowbreak Fences) in 1990. The manual was revised by the Bureau and the Civil Engineering Research Institute of Hokkaido (CERI) in 2003. The General Guide, which provides basic information on blowing-snow control measures, snowbreak woods and snow fences were combined with the manual to create a single publication.

However, in the 7 years that have passed since the last revision in 2003, blowing-snow control technologies have been developed and new findings have been made. Against this backdrop, the Civil Engineering Research Institute for Cold Region (CERI; the former Civil Engineering Research Institute of Hokkaido) spent 3 years from 2008 to March 2011 revising the manual.

This document provides an overview of the revised *Highway Snow Countermeasure Manual* (referred to simply as “the manual” below) with focus on snowbreak woods.

## **CONFIGURATION OF *HIGHWAY SNOWSTORM COUNTERMEASURE MANUAL***

The manual is organized into four volumes as shown below, each consisting of a main section and a reference section. Volume 4 (Other Blowing-Snow Control Facilities) is new to this revised version and details measures based on road structures (e.g., drift control fill) as described in the previous General Guide volume, and includes the content of the draft *Manual for Delineation Facilities Against Snowstorms* published by CERl in 2007. To eliminate duplication of content in these volumes, the General Guide volume provides a general introduction to blowing-snow control measures, and the Snowbreak Woods volume and subsequent volumes detail various blowing-snow control facilities. The four volumes are

- Volume One: General Guide;
- Volume Two: Snowbreak Woods;
- Volume Three: Snow Fences; and
- Volume Four: Other Blowing-Snow Control Facilities.

## **GENERAL GUIDE VOLUME**

The General Guide volume was added in the revision of 2003. It provides an outline of various blowing-snow control facilities, describes assessment of the degree of snowstorm danger, details plans for blowing-snow control measures, discusses blowing-snow control facilities, and provides basic information on general blowing-snow control measures.

- Chapter 1: General Provisions;
- Chapter 2: Basic Concept of Blowing-Snow Control Measures;
- Chapter 3: Procedure for Formulating a Snow-Control Facility Installation Plan and Investigation of the Control Measures; and
- Reference.

### **Procedure for Formulating a Snow-Control Facility Installation Plan**

Snowstorm countermeasure work was previously considered at the road construction stage or in response to incidents after the completion of construction work. However, it was often difficult to select effective measures sufficiently since the route is determined in the construction stage and types of blowing-snow control facilities that can be selected after the stage are limited due to weather and environmental restrictions along routes. Accordingly, this manual specifies the investigation of blowing-snow control measures in the following four stages according to the flow of road design so that facilities can be set during the planning stage:

1. Schematic survey,
2. Basic survey and analysis,

3. Design conditions survey, and
4. Follow-up survey.

The schematic survey is the first investigation conducted during planning for blowing-snow control measures on new routes. It involves the collection of existing documents (e.g., distribution maps showing amounts of snow accumulated in snowdrifts and data on past snowstorm phenomena) to clarify the degree of snowstorm risk. The need for blowing-snow control measures is considered, and the results are used for the selection of routes where snowstorms can be avoided.

For the basic survey and analysis, data on meteorological statistics and ambient environments are collected, meteorological observations are made, the degree of snowstorm risk is evaluated, blowing-snow control facilities are selected and a schematic design is worked out, and the main investigation is the first step for existing routes. In this investigation, snowstorm-related incidents are divided into those caused by snowdrifts and those stemming from visibility hindrance, which are assessed by quantifying the degree of snowstorm risk according to meteorological conditions and ambient environments.

The design conditions survey is carried out to examine information required for detailed design, such as soil conditions in snowbreak woods and  $N$  values (hardness index of foundation soil used in Japan) for snow fences. The follow-up survey is conducted to verify related effects and to consider matters of maintenance and management.

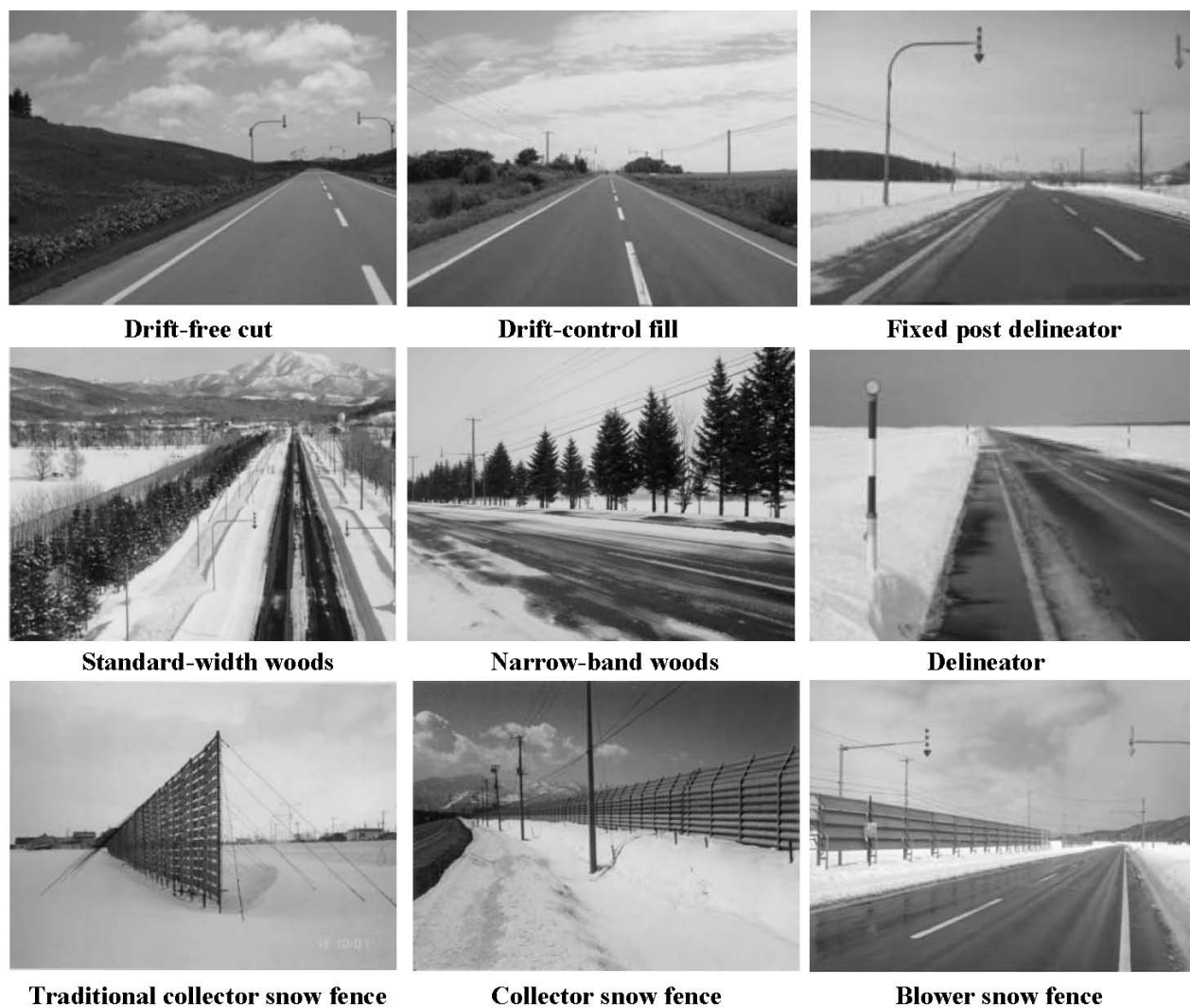
### **Method of Selecting Blowing-Snow Control Facilities**

The various types of blowing-snow control facilities adopted include drift-control fill, drift-free cut, snowbreak woods, snow fences, delineation facilities, and snow shelters (Figure 1), and it was important for the conditions of compatibility for such facilities to be appropriately specified in the manual. The previous publication described cross-sections of roads, the purposes of snow control, main wind directions, and site availability, and included a flowchart for selecting blowing-snow control facilities according to the number of traffic lanes. However, as it was difficult even for informed and experienced engineers to select blowing-snow control facilities and use multiple facilities together, the flowchart was replaced in this revision with a selection table showing applicable facilities (Table 1).

In the example of the embankment road shown at the top of Table 1, if the main wind direction is orthogonal and a site can be secured to implement measures against snowdrifts, standard-width woods should be selected as a first choice, followed by snowbreak embankments, gradual embankments, snow fences, collector snow fences, and large structures. Delineation facilities are marked with a triangle to indicate that they can be used together with measures marked with a circle or double circle.

### **SNOWBREAK WOODS VOLUME**

The concept of snowbreak woods involves the mitigation of effects from snowdrifts and visibility hindrance by reducing wind speed using woodland created on the windward side or both sides of roads. Snowbreak woods are either the standard-width type, used as a measure



**FIGURE 1** Various blowing-snow control facilities.

against snowdrifts and visibility hindrance, or the narrow-band type with a width of less than 10 m, used as a measure against visibility hindrance (Figure 2).

Snowbreak woods along roads were first adopted with the construction of General Highway 12 by the Hokkaido Regional Development Bureau in 1977 and have been created mainly in northern and eastern parts of Hokkaido. More than 30 years have passed since the first snowbreak wood was formed, and issues relating to its maintenance and management have been clarified. Accordingly, new findings made since the previous revision have been included in this revision. Methods of assessing the growth of planted trees are also explained, information on service roads and drainage work has been added, standard figures relating to trees have been changed, and a technique for the thinning of narrow-band woods is described. The Snowbreak Woods volume has the following chapters:

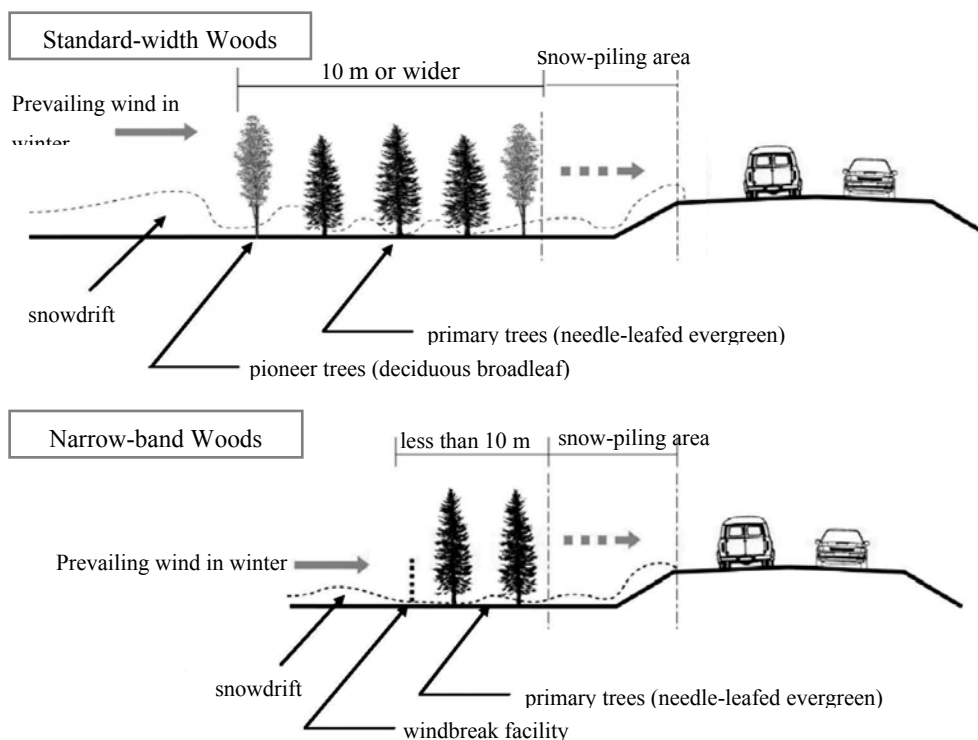
**TABLE 1 Application Criteria of Blowing-Snow Control Facilities (Covering Road Structures and Ancillary Facilities)**

Blowing-snow control facilities					Road structure			Snowbreak woods		Snow fence			Delineation facilities	Large-scale facility	
Selection criteria	Target or countermeasure	Prevailing wind direction	Land available?	No. of lanes*	Gentle slope fill	Drift-control fill	Drift-free cut	Standard-width woods	Narrow-width woods	Trad collector snow fence	Collector snow fence	Blower snow fence**			
Fill	Snowdrifts	Perpendicular	Yes	Multiple lanes or one lane each way	○	○	—	⊙	×	○	○	×	△	○	
			No	Multiple lanes or one lane each way	×	⊙	—	×	×	×	○	×	△		
		Shallow angle	Yes	Multiple lanes or one lane each way	○	○	—	⊙	×	○	○	×	△		
			No	Multiple lanes or one lane each way	×	⊙	—	×	×	×	○	×	△		
	Snowdrifts & poor visibility	Perpendicular	Yes	Multiple lanes or one lane each way	○	○	—	⊙	×	○	○	×	△	○	
			No	Multiple lanes or one lane each way	×	○	—	×	×	×	⊙	×	△		
		Shallow angle	Yes	Multiple lanes or one lane each way	○	○	—	⊙	×	○	○	×	△		
			No	Multiple lanes or one lane each way	×	○	—	×	×	×	⊙	×	△		
	Poor visibility	Perpendicular	Yes	Multiple lanes	○	○	—	○	⊙	○	○	○	×	○	○
			No	One lane each way	○	○	—	○	⊙	○	○	○	×	○	
		Shallow angle	Yes	Multiple lanes or one lane each way	○	○	—	○	⊙	×	○	○	×	○	
			No	Multiple lanes or one lane each way	×	○	—	×	⊙	×	○	○	×	○	
Flat	Snowdrifts	Perpendicular	Yes	Multiple lanes or one lane each way	—	○	—	⊙	×	○	○	×	△	○	
			No	Multiple lanes or one lane each way	—	⊙	—	×	×	×	○	×	△		
		Shallow angle	Yes	Multiple lanes or one lane each way	—	○	—	⊙	×	○	○	×	△		
			No	Multiple lanes or one lane each way	—	⊙	—	×	×	×	○	×	△		
	Snowdrifts & Poor visibility	Perpendicular	Yes	Multiple lanes or one lane each way	—	○	—	⊙	×	○	○	×	△	○	
			No	Multiple lanes or one lane each way	—	○	—	×	×	×	⊙	×	△		
		Shallow angle	Yes	Multiple lanes or one lane each way	—	○	—	⊙	×	○	○	×	△		
			No	Multiple lanes or one lane each way	—	○	—	×	×	×	⊙	×	△		
	Poor visibility	Perpendicular	Yes	Multiple lanes	—	○	—	○	⊙	○	○	○	×	○	○
			No	One lane each way	—	○	—	○	⊙	○	○	○	×	○	
		Shallow angle	Yes	Multiple lanes or one lane each way	—	○	—	⊙	×	○	○	×	○	○	
			No	Multiple lanes or one lane each way	—	○	—	×	⊙	×	○	○	×	○	
Cut	Snowdrifts	Perpendicular	Yes	Multiple lanes or one lane each way	—	—	○	⊙	×	○	○	×	△	○	
			No	Multiple lanes or one lane each way	—	—	×	×	×	×	⊙	×	△		
		Shallow angle	Yes	Multiple lanes or one lane each way	—	—	○	⊙	×	×	×	○	×		△
			No	Multiple lanes or one lane each way	—	—	×	×	×	×	⊙	×	△		
	Snowdrifts & Poor visibility	Perpendicular	Yes	Multiple lanes or one lane each way	—	—	○	⊙	×	×	○	○	×	△	○
			No	Multiple lanes or one lane each way	—	—	×	×	×	×	⊙	×	△		
		Shallow angle	Yes	Multiple lanes or one lane each way	—	—	○	⊙	×	×	×	○	×	△	
			No	Multiple lanes or one lane each way	—	—	×	×	×	×	⊙	×	△		
	Poor visibility	Perpendicular	Yes	Multiple lanes or one lane each way	—	—	○	○	×	×	○	○	×	⊙	○
			No	Multiple lanes or one lane each way	—	—	×	×	×	×	○	×	⊙		
		Shallow angle	Yes	Multiple lanes or one lane each way	—	—	○	○	×	×	×	○	×	⊙	
			No	Multiple lanes or one lane each way	—	—	×	×	×	×	○	×	⊙		

Legend:  
 ⊙: Recommended, in principle.  
 ○: Acceptable, but it is necessary to examine applicability, taking detailed local conditions into consideration.  
 ×: Unacceptable, in principle.  
 △: Acceptable for combined use as a complementary snow-control facility with facilities denoted with ⊙ or ○.  
 —: Acceptable, in principle.

Note: The above table shows standards for selecting blowing-snow control facilities.  
 \* Additionally, road width and presence or absence of median should be taken into consideration.  
 \*\* Maintenance including snow removal at the bottom part is necessary.





**FIGURE 2** Schematic diagram showing the concept of highway snowbreak woods.

1. Chapter 1: General Provisions;
2. Chapter 2: Definition, Characteristics, and Basic Concept of Highway Snowbreak Woods;
3. Chapter 3: Basic Planning of Highway Snowbreak Woods;
4. Chapter 4: Basic Design of Highway Snowbreak Woods;
5. Chapter 5: Detailed Design for Execution of Highway Snowbreak Woods;
6. Chapter 6: Planting Work of Highway Snowbreak Woods;
7. Chapter 7: Growth Management of Highway Snowbreak Woods; and
8. References.

### Standard-Width Woods

Standard-width woods are used as a measure against snowdrifts and visibility hindrance when the maximum amount of snow accumulated in snowdrifts is  $20 \text{ m}^3/\text{m}$  or more. They consist of primary trees intended to enhance snowbreak effects and pioneer trees intended to protect primary trees, and the forest belt width is determined by the maximum amount of snow accumulated in snowdrifts (Table 2). High evergreen needle-leaved trees (e.g., Sakhalin fir, Sakhalin spruce, and Norway spruces) are mainly used as primary trees, and high deciduous broad-leaved trees (e.g., willows) are used as pioneer trees. If the width is 20 m or more, fast-growing deciduous broad-leaved trees can be used as some of the primary trees.

As trees in snowbreak woods grow, the branches on both sides form a thick mass, making it difficult to see into the woods from the roadside and possibly slowing maintenance-related

thinning. As overgrown branches may interfere with the entry of maintenance and control vehicles, the revision specifies the construction of approach roads to snowbreak woods and service roads in standard-width woods with widths of 23.0 m and 32.0 m.

Recent studies have reported poor development of snowbreak woods due to excessive humidity in the growing environment (1). Accordingly, a new chapter on drainage work was included in the revision to give details on requirements for surface drainage, ditches and underdrainage.

A standard figure for planting in standard-width woods was created in conjunction with the changes related to approach roads, service roads, and drainage work (Figure 3). The increased width of woods stemming from the addition of control roads is compensated for by reducing the intervals between rows of trees in such a way that their growth is not inhibited and the overall width of woods remains the same as before.

### Narrow-Band Woods

Narrow-band woods are snowbreak woods with a smaller width. They are used as a measure against visibility hindrance when the maximum amount of snow accumulated in snowdrifts is less than  $20 \text{ m}^3/\text{m}$ , and consist only of primary trees. Low and medium-sized evergreen needle-leaved trees (e.g., Mountain pine and Northern white cedar) are mainly used.

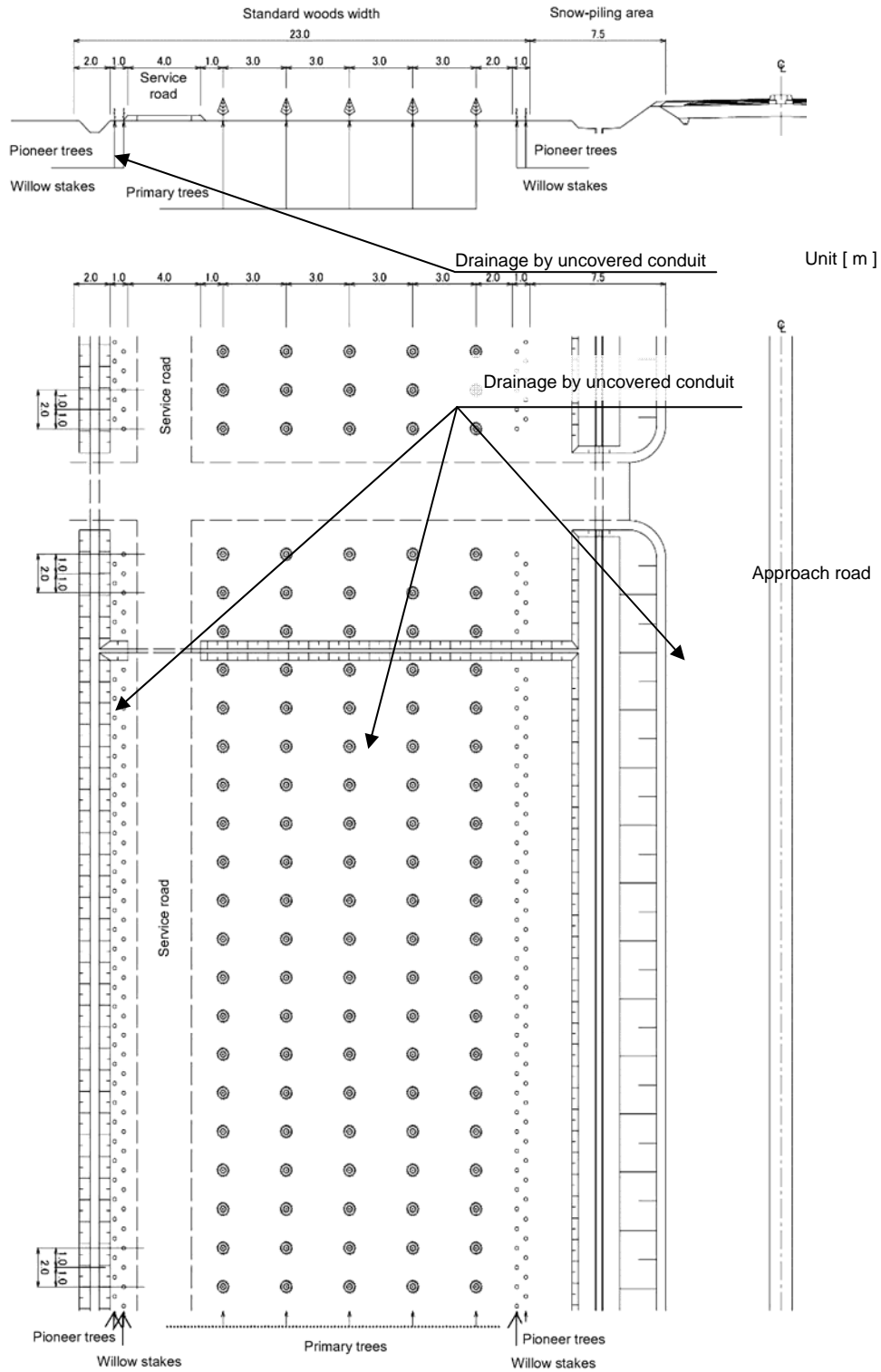
If the branches of adjacent trees in snowbreak woods touch each other as they grow, they may wither as a result of insufficient natural light, and their windbreak function may be reduced (2). As the interval between rows of trees in narrow-band woods is small at 2 m, appropriate maintenance and management is considered more important than for standard-width woods. This revision includes a standard figure showing optimal planting for narrow-band woods and the completed form (Figure 4) to highlight the thinning work required for more reliable maintenance and management as narrow-band woods grow.

### Simple Evaluation of Tree Growth

Management of snowbreak woods requires the handling of living trees. However, it is difficult for most civil engineers to evaluate growth conditions and determine the causes of poor development because such matters are outside their areas of specialization. To address this problem, a table outlining conditions and evaluation of growth in snowbreak woods (Table 3) is included in the revision to show growth conditions in photographs and model maps so that road administrators can evaluate growth conditions more easily. A flowchart for determining the causes of poor development (Figure 5) is also shown to facilitate the swift implementation of related measures as required.

**TABLE 2 Maximum Amount of Snow Accumulated in Snowdrifts and Widths for Standard-Width Woods**

Maximum amount of snow at snowdrifts (annual average)	Width of woods required for snow control
20 to $30 \text{ m}^3/\text{m}$	11.0 m
30 to $50 \text{ m}^3/\text{m}$	23.0 m
$50 \text{ m}^3/\text{m}$ and more	32.0 m



**FIGURE 3** Standard figure for planting in standard-width woods (wood width: 20 m).

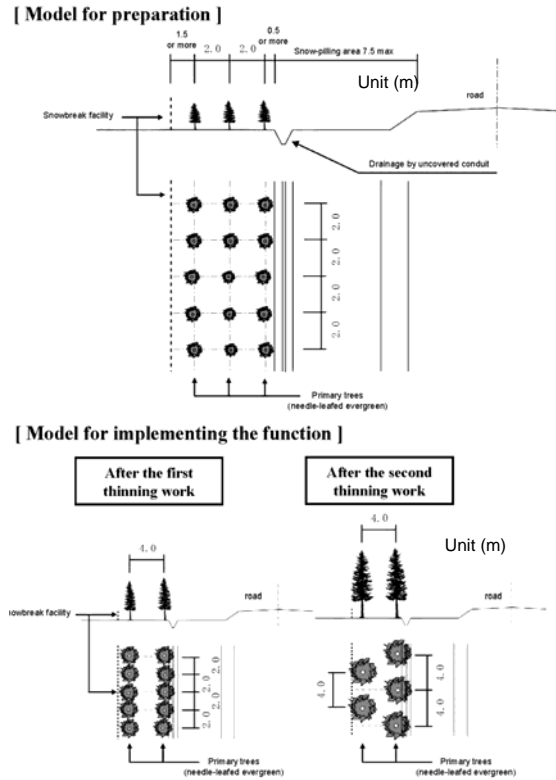
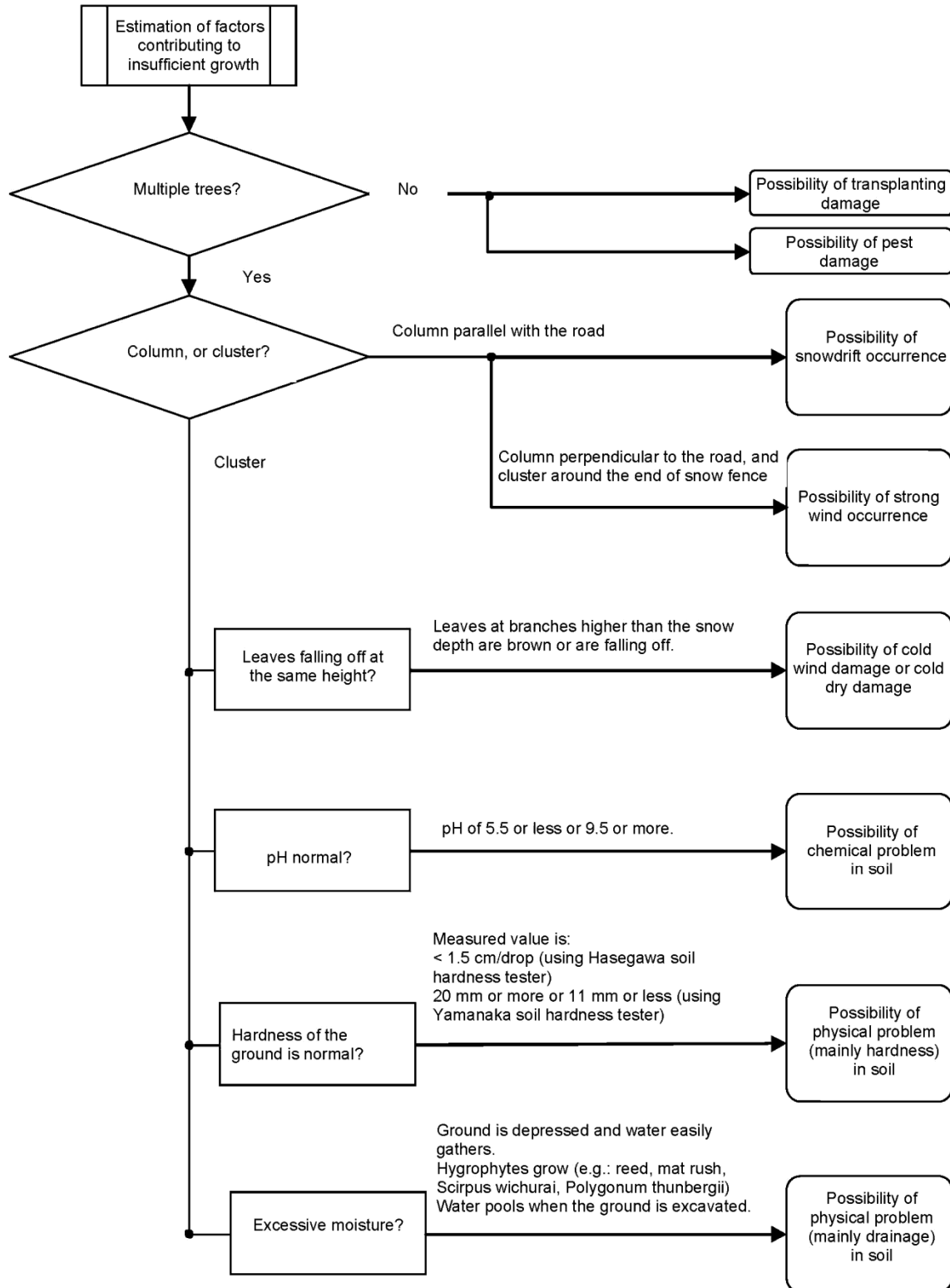


FIGURE 4 Standard figure for planting in narrow-band woods and completed form.

TABLE 3 Growth Conditions of Snowbreak Woods and Related Evaluation (Extract)

Growth rank and Check point	Evaluation	Schematic	Photo
Rank 1 - Growth increase in a year: 15cm or more - Blighted apical or lateral bud on the top?: No - Blighted lateral buds on the upper part?: No - Leaf color: ordinary green to dark green	- Growth is healthy. - Normal maintenance should be conducted.		
Rank 2 - Growth increase in a year: Less than 15cm - Blighted apical or lateral bud on the top?: No - Blighted lateral buds on the upper part?: No - Leaf color: Light green	- Some factors may be hindering growth. - Countermeasures may be necessary, if the leaf color or amount of leaves do not improve for several years.		
Rank 3 - Growth increase in a year: 3 - 5cm - Blighted apical or lateral bud on the top?: Yes - Blighted lateral buds on the upper part?: Yes - New leaves?: Yes - Branch on the upper part of the tree has become a main trunk?: Yes - Leaf color: Light green or light brown	- There has been recovery from transplanting damage - Growth has stagnated. - Countermeasures may be necessary, if the leaf color or amount of leaves do not improve.		
Rank 4 - Growth increase in a year: 0cm - Blighted apical or lateral bud on the top?: Yes - Blighted lateral buds on the upper part?: No - New leaves?: No - Branch on the upper part of the tree has become a main trunk?: No - Leaf color: Light green or light brown	- Blight is regarded as inevitable. In principle, the tree should be replaced.		
Rank 5 - Blighting - New/old leaves?: No (Deemed a blighted tree if a few old leaves remain.)	- If the tree is deemed to be blighted, it should be replaced.		



**FIGURE 5** Flowchart for determining the causes of poor development.

## CONCLUSION

This document outlines the details of snowbreak woods included in the 2011 revision of the *Highway Snow Countermeasure Manual* as technical criteria for blowing-snow control facilities in cold snowy regions of Japan.

In the revision, descriptions of snowbreak woods were changed with focus on the issue of maintenance and management. Methods of assessing the growth of planted trees are also explained, information on service roads and drainage work has been added, standard figures relating to trees have been changed, and a technique for the thinning of narrow-band woods is described.

This manual has been available on the CERI website since March 2011. The English version (an overview) can be found at [http://www2.ceri.go.jp/fubuki\\_manual/index\\_e.html](http://www2.ceri.go.jp/fubuki_manual/index_e.html).

## ACKNOWLEDGMENT

Finally, thanks to the members of the Blowing-Snow Control Measure Investigative Commission for their advice and to the staff of the Hokkaido Regional Development Bureau for their cooperation.

## REFERENCES

1. Civil Engineering Research Institute for Cold Region Snow and Ice Team. Relationship Between Growth of Snowbreak Woods and Physical Conditions of Planting Foundations. *Monthly Report*, Vol. 688, 2010, pp. 2–13.
2. Civil Engineering Research Institute for Cold Region Snow and Ice Team. Effects of Relieving Visibility Hindrance with Highway Snowbreak Woods. *Monthly Report*, Vol. 664, 2008, p. 36.

## BLOWING AND DRIFTING SNOW

**Snow Transport and Mitigation Modeling System  
for Managing Snow Drifting Along Highways****PATRICK GROVER****NEIL HELLAS****STEVEN MCARDLE***4DM Inc., Canada*

**This paper presents an overview of the snow drift and snow barrier modeling tools developed by 4DM over the past 6 years to assist in the mitigation of snow drift issues along Ontario's roadways. A continuous three-dimensional (3-D) snow transport model was developed to simulate snow transport along highways. This model uses a topographically based wind field submodule to account for the effects of terrain on wind speeds. A mass-balance snow transport submodule accounts for various processes such as saltation and turbulent flux, sublimation, melting, accumulation, and hardening of the snow pack. The model uses a description of the vegetated land cover to adjust the threshold shear velocity. The snow transport model results are fed into a snow mitigation model that uses a mass-balance approach to simulate the evolving snow trapping efficiency of snow fences and hedges throughout the winter season. The mitigation model also can simulate the impact of snow ditches and calculate drift profiles created by highway embankments. This numerical model produces more cost-effective snow control solutions since they predict the downwind drift length and reduction of drifting snow produced by different mitigation approaches more accurately than is possible using traditional rule-of-thumb approaches. This paper presents an overview of the development of the modeling system and its theoretical aspects.**

**S**now drifting onto roadways and highways results in decreased road safety and increased winter maintenance costs. The Ontario Ministry of Transportation (MTO) has been actively involved in a variety of programs designed to reduce and manage snow drifting across the provincial highways. This includes educational programs to encourage farmers to install vegetative wind breaks in their fields as well as funding studies of new and existing highways to determine mitigation strategies to prevent blowing snow.

During the 1990s the MTO funded the development of the SNOWDRIFT computer modeling system that was used by highway engineers to design both active (snow fencing, hedges, and ditches) and passive (cross-section profile) treatments for highways in Ontario. In 2000, the modeling system was implemented as an ESRI ArcView extension allowing for extensive visualization and pre- and post-processing functionality (referred to as SNOWDRIFT II) (1).

4DM has used the SNOWDRIFT II model to design active treatments of drifting snow along Highway 115 south of Peterborough, Ontario, and as a tool to assist in a highway safety investigation on Highway 6 near Hamilton, Ontario. From these experiences, 4DM saw the need to develop an enhanced model that would move from the design storm approach used in SNOWDRIFT II to a continuous simulation and improve the algorithms for snow transport and the modeling of snow barriers. In 2008, 4DM Inc., with funding from National Research

Council of Canada's Industrial Research Assistance Program, developed a new snow transport and mitigation model.

The purpose of this paper is to describe the development and application of a continuous time computer model for physically based modeling of snow transport specifically for use in snow drifting studies along highways and roadways. The model has been coupled to a snow mitigation model that is capable of modeling a variety of different snowdrift mitigation strategies.

## MODEL DESCRIPTION

Liston et al. (2) provides a detailed breakdown of recently developed snow transport models. These models fall into two categories: design storm (event-based) models and continuous models designed to simulate entire snow seasons. The different time scales of these two classes can impact the spatial scale of the model as well as the complexity of the underlying modeling of the wind-field dynamics. Event-based models such as the one from Beyers and Waechter (3) can use computational fluid dynamics to model the 3-D wind fields and can work on submeter spatial scales. Continuous models such the SnowTran-3D model (2, 4) and the Prairie Blowing Snow Model (5) work on much larger spatial and temporal scales and tend to make use of simplified wind-field models to incorporate the effects of topography.

Although both classes of models are useful for snowdrift modeling along highways, continuous models offer many benefits. They can be used over large areas and can calculate the snow transport over many snow seasons allowing for proper design of active mitigation solutions such as snow fences, hedges and ditches. A drawback of continuous models is that they need to incorporate additional snow hydrology factors such as snow melt, sublimation, and snow hardening.

The highway snow transport model described in this paper consists of three sub-modules: a meteorological pre-processor, a snow transport model, and a mitigation model. The meteorological model is responsible for processing weather station data and supplying wind, precipitation, and temperature input values to the snow transport model. The snow transport model is a gridded mass-balance model that accounts for the variation of snow depth and transport within each cell in the study area. The mitigation model is used to model the effectiveness of various mitigation strategies including snow fences, snow hedges, and snow ditches.

### Meteorological Preprocessor

The meteorological preprocessor collects and processes meteorological data from weather stations, generates reports on historical snow transport, and provides the atmospheric forcing parameters into the snow transport model.

A user interface has been developed to download daily and hourly weather station data from Environment Canada's website and load the datasets into a common database schema. Tools are provided to perform pre-processing tasks such as reviewing the quality of the datasets, filling gaps, and estimating hourly precipitation from daily values. The preprocessor also offers reporting functionality including the generation of yearly graphs of the winter seasons and estimation of the annual maximum potential snow transport based on the approach



described by Tabler (6). This information assists the analyst in determining typical snow drifting season length and the dominant directionality and variability of the snow transport.

The current meteorological preprocessor is limited in that it can only provide data to the snow transport model from one single weather station. For areas where there is significant topographical variation a lapse rate model is implemented to adjust the temperature based on the current computational cell's elevation.

A topographically based wind model described by Liston et al. (2) was used to efficiently generate realistic wind fields over the study area. This model is based on a set of empirically derived wind speed and direction relationships (7). The wind model uses the first and second derivatives (slope and curvature) of a digital elevation model as well as aspect to develop wind weighting and wind diverting grids. These grids are used to scale the wind speed and direction at each time step.

### **Snow Transport Model**

The operational snow transport model is a two-dimensional mass–balance model that describes the storage and movement of snow throughout the study domain. The snow transport model captures the first-order snow physics (conservation of mass) simulating both the saltation and turbulent suspension modes of snow transport. Elements of the model are based on the SnowTran-3D model described in Liston et al. (2) and Liston and Sturm (4).

#### *Snow Storage Model*

A two-stage snow storage model is used to account for available and non-available snow for transport. Available snow is snow that is available for transport by the wind. Non-available snow is snow that has hardened or formed a crust so that wind shear is no longer able to erode the surface. Newly fallen snow is added to the available snow surface.

Aging of snow—the process where the snow pack and surface begin to harden through wind-induced sintering and bonding between snow particles—is accounted for. A simple time-based aging model was implemented based on the relationship from Jellinek (8) and reproduced in Tabler (9). This model increases the required threshold shear velocity for initiation of snow transport. The aging model also accounts for temperature, whereby the entire available snow is moved to the unavailable snow layer when the temperature rises above 0°C. Snow melt was modeled using the degree–day method and applied to both available and unavailable layers.

#### *Threshold Friction Velocity and Nonerodible Threshold Friction Factor*

The wind blowing over the ground surface imposes a shear stress. The shear stress at the surface,  $\tau_0$ , is typically expressed as the shear velocity  $u^*$  where  $\tau_0 = u^{*2}\rho$  and  $\rho$  is the density of air. For rough turbulent boundary layers, the friction velocity is determined from the logarithmic vertical profile of the wind speed:

$$\frac{u_z}{u^*} = \frac{1}{\kappa} \ln\left(\frac{z}{k}\right)$$

where

- $\kappa$  = Von Kármán's constant (0.4),
- $u_z$  = the wind speed expected at elevation  $z$ , and
- $k$  = the roughness height.

When the wind-shear velocity,  $u^*$  exceeds the threshold shear velocity for the snow surface,  $u^*_{t}$ , the snow surface will begin to erode. The threshold shear velocity for fresh snow was set to a constant (0.2 m/s). More complex methods (10, 11) may be implemented in the future.

Vegetation on the land surface acts to increase the required threshold shear velocity. The approach developed by Gillette and Stockton (12) and Raupach et al. (13) was used to determine a modified threshold shear velocity. They introduced the “threshold friction velocity ratio”  $R_t = u^*_{tS}/u^*_{tR}$ , which is the ratio of the threshold shear velocity for an erodible surface without vegetation ( $u^*_{tS}$ ) to that with roughness present ( $u^*_{tR}$ ). The threshold friction velocity ratio is determined by

$$R_t = \frac{1}{\sqrt{(1 - m\sigma\lambda)(1 + m\beta\lambda)}}$$

where

- $\beta$  = the ratio of the drag coefficient of an isolated roughness element on the surface to the drag coefficient of the erodible surface,
- $\lambda$  = the frontal area index,
- $\sigma$  = the basal-to-frontal area ratio of the roughness elements, and
- $m (< 1)$  = a parameter accounting for differences between the average substrate surface stress and the maximum stress on the surface at any one point.

These factors are calculated for each land cover class in the study area based on the typical height, diameter, and density (elements per hectare) of vegetation. The model accounts for the change in effective height of the elements as the snow depth changes.

### *Saltation and Turbulent Suspension*

Determination of the saltation rate,  $Q_s$ , was determined following the formation from Pomeroy and Gray (14), which first determines the maximum saltation snow transport flux:

$$Q_{s\_max} = \frac{0.68}{u^*} \left( \frac{\rho_{air}}{g} \right) u^*_{t} (u^{*2} - u^{*}_{t}{}^2)$$

This is then modified based on the change in the shear velocity and the incoming saltation transport rate.

Turbulent transport can occur only if saltation is present. The turbulent transport rate is based on Kind (15). The concentration of snow in turbulent suspension is determined by

$$c(x^*, z) = c_r \left[ \left( \frac{\phi^* u^*}{c_r} + 1 \right) \left( \frac{z}{z_r} \right)^{\frac{-s}{\kappa u^*}} - \frac{\phi^* u^*}{c_r s} \right]$$

where  $c_r$  is the mass concentration at reference level  $r$  (usually taken to be the top of the saltation layer),  $s$  is the settling velocity of the snow particles (assumed to be 0.3 m/s), and  $\phi^*$  is a concentration scaling parameter. The concentration is integrated from the saltation height to the maximum turbulent suspension height (a function of wind speed, shear, and settling velocity).

Sublimation of snow particles in saltation and suspension was accounted for by applying a constant sublimation loss factor to all moving snow.

### Sensitivity Analysis

Sensitivity analysis was performed on the model using a flat 25-km x 25-km grid with 25-m cell. The model was run at a 1-h time step for 2 days with a constant 10-m wind speed,  $U_{10}$ , of 30 km/h (8.33 m/s) and an initial snow depth of 20 cm. The theoretical maximum snow transport for an infinite fetch can be estimated from Tabler (16):

$$Q_{0-5} = \frac{U_{10}^{3.8}}{233847}$$

where  $Q_{0-5}$  is the snow transport below 5 m in kg/s. For this experimental setup, the maximum snow transport was found to be 2331.97 kg/m over the 2 days. Results of the analysis are presented in Table 1.

The model was found to be most sensitive to changes to the saltation transport variables; specifically the air density and the threshold shear velocity. Changing the saltation height calculation to use the method described by Pomeroy and Male (17) was also found to have a significant impact on the total snow transport.

### Snow Drift Mitigation Model

The snowdrift mitigation model uses the output of the snow transport model to determine the effectiveness of different snowdrift treatment approaches including snow fences, snow hedges, and snow ditches. The model has the ability to evaluate combinations of treatments (e.g., multiple fences or a fence and ditch). The model also determines the downwind drift length, which is a key design parameter.

The mitigation model uses a mass-balance approach to determine the amount of drifting snow that will reach the roadway. The mass-balance at each time step is calculated as follows:

$$Q_{in}^t - Q_{out}^t = \Delta M$$

The equation states that the difference between the incoming and outgoing snow transport ( $Q$  in kg/m/s) at time step  $t$  is equivalent to the change in the mass of snow captured by the fence.

**TABLE 1 Results of the Sensitivity Analysis**

Category	Parameter	Values Tested	Comment
General	Grid cell size	1, 5, and 25 m	Less than 1% difference in the maximum and mean snow transport.
	Snow Density	80, 100, 120 kg/m <sup>3</sup>	Less than 1% difference in the maximum and mean snow transport.
	Snow roughness	3, 4, 5 mm	4.5% difference in the maximum and mean snow transport.
	Sublimation	0%, 0.1%, and 0.2%	1.5% difference in the maximum and mean snow transport.
Saltation	Air density	0.8, 1, and 1.2 kg/m <sup>3</sup>	±20% change in the maximum and mean snow transport.
	Threshold shear velocity	0.16, 0.2, 0.25 m/s	Lowering the threshold shear by 20% resulted in 1.2% increase the maximum and mean snow transport; however, 20% increase in the threshold shear resulted in a 4% decrease in snow transport.
	Scaling factor	0.005, 0.006, and 0.0075	No change in the maximum and mean snow transport.
Turbulent Transport	Beta	0.4, 0.5, and 0.6	The value of 0.4 resulted in 8.5% increase in the maximum and mean snow transport and 0.6 resulted in 6.5% decrease in the maximum and mean snow transport.
	Settling velocity	0.24, 0.3, and 0.36 m/s	20% decrease resulted in 18% increase in the mean transport, 20% increase resulted in 12% decrease in snow transport.

The incoming snow transport is extracted from the snow transport model at each time step. The change in the mass of snow captured by the snow fence is determined by the instantaneous trapping efficiency of the snow fence at a given time step:

$$\Delta M = \eta_{\text{fence}}^t Q_{\text{in}}^t$$

where  $\eta^t$  is the trapping efficiency of the snow barrier at time  $t$ . The model assumes that suspended snow above the height of the fence cannot be trapped by the fence. The incoming snow transport below the height of the fence is determined using the vertical distribution of snow as a function of wind speed described by Tabler (18).

The trapping efficiency is a function of the ratio between the current cross-sectional area of the drift on the barrier to that of the equilibrium drift. Tabler and Jairell (19) proposed the following relationship:

$$\eta_{\text{fence}}^t = 95\sqrt{1 - (A^t / A_e)^2}$$

where  $A^t$  is the cross-sectional area of the drift and  $A_e$  is the cross-sectional area of the drift at equilibrium.  $A_e$  is assumed to be a function of the fence porosity and the wind attack angle.

The maximum capacity,  $Q_e$ , is based on the porosity of the snow fence:

$$Q_e = (3 + 4P + 44P^2 - 60P^3)H^{2.2}$$

where  $P$  is the barrier porosity,  $H$  is the height of the barrier, and  $Q_e$  is the equilibrium capacity of the barrier in t/m.

The cross-sectional area of the downwind drift will vary with the angle of the wind relative to the alignment of the barrier (20):

$$A'_e = A_e \sin(\alpha)$$

where  $A'_e$  is the modified maximum capacity of the barrier and  $\alpha$  is the wind attack angle relative to the fence.

Once the current cross-sectional area of the snow fence is known, the downwind drift length at the time step can be determined. The mass ratio of the drift downwind of the barrier to the downwind drift mass at capacity is calculated by portioning the current fence storage into upwind and downwind components. The downwind drift length is calculated using the results from Tabler (21).

$$L^t = H(10.5 + 6.6(A^t / A'_e) + 17.2(A_d^t / A'_{e-d})^2)$$

where  $L^t$  is the downwind drift length at time step  $t$ ,  $H$  is the fence height, and  $A_d$  and  $A_{e-d}$  are the downwind accumulation of snow and the downwind maximum capacity. The drift length is then scaled to account for barriers of different porosity.

### *Living Snow Fences*

The approach introduced is general enough to cover all vertical snow barriers as long as the barrier can be characterized by its height and porosity. For living snow fences, the approach described by Tabler (9) for determining the porosity of living snow fences was used. The porosity is determined by calculating the ratio of open space between the individual tree–shrub silhouettes to the total area bounded by the ground and the top of the tree–shrub. The model can simulate seasonal growth of a living fence, allowing the user to examine the changing effectiveness of a living fence over time.

### *Snow Ditches*

Snow ditches are a common solution in Ontario, where limited space along rights-of-way makes installation of fencing difficult due to potential encroachment of downwind drifts onto the roadways. The approach used for modeling of snow ditches is also a mass–balance model. As is the case for snow barriers, the ditch model assumes that  $\Delta M$  is a function of the incoming snow transport and that ditches are only effective at trapping drifting snow near the ground:

$$\Delta M = \eta Q_{in,0-50}$$

where  $\eta$  is the trapping efficiency of the snow ditch and  $Q_{in,0-50}$  is the snow in the bottom 50 cm of the air column. Efficiency is modeled as a function of the vertical attack angle at the lip of the

ditch as determined by Schmidt and Randolph (10). The trapping efficiency is assumed to remain constant until the ditch reaches its capacity, once all incoming snow has been transported downwind.

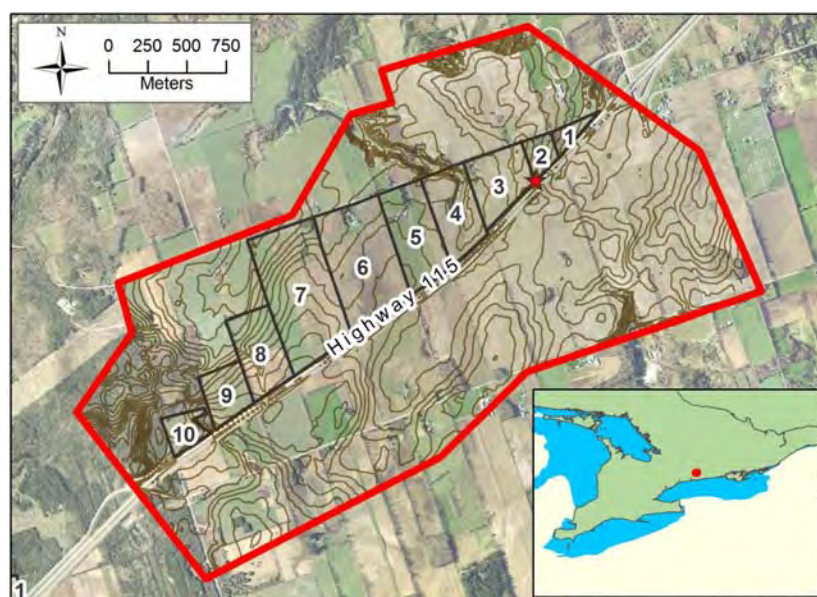
## APPLICATION

The snow transport and mitigation models were applied to a 12 km<sup>2</sup> area in southern Ontario along Highway 115, south of Peterborough. This section of highway has been known to experience problematic snow drifting conditions. 4DM participated in a design review of a 45-km section of the highway in 2006 and was tasked with determining the location of drifting problems and proposing mitigation treatments. During the winter of 2007, 4DM monitored the drift growth rate along the snow fencing in order to generate an estimate of snow transport.

### Description of the Study Area

The study area consists of a number of agricultural fields on either side of the highway with crops of either soy or corn. The crop stubble heights vary from field to field, a significant fact since this variable is known to have a significant impact on the amount of snow transport. The topography is varied with a total elevation change of 50 m with a general slope to the north. The highway runs along an elevated ridge that runs approximately north–northeast. Large drifts have been found to accumulate along both sides of the highway, where steep embankments exist (Figure 1).

The ground cover for each agricultural field identified in Figure 1 is described in Table 2. The highway is oriented in a west–northwest direction. The dominant snow transport direction is from the west thus the snow fencing was installed oriented north–south.



**FIGURE 1** Topography within the study area with 2-m contours. Red star signifies observation of historically most significant snow drifting.

## Meteorological Conditions

Climate data was collected from two Environment Canada weather stations: Peterborough automated weather observing system (AWOS) and Tapley. Peterborough AWOS reports daily and hourly temperature, precipitation, and wind data. The Tapley weather station collects daily precipitation such as rainfall, snowfall, and snow-on-ground measurements. The Tapley and Peterborough AWOSs are located 2 and 10 km from the study area, respectively. [Figure 2](#) shows the minimum, mean, and maximum daily temperatures recorded at Peterborough and the snow-on-ground measurements from Tapley. The graph shows continuous snow coverage and below-freezing conditions from the middle of January to the middle of March. This period is defined as the snow accumulation season, or the period during which snow drifts are most likely to form along the snow fencing.

## Wind Analysis

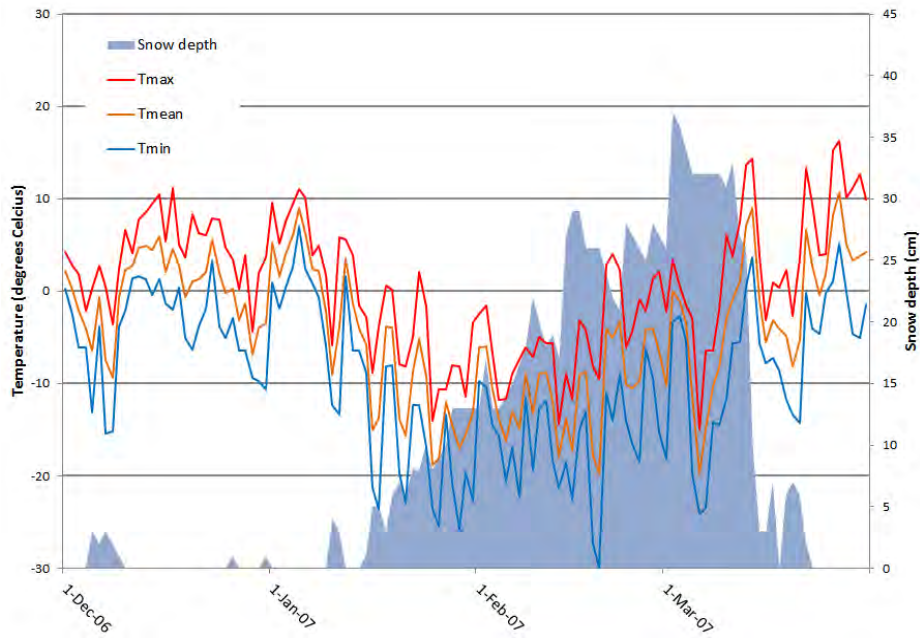
The wind frequency and potential snow transport (PST) distributions for the 2007 snow accumulation period as measured at Peterborough Airport are shown in [Figure 3](#). The wind frequency distribution shows that the westerly winds are the most frequent and the strongest with 47.4% of wind frequency between west–southwest to west–northwest. Seventy-five percent of the PST originated between the west–southwest and west–northwest directions.

## Snow Transport Modeling Results

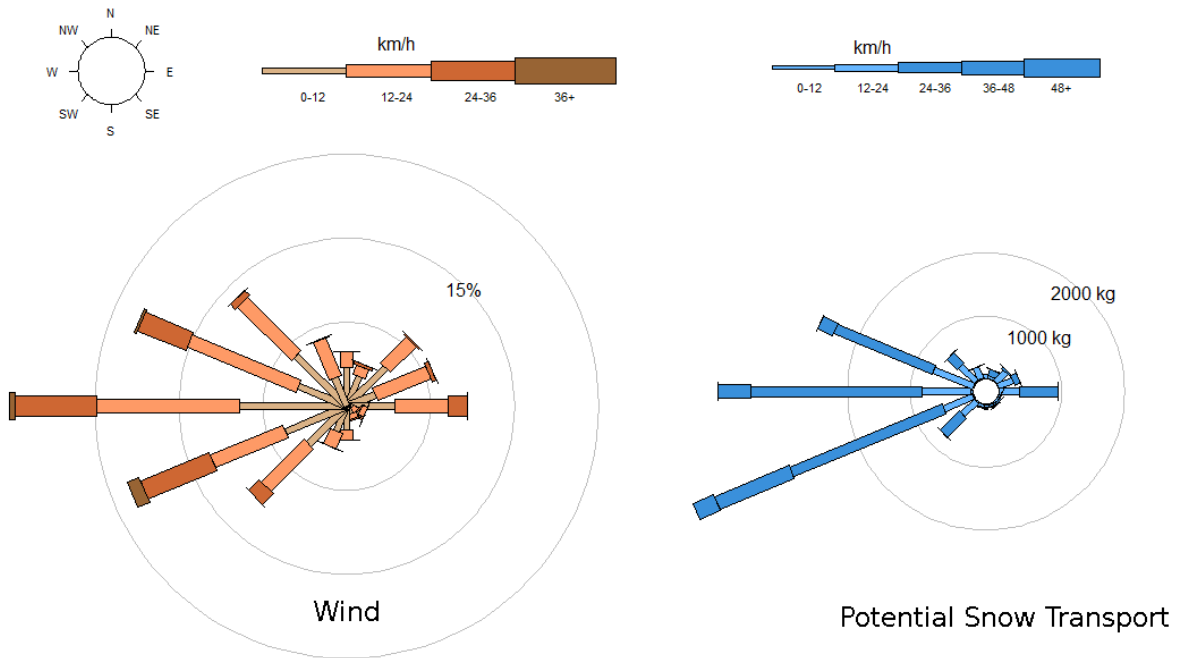
The modeled cumulative snow transport for the snow accumulation period over the study area is shown in [Figure 4](#). Estimated, cumulative snow transport ranges between 10,000 to 15,000 kg/m in the agricultural fields located along the north side of the highway, but values are much lower in forested sections.

**TABLE 2 Field Conditions, 2007**

Field	Condition
1	Uncut tall grass
2	Uncut tall grass: no fencing installed
3	Corn (unharvested): no fencing installed
4	Soy (unharvested)
5	Harvested soy
6	Harvested corn
7	Harvested corn–soy
8	Harvested soy
9	Harvested soy
10	Uncut tall grass

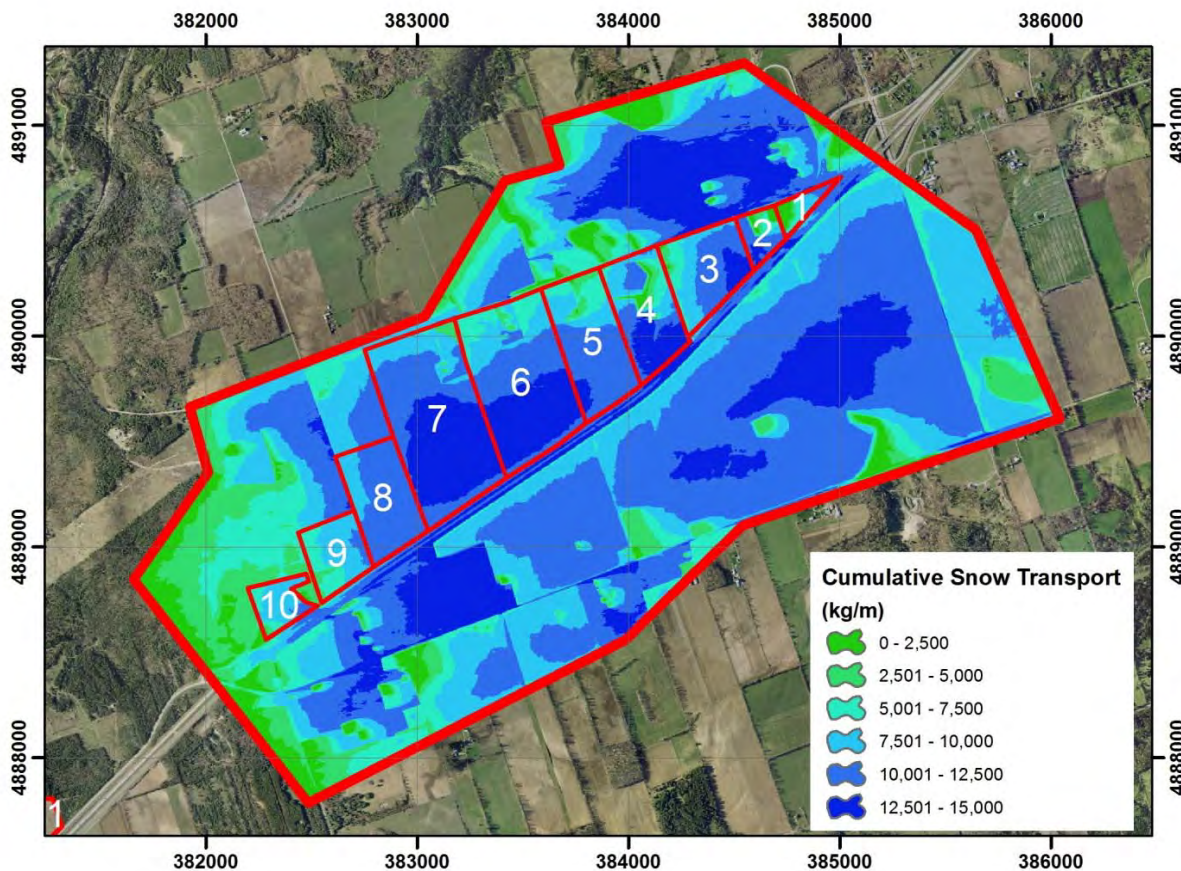


**FIGURE 2** Temperature and snow cover data for the 2006–2007 winter season recorded at Peterborough AWOS and Tapley weather stations.



**FIGURE 3** Wind frequency and potential snow transport at Peterborough over the 2007 snow accumulation season.





**FIGURE 4** Cumulative snow transport over the study area.

### Snow Mitigation Modeling Results

The effect of snow fencing was modeled using the output from the snow transport model for specific locations along the north side of the highway where the snow fencing had been installed; 1.2-m fences were modeled in a north–south orientation with 40% porosity to simulate fences that had been installed in those fields. A number of outputs were used for evaluating snow fence performance and design requirements, including the total trapped mass of snow, the trapping efficiency (mass of snow trapped relative to the total incoming snow flux), and the tail drift length (Table 3).

The drift lengths vary from 19.7 to 23 m for the fields for which the model had predicted the most snow drifting (fields 4, 5, 6, 7, and 8). The overall trapping efficiency is predicted to be fairly consistent between the fields and ranges from 69% to 73%. The instantaneous trapping efficiency of a snow fence remains fairly high (60% to 90%) until it reaches about 80% of its total trapping capacity (approximately 12,000 kg/m).

**TABLE 3 Snow Mitigation Model Results for the 2007 Winter Season**

	<b>Average Drift Length (m)</b>	<b>Average Tail Mass (kg/m)</b>	<b>Average Total Mass (kg/m)</b>	<b>Average Trapping Efficiency</b>
Field 2	21.1	5164.1	7571.2	74%
Field 3	20.7	5015.7	7308.8	71%
Field 4	23.0	5785.5	8340.0	69%
Field 5	20.8	5100.9	7501.3	70%
Field 6	21.2	5214.0	7667.7	71%
Field 7	21.0	5147.2	7569.4	70%
Field 8	19.7	4710.8	6927.6	71%
Field 9	15.8	3113.0	4578.0	73%

### Comparison with Observed Drifting Conditions

Three field trips were made to the study area in 2007 to collect information on snowdrift growth along the snow fencing and snow-in-field conditions. Observations of the size of drifts formed along the snow fencing within each field allowed for a qualitative estimation of the snow transport within the field. In fields where no snow fencing was installed the area was inspected for other signs of drifting such as the depth of snow in the field and the presence of drifts formed around vertical obstructions or along the roadside embankments. Measurements and observations of the drift dimensions at representative snow fences were taken within fields 5, 6, and 7. This information was compared with the estimates of snowdrift dimensions determined by the snowdrift mitigation model (Table 4).

Comparing the observations in Table 4 with the predicted snow transport in Figure 4 researchers see that the model did correctly identify that the heaviest drifting would occur in fields 5 to 7. It also reasonably estimated that fields 8 to 10 would experience less drifting than the other fields. The model appears to have over-predicted the snow transport that occurred in fields 1 to 4. In these fields, especially field 3, which contained unharvested corn, minimal snow

**TABLE 4 Observed Snow Drifting Conditions**

<b>Location</b>	<b>Observed Drifting</b>	<b>Drift Length</b>		<b>Tail Mass</b>	
		<b>Measured (m)</b>	<b>Modeled (m)</b>	<b>Measured (m)</b>	<b>Modeled (m)</b>
Field 1	Negligible				
Field 2	Negligible				
Field 3	Negligible				
Field 4	Negligible				
Field 5	Large drifts on fencing	15.8	20.9	2,621	5,113
Field 6	Medium drifts on fencing	11.4	21.2	963	5,211
Field 7	Small drifts (north end) Large drifts (south end)	14.1	21.0	2,221	5,146
Field 8	Medium drifts on fencing				
Field 9	Small drifts on fencing				
Field 10	Small drifts on fencing				

transport would occur. This likely indicates a problem with the calibration of the field roughness parameters. The model correctly predicts that there will be lower snow transport in the forested areas north of field 10. However, it still is predicting an unacceptably high value.

The geometry of the snow drifts formed along the snow fences in the study area were skewed to the south indicating that the actual primary snow transport direction was from a north-westerly direction. The drift tail mass was estimated using measurements of the downwind tail length and maximum drift height as well as the density of snow, calculated based on the average drift height,  $Y_{\text{avg}}$  (9):

$$\rho_s = 522 - \left[ \frac{304}{1.485Y_{\text{avg}}} \right] \left[ 1 - e^{-1.485Y_{\text{avg}}} \right]$$

The results show that the snowdrift model over-predicted both the drift tail length and mass. The differences between the predicted and observed values can be explained by a number of factors, including bias in the meteorological data and the limitations of the snow transport model and snow mitigation models.

Collection of accurate meteorological data, especially wind speed and direction on site, is highly desirable but not always feasible. Using the wind data recorded at the Peterborough Airport the dominant snow transport direction was determined to be from the west. However, the geometry of the drifts on the snow fences (installed north–south) suggested that the dominant transport direction was from the north-west, an attack angle of almost 45°. Tabler (21) concluded from empirical studies he conducted that the downwind drift as measured perpendicular to the snow fence decreases in proportion to the sine of the attack angle. Therefore, the actual drift length perpendicular to the assumed dominant transport direction of 45° would be 19.6, 14.1, and 17.5 m for fields 5, 6, and 7, respectively. This highlights a need for more advanced methods for extrapolation of meteorological data to account for spatial variability.

As previously discussed, the snow transport model appeared to underpredict the snow transport in some locations and overpredict in others. It is felt that this is mostly due to incorrect specification of the surface roughness parameters. Further calibration of the model is recommended to generate more realistic estimates of snow transport.

The snow mitigation model is limited in that it does not account for melting, compaction, or sublimation processes. Since snow is not removed from the drift this can lead to an over prediction of the drift length and mass. However since snow drift length is a key factor for determining the minimum setback distance from the roadway, this introduces a factor of safety.

## CONCLUSIONS

A physically based snow transport model suitable for estimating blowing and drifting snow along highways has been developed. The model is able to capture the physics of snow transport in both the saltation and turbulent suspension modes. A physically based roughness model is used to account for the distribution of the shear between erodible (snow) and non-erodible elements. The model can be run continuously over many winters to better quantify the extent of the problem and identify and rank drift prone areas.

The output of the snow transport model has been coupled to a snow mitigation model which is capable of modeling commonly implemented snowdrift mitigation strategies. The

model enables the user to compare the effectiveness of different approaches and provides the output required to properly design and implement treatments.

The model has a number of advantages compared with previous approaches for evaluating and designing snowdrift mitigation strategies, including

- Providing a mechanism for identifying and ranking drift-prone sections,
- Being able to examine the year-to-year variability of snow drifting problems,
- Reducing the need for local calibration due to its physically-based nature,
- Having the capability to perform different mitigation strategies can be quickly compared, and
- Being able to produce less conservative designs compared to rule-of-thumb approaches for determining setback distance of snow fences from roadways.

## ACKNOWLEDGMENTS

The National Research Council of Canada's Industrial Research Assistance Program provided support for the development of the model. Max Perchanok of the Ontario Ministry of Transportation provided expert advice on the application of the model to provincial highway winter safety studies. Their assistance and contributions are acknowledged and appreciated.

## REFERENCES

1. Ontario Ministry of Transportation. *SNOWDRIFT V2 Extension for ArcView 3.x Snow Drifting Simulation Program*. [www.xfer.mto.gov.on.ca/PTASapps/index.htm](http://www.xfer.mto.gov.on.ca/PTASapps/index.htm). Accessed Oct. 25, 2011.
2. Liston, G. E., R. B. Haehnel, M. Sturm, C. A. Hiemstra, and S. Berezovskaya. Simulating Complex Snow Distributions in Windy Environments Using SnowTran-3D. *Journal of Glaciology*, Vol. 53, No. 181, 2007, pp. 241–256.
3. Beyers, M., and B. Waechter. Modeling Transient Snowdrift Development Around Complex Three-Dimensional Structures. *Journal of Wind Engineering and Industrial Aerodynamics*, Vol. 96, No. 10–11, 2008, pp. 1603–1615.
4. Liston, G. E., and M. Sturm. A Snow-Transport Model for Complex Terrain. *Journal of Glaciology*, Vol. 44, No. 148, 1998, pp. 498–516.
5. Pomeroy, J. W., P. Marsh, and D. M. Gray. Application of a Distributed Blowing Snow Model to the Arctic. *Hydrological Processes*, Vol. 11, No. 11, 1997, pp. 1451–1464.
6. Tabler, R. D. *Safety Improvement Study: Interstate 80 Mile 324-335, Final Report*. Agreement No. 54839. Transportation Commission of Wyoming, 2002.
7. Ryan, B. C. A Mathematical Model for Diagnosis and Prediction of Surface Winds in Mountainous Terrain. *Journal of Applied Meteorology*, Vol. 15, No. 6, 1977, pp. 571–584.
8. Jellinek, H. H. G. *Research Report 34: Compressive Strength Properties of Snow*. U.S. Army Snow Ice and Permafrost Establishment, 1957.
9. Tabler, R. D. *Controlling Blowing and Drifting Snow with Snow Fences and Road Design, Final Report*. NCHRP Project 20-7(147). NCHRP, Transportation Research Board of the National Academies, 2003.
10. Schmidt, R. A., and K. L. Randolph. Predicting Deposition of Blowing Snow in Trenches from Particle Trajectories. Presented at the Western Snow Conference, St. George, Utah, April 14–16, 1981.

11. Li, L., and J. W. Pomeroy. Estimates of Threshold Wind Speeds for Snow Transport Using Meteorological Data. *Journal of Applied Meteorology*, Vol. 36, No. 3, 1997, pp. 205–213.
12. Gillette, D. A., and P. H. Stockton. The Effect of Nonerodible Particles on Wind Erosion of Erodible Surfaces. *Journal of Geophysical Research*, Vol. 94, No. D10, 1989, pp. 12885–12893.
13. Raupach, M. R., D. A. Gillette, and J. F. Leys. The Effect of Roughness Elements on Wind Erosion Threshold. *Journal of Geophysical Research*, Vol. 98, No. D2, 1993, pp. 3023–3029.
14. Pomeroy, J. W., and D. M. Gray. Saltation of Snow. *Water Resources Research*, Vol. 26, No. 7, 1990, pp. 1583–1594.
15. Kind, R. J. One-Dimensional Aeolian Suspension Above Beds of Loose Particles—A New Concentration-Profile Equation. *Atmospheric Environment*, Vol. 26A, No. 5, 1992, pp. 927–931.
16. Tabler, R. D. Snow Fence Guide. SHRP, National Research Council, Washington, D.C., 1991.
17. Pomeroy, J. W., and D. H. Male. Steady-State Suspension of Snow. *Journal of Hydrology*, Vol. 136, 1993, pp. 275–301.
18. Tabler, R. D. Snow Transport as a Function of Wind Speed and Height. Proc., Cold Regions Sixth International Specialty Conference TCCP/ASCE, Feb. 26–28, 1991, West Lebanon, N.H.
19. Tabler, R. D., and R. L. Jairell. Trapping Efficiency of Snow Fences and Implications for System Design. *Transportation Research Record 1387*, TRB, National Research Council, Washington D.C., 1993, pp. 108–114.
20. Tabler, R. D. *Snow Fence Handbook (Release 1.0)*. Tabler and Associates, Laramie, Wyo., 1986.
21. Tabler, R. D. Geometry and Density of Drifts Formed by Snow Fences. *Journal of Glaciology*, Vol. 26, No. 94, 1980, pp. 405–419.

## BLOWING AND DRIFTING SNOW

**Operational Blowing Snow Modeling**  
*Benefits for the End User***LEON F. OSBORNE, JR.****BENJAMIN W. HERSHEY****JOHN J. MEWES***Meridian Environmental Technology, Inc.*

Wintertime precipitation presents a maintenance decision maker with challenges on how to address the varying road conditions that inevitably occur. Many locations that respond to snow and ice also undergo excessive high wind conditions resulting in blowing snow. Along with freezing rain, blowing snow conditions can strike fear into any maintenance decision maker on how best to address blowing snow effects and whether chemical treatments are required. The need to know when blowing snow will be affecting the roadway, including timing and severity of the event, is critical for the maintenance decision maker. The process of modeling blowing snow within the roadway presents many challenges. These challenges include the ability to effectively determine the snow pack characteristics (e.g., snow pack surface tension, snow pack temperature, snow depth, snow age, and more), the analysis of weather conditions along the roadway, and surrounding roadway vegetation contributing to snow fetch distance. The use of snow pack model data allows for an assessment of snow pack conditions, depth, and temperature. This information is then integrated to provide locations where snow may be affected by the wind and to an extent given in snow mass flux. Once an analysis of snow pack conditions has been determined and route-specific weather information is integrated into the model, a forecast of blowing snow conditions can be produced on a route-by-route basis. This information is valuable to winter maintenance decision makers in the field. However, a mechanism for conveying this information is critical for reviewing and assessing the future risk. The integration of blowing snow information into a maintenance decision support system (MDSS) provides the needed integrated interface for users to access the information. The MDSS can provide users a route-by-route visualization of blowing snow risk along with the severity of the alert that will be affecting the roadway for an extended period into the future. The blowing snow model also provides MDSS information about blowing snow risks, which allows the system to provide precautionary recommendations to maintainers. This information can be invaluable when weather conditions, other than wind, seem to be mundane and nonthreatening, but blowing snow may still present serious maintenance issues. In this paper and presentation the modeling aspects of the blowing snow model will be presented and discussed. The integration of observations and model data will demonstrate how this integration is brought to the route level. A demonstration and case study approach will be shown on how the blowing snow model provides MDSS the information needed to alert maintenance managers of possible issues that may occur due to blowing snow. Also, information will be presented on the effectiveness of the model to assist MDSS in the suppression of deicing chemical when blowing snow is a concern on the roadway.



# **Winter Mobility and Maintenance Performance**





## WINTER MOBILITY AND MAINTENANCE PERFORMANCE

**Quantifying the Mobility Effects of Winter Snow Events  
and the Benefits of Winter Road Maintenance****GARRETT DONAHER****LIPING FU****TAIMUR USMAN***University of Waterloo***MAX S. PERCHANOK***Ontario Ministry of Transportation*

A number of past studies have attempted to quantify the impact of winter snow events on highway mobility in terms of traffic volume, speed, and capacity. While consistent in their general findings, these studies have shown considerably different results in terms of effect size and contributing factors. More importantly, most of these efforts have not been able to capture the effects of winter maintenance operations on mobility or isolate them from those of snow event characteristics, rendering their results and the proposed methods of limited use for estimating the benefits of maintenance activities. This research attempts to address this issue through a statistical analysis of a data set that is unique in terms of spatial and temporal coverage and data completeness. The data set includes event-based observations of road weather and surface conditions, maintenance operations, traffic volume and speed, as well as several other measures from 21 highway routes over a period of three years. A matched-pair technique was employed to determine the changes in traffic volumes and speeds under matched conditions with and without snow events. A regression analysis was subsequently performed to relate the changes in traffic volume and speed over an event to various contributing factors such as highway type, snow event characteristics, and road surface conditions. A case study was conducted to illustrate the application of the developed models for quantifying the mobility impact of road surface condition and the mobility benefit of winter maintenance operations.

The benefits of winter road maintenance (WRM) services are intuitively clear to most people. They keep roadways in safe and reliable driving conditions; they minimize the weather-induced disruptions to people's daily lives. They ensure that emergency services are continually delivered where and when needed. Moreover, they enable sustained health of modern society and productivity of the economy.

However, what is not clear is the magnitude of these benefits. How much safer can WRM operations make a roadway? How much travel time can be saved with WRM? What is the effect of WRM on people's travel decisions? What is the end economic value of WRM?

Many attempts have been made in the past to address some of these questions related to the safety and mobility benefits of WRM (1–5). Most past efforts have however focused on the safety related issues and benefits (6, 7). In contrast, only a few studies have been conducted on the impact to highway mobility resulting from winter storms. Furthermore, for the few limited efforts the focus has been on the effects of various atmospheric factors with little consideration

on the effect of WRM. As a result, there is a lack of general methodologies or reliable models that can be used to quantify the mobility effects of winter storms and benefits of WRM.

Without sound benefit-estimation methods, WRM cannot be placed within the same framework for the assessment of other types of transportation investments such as construction of new roads and rehabilitation and maintenance of the existing roads, and receive the funding priority that it warrants. This knowledge gap makes it difficult to develop communication materials to convey the justification for consistent and adequate funding for winter maintenance operations.

The objective of this research is twofold. First is to quantify the mobility impact of winter storms in terms of impact to volume and speed. Second is to quantify potential mobility benefits of WRM activities.

This study makes use of a data set that comprises atmospheric, road surface, and traffic conditions at 21 highway sites throughout Ontario, Canada, for over 4,800 site–event pairs. Volume and speed effects are the focus of this study. Using this event-based data set, a regression analysis estimates average reduction in volume and median speed over the course of a snow event as a function of temperature, wind speed, visibility, total precipitation over the event, road surface index (RSI), and time of day. While the bulk of the data includes only free-flow conditions, some events do contain data that spans congested conditions.

## LITERATURE REVIEW

Several past studies have investigated the relationship between winter weather and highway volume or speed. Hanbali and Kuemmel (1), in a study of 11 rural and suburban highways in the United States, found weekday volumes fell between 7% and 53% depending on snowfall amount. Knapp et al. (5) identified a relationship between snowfall amount, the speed of wind, and reduction in traffic volume. In that study, each additional inch of snowfall correlated to a drop of about 2.3% in traffic volume. Kumar and Wang (8) studied two rural highways in Oregon and found that rain and snow events reduced traffic volume by 2% to 7%, but with a large variability. Datla and Sharma (9), using a data set from Alberta, Canada, that spanned 11 years found volume reductions between 7% and 51% depending on snowfall amount. None of these studies included road surface condition (RSC) as a contributing factor to volume reduction.

Liang et al. (10) found a reduction in speed of 18.13% due to snow based on data collected over one winter season in Idaho. That study also included a regression analysis that included visibility, wind speed, temperature, time of day, and a binary variable for RSC. The regression found a 3.5-km/h reduction in average speed when the road surface was covered in snow. In the study by Knapp et al. (5) found a reduction of speed of 16% due to winter storms. The regression in Knapp et al. (5) also used a binary variable for road condition and found a 7.23-mph (11.57-km/h) average speed reduction when the road surface was snow covered. Agarwal et al. (11) found an average speed reduction of 11% to 15%. Kumar and Wang (8) identified a 6% to 11% reduction in average speed due to snow events on three rural highways in Montana.

There is general agreement in the literature that winter weather conditions, particularly snowfall have an impact on highway volume. Assuming that the highways studied, which were primarily rural in nature, were not experiencing capacity constraints, the most obvious rationale

is that during snow events people choose to shift their travel to another time or cancel their trip entirely. No correlation has yet been shown in the literature between volume and RSC.

Again, there is general agreement in the literature that winter weather and RSC have an effect on average travel speeds. However, the effect of RSC has been limited to a binary variable describing only if a highway is snow covered or not.

## DESCRIPTION OF DATA

### Study Sites

Twenty-one maintenance patrol routes were selected from different regions of Ontario, Canada, as shown in Figure 1 (different line colors serve only to facilitate differentiation of patrol routes). These sites were selected based on traffic, weather, and RSC data availability. The selected road sections belong to different highway classes, including low-volume rural two-lane sections through to high-volume multilane urban freeways.

### Data Sources

Data spanning three winter seasons (2003–2006) were obtained from different sources. A description of each data source is given in the next section.



**FIGURE 1** Study sites.

### *Road Weather Information System Data*

The 21 study sites selected all have at least one road weather information system (RWIS) station installed along the route, which provides real-time climatic data such as temperature, precipitation type, visibility, wind speed, and RSC. All data except precipitation were available on an hourly basis. Hourly precipitations from RWIS sensors were either not available or unreliable. As a result, the precipitation information is derived from the daily precipitation amount reported by Environment Canada (EC). RWIS stations record data every 20 min. Data from 45 RWIS stations were used in this research. When there was more than one station covering a maintenance route, average values from all the stations were used.

### *Environment Canada Data*

Weather data from EC includes temperature, precipitation type and intensity, visibility, and wind speed. With the exception of precipitation intensity, all data given are in an hourly format. Data from most EC stations were incomplete; for this reason, EC data were obtained from 217 stations for the study routes. This data set was processed in three steps. In the first step, a 60-km arbitrary buffer zone was assumed around each route and all stations within this boundary were assigned to the particular route. In the next step, EC stations near the routes were identified and filtered based on a *t*-test to remove EC stations that showed significantly different weather. In the last step, data from different EC stations around a route were converted into a single data set by taking their arithmetic mean. It was found that arithmetic means provide better results than weighted averages.

### *Road Condition Weather Information System Data*

Data on road surface conditions and maintenance activities were extracted from MTO's road condition and weather information system (RCWIS). RCWIS contains information about road surface conditions, maintenance operations, precipitation type, accumulation, visibility, and temperature. The data in RCWIS are collected by MTO and contract maintenance personnel who patrol the maintenance routes during snow events, three to four times on the average. Information from all patrol routes is conveyed to a central system six times a day. One of the most important pieces of information in this data source is the description of the overall road surface conditions of the highway section at the time of observation. This description is used as a basis for determining a scalar variable called RSI as described in the section Data Processing.

### *Traffic Volume Data*

The data on the response variables of researchers' main concern, namely traffic volume and speed, were obtained from MTO's permanent data collection stations (PDCS). The original PDCS data included traffic counts and binned speed measurements for each lane over each hour. The binned speed measurements cannot be used to obtain a good estimate on the average hourly speed because of the large bin size at the low speed range (e.g., the lowest speed bin is from 0 to 60 km/h). For this reason, the sample median speed is estimated from the binned speed measurements and is used as the response variable for evaluating the effect on speed in the

subsequent analysis. It should be noted that the mean speed should be close to the median speed because traffic speed commonly follows a symmetrical distribution.

## Data Processing

The data obtained from all the data sources were subsequently processed, screened, and converted to hourly data records. RSC is an important variable in this research, representing the joint effect of weather, winter road maintenance, and traffic. As described previously, the raw data on RSC are from patrol reports, which are descriptive in nature including seven major categories and 486 subcategories. This variable was therefore mapped into a continuous road surface index. The resulting RSI decreases with increasingly difficult operating conditions as shown in Figure 2. A detailed description on the rationale behind this mapping is given in Usman et al. (6).

All the data sources except traffic data were then combined to form an integrated data set for each site treating location, date, and time as the common basis for merging. In the next step data from all the sites were pooled into a single dataset with each site assigned a unique identifier (site-specific variables) to retain its identity.

The lane traffic volumes and speeds were aggregated into hourly volumes and median speeds by direction and then merged with the atmospheric and surface condition data set. Snow events were then identified and the hourly data were subsequently merged into an event-based data set by highway and by direction (6), which yielded 4,822 records of directional highway-event pairs. This data set is directly used for traffic speed analysis. For traffic volume analysis, however, the total traffic volume of a highway over an event is considered. As a result, the data set is further aggregated to form a non-directional data set, including 2,411 records (Table 1).

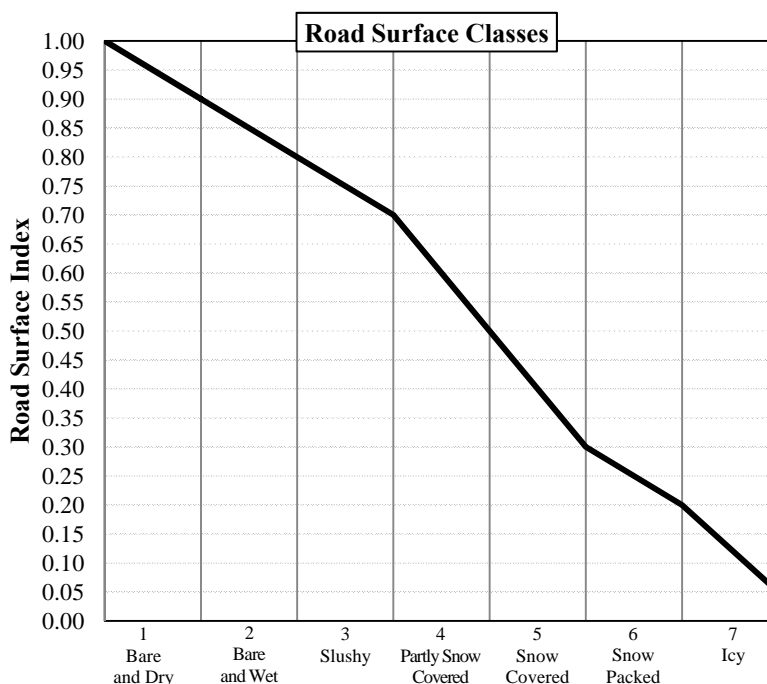


FIGURE 2 RSI for different RSC classes.

For each snowstorm in the event data set described previously, the same period (day of week and time of day), a week either before or after the snow event, is identified as the control of the analysis. The control period must have normal road weather condition with good road surface conditions (RSI >0.9). In case a control period could not be identified for a given event, the event was dropped from the analysis. Tables 2 and 3 give the summary statistics of the two data sets.

**ANALYSIS AND RESULTS**

A regression analysis was performed on the event-based data sets described in the previous section. Separate models were developed for both traffic volume and median speed based on different assumptions on their distributions as described below.

**Model for Traffic Volume**

Traffic volume on highways generally varies over space and time due to the inherent variation in the decisions made by individual travelers. For the same reason, traffic volume also varies randomly, that is, different volumes could be observed by the same time of day, day of week and month, and under the external conditions (e.g., weather). The randomness of traffic counts can be captured reasonably by Poisson distribution. Let  $Y_{h,k}$  represent the total traffic volume on highway  $h$  over a given snowstorm  $k$ . Assume  $Y_{h,k}$  follows a Poisson distribution with its mean,

**TABLE 1 Characteristics of Volume Analysis Dataset (2,411 Observations)**

Variables	Min.	Max.	Avg.	St. Dev.
Temperature (°C)	-29.99	5.00	-4.519	4.886
Wind Speed (km/h)	0.00	60.50	12.849	8.876
Visibility (km)	0.00	26.82	10.478	6.944
Total Precipitation (cm)	0.00	40.00	2.341	3.161
RSI	0.12	1.00	0.761	0.156

Site 1	4%	Site 12	5%
Site 2	3%	Site 13	4%
Site 3	5%	Site 14	8%
Site 4	5%	Site 15	4%
Site 5	6%	Site 16	4%
Site 6	4%	Site 17	2%
Site 7	3%	Site 18	5%
Site 8	9%	Site 19	5%
Site 9	5%	Site 20	4%
Site 10	5%	Site 21	3%
Site 11	5%		

**TABLE 2 Characteristics of Median Speed Analysis Dataset (4,822 Observations)**

Variables	Min.	Max.	Avg.	St. Dev.
Temperature (°C)	-29.99	5.00	-4.464	4.878
Wind Speed (km/h)	0.00	60.50	12.991	8.856
Visibility (km)	0.00	26.82	10.488	6.941
Hourly Precipitation (cm)	0.00	13.80	0.503	0.761
RSI	0.12	1.00	0.763	0.156
V/C	0.00023	0.35189	0.046	0.060

Posted Speed Limit (80 km/h)	33%
Posted Speed Limit (90 km/h)	35%
Posted Speed Limit (100 km/h)	31%

Site 1	4%	Site 12	6%
Site 2	3%	Site 13	5%
Site 3	6%	Site 14	9%
Site 4	5%	Site 15	5%
Site 5	7%	Site 16	5%
Site 6	5%	Site 17	2%
Site 7	3%	Site 18	3%
Site 8	10%	Site 19	3%
Site 9	6%	Site 20	2%
Site 10	6%	Site 21	2%
Site 11	5%		

NOTE: V/C = volume-to-capacity ratio.

denoted by  $Q_{h,k}$ , being a function of some independent variables, representing factors such as highway characteristics and road weather conditions. The relationship between  $Q_{h,k}$  and the influencing factors is assumed to take the form shown in Equation 1.

$$\ln(Q_{h,k}) = \ln(\bar{Q}_{h,k}) + \beta_0 + \text{Site}_h + \sum \beta_i x_{k,i} \quad (1)$$

where

$\bar{Q}_{h,k}$  = An offset term representing the expected total traffic volume for the event period if the event had not occurred. This value is approximated using the observed traffic volume for the same period one week before or after the event day, as discussed previously.

$x_{k,i}$  = Attribute related to weather and road conditions.

$\text{Site}_h$  = Constant term that varies by site.

Equation 1 can be calibrated using Poisson regression with the data set described in the previous section. The independent variables tested for significance include temperature (°C), wind speed (km/h), visibility (km), total precipitation over the event (cm), RSI (unitless), and site variation indicators (binary variable).



After testing a variety of options, it was found that all variables except temperature were statistically significant in improving the explanatory power of the traffic volume model. The final regression result that was found to best fit the full data set is given in along with the elasticity (marginal effect) of each significant factor. Equation 2 shows the resulting model.

$$\ln(Q_{h,k}) = \ln(\bar{Q}_{h,k}) - 0.264 - 0.004 * \text{WindSpeed} - 0.005 * \text{Visibility} - 0.007 * \text{Precipitation} + 0.265 * \text{RSI} + \sum_1^n (y_i * \text{Site}_i) \tag{2}$$

**TABLE 3 Modeling Results for Traffic Volume of a Highway over a Storm Event**

Variable	Coef.	Sig	Std. Err.	z	Elasticity
Constant	-0.264	0.000	0.002	—	
Wind speed	-0.004	0.000	0.000	—	-0.048
Visibility	0.005	0.000	0.000	113.460	0.052
Precipitation	-0.007	0.000	0.000	-89.030	-0.015
RSI	0.265	0.000	0.002	153.840	0.201
Site 1	0.041	0.000	0.006	6.320	0.040
Site 2	-0.129	0.000	0.016	-8.230	-0.137
Site 3	-0.019	0.000	0.003	-7.310	-0.019
Site 4	0.041	0.000	0.004	11.120	0.040
Site 5	0.071	0.000	0.003	27.960	0.068
Site 6	-0.017	0.000	0.003	-6.280	-0.017
Site 7	0.068	0.000	0.004	18.470	0.066
Site 8	-0.008	0.000	0.002	-4.740	-0.008
Site 9	0.025	0.000	0.001	20.060	0.024
Site 10	0.063	0.000	0.003	21.830	0.062
Site 11	-0.021	0.000	0.003	-7.340	-0.022
Site 12	0.084	0.000	0.001	66.330	0.080
Site 13	0.006	0.006	0.002	2.730	0.006
Site 14	0.0003	0.827	0.001	0.220	0.000
Site 15	-0.0003	0.875	0.002	-0.160	0.000
Site 16	-0.069	0.000	0.002	-36.990	-0.072
Site 17	-0.025	0.000	0.002	-16.170	-0.026
Site 18	-0.031	0.000	0.001	-45.120	-0.032
Site 19	-0.003	0.000	0.001	-5.630	-0.004
Site 20	0.043	0.000	0.001	54.160	0.042
Site 21					
Observations	2411				
LL(null)	-312547				
LL(model)	-247673				
df	25				
AIC	495396				
BIC	495541				
Pseudo R <sup>2</sup>	0.2076				

NOTE: AIC = Akaike information criterion; BIC = Bayesian information criterion

## Model for Traffic Speed

The median speed during a snow event is modeled differently than volume. It is assumed to be a normally distributed random variable with its mean assumed to be a linear function of various influencing factors. Independent variables tested for significance include posted speed (categorical), temperature (°C), wind speed (km/h), visibility (km), hourly precipitation over the event (cm), RSI (unitless), average volume-to-capacity (V/C) ratio (unitless), and site variation indicators (binary variable). A standard capacity of 2,200 vehicles per lane per hour is assumed for all highways. Table 4 gives the modeling results with the final linear model that was found to best fit the full data set. The resulting model is given in Equation 3.

$$\begin{aligned}
 V = & 69.082 + 0.089 * \text{Temperature} - 0.078 * \text{WindSpeed} - 0.310 * \text{Visibility} \\
 & - 1.258 * \text{Precipitation} - 16.974 * \text{RSI} - 4.325 * \frac{v}{c} \\
 & + \sum_1^n (x_i * \text{Speed}_i) + \sum_1^n (y_i * \text{Site}_i)
 \end{aligned} \tag{3}$$

## FINDINGS

The relationship between the results of this analysis and real world phenomena are discussed below. The results above agree with the findings of the literature as they relate to the atmospheric variables. Results in the literature showing a reduction in average speed on snow-covered roads agree with the median speed reduction related to drops in RSI (5, 10).

### Interpretation of the Models

Observations on each of the modeled variables and a comparison of effects between volume and median speed models reinforce several intuitive relationships. Results of the volume-based analysis indicate impacts on trip-making decisions or trip-making utility. Similarly, results of the median speed analysis indicate driving behavior factors or travel time impacts.

#### *Temperature*

The average temperature during an event was not a significant variable affecting traffic volume. This indicates that temperature does not play an important role in travelers' trip-making decisions. A small impact on median speed was observed indicating that driving speed in winter conditions is only influenced by temperature by a small amount; not a surprise given most vehicles are able to control cabin temperature.

#### *Wind Speed*

Wind speed was found to be significant in both models. A 10% increase in wind speed is expected to result in 0.48% drop in volume. The effect of wind speed on traffic speed is relatively small. Each 10-km/h increase in wind speed is correlated with a 0.8-km/h drop in median speed. This relatively small impact on speed is supportive of literature findings that wind speed was only a strong factor when very high wind speeds were reached (8, 10). Despite the

**TABLE 4 Modeling Results for Median Speed**

Variable	Coeff.	Sig	Std. Err.	z	Elasticity
Constant	69.082	0.000	0.787	87.790	
Temperature	0.089	0.000	0.022	3.980	-0.004
Wind speed	-0.078	0.000	0.013	-6.060	-0.010
Visibility	0.310	0.000	0.019	16.380	0.034
Hourly precipitation	-1.258	0.000	0.140	-8.960	-0.007
RSI	16.974	0.000	0.708	23.970	0.133
V/C	-4.325	0.004	2.966	-2.920	-0.004
Posted speed limit (80 km/h)					
Posted speed limit (90 km/h)	1.951	0.007	0.718	2.720	0.020
Posted speed limit (100 km/h)	12.621	0.000	0.818	15.430	0.130
Site 1					
Site 2	-4.521	0.000	0.807	-5.600	-0.047
Site 3	7.664	0.000	0.664	11.530	0.079
Site 4	12.023	0.000	0.704	17.080	0.124
Site 5	12.459	0.000	0.658	18.920	0.129
Site 6	12.812	0.000	0.718	17.850	0.132
Site 7	7.825	0.000	0.857	9.130	0.081
Site 8	10.295	0.000	0.791	13.010	0.106
Site 9	17.189	0.000	0.716	24.010	0.178
Site 10	11.380	0.000	0.690	16.500	0.118
Site 11	10.031	0.000	0.672	14.930	0.104
Site 12	7.244	0.000	0.662	10.950	0.075
Site 13					
Site 14	8.408	0.000	0.600	14.010	0.087
Site 15	9.897	0.000	0.807	12.270	0.102
Site 16	8.411	0.000	0.817	10.300	0.087
Site 17	15.273	0.000	0.926	16.490	0.158
Site 18	0.740	0.276	0.679	1.090	0.008
Site 19	13.331	0.000	0.676	19.720	0.138
Site 20	8.230	0.000	0.720	11.430	0.085
Site 21					
Observations	4822				
$R^2$	0.5879				
Adj. $R^2$	0.5857				

small coefficient, strong winds could still result in large traffic volume and median speed reductions.

### Visibility

Visibility had only a modest impact on volume reduction in the models. A 10% drop in visibility is correlated with a 0.52% drop in volume. However, it did have a much stronger effect on

median speed. Each 10-km drop in visibility could lead to a 3.1-km/h drop in median speed. This is an intuitive result and supports the literature findings related to fog (10).

### *Precipitation*

Study results indicate that precipitation has the anticipated impact on both volume and median speed. A 10% increase in precipitation is correlated with a 0.15% drop in volume, whereas each additional centimeter of precipitation is expected to result in a 1.3-km/h drop in median speed. Similar effects of precipitation are well documented in the literature (1, 5, 8, 9).

### *Volume*

The impact of average volume (or V/C ratio) on median speed was found to be relatively small, which is consistent with the general traffic stream patterns. A 0.1 increase in volume to capacity ratio would lead to 0.4 km/h reduction in median speed. It should be noted that traffic volume is expected to have a nonlinear effect on traffic speed, which needs to be examined in future research.

### *Site Variation*

The variation by site could be interpreted in several ways. Some of the possible contributions to this variation are

- More or fewer discretionary trips in different areas;
- More or less tolerance for winter conditions in different areas; and
- Merging or weaving, curves, interchange density, or other operational characteristics.

More extensive research is needed to identify the causes of the variation and quantify the exact impacts of these factors.

### *RSI*

RSI was shown to be a significant factor in both volume and median speed models. A 10% drop in RSI was correlated with a 2% drop in volume and each drop of 0.1 in RSI is correlated with a 1.7-km/h drop in median speed. A reduction value of approximately 6.8 km/h in median speed was found for a 0.4 drop in RSI. This drop in RSI roughly corresponds to the difference between bare pavement and snowy roads (Figure 2). Higher drops, such as 0.6 to 0.8 that might be typical of the difference between bare pavement and snow-packed or ice-covered roads, are associated with larger speed and volume reductions: on the order of 10.2 to 13.6 km/h.

## **Mobility Benefits of WRM: Case Study**

This section shows an application of the developed mobility impact models for quantifying the mobility implications of alternative WRM policy and programs. As shown in the previous section, a small reduction in highway volume could represent a significant displacement of

vehicles and a large impact on mobility of the surrounding community. For example, if work trips are postponed or cancelled, there is an obvious loss of productivity and loss of income. Discretionary trips are likely to be among the most commonly displaced. Loss of these trips represents a loss of the economic activity and social well-being commonly associated with these types of trips. A correlation between RSI and volume indicates that people will make cancellation or rescheduling decisions based on their knowledge of road conditions.

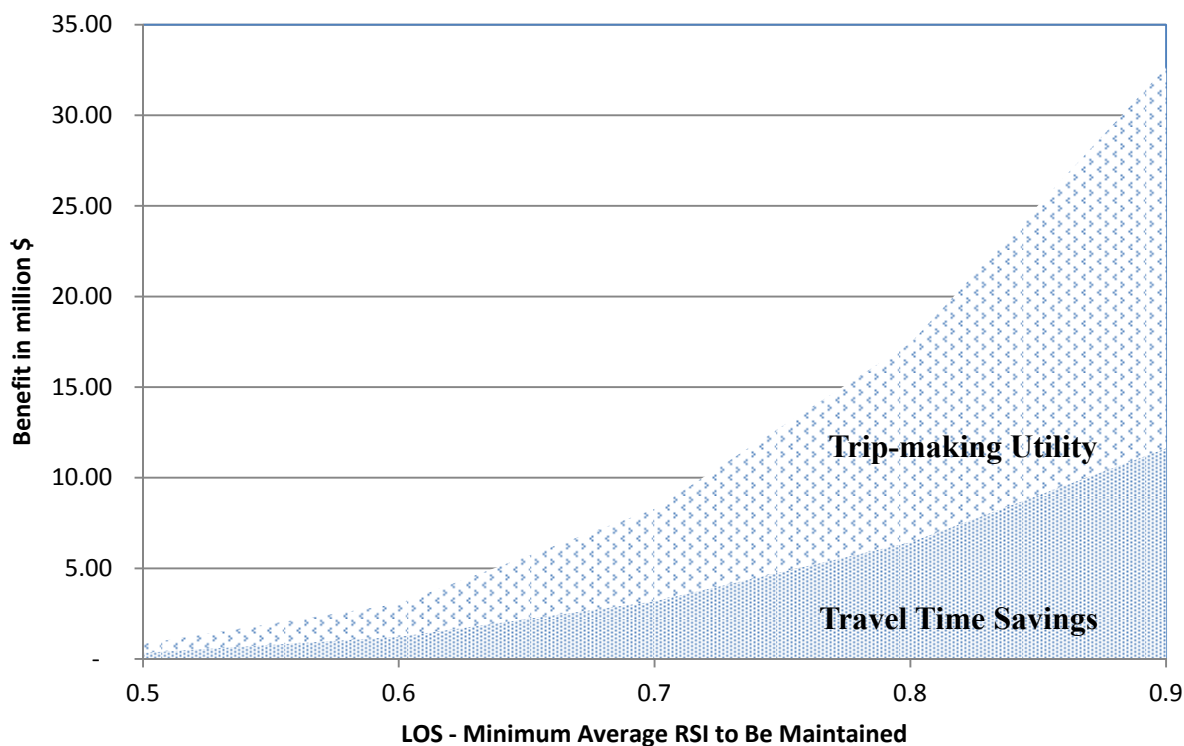
Likewise, a small reduction in speed can dramatically increase travel times. This supports the common knowledge that drivers will slow for poorer road conditions. On a typical 10-km highway segment with a posted speed of 90 km/h, a drop to 70 km/h translates to an additional 1.9 min of delay per vehicle.

A case study is developed to demonstrate these results using the three winter seasons of snow event data for the 21 sites. For the purposes of this case study the level of service (LOS) achieved through WRM activities is described by the average RSI during a snow event. For example, if the WRM goal is to achieve pavement minimum RSI of 0.6, then the average RSI of each highway over each event of a winter season must be greater than 0.6.

Benefits are calculated as increases in speed (travel time savings) and trips not displaced (trip-making utility) by achieving a given RSI target as a result of WRM activities. For a given target RSI, all events are examined and their RSIs under the existing WRM program are estimated. If the average RSI during a snow event in the data set is higher than the target value then no benefit is calculated. For those events that have an RSI less than the target RSI, it is assumed that, under the new target LOS goal, additional WRM operations would be provided to improve their RSI to the target value. The improvement in RSI would lead to increase in traffic volume over these events, which can be predicted using Equation 2. The increase in traffic volume could then be translated benefit due to improved trip-making utility (i.e., these trips would otherwise be canceled or shifted to other periods). In addition, the increase in RSI would also improve the average traffic speed, as predicted by Equation 3. This will result in reduction in travel time, which can then be translated into dollar value based on value of time. In this research, we assumed a uniform \$10 per trip not displaced (for trip-making utility) and a value of time of \$20 per hour (for travel time savings).

These benefits on a storm-by-storm basis for all the study sites are aggregated to the total of the three seasons in the data set and averaged to represent a single typical winter season. For the purposes of this case study, the results are scaled to the entire Ontario provincial highway network. This is achieved based on a simple ratio considering the study sites are made up of about 13% of the complete network (in terms of lane kilometers). It should be noted that the resulting amount represents the additional benefit that could be expected from implementing the new target LOS goal (minimum RSI to be maintained over each storm).

As shown in [Figure 3](#) the mobility benefit of achieving the target RSI of 0.8 bare pavement condition is on the order of \$17 to \$32 million per winter season on the provincial highway network in Ontario. This figure represents the monetized value of WRM to maintain bare pavement. The WRM policy for the study sites expects bare pavement recovery within 8 h of bare pavement loss. There is significant benefit that occurs after an event has finished that is currently realized through ongoing WRM activities (but not included in this case study).



**FIGURE 3** Mobility benefit of WRM versus WRM LOS standard (Ontario Provincial Network).

## CONCLUSIONS

Data from 21 highway locations over a period of three winter seasons were compiled to describe the traffic conditions during individual snowstorm events along with the corresponding atmospheric and RSC. A Poisson and a linear regression analysis were performed that identified the best-fit models to describe changes in volume and median speed, respectively, as a function of weather conditions, site and RSI.

The literature identified that atmospheric variables contribute to both lower volume and lower travel speeds. These findings were supported by the analysis in this research. Most importantly, both traffic volume and speed were found to be related to RSI. This indicates that drivers are not only sensitive to winter road conditions and reduce speed during periods of low RSI, but that people may tend to cancel or reschedule trips as a result of their knowledge of the expected RSC or the expected WRM LOS or service class of the highway. The case study has shown that the mobility benefits of achieving higher service standards could amount to millions of dollars for the province of Ontario.

Several extensions to this research are possible, which could lead to a better understanding of WRM policy impacts to driver mobility. In particular, the following possible extensions to this research would improve on the ability to apply practically these findings to WRM policy.

- As this study only considered linear regression for the speed model, an obvious extension of this research would be to investigate the possible non-linear relationships between volume or speed and the independent variables identified. For example, previous studies have suggested that a square of wind speed may have a stronger correlation to speed.
- Several previous studies have attempted to group variables to take into account possible correlation between some factors and travelers' complex decision-making behavior. A study investigating different categorizations may improve the ability of these models to estimate impacts of snow events on speed and volume.
- The analysis above considered only first order effects. Interaction between variables, particularly those with intuitive relationships like visibility and precipitation, should be investigated to improve model performance and estimation power.

## REFERENCES

1. Hanbali, R. M., and D. A. Kuemmel. Traffic Volume Reduction Due to Winter Storm Conditions. *Transportation Research Record 1387*, TRB, National Research Council, Washington, D.C., 1993, pp. 159–164.
2. Wallman, C. G., and H. Astrom. *Friction Measurement Methods and the Correlation Between Road Friction and Traffic Safety—A Literature Review*. VTI report M911A, 2001.
3. Shahdah, U., and L. Fu. Quantifying the Mobility Benefits of Winter Road Maintenance: A Simulation-Based Analysis. Presented at 89th Annual Meeting of the Transportation Research Board, Washington D.C., 2010.
4. Shahdah, U., and L. Fu. Assessing the Mobility Effect of Alternative Winter Road Maintenance Standards. International Winter Road Congress, February 8–11, 2010, Quebec.
5. Knapp, K. K., D. Kroeger, and K. Giese. Mobility and Safety Impacts of Winter Storm Events in a Freeway Environment. Final Report. Iowa State University, 2000.
6. Usman, T., L. Fu, and L. F. Miranda-Moreno. Quantifying Safety Benefit of Winter Road Maintenance: Accident Frequency Modeling. *Accident Analysis and Prevention*, Vol. 42, No. 6, 2010, pp. 1878–1887.
7. Usman, T., L. Fu, and L. F. Miranda-Moreno. Accident Prediction Models for Winter Road Safety: Does Temporal Aggregation of Data Matter? Presented at 90th Annual Meeting of the Transportation Research Board, Washington D.C., 2011.
8. Kumar, M., and S. Wang. Impacts of Weather on Rural Highway Operations. Final report prepared for the U.S. Department of Transportation, 2006.
9. Datla, S., and S. Sharma. Impact of Cold and Snow on Temporal and Spatial Variations of Highway Traffic Volumes. *Journal of Transport Geography*, Vol. 16, No. 5, 2008, pp. 358–372.
10. Liang, W. L., M. Kyte, F. Kitchener, and P. Shannon. Effect of Environmental Factors on Driver Speed: A Case Study. *Transportation Research Record 1635*, TRB, National Research Council, Washington, D.C., pp. 151–161.
11. Agarwal, M., T. H. Maze, and R. Solleyrette. Impacts of Weather on Urban Freeway Traffic Flow Characteristics and Facility Capacity. *Proc., 2005 Mid-Continent Transportation Symposium*, Ames, Iowa, 2005.

## WINTER MOBILITY AND MAINTENANCE PERFORMANCE

**Winter Performance Measurement Using Traffic Speed Modeling****TINA GREENFIELD****MATT HAUBRICH***Iowa Department of Transportation***MARK KAISER****ZHENGYUAN ZHU****DANIEL FORTIN****JING LI***Iowa State University*

**Traffic flow is often disrupted to varying degrees during precipitation, frost, and blowing snow events. In general, as winter weather events cause road conditions to deteriorate, traffic has a tendency to slow down. Winter maintenance activities affect road conditions and therefore impact traffic speed, so a measurement system using traffic speed has the potential to be a direct measure of the impact of maintenance activities. A prototype model has been developed to predict the average traffic speed at a given time during a winter storm event using commonly reported and forecast road weather data. The prototype model has shown much promise in the quantitative evaluation of winter maintenance by comparing the simulated traffic speed at any point in time to the actual traffic speeds observed by traffic speed sensors. Winter operations may be considered successful when observed traffic speed is found to be at or above the model prediction, and operations may be considered unsuccessful when speeds are significantly less than the model predicts. The minute-by-minute nature of the model output makes it easier to evaluate the specific series of events contributing to the microscale successes or failures over the course of an event. The prototype model is being analyzed and improved for incorporation into real-time performance analysis systems.**

**T**he Iowa Department of Transportation (DOT) spends about \$40 million annually clearing primary highways of snow and ice. Winter operations efficiencies could provide improved level of service to highway travelers, reduced costs, or both. Performance analysis is an important step in ensuring efficient operations; however, collecting reliable outcome measurements is difficult. Common outcome measures include (a) the time it takes to return the road to normal conditions, (b) friction measurements, and (c) public surveys. Time-to-normal statistics are often self-reported and the assessment of normal can be subjective. Friction measurements require costly and specialized equipment that can traverse the road with sufficient frequency and spatial distribution to gain an adequate sample. Consumer surveys are important but often collect only generalities about statewide and winter-long service. Therefore, none of these common outcome measures provide what is desired, which is an easily collected, spatially and temporally dense, and objective outcome measurement.

Seeking a better measure of winter operations outcomes, the research team began by considering the purpose of winter maintenance, which is to mitigate the full impact of the weather on traffic flow. The hypothesis of this study is that a performance measurement system



using traffic speed has the potential to be a useful and quantitative measure of the impact of maintenance activities. However, since both weather and maintenance actions impact traffic speed, the effect of weather must be considered before making any assumptions about the quality of the maintenance actions using traffic speed.

Several research projects have studied the impact of weather on vehicle speeds. Knapp et al. (1) investigated speed characteristics in Iowa Interstates in seven winter storms and found that average free-flow speeds were calculated to be approximately 8 mph (12.9 km/h) less in winter storm event conditions compared to normal conditions. Kyte et al. (2) developed models for storm average reductions in weather conditions and found that heavy snow could slow traffic speeds by over 18.6 mph (30 km/h).

Qiu and Nixon (3) parameterized the effects of several significant, commonly observed storm characteristics and developed a simple equation to compute the estimated average free-flow traffic speed drop as a result of a winter storm under nominal maintenance. Winter operations may be considered successful when observed traffic speed is found to be at or above the model prediction, and operations may be considered unsuccessful when speeds are significantly less than the model predicts. In this way, the benchmark for comparison already accounts for the impact of weather and helps isolate the impacts of maintenance activities.

While studying traffic speed drops as averaged over an entire storm is helpful for broadly analyzing winter performance, the authors felt that much deeper analysis could be performed if the temporal resolution of the traffic estimations were smaller. Smaller time periods would allow evaluation of specific events, such as shift changes, adaptation to evolving weather conditions, changes in treatment strategy, or other decision points.

A traffic estimation model has been developed to compute expected traffic speed reductions at a given time during a winter storm using commonly reported and forecast road weather data. The Iowa DOT intends to incorporate this model into a winter operations performance monitoring tool that would allow managers to view the observed and simulated traffic speeds, weather conditions, and crew activities over a time period. This information will help evaluate service quality and the impact of operational practices on driving conditions. Real-time pavement, traffic, and atmospheric information available from the DOT's roadside weather information stations (RWIS) and other sources could flow automatically into the monitoring tool to create on-demand performance reports and analysis. Two challenges must be met to reach this goal: a reliable traffic speed model must be developed, and this model must be able to gracefully handle the anomalies commonly present in real-time observations, particularly those of precipitation occurrence and type.

## MODEL DEVELOPMENT

### Model Adaptation

In this study, Qiu and Nixon's (3) equation for storm-average speed reductions was modified to produce expected traffic speed reductions at a given time during a winter storm event using commonly reported and forecast road weather data. The original equation for estimated speed reduction in miles per hour (SSI) used parameterized values for the effect of storm type, during-storm and post-storm temperatures, pre-storm behavior, and in-storm and post-storm wind conditions.

$$SSI = c * \left(\frac{1}{b}\right) * ((E_s * E_T * E_w) + B_i + T_p + W_p - a)^{0.5} \quad (1)$$

The constant  $c$  is a scaling factor for the maintenance service level of the road. In this study,  $c$  is 20, constant  $b$  is 1.6995, and constant  $a$  is 0.0005. The other variables are determined by the weather conditions as described in Table 1.

Since there was no dependency on time duration in the original equation or variables, it was a reasonable starting point to assume that the original form and parameterization for average estimates would also be valid for real-time or sequential operation, with the exception of the post-storm variables. Equation 1 was designed under the assumption that all of the storm characteristics (pre-storm through post-storm) could be collected and parameterized prior to computing any traffic speed estimation. In a real time operating mode, at any time in a sequence, what would happen in the future has no impact on the current outcome. Therefore, the post-storm variables were removed from Equation 1. The equation for the real time traffic speed reduction for any given point in a winter storm is now given by

$$SSI = c * \left(\frac{1}{b}\right) * ((E_s * E_t * E_w) + B_i - a)^{0.5} \quad (2)$$

Although post-storm temperature and wind effects were removed to form Equation 2, observations indicate that there are lingering effects on traffic speed even after the end of a storm. Therefore, additional logic had to be developed to estimate traffic's gradual return to normal speeds after the storm.

### Post -Storm Parameterization

Post-storm wind primarily impacts winter storm operations by picking up fallen snow and blowing it across or onto the road. Wind-driven snow can impair driver visibility and can accumulate on the pavement and produce slick or obstructed driving conditions that slow drivers and require plowing or chemical treatment. The impact of post-storm wind is handled by adding a blowing snow storm type to the possible values of  $E_s$ .

$$E_s = 0.35 \text{ if storm type is blowing snow} \quad (3)$$

**TABLE 1 Definition of Model Variables and Assignment Values**

Definition		Variable		Assignment Values	
Storm type	$E_s$	If freezing rain = 0.72	If light snow = 0.35	If medium snow = 0.52	If heavy snow = 1
Storm temperature	$E_T$	Warm = 0.25	Midrange = 0.4	Cold = 1	
In-storm wind	$E_w$	Light = 1	Strong = 1.2		
Early storm behavior	$B_i$	Starts as snow = 0	Starts as rain = 0.1		
Post-storm temperature	$T_p$	Same = 0	Warming = -0.087	Cooling = 0.15	
Post-storm wind	$W_p$	Light = 0	Strong = 0.25		

In effect, this treats blowing snow as a new storm type to be handled in Equation 2. Blowing snow is not normally observed by RWIS; however blowing snow occurrence is logged in Iowa DOT crew reports and is therefore available for use in calculation.

After snow and ice cease accumulation on the road (either via precipitation or blowing snow), the accumulated snow and ice will remain on the pavement until it is melted or physically removed by plows. Post-storm temperature impacts both the physical removal and melting processes because it determines whether the snow and ice will naturally melt and the extent and speed by which it can be melted with deicing chemicals. Temperature thus impacts the time and effort required to clean the pavement after a storm, and thereby the ability for traffic to recover to normal speeds.

The preliminary method of calculating post-storm traffic speed recovery time as a function of temperature was through a linear relationship between binned surface temperature and the time expected to increase the traffic flow by 20 mph (32.2 km/h). Table 2 provides the linear regain benchmarks.

The method to fit these relationships was loosely based on salt's melting effectiveness at different pavement temperatures.

## PRELIMINARY MODEL PERFORMANCE

Equation 2 and the weather parameterizations mentioned previously were coded into a Python computer program. The program accepted a file containing crew report and RWIS weather conditions in 2-min increments. These observations were used to calculate the weather parameters and the expected traffic speed reduction for each time period. The model repeated the calculations for each weather record in the input file. The model output was time matched with traffic speed information for comparison.

In the first attempts, it was clear that the conversion of RWIS or crew precipitation reports into the value for  $E_S$  was not straightforward. The two sources of precipitation observations sometimes disagreed on the occurrence of precipitation and determining the storm type category was challenging. A number of different methods to parameterize  $E_S$  were tried for best fit. The method that appeared to have the best results was to rely on the crew report for the  $E_S$  category selection, and allow RWIS observations to modify  $E_S$  only in the case when the crew reported precipitation type is "none."

The initial analysis used data from the Adair, Iowa, RWIS station and Adair garage crew reports from December 1, 2008, through January 19, 2009, and included 35,780 records of traffic speed and weather observations. The Adair RWIS station is situated near Interstate 80, about 4 mi (6.4 km) west of the town of Adair. The speed observations used in the comparisons were of

**TABLE 2 Linear Regain Benchmarks for After-Storm Speed Recovery**

Surface Temperature Bins	Linear Recovery Benchmarks
Temperature < 15°F	7 h regain of 20 mph
Temperature ≥ 15°F and temperature < 25°F	5 h regain of 20 mph
Temperature ≥ 25°F and temperature < 32°F	3 h regain of 20 mph
Temperature ≥ 32°F	1 h regain of 20 mph

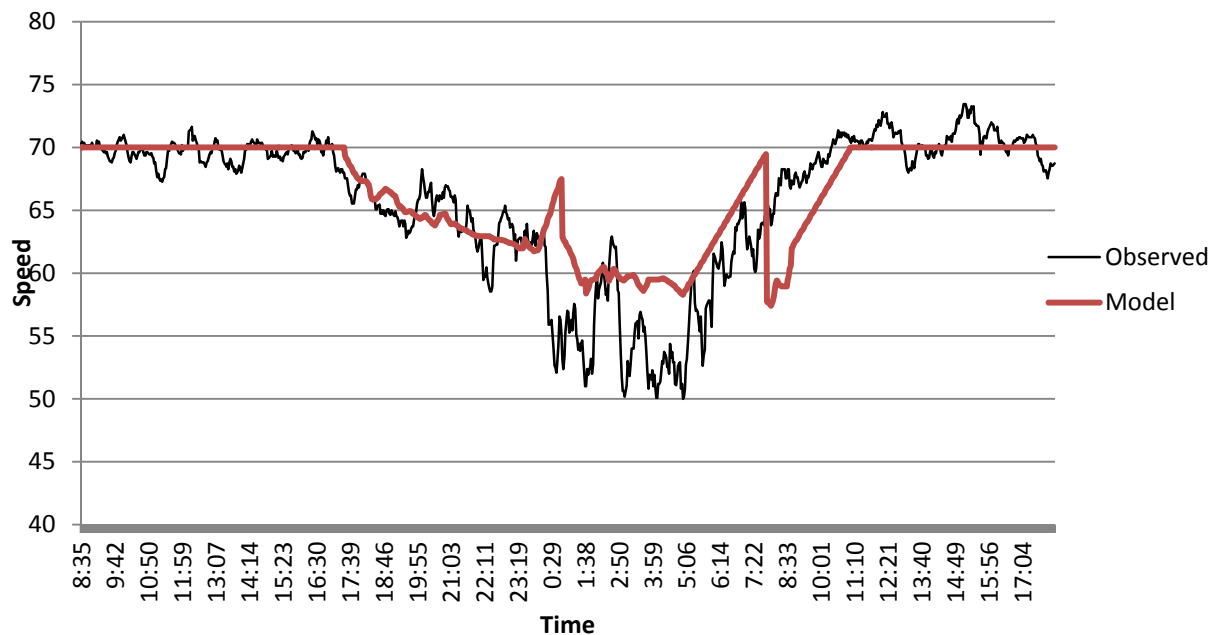
the I-80 Eastbound driving lane. The speed observations were smoothed prior to comparison via a centered, 10-min average.

The average absolute difference between the smoothed speed and the modeled speed for the entire period was 3.0 mph (4.8 km/h). This comparison is heavily influenced by the relatively large amount of time in normal conditions when neither the model nor the traffic was displaying any significant deviation from the posted speed limit. Isolating only the 9,109 records when the model or the smoothed observed speed had dropped 5 mph (8 km/h) from the posted limit, the average absolute difference is 6.5 mph (10.5 km/h).

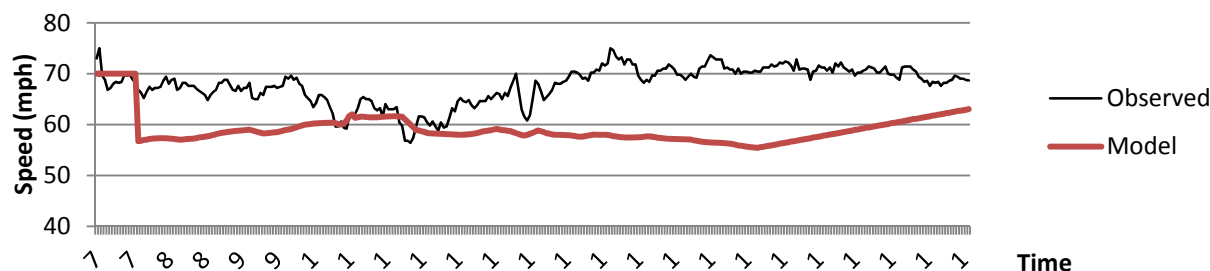
Figure 1 shows the comparison between smoothed observed speed in miles per hour (black line) and the estimation (red line) for one particular storm on December 8 and 9, 2008.

In the beginning of the storm, the observed and modeled traffic speeds behave similarly until about midnight, when there is an abrupt upward spike in the modeled speed. Another abrupt change in modeled speed occurs in the morning hours during a general upward climb in observed traffic speed. These abrupt changes were found to be due to the sudden change in the parameterized storm type. At the midnight spike, the observation records reported a period with no precipitation, and therefore the model assumed traffic would regain speed. As soon as precipitation was reported again, the estimated speeds dropped to their original level. The same happened in the morning hours: precipitation ceased and later returned briefly, interrupting the linear post-storm return to normal speeds.

A relatively poorly modeled example of a December 20 daytime storm event is shown in Figure 2. The *x*-axis represents 2-min intervals starting at 7:30 a.m. and ending at 6:00 p.m. In this example, the average absolute difference between the original model and the smoothed observed speed was 8.9 mph (14.3 km/h).



**FIGURE 1** Results of December 8 and 9, 2008, case study.



**FIGURE 2 Results of December 20 case study.**

Observed traffic speed gradually declined whereas the model abruptly dipped at the onset of the moderate snow event. The end effect is poorly modeled, likely exacerbated by disagreement between the crew and RWIS precipitation records. RWIS indicated several intermittent precipitation categories whereas crew reports indicated moderate snow throughout the event and for 2 h after the last RWIS report of snow. The original parameterization of  $E_S$  does not have a sophisticated method of dealing with uncertainty, fluctuation, or conflict in the actual observations.

## MODELING DYNAMIC STRUCTURE IN SENSOR-DRIVEN VARIABLES

The abrupt jumps and conflicts illustrated in the previous discussion highlight some of the issues that can arise when using real-time data, particularly those of precipitation occurrence and type. Winter precipitation meteors tend to be comprised of relatively small masses of water and are somewhat difficult for many automatic sensors to detect. Furthermore, the discrete nature of precipitation events makes common automated quality control procedures difficult to apply. While quality control is much easier for some of the other model variables, unusual data can still appear in the input files. Since this model is eventually intended to run in real time without human intervention, it is necessary that the model be able to handle uncertainty in its observational input. In general, our goal is to utilize the existing model structure given in Equation 2, but account for the fact that its terms need to be computed from data recorded by imperfect sensors.

The DOT collaborated with researchers at the Iowa State University Department of Statistics with the purpose of improving the model variables for real-time use.

### A Sequential Bayes Approach to Dynamic Modeling

With observations available every 10 min, it is logical to anticipate temporal dependence in the observed weather and temperature variables. Thus, the state of a particular input variable should be influenced both by the current observation as well as observations in the recent past. This type of observation process can be modeled through a Bayesian approach.

The speed reduction at a particular time is influenced both by the current input variables as well as input variables in the recent past. Let  $SR(t)$  be reduction in speed at time  $t$  and let  $\pi(SR(t)|D(t-1))$  denote the current knowledge about  $SR(t)$  based on all data,  $D(t-1)$ , up to time

$t - 1$ . Based on new data at time  $t$ , update what is known about  $SR(t)$  to obtain  $P(SR(t)|D(t))$ , which now represents current knowledge about  $SR(t)$  based on all data up to and including time  $t$ .

Updating current knowledge about  $SR(t)$  is accomplished by developing models for each of the three key variables: wind speed, pavement temperature, and storm type. Modeling the individual input variables involved assigning a probability distribution ( $\theta$ ) to the input variable at time  $t$  and a prior distribution to its parameters. Posterior distributions then become prior distributions for the next observation in time. This is known as a sequential Bayes framework.

### *Storm Type*

In modeling storm type, a multivariate extension of the Beta distribution known as the Dirichlet distribution was selected to model the distributions of the probabilities of storm-type categories, which were taken to have a multinomial distribution at time  $t$ .

At this initial stage the model is essentially reporting the sample proportions for each category of storm type and does not account for the temporal nature of the data. In the physical world, the closer in time two weather observations occur, the more likely they are to represent the same conditions. In other words, an observation of heavy snow is more likely to be preceded by an observation of heavy snow if the elapsed time between observations is small. The further apart these observations are in time, the less likely they are to be the same. This fact is not accounted for in the basic specification of a sequential Bayes model. Therefore, a modification was incorporated using a tuning parameter ( $\lambda$ ) that controls how influential past observations are on the model's belief about the current state of the weather given the sensor data available. The parameter  $\lambda$  can take on any value between 0 and 1. A value near zero will heavily discount observations that occurred in the distant past, thus making only recent observations influential in determining our belief about the current state.

### *Wind Speed and Temperature*

Both wind speed and temperature are modeled with a conjugate normal model assuming constant variance. This converts the discrete values of these variables into continuous probability functions to more closely approximate the real-world physical impact of the effects of these parameters.

### **Modeling the Effect Variables: $E_S$ , $E_T$ , and $E_W$**

The variables  $E_S$ ,  $E_T$ , and  $E_W$  translate information about storm precipitation, wind, and temperature into effects on traffic. Storms that involve snowfall effect traffic more through the accumulation of snowfall than the rate of snowfall at a particular moment in time. For example, if a current reading of heavy snowfall is preceded by an hour of consistent readings of heavy snowfall, the effect on traffic should not be the same as when the reading is preceded by no records of snowfall. Conversely, a reading of no snowfall should not necessarily translate to no effect on traffic (i.e., the effect of snowfall persists even after it stops snowing). The following section considers snowfall, which is recorded as an ordinal categorical variable, and describes a way to model its cumulative effect.

### Modeling $E_S$ Through the Cumulative Effect of Snowfall

The three categories of snowfall are light, moderate, and heavy. These categories have associated rates equal to less than 0.4 in. (1 cm) per hour, between 0.4 and 1 in. (1 to 2.54 cm) per hour, and over 1 in. (2.54 cm) per hour, respectively. This gives a way to associate snow type to the rate of snowfall, and thus a way to model  $E_S$  as a function of the rate of snowfall. For example, an observation of light snow corresponds to a rate of snowfall between 0 and 0.4 in. (0.4 cm) per hour. The relationship between  $E_S$  and rate of snowfall is a step function when only considering three possible categories of snowfall, but a smooth approximation to this relationship is more reasonable and can be utilized since we can estimate snow rate at each time point through a continuous function:

$$E_S(r) = 1.4 \left( 1 - \frac{1}{1.3r+1} \right) \quad (4)$$

Since the time intervals between sensor observations are fairly short it is reasonable to assume constant rate over each time interval, which allows for estimation of snow accumulation for each time interval. Thus, an estimate of the current hourly rate ( $r$ ) is given by estimating the snowfall during the previous hour. More precisely, consider the following steps in the proposed method of estimating the hourly rate of snowfall at time  $t^*$ :

1. For each observation  $t_k$ ,  $k = t^* - m + 1, \dots, t^*$  in the previous hour ( $m = 30$  for 2-min time intervals), randomly sample an observation of storm type using the multinomial distribution with parameters  $\theta_k$ , as estimated by the sequential Bayes model.

$$S(t_k) \sim \text{Multinomial}(\theta_k) \quad (5)$$

2. Given storm type, randomly sample from the snow rate distribution.

$$r_k | S(t_k) \sim \begin{cases} F_1 & \text{if } S(t_k) = \text{light snow} \\ F_2 & \text{if } S(t_k) = \text{moderate snow} \\ F_3 & \text{if } S(t_k) = \text{heavy snow} \end{cases} \quad (6)$$

In the second step  $F_1$  could be uniform distribution on (0, 0.4) or the estimated marginal distribution of snowfall on the interval (0, 0.4);  $F_2$  and  $F_3$  could be assigned similarly. Since the rate  $r$  is in units of inches per hour, dividing by 60 results in inches per minute and multiplying by 2-min results in the estimated accumulation in inches during the time interval (assuming the rate is constant over each time interval).

3. The estimated accumulation of snow over the past hour is given by

$$r(t^*) = \sum_{j=1}^{30} r_j \times \left( \frac{2}{60} \right) \quad (7)$$

which gives  $E_S(t^*) = E_S(r(t^*))$  as the estimated effect on traffic due to storm precipitation.

Steps 1 and 2 can be repeated to produce a distribution on  $E_S(t^*)$ .

So far only storm types involving snow have been considered due to the focus on modeling the cumulative effect of snowfall. Other types of precipitation like freezing rain need

to be incorporated. This can be accomplished by converting the known effects of storm types given in Table 1 to corresponding snow rate values via the inverse relationship between snow rate and storm type effect,  $E_S$ .

### Modeling $E_T$ and $E_W$

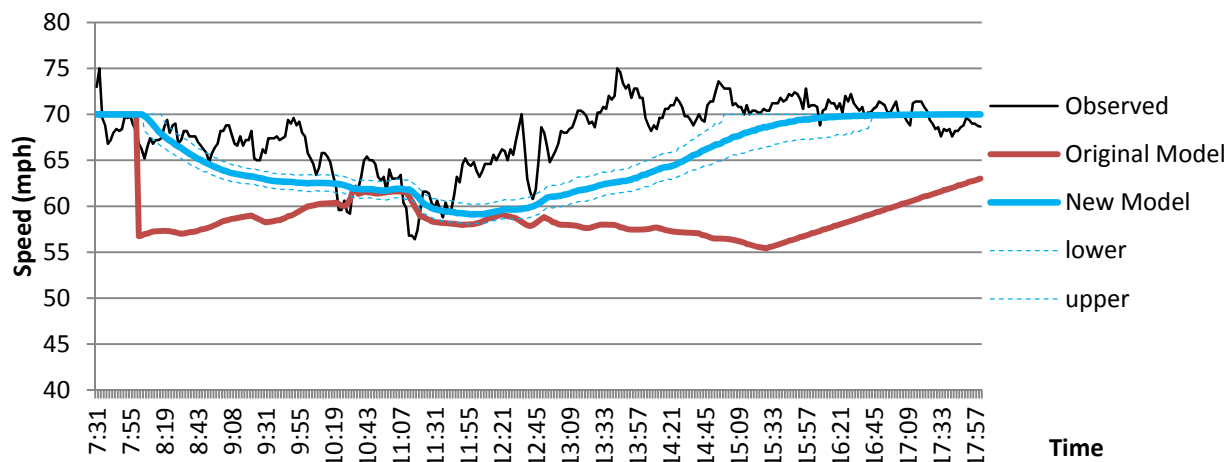
The conjugate normal model is easily implemented using the sequential Bayes approach in order to estimate the distribution of wind speed and temperature at every time point. Using the conjugate normal model we can compute the posterior distribution at each time point, thus for any time point  $t^*$  the temperature distribution  $E_T(t^*)$  can be estimated by randomly sampling from a  $N(\theta_{t^*}, \sigma_T^2)$  and evaluating  $E_T$  at the sampled points, similarly for wind speed.

The functions  $E_T$  and  $E_W$  are step functions in Equation 2, but with nearly continuous time observations of these processes it makes more sense to use continuous functions. Logistic functions may provide adequate approximations.

### Implementation of the Model

The model was implemented using the statistical programming language R to produce fitted values and error bounds for the model using the data set from the December 20 winter storm event as referenced in the section on Preliminary Model Performance. Figure 3 shows the new model results and results from the previous model for comparison. The blue dotted lines are 90% error bounds resulting from the distribution estimation of the model parameters.

In this example, the average absolute difference between the original model and the smoothed observed speed was 8.9 mph (14.3 km/h). The average absolute difference between the revised parameterization and the smoothed observed speed is only 3.4 mph (5.5 km/h). The revised parameterization features a smoother decline in the beginning of the storm and handles the intermittent precipitation behavior at the end of the storm in ways that seem to better follow the observed conditions.



**FIGURE 3** Results of December 20 case study with original and new model results.



## DISCUSSION AND FUTURE WORK

The Iowa DOT modified the Qiu and Nixon (3) model for real-time use in a winter operations performance measurement system. Initial model results were promising but exposed some areas for improvement, particularly in the parameterization of the storm type variable,  $E_S$ . Researchers at the Iowa State University Department of Statistics modeled input variables used in the formulation of  $E_S$ , and developed a structure that allows uncertainty in the sensor-based inputs to propagate into uncertainty in speed reduction as produced by the model. The probabilistic structure provides the following benefits to the DOT's proposed application of this model:

- Confidence bands can act as a buffer zone when measuring performance of winter operations. Benchmark ranges can be increased or decreased appropriately to account for differences that may be attributable to the model input itself.
- The new structure also decreases the likelihood that an unusual or errant sensor reading will cause poor model results. Since the model will be using real-time data in a relatively unsupervised manner, the ability to ride through input errors should greatly improve model reliability.
- The persistence of the effect of past weather naturally handles the gradual cleanup process after the end of a storm. Snow or ice accumulated on the pavement does not suddenly disappear after precipitation ends or switches type, and nor does its effect on traffic. The model can now more adequately estimate the lingering effect of fallen precipitation and the transitions from one precipitation type to another.

There are a number of additional needs and potential improvements that could make the model of greater use in monitoring and predicting the effects of storms on traffic flow.

- The greatest deficiency of the modified model presented here is that, while it takes into account uncertainty in model inputs, it does not take into account uncertainty in model form or structure or the predictability of traffic itself under certain weather conditions. The current confidence bands only take into account the confidence around the parameterization of the model inputs and therefore are too narrow to describe the total uncertainty in the traffic speed estimation. There are at least two distinct approaches to mitigating this deficiency, assigning additional stochastic structures to “weather effect” variables, and taking a more empirical approach to the entire model itself.
- At this time one cannot attribute any differences that exist between the modeled and observed traffic speed as errors or attempt to tune the model to fit these differences better. This is because for any given storm researchers do not yet know whether the difference is attributed to the model's performance or DOT winter operation performance during that storm. To address this issue, the DOT will have to collect and assess a set of storms for adherence to performance targets to be used for model tuning.
- The effect of “previous storm type” has not been dealt with in as detailed a manner as other model input variables. Additional attention to this aspect of the model may be warranted.
- There is the possibility that distributional forms for wind speed and temperature could be improved. Modeling these input variables with normal distributions was chosen primarily for mathematical convenience. Whether other distributional forms might be more appropriate has not been examined in any detail.

- The new model input parameterization is now more computationally challenging and will require more effort in operational implementation.

## REFERENCES

1. Knapp K. K., D. Kroeger, and K. Giese. *The Mobility and Safety Impacts of Winter Storm Events in a Freeway Environment*. Final Report TR-426. Iowa Highway Research Board, 2000.
2. Kyte, M., Z. Khatib, P. Shannon, and F. Kitchener. Effect of Weather on Free-Flow Speed. In *Transportation Research Record: Journal of the Transportation Research Board, No. 1776*, TRB, National Research Council, Washington, D.C., 2001, pp. 60–68.
3. Qiu, L., and W. Nixon. *Performance Measurement for Highway Winter Maintenance Operations*. Final Report TR-491. Iowa Highway Research Board, 2009.

## WINTER MOBILITY AND MAINTENANCE PERFORMANCE

## Weather and Friction Data Collection for Winter Road Performance Evaluation

**ROBERTO A. TOKUNAGA**

**MAKOTO KIRIISHI**

**TETSUYA TAKADA**

**NAOTO TAKAHASHI**

*Civil Engineering Research Institute for Cold Region, Japan*

**TATSUYA YAMAZAKI**

*Hokkaido Regional Development Bureau*

**In this project, the authors constructed a Winter Road Management System as part of technological development contributing to improvements in the efficiency, accuracy, and transparency of winter road management by providing weather forecasts, road-surface forecasts, and real-time friction data to road administrators and operators. At the same time, in this system a database linked to the data and combined with winter maintenance data and digital road maps was constructed to display the data on geographic information system maps and also to conduct winter road performance evaluation by using the accumulated data. As a result, it is possible to evaluate the judgment, results, and achievements of winter road management using more objective and transparent methods, which is expected to contribute to more efficient plan-do-check-action cycle-based management. In this report, the authors used the collected and accumulated data by the system to carry out a series of basic analyses on temporal and spatial changes in winter road performance as a function of meteorological variation and road characteristics, with a case study on the 45-km section of National Highway 230 in the Sapporo area. This paper describes a summary of the system development to date, the usability of accumulated data for winter performance evaluation, and future prospects to promote more effective and efficient winter road management.**

**I**n cold regions of Japan, lower temperatures and snowfall in winter can cause reduced roadway width, icy road surfaces, poor visibility, and other types of road condition deterioration, thereby hindering smooth traffic flow. In response, road administrators work to manage winter road conditions by removing snow, applying chemical agents, and taking other measures on an ongoing basis to ensure safe and comfortable road environments. However, recent demographic changes, road management budget constraints (*I*), and other restrictions have given rise to the need for a more efficient and appropriate method for securing and maintaining the flow of winter road traffic.

As part of technological development to support more efficient, appropriate, and transparent winter road management, the Civil Engineering Research Institute for Cold Region (CERI) provides data for weather forecasts, road icing forecasts, and winter road friction monitoring. It also maintains a database that links these data and road maintenance information to digital road maps to enable related data display on the geographic information systems (GIS) maps, and has developed a winter road management system that allows

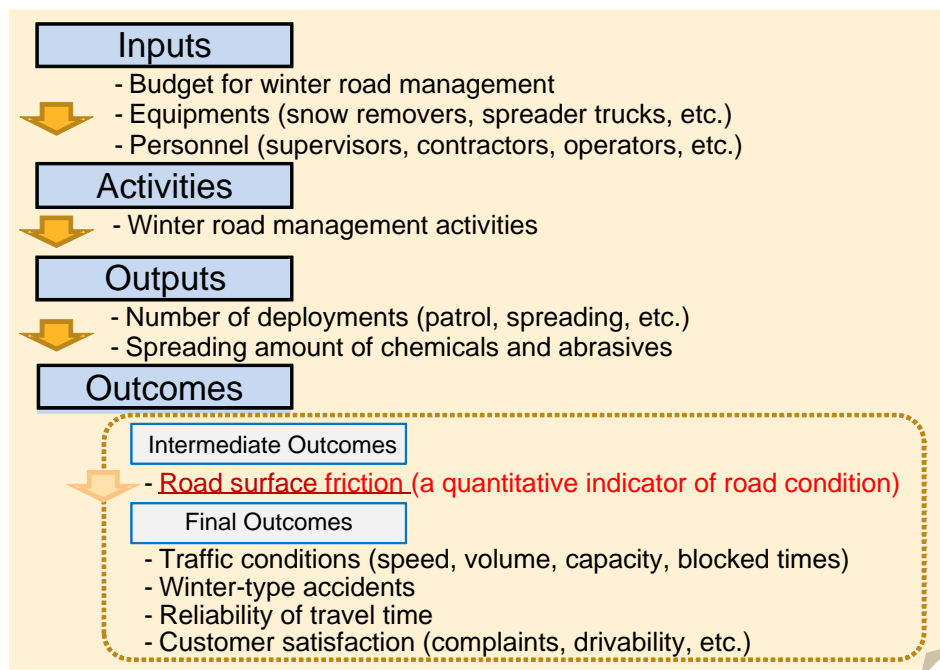
diverse analysis by using accumulated data. This facilitates more objective and transparent evaluation of winter road management decisions and related outcomes, which in turn is expected to contribute to more efficient winter road management based on the plan-do-check-action (PDCA) cycle. In this report, the authors utilized the data accumulated by the said system to carry out a series of basic analysis on temporal and spatial changes in winter road performance as a function of meteorological variation and road characteristics, with a case study on the 45-km section of National Highway 230 in the Sapporo area. This paper details the research work conducted and outlines the potential direction of future developments in the field.

## DATA COLLECTION FOR PERFORMANCE EVALUATION

### Literature Review

To facilitate a shift toward more effective, efficient, and highly transparent road management, road administrators participate in an initiative known as Road Administration Management in Japan (2). Under this project, numerical goals are set (plan), measures and projects are implemented (do), achievements are evaluated (check) and feedback is reflected in subsequent administrative management (action). This PDCA cycle also needs to be established in the area of winter road management. Against this background, a number of related studies on winter road performance evaluation and management have been conducted in northern European countries. In Sweden for example, a winter model (3) was proposed to promote the optimization of winter road management by assigning monetary values to the considerations of traffic safety, accessibility (travel speed, etc.), fuel consumption, corrosion (metal deterioration of bridges and other structures stemming from the application of chemical agents), road management costs, and environmental impacts.

Takahashi (4) proposed a logic model for the evaluation of winter road performance. This tool which identifies cause-effect linkage relationships and clarifies the process by which initial resource investment results in improvement effects (i.e., outcomes) on beneficiaries is widely used in program evaluation. Figure 1 shows the conceptual diagram of proposed logic model for winter road performance evaluation, which has inputs including data on winter road management budgets, equipment, personnel and other variables, and outputs including operation frequency and the chemical agent application rate. Road surface friction is selected as an intermediate outcome, whereas winter traffic characteristics, winter accidents, travel time reliability, and road-user satisfaction are selected as final outcomes. As winter road management is implemented to improve road conditions with the ultimate goal of providing a safe and comfortable road traffic environment for users, road surface friction is set as an intermediate outcome with a direct connection to winter road management, and traffic characteristics are included among the final outcomes as metrics of road traffic behaviour. This paper focuses on road surface friction as an intermediate outcome of the logic model, presents analysis results highlighting how winter road surface conditions are influenced by meteorological and other changes, and clarifies the relationships between winter road surface conditions and winter traffic characteristics.



**FIGURE 1** Conceptual diagram of logic model for performance evaluation.



**FIGURE 2** Bus-type locked-wheel friction tester.

### Friction Measurement Device

In Japan, bus-type locked-wheel friction testers (LWFT) are used as standard equipment to evaluate roadway friction (Figure 2). However, as such testers are expensive to introduce and maintain they are reserved mostly for testing and research purposes, and are unsuitable for introduction in practical application.

Accelerometers are another type of evaluation equipment, and have been introduced for practical use in winter road surface management in northern European countries and elsewhere. However, although accelerometers are relatively inexpensive, they allow friction evaluation only within a limited range of road traffic conditions because test vehicles must come to a sudden

brake to take friction values. Accelerometers have other disadvantages, such as the influence of driving technique on evaluation and the need for certain technical specifications in regard to test vehicles. Furthermore, bus-type friction testers and accelerometers can determine friction values only in places where braking is applied and cannot perform continuous friction evaluation along the length of a route.

In 2006 our research group introduced a continuous friction tester (CFT) (5) to measure friction value on roadways continuously in real time (Figure 3). This device calculates friction value by measuring the axial force created by installing a test tire one to two degrees off axis from the direction of travel, as shown in Figure 4. The friction value computed by the tester is called the Halliday friction number (HFN), which is originally determined by this device's designer, and this HFN scale usually varies from 0 to 100. As shown in Figure 5, there is a linear relationship between the HFN value and the axial force, and the value shows lower while the side force is lower. HFN is defined as 0 when there is no force between the tire and the road and as 100 with side force between the tire and the road when the tire is being run on a dried pavement (fine and gap-graded asphalt concrete) at  $-17.8^{\circ}\text{C}$ . Funahashi et al. performed a series of comparison tests between CFT and LWFT. As result, an acceptable correlation between HFN from CFT and friction coefficient ( $\mu$ ) from LWFT has been proven (6).



FIGURE 3 CFT.

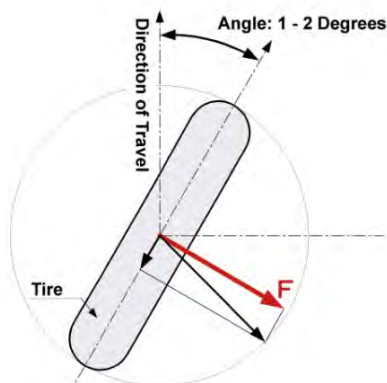
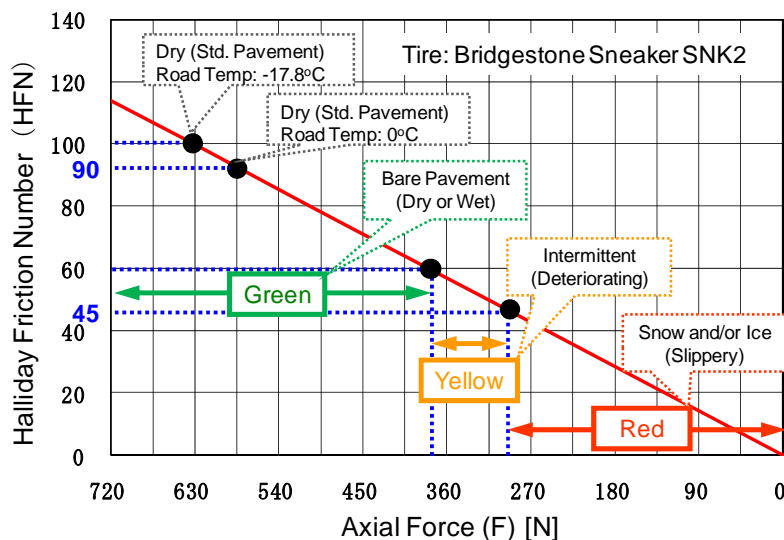


FIGURE 4 Measurement principle of CFT.



**FIGURE 5 Correlation between axial force and HFN.**

In North America and Europe, some road authorities have practically used this device to measure friction value on winter roadways. Besides, in the case of the Ohio DOT, the device is used not only to measure road surface grip but also to apply the device, which is installed in the lower part of the truck for chemical spreading operation, as a sensor to determine whether distributing materials or not.

The sampling rate of friction values measured by the CFT is 10 Hz as default (maximum 100 Hz), and real-time friction can be checked via an onboard display inside the vehicle. Friction data is combined with information on date, time, positioning, road surface temperature, weather conditions (sunny, cloudy, rainy, or snowy), road surface conditions (dry, wet, slushy, compacted snow, or icy), vehicle ID, test tire speed, and other data, and are stored on a recorder. These data also can be transferred to the server every 15 s by using communication terminal.

In order to create a database linked to road sections of a digital road map and to enable the display of monitoring results on GIS maps, the authors combined HFN data transferred from CFTs with weather mesh data (air temperature, snowfall, rainfall, and visibility), road configuration data, and other information. The weather mesh data is created and provided by the local weather forecasting organization. And also the authors developed a Winter Road Surface Friction Monitoring System capable of real-time information providing and conducting various types of analysis using accumulated data. The establishment of the system enabled clarification for the details of temporal and spatial changes in road surface conditions (friction values) relating to meteorological conditions and road structures.

### Winter Road Surface Monitoring

In this study road surface friction has been monitored on National Route 230 between KP 1.0 and 45.0 ( $L = 44.0$  km) over two round trips per weekday in winter (mid-December to late February) since FY 2007 in order to examine the feasibility of using the data obtained to clarify road condition trends in this road section based on HFN values and to evaluate the winter road

performance (Figure 6). The road section starts in downtown area of Sapporo (Kita 1-jo St.) at an elevation of 25 m, passes through urban (DID section), suburban and mountainous areas, and ends in the Nakayama Pass at an elevation of 835 m.

## WINTER ROAD PERFORMANCE EVALUATION

### Trend of Winter Road Surface Conditions

Figure 7 shows road surface conditions based on HFN data obtained from evaluations made in winter (January) from FY 2007 to FY 2010 on National Route 230 with values divided into the three levels of 44 or below (red: snowy and icy), from 45 to 59 (yellow: intermittent) and 60 or over (green: bare pavement). As the ratio of each road condition's appearance was computed for the road section at 100-m intervals, the values do not correspond exactly to the locations of the road structures. Nonetheless, it can be seen that the ratios for intermittently snowy-icy and snowy-icy road conditions were markedly higher in the mountainous area of the road during January of the years in question.

The ratio of intermittently snowy-icy appearance was the highest in the section between the tunnel mouth near KP 38.0 and the Nakayama Pass. This can be attributed to the fact that road surfaces in this area are prone to snow and ice accumulation even during the daytime

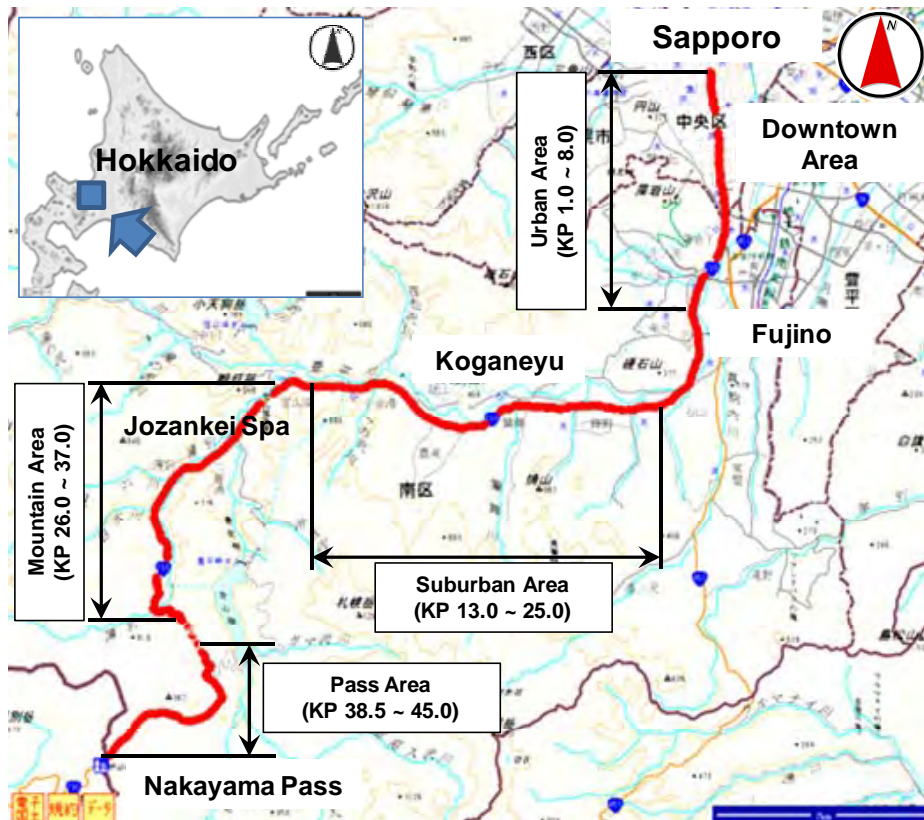


FIGURE 6 National Route 230 (KP 1.0 ~ KP 45.0 section).





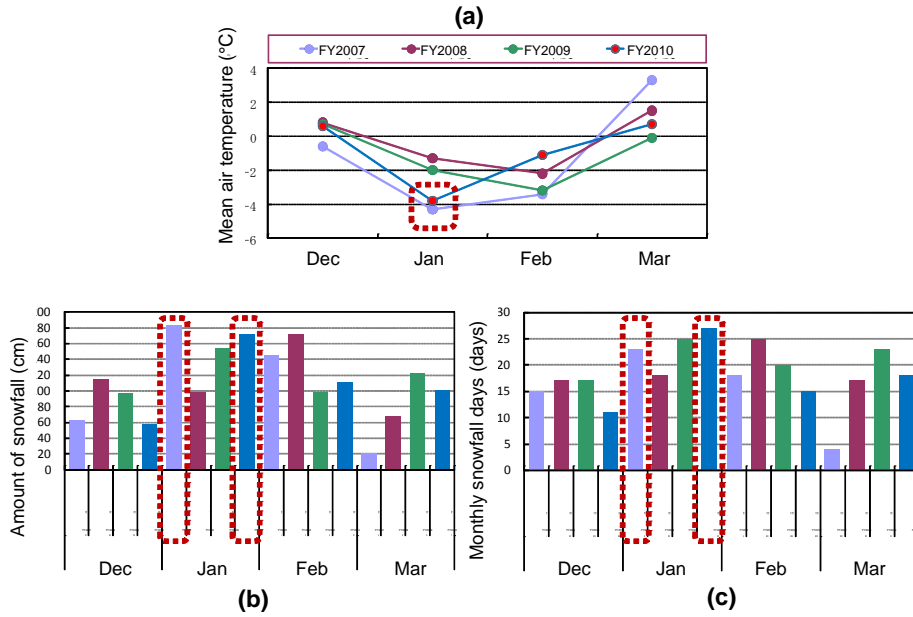
**FIGURE 7** Appearance ratios of road surface conditions (friction) on National Route 230 during January of 2008, 2009, 2010, and 2011.

because sunlight is blocked by mountain slopes and other obstacles in addition to the high-altitude conditions of the mountainous area. RSC often change suddenly in the underpass and near the tunnel's mouth. These results are expected to be useful in preventing unnecessary road treatment and identifying sections in need of attention as part of efforts to implement appropriate winter road management.

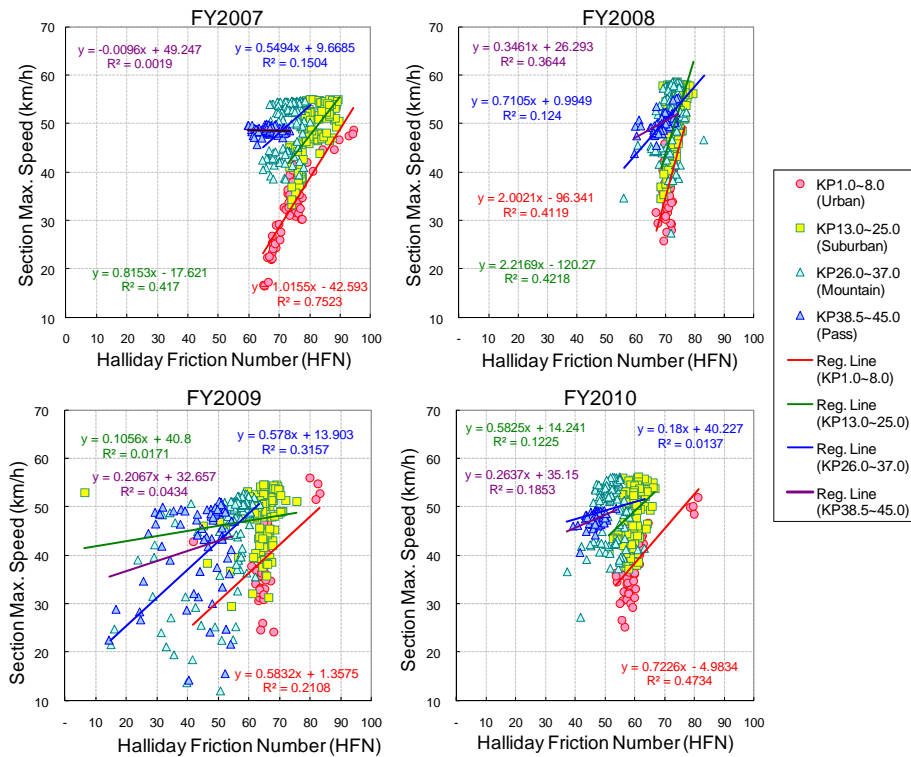
The evaluation results for January of the four winter seasons shown in the figure indicate that the frequency of each road surface condition varied by year. A factor influencing this seems to be the different measuring wheels used in the friction monitoring tests conducted each winter, but varying meteorological conditions from one winter to another also had an impact, as shown in Figure 8. Comparison of figures from January of FY 2007 with those from January of FY 2010, which show similar monthly values for mean air temperature, cumulative snowfall, and the number of days with snowfall, indicates that the appearance ratio for HFN values of 60 or below was significantly higher in FY 2010. As mentioned in the introduction to the present paper, this may have been influenced by a revision of the criteria for snow removal operations, deicing agent application, and other measures resulting from budget cuts to road maintenance in FY 2010. Accordingly, further analysis will be performed on newly collected maintenance records and other data.

### Winter Traffic Characteristics

National Route 230 was divided into four areas: urban (daytime traffic volume in winter: approximately 22,000 vehicles), suburban (daytime traffic volume in winter: approximately 8,000 vehicles), mountainous, and pass (daytime traffic volume in winter: approximately 5,000 vehicles) sections. The distributions of mean HFN values and CFT towing vehicle speeds (maximum values) in each area for the four winters from FY 2007 to FY 2010 are shown in Figure 9.



**FIGURE 8 (a) Monthly mean air temperature (°C), (b) monthly cumulative snowfall (cm), and (c) monthly number of days with snowfall (days). (Source: Sapporo District Meteorological Observatory.) (7).**



**FIGURE 9 Distribution of mean HFN and interval maximum speed on National Route 230 (urban, suburban, mountainous, and pass areas) during the four winter seasons.**

Although yearly meteorological and road condition variations (for example, several roadwork on the study section were conducted during winter of FY 2009) seem to have resulted in distribution pattern differences, the figure indicates that reduced HFN values generally coincided with reduced speeds. Area-based investigation of values reveals a trend by which speed reductions in relation to reduced HFN values diminished as vehicles moved from the urban area to the pass area. This is considered to have been influenced by the number of signalized intersections and the distances between them, as well as by traffic volumes and other conditions varying among areas. In the winter of FY 2010, when the appearance of snowy and icy road surface conditions was the most frequent among the four winters, HFN values were generally distributed between 40 and 65, which was lower than the distribution ranges for FY 2007 and FY 2008 in particular. In terms of the relationship between reduced HFN values and lower travel speeds (especially in the urban area) for FY 2007, when the ratio of the appearance of snowy and icy road conditions was the highest among the four winters, the reduction in speed was less than that seen in FY 2010, when similar meteorological conditions were observed. As the reasons for this difference have not yet been clarified, further analysis in consideration of road structures, traffic management and other factors is needed.

The above results indicate that the magnitude of impacts on trends of road surface conditions and travel speeds depends on meteorological conditions and regional characteristics. Accordingly, the study outcomes are expected to be useful in establishing and studying the validity of new road management standards and in setting measures and implementation frequency for individual roads and regions.

## CONCLUSIONS AND FUTURE STUDIES

With the goal of establishing and proposing an effective, efficient winter road surface management method based on winter road performance evaluation, CERI formulated a logic model to enable the assessment of related management performance. It also worked to clarify the characteristics of winter road surface condition variations with meteorological changes based on continuous evaluation and cumulative data collected during winter FY 2007 and subsequent winters on National Route 230 in the Sapporo region using friction values (HFN) as an intermediate outcome of the model. Further, the authors analyzed the relationship between winter road surface conditions and winter road traffic characteristics, thereby demonstrating the feasibility of this winter road performance evaluation approach.

For the development of technology to enable the assessment of criteria for road surface conditions based on winter road performance evaluation in cooperation with road administrators, friction values obtained before and after the implementation of various measures will be continuously monitored and accumulated. Studies with increased levels of practicality will also be conducted based on the clarification of winter road surface trends and the identification of road areas and conditions where attention is required in consideration of meteorological, traffic, road structure, and other conditions.

## REFERENCES

1. *Snow Removal Operations on National Highways in Crisis: Record 20% Cut in Road Maintenance Budgets*. The Hokkaido Shimbun Press, 2010 (in Japanese).

2. Road Bureau, Ministry of Land, Infrastructure, Transport and Tourism. *Performance Management of Road Administration in Japan*. <http://www.mlit.go.jp/road/management/about.html>, 2006 (in Japanese).
3. Wallman, C.-G. The Winter Model: A Winter Maintenance Management System. *Transportation Research Circular E-C063: Sixth International Symposium on Snow Removal and Ice Control Technology*, Transportation Research Board of the National Academies, Washington, D.C., 2004, pp. 83–94.
4. Takahashi, N. A Study on Advanced Winter Road Management in Cold Snowy Regions. Academic dissertation. Hokkaido University, 2010 (in Japanese).
5. Halliday Technologies. <http://www.hallidaytech.com>. Accessed 2011.
6. Funahashi, M., R. Tokunaga, N. Takahashi, and S. Kasai. A Study on Winter Road Surface Friction Measurement Testing. *Hokkaido-no-Seppyo*, No. 27, 2008, pp. 57–60 (in Japanese).
7. Sapporo District Meteorological Observatory, Japan Meteorological Agency. *Climate Statistics*, <http://www.jma-net.go.jp/sapporo>. Accessed 2011 (in Japanese).

## WINTER MOBILITY AND MAINTENANCE PERFORMANCE

**Simulating Winter Maintenance for Performance Measurement****JOHN J. MEWES****JEFFREY KUNTZ****BENJAMIN W. HERSHEY***Meridian Environmental Technology, Inc.*

**A common problem for transportation agencies performing winter maintenance is adequately measuring the effectiveness and efficiency of winter maintenance operations. A lack of quantifiable data hinders an agency's capability to improve the effectiveness and efficiency of winter maintenance operations. The current practice for many agencies is to use or create winter severity indices to measure whether or not the overall efficiency of maintenance operations has improved relative to historical norms. However, when deviations from historical norms are noted, it is difficult to know whether (weather-normalized) changes in resource utilization are the result of changes in maintenance efficiency and effectiveness, or limitations of the underlying winter severity index. One promising new approach is to leverage maintenance information decision support technologies being developed and deployed to support real-time winter maintenance decision making. Technologies such as the Pooled Fund Study (PFS) Maintenance Decision Support System (MDSS) can be re-tasked to simulate likely maintenance requirements (resource utilization) and expected maintenance outcomes (road conditions) on a particular maintenance route given input-observed weather conditions and maintenance resource constraints. This simulation capability, applied over an extended time, promises to provide a new understanding of the relationships between weather conditions, roadway characteristics, resource constraints, and the resulting maintenance resource utilization and road conditions. This paper will provide an overview of current efforts to apply the PFS MDSS to the problem and will include an overview of the obstacles encountered and preliminary results of the concept in several locales across the United States.**

**A** common problem facing agencies involved in the practice of winter maintenance is the difficulty of measuring the effectiveness and efficiency of winter maintenance operations. Temporal and spatial variability in weather, resource constraints, and expected level of service, along with a general lack of quantifiable information on the results of maintenance activities, all conspire to make it exceedingly difficult to objectively measure performance. This lack of quantifiable data hinders an agency's capability to improve the effectiveness and efficiency of winter maintenance operations.

The current practice for many transportation agencies is to measure broad scale efficiency by developing statistical relationships between historical weather conditions and the resources expended when maintaining roads in the presence of those weather conditions. These relationships are often referred to as winter severity indices. Once developed, these indices can then be applied in future years to measure whether or not the overall efficiency of maintenance operations has improved relative to historical norms. However, when deviations from historical norms are noted, it is difficult to know whether normalized increases or decreases in resource utilization are the result of changes in efficiency, effectiveness, or limitations of the underlying winter severity index. Further, since the relationship between

weather conditions and winter maintenance needs are functions of a given roadway's level of service, traffic patterns, environment, and local maintenance resource constraints, such simplified winter severity indices provide little insight into the justifications for spatial variability in winter maintenance effectiveness or efficiency over the same time period.

Given the importance of the information and the inherent limitations of traditional winter severity indices, a new approach is in order. One promising new approach is leveraging maintenance information decision support technologies being developed and deployed to support real-time winter maintenance decision making. These technologies, broadly referred to as Maintenance Decision Support System (MDSS), generally possess an ability to simulate the maintenance response required for a particular maintenance route given the weather conditions it is exposed to. In particular, the Pooled Fund Study (PFS) MDSS possesses an ability to simulate the likely maintenance requirements (resource utilization) and expected maintenance outcomes (road conditions) given input weather conditions and maintenance resource constraints. This simulation capability, applied over an extended time, promises to provide a new understanding of the relationships between weather conditions, roadway characteristics, resource constraints, and the resulting resource utilization and road conditions. Meridian Environmental Technology, Inc., as the research and development contractor for the PFS MDSS, has recently begun to explore this potential application of the MDSS technologies.

## APPROACHES TO NORMALIZING FOR WINTER SEVERITY

The goal of this document is not to provide the specifics of historical approaches to quantifying winter severity, but rather to identify the underlying classes of approaches that have been taken and their relative merits and limitations. Meridian's previous work in this area has revealed at least four distinct approaches (though these classes of approaches have not been formally named previously by the industry):

1. Expert-based classifications of maintenance demand;
2. Statistical classifications of maintenance demand;
3. Expert-based, statistically tuned, classifications of maintenance demand; and
4. Model-based classifications of maintenance demand.

Each class of approach has strengths and weaknesses, as highlighted below.

One class of approach may be labeled as expert-based classifications of winter maintenance demand (1–3). They are based on experts' experience working with weather–maintenance relationships over numerous years. The primary strengths of expert-based classifications of winter maintenance demand are that they can be relatively simple to implement, can be developed in the absence of quantitative historical maintenance data, and—through the experts' understanding of the problem—can be designed for specific data normalization applications. However, since these approaches typically involve the application of substantially simplified relationships between (already simplified) weather data and the maintenance impacts of those weather conditions, the degree to which such indices or classifications can explain the variance in maintenance resource utilization is often limited.

Statistical approaches represent a second class of approach to quantifying winter severity. Most solutions use some form of statistical regression technique or neural network to quantify the level of influence of each weather parameter (4–6). Statistical approaches to classifying winter maintenance demand associated with weather conditions can be more difficult to develop than expert-based approaches, and typically require considerable additional data collection and quality control. However, they have the potential to improve upon expert-based approaches because the relationships between the weather and maintenance data may be much more complex, and may be based on actual relationships between recorded weather and maintenance datasets. This typically permits statistical approaches to winter severity to explain a larger portion of the variance in maintenance resource utilization over time.

A third option is expert-based, statistically tuned approaches (7). The class is an extension of the second class; it permits adjustment or configuration of, for example, coefficients within the statistical equation to more effectively represent the relationship between the weather variables and the maintenance outcome. Since this technique is a derivation of the approaches above, it exhibits similar advantages and disadvantages of those two classes. For example, if the general nature of the relationship between a causal weather-related quantity and the associated maintenance impact is well understood, the form of the relationship can be fixed within the index so as to be realistic—yet the relationship can be tuned to fit actual data through manipulation of specific equation coefficients and exponents. On the other hand, the approach then requires detailed maintenance and weather data to support the statistical tuning, and the simplicity advantage of the expert-based approach is diminished.

Finally, a fourth class is represented by model-based approaches to classifying winter maintenance demand. They represent a relatively new conceptual perspective that uses simulation of maintenance activities in response to actual recorded weather events, typically at a time interval of one hour or less. This class of approach requires considerable infrastructure for modeling the relationships between weather, road conditions, and maintenance activities, and as such is not feasible for many agencies. In fact, there are only two known examples of this type of approach: the Swedish Winter Model (8) and the present efforts building on the modeling capabilities of the PFS MDSS.

Historically, there are at least two obstacles that have likely prohibited application of this type of approach. First, the level of detail required in the weather datasets applied is far beyond that required for more traditional approaches. Some of the necessary weather parameters are not typically even measured directly by the meteorological community on a broad scale (e.g., solar and infrared radiation). Second, developing a system that can simulate the interactions between weather conditions, traffic, maintenance activities, and road conditions is an onerous task. In spite of these obstacles, once developed, these approaches can explicitly simulate the road condition and maintenance impacts of each and every weather event.

The problem of oversimplification of the basic relationships that is present in the aforementioned approaches is therefore greatly diminished. In spite of the ability to better represent the complexity of the relationships between weather conditions and maintenance activities, the relationship between (weather-based) causes and maintenance effects is much clearer in these model-based approaches. While there is no way to statistically tune the raw data resulting from the simulation process to better match actual data recorded by an agency,

the simulation process typically contains a degree of configurability on simulation constraints that may permit tuning of the simulation process to better match agency practices. (Note that it would also be possible to develop statistical relationships between maintenance records and the raw data coming out of the simulation process, although the clarity of the cause–effect relationship would be lost at that point.)

The model-based approach offers two other distinct advantages over more traditional approaches. First, since the simulation process yields information on both road conditions and maintenance activities, there is an inherent ability to control for outcome. In other words, while traditional approaches may yield relationships between weather conditions and maintenance resource utilization, they typically do not provide for an understanding of the outcome associated with increased or decreased maintenance resource utilization. If more (less) resources are being used on one route versus a neighboring route, it is naturally assumed the maintenance operations have been less (more) efficient. However, this may be a very poor assumption without corresponding knowledge of the road conditions that resulted on the neighboring routes relative to desired agency standards, or without an understanding of the relative operating constraints placed on each maintenance route.

Second, different environments and approaches to maintenance may yield different maintenance resource utilization responses from similar weather conditions. This is borne out by studies that have found that relationships developed for agencywide application often do not correlate well with sub-agency level data (4), or with data from peer agencies when applied in their respective domains. When this occurs, traditional approaches offer no recourse for gaining a better understanding of the sub-agency or agency-to-agency variations, which inherently limits the ability to use these measures for identification of best practices within the individual elements of an agency (or between agencies). To the extent that the real-world deviations in maintenance approach can be configured into the model-based simulation system, and the simulated impact of those deviations can be demonstrated to be realistic, the model-based approach offers the prospect for spatial applications of the resulting indices for purposes such as identifying best practices.

One particular advantage traditional approaches may have over the model-based approach is that they are more amenable to the use of agency-collected weather data, such as storm reports filled out by agency personnel. The level of detail in the weather information required by model-based approaches is beyond that which maintenance personnel typically record during storm events. One reason the use of agency storm reports is attractive is that they may have spatial resolution superior to more objective weather observing equipment. Further, since these records typically only exist for weather events that required maintenance, there is a higher likelihood the data will correlate well with agency maintenance resource utilization data than there is for more objective data from a weather station. While these advantages are real, they can also act to significantly degrade the usefulness of the analysis, as the weather-rooted performance measure is no longer objective and spatially consistent. The Wisconsin Department of Transportation (DOT), for instance, has noted that this problem may lead to discrepancies with their index (9), particularly in cases where one crew chooses to call out forces for a minor event whereas a neighboring crew does not—thereby leading to more weather events and a more severe winter for the crews that tend to call out forces more often.

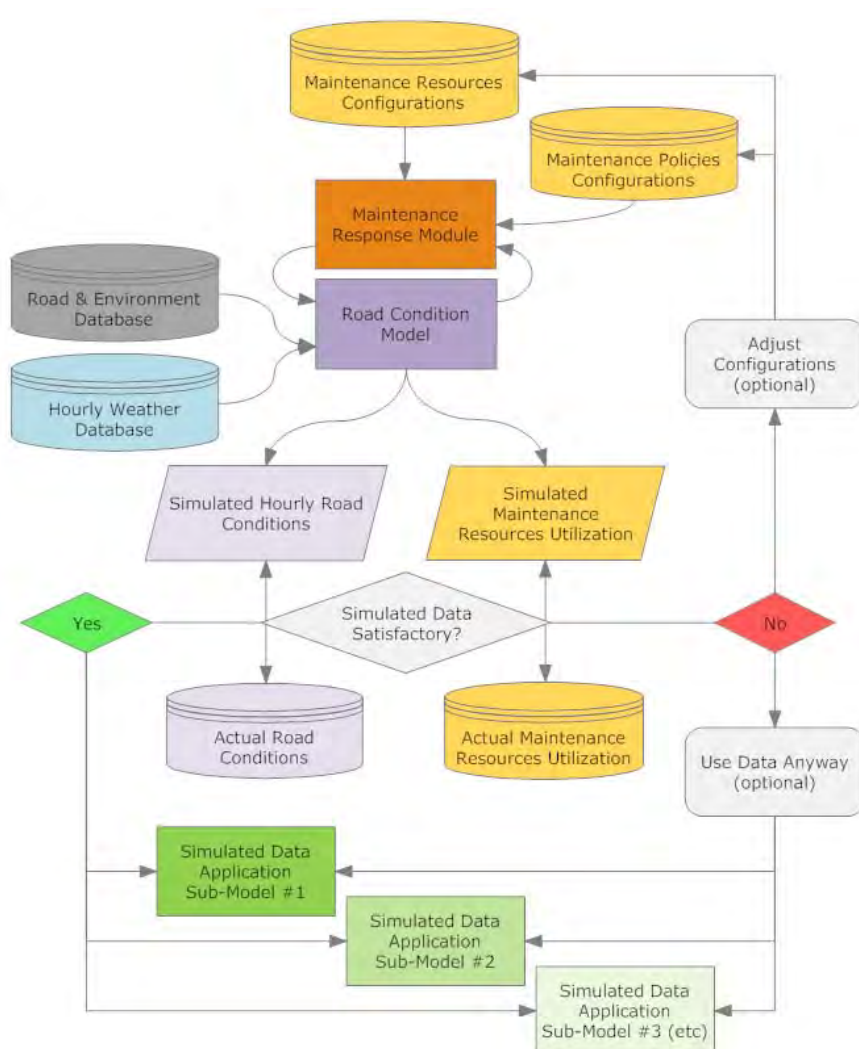


## SIMULATING WINTER MAINTENANCE WITH THE PFS MDSS

### Simulation Process Overview

Under the model-based approach, the weather conditions over a potentially lengthy period of time are defined at an hourly level using a variety of meteorological data resources. Using a road condition model, this weather information can be transformed into road conditions over time, influenced by the prior road condition, weather conditions, maintenance actions, and traffic. The resulting data can then be used to estimate the impacts on road users, road administrators, and the environment.

A schematic of the model-based approach using the PFS MDSS is provided in [Figure 1](#). Weather, road, and environmental databases are used as inputs to a road condition model. The output of this road condition model, as well as the detailed time-series of weather data, are used by modules that prescribe maintenance actions appropriate for the situations that are



**FIGURE 1** Schematic of the PFS MDSS simulation system as it pertains to simulating winter maintenance to facilitate performance measurement.

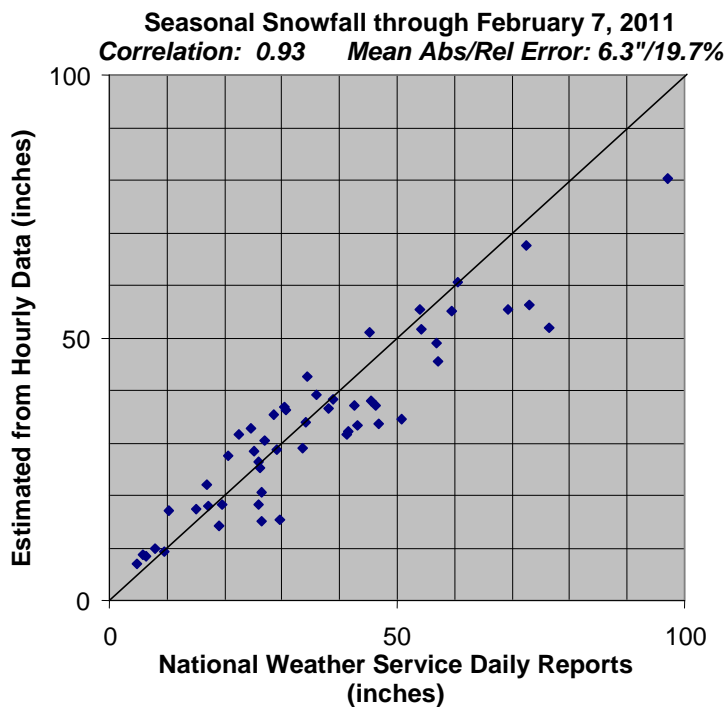
detected in the weather and simulated road condition data. The PFS MDSS system can be configured to either use rule-based approaches to determining the appropriate maintenance response for each situation or to create dynamic maintenance prescriptions based on available maintenance resources as defined for the simulation location. The resulting weather, road condition, and maintenance data can then be applied in various sub-models that explore the relationships between simulated and real-world costs and conditions. There are a wealth of potential applications for data resulting from the ability to simulate the winter maintenance process, but developing these applications will take considerable time and research.

From the perspective of a winter severity or maintenance demand index, the important distinction of the model-based approaches is that they yield an explicit simulation of the maintenance activities required to address the weather and road conditions each maintenance route is exposed to rather than attempting to draw expert-based or statistical relationships between simplified representations of the weather conditions and maintenance activities. While the resulting data can be used as the basis for one or more specific indices intended to normalize specific aspects of winter maintenance resource utilization, the simulated data itself is the unique building block offered by this class of approaches, as it removes the mystery from the relationships between weather, road conditions, and maintenance activities. The relationships between cause and effect become more clearly identifiable.

### **Weather Data Acquisition and Processing**

The model-based approach requires a very detailed record of weather conditions. This requires (at least) hourly records of commonly-observed weather parameters such as temperatures, humidity, and winds, as well as a number of less-readily observed (or completely unobserved) weather parameters such as downwelling solar and infrared radiation, blowing snow fluxes, and wintertime precipitation rates. The manner in which this information is acquired or generated is situation dependent. For PFS MDSS applications, Meridian has developed processes for tapping the wealth of real-time weather information that is presently available for current-season simulations. As time passes, this wealth of data permits a high-accuracy assessment of seasonal weather conditions on each maintenance route. However, for historical context, processes have also been developed to extract the required data out of archived National Weather Service (NWS) hourly Meteorological Aviation Reports (METAR) as well as the North American Regional Reanalysis dataset from the National Centers for Environmental Prediction.

One troublesome problem that is encountered under the model-based approach is an extreme lack of observations of hourly snowfall, a quantity which is vitally important to the winter maintenance simulation processes. The NWS does provide daily snowfall measurements at select locations across the United States, but this data is of inadequate spatial and temporal resolution relative to the needs of the simulation process. To address this problem, Meridian has developed a suite of algorithms for post-processing the information collected by more commonly available sensors in order to estimate hourly snowfall rates. A comparison of the NWS' measured seasonal snowfall amounts and the estimated snowfall amounts from this suite of algorithms is provided in [Figure 2](#), where the hourly estimation technique is shown to exhibit excellent correlation and very little bias relative to the official, daily NWS measurements at the few locations where such NWS measurements are available.



**FIGURE 2** A comparison of snowfall totals as estimated using snowfall estimation algorithms, applied to widely available hourly weather station data, against daily measurements taken by professional, paid observers at select locations across the country.

Another important shortcoming of all broadly available weather records, including the METAR data, is the lack of reliable information regarding the occurrence of drifting snow. Drifting snow is a major factor in winter maintenance operations across a broad swath of the United States, so it is essential that it be considered when attempting to define winter severity from a maintenance perspective. Parallel bodies of work within the MDSS PFS have provided algorithms for post-processing the detailed METAR weather records in order to estimate and track both the depth of blowable snow and its propensity to blow in the presence of varying wind speeds. The end result of application of these post-processing algorithms is an hour-by-hour estimate of the horizontal flux of blowing and drifting snow at locations where no such observation is available.

### Road Condition Model

A key premise of the PFS MDSS system, and the simulation approach used in this study, is that the behavior of the mixture of water, snow, ice, and freeze point depressants (the dynamic layer) atop the roadway is predictable. Predicting its characteristics and evolution requires a great deal of sophistication. A key enabling technology for the PFS MDSS was the development of Meridian's HiCAPS pavement condition prediction model, a mass and energy balance model that possessed a proven ability to simulate the characteristics of the dynamic layer. To allow its use in maintenance decision support, the HiCAPS model has tapped additional modules developed during the PFS MDSS project. The processes modeled by the PFS MDSS, many

through the HiCAPS model, are listed in [Table 1](#). Functions for modeling traffic and the effects of freeze-point depressing chemicals placed atop the roadway are newly developed during the Pooled Fund Study, and are held in a library of MDSS-related functions accessible by the HiCAPS model.

### Simulated Maintenance Response

Appropriate maintenance responses to each encountered situation can be assessed by the PFS MDSS software using one of two available modules. Standard or best practices for an agency are the predominant means of providing guidance to operators on how to approach maintenance in various situations. This type of guidance may be referred to as an analogue approach in that guidance is made by drawing analogies to what has been proven to work in similar situations in the past. One approach to generating maintenance responses to encountered conditions in MDSS is the computerization of these policy documents using what may be referred to as the standard practice module. Since these documents have been generated based on proven experiences over time they generally provide a safe, but not necessarily optimal, approach to maintenance. When using this module, MDSS is not provided the authority to stray from standard practice in such a situation. It simply models the impacts of the prescribed maintenance treatment and then uses the same module to prescribe additional later treatments as necessary.

While field proven and typically a safe response, the standard practice approach also has drawbacks. One of the most significant is an oversimplification of situations. While road conditions may vary substantially due to traffic, environmental, or other subtle considerations,

**TABLE 1 Capabilities of the HiCAPS Model Used as the Pavement Model of the PFS MDSS Modeling System**

<b>Processes Modeled Within the PFS MDSS Modeling System</b>	
Evaporation (mass/energy balanced)	Condensation (mass/energy balanced)
Sublimation (mass/energy balanced)	Frost Formation (mass/energy balanced)
Conduction of heat from precipitation	Internal heat conduction within pavement
Traffic splatter, splash, spray, compaction	Snow/ice removal by plow
Natural phase changes	Chemically induced phase changes
Heat exchange between air and pavement	Emission of infrared radiation by pavement
Absorption of solar and infrared radiation	Time-varying pavement reflectance
Insulating effects of snow and ice buildup	Condition-dependent snow adherence
Variable freeze points	Water and chemical runoff
Chemical dilution	Chemical removal by traffic
Residual chemical amounts and effects	

<b>Other Special Features of the PFS MDSS Modeling System</b>
Explicit calculation of liquid, ice, frost, compacted snow, and snow depths on the road, allowing for mixed conditions such as slush
Support for modeling the effects of freeze-point depressing chemicals
Highly configurable pavement and maintenance equipment specifications
Coupled mass and energy balance
Support for modeling the effects of reported and proposed maintenance actions

these types of variances are not typically accommodated by Standard Practice approaches to maintenance. Standard Practice guidance also typically leaves the ongoing response to a storm after the completion of the first maintenance action rather vague. Also problematic is the fact that many agencies are exploring the use of new chemicals, and there is little or no existing basis upon which the agency can draw to prescribe how these new chemicals should be used. Because of these and other considerations, the PFS MDSS has also pursued a parallel approach using what may be referred to as the dynamic maintenance response module. In this approach the characteristics of the dynamic layer, as compared to a configurable goal for its condition, are used as the basis for prescribing maintenance actions. When a condition requiring maintenance is detected, the MDSS can look at crew schedules, available materials, and forthcoming weather and traffic conditions to identify the maintenance approach and timing most likely to yield favorable results. The system accomplishes this by identifying one or more candidate maintenance actions that will adequately maintain the road from a safety and mobility point of view, then selecting the optimal response, which most effectively maintains that desired condition based on cost, environmental impact, and other considerations.

### **Simulation Output**

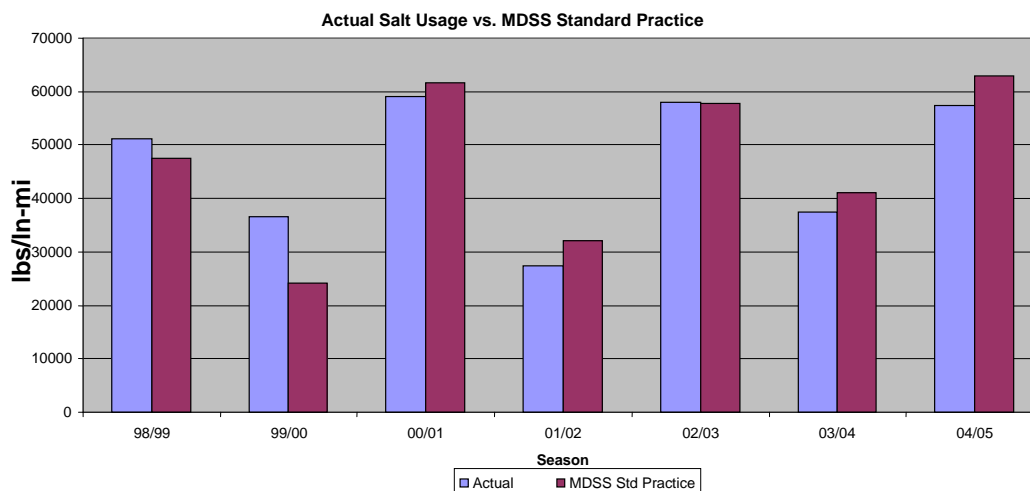
The end results of the simulation process are three datasets: an hourly-resolution time series of weather conditions; road conditions and temperatures, throughout the simulation period; and a listing of the specific maintenance activities that the corresponding MDSS module determined as needing to have been applied to achieve those conditions. The simulated road conditions and maintenance activity information can then be compared to actual agency records to facilitate performance measurement.

## **INITIAL APPLICATIONS**

### **MDSS Cost–Benefit Study Support**

Due to serious limitations in the data available to support a cost–benefit analysis, the approach taken in the Western Transportation Institute’s cost–benefit study for deployment of the PFS MDSS was to use the available data wherever possible and then to fill in the missing information using a simulation approach. In this simulation approach, historical weather information was provided to the PFS MDSS modeling system, which then simulated both the road conditions and maintenance activities necessitated by those weather conditions using MDSS’ Standard Practice module. The resulting road condition and maintenance data were then compared to actual agency records for the same time period, and used to establish a more fully populated control dataset against which MDSS’ Dynamic recommendations could be evaluated.

The cost–benefit study was carried out in three distinct locations across the United States. These locations were selected to explore the potential benefits of MDSS in terms of geography, weather regimes, traffic volumes, and maintenance approaches, among other things. Given the stated data availability of the PFS MDSS member states it was determined that the study’s simulations should focus on one or more routes in each of New Hampshire, Minnesota, and Colorado. Further details on the specifics of the cost–benefit study, and the details of the simulations performed, are available in the final report of the study (10). [Figure 3](#) below provides



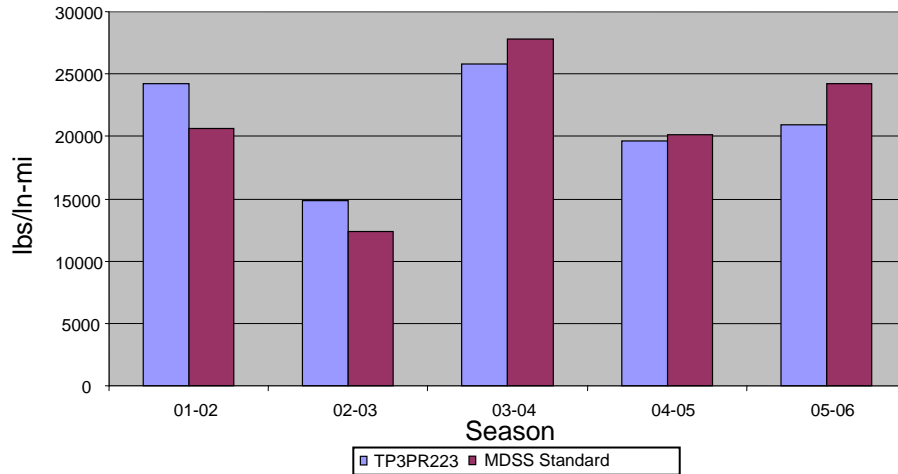
**FIGURE 3** A comparison of the historical annual salt usage on New Hampshire DOT maintenance patrol M528 with simulated salt usage as derived from the MDSS standard practice module.

an example of the comparison of the simulated winter maintenance data to the New Hampshire DOT's actual resource utilization data for the corridor selected for the cost-benefit study (M528). An annual correlation in seasonal salt usage of 0.91 was achieved between the M528 records and the standard practice simulation data for the 1998–2005 period. Simulated salt usage averaged 94% of actual salt usage over this same period. Over the period spanning the last five full seasons of data available to the cost-benefit study, 2000–2005, the correlation between the actual and simulated salt usage increased to 0.99 and the average annual salt usage was within 0.1% of actual salt usage over the period as a whole.

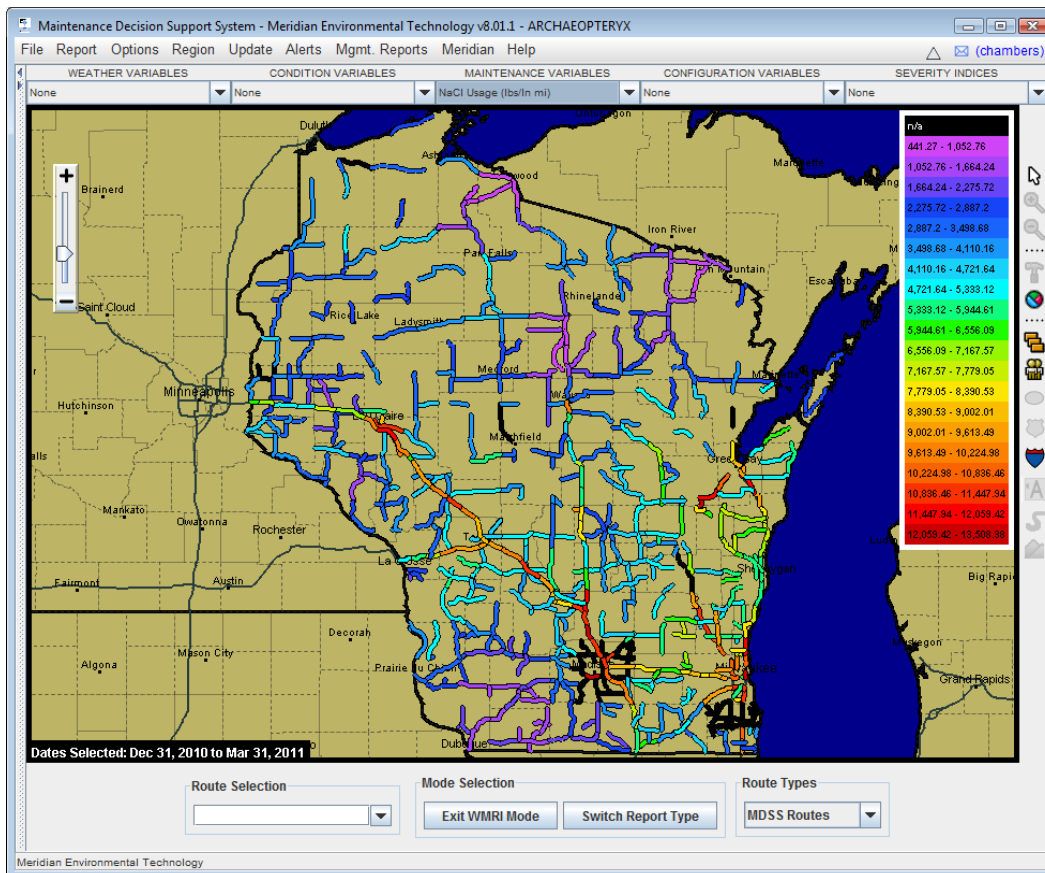
Similar results were obtained when comparing a standard practice simulation against resource utilization data for selected routes maintained by the Minnesota and Colorado DOTs (see example for Minnesota DOT route TP3PR223 in [Figure 4](#)).

### MDSS Winter Maintenance Response Index Tool

The multi-year simulations discussed above are presently performed offline, with the resulting data made available to support the analysis desired by the user. For agencies with MDSS deployments, a similar, real-time capability is also available for a rolling window of time via a graphical user interface associated with a suite of management-oriented tools. This tool permits ongoing storm-by-storm and season-to-date assessments of agency resource utilization data relative to the corresponding simulated data for the same period of time. The interface provides both time-series and map-based presentations of the simulation data, as well as data export tools (see [Figure 5](#)). A calculator tool is also available, permitting agencies to combine multiple parameters (both simulation input and output parameters) together via an equation editor and thus visualize more complex relationships present within the data. The calculator tool also permits the calculation and visualization of other, more traditional winter severity measures, to the extent that the parameters utilized in those measures are available within the tool.



**FIGURE 4** A comparison of the historical annual salt usage on Minnesota DOT maintenance route TP3PR223 with simulated salt usage as derived from the MDSS standard practice module.



**FIGURE 5** A real-time simulation capability is available for post-storm and season-to-date performance measurement applications.

## FUTURE WORK

The range of possible applications of a winter maintenance simulation capability for facilitating performance measurement is immense. However, many complex issues remain to be resolved. One particular troublesome problem that has been the focus of considerable research to date has been the need to understand and adjust for the tendencies of individual weather stations that provide the data that underlies the simulations. Research into this issue has revealed that neighboring weather stations often have substantially different responses to the same weather conditions. Some of these differences are random, others are more systematic (such as significant sensitivity differences between different precipitation sensors used in the various weather observing networks). These weather station biases can impact the entire simulation process, potentially leading users of the data to erroneous conclusions if the data are not treated properly.

Another complex issue is data validation. While the agreement that has been found between simulated and actual agency resource utilization data is encouraging, when differences arise it is very difficult to understand why. In many cases, maintenance policies and practices may be varying over time, or between locations, in ways that are difficult to quantify. Given the complexity of the problem, there are also almost certainly still numerous shortcomings in the simulation system that will need to be identified and addressed over time. A substantial body of field research may be necessary in order to better quantify the nature of road weather processes.

## REFERENCES

1. Marquis, B., V. Nouhan, S. Colson, and J. Payeur. A Winter Severity Index for the State of Maine. Technical Report 09-1. Maine Department of Transportation Research Division, 2009.
2. Nixon, W. A., and L. Qiu. Developing a Storm Severity Index. In *Transportation Research Record: Journal of the Transportation Research Board*, No. 1911, Transportation Research Board of the National Academies, Washington, D.C., 2005, pp. 143–148.
3. Rissel, M. C., and D. G. Scott. Staffing of Maintenance Crews During Winter Months. *Transportation Research Record 1019*, TRB, National Research Council, Washington, D.C., 1985, pp. 12–21.
4. McCullough, B., D. Belter, T. Konieczny, and T. McClellan. Indiana Weather Severity Index. *Transportation Research Circular E-C063: Sixth International Symposium on Snow Removal and Ice Control Technology*, Transportation Research Board of the National Academies, Washington, D.C., 2004, pp. 167–178.
5. Gobeli. Winter Weather Severity Index: MnDOT (Wisconsin) Index Rebuild. Internal MnDOT Presentation, 2009.
6. Carmichael, C. G., W. A. Gallus Jr., B. R. Temeyer, and M. K. Bryden. A Winter Weather Index for Estimating Winter Roadway Maintenance Costs in the Midwest. *Journal of Applied Meteorology*, Vol. 43, 2004, pp. 1783–1790.
7. Boselly, S. E., III. Road Weather Information Systems: What Are They and What Can They Do for You? In *Transportation Research Record 1387*, TRB, National Research Council, Washington, D.C., 1993, pp. 191–195.
8. Wallman, C. G. The Winter Model: A Winter Maintenance Management System. *Transportation Research Circular E-C063: Sixth International Symposium on Snow Removal and Ice Control Technology*, Transportation Research Board of the National Academies, Washington, D.C., 2004, pp. 83–94.
9. Adams, M. J. Winter Severity Index. Wisconsin DOT Internal Document, 2001.



10. Ye, Z., C. Strong, X. Shi, S. Conger, and D. Huft. Benefit–Cost Analysis of Maintenance Decision Support System. *Transportation Research Record: Journal of the Transportation Research Board*, No. 2107, Transportation Research Board of the National Academies, Washington, D.C., 2009, pp. 95–103.

# Road Weather Data Management



## ROAD WEATHER DATA MANAGEMENT

**Using *Clarus* Data for Disseminating Winter Road Weather Advisories and Other Weather-Related Alerts****ROEMER M. ALFELOR****PAUL A. PISANO***Federal Highway Administration***DOUGLAS GALARUS***Western Transportation Institute***DAVID YOHANAN***Telvent USA Corporation*

FHWA's Road Weather Management Program worked with two contractors to demonstrate the use of *Clarus* data for disseminating road weather advisory and control information to travelers. One application, developed by Telvent Inc. and designed for the New York State 511 system (511NY) combines the road weather information from *Clarus* and other weather data sources to generate various weather alerts pertaining to snow, ice, winds, and other severe weather conditions, and posts these alerts on the 511NY website. The other application, developed by Western Transportation Institute, produced a website that displays weather and other relevant travel conditions for a four-state region that includes California, Oregon, Washington, and Nevada. For this one-stop shop, web portal users view a map that allows them to see a variety of information for a selected point along the roadway, including closed circuit television images, road closures, *Clarus* weather sensor readings, and National Weather Service forecasts. The web portal also offers route and trip planning tools. This paper describes the applications that have been developed and their effectiveness in disseminating road weather information. It also provides recommendations and some guidelines on how *Clarus* data can be used or improved for these types of applications.

The *Clarus* Initiative, started in 2004, is a multiyear program administered and funded by the U.S. Department of Transportation (DOT) through the FHWA Road Weather Management Program. The goal of the initiative is to create a robust data assimilation, quality checking, and data dissemination system that could provide near real-time atmospheric and pavement observations from the collective state's investments in road weather information system (RWIS), environmental sensor stations (ESS), and mobile observations from automated vehicle location-equipped trucks. The initiative also envisioned utilizing weather data collected from passenger vehicles equipped with transceivers, research that would be conducted under the Intelligent Transportation Systems (ITS) Joint Program Office's Connected Vehicles research initiatives. The ultimate objective is to provide information to all transportation managers and users to alleviate the effects of adverse weather (e.g., fatalities, injuries, and delays).

*Clarus* system design was completed in 2006 and the system was implemented via a proof-of-concept demonstration to ensure that the system components operated and interfaced properly. Following the proof of concept and actual development and deployment of the *Clarus*

System, FHWA proceeded with a 2-year regional demonstration focused specifically on deployment of *Clarus*-enabled services. The objectives of these regional demonstrations were

1. Demonstrate that the *Clarus* system functions as designed by providing incentives to a large number of states, provinces, and local agencies to contribute data from their ESS networks;
2. Enable proactive transportation system management through utilization of *Clarus* system data; and
3. Provide an environment for the private sector and academic organizations to innovate and create new and improved services that will benefit the public (both agencies and travelers), academia, and the weather enterprise.

State and provincial DOTs in the United States and Canada teamed up in response to the solicitation, and the following five use cases were selected for further development:

- Use Case 1: Enhanced road weather forecasting enabled by *Clarus*;
- Use Case 2: Seasonal weight restriction decision support tool;
- Use Case 3: Nonwinter maintenance and operations decision support tool;
- Use Case 4: Multistate control strategy tool; and
- Use Case 5: Enhanced road weather content for traveler advisories.

These projects provided new products and services that use *Clarus* data to support and enhance transportation agency operations. All projects were concluded in 2010 and an independent evaluation of the results was concluded in the spring of 2011.

Following the completion of these use cases, the DOT issued a broad agency announcement (BAA) for research projects to continue demonstrations of *Clarus* systems data use. This BAA specifically targeted the third objective above related to fostering development of innovative and improved tools and applications by academic institutions and private companies.

## **CLARUS RESEARCH PROJECTS**

In 2010, the U.S. DOT issued a BAA for research projects to develop additional tools and applications that utilize *Clarus* system data. Tools and applications would include interfaces, visualization systems, data validation techniques, decision-support systems, algorithms, dissemination systems, and more. It is expected that the new tool or application could be used by transportation agencies to support system operations and management or could be used to assist the public in making travel decisions when faced with adverse weather (e.g., rain, snow, sleet, wet pavement, snowy pavement, icy pavement, high winds, flooding, hurricanes, and more).

Under this BAA, the U.S. DOT sought to foster collaboration between transportation engineering, computer science, and atmospheric science disciplines and support research on the use of *Clarus* system data to develop new or improved road weather management and operations procedures; create innovative user interfaces; and develop new applications, including weather-responsive traffic management tools. The tools and applications developed from research must address a specific road weather management problem and be implementable by agencies that draw data from the *Clarus* system.

Eight contracts were awarded in the fall of 2010. The periods of performance for these projects are no more than 1 year, so most of them were completed in 2011. The research projects focused on a variety of applications including enhanced data integration and visualization, traffic management, transit information system, mobile data utilization, safety analysis, and real-time traveler information system. This paper describes two applications that were developed and evaluated pertaining to rural traveler information and 511 weather alerts.

## WESTERN STATES ONE-STOP SHOP FOR RURAL TRAVELER INFORMATION

### Overview and Purpose of the Western States One-Stop Shop

The primary goal of this FHWA project with the Western Transportation Institute (WTI) at Montana State University is to create a user-friendly website that integrates and displays weather and road condition information for a four-state region. To address the shortcomings of current web-based weather information sources for travelers, the website was designed to display multistate *Clarus* ESS data, along with other information streams as available, such as DOT ITS field elements, CCTV, planned and active closures, incidents, weather sensor readings from non-DOT sources, and National Weather Service (NWS) forecast information. Building on the original one-stop shop efforts in California, the region covered for this project would be extended to include all of California, Oregon, Washington, and Nevada.

The specific objective of this project was to integrate a variety of real-time information into a single web-based location and in a user-friendly format. The system would display weather information for the four-state region in a manner that is easily accessed and understood by users. This work demonstrated the use and presentation of *Clarus* data across multiple states in conjunction with other traveler information, providing travelers and agency personnel with a useful planning and management mechanism.

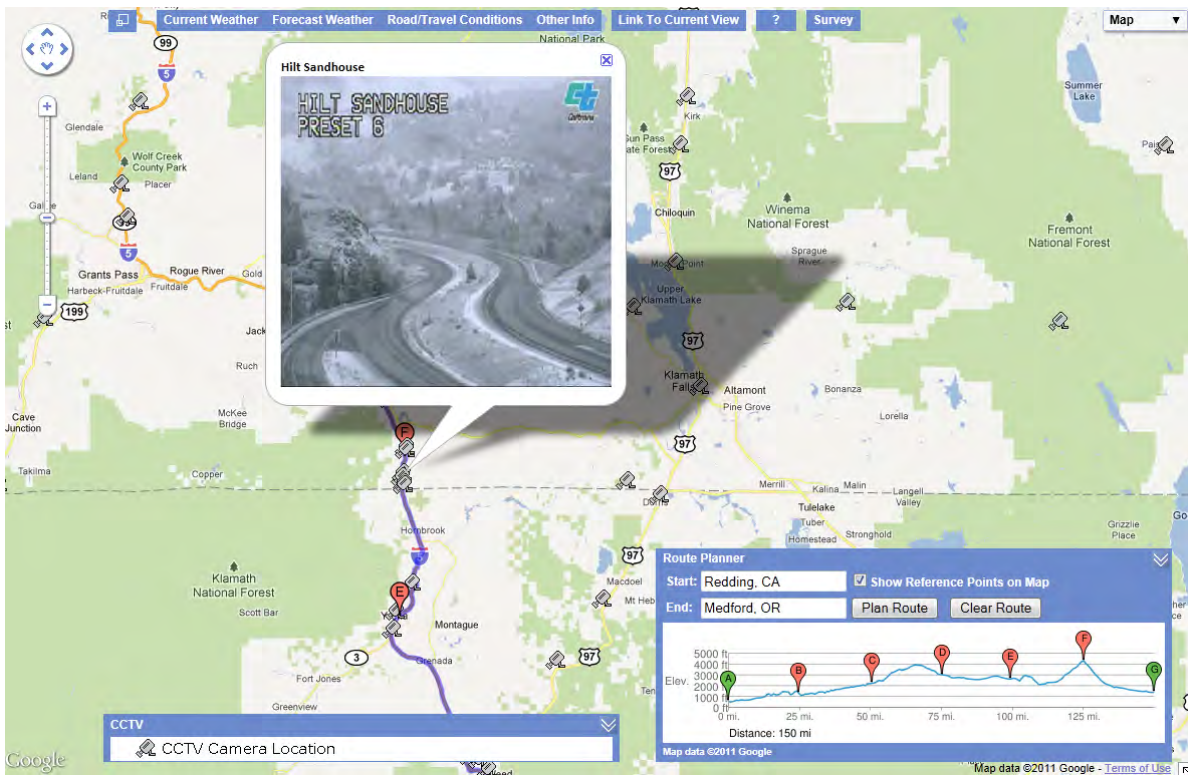
### System Functions and Modules

A web interface presents the Western States One-Stop Shop to users via a Google Maps display. Custom controls provide data layer selection, timeframe selection (where applicable), help, survey access, legend, and route-planner functionality. Users can generate a route between two points using the route planner. The system highlights the route on the map along with associated reference points, and shows an elevation profile for the route (see [Figure 1](#)).

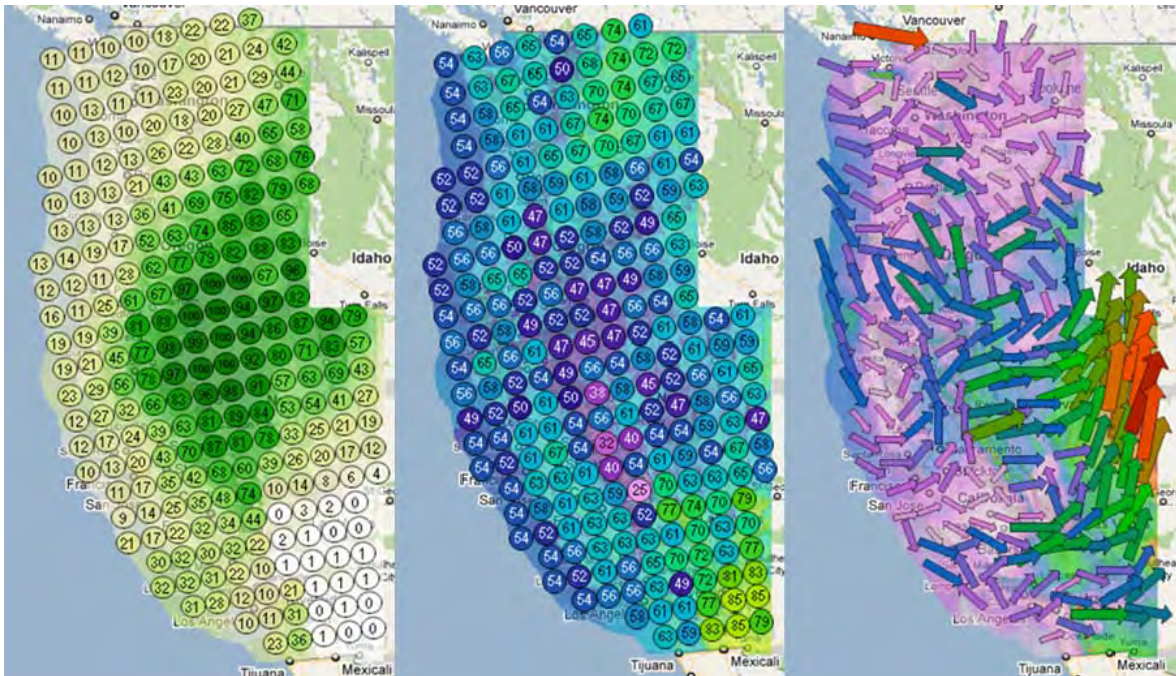
Weather forecast layers exemplify the design goal of information at glance—conveying information in an intuitive fashion so that it can be readily interpreted. [Figure 2](#) shows forecasts covering the four-state region.

### Data Requirements and Data Sources

To prepare for system development, the WTI project team classified prospective users of the Western States One-Stop Shop into four primary user groups: (a) long-distance travelers, (b)



**FIGURE 1 One-Stop Shop route planner and CCTV layer.**



**FIGURE 2 Weather forecast layers, information at a glance.**

local travelers, (c) goods movement, and (d) DOT personnel. The project team then identified available data sources to address the needs of these users. [Table 1](#) summarizes use and data coverage and availability.

### How *Clarus* Data Are Used

The Western States One-Stop Shop retrieves *Clarus* ESS data from the *Clarus* System via a subscription that is polled every 15 min. The one-stop shop presents only those ESS (RWIS) sites having data retrieved in the most recent feed.

RWIS sites are complemented in the system by other weather stations in proximity. For instance, air temperature readings from RWIS sites are shown in conjunction with air temperature readings from non-RWIS sites in the current air temperature layer, increasing the coverage and availability of readings.

### Applications

The principal application of the Western States One-Stop Shop is pre-trip planning. Travelers seeking real-time or near real-time weather and road conditions will also find utility in the system. Additional applications involve DOT maintenance and operations personnel monitoring road conditions in transportation management centers and other facilities. The system naturally serves as a research and development platform for the provision of multistate traveler information. The project team administers an ongoing survey of users and logs usage analytics

**TABLE 1 Data by User Group and Coverage and Availability**

Data Item	Source	User Group				Coverage and Availability			
		Long Distance	Short Distance	Goods Movement	DOT Personnel	California	Oregon	Nevada	Washington
RWIS	<i>Clarus</i>	X	X	X	X	X	X	X	X
Current and forecast weather conditions	<i>Clarus</i> , NWS	X	X	X	X	X	X	X	X
CMS messages	DOT	X	X	X	X	X	X		X
CCTV images	DOT	X	X	X	X	X	X		X
Chain requirements	DOT	X	X	X	X	X	X		X
Planned and active construction and maintenance closures	DOT	X	X	X	X	X	X		X
State police-reported incidents	DOT, State Police	X	X	X	X	X	X		X
Safety roadside rest areas	DOT	X		X		X	X		X
Points of interest	DOT					X	X		
Commercial vehicle enforcement sites	DOT			X		X	X		
Highway summit locations	DOT	X	X	X		X			X



data to assess strengths and deficiencies of the system. Additional applications could be realized via customized deployment of smartphone applications and traveler information kiosks, as well as mobile provision of road condition information to DOT and other public safety personnel.

### Next Steps

Caltrans originated the one-stop shop concept within COATS, the California Oregon Advanced Transportation Initiative, to provide traveler information spanning California and Oregon. The effort described in this paper expanded coverage to include Nevada and Washington, and incorporated *Clarus* System data to provide multistate ESS data. By way of the Western States Rural Transportation Consortium pooled-fund study, the Caltrans (the California DOT) and WTI at Montana State University are funding a next phase of research and development for the Western States One-Stop Shop to prepare the system for wider user. This phase began in late 2011 and will last 2 years. For more information see <http://www.westernstates.org/> and <http://clarusoss.weather.share.org/>.

### 511 NEW YORK WEATHER ALERT SYSTEM

The goal of the New York State 511 system (511NY) weather alert project is to demonstrate the feasibility of collecting, integrating, and disseminating various types of current and forecast location-specific weather alert data for use by traffic managers and motorists to help make better travel decisions, reduce congestion, and improve safety. The project involves the design, development, and implementation of an ITS that collects real-time *Clarus* RWIS data and other pertinent weather alert data from various sources on selected roadways in New York State and integrates the information for display to the end-user through a modified 511NY traveler information website. The collected data can also be integrated into other traveler information systems such as the New York connected vehicle system currently under development.

Through this project, the Telvent project team integrated *Clarus* data into the Telvent road segment alerting engine. This product, called *SiteWatch*, is a patented system that analyzes multiple weather factors against specific road segments along a transportation corridor. If weather conditions exist that can cause issues with the transportation system, an alert is generated for the individual road segments that are affected. These road segment alerts are integrated into the 511NY preproduction system to provide enhanced, detailed, localized road weather condition information, including information from *Clarus*. In addition, the road segment alerts are provided through a data feed for use by the New York connected vehicle system.

The coverage area for this project includes the New York transportation corridors of the Long Island Expressway (I-495) and I-87 west of the Hudson River to the Canadian border (see [Figure 3](#)). Since the number and location of the RWIS sensors along the project corridors are limited, Telvent extended a radius of influence around the locations for 8 mi. This means that only road segments within this area would be candidates for *Clarus*-based road weather alerts.

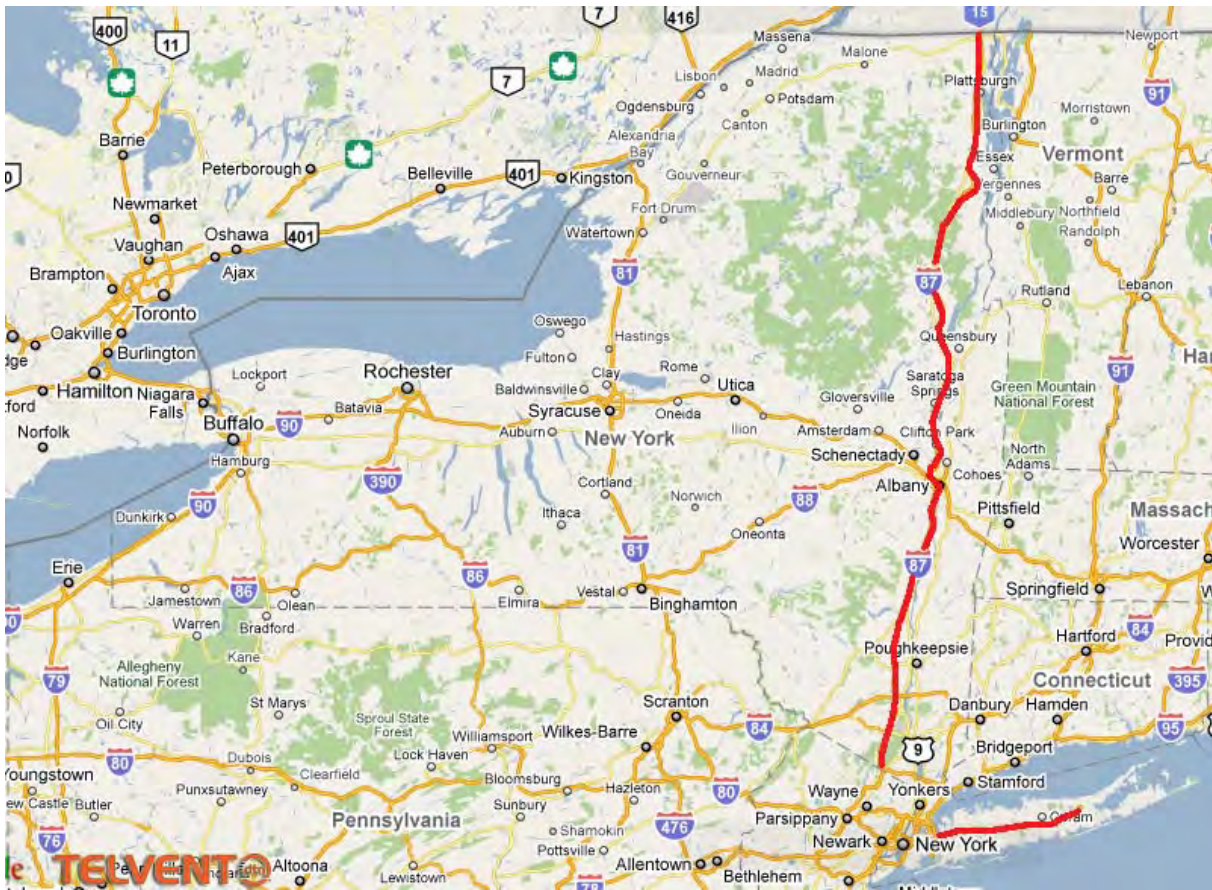
To supplement the RWIS data received from *Clarus*, weather information from a number of other data sources was accessed and integrated into the resulting system, including NWS surface observations, Doppler radar, storm corridors, and NWS bulletins.

## System Development Process

A structured system development lifecycle (SDLC) approach was used to develop the system created for this project. The first step was to define a set of technical requirements for the system to be developed and maintained during the course of the project. The goal of this effort was to ensure a common understanding between all parties on the expected functionality of the resulting system. The requirements were gathered from the original request for proposal for the project, Telvent's proposal, and additions and clarifications based on discussions between FHWA, New York State DOT, and the Telvent project team.

The next step in the SDLC was to design the system. The Telvent team produced a design specification that defines the various sub-systems comprising the overall system and how each of these sub-systems is configured from existing software products and developed for new system functionality.

Development of the system proceeded in accordance with the system design. Although most of the development focused on new system functionality, there were opportunities to utilize existing system tools. For example, the base *SiteWatch* road segment alerting system already included interfaces to existing weather data sources such as the NWS. In addition, the current 511NY preproduction website infrastructure was used as the base platform to develop the user interface for displaying the weather alerts.



**FIGURE 3 Coverage area for 511NY Weather Alert Project.**

Testing of the resulting applications was conducted in multiple phases. In the first phase (unit testing), each component was individually tested to ensure independent functionality was operating properly, for example, to test the *SiteWatch* retrieval of RWIS data from the *Clarus* system. Unit testing was performed in a lab and system development environment. The second testing phase (integration and system testing) was performed against a fully integrated system to verify that interactions between all system components operated properly.

The final phase of testing, system acceptance testing (SAT), was based on the development of a test plan that defines the plans and a set of procedures used to verify that the integration of the *Clarus* data and related weather alerts into the 511NY preproduction website complies with the functional system requirements defined in the requirements specification document.

## System Description

The 511NY preproduction system configuration is divided into functional groups consisting of data collection, data integration or fusion, and data dissemination. The data collection group requests and receives inbound XML-based data streams from *SiteWatch* on a configurable, periodic basis and forwards the received data flows for data storage and analysis. The data dissemination group distributes the processed information through to the public web platform.

Only RWIS observations that pass both Telvent and *Clarus* quality control checks are candidates for a weather alert. These RWIS observations are checked against gross and climate ranges, compared to similar sensors in the area, and analyzed against previously reported observations as a way to assess reasonableness and quality.

During the course of the project, Telvent ingested and analyzed numerous incoming New York State DOT RWIS observations from *Clarus* utilizing these quality control checks. Analysis of the data quality shows that some key parameters that would have been candidates for observation-driven weather alerts routinely fail the quality control checks. While there are several other datasets that drive weather alerts, the list of possible RWIS parameters from the New York State DOT RWIS network used to drive these weather alerts is relatively small. In general, only quality pavement temperature readings are routinely available from *Clarus* for the available New York State DOT RWIS stations.

Early in the project, the project team determined that the following *Clarus* RWIS sensor readings would be most applicable for delivery of potential hazardous weather condition alerts:

- Pavement temperature,
- Wind speed,
- Surface status (i.e., ice warning, snow warning, ice watch, snow watch, frost, chemically wet, wet, trace, absorption dew, absorption, dew),
- Precipitation rate, and
- Precipitation situation (i.e., slight, moderate, heavy unidentified, snow, rain, frozen precipitation).

The system categorizes the received weather conditions for each roadway segment and link and prioritizes and displays them on the 511NY preproduction website map as a section of roadway color coded to a specific weather condition category or textually via a tool tip message. The tool tip contains supporting textual information associated with the primary link condition.

The selected colors are configurable. The map includes existing pan-and-zoom capabilities with the ability to select a specific 511NY region for display. The integrated data represents a combination of roadside weather alert information including roadway temperature, roadway condition and wind speed, as well as NWS alerts and detection of possible severe weather. The weather alerts are depicted through a separate layer on the 511NY preproduction public website map titled “*Clarus Weather*” and categorized as follows:

- Wet,
- Snow–ice,
- Severe snow–ice,
- High winds,
- Severe weather alert, and
- Severe weather detected.

### *Data Collection and Integration*

Below is a sample of the Schodack RWIS sensor data from the *Clarus* website used for the project (Figure 4). In this example, a red X indicates that the *Clarus* quality control checks identified invalid data for surface status and precipitation rate. Note that only two of the five RWIS stations (Schodack and Albany Toll Plaza) are equipped to collect all of the above readings; the remaining three stations can only provide pavement temperature.

As new weather data arrives, *SiteWatch* spatially intersects this new weather with known assets, in other words, the 511NY roadway segments and landmarks. If weather conditions at these intersections exceed predetermined thresholds, *SiteWatch* generates an alert (e.g., hazardous pavement temperatures) for each asset (e.g., I-87) and weather data type (e.g., RWIS observations) combination. These thresholds are shown in Table 2. Note that there are gaps in the thresholds between light, moderate, and heavy precipitation in this table as these readings are only provided in 5 dbz increments.

When an alert is created, it remains active until the weather condition no longer exists (plus a brief delay to ensure the condition does not reappear). Note that the weather alerts are not direction-specific within the asset or roadway.

When an alert is created *SiteWatch* also creates an XML alert message. This XML message is combined with other active alert messages and made available through a web service to remote clients. For the *Clarus* integration project, the 511NY preproduction system and NY connected vehicle system act as remote clients. Both systems receive the same XML message from *SiteWatch*.

### *Data Dissemination*

The existing 511NY preproduction public website was used as the base platform to disseminate the collected weather alert data, although a separate copy of the website was created for this project so that each system could be updated and maintained separately in order to prevent conflicts between the two systems. The 511NY preproduction hardware platform resides at the Savvis hosting facility in New Jersey. Note that references to the 511NY preproduction platform in this document are for the segregated platform.

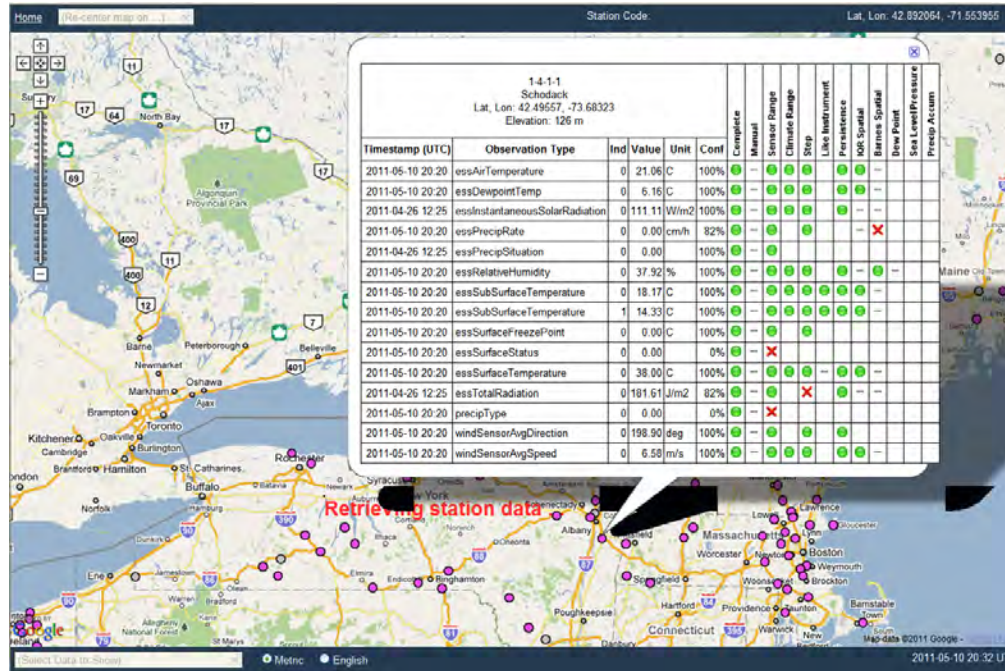


FIGURE 4 NYSDOT RWIS data from Clarus.

TABLE 2 SiteWatch Weather Alert Thresholds

Weather Alert	Threshold
Hazardous wind speed	>= 40 mph
Light rain	15–25 dbz
Light mixed precipitation	15–25 dbz
Light snow	5–15 dbz
Moderate rain	30–40 dbz
Moderate mixed precipitation	30–35 dbz
Moderate snow	20–30 dbz
Heavy rain	45+ dbz
Heavy mixed precipitation	40+ dbz
Heavy snow	35+ dbz
Hazardous pavement temp	<=33°F

The 511NY preproduction public website was augmented to display link based (i.e., road segment based) weather conditions on the existing Google-based map. The website map page includes various layers of information already received by the 511NY system. The new layer added is called the *Clarus* Weather layer since *Clarus* weather data integration is the focus of the project and to differentiate it from other weather related layers, although it is important to note that this layer contains weather alerts from various sources, not just *Clarus*. The new layer represents a combination of roadside weather alert information including roadway temperature,

roadway condition and wind speed, as well as NWS alerts and detection of possible severe weather.

The *Clarus* weather layer includes color-coded, graphical link coverage for I-87 west of the Hudson River and the Long Island Expressway (I-495) as well as tool tip coverage for the same roadways to indicate current weather alerts. The selected colors are configurable. The map includes existing pan-and-zoom capabilities with the ability to select a specific 511NY region for display. A sample screen with the new *Clarus* weather layer depicting actual, real-time weather conditions is shown in Figure 5.

This screen shows light snow along the northern portions of I-87 toward Canada. The tool tip appeared by hovering the mouse over the colored section of roadway near Albany, New York, revealing that the pavement is wet and below 29°F in that area as of March 7, 2011, at 10:10 a.m. In this example, the light snow precipitation data was provided by NWS Doppler Radar, and *Clarus* was the source of the pavement temperature and pavement condition readings. Another sample screen with the new *Clarus* weather layer is shown in Figure 6. Here, several different types of weather alerts occurred along most portions of I-87, including wet warnings, severe weather alerts, and severe weather detected. Through the tool tip, the red section of I-87 near Glens Falls, New York, indicates a possible tornado along with light rain in the area. Since the severe weather detected alert is a higher priority than that for light rain, the coloring was red and not green as per the legend. This alert occurred because Doppler radar detected a storm cell that contained characteristics that often generate tornados. Note that this did not mean a tornado

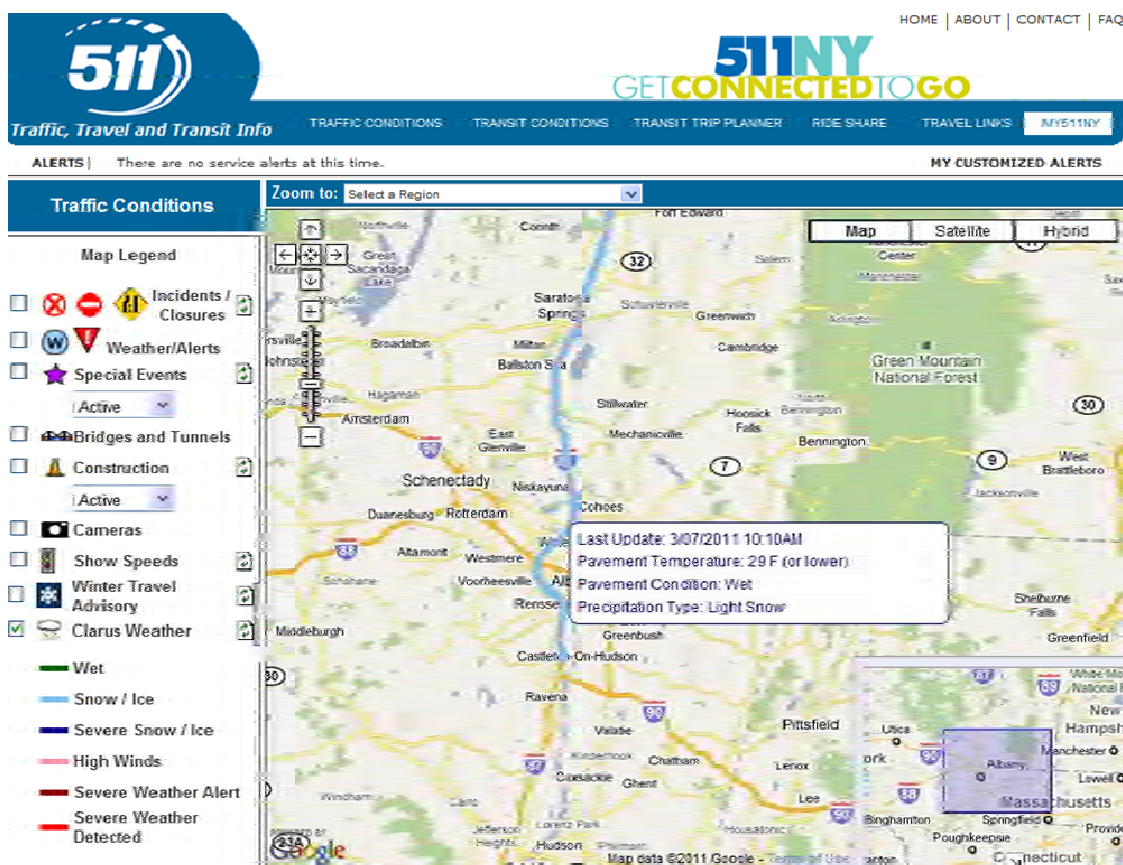


FIGURE 5 511NY preproduction website page with *Clarus* and Doppler radar alerts.

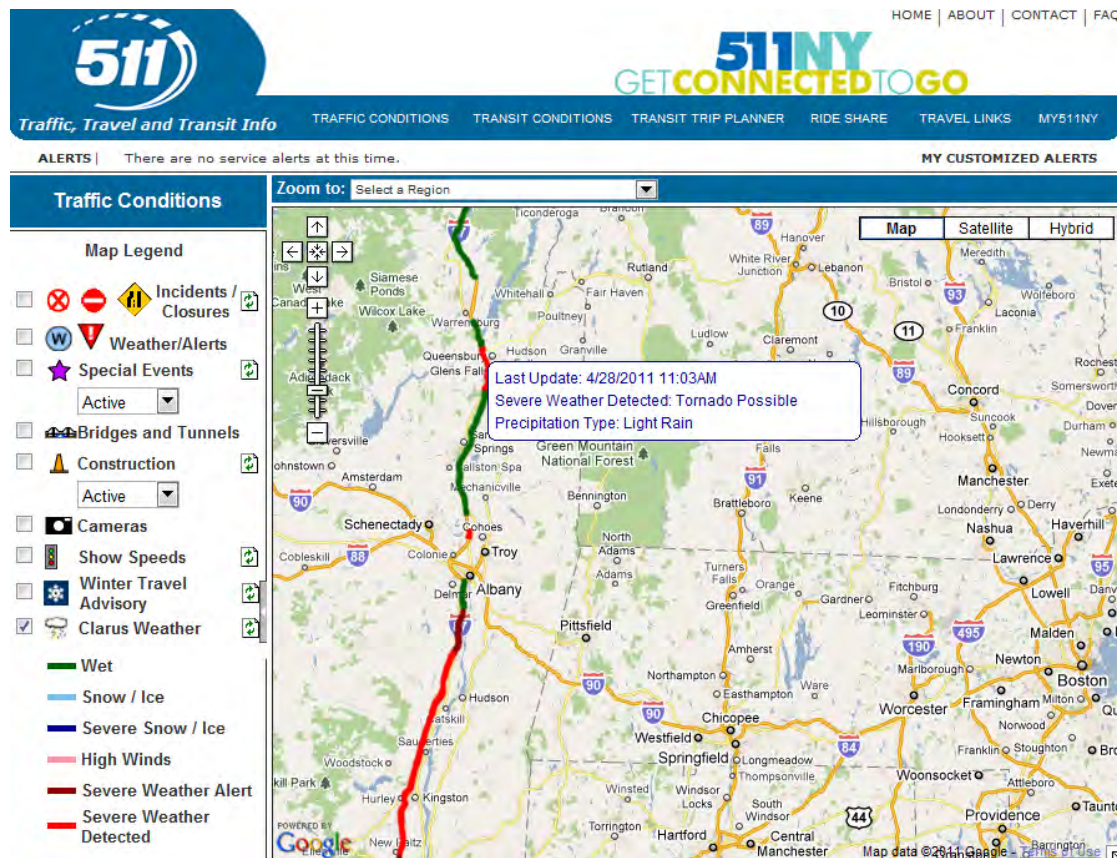


FIGURE 6 511NY preproduction website map page with various alerts.

hit the ground, but that all conditions are right for a tornado to form resulting in a dangerous condition for motorists.

The existing layers on the 511NY website map page provide additional information as it is received by the 511NY preproduction system. If the *Clarus* weather layer is toggled on (through a user selected checkbox), the winter travel advisory layer (which contains winter roadway conditions manually reported by maintenance staff) and the show speeds layers will both be automatically toggled off.

In addition to the color-coded link representation of weather alerts, each color-coded link includes a tool tip that contains supporting textual information associated with the primary link condition. Note that information for all weather alerts for the selected link appears in the tool tip. The tool tip is invoked when the mouse cursor hovers over a color-coded link. The following tool tip information accompanies a link with a current weather condition, in addition to an update time (Table 3).

## System Evaluation

A 3-month evaluation phase of the resulting system followed immediately upon completion of SAT in late March 2011. This was the final phase of the project completed in June 2011. This timeframe was selected in order to capture weather alerts from the late winter season through spring 2011.

**TABLE 3 511NY Website Map Tool Tip Information**

<b>Tool Tip Label</b>	<b>Possible Conditions</b>
Pavement temperature	33°F (or lower)
Pavement condition	Snow, ice, wet
Precipitation	Heavy mix, heavy rain, heavy snow, moderate mix, moderate rain, moderate snow, light mix, light rain, light snow
Wind speed	40 mph (or higher)
Severe weather alert	Tornado warning, severe thunderstorm warning, flood warning, flash flood warning, dense fog advisory
Severe weather detected	Hail possible, severe thunderstorm possible, tornado possible

Evaluation of the system was conducted by FHWA staff, New York State DOT staff, and members of the Telvent project team. The evaluation process consisted of exchanges of observations and feedback through e-mail and teleconferences over the 3-month period. To help guide the process, the project team also developed an evaluation survey that was completed by FHWA and New York State DOT staff in early May 2011.

The system produced a wide range of results representing varying weather conditions and alerts during the evaluation phase, although it was observed that a relatively small number of alerts were based on *Clarus* RWIS data. Most of the valid *Clarus* RWIS alerts were only for roadway surface temperatures (e.g., below 33°F) during the late winter and early spring seasons. There were also some valid surface condition readings (e.g., from the Schodack RWIS station), but most other readings were flagged as erroneous by the *Clarus* and *SiteWatch* quality control checks.

In general, the representation of weather alerts on the 511NY preproduction website was accurate, clear, and easy to understand, although there was some concern that some results could be misinterpreted by the public.

The information from the system was also very useful from a traffic management perspective as it can help transportation managers alert motorists of upcoming weather disturbances and provide assistance in readying public safety and incident management staff and resources for impending weather conditions that could negatively affect the transportation system.

### Next Steps

During the evaluation phase, a number of recommendations were developed to help improve the usability and effectiveness of the system in terms of alert prioritization, data quality, and information clarity. In addition, the project team defined a series of potential next steps beyond this project including integrating weather alerts into the New York Connected Vehicle system and exploring options to integrate weather alerts and related data into the 511NY production system for both the public and mobile website and interactive voice response (IVR) telephone system. Note that transitioning this information to a telephone-based system may require extensive design and development efforts due to the constrained format of that type of system compared with a more visual environment such as a website. Although challenging, various types of weather alerts have been integrated into IVR telephone systems for other projects, and examples are available for reference.



## **ACKNOWLEDGMENT**

Many thanks to Sean Campbell and Ian Turnbull of Caltrans for their guidance, input, and assistance in establishing the one-stop shop concept that led to this work, as well as the members of the Western States Rural Transportation Consortium, specifically California, Nevada, Oregon, and Washington for their support. We also acknowledge Rexella William and Joe Doherty of New York State DOT for providing the 511NY Traveler Information System platform for use in the project as well as for their support in testing and evaluating the system.

## **REFERENCES**

1. *Clarus* System website. Federal Highway Administration and Research and Innovative Technology Administration. Available at <http://www.clarus-system.com/>.
2. Western States One-Stop Shop for Rural Traveler Information—Research on Clarus System Data. Final Report. FHWA JPO-11-153. August 2011.
3. Integrating Clarus Data with the 511 New York Traveler Information System. Final Report. FHWA-JPO-11-112, June 2011.

## ROAD WEATHER DATA MANAGEMENT

*Clarus System***BRENDA BOYCE***Mixon/Hill, Inc.*

The *Clarus* Initiative, established in 2004, is a multiyear program sponsored by the U.S. Department of Transportation's (DOT's) FHWA Road Weather Management Team and the Research and Innovative Technology Administration Joint Program Office to organize and make available more effective environmental and road condition observation capabilities in support of four primary motivations: (1) Provide a North American resource to collect, quality check, and make available surface transportation weather and road condition observations so that DOTs and other transportation agencies can be more productive in maintaining safety and mobility on all roads and surface transportation modes. In addition to increasing productivity, it will maximize their road weather information system and environmental sensor station investments; (2) Surface transportation-based weather observations will enhance and extend the existing weather data sources that support general-purpose weather forecasting for the protection of life and property; (3) Collection of real-time surface transportation-based weather observations will support real-time operational responses to weather; and (4) Surface transportation-based weather observations integrated with existing observation data will permit broader support for the enhancement and creation of models that make better predictions in the atmospheric boundary layer and near the Earth's surface to support more accurate forecasts. The *Clarus* initiative specifies the necessary infrastructure to consolidate data from a multitude of independent data collection systems. This infrastructure offers the benefits of enhancing data coverage, improving the performance of meteorological support services, and providing guidance to owners of these data sources regarding the quality of their data and performance of their data collection systems. The *Clarus* system has been developed using proven systems engineering practices, best practices in information technology and coding standards, and industry standards such as the TMDD and NTCIP 1204. Throughout the *Clarus* initiative and the *Clarus* system design, public and private stakeholders have been actively engaged through the Initiative Coordinating Committee and task force meetings to provide guidance and consensus for the documentation, system design, quality checking algorithms, metadata, and system performance. The purpose of this presentation is to describe the *Clarus* system design details, demonstrate the system, and highlight the broader initiative activities.

## ROAD WEATHER DATA MANAGEMENT

**Clarus Multistate Regional Demonstrations**  
*Summary of Evaluation Results and Lessons Learned*

**DEEPAK GOPALAKRISHNA**

**CHRIS CLUETT**

*Battelle*

**KEVIN BALKE**

*TTI/TransLink Research Center*

**PAUL A. PISANO**

*Federal Highway Administration*

**Clarus is a national data management system that integrates road weather data from multiple agencies and shares quality-checked surface transportation weather and pavement observations. Operated as an experimental system for demonstration and evaluation purposes, Clarus has grown substantially since its inception in 2004. As of August 2011, Clarus ingests data from over 2,250 environmental sensor stations in 38 states, four Canadian provinces, and five local department of transportation (DOT) organizations. To spur the growth of applications using Clarus data, the FHWA funded a phased multistate research effort to create and demonstrate operational decision tools in a real-world setting. In addition to an overall application demonstrating the enhanced weather forecasting capabilities possible using Clarus data, four new applications, termed use cases, were developed as part of this effort. These included tools for seasonal load restrictions decision support, nonwinter maintenance and operations decision support, multistate control strategy coordination, and enhanced road weather content for traveler advisories. Proof-of-concept prototype applications were developed by two different systems integrators and deployed by the participating state DOTs during 2010–2011. These deployments were independently evaluated for their potential to improve system operations. This paper summarizes the results of the independent evaluations, providing a glimpse into the value of these applications to state DOTs. Results show that the Clarus system enables innovative applications that provide a wide array of decision support system possibilities. While each of the applications has additional research requirements and implementation challenges to overcome, they demonstrate the potential to proactively change maintenance and weather-responsive management.**

**T**he Clarus Initiative (1) is a 6-year joint effort of the U.S. Department of Transportation (DOT) Intelligent Transportation Systems Joint Program Office and FHWA's Road Weather Management Program (RWMP) to develop and demonstrate an integrated weather observation data management system that can reduce the impact of adverse weather conditions on surface transportation.

The Clarus system (2) is at the core of the initiative serving as the national data management system that integrates road weather data from multiple agencies and shares quality-checked surface transportation weather and pavement observations. Operated as an experimental system for demonstration and evaluation purposes, Clarus has grown

substantially since its inception in 2004. As of August 2011, *Clarus* ingests data from over 2,250 environmental sensor stations in 38 states, four Canadian provinces, and five city DOT organizations.

Leveraging the quality-checked road weather data available through the *Clarus* system into applicable decision-support tools was the primary objective of the multistate regional demonstration project. As part of the demonstration, proof-of-concept, prototype applications were developed by two different systems integrators (Meridian Environmental Technologies, Inc., and Mixon Hill) and deployed by a set of participating state DOTs during the period 2010–2011. These deployments were independently evaluated for their potential to improve system operations.

State DOTs were selected to participate in each of these demonstrations, and the evaluations focused on how these agencies used these tools. Quantitative and qualitative data were collected that sought to measure the level of user satisfaction with each tool, its measurable benefits, and the potential long-term value that further development and deployment of these tools might offer. The four tools and the states participating in the demonstrations are shown in [Table 1](#).

This paper summarizes the results of an independent evaluation that assessed the ability of such tools to improve state DOT operations and maintenance. The full evaluation reports will be available on the RWMP website (3).

## SEASONAL LOAD RESTRICTION TOOL

The seasonal load restriction (SLR) tool couples a pavement and subsurface temperature prediction model with a long-range atmospheric model to forecast thermal profiles of subsurface conditions up to 48 in. in depth and 15 days into the future. For this demonstration the tool was made available to state DOT decision makers in the early spring warming period in 2010 and 2011 to help forecast the timing of subsurface thawing in order to avoid the potential pavement damage that can be caused by heavy truck traffic when pavements are most vulnerable. The tool added the following capabilities to the state's current restriction processes:

- Modeled subsurface temperatures up to 48 in. below the pavement surface at specific pre-determined locations;
- Modeled soil strength parameters (resilient modulus, phase conditions such as percent ice, percent water) to the same depth; and
- Forecasted subsurface conditions up to 2 weeks in advance.

**TABLE 1** *Clarus*-Enabled Tools and Demonstration States

<b><i>Clarus</i>-Enabled Application Tools Demonstrated</b>	<b>States Participating in the Demonstration</b>
SLR tool	Montana, North Dakota, South Dakota
Nonwinter maintenance decision support tool	Iowa, Illinois
Multistate control strategy tool	Iowa, Illinois
Enhanced road weather forecasting tool	Idaho, Montana, North Dakota, South Dakota

The tool does not directly provide restriction imposition or removal recommendations nor does it provide notification or alerts. The SLR tool currently is restricted to providing site-specific soil profile information for the maintenance chiefs considering their decision to place or remove load restrictions.

Figure 1 provides a screenshot of a detailed subsurface temperature profile generated by the tool, showing forecasts out to 10 days from the user selected start date shown on the x-axis and depth in inches from the surface on the y-axis.

### Evaluation Approach

The evaluation was a validation exercise to see how a user need might be met or improved, and not a verification study that would look at quality of the subsurface prediction. Montana and North Dakota were selected as the states to participate in the evaluation of the tool during the spring of 2010 and the spring of 2011. In addition to state-level participation and use of the tool, the evaluation solicited information via a web-based survey from motor carriers using highways

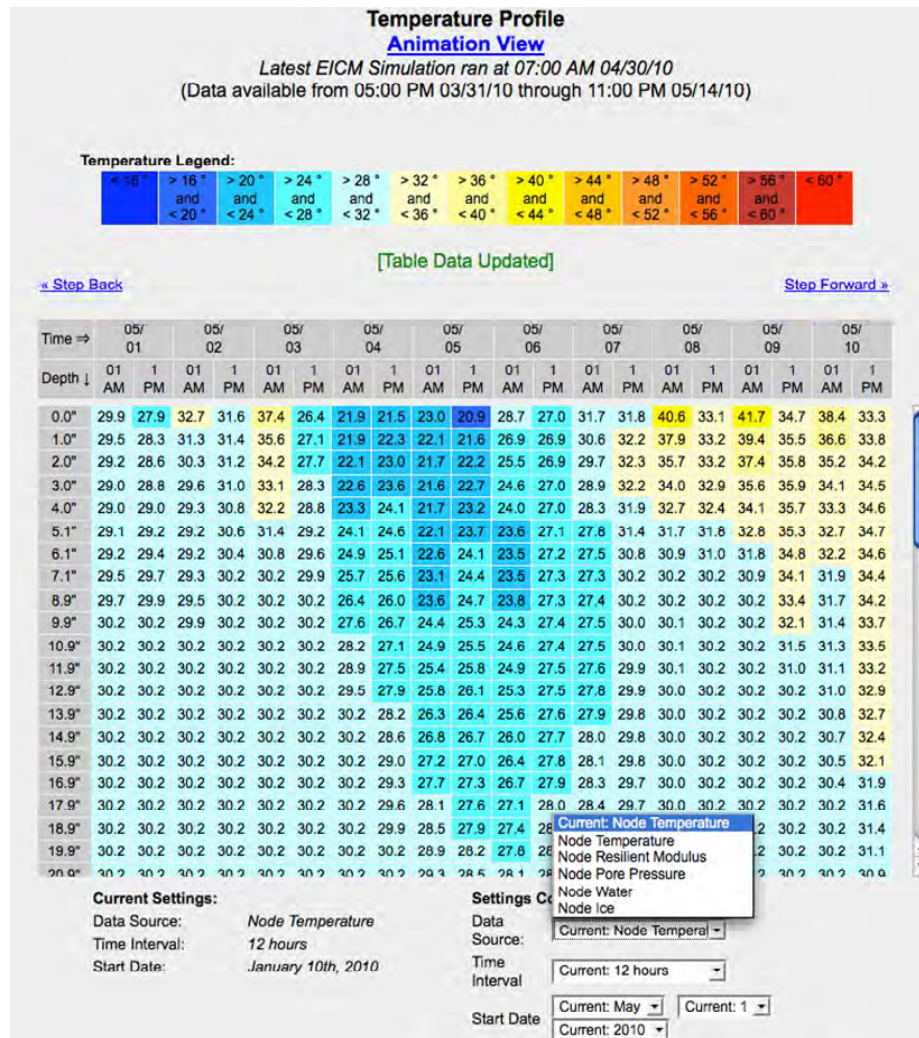


FIGURE 1 Example subsurface temperature profile (4).

in these two states to investigate the impacts of SLRs on their operations. This approach offered extensive participation among these northern tier states.

This tool was expected to yield measurable benefits primarily in four areas: mobility, efficiency, productivity, and customer satisfaction. Because there are two main customers for the information offered by the tool, for the purposes of the evaluation, customer satisfaction was divided into state DOT satisfaction and commercial operator satisfaction. Measurable benefits were not expected in the areas of safety or energy and environment due to this tool. Table 2 lists the hypotheses that were tested in each of the areas.

## Evaluation Results and Lessons Learned

The hypotheses presented in Table 2 were tested to the extent that the available data would allow. The data from the motor carrier survey, along with comments received from the participating DOTs, were assessed in terms of the support they offered for each of the hypotheses. Table 3 presents the results of these tests and the degree of support for each hypothesis.

The evaluation of this use-case demonstration offers lessons and conclusions that provide insights potentially useful both for future demonstrations of road weather tools and for DOTs that might seek to implement this pavement condition forecast tool on a long-term basis. Lessons learned include

- The demonstration tool fills a need in supporting SLR decision making. A demonstration of a new road weather tool is likely to be better received and valued as more beneficial if it offers a new capability that users (e.g., state DOTs) want and previously did not have. Forecasts of subsurface conditions have not been included in the suite of weather information content typically available to state DOTs.
- The demonstration tool shows promise for providing advance notification of thawing conditions. By providing advance notification of thawing conditions, the tool allows maintenance chiefs to be proactive in their decision making. Instead of waiting for visual evidence such as weeping, the tool allows for restrictions to be placed in a more timely manner.

**TABLE 2 Evaluation Areas and Hypotheses**

Area	Hypotheses
Mobility Efficiency Productivity	The tool allows state decision makers to more accurately determine when to place and remove load restrictions, preserving both the pavement integrity and commercial vehicle operator productivity.
Customer satisfaction (state DOTs)	States are satisfied with the tool and have a level of confidence in using it in their decision-making process. States experience improved coordination and consistency between jurisdictions due to the tool.
Customer satisfaction (commercial operators)	Commercial operators value the potential reductions in restriction durations and improvements to the restriction process.

**TABLE 3 Evaluation Results for Seasonal Weight Restriction Evaluation**

<b>Hypotheses</b>	<b>Evidence</b>	<b>Level of Support</b>
<p>The tool allows state decision makers to more accurately determine when to place and remove load restrictions, preserving both the pavement integrity and commercial vehicle operator productivity.</p>	<p>Following an unseasonably warm period in February, a maintenance chief decided to delay restriction placement by 14 days when he might otherwise have placed it sooner. Another maintenance chief was able to decide to place restrictions at least 7 days in advance based on his interpretation of the tool’s subsurface temperature profiles.</p>	<p>Moderate</p>
<p>States are satisfied with the tool and have a level of confidence in using it in their decision-making process.</p>	<p>Interviews with state DOT users show moderate level of confidence with the tool. Users of this experimental tool report that they expect trust and confidence in the tool to increase with additional use and experience. They expect over time that the use of this tool can shorten the restriction period and support more advance notice at the beginning and end of the restriction period of 7 to 10 days.</p>	<p>Moderate</p>
<p>States experience improved coordination and consistency between jurisdictions due to the tool.</p>	<p>Maintenance chiefs currently communicate with adjacent districts to coordinate restriction decision making and increase their awareness of impending weather conditions. This process is independent of the tool and is expected to continue. Interviewees noted the potential of the tool to allow for common understanding of subsurface conditions in the region.</p>	<p>Uncertain due to limited coordination</p>
<p>Commercial operators value the potential reductions to restriction durations and improvements to the restriction process.</p>	<p>Reducing the length of time of the restriction period was important to 86% of the responding motor carriers. They said, in response to the survey, shorter restriction durations and earlier notifications would save them time and money. There was an even split across responses from the motor carriers regarding improvements to the restrictions process. About 53% indicated no improvements were necessary, and the remainder (47%) indicated that improvements were needed for the process. Improvements noted by the respondents included facilitating permitting convenience, adjusting weight policies, additional coordination between state and counties, use of speed restrictions instead of load restrictions, and upgrading of roads and eliminating restrictions. They said they would value greater consistency and fairness in the restriction process. Most carriers appreciate the need for restrictions but want them to be less burdensome and of shorter duration.</p>	<p>High</p>

- The tool provides state DOT personnel with additional information during early spring thaws and refreezes. One of the challenges with SLRs is the occasional days of warm weather in early spring. The transition from cold winters to spring warming is never uniform, and typically involves cycles of thawing and refreezing. In the absence of the tool, these conditions represented a difficult decision point for maintenance chiefs. This tool provides estimates for how far below the pavement surface the thaw has penetrated, the presence of moisture in the soil, and the strength of the subsurface.
- The tool provides state DOTs with an approach for determining return of pavement strength. The tool provides a more defensible rationale for removing restrictions, as the maintenance chiefs can use the resilient modulus information to estimate the recovery of pavement strength. This was the case in the demonstration but additional verification of the resilient modulus information from the tool is needed to build operator and carrier confidence.
- Having new data implies learning new interpretation methods. Some of the challenges involved in the demonstration stemmed from the fact that there were new data points such as the resilient modulus, pore pressure, percent ice, and percent water, all of which provided useful information but were new to the maintenance chiefs. The chiefs were unclear about how to interpret changes in these parameters and what thresholds are critical for decision making.
- Verification and validation of the tool is still a challenge. Related to the above finding, the developers were not yet prepared to offer threshold information for validation and verification of the tool because additional research is needed. Overall, at a qualitative level, some maintenance chiefs indicated that the tool forecasts were consistent with what happened over the spring of this year but they expressed a need to validate the forecasts through the use of more probes and sensors.

## ENHANCED ROAD WEATHER FORECASTING TOOL

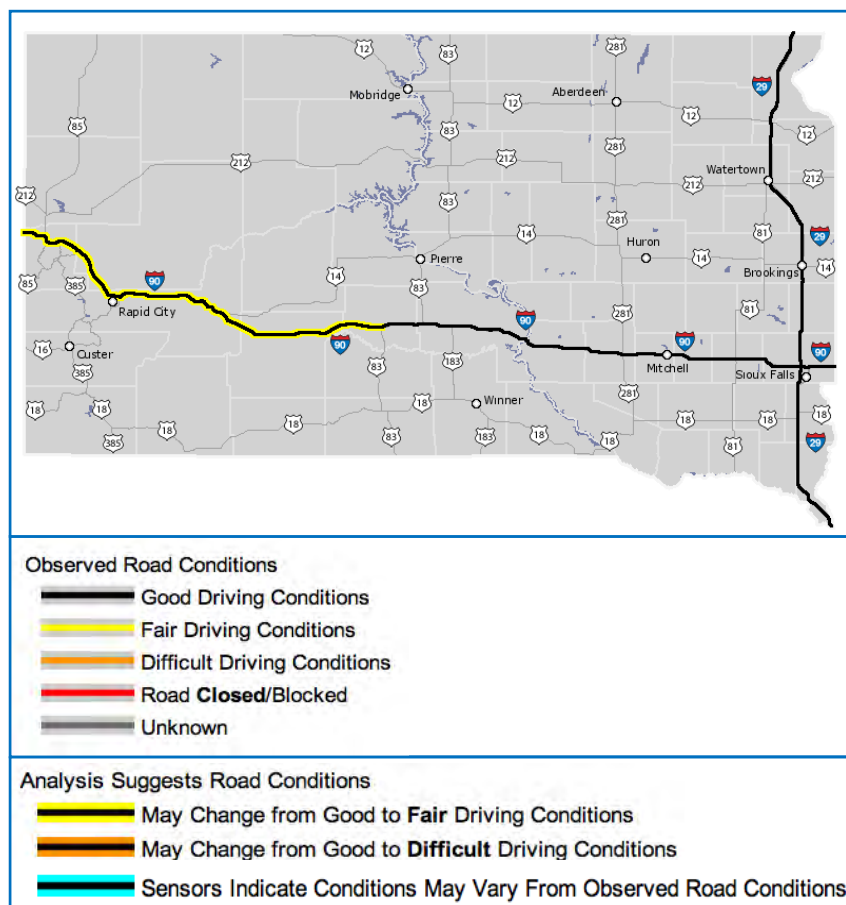
The Enhanced Road Weather for Traveler Advisories tool provides enhanced road weather and pavement condition forecast information for Interstates in five northern tier states. The road weather information includes forecasts up to a day ahead (12 h) based on a decision tree that seeks to avoid conflicts with other information provided by the states. The forecast takes into account atmospheric conditions close to the surface, information from environmental sensing stations in the *Clarus* database regarding pavement surface conditions, state agency road condition reports, and *Clarus*-enhanced weather and road condition analyses and forecasts to provide enhanced traveler advisories.

For this demonstration, the information is restricted to the interstates, but the tool can be expanded in the future to cover secondary roads. By providing current and forecasted road conditions, the tool aims to decrease the latency and improve the usefulness of road condition information systems. [Figure 2](#) shows a screenshot from the demonstration tool from South Dakota highlighting the banded lines where pavement forecasts are provided.

### Evaluation Approach

The evaluation was based primarily on user perceptions of expected use and benefit, rather than on revealed preferences based on observations of uses and subsequent effects on driving decisions that could be attributed to the new road condition forecast information from the tool.





**FIGURE 2** Map of South Dakota showing forecast road conditions (5).

The three main objectives of this evaluation were as follows:

- Understand how the use of the road condition forecast tool offered benefits to the state DOT and to end users of the enhanced traveler information;
- Understand the value added by the tool and the information products it offered, beyond information already available to travelers in these states; and
- Document the lessons learned from the evaluation to help guide further development and deployment of the forecast tool beyond this demonstration.

Seven hypotheses were specified for testing in the evaluation, two of which were related to the satisfaction of the state DOTs with the tool and the remaining five of which were related to traveler satisfaction. These hypotheses are shown in [Table 4](#).

South Dakota was selected as the site to conduct two focus groups (commercial and general travelers), and Idaho, Montana, and North Dakota agreed to post a link to the experimental website created for the demonstration of the tool on their existing DOT websites. Visitors to those state DOT's traveler information web pages could elect to click on a link that would take them to experimental website where users were able to view the enhanced forecasts and respond to a travel survey. The total number of respondents across the three states was 216.

**TABLE 4 Evaluation Areas and Hypotheses**

Areas	Hypotheses
Customer satisfaction (state DOTs)	<p>DOTs will perceive the tool to constitute a useful, high-quality enhancement to their current traveler information.</p> <p>DOTs will be interested in making further investments in the tool past the demonstration phase to integrate the new information with their current traveler information (website and 511).</p>
Customer satisfaction (general travelers and commercial operators)	<p>End users will perceive that the new tool offers valuable information to support their trip planning and decision making.</p> <p>End users will express a willingness and desire to use the new information when it becomes available to them.</p> <p>Long distance and cross-state travelers will value the new information provided consistently across state boundaries.</p> <p>End users will perceive that the new forecast information will enhance the safety and mobility of their travel.</p> <p>The use of the new information will result in decisions to adjust travel plans and behaviors in response to forecasts of pavement conditions.</p>

### Evaluation Results and Lessons Learned

While overall support for this new road weather forecasting capability was positive and widespread across the different user groups, there were many suggestions offered for making this tool work effectively for both different user groups and different geographic locations. Results of the tests of the hypotheses are shown in [Table 5](#) with specific quotations and data shown as evidence supporting the hypotheses.

As described earlier, the beta test site for this tool was made available through links with the DOTs in Montana, Idaho, and North Dakota. As can be seen in [Table 6](#), the results of the online survey indicate that motorists have a high perceived utility of the tool.

The evaluation of this tool demonstration offers lessons that provide insights potentially useful both for future demonstrations of road weather tools and for DOTs that might seek to implement this pavement condition forecast tool on a long-term basis. Lessons learned include the following:

- Understand end-user needs. A demonstration of a new road weather tool is likely to be better received and seen as more beneficial if it offers a new capability or piece of information that users want and previously have not had.
- Communicating complex information without overwhelming the user. The multistate pavement condition forecasting tool adds a new level of richness to the road condition data traditionally provided on state DOT websites. Transitioning the user from a consumer of current condition information to a user of forecasted road condition information presents a challenge.
- Challenges of integrating the tool with existing information services. The multistate pavement condition forecasting tool evaluated for this demonstration presents challenges to successful integration with existing state traveler information systems, especially on websites. Even as a standalone test configuration, many users found the graphics, icons, and pavement condition descriptors complex and often confusing.

**TABLE 5 Identified Level of Support for the Hypotheses**

Hypotheses	Evidence	Level of Support
DOTs will perceive the tool to constitute a useful, high-quality enhancement to their current traveler information.	DOT officials scored “perceived need for the concept” an average of 7.7 on scale of 0 to 10. They further noted: “If the tool could be incorporated into our current road condition map information, it would provide more value.” “This product has potential. The largest benefit would be from the public actually canceling travel plans when conditions are forecasted to deteriorate. Getting to the point of having the public’s trust would be a tremendous undertaking.” “I believe this is the direction our DOT will eventually move toward—more focus on predicted impacts to roadway conditions.”	High
DOTs will be interested in making further investments in the tool past the demonstration phase to integrate the new information with their current traveler information (website and 511).	“It will take some innovative work to integrate the tool with our current traveler information website.” “The cost of providing this is not high, given that we already do road condition forecasts through the Maintenance Decision Support System (MDSS).” “Public and agency acceptance would be high.”	High
End users will perceive that the new tool offers valuable information to support their trip planning and decision making.	78% of web users want their DOT to integrate the new information on the state’s website, and 83% say it would be a good addition.	High
End users will express a willingness and desire to use the new information when it becomes available to them.	Users scored “need for the tool” 8.5 on scale of 0 to 10. Users scored “trust in the tool” 7.1. 39% said they wanted secondary routes covered in addition to the Interstates.	High
Long distance and cross-state travelers will value the new information provided consistently across state boundaries.	93% of users say providing this new info across states is useful. 100% of CVO respondents said very or somewhat useful.	Almost universal
End users will perceive that the new forecast information will enhance the safety and mobility of their travel.	86% say the new info will help them avoid hazardous routes. Users scored “potential to improve safety” 8.6 on scale of 0 to 10.	High
The use of the new information will result in decisions to adjust travel plans and behaviors in response to forecasts of pavement conditions.	60% of first time visitors to new website said they used the information to plan trip. Between 75% and 79% said the website is useful for making trip adjustments (timing, route, postponement). Frequent users of the new tool made proactive behavior change decisions based on the new information.	Moderate to high

NOTE: CVO = commercial vehicle operators.

**TABLE 6 Website User Perceptions of Usefulness of Forecast Tool**

<b>How useful do you find this new website as a source for</b>	<b>Useful</b>	<b>Neutral or No Opinion</b>	<b>Not Useful</b>
Providing information across several adjacent states?	93%	4%	3%
Providing current pavement conditions?	87%	2%	10%
Helping me improve my preparedness for a driving trip?	86%	7%	7%
Helping me avoid hazardous routes?	86%	8%	6%
Providing forecast pavement conditions?	84%	8%	8%
Helping me decide whether or not to postpone or cancel a trip?	79%	15%	6%
Helping me decide between different possible routes?	77%	12%	11%
Providing a repeating loop image of conditions?	77%	21%	3%
Helping me decide when to start my trip?	75%	18%	7%

- Advantages of multistate approach. Users, and especially commercial operators, welcomed the idea of a multistate information system as the one place they could go to plan a multistate trip. Currently, travelers have to go to multiple DOT websites, each with different conventions and notations, to piece together the segments of their planned travel.
- Expand forecasts beyond the Interstate highway system to include more local and state roadways. Given that this was an experimental system, its various limitations were necessary and understandable. However, users were very clear about the importance of expanding coverage widely beyond the interstate system, as well as adding key additional states.

The enhanced road weather for traveler advisories tool can be viewed as a reasonably successful demonstration of a road weather forecasting capability that is perceived by states and travelers as needed and of great potential value. The technical concept and potential capabilities of this tool have been well demonstrated. The challenge now is to make a benefit–cost case for deployment and address the institutional hurdles to a multistate approach to providing integrated, consistent, and reliable current and forecast road weather information to support transportation operations and meet traveler needs.

## **NONWINTER MAINTENANCE AND OPERATIONS DECISION SUPPORT**

The nonwinter maintenance and operations decision support tool expands decision support beyond snow and ice control to incorporate *Clarus* data to assist maintenance, operations, and construction-related scheduling decisions. This tool demonstrates a decision-support system for nonwinter operations that translates location-specific weather forecasts into favorable or unfavorable conditions for nonwinter maintenance and construction activities.

This tool offers two major capabilities. First, it integrates a wide variety of observations, forecasts, and alerts that may be of interest to a maintenance supervisor for planning current and future activities. The tool provides the following data in a map-based interface:

- A range of surface weather station observations from *Clarus* and other available sources (i.e., automated surface observing system and automated weather observation system);

- National Oceanic and Atmospheric Administration (NOAA) satellite and National Weather Service (NWS) radar observations;
- NWS advisories, watches, and warnings;
- U.S. Geological Survey earthquake alerts;
- Forecast model provided by NOAA: National Digital Forecast Database; and
- Forecast models provided by the National Center for Atmospheric Research (NCAR): Weather Research and Forecasting, Road Weather Forecasting System, and Model of the Environment and Temperature of Roads.

The multistate observations available through the *Clarus* system were also used in the NCAR's forecast models that are available as part of the system.

Second, the tool aims to assist agencies in making better scheduling decisions based on observations, targeted *Clarus*-enhanced weather forecasts, and agency rules of practice. The tool allows a maintenance supervisor to define the weather-related rules of practice for a variety of activities using a menu-driven interface. Using the weather-related rules of practice, the user can schedule activities taking into account forecasted weather conditions. Once an activity is scheduled, the tool continues to monitor the weather conditions, and if conditions are not expected to be met for the activity, an alert is sent to the user indicating that the activity can no longer be performed according to the rules of practice. The tool sends the alert via an e-mail or a text message with the pre-specified message to users who have been identified for each activity. The user has the option to reschedule, cancel, or relax the rules of practice if desired to identify new possible times based on experience and judgment. This rescheduling can be done in the office or potentially from the field by responding to the alerts. However, while the functionality of the communication to the field was demonstrated, technical difficulties resulted in this functionality not being tested during the evaluation period.

## Evaluation Approach

The evaluation of this tool was conducted in two maintenance districts in Illinois and Iowa. The evaluation in Illinois was carried out under the jurisdiction of the maintenance yards in Henry County located in northwest central Illinois. The evaluation included three crews working within the county. One crew (Geneseo) that consisted of 15 maintenance persons continued to schedule operations in their usual way without using this tool. This crew served as the control group for the evaluation. Two other crews (Lynn Center and Galva) that consisted of seven individuals each used the tool to schedule activities and served as the experimental group. In Iowa the tool was tested and evaluated in the northwest part of District 3, namely the Spirit Lake, Spencer, and Emmetsburg garages. The entire district constituted an experimental group. The use of the tool was expected to have benefits in the areas of safety, efficiency, productivity and customer satisfaction. The evaluation hypotheses associated with each of these areas are shown in [Table 7](#).

The evaluation was conducted from April 1 to October 1, 2010, for Illinois and April 1 to August 30, 2010, for the Iowa DOT. Both groups recorded detailed logs of their activities performed and the weather conditions encountered in the field. The evaluation also included interviews with the maintenance crew chiefs and supervisors to understand qualitatively the potential of the tool for use in nonwinter operations.

**TABLE 7 Evaluation Areas and Hypotheses**

Area	Hypotheses
Safety	Use of the tool will result in fewer occasions where crews are dispatched and find hazardous conditions at their field site due to weather.
Efficiency and productivity	Use of the tool will result in improved scheduling efficiency and productivity of maintenance crews over the season. Notifications and alerts from the tool will result in greater agency responsiveness and flexibility in adjusting maintenance and operations schedules on a day-to-day basis.
Customer satisfaction: state DOT	Maintenance personnel view the use case as a useful and beneficial aspect of nonwinter maintenance decision making.

### Evaluation Results and Lessons Learned

The hypotheses for the evaluation were tested to the extent that the available data would allow. The data from crew records, e-mails and interviews, along with comments received from the participating DOTs, were assessed in terms of the support they offered for each of the hypotheses.

Neither of the two agencies reported any differences in scheduling approaches between the control and experimental groups. However, the notifications and alerts did lead to improvements in the responsiveness and flexibility of adjusting maintenance and operations schedules on a day-to-day basis. In Iowa, the maintenance chief was able to effectively use the alert function of the tool to dynamically adjust his schedules several times during the evaluation period. In the summer of 2010, 11 schedule changes were made based on the use of the tool in about 37 days. In Illinois, the tool was not as useful primarily due to implementation and software problems. Over the 64-day evaluation period, 15 days were impacted by weather. Of these, the tool was able to provide notification only three times.

Interviews revealed acceptance of the potential of the tool but also indicated a need for further refinement of the software tool to be useful in daily operations. Overall, the interviewees thought the concept was sound and effective if software difficulties were overcome. While technical issues regarding the software were challenging during the demonstration phase of the tool, the primary users of the tool (maintenance supervisors) provided continuous feedback that already has led to various software enhancements. In many ways, the supervisors were unsure of what technology or system they would need at the outset of this project, and this demonstration helped clarify their needs and expectations similar to a prototype approach. A more clear expectation of the needs of a nonwinter maintenance decision-support system should lead to better system development henceforth.

Overall, both the Iowa DOT and the Illinois DOT noted that the tool and the concept should be easy to adopt if some of the technical issues were resolved with respect to the software. They noted that once some of the demonstration issues have been worked out, this system would be helpful to use regularly and could be easily integrated into their operations philosophy.

### MULTISTATE CONTROL STRATEGY TOOL

The multistate control strategy tool (MSCST) allows decision makers in one state or agency to have knowledge of and access to the latest advisory and control information and deployment

decisions made by other states and agencies in a timely manner. The tool seeks to improve coordination and information dissemination between agencies at all levels during weather events such as

- Bridge frost development,
- Blowing snow,
- Precipitation on cold pavements,
- Slick road condition,
- Limited visibility,
- High winds, and
- Precipitation in excess of a particular rate.

The tool was also envisioned to facilitate the participation of stakeholders who are not presently in the loop regarding communications on events that involve weather, and to fill gaps in how agencies communicate and share information about traffic management responses and actions taken in response to weather events with other agencies as well as internally. The tool was designed so that agencies could share information about automated responses and actions in an almost instantaneous manner. The tool provided users with access to real-time weather observational data from *Clarus* and other weather information providers.

### **Evaluation Approach**

The independent evaluation of this tool examined how the Iowa DOT and the Illinois DOT used the tool during a 3-month period to improve their coordination and communication during specific significant weather events focusing on the Quad Cities region. The DOT operations supervisors and dispatch personnel were asked to use the tool to assist them in making and coordinating response decisions to the above-listed weather events. Four main hypotheses were tested as part of the evaluation of this tool. These included an hypothesis relating to customer satisfaction (state DOT):

- Having access to accurate and timely weather information through the tool helped agencies proactively respond to changing roadway and travel conditions resulting from changing weather conditions.
- As a result of using the MSCST, agency responses to weather-related events are better coordinated.
- Because of using the MSCST, agency responses to weather-related events are more timely and appropriate.
- State DOTs view the MSCST as useful and beneficial for improving coordination between agencies during weather events.

The evaluation used a combination of studies to answer the evaluation questions that were refined and framed into testable hypotheses. First, tool usage statistics were collected to determine the frequency with which alerts were received about the above-listed weather conditions and whether and when agencies responded proactively to these alerts. Second, the evaluation team conducted a tabletop exercise to assess how the tool potentially could be used to assist in coordinating responses between transportation operators and emergency responders

during an incident under changing weather conditions. Finally, agency interviews were conducted to assess user perceptions of the utility and maturity of the MSCST in assisting agencies in developing and coordinating advisory and control traffic management responses during weather events.

### **Evaluation Results and Lessons Learned**

The findings from the evaluation study generally show that inter-agency cooperation and communications were minimally affected through the use of the tool. While agencies used the tool to receive alerts about changing weather conditions, there were no recorded or logged responses indicating that the tool changed the way that agencies responded to these events. Furthermore, the evaluation team could not find any evidence that the agencies used the tool to share information about how they responded to weather conditions. During the evaluation period, the tool was used by the agencies primarily for issuing alerts about potential deteriorating (or improving) weather conditions. Notable observations from the qualitative evaluation include

- Field personnel are not likely to take the time to use the tool to enter and extract weather information.
- Significant modifications are needed with respect to the manner in which weather information is presented.
- The tool was not used by agencies to improve the timeliness of responses to weather events.
- With some revisions, the tool could be used as a resource tracking tool to let agencies know the availability of resources, particularly that status of personnel (who was on duty and who was off duty), contact information, etc., during weather events.

Based on the findings of the usage statistics, agency interviews, and tabletop exercise, the overall conclusion of this evaluation is that while agencies generally agreed that the overall concept of the MSCST was valid, significant modifications to the tool are needed before it will be ready for widespread deployment and acceptance.

Furthermore, the tool, as currently envisioned, is best suited for dispatch and control center personnel, and not field personnel. Emergency responders indicated that during incident events, they do not have the time to check weather conditions once they are managing an incident condition. Rather, field emergency responders would prefer to be alerted by dispatchers and control center operators of the time when significant weather changes are likely to occur.

### **CONCLUSIONS AND RECOMMENDATIONS**

These four *Clarus* demonstration tools illustrate how the availability of quality-checked *Clarus* data can lead to development of tools providing decision support capabilities to the state DOT. On the whole, these concepts were favorably received by the participant state users. They felt that further refinements will be needed on each of them to boost trust and confidence in the information provided and to adapt them in the most useful ways to their current operational systems and procedures. Some cross-cutting conclusions and lessons include the following:



- The applications showed promise in translating *Clarus* data to user-oriented applications and decision-support tools. Concepts were rated highly by the state DOTs, especially those that added new functionality to the state DOT toolbox.
- Application development needs to include careful considerations of the user interface, focusing on the delivery of information most pertinent to the user. As *Clarus*-enabled applications promise to provide a lot more information and capabilities to the user, it is important to consider how this information will be presented to the user during the design phase.

## REFERENCES

1. *Clarus Initiative*. Research and Innovative Technology Administration, U.S. Department of Transportation. <http://www.clarusinitiative.org/>. Accessed on Nov. 1, 2011.
2. *Clarus System*. FHWA Research and Innovative Technology Administration, U.S. Department of Transportation. <http://www.clarus-system.com/>. Accessed on Nov. 1, 2011.
3. Road Weather Management Program. FHWA, U.S. Department of Transportation. <http://ops.fhwa.dot.gov/weather/index.asp>. Accessed on Nov. 1, 2011.
4. *Clarus Multi-State Regional Demonstration*. Experimental Seasonal Load Restriction website screenshot. Meridian Environmental Technology, Inc.
5. *Clarus Multi-State Regional Demonstration*. Experimental Enhanced Road Weather for Traveler Advisories website screenshot.

## ROAD WEATHER DATA MANAGEMENT

**Evaluating Quality and Value of Road Weather Information****ROEMER M. ALFELOR****PAUL A. PISANO***Federal Highway Administration***LEON F. OSBORNE, JR.****ROBERT D. HART***Meridian Environmental Technology, Inc.*

Road weather information is used by transportation agencies for maintenance decision making, traffic management, and other operational activities that are impacted by weather condition. In 2007 the FHWA Road Weather Management Program initiated a baseline study to characterize the quality and value of road weather information and to establish a framework for tracking and monitoring these attributes over time. The results of the study are intended to be used by surface transportation weather data users and providers as a benchmark for identifying needs and measuring improvements in road weather information resulting from advanced technologies and tools for data collection, communication, and management such as *Clarus*. Two online surveys have since been conducted and summarized for this study, one in 2008 and the other in 2010. The surveys focused on the content and usefulness of road weather information as evaluated by transportation agencies presently using this information for weather-responsive advisory, control, and treatment strategies. The characterization used attributes that the majority of users felt were important and directly applicable to weather information and associated products. In addition to importance, six quality attributes were used to describe quality, namely (a) accuracy and precision, (b) completeness, (c) relevance, (d) currency and latency, (e) timeliness and reliability, and (f) ease of use. This paper discusses the results of the 2008 and 2010 surveys, describes how the quality and importance of road weather information have changed between both surveys, explains the nature and sources of the observed differences, and recommends ways to improve or enhance the quality assessment process.

Existing sources of road weather information may be characterized by varying levels of quality, and general weather information often paints an incomplete or inaccurate picture of conditions on or near the road surface. These deficiencies were well documented in the 2004 National Research Council report titled *Where the Weather Meets the Road: A Research Agenda for Improving Road Weather Services (I)*. To overcome the deficiencies identified in the report and to improve road weather information products, the U.S. Department of Transportation (DOT) has invested in intelligent transportation systems (ITS), including road weather management systems and technologies. The goal of *Clarus*, one of the ITS initiatives, has been the development and demonstration of an integrated surface transportation weather observing, forecasting, and data management system. The *Clarus* system, developed as part of the *Clarus* initiative and several other public and private road weather services, provides information resources to assist transportation decision makers. The road weather management program within the FHWA initiated a project in 2007 to establish quality measures for these road weather information resources. The objective was to acquire quality ratings of the road weather

information resources used by transportation personnel in the state DOTs in support of their transportation-related operational decisions. The methodology chosen to obtain user input and establish a baseline assessment of quality was a series of web-based surveys performed at a 2-year interval. The first survey and associated analysis were completed in 2008 (2). The second survey was concluded in 2010 (3). Both surveys acquired responses from DOT participants responsible for transportation support services within the three primary management strategies associated with advisory, control, and treatment responsibilities.

## ESTABLISHMENT OF A QUALITY BASELINE

Transportation personnel whose operational decisions are impacted by weather or weather-related road conditions typically look for a number of resources to acquire road weather information. In order to characterize these resources a scanning review was done to analyze and catalog existing road weather information through

- Identification of the full spectrum of road weather observations and forecasts available from public and private providers;
- Categorical representation of the communications methods of road weather observations and forecasts information dissemination; and
- Characterization of the quality attributes of each of the identified sources of road weather information.

The review yielded a set of tables listing road weather information sources [weather service providers, advanced transportation information systems (ATIS), DOT-provided ATIS services, and DOT advisory services] and the type of data provided by each.

The data available from these provider agencies are typically encapsulated within organized formats called products, which may be characterized as website images, bulletins (delivered via the Web, fax, or smart phone), or audio messages (received via radio, television, phone, or pagers). The provider agencies create unique products to deliver information for specific timeframes (e.g., observations, histories, forecasts) and spatial presentation formats (single site data, lists of data for multiple sites, or maps containing data for sites over a region). Each product contains data for a number of road weather parameters, such as weather information, pavement conditions, and advisory messages that DOT personnel must monitor or integrate into their operational decisions. Thus, the scanning review differentiated two distinct classes of road weather information that can be called *products* and *elements*. In the 2008 and 2010 survey reports as well as in this paper, these two words are italicized to distinguish them from the common definitions of products and elements. *Products* used by DOTs include National Weather Service (NWS) current observations, environmental sensor station (ESS) historical information, pavement-specific weather forecasts, road condition reports, and severe weather watches and warnings. *Elements* encompass weather parameters, pavement-related parameters, camera images, advisory messages, watches, and warnings. After considerable discussion, both *products* and *elements* were chosen as instruments for the evaluation of road weather quality and the *products* and *elements* in Figures 1 and 2 were selected as the approved list for the baseline study. The *product* list (Figure 1) shows the character of each *product* by listing the provider, the

PRODUCT	SOURCE	SPATIAL FORMAT		TIME FRAME		
		SINGLE	MAP	HISTORY	CURRENT	FORECAST
Weather Summary	NWS	◆			◆	
Weather History	NWS	◆		◆		
ESS Current Conditions	DOT	◆			◆	
ESS History	DOT	◆		◆		
Regional Weather Map	STWSP		◆		◆	
Regional Forecast (Zone Forecast)	NWS	◆				◆
Pavement Forecast (511 Forecast)	STWSP	◆				◆
Road Weather Alert	STWSP	◆				◆
Watches and Warnings	NWS		◆			◆
MDSS	STWSP	◆				◆
Road Condition Report	DOT	◆			◆	
Flood Warning	NWS	◆			◆	
Camera Images	DOT	◆			◆	
Radar	NWS & WSP		◆		◆	

**FIGURE 1** *Products* used in the baseline study and a description of the source agency, the spatial format, and the time category of the information in the product.

ELEMENT	
Air temperature	Visibility
Dew point temperature	Pavement temperature
Relative humidity	Pavement condition
Wind direction	Chemical concentration
Wind speed	Freeze point temperature
Wind gust	Frost probability
Precipitation type	Treatment recommendation
Precipitation rate	Road closure
Precipitation accumulation	Severe weather advisory
Snow rate	Wind advisory
Snow accumulation	Winter weather advisory
Weather type	Dense fog advisory
Precipitation start time	Flood advisory
Precipitation end time	Flood stage
Precipitation probability	Camera – road conditions
Probability of precipitation type	Camera – weather conditions
Maximum temperature	Camera – traffic
Minimum temperature	Radar images
Cloud cover	

**FIGURE 2** *Elements* used in the baseline study.

spatial format, and the timeframe of the data in the *product*. The sources may be public or private organizations and the list includes the NWS, DOT agencies, general weather service providers, and surface transportation weather service providers.

A web-based survey was selected as the primary method to acquire quality assessments from DOT personnel with transportation-related decision-making responsibilities. The surveys and their results are covered in the sections on Quality Assessment Surveys, Survey Results: 2010, and Comparison of 2008 and 2010 Survey Results in this paper.

The results of the 2008 survey indicated DOT users actually determine the quality of road weather data based on the *elements* within specific *products*. Figure 3 is an example of a current

weather condition *product* issued by the NWS. It contains weather parameters that fell within the *elements* classification for the 2008 study. But to the DOT users an *element* in the NWS current weather *product* represents a different decision support tool than the same *element* in a pavement forecasting *product*. To reorient the quality assessment program for the 2010 survey, the *elements* within a specific *product* were given a new name, *product components*, to minimize confusion. The 2010 survey was then modified to request input on *product components*, not *elements* or *products*. This focused the 2010 survey on the resources DOT personnel use to support their operational decisions. Fortunately, quality assessments of *product components* could also be directly related to both *products* and *elements*, and it was possible to use the quality assessment answers from the 2010 *product component* survey to derive quality score estimates for *products* and *elements*. Consequently, the 2010 survey evaluated the quality of *product components* and used this data to generate derived results for *products* and *elements*, thereby retaining continuity with the results from the 2008 survey.

## QUALITY ASSESSMENT SURVEYS

In 2008 the project team contacted DOT representatives in 35 states to find individuals willing to participate in the survey. The opportunity to participate in the survey was increased to 45 states in 2010. Representatives from 26 states participated in the 2008 survey and 28 states provided input in 2010. Surveys were distributed to 84 DOT representatives in 2008 and 92 in 2010. Forty-one individuals started the survey in 2008 and 28 completed at the survey. In 2010, 45 individuals started the survey and 37 completed it. In 2008, three separate surveys were prepared, one for personnel in each of the three primary management strategy classes: advisory, control, and treatment. Of the 28 completed surveys in 2008, 12 were advisory personnel, four were control personnel, and 12 were treatment personnel. In 2010, a uniform survey format was



**FIGURE 3** Example of an NWS current weather *product* with a listing of the *elements* within the web page display that are used in the baseline study. (Note: red highlight is from NWS website.)

used for all participants; however, in the demographic questions at the beginning of the 2010 survey respondents were asked to indicate their primary area of responsibility. From this input the distribution of participation from the three management areas was 15, five, and 17 responses for advisory, control, and treatment, respectively.

The web-based surveys in 2008 and 2010 were structurally the same, except the 2008 survey requested quality assessment responses for *products* and *elements* and the 2010 survey asked for input on *product components*. The participant's assessment of quality in both survey years was measured using the following six attributes that addressed different facets of quality:

1. Accuracy and precision;
  2. Completeness of the information;
  3. Relevance to the user's needs;
  4. Currency and latency of the information (i.e., how old is the information when the user receives it);
  5. Timeliness of the information and reliable delivery of the required information;
- and,
6. Ease of use of the information.

In addition to the attribute assessments, users were asked to indicate the importance of each *product component* in the 2010 survey and the Importance of *products* and *elements* in 2008. The remainder of the discussion in the sections on Quality Assessment Surveys and Survey Results: 2010 addresses the survey structure and the computation of survey results related to the 2010 survey.

The 2010 survey was a web-based electronic survey, containing a set of six demographic questions followed by a series of multiple-choice questions related to the quality and importance of the road weather *product components*. Survey participants had the opportunity to rate the quality of any of the 92 different *product components* they use operationally. Since the DOT participants receive the *product components* as part of distinct *products*, the *product components* were consolidated into question sets organized around the 14 *products*. Different *products* had varying numbers of *product components* that ranged in number from 1 to 22. On the first page of each *product* section, the survey provided a description of the *product* and a list of the *product's* components. If the *product* was not a road weather resource normally used in the participant's decision-making process, the participant could completely skip the quality assessment questions related to that *product* and move on to the next *product*.

Once a participant opted to input assessment ratings for a *product*, the participant would have the opportunity to complete seven multiple-choice questions, one for each of the six quality attributes and one for the importance of each *product component* in the user's decision-making process. An example of one of the seven questions for *product components* in the NWS Current Weather *product* appears in [Figure 4](#). The possible response options included quality or importance ratings of very high, high, medium, low, very low, and not applicable. To facilitate answer entry, each *product component* was listed on the left side of the page and the multiple-choice options were placed as columns. Thus, survey participants could choose their quality or importance rating by selecting one of the radio buttons for each *product component* in the list.

### SURVEY RESULTS: 2010

The survey responses were transformed into a five-level scale of Likert scores ranging from 5 for very high down to 1 for very low, and the Likert scores and the results from the demographic section of the survey were transferred to a MySQL database. The data were then extracted from the MySQL relational database and organized into four data sets necessary to evaluate quality for different demographic sample groups. The primary data sets included all user responses and three sub-sets for responses from advisory, control, and treatment management strategy users. The Likert scores for each of the four data sets were then evaluated using standard variance statistics.

The primary quality metric was the average quality rating for each of the 92 *product components*. These averages were computed for each of the six quality attributes and importance. In addition, the responses for all six attributes were lumped together into a composite average. Standard variance statistics for the attributes, importance, and the composite of all attributes for all respondents are presented as a table in Figure 5. The mean and median composite averages of the quality attribute scores for all *product components* combined were 3.94 and 3.95, respectively; however, when the composite averages are separated into a list of the individual *product components*, the averages ranged from 2.97 to 4.36. The Likert score average of 3.94 represents an average participant rating of just under high, while the Likert range represents a user assessment varying from medium for the lowest-rated *product component* to a rating midway between high and very high for the highest-rated *product component*. The distribution

**Product: Current Weather**

Source: National Weather Service  
 Spatial Format: Single Site Report  
 Time Frame: Current

**1. In your opinion, please indicate the level of Accuracy/Precision for the following Road Weather Components within Current Weather products.**

**Accuracy/Precision - How close is the observed or forecasted condition to the actual condition?**

	Very High	High	Moderate	Low	Very Low	Not Applicable
Air Temperature	<input type="radio"/>	<input type="radio"/>	<input type="radio"/>	<input type="radio"/>	<input type="radio"/>	<input type="radio"/>
Dew Point	<input type="radio"/>	<input type="radio"/>	<input type="radio"/>	<input type="radio"/>	<input type="radio"/>	<input type="radio"/>
Relative Humidity	<input type="radio"/>	<input type="radio"/>	<input type="radio"/>	<input type="radio"/>	<input type="radio"/>	<input type="radio"/>
Wind Direction	<input type="radio"/>	<input type="radio"/>	<input type="radio"/>	<input type="radio"/>	<input type="radio"/>	<input type="radio"/>
Wind Speed	<input type="radio"/>	<input type="radio"/>	<input type="radio"/>	<input type="radio"/>	<input type="radio"/>	<input type="radio"/>
Weather	<input type="radio"/>	<input type="radio"/>	<input type="radio"/>	<input type="radio"/>	<input type="radio"/>	<input type="radio"/>
Precipitation Type	<input type="radio"/>	<input type="radio"/>	<input type="radio"/>	<input type="radio"/>	<input type="radio"/>	<input type="radio"/>
Precipitation Amount	<input type="radio"/>	<input type="radio"/>	<input type="radio"/>	<input type="radio"/>	<input type="radio"/>	<input type="radio"/>
Snow Amount	<input type="radio"/>	<input type="radio"/>	<input type="radio"/>	<input type="radio"/>	<input type="radio"/>	<input type="radio"/>

Comment on this question?

5
6

**FIGURE 4** Quality assessment rating page from the 2010 web-based survey.

of scores was fairly compact (standard deviation of 0.90), but tended to skew slightly towards the lower scores. The average scores for the completeness, relevance, timeliness and reliability, and ease of use attributes were all near 4.0; however, the averages for the accuracy and precision and currency and latency attributes were lower (3.7 to 3.8). The Likert scores for all importance responses yielded an average of 4.25 with a range of scores for individual *product components* from 3.37 to 5. The implication from these results is that road weather information is viewed as having a high to very high level of importance to DOT users and, in general, the quality of road weather data is considered high. However, the DOT respondents felt accuracy and expedient delivery of data detracted slightly from the overall road weather information quality and these attributes could be improved.

The combined statistics provided an understanding of the perceived quality of all road weather parameters lumped together. But did DOT personnel view certain *product components* as more important to their decision making and were there differences in the perceived quality of different *product components*? A simple approach to address this question was to put all of the averages for all *product components* for each of the six attributes and importance in a table and look for patterns. This was done. The first step was to place the averages for each attribute into separate tables and reorganize each table so the *product component* with the highest average was at the top and the lowest at the bottom. The ranked *product components* names for the six attributes were placed side by side and compared. The result was nearly total confusion because the ranking order across attributes was inconsistent. Next, the *product components* were organized into a list based upon their *product* categories and the attribute averages for each of the six attributes for each *product component* were entered into the table. This also proved problematic because of the inconsistency across attributes. Visually, it was challenging to look at values to two decimal points and assess relative positions in a rating scale. To make it easier to visualize the relative order of the *product component* average scores, the *product components* under each quality attribute were ranked from 1 to 92 and the ranking values were put into the table in place of the means. Then, to aid visual inspection the ranks were split into quartiles and each quartile was assigned a color. Green was used for the first 23, blue for the second 23, yellow for the third, and red for the last 23. The cells in the table were then filled with the appropriate color to match the ranking value in that cell. This permitted visual inspection of the distribution of the means, providing an easier assessment of patterns of the means in the overall distribution of scores for each attribute and importance.

STATISTIC	QUALITY ATTRIBUTE							Importance
	Accuracy / Precision	Completeness	Relevance	Currency / Latency	Timeliness / Reliability	Ease of Use	Average Composite Attribute Score	
MEAN OF QA AVERAGES	3.71	4.01	4.03	3.84	4.00	4.04	3.94	4.25
STANDARD DEVIATION	0.85	0.86	0.92	0.98	0.86	0.89	0.90	0.92
MAXIMUM PRODUCT COMPONENT AVERAGE	4.21	4.50	4.60	4.29	4.38	4.67	4.36	5.00
MINIMUM PRODUCT COMPONENT AVERAGE	1.83	2.68	3.00	3.20	3.29	2.57	2.97	3.37
MEDIAN PRODUCT COMPONENT AVERAGE	3.79	4.12	4.04	3.83	4.10	4.00	3.95	4.26
SKEWNESS OF QA AVERAGES	-1.89	-1.20	-0.40	-0.49	-0.62	-1.05	-1.10	-0.15

**FIGURE 5** Statistical values for responses from all participants in the 2010 road weather information quality survey.



Figure 6 is a section extracted from the ranking table that contained the full list of 92 *product components*. By visually scanning the color scheme and then the rankings across attributes for a given *product component*, the inconsistency between quality assessments for different attributes is more evident. What also jump out are changes in the rankings from one *product group* to the next. For example, the *product components* within the pavement forecast *product* received relatively high-quality attribute mean scores whereas the *product components* in the zone forecast *product* received attribute means near the low end of the attribute means distribution. This approach made it possible to see distinct patterns in the table and determine relationships between the *product components*. However, a strong word of caution is necessary in using the rankings to characterize quality relationships between different resources and their value to DOT users. Although there were a few outliers on the lower end of the attribute average scores, most attribute averages ranged from 3.0 to 4.5 and were highly clustered around an attribute average value of about 4.0. This indicates that road weather information is generally seen as high in quality and the rankings represent the distribution of averages from about half way between high and very high on the top end to around high and moderate on the lower end. And other than the rankings in the top half of the top quartile and the lower portion of the fourth quartile of the rankings list, most of the rankings represent minor differences in the actual attribute averages between *product components*. A low ranking does not imply a low-quality score; it merely indicates that *product component* received one of the lower scores in the distribution of scores around a high-quality score.

Map - Wind Direction	22	30	30	64	38	21	23	70
Map - Wind Speed	23	31	31	65	39	27	29	52
Map - Precip Type	57	52	17	43	49	55	42	44
Map - Pavement Temperature	46	51	20	68	45	34	36	36
Map - Pavement Condition	67	76	55	45	44	40	57	45
Map - Chemical Concentration	83	84	89	79	55	68	82	87
Map - Freeze Point Temperature	71	66	63	66	41	49	63	66
Zone Forecast - Maximum Temperature	58	22	90	46	73	57	69	83
Zone Forecast - Minimum Temperature	66	23	85	47	74	58	68	74
Zone Forecast - Wind Direction	73	24	86	67	68	59	73	54
Zone Forecast - Wind Speed	69	25	82	76	69	60	70	55
Zone Forecast - Weather	76	50	77	48	75	72	74	30
Zone Forecast - Probability of Precipitation	80	59	78	49	76	85	78	37
Pavement Forecast - Air Temperature	5	1	26	27	3	1	4	21
Pavement Forecast - Dew Point	18	10	19	28	4	8	12	22
Pavement Forecast - Relative Humidity	19	11	43	29	5	9	16	65
Pavement Forecast - Wind Direction	2	2	11	11	6	2	1	23
Pavement Forecast - Wind Speed	9	3	5	12	7	3	2	12
Pavement Forecast - Wind gust	38	4	15	30	8	4	6	49
Pavement Forecast - Weather	10	5	6	13	9	5	3	17
Pavement Forecast - Visibility	54	17	56	44	31	14	30	40
Pavement Forecast - Cloud Cover	7	28	57	35	30	15	20	73
Pavement Forecast - Precipitation Type	20	20	3	14	10	6	5	1
Pavement Forecast - Precipitation Start Time	52	6	1	31	11	10	7	2
Pavement Forecast - Precipitation End Time	59	7	2	32	12	11	9	3

FIGURE 6 A section of the ranking table for quality attributes and importance. The column headers are the same as those used in Figure 3.

With this caveat in mind an analysis of the rankings and their patterns provided these findings:

- Weather summaries suffered because the key components of interest were considered lower in accuracy than and not as current as desired by the DOT personnel.
- DOT personnel found the NWS history information of less value than the information in all other *products* across all quality attributes.
- ESS observations have a lower level of importance to the DOT respondents than many of the other resources in this baseline study and are viewed as having marginal quality to the users. Specifically,
  - Data accuracy, timeliness, and reliability are a concern.
  - These limitations impact usage of data by DOT users, NWS, weather service providers, media, and the *Clarus* program.
- ESS histories were considered one of the least important tools and they generally received quality rankings that were below the median values.
- Map displays had middle of the road *product components* averages both in importance and quality attribute scores.
- Pavement weather forecasts were the most important road weather information tool to the DOT participants and they found the quality of the forecast information well above average except for pavement condition-related *product components* (e.g., pavement status, chemical concentration, and percent ice).
- Road weather alerts were important to DOT users, but DOT participants were disappointed with the limited content of the information and its availability on a timely basis.
- Watches and warnings were an important decision support tool that rated second to pavement forecasts in its value to the DOT participants in this study.
- MDSS treatment recommendations were viewed as a relevant and reasonably important tool but were thus far not perceived as one of the more accurate, timely, reliable, and easy to use resources.
- Road condition reports were considered of average importance by DOT users; the quality scores near the lower end of the distribution indicated users see a lot of room for improvement in this resource.
- Flood warnings were of lesser value to DOT users and the quality of the information provided was lower than with most other road weather information resources.
- Camera imagery was an important resource for DOT operations and survey participants suggested that this tool could be even more effective with more or better selection of camera views.
- Radar information scores indicated users see the fundamental radar images as easy to use, timely, and reasonably accurate. Future radar and storm track derived services needed to improve to gain an equivalent acceptance to the observed radar products.

## COMPARISON OF 2008 AND 2010 SURVEY RESULTS

In the 2008 survey the results were generated for *product* and *element* results for each of the three management strategies. Because it was determined that users actually assessed road weather information quality based upon *product components*, the 2010 survey did not query

participants specifically on *products* or *elements*. However, since an aggregate average of all *product components* in a given *product* would be equivalent to a user's assessment of that *product*, it was feasible to compute a set of equivalent *product* statistics. For example, if the Likert scores for all of the *product components* in the zone forecast *product* in Figure 6 were analyzed statistically as one group it would provide the statistical scores for the 2010 equivalent of the zone forecast *product*. In like manner, if all of the Likert scores for all of the *product components* that were forms of an *element* were aggregated together and analyzed statistically, the result would be a 2010 equivalent of that *element* from the 2008 survey. As an example air temperature (an *element* in the 2008 survey) occurs as a *product component* in the following *products* from the list in Figure 1: weather summary, weather history, ESS current conditions, ESS history, regional weather maps, and pavement forecasts. Using these relationships the *product component* averages from the 2010 survey were converted into equivalent *product* and *element* scores for each of the three management strategy classifications and then the variance statistics were computed in the same manner as shown in Figure 5 for the 2010 results. The composite averages from 2010 were then compared to their counterparts from 2008 to assess trends in the quality. The equivalent *element* scores in 2010 for all three management strategy groups increased slightly over the 2008 scores (advisory +0.54, control +0.54, and treatment +0.08). The equivalent *product* scores yielded a slight decrease over the 2008 average scores (advisory -0.19, control +0.34, and treatment -0.08). Even though the control group was positive, the number of participants in that group was so much lower than the number in the advisory and treatment groups that the trend when all *product* comparisons were combined was a decrease of 0.08. However, the trend analyses were questionable due to the small number of comparisons. When the differences between the 2008 and 2010 surveys were evaluated statistically the changes did not represent a statistically significant trend in quality over the 2-year period and the quality scores from the two survey years must be considered to be essentially the same.

The uncertainty in the comparative results may be the result of a number of factors. First, the 2010 survey question set was substantially different than the 2008 survey. As indicated in the last paragraph in the section on Establishment of a Quality Baseline the change to *product component* questions for the 2010 survey resulted from DOT user input. And even though a mechanism was employed to produce a reasonable comparison, the fact remains that the questions the DOT participants answered in 2010 were not the same as those in 2008. Another change made in 2010 was to eliminate the separate surveys for each of the three management strategy groups and have all participants address the same survey questions. The FHWA evaluation team felt these changes produced a more representative baselining tool but it added an unknown level of uncertainty to the comparison of results between 2008 and 2010.

A second source of uncertainty in the results accrued from the limited sample size in the two survey years. The decision was made early in the baseline study to involve DOT personnel who had extensive knowledge in weather's impact on transportation or whose current capacity in the DOT provided them with a broad understanding of how weather impacted operations within their management area. The respondents who participated in the surveys have impressive credentials within their organizations and formed a solid base for the assessment of the level of quality of road weather information from the three major transportation perspectives. However, when the size of the group was evaluated from a statistical perspective, both survey years did not provide a large enough sample size to eliminate uncertainty. Some of the sample size concern was not outwardly obvious. Survey participants each had the option to skip particular parts of the

survey if those individuals did not use particular data sets. The results indicated that even though 37 participants completed the survey, the number of responses to a number of the *product components* were as low as five to 10 responses. This limited set of comparisons became particularly problematic when the responses were separated into the three management categories and comparisons of results were performed.

The third source of uncertainty was tied to human factors considerations associated with using surveys to determine one's assessment of quality. The web-based survey permitted survey participants to enter comments at the bottom of each set of questions (see Figure 2). These comments became invaluable in understanding how the survey respondents interpreted the questions. The 2010 survey was designed to make sure participants were rating the quality of specific *product components*, but several comments indicated that respondents were entering quality assessments based upon their reaction to items in different *product components*. Although the design team thought the survey was straightforward, the comments indicated that participants interpreted the intent of certain questions in a different way than expected. Another level of uncertainty in the quality assessment resulted from the way each individual scaled or weighted their answers in responding to the surveys. When survey results from several individuals were placed side-by-side there were obvious, consistent differences in the Likert scores from one individual to another. Certain respondents had scores that were consistently 4 and 5 on the Likert scale throughout, while another individual rarely submitted a Likert score of 4 or 5. These seem to represent different individual approaches to evaluating quality or value that reflect personal perspectives. In tests with a large sample size these scaling preferences are averaged out; however, when the sample size is small—as in portions of this analysis—individual approaches to survey response scaling affect the results. This factor was particularly important in the comparison of the 2008 and 2010 results, since a number of the *product* and *element* comparisons were based on averages from five or less respondents.

Finally, survey participants indicated within the concluding comments and separately that the surveys were too long. This factor has the potential to impact the quality assessments as participants lose interest in completing the survey or start to enter consistent repetitive responses in order to expedite their completion of the survey. These repetitive patterns did appear in some of the individual responses and were anomalies from the averages seen when the answers from other respondents were computed.

## RECOMMENDATIONS

The redesign of the survey in 2010 resolved two issues discovered after the 2008 survey. It made *product components* the criteria for the assessment of quality (based upon feedback from the 2008 survey participants) and it established a single survey for all survey participants no matter what the participant's area of interest was in transportation. These changes made the 2010 survey a more effective tool for the assessment of road weather information quality, and this format should be retained in future survey years.

However, concerns about the length of the survey and the evaluation of the potential sources of uncertainty discussed in the section on Comparison of 2008 and 2010 Survey Results argue that adjustments are still needed in the baseline procedures. First, the number of participants in the survey needs to be increased. Nearly all members of the DOT community use road weather information to support their operational decisions and have opinions on the quality

of this resource. Statistical principles argue that a larger number of participants would improve the stability of the variance statistics and give a better representation of the DOT's view of the quality of road weather information. Analysis of the 2008 to 2010 trend results using *T*-test techniques indicated that the sample size would need to be in the range of 100 to 300 respondents depending upon the level of significance desired and the extent of the standard deviation of the averages being compared in order to assure a reliable comparison.

The second concern that needs attention is the length of the survey. From the perspective of the evaluation team this creates a challenge because the 2010 survey provides an excellent tool to measure the importance and quality of the key road weather information components. Modification of the survey structure or reduction in its size would induce further uncertainty into the results. The primary issue from the participants has been that the existing survey takes too long to complete in a reasonable period of time. The evaluation team believes that the assessment of quality provided by a given individual will not change appreciably over a short period of time (e.g., over a year). Therefore, the team recommends that the survey be broken into sections and that different parts of the survey questions be offered at different times of the year. It is hoped that if DOT participants answer a survey that takes 15 to 20 min (say possibly one-quarter of the 2010 survey) and then are asked to answer a similar survey three months later, they would be more willing to complete the full survey over several months.

The third recommendation is to restructure the description pages associated with each *product* so there is no confusion regarding the characteristics of the *product* and the characteristics of the *product components* within the *product* group. The evaluation team recommends that examples of each of the *product* packages be illustrated as part of the description page at the beginning of each set of quality questions. For example, if the NWS current weather page shown in Figure 3 were presented along with the information about the *product components*, the provider, the type of spatial display used in this *product*, and the time frame of the information, participants would be less likely to misinterpret what *product components* they are rating.

## REFERENCES

1. Committee on Weather Research for Surface Transportation: The Roadway Environment, Board on Atmospheric Sciences and Climate, Division on Earth and Life Sciences, Transportation Research Board. *Where the Weather Meets the Road: A Research Agenda for Improving Road Weather Services*, The National Academies Press, 2004.
2. FHWA. *Baselining Current Road Weather Information*. Final Report, FHWA-JPO-09-055, [http://ntl.bts.gov/lib/31000/31000/31065/14486\\_files/14486.pdf](http://ntl.bts.gov/lib/31000/31000/31065/14486_files/14486.pdf). Accessed 2009.
3. FHWA. *Baselining Current Road Weather Information: Results of the 2010 Quality and Importance Survey*. Final Report, FHWA-JPO-11-018, [http://ntl.bts.gov/lib/37000/37800/37840/2010\\_Baseline\\_Survey\\_FinalReport-508.pdf](http://ntl.bts.gov/lib/37000/37800/37840/2010_Baseline_Survey_FinalReport-508.pdf). Accessed 2011.

# Climate Trends and Large-Volume Snow Control



## CLIMATE TRENDS AND LARGE-VOLUME SNOW CONTROL

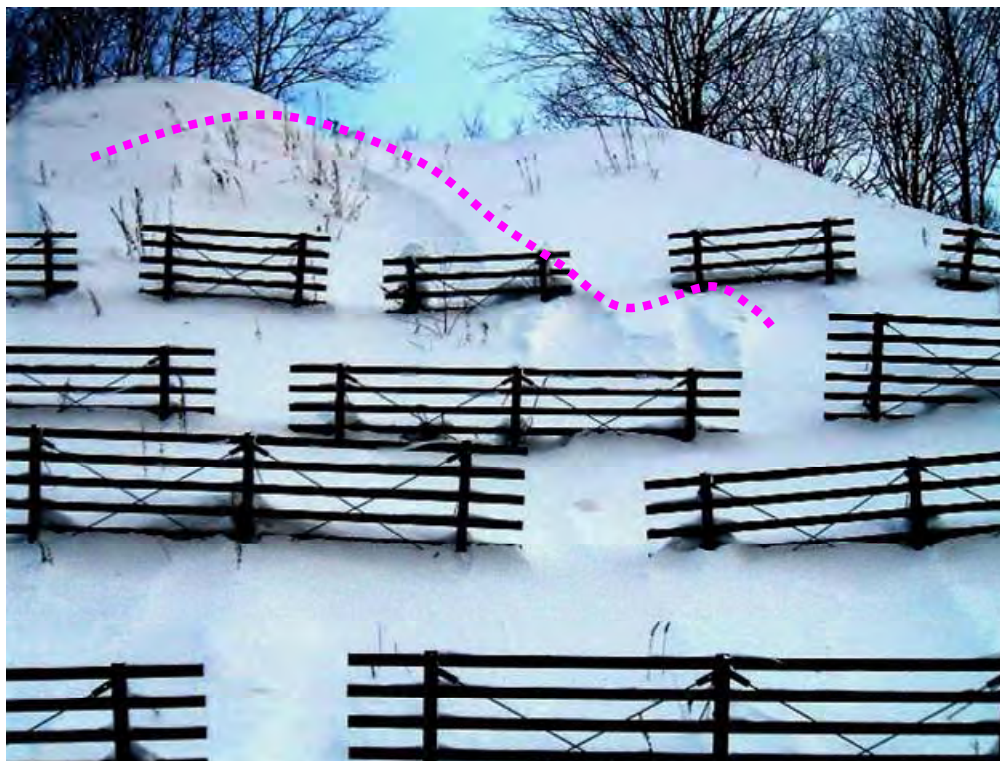
**Measures Against Avalanches Where Snow Slides  
Through Supporting Surfaces of Snow Bridges****HIROKI MATSUSHITA****MASARU MATSUZAWA****OSAMU SAKASE****HIROSHI NAKAMURA***Civil Engineering Research Institute for Cold Region, Public Works Research Institute, Japan*

**In this study, analysis of avalanche cases was carried out to clarify the conditions under which snow that has accumulated on slopes slides through snow bridges to prevent avalanche. Field tests and model experiments were also conducted using naturally accumulated snow to determine the effectiveness of nets installed on such bridges with the aim of preventing the occurrence of slide-through. The results of the analysis showed that slide-through mainly occurs with dry-snow avalanches when the air temperature is low and the snowfall intensity is high. According to theoretical estimation of the stability of snow accumulated on slopes and snow hardness, it was concluded that avalanches accompanied by slide-through occurred when the snow became unstable after about 12 h from the onset of snowfall under high snowfall intensity conditions. It was also considered that low hardness of the snow due to low temperatures caused accumulated snow on slopes to slide through the supporting surfaces of bridges. Field tests in which natural avalanches were caused confirmed that net installation prevented the occurrence of slide-through. Furthermore, the results of the model experiments using naturally accumulated snow with low density and hardness indicated that net installation increases the snow contact area on the supporting surface of a bridge, thereby distributing the snow load and preventing the occurrence of slide-through, resulting in a lower likelihood of compression fracture even with low-hardness snow. Accordingly, it can be concluded that net installation has a slide-through prevention effect.**

**A**valanche snow bridges installed on slopes significantly contribute to the prevention of avalanches onto roads in Hokkaido. In recent years, however, cases have been reported in which snow that has accumulated on slopes has slid through the supporting surfaces of snow bridges down onto roads below them, as shown in [Figure 1](#) (a phenomenon hereinafter referred to as slide-through) (1, 2). As a preventive measure for this phenomenon, steps are taken to install nets or similar on existing snow bridges (3). However, the conditions that cause slide-through previously remained unclear, and the effectiveness of measures to prevent the phenomenon had not been evaluated.

This report outlines the results of meteorological analysis regarding avalanche cases relating to national highways in Hokkaido. These investigations were carried out to clarify the occurrence conditions of avalanches accompanied by slide-through. Also, in order to determine the effectiveness of nets installed on snow bridges in preventing the phenomenon, researchers conducted field tests and model experiments using naturally accumulated snow.





**FIGURE 1** Example of an avalanche accompanied by slide-through. Dotted line means crown face of snow in starting zone of avalanche.

## INVESTIGATION METHOD

### Case Analysis

For the analysis, 41 avalanche cases were selected from the record of incidents occurring on Hokkaido roads in the previous 5 years (April 2000 through March 2006). Among these, incidents caused by slide-through were determined based on descriptions in the record and existing documentation. For meteorological analysis, data from road weather telemeters of the Hokkaido Development Bureau installed near avalanche occurrence sites as well as air temperature and snow depth statistics observed at 1-h intervals by the Japan Meteorological Agency's AMeDAS network were used.

In the meteorological analysis, the avalanches were first classified into dry-snow and wet-snow types based on the descriptions in the record. Next, researchers focused on the temperature, snow depth, and snowfall amount for the snowfall periods, defined as the time from the onset of snowfall to the occurrence of avalanche. Here, if the difference between hourly snow depths was positive, it was assumed that there was snowfall; periods of less than 5 h without snowfall were taken as part of the snowfall period. The snowfall amount was considered to be the sum of differences in hourly snow depth. Additionally, the snowfall intensity was obtained by dividing the snowfall amount by the snowfall period. It should be noted that the snow depth was not measured in three of the 41 avalanche cases, and these were excluded from the meteorological analysis.

## Field Test

In order to determine the effectiveness of net installation for slide-through prevention in conditions of natural snowfall and snow coverage, field tests were conducted in the Nakayama Pass (altitude 835 m) near Sapporo from December 14, 2007, to February 29, 2008. Four snow bridges measuring 2.5 m in height and 2.75 m in width were installed on a test slope (inclination 37 degrees) as shown in Figure 2 and used for the tests.

The tests were conducted with nets installed on bridges A and D, and without nets on bridges B and C, to determine whether there was any difference in the occurrence of slide-through with and without nets. Table 1 shows the specifications of the installed nets. To determine whether differences in net structure influence the effectiveness of the preventive measure, we first installed metal nets (XS62 and JIS G3351) and then replaced them with plastic nets (see Figure 2b and Table 1) on February 9. The void ratio in Table 1 expresses the non-grid area to the area of the whole net; a higher ratio indicates a coarser net and greater permeability.

In the tests, plastic sheets (#3000; width 5.4 m; length 9.0 m) were placed over the accumulated snow to facilitate the occurrence of avalanche. The shear strength (4) and adhesion strength (5) of the snow that accumulated on the plastic sheet were approximately 200 to 300 N/m<sup>2</sup>, which was approximately the same as the shear strength of a weak layer of snow with a density of 100 kg/m<sup>2</sup> or less (6). Accordingly, placement of plastic sheets is considered to be equivalent to forming an artificial weak layer of snow as a condition for causing an avalanche.

In the test, snow that had accumulated on the plastic sheets was removed before expected periods of snowfall to increase the likelihood of avalanches. We recorded the conditions of the slope using a video camera, and the footage was referenced to count the number of avalanches and slide-through occurrences. Air temperature and snow depth used for the analysis were also observed near the field test site.

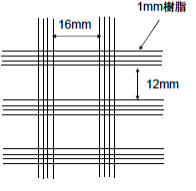
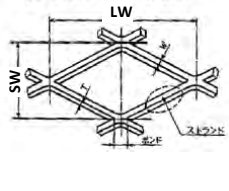
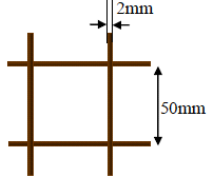
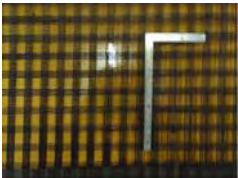


## Model Experiment

To clarify the slide-through prevention mechanism under the conditions of net installation, model experiments were conducted in the Nakayama Pass on February 2, 2009. Researchers tilted the entire model of a snow bridge as shown in Figure 3, measured the load applied to the bridge, and observed how the snow broke and moved as well as how slide-through occurred. Three types of

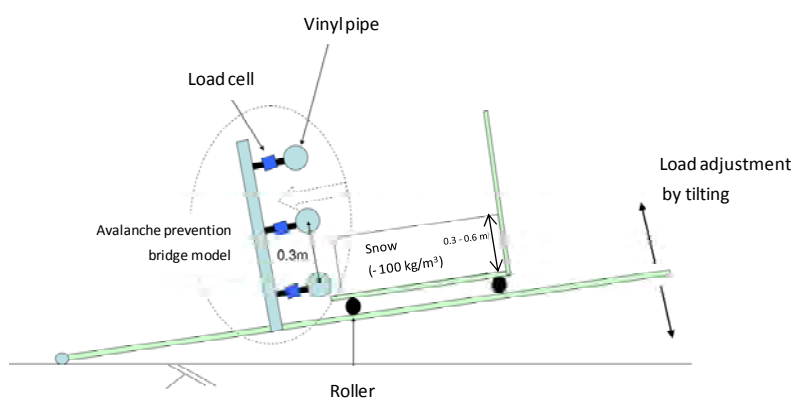


**FIGURE 2** (a) Slope condition for field tests and (b) snow bridge with steel net.

**TABLE 1 Net Specifications\***

Net type	Plastic	Steel	Welded wire mesh
Specifications	$\phi$ 1mm 16mm $\times$ 12mm  Void rate = 20 %	SW=34 mm LW=76.2 mm  Void rate = 69 %	$\phi$ 2mm 50mm $\times$ 50mm  Void rate = 84 %
Photo			

\*NOTE: Long side of carpenter's square is 15 cm.

**FIGURE 3 Schematic of avalanche prevention snow bridge model.**

nets with different mesh sizes and materials were installed as shown in Table 1. The experiments were performed with and without these nets installed. Round vinyl chloride pipes (diameter 84 mm) were used for the horizontal bars constituting the supporting surface of the snow bridge. Three pipes were installed at 0.3-m intervals to form the same structure as an actual snow bridge. A snow-loaded cart was placed on this model, and the loads ( $N$ ) applied to the horizontal bars were measured using load cells (LC1205-K100, A&D) installed between the bars and the support post (see Figure 3). Loading was applied continuously by releasing the cart after fixing the angle of the model at 20 or 30 degrees. The values used for the analysis were obtained by subtracting the loads without the snow-loaded cart from the measured values.

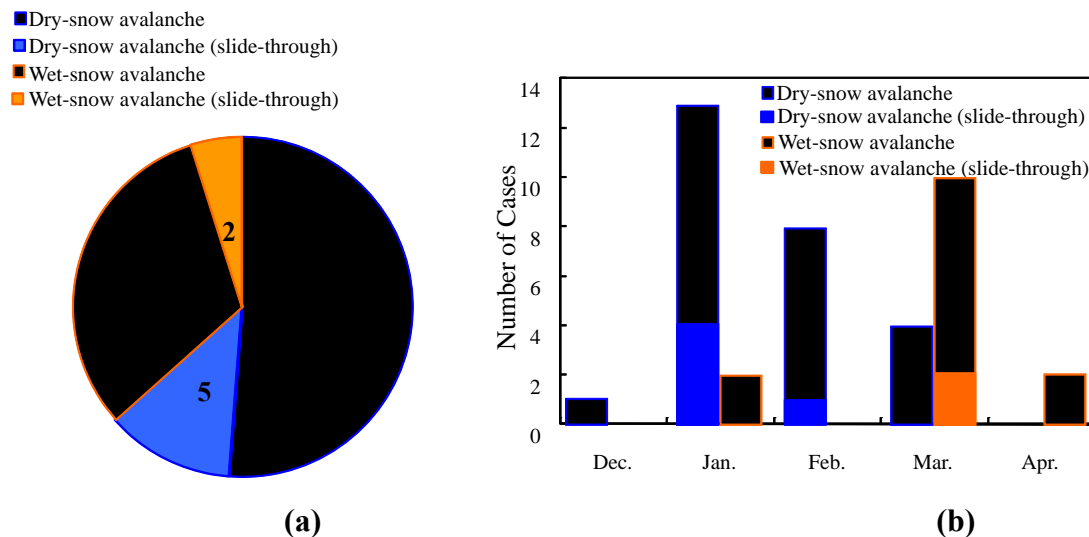
The snow used for the experiments was a rectangular solid (height 0.2 to 0.3 m; width approximately 0.6 m; length approximately 0.6 m) formed by filling a cart with natural snow that had fallen on the previous day. Density, hardness, and temperature were measured at three points (top, middle, and bottom) in this snow mass, and the average values were used for the analysis. Hardness was measured with a digital push-pull gauge (RX-2, Aiko Engineering; attachment diameter 30 mm).

## RESULTS

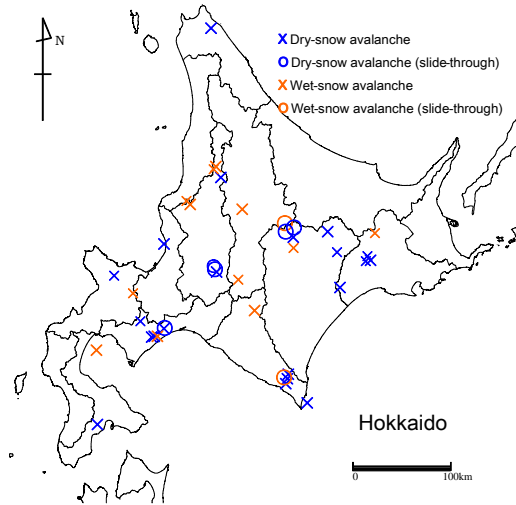
### Results of Case Analysis

The number of avalanches occurring in the previous 5-year period was 26 (63%) for dry snow and 15 (37%) for wet snow (see Figure 4a). Among these instances, slide-through was seen in seven cases (five for dry snow and two for wet snow). The monthly number of avalanches (Figure 4b) shows that the dry-snow avalanche was common in the period from January to February, while the wet-snow avalanche prevailed in March. Four out of five dry-snow avalanches accompanied by slide-through occurred in January, and wet-snow avalanches accompanied by the phenomenon occurred in March. No significant difference was seen in terms of the regional distribution (Figure 5) of dry- and wet-snow avalanches, with both occurring over a large area of Hokkaido. Conversely, avalanches accompanied by slide-through occurred in a relatively limited number of areas.

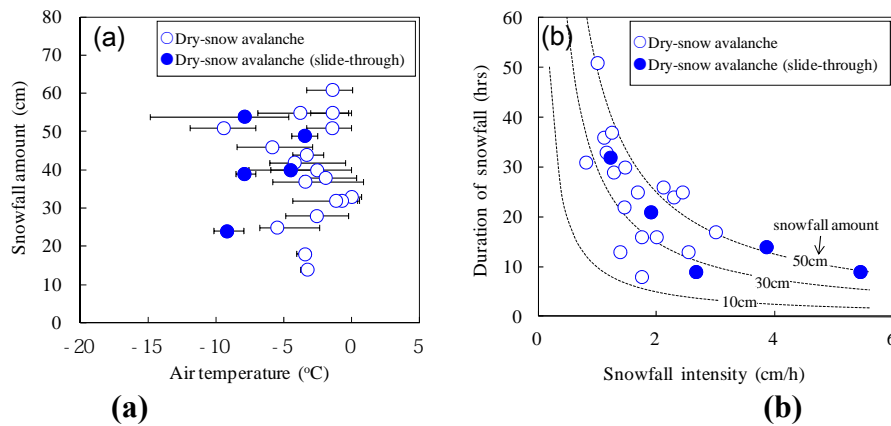
Next, since slide-through mainly accompanies dry-snow avalanches, researchers examined the weather conditions seen when this type of avalanche occurred for 23 cases excluding those where snow depth was not measured. Figure 6a shows the relationship between average air temperature and total snowfall amount, with the horizontal axis indicating the highest and lowest temperatures seen during the snowfall period. The figure shows that many of the avalanches occurred when the snowfall amount was 30 cm or more. Those accompanied by slide-through occurred at relatively low temperatures of below  $-4^{\circ}\text{C}$ , and also when the amount of snowfall was large at 30 cm or more in all but one case. The relationship between snowfall duration and the snowfall intensity (Figure 6b) indicates that some avalanches occurred when the snow depth reached 30 cm or more within a short period of about 10 h, while others occurred when the snowfall intensity was low (about 1 cm/h) but snowfall continued for 30 h or more. Among these avalanches, those accompanied by slide-through often occurred when the snowfall duration was short (20 h or less) and the snowfall intensity was 2 cm/h or more.



**FIGURE 4** (a) Types of avalanches occurring on Hokkaido roads and (b) monthly avalanche count. (“Slide-through” means avalanches accompanied by slide-through. Statistical period: April 2001–March 2006.)



**FIGURE 5 Regional distribution of avalanche locations.**  
(Statistical period is same as in Figure 4.)

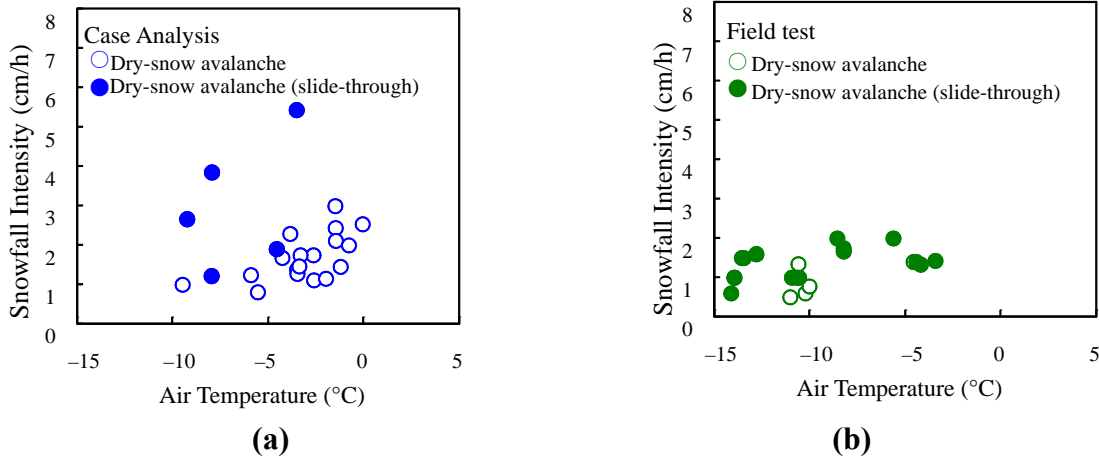


**FIGURE 6 (a) Relationship between mean air temperature and snowfall amount and (b) relationship between snowfall duration and snowfall intensity.**  
(Statistical period is same as in Figure 4.)

As described above, slide-through typically occurs when the air temperature during snowfall is low and the snowfall intensity is high. Figure 7a shows the relationship between air temperature and the snowfall intensity that causes the phenomenon.

**Results of Field Tests**

The numbers of avalanches occurring during the tests were 13 and 15 for snow bridges A and D (both with nets), respectively, and 19 and 10 for snow bridges B and C (both without nets), respectively. Table 2 shows the ratio of the number of slide-through occurrences to the number of avalanches. The slide-through occurrence rate with bridges B and C was from 66.7% to 71.4%. Here, for the period during which the steel net was installed (December 14 through February 8) and the



**FIGURE 7 Relationship between air temperature and snowfall intensity during the snowfall period investigated by case analysis (a) and field test (b).**

period during which the plastic net was installed (February 9 through 29), no difference is seen in the slide-through occurrence rate for netless bridges B and C. Accordingly, it can be concluded that the slide-through occurrence conditions seen during the test period were uniform.

Based on the above, the slide-through occurrence rate for steel nets was compared with that for plastic nets. It was found that the value was 0.0% for both nets with snow bridge A. In contrast, the rate for bridge D with the steel net installed was 11.1%, and slide-through was seen once. In this case, however, the amount of snow that slid through the steel net was small. Accordingly, it was confirmed that net installation helps to prevent the occurrence of slide-through.

Additionally, Figure 7b shows the relationship between the average temperature and the snowfall intensity during the snowfall period of this test. As seen with the results of the case analysis (Figure 7a), more avalanches accompanied by slide-through occurred when the snowfall intensity was high than for those without slide-through.

**TABLE 2 Ratio of Slide-Through Events to Natural Avalanche Occurrences\***

Period		12/14 to 2/8	2/9 to 2/29
Without net	Snow bridge B	66.7% (8/12)	71.4% (5/7)
	Snow bridge C	71.4% (5/7)	66.7% (2/3)
With net (steel)	Snow bridge A	0.0% (0/8)	—
	Snow bridge D	11.1% (1/9)	—
With net (plastic)	Snow bridge A	—	0.0% (0/5)
	Snow bridge D	—	0.0% (0/6)

\*NOTE: Figures in parentheses indicate number of slide-through events and avalanches.

## Results of Model Experiment

The snow used for the experiments had a density of 47 to 80 kg/m<sup>3</sup>, a hardness of 0.8–2.5 kN/m<sup>2</sup>, and a temperature from –4.1°C to –5.6°C. In the tests, slide-through occurred in all cases without net installation, but was not seen when nets were installed, although snow compression fracture did occur.

Figure 8a shows a time series of the snow loading and snow conditions seen when nets were not installed. As the cart was released, the load was applied at a stroke. For a short period before the load peaked, there was amplitude of 0.03 kN around it. At this time, slide-through occurred and the whole mass of snow slid through the supporting surface. Conversely, when a net (e.g., the steel type) was installed as shown in Figure 8b, the snow underwent compression fracture and the load increased instantly to its peak value. During this period, snow did not slide through the supporting surface. This tendency was the same for welded wire mesh and plastic mesh.

Figure 9 compares the load and the hardness of snow seen at the time when slide-through or compression fracture occurred. Here, the measured load (N) was divided by the area values for the round vinyl chloride pipes and nets to determine the load per unit area (N/m<sup>2</sup>). However, as vinyl chloride pipes are round, the area of contact with the actual snow is smaller than that projected, and the load may thus be larger than expected. Additionally, the hardness value (N/m<sup>2</sup>) measured using a push gauge is taken as the compression fracture resistance value for the point at which its attachment was inserted into the snow (7). According to Figure 9, when the load on the supporting surface became equivalent to the hardness of the snow, slide-through occurred. The load and hardness values were also almost the same when nets were installed, but compression fracture occurred instead of slide-through. Further, the load when a net was installed was smaller than that seen when no net was installed because net installation resulted in an increased snow contact area and a reduced load per unit area.

## CONSIDERATION

### Slide-Through Occurrence Conditions

To examine the occurrence conditions for avalanches accompanied by slide-through, snow stability index (SI) (8) (i.e., the ratio between the shear strength and the shear stress of snow accumulated on a slope) was used.

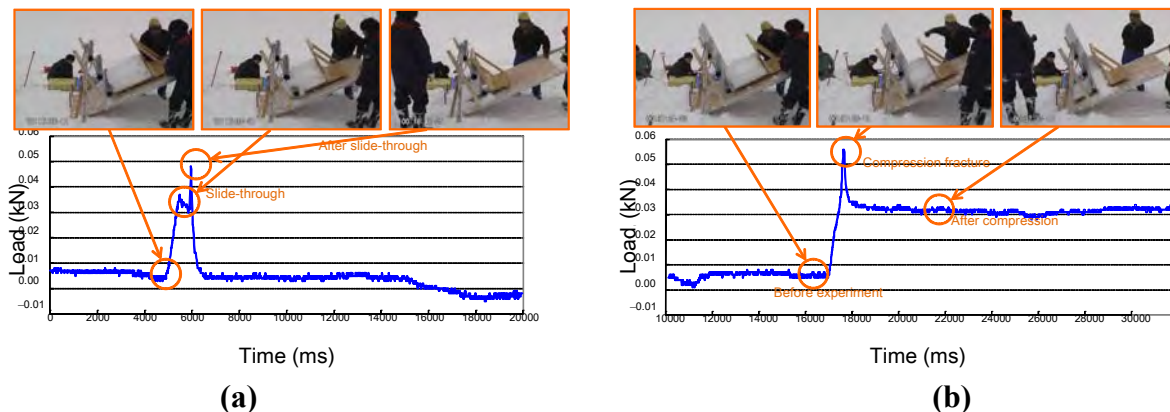
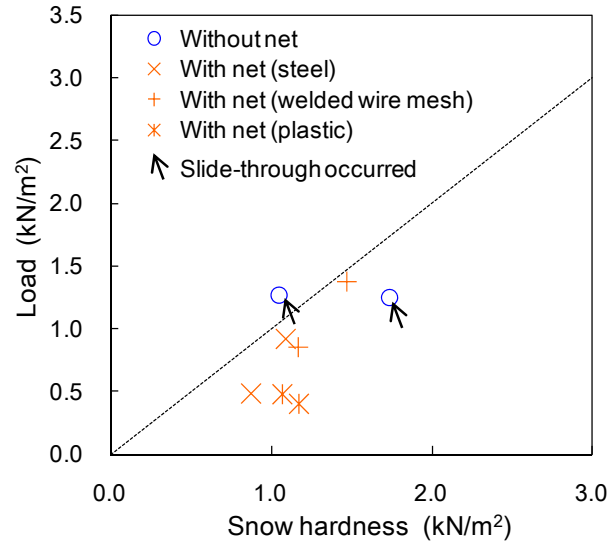


FIGURE 8 Loading time series and snow conditions (a) without net and (b) with steel net.



**FIGURE 9 Comparison of loading and snow hardness at the time of slide-through or compression fracture.**

$$SI = \frac{\sigma}{h \rho g \sin \theta \cos \theta} \quad (1)$$

where  $h$  is the snow depth (m),  $\rho$  is the snow density ( $\text{kg/m}^3$ ),  $g$  is the gravity acceleration ( $\text{m/s}^2$ ),  $\sigma$  is the shear strength ( $\text{N/m}^2$ ), and  $h \rho g \sin \theta \cos \theta$  is the shear stress ( $\text{N/m}^2$ ). The lower the snow stability SI, the higher the avalanche occurrence risk (9). Shear strength  $\sigma$  was estimated from the expression (8) showing the relationship between the shear strength and density of accumulated snow.

$$\sigma = 3.10 \times 10^{-4} \rho^{3.08} \quad (2)$$

However, since snow density  $\rho$  increases with time due to densification, snow density  $\rho_t$  ( $\text{kg/m}^3$ ) at time  $t$  in consideration of this densification process was determined using the following equation (8):

$$\rho_t = \left\{ \frac{2Ag}{C} \cdot \cos^2 \theta \cdot t^2 + \rho_0^4 \right\}^{1/4} \quad (3)$$

where  $\rho_0$  is the initial snow density ( $\text{kg/m}^3$ ) of newly accumulated snow,  $A$  is the snowfall intensity ( $\text{kg}/(\text{m}^2/\text{h})$ ), and  $C$  is a coefficient ( $\text{N}/\text{m}^2/\text{s}/(\text{kg}/\text{m}^3)^4$ ) determined using the relational expression for snow temperature  $T_s$  ( $^{\circ}\text{C}$ ) as shown below (10). For new snow, it can be assumed that  $T_s$  is equal to the air temperature.

$$C = 0.21 \exp(-0.166T_s) \quad (4)$$



Figure 10 shows the results of calculation for snow stability SI as determined by Equations 1 to 4 for snow temperatures (= air temperatures) of  $-3^{\circ}\text{C}$ ,  $-7^{\circ}\text{C}$ , and  $-10^{\circ}\text{C}$ , with snowfall intensity  $A$  assumed to be 3 cm/h. The figure shows the change of SI with time, and indicates that the value was at its lowest 8 h after the start of snowfall for  $T_s = -3^{\circ}\text{C}$ , 12 h for  $T_s = -7^{\circ}\text{C}$ , and 16 h for  $T_s = -10^{\circ}\text{C}$ . It can be inferred that the period within 20 h of the onset of snowfall during which slide-through often occurs (as outlined above) is characterized by particularly low values of snow stability SI and a higher likelihood of avalanches.

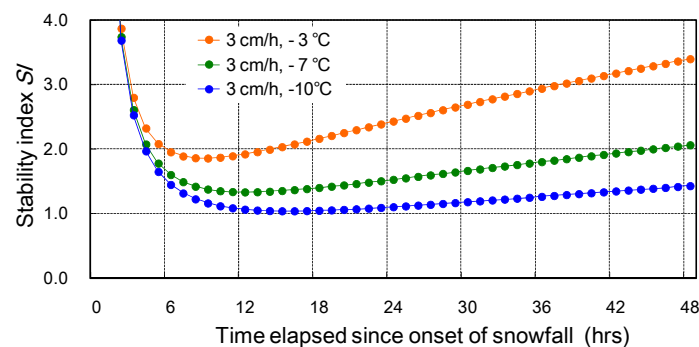
Figure 11 shows the results of calculation for snow stability SI and snow hardness  $H$  with air temperature and the snowfall intensity used as indexes. Snow hardness  $H$  ( $\text{N}/\text{m}^2$ ) was calculated from snow density  $\rho_t$  in consideration of consolidation using the following equation (11):

$$H = 1.31 \times 10^{-5} \rho_t^4 \quad (5)$$

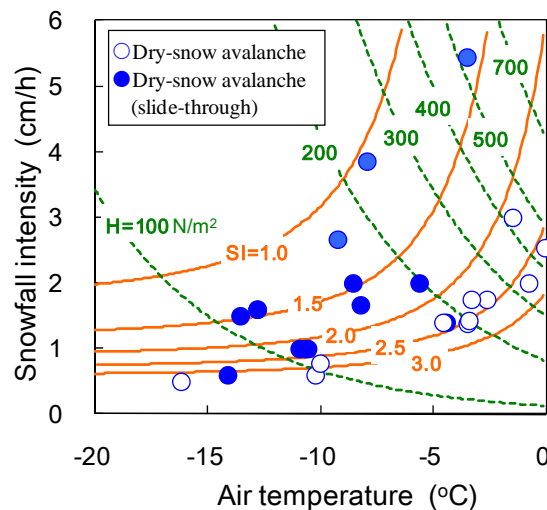
For the calculation shown in this figure, as slide-through tends to occur with snow falling over a relatively short period, the values of snow stability SI and hardness  $H$  12 h after the start of snowfall were determined. To achieve this, cases in which the time from the onset of snowfall to avalanche occurrence was 6–18 h were extracted from among those described in the case analysis (Figure 7a) and the field tests (Figure 7b). These are shown in Figure 11, which indicates that conditions with a low air temperature, a high snowfall intensity and avalanches accompanied by slide-through are equivalent to those with a snow stability SI value of 2.0 or less and a snow hardness  $H$  of about  $250 \text{ N}/\text{m}^2$  or less.

Conditions where snow stability is low and snow is unstable are considered to be those where compression force is applied to snow that has accumulated around snow bridges. Examination of the slide-through occurrence mechanism in these conditions based on the experiment results indicates that stress acting on snow accumulated around a snow bridge caused compression fracture of this snow, and the impact of the snow hitting the supporting surface of bridge was greater than the strength of the accumulated snow, resulting in the snow sliding through the supporting surface of the bridge.

Based on the above, it can be said that avalanches accompanied by slide-through occur when snow accumulating on a slope becomes unstable within about 12 to 20 h under weather conditions with a high snowfall intensity and low air temperatures (first condition), and that snow strength is low and snow destruction tends to occur at this time (second condition).



**FIGURE 10** Example of snow stability index (SI) calculation results (snowfall intensity: 3 cm/h; air temperatures:  $-3^{\circ}\text{C}$ ,  $-7^{\circ}\text{C}$ ,  $-10^{\circ}\text{C}$ ).



**FIGURE 11 Relationship among weather conditions upon avalanche occurrence, stability index  $SI$ , and snow hardness  $H$  ( $SI$  and  $H$  are calculation results for 12 h after the onset of snowfall, and the avalanche examples are cases occurring from 6 to 18 h out of those shown in Figure 7).**

### Effectiveness of Net Installation for Avalanche Prevention

The results of the field tests confirmed that net installation is effective in preventing slide-through. One reason for this may be that the snow contact area (Figure 9) is increased by net installation and the snow load acting on the supporting surface of snow bridges is dispersed, thereby reducing the likelihood of compression fracture. Furthermore, even if compression fracture occurs and accumulated snow starts to move, the snow does not slide through the net, and its density and hardness therefore increase due to compression (the snow hardness after compression in the model experiment was 2.3 to 8.2 kN/m<sup>2</sup>), thereby further increasing its strength against destruction. Consequently, a larger load is necessary to cause compression fracture. Accordingly, net installation is considered to suppress compression fracture in snow around snow bridges and to prevent slide-through.

In terms of the effectiveness of slide-through prevention based on net installation, the influence may increase with the net void ratio. However, even welded wire mesh is expected to have a slide-through prevention effect equivalent to that demonstrated in the experiment if the net void ratio is in the range of 20% to 84%.

### CONCLUSION

In this study, researchers conducted avalanche case analysis to clarify the conditions necessary for the occurrence of the phenomenon in which snow that has accumulated on a slope slides through snow bridges to prevent avalanche. Additionally, in order to clarify the slide-through prevention effect achieved by installing nets on such bridges, field tests and model experiments were conducted using naturally accumulated snow.

The case analysis showed that slide-through mainly accompanies dry-snow avalanches, and occurs when the air temperature is low and the snowfall intensity is high. Researchers theoretically estimated the stability and hardness of snow accumulating on slopes using air temperature and the snowfall intensity as indexes, and concluded that avalanches accompanied by slide-through occurred after about 12 h from the onset of snowfall when the snowfall intensity is high. It is also considered that snow hardness was low due to the low temperature, and the snow accumulated on the slope slid through the supporting surface.

The field tests involving natural avalanches confirmed that net installation helps to prevent the occurrence of slide-through. Additionally, the results of model experiments using naturally accumulated snow with low density and hardness clarified the net-based slide-through prevention mechanism, indicating that an increased snow contact area on the supporting surface of the bridge disperses the snow load, meaning that even snow with low hardness is unlikely to undergo compression fracture. That is, net installation suppresses the movement of snow accumulated on slopes, which is the original purpose of snow bridges, and a slide-through prevention effect can thereby be achieved.

## REFERENCES

1. Takeuchi, M., M. Otsuki, T. Yamada, and K. Ishimoto. Avalanches and Measures on Highway in Hokkaido. *Journal of Snow Engineering of Japan*, Vol. 21, 2005, pp. 202–211 (in Japanese).
2. Takeuchi, M., M. Otsuki, and T. Yamada. New Snow Avalanche Flowing Down Through Trees and Fences. *Proc., 2005 Cold Region Technology Conference*, Vol. 21, 2005, pp. 768–771 (in Japanese).
3. Matsushita, H., M. Matsuzawa, Y. Ito, T. Miyoshi, Y. Kajiya, and M. Otsuki. Countermeasures for Snow Avalanche Flowing Through Fences: In Case Around Taisetsu Lake in Hokkaido. *Proc., 2006 Cold Region Technology Conference*, Vol. 22, 2006, pp. 351–356 (in Japanese).
4. Kamiishi, I., H. Hirashima, S. Yamaguchi, A. Sato, and T. Machida. The Occurrence and Measurement of Shearing-Strength for the Prediction of Slope Face and Collapse Slope Avalanche. *Proc., 2007 Cold Region Technology Conference*, Vol. 23, 2007, pp. 181–185 (in Japanese).
5. Sato, T., K. Kosugi, M. Nemoto, O. Abe, and S. Mochizuki. Snow Block Sliding on the Roof Covered by a Blue Sheet (2): Sliding Conditions of Roof Snow. *Proc., 2006 Cold Region Technology Conference*, Vol. 22, 2006, pp. 324–329 (in Japanese).
6. Jamieson, B., and C. D. Johnston. Evaluation of the Shear Frame Test for Weak Snowpack Layers. *Annals of Glaciology*, Vol. 32, 2001, pp. 59–69.
7. Sato, T., O. Abe, K. Kosugi, and Y. Nohguchi. Measurement of the Hardness of Snow by Using a Portable Load Gauge and Comparison with the Kinosita-Type Hardness Meter. *Journal of the Japanese Society of Snow and Ice (Seppyō)*, Vol. 64, 2002, pp. 87–95 (in Japanese with English abstract).
8. Endo, Y. Forecasting of Direct-Action Avalanches in Terms of Snow Accumulation Rates. *Journal of the Japanese Society of Snow and Ice (Seppyō)*, Vol. 55, 1993, pp. 113–120 (in Japanese).
9. Nishimura, K., H. Hirashima, M. Lehning, K. Ishimoto, and H. Kawami. Development of Snow Avalanche Danger Index. *Proc., 2005 Cold Region Technology Conference*, Vol. 21, 2005, pp. 244–248 (in Japanese).
10. Abe, O. Creep Experiments and Numerical Simulations of Very Light Artificial Snowpacks. *Annals of Glaciology*, Vol. 32, 2001, pp. 39–43.
11. Takeuchi Y., Y. Nohguchi, K. Kawashima, and K. Izumi. Measurement of Snow-Hardness Distribution. *Annals of Glaciology*, Vol. 26, 1998, pp. 27–30.

## CLIMATE TRENDS AND LARGE-VOLUME SNOW CONTROL

**Implementing Winter Climate Studies for  
Transportation Projects in Ontario, Canada**

STEVEN MCARDLE

PATRICK GROVER

NEIL HELLAS

*4DM Inc.*

Ontario highways are exposed to a variety of severe winter conditions that can lead to significant road hazards resulting in economic loss and impact to society from the loss of life. According to provincial transportation records, collisions resulting from snow and drifting snow conditions were the second largest cause of fatalities, personal injury, and property damage in Ontario. Over the past few years the Ontario Ministry of Transportation has elevated the importance of incorporating winter study components into a range of transportation projects. These studies pertained to projects involving new highway extensions, redesign of highway sections, winter transportation studies resulting from severe collisions, and highway bypass routes. The studies included snowdrift severity, identification of microclimate zones, impacts of lake-effect snow, equilibrium drift analysis at highway cross sections and mitigation assessment (i.e., snow fences, hedges, and ditches). The analysis conducted in these projects utilized the latest technology and information from satellite imagery, geographic information system tools, regional reanalysis data, roadway weather information system data, and weather radar composites. Through these studies new knowledge and tools have emerged, including a new numerical snow transport model that has been developed to enhance the mitigation of winter hazard conditions. The outcome has led to improved placement of snow fences, alterations to highway cross sections, landscape modifications, changes to the placement of highway guiderails, and an understanding of the impacts of winter weather. This paper presents an insight into Ontario's recent studies focused on the better understanding and control of snowdrift events through new modeling techniques, field observations, and climate analysis.

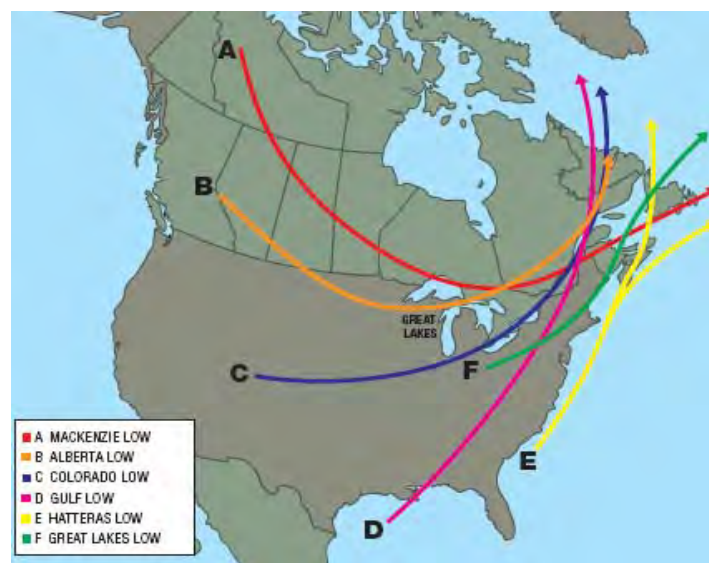
**WINTER TRANSPORTATION CHALLENGE IN ONTARIO**

Ontario has more than 16,500 km of provincial highways 90% of the population lives within 10 km of a highway (1). Over 95% of Ontario's population is located in Southern Ontario and produces 68% of Ontario's gross domestic product or about 27% of Canada's economic output (2). A significant part of Ontario's economic prosperity is dependent on a reliable transportation infrastructure. The provincial road network is an essential part of the infrastructure providing transportation routes ranging from tertiary roads to multilane highways. Ontario's 400 series highways are vital links within Ontario and the key interconnection with Quebec and the United States for commerce and mobility. Highway 401 is considered the main highway in the province extending from Quebec to the United States Windsor–Detroit border. It is considered the busiest highway in the world where sections of the highway through Toronto experience an annual average day traffic (AADT) count of 442,500 vehicles in 2008 (3) and has a peak AADT of over half million vehicles.

The movement of people, goods, and services is greatly impacted by severity of winter weather conditions, which can span from the beginning of November into April in Southern Ontario. Geography plays an important factor in the type of winter conditions experienced in Southern Ontario. The influence of the Great Lakes has the most notable impact on the regional winter weather patterns. The large bodies of water act as a heat exchange, moderating winter air temperature but also can intensify or alter winter storm patterns that affect Southern Ontario. The atmospheric circulation patterns along the Atlantic seaboard gives rise to severe winter storms, commonly known as Nor'easters, that intensify as they move northwards up the coast colliding with colder air masses, releasing significant amounts of precipitation. In the Rocky Mountains of western Canada, Alberta Clippers develop and become fast-track storms that move along the jet stream into Southern Ontario with frequent, low-intensity precipitation events. Other major winter storm types impacting Southern Ontario include Colorado Lows and Gulf Lows, which typically bring intense winter storms over the region. Figure 1 shows the prevalent winter storm patterns over Southern Ontario (4)

In addition to winter storm patterns, winds that traverse open and relatively warm waters, such as the Great Lakes, in early winter can result in weather phenomena known as lake-effect snow (5). There are a number of regions in Southern Ontario that are affected by this condition and are commonly known as the Snow Belt Regions. Snow precipitation in these regions can range from 250 cm to 400 cm per year in comparison to the typical snow amounts for non-lake effect snow areas of 100 to 200 cm per year. The combination of snow availability from winter storms and the prevailing wind patterns can induce snow drifting onto provincial highways, increasing potential road hazard conditions through reduce visibility and surface friction. In Ontario, the impact of snow accumulation and drifting snow on provincial highways results in approximately 12% or 31,000 vehicle collisions in 2008 (6).

Ontario winter highway maintenance is regulated by the government, and managed at the provincial and municipal levels. The minimum municipal winter maintenance standards are set by Ontario Regulations 239/02, which specified the minimum standards for municipal highways by AADT and type of highway. Alternatively, provincial highway winter maintenance standards



**FIGURE 1** Winter storm patterns over Southern Ontario.

are regulated by the Ministry of Transportation (MTO), who use performance-based maintenance standards that are set to achieve bare road conditions on provincial highways within a standard time after winter storm 90% of the time.

Winter maintenance operations are outsourced to area maintenance contractors (AMC), who are responsible for snow and ice control based on the regulatory standards. In Canada, it is estimated that winter road maintenance costs approximately \$1 billion and 50% of Ontario's highway maintenance budget is used for winter maintenance (7). Based on Ontario's 2009–2010 provincial expenditure report, winter road maintenance at today's estimates would be closer towards \$180 million (8).

AMC are responsible for addressing wind-induced snow transport (i.e., snow drifting), which can significantly increase the amount of non-precipitated snow onto the highways thus requiring more winter maintenance. The MTO has guidelines for understanding and managing snow drifting conditions that were developed in 1998 and are still applicable today (9). The MTO estimates that blowing and drifting snow is responsible for approximately 30% of plowing, salting, and sanding, or approximately \$3,000 per two-lane kilometer section annually in rural areas. Prevention of snow drifting has net benefit for improving road safety and reducing winter maintenance costs.

As result, the MTO has updated contract specifications related to snow drifting work to include analysis into appropriate transportation studies and highway engineering projects through their tendering process. In recognition of the importance of managing snow drifting, a number of transportation studies have included elements of winter climate and snow drifting analysis, which are presented in this paper.

## MEETING THE CHALLENGE

Predicting and managing snow drifting conditions on highways in a comprehensive manner would ideally be initiated in the early stages of transportation planning. For example, when assessing highway routing, including snowdrift exposure could be incorporated into the planning process when it is feasible to do so. However, the majority of highways will more likely undergo engineering redesign or expansion. Snow drifting impacts can be anticipated and the implications on road safety can be minimized by incorporating into the preliminary or detail design to account for the potential drifting of snow. Other types of studies are winter operational reviews that include modifications to road infrastructure, winter collision assessment, and maintenance analysis. The goal of these studies is to examine problematic conditions and determine causality and recommend mitigating treatment. The results of the study may lead to change in road design, implementation of mitigation measures, and modification maintenance practices.

Effective management of snowdrift severity is best achieved through an integrated approach. Local input coupled with in situ observations of snow drifting condition backed-up with the utilization of numerical snow transport models that are driven by meteorological input can be used to confidently identify areas with potential snow drifting problem. Snow transport models emulate natural environment through mass and energy balance equations to determine accumulation and flux of snow within an exposed area along highway corridors. Winter collision history can also provide further insight into snow drifting locations by correlating field observation, model predictions, and winter collision history. Once the snow drifting areas have been identified the focus shifts towards mitigation treatments to reduce the snow drifting on to the road. Snow and living fences are barrier techniques for reducing snow flux and accumulation.

Other measures include snow storage such as ditches, modification to highway cut sections, and land management practices such as leaving corn row stubble in the field. Recent winter study projects conducted in Ontario have involved unique analyses related to highway design, transportation planning studies, and operational review.

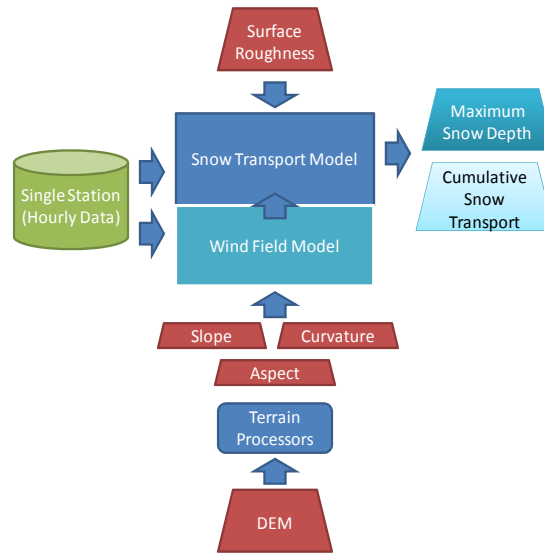
## EVOLUTION OF SNOWDRIFT MODEL DEVELOPMENT

In recognizing the significance of snow drifting on provincial highway, the MTO through the 1990s invested in the development of a numerical model for predicting and designing mitigation measures known as SNOWDRIFT. SNOWDRIFT was derived from an empirical model based on predicting traffic over snow and evolved it to a gridded mass balance approach based on a 1 km × 1 km resolution using elevation, surface roughness, meteorological data, and snowdrift parameters. The model was originally developed as a DOS tool in 1989–1992, was then converted to MS Windows environment in 1992–1996, and was updated to become SNOWDRIFT II in 2001 by 4DM Inc. SNOWDRIFT II included embedding the input and output data, and updated the model algorithms within a geographic information system (GIS) environment using ESRI ArcView 3.2 components (11). The upgrade allowed for easier integration of land cover data to be converted into surface roughness classes, topography and initial snow depth boundary conditions. Core changes to the model included dynamic grid sizes and resolution, transects, and fence lines to unlimited lengths, binary file input of raster data; the model also was recompiled into Windows 32-bit dynamic libraries (DLL). The model is event-based utilizing real or artificial datasets, and standard designed input storm events for nine different meteorological zones in the province for 1- and 5-year return events. The model software could also place geographical treatments such hedges, fences, and structural barriers to predict their effectiveness.

SNOWDRIFT II is a risk-based model using design storms and return period probabilities but has limitations in terms of site specific analysis that does not take into account snow accumulation over seasons and parameters of the model are not readily available to allow for parameter calibration without modifying the code. 4DM began an internal research project partially funded by National Research Council of Canada–IRAP program to develop a snow transport model called SnowStream. The model is a 2-D–gridded snow hydrology model designed to run continuously over a winter season at an hourly time-step. A high-level view of the model showing the inputs, outputs, and sub-models is shown in [Figure 2](#).

There are two core models: the wind field model and the snow transport model. The wind field model is a topographically-driven model based on the work of Liston et al. (12) that generates wind speed and direction modifiers based on the surface topography (i.e., slope, aspect, and curvature).

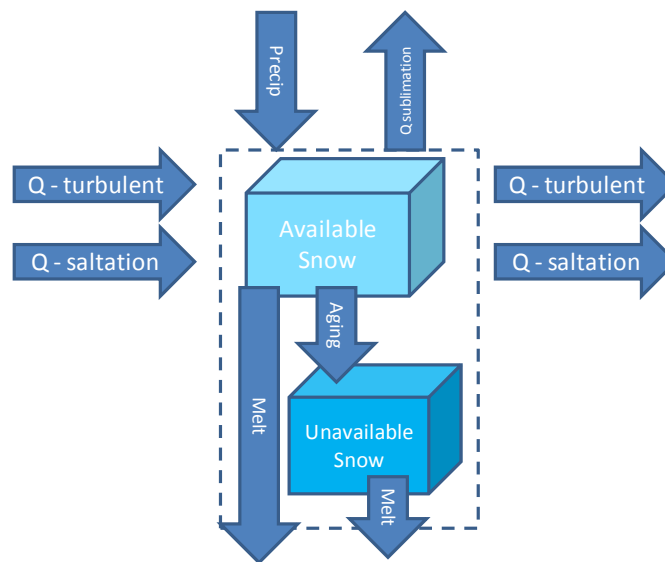
The snow-transport model captures the first-order snow physics, modeling both the saltation and turbulent suspension modes of snow transport. Saltation is a form of particle transport in which snow particles are ejected from the snow pack and carried by wind currents for a distance before being returned to the surface. Turbulent suspension occurs at higher wind speeds when the upward turbulent motion of the airflow is able to overcome the force of gravity and the snow becomes suspended in the air column.



**FIGURE 2 High-level view of the snowdrift simulation model.**

A two-stage snow storage model is used to account for erodible and non-erodible snow. Erodeable snow refers to snow that is available for transport. Non-erodible snow is snow that has aged and hardened to the point where it becomes resistant to erosion. The snow model also accounts for other key snow processes such as melting and precipitation. The conceptual scheme for the snow transport model is shown in [Figure 3](#).

The model outputs the cumulative snow transport (or flux/ $Q$ ) and the maximum and final snow depths in a grid (raster) format. The SnowStream model has been used to support a number of transportation studies in Ontario. The following sections outline some of the unique aspects of the studies conducted.



**FIGURE 3 Conceptual model of the snow transport model.**



## TYPES OF SNOW DRIFTING STUDIES IN ONTARIO

Ontario provincial highway studies involving snowdrift analysis can be categorized as winter road hazard assessments, new highway design studies, and transportation planning studies. In winter road hazard assessment studies, the focus is to conduct a technical review of the highway corridor that includes collision analysis, road friction, highway safety features, review of winter maintenance operations, and severity of snow drifting. The goal of snowdrift modeling is to determine the location of and quantify the severity of snow drifting impacting road safety where mitigation treatments can be designed to minimize adverse impacts to maintain highway safety.

### Winter Road Hazard Assessment

A winter road hazard project was undertaken along the southern portion of Highway 6 an hour southwest of Toronto, Ontario. A severe winter storm had passed through the region creating white out conditions due to wind gusts ranging from 37 km/h to 63 km/h that was blowing previous fallen snow across the highway. A fatal collision had occurred during this adverse weather conditions. The MTO initiated a snowdrift study for the 26 km section of Highway 6 where 4DM was selected to conduct the modeling analysis using SNOWDRIFT II. The meteorological and snow drifting conditions were examined during this fatal collision as well as using design storms to determine appropriate mitigation treatment for the section along the highway. An output example of the model result for change in snow depth is shown in [Figure 4](#).

This study was the first use of the SNOWDRIFT II model for a transportation application and had demonstrated the benefit of using snow transport modeling tools for examining snowdrift events. From the results of this project, recommendations were made for the modification of the highway infrastructure in terms of snow fences installation to reduce snow drifting.



**FIGURE 4** Snow depth from SNOWDRIFT II accumulation (blue) and depletion (pink).

Another application of the model was undertaken for four-lane Highway 115 east of Toronto, Ontario, that was experiencing a disproportional amount of reported and unreported collisions due to adverse winter conditions. The highway is exposed to numerous large rural open areas that can create opportunities for snow drifting events. Furthermore, there were concerns that the different road surface material (mix of asphalt and concrete) may have caused changes in road friction. A winter operational study was initiated by the MTO to review and determine causality of winter collisions. The study analyzed collision records over an 11-year period that was linearly referenced by environment and road surface condition type collisions. Further analysis examined road geometry, signage, and delineation and snowdrift analysis. Field observations were conducted to observe and identify snow drifting sections along the road. Meetings with maintenance contractors, the local police authority, and MTO staff were also conducted to obtain input on identifying snow drift locations. Potential snow transport over an infinite fetch was calculated for 16 cardinal directions. Then more detail analysis examined the mean annual snow transport that included the openness or distance on the east and west sides of the highway. SNOWDRIFT II and the 4DM snow transport model were used to support the snowdrift analysis and assess treatment types to prevent accumulation onto the highway. Using winter collision information, snow transport, observed conditions, and local input, sections of the road susceptible to snow drifts were identified and ranked. A mitigation analysis was done to review a number of potential treatments including the engagement of landowners adjacent to the highway section to leave corn stubble in fields as means to reduce snow drifting, and the implementation of temporary snow fences.

This project was the first of its kind in Ontario to design and implement snow fencing at oblique angles to optimize for the prevailing winds. This analysis revealed the optimum direction to minimize drifting snow where the fence attack angle, offset, separation, and height were determined. Monitoring of the fences demonstrated their effectiveness of trapping snow as drift lengths of 20–25 m were measured. An example of the oblique fencing is shown in [Figure 5](#).

### Winter Climate Study

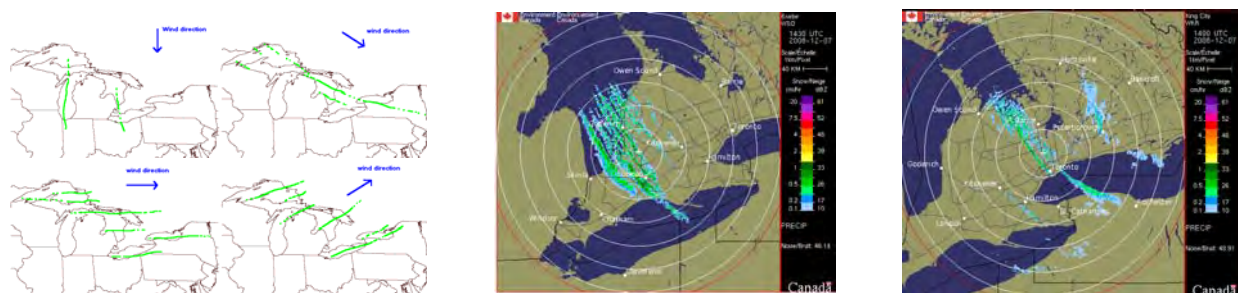
Another study was carried out about an hour east of Toronto, along the Highway 401 corridor that travels from Lake Ontario through the Oak Ridge Moraine, which includes undulating



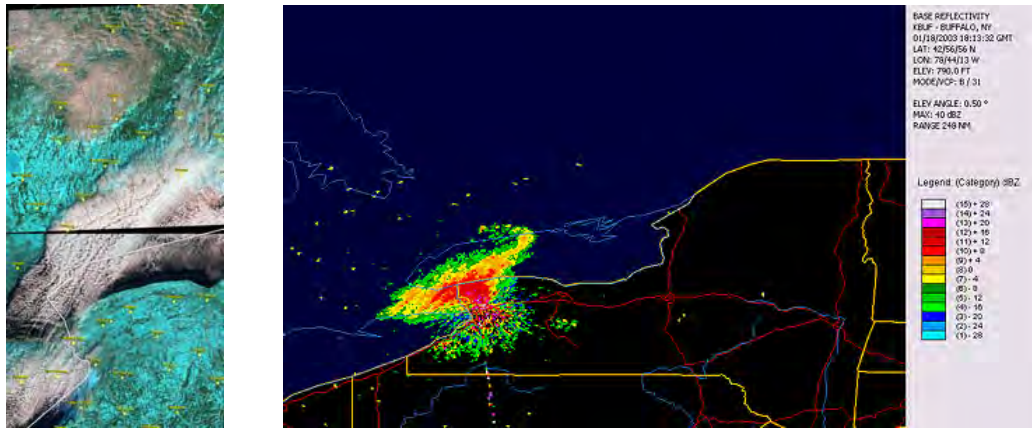
**FIGURE 5** 1.2-m oblique fetching optimized for prevailing wind direction.

topography resulting in vertical and horizontal highway variations. A major fatal multi-vehicle collection occurred during extreme white-out conditions that temporally closed the highway. The MTO initiated a project to investigate the role of winter weather and highway safety for a 76-km section of highway through Northumberland County. Uniquely, the study involved the examination the micro-climate, the presence of unique weather, snow drifting, and highway engineering elements contributing to occurrence of winter collisions. Climate analysis included using North American Regional Reanalysis data (NARR) and more than 200 active and historical hourly and daily Environment Canada weather stations to analyze wind patterns, temperature profiles, and winter precipitation type, intensity, and frequency. The physical study area was characterized to determine micro-climatic regions by comparing climatic conditions to physiographic features such as land cover, elevation, proximity to the lake, solar irradiance exposure, and soil conditions. The study of unique weather patterns within corridor focused on the presence and determination of Lake Effect Snow (LES) within the region. LES is a mesoscale convective weather phenomenon that typically occurs within 2 km of a boundary layer driven by temperature and moisture differences in the winter between a large water body and land (13). The snow event associated with LES typically creates intense localized precipitation events with the potential of whiteout conditions along transportation corridors. During the winter when the lakes are open and the temperature gradient is large between air and water, and the winds blow across the fetch of the Lakes, LES will likely develop. Figure 6 on the right shows the common origin direction of LES in Southern Ontario and Figure 6 left shows examples of the “bands” on weather radar images. It is worth noting that these radar images are at the same time for same event at two different stations approximately 200 km apart. LES does not always appear in the weather radar because the events occur close to the ground.

To develop LES conditions requires the presence of convection instability between lake and air temperature aloft, typically greater than 13°C at 850 hpa, surface winds across open water fetch, wind shear aloft between the boundary layer and 750 hpa at 60°C, moderate wind speed within the boundary level between 4 to 6 m/s, and boundary layer temperature below 0°C (14). This methodology is used by the U.S. National Weather Service and Environment Canada and was applied to historical meteorological data to see if LES events occur in the study areas. An LES event was analyzed for January 18, 2003, using meteorological data and verified from observed data, weather radar and satellite imagery. Figure 7 shows the LES coming off of Lake Ontario into the study area supported by Buffalo, New York, Doppler weather radar.



**FIGURE 6 LES direct and Exeter/King City Weather Radar station.**



**FIGURE 7** LES snow event January 18, 2003, Optical satellite imagery and weather radar.

### Highway Design Studies

In new highway design studies, provincial requirements for highway expansion with respect to route changes, additional lanes, or extending the highway service areas are addressed. The preliminary and detailed design work for the highway corridor has incorporated modification in snow drift prone areas to minimize the impact of accumulation onto the highway. Measures include modification to cut sections, changes to landscape design, and expansion of right-of-way for permanent snow fencing (living or structural fences).

An example project where snowdrift prevention measures were incorporated into highway design involves the 13-km expansion of Highway 404. Highway 404 is a north-south four-lane highway that extends north from Toronto, Ontario, for 37 km. For part of the expansion area, snowdrift modeling was undertaken using the 4DM snow transport model for maximum snow conditions and 5-year return periods over a 19-year period of meteorological data. The new highway corridor required numerous cut sections to accommodate the new highway route. Figure 8 shows the highway extension looking south illustrated by the cut-section embankment along western edge of the highway.

From a snowdrift perspective, cut-section embankments along highways alter airflow due to abrupt changes in topography that modifies snow particle velocity resulting in deposition at the transition point where the elevation change occurs. Depending on the embankment slope, height, and land cover deposition continues downwind over time, filling in topographical



**FIGURE 8** Highway 404 corridor extension looking south.

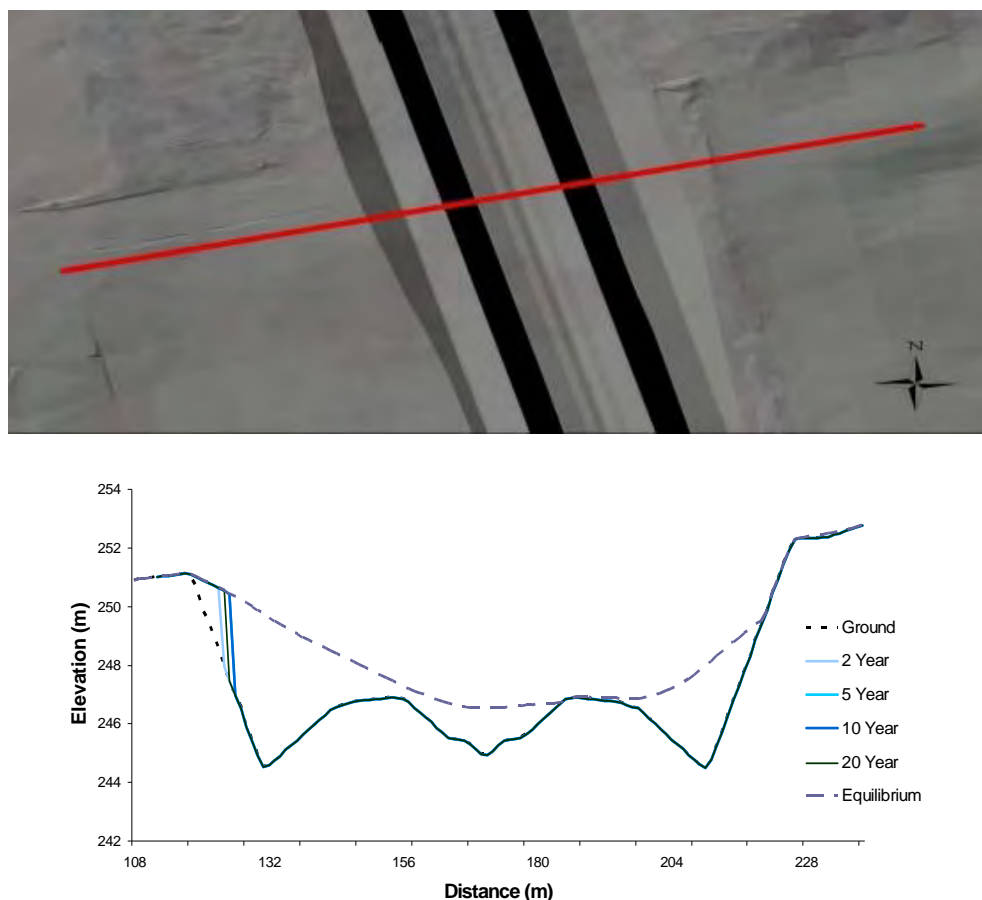
depressions where the upwind section rapidly approaches equilibrium at the snow surface. The concept is known as an equilibrium drift profile which represents a snow surface that corresponds to maximum snow retention depth of a topographic feature (15). An example cut-section of the highway and equilibrium drift profile for a cut section of the new highway is shown in Figure 9 below.

The results of the snowdrift analysis for the highway corridor led to landscape designs that incorporated the use of temporary and living snow fences within the right-of-way to control drifting snow.

### Transportation Planning Studies

In transportation planning studies, the objectives are to address future requirements of transportation capacity, improve transportation deficiencies, and identify the needs of transportation networks for both passage and commercial traffic requirements. Studies are conducted for the improvement to existing highway corridors such as highway bypass routes and to identify specific corridors as part of environmental assessments.

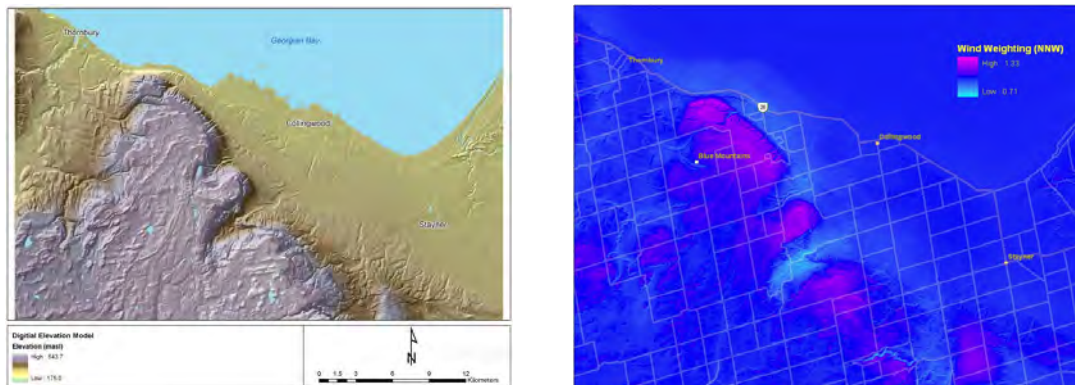
An example of this type of project is the Highway 26 Transportation Planning study. The project focus was to identify current and future travel needs for the Highway 26 Georgian Triangle area, and to determine the short- and long-term transportation network needs for the



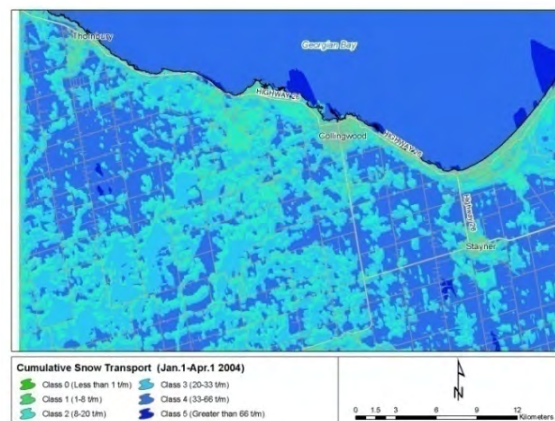
**FIGURE 9** Equilibrium drift profile for different return period profiles.

region. The section of Highway 26 studied ran within close proximity to Georgian Bay, a part of Lake Huron about 1.5 h northwest of Toronto, Ontario. The area is known for significant snowfall from Lake Effect snow originating from the influence of Georgian Bay and affected by the Niagara Escarpment, which has an abrupt vertical elevation change of over 300 m. Average annual snowfall in this area averages 280 cm for season. Past and current transportation studies are assessing the realignment of Highway 26 to bypass communities along the route. In planning the new highway route, snow drifting is important consideration in assessing the corridor in this area. A regional map of snow transport was needed for the route planning where the SnowStream model was utilized on a regional scale for the first time in the province. Land cover information (surface roughness), topography (wind shear), and hourly meteorological data were assembled and input into the model. A key component of the model is the ability to include wind shear to account for change in wind speed and direction. Figure 10 shows the topographic change within the study area and modification factor for winds from the NNW direction.

The modeling results for this region produced a regional snow transport map for transportation planning requirements (Figure 11). The map represents the amount of snow transported (ton/m) over a snow accumulation period. A snow accumulation period is the period in which the temperature remains below the freezing point.



**FIGURE 10** Topographic map of the study area and wind modeling results.



**FIGURE 11** Cumulative snow transport for planning study on Highway 26.

## **BENEFITS OF SNOWDRIFT STUDIES**

Snowdrift studies have advanced the knowledge within the Ontario MTO on the role that snow drifting analysis can play with respect to reducing winter road hazard condition. Temporary and permanent snow and living fences installed as part of previous studies are still being used today. The benefits at this point have not been quantified, but it is suspected that road visibility during snowdrift events, reduced road icing from accumulation of drifting snow, and road maintenance efficiency have been improved.

## **FUTURE DIRECTIONS**

Winter highway safety is complex and needs to consider the climatology of the area, highway design, operational management, characteristics of the surrounding landscape, and driver behavior. Climate studies undertaken for Ontario highways, particular snowdrift modeling and analysis, have provided highway engineers with improved corridor designs, new planning information, and winter maintenance prevention measures, especially snow drifting mitigation treatments. The movement to performance-based service contracts for highway maintenance in Ontario will benefit from the better understanding of the severity of snow drifting in terms of the number locations and magnitude along highway.

Correlating winter maintenance costs with snow drifting events is next step in the progression. The knowledge from this and other work can be used to create a provincial index to quantify severity of snow drifting by region. The goal would be to create a classification scheme that could be used for benchmarking winter maintenance requirements and eventually translated to efficiency and cost consideration. Other advancements planned for the SnowStream model include better modeling around mitigation features such as trees and hedges using Computational Fluid Dynamics (CFD). CFD modeling is used extensively in fluid and sediment transport modeling and is applied to model complex environments, in this case snow dispersion around objects.

4DM recently received funding from National Research Council of Canada Industrial Research Applied Program to support internal development of a web-based snowdrift forecasting model. The project will integrate high resolution GRIB 2 forecast data from Environment Canada's Global Environmental Model (GEM) at 6-h intervals for forecasting up to 48 h, and coupling it with a model to define the local wind field and precipitation distributions. The outputs from this model will be integrated into the SnowStream model to predict snow drifting conditions at various locations, initially in Ontario. The ultimate goal is to provide reliable predictive information on snow drifting along major transportation corridors.

## **ACKNOWLEDGMENTS**

The National Research Council of Canada's Industrial Research Assistance Program provided support for the development of the SnowStream model and forecasting system. The authors also thank Max Perchanok of the Ontario Ministry of Transportation for the ongoing dialog on snow drifting and moving the benchmark forward one projects at time, John McGill for the opportunities to demonstrate our capabilities along the way. The coauthors of this paper are

thanked for their innovative thinking and braving the cold. Their assistance and contributions are acknowledged and appreciated.

## REFERENCES

1. Ministry of Transportation. *Quickfacts*. <http://www.mto.gov.on.ca/english/about/quickfacts.shtml>. Accessed October 25, 2011.
2. L-P Tardif & Associates. *Southern Ontario Gateway Council Strategic Plan – Building a Foundation for Prosperity*. October 23, 2006. [http://www.gatewaycouncil.ca/downloads2/Strategic\\_Plan.pdf](http://www.gatewaycouncil.ca/downloads2/Strategic_Plan.pdf). Accessed October 25, 2011.
3. Ontario Ministry of Transportation. *Provincial Highways Traffic Volumes (AADT Only) 2008*. [http://www.raqs.mto.gov.on.ca/techpubs/TrafficVolumes.nsf/fa027808647879788525708a004b5df8/f51986ea499a13b08525745f006dd30b/\\$FILE/Provincial%20Highways%20traffic%20Volumes%202008%20AADT%20Only.pdf](http://www.raqs.mto.gov.on.ca/techpubs/TrafficVolumes.nsf/fa027808647879788525708a004b5df8/f51986ea499a13b08525745f006dd30b/$FILE/Provincial%20Highways%20traffic%20Volumes%202008%20AADT%20Only.pdf). Accessed October 25, 2011.
4. Nav Canada. *LAKP-Ontario and Quebec – Weather Patterns of Ontario and Quebec 2002*. <http://www.navcanada.ca/ContentDefinitionFiles/publications/lak/OnQc/3-OQ33E.PDF>. Accessed October 25, 2011.
5. Liu, A. Q., and G. W. K. Moore. Lake-Effect Snowstorms over Southern Ontario, Canada, and Their Associated Synoptic-Scale Environment. *Monthly Weather Review*, Vol. 132, 2004, pp. 2595–2609.
6. Ontario Ministry of Transportation. *Ontario Road Safety Annual Report (ORSAR) 2008*. <http://www.mto.gov.on.ca/english/safety/orsar/orsar08/index.shtml>. Accessed October 25, 2011.
7. Usman, T., L. Fu, and L. F. Miranda-Moreno. Quantifying Safety Benefit of Winter Road Maintenance: Accident Frequency Modeling. May 11, 2010. <http://www.civil.uwaterloo.ca/iTSS/papers%5C2010-4%20%28Safety%20benefits%20of%20winter%20road%20maintenance%29.pdf>. Accessed October 25, 2011.
8. Ontario Ministry of Finance. Provincial Highways Management Program: Vote 2704. [http://www.fin.gov.on.ca/en/budget/estimates/2011-12/volume1/MTO\\_788.html](http://www.fin.gov.on.ca/en/budget/estimates/2011-12/volume1/MTO_788.html). Accessed October 25, 2011.
9. Ontario Ministry of Transportation. *Snow Manual – MAT-98-01*, 1998.
10. Ontario Ministry of Transportation. Innovative Farm Windbreaks Projects: Improving the Safety of Winter Highways. <http://www.mto.gov.on.ca/english/transtek/roadtalk/rt16-2/RT16-2.pdf>. *Ontario's Transportation Technology Transfer Digest*, Spring 2010, pp. 1–2.
11. Ontario Ministry of Transportation. SNOWDRIFT V2 Extension for ArcView 3.x Snow Drifting Simulation Program. July 18, 2011. <http://www.xfer.mto.gov.on.ca/PTASapps/index.htm>. Accessed Oct. 25, 2011.
12. Liston, G. E., R. B. Haehnel, M. Sturm, C. A. Hiemstra, and S. Berezovskaya. Simulating Complex Snow Distributions in Windy Environments Using SnowTran-3D. *Journal of Glaciology*, Vol. 53, No. 181, 2007, pp. 241–256.
13. Byrd, G. Lake-Effect Snow. <http://www.comet.ucar.edu/class/smfaculty/byrd/sld001.htm>.
14. Niziol, T. A. Operational Forecasting of Lake Effect Snowfall in Western and Central New York. *Weather Forecasting*, Vol. 2, 1987, pp. 310–321.
15. Tabler, R. D. *NCHRP Project 20-7(147): Controlling Blowing and Drifting Snow with Snow Fences and Road Design, Final Report*. NCHRP, Transportation Research Board of the National Academies, Washington, D.C., 2003.



## CLIMATE TRENDS AND LARGE-VOLUME SNOW CONTROL

## Recent Trends in Changes in Snowfall and Snow Depth in Japan and Their Impact on Snow Control Measures

MASARU MATSUZAWA

YUSUKE HARADA

MASAYO UEDA

HIROKI MATSUSHITA

*Civil Engineering Research Institute for Cold Region, Public Works Research Institute, Japan*

YASUHIKO ITO

*Erosion and Sediment Control Research Group, Public Works Research Institute, Japan*

Recently, cold snowy regions of Japan have occasionally seen trends of lighter snowfall due to warm winters, heavy snow in areas that previously had little snowfall, very heavy localized snowfall, and other unusual snowfall patterns. It is considered important for the snow and ice control to understand the climate change-related metamorphosis of snow and ice environments to enable contribution to the development of long-term snow and ice-control plans and measures. Accordingly, in this study, trends of change in snowfall and snow cover over the last 26 years were surveyed using past data. The items surveyed were seasonal maximum snow depth; accumulated seasonal snowfall; maximum 24-, 48-, and 72-h snowfall from the onset of snowfall; the frequency of days with snowfall totaling 30 cm or more; and the number of days with continuous snow cover in winter. The collected results revealed that the annual maximum depth of snow cover and the number of days with snowfall totaling 30 cm or more were on the rise in eastern Hokkaido, where it faces the Sea of Okhotsk and the Pacific Ocean. In general, this region is considered to have little snowfall as long as stable winter pressure patterns continue, while snowfall increases when low pressure develops over the Pacific Ocean and the Sea of Okhotsk. It was clarified that there were changes in snowfall patterns and in the distribution of areas with heavy snowfall.

Recently, cold snowy regions of Japan have occasionally seen trends of lighter snowfall due to warm winters, heavy snow in areas that previously had little snowfall, very heavy localized snowfall, and other unusual snowfall patterns. In winter 2010–2011, heavy snowfall within short periods of time resulted in hundreds of vehicles becoming stuck on national highways. For example, approximately 300 vehicles were stranded on National Route 49 in Fukushima from December 25 to 27, 2010, and around 1,000 vehicles became stuck on National Route 9 connecting Shimane and Tottori from December 31, 2010, to January 2, 2011. Nishiaizu Town in Fukushima saw record daily snowfall of 138 cm on December 25, shattering the previous record of 81 cm, and cumulative snowfall exceeded 200 cm.

In winter, seasonal winds accompanied by cold air flowing from eastern Siberia pick up large amounts of moisture over the Sea of Japan and blow down to the backbone range of Japan. This causes ascending air currents and generates clouds, bringing heavy snow to areas on the Sea of Japan side. Conversely, dry winds blowing in areas along the Pacific Ocean on the leeward side of the backbone range result in little snowfall (Figure 1). Figure 2 shows the normal values

for the annual maximum depth of snow cover ( $I$ ). Areas with amounts exceeding 1 m are seen in Hokkaido and on the western side of the mountain ranges of mainland Japan. The values are between 0 and 10 cm in mainland Japan on the Pacific Ocean side.

Many people involved in the implementation of road snow and ice-control measures have noted an increase in the amount of snow falling at one time and changes in the distribution of areas with heavy snowfall. It is considered important to understand the climate change-related metamorphosis of snow and ice environments in order to enable contribution to the development of long-term snow and ice-control plans and measures. Accordingly, in this study, trends of change in snowfall and snow cover over the last 26 years were surveyed using past data.

## SURVEY METHODOLOGY

Among cold snowy regions in Japan, Hokkaido and the northern part of the mainland above latitude 37°N were selected as the target regions for this study (Figure 3). The data used for the survey consisted of hourly snow depth figures measured at 141 points in the target regions, which are covered by the Japan Meteorological Agency's Automated Meteorological Data Acquisition System network. The increase in hourly snow depth was considered to indicate the amount of snowfall in the hour concerned. The survey period was from the winter of 1983–1984 (or from the start of observations in that winter) to the winter of 2008–2009. In this study, winter was deemed to run from November 1 to April 30 the following year.

The items surveyed were seasonal maximum snow depth (cm), accumulated seasonal snowfall (cm), maximum 24-, 48-, and 72-h snowfall from the onset of snowfall, the frequency of days with snowfall totaling 30 cm or more (%), and the number of days with continuous snow cover. These items were greatly changed every winter; linear approximation was used to visualize trends of overall changes during the survey period. For this calculation, the approximation expression shown in Equation 1 was found using the least-squares method, and the  $a$  gradient was regarded as the trend of varying values. In this study, positive and negative  $a$  values were considered to represent increasing and decreasing trends, respectively.

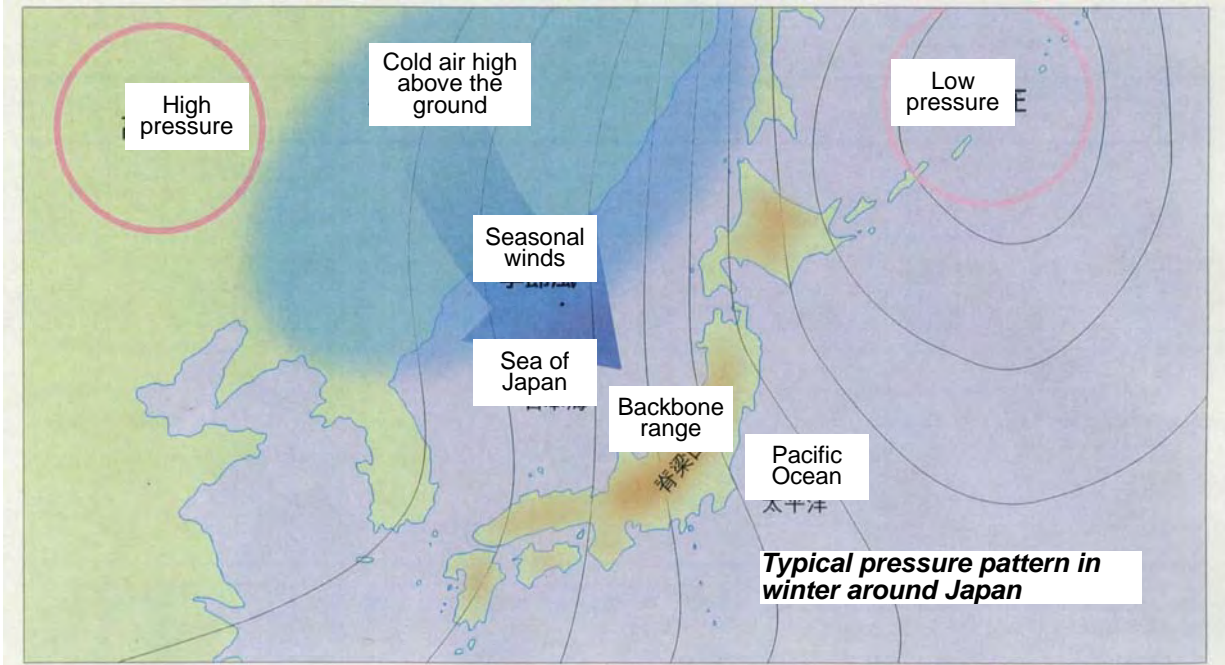
$$y = ax + b \tag{1}$$

where  $y$  is the survey item,  $x$  is the number of winters, and  $a$  and  $b$  are the constants.

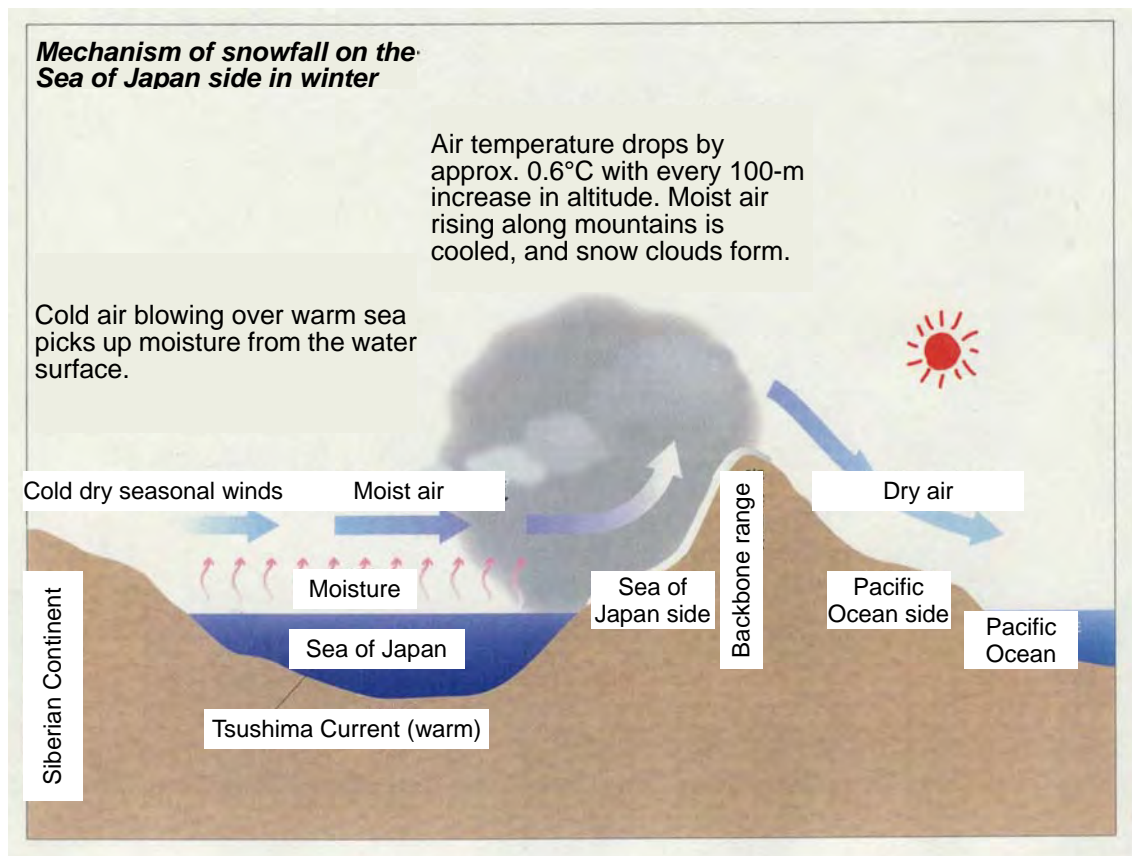
Figure 4 shows an example of the results. It shows the trend of change on seasonal snowfall during the survey period in Takinoue. The value  $-11.9$  was obtained as the  $a$  in the Equation 1 by this calculation.

## RESULTS

The seasonal maximum snow depth showed a tendency of increase in western Hokkaido on the Sea of Japan side, in inland Hokkaido, in eastern Hokkaido along the Sea of Okhotsk and the Pacific Ocean, and on the northern part of the mainland facing the Sea of Japan (Figure 5). The number of days with continuous snow cover showed an increase in western and eastern



(a)



(b)

**FIGURE 1** (a) Typical pressure pattern in winter around Japan and (b) mechanism of snowfall on the Sea of Japan side (1).

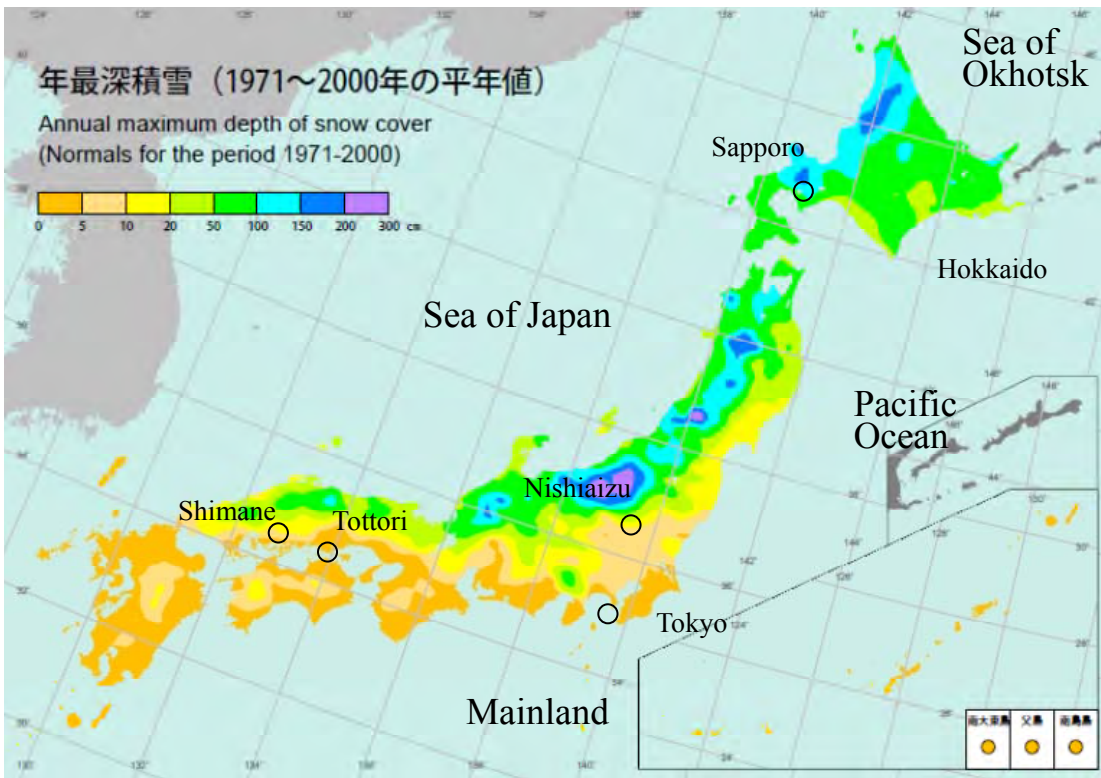


FIGURE 2 Normal values for annual maximum depth of snow cover (1971–2000) (2).

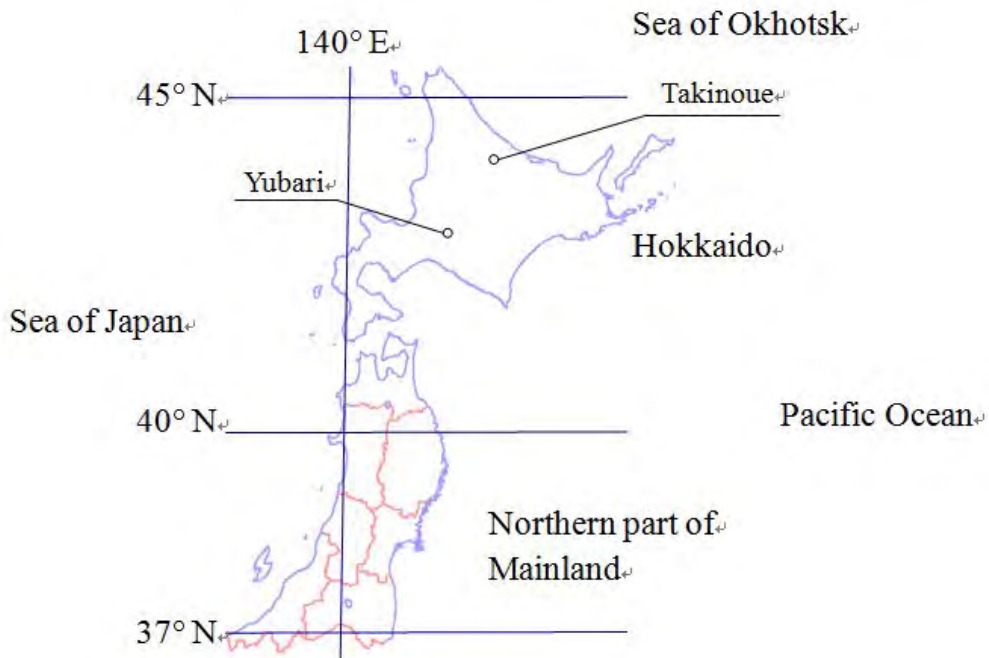
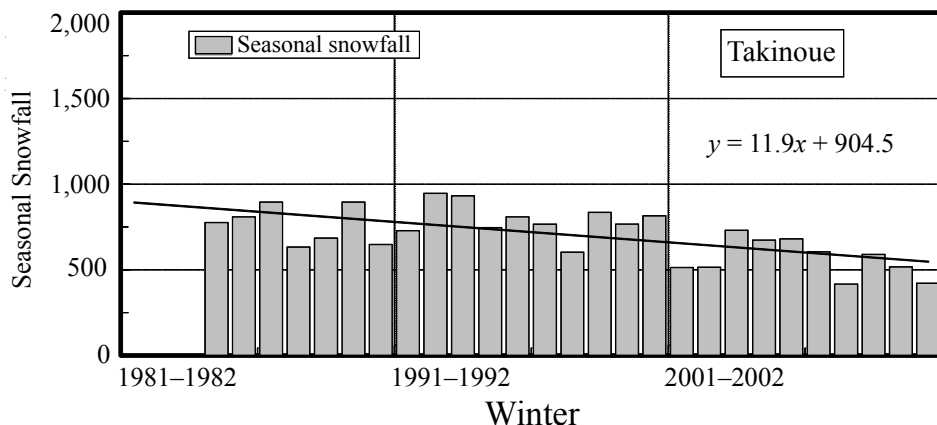


FIGURE 3 Overview of survey regions.



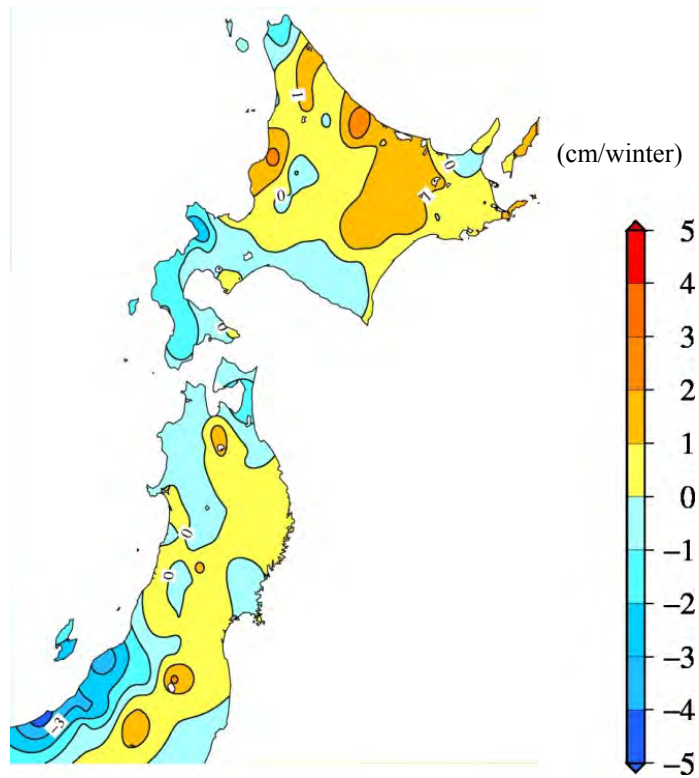
**FIGURE 4** An example of the results: trend of change on seasonal snowfall in Takinoue.

Hokkaido (Figure 6). Although seasonal snowfall showed a tendency to decrease in most areas of the target regions, the frequency percentage of days with snowfall totaling 30 cm or more showed an increasing tendency in eastern Hokkaido along the Sea of Okhotsk and the Pacific Ocean and on the Pacific Ocean side of mainland Japan (Figures 7 and 8).

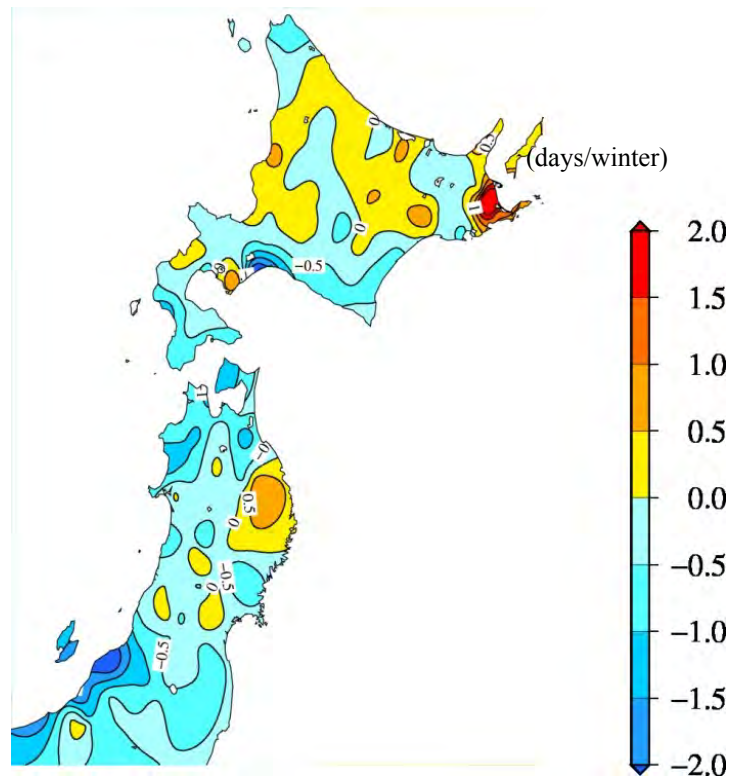
It was clarified that there were changes in snowfall patterns and in the distribution of areas with heavy snowfall (Figure 9). It is therefore suggested that localized heavy snowfall may occur within a short time due to winter low-pressure systems in the future, and this may result in disasters.

The seasonal snowfall and the maximum 24-, 48- and 72-h snowfall measured at two points (at Takinoue and Yubari, Figure 3) representing eastern Hokkaido along the Sea of Okhotsk and western Hokkaido along the Sea of Japan are shown in Figure 10. At both points, the seasonal snowfall showed a decreasing tendency, but the maximum 24-, 48-, and 72-h snowfall figures did not show the same declining trend. In Yubari, no remarkable increase in the maximum 24-, 48-, and 72-h snowfall figures was seen, whereas Takinoue showed an increasing trend from 2000 onward. Differences in the maximum 24-, 48-, and 72-h snowfall figures were smaller for Takinoue than for Yubari. This was caused by transient snow brought by low pressure in Takinoue, where it snowed continuously for approximately 24 h. In Yubari, the maximum snowfall increased over time, indicating that snow fell more heavily as it continued.

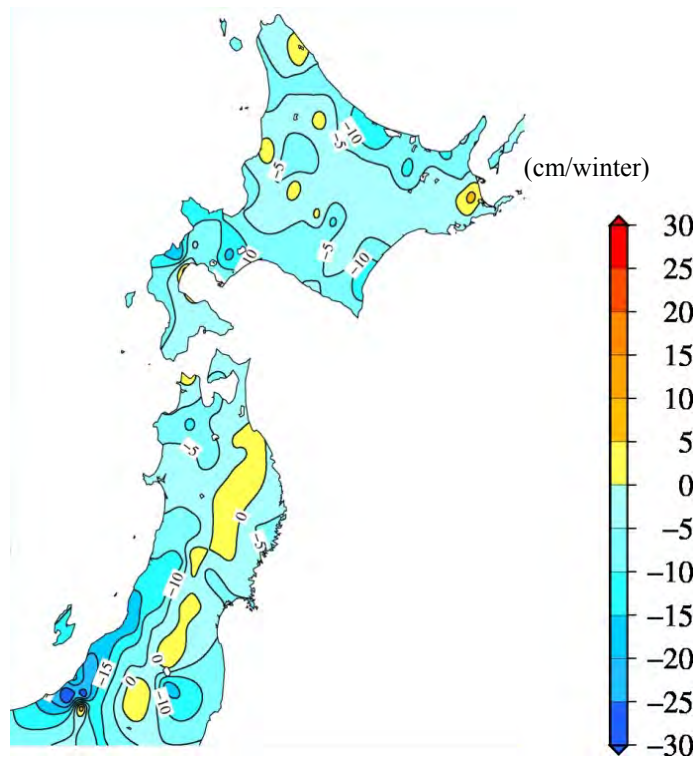
The collected results revealed that the annual maximum depth of snow cover and the number of days with snowfall totaling 30 cm or more were on the rise in eastern Hokkaido and mountainous areas of northern mainland Japan. Eastern Hokkaido faces the Sea of Okhotsk and the Pacific Ocean. In general, this region is considered to have little snowfall as long as stable winter pressure patterns continue, while snowfall increases when low pressure develops over the Pacific Ocean and the Sea of Okhotsk. Figure 11 shows the typical surface weather map patterns at the time of snowfall. Yubari (on the Sea of Japan side of Hokkaido) is a cold region with snow brought by the pattern of high pressure in the west and low pressure in the east. Also Takinoue (on the Sea of Okhotsk side of Hokkaido) is a region with snow brought by low pressure approaching and passing.



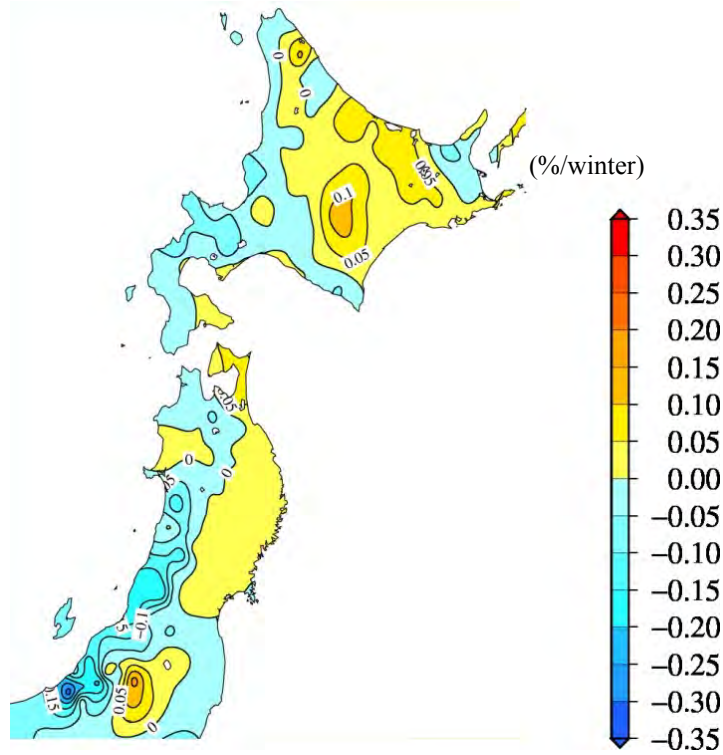
**FIGURE 5 Trends of change in seasonal maximum snow depth.**



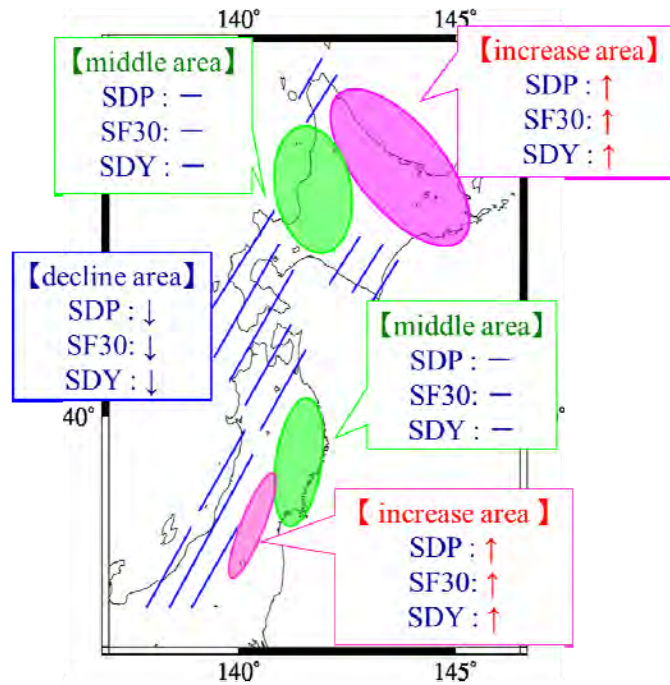
**FIGURE 6 Trends of change in the number of days with continuous snow cover.**



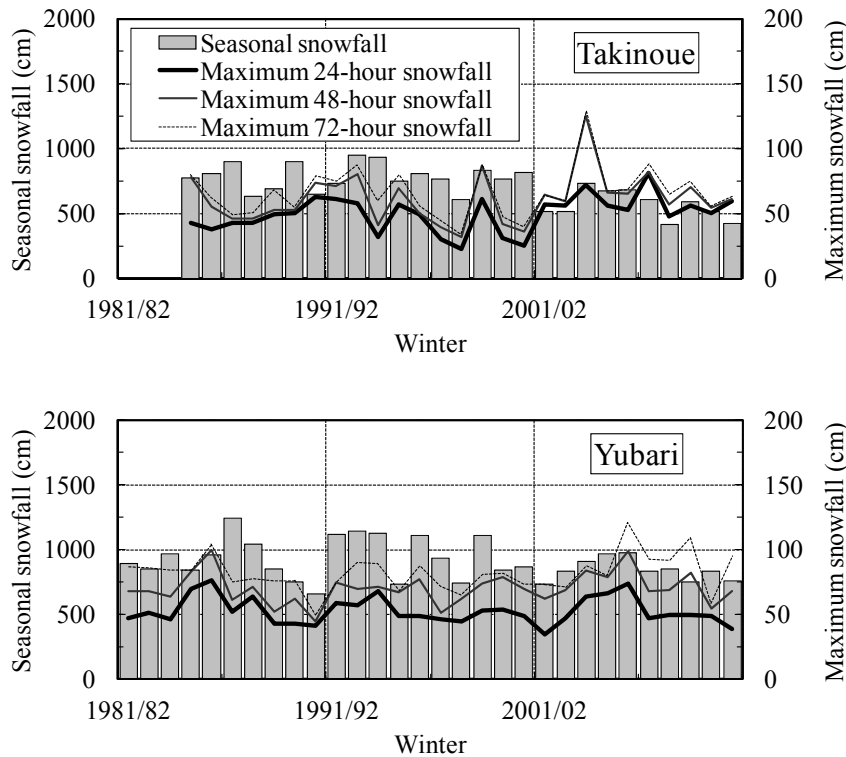
**FIGURE 7 Trends of change in seasonal snowfall.**



**FIGURE 8 Trends of change in the frequency of daily snowfall totaling 30 cm or more.**

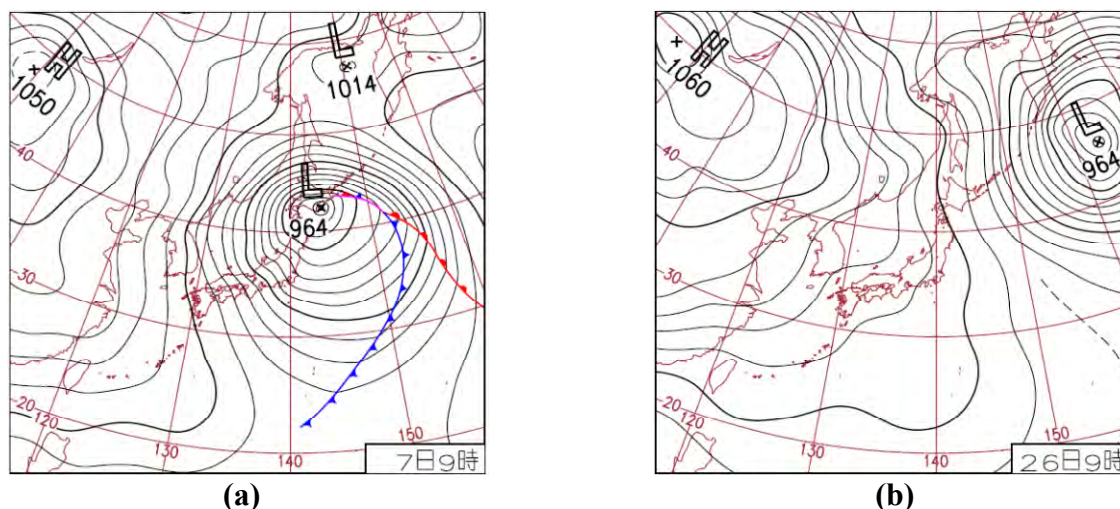


**FIGURE 9** Summary of recent trends of change in seasonal snowfall–snow cover. Seasonal snowfall shows a decline in all areas. [SDP = seasonal maximum snow depth; SF30 = rate of daily snowfall totaling 30 cm or more (%); SDY = days of continuous snow cover.]



**FIGURE 10** Seasonal snowfall and maximum 24-, 48-, and 72-h snowfall (at Takinoue and Yubari).





**FIGURE 11** Typical surface weather map patterns at the time of snowfall: (a) on the Sea of Japan side, snow followed high pressure in the west and low pressure in the east; and (b) on the Pacific Ocean and the Sea of Okhotsk side, snow followed low pressure approaching and passing.

## DISCUSSION OF RESULTS

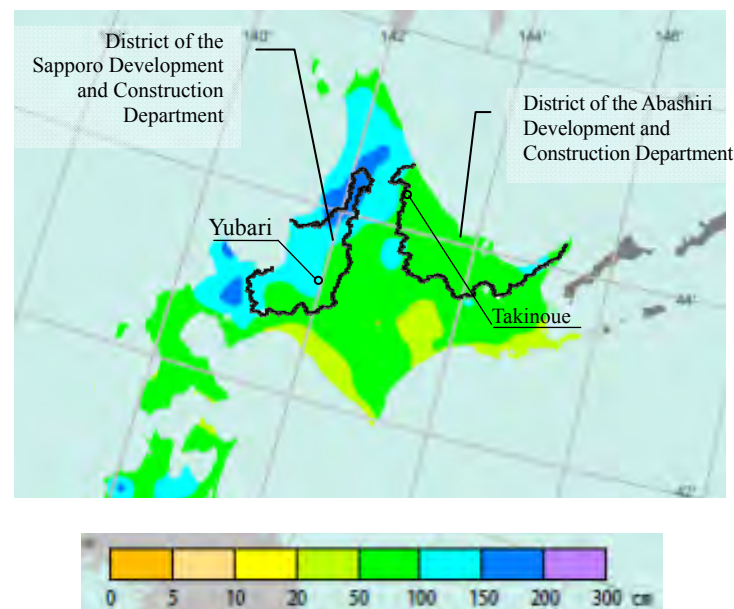
Maximum snow depth and maximum daily snowfall are taken into account in the discussion of road snow protection plans and the design of related protection facilities. Although values from past data are used, it is seen as important to consider trends of change in snowfall and snow cover so that such facilities can remain effective for a long time after construction.

It may also be necessary to review the allocation of snow removal machinery. Taking the example of two local districts of the Hokkaido Regional Development Bureau, which is responsible for the management of national highways in Hokkaido (Figure 12). Approximately 19 snowplows per 100 km were allocated in the area managed by the Sapporo Development and Construction Department on the Sea of Japan side in winter 2009–2010, while approximately 10 snowplows per 100 km (almost half) were allocated in that of the Abashiri Development and Construction Department on the Pacific Ocean side (3). This difference can be explained by amount of snowfall (Figure 12). It can be inferred that snowplow allocation needs to be reviewed based on snowfall in areas where the seasonal maximum snow depth and the frequency of continuous snowfall totaling 30 cm or more are on the rise (Figures 5 and 8). In addition, extension of the snow removal season must be considered in response to the increasing trend in the period of continuous snow cover (see Figure 6).

## CONCLUSION

In this study, trends of change in snowfall and snow cover over the last 26 years were surveyed using past data measured at 141 points of weather observatory stations. The items surveyed were seasonal maximum snow depth (cm); seasonal snowfall (cm); maximum 24-, 48-, and 72-h snowfall; the frequency of days with snowfall totaling 30 cm or more (%); and the number of

days with continuous snow cover. The results revealed that the annual maximum snow depth and the number of days with snowfall totaling 30 cm or more increased in eastern Hokkaido and mountainous areas of northern mainland Japan. It was considered that there were changes in snowfall patterns and in the distribution of areas with heavy snowfall. Finally, maximum snow depth and maximum daily snowfall are taken into account in the discussion of snow control plans. It is seen as important for snow control plans and the design of related protection facilities to consider trends of change in snowfall and snow depth.



**FIGURE 12** Normal values for annual maximum depth of snow cover and focused districts (2).

## REFERENCES

1. Niigata Nadare Kenkukai. *Nadare No Hanashi (The Story of Avalanche)*. Niigata Nippo Jigyousha Corp., December 2008 (in Japanese).
2. Japan Meteorological Agency. *Climatic Atlas of Japan for the Period of 1971–2000*, March 2003.
3. Hokkaido Regional Development Bureau. *The Winter of 2009–2010 Overview of Snow Removal Projects by the Hokkaido Regional Development Bureau*, April 2009.



# **Winter Maintenance Policy and Management**



## WINTER MAINTENANCE POLICY AND MANAGEMENT

## Weather or Not?

### *State Liability and Road Weather Information Systems*

**JAIME RALL**

*National Conference of State Legislatures*

**Weather significantly affects the traveling public and the transportation agencies that operate and maintain the nation’s roadways. As of 2010, at least 44 states and the District of Columbia used advanced technologies called road weather information systems (RWIS) to provide accurate, detailed, and timely information about weather-related road conditions. By having up-to-date weather conditions for roadways, transportation agencies can make decisions that improve public safety, mobility, and productivity—decisions such as when to deploy snowplows, close roads, or warn motorists of dangerous conditions. Although these systems are a vital resource for states and their transportation agencies, as with most new technologies, RWIS has raised some concerns about potential legal liabilities related to its use. The National Conference of State Legislatures—in collaboration with the FHWA—issued a report in 2010 entitled “Weather or Not? State Liability and Road Weather Information Systems.” The report details states’ RWIS liability concerns and offers a menu of state-of-the-practice strategies for addressing those concerns. Strategies include limitations on data sharing, online disclaimers regarding RWIS data, public outreach and education, and allocation of funds by state legislatures. Based on original survey data and legal research, the report is illustrated by real-life knowledge and experiences from the states and includes in-depth legal information for all 50 states and the District of Columbia. The findings can help transportation and weather managers, planners, and other practitioners as well as state legislators assess and mitigate liability issues related to surface transportation weather management and RWIS technologies.**

## ROAD WEATHER INFORMATION SYSTEMS

Weather significantly affects the traveling public and the transportation agencies that operate and maintain the nation’s roadways. Recent studies estimate that 24% of all crashes and 17% of traffic fatalities are weather-related: more than 1.5 million accidents per year, resulting in over 673,000 injuries and nearly 7,400 fatalities (1, 2). Adverse weather also is the second largest cause of nonrecurring highway congestion, accounting for about 15% of traffic delays nationwide (3). In addition, winter road maintenance alone accounts for about 20% of state department of transportation (DOT) maintenance budgets. State and local transportation agencies spend more than \$2.5 billion each year on snow and ice-control operations, and more than \$5 billion to repair weather-damaged roadway infrastructure (4, 5).

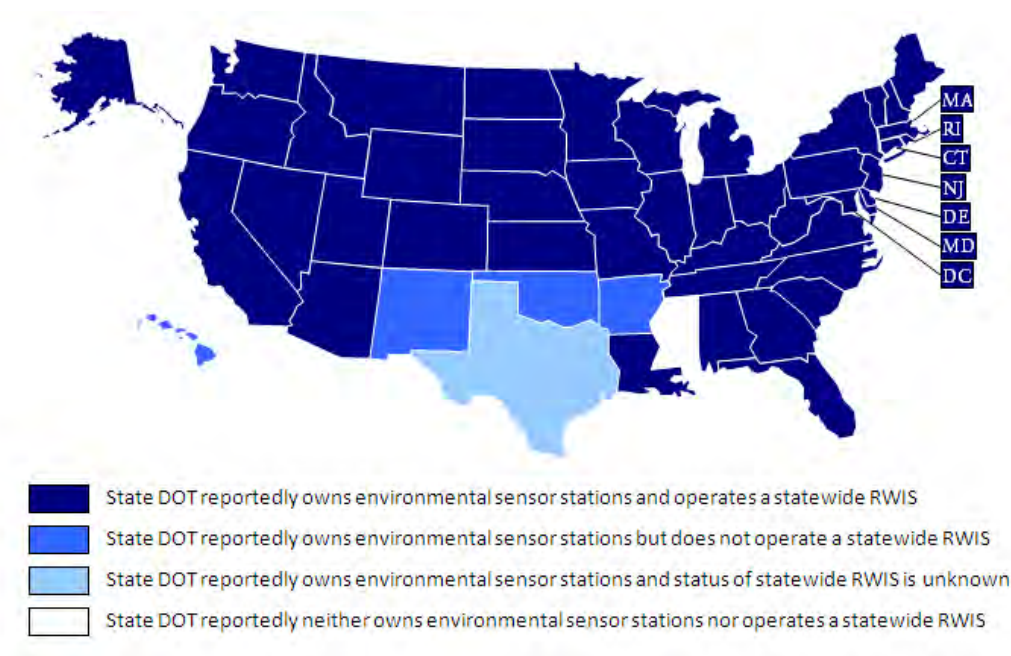
Roadway weather information systems (RWISs) are advanced technologies that collect, transmit, process, and disseminate accurate, detailed, and timely information about weather-related road conditions. By having up-to-date, roadway-specific weather information, state and local transportation agencies can make decisions that improve public safety, mobility, and productivity, such as when to deploy snowplows, close roads, or warn motorists of dangerous conditions. In addition, some road treatment or traveler advisory strategies can be automated

based on RWIS data. All current studies indicate that the benefits of RWIS far outweigh its costs, with an estimated benefit–cost ratio of between 2:1 and 10:1 (6, 7).

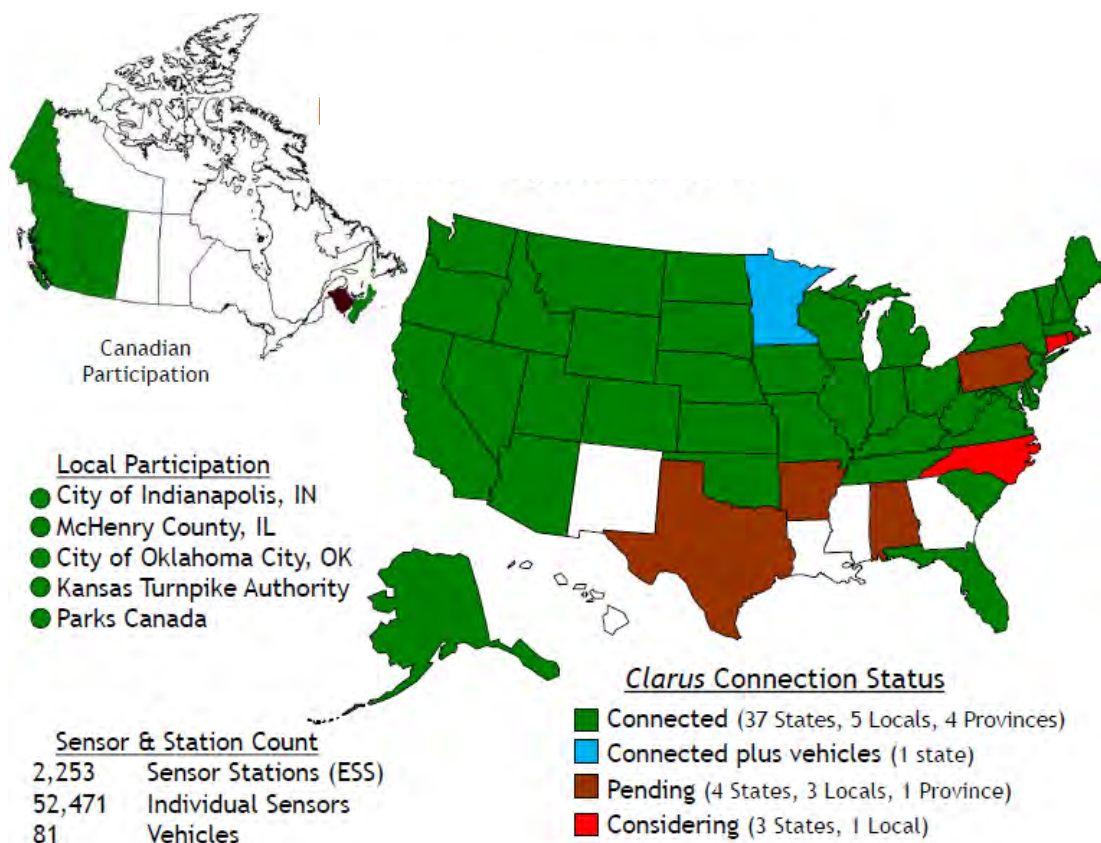
The current use of RWIS by state DOTs is widespread. As of 2010, at least 44 states and the District of Columbia reported using an integrated RWIS (Figure 1). In addition, as of October 2011, follow-up survey information revealed that Mississippi—the one state that in 2010 reported having neither sensor stations nor RWIS—was in the process of designing an RWIS pilot project focused on detecting wet and icy road conditions.

Further, as of August 2011, 37 state DOTs, five local transportation agencies, and three Canadian provinces reported sharing RWIS data with a broad audience via *Clarus*, a North American integrated weather observation and data management system. *Clarus* collects and quality checks road weather information and makes it available anytime, anywhere to all transportation users and operators (Figure 2) (8). The *Clarus* system is accessible at [www.clarus-system.com](http://www.clarus-system.com).

Although RWIS is a vital resource for states and their transportation agencies, as with most new technologies, it has raised some concerns about potential legal liabilities related to its use. The National Conference of State Legislatures (NCSL), in collaboration with the FHWA, issued a report in 2010 entitled “Weather or Not? State Liability and Road Weather Information Systems” (9). Based on original survey data and legal research, the report details states’ RWIS liability concerns and offers a menu of state-of-the-practice strategies for addressing those concerns, illustrated by real-life knowledge and experiences from the states. The report also includes in-depth legal information for all 50 states and the District of Columbia. The findings can help transportation and weather managers, planners, and other practitioners as well as state legislators assess and mitigate liability issues related to surface transportation weather management and RWIS technologies.



**FIGURE 1 State use of RWIS as of April 2010.**



**FIGURE 2 Participation status for *Clarus* as of August 24, 2011 (8).**

This paper summarizes the report's findings and is largely drawn from its executive summary, supplemented by updated information about developments in the states based on legal research and responses to follow-up survey research in July 2010 and October 2011. This summary is intended to accompany a presentation of the findings at TRB's 2012 International Conference on Winter Maintenance and Surface Transportation Weather.

### **Key Finding 1: RWIS Can Help Reduce State Exposure to Liability**

The research found that, in general, RWIS technologies are helping states keep their roads safer for travelers, and thus can help state DOTs reduce their exposure to liability (10). By providing unprecedented access to detailed, timely, roadway-relevant weather observations and forecasts, RWIS technologies can help state DOTs meet their traditional legal duties. Generally, when a DOT has notice of a dangerous roadway condition, its duties include exercising reasonable care to either alleviate the condition or provide adequate warning to the traveling public. RWIS can help a DOT meet those responsibilities, for example by supporting better informed maintenance decisions, automated road treatments, and real-time traveler information.

In addition, RWIS data has been known to act as a source of legal evidence in support of a DOT. According to follow-up survey responses, in 2010 the New Hampshire DOT was acquitted of liability for an accident during a 2007 winter storm. In that case, the DOT used RWIS data indicating chemicals on the roadway as evidence for the timing of a salt application.



## **Key Finding 2: RWIS Is a Largely Unexplored Question of Law That Must Be Conceptualized Within Complex, State-Specific Legal Contexts**

As yet, RWIS-related liability is a largely unexplored question of law, with few relevant precedents. Only two legal cases involving RWIS technologies had been reported at the time the report was released—one in Nevada and one in Pennsylvania—and one since, the New Hampshire case mentioned above. In addition, the law can take decades to adapt to changes in technology (11). In theory, certain legal concepts can be considered possible context for RWIS liability concerns, but in practice, the applicability is unknown. In any case, the legal context for RWIS liability is complex and state specific.

One relevant legal concept is sovereign immunity. Traditionally, the legal doctrine of sovereign immunity has protected federal and state governments and their employees from being sued without their consent. Thus, federal and state governmental entities such as DOTs can be held liable only for negligent actions under circumstances in which sovereign immunity does not protect them. The Federal Tort Claims Act (28 U.S.C. §2674) waives immunity for federal entities, with exceptions where immunity still applies. The discretionary function exception, for example, retains immunity for essentially governmental functions that require discretion or judgment—such as planning or policy-level decisions, often to do with resource allocation—but not in cases where a clear mandate was violated (12). Another—the misrepresentation exception—protects governmental entities from liability for a failure to provide correct information. Generally, a case will be dismissed without reaching a decision on its merits if one of these exceptions applies. Claims against federal agencies related to weather information or warnings have generally, but not universally, been resolved in favor of the government due to these exceptions (11–13).

State statutes that define the limits of sovereign immunity vary, and whether a state entity will be protected depends on the specifics of the relevant statute and how it has been interpreted, as well as the factors in a specific case. At least 26 states' tort claims acts include discretionary function exceptions and at least seven states' acts contain misrepresentation exceptions. Some federal and state courts, however, have found that such exceptions do not apply to all weather-related activities.

Some state statutes also specifically define the limits of immunity for weather-related road conditions. Some states, such as Colorado and Massachusetts, allow the state to be held liable for dangerous road conditions, including weather-related conditions. At least 13 states expressly provide some immunity for weather-related road conditions, though these laws vary (14, 15).

Legal concepts of duties and standards of care may also be relevant. Undertaking a new practice or service that affects public safety creates a duty to perform it with reasonable care—especially if reliance upon it is induced (11)—and some federal and state cases suggest that using RWIS can cause DOTs to assume new duties. In the 1990s, for example, the Nevada DOT adopted a new automated system that indicated RWIS-informed warnings would be provided in case of dangerous weather conditions. The DOT was held liable when those warnings then were not provided. States may address duties of care within their statutes. Colorado, for example, defines in law when a governmental entity can be deemed to have assumed a new legal duty, but the application of this statute to RWIS is unknown.

RWIS might also raise the bar for what constitutes a standard of reasonable care—essentially raising expectations for how DOTs handle dangerous situations. A notable 1982

Michigan Supreme Court case, for example, held the state DOT not negligent because, among other factors, “the technology available at the time of the accident was not advanced to such point as would permit the installation of a flashing sign which would be automatically activated upon the actual appearance of ice on [a] bridge...” (15, p. 3). Now, however, real-time detection and automated warnings are available.

Other relevant legal concepts include actual and constructive notice. DOTs generally have a duty to correct or warn of dangerous conditions of which they actually know (actual notice) or, in some cases, of which they reasonably should have known (constructive notice) (14–16). RWIS, however, might give a DOT notice of more hazards than it has the resources to address. In cases relating to roadway maintenance, courts have generally acknowledged DOTs’ practical limitations when defining their duties (15, 16). Further, resource allocation decisions are often—but not always—protected as discretionary functions (16).

### **Key Finding 3: Most Experts Identified No RWIS-Related Liability Concerns**

The research for this report was based on original survey research with operations managers in, and legal counsel for, state DOTs. Responses were received from 19 operations managers and 17 legal advisors in a total of 32 states and the District of Columbia. It is notable that more than half the respondents expressed no liability concerns related to use of RWIS.

At the same time, the use of RWIS has rapidly expanded in the past decade and as with any new technological innovation, some concerns have been raised about potential legal liabilities related to its use. Survey respondents identified four areas of potential concern:

1. Direct dissemination of RWIS information to the traveling public, especially online, since such information might be false, untimely, or misunderstood;
2. Providing RWIS information to the public indirectly, via a third party such as *Clarus* or a weather service provider that repackages and redistributes DOT data, especially if the third party fails to maintain the data’s accuracy, timeliness, or accompanying disclaimers;
3. DOTs having a legal duty to respond to notice of weather-related hazards, even if it has limited resources to respond to all the additional data an RWIS system provides; and
4. Liability for not using RWIS when it is expected or indicated, or where no other viable or effective option exists to protect public safety.

As reviewed under Key Finding #4, state DOTs and legislatures have employed many strategies to address all four liability concerns.

### **Key Finding 4: State DOTs and Legislators Have Many Strategies to Address RWIS-Related Liability Concerns**

Strategic options to address liability concerns related to RWIS are available to both DOT personnel and state legislators, who can increase their effectiveness by maintaining good communication across branches of government (17) and by learning from their counterparts in other jurisdictions. The following strategies were drawn from survey responses, interviews, the literature, and other resources. Taking these actions not only can reduce RWIS-related liability, but also maximize the benefits of these innovative technologies for transportation agencies and the traveling public.

## State DOT Strategies

Options for DOTs include making careful choices about how they implement, monitor, maintain, fund, and use RWIS; what information is shared, how and with whom; and how they address RWIS-related issues with departmental policies, public outreach, and risk management programs.

### *Limits on Information Sharing*

Evaluation data indicate that up to 94% of drivers who use traveler information websites believe road weather information enhances their safety and prepares them for adverse road weather conditions (7). At the same time, direct dissemination of RWIS information to the public was the concern most commonly identified by survey respondents.

One DOT strategy to address information-sharing concerns is to restrict what RWIS data is shared, with whom, and via what media. The complete RWIS data set is then primarily—and sometimes solely—accessible to DOT personnel. This was the most commonly described strategy in the survey responses. As of late 2009, however, at least 17 states shared detailed sensor data online. Of those, at least 10 also provided other weather-related information online, but on a different web page. This may help address liability concerns by keeping site-specific RWIS data separate from other information that is intended to be used for travel decisions.

The decisions DOTs make about which road weather information to make publicly accessible, to whom and how, require careful assessment of which information is most relevant, useful, and appropriate to share with the public. Another important consideration is whether other strategies are available to address liability concerns.

### *Online Disclaimers*

The next most commonly described strategy is the use of online disclaimers for content provided on a DOT's public website. These are legal statements intended to provide a measure of legal protection by limiting liability for website operators. Of the 43 states that shared any road weather information online as of 2010, only seven did not include an accompanying disclaimer.

Disclaimers vary widely by context, location, type, and content, and although they are generally considered a valuable tool to provide extra protection against liability, their enforceability and effectiveness are not guaranteed. Specific concerns exist about disclaimers that are accessible as a link that may not be noticed by website users, and for which “mutual assent is marginal at best” (18, p. 552). The Texas DOT, in contrast, requires all users to click to actively accept its disclaimer before accessing its road conditions map. Crafting an appropriate disclaimer is best done with expert legal advice, and since it may not provide absolute protection, integration with other strategies may be appropriate.

### *Agreements with Third Parties*

A strategy to address concerns about indirect information sharing is the use of data-sharing agreements that define the allowable uses of RWIS data by third parties and describe the limits on DOT liability for such uses. Three approaches are generally taken in these agreements: online terms of use agreements that seek to define the legal relationship between website operators and

users; formal data-sharing agreements with select third parties; and informal agreements with parties that have privileged data access. All three are best approached with expert legal advice.

### *System Optimization*

One of the most important protections against RWIS-related liability is to operate the best possible system—one that functions as intended, is meaningfully integrated into an overall road weather management program, provides accurate and timely information, and for which reasonable care has been demonstrated or exceeded in planning, deployment, maintenance, and use. Certain areas of system optimization—including system planning, DOT training, implementing user-friendly systems, monitoring and data quality checking, ongoing maintenance, and integrating RWIS with other existing data sources and practices—can particularly address RWIS-related liability concerns. For example, New Hampshire uses information from field observations in cases where its RWIS data is known to be insufficient, which was a factor in its 2010 court case.

Since the report was released in 2010, other states have also made additional system optimization efforts. As of October 2011, follow-up survey results revealed that California had executed a statewide calibration contract; Connecticut was transitioning to the latest detection technologies and working toward preparing a statewide deployment plan; Idaho was improving and expanding its system and had added a quality assurance check of temperature and surface conditions data from noninvasive pavement sensors; Kentucky was contracting on-site maintenance for all its sensor stations; Nevada was providing preventative maintenance for all sites and troubleshooting and repair for troublesome sites; North Carolina was upgrading its system to provide roadway information as well as fog detection; and North Dakota was pursuing its next generation of RWIS technologies.

### *DOT Departmental Policies and Regulations*

A DOT's approach to its policies can help address RWIS-related liability concerns. Detailed, written departmental policies can provide specific guidance to promote appropriate RWIS use, maintenance and monitoring. However, the level of detail also may affect the applicability of a discretionary function exception to a waiver of state sovereign immunity.

### *Public Outreach and Education*

Regular public outreach and education activities—particularly relating to adverse weather, winter maintenance, and RWIS technologies—can help address liability concerns by informing travelers about the appropriate uses of RWIS, limitations of the technology, and a DOT's approach to winter maintenance. Many DOTs use public relations programs or post explanatory statements, winter maintenance policies, or winter driving tips on their websites.

### *Risk Management*

RWIS-related liability concerns can be addressed by an overall DOT risk management program. Risk management for DOTs has been defined as “the identification, measurement and treatment of exposure to potential crashes and tort liability” (19), with the general goal to minimize both

the fiscal impact of tort claims and the human suffering resulting from accidents (20). Risk management includes several strategies reviewed here, as well as a DOT commitment to a preemptive risk management approach, a comprehensive risk management program, an ongoing, effective relationship with legal counsel, claims management, an accurate up-to-date database of relevant information, risk transfer, and a review of documentation procedures (17, 20).

### *Ongoing Allocation of Funds*

In the context of a nationwide transportation funding crisis and increasing competition for funding, states may have difficulty securing ongoing, stable funding for RWIS. Ongoing support, however, is what allows RWIS to continue to meet the needs of the public and DOT personnel for which the investment was first made. It is important to document and communicate the benefits of RWIS use and maintenance (21), including financial benefits. These can include increased efficiency, productivity, and roadway safety; reduced likelihood of litigation; and preemption of costly, responsive maintenance or systemwide upgrades.

Most state DOTs provide RWIS funding from maintenance and operations budgets. Innovative, cost-effective financing options also may be available. For example, as of 2010 there were at least two active RWIS public-private partnerships, in Arizona and Canada, although some states have been less successful in pursuing these arrangements. As another way to save costs, some states—such as Alaska, Iowa, and Ohio—have used integrated intelligent transportation system platforms that support both weather and traffic sensing capabilities. Combining both technologies into a single system saves money and allows both traffic and weather observation systems to expand beyond their traditional applications (22).

### **Legislative Strategies**

Legislators also can take actions that may affect states' exposure to liability—both generally and in relation to RWIS. These options include legislation relating to tort liability, immunity, and appropriations for RWIS investments.

#### *Legislation Relating to Tort Liability and Immunity*

Legislators can consider several legislative options to reduce liability exposure, including statutes relating to immunity for highway defects and the effects of weather, statutes relating to procedures for filing a claim against the state, or statutes limiting the damages that can be recovered for judgments against the state.

In the latter category, at least 33 states have enacted statutory provisions that limit, or “cap,” damages by specifying a maximum dollar amount that can be recovered per individual, per occurrence, or per cause of action. In 2010, these ranged from \$75,000 per cause of action in Nevada to \$1.5 million per individual in Oregon and \$5 million per occurrence in Indiana. In 2011, Nevada's cap increased to \$100,000, according to a statutory schedule.

In addition, at least 29 states have adopted a provision that prohibits judgments against the state from including punitive or exemplary damages [14, 23; Morton, 2007 (unpublished data)]. In the absence of immunity, such provisions can help protect the state and reduce the fiscal impact of tort liability.

### *Appropriations*

In most cases, DOTs allocate funding for RWIS from their maintenance and operations budgets based on departmental priorities (21). Legislators, however, may also play a vital role in ensuring ongoing funding for RWIS, depending on the state and its processes for allocating funds to DOTs. Legislators may be especially important in this respect in states where the legislature approves specific DOT appropriations. Legislators can participate in this strategy by staying informed about and, as appropriate, involved in the process for funding RWIS in their states.

### *Other Legislative Strategies*

Legislatures have other options to address liability concerns. For example, some states have created task forces or commissions to review state liability exposure, as Oregon did with its Senate Bill 311 in 2009. Likewise, in 2010, Louisiana directed a study of all aspects of liability relating to road hazards with House Concurrent Resolution 161.

Another relevant area of legislation can include the facilitation of state risk assessment activities. In 2011, for example, New York legislators introduced several bills—including Senate Bill 1029, Assembly Bill 8612, and Assembly Bill 6731—that proposed to establish a state Office of Risk Assessment and Management. As of October 2011, however, none had passed.

## **ACKNOWLEDGMENTS**

The NCSL prepared the original report upon which this paper was based in collaboration with the FHWA Road Weather Management Program, under an agreement with the FHWA Office of Operations.

## **REFERENCES**

1. *Where the Weather Meets the Road: A Research Agenda for Improving Road Weather Services*. National Academies Press, Washington, D.C., 2004.
2. Pisano, P. A., L. C. Goodwin, and M. A. Rosetti. *U.S. Highway Crashes in Adverse Road Weather Conditions*. FHWA, U.S. Department of Transportation, 2008. Available at <http://ams.confex.com/ams/pdfpapers/133554.pdf>.
3. Cambridge Systematics, Inc., and Texas Transportation Institute. *Traffic Congestion and Reliability: Trends and Advanced Strategies for Congestion Mitigation*. Cambridge Systematics, Inc., Cambridge, Mass., 2005. Available at [http://ops.fhwa.dot.gov/congestion\\_report/congestion\\_report\\_05.pdf](http://ops.fhwa.dot.gov/congestion_report/congestion_report_05.pdf).
4. *How Do Weather Events Impact Roads?* FHWA, U.S. Department of Transportation, 2009. Available at [http://ops.fhwa.dot.gov/weather/q1\\_roadimpact.htm](http://ops.fhwa.dot.gov/weather/q1_roadimpact.htm).
5. Pisano, P. A., L. C. Goodwin, and A. D. Stern. *Weather Information for Road Managers*. FHWA, U.S. Department of Transportation, 2005. Available at [http://ops.fhwa.dot.gov/weather/best\\_practices/1024x768/transform\\_param2.asp?xslname=pub.xsl&xmlname=publications.xml&keyname=918](http://ops.fhwa.dot.gov/weather/best_practices/1024x768/transform_param2.asp?xslname=pub.xsl&xmlname=publications.xml&keyname=918).
6. *Investment Opportunities for Managing Transportation Performance Through Technology*. Intelligent Transportation Systems Joint Program Office, U.S. Department of Transportation, 2009. Available at <http://www.ntoctalks.com/articles/investment.php>.

7. Maccubbin, R. P., et al. *Intelligent Transportation Systems Benefits, Costs, Deployment, and Lessons Learned: 2008 Update*. U.S. Department of Transportation, 2008. Available at [http://www.its.knowledgeresources.its.dot.gov/its/benecost.nsf/images/Reports/\\$File/BCDLL-14412\\_full.pdf](http://www.its.knowledgeresources.its.dot.gov/its/benecost.nsf/images/Reports/$File/BCDLL-14412_full.pdf).
8. Boyce, B. The *Clarus* System. Presented at Road Weather Stakeholder Meeting, Albuquerque, N.M., 2011. Available at <http://www.its.dot.gov/presentations/roadweather/pdf/Boyce%20-%20Clarus%20System%20Update.pdf>.
9. Rall, J. *Weather or Not? State Liability and Road Weather Information Systems (RWIS)*. National Conference of State Legislatures, Denver, Colo., 2010. Available at <http://www.ncsl.org/?tabid=20241>.
10. Ballard, L., et al. *Handbook and Summary Report: Assess Caltrans Road Weather Information Systems (RWIS)*. Western Transportation Institute, Bozeman, Mont., 2002. Available at [http://www.westerntransportationinstitute.org/documents/reports/426134\\_Final.pdf](http://www.westerntransportationinstitute.org/documents/reports/426134_Final.pdf).
11. Sandler, R. B. *Tort Liability in the U.S.A. for Negligent Weather Forecasts*. Self-published, 2003. Available at <http://www.rbs2.com/forecast.pdf>. [Place of publication not ascertainable.]
12. Klein, R., and R. A. Pielke, Jr. Bad Weather? Then Sue the Weatherman! Part I: Legal Liability for Public Sector Forecasts. *American Meteorological Society*, Vol. 83, No. 12, 2002, pp. 1791–1799.
13. Loper, R. B. Red Sky in the Morning, Forecasters Take Warning: The Liability of Meteorologists for Negligent Weather Forecasts. *Texas Law Review*, Vol. 66, 1988, pp. 683–713.
14. *Civil Actions Against State and Local Government: Its Divisions, Agencies and Officers* (J. L. Craig, ed.). Shepards/McGraw-Hill, Colorado Springs, Colo., 2002.
15. Vance, J. C. *NCHRP Legal Research Digest, No. 9: Supplement to Liability of State and Local Governments for Snow and Ice Control*. TRB, National Research Council, Washington, D.C., 1990.
16. Thomas, L. W. Tort Liability of Highway Agencies. In *Selected Studies in Transportation Law Vol. 4*, TRB, National Research Council, Washington, D.C., 1992.
17. Giraud, T., et al. *The Development of a Highway Tort Liability Risk Management System for the Indiana Department of Transportation*. FHWA/IN/JTRP-2003/20, SPR-2662. Purdue University, West Lafayette, Ind., 2003. Available at <http://docs.lib.purdue.edu/jtrp/207>.
18. Sandeen, S. K. The Sense and Nonsense of Web Site Terms of Use Agreements. *Hamline Law Review*, Vol. 26, No. 3, 2003, pp. 500–553.
19. Datta, T. K. Accidents and Risk Management. *Proc., ITE 1996 International Conference*, Dana Point, Calif., 1996. Quoted in T. Giraud, et al. *The Development of a Highway Tort Liability Risk Management System for the Indiana Department of Transportation*, FHWA/IN/JTRP-2003/20, SPR-2662. Purdue University, West Lafayette, Ind., 2003. Available at <http://docs.lib.purdue.edu/jtrp/207>.
20. Lewis, R. M. *Synthesis of Highway Practice 206: Managing Highway Tort Liability*. TRB, National Research Council, Washington, D.C., 1994.
21. *Review of the Institutional Issues Related to Road Weather Information Systems (RWIS)*. Aurora Program, Eagan, Minn., 1998. Available at [http://www.aurora-program.org/pdf/inst\\_issues.pdf](http://www.aurora-program.org/pdf/inst_issues.pdf).
22. Tarleton, J. *The Synergy of Road Weather Information and Near Real-Time Traffic Data*. Quixote Transportation Technologies, St. Louis, Mo., 2009. Available at [http://www.vaisala.com/Vaisala%20Documents/White%20Papers/RDS\\_Vaisala%20Synergy%20of%20ITS%20Data\\_Tarleton\\_2009.pdf](http://www.vaisala.com/Vaisala%20Documents/White%20Papers/RDS_Vaisala%20Synergy%20of%20ITS%20Data_Tarleton_2009.pdf).
23. *State Sovereign Immunity and Tort Liability*, National Conference of State Legislatures, Denver, Colo., 2010. Available at <http://www.ncsl.org/default.aspx?tabid=20628>.

## WINTER MAINTENANCE POLICY AND MANAGEMENT

**Implementing the Pennsylvania Department of  
Transportation's Winter Services Strategic Plan****CHARLES C. GOODHART****BONNIE J. FIELDS***Pennsylvania Department of Transportation***ROBERT J. VANCE****MICHAEL S. RENZ***Vance & Renz, LLC***MARY W. TREISBACH***Mary W. Treisbach, Consultant***BARBARA T. HARDER***B. T. Harder, Inc.*

**This paper describes events associated with a major winter storm that convinced the Pennsylvania Department of Transportation (DOT) of the need to create and implement a strategic plan to improve its winter service operations. A leadership team directed the work of expert task groups who wrote a plan that addresses major deficiencies revealed by the storm. The plan's five objectives, 17 strategies, and 63 action items emphasize fundamentals including staffing, equipment, materials application, situational awareness, contingency planning, environmental stewardship, and performance management. With the aid of Pennsylvania DOT's implementation system staff and consultants, deployment followed the system's principles of effective implementation. These principles include top management support, dedicated resources, effective communications, implementation teams with the requisite skills, credibility, enthusiasm, broad involvement of the field, and a supportive culture of innovation. Work began to accomplish quick-kill action items even before the plan was completed and continues with a goal of full deployment by late 2013. Implementation challenges and lessons learned are described. Notable successes in fighting recent storms attest to the value of a coordinated and consistent approach.**

**O**n February 13 and 14, 2007, a major winter storm struck the northeastern United States. Pennsylvania was caught in the middle of the storm between a boundary with snow on the northern side of the state and ice and freezing rain on the southern side. Several Pennsylvania Department of Transportation (DOT) districts and county maintenance organizations that got freezing rain and ice were not prepared and did not adequately respond to the unusual roadway conditions that the storm event presented. A major Interstate highway closed in one district which caused two other Interstates to close in other districts due to increased truck traffic and blizzard conditions. Approximately 150 Interstate miles were closed at the height of the event as stuck vehicles, jackknifed tractor-trailers, and deep snow and packed ice rendered them impassable. Hundreds of motorists were stranded in their vehicles for up to 24 h before being rescued by National Guard and other emergency responders. It was longer still until the



Pennsylvania DOT cleared the roads and normal traffic flow resumed, partly due to air temperatures remaining below 25°F for 4 consecutive days. Pennsylvania DOT staff who battled the storm know it as the “Valentine’s Day Massacre,” a holiday marred by bad weather compounded by Pennsylvania DOT’s unacceptable performance.

On Friday February 16, 2007, then-Governor Ed Rendell held a press conference and expressed his disappointment in the performance of state government’s response to this emergency. In what became national news, he apologized to the citizens of Pennsylvania and admitted a “total breakdown in communications” and inadequate response to this winter storm. He announced that an independent investigation would be conducted over the next few months by James Lee Witt Associates of Washington, D.C., a firm specializing in emergency management operations. Then Pennsylvania DOT Secretary Allen Biehler also formed an internal investigation team, asking for recommendations to improve Pennsylvania DOT winter and overall emergency operations (1).

Both investigations produced reports that promulgated numerous recommendations and proposed changes to Pennsylvania’s emergency preparedness policies and to the Pennsylvania DOT’s procedures for fighting winter storms and managing other emergency events. The following are some of the key findings and recommendations related to Pennsylvania DOT:

- Pennsylvania DOT needed 24/7 winter staffing guidelines for all snow routes. The Witt report cited a county where there were insufficient equipment operators available to cover two 12-h shifts (2).
- The Pennsylvania DOT lacked a statewide weather forecasting contract. A few districts had contracts with commercial weather forecasting vendors that provided timely region-specific information, whereas other districts relied on National Weather Service or other no-cost forecasting services. These differences highlighted inconsistencies in planning and preparations.
- The Pennsylvania DOT lacked a policy to staff district and county maintenance offices with managers experienced in fighting winter storms. The Witt report cited a county management team that was in place for less than 1 month after the previous team retired en masse on January 18, 2007 (2).
- Technologies that would have enhanced situational awareness and assisted with managing the event were unavailable or out of commission. The Witt report specifically cited roadway weather information system (RWIS) devices (which provide current weather condition information but which were mostly inoperable during the event due to inadequate maintenance) and variable message signs (had they been working, they could have warned motorists of hazardous conditions) (2).
- The Pennsylvania DOT customer information systems were not updated or not functional. Specifically, highway information advisory signs, the customer toll-free highway information phone line, Pennsylvania DOT’s website and the highway advisory radio system were not maintained with current information.
- The Pennsylvania DOT had neither formal contingency plans to divert traffic around blocked Interstates, nor policies and procedures to close highways when conditions warranted.
- Coordination and communications among Pennsylvania agencies (Pennsylvania DOT, the Pennsylvania Emergency Management Agency/State Emergency Operations Center, state police, Department of Military and Veterans Affairs, and others) before and during emergencies were deficient.

The Pennsylvania DOT's review of the findings and recommendations of the Witt and internal review reports revealed another problem area: variations in procedures across districts. Some variations resulted from differences in terrain, weather, types of roads, and average daily traffic volumes. Others, however, were identified as inconsistencies: differences in decision rules for application of brine, salt, and anti-skid materials, when to call out employees, shifting plans, etc., given current and anticipated roadway conditions. The Pennsylvania DOT executives recognized that they had been complacent and had not instituted a process to promote continuous improvement of winter services for as long as anyone could remember.

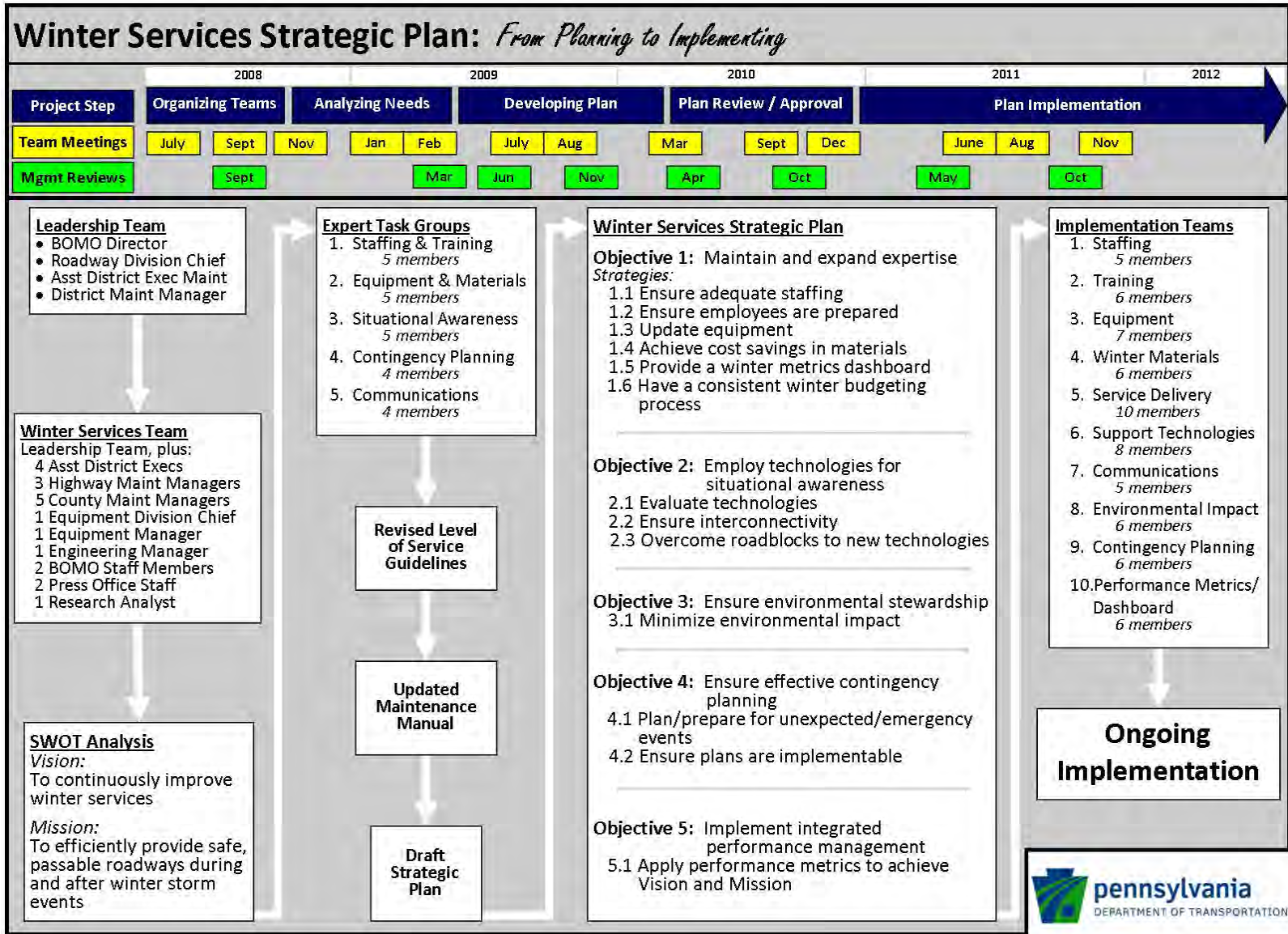
Pennsylvania DOT's deputy secretary for highway administration determined that a strategic plan for winter services could enhance the efficiency and consistency of winter operations and thereby improve response and management of future storm events. He asked Pennsylvania DOT's Bureau of Planning and Research (BPR) implementation system manager to support the Bureau of Maintenance and Operations (BOMO) to develop and implement such a plan. It was time for Pennsylvania DOT to "up their game"; a winter services strategic plan (WSSP) was the key to starting on that journey.

## **MARSHALING RESOURCES, SELECTING A TEAM, AND DEFINING NEEDS**

BPR began building the Pennsylvania DOT Research and Innovation Implementation System in 2004, responding to a department wide need for a programmatic approach to maximize return on its investments in research, achieve the benefits of winning innovations, and deliver results in line with its strategic goals and objectives (3). By 2008 the implementation system was fully operational and available to help create the WSSP and facilitate its subsequent deployment.

Creation of the WSSP depended first on the department's acceptance of the need for it, and second on providing sufficient financial and technical resources to see it through development and implementation (4). Creating and implementing the plan was not a budgeted activity within BOMO, and the resources contributed by BPR were therefore both welcome and necessary. This situation is a classic fit for the implementation system, which was designed to bridge the gap between developed innovations and their application to practice. The WSSP quickly passed the implementation system's "checklist for winning innovations"—meeting the criteria of having high potential for successful implementation as well as being a priority investment with significant operational impact—and work commenced. [Figure 1](#) shows significant project steps beginning in 2008 and continuing to 2012.

The bedrock of the WSSP was the direction of Pennsylvania DOT management and the input of key players who would be involved in its implementation. Planning began with project scoping discussions in early summer 2008, followed by initial work sessions with a seasoned, cross-functional leadership team comprised of BOMO's director, the chief of the roadway management division, an assistant district executive for maintenance, and a district maintenance manager; the latter two individuals represented two of Pennsylvania DOT's 11 districts. A BPR program manager and four external implementation system consultants completed this core team.



**FIGURE 1 Winter services strategic plan: from planning to implementing.**

## **Initial Strengths, Weaknesses, Opportunities, and Threats Analysis**

Working with the implementation system consultants, the leadership team held a pivotal work session in July 2008. The goal was twofold: to conduct a candid assessment of the department's winter operations, including strengths, weaknesses, opportunities, and threats (SWOT); and to develop a working vision and mission for winter services. The team summarized Pennsylvania DOT's strengths: dedicated, committed people; safety conscious and environmentally responsible operations; knowledge and experience; and openness to innovation.

Pennsylvania DOT's workforce had long been an asset; local creativity and problem solving were hallmarks of committed employees who had always been at their best when tested by adversity. The Valentine's Day storm not only challenged the entire workforce, but the poor performance and negative publicity were strong blows to the "get it done" culture at Pennsylvania DOT. Turnover in the department was another challenge. A large segment of the experienced workforce had recently retired or was considering retirement. The core team identified weaknesses connected to replacing the seasoned staff, along with inconsistency of operations statewide, aging equipment, training deficits, and a sense that Pennsylvania DOT had fallen behind in technology and best practices.

The team identified opportunities in attracting and retaining staff, sharing expertise and best practices internally and with other states, and more communication including consumer education and setting driver expectations. Also considered were threats to the department's future success with winter operations including internal issues with staffing, retention, and budgets, and external factors like political pressure and fuel costs. The team crafted a preliminary vision and mission focused on winter operations and during August and September of that year, started to gather more input and support for the plan through discussions with field staff.

## **Broadening Plan Input**

The next step was to see how the management level assessment aligned with the thoughts of those who would ultimately implement the plan. The leadership team identified a 20-member winter services team (Figure 1). Drawn from all 11 engineering districts and Pennsylvania DOT's central office staff, the winter services team represented all facets of winter planning and operations. Members of the team, from county maintenance managers to equipment managers to press office representatives, were all painfully aware of the shortcomings in the Valentine's Day storm response and its effect on department image and employee morale.

In advance of the first joint meeting of the winter services and leadership teams, the implementation system consultants reached out to the winter services team members individually to test the initial SWOT. In candid one-on-one interviews, participants revealed both their confidence in the traditional strengths of Pennsylvania DOT and their concerns about the development of a one-size-fits-all strategic plan that might hamper their local storm-fighting capabilities. With 11 engineering districts operating fairly autonomously and with decentralized budgeting based on prior year expenditures, some saw the plan as a serious threat to the status quo. There was agreement, however, that the status quo needed to be challenged and changed.

On September 19, 2008, the entire WSSP team (winter services and leadership teams, BPR program manager, and consultants) met for the first time to review their common feedback and begin to shift from assessment into planning mode. Each participant was called on to wear his or her Pennsylvania DOT hat to develop a comprehensive statewide plan rather than one tailored to one's own functional or geographic unit. A search for common goals and common implementation was the key. First the WSSP team refined the SWOT and reviewed the draft vision and mission developed by the leadership team (Figure 1). Then in facilitated breakout sessions, the participants began to address the nuts and bolts of the strategic plan, identifying strategic focus areas of staffing and training, equipment and materials, situational awareness, contingency planning, and communications.

Less than a week later, representatives from the leadership team and consultants met with the deputy secretary for highway administration. He reviewed the initial work on the project and, based on his top-level perspective on the department's deficiencies, clearly directed the team to address four key themes.

- **Fundamentals.** By starting with the basics of effective service, the plan would need to focus on the fundamentals of staffing, equipment, materials, and budgeting. The leadership team was told to identify gaps in performance and look for the best ways to leverage department resources in these areas.

- **Communications.** The experience of the Valentine's Day storm highlighted deficiencies in intradepartmental communications, along with breakdowns in communication with external partners like the state police, municipalities, and the Pennsylvania Emergency Management Agency (PEMA). The new plan would repair these internal failings and tackle new ways to engage external partners and the public.

- **Situational awareness.** By failing to monitor and adapt to changing situations, the department did not field its best effort to fight the Valentine's Day storm. Something as basic as a reliable, statewide weather forecasting system did not exist. Whatever the circumstances—weather, traffic, road closures or other factors—it was incumbent on the team to develop a system that would track and monitor these situations and develop a flexible plan to address them.

- **Contingency planning.** With a mindset to fight each storm with maximum effort within each district, the department did not have a system for contingency planning involving multiple districts. This could take the form of staging resources within districts in anticipation of events, and sharing information and resources among districts and with partner agencies to prepare for alternative actions as needed.

## **CREATING A STRATEGIC PLAN**

During the months that followed, expert task groups, which included WSSP team members and subject matter experts as needed, continued to address the four themes and develop the plan (5). Through conference calls, webinars, and meetings, team members shared ideas, investigated best practices, and worked on plan details. Other running changes (i.e., necessary actions before final plan completion) included revising the department's level of service guidelines, which specify standards of care (cycle times and minimum allowable roadway

conditions) for classes of roadways during winter storm events, and updating the winter operations section of the maintenance manual.

### **Engaging the Field**

Creating a detailed plan and then successfully implementing it require, in the first place, a plan that is implementable. Such a plan must take account of organizational realities, recognizing that implementation involves changing current practices (6). The WSSP team was carefully staffed with individuals representing all relevant functions as well as all districts plus central office. Work was divided among the five expert task groups according to the four themes (as shown in Figure 1 work relating to the first theme—fundamentals of staffing, equipment, materials, and budgeting—was allocated to Groups 1 and 2). Team members were assigned to expert task groups according to their experience and interests. The groups worked continuously via e-mail, conference calls, and in-person meetings, and their work was discussed and finalized by the entire WSSP team during in-person meetings held at regular intervals throughout the planning process.

Consider the inadequate 24/7 staffing problem Pennsylvania DOT faced. As documented in the Witt report (2), in some instances trucks were without operators for as long as 10 h during the storm event. In some counties there were no foremen or assistant managers on duty for entire shifts, hindering coordination of operations and impeding situational awareness throughout the chain of command. One aspect of the plan illustrates how the WSSP tackled this problem (Table 1).

Temporary equipment operators are hired prior to each winter season to augment the regular complement and enable 24/7 operations during storm events. The WSSP team defined the five steps of Action Item 1.1.1 to enhance the temporary operator staffing process. To forestall recurrence of bottlenecks in this process, the plan further stipulates that this action item is to be performed annually. Writing this and the other 62 action items of the plan required a team with deep understanding of winter services planning, preparations, operations, and past shortcomings. The staffing and training task group who wrote Action Item 1.1.1 included two assistant district executives for maintenance, district and highway maintenance managers (one each), and a county maintenance manager. This group collectively had extensive real-world experience in dealing with the department's sometimes inefficient staffing procedures; in addition, they conferred as needed with district and central office human resources personnel to identify practical enhancements to the process.

### **Planning and Review**

Through the concerted efforts of vested and knowledgeable members, the WSSP team produced a plan with five strategic objectives. These supported the stated vision and mission, and flowed from both the SWOT analysis and the four themes directed by the deputy secretary. Shown in Figure 1, Objective 1 addresses the fundamentals theme (staffing, equipment, materials, and budgeting), Objective 2 addresses the situational awareness theme, Objective 3 relates to the fundamentals theme concerning materials use and to the vision of continuous improvement, Objective 4 addresses the contingency planning theme, and Objective 5 relates to the vision and mission. The communications theme cuts across all five objectives, particularly Objectives 2, 4, and 5.

For each objective, the team crafted specific strategies that would contribute to its achievement. Plan strategies are shown in Figure 1. Within each strategy, there was a numbered list of action items, complete with timing and the identification of responsible parties, which further elaborated the work to be accomplished during plan implementation. By being specific about what, how, when, and by whom

**TABLE 1 Objective 1, Strategy 1.1, Action Item 1.1.1**

<b>Objective 1: Maintain and expand levels of expertise and performance.</b>
Strategy 1.1: Ensure availability of adequate, capable staffing.
Action Item 1.1.1: Ensure timely hiring and training of winter temporary operators.
Create model timelines of the current temp hiring and training processes: hire by October 20, train by November 1.
Identify bottlenecks and opportunities to increase efficiency and reduce costs.
Review the model timelines with appropriate personnel in Human Resources and the Equipment Division.
Identify and recommend solutions to streamline these timelines.
Meet with the Bureau of Human Resources Director to request changes to these model timelines.

the work would be done, the winter services plan graduated from theoretical to implementable. The ownership felt by the team members who developed the action items would transform into accountability as implementation began.

Senior management periodically reviewed the plan as it developed (approximate dates are shown in Figure 1). Feedback resulting from each review helped to shape the final product. For example, one of the latter reviews, provided by the deputy secretary for highway administration, prompted the team to write Strategy 1.6: Develop a consistent department-wide method for budgeting, tracking, and reporting winter services expenditures.

The final WSSP review was via the department's clearance transmittal process, whereby the plan was distributed to the district executives for approval during September and October 2010. With the conclusion of that process the plan became official in November 2010, and the team shifted into implementation mode.

## FROM PLANNING TO IMPLEMENTING

A team with the right expertise is necessary but not sufficient for formulating a workable plan and implementing it; team members must also embrace the need for change and commit to making it happen (7, 8). Implementation occurs at the level of action items, not at the level of plans. Taking the steps that lead from paper to practice requires a champion to lead the way, and each of the 10 implementation teams listed in Figure 1 has a champion. The implementation teams, created to put the plan in action, in total have about 45 members, chosen for specific teams according to their individual backgrounds and passion for improvement (many serve on more than one team). These teams include many but not all of the WSSP team members. Two examples illustrate how the teams approached implementation activities.

### Example 1: Prestorm Virtual Meetings

The investigative reports of the Valentine's Day storm criticized Pennsylvania DOT for lack of a statewide weather forecasting service, deficient intra- and interagency communications and coordination, and inadequate contingency planning. In response, Objective 2 (situational awareness), Objective 4 (contingency planning), and Objective 5 (performance management) were written. These objectives encompass strategies and action items that specifically address timely weather information and associated technologies (e.g., RWIS), road closure and traffic diversion plans and associated

communication—coordination with partner agencies, and performance metrics to drive improvements. With the BOMO director as champion, these elements were put into practice beginning in late 2009 in the form of prestorm virtual meetings held approximately 36 h prior to the forecasted start of each winter storm event.

Participants in prestorm meetings include: for BOMO, the director, the roadway division chief, the winter services manager, the roadway programs manager, plus support staff; for Pennsylvania DOT's 11 districts, the assistant district executives for maintenance plus support staff; representatives of the Pennsylvania Turnpike Commission; representatives of the Governor's Office of Administration; representatives of PEMA; and a meteorologist from AccuWeather, Inc. (the weather service provider now under contract to the State of Pennsylvania). The meeting follows a set written script which begins with a roll call. Next, the meteorologist provides a current forecast using a series of maps showing region-specific precipitation types, start and end times, temperatures, wind speed, and direction, etc. This is followed by a question-and-answer period during which district personnel typically ask for additional forecast details, and probe for various what-if scenarios and associated probabilities. The forecast segment of the meeting usually ends with a discussion of the longer-term weather outlook, anticipating conditions over the next month or so.

The assistant district executives then report on the status of storm preparations in their districts with respect to staffing (equipment operators, foremen, and managers) and shift coverage (planned call-out times and overtime scheduling given forecasted precipitation start and end times); equipment and fuel (operability of all essential pieces); materials (salt, antiskid, brine, etc., stockpiled and available); communications (designated point of contact for condition reporting, cross-district coordination in the event of road closures and traffic diversions, media spokesperson, etc.); and requests for additional resources or assistance. Individual reports are followed by group discussion of circumstances such as holiday or special event traffic that may affect department operations (e.g., inclement weather affecting tens of thousands of spectators traveling to a sporting event in Philadelphia or Pittsburgh). Meetings usually end with a review of operational details of BOMO's area command (the unit that provides overall incident command, coordination, and communications within Pennsylvania DOT and with external partners such as PEMA and the state police during storm events) including activation time and schedule for districts to report conditions.

Shortly after inception, prestorm virtual meetings became standard practice as their value was increasingly apparent. The number of participants has grown, including more district and county staff as well as more representatives of partner agencies. To facilitate these meetings, in 2011 BOMO created a dedicated war room equipped with the latest communications, information, and display technologies. Originally intended only for winter storm preparations, prestorm meetings are now held year round, for example, in August 2011 for Hurricane Irene and in September 2011 for Tropical Storm Lee (a major flood event). In an open letter to the Pennsylvania DOT community following these devastating events, Secretary Barry Schoch reported that during a review meeting with senior government officials "The Governor, Lt. Governor, and other cabinet members repeatedly complimented me about your efforts and PennDOT's overall organizational approach to the catastrophe... Your sacrifice, courage and commitment to ensuring the safety of others are beyond words."

## **Example 2: Technology and Operational Efficiency**

The investigative reports of the Valentine's Day storm criticized Pennsylvania DOT for nonfunctional RWIS devices and inoperable variable message and highway advisory signs. If in service, these could



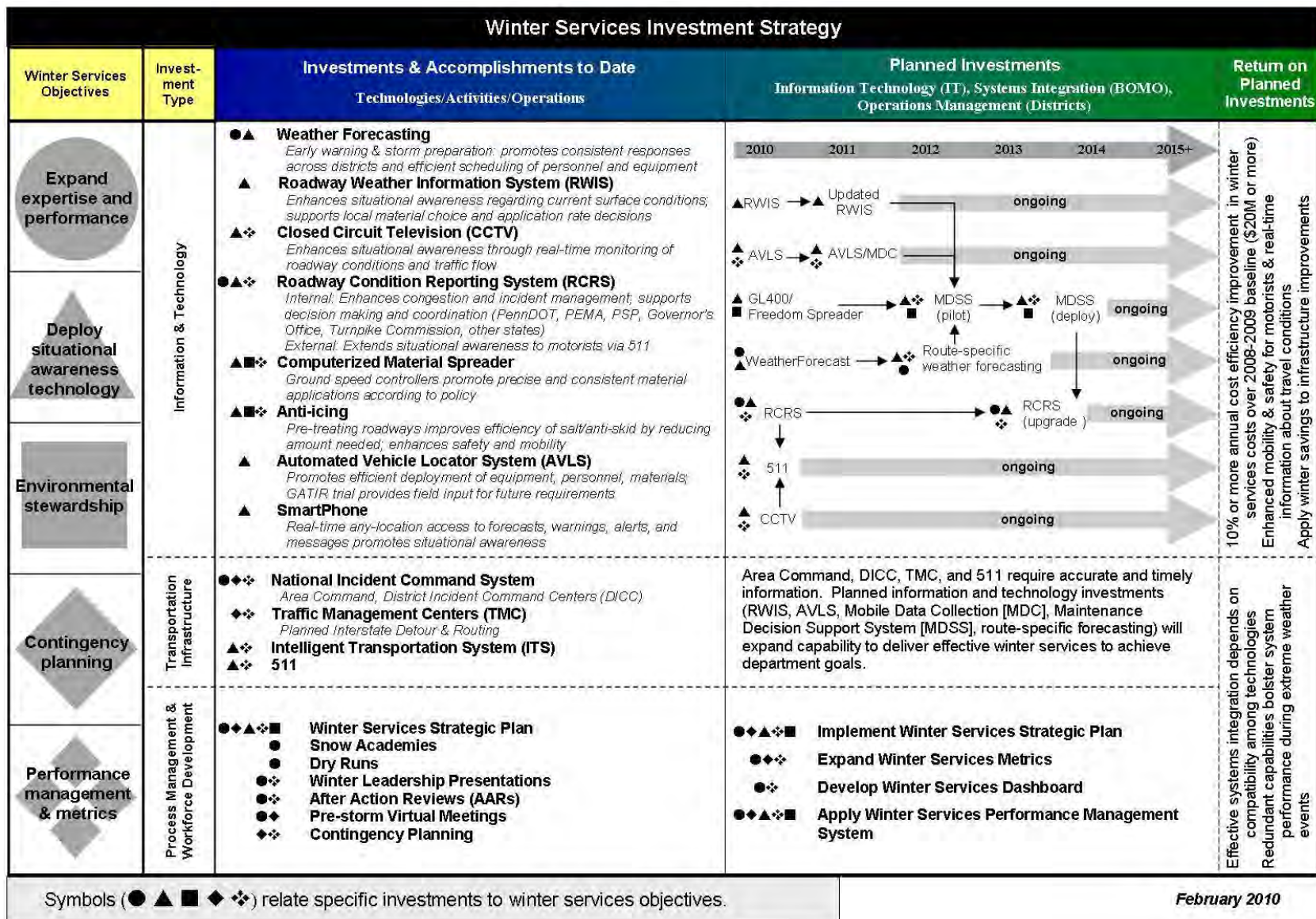
have contributed to situational awareness during the event. In response, Objective 2 was written to guide investments in and piloting of technologies to enhance situational awareness, and to upgrade existing technologies. The expert task group who wrote Objective 2 and its associated strategies and action items produced a chart early in 2010 that depicts planned technology investments in a larger context of Pennsylvania DOT's systems and practices. This chart is shown in [Figure 2](#). Symbols relate strategic plan objectives to technologies already in use and to future technology investments; the chart also shows the interrelationships among technologies.

Since adoption of the plan and following Action Item 2.1.1, "Deploy updated RWIS," the department has advanced the contracting process to acquire and maintain the latest generation of RWIS technology, with an expectation that this system will be completely updated by the end of 2012. Beginning in 2009, an automatic vehicle locator system (AVLS) was launched on a pilot basis [Action Item 2.1.2: Deploy in-vehicle AVLS with MDC (mobile data collection)]. Initial results led to a system upgrade to increase the vehicle location refresh rate (thereby improving the timeliness of the data). As of this writing, a dynamic and fully functional AVLS–MDC system request for proposals is being drafted and the new system should be operational by sometime in 2013.

Maintenance decision support system (MDSS) is a technology that integrates detailed route-specific weather forecast information with real-time measurements of roadway conditions, treatments applied, and traffic data (9). MDSS helps managers and equipment operators make better decisions during winter storms regarding the timing of deployment of personnel and equipment, and the types and amounts of materials to apply for maximum benefit and efficiency. With the assistance of the implementation system consultants, the situational awareness expert task group conducted a review of the state of practice and technology for MDSS. From their report stemmed Action Item 2.1.3: Deploy a Maintenance Decision Support System.

The first step of Action Item 2.1.3 advised that Pennsylvania DOT should join the MDSS Transportation Pooled Fund (TPF) study to take advantage of the knowledge and resources available through that mechanism (10). Accordingly, BOMO's winter services manager was appointed as Pennsylvania DOT's representative to the MDSS TPF in September 2009. That paved the way for a field trial of MDSS. In November 2010 a TPF representative provided training to the managers, foremen, and equipment operators involved in the trial. Testing of the system occurred on 15 snow routes in three Pennsylvania DOT districts throughout the 2010–2011 winter season. Implementation system consultants assisted in evaluating this field trial and contributed to a summary report.

Among the findings of this report were that, although MDSS holds great promise, reaching its full potential will require an upgraded RWIS system and AVLS with MDC capabilities. To be effective, MDSS requires accurate local weather forecasts. In two of the three test districts, forecasts proved to be problematic due to the distance of the test routes from the weather radar stations upon which MDSS depends. Route-specific forecasts could be substantially improved with upgraded RWIS (11). Pennsylvania DOT trucks included in the test were not equipped with MDC technology (the department has not yet acquired this technology), which would allow for real-time electronic transfer of road temperature, precipitation, and roadway condition data between the field and MDSS. Instead, a cumbersome process of entering operators' roadway condition reports by hand into MDSS was used. As shown in [Figure 2](#), the contributions of an updated RWIS system and AVLS–MDC capabilities to effective use of MDSS were recognized before the field trial began, but the field trial confirmed their importance in a way that a white paper report could not. The field trial also confirmed an assumption implicit in [Figure 2](#): situational awareness technologies must be mutually compatible, having



Symbols (● ▲ ■ ◆ ❖) relate specific investments to winter services objectives.

February 2010

FIGURE 2 Winter services investment strategy.

interoperability. Of course, these technologies serve the greater needs of their users, so in making these investments the bigger picture of the department's related systems and practices, also shown in Figure 2, must be considered.

## Going Forward

Implementation of the strategic plan involves personnel and practices throughout Pennsylvania DOT and beyond. This is illustrated in Figure 2 and in the examples described above. The implementation teams help to motivate, organize, and guide adoption of new technologies and procedures, but their deployment depends on a much greater segment of the workforce. The department has a long history of innovation, aided by creative and committed employees. Since the outset of the planning process, regular communication from the WSSP team to the Pennsylvania DOT community helped to pave the way for the changes described above (3). Communication vehicles include *PennDOT Innovations*, the implementation system newsletter; individual innovation information bulletins on new technology or procedural improvements; management updates within districts; postings on the implementation system website's dedicated WSSP section; briefings at local and statewide meetings, and more. By the time roll-out of a new practice or technology begins, most or all of the implementers have had ample opportunity to learn their roles.

As noted in Figure 1, implementation of the plan's action items is ongoing. Success is built one accomplishment at a time, and even when an initiative falls short of expectations, such as the MDSS field trial, the organization learns from it and moves forward. Accomplishments are periodically acknowledged and reinforced by laudatory messages from the secretary, the deputy secretary, the press, and others. Positive feedback validates the contributions of WSSP team members who created the plan and inspires commitment to change among implementers statewide. Recognizing successes by means of newsletter stories, after action review meetings, and so on, expands the sense of ownership for the plan throughout the organization and helps to sustain the implementation process.

## IMPLEMENTATION CHALLENGES

An ideal strategic planning process includes clear management leadership and direction, collaboration in plan development from the team members who are ultimately tasked with implementation, consensus on the plan itself, ongoing management support, and sufficient resources to implement (12–15). Pennsylvania DOT encountered roadblocks and detours along the way to implementation of its winter services strategic plan. Some examples:

- Management changes. During the course of the planning process and implementation to date, Pennsylvania DOT has had three BOMO heads, two deputy secretaries for highway administration, and two secretaries of transportation. As each has influenced the plan, the plan has grown stronger.
  - One leader had a single-minded focus on metrics that added a strong accountability component to the plan.

- Another brought knowledge and innovative ideas gleaned from regional, national, and international counterparts to broaden the plan and challenge the organization to change.
- Another focused the team’s attention on technologies such as RWIS, AVLS, MDSS, and 511 travel information service, their interconnections and the training that would be required for full implementation, plus costs of materials such as salt and antiskid and environmental issues associated with their use.
- Staff turnover. Since 2008, many equipment operators and county and district staff have left Pennsylvania DOT, mostly through retirements. Turnover has impacted some of the implementation teams; the retirement of valued members means loss of decades of practical experience and institutional memory. Recruiting passionate and knowledgeable replacements has been key.
- Competing priorities. With any organization, there will always be strains on resources and staffing depending on priorities identified and championed by management. Simultaneous to the WSSP, Pennsylvania DOT embarked on an urgent bridge improvement program that sometimes drew staff and organizational attention away from winter implementation.
- Budget issues. Limits to in-state business travel reduced face-to-face planning sessions. Resource programming (funding, information technology priorities, staffing) extended the time horizon for full implementation of some technology pilots. The team coped with these challenges by revising timelines and piggybacking initiatives (e.g., the prestorm virtual meetings integrate event-specific weather forecasting, intra- and interagency communications and coordination, and contingency planning) to maximize resource efficiency.
- Inconsistent participation. Some implementation team members could not allocate the same amount of time and energy to the process as others. Generally, other team members filled the gap or suitable replacements were found. A related challenge was to maintain overall enthusiasm because of sporadic lack of support.

A final challenge has been self-assessment, particularly to answer the question: Have we made sufficient progress? Often consumed by the day-to-day challenges of the job, the team members must periodically reflect on and celebrate how far Pennsylvania DOT has come with this plan. Keeping the plan’s implementation in front of the 11,000+ employees of Pennsylvania DOT through regular reporting in *PennDOT Innovations*, being accountable to management, sharing progress with peers at regional and national meetings, ensuring that the public is aware of the benefits of a well-executed plan through the press office—all of these are mile markers on the road to successful implementation of Pennsylvania DOT’s winter services strategic plan.

## CONCLUSIONS

The shortcomings in Pennsylvania DOT’s winter preparations and operations, exposed by the Valentine’s Day storm and documented in the investigative reports that followed, were addressed by the objectives, strategies, and in particular, the 63 action items of the WSSP. Rectifying these shortcomings depends on full and effective implementation of these action items, which is expected by the end of 2013.

BPR's implementation system staff and consultants helped to create the WSSP and are facilitating its implementation according to the nine principles described by Bonini et al. (3). Applied to the winter services planning and implementation processes, these are:

1. Accept that a need exists. The Valentine's Day storm brought the department's winter services weaknesses into sharp focus and moved the strategic planning remedy to the top of the priority list. Implementing such a plan implies changes in policies and practices which can be far reaching. The need must be generally recognized from the outset, otherwise, organizational inertia and natural resistance to change will stymie progress.

2. Be guided by the department's strategic objectives. Work on the plan began at the directive of top executives; ipso facto the initiative was aligned with the department's objectives. Regular top management reviews ensured that alignment continued throughout the planning and implementation processes.

3. Provide financial and technical resources. The resources contributed by BPR paired with those of BOMO yielded a dynamic combination. Implementation system staff and consultants augmented the foundational expertise of the maintenance personnel with process skills shaped to meet particular planning and implementation task demands.

4. Develop a team. Or teams. The scope and progression of this initiative from 2008 to the present necessitated multiple teams, each with its own role and skill requirements. Success of the initiative in large part hinged on the right combination of skills, expertise, and enthusiasm among team members, together with flexibility to reconstitute teams as their missions proceeded and requisite skills changed.

5. Engage the field. Implementation activities involve many department employees and partner agencies who were not authors of the plan. Expert task group and implementation team members directly involved in the plan's creation were selected to be broadly representative of the maintenance organization—this contributed to a plan that was indeed implementable.

6. Identify champions at all levels. The BOMO director was the planning process champion, and each implementation team has a champion who volunteered to lead the charge. Champions provide the vision, the organizational skills, and above all the passion to make it happen.

7. Communicate. The Valentine's Day Massacre garnered a lot of publicity for Pennsylvania DOT, all bad. Pennsylvania DOT is a different organization today thanks to the tireless efforts of the many employees who worked together to make it better. It is easy to lose sight of the big picture when one is focused on the details. Timely communications about successes large and small help keep everyone informed, motivated, and on track.

8. Build a foundation for success. Pilot tests and field trials increase the likelihood of ultimate success by revealing needed adjustments, and even complete changes of direction, during a learning phase when the consequences of missteps and errors are minimized. Regular progress reports keep those who need to know aware of accomplishments, and also help to acknowledge the contributions of participants.

9. Measure results. After pilot testing during the 2011–2012 season, the winter services dashboard (Strategy 1.5) will track metrics for resource expenditures (personnel and equipment hours, amount and dollar value of material used), operational performance (e.g., levels of service provided), and outcomes (e.g., elapsed time from end of storm until traffic resumes normal travel speed). This information will help the maintenance organization to achieve its vision of continuously improving winter services.

Development and implementation of Pennsylvania DOT’s WSSP yielded innumerable hard-earned lessons learned. Perhaps the most illuminating of these are encapsulated in the top 10 list of [Table 2](#). We offer them in the hopes that they will help pave a smooth road for readers embarking on a similar journey.

**TABLE 2 Lessons Learned from Implementing the Pennsylvania DOT’s Winter Services Strategic Plan**

<b>Lessons Learned</b>	
1.	Engage those <b>responsible for implementation</b> in the planning process. Their expertise, real-world perspective and focus on success will drive the plan through effectively
2.	Be selective in building the implementation team. More than just expertise, look for individuals with a <b>passion</b> for their subject matter area and zeal for improvement.
3.	<b>Face reality</b> . Through its SWOT analysis, Pennsylvania DOT confronted its limitations in key areas (staffing, equipment) and built a plan to address them.
4.	Think implementation every step of the way during the planning process. <b>Be thorough and specific</b> , as Pennsylvania DOT did with five objectives, 17 strategies, and 63 action items. Overall implementation of the WSSP is like a pixilated photograph: many individual items form the big picture. Some take longer to focus.
5.	<b>Work together</b> and see the big picture. An effective statewide plan relies on the willingness of independent entities to collaborate. Pennsylvania DOT’s WSSP formalized knowledge transfer and resource sharing among the 11 districts—and built confidence in a more consistent and professional approach to winter.
6.	<b>Keep implementing</b> even through management and staff turnover. A well-crafted plan can continue to move forward even as key players move into different positions or retire. Engage remaining team members, recruit new champions and subject matter experts, and communicate the plan’s success.
7.	<b>Make running changes along the way</b> . Improvements in winter operations were not stalled until the plan was finished and approved. In fact, the department made changes along the way, including revising level of service guidelines and updating the maintenance manual.
8.	Realize that innovations implemented successfully for one season can have <b>effective application year round</b> . <ul style="list-style-type: none"> <li>• Pennsylvania DOT’s prestorm virtual meetings have become a standard operating procedure prior to all major weather events, improving situational awareness and contingency planning.</li> <li>• Enacting a 45-mph advisory speed limit on major roadways during severe weather events—winter or summer—has helped reduce the number and severity of accidents.</li> </ul>
9.	<b>Learn from pilots</b> even if they are not 100% successful or fail to yield the anticipated results. Pennsylvania DOT’s piloting of MDSS revealed gaps in its data gathering procedures that made MDSS “not ready for prime time” in Pennsylvania. Work continues to map out the additional technology, training, and communication required for successful implementation.
10.	<b>Engage external partners</b> in the planning process. Ultimately, this isn’t “just” Pennsylvania DOT’s plan. It is a Pennsylvania winter services strategy that relies on involvement, cooperation, and shared communication from the Pennsylvania State Police, PEMA, local municipalities, and more.

## ACKNOWLEDGMENT

This work was sponsored by the Pennsylvania DOT and the U.S. Department of Transportation, Federal Highway Administration. The contents of this report reflect the views of the authors, who are responsible for the facts and the accuracy of the presented data. The contents do not necessarily reflect the official views or policies of the U.S. Department of Transportation, Federal Highway Administration, or the Commonwealth of Pennsylvania at the time of publication. This report does not constitute a standard, specification, or regulation.

## REFERENCES

1. PennDOT chief apologizes for stranding hundreds during winter storm. *USA Today*, February 23, 2007. Available at [http://www.usatoday.com/weather/news/2007-02-23-penn-storm-strandings\\_x.htm](http://www.usatoday.com/weather/news/2007-02-23-penn-storm-strandings_x.htm). Accessed Oct. 21, 2011.
2. Independent Report on the Mid-February 2007 Winter Storm Response for the Commonwealth of Pennsylvania. James Lee Witt Associates, March 27, 2007.
3. Bonini, M. R., B. J. Fields, R. J. Vance, M. S. Renz, B. T. Harder, M. W. Treisbach, and L. I. Bankert, Jr. How to Build a System to Implement Research and Innovation: Lessons Learned in Pennsylvania. In *Transportation Research Record: Journal of the Transportation Research Board*, No. 2211, Transportation Research Board of the National Academies, Washington, D.C., 2011, pp. 1–9.
4. Bikson, T. K., S. A. Law, M. Markovich, and B. T. Harder. *NCHRP Report 382: Facilitating the Implementation of Research Findings: A Summary Report*. TRB, National Research Council, Washington, D.C., 1996.
5. PennDOT Winter Services Strategic Plan: Working Document. Pennsylvania Department of Transportation, November 18, 2010.
6. Klein, K. J., and J. S. Sorra. The Challenge of Innovation Implementation. *Academy of Management Review*, Vol. 21, No. 4, 1996, pp. 1055–1080.
7. Daniel, L. J., and C. R. Davis. What Makes High-Performance Teams Excel? *Research-Technology Management*, Vol. 52, No. 4, pp. 40–45.
8. Rizzuto, T. E., and J. Reeves. A Multidisciplinary Meta-analysis of Human Barriers to Technology Implementation. *Journal of Consulting Psychology*, Vol. 59, 2007, pp. 226–240.
9. Smithson, L. D., and W. A. Nixon. Developing a Winter Maintenance Decision Support System: Prototype to Field Tests to Payback—and Beyond. *TR News*, No. 265, 2009, pp. 10–16.
10. Maintenance Decision Support System: Multi-State Pooled Fund Study. Available at <http://www.meridian-enviro.com/mdss/pfs/>. Accessed Oct. 21, 2011.
11. Petty, K. R. Winter Weather and Road Condition Forecasts: Advances in Models, Sensors, Tools, and Platforms Improve Maintenance Operations. *TR News*, No. 265, 2009, pp. 4–9.
12. Allison, M., and J. Kaye. *Strategic Planning for Nonprofit Organizations: A Practical Guide and Workbook*, 2nd ed., John Wiley & Sons, Hoboken, N.J., 2005.
13. Nutt, P. Making Strategic Choices. *Journal of Management Studies*, Vol. 39, No. 1, 2002, pp. 67–96.
14. Rizzuto, T. E., S. Mohammed, and R. J. Vance. Marching In-Step: Facilitating Technological Transitions Through Climate Consensus. *Computers in Human Behavior*, Vol. 27, 2011, pp. 185–194.
15. Klein, K. J., and A. P. Knight. Innovation Implementation: Overcoming the Challenge. *Current Directions in Psychological Science*, Vol. 14, 2005, pp. 243–246.

## WINTER MAINTENANCE POLICY AND MANAGEMENT

## Winter Storm Responses

### *Adverse Conditions Communication–Coordination Plan 2008*

PAUL KELTNER

*Wisconsin Department of Transportation Statewide Traffic Operations Center*

The State of Wisconsin partners with all counties within its borders to maintain roads to be reliable, safe, and passable in all types of conditions. To be in a constant state of readiness, the state's Emergency Transportation Operations (ETO) plan was developed by the Wisconsin Division of Transportation System Development (DTSD) and the Division of State Patrol (DSP). The ETO Plan formalizes Wisconsin's coordinated, performance-oriented approach to operating the transportation system during and between ETO events. An ETO event is an exceptional event that disrupts the normal flow of traffic on the Interstate or state highway network and requires an extreme response beyond normal operation and capabilities—or when the operations of a Wisconsin Department of Transportation (DOT) business facility are disrupted. For Wisconsin, most ETO events are due to adverse weather conditions. The responsibility for monitoring conditions and communicating weather event and incident notifications, resource requests, and road closure notifications for Wisconsin DOT falls upon the Statewide Traffic Operations Center (STOC), which is manned on a 24/7/365 basis. Once storm-related winter driving conditions degrade to an emergency level, and an advisory or warning is issued by Wisconsin DOT, the STOC immediately begins providing information (where needed) to federal and state agencies, county highway and law enforcement agencies, state border agencies, various advisory agencies, freight carriers, and the media. The STOC may activate a Regional Incident Management Coordinator (an ETO plan-defined role) who is deployed on scene to help those responding to the emergency and to provide information back to the STOC for further action and updates. Acting as the communication hub during these types of severe winter weather emergency conditions, the STOC is in constant contact with the supporting agencies until the emergency status is lifted or on-scene personnel deem that their local situation is no longer hazardous. The STOC's communication of traffic conditions also extends to the general public via the state's 511 Travel Information website and call center, dynamic messaging signs located on major expressways, closed circuit television camera's (CCTV) broadcasting road conditions to the web and associated television stations, and most recently, Twitter. The value of this approach to the STOC coordinating information between various agencies, while also providing information to the public, is evidenced in statistics related to the December 11–12, 2010, storm that produced nearly 20 in. of snow in some regions of Wisconsin. This midweek storm required a regional ETO response which was, per plan, communicated by the STOC in an orderly, efficient, and effective manner. The public flocked to the 511 real-time information system by phone and via the Internet to help them decide on the viability of travel during and after the storm. More than 175,000 visits were recorded to the 511 website ([www.511.gov/Web](http://www.511.gov/Web)) and calls to the 511 phone system skyrocketed. Television stations were able to broadcast, in real-time, the actual conditions of the roads via the STOC CCTVs, which also helps locate stranded motorists and manage related traffic incidents. The winter storm response of the STOC and Wisconsin DOT is designed to quickly and efficiently assess the need for an emergency response, coordinate communication, deploy resources, and inform the public to improve safety by alleviating or avoiding road hazards. It is also an ongoing effort that is refined and expanded as needed based on statistical information and the experience of all agencies and personnel involved in emergency responses.



## WINTER MAINTENANCE POLICY AND MANAGEMENT

## Importance of a Comprehensive Winter Operations Plan and Manual

DAVID L. BERGNER

*Retired, Public Works Superintendent, City of Overland Park, Kansas*

**Snow and ice control is a primary function of public works (PW) and department of transportation agencies in most of the United States and Canada. Regardless of size of agency or amount and frequency of snow events, it is essential to have a sound operations plan and comprehensive manual that explains the mission, goals, and objectives; states the policies, protocols, priorities, and level of service; details specific duties, roles, and responsibilities; defines the operational strategies and tactics; improves training; outlines the communication and control structures; enhances public information and relations; and reduces liability exposure. Though many managers realize the value of such a manual, developing and maintaining one is difficult because of the time and effort involved and a general dearth of good examples. PW agencies have incurred substantial reductions in staff and budgets in recent years, a trend that likely will continue for some time. Therefore, management will have to find ways to provide critical snow and ice control with limited resources and ensure transfer of knowledge to newer staff. This paper discusses the general components of a plan and subjects recommended for inclusion in a manual.**

Keeping streets, roads, and highways clear of snow and ice is a fundamental responsibility of local public works (PW) departments and state and provincial departments of transportation (DOTs). While Canada and much of the United States routinely experience winter storms, the 2010–2011 season was significantly harsh. Even the southern states were hit with major snow and ice events and the mid-Atlantic and northeast regions suffered massive blizzards that overwhelmed capabilities of the affected agencies. Whether a sign of long-term climate change or just an aberration in weather patterns, it is increasingly obvious that nearly all areas of the United States must be prepared to deal with snow and ice.

Until recently, snow fighting was fairly straightforward: keep plowing and apply a lot of salt and sand. Operators would routinely deviate from the prescribed route patterns and application rates based on their observations and preferences. Levels of service (LOS) were usually ill-defined or nonexistent. Weather forecasting was good but lacked the precision that is now available. Equipment was rudimentary; a front-mount plow and a tailgate spreader was the typical setup. Training was minimal and only for new operators.

Snow removal was considered secondary to other routine operations except in those locales that historically had long, snowy winters. For a large part of the United States the number of snow storms and total snow amount each season was quite variable. Thus, when budgets needed to be reduced a common target was funding for snow removal. Because managers placed more emphasis on construction and maintenance of infrastructure, less attention was given to keeping snow equipment in good condition, material stockpiles replenished, and personnel trained and available. Inevitably, a bad winter came and these agencies lacked the proper resources to adequately respond. LOS was likewise curtailed generating much criticism from the public. For example,

Denver, Colorado, decided one year not to plow residential streets after a heavy snowfall. In Seattle, Washington, the city was inadequately prepared when a snowstorm struck in 2009. Atlanta, Georgia, had only four plow trucks for the entire city to deal with a snowstorm in the 2010–2011 season.

In the 1990s, winter operations began to change with the development of alternative chemicals, improvements in equipment, application of new technologies such as geographic information systems and automatic vehicle location (AVL), the evolution of wireless two-way communication, and advancements in weather forecasting and condition reporting. Also, the public's expectations increased as the Internet provided better access to local governments; for example, residents in some jurisdictions can view snowplowing progress online and submit complaints or comments via e-mail, websites, texts, social media sites, or even call from cell phones while driving. This immediacy of contact places additional demands on an agency.

The growing complexity of winter operations, the need to ensure continuity as staffs change over time, more emphasis on transparency of governance, and the concern over increased claims and litigation from accidents caused by snowstorms underlines the need for clear and comprehensive plans. It is not necessary to have extensive, detailed strategies for every conceivable scenario; instead, there should be guidelines established for the general types of events that are likely to occur. "All agencies responsible for snow and ice control should have written policies and guidelines that document the intent, capabilities, and procedures... Guidelines provide the managers and operators with a basis for conducting specific operations under certain conditions." (*I*)

Though winter storms can be categorized by precipitation type, severity, and duration, a number of other variables such as temperature range, wind direction and speed, humidity, pavement moisture, existing snow and ice accumulations, projected traffic activity, topography, etc., are considered when determining the course of action. Additional factors such as availability of staff, materials, and equipment also bear upon these decisions. A sound plan will account for the different items that must be included in developing the strategy for each storm.

## VALUE OF A WRITTEN PLAN AND OPERATIONS MANUAL

A plan includes the mission, goals, objectives and the strategies, tactics, and resources. For winter operations the mission could be to keep the public streets, roads, and highways safely passable employing the most efficient and environmentally safe use of resources. A related goal would be to provide clear streets and roads within a reasonable time after the end of typical snowfall. An objective connected with that would be to achieve bare pavement on all travel lanes of arterial streets and roads within specified hours after cessation of snowfall in normal conditions.

Any entity that encounters snow and ice should have its plan, even if very rudimentary, documented in a manual. There is no universal template as to size, scope, or style. Such plans may range from a simple resolution assigning responsibility and authority for snow and ice control to a multivolume manual that covers all facets in great detail. Based on informal surveys of attendees at the author's presentations on this subject, the anecdotal conclusion is that many local PW departments either do not have a manual or believe that their existing ones need improvement. Though they have written policies, procedures, and practices, they are usually not compiled into a single-source document. Additionally, many agencies lack a formal, regular, and

frequent review process to ensure that the plan and related documents are kept current. “One of the most important things a political entity can do is to have a reasonable, written snow and ice control policy and adhere to [it]... The policy should also be a ‘living’ document that is reviewed and updated annually”(2). This living document is a comprehensive manual that

1. Explains the legal and statutory reason, responsibility, and authority for winter operations;
2. Compiles all pertinent information into a single accessible format with a uniform format;
3. Eliminates redundant, obsolete, or contradictory documents;
4. Promotes maximum feasible efficiency and effectiveness with available resources;
5. Provides consistency and continuity of operations;
6. States the policies, protocols, and LOS;
7. Communicates goals, service levels, priorities to staff, elected officials, and the public;
8. Establishes a historical documentation of why and when certain decisions were made;
9. Defines what materials are used and application processes;
10. Specifies vehicles and equipment used;
11. Identifies supplemental staffing from other departments or contractors;
12. Details specific roles and responsibilities;
13. Describes formal relationships with other departments, agencies, and jurisdictions;
14. Improves training;
15. Aids in justifying budget requests and expenditures; and
16. Reduces liability exposure.

It is highly recommended that the plan and manual conform to requirements of the National Incident Management System (NIMS) for several reasons:

1. NIMS is a scalable, flexible system for all levels of government to use in all-hazards incidents and planned events. Most are handled at the local level and involve one or multiple agencies in a single jurisdiction. Structuring winter operations on NIMS helps an agency to prepare plans for other emergencies and events.
2. In all situations where the size, scope, and severity of an incident exceed a jurisdiction’s financial capabilities, a firm requirement for reimbursement from the Federal Emergency Management Administration is verification that the agency was NIMS compliant. Some winter storms have been extensive enough to qualify for federal assistance.
3. A winter operations scenario is used, with sample forms, as part of the NIMS 300 (Intermediate Level) course. Though a PW agency may not actually use these forms, they are good templates for planning, organizing, and executing a program.

## **THE PLANNING PROCESS**

Planning involves reviewing what has occurred, how it was handled, what did or did not work well, and envisioning what may happen in the future and what would be the response. Good planning begins soon after the conclusion of the preceding season. It can be difficult to stay

focused on snow removal during spring and summer, especially as other programs and functions take precedence during these seasons. Still, it is important to bear in mind that in only a few months preparations for the next winter begin. Steps to take in planning include the following:

1. Establish time frames, schedules, and due dates;
2. Identify successful practices as well as determine where improvements are needed;
3. List suggestions for further research;
4. Evaluate available resources including personnel, vehicles, contractors, and materials;
5. Assign distinct tasks for follow-through and delegate responsibility;
6. Assess value of each item recommended based on need, priority, and feasibility;
7. Develop, revise, or modify policies, protocols, procedures, and practices;
8. Devise new or change existing LOS to conform with those capabilities;
9. Present draft changes for review to stakeholders for comment and official approvals;
10. Incorporate changes into the overall plan; and
11. Ensure that staff, elected officials, and the public are informed of significant changes.

Because of the vagaries and complexities of winter operations, planning should be continuous. Program managers should be constantly monitoring and assessing the strengths and weaknesses of the existing plan and conduct an after-action review shortly after each episode.

Once the current season has officially ended the planning for the next begins. It is recommended that in addition to a cross-section of employee groups (supervisors, operators, mechanics, dispatchers, and administrative), representatives from other departments or divisions, such as finance and human resources, that support PW be involved. Also, stakeholders such as police, fire, medical providers, public transit, school districts, adjacent jurisdictions, and commercial organizations, may be invited to feedback forums.

## **DEVELOPING A MANUAL**

### **Objectives**

Writing a manual may seem like a very time-consuming task and one that is often deferred because of other issues needing immediate attention. However, it should receive priority due to its value to the agency and focus on achieving the following:

- Comprehensive: includes all essential information,
- Cohesive: organized in a logical sequence,
- Clear: plain language that avoids excessively technical terms,
- Concise: succinct, keeps to the essentials,
- Correct: grammatically and factually accurate, and
- Current: information included is up-to-date.

### **Format and Content**

There is no standard format for winter operations manuals; a large agency might have a voluminous bound document whereas a smaller agency's manual may be only several stapled

pages. Regardless of the presentation style or length, it is recommended that a manual contain the following general categories:

- Policies: the statutes, ordinances, and resolutions that establish the reason, responsibility, and authority for snow and ice control;
- Protocols: prescribes the type of activity for certain conditions;
- Procedures: steps for specific tasks, functions, or activities;
- Processes: systems for communication, documentation, procurement, etc; and
- Positions and people: outlines organizational structure and responsibilities.

It is not necessary to include every relevant document. For example, the ordinances authorizing snow removal can be summarized and cited instead of fully printed in the manual. Another option is to include important documents and other information as attachments; this allows for customizing different versions of the manual for particular groups. For instance, elected officials may only receive an executive summary and the program managers and key staff have the full compendium.

### **Scope of Responsibility and Authority**

The agency must establish what it is legally mandated and cite the statutes, ordinances, and resolutions that assign authority to execute snow removal. Certain powers may be granted, such as for declaring a snow emergency and the enforcement of other related regulations governing on-street parking and use of snow tires and chains.

A municipality may have major highways within its boundaries that are the responsibility of the state or county to maintain or streets that are shared with bordering communities. Agreements between entities to transfer or share snow and ice control must be properly documented and approved. Color-coded maps are quite useful to delineate the jurisdictional responsibilities. Snow control on private streets is often handled by property owners; any exceptions need to be stated. It is also important to explicitly state what the agency is not responsible for. The following is a sample policy statement:

The Public Works Department is responsible for snow and ice control on municipal streets within the city limits. Responsibility for streets and roads that are on the borders with adjacent jurisdictions are determined by mutual agreements.

- The Interstate freeway and state routes within the city limits are maintained by the state Department of Transportation,
- The Tollway is maintained by the Turnpike Authority,
- The County maintains certain designated routes within the city limits,
- The transit stops are the responsibility of the Metro System,
- Roads, paths, and lots in the parks are maintained by the Park District,
- The City does not treat private streets, parking lots or driveways,
- The City is not responsible for snow and ice control on sidewalks except those immediately abutting or within municipal facilities or properties.

## LOS

At the core of an agency's plan is the level of service it intends to provide. There are no standard definitions of LOS for winter maintenance. Some agencies use charts with different brackets or classifications while others use a simple text description. Several agencies, Missouri DOT for one, use photographs of actual road conditions to illustrate as standards to be achieved.

An agency's LOS should be structured on what could reasonably be accomplished for a routine snow event as determined by a number of factors. This should be based on historical winter weather patterns including average snowfall, usual number of storms, normal temperature ranges of each month of the season, typical percentage of sunny days, prevailing wind direction and speeds, etc. Also, local topographical features (mountains, hills, large lakes, or major rivers) that have significant impact on conditions should be considered. Each region of snow country has somewhat unique situations.

LOS may be defined in a number of ways. The most common is to define the level of effort and sequence, priority, and type of treatment for various locations for particular storm types. Another common technique is to define LOS in terms of results by evaluating the surface condition of a particular road at specified times during and after the storms (3).

Also, an agency must assess its resources including personnel (regular and supplemental), vehicles and special equipment, materials, storage locations and capacities, main operational facilities, communications systems, contractor support, and funds for resupply and repair. It is more than an inventory; this should be an evaluation of the availability, capability, and condition of each factor. Thus, each agency should predicate its LOS on the characteristics of its locale and current capabilities. "The primary...operational considerations relating to LOS are cycle time, available material treatments, weather conditions, site conditions and traffic" (4).

A key factor in determining cycle time is lane-miles (LM) per route. Dividing total LM by available trucks (excluding reserve and nonfunctional) gives a quick ratio or current LM average. To illustrate, a city has 15 trucks and 1,000 LM which equates to nearly 67 LM per truck. However, to find out how many trucks would be needed for a specific target or ideal, simply divide the total LM by a desired LM per truck. Using the above example, a city has 1,000 LM and wants a target of 50 LM per truck; this works out to needing 20 trucks. In this scenario the quick ratio indicates a shortfall of five trucks. Options are

1. To acquire more trucks by purchasing, borrowing from other departments, renting, or contracting for trucks and drivers from private firms;
2. To assign trucks from reserve status, if any, into ready line; or
3. To stay with this ratio and adjust LOS.

In the first option, the agency may not be able to afford buying or renting new trucks. Contracting can be expensive plus there are additional considerations of finding qualified contractors. Borrowing from others is limited as the vehicles may not be suitable or available.

In the second option, most agencies have only a small reserve fleet, if any. They are usually older vehicles that require higher maintenance or do not have full capabilities. Regardless, reassigning from reserve to ready line depletes the number available as substitutes during snow operations.

The third option, adjust LOS, is the least costly but also the least effective. LM per truck equates to cycle time, the interval needed by each truck to complete one pass over its assigned

route. Trucks that are in plow mode are limited as to speed, especially in denser urban areas, to minimize cast or the distance and velocity of snow plowed to the side. The ideal speed for urban areas is 15 to 20 mph. The same principle applies when spreading material; the higher the speed the wider the dispersal pattern and lesser density, particularly with dry granular material. Thus, increasing LM per truck cannot be easily offset by increasing the speed of the trucks.

As a general rule, the longer the route cycle time the greater the interval when the truck passes a certain point. This becomes a critical matter on streets and roads with high traffic volumes. The fundamental purpose of plowing and material application is to achieve and maintain surface friction. The longer the cycle time the more difficult it is to sustain surface friction. The result is slower traffic and increased accidents. Agencies must carefully evaluate the consequences of fleet size and composition in establishing reasonable and feasible LOS.

LOS can also be described in broader terms.

- The best LOS is reached when the major thoroughfare streets are down to bare pavement clear of snow and ice from curb to curb. Reaching that objective takes time which is affected by the variables of meteorological conditions, traffic activity and type, and amount of materials applied. The width of certain streets and number of turn lanes also are factors.
- The minimum LOS for thoroughfares is to clear the through lanes and left-turn lanes at intersections and median breaks down to a packed snow cover. Exclusive right-turn lanes and joint center turn lanes may be left unplowed during main operations.
- For residential and other low-volume streets and cul-de-sacs the acceptable LOS is to provide a navigable surface; the street may still have snow or packed ice on it but plowing and material application allow a vehicle to travel the street safely on at least one center lane.

### **Priority Classification of the Street and Roadway System**

LOS is also directly tied to the priority ranking of streets, roads, and highways. Typically this is based on the classification by traffic volumes. In urban areas the classifications are commonly termed major and minor arterials, collectors, residential, and other lightly used streets. Obviously, a multilane expressway with high daily traffic counts should get more attention than a dead-end street. County and state agencies use similar ranking systems.

Other factors in determining priority rankings are the location of important community facilities such as hospitals, schools, transit stations and routes, fire and police stations, major industrial, commercial, or transportation hubs and terminals, and large convention and entertainment venues. Though most would likely be on or near arterials, their presence nonetheless should be noted as that may help determine size and configuration of routes. Major revisions should be discussed with affected stakeholders before adoption; as an example, lessening the priority rank of a minor arterial that serves only a vacant industrial area. Aside from the businesses, police, fire, and public transit should be consulted. In certain situations, political influences may override facts. For instance, an old neighborhood may have gotten preferential treatment in the past because of a prominent official; lowering the LOS could incite strong opposition. Program managers should present their recommendations in objective, neutral terms but anticipate that subjectivity may prevail.

As mentioned, LOS will vary according to the priority classification. Basic cost-benefit analysis will indicate that the greater good is achieved by using identical resources on a major arterial versus a residential street. A truck plowing and spreading material on 1 LM of arterial with

600 vehicles per hour is more efficacious than the same truck on 1 LM of a less-traveled residential street. Because of the higher traffic volume and speeds on an arterial, it is more justifiable to set an LOS of bare pavement at all times. However, the residential street may need plowing only after the snow has accumulated over 3 in. Therefore, the arterial requires a much shorter cycle time than the residential street.

There are several ways by which highway agencies characterize the LOS they provide; level of effort category includes assigning more people and equipment to higher priority routes, providing more or less effort during certain time frames and varying the number of people and equipment providing treatment on relationship to the predicted severity of the event. The priority of treatment includes giving first or more frequent treatment to higher traffic routes, high accident or problem locations. Some highway agencies provide treatment on a priority basis whereby the next lower category of highway is not treated until higher category roads are in satisfactory condition (5).

It is important that the LOS and the priority classifications of streets and roads be based on objective criteria and clearly stated. A general explanation, such as the following, is advisable.

Snow and ice control measures are directed to achieving and maintaining relatively safe traffic movement on public streets within a reasonable time period by following the above priority ranking of streets. Therefore, efforts are first concentrated on the main thoroughfares and collectors that carry most of the traffic before residential and other low-volume streets and cul-de-sacs are handled.

Special attention will be given whenever practicable to grades, curves, bridges, or other locations known to be more difficult or hazardous to negotiate by vehicle. Streets that provide access for certain institutional, academic, cultural and social, or commercial areas may also receive additional treatment as time, traffic, and conditions warrant.

### **Resource Allocation and Management**

As noted, there is a strong correlation between roadway system priority classifications and LOS. These two elements of the overall plan also have a direct bearing on resource allocation; the distribution of various assets for maximum efficiency and utility. For example, an arterial road with the highest priority LOS for bare pavement will require anti-icing measures prior to the storm, short cycle times of plowing and reapplication of materials (if needed) during the storm, and push-back of piled snow along the curblines, shoulders, and bridges afterwards. Basic resources needed include best trucks, most proficient operators, and ample materials. In this scenario, if there is a shortage of operable trucks, materials, repair parts, or even overtime for operators, the priority would be given to the routes with the highest LOS. This is a logical, rational approach, but program managers need to carefully balance the allocation of resources so that all areas receive a fair share even at a reduced level, except in extreme situations.

### **Material Selection and Application**

The most commonly used material for snow and ice control is rock salt. It is readily available, inexpensive, and easily stored, handled, and dispersed. Salt can be used in its natural solid form or diluted in water to form brine. However, it loses usefulness at lower temperatures. Calcium chloride is effective at a very low-temperature range and is often mixed with salt or applied



directly to pavement. Both salt and calcium chloride are corrosive and their use has raised environmental concerns.

Newer products include magnesium chloride, potassium acetate, and organics such as beet juice and corn byproducts. Each has benefits and limitations. For example, one product works well at low temperatures but makes pavements slippery near the freezing mark. Cost per LM is another consideration as these products tend to be more expensive than salt or calcium chloride.

Abrasives, like sand, do not melt snow or ice but can temporarily improve surface friction. Use of sand should be restricted due to the costs of eventual cleanup on streets and in storm sewers, air pollution from released fine particulates, and safety concerns (loose sand on bare pavement).

There is extensive information on the various materials and much research is still underway. It is beyond the scope of this paper to thoroughly describe the various products and their characteristics. Each agency needs to determine what will constitute its material arsenal and review annually. However, the materials selected will have an impact on accomplishing LOS. As part of the overall manual, detailed material storage, handling, and usage plans are needed.

## **Vehicles and Equipment**

No plan will work without sufficient vehicles and equipment. As discussed earlier, the ratio of operable trucks to LMs is a prime determinant of LOS. A snow fleet may consist of the following:

1. Full-duty trucks (single or multiple axle) equipped with front and wing plows and spreader bodies. One-ton trucks can also be so equipped. Some agencies in hard winter areas use undermount plows to scrape packed snow or ice. The dump bodies of the trucks either have a drop-in V box or a conveyor built into the bottom of the bed for moving material to a removable spinner. These trucks are used for other functions besides snow duty.
2. Limited-duty trucks usually can only be equipped with a front plow. New York City Department of Sanitation uses much of its trash truck fleet in this manner. Smaller pickup trucks can also be equipped with plows. It is also possible to equip certain vehicles to apply liquid materials.
3. Supplemental vehicles or equipment for special situations include road graders, front-end loaders with V-plow attachments, backhoes, and skid-steers with buckets for clearing limited areas like bridge decks, parking stalls, or lots, snow cats with various attachments for clearing sidewalk, and snow melters.
4. Material-handling equipment used for storing and loading bulk materials; this includes portable or fixed belt conveyors, front-end loaders, and track loaders.

Each agency's fleet is unique and based on various factors, primarily what is needed for year-round routine operations. Other factors include the organization's size, climate, availability of shared equipment, procurement policies, and budgets. Just as important as the number and type of vehicles is their condition. A full-service truck with an inoperable spreader is no more useful than a limited-duty truck. A strong winter operations plan can be advantageous in justifying funding for acquisition, maintenance, and upgrading to achieve maximum reliability and versatility of a snow fleet.

## Personnel

Staffing is another critical component of the winter operations plan. In the past several years, many positions have been eliminated in state and local governments, especially in the maintenance workforces, due to the severe recession. These reductions are likely to be permanent and more positions may be eliminated as the post-World War II baby boomer generation retires. Younger workers in maintenance operations are expected to leave for better jobs in the private sector when the national economy improves. It is becoming more difficult to attract and retain good employees.

With these changes comes a substantial loss of experience and institutional knowledge thus emphasizing the need for a comprehensive winter operations plan and manual. The training program should be a core part of this. There is increased awareness by snow program managers that training needs to be a recurring event and include veteran as well as new operators. Auxiliary help (from other departments or agencies, seasonal workers, and contractors) need this training as well. The curricula can be adjusted so that experienced employees receive only a refresher. All field staff should be informed of revisions to LOS, route changes, updates of material selection and application, new equipment, and a reminder of important policies, procedures, and rules.

Winter operations are, obviously, a deviation from normal work schedules and assignments. The unpredictability and fluidity of each situation may complicate the application of routine rules and policies, especially when it comes to pay. Covering these issues in advance can preclude unnecessary administrative problems later. At a minimum, the manual should

- Detail the number and type of billets, or positions, and respective duties;
  - List each individual involved and assignment by billet, shift, location, and vehicle;
  - Describe the procedure for informing employees on and off duty of pending activity;
  - State employee responsibility to report for work in adverse conditions and also the maximum allowed hours of continuous duty;
  - Summarize applicable regulations regarding operator's licenses and permits;
  - Describe how and when employees can be excused from duty (approved leave);
  - Specify the proper personal clothing and equipment required for each billet;
  - Reference the main organization's policies and rules regarding calculation for overtime, shift differential, holiday pay, compensatory and flex time, and what constitutes stand-by, call-in pay, and out-of-class pay (if allowed);
  - Explain applicable rules regarding meal and rest breaks;
  - Describe emergency transportation and lodging for employees in extreme situations;
- and
- Include any other topic that program managers regard as pertinent.

Note that the information must conform to the official rules, regulations, and policies of the organization, including agreements with a recognized union, and state and federal laws unless specifically exempted. If the agency has informally adopted practices that do not violate these then they should be mentioned in the manual but with a stipulation that they could be suspended or eliminated at any time.

## Route Design and Optimization

Configuration of routes is directly related to LOS. In simplest terms, the less LM for a plow truck, the less time to complete one circuit or cycle along the assigned route. The less time for each circuit then the more efficient the snow-removal operation. Many variables affect how a route is designed:

- Number of trucks and other equipment, both agency and contract-operated;
- Total LM that the agency is responsible for;
- Priority classifications of the system;
- Topography;
- Traffic volumes by time of day or day of week;
- Connection to or proximity of important employment, education, medical, transportation, and commercial nodes; and
- Distance from agency material stockpiles and fuel sources.

Other factors may be specific to a certain locale and politics. Nonetheless, routes should be based upon providing service according to well-defined, measurable, and rational criteria.

Route optimization refers to enhancing the efficiency of a plow truck by plotting a travel pattern that eliminates as much as reasonably possible dead-heading, doubling-over, and unnecessary turn arounds and delays caused by running in heavy traffic if it can be avoided. For example, it is fairly easy to plan a route for a truck that works only on an expressway: go down this lane from Point A to Point B, turn around and back to Point A. It's far more difficult in an urban area with varying street classifications (priorities), one-way streets, dead ends, and cul-de-sacs, winding and short-segment streets, T-intersections, etc. Furthermore, when dealing with residential streets, every resident wants his block plowed first.

Snow routes have traditionally been determined by calculating how far a plow truck could go spreading material at a certain rate before it ran empty. Natural (topographic) features and political (jurisdictional) boundaries also influence the shape of some routes as does the classification and pattern of streets. A typical approach is to select tentative start and end points for highways or major urban thoroughfares, calculate travel mileage and then do a dry run to determine average cycle time under various situations. Then adjustments are made for extra lanes, ramps, wide intersections, etc.

For neighborhood or residential routes, the boundaries of the area are identified and then a particular sequence or travel pattern covering all the streets within that area is devised. Several dry runs are conducted to determine what seems to be the best way to run the route. It is not uncommon that during snowstorms the assigned operator will deviate from the prescribed pattern and use his or her own judgment as to how to run the route.

Global positioning and AVL systems can provide agencies with data useful for route optimization. However, such systems are still expensive for many agencies to acquire. Meanwhile, it is a good idea to review each route annually for needed changes. Surveying each route operator for suggestions at the end of a season is recommended. Adding new LM through road widening or new construction, closure road segments, changes in the street classifications and traffic control, increased development or decrease of housing, commercial, industrial, or educational institutions along a route, etc., can substantially affect route configuration. At the very least, a windshield tour of each route can reveal possible opportunities for change.

## Operations

The operations portion of the plan details the strategies, tactics, and methods for attacking a storm. Operations topics include

- Determination of when to commence prestorm activities;
- Notification to staff to report;
- Communications between field and dispatch;
- Initial strategies (pre-treatment, and application rates at beginning of storm);
- Decisions as to when plowing begins;
- Plowing and spreading patterns and techniques;
- Midstorm changes and special situations;
- Post-storm completion and spot complaints; and
- Safety practices and incident investigations.

Monitoring developing winter storms is an important duty of the program managers and the manual should indicate the sources of weather information upon which they rely. As with materials and equipment, there is a large body of knowledge—theoretical and practical—on operations available through numerous sources.

## Communications and Public Relations

Another important component of the plan is communications. This describes what, how, and by whom information is produced, conveyed, and documented. The manual itself should provide much of the information needed regarding policies, procedures, protocols, and practices in one readily accessible source.

The internal communication system includes wired and wireless phones, pagers, two-way radio, fax, e-mail, text, electronic data, and printed and written messages, reports, and memoranda. The manual should contain a listing of phone numbers (office, cell, and home) and pager numbers, if applicable, for all key employees and support staff. Lists of the home addresses, personal e-mail addresses, and emergency contacts for staff involved in snow operations should be restricted and not openly disseminated.

Other listings include work key contact names, titles, e-mail addresses, fax numbers, and mailing addresses for other entities that should receive specific information about the winter operations, for example police, fire, school districts, mass transit, and other departments that assist with or support the operations.

List the two-way radio frequencies or channels and individual call numbers that will be used and to whom they are specifically assigned. A brief instruction on radio protocol is advisable. Note the phone numbers published for the public to use for questions or complaints (or compliments). Also indicate if the agency has a website or e-mail address that allows citizens to post concerns or requests. Specify who (by position) is responsible for answering phones and monitoring incoming electronic messages and the process for handling responses. Identify where the dispatch activity will be located; most agencies use the maintenance facilities but in some jurisdictions dispatch may be handled in an emergency operations center or traffic management center.

The public relations piece includes preseason activities such as community outreach to keep the citizens informed about the snow program. Methods include open-house activities at the maintenance facilities, equipment displays at events such as fairs and neighborhood gatherings, mailing or distributing brochures, notices in community publications, news releases, announcements on television and radio, etc. As an agency prepares to activate for a coming storm it is vital to use the media to remind the public of the LOS, the priority ranking of roads and streets and designated emergency snow routes, required tires or chains, parking restrictions, and tips for driving on snow or ice.

The local media are always looking for news and are keenly interested in snow and ice operations. For consistency of message, the agency should designate a spokesperson to handle media interviews and inquiries or be the contact person if the spokesperson will be someone outside of PW. It is also a good idea that all staff are informed on how to deal with the media and to whom they should refer reporters to for details. Throughout the storm, periodic updates help manage the flow of information. The messages should be succinct and factual. At the conclusion of the storm there should be a statement as to when the main snow removal operations will cease and what will be the provisions for final clean up and handling reports of trouble spots. Finally, at the end of the season, issue a statistical summary of what occurred over the winter including number of storms, total amount of snow, how much material was used, number of hours worked, LM covered, and other relevant facts.

## **Risk Management**

Having a cogent winter operations plan and manual is a good defense against claims and litigation, as long as an agency adheres to what is stated. The manual is a legal document and public record; therefore, it should be reviewed by an organization's attorney or law department before official adoption. A major pitfall to avoid is describing LOS that the agency does not have (or anticipates not having) sufficient resources to deliver.

The most important policy issue pertaining to the application of snow and ice control treatments is the LOS. Policy makers have to balance cost, environmental impact, the safety of the highway users, and the safety of the people performing snow and ice control operations. If that policy is reasonable, and the agency follows that policy to the extent possible, there will be very little successful litigation (6).

Disclaimers that specifically state what the agency is not responsible for (private streets, sidewalks, bus stops, plowed snow pushed onto driveway approaches, for example) are recommended. Also, limitations imposed by extraordinary situations should be mentioned. For instance, extreme temperatures and heavy snow will severely hinder even the best prepared agency's ability to meet standard LOS.

Accurate and complete records of vehicle and equipment maintenance, material specifications and storage, plowing and treatment start and finish times, weather forecasts and periodic conditions, accidents, and reports of problems and responses are vital.

Operator training reduces liability exposure as well but the agency must be able to prove that the operators were properly trained and qualified. Also, if operators are required to have certain licenses or permits the agency must have verification that these are current.

Conduct preseason and midseason inspection of each route to identify deficiencies and hazards such as fixtures and vegetation protruding into the roadway, pavement defects, clogged storm-water inlets or ditches, traffic calming devices, and abandoned vehicles. These potential

problems should be recorded and corrective action taken. Disclaimers that explicitly state that the agency is not responsible for damage to private property in the right-of-way (for example, portable basketball goals or nonpermitted landscaping) are advisable.

### Other Elements

Due to limitations on length, this paper cannot cover all the information that could possibly be part of a winter operations manual. It is advisable to include material specification sheets, charts of application rates for different conditions, vehicle and equipment checklists, cold weather medical hazards and precautions, lists of all mobile equipment, contractors, and all-hour contact information for critical service, commodity, and supply vendors. Much of this can be as appendices or attachments.

It is recommended that the manual have a cover page, a table of contents, index, glossary of terms, a preface explaining the purpose, a distribution list by name, agency, or position, and a list of the principal staff and officials involved with conduct of the program.

### Body of Knowledge

A literature search discovered considerable information on the technical and scientific aspects of winter operations but relatively few references from the legal, administrative, and managerial perspective. A foremost expert on all aspects of snow and ice control operations is Duane “Dewey” Amsler, formerly New York State DOT’s principal snow and ice control planner, who has conducted many classes and courses, made numerous presentations and authored articles. In addition to the cited references, the following publications from various sources are recommended for those wanting to develop or refine snow and ice control plans:

- Amsler, D. *Snow and Ice Control*. CLRP No. 06-7. Cornell Local Roads Program, August 2006.
- Amsler, D. *Basic Concepts of Snow and Ice Control*. Presented at American Public Works Association North American Snow Conference, April 2005.
- Amsler, D. Legal Issues and Risk Management Associated with Municipal Snow and Ice Control Operations. *Salt and Highway De-Icing*, Vol. 44, No. 4, 2007.
- Amsler, D. Levels of Service. *Salt and Highway De-Icing*, Vol. 45, No. 1, 2008.
- Amsler, D. Written Snow and Ice Control Plan and Policy Documents Absolutely Essential for Winter Maintenance Agencies. *Salt and Highway De-icing*, Part I, Vol. 43, No. 3, 2006; Part II, Vol. 43, No. 4, 2006; Part III, Vol. 44, No. 1, 2007.
- *Crafting a Written Snow and Ice Plan*. American Public Works Association, Oct. 18, 2007.
- *Developing an Effective Snow and Ice Program*. American Public Works Association.
- Bergner, D. Keys to Preparing a Winter Operations Manual. APWA Reporter, October 2007.
- Bergner, D. Optimizing Snow Routes: Factors to Consider. APWA Reporter, October 2009.
- *NCHRP Synthesis 344: Winter Highway Operations*, Transportation Research Board, of the National Academies, Washington, D.C., 2005.
- Florquist, B. *Urban Snow and Ice Control*. American Public Works Association, 2005.

- Fay, L., D. Veneziano, Z. Ye, D. Williams, and X. Shi. Costs and Benefits of Tools to Maintain Winter Roads. In *Transportation Research Record: Journal of the Transportation Research Board*, No. 2169, Transportation Research Board of the National Academies, 2010, pp. 174–186.
- Category: 133 Snow and Ice Control. *Missouri Department of Transportation Engineering Policy Guide*, 2011.
- Chapter 2: Clear Roads. *Minnesota Department Transportation Maintenance Manual*, 2005.
- Statewide Snow and Ice Plan, 2010–11. Washington State Department of Transportation.
- Highway Maintenance Guidelines, Snow and Ice Control. New York State Department of Transportation, 2006.

## CONCLUSION

Nearly all PW agencies have some form of plan for snow and ice control; however, many of these same agencies have not updated plans or consolidated the documents into a single cohesive document. A comprehensive and current manual is essential for ensuring efficiency and effectiveness of winter maintenance operations. As new concepts, methods, and technologies relevant to snow and ice control are introduced, PW agencies must have a framework that is adaptable to assess and adopt these advancements. The forthcoming wave of retirements coupled with recent workforce reductions will result in smaller, inexperienced, and less knowledgeable staffs. Written policies and manuals provide consistency and continuity of operations and promote better communication with the public and officials. Good plans and manuals mitigate liability exposure by clearly stating scope of responsibility and authority, disclaimers and exceptions, reasonable LOS, rational priorities, weather and topographic factors, material selection and application decisions, workforce composition and training, and equipment capabilities. Though much information is available on the technical aspects of snow and ice control, more guidance on the legal, political, and administrative perspectives is needed.

## REFERENCES

1. *Guide for Snow and Ice Control*. American Association of State Highway and Transportation Officials, Washington, D.C., 1999, p. 3.
2. *Guide for Snow and Ice Control*. American Association of State Highway and Transportation Officials, Washington, D.C., 1999, p. 15.
3. *Guide for Snow and Ice Control*. American Association of State Highway and Transportation Officials, Washington, D.C., 1999, p. 16.
4. Blackburn, R., K. Bauer, D. Amsler, S. E. Boselly, and A. D. McElroy. *NCHRP Report 526: Snow and Ice Control: Guidelines for Materials and Method*. Transportation Research Board of the National Academies, Washington, D.C., 2004, p. 4.
5. *NCHRP Report 526: Snow and Ice Control: Guidelines for Materials and Method*. Transportation Research Board of the National Academies, Washington, D.C., 2004, p. 3.
6. *Guide for Snow and Ice Control*. American Association of State Highway and Transportation Officials, Washington, D.C., 1999, p.16.

# Data Networks and Quality





## DATA NETWORKS AND QUALITY

**New Methods to Quality Check Road and Weather Observations for Vehicle Data****DANIEL KOLLER****BENJAMIN W. HERSHEY****JOHN J. MEWES****ANTHONY K. MCCLELLAN***Meridian Environmental Technology, Inc.*

The FHWA's Connected Vehicle (formerly IntelliDrive) research project initiative for mobile data collection from consumer automobiles requires knowledge and trust in the quality of data coming from these vehicles. Connected Vehicle is designed to create a fully connected transportation system to provide road and weather data collection from an extensive array of vehicles. While the implementation of Connected Vehicle is in the future, some of the elements and technologies are already in place today. Since 1996, automobiles sold in the United States are required to be equipped with an Onboard Diagnostic Version 2 (OBDII) port that streams live data from sensors located onboard the vehicle. While these sensors were designed for vehicle diagnostics, some of the data can be used to determine weather characteristics around the vehicle. The OBDII data can be collected by a smartphone and sent to a server in real-time to be processed, thus providing a test bed for research into potential applications of mobile data. Some initial studies raise the question about the quality and biases from the OBDII data. Over time, effective operational techniques for stationary atmospheric sensor data have been developed; yet, no techniques exist for operational quality control of surface mobile data. Current methods of road weather data reporting have been limited to static in situ sensor stations. These road weather information systems (RWIS) provide varied data about precipitation, winds, temperature, road conditions, and more, but their siting does not always provide an accurate representation of weather and road conditions along the roadway. The use of mobile data collection from vehicles travelling the highway corridors may therefore assist in the locations where RWIS sitings are sparse or nonexistent.

**OBJECTIVE**

The work performed included an in-depth analysis of the current quality checking methods used for road and weather observations collected using stationary environmental sensor stations and development of quality checks for observations collected using mobile platforms. In developing a new quality check system for mobile road and weather observations, new and modified quality checks including gap-analysis quality checks were used to compare against preexisting methods. Gap-analysis quality checks use nearby observations to determine whether the observations of interest were errant. The quality checks developed include modified versions of the *Clarus* system checks along with additional gap-analysis tests, such as the Barnes spatial test. The performance of the new mobile quality checks was analyzed against quality checks using the *Clarus* system.

The impacts of quality checks on these data were evaluated by comparing results with quality-checked observations obtained using stationary environmental sensor stations, which for

this study are considered to provide truth. Stationary environmental sensor stations may not be perfect, but because their performance characteristics are generally known, they do provide a baseline for evaluating the quality of mobile data. This work also used data obtained from six OBDII vehicles.

## BACKGROUND

Mobile data collection has been used in many meteorological applications. Ships and airplanes are and have been two of the most prominent mobile platforms. In the past two decades, automobiles have slowly joined mobile data collection. During VORTEX and VORTEX2, teams of vehicles called Mobile Mesonets were equipped with racks of surface weather instruments on the roofs of vehicles (1). The types of measurements taken from these stations include wind, temperature, relative humidity, and pressure (2). This application of data collection deems useful when the vehicles are primarily stationary and placed in specific locations. Prior to any use in the field, the Mobile Mesonet instruments were checked for being within the factory specifics for tolerance against the Oklahoma Mesonet calibration facilities. In addition to the calibration, the instruments were spot checked twice each day to detect drift. After the field tests, experiment data quality assurance was applied. Flags were applied to known errors such as when a vehicle was accelerating, the wind speed, and wind direction. In addition, suspicious data was determined by using data bounds, standard deviation thresholds, various filters, and instrument time constants. This collection type also is useful in small-scale research since the instrument rack is intrusive to the vehicles primary operation.

The first major emphasis for nonintrusive mobile data collection began in 2005. Vehicle infrastructure integration (VII) took the idea of the automobile and made it connected. The use of technologies like dynamic short-range communication along with sensors already built into the vehicle facilitated the goal of developing an application for the improvement of safety, increased mobility, and efficiency along the roadways. One goal of VII was “for the weather enterprise to utilize the vehicle data to improve weather and road condition products and to provide those products to transportation system decision makers, including travelers” (3). The connectivity of VII was for the vehicle to transmit and collect data from vehicle-to-vehicle and vehicle-to-infrastructure. Information collected from VII would include direct measurements such as exterior temperature, and indirect measurements such as traction control or antilock brake systems for understanding pavement condition. Additional sensors are included in [Table 1](#). The technology barrier and sheer size for the deployment strategy of VII was a lofty goal during a tough economic period in the United States, and for many of the automobile manufacturers. These problems, along with a lack of awareness of the program, led to the demise of VII in 2009.

In 2005–2006, researchers at the National Oceanic and Atmospheric Administration (NOAA) began researching the use of current vehicles on the road. NOAA researchers compared data from the OBDII port along with additional temperature sensors placed in other locations around the vehicle to research the usability of vehicles as mobile meteorological platforms (4). The primary research areas were temperature bias versus vehicle speed, mobile temperature versus in situ observations, importance of sensor placement, thermal characteristics of similar vehicles, and the effects of external phenomena on mobile temperatures. The equipped vehicles included Noblis’ Mobile Wireless Lab, and two 1998 Ford Crown Victorias (one light blue and the other silver). Each vehicle was equipped with additional temperature sensors, GPS,

**TABLE 1 Potential Sensors and Equipment on VII-Fitted Vehicles**

Potential Vehicle-Based Elements	
Hours of operation	Impact sensor
Elevation	Barometric pressure
Accelerometer data	Fog lights
Heading and GPS location	Headlights
Steering wheel rate of change	Antilock braking system
Exterior temperature	Traction control
Windshield wiper rate	Stability control
Rain sensor	Pavement temperature
Sun sensor	Brake boost
Adaptive cruise control radar	Wiper status

NOTE: GPS = global positioning system.

and a data logger. The data were collected during wintertime (December 15, 2005, to March 31, 2006, with 39 runs) and summertime (July 1, 2006, to September 20, 2006, with 33 runs). The data collection strategies were to drive the speed of traffic during morning and evening commutes and midday trips, taking advantage of varied weather conditions. The test results concluded there were significant differences in bias of like vehicles, biases were more distinct in winter, and bias variability is large in the summertime.

During the winter of 2009, scientists at the National Center for Atmospheric Research (NCAR) conducted a study similar to NOAA's study in 2005–2006. They attempted to determine how good the vehicle observations were (5). In this test, they used a Ford Edge and a Jeep 5.7L Hemi. The tests measured air temperature and pressure directly from the OBDII port. From the collected data, there were approximately 270,000 temperature readings and approximately 260,000 pressure readings. The scientists at NCAR then developed quality-checking tests to help verify the data coming from the vehicles. The tests developed included sensor range, climatological range, neighboring vehicle, neighboring surface station, model analysis, and remote observation. The study results concluded that the temperature observations are better than the pressure observations, quality check failures were related to many underlying factors, and vehicle type and weather conditions seem to influence vehicle observation quality. Some of the underlying factors, among additional errors, include null values and persistence errors where the vehicle's sensor was stuck at 10°C.

## QUALITY-CHECK ALGORITHM DESIGN

The quality-checking algorithm development included the design of various progressive tests used to assess data quality. These tests take many of the qualities from the *Clarus* system quality checks but are modified to account for a moving observation. For the purpose of testing a quality-checking algorithm, each of these tests has been configured to work for air temperature and pavement temperature sensors that are equipped on many of the mobile environmental sensor station (ESS) platforms. Each of these tests is described below.

The order of the quality checks ([Figure 1](#)) begins with the speed check and then continues to the gross check. If either of the speed or gross checks fails, the secondary tests

are not run. The secondary tests include the vehicle-to-vehicle test, persistence test, and Interquartile Range (IQR) test. If the IQR test fails or produces an error, then the Barnes spatial test for RWIS will run. Otherwise the Barnes Spatial test for RWIS will not run. These tests are described in more detail below.

## Primary Tests

### *Speed Check*

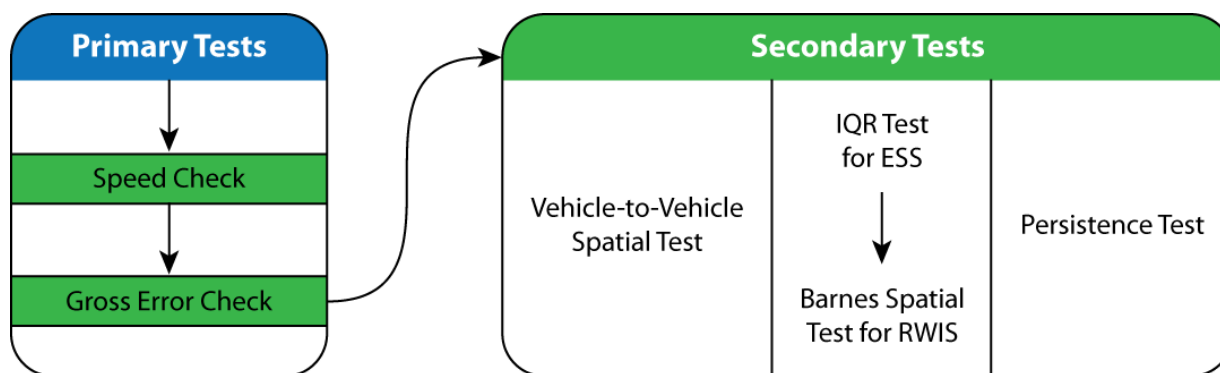
Speed check tests are applied to determine if the vehicle is moving. This test uses the OBDII reported speed since OBDII speed displays the speed of the vehicle.

The speed check is not as much a quality test as it is a threshold test to determine whether to run subsequent tests. If the speed of the vehicle falls within the defined threshold of 5 and 90 mph, the test passes and the observations are allowed to pass into the next tests. If this test fails, the next tests are not run and the quality checks for this set of observations are flagged with an error code. This threshold test is used to help account when the vehicles are idling at a stop, more commonly exiting a garage, or idling while the vehicle is warming up before departure. The use of this threshold test is to help mitigate the impact in the data from temperature readings influenced by the radiant heat from the engine or by the heated garages.

### *Gross Error Check*

Gross error checks are performed to determine whether temperature observations for air or pavement temperature fall within a predefined range for the onboard instrument. This test reports an error if no value is reported from the observation from the vehicle. If this test fails or reports an error, the subsequent tests are not run and the observation is flagged with an error code.

Each time this test is run, it is given a single observation from a sensor. If the sensor reading is not available, the test returns an error condition that the test failed to run. The sensor provides the sensor range in the form of a maximum and a minimum value. If the observation is greater than, equal to the minimum value or less than, or equal to the maximum value, the test passes.



**FIGURE 1** Quality-check algorithm flowchart.

### *Minimum Value $\leq$ Observation $\leq$ Maximum Value*

If the target observation is less than the minimum value, or greater than the maximum value, then the test does not pass. For air temperature, this test is set to use minimum air temperature of  $-60^{\circ}\text{F}$  and a maximum air temperature of  $150^{\circ}\text{F}$ .

## **Secondary Tests**

### *Persistence Test*

The persistence test is used to detect if any of the observation types become “stuck” or remains constant for a specific period. For example, if the vehicle’s intake sensor remains unchanged to the precision of the instrument ( $1^{\circ}\text{C}$ ) for 5 min as the vehicle is moving, the current sensor reading does not pass. Each time the test is run, it is given a single observation from a sensor. Based on the type of observations, the test then determines the persistence range for the sensor. Consecutive identical observations readings from the same sensor result in a preliminary flag or error. If one or more of the consecutive sensor observations changes, the current sensor reading passes the persistence test. If the observations remain identical through the persistence range for the sensor, the test will be flagged as a failure.

### *IQR Test for RWIS*

The IQR spatial test checks whether a sensor reading is consistent with the neighboring observed sensor readings. The test checks if the target observation differs by more than a threshold amount from other neighboring sensor observations in a target area.

The target sensor observation does not pass the IQR test if the absolute value between the median of the neighboring readings and the target observation is greater than the higher value from either an adjusted IQR or the minimum tolerance bound defined for each observation type. The minimum tolerance bound is a fixed value to each type of observation that bounds a minimum acceptable spread between the target observation and the estimate. To account for sufficient spatial variation from neighboring sensors, adjustable tolerance bounds are used for different observation types. The values for the minimum tolerance bound are initially defined by the values set by the *Clarus* quality checks, which are air temperature of  $3.5^{\circ}\text{C}$ .

For the IQR test to be effective there needs to be at least five or more RWIS neighbors within the target area. These sensors must be within a radius of influence of 69 mi and have readings within the previous hour. The reason for a radius of influence of 69 mi is to help account for areas where observations are widely spaced or where observations are sparse. This is an empirically set value and can be adjusted for areas where dense observations exist. For the tests conducted in this report, 69 mi was used in conjunction with the *Clarus* quality checks. The test will not run if these criteria are not met. If the IQR test passes, the sequent Barnes spatial test for RWIS is not run. If the IQR test fails or produces an error, the Barnes spatial test for RWIS will run (Figure 1).

### *Barnes Spatial Test for RWIS*

A spatial test, using a distance dependent weighting scheme used in mesoscale analysis (6), provides a geographical comparison based on tolerance bounds within a region. The Barnes

spatial test uses neighboring sensor readings and weights them based on their distance from the target sensor. The weights from the neighboring sensors drop exponentially as the distance from the target sensor increases. This test only takes neighboring stations that fall within a set distance set by a configurable parameter (7).

Each time this test is run, it is given a single mobile observation. This observation includes the location along with the vehicle identifier and time. If the sensor observation or the location is missing, the test will return an error and the test will not run. If the information is available, then a query of observations for spatial analysis is completed to determine how many observations of the same type are available. If there are less than two observations of the same type, the test returns an error result indicating it was unable to complete the test.

The target observation fails the Barnes spatial test if the target observation is outside of the range defined by the number of standard deviations from the weighted mean of the neighboring observations. The configurations for the test are set with a radius of influence of 69 mi from the target location and one standard deviation.

### *Vehicle-to-Vehicle Spatial Test*

The vehicle-to-vehicle spatial test uses a comparison of surrounding vehicles observations to compare against those of the target vehicle. This test uses a technique similar to the Barnes spatial test for RWIS. The vehicle-to-vehicle test uses neighboring mobile ESS around the target vehicle and weights their observations, from the past hour, based on their distance from the target observation. The weight of the observation from the neighboring mobile ESS drops exponentially as the distance from the target sensor increases. This test only takes observations from neighboring mobile ESS falling within a defined radius of influence set in the configuration parameter.

Each time the test is run, it is given an observation. This observation includes the location along with the vehicle identifier and time. If the sensor observation or the location is missing, the test will return an error and the test will not run. If the information is available, then a query of observation for spatial analysis is conducted to determine how many mobile ESS observations of the same type are available from the past hour. If there are less than two observation of the same type, the test returns an error result that it was unable to complete the test.

The target observation fails the vehicle-to-vehicle test if the target observation is outside of the range defined by the number of standard deviations from the weighted mean of the neighboring mobile ESS. The configurations for the test are set with a radius of influence of 69 mi from the target location and one standard deviation.

## **DATA-ALGORITHM TESTING METHODOLOGY**

When processing the quality checks for vehicles, certain data sources need to be acquired to complete the tests. These include the *Clarus* data used for the IQR and Barnes spatial test for RWIS. A test of the algorithm used cases from December 9–12, 2010, February 8–11, 2011, March 22–23, and April 15–16, 2011, to validate the algorithm methodology. In the algorithm test, the air is gathered from all the available ESS within the *Clarus* system for the test date.

In addition to the *Clarus* system data, vehicle data from the six participating drivers were provided in a document of comma-separated variables. To keep the data anonymous, the vehicle

data was processed with the session ID tag each time the vehicle turned on the OBDII tool, Torque Pro. Torque Pro is a vehicle–car performance–diagnostic Android-based smartphone–tablet application tool that communicates with the engine control unit through a Bluetooth OBDII adapter. The consumer vehicle data was collected using a PLX Kiwi OBDII Bluetooth adapter connected to the OBDII port located within the cabin of the vehicle. The application allows for data collection and transmission in near real-time to a server.

For each of the events, observations were recorded at 1-s intervals on the OBDII-equipped vehicles ranging in age from 1996 to 2010. The data transmitted includes location, time, and OBDII observations. The observations that are currently accessible across most vehicles include but are not limited to vehicle speed, intake air temperature, and ambient air temperature. The observations data are run through the quality-check algorithm. This paper focuses on the air temperature sensors onboard the consumer vehicles.

Tests were run on a session-by-session basis. After one session was completed, the next session began. [Figure 2](#) shows the area of interest in the algorithm testing for Eastern North Dakota along the I-29 and Grand Forks area. As the algorithm processed each vehicle’s session data, it produced an output file for the individual session, which scored each observation based on whether it passed, failed, generated an error, or was not run.



**FIGURE 2** Area of interest for data collection in eastern North Dakota along the I-29 and Grand Forks area.



### OBDII VEHICLE RESULTS

Many of the sessions only lasted 5 to 15 min, so the results for the individual observations and scores are depicted in the graphs. On average, a single session with 500 to 1,000 observation points during the period of the event requires 30 to 60 min to run through the quality-check algorithm. The algorithm was executed on a quad-core 3-GHz processor computer without threading enabled with 4 GB of available RAM. The analysis period of February 8–11, 2011, had arctic temperatures impacting Minnesota and North Dakota. For the sake of clarity, the results presented below have been filtered to show only data that passed the primary speed and gross error checks.

The travel pattern (Figure 3) for the drivers on the morning of February 10, 2011, was created from the data received from the OBDII-equipped vehicles. The area receiving the most traffic was along 42nd Street, circled in red on the map in Figure 3. The numbers represent the intake temperatures recorded by the vehicle at the specific coordinate.

Figure 4 is an example of a vehicle starting in a heated garage then driving out into the environment. Below are the quality-check scores and temperature profile for session 1297346818227. The data received from the vehicle when it was moving was continuous, and resulted in the gross check and persistence test for the air intake to pass at 100%. The persistence

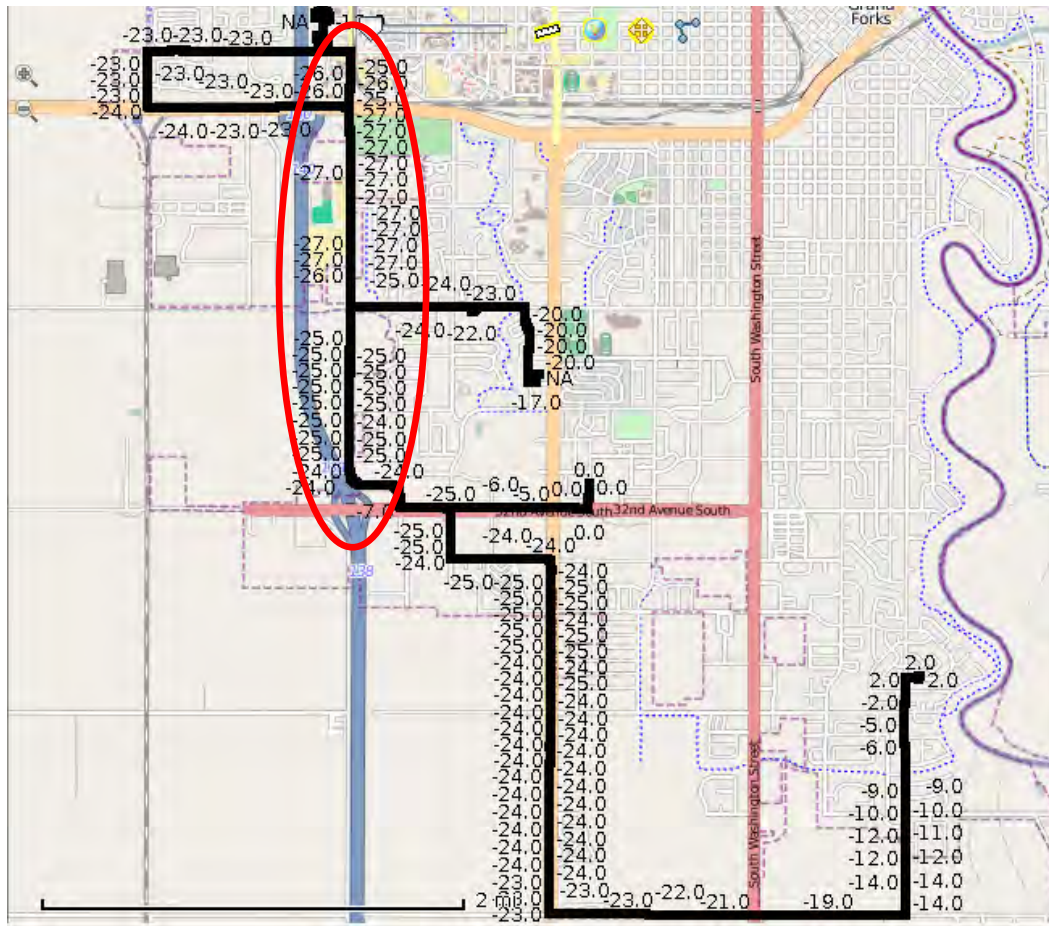
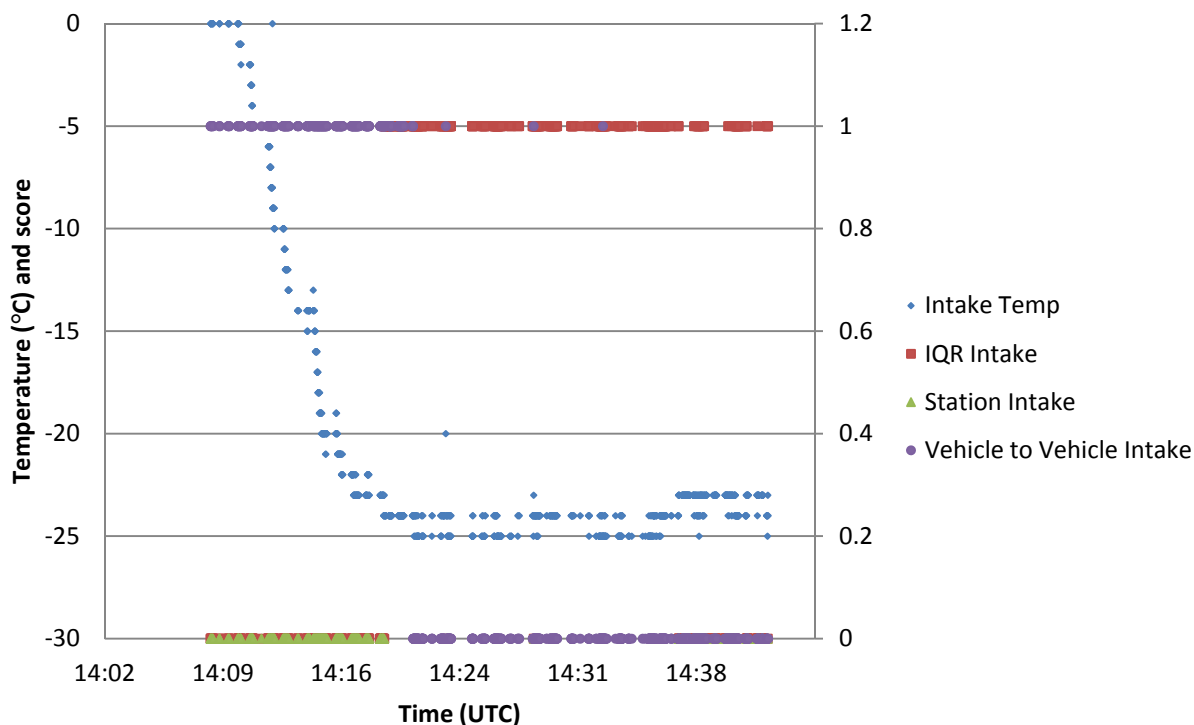


FIGURE 3 Travel pattern for drivers during the morning of February 10, 2011.

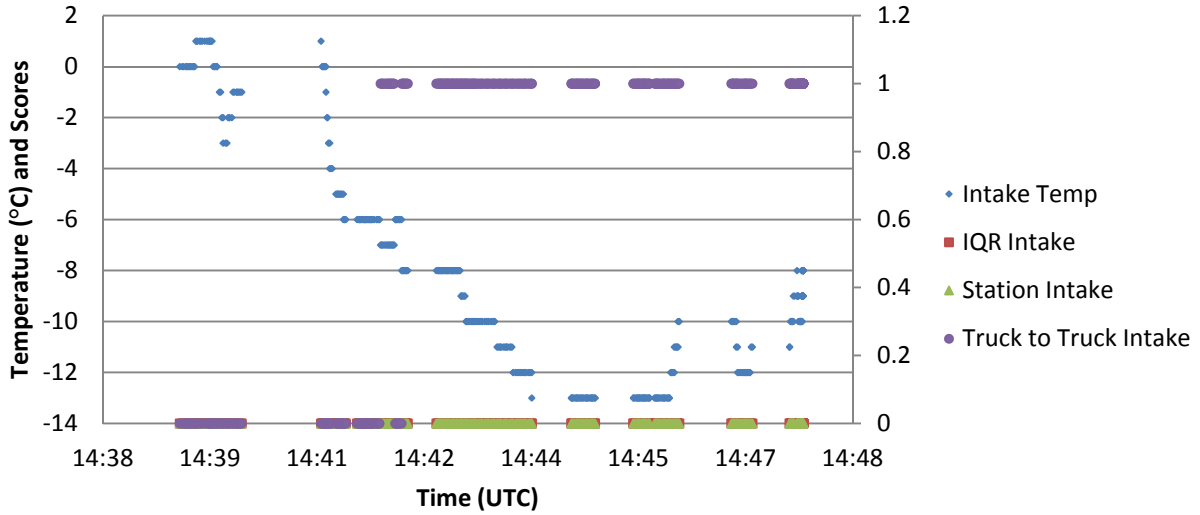


**FIGURE 4 Overview of results from session 1297346818227, including tests for IQR, Barnes, and vehicle-to-vehicle.**

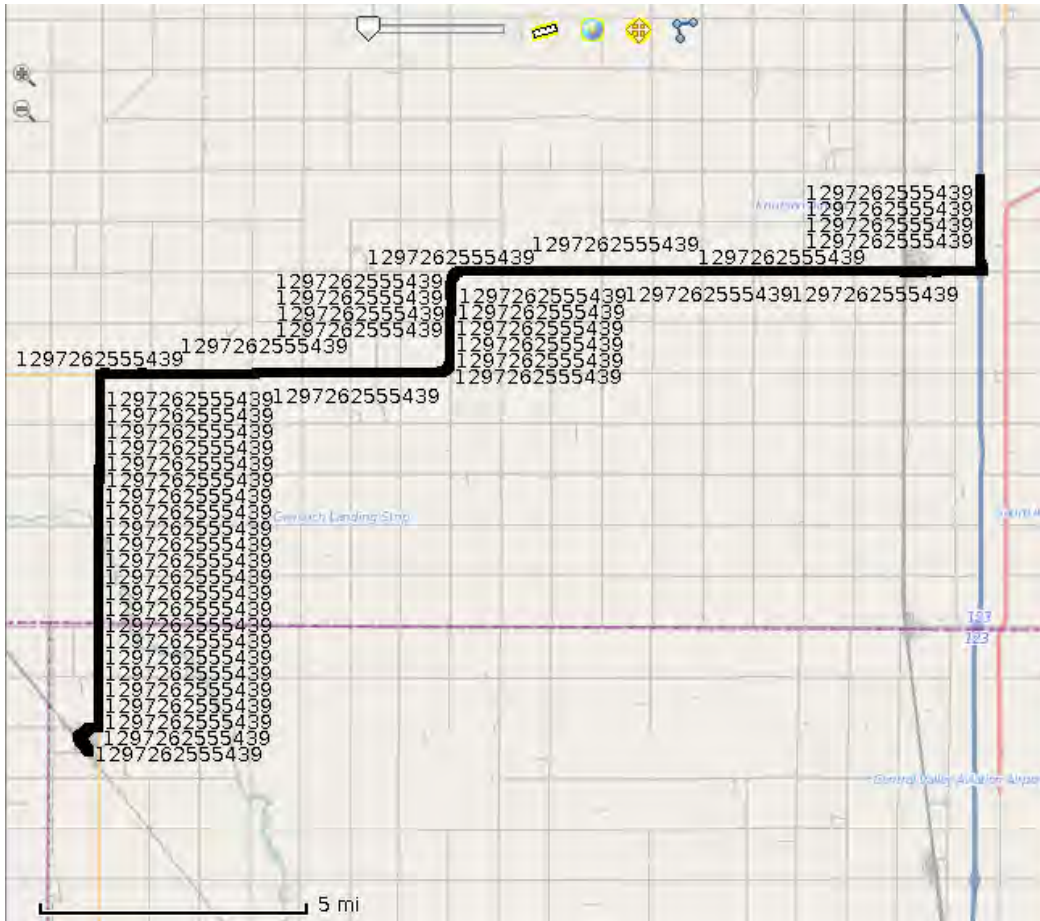
test was not included in the graph below because it passed at 100%. The IQR and Barnes spatial test produced failing results as the sensor adjusted for the environment around it. The sensor had to adjust 24 degrees before the IQR test passed. Once the sensor adjusted to the surroundings, the IQR test began to pass. The test that produced opposite results was the vehicle-to-vehicle because the other vehicles that were used had higher intake temperatures during this period.

Session 1297348646297 (Figure 5) is an example of one vehicle impacting the vehicle-to-vehicle results. The vehicle started out in garage also, but this vehicle had periods where it was stopped and the indirect heat from the engine had some influence on the intake temperature sensor. Gaps in the data observations are locations where the vehicle was stationary. From 14:14 UTC to 14:44 UTC the temperature continued to drop, except for the 3 min the vehicle was stopped three times. This caused the temperature sensor to stop dropping and at 14:15, the sensor began to rise again. Through the tests that were conducted, the results from the IQR and Barnes tests comparing RWIS to the vehicle all failed. The vehicle-to-vehicle initially seemed to fail the temperatures that were too warm for the environment, but when temperatures later reached  $-6^{\circ}\text{C}$  and lower the test passed all those results. The persistence test passed at 100% for this session and was not included in the graph below.

Examining the more rural test, the results from a vehicle and comparing it against neighboring RWIS observations the results were a bit surprising. The path the vehicle traveled on February 9, 2011, from Hatton, North Dakota, to I-29 by Thompson, North Dakota, is in Figure 6.

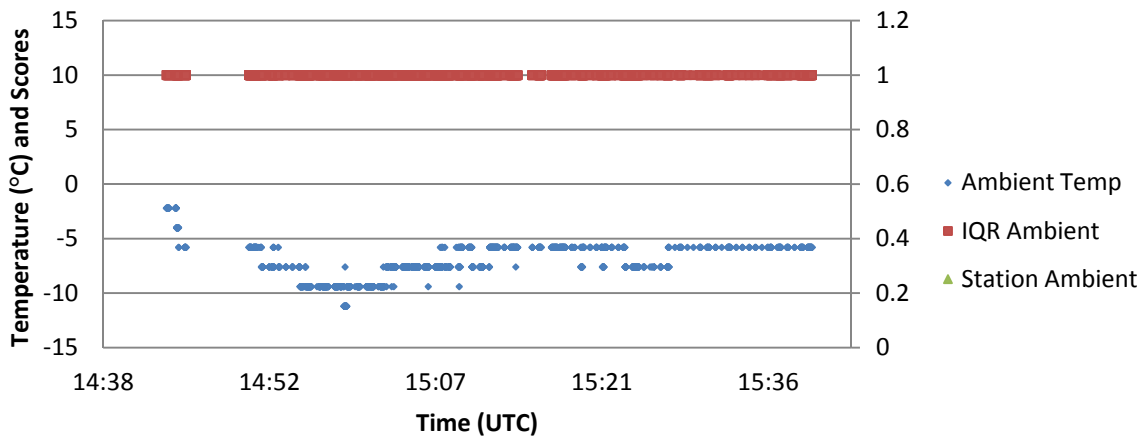


**FIGURE 5 Overview of results from session 1297346864297, including tests for IQR, Barnes, and vehicle-to-vehicle.**

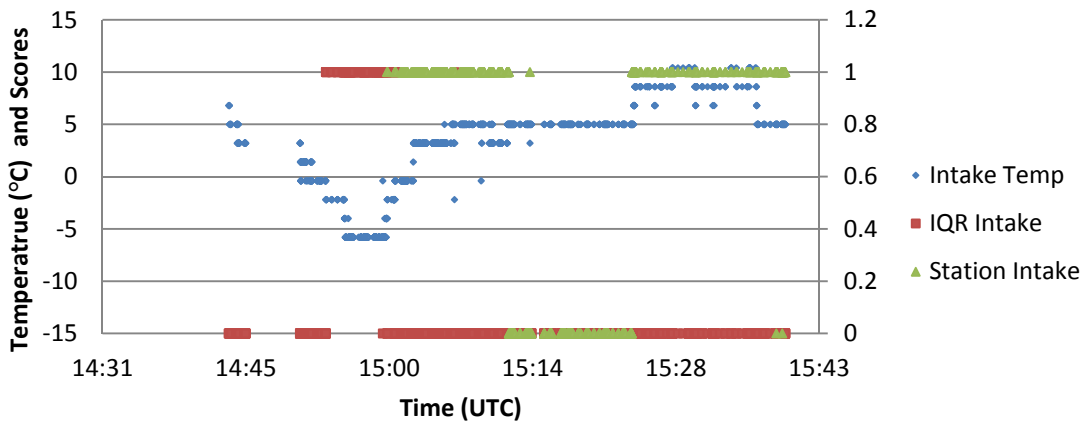


**FIGURE 6 Travel pattern for driver during the morning of February 9, 2011.**

For this example, the vehicle was reporting ambient and intake air temperature. The data from the ambient air temperature sensor (Figure 7) returned results that passed IQR test at 100%. The intake air temperature (Figure 8) returned mixed results. On the intake air temperature, the vehicle only passes the IQR test from 14:52 to 15:00 UTC when the temperature was at  $-6^{\circ}\text{C}$ . During other times through the trip, the Barnes spatial test did pass when the IQR failed. The main reason for the Barnes spatial test passing was the standard deviation of the stations near the vehicle was  $8^{\circ}\text{C}$  to  $9^{\circ}\text{C}$ . When looking at the temperatures alone there are differences between them. The ambient air temperature overall is about  $5^{\circ}\text{C}$  cooler than the intake air temperature. Also, the intake air temperature did warm up and hovered from  $8^{\circ}\text{C}$  to  $10^{\circ}\text{C}$  when the vehicle reached the town where the speed limit decreases to 25 mph while the ambient air temperature remained at  $-6^{\circ}\text{C}$ . The vehicle-to-vehicle tests were included because there were no other observing vehicles out during the time this vehicle was driving, so this test continually produced an error.



**FIGURE 7 Overview of results from session 1297262555439 using ambient air temperature.**



**FIGURE 8 Overview of results from session 1297262555439 using intake air temperature.**

## SUMMARY

The performed quality checks of vehicle observations were produced by a working software application that generated quality-check markers to individual mobile observations. The volume of data generated by mobile platforms present significant challenges in providing timely quality control checks. Even selecting a subset of the available data from a given vehicle as was done in this study, the amount of processing for a given storm event is a significant fraction of the total time of the storm event. However, with sufficient computing resources this limitation could be reduced as the processing is expected to be scalable. During the algorithm testing process, a few intriguing items began to surface when working with the OBDII vehicle data. A few of the more salient items are presented below.

- Amount of data:
  - Data amounts depend on the sensors installed and reporting through the OBDII port as well as if the sensors are functioning properly. Some vehicles report all available sensor information dependably along with a time stamp and location. Other vehicles tend to report the time stamp and observations reliably, but the global positioning systems location lock occasionally is lost and subsequent observations become stacked on the last locked position until the location is locked again.
  - Cell phone performance also has an impact on the amount of data. If the device locks or crashes during a trip, the data that was in query to be uploaded is lost.

- Timing of data:

When working with historical data for specific sessions taken from data archives, the data are rather straightforward where the vehicles report in an interval near 1 s and the data are available in chronological order. The real-time or operational data received may prove to be more problematic. Since the data is sent over a cellular signal, the data can back up if the collection is too high or if signal is lost. In this case, the data may be delayed for a few minutes to a few hours depending on how long signal is lost and how many observations need to be uploaded. Alternatively, some of the data might be lost if the user closes the program before all the data has been uploaded.

- Idle vehicles impact on vehicle-to-vehicle:

This affected a few vehicles where all the other tests were passing and the vehicle-to-vehicle was failing. The test is taking data from the surrounding vehicles and comparing the temperatures. When vehicles sit idling, the engines produce heat affecting the intake temperature sensor. When it compares the observations using a Barnes method, the influence from the idling car if it is close by has significant impacts on the weight.

- Adequate observation network to compare against:

The tests utilizing data from either fixed stations or other vehicles seem to fair well if the reporting vehicle is near enough to similar types of observations. The issue that arises is when there are not enough similar types of observations to compare against. This makes specific types of data harder to quality control, and puts more emphasis on the other quality checks to validate the vehicle observations.

- Limitations:

Post or delayed versus real-time processing is a concern depending upon how the data are planned on being used. If the data are primarily used in assessing current conditions, then real-time processing of the data is needed to determine if any problems are arising

with the sensors during driving and ignore the data coming from that vehicle. If the data are planned on being used in prediction models for pavement or atmospheric conditions, then the processing of the data will not need to be run on every data point. In this event, the quality checking needs to only be performed for data times when the data are going to be ingested into the model. Depending on the style of processing, the time to complete the quality-checks processing will vary. Caveats are the following:

1. For the real-time use, and depending on the surrounding observations, processing time may be short if there are very few observations. Alternatively, it may take more time than the frequency of the received observations if there are many observations around the target observation. The advantage of this method is knowing that all observations coming from the vehicle have gone through the tests and the bad data would be flagged.
2. For the delayed checks, only the observations used during the model initialization need to be checked. This would limit the number of observations necessary to run through the quality-check tests. The advantage of this would reduce the amount of processing time needed to focus on the quality checks. However, this could hinder the identification of transient sensor problems.

## NEXT STEPS

This paper is a summary of accomplishments to date with the algorithm design and testing. The next steps in the study of the quality-check algorithm include testing more vehicles in other wintertime events. Further, efforts will be made to determine alternative ways to run the quality checks to improve algorithm performance and increase throughput of high volumes of mobile observations. For example, a method of only quality-checking observations at different intervals (5 to 10 min) will be investigated. In part, this will also analyze the utilization of the quality-checking by gaining an understanding where the most benefit will be in either real-time or delayed processing of mobile observations. Also, developing like-sensor tests is only valid on vehicles that report both ambient and intake air temperature. During these tests, only one vehicle reported both. A buffer value needs to be developed for vehicle start up and idling since these conditions cause the intake temperature to be abnormally high.

## REFERENCES

1. Richardson, Y., P. Markowski, S. Waugh, and S. Fredrickson. Mobile Mesonet Observations During VORTEX2. *Proc., 5th European Conference on Severe Storms*, 2009, pp. 6.4 1–3.
2. Straka, J. M., E. A. Rasmussen, and S. E. Frederickson. VORTEX-1994 Intercept Vehicles: Integrating GPS and Mobile Surface Meteorological Measurements. *American Meteorological Society*, 1995, pp. 921–936.
3. Petty, K. R., and W. P. Mahoney. Weather Applications and Products Enabled Through Vehicle Infrastructure Integration (VII). Boulder, Colo., 2006.
4. Stern, A. D., V. P. Shah, K. J. Biesecker, and C. Yeung. *Vehicles as Mobile Sensing Platforms form Meteorological Observations: A First Look*. Federal Highway Administration, U.S. Department of Transportation, 2006.

5. Drobot, S. *Vehicle Data Quality—Preliminary Results from the Detroit Testbed*. Available at <http://www.ametsoc.org/boardpages/cwce/docs/BEP/Mobile-Obs/2009-08-24/drobot.pdf>. Accessed July 26, 2010.
6. Barnes, S. L. A Technique for Maximizing Details in Numerical Weather-Map Analysis. *Journal of Applied Meteorology*, Vol. 3, 1964, pp. 396–409.
7. Daley, R. *Atmospheric Data Analysis*. Cambridge University Press, New York, 1996.

## DATA NETWORKS AND QUALITY

**National Mobile Environmental Observation Network**  
*Increasing Insight to Road Weather and Surface Conditions***BRIAN BELL****PAUL HEPPNER***Global Science & Technology*

Global Science & Technology, Inc. (GST) primarily developed the United States' first mobile (vehicle-based) environmental observation network. Funded by the National Oceanic Atmospheric Administration's (NOAA) National Weather Service (NWS), GST has established a foundational infrastructure for a national mobile environmental observation network that offers enormous potential for providing real-time road weather and surface conditions for the entire country. The funded Mobile Platform Environmental Data (MoPED) system is a proprietary environmental sensing system with partner commercial fleets on which the sensing systems are installed. MoPED is an information processing system that acquires and disseminates mobile environmental and vehicle data to government and commercial interests. Through the development of MoPED, GST has established new mobile observation and metadata standards and created quality control methodologies. The MoPED project is presented as a case study to share GST's experience and knowledge related to the state-of-the-art technologies and methods for vehicle acquisition of environmental observations as weather information to improve operations, safety, and performance of surface transportation systems. MoPED's purpose to acquire mobile environmental and vehicle data for inclusion in the national mesonet is per the policy recommendation of the National Research Council to improve meteorological observation and detection of phenomena at the mesoscale level. The first prototype MoPED system was successfully demonstrated to NOAA with the U. S. Department of Transportation, FHWA, and Research and Innovative Technology Administration in attendance. GST then advanced the prototype into an initial capability with national coverage provided by hundreds of commercial vehicles, which provide millions of data observations. This detailed national coverage of environmental data along important transportation corridors provides enormous insight to road weather and surface conditions. The benefit to the user is increased situational awareness, which potentially factors into decisions taken regarding travel risk. Moreover, the NWS is able to refine forecasts, watches, and warnings based on the detailed data provided by mobile platforms in areas that otherwise would be unsampled. NWS further benefits by the possible inclusion of mobile platform observations from MoPED into the initialization of predictive models. Because the participating commercial fleets travel major transportation routes, the fleets provide excellent urban coverage near population centers, as well as more remote areas between the origin and destination points of travel. Using mobile platforms to acquire environmental data supplements traditional fixed weather stations from airports and road weather stations (i.e., *Clarus*) with observations that have finer temporal and spatial resolutions. Vehicles taking data observations every 10 s at highway speeds provide data at the microscale level of spatial detail to the MoPED system, which exceeds expectations for mesoscale meteorological data resolution.

**A**dverse weather significantly affects our nation's highways and consequently causes hazards for commercial companies and the traveling public. Operational efficiency, occupant safety, and the cost of services are all compromised by adverse weather.



Conditions such as snow, ice, fog, rain, and black ice greatly impair public safety, reduce travel capacity, and cause travel delays. Weather-related accidents and delays are directly responsible for thousands of lives lost, hundreds of thousands of injuries, billions of dollars of property damage, and countless business disruptions on an annual basis in the United States. Furthermore, adverse weather presents logistical problems, public safety concerns, and economic disruption at both the national and local levels.

Accurate weather information is critical for enhancing safety and operational efficiency associated with vehicular travel. Providing better and more timely weather information to operations, drivers, and the traveling public will have positive societal and economic benefits. Weather information, delivered as meaningful and relevant information products, has national implications of improving the efficiency and safety of an entire industry and local implications of providing better transportation services in our communities.

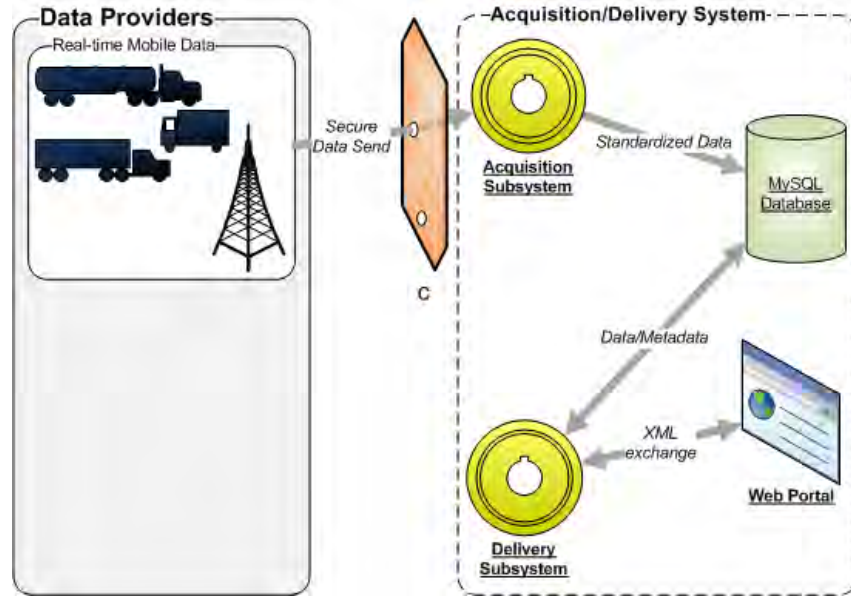
There is an expressed need to increase both the temporal and spatial resolution of surface environmental (weather) observations. The public and private sectors benefit from improved dissemination of observed surface conditions, including consumer access to specific real-time data and integrated products. At the National Oceanic Atmospheric Administration (NOAA), the numerical predictive models may benefit from improved initial conditions in the boundary layer. Likewise, maintenance decision support systems that use point data as input will also benefit from the inclusion of environmental observations acquired by mobile platforms that travel various transportation routes, major highways, and local roads.

Presently, the monitoring and predictability of surface weather phenomena are highly dependent on automated surface observation stations (ASOS) at airport locations and road weather information systems (RWIS) along highways. One way to greatly increase surface data is with mobile observations—relevant environmental data (i.e., air temperature, pressure, humidity) that may be available from the vehicle data equipment on commercial fleets. These mobile data describe the environmental conditions along the pathways of the fleet, which include valleys, mountains, and other critical topography. The delivery of mobile platform data to NOAA, the U.S. Department of Transportation, and consumers will help to better inform decision makers, improve user situational awareness, and improve the prediction of weather and road surface conditions.

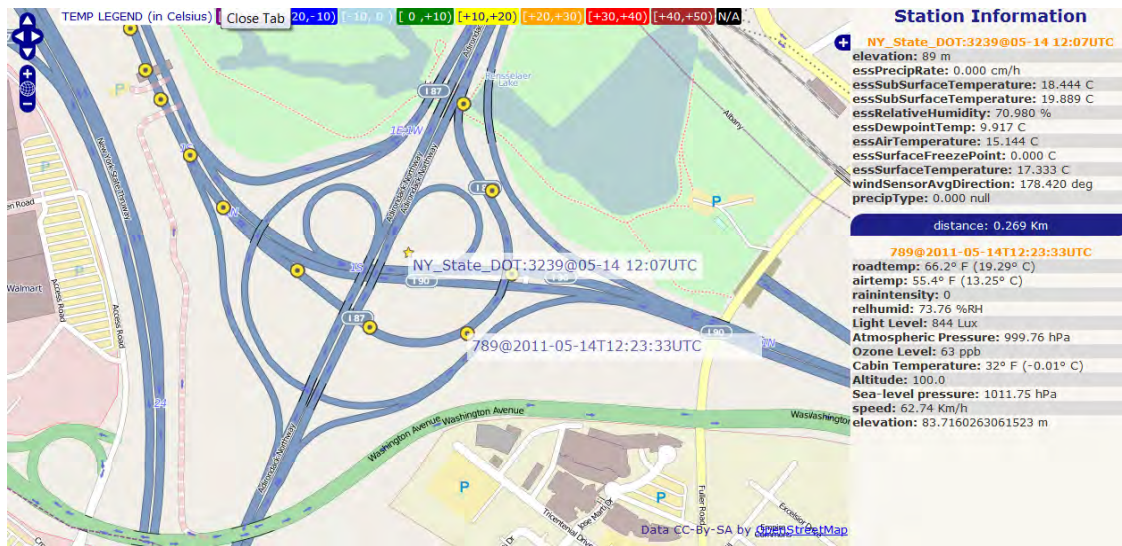
## **DEVELOPING A MOBILE PLATFORM**

During 2009 and 2010, NOAA awarded Global Science & Technology, Inc., a contract to develop the Mobile Platform Environmental Data (MoPED) system that acquires relevant environmental data from commercial fleets and make them available as part of NOAA's national mesonet program. [Figure 1](#) shows the high-level architecture of the MoPED system.

Vehicles taking data observations every 10 s at highway speeds provide data at the microscale level of spatial detail to the MoPED system. This level of microscale detail means that more observations are taken when vehicles travel near critical areas of interest (e.g., bridges susceptible to icing and known areas prone to fog formation). In the following example, mobile platform observations are taken at an Interstate interchange. Each dot represents a mobile platform observation. The mobile platform observations supplement the RWIS that is situated in the middle of the interchange. The mobile platforms provide further definition of road temperature, for example, at the various bridges and underpasses ([Figure 2](#)).



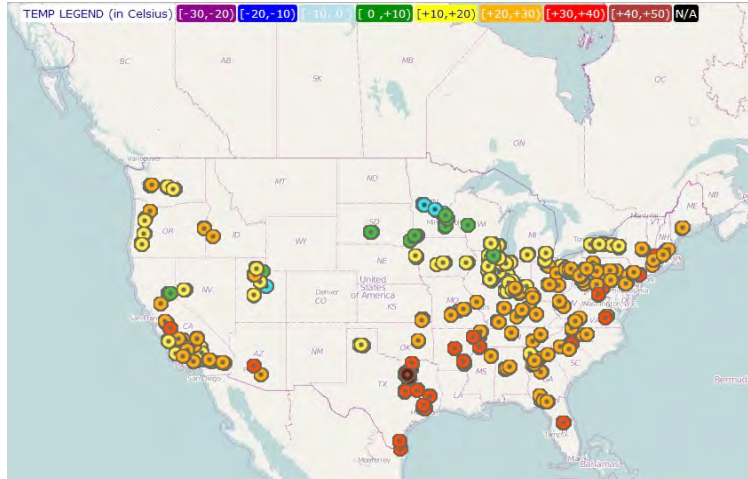
**FIGURE 1** MoPED system architecture.



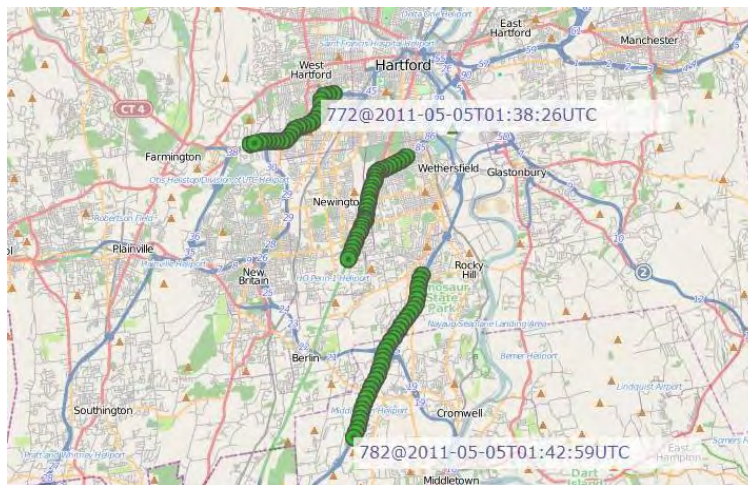
**FIGURE 2** Mobile platform observations at an interchange.

The mobile platforms cover large areas of geography. The coverage is national, and it is mostly aligned with the transportation routes of the traveling fleet (Figure 3). There is extensive coverage along the Interstate system (I-81, I-70, etc.) and considerable local coverage in the area near the terminals or hubs of the traveling fleet.

With deployments of dozens of instrumented vehicles in the northeastern United States, for example, the vehicles conduct their regional routes, which frequently traverse geography on multiple roads near urban areas. In this example, the vehicles are on Interstates 91 and 84, along with other state roads in the Hartford, Connecticut, area (Figure 4).



**FIGURE 3** Snapshot of mobile platform observations.

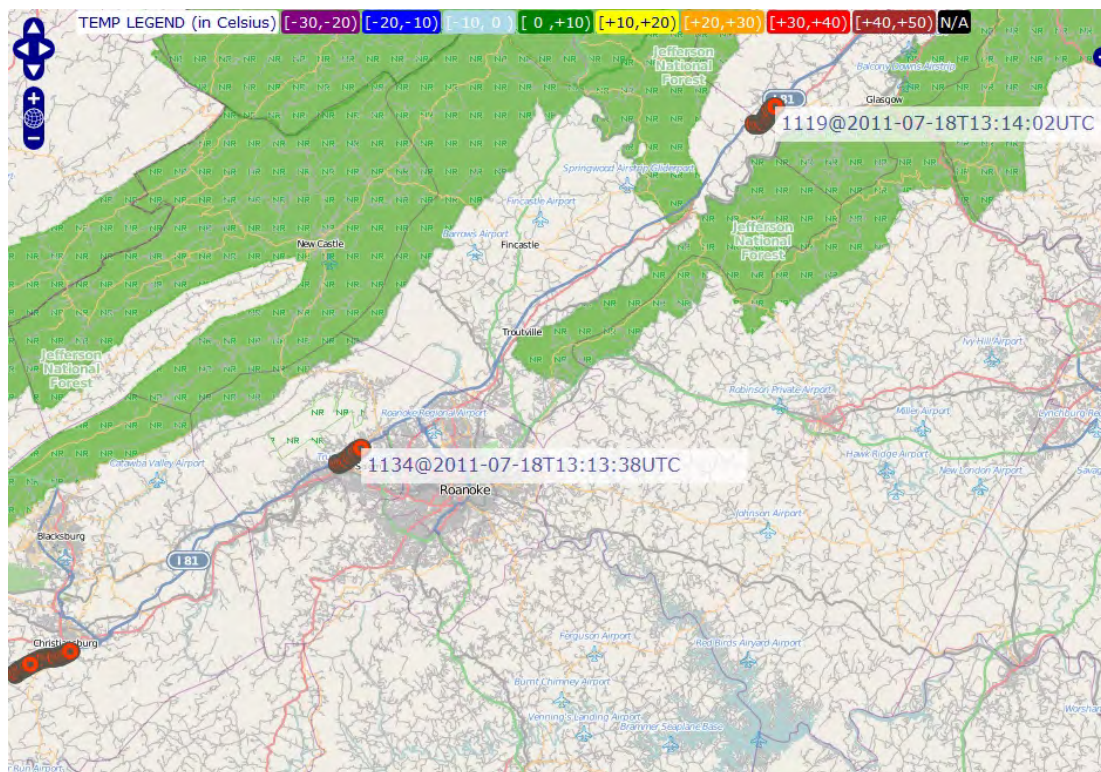


**FIGURE 4** Mobile platforms traveling near Hartford, Connecticut.

Vehicles can also travel in tandem or sequentially. A vehicle might take an observation at milepost 20, for example, at time 8:00 p.m., then another vehicle that passes 40 min later provides another observation at the same location. In some cases, there is a rhythm or regularity if a fleet travels prescribed routes at prescribed times. Otherwise, there is randomness to geography covered by vehicles at any given time. Both types of coverage are desirable. Random coverage aids in geographical spread, whereas regular coverage might be beneficial in a corridor. [Figure 5](#) shows sequential coverage along the I-81 corridor by multiple mobile platforms.

Data attributes fall into one of two categories: environmental (e.g., air temperature) and vehicle (e.g., brake status). The vehicle data provide ancillary information to the direct environmental readings. For example, if the vehicle traction control (vehicle attribute) engages and the road temperature (environmental attribute) is less than 0°C, the pavement condition might be icy.

Acquiring the environmental attributes generally involves adding a third-party sensor to the vehicle. An example is shown in [Figure 6](#).



**FIGURE 5** Sequential vehicle coverage along I-81 on July 18, 2011.



**FIGURE 6** Sensors mounted on the mobile platform.

These sensors are tied into a telematics communications device. The J-protocol vehicle data also communicates through the telematics box.

The mobile platform environmental data is highly accurate. The following attributes are acquired or derived: air temperature, road temperature, relative humidity, dew point, barometric pressure, sea-level pressure, ambient light, precipitation, and ozone (Table 1).

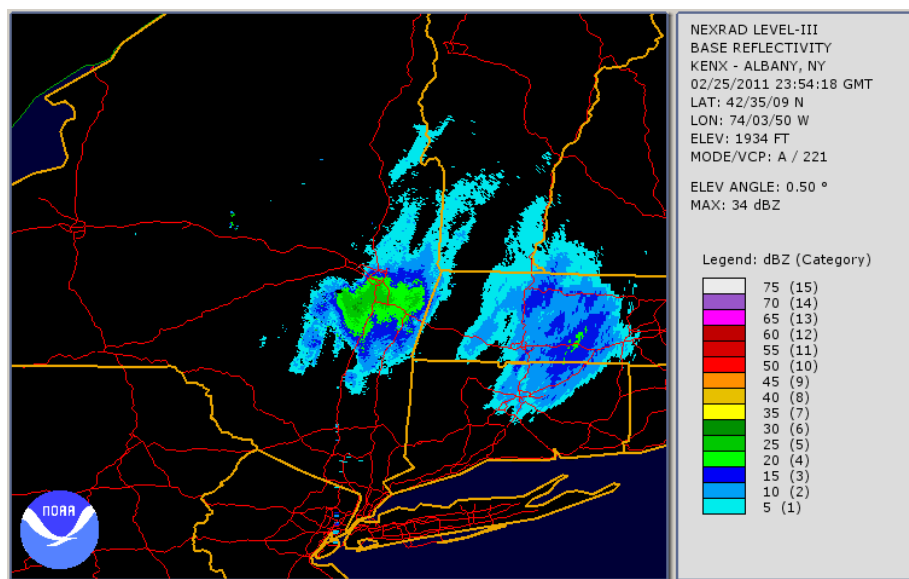
**TABLE 1 Example Mobile Platform Observation**

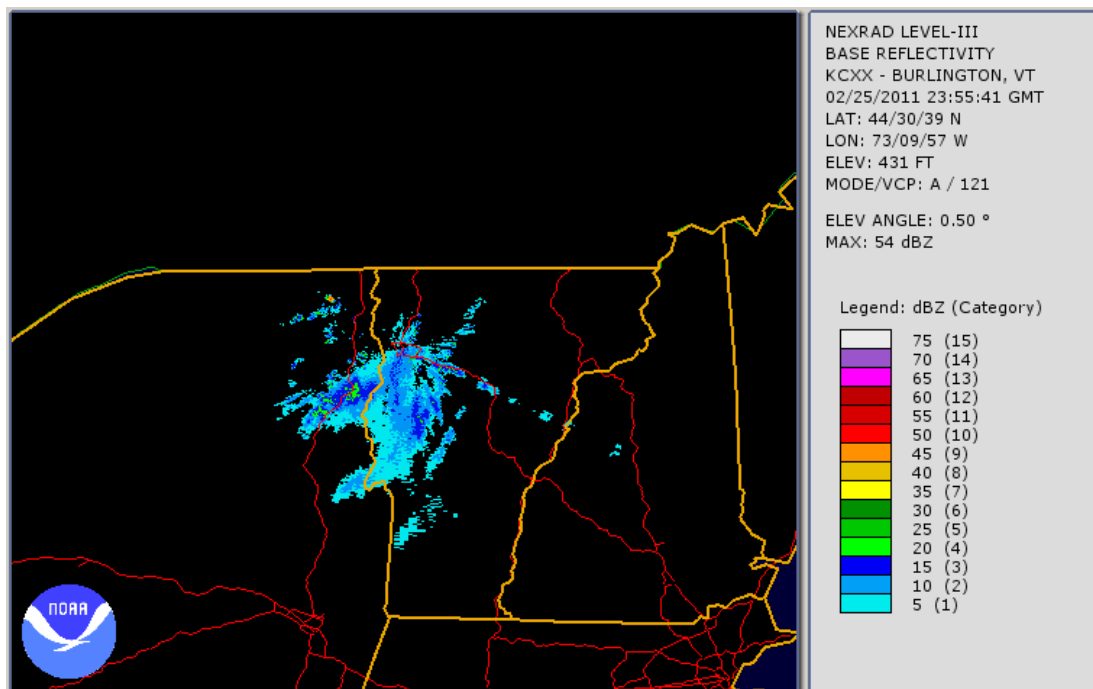
Date and Time	Latitude (deg)	Longitude (deg)	Elevation (m)	Air Temp. (°C)	Road Temp. (°C)	Rel. Hum. (%)	Pressure (hPa)	Light (lux)	Precip.
2010-12-16 13:54:07	53.3985	-2.3571	31.8	2.31	1.33	88.67	1,001.03	5,900	45
2010-12-16 13:54:17	53.3987	-2.3557	30.4	2.31	1.67	88.69	1,002.02	6,830	57
2010-12-16 13:54:27	53.3988	-2.3557	19.7	2.62	1.97	88.69	1,002.24	7,070	61
2010-12-16 13:54:37	53.3988	-2.3557	21.3	2.75	1.71	88.62	1,002.3	7,470	56
2010-12-16 13:54:47	53.3989	-2.3556	28.3	2.75	2.13	88.58	1,002.18	7,920	52

There are occasions when the vehicles detect precipitation in areas that are in radar gaps. This phenomenon is more pronounced farther away from the radar, particularly in mountainous areas with low-level-based precipitation, such as drizzle or light snow.

The following radar images from Albany, New York (Figure 7), and Burlington, Vermont (Figure 8), show that I-89 in eastern Vermont and western New Hampshire can sometimes fall into a gap between radar sites. Light precipitation, particularly during the wintertime, might be hard or impossible for radar to detect in this region. The Albany radar image at 23:54 UTC on February 25, 2011, does not resolve any precipitation between Montpelier, Vermont, and White River Junction, Vermont (Table 2). The Burlington radar shows precipitation in western Vermont, but has difficulty in the eastern half of the state (see straight line of 5 to 10 dBz returns).

A mobile platform traveling on I-89 south of Montpelier at this time reported light precipitation.

**FIGURE 7 Albany radar image at 23:54 UTC on February 25, 2011.**



**FIGURE 8** Burlington radar image at 23:55 UTC on February 25, 2011.

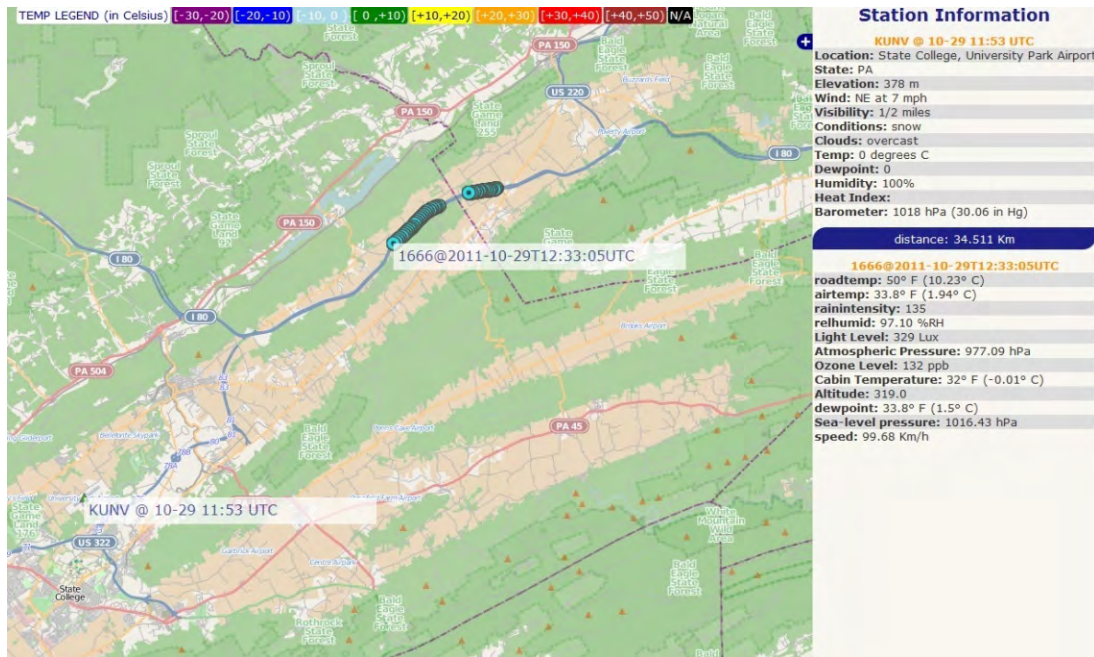
**TABLE 2** Precipitation Observations from a Mobile Platform on February 25, 2011

Date and Time	Latitude	Longitude	Precipitation Intensity (0–250)
2011-02-25 T23:55:06	44.32243	-72.73029	12
2011-02-25 T23:55:15	44.32403	-72.73269	12
2011-02-25 T23:55:26	44.32566	-72.73682	0
2011-02-25 T23:55:35	44.32673	-72.73951	0
2011-02-25 T23:55:46	44.32863	-72.74256	12
2011-02-25 T23:55:55	44.3302	-72.74422	11
2011-02-25 T23:56:06	44.33206	-72.74554	10

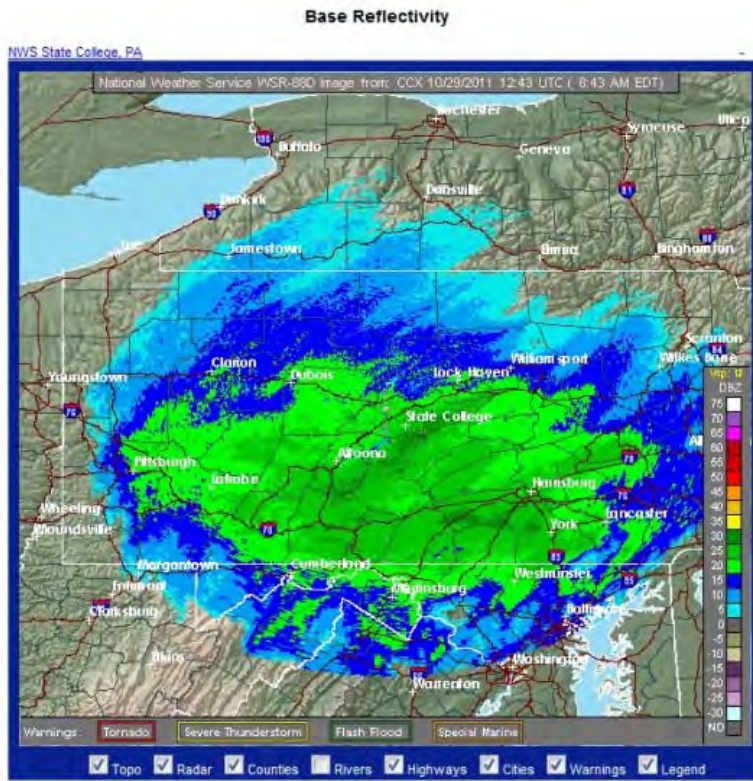
During winter storms, road temperature readings can help determine surface conditions. In the following example, snow was detected by the mobile platform (Figure 9), but the road temperature was 5°C, which would indicate melting upon contact.

The detection of precipitation by the vehicle adds interpretative value to the radar image (Figure 10), especially if there is a question of precipitation reaching the ground.

The ability to determine the probability or likelihood of black ice can be assisted by the data acquired by mobile platforms. When the road temperature is less than 0°C, certain weather, such as freezing fog (Figure 11) or precipitation, might be uncovered by mobile platforms in areas without ASOS or RWIS coverage. Algorithms that include road temperature, air temperature, precipitation, and relative humidity can aid in determining the likelihood of dangerous surface conditions.



**FIGURE 9** Mobile platform near State College, Pennsylvania, on October 29, 2011, during a snow event.



**FIGURE 10** Radar image near State College during the snow event depicted in Figure 9.



**FIGURE 11 Freezing fog.**

In addition to environmental conditions measured directly by third-party instrumentation, vehicle J-protocol data can also be obtained from the vehicle's original equipment manufacturer (OEM) equipment, and then transmitted from the data communications bus to MoPED. Initial studies show that some of the J-protocol values are meaningless (high end of range). In the following example, the vehicle's message for external air temperature, attribute 171, is 1775°C (C) from the OEM equipment.

```
<observation time="2010-06-02T05:54:41" ingestionTime="2010-06-09T14:58:02"
```

```
lat="42.34345" lon="-71.05166">
```

```
<attribute equipId="210">0.0</attribute>
```

```
<attribute equipId="79">510.96875</attribute>
```

```
<attribute equipId="108">102.0</attribute>
```

```
<attribute equipId="170">1774.96875</attribute>
```

```
<attribute equipId="171">1774.96875</attribute>
```

```
<attribute equipId="172">215.0</attribute>
```

```
<attribute equipId="242">-273.0</attribute>
```

```
<attribute equipId="1680">0</attribute>
```

```
<attribute equipId="2610">81.6</attribute>
```

```
<attribute equipId="2611">102.0</attribute>
```

```
<attribute equipId="4490">655.35</attribute>
```

```
<attribute units="kmph" name="speed">31.71</attribute>
```

```
</observation>
```

#### **RAIN TRACKER**

**PAVEMENT TEMP (C)**

**BAROMETRIC PRESSURE (kPa)**

**CABIN TEMPERATURE (C)**

**EXTERNAL AIR TEMP. (C)**

**ENGINE INTAKE AIR TEMP. (C)**

**TIRE TEMPERATURE (C)**

**CAB HEATING ZONE (0=off)**

**SOLAR INTENSITY (%)**

**SOLAR MAX INTENSITY (%)**

**SPECIFIC HUMIDITY (g/kg)**



Certain parameters, such as barometric pressure, might be accurate (i.e., 102 kPa), but the resolution is too coarse to offer much value in a meteorological analysis. Therefore, there is much more research and investigation needed for determining the usefulness of OEM equipment for providing weather data.

The mobile platforms are capable of added sensing for environmental data (carbon monoxide, carbon dioxide, etc.) and other biochemical or radiological hazards. The vehicles serve as probes in the detection of the phenomenon they encounter.

## CONCLUSION

Mobile platforms that are equipped with third-party sensors take accurate and effective meteorological data observations, which serve the national objective of increased situational awareness. Over time, the validation of such data obtained by mobile platforms will prove extremely valuable to road weather models (i.e., winter maintenance) and other meteorological models. The ability to alert drivers about the potential of surface hazards, such as black ice, can be based on observations taken directly by the vehicle itself.

Further work is needed with OEM equipment on the vehicle. Preliminary analysis suggests only limited usefulness in the value of such data for enhancing the total meteorological observation provided by the vehicle.

## RESOURCES

- ASOS User Guide*. National Weather Service, National Oceanic Atmospheric Association.
- Clarus Quality Checking Algorithm Documentation Report*. FHWA, U.S. Department of Transportation.
- NTCIP ESS Interface Standard 1204. National Transportation Communication for ITS Protocol.
- NWS Instruction 10-1302: Requirements and Standards for NWS Climate Observations. National Weather Service, National Oceanic Atmospheric Association.
- Observing Weather and Climate from the Ground Up: A Nationwide Network of Networks*. National Research Council of the National Academies, Washington, D.C., 2009.
- Weather Applications and Products Enabled Through Vehicle Infrastructure Integration: Feasibility and Concept Development Study*. FHWA, U.S. Department of Transportation.
- Weather Information for Surface Transportation: National Needs Assessment Report. Office of the Federal Coordinator for Meteorology.
- When Weather Matters: Science and Service to Meet Critical Societal Needs*. National Research Council of the National Academies, Washington, D.C., 2010.
- Where the Weather Meets the Road: A Research Agenda for Improving Road Weather Service*. National Research Council of the National Academies, Washington, D.C., 2004.

## DATA NETWORKS AND QUALITY

**Multistate, Multisensor, and  
Predictive Road Condition Information****JOHN J. MEWES****GREGORY M. OSTERMEIER****JULIE L. THEISEN***Meridian Environmental Technology, Inc.*

The U.S. Department of Transportation established the *Clarus* Initiative in 2004 to reduce the impact of adverse weather conditions on surface transportation users. *Clarus* has been a research and development initiative to demonstrate and evaluate the value of “Anytime, Anywhere Road Weather Information” to the breadth of transportation users and operators. The goal of the initiative was to create a robust data assimilation, quality checking, and data dissemination system that could provide near real-time atmospheric and pavement observations from the collective states’ investments in road weather information systems and related weather-observing technologies. Beginning in 2008, the FHWA initiated multistate regional demonstrations intended to show how *Clarus* facilitates better transportation system management and enables the private sector to create improved road weather information business solutions. In response to Use Case 5 of the *Clarus* Regional Demonstration, termed *Enhanced Road Weather Content for Traveler Advisories*, Meridian Environmental Technology teamed with the state agencies that comprise the North–West Passage Transportation Pooled Fund study to design and develop an enhanced, multistate traveler information system. This traveler information system, composed of a web portal and computer telephone systems, was intended to leverage the multistate nature of *Clarus*’ data to provide a seamless source for traveler information across the I-90, I-94, and intervening corridors that make up the North–West Passage. The demonstration was also intended to break new ground in the provision of traveler information via enhancement of road weather content, enabled through multisensor analyses enhanced by *Clarus*’ environmental sensor station data, and through predictive road and travel condition information leveraging maintenance decision support system technologies. This paper will provide an overview of the resulting traveler information system as well as the lessons learned through its implementation. Specific topics of discussion include addressing the conflicts between the underlying systems for tracking and reporting road conditions between the participating states, issues encountered in interpreting and conveying potentially conflicting data from competing information resources, considerations in the provision of predictive road condition information, and an assessment of user receptiveness to these concepts as determined via independent evaluation of the *Clarus* Use Case 5 Regional Demonstration.

## DATA NETWORKS AND QUALITY

## Assessment and Evaluation of Maintenance Decision Support System Recommendations

ANTHONY K. MCCLELLAN

BENJAMIN W. HERSHEY

ROBERT D. HART

JOHN J. MEWES

*Meridian Environmental Technology, Inc.*

Since the late 1990s there has been an effort to develop and deploy a system integrating maintenance and weather data for winter maintenance operation decision makers to conduct safe and effective maintenance strategies on the roadway. In 2002, a group of state departments of transportation (DOT) created the Pooled-Fund Study (PFS) maintenance decision support system (MDSS) to develop a system that could augment current winter operation techniques and provide decision makers with a one-stop shop for road weather information. The primary objective was the integration of road, weather, maintenance actions, and traffic information to generate the most cost-effective maintenance recommendations for snow and ice control. The PFS MDSS solution was developed as a cooperative research program and has evolved into an operational decision support tool for the seventeen states that have participated in the program. As part of the ongoing evaluation of the program the DOT participants in this study have asked “Are DOT personnel who make the final maintenance treatment decisions using the recommendations; and, if not, why not?” An evaluation tool was developed to capture whether maintenance personnel accepted or rejected the MDSS recommendations during routine operations and, if they rejected the MDSS recommendations, why the MDSS recommendation was declined. This paper discusses how the evaluation tool was developed and the results from the evaluation. It addresses the process developed to assess how, when, and what recommendations would be evaluated and who would participate in the evaluation. Case studies were done on the road weather conditions concurrent with and prior to the evaluated recommendations to provide greater insight into the DOT selection regarding whether to use or not use the recommendation. The paper discusses the findings of these case studies and the complexities involved in assessing whether to honor an MDSS recommendation or use alternative maintenance actions.

### HISTORY OF THE POOLED-FUND STUDY MAINTENANCE DECISION SUPPORT SYSTEM

Agencies involved in highway winter maintenance activities have realized the benefits of road weather information systems (RWIS) since their introduction in the 1970s, but have also seen certain limitations of these systems in the operational support of maintenance activities. The primary limitations have been

- Data presentations in a scientific format rather than in terms maintainers understand;

- The requirement for maintenance personnel to interpret additional weather-related data as part of their decision process;
  - The need to interpolate point-specific observations into route-specific estimates;
- and
- The lack of a mechanism to transfer RWIS observations and pavement-specific forecasts into actual maintenance practices.

Many maintenance personnel have difficulty fully comprehending the presentation formats used for RWIS data. Observations include weather and pavement-specific parameters not typically used by field personnel, such as dew point temperature, percent ice, and chemical concentration. Forecasts include items such as probability of precipitation, probability of frost, precipitation type, precipitation rates, and the projected depths of the water, ice, frost, and snow components in the layer atop the pavement. Although these are essential components for a scientific analysis, they are rarely used or understood by many maintenance personnel. To complicate matters, a number of the observed RWIS values are valid in certain conditions but are incorrect in others. Thus, it requires a thorough understanding of the measurement process and existing conditions to be able to assess whether the numbers visible on the user interface are realistic. Thus, maintenance personnel must decide what treatments to apply and when to apply them based on imperfect knowledge of current pavement conditions, current and forecast weather conditions, and the impact of these weather-related conditions on available maintenance techniques and resources. In large part, these decisions revert back to knowledge gained from prior experience in dealing with similar situations.

To overcome these deficiencies and improve the overall effectiveness of winter maintenance operations, new maintenance decision support systems (MDSS) solutions were developed that integrate all data routinely available to maintenance decision makers; employ sophisticated scientific processing and simulation methods to improve analysis and forecasting techniques; and synthesize the information into the most cost-effective maintenance response recommendation. The intent was to simulate the decision process typically used by decision makers, yet enhances this process by integrating a detailed analysis of the physical and chemical interactions that occur due to actual or projected maintenance treatment actions. Maintenance personnel relate to recommendations provided in terms of chemical type, application rates, and treatment timing and therefore could evaluate whether the recommendations represented how they would respond to the current or forecast conditions.

The pooled-fund study (PFS) MDSS approached maintenance actions from a proactive approach. Historically, maintenance personnel establish practices that prove most successful based on field experience. However, research indicates there may be more-effective approaches to winter maintenance available at substantially reduced resource costs. Many of these approaches seem counterintuitive to today's maintainers because of a general lack of understanding of the complex interactions occurring in the dynamic layer, the layer of snow, ice, frost, water, chemicals, and abrasives atop the road. The PFS MDSS took the tactic that appropriate combinations of human experience, scientific understanding, and high-performance computing could be used to assess the economic value of various treatment options for each winter scenario. The recommendations derived from the MDSS simulation had the potential to improve decision making and offer modified or new practices that were more cost effective or provided a higher level of service (LOS).

The PFS MDSS began in November 2002 and reflects the research investment of the states of California, Colorado, Indiana, Iowa, Kansas, Kentucky, Maryland, Minnesota, Nebraska, New Hampshire, New York, North Dakota, Pennsylvania, South Dakota, Virginia, Wisconsin, and Wyoming. Meridian Environmental Technology, Inc. (Meridian), served as the contractor for the pooled-fund research effort. The decision support system that was developed simulates actual pavement conditions related to recent weather events, maintenance treatment actions, and traffic activity on a maintenance route or segment and projects the most feasible maintenance response based on the maintenance resources and policies applicable (1). The success of the simulation is highly dependent on correct input of weather events, maintenance actions, traffic, resource availability, operational practices, and expected LOS (2). Assessment of MDSS recommendations is crucial to the long-term acceptance of the system, determining which factors lead to incorrect recommendations, determining areas in need of improvement, and to determine the reliability of the system.

### **PROBLEMS LEADING TO NEED FOR ASSESSMENT OF RECOMMENDATIONS**

As MDSS becomes more popular with winter road maintenance managers, there exists a need to determine the reliability of its recommendations. State department of transportation (DOT) cultures tend to embrace new technologies slowly, often wanting significant proof that a technology works before adopting it. One of the first goals of evaluating MDSS recommendations is to establish some reliability measures in which winter maintenance managers can believe.

A key issue in evaluating MDSS recommendations is understanding why recommendations are rejected. Numerous reasons are possible. Those that surfaced during the development of the PFS MDSS and which seemed relevant to the DOT members of the technical panel included:

- The difficulty for many maintainers to accept a recommendation that is different from “the way we’ve always done it.”
- MDSS assessed road conditions that did not match observation of the road conditions.
- MDSS assessed pavement temperatures that did not match observed pavement temperatures.
- The desired LOS was already met and further maintenance actions were not deemed necessary.
- Application rates were perceived as too high or too low.
- Improper configuration of maintenance characteristics (e.g., permissible application rates, route timing, equipment availability, material resources).
- Incorrect forecast.

### **METHODS CONSIDERED TO ASSESS RECOMMENDATIONS**

The evaluation team looked at three possible ways to assess the performance of MDSS maintenance recommendations:

- An experiential measure. How well does the MDSS recommendation match the maintenance action a maintenance supervisor would use based upon personal experience or agency policies?
- An operational measure. How well do MDSS recommendations deal with current conditions and maintain the LOS required by the agency?
- A resource management measure. How effective the treatment actions were in a given event as measured by maintaining the desired LOS at a minimal cost.

### **Option 1: The Experiential Measure**

Participating DOT contributors would rate the degree to which the MDSS recommendation matched their decision in a computer-based log. The log would contain date, time, supervisor identification, MDSS recommendation, DOT assessment of the recommendations appropriateness, DOT decision if different from the recommendation, whether all MDSS-displayed conditions are correct estimates of actual conditions, and comments. Each participant should establish criteria for reporting that might be regularly during winter events, at one or more set times each day, or at the beginning of each potential event.

### **Option 2: The Operational Measure**

Participating DOT contributors and the evaluation team would rate the degree to which the MDSS recommendation facilitates the desired LOS conditions. A log would be established to collect the date, time, and location of each event, supervisor or evaluator's identification, the MDSS recommendation, MDSS indicated road conditions at specified intervals after the application, assessment of the recommendation's correlation with actual conditions, and comments. A specified reporting and analysis schedule should be set up for each test site.

### **Option 3: The Resource Management Measure**

This test scenario would require the use of nearby or adjacent routes that would receive different treatment actions:

1. One route of the test evaluation pair will need to be managed using best practices recommendations.
2. One route of the test evaluation pair will need to be managed using the MDSS recommendations.

DOT participants would be responsible to assure the MDSS maintains a correct representation of the actual road conditions. This requires the DOT participant to confirm all maintenance actions get into the MDSS, and adjustments are made to the road conditions to better fit observed conditions on the route. The DOT participant would need to assure each road segment is treated according to the appropriate treatment guidance, all exceptions to these procedures are fully documented, and a detailed comparison of the road conditions between the two test segments are maintained throughout the evaluation.

## METHOD USED TO ASSESS RECOMMENDATIONS

The evaluation team chose Option 1 for the first attempt to assess MDSS recommendations. Each evaluator was asked to review one or two routes near their location, or a route within their responsibility area.

- Routes were selected that had most of the following characteristics:
  - RWIS on or near route;
  - A camera near a lighted area that has a historical database;
  - Similar topography, road make up and traffic counts throughout the route; and
  - Automated vehicle location and maintenance data collection (AVL–MDC) capabilities reporting on the route.

An option was set up as part of the MDSS user interface that allowed participants to easily enter their assessments as part of their decision process. Once on the recommendation evaluation page ([Figure 1](#)), each participant was asked to select one of three options for each recommendation:

- Accept,
- Accept conditionally, or
- Decline.

**FIGURE 1** Participant interface for evaluating MDSS recommendations.

Participants were then asked to indicate why they declined the recommendation or accepted it conditionally. Possible choices were separated into categories and evaluators were asked to select any or all reasons to indicate why the user accepted or declined the recommendation. The categories and the possible reasons are shown in Figure 1. Participants also had the opportunity to submit detailed comments on why a recommendation was perceived as inaccurate.

There was no option for the evaluator to indicate when an action was taken with no recommendations, but this should be considered in further assessments of MDSS recommendations.

## **PARTICIPANTS CHOSEN TO ASSESS RECOMMENDATIONS AND THEIR CHARACTERISTICS**

Assessing MDSS recommendations required a tool that would give DOT participants a method to accept or decline a recommendation and to explain why the recommendation was declined or accepted with reservations. To complete this evaluation test, selected contributors would have to be capable of assessing recommendations but also be able to assist in development of the collection tool. The intent of the assessment and evaluation of MDSS recommendations was to analyze the acceptance rate of recommendations and to determine the root causes for declining a recommendation. Participants needed to provide input into the selection of the correct characteristics to carry out this task successfully.

Meridian and the PFS MDSS technical panel selected a small group of participants. Participants of this evaluation had to be familiar with standard practices within their state, familiar with actual treatments on the road surface during evaluation periods, and willing to submit reports on a regular basis during their evaluation time. Participants made a commitment to report information about why they accepted or rejected the MDSS recommendation at each reporting time and enter data on the evaluation page shown in Figure 1 for each truck cycle on the route while they were on shift unless constrained by operational responsibilities. Meridian held a conference call with each participant to discuss the process needed to accomplish the evaluation.

Participants were asked to monitor one or two routes near their responsibility for whatever period they could reasonably dedicate to the program. While monitoring recommendations, the observers were asked to be aware of road conditions and the treatments actually used. The participants included representatives from Colorado, Idaho, Indiana, Kentucky, Minnesota, Nebraska, New Hampshire, and North Dakota. The participants permitted evaluation of recommendations with a wide variety of weather conditions in different climatic zones in hopes of limiting any bias toward specific weather types. The influence of topography was also considered in the input from Colorado, Idaho, and New Hampshire. By covering geographic regions across the country, the evaluation team tried to ensure the evaluation had enough evaluated storms to complete preliminary studies. If the study had been limited to one area, there was a chance that area would have a limited number of winter events.



## RESULTS FROM ASSESSMENTS

The evaluations of MDSS recommendations began the first week of January 2011 and continued for the rest of the winter weather season. The study period had an above-average number of storms, and above-average snowfall that proved advantageous for the development and refinement of the collection tool. Each state in the study area was able to provide several storm evaluations that included weather from extreme snowfall to blowing snow to freezing rain events (Table 1).

The evaluation indicated the participants in this sample assessment accepted the recommendation (fully or conditionally) approximately 60% of the time. Those who rejected the recommendations pointed out their reasoning for rejection was based on MDSS-simulated road conditions that were different from actual conditions, forecasted precipitation inconsistencies, application rates that differed from the user's expectations, or the fact that LOS was already being met. The reasons were not mutually exclusive selections thus the numbers in Table 2 may include multiple causes for a single rejection. It is not possible to determine the primary cause; however, these four reasons represent the most significant responses. The evaluation was set up as an experiential assessment, so these reasons are subjective causes for a participant to take an alternative action and not necessarily a deficiency in the MDSS guidance. For example, the "LOS being met" reason represents a resource management consideration, wherein previous maintenance actions have road conditions within the LOS requirements and the recommended action is deemed unnecessary. This response may mask the real reason for the rejection, which is more likely that the maintenance actions have resulted in better road conditions than those simulated by MDSS.

Simulated road conditions are a known problem area in MDSS. The PFS MDSS uses Meridian's HiCAPS pavement model to simulate the character of the dynamic layer for highway segments typically designated as maintenance routes. The model requires accurate input of the mass flux of all forms of precipitation and maintenance materials. HiCAPS then computes the correct state of the dynamic layer as the layer is impacted by temperature changes, mass decreases (evaporation, sublimation, runoff, and splatter), mixing caused traffic action, and maintenance actions (2). Precipitation estimates along remote highway segments are limited by the current capabilities to accurately measure precipitation and

**TABLE 1 Actual Responses and Their Statistical Averages for the Evaluation Question on Acceptance or Rejection of MDSS Recommendations**

State	Total	Accept	Accept %	Accept Cond.	Accept Cond. %	Decline	Decline %
Colorado	47	12	26	5	11	30	64
Idaho	9	9	100	0	0	0	0
Indiana	13	6	46	1	8	6	46
Kentucky	28	15	54	0	0	13	46
Nebraska	15	4	27	2	13	9	60
New Hampshire	12	10	83	0	0	2	17
North Dakota	40	37	93	1	3	2	5
<b>Total</b>	<b>164</b>	<b>93</b>	<b>57</b>	<b>9</b>	<b>5</b>	<b>62</b>	<b>38</b>

**TABLE 2 Number of Recommendation Responses for Each of the Reasons for Rejection, Shown by State**

Category	Reason	CO	ID	IN	KY	NE	NH	ND	Total
Weather condition	Temperature				1				1
	Amount of precipitation	2	3 2			7		1	15
	Start time of precipitation	2	3 1 2			2			10
	Type of precipitation	1	5		1			1	8
Road condition	LOS is being met	16		1		1	2	1	21
	Road temperature				1	1		1	3
	Road condition does not match MDSS	20	7 4		10	5		3	49
	Snow too thin to plow					1		1	2
Route configuration	Truck down			1 1		1			3
	Longer traversal times (weather)						1		1
Application rates	Too low	7	7 5 6			7		4	36
	Too high	16		2 7			1		26
Colorado only	Wrong material	12							12

precipitation type and the input of maintenance actions in an accurate and timely manner is a developing, but immature capability. Thus, the simulation of current road conditions is improving but is still prone to inconsistencies. All MDSS recommendations represent the most cost-effective solution to treat the existing dynamic layer or the likely change in the layer due to forecasted weather events; therefore it is critical that the simulated dynamic layer be accurate. The preponderance of responses in the “road condition doesn’t match MDSS” reason is a strong indication that more effort must be directed to improve the quality of the input parameters into MDSS.

The somewhat even distribution of answers above and below the expected application rate within the application rates category suggests that the DOT participants had difficulty accepting rates that were inconsistent with the practices that they have followed for years. During the implementation of the MDSS program, a couple of states have opted to follow the recommendations exactly even though they did not match their current best practices. DOT personnel in these states were surprised to find that the MDSS recommendations that differed from the approach they would normally use worked effectively. This observation does not negate the possibility that the application rate rejections are due to legitimate over or under recommended treatment rates associated with specific situations, but a common push back to MDSS is that it doesn’t duplicate the rates from our agency’s practices guidelines.

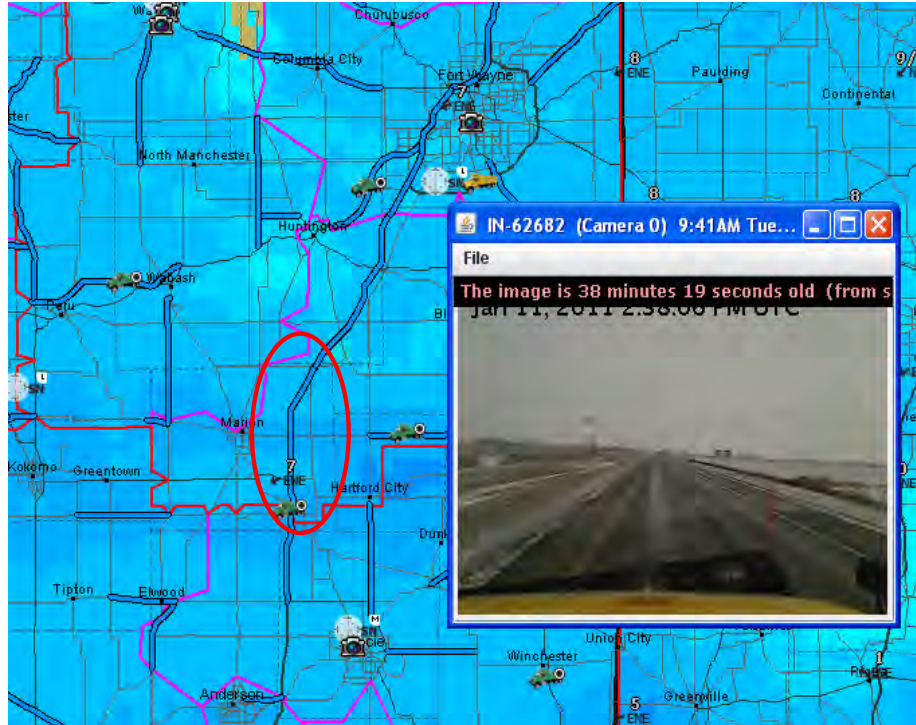
The comments box in the evaluation tool provided insight into a number of the selected reasons for rejecting the recommendation. A sample of these appears in the case study section that follows. The comments indicate that the reasoning process is far more complex than the

simple set of reasons devised for the evaluation. Participants also pointed out that the evaluation did not provide an option to enter reasons for treating roadways when MDSS generated no recommendation.

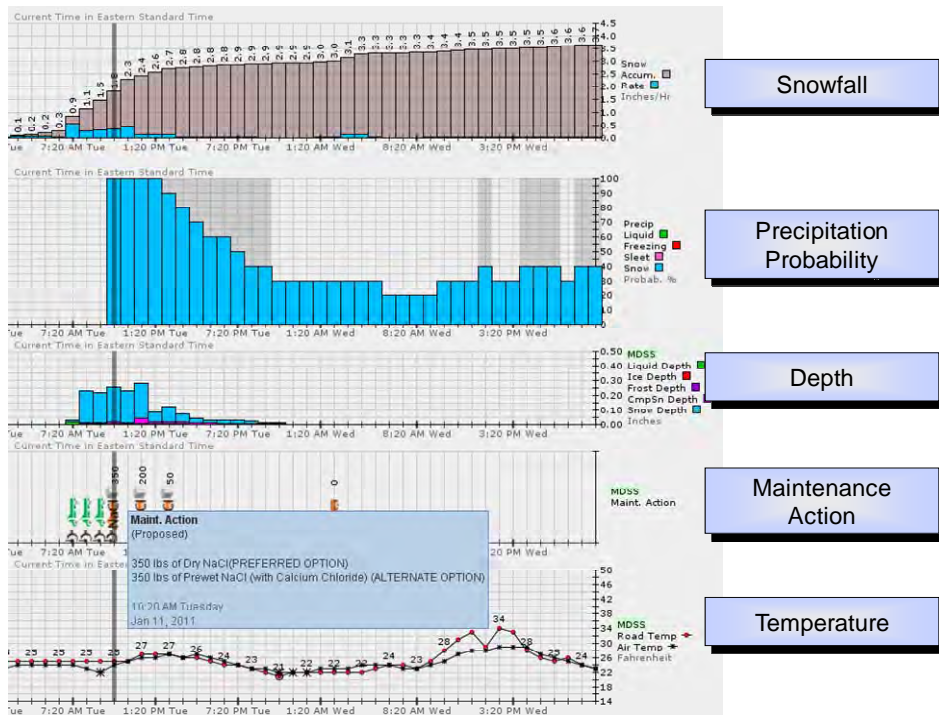
## CASE STUDIES

To gain a better understanding of the decision process the participants were using, the Meridian evaluation team captured images from the same time the participants entered their recommendation evaluations via the MDSS interface. This duplication process was possible because of a playback feature in MDSS that permits an MDSS user to reset the MDSS user interface to a specific time in the past. The MDSS program responds by presenting images exactly as the user would have seen them at that time. This capability permitted the evaluation team to view all the guidance the user had at the time of the decision. This includes the recommendations, observed and forecasted weather conditions, past and projected simulated road conditions, treatment actions, and camera imagery from the truck or roadside camera. Since many of the participant entries occurred in a sequence during a winter event, the evaluation team captured imagery throughout the storm to follow the evolution of the storm and how conditions and recommendations transpired. It also allowed the evaluation team to better understand the road conditions and correlate these conditions with the comments made by participants.

The evaluation team performed case studies on winter events in Colorado, Indiana, Kentucky, and Nebraska that lasted 6 h or more. Snapshots of the user interface images that the participants had available were captured at regular intervals throughout the event. An example of the information used in the analysis is shown in [Figures 2 and 3](#). The map view (Figure 2) provides a regional view of weather and road conditions at and around the IN-119 location. The route segment along I-69 is within red circle. All routes within Indiana's MDSS program are shown as bold overlays on the background map. In Figure 2, all of the overlaid lines are blue indicating that these roads are snow covered. The background blue–brown shading overlaid on the highway map represents the radar intensity with darker blue areas having heavier precipitation rates and the brown area with no precipitation measured by radar. Indiana has a number of trucks with AVL–MDC; the truck icons show the position of these trucks at 10:20 a.m. The snowflake icons represent the current weather at the National Weather Service (NWS) reporting sites, and the numbers with the cardinal wind directions directly below provide the wind information from the RWIS environmental sensor stations (ESS) in the displayed region. Users could change the NWS and ESS displays to present any observed parameter on the map. The evaluation team used this capability to look at specific ESS road condition reports, pavement temperatures, and weather conditions. For the situation in Figure 2, the ESS site is in the lower portion of the circled area. The camera image is a separate window that is overlaid on top of the map view. The most current image in Figure 2 that had been transferred by the AVL–MDC unit as of 10:20 a.m. was 38 min old. However, in the evaluation process it was possible to step through the images from a given truck and find an image close to the time of each snapshot in the analysis sequence.



**FIGURE 2** Map view covering Indiana route IN-119 on I-69 at 10:20 a.m. on January 11, 2011, with an overlaid picture from an in-cab camera.



**FIGURE 3** Route view of IN-119 current and forecasted conditions at 10:20 a.m. on January 11, 2011.

The route view (Figure 3) provides an analysis of conditions over the previous 24 h and a forecast of weather and pavement conditions for the next 24 h. The forecast period and part of the analysis are shown in Figure 3. The vertical gray line represents the current time on the graph. The depth portion of the graph derives from the simulation of the dynamic layer in the HiCAPS module of MDSS. It shows the depth of the liquid, snow, ice, and compacted snow layers resulting from the snowfall, traffic, and maintenance actions. The recommendations for the period of the storm are shown on the maintenance actions line. A highlight box displays the current recommendation and the one that the Indiana participant would have evaluated.

The 10:20 a.m. recommendation assessment was one of five submitted for the January 11 event in Indiana (Figure 4). Imagery similar to that in Figures 2 and 3 was collected for each of the other times in this case study listing. The listing contains the primary recommendation and an alternative for each of the evaluation times; whether the participant chose to accept, decline, or accept conditionally the recommendation; and, comments regarding the decision. The Accept/Decline column indicates the actual decision but the thought process is shown in the Comments/Reason cells. By reviewing the Accept/Decline decision and the comments associated with this decision in context of the weather and road condition scenario, the evaluation team was able to gain a much better understanding of the decision process participants went through in determining how to respond to the MDSS recommendation.

On the morning of January 11, the Indiana maintenance supervisor on route IN-119 was faced with a forecast of 3 in. of snow which was expected to fall between 6:00 a.m. and midnight followed by light snow or flurries. At 6:30 a.m., MDSS recommended an application of dry salt at 350 lb/lane mile. The supervisor accepted this recommendation conditionally at 7:30 a.m.

Time	Accept/Decline	Recommendation	Alternative	Comments/Reason
7:30 a.m. (6:30 a.m.)	Cond. Accept	Dry salt @ 350	Prewet Salt @ 350*	Started treating at 7:30 a.m. @ 350 lbs; probably plenty of salt maybe could have been less .
8:10 a.m. (8:20 a.m.)	Decline	Dry salt @ 350	Prewet Salt @ 350*	Forecast says we should have 1.8 in. on the ground and we have gotten approx. a tenth of an inch. We are treating at 200 lbs this round.
10:10 a.m. (10:20 a.m.)	Decline	Dry salt @ 250	Prewet Salt @ 250*	Road condition is getting worse starting to get thin ice layer. going to treat at 350 lbs this round. Last round was treated at 250 on the asphalt section and 300 on the concrete.
2:20 p.m. (1:00 p.m.)	Accept	Dry salt @ 200	Prewet Salt @ 200*	
6:30 p.m. (6:00 p.m.)	Decline	Patrol for trouble spots		Still getting light snow we thought it still needed salt or it would refreeze treated at 250 lbs per mile.

\*NOTE: Prewet chemical of calcium chloride.

**FIGURE 4 Recommendation evaluations associated with the weather event of January 11, 2011, for IN-119.**

feeling that it was appropriate to treat at the beginning of the storm to avoid any bonding of the early snowfall, but that a treatment rate of 350 lb/lane mile might be excessive for the amount of snow that had fallen and the supervisor's sense of how much snow was likely in the cycle time on the route. MDSS was generating the recommendation based on a forecast of 0.5 to 1 in. of snow during that cycle time. The supervisor's reservation about the recommendation rate seemed justified by the comment entered at 8:10 a.m. indicating they had only received a tenth of an inch of snow rather than the inch or more that was forecasted by that time. The recommendation at 8:10 was rejected and the supervisor went with a lower application rate of 200 lb/lane mile. The snowfall rate finally increased after 10:00 a.m. and snow and blowing snow started to create an issue on the highway. MDSS now recommended 250 lb/lane mile, but the supervisor felt that a heavier treatment was necessary to deal with the existing conditions and the potential effect of the projected snowfall. By midafternoon the effects of the residual salt from the morning treatments was keeping the pavement chemically wet with only minor amount of slush. The supervisor accepted the 2:20 p.m. recommendation of dry salt at 200 lb/lane mile to maintain the chemical wet situation and provide enough additional chemical to handle the additional 0.5 in. of snow projected in the next couple of hours. At 6:30 p.m., MDSS computed there was adequate chemical residue to maintain a thin layer of slush and allow traffic and evaporation to dry the road. However, the supervisor felt the thin layer of slush might refreeze during the night so the decision was made to treat the roads with 250 lb/lane mile of salt. It is conceivable that by patrolling the roadway and looking for spots where localized treatment was needed might have been a less costly approach; however, based on experience and a desire to avoid the potential risk of problems the recommendation to patrol only was rejected.

The Indiana scenario is a typical winter event situation. Forecasts tend to provide a smooth projection of snowfall amounts with a specified start time and subsequent end time. The snowfall forecast in Figure 2 is a good example. In reality, snowfall is more likely to occur in irregular bursts of snowfall associated with snow bands and the actual start and end times may be offset from the forecasted times. The HiCAPS model provides the most cost-effective approach to deal with the forecasted conditions based upon the short-term forecasted precipitation and associated weather conditions plus the initial road conditions. When the actual precipitation pattern differs from the short-term forecast, the recommendations may not match with currently observed conditions and a supervisor's assessment of the likely amount of precipitation in the short term. Thus, when precipitation is irregular, MDSS recommendations temporarily may become inappropriate. Once MDSS gets new input on the actual amount of precipitation and the actual road conditions, it adjusts the recommendations to fit the actual conditions. This is the situation that occurred in the Indiana scenario. In the first two responses, the supervisor is making decisions based on conditions that do not match what MDSS is using to make recommendations. The supervisor senses that the MDSS recommended rates are too high. However, once the snow starts to fall at the rate originally forecast (around 10:00 a.m.) the supervisor feels that the recommended rates are too low. The conditional acceptance and rejection at 7:30 and 8:10 are due to observations that do not match exactly with snowfall rates indicated in the forecast at the time of the decision. However, over the course of the cycle the recommendations may have been appropriate. The question the evaluation team feels must be considered regarding the 10:10 decision by the supervisor is whether the decision to use 200 lb/lane mile for the first application resulted in a need to catch up with the 350 lb/lane mile in the second application. If the user had followed both recommendations, would he have been better off?

In-depth analyses of actual storms with the associated review of participant's decisions suggest that the assessment of the performance of recommendations is a complex undertaking. The results indicate that MDSS recommendations may not represent effective guidance when MDSS does not have the correct current information or the short-term forecast is incorrect, improperly timed, or does not reflect the irregular manner of the precipitation event. However, if MDSS is providing the most cost-effective solution when it does have a correct assessment of the current road conditions and a reasonable forecast of short-term weather conditions, are decisions to decline the recommendation and adjust the treatment missing an opportunity to benefit from the MDSS recommendations? The case studies provide the ability to see those situations where MDSS recommendations appear to be inappropriate and offer reasons why they are wrong; however, they do not provide a method to assess whether a treatment action changed by a DOT participant from the recommended option was appropriate. This factor reflects back to the results presented in Table 1 since the case studies create an uncertainty regarding whether declined recommendations reflect issues with the recommendations or personal preferences of the DOT participant that do not match the MDSS recommendation.

## **FINDINGS AND CONCLUSIONS**

The evaluation indicates that an assessment of the performance of MDSS recommendations is a very complex process, and considerable thought is needed in the design of the data collection tool and the case study methods. The interface used during this first phase allowed a simple, short set of reasons for declining recommendations. The list was too abbreviated to adequately define the reasons or conditions that drove the decision to reject and needs to be expanded. However, any expansion in the reason options needs to be carefully weighed against the time it will take for participants to make their selections.

The involvement of the Meridian evaluation team and the use of case studies was an essential element in understanding the causes for acceptance or rejection of the MDSS recommendation. The case studies lay out the resource information available to the participant and provide the evaluation team with the ability to determine whether MDSS was working with similar information that the participant would have from DOT resources. There are known latencies in the transfer of data from ESS and NWS sites, AVL-MDC systems, cameras, and DOT field personnel. There are also quality and data interpretation issues with some of the measurement techniques, especially associated with road conditions and precipitation type, rate, and accumulation. The result is MDSS generates simulated conditions that do not match conditions that actually exist in the field at the current time that may result in incorrect recommendations based upon the incorrect inputs. Thus, this first phase of the assessment and evaluation of MDSS recommendations project indicates that tactical methods and processes need to be added to the MDSS data ingest and forecasting procedures. One solution is the implementation of a method that quickly reports back to the weather forecaster those parameters that do not match the prediction. This would allow the forecaster to adjust exceptions in the forecast thereby returning MDSS recommendations back to expectations more quickly.

Currently, DOT resource configurations for routes are done on a seasonal basis, and they have to be changed by the Meridian customer support team. While this serves as a good check and balance to ensure the proper resource allocations are in the MDSS database for each route, this method does not facilitate rapid adjustments in MDSS processing when a chemical is not

available or an agency opts to load a specific chemical. MDSS needs a module that permits DOT users to swiftly change available or preferred materials on a route as needed.

The input of road conditions and treatment actions may come from driver inputs at the truck, automated AVL–MDC measurements, or from supervisor input via the graphical user interface in the MDSS. The input process may not complete properly if a driver forgets to enter feedback, communications, or in-vehicle equipment fails or a supervisor is too busy to provide feedback. This break in the communication of field conditions or treatment actions causes MDSS to compute incorrect dynamic layer conditions that subsequently results in incorrect recommendations. An associated issue became evident in the case study evaluation. At times, DOT users did enter the appropriate information into MDSS from their end, but the transmission of the data took long enough that users did not see the impact of their submission and the recommendations that the user knew was incorrect was not rectified.

MDSS takes input from users, such as reports of road conditions and modifies the road conditions and associated recommendation. After a period of time, the influence of this report is superseded by road conditions generated by HiCAPS from more current information. If there are issues with the input used by HiCAPS then the incorrect road condition that the user corrected earlier returns. This frustrates MDSS users who take an active interest in keeping their information up to date.

## **FURTHER WORK NEEDED**

To increase the acceptance of MDSS recommendations, actions are necessary in three primary areas. First, the evaluation of recommendation acceptance needs to become an ongoing process. Lessons learned from this initial study should be used to establish a stable assessment instrument that can capture recommendation evaluations in ensuing years in a recurring manner. Meridian should establish criteria for its case study program to include who will be involved, how many case studies will be performed, what data should be collected, and how should it be organized and used to perform the evaluations. Also, if possible, a mechanism should be implemented to permit a broader base of users to simply indicate that they accepted or rejected the recommendation in order to establish a larger sample of responses.

Second, Meridian needs to take steps to minimize adverse impacts on recommendations caused by inadequate, incorrect, or delayed data, incorrect forecasts, and rapidly changing conditions. These include steps such as

- Ways to reduce the latency in acquisition of data from various sources,
- Methods to assure input data is accurate and interpreted properly,
- Development of a forecast monitoring system to capture forecasts that are inaccurate and a method for forecasters to correct the forecasts to alleviate the issue,
- Creation of an MDSS module to permit users to temporarily change resource configurations, and
- Refinement in MDSS processing to maximize integration of user input into HiCAPS logic.

Third, the MDSS technical panel and Meridian need to establish recommended standards for resource information that serves as input into MDSS. These would include data formats,



quality specifications, acceptable latencies, and interface protocols. The design and execution of the devices necessary to provide much of the essential data for MDSS is external to MDSS and the responsibility of other providers. Nevertheless, it is important that the PFS MDSS team takes the lead to assure that resources used in the future provide the desired information necessary to make the recommendation process work effectively.

## REFERENCES

1. Mewes, J. J., R. D. Hart, L. F. Osborne, and B. Podell. The Pooled Fund Study Maintenance Decision Support System: A Functional Overview. Presented at American Meteorological Society 21st International Conference on Interactive Information Processing Systems for Meteorology, Oceanography, and Hydrology, San Diego, California, 2005.
2. Mewes, J. J., R. D. Hart, L. F. Osborne, B. W. Hershey, and D. Huft. Maintenance Decision Support Systems: Research Progress and Continuing Needs. Presented at American Meteorological Society 24th International Conference on Interactive Information Processing Systems for Meteorology, Oceanography, and Hydrology, New Orleans, Louisiana, 2008.

# **Delivery Approaches and Performance Measures**



## DELIVERY APPROACHES AND PERFORMANCE MEASURES

## Evaluation of Three Methods for Delivery of Winter Operations Contracting

AMY BURLARLEY-HYLAND  
*DBi Services LLC*

Many states and localities subcontract part or all of their winter operations. DBi Services has three contracts with the Virginia Department of Transportation (DOT) that include winter operations. Each of these contracts is distinctly different in the manner in which winter work is managed, performed and paid for by Virginia DOT. The Woodrow Wilson Bridge contract is a full asset maintenance contract with the entire responsibility of management and operations of winter work resting with DBi Services. Payment for snow and ice operations is included in the lump sum monthly fee for all maintenance of this section of Interstate. The Northern Virginia Interstate 66 winter operations contract is a line item contract managed by Virginia DOT. DBi Services is paid by the hour for each piece of equipment that it provides and operates at the direction of Virginia DOT. The Staunton North Turnkey Asset Maintenance contract is a hybrid contract for winter operations work. DBi Services is completely responsible for winter operations up to a specific snowfall amount. Above that amount Virginia DOT reimburses DBi Services per inch of snowfall over 6 in. as measured at specific sites along the project corridor. The purpose of this paper is to describe each of these contract methods and compare and contrast the advantages and disadvantages of each. This information will assist those agencies currently contracting winter maintenance looking for additional options as well as agencies considering contracting winter operations in determining which method would be most beneficial for their particular application.

Providing safe transportation systems is one of the fundamental goals of department of transportation (DOTs). In many states this mission includes winter operations. Various methods were utilized to ensure that organizations were ready to perform winter operations safely and effectively. Some DOTs increased their staff with temporary workers to accommodate the increased workload of winter operations and some states supplemented their operations with contracts to private industry or to local governments. Over the years as budgets have become more constrained, DOTs sought to identify additional cost-effective means of providing winter operations.

### CONTRACTING MODELS

There are several models that are used to contract winter operations: traditional line item contracts, comprehensive performance based contracts, and hybrid contracts that combine elements of both. Each of these models has advantages and challenges. The following diagram depicts DBi Services' contracts with the Virginia DOT ([Table 1](#)).

**TABLE 1 DBi Services' Contracts with VDOT**

	<b>Routine Maintenance</b>	<b>Emergency Management</b>	<b>Bridge Inspection</b>	<b>Bridge Maintenance and Operations</b>	<b>Maintenance Rating Targets</b>	<b>Winter Operations</b>
I-66 Winter Operations	✓	✓	✓	✓	✓	✓
Woodrow Wilson Bridge Asset Management	✓	✓	✓	✓	✓	✓
Staunton North Asset Management	✓	✓		✓	✓	✓
Staunton South Asset Management	✓	✓		✓	✓	

### Interstate 66 Winter Operations

The I-66 winter operations contract is a traditional line item contract. Roadways include I-66, SR-267, and all associated ramps, connectors and frontage roads, from mile marker 13 (Linden exit) to the Washington, D.C., line for I-66, and from I-66 to the toll booths on SR-267. Included in this section of I-66 are high-occupancy vehicle lanes as well as a shoulder lane. This contract was let by the Virginia DOT in 2009 and is in its third year of providing winter operations.

Virginia DOT included a specific list of 112 pieces of equipment to be provided by the contractor including

- Fifty tandem-axle large dump trucks equipped with plows and spreaders,
- Forty-eight tandem-axle dump trucks with plows,
- Three loaders,
- One backhoe,
- One grader,
- One truck mounted snow blower,
- Eight anti-icing liquid application trucks, and
- Attenuator trucks as needed (attenuator trucks provide escort and traffic control for anti-icing and loader operations on the highway).

There is a mobilization payment for each piece of equipment paid to the contractor at the start of each winter once the equipment is inspected and approved for use on this contract by the Virginia DOT. The Virginia DOT provides all direction for winter operations on this contract including types and numbers of equipment to mobilize, time to mobilize, when and how much material to spread, when to stand by, and when to initiate clean-up operations. DBi Services provides the equipment and operators, mechanics, and field supervisors who directly supervise the equipment and relay directions to the staff from the Virginia DOT. All equipment is equipped with automatic vehicle location (AVL) which is reported in real-time on a website provided by DBi Services for use by the Virginia DOT and DBi.

This contract contains penalties if equipment is not available when requested by the Virginia DOT or if equipment breaks down and is not repaired or replaced within the required time frame. DBi Services is allowed 4 h to respond when notified by the Virginia DOT that an initial mobilization is required. A deduction of \$300 per unit per half hour is assessed for any equipment that is not present and ready for mobilization. If there is an equipment malfunction, repairs must be made within 1 h or a substitute piece of equipment must be mobilized in its place or the same deduction of \$300 per half hour will be assessed. If the AVL is not functional on a piece of equipment, it will be counted as not mobilized with the same \$300 per half-hour deduction.

The advantages of this contracting method to the Virginia DOT are

- The Virginia DOT is in complete control of how winter events are managed and
- The Virginia DOT can adjust operations as they desire to accommodate changes in conditions.

The disadvantages include the following:

- In years when winters are severe, the Virginia DOT runs the risk of significantly overrunning their winter budget;
- All risk is assumed by the Virginia DOT;
- The Virginia DOT can be subjected to pressure from constituents to perform at a higher level than their snow plan dictates;
- The Virginia DOT routinely has to guarantee minimum payments once the contractor is notified to respond, as well as pay an annual mobilization for each piece of equipment; and
- Tracking hourly equipment usage takes significant resources and staff to manage to verify invoices for payment.

Advantages for the contractor include

- Very little risk;
- Capital expenses that can be covered by mobilization fees; and
- Use of the Virginia DOT's infrastructure, including equipment yards and salt storage reduced cost.

Disadvantages for the contractor include

- The necessity to train and keep staff available for events that are infrequent;
- The need to keep large complements of equipment in good working order for a worst-case scenario winter event; and
- In years with mild winters, there may be few opportunities to make a profit.

### **Turnkey Asset Maintenance on the Woodrow Wilson Bridge**

This project includes full asset maintenance and operations of the Woodrow Wilson Bridge along with winter operations. Although this project is relatively short in length at approximately 10 centerline miles, it includes express and local lanes as well as complex ramps and

interchanges. Adequate performance for winter events is ensured through the contract specifications that dictate the condition that the roadways must be in but not the method of how DBi Services achieves this level of service. Failure to comply with contract requirement results in penalties for lack of performance. The following are performance specifications and penalties for winter operations.

During severe weather events all travel lanes, turn lanes, intersections, shoulders and interchanges, bridge operator parking lots and access facilities, enforcement areas and police parking locations shall be kept free of snow or ice so that traffic can proceed in a safe and orderly manner except in periods of heavy falling or drifting snow. During any times of precipitation, the contractor shall make a constant, continued, and diligent effort to treat and remove any snow or frozen precipitation from the roadway, and shall achieve complete removal of frozen precipitation from all travel surfaces including gore areas and crossovers within 2 h after the cessation of such precipitation. The contractor shall be responsible for the removal of any snow, ice, or combination thereof that may appear after the cessation of a drifting snow, refreezing of water, etc. At all times contractor shall ensure that snow removal operations (including plowing) do not obstruct other routes and shall not cause any connectors, gore areas or emergency crossovers to be obstructed.

The following time frames after the cessation of the severe weather event are for removal of frozen precipitation from nonvehicular surface areas (including multiuse trails and sidewalks):

- 0- to 4-in. accumulation within 12 h,
- >4- to 12-in. accumulation within 24 h,
- >12- to 18-in. accumulation within 36 h, and
- >18-in. accumulation within 48 h unless the department authorizes in writing an extension of time.

If the contractor fails to meet the time frames above, it will be assessed a non-vehicular surface area user cost of \$1,000 per event.

If the contractor fails to perform in accordance with the performance criteria set forth, the following remedies are applied.

#### *During the Snow and Ice Event*

In the event that any pavement travel lanes are not kept open, drivable, and passable during an event, a road user cost of \$2,350.00 per half-hour per lane mile per section of road (as defined in Section IV, Scope of Services, A. Route Plan Sheet) will be assessed until opened, drivable, and passable and deducted from the monthly payment to the contractor. The department shall consider the contractor's compliance with the severe weather plan as approved by the department in determining whether to assess road user costs.

Road user cost assessments will be deferred during times of heavy conditions provided the contractor was operating at 100% of the severe weather plan to remedy the situation and at least 50% of the travel lanes in each direction remain open, safe, and passable for traffic. The department is the final authority for making any such determinations ([Table 2](#)).

**TABLE 2 Tolerance and Criteria**

Asset	Outcome	Tolerance and Criteria
Severe weather, snow and ice control, tree and debris removal	Safe, effective, efficient	<p><b>Requirements:</b>                      During severe weather events and snow and ice events, all travel lanes, turn lanes, intersections, interchanges, and bridge operator parking areas and facilities shall be kept free of snow or ice.                      Contractor shall mobilize minimum equipment for the established level of mobilization prior to the start time as set in conjunction with the department in the conference call. Contractor may decide to increase amount of equipment to meet established requirements.                      Remove tree and debris so that traffic can proceed in a safe and orderly manner without service delay except in periods of heavy falling or drifting snow.</p> <p><b>Timeliness Requirement:</b>                      During time of precipitation, the Contractor shall make a constant and diligent effort to remove any snow or frozen precipitation from the roadway from the beginning of such precipitation to the end of such precipitation and shall achieve complete removal of frozen precipitation from all travel surfaces including shoulders, gore areas and crossovers within 2.0 hours after the cessation of such precipitation. The Contractor will be responsible for the removal of any snow or ice or combination thereof that may appear after the cessation of a Severe Weather Event (e.g., drifting snow, refreezing of water, etc.).                      If Contractor fails to respond with less than the set number of pieces, they will be assessed \$250.00 per piece of equipment with operator not on site per ½ hour.                      In case of equipment failure, Contractor shall have equipment repaired and back in operation or replaced within ½ hour or they will be assessed \$250.00 per ½ hour per piece of equipment not in service.</p> <p>The following time frames are for removal of precipitation from non-travel surface areas (including multi-use trails) after the cessation of the weather event:</p> <ul style="list-style-type: none"> <li>• 0 to 4-in. accumulation within 12 h.</li> <li>• &gt;4- to 12-in. accumulation within 24 h.</li> <li>• &gt;12- to 18-in. accumulation within 36 h.</li> <li>• &gt;18-in. accumulation within 48 h.</li> </ul> <p>During times of severe weather events, the contractor shall make a constant and diligent effort to remove trees and debris from the roadway, from the beginning of such events to the end of such events and shall achieve complete removal of the trees and debris from all travel surfaces including shoulders, gore areas, and crossovers within 2 h after the cessation of such an event. The contractor will be responsible for the removal of any trees or debris that may appear after the cessation of a severe weather event as specified under tree and brush performance criteria.</p>



### *After the Cessation of Precipitation*

In the event the contractor fails to meet the established deadlines required in the performance criteria, a road user cost of \$2,350.00 per half hour per lane mile per section of road is assessed until met. The contractor will not incur assessments if in the department's judgment prior conditions prohibited normal clean-up operations.

After a thorough review of the highway system, DBi Services prepared a comprehensive winter plan for operations to ensure that we consistently achieve compliance with the winter operations specifications. For this project, DBi Services' winter operations plan includes

- Thirty-five tandem-axle large dump trucks equipped with plows and spreaders,
- Two F-450 service trucks with plows for constrained locations,
- One Bobcat with plow for sidewalks and pedestrian facilities,
- Four loaders,
- Three graders,
- Two truck-mounted snow blowers,
- Three anti-icing liquid application trucks, and
- Three attenuator trucks (attenuator trucks provide escort and traffic control for anti-icing and loader operations on highways).

All of the equipment for this project is equipped with AVL and both the Virginia DOT and DBi Services can monitor the location and operations of all project equipment in real-time through a web-based interface.

Each year, DBi Services submits a winter operations plan to the Virginia DOT that details the type and number of equipment that are planned for each level of mobilization. Mobilization levels are rated from one to five and are determined by the forecast for an impending event. Once this plan is approved, DBi Services is completely responsible for determining all aspects of each winter event response.

Decisions made by DBi Services include

- Whether or not anti-icing will be beneficial,
- When to mobilize,
- How many pieces of equipment to mobilize,
- Where to stage equipment,
- When to begin plowing and spreading,
- When to begin echelon plowing operations,
- When and where to place equipment on standby,
- Strategy to handle winter operations in the direction of peak traffic flow,
- When to begin clean-up operations, and
- When the event is over.

All of this work is reviewed by the Virginia DOT and Maryland State Highway Administration (SHA) contract monitors. Condition of roadways, timeliness, and locations of equipment are confirmed by visual inspection in the field as well as through AVL reports and

intelligent transportation system cameras along the corridor. The advantages of this contracting method to the Virginia DOT and the SHA are the following:

- Budget costs are fixed so that the contractor absorbs any additional costs in years of extreme winter events.
- Oversight of operations is greatly reduced so that the Virginia DOT and the Maryland SHA do not need to track hours of operations for equipment for payment.
- Poor performance can be penalized, ensuring that services not provided are not paid.
- The contractor assumes the majority of the risk.
- The Virginia DOT and the Maryland SHA no longer have a large capital investment in equipment.

The disadvantages include the following:

- Staff is no longer in direct control of operations.
- The Virginia DOT and the Maryland SHA may be competing with the contractor for staff or materials for which they would normally be the sole source of procurement.
- Once staff and equipment are lost to subcontracting it is frequently difficult, if not impossible, to increase to prior staff and equipment levels if the contract is not renewed.
- There is no reduction in cost for mild winters.

Advantages for the contractor include the

- Ability to manage operations and
- The ability to utilize new technologies or methods.

Disadvantages for the contractor include

- The necessity to train and keep staff available for large events that are infrequent,
- The assumption of risk,
- The possibility of high penalties for poor performance,
- No additional payment for severe winters, and
- Higher cost for procurement of materials such as rock salt unless purchased from the Virginia DOT or the Maryland SHA.

### **Staunton North Turnkey Asset Maintenance Contract**

The Staunton North Contract was initially a full asset maintenance contract similar to the Woodrow Wilson Bridge contract. Maintenance and operations services are provided for 88 centerline miles of I-81 and 13 centerline miles of I-66 in the Virginia DOT's Staunton District. However, due to budget constraints, this contract was modified through a cooperative partnering process between the Virginia DOT and DBi Services to adjust the scope to meet the Virginia DOT's funding constraints.

The contract modification performed prior to award of the contract adjusted winter operations to a hybrid model which included full responsibility for winter operations cost and

outcomes for storms that do not exceed 6 in. in accumulation as measured at several National Weather Service monitoring stations along the project corridor. An additional payment per inch of accumulation over 6 in. is then implemented as soon as this condition is met. Given an average winter, this allows for a significant decrease in the lump sum cost and results in fair compensation to the contractor while allowing the Virginia DOT to absorb some risk for less likely major events. This modification was in place for the first winter of operations.

DBi Services utilizes the following four National Oceanic and Atmospheric Administration (NOAA) sites in the calculation of charges for snow and ice removal when snow or ice amounts exceed 6 in. at these NOAA sites:

- Front Royal, Virginia, ID 443229;
- Edinburg, Virginia, ID 442663;
- Harrisonburg, Virginia, ID 442208; and
- Staunton, Virginia, ID 448062.

For example: this will result in an \$80,000 additional payment to DBi Services if there is a 7-in. snowfall recorded at all four stations. If one of the NOAA sites ceases to record active data, DBi Services will identify a replacement site acceptable to the Virginia DOT. If no acceptable site can be located, additional payment will be based on three active NOAA sites and the additional payment per inch for storms over 6 in. will become \$26,666.67 per site. Likewise, should there be only two acceptable NOAA sites available the additional payment per inch for storms over 6 in. will become \$40,000 per site, etc.

The Virginia DOT also committed to provide, at no cost to DBi Services, any available plows and spreaders that normally would have been provided to private contractors that now would not be needed for the Virginia DOT operations. This does not include the Virginia DOT installation or maintenance of the units.

DBi Services provides the following equipment to fulfill its winter operations responsibilities:

- Forty-two tandem-axle large dump trucks equipped with plows and spreaders,
- Four loaders,
- Three graders,
- Four anti-icing liquid application trucks, and
- Two attenuator trucks.

The following are advantages of this hybrid contracting method to the Virginia DOT:

- Budget costs are fixed for the majority of winter events;
- Oversight of operations is reduced;
- Poor performance can be penalized, ensuring that services that are not provided are not paid for during smaller events; and
- The contractor assumes the majority of the risk for the majority of winter events.

The disadvantages include the following:

- Staff is no longer in direct control of most winter operations and

- Costs for major events that can have severe impacts on budgets.

Advantages for the contractor include

- Decreased risk and
- Less opportunity for penalties.

Disadvantages for the contractor include

- No relief in winters when there are frequent events with low accumulation and
- The possibility of constraints to employing new or innovative winter operations technologies.

There is currently a second modification under consideration. This modification would further reduce winter responsibilities and risk for DBi Services and may reduce costs for the Virginia DOT. This modification would be achieved by eliminating the payment for storms in excess of 6 in. of accumulation and instead allowing the Virginia DOT to supervise and mobilize additional equipment and operators during more severe events. This equipment and these operators can be either the Virginia DOT staff and equipment or the Virginia DOT-contracted staff and equipment. Once a major event is predicted, the Virginia DOT would take control of the management of all winter operations and direct DBi Services and any other contractors or staff that Virginia DOT mobilizes until the event is over.

The following are the advantages of this hybrid contracting method to the Virginia DOT:

- Budget costs are fixed for the majority of winter events.
- Oversight of operations is reduced for the majority of events.
- Poor performance can be penalized, ensuring that services not provided are not paid for during smaller events.
- The contractor assumes the majority of the risk for the majority of winter events.

The following are disadvantages:

- Staff is no longer in direct control of most winter operations.
- It may be difficult to redirect staff or subcontractors to the Interstate when there is a major event.
  - Subcontractors who do not routinely work on the Interstate may not be familiar with the winter operations plan and may not have knowledge of the area and specific issues such as cold spots or bridge joints that are at the same angle as plows and can be a hazard.
  - Coordination and communication may be more difficult, especially if there are several supplemental subcontractors who may utilize different technologies for communication.
  - There is an increased possibility for safety issues and damage to facilities utilizing contractors who are not familiar with the area.
  - Costs for major events can have severe impacts on budgets.

Advantages for the contractor include

- Decreased risk and
- Less opportunity for penalties.

Disadvantages for the contractor include the following:

- Opportunity for poor communication and coordination.
- Lack of ability to control additional subcontractors; for instance, if plows damage shoulders or guardrails it may be difficult to identify the responsible party.
- Risk of safety issues with additional subcontractors.

## **CONCLUSION**

There are many options when designing a subcontract for winter operations. Subcontracts can be tailored to the agency's specific needs and budget constraints. As described in this paper, the Virginia DOT's current winter operations contracts with DBi Services contain three distinctly different specifications. All of these have their own advantages and disadvantages for both the owner agency and the contractor. A decision regarding the best method of contracting has to take into account many factors including the agency's desire and ability to assume risk, budgetary constraints, and statutory regulations that may preclude the use of some contracting vehicles.

# **Delivery Approaches and Performance Measures**



## DELIVERY APPROACHES AND PERFORMANCE MEASURES

## Evaluation of Three Methods for Delivery of Winter Operations Contracting

AMY BURLARLEY-HYLAND  
*DBi Services LLC*

Many states and localities subcontract part or all of their winter operations. DBi Services has three contracts with the Virginia Department of Transportation (DOT) that include winter operations. Each of these contracts is distinctly different in the manner in which winter work is managed, performed and paid for by Virginia DOT. The Woodrow Wilson Bridge contract is a full asset maintenance contract with the entire responsibility of management and operations of winter work resting with DBi Services. Payment for snow and ice operations is included in the lump sum monthly fee for all maintenance of this section of Interstate. The Northern Virginia Interstate 66 winter operations contract is a line item contract managed by Virginia DOT. DBi Services is paid by the hour for each piece of equipment that it provides and operates at the direction of Virginia DOT. The Staunton North Turnkey Asset Maintenance contract is a hybrid contract for winter operations work. DBi Services is completely responsible for winter operations up to a specific snowfall amount. Above that amount Virginia DOT reimburses DBi Services per inch of snowfall over 6 in. as measured at specific sites along the project corridor. The purpose of this paper is to describe each of these contract methods and compare and contrast the advantages and disadvantages of each. This information will assist those agencies currently contracting winter maintenance looking for additional options as well as agencies considering contracting winter operations in determining which method would be most beneficial for their particular application.

Providing safe transportation systems is one of the fundamental goals of department of transportation (DOTs). In many states this mission includes winter operations. Various methods were utilized to ensure that organizations were ready to perform winter operations safely and effectively. Some DOTs increased their staff with temporary workers to accommodate the increased workload of winter operations and some states supplemented their operations with contracts to private industry or to local governments. Over the years as budgets have become more constrained, DOTs sought to identify additional cost-effective means of providing winter operations.

### CONTRACTING MODELS

There are several models that are used to contract winter operations: traditional line item contracts, comprehensive performance based contracts, and hybrid contracts that combine elements of both. Each of these models has advantages and challenges. The following diagram depicts DBi Services' contracts with the Virginia DOT ([Table 1](#)).



**TABLE 1 DBi Services' Contracts with VDOT**

	<b>Routine Maintenance</b>	<b>Emergency Management</b>	<b>Bridge Inspection</b>	<b>Bridge Maintenance and Operations</b>	<b>Maintenance Rating Targets</b>	<b>Winter Operations</b>
I-66 Winter Operations	✓	✓	✓	✓	✓	✓
Woodrow Wilson Bridge Asset Management	✓	✓	✓	✓	✓	✓
Staunton North Asset Management	✓	✓		✓	✓	✓
Staunton South Asset Management	✓	✓		✓	✓	

### Interstate 66 Winter Operations

The I-66 winter operations contract is a traditional line item contract. Roadways include I-66, SR-267, and all associated ramps, connectors and frontage roads, from mile marker 13 (Linden exit) to the Washington, D.C., line for I-66, and from I-66 to the toll booths on SR-267. Included in this section of I-66 are high-occupancy vehicle lanes as well as a shoulder lane. This contract was let by the Virginia DOT in 2009 and is in its third year of providing winter operations.

Virginia DOT included a specific list of 112 pieces of equipment to be provided by the contractor including

- Fifty tandem-axle large dump trucks equipped with plows and spreaders,
- Forty-eight tandem-axle dump trucks with plows,
- Three loaders,
- One backhoe,
- One grader,
- One truck mounted snow blower,
- Eight anti-icing liquid application trucks, and
- Attenuator trucks as needed (attenuator trucks provide escort and traffic control for anti-icing and loader operations on the highway).

There is a mobilization payment for each piece of equipment paid to the contractor at the start of each winter once the equipment is inspected and approved for use on this contract by the Virginia DOT. The Virginia DOT provides all direction for winter operations on this contract including types and numbers of equipment to mobilize, time to mobilize, when and how much material to spread, when to stand by, and when to initiate clean-up operations. DBi Services provides the equipment and operators, mechanics, and field supervisors who directly supervise the equipment and relay directions to the staff from the Virginia DOT. All equipment is equipped with automatic vehicle location (AVL) which is reported in real-time on a website provided by DBi Services for use by the Virginia DOT and DBi.

This contract contains penalties if equipment is not available when requested by the Virginia DOT or if equipment breaks down and is not repaired or replaced within the required time frame. DBi Services is allowed 4 h to respond when notified by the Virginia DOT that an initial mobilization is required. A deduction of \$300 per unit per half hour is assessed for any equipment that is not present and ready for mobilization. If there is an equipment malfunction, repairs must be made within 1 h or a substitute piece of equipment must be mobilized in its place or the same deduction of \$300 per half hour will be assessed. If the AVL is not functional on a piece of equipment, it will be counted as not mobilized with the same \$300 per half-hour deduction.

The advantages of this contracting method to the Virginia DOT are

- The Virginia DOT is in complete control of how winter events are managed and
- The Virginia DOT can adjust operations as they desire to accommodate changes in conditions.

The disadvantages include the following:

- In years when winters are severe, the Virginia DOT runs the risk of significantly overrunning their winter budget;
- All risk is assumed by the Virginia DOT;
- The Virginia DOT can be subjected to pressure from constituents to perform at a higher level than their snow plan dictates;
- The Virginia DOT routinely has to guarantee minimum payments once the contractor is notified to respond, as well as pay an annual mobilization for each piece of equipment; and
- Tracking hourly equipment usage takes significant resources and staff to manage to verify invoices for payment.

Advantages for the contractor include

- Very little risk;
- Capital expenses that can be covered by mobilization fees; and
- Use of the Virginia DOT's infrastructure, including equipment yards and salt storage reduced cost.

Disadvantages for the contractor include

- The necessity to train and keep staff available for events that are infrequent;
- The need to keep large complements of equipment in good working order for a worst-case scenario winter event; and
- In years with mild winters, there may be few opportunities to make a profit.

### **Turnkey Asset Maintenance on the Woodrow Wilson Bridge**

This project includes full asset maintenance and operations of the Woodrow Wilson Bridge along with winter operations. Although this project is relatively short in length at approximately 10 centerline miles, it includes express and local lanes as well as complex ramps and

interchanges. Adequate performance for winter events is ensured through the contract specifications that dictate the condition that the roadways must be in but not the method of how DBi Services achieves this level of service. Failure to comply with contract requirement results in penalties for lack of performance. The following are performance specifications and penalties for winter operations.

During severe weather events all travel lanes, turn lanes, intersections, shoulders and interchanges, bridge operator parking lots and access facilities, enforcement areas and police parking locations shall be kept free of snow or ice so that traffic can proceed in a safe and orderly manner except in periods of heavy falling or drifting snow. During any times of precipitation, the contractor shall make a constant, continued, and diligent effort to treat and remove any snow or frozen precipitation from the roadway, and shall achieve complete removal of frozen precipitation from all travel surfaces including gore areas and crossovers within 2 h after the cessation of such precipitation. The contractor shall be responsible for the removal of any snow, ice, or combination thereof that may appear after the cessation of a drifting snow, refreezing of water, etc. At all times contractor shall ensure that snow removal operations (including plowing) do not obstruct other routes and shall not cause any connectors, gore areas or emergency crossovers to be obstructed.

The following time frames after the cessation of the severe weather event are for removal of frozen precipitation from nonvehicular surface areas (including multiuse trails and sidewalks):

- 0- to 4-in. accumulation within 12 h,
- >4- to 12-in. accumulation within 24 h,
- >12- to 18-in. accumulation within 36 h, and
- >18-in. accumulation within 48 h unless the department authorizes in writing an extension of time.

If the contractor fails to meet the time frames above, it will be assessed a non-vehicular surface area user cost of \$1,000 per event.

If the contractor fails to perform in accordance with the performance criteria set forth, the following remedies are applied.

#### *During the Snow and Ice Event*

In the event that any pavement travel lanes are not kept open, drivable, and passable during an event, a road user cost of \$2,350.00 per half-hour per lane mile per section of road (as defined in Section IV, Scope of Services, A. Route Plan Sheet) will be assessed until opened, drivable, and passable and deducted from the monthly payment to the contractor. The department shall consider the contractor's compliance with the severe weather plan as approved by the department in determining whether to assess road user costs.

Road user cost assessments will be deferred during times of heavy conditions provided the contractor was operating at 100% of the severe weather plan to remedy the situation and at least 50% of the travel lanes in each direction remain open, safe, and passable for traffic. The department is the final authority for making any such determinations ([Table 2](#)).

**TABLE 2 Tolerance and Criteria**

Asset	Outcome	Tolerance and Criteria
Severe weather, snow and ice control, tree and debris removal	Safe, effective, efficient	<p><b>Requirements:</b>                      During severe weather events and snow and ice events, all travel lanes, turn lanes, intersections, interchanges, and bridge operator parking areas and facilities shall be kept free of snow or ice.                      Contractor shall mobilize minimum equipment for the established level of mobilization prior to the start time as set in conjunction with the department in the conference call. Contractor may decide to increase amount of equipment to meet established requirements.                      Remove tree and debris so that traffic can proceed in a safe and orderly manner without service delay except in periods of heavy falling or drifting snow.</p> <p><b>Timeliness Requirement:</b>                      During time of precipitation, the Contractor shall make a constant and diligent effort to remove any snow or frozen precipitation from the roadway from the beginning of such precipitation to the end of such precipitation and shall achieve complete removal of frozen precipitation from all travel surfaces including shoulders, gore areas and crossovers within 2.0 hours after the cessation of such precipitation. The Contractor will be responsible for the removal of any snow or ice or combination thereof that may appear after the cessation of a Severe Weather Event (e.g., drifting snow, refreezing of water, etc.).                      If Contractor fails to respond with less than the set number of pieces, they will be assessed \$250.00 per piece of equipment with operator not on site per ½ hour.                      In case of equipment failure, Contractor shall have equipment repaired and back in operation or replaced within ½ hour or they will be assessed \$250.00 per ½ hour per piece of equipment not in service.</p> <p>The following time frames are for removal of precipitation from non-travel surface areas (including multi-use trails) after the cessation of the weather event:</p> <ul style="list-style-type: none"> <li>• 0 to 4-in. accumulation within 12 h.</li> <li>• &gt;4- to 12-in. accumulation within 24 h.</li> <li>• &gt;12- to 18-in. accumulation within 36 h.</li> <li>• &gt;18-in. accumulation within 48 h.</li> </ul> <p>During times of severe weather events, the contractor shall make a constant and diligent effort to remove trees and debris from the roadway, from the beginning of such events to the end of such events and shall achieve complete removal of the trees and debris from all travel surfaces including shoulders, gore areas, and crossovers within 2 h after the cessation of such an event. The contractor will be responsible for the removal of any trees or debris that may appear after the cessation of a severe weather event as specified under tree and brush performance criteria.</p>

### *After the Cessation of Precipitation*

In the event the contractor fails to meet the established deadlines required in the performance criteria, a road user cost of \$2,350.00 per half hour per lane mile per section of road is assessed until met. The contractor will not incur assessments if in the department's judgment prior conditions prohibited normal clean-up operations.

After a thorough review of the highway system, DBi Services prepared a comprehensive winter plan for operations to ensure that we consistently achieve compliance with the winter operations specifications. For this project, DBi Services' winter operations plan includes

- Thirty-five tandem-axle large dump trucks equipped with plows and spreaders,
- Two F-450 service trucks with plows for constrained locations,
- One Bobcat with plow for sidewalks and pedestrian facilities,
- Four loaders,
- Three graders,
- Two truck-mounted snow blowers,
- Three anti-icing liquid application trucks, and
- Three attenuator trucks (attenuator trucks provide escort and traffic control for anti-icing and loader operations on highways).

All of the equipment for this project is equipped with AVL and both the Virginia DOT and DBi Services can monitor the location and operations of all project equipment in real-time through a web-based interface.

Each year, DBi Services submits a winter operations plan to the Virginia DOT that details the type and number of equipment that are planned for each level of mobilization. Mobilization levels are rated from one to five and are determined by the forecast for an impending event. Once this plan is approved, DBi Services is completely responsible for determining all aspects of each winter event response.

Decisions made by DBi Services include

- Whether or not anti-icing will be beneficial,
- When to mobilize,
- How many pieces of equipment to mobilize,
- Where to stage equipment,
- When to begin plowing and spreading,
- When to begin echelon plowing operations,
- When and where to place equipment on standby,
- Strategy to handle winter operations in the direction of peak traffic flow,
- When to begin clean-up operations, and
- When the event is over.

All of this work is reviewed by the Virginia DOT and Maryland State Highway Administration (SHA) contract monitors. Condition of roadways, timeliness, and locations of equipment are confirmed by visual inspection in the field as well as through AVL reports and

intelligent transportation system cameras along the corridor. The advantages of this contracting method to the Virginia DOT and the SHA are the following:

- Budget costs are fixed so that the contractor absorbs any additional costs in years of extreme winter events.
- Oversight of operations is greatly reduced so that the Virginia DOT and the Maryland SHA do not need to track hours of operations for equipment for payment.
- Poor performance can be penalized, ensuring that services not provided are not paid.
- The contractor assumes the majority of the risk.
- The Virginia DOT and the Maryland SHA no longer have a large capital investment in equipment.

The disadvantages include the following:

- Staff is no longer in direct control of operations.
- The Virginia DOT and the Maryland SHA may be competing with the contractor for staff or materials for which they would normally be the sole source of procurement.
- Once staff and equipment are lost to subcontracting it is frequently difficult, if not impossible, to increase to prior staff and equipment levels if the contract is not renewed.
- There is no reduction in cost for mild winters.

Advantages for the contractor include the

- Ability to manage operations and
- The ability to utilize new technologies or methods.

Disadvantages for the contractor include

- The necessity to train and keep staff available for large events that are infrequent,
- The assumption of risk,
- The possibility of high penalties for poor performance,
- No additional payment for severe winters, and
- Higher cost for procurement of materials such as rock salt unless purchased from the Virginia DOT or the Maryland SHA.

### **Staunton North Turnkey Asset Maintenance Contract**

The Staunton North Contract was initially a full asset maintenance contract similar to the Woodrow Wilson Bridge contract. Maintenance and operations services are provided for 88 centerline miles of I-81 and 13 centerline miles of I-66 in the Virginia DOT's Staunton District. However, due to budget constraints, this contract was modified through a cooperative partnering process between the Virginia DOT and DBi Services to adjust the scope to meet the Virginia DOT's funding constraints.

The contract modification performed prior to award of the contract adjusted winter operations to a hybrid model which included full responsibility for winter operations cost and

outcomes for storms that do not exceed 6 in. in accumulation as measured at several National Weather Service monitoring stations along the project corridor. An additional payment per inch of accumulation over 6 in. is then implemented as soon as this condition is met. Given an average winter, this allows for a significant decrease in the lump sum cost and results in fair compensation to the contractor while allowing the Virginia DOT to absorb some risk for less likely major events. This modification was in place for the first winter of operations.

DBi Services utilizes the following four National Oceanic and Atmospheric Administration (NOAA) sites in the calculation of charges for snow and ice removal when snow or ice amounts exceed 6 in. at these NOAA sites:

- Front Royal, Virginia, ID 443229;
- Edinburg, Virginia, ID 442663;
- Harrisonburg, Virginia, ID 442208; and
- Staunton, Virginia, ID 448062.

For example: this will result in an \$80,000 additional payment to DBi Services if there is a 7-in. snowfall recorded at all four stations. If one of the NOAA sites ceases to record active data, DBi Services will identify a replacement site acceptable to the Virginia DOT. If no acceptable site can be located, additional payment will be based on three active NOAA sites and the additional payment per inch for storms over 6 in. will become \$26,666.67 per site. Likewise, should there be only two acceptable NOAA sites available the additional payment per inch for storms over 6 in. will become \$40,000 per site, etc.

The Virginia DOT also committed to provide, at no cost to DBi Services, any available plows and spreaders that normally would have been provided to private contractors that now would not be needed for the Virginia DOT operations. This does not include the Virginia DOT installation or maintenance of the units.

DBi Services provides the following equipment to fulfill its winter operations responsibilities:

- Forty-two tandem-axle large dump trucks equipped with plows and spreaders,
- Four loaders,
- Three graders,
- Four anti-icing liquid application trucks, and
- Two attenuator trucks.

The following are advantages of this hybrid contracting method to the Virginia DOT:

- Budget costs are fixed for the majority of winter events;
- Oversight of operations is reduced;
- Poor performance can be penalized, ensuring that services that are not provided are not paid for during smaller events; and
- The contractor assumes the majority of the risk for the majority of winter events.

The disadvantages include the following:

- Staff is no longer in direct control of most winter operations and

- Costs for major events that can have severe impacts on budgets.

Advantages for the contractor include

- Decreased risk and
- Less opportunity for penalties.

Disadvantages for the contractor include

- No relief in winters when there are frequent events with low accumulation and
- The possibility of constraints to employing new or innovative winter operations technologies.

There is currently a second modification under consideration. This modification would further reduce winter responsibilities and risk for DBi Services and may reduce costs for the Virginia DOT. This modification would be achieved by eliminating the payment for storms in excess of 6 in. of accumulation and instead allowing the Virginia DOT to supervise and mobilize additional equipment and operators during more severe events. This equipment and these operators can be either the Virginia DOT staff and equipment or the Virginia DOT-contracted staff and equipment. Once a major event is predicted, the Virginia DOT would take control of the management of all winter operations and direct DBi Services and any other contractors or staff that Virginia DOT mobilizes until the event is over.

The following are the advantages of this hybrid contracting method to the Virginia DOT:

- Budget costs are fixed for the majority of winter events.
- Oversight of operations is reduced for the majority of events.
- Poor performance can be penalized, ensuring that services not provided are not paid for during smaller events.
- The contractor assumes the majority of the risk for the majority of winter events.

The following are disadvantages:

- Staff is no longer in direct control of most winter operations.
- It may be difficult to redirect staff or subcontractors to the Interstate when there is a major event.
  - Subcontractors who do not routinely work on the Interstate may not be familiar with the winter operations plan and may not have knowledge of the area and specific issues such as cold spots or bridge joints that are at the same angle as plows and can be a hazard.
  - Coordination and communication may be more difficult, especially if there are several supplemental subcontractors who may utilize different technologies for communication.
  - There is an increased possibility for safety issues and damage to facilities utilizing contractors who are not familiar with the area.
  - Costs for major events can have severe impacts on budgets.

Advantages for the contractor include



- Decreased risk and
- Less opportunity for penalties.

Disadvantages for the contractor include the following:

- Opportunity for poor communication and coordination.
- Lack of ability to control additional subcontractors; for instance, if plows damage shoulders or guardrails it may be difficult to identify the responsible party.
- Risk of safety issues with additional subcontractors.

## **CONCLUSION**

There are many options when designing a subcontract for winter operations. Subcontracts can be tailored to the agency's specific needs and budget constraints. As described in this paper, the Virginia DOT's current winter operations contracts with DBi Services contain three distinctly different specifications. All of these have their own advantages and disadvantages for both the owner agency and the contractor. A decision regarding the best method of contracting has to take into account many factors including the agency's desire and ability to assume risk, budgetary constraints, and statutory regulations that may preclude the use of some contracting vehicles.

## DELIVERY APPROACHES AND PERFORMANCE MEASURES

## Research Programs for Winter Road Maintenance in Third Medium-Term Plan of Public Works Research Institute of Japan

**MOTOKI ASANO**  
**MASAYOSHI WATANABE**  
**MASARU MATSUZAWA**  
**MASAYUKI KUMAGAI**  
**YUJI YANAGISAWA**

*Civil Engineering Research Institute for Cold Region of  
Public Works Research Institute, Japan*

Recent years have seen an increased need for efficient and effective improvement of winter road characteristics to promote favorable socioeconomic conditions and quality of life under the constraints of today's challenging financial environment. At the same time, Japan is influenced by extreme regional heavy snowfall, windstorms, and abnormal warm winds, which have caused intensification of snow and ice-related accidents and a change in the characteristics of disaster occurrence in recent years. As many factors related to the attribution of such disasters are not yet understood, clarifying them and developing countermeasure technologies are important considerations. The Public Works Research Institute has implemented research programs under 5-years medium-term research plans in recent decades. The third such plan, started in FY 2011 (April 2011 to March 2012), includes 16 research projects in five categories. Two of these projects are related to winter road maintenance. One of these two projects is called Research on Winter Road Performance Improvement Technologies and has five individual study programs titled as follows: (a) Study on Decision Support Technology for Winter Road Surface Maintenance Using Continuous Friction Testers; (b) Study on the Development of Efficient Composite Road Surface Maintenance Technology; (c) Study on Technology for Efficient and Effective Snow Removal Management Using information and communication technology; (d) Study on Technology for Sidewalk Surface Maintenance; and (e) Study on the Development of Measures to Prevent Lane Deviation in Suburban Areas. The other winter-related research project is titled Research on Technologies for Reducing Snow-Ice Disasters and has four individual study programs titled as follows: (a) Study on Changes in Snow-Ice Environments under the Influence of Climate Change; (b) Study on the Development of Technology for Forecasting Large Snowstorms-Induced Poor Visibility; (c) Study on Technology for Continuous Evaluation of Snowstorm Risk Along Routes; and (d) Study on Technology for the Evaluation of Avalanche Risk Accompanying Rainfall in Winter. This paper presents an outline of the third medium-term plan of the Public Works Research Institute of Japan.

### MEDIUM-TERM PLANS OF THE PUBLIC WORKS RESEARCH INSTITUTE

The Public Works Research Institute implements operations according to medium-term plans developed with the aim of achieving the medium-term goals set by the Minister of Land, Infrastructure, Transport and Tourism, and receives assessment from third-party experts.

Following on from research conducted in accordance with the first two 5-year medium-term plans since the institute's establishment in 2001, the third such plan was developed in 2011.

### THIRD MEDIUM-TERM PLAN

The four goals of the social demand-based third medium-term plan are: (a) realization of a safe, secure society; (b) establishment of a sustainable society through green innovation; (c) strategic maintenance and lifetime prolongation for elements of infrastructure; and (d) international contribution to civil engineering.

Focus will be placed on research necessary to achieve the following: prevention and reduction of damage caused by disasters and early recovery in the event of damage (for the goal of realizing a safe, secure society); utilization of renewable energy and realization of a low-carbon, low-environmental-impact sustainable society where symbiosis between people and nature is preserved (for the goal of establishing a sustainable society through green innovation); efficient infrastructure maintenance, enhancement of the primary functions of infrastructure, and promotion of social optimization and lifetime prolongation of infrastructure (for the goal of strategic maintenance and lifetime prolongation for elements of infrastructure); and promotion of support for international organizations and developing countries and international contribution (for the goal of international contribution to civil engineering).

To these ends, the third medium-term plan includes 16 research projects:

- Technical development to prevent or mitigate the increased number of water-related disasters stemming from climate change and other factors;
  - Development of disaster mitigation and early restoration technologies for large-scale landslides and other disasters;
  - Research on securing the functions of diverse structures based on seismic performance;
    - Research on technologies for reducing snow–ice disasters;
    - Research on technologies for efficient utilization of information on disasters and disaster prevention;
    - Research on technologies for the utilization and regional introduction of renewable energy and fertilizers made from waste-based biomass;
    - Development of low-carbon, low-environmental-impact construction materials and technologies using recycled materials;
    - Development of effective channel design–management technologies for preservation and restoration of river ecosystems;
    - Clarification of sediment movement characteristics in rivers and research on related river environment impacts and protection technologies;
    - Identification of the dynamic state of substances on a basin-wide scale and water quality control technologies;
    - Research on technologies to preserve ecosystems in response to global environment change;
    - Consolidation of the functions of food production bases for adaptation to environmental change and establishment of sustainable systems;
    - Research on the development and systematization of maintenance/management technologies for life prolongation of infrastructure stock;
    - Technical development for maintenance of the functions of structures in cold natural environments;
    - Development of technologies to enhance the functions and improve the durability of

infrastructure; and

- Research on winter road performance improvement technology.

Among these, the two projects related to winter roads are research on winter road performance improvement technology and research on technologies for reducing snow and ice disasters.

## **RESEARCH ON WINTER ROAD PERFORMANCE IMPROVEMENT TECHNOLOGIES**

This project will address the development of technologies relating to the evaluation, maintenance decision support, and countermeasures for winter road surface maintenance, which have an enormous impact on winter road performance, with the aim of maintaining and improving the performance (e.g., mobility, safety, and reliability). It will also deal with technical development for improved snow removal efficiency over entire routes and sections, improved winter sidewalk safety and reliability, as well as countermeasures for winter traffic accidents.

To achieve these goals, the following five specific studies are planned and will be individually summarized:

- Study on Decision Support Technology for Winter Road Surface Maintenance Using Continuous Friction Testers,
- Study on the Development of Efficient Composite Road Surface Maintenance Technology,
- Study on Technology for Efficient and Effective snow Removal Management Using Information and Communication Technology (ICT),
- Study on Technology for Sidewalk Surface Maintenance, and
- Study on the Development of Measures to Prevent Lane Deviation in Suburban Areas.

### **Study on Decision Support Technology for Winter Road Surface Maintenance Using Continuous Friction Testers**

In this study, research will be conducted to achieve the following goals for the development of technologies to support decision making in winter road surface maintenance (Figure 1).

#### *Examination of the Appropriateness of Winter Road Surface Maintenance*

Skid resistance will be evaluated before and after the implementation of operations to accumulate data for use in determining their effects and verifying the appropriateness of their execution and management.

#### *Determination of Skid Properties on Routes and Establishment of Diagnostic Technology*

Based on the skid resistance of road surfaces as well as weather, road structures, and other factors, technologies will be established to diagnose the tendencies of winter road surface conditions (slipperiness) and identify sections and conditions requiring attention.



**FIGURE 1** Continuo us friction tester.

*Establishment of Technology for Decision Support in Winter Road Surface Maintenance Based on Road Weather and Diagnostic Technology*

Technology to support judgment of weather conditions, sections, timing and other factors relating to the commencement of operations will be established and presented based on accumulated data relating to weather and skidding.

**Study on the Development of Efficient Composite Road Surface Maintenance Technology**

This study will be conducted to achieve the goals listed below.

*Establishment of Technology for Effective and Efficient Antifreezing Agent Application Depending on Pavement Types*

Effective and efficient antifreezing agent application technology depending on pavement types will be considered by clarifying application status and evaluating the effects of application for different kinds of pavement surface (Figure 2).

*Establishment of Technology for Frozen Road Surface Treatment in Combination with Improvements to Antifreezing Agents, Application Technologies, and Machinery*

Effective and efficient frozen road surface treatment technology will be considered through improvements to nonchloride antifreezing agents, application technology, and application machinery and by testing the combined effects of these improvements on test roads and actual roads.

**Study on Technology for Efficient and Effective Snow Removal Management Using ICT**

To develop technology for optimal judgment on the dispatch of snow removal machinery and snow removal operation support, this study will be conducted to achieve the goals listed below.

*Establishment of Technology for Analysis and Evaluation of Snow Removal Operation Efficiency Through Visualization of Weather and Snow Removal Machine Operation Information*

First, weather information and data on the locations and operations of snow removal machinery in the snow removal machine management system will be visualized on a chart that indicates changes of conditions and formations of snow removal machines passed by the time. Through the visualization, surveys will be conducted on changes in operation speed and echelon formation of snow removal machines, timing of snow removal in relation to adjoining sections and other matters. Next, inefficiency and waste in current snow removal operations will be



**FIGURE 2** Difference of road surface by pavement type

identified through detailed analysis of the efficiency of usual snow removal work, the relevance of dispatch timing, and changing in formations of operation during heavy snowfall as well as their relation to snowfall data.

*Establishment of Technology for Decision Support in Snow Removal Machinery Dispatch and Support for Machinery Operation Through Analysis of Weather and Snow Removal Operation Information and Sharing of Data Using ICT*

Technology for efficient and effective snow removal operations will be considered through analysis, evaluation, and simulation of weather and snow removal machine operation information. Furthermore, technology for decision support in the optimal dispatch of snow removal machinery will be considered through collection, management, and sharing of local snowfall and road surface information and analysis of snowfall and surface-freezing forecast and operation data.

*Establishment of Methods for Application of Management Technology to Improve Snow Removal Machine Operation Efficiency Using Information on the Locations and Operations of Such Machinery*

Support technology to ensure prompt snow removal operations during periods of heavy snowfall and other conditions will be considered through snowfall weather information and real-time analysis of snow removal machine operations (Figure 3).



**FIGURE 3** Data on the locations and operations of snow removal machinery.

## Study on Technology for Sidewalk Surface Maintenance

To develop technologies for safe, secure winter sidewalk surface maintenance; this study will be conducted to achieve the goals listed below.

### *Clarification of the Road Surface Performance Factors of Sidewalks in Cold Regions in Response to Aging Society*

The surface performance factors of sidewalks (e.g., flatness, gradient, snow surface texture) required for easy walking during the snowy season will firstly be identified through surveys on the status of sidewalks in winter and walking experiments.

### *Establishment of Technology for Sidewalk Design Relating to Snow Accumulation and Removal*

Sidewalk design and maintenance methods relating to snow accumulation and removal will be examined and proofed through test construction.

### *Development of New Winter Surface Treatment Machinery for Sidewalks*

Technology for mechanical treatment of sidewalk surfaces covered with compacted snow and ice sheets will be examined through snow-ice treatment experiments.

### *Establishment of Optimal Winter Sidewalk Surface Maintenance Technology*

Sidewalk surface maintenance technology that appropriately combine mechanical snow removal and surface treatment with the application of antiskid agents and other maintenance methods will be considered (Figure 4).



**FIGURE 4** Example of poorly maintained sidewalk.



**Study on the Development of Measures to Prevent Lane Deviation in Suburban Areas**

This study will investigate technology for the prevention of lane deviation in suburban areas using wire-rope fences and other means.

**RESEARCH ON TECHNOLOGIES FOR REDUCING SNOW AND ICE DISASTERS**

In this project, snow and ice disaster environment changes caused by the climate change will be clarified to enable a response to the conditions of heavy snowfall and snowstorms that have intensified with the recent climate change, as well as with wet snow avalanches and other disasters caused by temperature fluctuations. Research will also be conducted in regard to related countermeasures, such as forecast and evaluation of risk levels for poor visibility caused by snowstorms (a major reason for road closures in cold snowy areas) and measures against avalanches during periods of rainfall in winter.

The four specific study programs of this project are

- Study on Changes in Snow–Ice Environments under the Influence of Climate Change,
  - Study on the Development of Technology for Forecasting Large Snowstorms-Induced Poor Visibility,
  - Study on Technology for Continuous Evaluation of Snowstorm Risk Along Routes,
- and
- Study on Technology for the Evaluation of Avalanche Risk Accompanying Rainfall in Winter.

These studies are individually summarized below.

**Study on Changes in Snow–Ice Environments Under Influence of Climate Change**

This study will be conducted to achieve the goals listed below.

*Clarification of the Changing Tendencies of Snow and Ice Environments in Recent Years*

Current basic weather statistics (e.g., those on temperature and precipitation) will be analyzed, and the tendencies of related changes in recent years will be clarified.

*Clarification of the Relationship Between Snow and Ice Climate Statistics and Basic Weather Statistics*

The relationship between snow and ice climate statistics (e.g., those on the snowdrift transport rate and the frequency of poor visibility) necessary in considering measures against snow and ice disasters and basic weather statistics (e.g., those on temperature and precipitation) will be clarified.

### *Preparation of Distribution Maps Showing Snow and Ice Climate Statistics in Recent Years*

Distribution maps of snow and ice climate statistics (e.g., those on the snowdrift transport rate, the frequency of poor visibility, and the freezing index) reflecting weather changes in recent years will be prepared and provided as data for use in the design of snow control facilities (Figure 5).

### *Establishment of Technology for Forecast of Snow and Ice Climate Conditions Using Future Climate Forecast Values*

Technology for the forecast of snow and ice climate conditions will be presented using RCM20 based on the relationship between snow and ice climate values and basic weather values.

### *Preparation of Distribution Charts Showing Future Snow and Ice Climate Values*

Distribution charts of forecasted future snow and ice climate values (e.g., those relating to the snowdrift transport rate, the frequency of poor visibility and the freezing index) will be prepared.

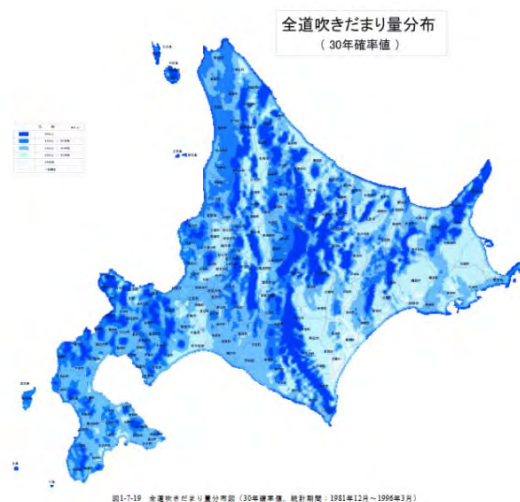
The research results will be reflected in related manuals and other applications.

## **Study on the Development of Technology for Forecasting Large Snowstorms-Induced Poor Visibility**

This study will be conducted to achieve the following goal:

### *Clarification of Conditions for the Occurrence of Snowstorms in Consideration of Hysteretic Weather Data*

Conditions for the occurrence of snowstorms will be clarified in consideration of hysteretic differences in wind velocity and temperature data.



**FIGURE 5** Distribution chart of snowdrift amount.

### **Development of Technology to Forecast Poor Visibility During Snowstorms**

Technology to forecast poor visibility during snowstorms will be developed based on the conditions for the occurrence of snowstorms and the weather forecast data in consideration of hysteretic weather data.

#### *Development of Technology for the Provision of Information on Forecast of Poor Visibility During Snowstorms*

A system that can provide forecasts of poor visibility during snowstorms to road users and administrators in real time will be developed (Figure 6).

### **Study on Technology for Continuous Evaluation of Snowstorm Risk Along Routes**

This study will be conducted to achieve the goals listed below.

#### *Clarification of Quantitative Influences of Risk Factors on Snowstorms*

Traveling observation will be conducted during snowstorms to identify risk factors and their quantitative influences in evaluating the risk of snowstorms (Figure 7).

#### *Evaluation of Snowstorm Risk Levels in Consideration of Wind Direction*

Technology for the evaluation of risk levels during snowstorms in consideration of wind direction will be presented based on analysis of data collected during traveling observation with different wind directions.



**FIGURE 6** Snowstorm-induced poor visibility.



**FIGURE 7** Traveling observation vehicle.

*Establishment of Technology for Continuous Snowstorm Risk Evaluation of Entire Routes*

Technology for the continuous evaluation of entire routes will be presented based on clarification of the quantitative impacts of risk factors and evaluation of the risk of snowstorms in consideration of wind direction.

**Study on Technology for the Evaluation of Avalanche Risk Accompanying Rainfall in Winter**

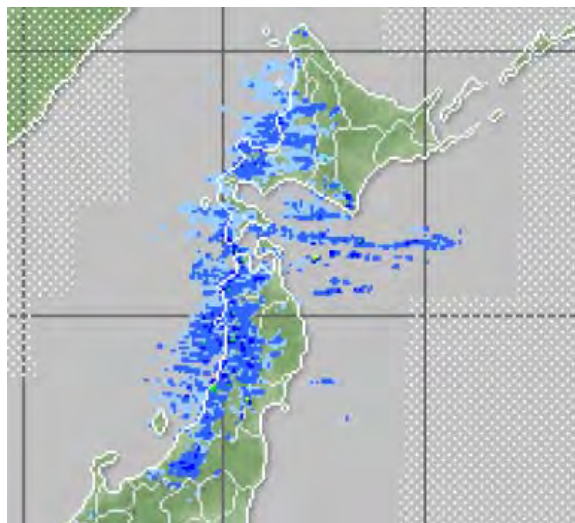
This study will be conducted to achieve the goals listed below.

*Clarification of Conditions for the Occurrence of Wet Snow Avalanches*

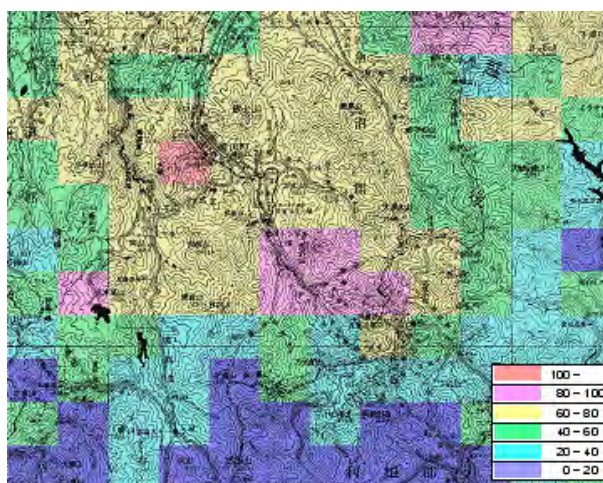
Weather conditions for the occurrence of wet snow avalanches (e.g., temperature rise, sunshine, and rainfall) will be clarified. Snow accumulation conditions for the occurrence of wet snow avalanches (e.g., formation of aquifers in accumulated snow and the shear strength properties of wet snow) will be clarified.

*Establishment of Technology to Evaluate the Risk of Wet Snow Avalanches*

A snow accumulation model that can reproduce the location and thickness of aquifers using weather data will be developed. Technology to evaluate the risk of wet snow avalanches using radar precipitation data and other information will be presented (Figures 8 and 9).



**FIGURE 8** Radar precipitation data.



**FIGURE 9** Evaluated risk image of wet snow avalanches.

## CONCLUSION

This paper presents winter road-related research studies in the third medium-term plan that started in FY 2011. Following the Great East Japan Earthquake, which struck on March 11, 2011, during the decision-making process for the third medium-term plan, the details were slightly modified to place greater focus on research relating to earthquake disasters.

The third medium-term plan may be further modified as necessary in the future. In response to requests from experts for concrete numerical indices allowing the evaluation of winter road performances and research to address locally intensive heavy snowfall, research studies concerning these matters will also be carried out in the future.

## DELIVERY APPROACHES AND PERFORMANCE MEASURES

## Performance Measures and Prediction Models Applied to Management of Henan, China, Provincial Highways

LI NINGYUAN

*Changsha University of Science and Technology*

WEI WANG

*Henan Vocational and Technical College of Communications*

**This paper describes pavement performance measures and prediction models applied to management of the provincial highway networks in Henan, China. The primary objectives of the paper are twofold: to discuss the key performance indicators applied in evaluation of pavement structural and functional conditions during all seasons and to present the performance prediction models used to guide maintenance activities and operation strategies. Covered are a wide range of study areas, including pavement condition survey and data collection in the field, selection of the most appropriate prediction models for the provincial highway networks consisting of different pavement types and functional classified highways, performance trigger levels for maintenance and rehabilitation needs, and treatment activities. This study deals with pavement evaluation indicators and prediction models, focusing on impacts of the individual indicators on sensitivity analysis of pavement performance assessment. The main findings and conclusions resulting from the study include (a) impacts of changing individual performance indicators on pavement assessment and maintenance programming, (b) the needs to modify and improve the existing decision-making process in selection of the most effective treatments from the local experience, and (c) impacts of alternative performance indicators and changing performance trigger levels on pavement assessment and maintenance programming.**

One of the basic functions required for a pavement management system is its ability to evaluate and predict future pavement conditions within an analysis period. This evaluation involves the use of pavement performance indicators and performance prediction models. While performance indicators deal with evaluation of pavement structural and functional performance from different perspectives of road serviceability level, performance prediction models are used to relate future pavement conditions with its current condition in conjunction with other influential factors such as age, traffic, and pavement structural and environmental conditions.

This paper presents the issues relating to pavement evaluation indicators and pavement condition prediction models, with emphasis on individual performance indicators and their prediction models used in the Henan, China, provincial highway management systems, which consist of all classified highways and pavements, i.e., asphalt pavement, portland cement concrete (PCC), expressways, and Class I, II and II highways (1).

In view of the current practice in maintenance management of the highway networks in Henan Province (2), a number of performance indicators are used to evaluate pavement conditions, including pavement condition index (PCI), riding quality index (RQI), pavement structural strength index (PSSI), surface resistance index (SRI), and pavement quality index

(PQI). The PQI is calculated through its functional relationship with four other performance indices as detailed in Equation 1 below:

$$PQI = w_{PCI}PCI + w_{PSSI}PSSI + w_{RQI}RQI + w_{SRI}SRI \quad (1)$$

where

$$\begin{aligned} w_{PCI} &= \text{weight factor of PCI in PQI,} \\ w_{PSSI} &= \text{weight factor of PSSI in PQI,} \\ w_{RQI} &= \text{weight factor of RQI in PQI, and} \\ w_{SRI} &= \text{weight factor of SRI in PQI.} \end{aligned}$$

In Equation 1, PQI values change from 0 and 100, with 100 representing a flawless pavement condition. The RQI is converted from the international roughness index (IRI), which is obtained from measured longitudinal road profiles that reflect pavement riding quality or roughness. A detailed description of IRI and its calculation is documented in *Transportation Research Record 1260* (3). Roughness is an important pavement performance indicator because it not only affects ride quality but also affects vehicle delay costs, fuel consumption, and maintenance costs (4). The typical IRI values surveyed from Henan provincial highway networks range from 0.35 to 4.5 (m/km). The PCI addresses pavement surface distresses such as cracks, distortion, and defects. PCI is scaled from 0 to 100, with 0 representing the worst condition and 100 representing perfect condition of a pavement section. A number of individual distresses are identified and then combined with consideration of their weighting factors in the evaluation of pavement surface condition. The PCI is used to aggregate the effects of individual distresses present on a given pavement section and it is defined in Equation 2.

$$PCI = 100 - a_0 \left( 100 \frac{\sum_{i=1}^{21} w_i A_i}{A} \right)^{a_1} \quad (\text{Asphalt Pavement}) \quad (2)$$

where

$$\begin{aligned} i &= \text{distress type and} \\ W_i &= \text{weighting factor relating to distress severity and density; its value ranges from 0.1 to 1.0,} \\ &\quad \text{contributing to overall pavement surface condition of a road section, as listed in Table 1.} \end{aligned}$$

These weighting factors were established by the Highway Science and Research Institute that is associated with Ministry of Transport of China, and they are reviewed regularly by the Henan Provincial Highway Management Bureau in addition to inspection and collection of pavement condition data by all regional highway administrations.

The PSSI represents pavement structural capacity of bearing vertical traffic loads, which is based on measurement of pavement surface deflection under a given load and its relation to allowable deflection for the particular pavement. The SRI is obtained from direct or indirect

**TABLE 1 Weighting Factors ( $W_i$ ) Defined for Individual Pavement Distress**

Asphalt Concrete Pavement			PCC Pavement		
Distress Type	Distress Density	$W_i$	Distress Type	Distress Density	$W_i$
Alligator cracking	Light	<b>0.6</b>	Map or alligator cracking	Light	<b>0.6</b>
	Moderate	<b>0.8</b>		Severe	<b>1.0</b>
	Severe	<b>1.0</b>			
Longitudinal cracking	Light	<b>0.4</b>	Single cracking	Light	<b>0.3</b>
	Severe	<b>1.0</b>		Moderate	<b>0.6</b>
				Severe	<b>0.8</b>
Transverse cracking	Light	<b>0.4</b>	Diagonal corner or edge cracking	Light	<b>0.2</b>
	Severe	<b>1.0</b>		Moderate	<b>0.4</b>
				Severe	<b>0.6</b>
Potholes and raveling	Light	<b>0.7</b>	Faulting and joint failure	Light	<b>0.4</b>
	Severe	<b>1.0</b>		Severe	<b>0.6</b>
Distortion or deformation	Light	<b>0.4</b>	Edge or corner cracking or raveling	Light	<b>0.2</b>
	Severe	<b>1.0</b>		Moderate	<b>0.3</b>
				Severe	<b>0.4</b>
Rutting	Light	<b>0.4</b>	Loss of sealant materials	Light	<b>0.1</b>
	Severe	<b>1.0</b>		Severe	<b>0.2</b>
Rippling and flushing	Light	<b>0.4</b>	Potholes or severe raveling	All types	<b>0.5</b>
	Severe	<b>0.8</b>			

measurement of friction or resistance force generated in the contacted area between pavement surface and vehicle tire under a given load and other specified testing conditions.

The main tasks and research activities involved in this study are to review pavement performance trends observed from the classified provincial highway networks over the past 10 years, analyze alternative performance indicators and examine their impacts on pavement performance assessment, and verify pavement deterioration trends as compared to the outputs from the prediction models used in the systems. The main findings and conclusions include the impacts of using alternative pavement performance indicators on pavement condition assessment, sensitivity of changing performance trigger levels on pavement performance evaluation, and investment planning.

## **MULTIPLE ROLES OF PERFORMANCE INDICATORS IN MINISTRY OF TRANSPORTATION PAVEMENT MANAGEMENT SYSTEM**

Performance measurement and performance management are often used interchangeably. However, performance management also implies determination of the appropriate level of performance and use of the actual level of performance against the desired level. Performance indicators, or measures, are developed as standards for assessing the extent to which these objectives are achieved. Pavement performance measurement indicators perform an important role in not only assessment of current or future road conditions but they also impact economic analyses of long-term maintenance and rehabilitation programs. Some performance indicators provide road agencies with information on pavement structural condition evaluation, while other performance indicators give a sense of pavement functionality on road safety and serviceability



level. When applied in road management, these performance indicators are used to establish the trigger levels relating to road service standards technically and economically. Yet, there exist some limitations of these performance indicators, such as localized experience and a subjective decision-making process, as well as lack of consistency and international criteria.

### Performance Indicators with Specific Measures

The following pavement performance indicators are commonly used by road agencies in their pavement management systems:

- IRI or RQI,
- PCI or surface distress index,
- Pavement serviceability index or PQI,
- Structural adequacy index or PSSI,
- International friction index or SRI, and
- Road safety index or pavement health index.

### Trigger Levels for Setting Pavement Condition Categories

The Henan Provincial Highway Management System was developed during 2003–2005, which allows the system users to set up trigger levels of pavement performance categories such as excellent, good, fair, and poor. It should be mentioned that the performance trigger levels and corresponding numeric values for a pavement performance category are different for pavement performance measurement indicators. Table 2 presents an example of pavement performance indicators used by Henan Department of Transportation for evaluation of freeway pavements. It shows the current pavement condition categories and trigger levels of individual performance indicators. This is an effective tool for identifying the pavement condition status and determining which pavement sections are in poor condition and need appropriate rehabilitation treatments.

The quantitative assessment by the individual performance indicators provides a technical guidance in determination of pavement's current and future needs for maintenance and rehabilitation treatments. Table 2 describes how pavement performance trigger levels are customized to fit properly for management of Henan provincial freeway pavement network, which defines the minimum acceptable level for each performance index. The trigger levels are primarily development and periodically modified through discussions within all regional highway management bureaus involved in pavement management and investment planning. By

**TABLE 2 Pavement Condition Category and Performance Trigger Levels**

Performance Indicator	Pavement Condition Category			
	Excellent	Good	Fair	Poor
PQI	≥85	≥70	≥60	<60
RQI	≥90	≥75	≥65	<65
PCI	≥85	≥70	≥60	<60
PSSI	≥85	≥75	≥55	<55
SRI	≥75	≥65	≥50	<50

specifying limits and acceptance values (e.g., threshold values) individual performance indicators can be established for both planned and existing road pavements.

Optimal performance indicators and thresholds for different functional highways should be defined on the basis of regional economic development levels. Furthermore, these individual performance indicators should be related to road safety, riding comfort, structural performance, and environmental performance, required by road users from different perspectives (5).

### **Trigger Levels for Preservation and Rehabilitation Actions**

Generally, any individual or combined performance indicators may be applied to the process of determining combined preventive and major rehabilitation treatments. These performance indicators include RQI trigger levels for pavement overlay, PCI trigger values for crack routing and sealing treatment, PQI trigger levels for major rehabilitation or reconstruction action, etc. Hence, pavement performance trigger levels play a crucial role in analyzing when and what treatment actions need to be implemented in the future.

Pavement rehabilitation is defined as a structural or functional enhancement of a pavement, which produces a substantial extension in service life by substantially improving pavement condition and ride quality. Pavement preservation activities, in contrast, are those treatments that preserve pavement condition, safety, and ride quality without increasing structure thickness and therefore aid a pavement in achieving its design life.

Trigger values are suggested for key condition levels at which a pavement is generally considered in need of structural improvement. Similarly, trigger values are suggested for key condition levels at which a pavement is generally considered in need of functional improvement.

## **IMPACTS OF USING ALTERNATIVE PERFORMANCE INDICATORS**

Almost all provincial highway agencies in China use PQI as the primary performance indicator in the process of pavement evaluation and rehabilitation programming at both regional and provincial network levels. This includes current pavement performance assessment and prediction of future pavement conditions through prediction models, optimization of pavement rehabilitation treatments, and decision of multiyear investment plans. All other performance indicators (PCI, RQI, PSSI, and SRI) are used as secondary performance indicators.

Since PQI is not a directly measurable performance indicator but is calculated on the basis of all other four indicators (RQI, PCI, PSSI, and SRI) by using their functional relationship, it has brought some concerns about data accuracy and consistency. Reviewing IRI and PCI data collection and evaluation procedures, PCI is currently obtained by subjective method that could bring significant variation and inconsistency issues. However, this can be resolved by using new technologies ensuring data collection and evaluation processes.

More and more highway agencies in the world use IRI in their pavement management systems as the primary performance measurement indicator along with its corresponding trigger levels, but what are the impacts of solely using IRI? What is the most reasonable and practical performance indicator in terms of cost-effective collection of pavement condition data and performance evaluation process? Some road agencies use IRI for pavement condition assessment and rehabilitation programming at network level, while many municipalities tend to use PCI in

assessment of pavement performance and programming rehabilitation treatments at both network and project levels.

Figure 1 presents pavement performance distribution in four categories (excellent, good, fair, and poor) measured by PQI, RQI, PCI, and PSSI performance indicators. Based on the survey and analysis of the Henan provincial freeway network (3,975 km) conducted in 2010, it is obvious that pavement performance distribution assessed by different indicators present significant variations, specifically PCI and PSSI versus PQI and RQI. In addition, it is evident that there is a large amount of variation in terms of the percentage of poor condition pavements screened by the three performance indicators. It is also apparent that PSSI varies the most from the other two three-performance indicators.

Figure 2 presents pavement performance distributions scanned by four indicators and the same trigger levels as defined in Table 2 for a selected road network that consists of 7,339 centerline kilometers of multifunctional classified highways. The performance distribution is shown as a percentage of regional roads in poor condition evaluated by four individual performance indicators. The information presented in this worksheet was exported from the

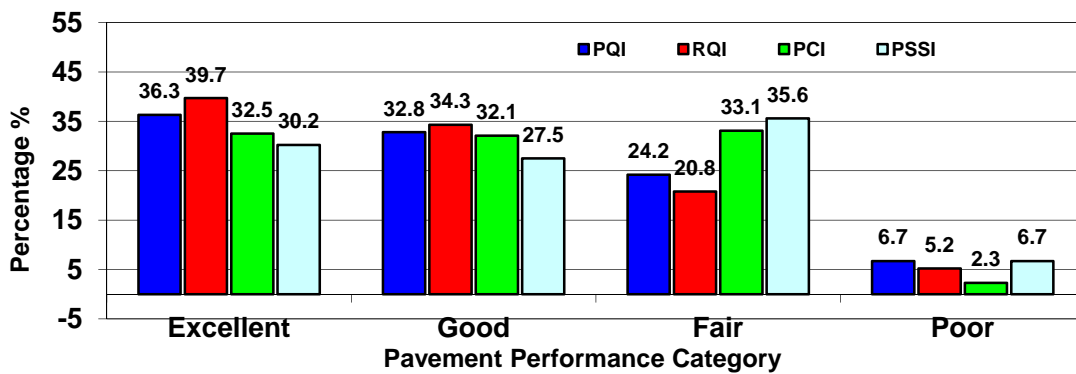


FIGURE 1 Pavement performance distributions scanned by individual indicators.

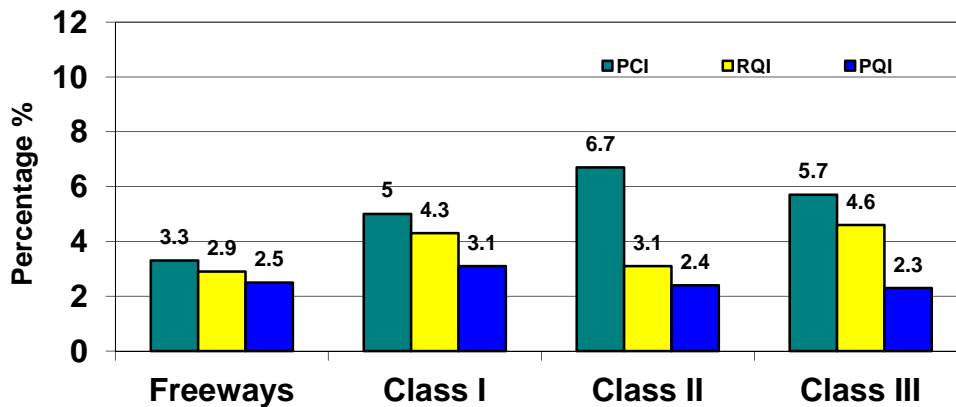


FIGURE 2 Pavements in poor condition scanned by individual indicators.

Henan provincial PMS. The figure shows that the percentage of pavement in poor condition varies substantially regardless of functional road class. Specifically, variations of the scanned pavements in poor condition in Class II and Class III highways are significant among the performance indicators.

Overall, the variation is significant in Class II roads, with a 4.3% difference between PCI and PQI and a 3.6% difference from PCI to RQI. The variation in Class III roads also differ dramatically as there is more than a 3.4% difference between PCI and PQI and 2.3% difference between RQI and PQI. The variation is 0.8% between PCI and RQI, which is relatively insignificant.

### SENSITIVITY OF CHANGING PERFORMANCE TRIGGER LEVELS

The sensitivity of changing performance trigger values was tested by increasing or decreasing PCI by 2 units and RQI by 1 unit. The effects of changing trigger levels can be seen through movements in poor condition regional roads as a percentage of the selected Henan provincial network which total 7,339 centerline kilometers.

Figure 3 illustrates the effects of increasing PCI trigger values. Consistent with the data presented below, an increase in PCI trigger levels also increases the amount of sections that fall below the trigger level. Increasing trigger levels can have significant effects on investment planning and budgeting, ultimately directing more costs towards rehabilitating the additional poor condition roads. Taking Class I roads for example, increasing PCI trigger levels by 2 units yields the largest marginal increase in poor condition roads at 2.0%. Increasing PCI trigger levels by 4 units and 6 units generate marginal increases of poor condition roads by 3.5% and 5.1%, respectively. The largest increase in the percentage of poor condition roads is in Class III roads by 9.3% when PCI is increased by 6 units. The smallest increase in the percentage of poor condition roads is in freeway and Class II roads by 0.5% when PCI is increased by 2 units. Figure 4 demonstrates the effects on the percentage of poor condition pavements as a result of decreasing the PCI trigger value. The lower the PCI trigger level, the lower the amount of poor pavement condition sections. The biggest effect is a decrease in PCI trigger levels by 6 units,

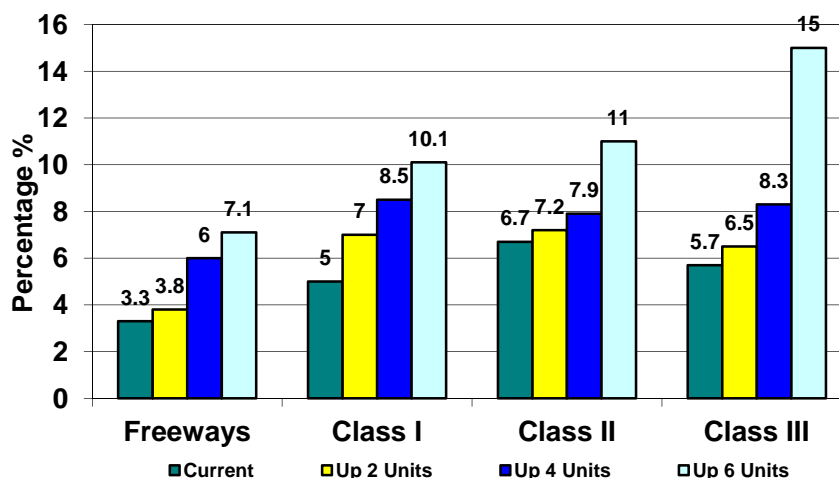
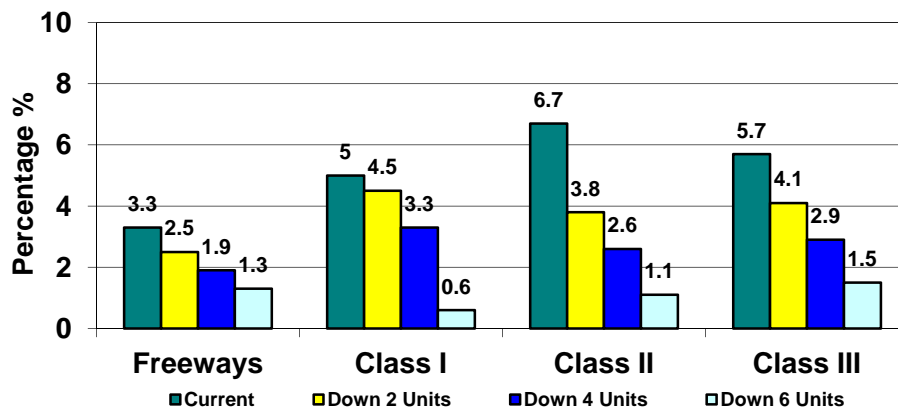


FIGURE 3 Sensitivity of pavement evaluation to increasing PCI trigger levels.



**FIGURE 4** Sensitivity of pavement evaluation to decreasing PCI trigger levels.

which marginally decreases the overall amount of poor condition for Class III roads by 5.6%. A decrease in PCI trigger levels by 2 units results in a marginal decrease of poor condition roads by 2.9% for Class II roads and 1.6% for Class III roads, respectively. For freeways, decreasing PCI by 2, 4, and 6 units has consistent and smooth effect on the percentage of poor condition roads. Class I roads have the biggest movements when it comes to decreasing PCI trigger levels by 6 units. Generally speaking, the impact of lowering trigger levels on pavement condition assessment is relatively significant to Class II and Class II roads.

Figure 5 presents the impacts of increasing RQI trigger levels on pavement evaluation in terms of percentage of pavements in poor condition in the selected Henan provincial road network. Consistent with the interval increases in PCI, the amount of poor condition roads grows in response to the incremental increases of 2.0 units. The most significant change in the total amount of poor condition roads is when RQI is increased by 6 units. Similar to changing PCI trigger levels, a change in RQI trigger levels also will affect investment planning. Increasing RQI levels will increase the amount of poor condition roads which increases the amount of rehabilitations performed to maintain road levels at good or fair conditions. The largest marginal increase occurs at Class I roads with 21% when increasing RQI by 6 units. The amount of poor condition roads are very sensitive to increase of RQI trigger level. The second most sensitive occurs at freeways when increasing RQI trigger levels by 6 units, marginally raising the overall level of poor condition roads by 16.3%. If RQI trigger level is increased by 2 units, the amount of poor condition roads is increased by a small margin for all classified roads. The smallest increase in the percentage of poor condition roads occurs at freeways by 1.4 when RQI is increased by 2 units.

Figure 6 describes the impacts of 2.0 incremental decreases of RQI trigger levels on the percentage of poor condition pavement sections for all functional classes. Lowering RQI by 2.0 units yields a substantial decline in the amount of poor condition pavements in the selected Henan provincial road network. The largest decrease in the percentage of poor condition roads is in the Class I and Class III roads when RQI is decreased by 6 units. The smallest decrease in the percentage of poor condition roads is in the Class II and Class III roads by 0.3% when RQI is decreased by 2 units.

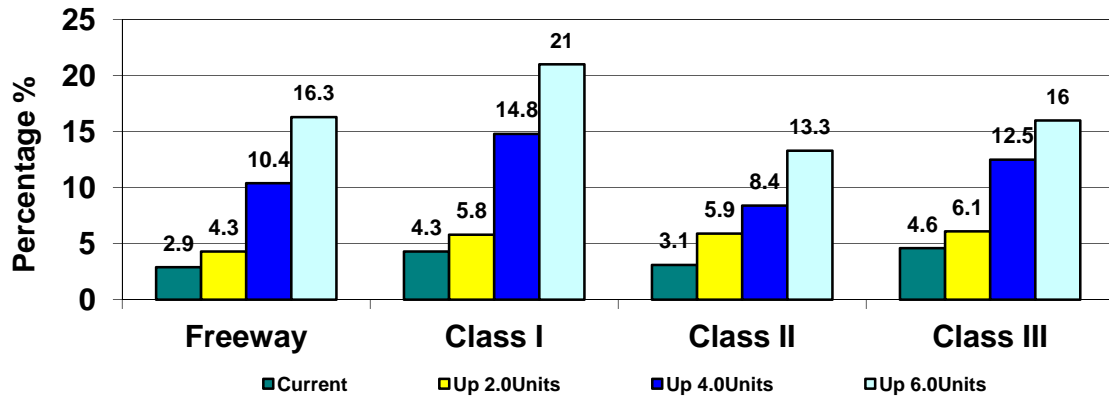


FIGURE 5 Sensitivity of pavement condition to increasing RQI trigger levels.

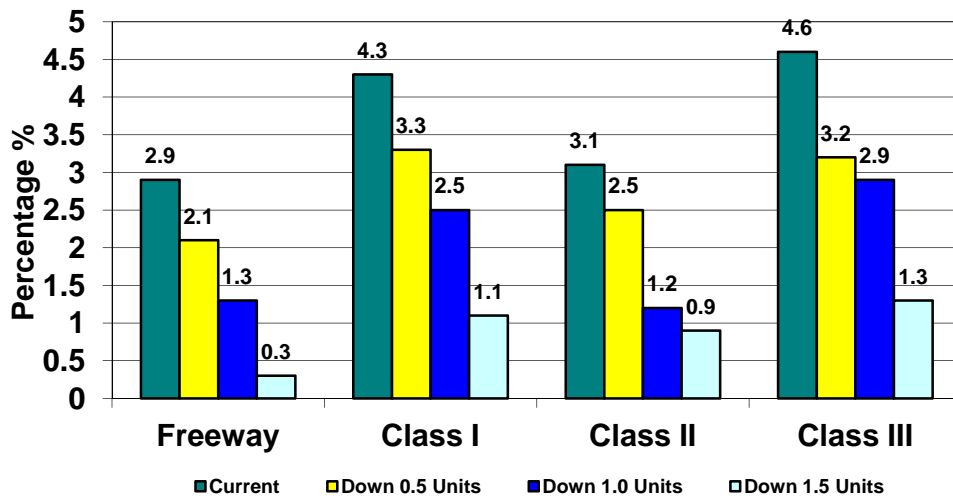


FIGURE 6 Sensitivity of pavement evaluation to decreasing RQI trigger levels.

## SUMMARY AND CONCLUSIONS

The analysis results reported in this paper present the current issues concerned with pavement performance measurement indicators and their individual impacts on pavement condition assessment and investment planning for rehabilitation programs. Specifically, the study examined what and how pavement management outputs can be significantly affected by selecting performance indicators and changing performance category trigger levels. A number of examples are presented to demonstrate how pavement performance assessment is affected in determining the needs for preservation and rehabilitation programs.

Conclusions can be drawn from this study that using alternative pavement performance indicators will have considerable impacts on pavement condition assessment and pavement rehabilitation programming at the network level. The current practice in management of the

Henan provincial highway network considers appropriate selection of performance measurement indicators, development of rational trigger levels corresponding to predefined performance categories. There are, however, several other areas that require future improvements.

- Develop a comprehensive performance indicator and its trigger levels for all performance categories (i.e., excellent, good, fair, and poor conditions) acceptable to all road design and management agencies in the province.
- Conduct a series of studies on examining individual performance indices and their trigger levels not only by road functional classification but also by pavement surface type.
- Modify the existing PQI relationship with the existing four indices (RQI, PCI, PSSI, and SRI) with emphasis on reducing the number of indices as collection of pavement structural strength and friction data at network level is very expensive.
- Introduce a new technical approach to prediction of pavement deterioration integrated with a number of standardized rehabilitation treatments and their individual treatment effects.
- Continue monitoring the effects of various rehabilitation treatments on pavement performance trends. Perhaps the most significant challenge facing pavement management engineers with respect to performance measurement indicators is developing a better understanding of the pavement condition assessments associated with selecting one performance indicator over another.
- Integrate pavement performance as part of pavement management, focusing on defining pavement failures (e.g., cracking, rutting, raveling, and faulting).
- Examine the long-term historic performance trends of all individual rehabilitation and preservation treatments that are currently used in Ministry of Transport PMS decision trees, including the 60 standardized rehabilitation treatments built into the decision trees. Although there is no consensus on which measures are most meaningful, it is widely believed that these measures do not adequately reflect the benefits of pavement preservation treatments.

## REFERENCES

1. Ministry of Transportation of China. Expressway Maintenance Quality Evaluation Standards. People's Communications Press, Beijing, China, 2002.
2. Ministry of Transportation of China. Highway Performance Assessment Standards. JTG H20-2007. People's Communications Press, Beijing, China, November 28, 2007.
3. Sayers, M. W. Profiles of Roughness. In *Transportation Research Record 1260*, TRB, National Research Council, Washington, D.C., 1990, pp. 106–111.
4. Li, N., R. Haas, and M. Huot. Integer Programming of Maintenance and Rehabilitation Treatments for Pavement Networks. In *Transportation Research Board 1629*, TRB, National Research Council, Washington, D.C., 1998, pp. 242–248.
5. Haas, R. A Perspective on Seven ICMPIAs. *Proc., 7th International Conference on Managing Pavement Assets*, Calgary, June 2008.

# Optimizing Winter Maintenance Materials





## OPTIMIZING WINTER MAINTENANCE MATERIALS

**Combined Use of Chemicals for Deicing and  
Dust Binding of Paved Roads**  
*Possibilities and Problems***MATS GUSTAFSSON****GÖRAN BLOMQVIST***Swedish National Road and Transport Research Institute***WOLFGANG HAFNER***Magistrat der Landeshauptstadt Klagenfurt am Wörthersee, Austria*

Deicing agents normally have high hygroscopicity, which results in prolonged wetness of treated roads and streets. This is often considered a problem, causing increased pavement wear and risk for reduced friction. But high hygroscopicity is simultaneously a desired property when trying to reduce road dust emissions through dust binding. In countries with freezing temperatures in winter, use of wintertime sanding and, in some countries, studded tires, results in high loads of road dust during winter and spring. Road dust contributes strongly to exceedances of air quality limit values for inhalable particles. One of several measures against road dust is dust binding. Agents like chloride salts (magnesium chloride and calcium chloride) used for deicing and dust binding of unpaved roads have been tested on paved roads and are now implemented in some cities in the Nordic countries. In the CMA+ project (EU Life+ Programme), the dust binder calcium magnesium acetate (CMA) is tested and implemented but also used for deicing in three cities in Austria and Italy. Since the periods with need for deicing and dust binding overlap, deicing measures might contribute to improved dust binding. Some dust binders are, however, known to decrease friction when applied, which affects traffic safety. This paper describes the possibilities and problems of the combined use of agents for deicing and dust binding, based on experiences from dust-binder tests in the Nordic countries and within the CMA+ project. Topics discussed are deicing and dust binding effect of different agents as well as influence on friction and which factors are important for a successful combinatory use.

In many countries with winter road conditions, usage of traction sanding, deicers, and studded tires produces large amounts of road dust contributing to problems with high concentrations of inhalable particles [particulate matter on the order of ~10 micrometers or less (PM<sub>10</sub>)]. Traction sanding often includes the spreading of fine particle fractions but also is crushed into dust by traffic as well as increasing the road surface wear [sand paper effect (*J*)]. Studded tires are commonly used in the Nordic countries of Norway, Sweden, Finland, and Iceland, and less frequently in Russia, United States, Canada, and some European countries. They cause high road wear rates and large local emissions of wear dust.

One way of mitigating emissions of road dust is to use dust-binding agents (also called dust suppressants). The agents used for this purpose are generally the same as for deicing since their hygroscopic properties keep the road surface moist for longer times and thereby hinders the dust from being suspended by traffic. Several tests have been made and the positive results have

resulted in that several Nordic and European cities use dust binding of paved roads as a measure to apply to the air quality directive concerning inhalable particles (2008/50/EG).

This paper discusses the possibilities of synergy effects of deicing for dust binding and points at some important issues that need to be taken into account when considering strategies.

## AGENTS CONSIDERED FOR COMBINATION OF DEICING AND DUST BINDING

Many aspects need to be considered when choosing appropriate agents for combined use for deicing and dust binding. Gustafsson et al. (2) summarized the main issues in a literature review, where the deicing, dust binding, corrosive, and environmental effects of calcium chloride ( $\text{CaCl}_2$ ), magnesium chloride ( $\text{MgCl}_2$ ), calcium magnesium acetate (CMA), and sugar solution were discussed. The selection for the review was the most interesting agents for the Swedish road administration at the time. At the same time a dust-binding test was performed including the same dust binders and evaluated both dust binding and friction effects. Except for these agents, there are a number of alternative agents that might be used. Potassium formate (KF) and lignosulphonate are noteworthy examples, but little is known about their function as dust binders of paved roads. KF is mostly used for deicing of airstrips, while lignosulphonate is used as a dust binder for unpaved roads and is considered an environmentally friendly product.

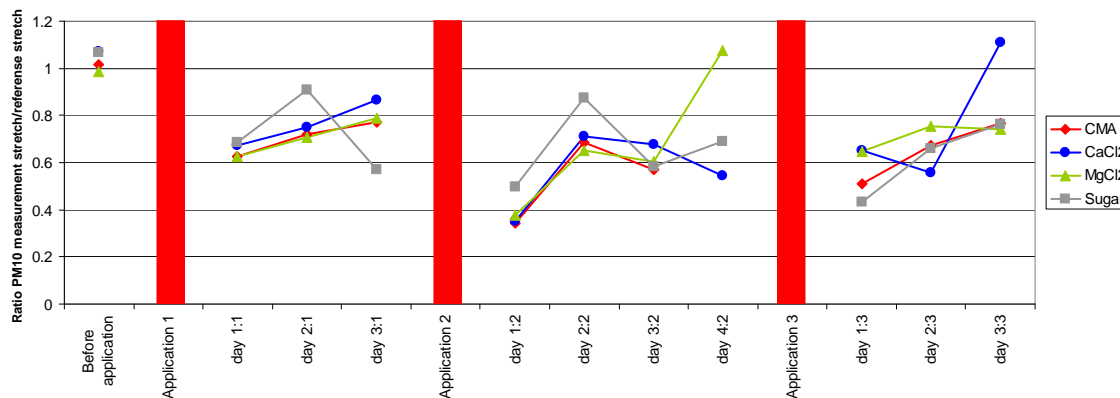
### Deicing Properties

Chloride salts, and especially sodium chloride ( $\text{NaCl}$ ) are, by all means, the cheapest and most commonly used deicers. They all perform well to about  $-10^\circ\text{C}$  below which the effect of  $\text{NaCl}$  decreases rapidly.  $\text{MgCl}_2$  and  $\text{CaCl}_2$  works to about  $-25^\circ\text{C}$ . CMA has the same melting capacity as  $\text{NaCl}$  but is considered most suitable for preventive use rather than melting existing ice and snow. Sugar solution mixed with  $\text{NaCl}$  has been tested as a possibility to reduce the use of  $\text{NaCl}$ . Gustafsson and Gabrielsson (3) conclude that a mixture of 50% raw sugar and 50%  $\text{NaCl}$  is likely to function as well as  $\text{NaCl}$  only for achieving the desired melt effect.

### Dust-Binding Properties

$\text{NaCl}$  has lower hygroscopicity than  $\text{MgCl}_2$  and  $\text{CaCl}_2$  and has not been used as such for dust binding of paved roads.  $\text{MgCl}_2$  has been used in several tests both in Norway and Sweden and in on operational use in Norway and Sweden, while  $\text{CaCl}_2$  is in operational use in Finland. CMA has earned some attention due to its environmental and corrosive advantages as compared to chloride salts and extensive tests have been made. In the EU Life+ project, CMA+, the agent is studied for implementation as a dust binder in three cities in Austria and Italy. Also, CMA is currently evaluated for dust binding in London (4).

Gustafsson et al. (2) made a simultaneous test of  $\text{CaCl}_2$ ,  $\text{MgCl}_2$ , CMA, and sugar solution to validate the dust-binding effects during the same meteorology and traffic conditions. The tests showed that all agents seem to reduce the  $\text{PM}_{10}$  concentration to a similar level and also that the duration of the effect was very similar (Figure 1). The tests were made on a rural road with no other strong PM sources and with rather low traffic volume (about 6,500 vehicles per day). Under these conditions, the tests resulted in a maximum effect on daily mean  $\text{PM}_{10}$  concentrations of between 40% to 60% and the duration was about 3 to 4 days. Tests in Swedish



**FIGURE 1** Dust binder effect on PM<sub>10</sub> concentrations along a rural road expressed as the ratio between PM<sub>10</sub> at treated sites and a reference site (2).

cities indicate slightly lower effects and shorter duration. In the cities of Klagenfurt, Austria, Bruneck, Italy, and Lienz, Austria, the effect of CMA is up to approximately 0% to 20%, while in London 10% to 14% (4). The somewhat lower effects of dust binding in Austria, Italy, and the United Kingdom is likely to depend on a smaller contribution of suspended road dust to the total PM<sub>10</sub> concentrations compared to in the Nordic countries. Dust binders can obviously only mitigate this part of the PM<sub>10</sub> concentration.

Since the dust-binding effect comes from keeping the road surface moist, traffic amounts as well as meteorology are important for the duration of the effect. Tests in Stockholm, Sweden, show that the dust binding effect is better in early winter than in spring due to increased insolation drying the streets faster (5).

### Environmental and Corrosive Properties

Deicers containing chloride salts are well-known environmental burdens, both to roadside vegetation and to ground and surface water recipients (6, 7) and efforts are made to reduce their usage. The alternative CMA is considered a better agent from this point of view, showing no damages to vegetation. In ground and water, it is oxygen consuming during breakdown, but no other negative effects have been recognized. Sugar solution is regarded similar to CMA regarding these issues.

As for environmental concerns, the chloride salts are rather problematic when it comes to corrosion. Compared to NaCl, MgCl<sub>2</sub>, and to some extent CaCl<sub>2</sub>, are more aggressive to concrete constructions, while CMA and sugar solution is less corrosive (2).

### Slipperiness of Deicers When Used as Dust Binders

A problem when using deicers as dust binders on paved roads is that some tend to reduce friction. Initial trials, where the doses were not well controlled, resulted in low friction values (8). Standard rotating plate spreaders and too-large doses were used and the agents were unevenly distributed resulting in puddles and friction reductions. During tests by Gustafsson et al. (2) the friction reduction of 20 g/m<sup>2</sup> of different dust binders was measured directly after application. The results show that CMA had the highest reduction, while the chloride salts and

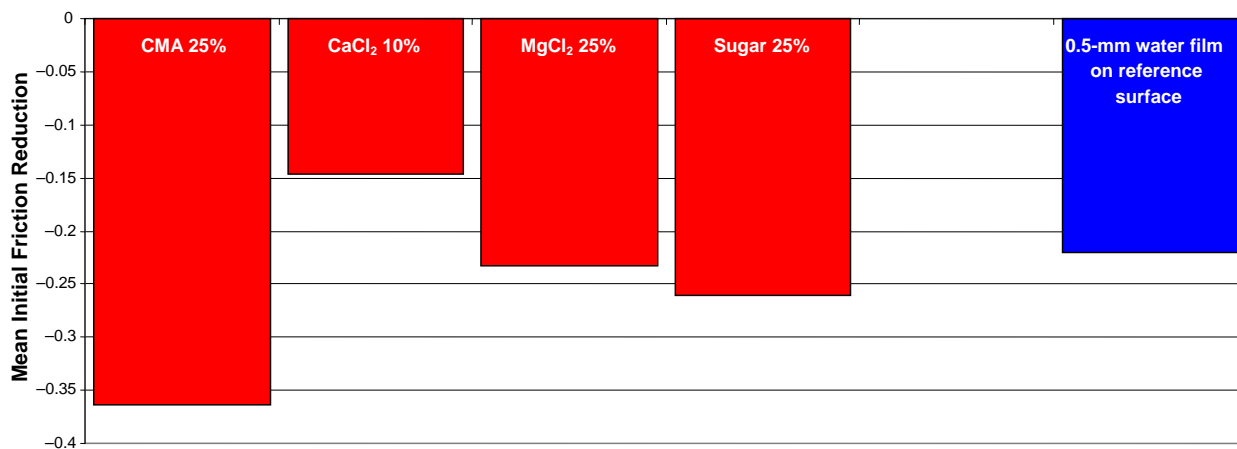
sugar solution were similar to the friction of an applied 0.5-mm water film (Figure 2). The reduced friction for CMA lasted for a couple of hundred passing cars. CMA has had the worst problems regarding friction reduction, but better techniques for even application and lower doses has reduced this problem dramatically and CMA is now used in 10 g/m<sup>2</sup> doses in the CMA+ project with no friction problems.

## RESIDUAL DEICERS ON THE ROAD SURFACE

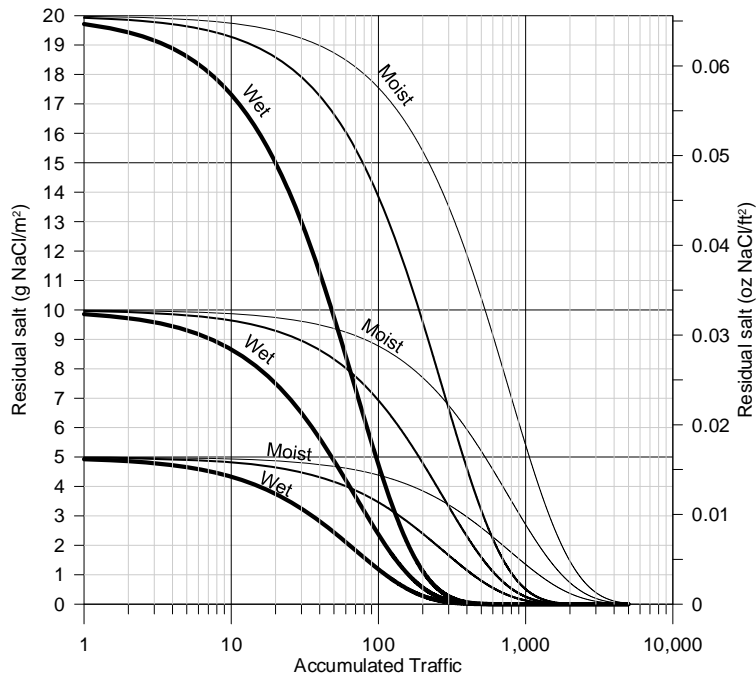
For a synergy effect on dust binding by deicing operation, the time the agent will stay on the road surface is important, as is the possible build-up of a deicer depot. The main research on residual amounts of deicers has been performed on NaCl to optimize the time for application and dose. The removal rate of NaCl is likely to be similar to other liquids applied to the road surface, why this research is valuable in the context of this paper. Residual salt has been studied and modeled by Blomqvist and Gustafsson (9), Lysbakken (10), and Blomqvist et al. (11).

These studies show that the road surface moisture and traffic amounts are crucial for the removal rate, and that salt doses under wet conditions may be almost totally gone from the road surface after only a few hundred vehicle passes. The duration and amount of residual salt increases as the moist content is reduced (Figure 3).

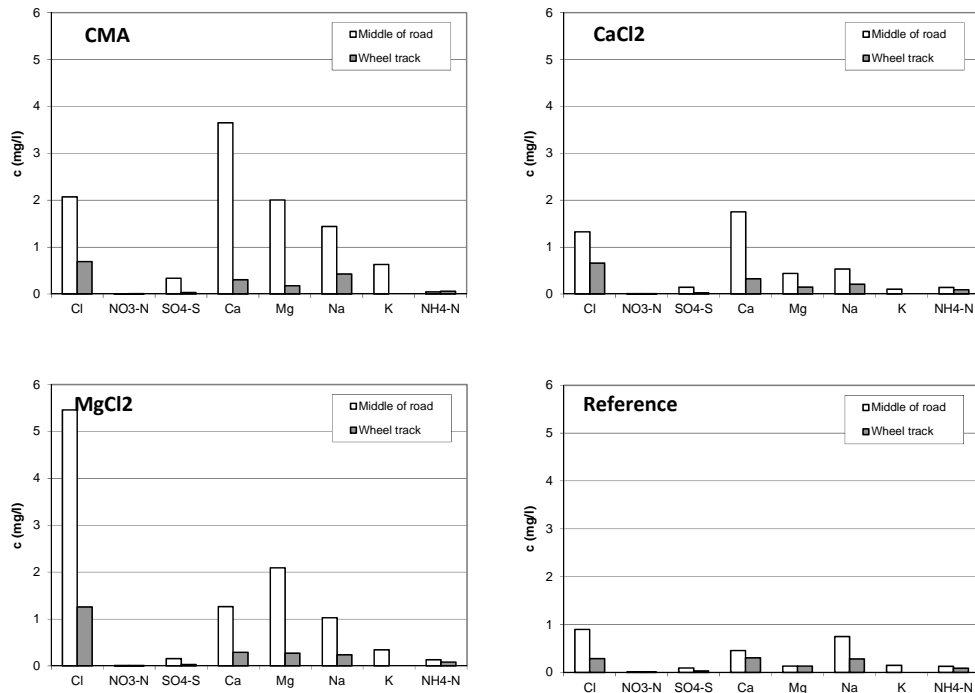
The reduction of salt during dry conditions has been studied by Klein-Paste (12), showing a much longer duration of salt on the road surface. Even after 30 h and 20,000 passing vehicles salt was still present on the surface. Also for the dust-binding agents used in Gustafsson et al. (2) it was clear that dry conditions promote the agents to remain on the surface for longer times. Twenty days after the last of six applications, each including spreading of 20 g/m<sup>2</sup> of dust binders, the chemical profiles of the binders were still obvious when sampling from the road surface using the VTI wet dust sampler (Figure 4). The reference site has a weak signal of residual NaCl; the last dose being applied for deicing almost 6 weeks before the measurement was made. These results indicate that during generally dry conditions, deicers and dust binders can remain on the road surface for weeks.



**FIGURE 2** Initial friction reduction on dry road caused by application of 20 g/m<sup>2</sup> of four dust binders as compared with a 0.5-mm water film (2).



**FIGURE 3 Modeled residual salt as a function of road wetness and accumulated traffic (11).**



**FIGURE 4 Ion content in filtrates from road surface samples showing remains of dust binders applied 20 days before the measurements were made. The reference site was not treated with dust binders, but a sodium chloride dose was applied for deicing about 6 weeks before the measurement.**

## POSSIBLE STRATEGIES FOR COMBINED EFFECTS OF AGENTS FOR DEICING AND DUST BINDING IN DIFFERENT CLIMATES

Strategies for optimal deicing and dust-binding effects need to take into account several issues to be successful. Different strategies are needed for different climates. In cold climates with common winter temperatures below  $-10^{\circ}\text{C}$ , the use of deicers that work at these temperatures are well motivated. This would be rather expensive, and why a more common solution during these conditions is gritting. Unfortunately, this winter operation adds to the road dust depot and will reduce the effect of dust binders in spring. Long periods with snow and ice-covered roads reduce the road dust emission during winter, but the high use of grit can result in high dust emissions in spring. In these climates the potential for synergy effects of deicing and dust binding are likely to be small. Nevertheless, low-temperature effective deicing agents are likely to have beneficial effects and could be used in local sites with known road dust problems.

In most parts of the Nordic countries, winter temperatures commonly fall below  $0^{\circ}\text{C}$  and sometimes below  $-10^{\circ}\text{C}$ . In these areas, NaCl is the most common deicer combined with winter gritting on paved walks and cycling lanes and on roads when needed. Here the road dust problems are most pronounced and can appear both during and after the winter period, and why an optimized strategy for combined deicing and dust binding is likely to be effective. The use of deicers with higher hygroscopicity are likely to have a positive effect on dust episodes during dry periods in winter as well as improving the possibilities to abate high particle concentration in early spring. Also the need for gritting at below  $-10^{\circ}\text{C}$  temperatures would be reduced, further reducing dust problems in spring from accumulated winter gritting material.

In areas where winter temperatures seldom go below  $0^{\circ}\text{C}$ , there is no need for low-temperature deicers. Also as mentioned before, the road dust source is normally weaker than in colder climates due to less use of abrasives and studded tires. If high  $\text{PM}_{10}$  concentrations from road dust are common, preventive use of, for example, CMA for deicing could have beneficial dust-binding effects. Alternatively, normal use of NaCl during winter could be switched to CMA for both deicing and dust binding in the later winter season and spring for better dust-binding effect.

Deicing is initiated by forecasted meteorology. In cities where dust binding is used this is often the case. Dust binding is then normally initiated by stable conditions, dry streets, and high particle concentrations during the previous day. In some cases, though, dust binding is performed in regular intervals, like sweeping. The forecast strategy probably gives a better effect on high-concentration episodes, while the regular interval strategy might have a better effect on long-term mean values. This is a speculation though, since these strategies have not been compared in any scientific studies. If forecasting is used for both operations a combined forecasting service would be beneficial for synergy effects.

In any strategy, the problem with decreased friction from application of deicers and dust binders on paved roads needs to be addressed. As mentioned above, low and evenly distributed doses for dust binding seem to solve the initial friction reduction problem. Also, applying the agent well before the morning rush hour evens out the agent on the surface and reduces the risk for slipperiness. Still, if deicers are continuously used throughout winter and spring, one might expect problems, and why continuous friction tests should be included in operations.

As always, economy is a main issue regulating what measures are feasible. From this point of view it is important to underline that road dust problems are normally local, meaning that dust-binding activities are not necessary for the same amount of roads and streets as

generally are subject to winter maintenance and the amounts of agents needed therefore not in the same order as for deicing. Even though costs will increase for additional dust binding, coordination of operations and techniques have the potential of cutting the costs.

## CONCLUSION

This paper is based on the fact that the same kind of chemical agents are used for both deicing and dust binding during the same period of the year and that there is a possibility to combine the properties of these agents for optimizing their effects in strategies adapted to climate conditions. Knowledge is rather substantial regarding deicing as well as dust binding capabilities, but no research is available regarding how to combine the properties for synergy effects. Some suggestions of simple strategies, based on current knowledge and the expertise of the writers are given here, but an important conclusion is that there is a need for cross-discipline research on using deicers for both increased traffic safety and improved air quality.

## REFERENCES

1. Kupiainen, K. Road Dust from Pavement Wear and Traction Sanding. Ph.D. dissertation. University of Helsinki, Finland, 2007.
2. Gustafsson, M., G. Blomqvist, P. Jonsson, and M. Ferm. Effekter av dammbindning av belagda vägar. *VTI Rapport*, No. 666, VTI, Linköping, 2010.
3. Gustafsson, A., and G. Gabrielsson. Dammbindning av grusvägar — Utvärdering av dammbindningsmedel (Slutrapport). Vägverket Produktion Borlänge, 2008.
4. Deakin, D., and C. Ren. Targeted Application of Calcium Magnesium Acetate (CMA) Pilot Study. URS Report 49306764/LERP0002. Transport for London, August 2011.
5. Norman, M. Försök med dammbindning med CMA mot höga partikelhalter i Stockholms innerstad 2007 och 2008. SLB-analys, Miljöförvaltningen, Stockholm, 2008 (in Swedish).
6. Blomqvist, G. Impact of De-Icing Salt on Roadside Vegetation. *VTI Rapport*, No. 427A, Swedish National Road and Transport Research Institute, Linköping, 1998.
7. Fischel, M. Evaluation of Selected Deicers Based on a Review of the Literature. Colorado Department of Transportation, 2001.
8. Ihs, A. Friktionsmätning på belagda ytor behandlade med dammbindningsmedel. PM VTI, 2006 (in Swedish).
9. Blomqvist, G., and M. Gustafsson. Patterns of Residual Salt on Road Surface: Case Study. *Transportation Research Circular E-C063: Sixth International Symposium on Snow Removal and Ice Control Technology*, Transportation Research Board of the National Academies, Washington D.C., 2004, pp. 602–608.
10. Lysbakken, K. R., and H. Norem. Processes That Control Development of Quantity of Salt on Road Surfaces After Salt Application. In *Transportation Research Record: Journal of the Transportation Research Board*, No. 2258, Transportation Research Board of the National Academies, Washington D.C., 2011, pp. 139–146.
11. Blomqvist, G., M. Eram, K. Unver, and M. Gustafsson. Prediction of Salt on Road Surface: Tool to Minimize Use of Salt. In *Transportation Research Record: Journal of the Transportation Research Board*, No. 2258, Transportation Research Board of the National Academies, Washington D.C., 2011, pp. 131–138.
12. Klein-Paste, A. SaltSMART, Reduksjon av saltforbruk ved bruk av tilsetningsstoffer — feltforsøk vinter 2007/08. Statens vegvesen, Rapport Nr 2523 (in Norwegian).



## OPTIMIZING WINTER MAINTENANCE MATERIALS

**Alternative Approaches to Measuring Deicer Ice-Melting Capacity**  
*Optimization of Test Accuracy and Precision*

**SCOTT KOEFOD**  
**JESSICA ADKINS**  
*Cargill, Incorporated*

**MICHELLE R. AKIN**  
*Western Transportation Institute, Montana State University–Bozeman*

The current industry standards for measuring ice-melting capacity are the SHRP methods H-205.1 and H-205.2. Depending on the test conditions, the accuracy and precision of the method can vary greatly. Ice-melting capacities measured using standard application rates are not always accurate measurements of total ice-melting capacity. It is important to understand the effect of test conditions on the results of the SHRP ice-melting capacity test so that the results can be correctly understood and applied. We have carried out an analysis of variance of the SHRP ice-melting capacity test under different conditions of application rate, temperature, and time. The data show that total ice-melting capacities are underestimated at low application rates and tend to converge on a constant value at high application rates. The data also show that test precision can be increased substantially by using higher application rates and longer measurement times. An alternative ice-melting capacity test in which ice cubes are allowed to melt in concentrated solutions of deicers until equilibrium is reached is also presented; ice melt quantity is determined by weight gain in the deicer solution, reducing the error associated with incomplete recovery of melt from the ice surface in the SHRP test. The data are presented with a discussion of the importance of distinguishing ice-melting rate from total ice-melting capacity, the relevance of this to deicer residual effect, and the utility of precise measurements in determining the effect of low-level additives in deicer blends.

Optimization of deicer performance through formulation remains an area of high research activity. The use of enhanced deicers in which the effectiveness of lower-cost sodium chloride is enhanced through the addition of relatively small amounts of calcium chloride, magnesium chloride ( $\text{MgCl}_2$ ), and various organic additives is becoming increasingly popular as a way to extract maximum value from these higher-priced additives and use them as efficiently as possible. With an ever-increasing number of additives and formulations to choose from, it is increasingly important to have test methods available which can be used to compare formulations and to serve as a basis for developing improved formulations.

A variety of test methods of deicer performance have been proposed over the years. Fay et al. have recently published a thorough review of past work in this area (1). Deicer performance can be characterized in a variety of ways including ice melting, ice debonding, residual effect, ice penetration, and ice undercutting. Perhaps the most fundamental measurement of deicing performance (as opposed to anti-icing performance) is ice-melting capacity (quantity of ice melted per quantity of deicer). Ice penetration and ice undercutting may be viewed as more direct measurements of the actual function of deicers in the field, but they have proven difficult to

measure precisely even under laboratory conditions. Ice-melting capacity is a more basic measurement with fewer sources of variation and has proven to be a more precise measurement than either ice penetration or ice undercutting. Akin and Shi reported lower coefficients of variation in ice-melting capacity measurements than in ice penetration or undercutting measurements (2). Since ice undercutting and ice penetration are ultimately dependent upon the chemical's ability to melt ice, ice-melting capacity is probably the most useful measurement among these three for the purposes of comparing the deicing effectiveness of different chemicals.

A number of approaches to measuring ice-melting capacity have been tried (1). The most commonly used are the SHRP Standards H205.1 and H205.2, developed for the SHRP in the *Handbook of Test Methods for Evaluating Chemical Deicers* (3). The SHRP method has a number of points in its favor. It is a relatively simple test to perform, and it is an intuitive, direct measurement of ice-melting effectiveness; the chemical is simply placed on a sheet of ice at a given temperature and the volume of melted ice is measured after a period of time. However, even though ice-melting capacities can be measured with more precision than ice penetration and undercutting, these measurements also suffer from an undesirable amount of variation. For example, we have found over the years that ice-melting capacities of standard rock salt sodium chloride measured by the same independent lab following SHRP H205.1 can vary by as much as 35%. Of course, this degree of variation makes it difficult to measure differences between deicer formulations, which in turn make product improvement more difficult.

Thus, it would be desirable if there were a way to measure ice-melting capacities with greater precision than is typical with the standard SHRP procedure. We report herein an analysis of variance in the SHRP ice-melting capacity test together with some modifications that permit an increase in both the accuracy and the precision of the test. We also report an alternative test method for measuring ice-melting capacity which involves measuring the mass of ice melted by a large excess of deicer solution.

## EXPERIMENTAL PROCEDURES

Ice-melting capacity tests were carried out following the SHRP H205.1 procedure as described in the *Handbook of Test Methods for Evaluating Chemical* (3) at a temperature of  $15.0 \pm 0.5^\circ\text{F}$  ( $-9.4 \pm 0.3^\circ\text{C}$ ). Tests were done both by the Western Transportation Institute (WTI) at the Subzero laboratory and by Cargill at their laboratory. Ice-melting capacities were measured on samples of Louisiana sodium chloride rock salt (typical purity = 98.9% NaCl). The same sample of salt was used for all of the tests. The salt was screened on #4 (4.76 mm), #8 (2.38 mm), and #30 (0.595 mm) sieves. Test samples were prepared by blending 50% of the 4-x-8 mesh fraction with 50% of the 8-x-30 mesh fraction. Application rates of salt were varied between 4 and 16 g (instead of the standard 4.17-g application rate specified in SHRP H205.1). Tests at WTI were carried out following the SHRP H205.1 procedure as described in the *Handbook of Test Methods for Evaluating Chemical Deicers* (3) in a walk-in cold room. The samples were stacked in an insulated box at a temperature of  $15.0 \pm 0.5^\circ\text{F}$  except while taking measurements, where the temperature variation was greater ( $15.0 \pm 1.3^\circ\text{F}$  or  $-9.4 \pm 0.7^\circ\text{C}$ ). Volume of ice melt was measured at intervals of 1, 5, and 7 h. SHRP H205.1 tests were carried out at Cargill using a refrigerated environmental chamber fitted with a glovebox (Despatch Environmental Chamber, model no. 16535M, with a Watlow Series F4 controller, approximately  $1 \text{ m}^3$ ). Temperature of the glovebox was maintained at  $15.0 \pm 0.2^\circ\text{F}$  ( $9.4 \pm 0.1^\circ\text{C}$ ). Temperature is verified by an

independent thermocouple inserted through the wall of the environmental chamber. In the Cargill tests, two modifications were made to the SHRP H205.1 procedure: (a) 260 mL of water was frozen in each test tray rather than 130 mL as specified in SHRP H205.1, and (b) the ice was used as formed, i.e., the surface was not smoothed before the test.

Ice-melting capacities were also measured by an alternative approach at WTI, called the “ice cube titration” ice-melting capacity test. For this test a beaker with 400 g of brine and a magnetic stir bar is placed on a magnetic stir plate in the walk-in cold room of the subzero laboratory. An ice cube was suspended into the beaker from fishing line that was frozen into the cube during ice formation. The beaker was covered with a lid to limit evaporation. The mass of the beaker was periodically measured to determine weight gain due to melting ice (the ice cube was removed during weight measurements). Subsequent ice cubes were introduced if the first one melted until the mass of the beaker was constant or started decreasing. These tests were conducted at  $5.0 \pm 0.9^\circ\text{F}$  ( $-15 \pm 0.5^\circ\text{C}$ ) with four replicates of each brine. (The cold room goes through a warming cycle during the night to prevent too much frost from accumulating on the chillers. Thus, ice cubes were not left in the beakers during nights when a defrost cycle occurred because the temperature variation is unacceptable and would have contributed to inaccurate ice melt.)

## SOURCES OF VARIANCE IN SHRP H205.1

The SHRP standard ice-melting capacity test is a good, intuitive method for comparing the raw ice-melting power of different chemicals and formulas. It is a fairly real-world test insofar as it involves applying deicer directly to an iced surface and measuring the volume of melt produced at a given temperature over a period of time. However, there are a variety of potential sources of variation in measuring ice-melting capacity, particularly on solid deicers. To begin with, it is important to distinguish between ice-melting rate and total ice-melting capacity. The SHRP standard calls for measuring ice melting over a relatively short period of time (the standard suggests making measurements at 10, 20, 30, 45, and 60 min after deicer application). This is a reasonable suggestion from the standpoint of obtaining information about expected performance under real-world conditions since maintenance workers will be expecting significant effectiveness within that time frame. However, it must be realized that this introduces the potential for test variation if there are significant differences in the rate of ice melting. For some solid deicers, and sodium chloride in particular, the deicer has not reached its full ice-melting capacity after 1 h. Several factors may influence the rate of ice melting. The SHRP method is a “static test” (i.e., there is no simulation of traffic action). Without traffic action continually grinding the deicer and ice together, solid deicer particles will tend to bore down into the ice and form little wells or pockets where the deicer particle will have inefficient contact with the ice, slowing the ice-melting progress to greater and lesser extents, depending on the size of particle. Also, since chemical ice melting is essentially a solid state reaction occurring at the interface of the ice and the deicer particle, variations in particle size gradation of the solid deicer may also result in significant variation from sample to sample. Thus, some care must be taken to not too quickly assume that the results of the SHRP H205.1 test provide a measure of true ice-melting capacity, if that term is understood to mean the total quantity of ice that can be melted by a given amount of chemical. The measured value provided by the SHRP test will only be the true ice-

melting capacity if the test has been carried out in a way that allows the deicer to reach equilibrium with the ice and achieve its full ice-melting capacity.

Another significant source of variation in ice-melting capacity tests is the difficulty of recovering all of the ice melt for the quantitative measurements. Typically, the sample is tilted to drain the melted ice towards one side where it can be more easily recovered. If undercutting occurs, melt can get trapped below the ice layer and not be measured. Furthermore, the surface of the ice is usually pockmarked and full of little ice melt wells that can retain liquid. This can introduce significant variation in the measurement, particularly when the total volume of melt is low.

While the standard SHRP approach provides a useful way to obtain an initial, approximate comparison of the relative ice-melting ability of different formulas, our experience over many years of testing has been that it is precise to only about  $\pm 30\%$ . That is, differences in ice-melting capacity need to be about 30% or greater for the test method to be able to measure them with statistical significance using a few replicates. It may be that differences smaller than this are significant under field conditions. Therefore, we decided to explore some modifications to the ice-melting capacity test method to see if more precise measurements were possible.

Any direct measurement of ice-melting capacity will necessarily involve creating a mixture of ice and deicer and measuring the amount of resulting melt, i.e., it will end up being essentially some variation on the basic SHRP approach. The variables that can be manipulated are the form of the ice, the form of the deicer, the relative quantities of ice and deicer, the way in which the two are mixed, and the way in which the melt is measured. In some early tests we hypothesized that mixing the deicer with finely shaved ice might provide a more precise measurement of ice-melting capacity than the SHRP approach in which deicer particles are broadcast on a flat ice surface. The thought was that mixing shaved ice and deicer would maintain more efficient contact between the ice and the deicer particles throughout the test. However, this approach did not work well. The high surface area of the shaved ice resulted in much greater retention of ice melt than occurs on a relatively flat ice surface, making quantitative recovery of the melt more difficult and even more imprecise than in the SHRP method. One could consider alternative approaches to measure the amount of ice melt. For example, addition of a small quantity of dye tracer, in principle, should permit precise measurement of the amount of total ice melt. After thoroughly mixing the ice–melt–dye mixture, the dye should be homogeneously diluted throughout the sample by all of the free liquid present. Recovery of an aliquot followed by dilution and measurement of absorbance with a standard UV-Vis spectrophotometer should permit a precise measurement of the degree of dilution of the dye, from which the volume of ice melt could be calculated without having to physically recover it quantitatively from the mixture. The downside to this approach is that it would be limited to deicers that were colorless at the dye tracer wavelength. Since many commercial products contain colorants that would interfere with this approach, we deemed it impractical.

Considered next was what might be gained by simply modifying some of the experimental conditions in the standard SHRP method, in particular by seeking to increase the quantity of ice melt in the test. If the sources of variation are primarily due to the difficulty in quantitatively recovering all of the ice melt, the relative magnitude of this error should decrease as the volume of measured ice melt increases. The volume of ice melt in the test can be increased two ways: (*a*) by increasing the application rate of deicer and (*b*) allowing the test to run for a longer period of time. Experiments were carried out to determine the effect of each of these variables at WTI. Results of these tests are summarized in [Tables 1](#) through [3](#). The deicer

application rate suggested by SHRP H205.1 is 4.17 g. Application rates of 4, 8, 12, and 16 g were tested to determine the effect on the test variation.

Table 1 shows data measured after 1 h, the longest period of time suggested by the standard SHRP procedure. For measurements taken within the standard time window of the SHRP test, there appears to be a significant decrease in variability in going from the standard application rate of about 4 to 8 g, as the standard deviation decreases by almost half, though increasing the application rate further above 8 g was not observed to result in any significant further improvement. The decrease in variation with increased application rate is less clear in data measured after 5 h (Table 2); there appears to only be a modest decrease in the standard deviations at application rates greater than 4 g. However, data measured after 7 h in Table 3 shows the same trend observed in Table 1; the standard deviation of the ice-melting capacity drops by more than 50% in going from a 4 g to an 8 g application rate. In general, the data in Tables 1 through 3 suggest that significant improvement in test precision may be obtained by increasing the suggested deicer application rate in the SHRP standard from 4.17 g to 8 g or higher.

Another interesting observation from the data in Tables 1 through 3 can be seen in [Figure 1](#), which shows how the measured ice-melting capacity changes as a function of application rate and time. This figure points to another problem with the standard SHRP approach. Ice-melting capacity, since it is the ratio of ice melted per quantity of deicer, should certainly not vary as a

**TABLE 1 Ice-Melting Capacity of NaCl by SHRP H205.1 Measured After 1 h at 15°F (−9.4°C)**

Mass of NaCl Applied (g)	Number of Replicates	Average Ice Melting Capacity (mL/g)	Standard Deviation (mL/g)	Coefficient of Variation (%)
4.00	20	2.18	0.51	23
8.00	16	2.16	0.29	14
12.00	16	1.86	0.27	15
16.00	20	1.69	0.43	25

**TABLE 2 Ice-Melting Capacity of NaCl by SHRP H205.1 Measured After 5 h at 15°F (−9.4°C)**

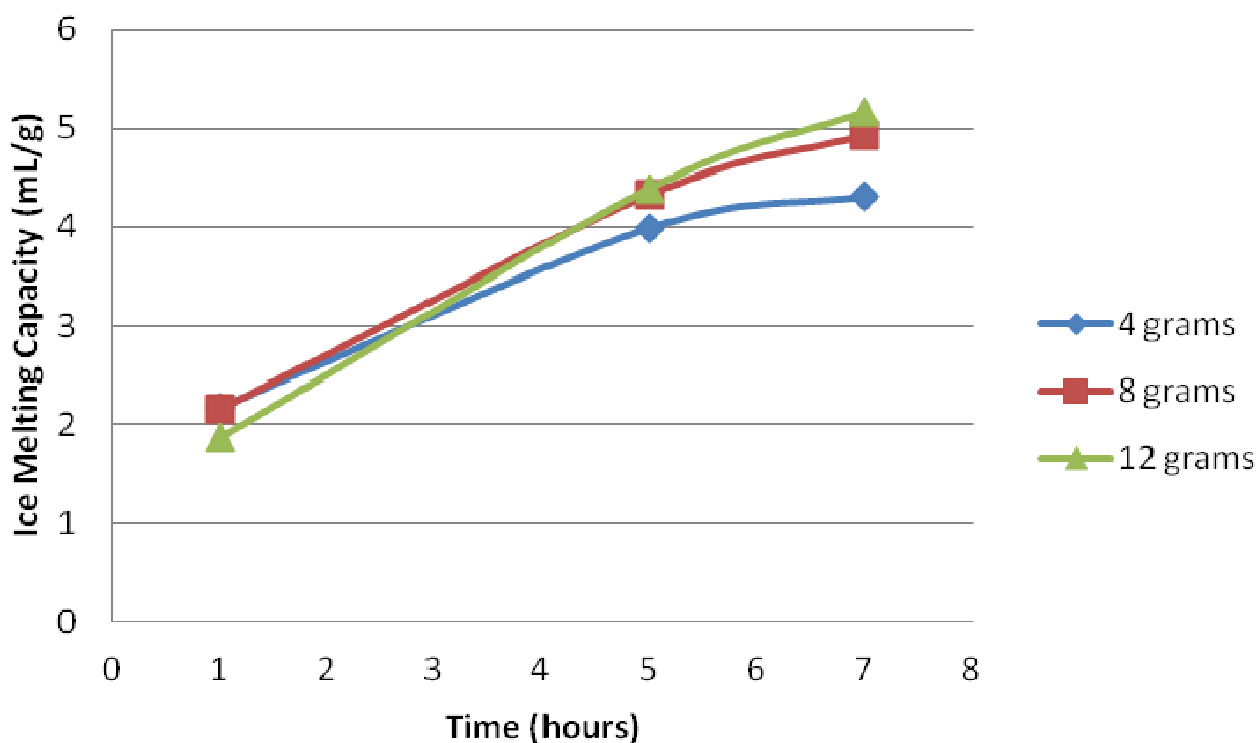
Mass of NaCl Applied (g)	Number of Replicates	Average Ice-Melting Capacity (mL/g)	Standard Deviation (mL/g)	Coefficient of Variation (%)
4.00	19	3.99	0.43	11
8.00	16	4.35	0.25	5.7
12.00	16	4.39	0.31	7.0
16.00	19	5.34	0.31	5.8

**TABLE 3 Ice-Melting Capacity of NaCl by SHRP H205.1 Measured After 7 h at 15°F (−9.4°C)**

Mass of NaCl Applied (g)	Number of Replicates	Average Ice-Melting Capacity (mL/g)	Standard Deviation (mL/g)	Coefficient of Variation (%)
4.00	19	4.31	0.50	11
8.00	16	4.94	0.18	3.6
12.00	16	5.16	0.26	5.0
16.00	19	4.84	0.20	4.2

function of test conditions at a given temperature. That is, a given quantity of salt will have a thermodynamically defined characteristic and constant quantity of ice it can melt in total (at equilibrium) at any given temperature. Figure 1 highlights the fact that sodium chloride is far from having reached its equilibrium ice-melting capacity after 1 h under the SHRP test conditions. The ice-melting capacity more than doubles over the next several hours and appears to be just beginning to approach a limiting value after 7 h. This underscores the fact that care must be taken in interpreting the results of the standard SHRP test after 1 h as a measure of the true, total ice-melting capacity of a given chemical. For sodium chloride, the standard SHRP test conditions greatly underestimate the total ice-melting capacity at 15°F (−9.4°C).

Another series of ice-melting capacity measurements using 4, 8, and 12 g applications of sodium chloride at time intervals of 1, 5, and 7 h was carried out at the Cargill laboratories. Two slight differences in procedure were followed compared to the tests at WTI. The tests at WTI followed the SHRP protocol of freezing 130 mL of water in the 9-in. diameter test dish. In the Cargill lab tests, the volume of water was increased to 260 mL with the idea that this might reduce the occurrence of ice undercutting and unrecovered ice melt. The other modification in the Cargill tests was that the ice surface was not smoothed prior to applying the deicer. Results of the Cargill lab tests are given in [Tables 4 through 6](#).



**FIGURE 1** SHRP ice-melting capacity of NaCl at 15°F as a function of application rate and time.

**TABLE 4 Ice-Melting Capacity of NaCl by SHRP H205.1 Measured After 1 h at 15°F (-9.4°C)**

Mass of NaCl Applied (g)	Number of Replicates	Average Ice-Melting Capacity (mL/g)	Standard Deviation (mL/g)	Coefficient of Variation (%)
4.00	16	2.94	0.55	19
8.00	16	3.33	0.41	12
12.00	16	3.32	0.34	10

**TABLE 5 Ice-Melting Capacity of NaCl by SHRP H205.1 Measured After 5 h at 15°F (-9.4°C)**

Mass of NaCl Applied (g)	Number of Replicates	Average Ice-Melting Capacity (mL/g)	Standard Deviation (mL/g)	Coefficient of Variation (%)
4.00	12	3.93	0.50	13
8.00	12	4.71	0.28	5.9
12.00	12	5.00	0.099	2.0

**TABLE 6 Ice-Melting Capacity of NaCl by SHRP H205.1 Measured After 7 h at 15°F (-9.4°C)**

Mass of NaCl Applied (g)	Number of Replicates	Average Ice-Melting Capacity (mL/g)	Standard Deviation (mL/g)	Coefficient of Variation (%)
4.00	8	3.92	0.42	11
8.00	8	4.75	0.23	4.9
12.00	8	4.99	0.098	2.0

The Cargill lab results reproduced the same basic observations seen in the WTI tests. There is a substantial decrease in test variation when the application rate is increased from 4 to 8 g. While there was no further decrease in variation by going to application rates greater than 8 g in the WTI tests, the Cargill tests indicated there was a further large decrease in test variation by going from an application rate of 8 to 12 g in the measurements made after 5 and 7 h. The reason for the difference between the results of the two labs is not clear, though perhaps it was due to the thicker ice layer used in the Cargill tests. Forgoing the smoothing of the ice layer in the Cargill tests did not appear to introduce any significant variation in the test results.

Akin and Shi (2) have also reported an analysis of variance in ice-melting capacity measured by a modified SHRP test procedure. They modified the procedure by using 3.356-in. (8.524-cm) diameter petri dishes and 25 mL of water to make their ice specimens and used an application rate of 1.0 g of solid deicer. Using fine-particle-size NaCl, they reported an average ice-melting capacity for NaCl of 3.4 mL/g after 1 h with a standard deviation of 0.25 mL/g and coefficient of variation of 7% for tests conducted at 15°F.

The decrease in test variation realized by using higher application rates and longer measurement times significantly improves the ability to differentiate the performance of different deicer formulas. For example, a 4-g replicate standard SHRP test carried out on sodium chloride with the variance shown in Table 4 would yield an ice-melting capacity after 60 min of 3.93 mL/g with a 95% confidence interval of  $\pm 0.88$ , or a relative uncertainty of 22%. Doing the same 4-g replicate measurement with a 12-g application rate after 5 h using the variance reported in Table 5 yields an ice-melting capacity of 5.00 mL/g with a 95% confidence interval of 0.16, or a relative uncertainty of only 3%, permitting a much more precise differentiation of different

product formulas. The application rates indicated for this increased precision are unrealistic in terms of actual field application rates. An application rate of 8 to 12 g in the SHRP test would correspond to 2,529 to 3,794 lbs/lane-mile (713 to 1,069 kg/lane-kilometer) or roughly 10 times a typical field application rate. However, even though this is an unrealistically high application rate, it should be noted that it does not really matter for the purposes of this test. Ice-melting capacity is a ratio: it is the amount of ice melted per weight of deicer. Thus, from the standpoint of realism it makes no difference what application rate of deicer is used in the test. Assuming the test is carried out under conditions that allow the full equilibrium ice-melting capacity to be measured, the value of ice-melting capacity will be the same no matter what application rate is used. Furthermore, the SHRP-suggested application rate of 4.17 g is already unrealistically high (equivalent to 1,318 lbs/lane-mile or 372 kg/lane kilometer).

The more relevant excursion from real world field conditions is arguably the extension of the test time to 5 to 7 h. The argument could be made that the winter maintenance professional will be primarily interested in the relative amount of melting a chemical can achieve within 1 h. There is certainly validity to this, and making SHRP ice-melting capacity measurements at shorter time intervals remains a useful way to get comparative information about relative short-term ice-melting rates. But this should not be confused with total ice-melting capacity. As long as a residual of deicer remains on the road, it may continue to provide valuable ice melting for periods of time that far extend the time of initial application. Thus, we suggest that there is value in determining the true, total equilibrium ice-melting capacity of different deicer formulations even if the test method does involve using extended periods of time.

## ICE CUBE TITRATION ICE-MELTING CAPACITY TEST

In an effort to explore other ways to measure ice-melting capacity more precisely, we experimented with a novel approach. Since a major source of variation in the standard ice-melting capacity test is the difficulty of recovering a relatively small amount of melt from a relatively large amount of ice, we explored whether it might be possible to get better results by taking the converse approach [i.e., might we get better results if we tried titrating a large amount of deicer (in solution form) with ice cubes?]. The concept was to add small ice cubes to a beaker containing 400 g of deicer solution with continuous stirring and periodically removing the ice cube and measuring the weight of the beaker. As long as the ice was continuing to melt, the weight of the beaker would increase. When the weight of the beaker stops changing, the brine is able to melt no more ice; the system is at equilibrium and has reached its ice-melting end point. Then the total amount of ice melted is determined simply from the difference between the initial and final weight of the solution. The deicer solutions were maintained at a temperature of  $5.0 \pm 0.9^\circ\text{F}$  ( $-15 \pm 0.5^\circ\text{C}$ ) in a cold room. Small ice cubes were used so that the endothermic melting of the ice would not cause a significant change in the temperature of the bulk deicer solution. Measurements were made on solutions of 23.3% sodium chloride, 27.95%  $\text{MgCl}_2$ , and a blend of 20% of the  $\text{MgCl}_2$  brine with 80% of the sodium chloride brine. The goal of the experiment was to attempt a more precise measurement of ice-melting capacity on some standard liquid deicers and a typical hot mix of  $\text{MgCl}_2$  brine and sodium chloride brine to see if there was evidence of any interaction between them that resulted in an unexpected enhancement of ice-melting performance at colder temperatures.



In principle, the total equilibrium ice-melting capacity of a chemical (on an anhydrous basis) should be the same whether the ice melting is measured on a dry, solid chemical or on the chemical in solution. However, an impracticality of this approach quickly became apparent: it can take many days for the mixture of brine and ice cubes to reach equilibrium. Since we started with 400 g of brine and one ice cube weighing approximately 8 g, the brines were capable of melting dozens of ice cubes. Furthermore, precise isothermal conditions were desired which prevented the introduction of many ice cubes (or shaved ice) because the increase in surface area of the ice greatly increased the rate of ice melting, resulting in a dramatic reduction in brine temperature. Consequently, a shortcut to the procedure was implemented. An initial “quick and dirty” experiment was carried out on a single beaker of brine to approximate the end point of the test (i.e., to determine approximately how much ice would be melted in total by the brine). Then a more precise experiment was carried out on replicate beakers of brine which were prediluted with water to dilute them close to the limit of their ability to melt any more ice. Then the ice cube titration was carried out carefully to precisely determine the final quantity of ice that would be melted. The sum of the mass of dilution water added and the mass of additional ice melted was taken to be the total ice-melting capacity of the brine.

Figure 2 shows the total ice melt of the three brines as they are titrated with ice cubes over time. The value of the mass of ice melted at time zero reflects the amount of predilution water that was added to the brine. For all three brines, there was some continued melting of the introduced ice cubes which eventually reached a plateau when no further ice melting occurred, indicating the mixture was at equilibrium and the deicer was exhausted at that temperature. The ice-melting behavior of the three brines as determined by this method is consistent with the generally understood ice-melting characteristics of sodium chloride and  $MgCl_2$ . At a temperature of 5°F (−15°C) sodium chloride is nearing the low temperature limit of its effectiveness and so the NaCl brine is providing relatively low ice-melting capacity.  $MgCl_2$ , however, is known to have a much lower effective ice-melting temperature

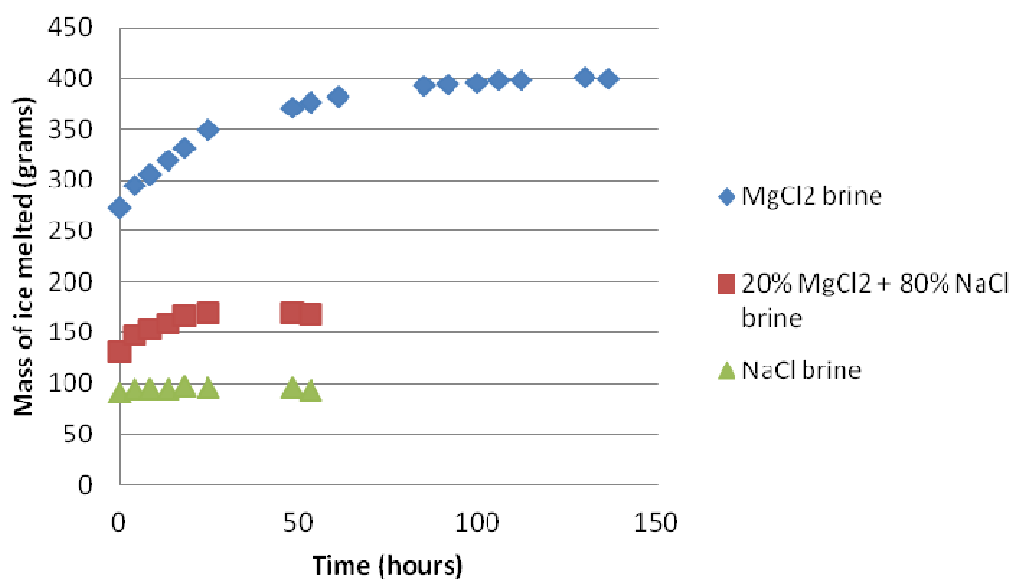


FIGURE 2 Ice melting by 400 g of liquid deicers in ice cube titration test at 5°F (−15°C).

than sodium chloride, and Figure 2 shows that the  $\text{MgCl}_2$  brine provides almost four times the ice-melting capacity of the NaCl brine.

Table 7 shows the values for the total equilibrium ice-melting capacity on the three brines measured by this approach. Four replicates of each brine were tested. The precision of this method appears to be about the same or perhaps slightly higher than that of the modified SHRP approach described above with higher application rates and longer measurement times. Coefficients of variation were 4% to 6% by this method, compared to about 2% to 7% for the SHRP approach using 8 g or more of deicer and measurement times of 5 h or more.

It is interesting to compare the ice-melting capacity measured on the hot-mix blend of 20%  $\text{MgCl}_2$ –80% NaCl brine with the theoretical value expected for the blend. Based on the data in Table 7, if the effect of blending a  $\text{MgCl}_2$  brine with NaCl brine were purely additive, the ice-melting capacity of the 20/80 brine blend would be  $(0.20)(394.65) + (0.80)(97.30) = 156.77 \pm 7.1$  (95% confidence interval) grams ice melt per 400 g of brine. The observed value was  $169.82 \text{ g} \pm 12.4$  (95% confidence interval). Thus, the ice-melting capacity of the hot mix appears to be simply the sum of the ice-melting capacities of each component. We see no evidence in this experiment for any unusual synergistic interaction between the  $\text{MgCl}_2$  and sodium chloride resulting in a greater than additive enhancement of ice-melting capacity at low temperatures.

## CONCLUSIONS

The SHRP H205.1 standard ice-melting capacity test can be both imprecise and inaccurate when using the standard experimental conditions suggested. For example, using the standard suggested deicer application rate of 4.17 g deicer, the test significantly underestimates the total, thermodynamic ice-melting capacity of sodium chloride. The precision and accuracy can be significantly improved by using higher application rates and longer measurement times than those suggested in the original standard. In measurements by two independent labs on solid sodium chloride, a decrease in the coefficient of variation from about 19% to 23% to about 2% to 7% was realized by increasing the application rate to 8 g or higher and increasing the measurement time to 5 h or longer. Ice-melting capacity measurements were also made on typical NaCl and  $\text{MgCl}_2$  brines and a hot mix of 20%  $\text{MgCl}_2$  brine/80% NaCl by an alternative ice cube titration approach. Ice-melting capacities could also be measured by this approach with

**TABLE 7 Ice-Melting Capacity of NaCl,  $\text{MgCl}_2$ , and 20/80  $\text{MgCl}_2$ /NaCl Brines Measured by Ice Cube Titration Method**

	Average	Standard Deviation	Coefficient of Variation (%)
<i>In Solution</i>			
Grams ice melt per gram NaCl brine	0.24	0.01	5.7
Grams ice melt per gram $\text{MgCl}_2$ brine	0.99	0.04	4.4
Grams ice melt per gram 20/80 $\text{MgCl}_2$ /NaCl brine	0.42	0.02	4.5
<i>Anhydrous</i>			
Grams ice melt per gram NaCl	1.04	0.06	5.7
Grams ice melt per gram $\text{MgCl}_2$	3.53	0.15	4.4
Grams ice melt per gram 20/80 $\text{MgCl}_2$ /NaCl blend	1.75	0.08	4.5

significantly greater precision than by the suggested SHRP H205.1 test conditions. Tests indicated that the ice-melting capacity of a hot mix of NaCl and MgCl<sub>2</sub> brines is simply the additive contribution from each of the deicers, and there was no evidence of any synergistic enhancement of ice-melting at 5°F (−15°C).

## REFERENCES

1. Fay, L., M. Akin, S. Wang, X. Shi, and D. Williams. Correlating Lab Testing and Field Performance for Deicing and Anti-icing Chemicals (Phase 1). Final Report for the Wisconsin Department of Transportation and the Clear Roads Program, Project 0092-10-17/CR09-01. Western Transportation Institute, Montana State University, Bozeman, August 2010.
2. Akin, M., and X. Shi. Development of Standardized Test Procedures for Evaluating Deicing Chemicals. Final Report, Project 0092-08-32/CR07-02. Western Transportation Institute, March 2010.
3. Chappelow, C. C., A. D. McElroy, R. R. Blackburn, D. Darwin, F. G. de Noyelles, and C. E. Locke. *Handbook of Test Methods for Evaluating Chemical Deicers*. SHRP, National Research Council, Washington, D.C., 1992.

## OPTIMIZING WINTER MAINTENANCE MATERIALS

**Residual Salt and Road Surface Wetness**  
*Comparison of Field Techniques***GÖRAN BLOMQVIST****MATS GUSTAFSSON***Swedish National Road and Transport Research Institute*

Understanding the processes behind salt loss from road surfaces is of great importance if optimization of the system is to be facilitated. Salt loss has been shown to be largely dependent on road surface wetness, and this is why accurate measurements of both the salt amount and the road surface wetness are crucial to predict the future salt amount. In this paper, two field techniques for salt measurements and two field techniques for wetness measurements are compared. Both SOBO 20 and the Swedish National Road and Transport Research Institute wet dust sampler (WDS) have been shown to be suitable to measure residual salt on wet road surfaces with dissolved salt. However, when it comes to measurements of dry salt crystals, the WDS is preferred. Measuring salt that has been in solution and then dried on the road surface is also possible by both the SOBO 20 and the WDS, but the variation is larger than when measuring on wet surfaces and the measured salt amount is underestimated. The wetness of a road surface can be well established using the Wettex cloth method, but the degree of underestimation seems to be positively related to the road surface texture. The wetness comb is a very fast and easily operated method to establish the road surface wetness. The measured value is, though, strongly dependent on the road surface characteristics and illustrates why further development of the method is needed before it is recommended for field use.

Chemical anti-icing and deicing are executed by road keepers in order to maintain traffic safety and road network accessibility on acceptable levels under the winter seasons in the Nordic region. In order to avoid negative environmental impacts and reduce costs, there is a constant intention by national road authorities to minimize salt use. Therefore, understanding of the processes behind salt loss from road surfaces, and the factors influencing these processes, is of great importance, if optimization of the system is to be facilitated. Salt loss has been shown to be largely dependent on road surface wetness, which is why accurate measurements of both the salt amount and the road surface wetness are crucial for the possibility to predict the future salt amount (1, 2).

Earlier findings, however, have indicated that some salt measuring instruments may not mobilize all of the salt within the road texture, especially under dry road conditions (1, 3, 4). It has also been shown that wetting the road surface before measuring the salt amount might increase the measured salt level (1).

This investigation aims to compare field techniques for both salt and wetness measurements. This is done under controlled conditions by applying water and salt solutions to known amount and concentration to asphalt slabs representing three pavements.

## MATERIALS, METHODS, AND DATA

### Salt Measurements

Four asphalt slabs representing the surface course of a standard pavement, all worn by studded winter tires in the Swedish National Road and Transport Research Institute (VTI) road simulator, was used as surface for the salt measurements. The slabs were exposed to salt solutions with different salt concentrations. Salt solution was spread on the pavement surface by applying it to delineated 1 dm<sup>2</sup> areas (Figure 1) by a wetted sponge, which was measured on an electronic scale before and after the application.

By altering the amount and concentration of the salt solution, different salt exposures were achieved. Measurements were made using the SOBO 20 (Marcel Boschung AG) and the VTI wet dust sampler (WDS) (3) both on wet surfaces and after having the exposed surfaces dried. The drying of the surfaces was enhanced by having heat fans create turbulence over the asphalt slabs. Tests were also made by measuring solid salt crystals (2 to 4 mm), which were placed in the center of each area.

Both the SOBO 20 and the WDS builds on the relation between salt concentration and the electric conductivity in a salt solution. The difference is that the SOBO 20 measure it in situ on the road surface while the WDS collects the sample in a bottle where the electric conductivity is measured. The WDS is further described in Jonsson et al. (3).

### Wetness Measurements

Three asphalt slabs with different characteristics were used in order to compare the field techniques for measuring road surface wetness. On each slab an area of 1 dm<sup>2</sup> was delineated on which clean water was applied using a sponge, which was weighed before and after using an electronic scale. The three pavements, all of the pavement type stone mastic asphalt, differed regarding their characteristics as described in Table 1.

Pavement slabs No. 1 and No. 2 were of the same road surface texture, but had different largest stone size, which gave them different appearances (Figure 2). Pavement slab No. 3 was of

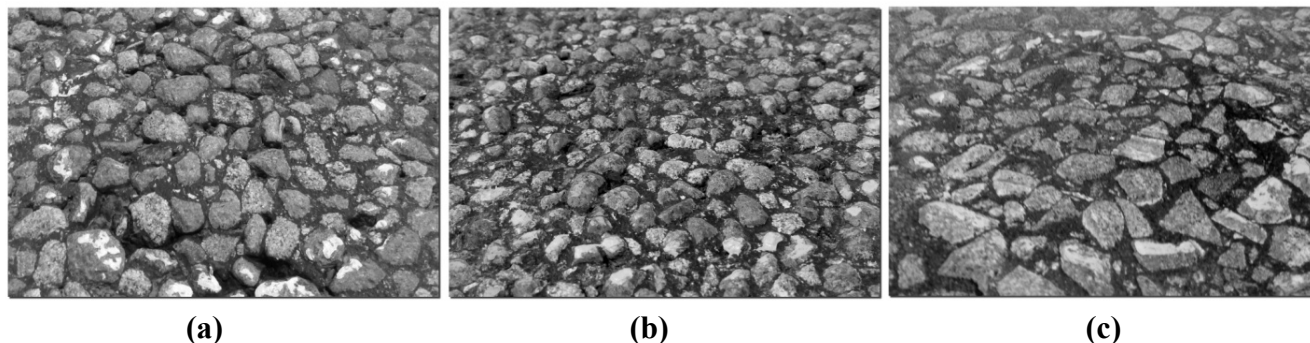


**FIGURE 1** Asphalt slabs used for comparison of salt measuring field techniques.

**TABLE 1 Pavements Used for Testing the Wettex Cloth Method and the Wetness Comb Method for Determining the Wetness of Road Surfaces**

Slab No.	Stone Mineral	Largest Stone Size (mm)	Road Surface Texture <sup>a</sup> (mm)
1	Porphyry	16	2.1
2	Porphyry	8	2.1
3	Quartzite	16	1.3

<sup>a</sup> Mean profile depth measured by sand patch, macro texture CEN-standard, EN13036-1 (equivalent to ASTM E965).



**FIGURE 2 Asphalt slabs used for wetness tests: (a) Slab 1 (texture 2.1 mm); (b) Slab 2 (texture 2.1 mm); and (c) Slab 3 (texture 1.3 mm). The circles marked on the slabs are of equal size, i.e., 1 dm<sup>2</sup>.**

a different stone mineral and was more worn, which gave it a lower texture with a smoother appearance (Figure 2).

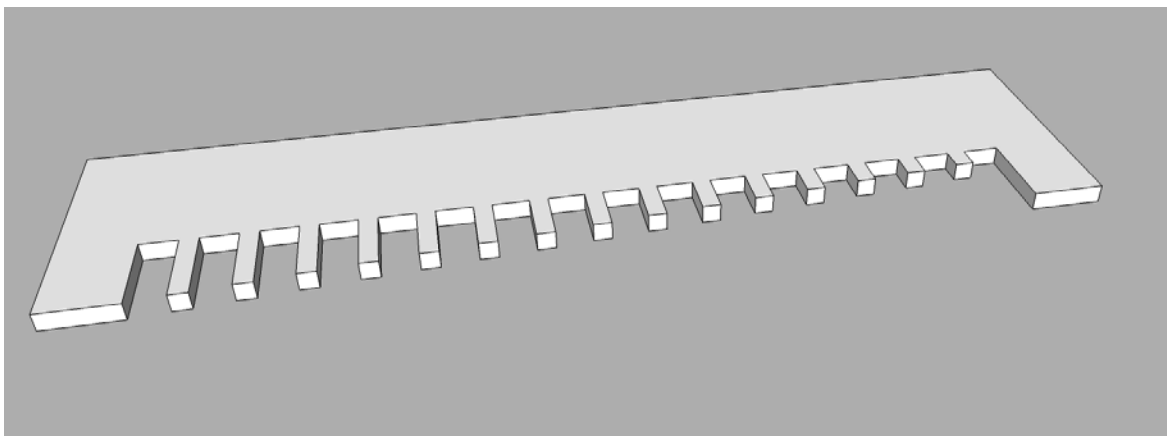
#### *Wettex Cloth*

The Wettex cloth was downscaled in size to a 1-dm<sup>2</sup> round piece (measured under wet conditions). The cloth was slightly prewetted before use and it was weighed on an electronic scale before and after the measurement in order to establish the gain in weight.

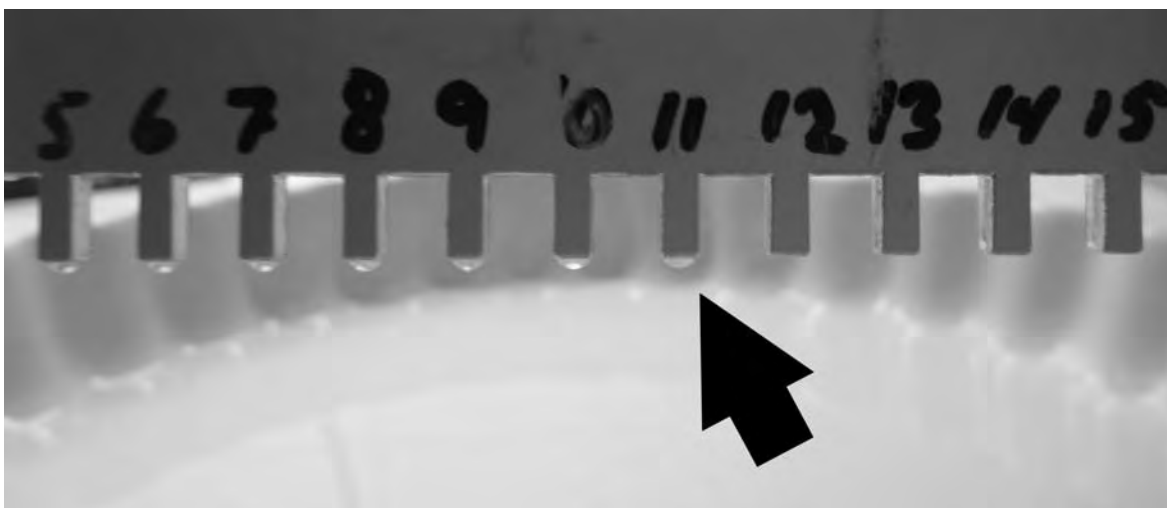
#### *Wetness Comb*

The wetness comb (also known as wet film thickness gauge) is made of aluminum and consists of a number of teeth that are of different lengths. Since the outer teeth are of equal length, they form a baseline to which each of the other teeth has a different distance (Figure 3). The difference in length between each tooth is 0.1 mm.

The wetness comb is held against the wet road surface and moved around in order to get the actual number of teeth to have contact with the water surface. When a tooth is in contact with the water surface a droplet will form and stick to the end of the tooth by the forces of surface tension. The actual wetness is then easily read by holding the comb into the air and checking where the droplets are situated (Figure 4).



**FIGURE 3** The principle of a wetness comb. Each tooth of the comb has a unique length. In the version used in this pilot study, the comb consists of 15 teeth within a 125-mm gap. The depth scale in the figure is exaggerated.

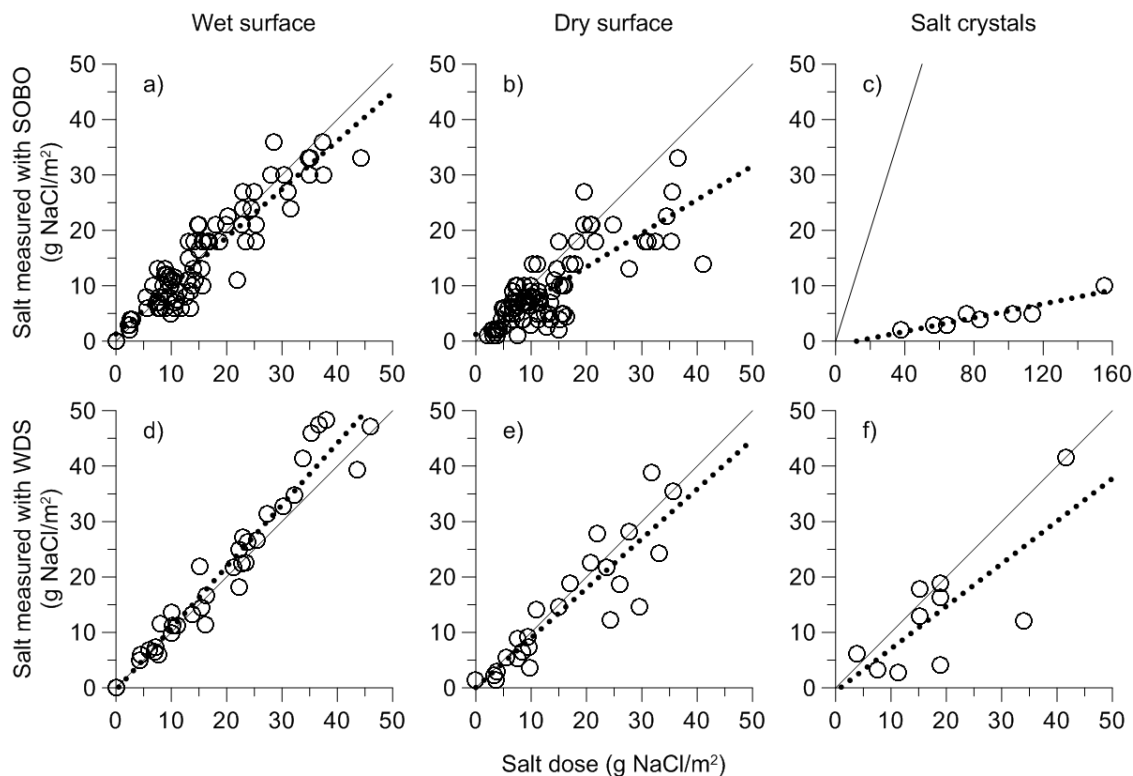


**FIGURE 4** Reading the wetness comb: water will stick to the teeth that have reached the water level on the road surface. In this case, tooth No. 11 has been in contact with the water, but tooth No. 12 has not. This means that the water level is situated 1.1 mm from the baseline formed by the outermost teeth.

## RESULTS AND DISCUSSION

### Salt Measurements

Both the SOBO 20 and the WDS showed good results when measuring during wet road surface conditions (Figure 5a and d), but when measuring after the road surfaces had dried, the variation was markedly wider, and the SOBO 20 was slightly underestimating the true salt amount. (Figure 5b and e). This underestimation was also seen by Klein-Paste (1) and why he suggested prewetting of the road surface before measuring with the SOBO 20 on dried road surfaces.



**FIGURE 5** The relation between measured salt amounts and salt doses: upper row (*a–c*) measurements with the SOBO 20 and lower row (*d–f*) measurements with the VTI Wet Dust Sampler. The solid lines show the 1:1 relation, and the dotted line is fitted to the data by linear regression.

When measuring on dry salt crystals, the SOBO 20 showed a good fit, but the salt amount was largely underestimated (Figure 5c). This is of no surprise, since there is not enough time for the crystals to dissolve and be mixed within the measuring solution, during a SOBO measurement.

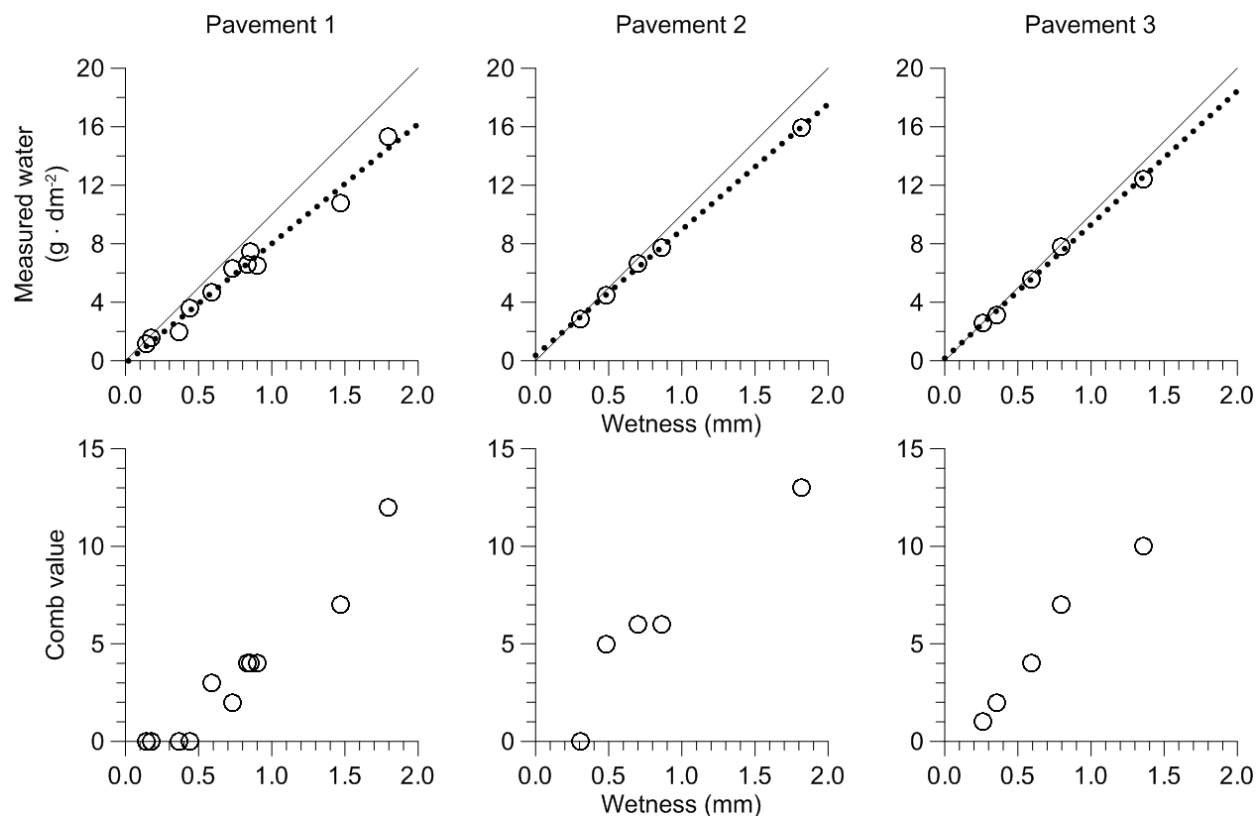
The WDS showed a better result on salt crystals, but some of the measurement points were largely underestimated, probably due to whether the salt crystals were transferred to the sampling bottle or not. Once in the sampling bottle, the transferred salt crystals can be given time to be dissolved, and hence the method could be used to measure salt amount when dry salt has been used.

### Wetness Measurements

The Wettex cloth showed a good linear fit between the pavement wetness and the captured water amount, but the values were slightly underestimated (Figure 6). The larger underestimations seem to be related to the two pavements with the largest texture values (Pavements 1 and 2).

The wetness comb values are also positively related to the pavement surface wetness, but there seems to be a lag below which the water amount does not affect the comb at all, at least at Pavements 1 and 2. This is not surprising, since the textures of Pavements 1 and 2 are larger than the texture of Pavement 3, and hence, can contain more water out of reach to the wetness comb.





**FIGURE 6** Top row: wetness measured with the Wettex cloth in relation to water amount on three asphalt slabs (Pavements 1–3) of different characteristics. Bottom row: wetness measured with the wetness comb as compared to water amount on three asphalt slabs (Pavements 1–3). The solid lines show the 1:1 relation, and the dotted line is fitted to the data by linear regression.

## CONCLUSIONS

Both SOBO 20 and the VTI sampler WDS are suitable to measure residual salt on wet road surfaces with dissolved salt. However, when it comes to measurements of dry salt crystals, the WDS is preferred since the crystals can be transferred into the sampling bottle where they can be given the time needed to be dissolved.

Measuring salt that has been in solution and then dried on the road surface is also possible by both the SOBO 20 and the WDS. The variation is then larger than when measuring on wet surfaces and the measured salt amount can be somewhat underestimated, probably depending on the solubility of the crystals formed during drying and how hard they stick to the pavement.

The wetness of a road surface can be well established using the Wettex cloth method, but the degree of underestimation seems to be positively related to the road surface texture.

The wetness comb is a very fast and easily operated method to establish the road surface wetness. The measured values is, though, strongly dependent on the road surface characteristics, and why further development of the method is needed before it is recommended for field use.

## ACKNOWLEDGMENT

This pilot study was financed partly by the Nordic research cooperation project MORS (modeling residual salt). More elaborated studies will take place at a road field site in Denmark during the winter 2012 where the techniques described here will be compared to other field sensors under field conditions. MORS is a cooperation between research partners in Sweden, Denmark, Norway, and Iceland and is financed by the road authorities in each country through the Nordic research and development collaboration NordFoU ([www.nordfou.org](http://www.nordfou.org)).

## REFERENCES

1. Klein-Paste, A. Reduktion av saltforbruk ved bruk av tilsetningsstoffer — feltforsøk vinter 2007/08. *Rapport Nr 2523*, Teknologiavdelningen, Statens vegvesen. 2008 (in Norwegian).
2. Blomqvist, G., M. Gustafsson, M. Eram, and K. Ünver. Prediction of Salt on Road Surface: Tool to Minimize Salt Use. In *Transportation Research Record: Journal of the Transportation Research Board*, No. 2258, Transportation Research Board of the National Academies, Washington, D.C., 2011, pp. 131–138.
3. Jonsson, P., Blomqvist, G. and Gustafsson, M. Wet Dust Sampler: Technological Innovation for Sampling Particles and Salt on Road Surface. *Transportation Research Circular E-C126: Surface Transportation Weather and Snow Removal and Ice Control Technology*, Transportation Research Board of the National Academies, Washington, D.C., 2008, pp. 102–111.
4. Lysbakken, K. R. Field Observations on the Quantity of Salt on Road Surfaces after Salt Application. Presented at 90th Annual Meeting of the Transportation Research Board, Washington, D.C., 2011.



# Measuring and Forecasting Pavement Surface and Subsurface Conditions



MEASURING AND FORECASTING PAVEMENT SURFACE  
AND SUBSURFACE CONDITIONS**Model to Forecast Short- and Long-Term Prediction of  
Road Surface Temperature in South Korea**

CHOONGHEON YANG

DUK-GEUN YUN

JUNG GON SUNG

*Korea Institute of Construction Technology*

The main objective of this study is to validate a performance forecasting model for road surface temperatures ranging from 3 to 24 h in the future using real-time weather forecasts as provided by the Korea Meteorological Administration. The model used here was developed by researchers at the Korea Institute of Construction and Technology. The core concept of the model is based on heat transfer between road surfaces and the atmosphere. Preliminary tests were performed by comparing historically observed road surface temperatures obtained from road sensors with predicted temperatures from model runs at a specific site on the CheongWon–Sang Joo Expressway. After testing, the model was partially run on the CheongWon–Sang Joo Expressway at the Bo-Eun Branch of the Korea Highway Corporation to predict road surface temperatures 24 h in advance. Test results showed that predicted road surface temperatures matched well with the observed temperatures. In addition, the average (either hourly or daily) difference between the two temperatures lies within  $\pm 2^{\circ}\text{C}$ , indicating that the model performance is reasonable. For a real-time model run, road surface temperatures were predicted only at night because there were no instruments to measure solar radiation in real time along the roads. Nonetheless, a 12-h forecast performed well, showing the average temperature differences between observed and predicted temperatures of about  $\pm 0.5^{\circ}\text{C}$ .

Recently, severe natural disasters during the winter season in South Korea have occurred, and scientists predict climate change may contribute to exacerbate such events. They emerge in a variety of forms such as unexpected heavy snowfall, freezing rain, rime, and frost. These obviously have great negative impacts on traffic safety. For example, the repetitive melting and refreezing of the snow and ice on the road surface frequently leads to serious traffic accident potential. In order to decrease such negative impacts, road salting is performed by road operators, though at times it may be unnecessary. This unnecessary salting should be avoided for several reasons, including increased cost and the risk of environmental damage. Even though it is quite difficult to predict road surface temperatures with high accuracy, precise road surface temperatures would be useful to road engineers and planners to determine the best time for salting routes. In addition, it would be useful to provide valuable weather information to drivers. With the need for addressing these matters, the Korea Institute of Construction Technology research teams have developed a model to predict road surface temperatures based on weather forecasts (1). The main contribution of this study is to validate a road surface temperature prediction model during the winter season based on real-time weather forecasts.

In this paper, the developed model is briefly described, and then the results are presented from the preliminary tests performed through the comparison of historically observed road surface

temperatures from road sensors with predicted temperatures from model runs from a specific site on the CheongWon–Sang Joo Expressway during October and December 2009. Second, the performance of the model was validated based on real-time weather forecasts in January 2011. For the real-time model run, the surface temperatures were predicted only in the evening (e.g., 07:00 p.m. to 07:00 a.m.) since there were no instruments to measure real-time solar radiation along the roads. Nonetheless, a 12-h prediction performed well at the study site.

## LITERATURE REVIEW

The research begins with a review of the literature related to this study. Since the 1980s, many numerical models to predict road surface temperatures have been developed in several countries across Europe, North America, and Japan.

Sass (2) developed a model based on the equation of heat conduction in the ground and the surface energy-balance equation for the nowcasts of road surface temperatures. This model has been tested using data obtained from a Danish road station. The most remarkable finding of this study was the relationship between a realistic temperature and the cloud structure at the lower part of the surroundings. Test results demonstrated that highly delicate road surface temperature forecasts could be generated up to a range of at least 3 h. In another study conducted by Sass (3), a numerical model was improved in accuracy to predict road surface temperature in Denmark. He used a wealth of historical weather data such as cloud cover and relative humidity from a Danish road station. As a result, the model successfully predicted surface road temperatures at least 3 h in advance. Although this model does not hold for water effects on the road surface, it was used as a fundamental module for a comprehensive numerical forecasting system in the late 1990s in Denmark. The performance of this model has since been improved compared with the previous research. Results have showed that maximum differences between observed and predicted temperatures have approached approximately  $\pm 0.5^{\circ}\text{C}$ . An automated nowcast model for road surface temperature was developed in the United States (4). In order to validate the model performance, the authors collected a plethora of observed road surface temperatures obtained from a total of 41 roadside weather sensors in seven countries. An interesting characteristic of this model is that it makes use of no external weather information other than the weather data collected from roadside sensors. The model appears to perform well for short periods of time. According to the results, the model performance tended to be dependent upon the actual road surface conditions such as wet, dry, and icy. Canadian weather centers have been operating a numerical model to forecast road surface conditions (5). The model requires two types of data: road weather information collected by roadside meteorological stations and broad weather forecasts obtained from the Canadian meteorological center. With these data, the model enables one to determine solutions for the energy balance on the road surface. They were adequate to portray the phenomenon of water build up on the road surface. They employed absolute temperature, usually an accepted unit for meteorological field, and about one-half of the forecast errors lie within  $\pm 2^{\circ}\text{C}$ , which is remarkable.

Prusa et al. (6) mainly considered potential thermal effects of traffic on snow- and ice-covered surface roads. Although this study was primarily theoretical, it would appear to work well under ideal intersection conditions, including calm wind speed, heavy traffic, and ambient zero temperature. In order to consider operational meteorological model forecasting of slippery road conditions, sensitive analyses were performed to evaluate variations in traffic density, speed, and

the emissivity of vehicle radiative surfaces. Some Japanese researchers [Ishikawa et al. (7) and Fujimoto et al. (8)] have also developed various road surface temperature prediction models. They believe vehicle heat effects are a significant factor. Many efforts have been made to conceptually identify the relationship between vehicle heat and road surface temperatures through frictional heat flux, vehicle radiant heat flux, and vehicle sensible heat flux.

Domestically, a sophisticated one-dimensional soil canopy model for the surface has been developed since the mid-1990s (9, 10). Studies usually have been focused on the micrometeorology field.

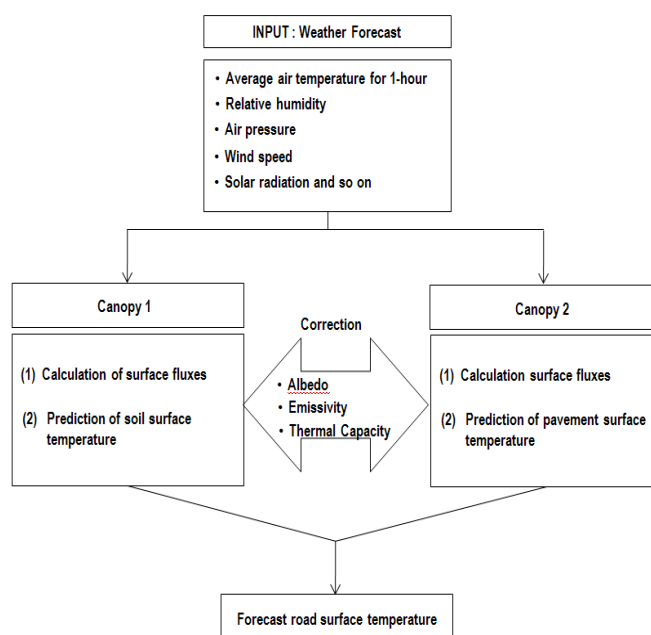
Finally, Canopy 1 and 2 was developed to forecast road surface temperatures for the road weather information system (RWIS), which is operated by the Korea Expressway Corporation (1). The main characteristics of this model are a reduced number of meteorological parameters that are required to run the model while maintaining reasonable predictive accuracy.

In summary, several models developed in advanced countries have already been tested and validated with weather forecast and road condition information. However, domestic models still must be validated with a wide variety of conditions based on the road and weather data.

### Overall Description of Prediction Model

The model used here is composed of two main modules (1). Canopy 1 describes the heat transfer between the soil surface and the atmosphere. This was developed by Park (9) to predict soil surface temperature. Canopy 2 focuses on pavement. This model is designated to consider that heat energy emitted from soil surfaces is usually greater than the pavement surfaces during nighttime. This is because the albedo of soil surfaces is generally greater than that of the pavement surfaces. Figure 1 demonstrates the overall core concept of the model in detail.

Surface fluxes are calculated first and then soil and road surface temperatures are predicted based on those surface fluxes.



**FIGURE 1 Overall concept of the model.**



### Surface Fluxes and Ground Heat Fluxes

Surface fluxes are closely related, showing the properties of flow through the use of drag and bulk transfer relations (9, 11). They are usually given by

$$\frac{\tau_0}{\rho_a} = u_*^2 = C_D (\bar{U}_a)^2 \quad (1)$$

$$\frac{H}{\rho_a C_p} = -u_* \theta_* = C_H \bar{U}_a (\theta_g - \theta_a) \quad (2)$$

$$\frac{E}{\rho_a} = -u_* q_* = C_B \bar{U}_a (q_g - q_a) \quad (3)$$

where

- $\tau_0$  = the surface stress;
- $\rho_a$  = the air density;
- $u_*$  = the friction velocity;
- $C_D$  = the drag coefficient;
- $\bar{U}_a$  = the average wind speed;
- $H$  = the kinematic sensible heat flux;
- $C_p$  = static pressure molar heat;
- $C_H$  = a drag coefficient for sensible heat flux;
- $\theta_*$  = the scale temperature;
- $\theta_a$  = potential temperature of the air;
- $\theta_g$  = potential temperature of the ground;
- $E$  = the evaporation rate;
- $q_*$  = the friction humidity;
- $q_g$  = the specific humidity if the ground;
- $q_a$  = the specific humidity of the air; and
- $C_B$  = a drag coefficient for latent heat flux.

In Equations 1, 2, and 3,  $u_*$ ,  $\theta_*$ , and  $q_*$  should be determined.

Next, the Bulk Richardson Number (BRN) can be employed. The BRN is a dimensionless number that is often used in micrometeorology. The BRN illustrates the ratio of thermally generated turbulence and turbulence produced by vertical shear. In other words, the BRN stands for the dynamic atmospheric stability between the roads and atmosphere when either turbulence or streamline flow may exist on the roads. If turbulence exists, heat energy transfers quite well. Otherwise, it does not. The following equation shows that the BRN is determined by friction velocity, scale temperature, and friction humidity (11).

$$R_{ib} = \frac{g}{\theta_0} \frac{Z_u^2 (\theta_a - \theta_g)}{Z_T \bar{U}_2} \quad (4)$$

where

- $Z_u$  = is the height where the wind is measured;
- $Z_T$  = the height where the temperature is measured;
- $g$  = acceleration due to gravity; and
- $\theta_0$  = average values between  $\theta_a$  and  $\theta_g$ .

The substring represents air and ground levels, respectively. The next step is to calculate the drag coefficient. This basically quantifies the resistance of an object in water and air:

$$C_{DN} = \frac{k^2}{\left[\ln\left(\frac{z}{z_0}\right)\right]^2} \text{ and } C_{HN} = \frac{k^2}{\left[\ln\left(\frac{z}{z_T}\right)\right]} \quad (5)$$

where

- $z_0$  = aerodynamic roughness length;
- $z_T$  = surface scaling length for temperature; and
- $k = 0.41$  is the Von Karman constant.

After that, the sensible heat flux and latent heat flux can be calculated. The sensible heat flux is heat energy transferred when there is a difference in the temperature between road surfaces and the atmosphere adjacent to the roads. The latent heat flux is one of the important components for illustrating surface energy budget, and is identical to a rate of evaporation which is divided by air pressure. For the estimation, various parameters such as friction temperature ( $u_*\theta_*$ ), air density ( $\rho_a$ ), static pressure molar heat ( $C_p$ ), and friction humidity ( $q_*$ ) are used.

$$\text{Sensible heat flux: } H = (\rho_a C_p) \times -u_* \theta_* \quad (6)$$

$$\text{Latent heat flux: } L = -u_* q_* \quad (7)$$

Ground heat flux ( $G_0$ ) represents heat energy that belongs to the pavement surface and thus it can be estimated using Equation 8:

$$G_0 = R_{Net} - H_0 - \lambda E_0 \quad (8)$$

where

- $H_0$  = the sensible heat flux that is the function of friction velocity and temperature,
- $\lambda E_0$  = the latent heat flux, and
- $R_{Net}$  = the net radiation flux.

Ground heat flux can be used as an important output to predict the road surface

temperature for the next time step from the present. It is also referred to as the surface energy balance equation.

### *Road Surface Temperature and Subsurface Temperature Prediction*

This core element of the model enables one to differentiate between Canopy 1 and 2. First of all, the solution equation of the soil surface temperature (Canopy 1) can be produced from the force restore method developed by Bhumrakar (12) and Blackdar (13):

$$\frac{\partial T_g}{\partial t} = C_T G_0 - \frac{2\pi}{\tau} (T_g - T_2) \quad (9)$$

$$\frac{\partial T_2}{\partial t} = \frac{1}{\tau} (T_g - T_2) \quad (10)$$

Where  $C_T$  is the road thermal coefficient,  $\tau$  is the time scale at 24 h, and  $G_0$  is the heat storage rate. The solution equation for the road surface temperature (Canopy 2) can be derived from the following equation (1):

$$\frac{\partial T_g}{\partial t} = C_T C_0 - \frac{2\pi}{\tau} (T_g - T_2) - \frac{2\pi}{\tau} (T_{p,g} - T_{p,2}) \quad (11)$$

Where  $CT$  is the road thermal coefficient,  $\tau$  is the time scale at 24 h,  $T_g$  is the surface temperature,  $T_{p,g}$  is the surface road temperature, and  $T_2$  is the second-layer temperature. After producing each output for Canopy 1 and 2, corrections are required to predict an accurate road surface temperature for the next time step. Finally, the mathematical model is then coded using FORTRAN and MATLAB. Most of the input weather data, such as air temperature, relative humidity, air pressure, and wind speed are as provided by the Korea Meteorological Administration (KMA) and such are compared with weather data obtained from roadside weather devices.

## **DATA DESCRIPTION**

In order to validate the performance of the model, two conditions are carefully considered to select appropriate study sites. The first condition is whether RWIS is installed and under operation. The other condition to consider is whether much weather information is available for the site. The CheongWon–Sang Joo Expressway was selected as both conditions are well satisfied. There are roadside meteorological stations for RWIS as well as a relatively large number of historical road surface temperature data. A specific location, the Moon Bridge, was chosen to test and validate the model. For the model input, weather forecast data such as air temperature and relative humidity are collected at 30-min intervals from weather observation stations operated by the KMA. Other weather data, including air pressure, solar radiation, wind speed and direction can be obtained from the CheongJoo, SangJoo, Gumi, and Chupyungryung weather observation stations.

After that, all weather data are corrected and properly adjusted in accordance with altitude and topography. The model is tested with two road surface temperature data sets for October and

December of 2009. In addition, the pavement surface properties are very important for the analysis. Thus, the following parameters and their corresponding values are properly determined to run the model:

- Asphalt

: Pavement density =  $1,700 \text{ kgm}^{-3}$

: Heat conductivity =  $0.5 \text{ Js}^{-1}\text{m}^{-1}\text{K}^{-1}$

: Thermal capacity =  $1.7 \times 10^6 \text{ Jm}^{-3}\text{K}^{-1}$

: Thermal diffusion =  $0.29 \times 10^6 \text{ m}^2\text{s}^{-1}$

- Concrete

: Pavement density =  $600\sim 2,300 \text{ kgm}^{-3}$

(According to type)

: Heat conductivity =  $0.19\sim 0.63 \text{ Js}^{-1}\text{m}^{-1}\text{K}^{-1}$

: Thermal capacity =  $0.6 \times 10^6 \sim 2.3 \times 10^6 \text{ Jm}^{-3}\text{K}^{-1}$

: Thermal diffusion =  $0.32 \times 10^6 \sim 0.71 \times 10^6 \text{ m}^2\text{s}^{-1}$

## PRELIMINARY MODEL TEST

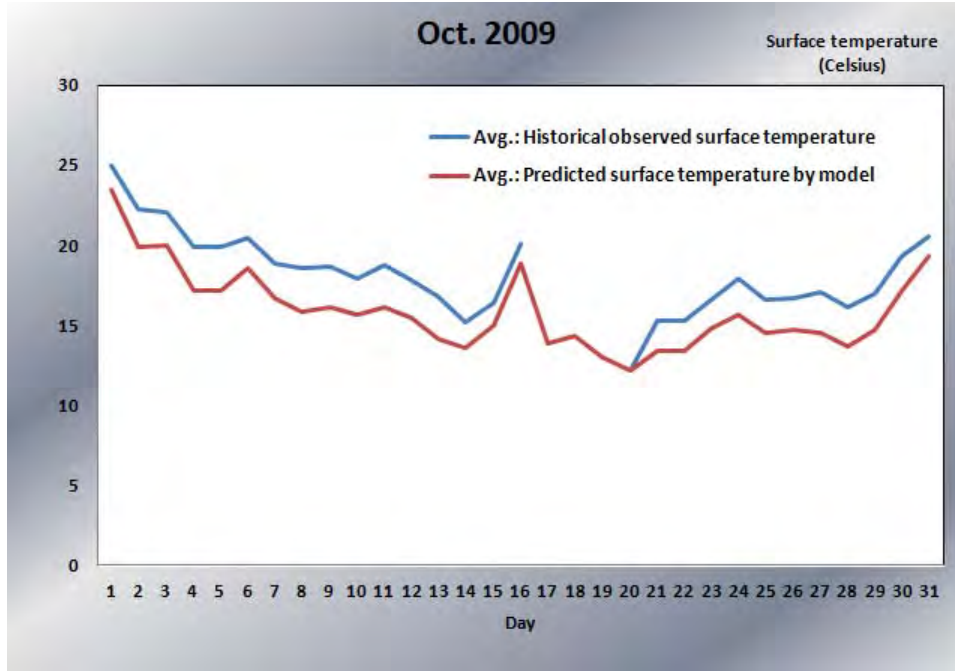
The model is tested to validate its performance after preparation of the data. First, predicted road surface temperatures produced by the model runs are plotted and compared with historical observed surface temperatures during 1 month (October 2009) as depicted in [Figure 2](#).

The model clearly describes the variation of road surface temperatures from day to day. From the meteorological point of view, when the average difference between observed and predicted road surface temperature lies within  $\pm 2^\circ\text{C}$ , it is generally accepted as “good.” As shown in [Figure 2](#), the average difference in October 2009 at the Moon Bridge is approximately  $2^\circ\text{C}$ , considered “good” though some deviations exist. In order to test the model in detail, the road surface temperature comparisons are performed over 24 h on a day with good weather in October as illustrated in [Figure 3](#).

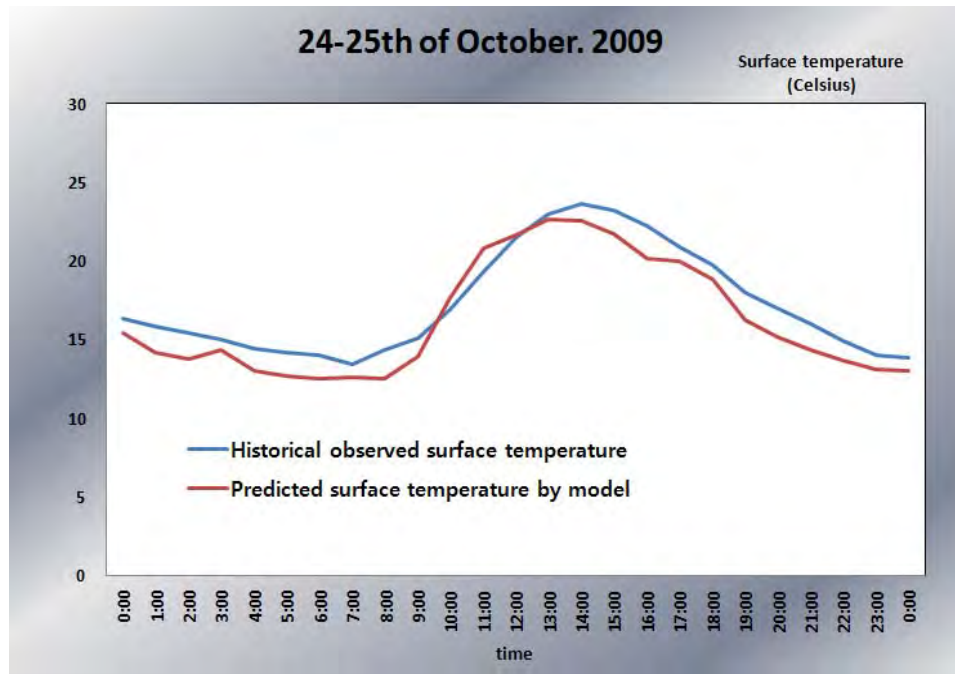
The average difference between actual observed and predicted road surface temperatures over 24 h is about  $1.04^\circ\text{C}$ , ranging from  $-0.1^\circ\text{C}$  to  $2^\circ\text{C}$ . In particular, there are relatively small differences from midnight to 7:00 a.m. This result is significant as this time period is considered prone to road freezing with both snowfall and rainfall during the winter season. To prove this fact, the road surface temperature data collected during the winter are utilized. [Figure 4](#) represents the variation of road surface temperature from day to day.

It is noted that the predicted road surface temperature is lower than the observed, even though the differences are acceptable from a meteorological standpoint. Again, a good weather day is chosen for the time period comparison. [Figure 5](#) demonstrates the comparison results.

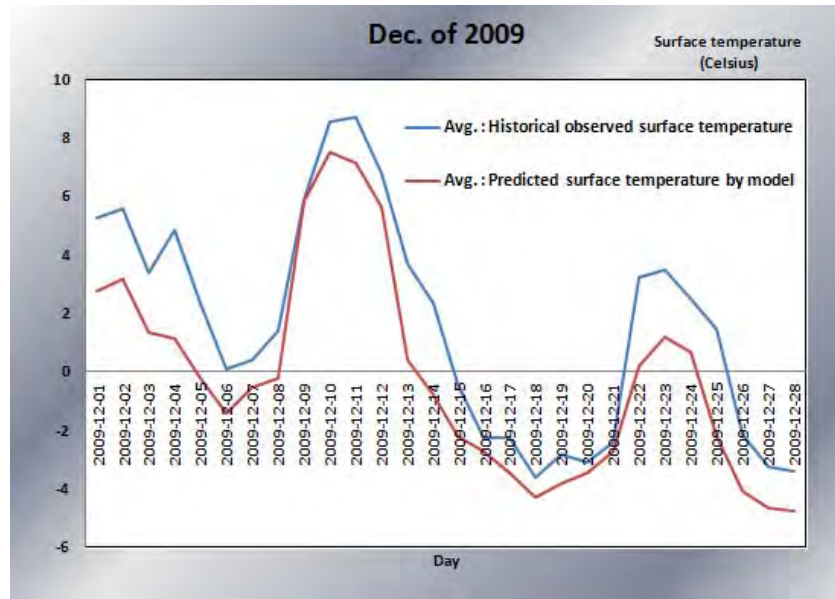
Similarly, this result is also significant, as this time period is considered prone to road freezing with both snowfall and rainfall during the winter season. The difference in the road surface temperature during the day is relatively larger than that during the night. It is assumed that solar radiation affects the road surface temperature greater during the daytime than during the evening. Measuring solar radiation in real-time is quite difficult as the devices used are quite



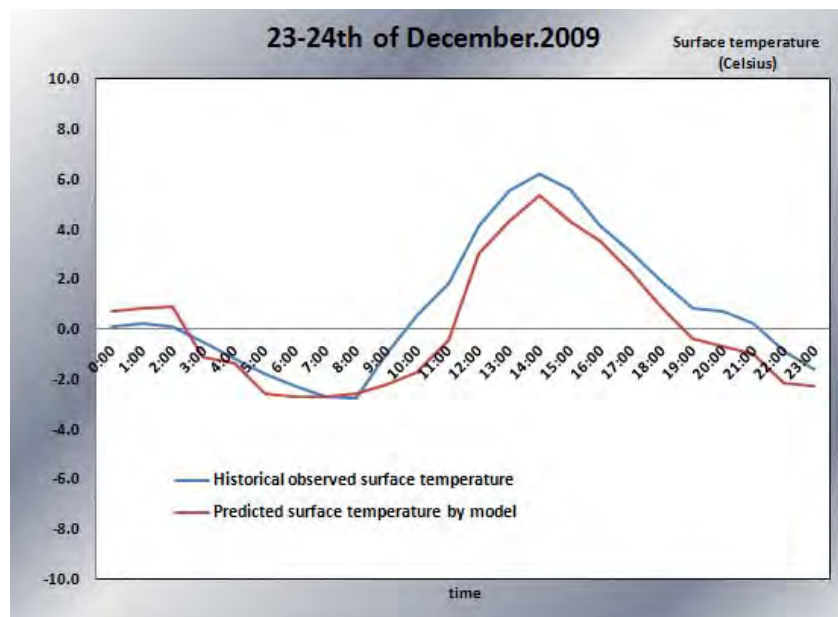
**FIGURE 2** Comparison between observed and predicted road surface temperatures in October 2009.



**FIGURE 3** Comparison between observed and predicted surface temperatures by time on October 24–25, 2009.



**FIGURE 4 Comparison between observed and predicted road surface temperatures in December 2009.**



**FIGURE 5 Comparison between observed and predicted surface temperatures by time.**

sensitive. Therefore, it is not reasonable to measure such along the road. Solar radiation used here is provided by agricultural weather stations operated by the KMA, but as such they are quite limited. Therefore, it is impossible to have solar radiation data along road surfaces for this study.

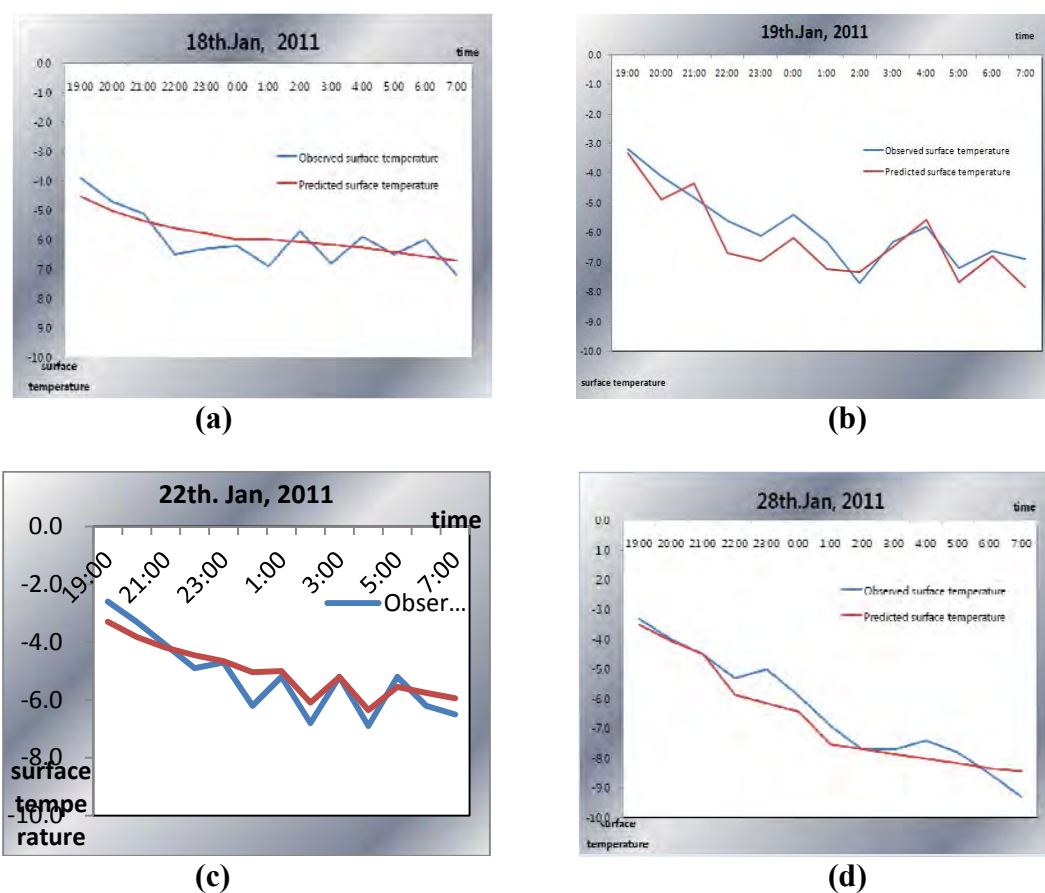
In conclusion, the preliminary test results show that the predicted road surface temperatures seem to match well with the observed ones in both periods. In addition, average differences between predicted and observed temperatures lies within  $\pm 2^{\circ}\text{C}$ , so that it appears that

the actual model performance is quite reasonable. In addition, the fact that predicted the road surface temperature is lower than the observed might be explained due to the solar radiation parameter, which could not be calculated for this study but indeed affects the road surface temperatures during the daytime, but not necessarily during the evening.

## MODEL VALIDATION USING REAL-TIME WEATHER FORECASTS

The RWIS that is installed along the CheongWon–Sang Joo Expressway is not fully operational since there is no accurate model for the road surface temperature prediction. Therefore, after testing the model performance, it was partially run along this expressway to forecast the road surface temperature 24 h in advance using a weather forecast. The predicted temperature is compared with the observed ones obtained from sensors embedded adjacent to the Moon Bridge.

However, the road surface temperatures are predicted only at night because solar radiation, which is systematic, is not monitored by the RWIS. The predicted results are illustrated over 12 h from 19:00 p.m. to 7:00 a.m. with high accuracy. Figure 6 shows the 12-h surface temperature forecast results over 4 days in January 2011.



**FIGURE 6** Comparison between observed and predicted road surface temperatures over 12 h: (a) prediction results on January 18, 2011; (b) prediction results on January 19, 2011; (c) prediction results on January 22, 2011; and (d) prediction results on January 28, 2011.

The average difference between the two temperatures lies within  $\pm 0.5^{\circ}\text{C}$  during validation. The weather during these days is moderate. Even though these results appear to be limited due to the lack of accurate solar radiation data, the model shows good performance during the night.

## CONCLUSIONS

A model for road surface temperature prediction has been validated for the RWIS installed on expressways in Korea. Road surface predictions range from 3 to 24 h in advance, and fundamental input data can be obtained from forecasted weather data of the KMA.

First, preliminary tests are performed to validate the performance of the model through the comparison of results with historical road surface temperatures at the Moon Bridge for October and December of 2009. The test results show that predicted surface temperatures seem to match well with the actual observed ones during both periods. In addition, the average difference between the two temperatures lies within  $\pm 2^{\circ}\text{C}$ , so that it appears that the model performance is quite reasonable. For the real-time model run, the road surface temperature was predicted at night (12 h in advance). The model predicts temperatures well on the selected days. Accuracy prediction in surface temperature is essential to establish deicing spreader strategies in snow-removal operations. According to *NCHRP Report 526 (14)* when the surface road temperature is less than  $-7^{\circ}\text{C}$  there is no reason to spread deicing materials on the roads such as NaCl and CaCl<sub>2</sub>. In other words, there is no effect to melt the snow on the surface when surface temperature is very low. At this temperature, snow plowing is more efficient than spreading in terms of both current practices and economic standpoints.

However, additional work must be performed to improve the model. For example, only one site was chosen to run the model, limiting the ability to completely prove the predictive capability of the model. In order to overcome such aspects, the model should be improved under a wide variety of weather conditions. In addition, a system that can receive real-time solar radiation data should also be established so as to fully operate the RWIS. The study is the first attempt for the development of a predictive model for road surface temperatures in Korea, and thus this trial is a starting point to improve the efficiency of winter maintenance and RWIS operations in the near future.

## REFERENCES

1. Yang, C. H., S. M. Park, and D. K. Yun. A Road Surface Temperature Prediction Modeling for Road Weather Information System. *Journal of Korean Society of Transportation Engineers*, Vol. 29, 2011, pp. 123–131
2. Sass, B. H. A Numerical Model for Prediction of Road Temperature and Ice. *Journal of Applied Meteorology*, Vol. 31, 1992, pp. 1499–1506.
3. Sass, B. H. A Numerical Forecasting System for the Prediction of Slippery Roads. *Journal of Applied Meteorology*, Vol. 36, 1997, pp. 801–817.
4. Shao, J., and P. J. Lister. An Automated Nowcasting Model of Road Surface Temperature and State for Winter Road Maintenance. *Journal of Applied Meteorology*, Vol. 35, 1996, pp. 1352–1361.
5. Crevier, L. P., and Y. Delage. METRO: A New Model for Road-Condition Forecasting in Canada. *Journal of Applied Meteorology*, Vol. 40, 2001, pp. 2026–2037.



6. Prusa, J. M., B. Segal, R. Temeyer, W. A. Gallus, and E. Takle. Conceptual and Scaling Evaluation of Vehicle Traffic Thermal Effects on Snow/Ice-Covered Roads. *Journal of Applied Meteorology*, Vol. 41, 2002, pp. 1225–1240.
7. Ishiikawa, N., H. Narita, and Y. Kajiya. Heat Balance Characteristics of Snow Melting on Roads. *Proc., Cold Region Technology Conference*, 2000.
8. Fujimoto, A., H. Watanabe, and T. Fukuhara. Influence of Vehicle Related Heats on ‘Black Ice’. Presented at 13th Road Engineering Association of Asia and Australia Conference, 2009.
9. Park, S. E. The Effect of Surface Physical Condition on the Growth of the Atmospheric Boundary Layer. *Journal of Korean Meteorological Society*, Vol. 30, No. 1, 1994, pp. 120–134.
10. Song, C. K., and B. R. Lee. Prognosis of the Road Surface Condition in Korea Using Surface Energy Balance Theory. *Journal of Korean Meteorological Society*, Vol. 1, No. 2, 2002, pp. 420–422.
11. Garrateo, J. R. *The Atmospheric Boundary Layer*. Cambridge University Press, 1992, p. 316.
12. Bhumralkar, C. M. Numerical Experiments on the Computation of the Ground Surface Temperature in Atmosphere General Circulation Model. *Journal of Applied Meteorology*, Vol. 14, 1975, pp. 67–100.
13. Blackadar, A. K., and H. Tennekes. Asymptotic Similarity in Neutral Barotropic Planetary Boundary Layers. *Journal of Atmospheric Science*, Vol. 25, 1968, pp. 1015–1020.
14. *NCHRP Report 526: Snow and Ice Control: Guidelines for Materials and Methods*. Transportation Research Board of the National Academies, Washington, D.C., 2004.

#### **Other Resources**

- Sato, N., J. E. Thornes, T. Maruyama, A. Sugimura, and T. Yamada. Road Surface Temperature Forecasting: Case Study in a Mountainous Region of Japan. *Transportation Research Circular E-C063: Snow Removal and Ice Control Technology*, Transportation Research Board of the National Academies, Washington, D.C., 2004, pp. 414–421.

MEASURING AND FORECASTING PAVEMENT SURFACE  
AND SUBSURFACE CONDITIONS

**Measuring and Predicting Soil Temperature and  
Moisture Content Beneath Highways in Nova Scotia, Canada**  
*One Year of Observations and Forecasts*

**BENOIT POULIOT**  
**PAUL DELANNOY**  
**PHIL WOODHAMS**  
**SHAWN ALLAN**  
*AMEC*

**OLGA KIDSON**  
*Nova Scotia Transportation and Infrastructure Renewal*

Heavy traffic during the spring thaw causes faster degradation of the pavement and leads to increased maintenance fees. To reduce the damage, most provinces in Canada implement spring load restrictions for heavy traffic. Given that conditions often veer from climatology, imposing load restrictions at fixed dates every year is not optimal. It can lead to increased road damage or increased costs to the transportation industry. With funding from the Nova Scotia Department of Transportation and Infrastructure Renewal (NSTIR), probes capable of measuring both soil temperature and moisture to a depth of 110 cm were installed at six different locations around Nova Scotia in fall 2010. Immediate uses of the observations by NSTIR are discussed. An objective guidance tool was developed to help departments of transportation to determine the beginning of the seasonal load adjustment periods, far enough in advance for the road transportation industry to adjust their plans. To achieve this, a soil energy and mass balance model was used to predict soil temperature. The model, SN THERM, is initialized with the probe observations and driven by atmospheric conditions from numerical weather prediction models. Simulations are run daily, out to 5 days for the six Nova Scotia sites and for one site in the Northwest Territories. Results to date are promising and indicate that it is possible to provide advance warning of the spring thaw in roads.

The civil engineering community estimates that during the period of spring thaw, roads may lose in excess of 70% of their load bearing capacity (*I*) exposing them to greatly increased structural damage from heavy traffic during this critical period. In an effort to preserve the investment of billions of dollars in roadway infrastructure, many jurisdictions impose weight restrictions during periods of the year when the roads are most susceptible to damage due to soft subsurface layers.

Through Atlantic Canada, thaws can occur at different points in the winter. With global climate change, midwinter thaws are becoming more frequent and more pronounced so that the thaw penetrates sufficiently below the roadway to cause some loss of load-bearing capacity. The final thaw of the season naturally occurs in the spring. However, in many recent years, final thaws have been occurring earlier than the long-term climatology would indicate. Those final

early spring thaws often occur before the traditional dates for the imposition of spring load restrictions with the result that more road damage is being reported in recent years.

Road engineers use deflectometers to measure a road's load bearing capacity. However, with the more frequent and lengthier midseason thaws and the earlier spring thaw, significantly increased testing is required and this, in turn, is placing a strain on operating budgets. A forecast of load bearing capacity is required. Toward this goal, a physical approach to forecasting subsurface temperatures is presented in this paper, with a focus on results obtained for Nova Scotia.

## EFFECTS OF SPRING THAW ON ROADS

Each year in Canada, the onset of cold winter temperatures causes roadbeds across the country to freeze. With successive incursions of cold air masses and shorter days, the roads gradually freeze from the top downwards. At what time and to what depth the roadbeds freeze depends on geography, climate, and road construction. A frozen roadbed generally means more weight can be carried on the road without structural damage and some jurisdictions take advantage of this in the form of a winter weight premium (WWP). During the WWP, heavy haulers are allowed to increase their weight per axle, effectively reducing transportation costs.

Serious problems arise in the spring as the roads thaw. This is a gradual process driven by successive incursions of warm air masses combined with longer days. Thawing is also a top-down process which, for a period of time ranging from days to weeks, creates a thawed layer consisting of the roadway and part of the substrate while still leaving a hard still frozen layer beneath. This traps spring rains and winter snow melt water in between the hard road surface and the ice layers at depth and seriously impacts the integrity and weight-bearing capacity of the road structure during this particularly vulnerable period. Heavy vehicles during the spring thaw cause faster degradation of the pavement and leads to very costly maintenance and repair. To reduce the damage, most provinces in Canada implement spring weight restrictions on certain roads. Secondary roads are particularly susceptible, especially in areas where there is heavy logging, industrial activity, etc. The restrictions generally begin sometime before the end of winter and carry over into spring. These restrictions create a variety of logistical difficulties to loggers, haulers, and other stakeholders who use the roads, such as the need for alternate routing, reduced revenue per load, etc.

## CURRENT IMPLEMENTATION OF SPRING THAW WEIGHT RESTRICTIONS

### Literature Review

The particular vulnerability of road infrastructure during the spring thaw period has been recognized for quite some time (1, 2). The phenomena giving rise to the weakening, the entrapment of a thawed moist layer between the hard road surface material and a hard frozen subsurface layer, is well understood (1, 3). The traditional approach of imposing fixed climate-derived calendar-based load restrictions to minimize the damages has drawbacks (variable dates from one jurisdiction to another and dates no longer valid with a warming climate) and detractors (haulers dissatisfied with their increased costs during this period and long after it is no longer

required). The sound understanding of the problem, including the great impact of meteorological influences on road weight-bearing capacity developed by the engineering community, led them to devise approaches to predict when the meteorological conditions might give rise to weakened infrastructure (1–4). The original approaches developed were fairly simplistic, consisting of running totals of a frost or freezing index and a thaw index.

The science of meteorology offers more rigorous physical approaches. The heat-balance approach, summing all of the heat gains and losses over a surface (the road) and propagating it downward, has also been well understood for many decades. Point, or one-dimensional (1-D), models have been developed to precisely calculate the resultant temperature changes at the surface and at depth (2, 5). These require as inputs a complete description of atmospheric influences (air temperature and humidity, wind speeds, sky cover, etc.) over the road for specific time steps in the future, calculating for each time step the change in surface and subsurface temperatures. In this way, these 1-D models can be applied to generate a forecast profile of subsurface temperature for as many days into the future as numerical weather prediction model outputs are available (6).

### **Nova Scotia Frost Probe Project**

Nova Scotia is a province with a very active forestry industry. All of the 100 series (major highways) and some of the trunk, route, and local type roads are Schedule C roads, which do not have spring weight restrictions. The majority of the local or secondary roads are subject to restrictions. There is also a category called Spring Exempt which applies to a road, or portion of a road, that has been tested and confirmed that it will carry heavy loads. Spring Exempt roads can be trunks, routes, and local roads.

Traditionally, restrictions were implemented primarily on an understanding of local climatology using air temperature as a proxy for when road beds would begin thawing. In addition, the restrictions would sometimes be lifted at night when the forecast was predicting air temperatures of  $-5^{\circ}\text{C}$  or colder along with cold 40-cm subsurface at nearby Road Weather Information System (RWIS) stations. In those cases it was expected that sufficiently cold weather lasting long enough would refreeze the upper road layers to a sufficient depth.

Regionally, there is considerable variation in climate and its associated effects on the spring thaw across Nova Scotia. The southwestern part of the province is much warmer, with reduced winter snow cover and daytime high temperatures that frequently are above freezing even in January. However, even in this region there are important differences. While primary roads tend to follow the coast where it is warmer, there is higher terrain inland where much of the forestry activity takes place. Inland and at higher elevation, temperatures are colder and road beds can still freeze during the winter where coastal roads in the same region may not. In Northern Nova Scotia, it is climatologically colder and ocean effects are less pronounced. Frost tends to penetrate the ground in most areas no later than January, and will thaw during March. In Cape Breton, terrain rises to elevations over 400 m in the Highlands, and deep snow cover in this area can persist into April. Spring thaws of the road bed tend to come later in the Cape Breton Highlands than anywhere else in the province.

All of these geographical features and climatological influences underscore the broad spatial and seasonal variation in road weight-bearing across the province. An evidence-based approach to preserve the infrastructure without imposing undue restrictions on its use is highly desirable. Even in much colder climates, for example the Northwest Territories, where climate

change influences are being felt more acutely, similar monitoring and forecasting approaches are required to make good use of, and to protect, expensive infrastructure.

## OVERVIEW OF PROJECT

### Equipment Used

The seasonal load adjustment (SLA) sites installed in Nova Scotia consist of temperature (thermistor) and moisture (conductivity) sensors mounted on a column manufactured by the Icelandic company SAMRAS Ltd. and available through Road Monitor Systems Ltd. The sensors installed in Nova Scotia are distributed every 5 cm along the probe from 10 cm below the surface down to 60 cm then they are distributed every 10 cm down to 110 cm. The accuracy of the thermistor temperature readings is 0.06°C. The SLA sites are polled every hour but have the capacity for more frequent polling if desired.

The network of RWIS sites in Nova Scotia is Vaisala equipment with a meteorological tower and pavement sensors at each site. Pavement sensors are located at the surface, in the pavement, 40 cm under the surface and 150 cm below the surface. Most RWIS sites in the province are polled every 20 min.

### Location of Equipment

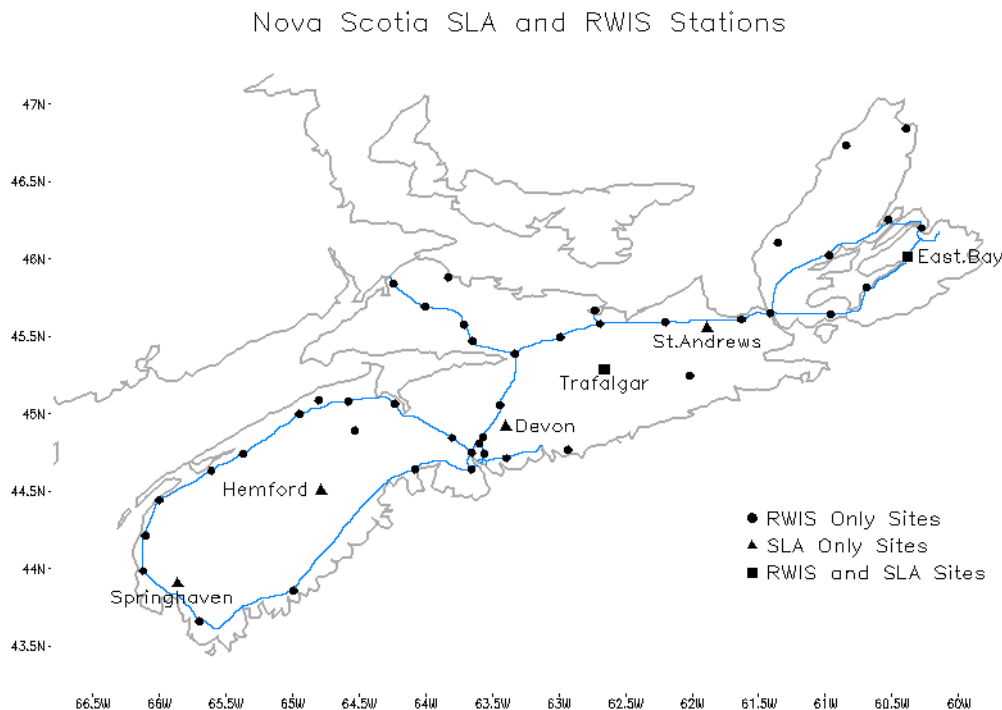
Nova Scotia has an extensive network of 45 RWIS stations located throughout the province (Figure 1), and two of the stations are operated by Parks Canada. The RWIS sites are mainly located along the 100 series highway and major trunk roads, the backbone of the provincial transportation network. The SLA sites measuring subsurface temperatures and moisture were installed in 2010 on secondary roads except for East Bay on Trunk 4. The East Bay and Tralfalgar SLA sites are collocated with RWIS sites.

### Polling and Website Display

SLA sites are polled once per hour. Temperature variations under the surface are slower as depth increase and more frequent polling would not give significantly more information except potentially for the shallowest levels. On AMEC's Nova Scotia RWIS website, data is updated every hour in a summary table. Data observed at 18 UTC is displayed for the past several days at all measured depths for individual sites, displayed in both table and graph format. These products also display the subsurface temperature forecast. Archived data is also available through the portal.

### Forecasting Approach

A subsurface temperature forecasting system was developed in 2008 and implemented in 2009–2010 to offer operational daily forecasts for the six Nova Scotia sites and for one site in the Northwest Territories.



**FIGURE 1 Nova Scotia SLA, RWIS network, and main highways.**

A complete physical deterministic approach to forecasting was used. The basis is a thermal balance model, driven by initial conditions provided by the SLA observation sites and surface boundary conditions provided by a numerical weather prediction model. The system is run on a server and the results are presented to the clients through the AMEC RWIS website.

The subsurface model used is SN THERM developed by the U.S. Army Cold Regions Research and Engineering Laboratory (CRREL). SN THERM is a research grade 1-D mass and energy balance model. It is flexible, allowing for arbitrary subsurface composition and takes as inputs the significant meteorological conditions. SN THERM was initially developed for snowpack modeling, in particular to forecast the temperature at the surface of the layer of snow, but it has been used successfully for bare soil. The availability of this tested model and its flexibility in representing various soil types and in handling varied weather conditions are some of the main advantages of SN THERM (5).

SN THERM requires surface boundary conditions in the form of meteorological data: temperature, relative humidity, wind speed, rain amount, snowfall amount, and radiation fluxes or cloud cover. The U.S. Global Forecast System (GFS), one of the world's leading global numerical weather prediction models, was the first model used to provide these forecast weather conditions. GFS data is available at full resolution out to 8 days with coarser resolution output available out to 16 days. To date, forecasts have been run out to 5 days as a compromise between the requirements for a useful product for decision making and the diminishing accuracy of numerical weather prediction models as lead time increases. Longer lead times will be considered, but rigorous verification will be necessary to evaluate the usefulness of the longer range forecasts.

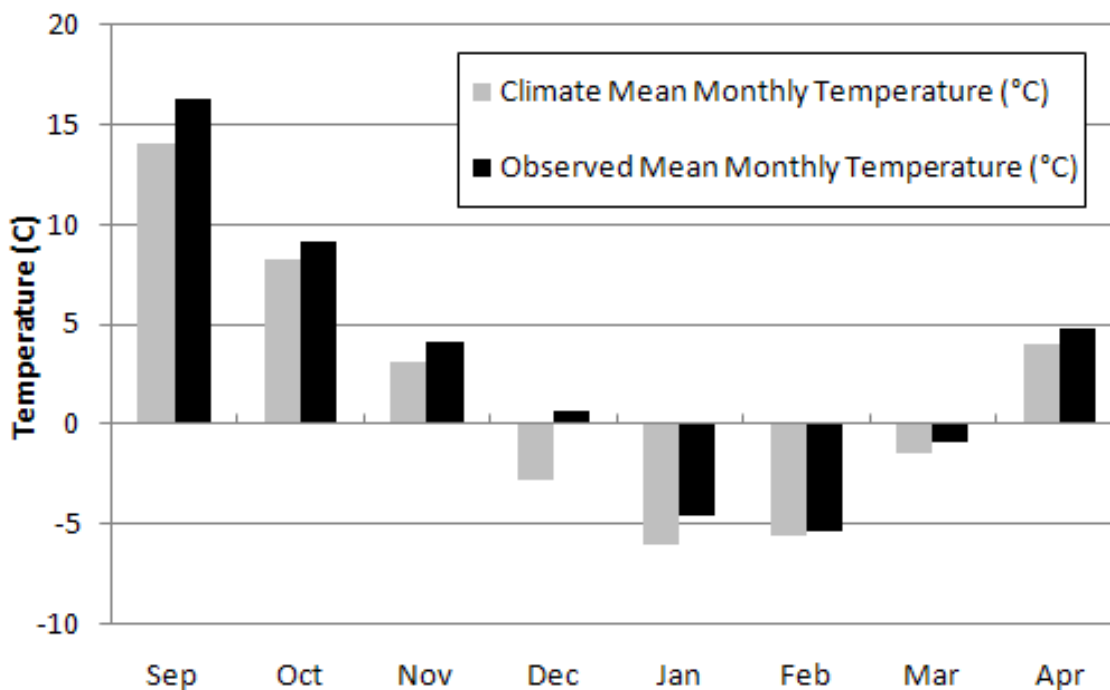
Temperature and bulk water density at each layer are needed as initial conditions for SNTHERM. The SLA observation sites provide direct measurement of temperatures at many depth levels while the bulk water density has to be derived from the measured relative humidity. In addition to observations at depths from 10 to 110 cm, the two Nova Scotia SLA sites collocated with RWIS stations additionally avail of temperatures observations at the surface and at 150 cm. Conditions at intermediate model layers are interpolated linearly from the nearest observations.

## RESULTS

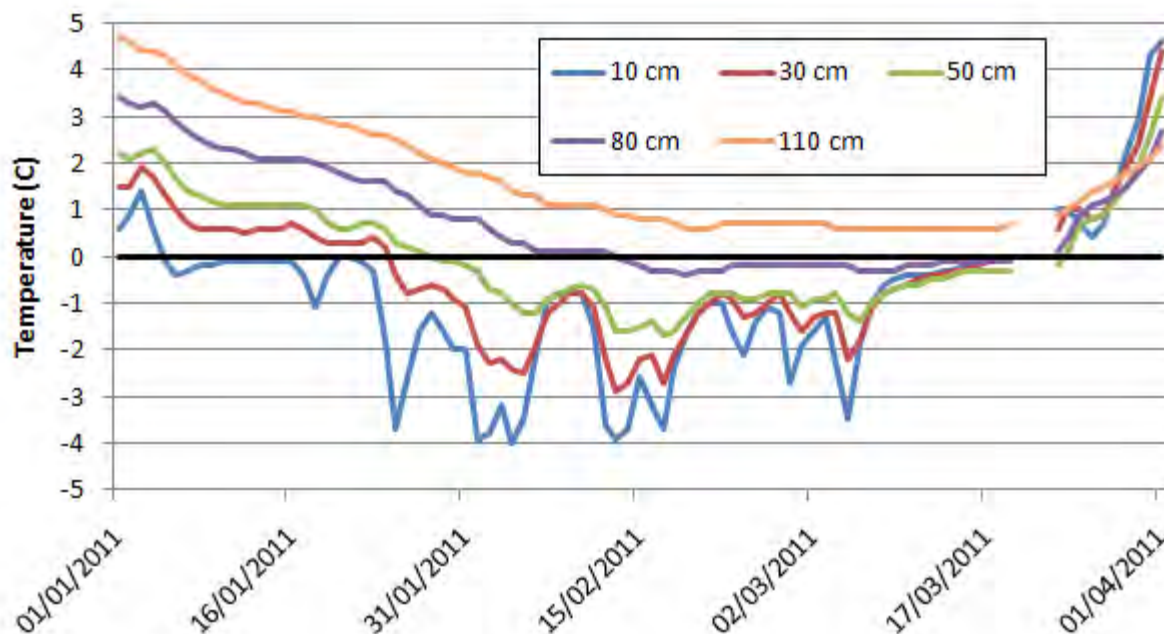
### Unseasonably Warm Season

The 2010–2011 winter season was particularly warm in Nova Scotia, with ice much sparser than usual in the Gulf of St. Lawrence. The winter proceeded in two fairly distinct phases as illustrated in Figure 2. Early winter featured temperatures well above. The warmth was primarily driven by an unusually large atmospheric block over the North Atlantic which brought long periods of mild weather due to sustained easterly flow off the Atlantic. In late January the pattern returned to more typical winter conditions, and temperatures were near climatic normals through the end of the winter season.

As a consequence of the warm early winter, frost was delayed in penetrating beneath the surface (Figure 3).



**FIGURE 2** Observed and climatic mean monthly temperature at Halifax International Airport for the 2010–2011 winter.



**FIGURE 3** Daily Averaged subsurface temperature at Trafalgar, Nova Scotia, at selected depths from January 1, 2011, to April 1, 2011.

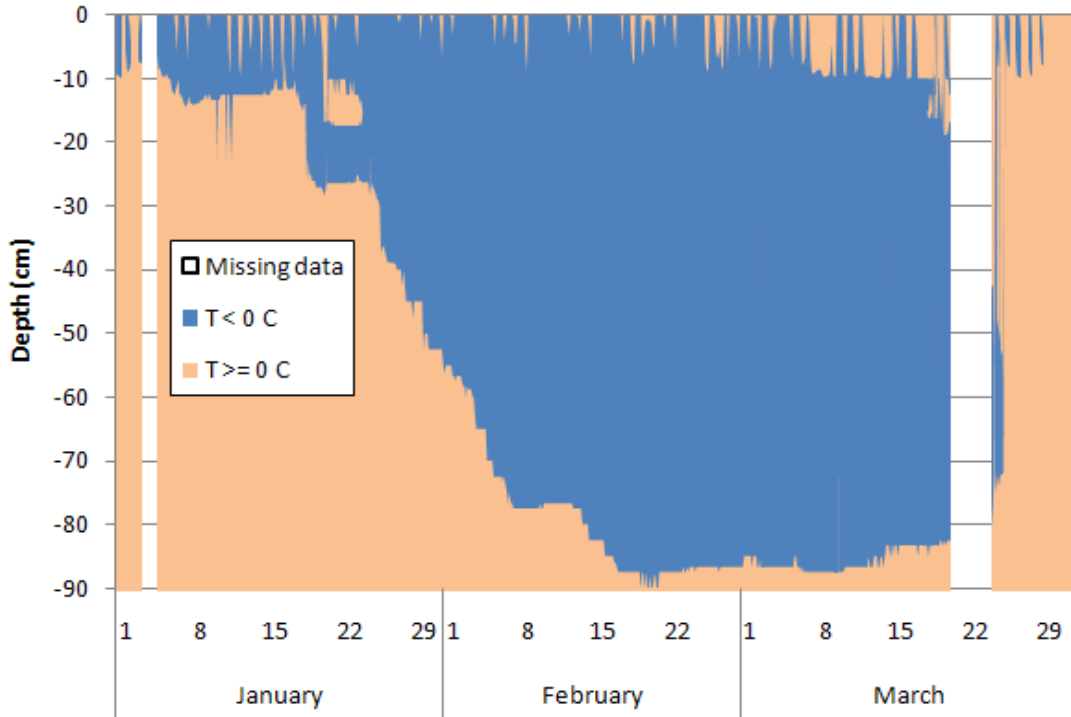
### Results on Frost Penetration at Two Sites

The buildup of the frost in the early winter is generally gradual from top to bottom while in the spring the frost layer has been observed to break down in only a few days in Nova Scotia. For comparison the evolution of the frost depths at two different sites in Nova Scotia is presented: Trafalgar is located significantly inland in central Nova Scotia at 45.3 N and Springhaven in Southwest Nova Scotia relatively near the ocean at latitude 43.9 N (Figure 1).

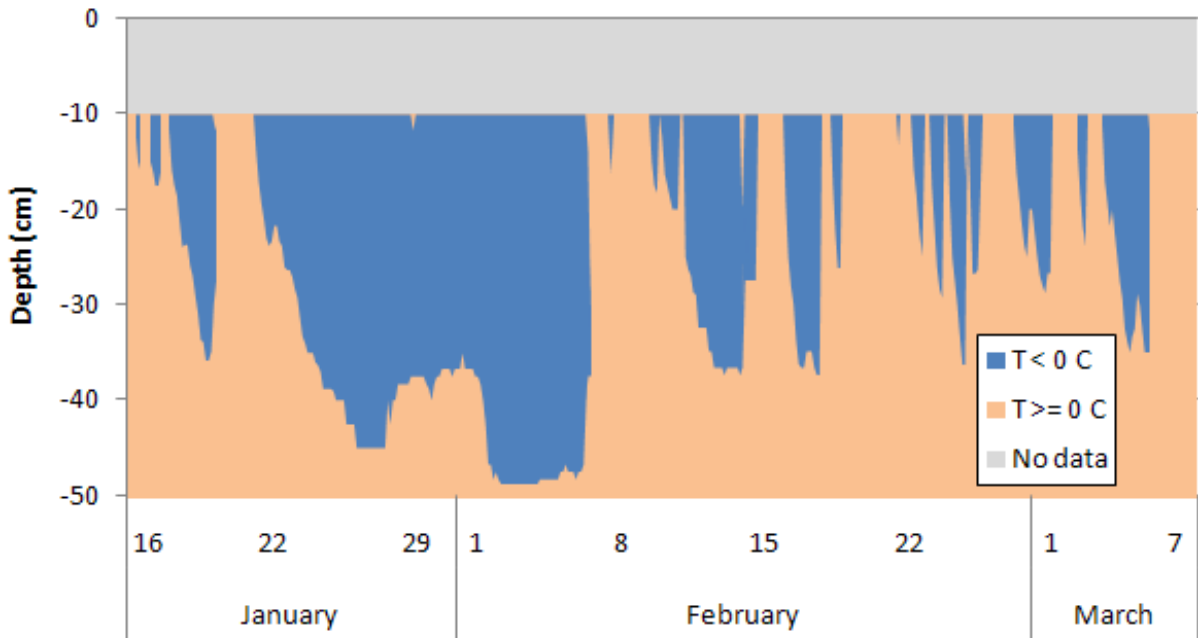
At Trafalgar (Figure 4), occasional nighttime freezing of the pavement began in November (not shown) and increased in frequency during a relatively warm December. The longest frost period lasted nearly 60 days from January 18 to March 24 with a maximum depth slightly less than 90 cm. By comparison frost reached a depth of 150 cm in February 2007 and February 2009. In March, the frozen layer began to erode, and collapsed relatively fast over the March 16 to March 24 period. The warmer soil below the frozen layer can have a significant impact on the nearby ground that is only slightly below 0°C at that time.

In southwest Nova Scotia, at Springhaven, the influence of a milder and more moderate oceanic climate kept frost penetration relatively short and to a limited depth as illustrated in Figure 5. The longest frost period lasted 17 days from January 21 to February 6 with a maximum depth slightly less than 50 cm.





**FIGURE 4 Frost by depth at Trafalgar from January 1 to March 31, 2011.**



**FIGURE 5 Frost by depth at Springhaven, Nova Scotia, from January 15 to March 7.**

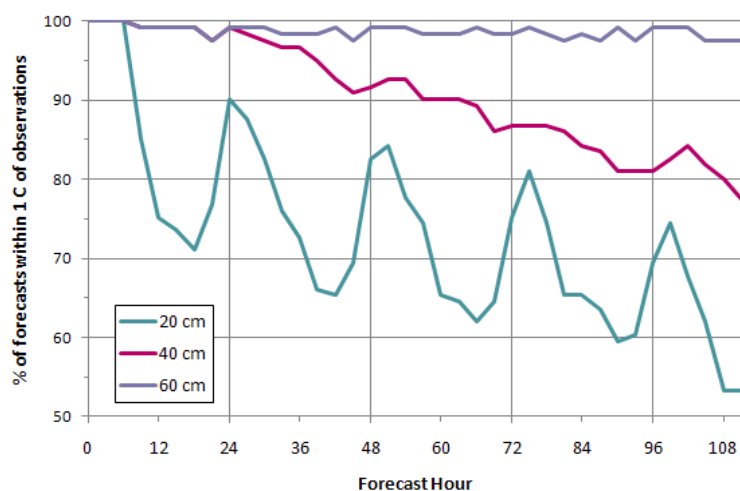
## Accuracy of Forecasts

The forecast system has shown significant skill. As can be seen in Table 1, large errors are relatively rare except in the top layers where rapid temperature swings are common. Slower temperature variation for deeper layers means more stringent error criteria are appropriate. However, for errors less than or equal to the 0.2°C thresholds, instrument reading errors estimated near 0.06°C become significant.

The model exhibits expected behaviour with performance deteriorating with longer lead times as can be seen in Figure 6. This is natural for any forecast model, even more so for one that uses as input a model for which accuracy also decreases with time. The impact of the numerical weather prediction model errors is significant at the surface, and then as depth increases SNTHERM's errors become dominant. An obvious problem is a strong diurnal variation in error levels. SNTHERM has a marked cold bias at the surface in the morning where actual temperatures rise much faster than forecast. This error dampens with depth but is still noticeable down to 40 cm.

**TABLE 1 Percentage of (Three-Hourly) Forecast Periods with Error Less than Threshold at Trafalgar from November 2010 Through March 2011 (All Lead Times up to Day 5)**

Depth (cm)	Error $\leq 2^{\circ}\text{C}$	Error $\leq 1^{\circ}\text{C}$	Error $\leq 0.5^{\circ}\text{C}$	Error $\leq 0.2^{\circ}\text{C}$
10	68	44	26	13
20	92	74	51	24
<b>30</b>	<b>97</b>	<b>83</b>	<b>60</b>	<b>32</b>
40	100	92	73	39
50	100	99	91	60
60	100	100	95	65
70	100	100	99	80
80	100	100	99	87

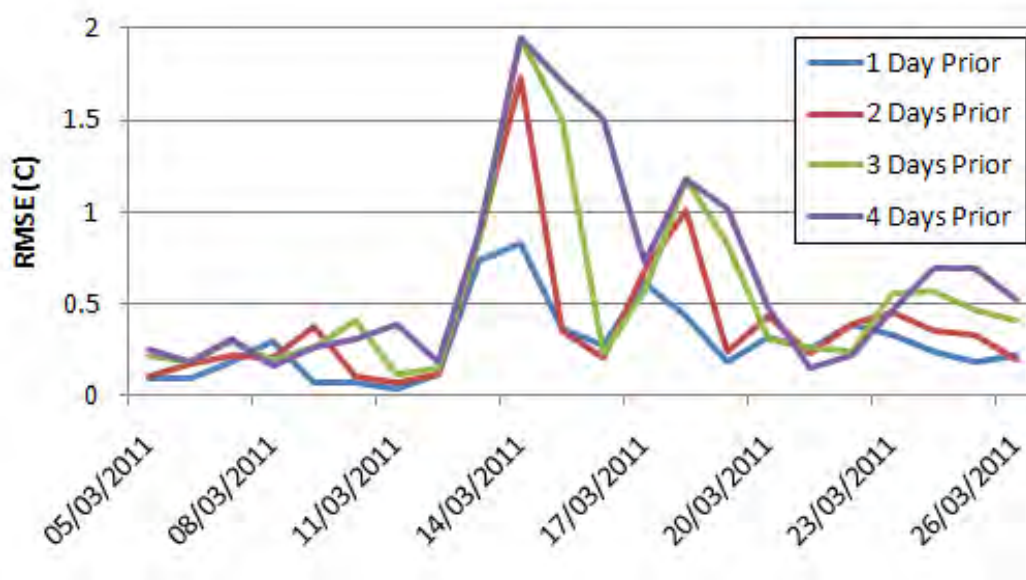


**FIGURE 6 Percentage of forecasts within 1°C of observations for all lead times at Trafalgar from November 2010 through March 2011.**

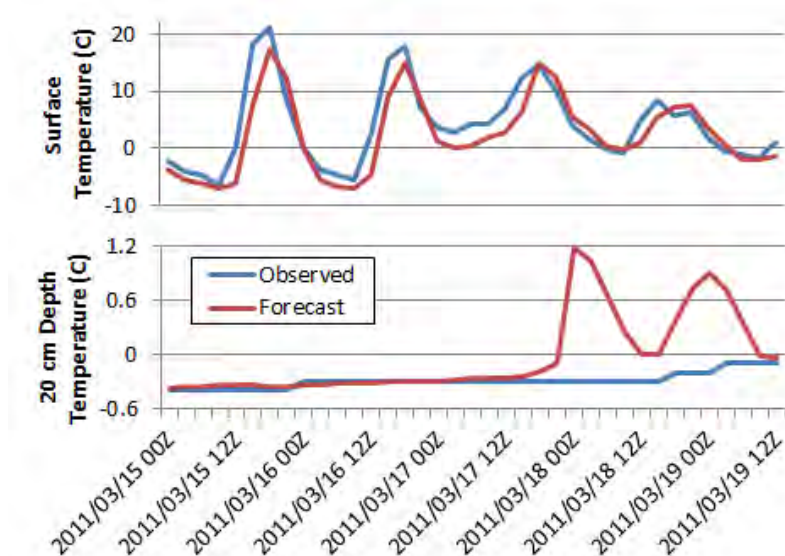
Another effect worth noting is that some days are disproportionately responsible for the forecast error at all lead times. The effect of heavy rain seems to be poorly handled by SNTHERM. One area that has been particularly concerning is difficulties around the critical time of the spring thaw where the model has been showing some of its worst performance as can be seen in Figure 7. In that period we observed slow temperature variation before the spring thaw followed by rapid variation once temperature breaks above 0°C (Figure 8). The earlier warming above 0°C noticed in the forecast and the subsequent higher amplitude temperature variation leads to relatively large errors around the time of the spring thaw. This earlier warming is observed in Figure 8 despite a surface temperature forecast that is a little cool for the first 2 days then very good afterward. It is surmised that some of the difficulties are related to the limited ability of SNTHERM to handle water flow in the ground.

Outside of the intrinsic bias and limitations of SNTHERM and the accuracy of the driving weather model, additional errors are due to uncertainty in the nature and distribution of materials under the road surface. The thickness of the asphalt layer, the nature and thickness of the base and subbase as well as the nature of the subgrade are major inputs of any subsurface model; more detailed samples taken at the time of installation would have been of great use. To remedy this, the model is getting tuned through the use of statistical tools. While this is a useful exercise, it should deal mainly with numerical model parameters and not fundamental physical parameters.

The initial forecast approach of setting the lowest model level as the lowest observed level led to poor forecast accuracy for the deeper layers. Forecasts accuracy at these lowest levels can be improved by inserting additional model levels below the deepest observed layer. To obtain an adequate lower boundary condition, the soil temperature at 6 m (20 ft) was set at the yearly averaged air temperature for the region. The temperature was linearly interpolated from this depth to the lowest observed layer.



**FIGURE 7** Root mean square error of forecast against observations at East Bay for depths of 60 to 80 cm. Notice the sharp increase on March 14, around the time when the frozen layer breaks down.



**FIGURE 8** Comparison of a forecast on March 15, 2011, at 00Z with corresponding observed temperature at the surface and at a depth of 20 cm at Trafalgar.

The initial forecast approach of setting the lowest model level as the lowest observed level led to poor forecast accuracy for the deeper layers. Forecasts accuracy at these lowest levels can be improved by inserting additional model levels below the deepest observed layer. To obtain an adequate lower boundary condition, the soil temperature at 6 m (20 ft) was set at the yearly averaged air temperature for the region. The temperature was linearly interpolated from this depth to the lowest observed layer.

## FUTURE WORK

In many respects, this project is still a work in progress. An important change in operation this winter will be the use of moisture data to initialize the forecast.

For all its strengths, the thermodynamic model used, SNTHERM, is not without weaknesses as noted in the previous section. The use of other point heat-balance models is investigated. While temperature and moisture are the parameters currently forecast, it would be interesting to investigate the use of a model to translate this information into some measure of road strength. The use of the FASST model also developed at the CRREL may be a solution to both problems. If it was not satisfactory other options would have to be considered in consultation with engineers, to collect precise data on the road composition and to obtain a good time series of deflectometer, or other strength testing device, for an SLA site.

For any future installation where there is an intention to do physical modeling, the installation crew should proceed with systematic coring or augering, take measurements of the thickness of each layers of different materials, and retain samples. Ground-penetrating radar may be an alternative for already installed sites or to obtain the characteristics of deeper soil layer were possible.

It is also thought that there may be an opportunity to extend the reach of the information provided by leveraging the denser RWIS network that offers temperature observations at pavement level, 40 and 150 cm. Using these limited observation levels from the RWIS network, more complete data sets from SLA stations, some knowledge of road and substrate construction and composition, and the pavement model, synthetic observations could be created for each RWIS site. And from there forecasts could be generated. The uncertainty would be greater but it would provide one more tool for more refined SLA decisions using existing data sets.

### **Nova Scotia's Perspective on the Benefits of the System**

In 2010, Nova Scotia Transportation and Infrastructure Renewal (NS TIR) commissioned the installation of six frost probes across the province measuring soil temperature and soil moisture at depths up to 110 cm. The frost probes were polled hourly through the 2010–2011 winter.

This data has immediately proven useful to NS TIR in the spring of 2011 in two ways. First, the measurements were used, in conjunction with the long-range weather forecast and input from the local area managers, to reach a decision on the date of the beginning of spring weight restriction season. Second, in prior years, weight restrictions were lifted on nights when specific air temperatures were forecast. This season, the data from the frost probes was used to determine if the weight restrictions would be lifted at night. The data had to demonstrate frost at a depth of 10 to 15cm for overnight openings; however this season no overnight openings occurred. This first season showed there is the potential for making more or regional (county-by-county) decisions in the future.

### **CONCLUSION**

The SLA program of NS TIR now has at its disposal a useful subsurface observation network of six stations and a new tool to determine road weight-bearing capacity. In the Nova Scotia context, load restrictions have been imposed in the day but removed on nights when favourable conditions were expected. This offers heavy haulers a means to maintain nearly constant hauling costs while limiting road damage. This dynamic application of load restrictions illustrates the direct benefit of these observations in critical periods. The subsurface observations were also helpful tools for the implementation of spring load restriction in this unusually warm winter. Future work needs to determine how moisture data can be used most effectively to support the removal of spring load restrictions.

Multiple forecasting approaches can and ideally should be considered to provide a full toolbox to support variable seasonal load restrictions. Deterministic physical modelling forecasting has presented here is an attractive option over other approach by being the most likely to assess all meteorological factors, which makes it more likely to correctly predict subsurface conditions when abnormal weather conditions prevail.

Early results using only six sites in Nova Scotia have shown very promising results for the single and first spring thaw where physical modeling approaches were attempted. Further work as outlined in the previous sections will have to continue to make this forecast solution as accurate as possible. Further verification will be needed to ascertain that this tool can be used confidently as a guidance to determine when load restrictions have to be implemented.

The observations and forecast can help identify the appropriate narrow window of time when deflectometer testing would be most appropriate. The sensor installations and predictive service are both good approaches to ensure maximum throughput at lowest cost on the road infrastructure while ensuring its preservation.

## REFERENCES

1. Bullock, M., B. Delsey, R. Brownlee, and S. Tighe. *ITS for Variable Load Restrictions*. Prepared for ITS Office of Transport Canada under the Strategic Highway Infrastructure Program, March 2005.
2. *Seasonal Load Restrictions in Canada and Around the World*. Canadian Strategic Highway Research Program Technical Brief #21, September 2000.
3. Tighe, S., B. Mills, C. Haas, and S. Baiz. *Using Road Weather Information Systems (RWIS) to Control Load Restrictions on Gravel and Surface-Treated Highways*. Ministry of Transportation of Ontario/Highway Innovation Infrastructure Funding Program, September 2007
4. Huen, K., S. Tighe, B. Mills, and M. Perchanok. Development of Tools for Improving Spring Load Restriction Policies in Ontario. Presented at Transportation Association of Canada Annual Conference, Prince Edward Island, September 2006
5. Jordan, R. *A One-Dimensional Temperature Model for a Snow Cover*. *Technical Documentation for SNTHERM.89*. Special Report 91-16. U.S. Army Corps of Engineers Cold Regions Research and Engineering Laboratory, October 1991.
6. Thordarson, S., N. Jonasson, E. Sveinbjornsson, A. H. Thorolfsson, and G. O. Bjornsson. Real-Time Frost Depth Forecast Model for Thaw-Induced Axle Load Limitation Management. *Proc., XIIIth PIARC Winter Road Congress*, Québec, February 2010.

MEASURING AND FORECASTING PAVEMENT SURFACE  
AND SUBSURFACE CONDITIONS**Evaluation of a Simulation of Subpavement Conditions  
as They Affect the Implementation and  
Removal of Seasonal Load Restrictions****ROBERT D. HART**  
**LEON F. OSBORNE, JR.**  
**JOHN J. MEWES***Meridian Environmental Technology, Inc.***MARK A. ASKELSON**  
**JENNIFER L. HERSHEY**  
*University of North Dakota*

The structural stability of highway pavements is significantly impacted by freeze–thaw processes, especially during the thaw period when a layer of water gets trapped between the pavement and the remaining frozen layer below. This reduces the structural stability of the sub-pavement materials and the subsurface structure remains in this weakened state until the freeze layer is completely thawed. The pavement degradation caused by heavy vehicles that traverse weakened pavements during this thaw may appear as rutting, depressions, cracking, frost heaving, pot holes, and corrugation. One current practice to minimize damage to the pavement is the application of load limits called seasonal weight restrictions (SWR). The decisions on when to employ SWR depend upon knowledge of when structural weakening begins and ends. Phase 3 of the *Clarus* Initiative included a demonstration of a Seasonal Weight Restriction Decision Support Tool to develop a data analysis, meteorological, and pavement modeling decision support tool to assist transportation agency control strategies during critical freeze–thaw periods. The Enhanced Integrated Climatic Model (EICM) was used to integrate *Clarus*-enhanced observations and forecasts into the EICM and display the EICM results in a web-based presentation. This paper discusses the structure of the EICM, its configuration requirements, and how the output relates to the sub-pavement conditions that impact structural stability of the base and subgrade layers. It provides presentations of past and current conditions based upon observed data and forecast guidance, and the findings from the 2-year demonstration test and findings from the 2-year demonstration project.

Structural damage to highways due to annual freeze–thaw cycles in sub-surface soils has been estimated to be in excess of \$100 million per year. This damage occurs in areas that experience ground frost annually or have permafrost conditions. As these frozen soils thaw during the late winter or early spring, a trapped layer of water forms directly beneath the pavement and above the still frozen soils beneath. Upward pressure on the base of the pavement causes asphalt pavements, in particular, to flex and crack. The tire loading of vehicles moving along the highway compresses the liquid layer and causes water from the subpavement layer (along with the clay and other fine particles) to extrude through cracks and joints in the pavement. This reduces the structural stability of the base layer and results in cracking and rutting of the pavement (1). According to Isotalo (2),

“paved roads with thin overlays on top of frost-susceptible soils may lose more than 50% of their load-bearing capacity in spring.” As the thaw depth reaches into the subgrade, the increased liquid content in the trapped thaw layer reduces the soil’s resistance to compression and lateral shear. Dynamic loading from traffic compacts the soils beneath the wheel tracks and forces the soil particles to shear outward from beneath the loading. As the water content of the soils decreases later in the thawing season, damage appears in the pavement as rutting, depressions, cracking, frost heaving, pot holes, or corrugation.

To alleviate or minimize the potential damage highway maintenance agencies institute seasonal load restrictions (SLR) on roadways susceptible to damage during the thaw period. A World Bank report (2) indicates that in the United States alone a 20% load reduction during the thaw season can increase the life of the pavement by up to 62% and a 50% load reduction can lead to a 95% increase in life expectancy. Van Deusen and Ovik (3) determined that delays in implementing SLRs in Minnesota can increase the annual road cost from \$12,000 to \$12,500 per mile per year; thus, judicious use of SLRs offers the potential to realize a cost reduction of approximately \$15 million per year in Minnesota alone. The underlying challenge in recognizing the proper timing of restriction placement and removal is the estimation of when the subsurface soils thaw sufficiently to lose structural stability and when the soil moisture from the thaw decreases to the point where vehicle loading will not induce further impact on soil structure. Transportation agencies impacted by the freeze–thaw process attempt to determine the condition of the subsurface soil during the thaw period by using methods such as frost tubes, deflection testing (falling weight deflectometers or benkelman beams), historical information from previous thaws, thaw indices, and expert judgment (4).

In 2003, the Surface Transportation Weather Research Center (STWRC) at the University of North Dakota (UND) initiated research with a SLR model that combined a comprehensive environmental effect model with a long-range weather prediction model to provide a system capable of estimating future subsurface temperature trends within the soil column beneath highway pavements. The environmental effect model used was the EICM. The original version of EICM was developed by the Texas Transportation Institute in 1989 and represented an integration of a climatic–materials–structures model, an infiltration and drainage model, and a frost heave and thaw settlement model. The EICM was enhanced with the addition of a rainfall precipitation model (PRECIP) in 2002. The EICM was driven by output from the National Centers for Environmental Prediction Global Forecasting System (GFS) numerical weather forecast model to generate profiles of sub-pavement conditions to 10 days beyond the forecast model run time. The STWRC research indicated that the EICM was capable of being coupled with an atmospheric model to provide guidance on future subpavement conditions (5). Sensitivity analyses of the EICM indicated that soil moisture had a significant influence on soil profile temperatures and the depths of the freeze penetration within the model, and the initialization of the water table depth at the beginning of the model year seemed to have an influence on the depth of the frost penetration during the freeze–thaw season. Evaluation of model performance showed that the model had a cold bias and responded to thermal changes faster than they actually occurred.

## **CLARUS REGIONAL DEMONSTRATION STUDY DESIGN**

The Road Weather Management Program of the FHWA issued a solicitation in June 2008 initiating the third phase of the *Clarus* initiative which sought proposals for five demonstration projects that would develop and implement new, innovative business-to-government services

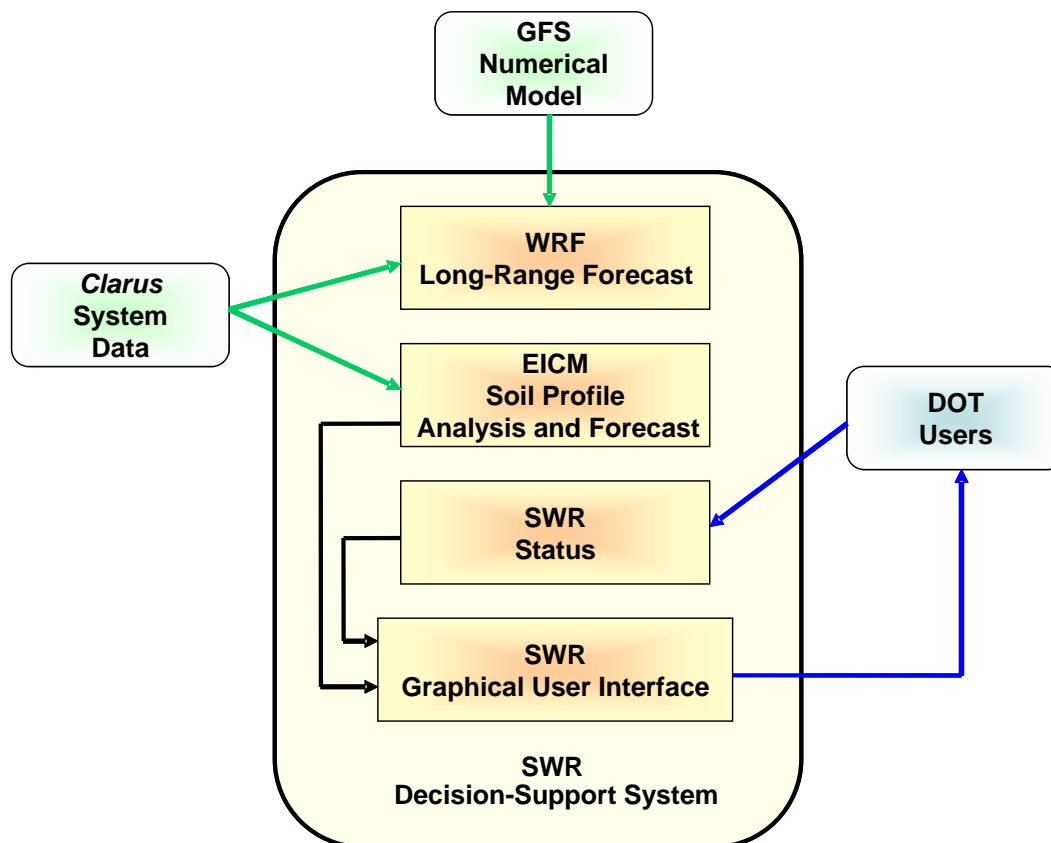


using *Clarus* information. One of the five demonstration projects was defined as Use Case Scenario 2: Seasonal Weight Restriction (SWR) Decision Support Tool. This tool was intended to build upon the requirement published in the ALCAN Highway Road Weather Portal *Clarus* Regional Demonstration Concept of Operations in Phase 2 of the *Clarus* Initiative. A team from Meridian Environmental Technology, Inc. (Meridian), the UND STWRC, and the state departments of transportation (DOT) from Montana, North Dakota, and South Dakota was chosen to develop and demonstrate a SWR decision support tool in conjunction with research efforts on Use Case Scenario 1: Enhanced Road Weather Forecasting System Enabled by *Clarus*. For clarity it should be noted that the terms seasonal load restrictions and seasonal weight restrictions are used interchangeably in the industry.

The STWRC research laid the foundation for this demonstration project. EICM was coupled with the output from the weather and research forecasting (WRF) model that was part of the Use Case 1 demonstration. The key components and the functional flow of information through the decision support instrument appear in [Figure 1](#). One of the specific objectives of the *Clarus* Initiative Phase 3 demonstration was to explore the impact of integrating roadway weather information system (RWIS) data collected and integrated by the *Clarus* System into the Use Case Scenarios. *Clarus* data were integrated into the WRF model processing and used as daily input into the EICM to update the soil profile data. The input of *Clarus* data into the WRF processing was an attempt to maximize the accuracy of the initial conditions for the WRF model run. The *Clarus* data input into EICM permitted the model to update the soil profiles each day based upon observed data for the past 24 h. The SWR demonstration processing was initiated on October 1 in both 2009 and 2010 and was run continuously throughout the winter and spring thaw seasons; thus the model within a given freeze–thaw season retained a running analysis of conditions from October 1 up to the current date. This provided an excellent resource to evaluate particular freeze–thaw–refreeze scenarios or to see developing trends in the sub-pavement frost and thaw zones.

The integration of the WRF model into the forecasting demonstration in Use Case 1 was enhanced by creating a long-range forecast run to support Use Case 2. The long-range WRF model utilized output from the GFS model for both the lateral boundary values and the initial WRF model grid point values. The GFS model provided 3-h lateral boundary value specifications for the first 180 h. From 180 to 384 h, the lateral boundaries were specified in 12-h increments. The GFS data were provided in GRIB format at a horizontal resolution of ~35 km for the first 180 h and at ~70 km beyond 180 h. The WRF generated the long-range forecasts at hourly intervals out to 384 h having a horizontal grid spacing of 20 km. The vertical configuration was 40 vertical levels extending from the Earth's surface to 10 millibars plus five soil levels. The input of hourly values from WRF into the EICM included date, time, air temperature, hourly precipitation, wind speed, relative humidity, and percent sunshine.

Each EICM run required an hourly time series of input weather information extending from at least 24 h prior to the current model run time out to 384 h into the future. Analyzed road weather data and the WRF mesoscale model output were retained in data stores as part of the Use Case 1 processing. The road weather information data store was updated routinely as new information arrived; the mesoscale model forecasts were scheduled for every 6 h but processing issues precluded completing every 6-h run. Thus the mesoscale model data store contained the most recently completed model run output. Both of these data stores could be accessed by the Use Case 2 processing as needed. The EICM software utilized in this study was Version 3.4, the most current version of EICM at the time of the demonstration. The



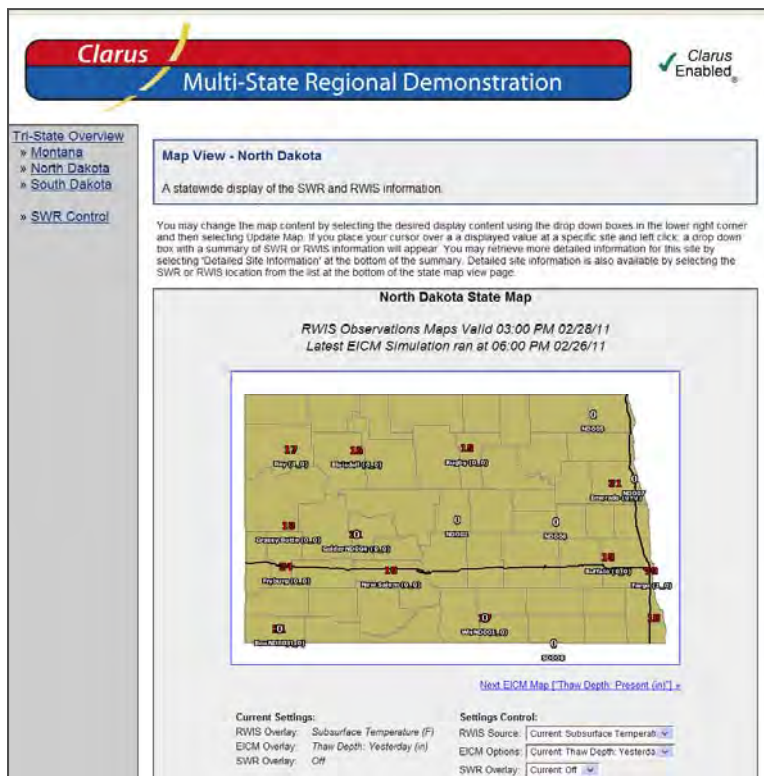
**FIGURE 1** An overview of the components and functional flow of the SWR decision-support system.

software operates within a Microsoft Windows operating environment so a PC running XP was used as the platform for the EICM model run. A Windows XP Scheduled Tasks tool was used to execute the program at a routine interval of 90 min from a base time of 6:00 a.m. local time. This approach was used to pick up delayed mesoscale model runs and keep the output from EICM as current as possible.

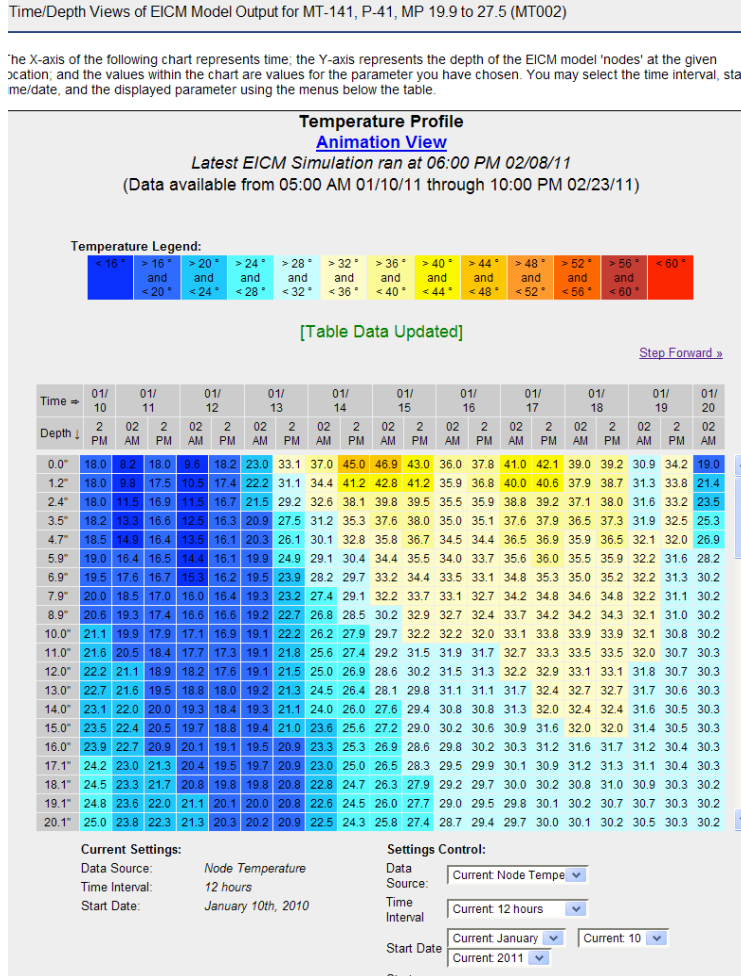
The EICM used a vertical grid of node points for the analysis of pavement and soil profile conditions. The top node was located at the top surface of the pavement. The spacing of nodes with depth could be configured to address specific research needs, but the spacing used in the SWR demonstration project was typically 1 to 1.5 in. in the pavement, base, and subgrade layers. For each model run data were acquired from Data Stores in Use Case 1. *Clarus*-enhanced hourly weather data were acquired for each of the SWR sites for integration into the lengthening database of historical weather information. The historical data were subsequently used to generate the soil profiles for each of the SWR sites from the season initialization date to the current date. The most current WRF mesoscale model forecast data were extracted, reformatted, and appended to the EICM input file that contained the configuration data for all of the SWR sites. EICM used this input to compute the thermal and moisture equilibrium values for each node point at each SWR site for the period from the beginning of the season to 384 h after the run time of the most current forecast. The output parameters from the EICM run included temperature, percent water, percent ice, pore pressure, and resilient modulus at each node point.

The output from EICM was post-processed to form map displays and time series-based animations on a web-based portal. The map displays were a set of maps that covered the three individual states and a composite display of the three-state region. Users could overlay current environmental sensor station (ESS) observations from the *Clarus* database, EICM information, and an indication of existing areas under current or pending published load restrictions. Drop-down menus in the “settings control” section shown in Figure 2 permitted users to select the desired data display options. The RWIS source option permitted display of the current primary weather and pavement condition observations while the EICM options drop down allowed an overlay of the freeze depth or thaw depth for yesterday, today, and each of the daily forecasted values for an equivalent hour on the respective days. If a user pointed to one of the RWIS values and left-clicked the mouse, the interface would display the most current RIWS observations for that ESS site. From the current observation page the user could request historical observations for the last 3 days. If the user selected one of the EICM value icons, the web interface brought up the time series animation for that location (Figure 3).

The time series animations used a unique visual presentation format currently in use by the Alaska Department of Transportation and Public Facilities to display pavement and subpavement data from their temperature data probe network (see Figure 3). Each row in the display matrix contains values for the user-selected parameter for the period of time shown in the



**FIGURE 2** Map display of North Dakota with overlays of RWIS subsurface temperatures and EICM thaw depths. The color-filled values are the temperatures from the subsurface probes on each of the ESS sites. The white numbers represent the simulated thaw depth from the previous day.



**FIGURE 3 Full-screen image of EICM simulation of the node temperatures for a test site in Montana in January 2011.**

column headings. The vertically stacked rows represent the nodal depths specified by the depth below the surface of the pavement. Each depth–time cell is color coded to represent the cells value in a specific range class for that parameter. Users had the option to select the display parameter (node temperature as shown in Figure 3), the time interval, and the start time. The tabular format was the default presentation; however, users could select the “animation view” link near the top of the web page to view an animated profile of that parameter’s values as a function of time. The presentation used Meridian’s adaptation of the Flash animation module. The Flash controls could be used to control the animation speed or step through the profile transition for each time interval.

**RESULTS FROM THE SWR DEMONSTRATION**

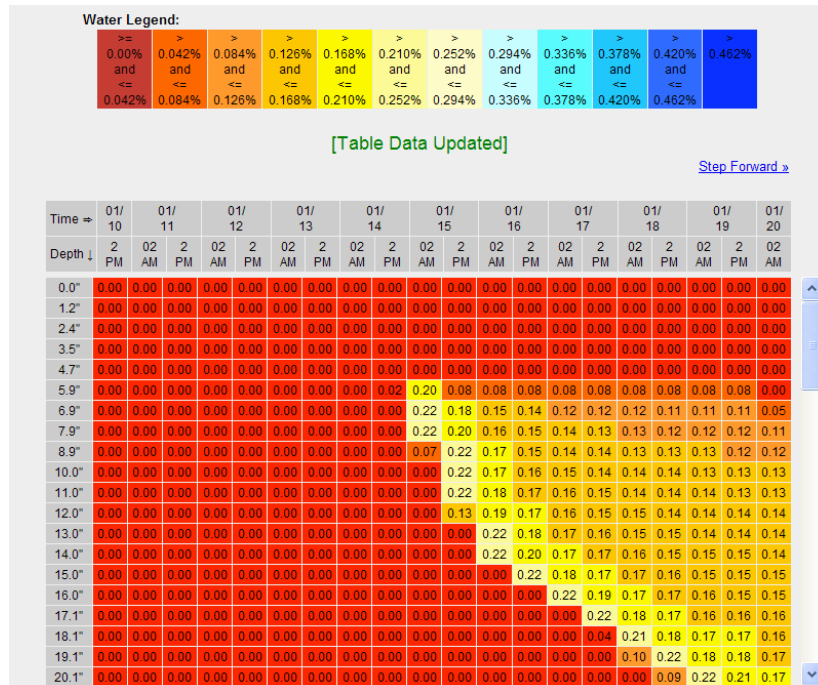
The SWR demonstration was a cooperative arrangement between the Meridian and UND teams and the three DOT agencies from Montana, North Dakota, and South Dakota. Coordination

between the team members was accomplished through regular teleconferences. State participation included coordinators for each state and a group of field representatives who had the responsibility to make SWR decisions within their local districts. The states selected the potential sites where they desired to evaluate the load restriction guidance and provided detailed information regarding pavement and soil profile characteristics at each of the chosen locations. The states also provided information regarding the methods they used to impose and remove load restrictions within their state, district, or local operational area. During the freeze–thaw periods of 2009–2010 and 2010–2011, the Meridian coordinator maintained routine interactions with state field representatives through e-mail discussions of the current weather and soil profile scenarios and phone discussions regarding the DOT representatives' decision process. During the *Clarus* Phase 3 project, Battelle served as an independent evaluator for the Use Case 2 study. To facilitate the evaluation, Meridian maintained a routine interaction with Battelle. As part of their evaluation process, Battelle maintained regular contact with the state representatives to evaluate the DOT's response to the SWR tool. This evaluation process turned into an effective method of information exchange regarding freeze–thaw scenarios and yielded an understanding of how the states were reacting to the SWR tool and its guidance from two separate perspectives.

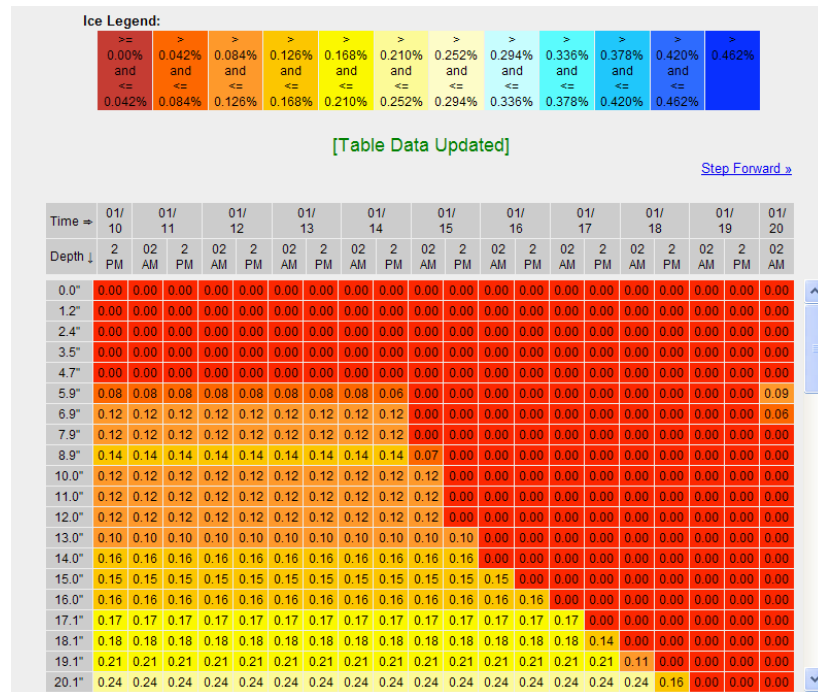
The original plan for the SWR project was to establish specific criteria for each state for the implementation and removal of load restrictions. The information collected regarding the policies and practices of the states yielded a variety of guidance techniques based upon several different ways to assess the timing of load restriction actions. Further, there was no obvious mechanism to convert the output from the EICM directly into the existing policies or practices. Thus, the decision was made to present the EICM guidance as a time series animation and to determine whether specific criteria associated with that information correlated well with the existing load restriction techniques. This became the objective of the SWR demonstration and forms the basis for the remaining discussion in this paper.

The sequence of images comprising Figures 3 through 6 illustrates the key instrument used in the analysis of the value of the EICM simulation to serve as a tool to support SWR decisions. Figure 3 is a screen capture of nearly the entire web page display for node temperatures for Montana route MT-141 from 2:00 p.m. January 10, 2011, through 2:00 a.m. on January 20, 2011. The setting controls in the bottom right of this figure show the setup to format the image. Above and to the right of the table is a link to Step Forward. This may be used to shift the display forward in time. The image in Figure 3 was moved as far back in time as possible at the time of the screen capture. Typically, there would be another link above and to the left of the table to scroll backwards. The date of the model run in Figure 3 is 6:00 p.m. on February 8, 2011; therefore, these images represent the simulation of conditions generated from historical observed information. Forecasted data had the exact same format so there was a seamless transition from historical data to forecast data. The ability to go back in time proved extremely beneficial in the performance of post-event analyses. Figures 4, 5, and 6 are cropped screen images for the same time and provide node-depth displays of node water, node ice, and node resilient modulus respectively.

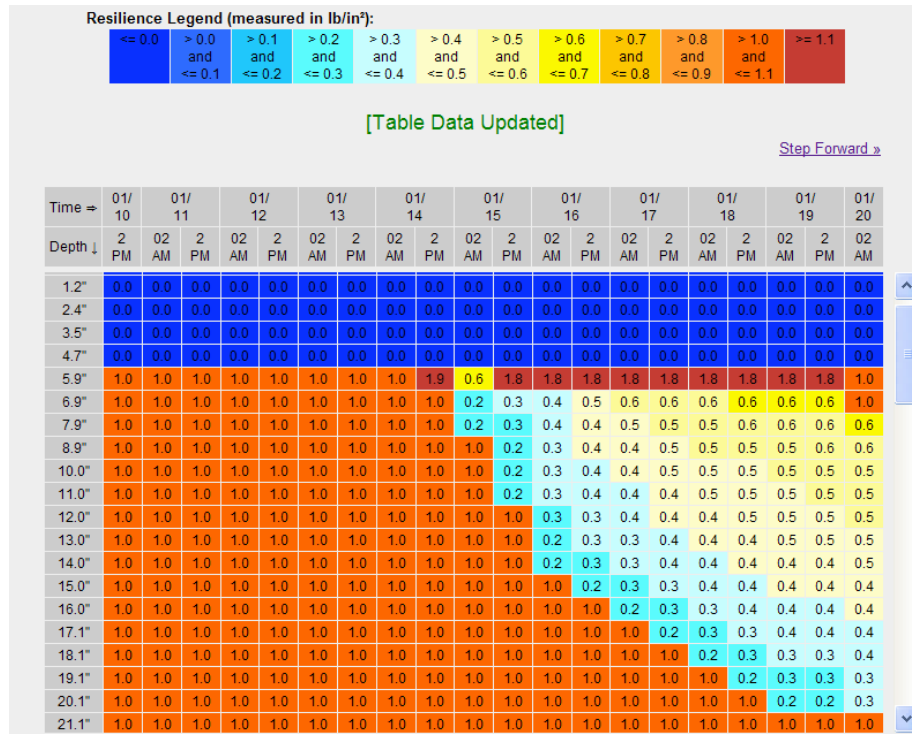
The ability to view images of these four parameters for the same site and timeframe was critical to understanding the EICM simulations and their value to SWR decisions. The four figures shown above represent a thaw event. Figure 3 shows that the pavement surface warmed to above freezing on the afternoon of January 13. By 2:00 p.m. on January 14 the entire pavement slab (5 in. in thickness) had warmed to 32°F or higher. Warmer environmental conditions at this site over the next 4 days kept pavement temperatures above freezing.



**FIGURE 4** EICM simulation of the pore water percentage at each node point as decimal fractions of 1 for the same location and time as Figure 3. Note that the values in the legend should not contain % signs.



**FIGURE 5** EICM simulation of the pore ice percentage at each node point as decimal fractions of 1 for the same location and time as Figure 3. Note that the values in the legend should not contain % signs.



**FIGURE 6 EICM simulation of the resilient modulus at each node point in lb/in.<sup>2</sup> for the same location and time as Figure 3. Note that the values in the legend should not contain % signs.**

The transfer of heat from the pavement downward can be seen in the simulation as it progresses through the base materials (5 in. thick) and into the subgrade. The deepest penetration during this warming episode was roughly 20 in. below the pavement surface or about 5 in. into the subgrade.

The simulation of the percent of the pore space filled by water or ice in Figures 4 and 5 provides insight into the effect of this thermal wave from the pavement downward into the subpavement. At 2:00 p.m. on January 14 the first indication of partial thawing appeared in Figure 4. By 2:00 a.m. the next morning the thawing had progressed to 3 in. below the pavement. Figure 5 indicates that the soil profile was frozen from the base of the pavement to well below 20 in. After January 13 this ice layer began to disappear in the base layer and downward into the subgrade. What is not necessarily obvious from the profile displays in Figures 4 and 5 is the fact that during the period from January 14 to the beginning of the next freeze cycle at this site on January 20 a layer of soil water was trapped between the pavement above and the layer of ice below. This layer of trapped water becomes critical for the determination of potential conditions for SWR. Dry soils have negative pore pressure readings of  $-100 \text{ lb/in.}^2$  or less. The data from the EICM pictographs during the two winters indicated that the pore pressures increased to values above  $-25 \text{ lb/in.}^2$  when the percent water content in the pores increased above 20%. High negative pore pressures act to hold soil particles together, since the negative pressure inside the pore pulls inward on the soil particles surrounding the pore. As the volume of water increases the suction-like pressure within the pore decreases and the soil pore configuration loses its ability to constrain movement between adjacent soil particles. The SWR research indicated that pore pressures of around  $-25 \text{ lb/in.}^2$  or

percent pore water content of approximately 20% were good indicators of the transition from structurally sound soil conditions to marginally stable soils.

The EICM output provided another tool to understand soil destabilization—the resilient modulus, which is the ratio of the stress to strain for rapidly applied loads such as the conditions that occur in and beneath the pavement due to traffic, especially heavy truck traffic. Figure 6 provides a pictograph of the resilient modulus during the thaw process shown in Figures 4 and 5. The resilient modulus for the frozen soils prior to January 14 had a value of 1.0. When the penetration of the thermal wave into the soil profile melted the ice, the strain increased for a given stress loading because of the increased water content in the soil pores. Therefore, the resilient modulus values dropped from 1.0 to 0.2 right after the thaw occurred (see Figure 6). As the thaw advanced deeper into the soil profile, part of the water in the pores redistributed within the soil column and the resilient modulus values started to increase. By monitoring thaw scenarios similar to the one shown in Figures 3 through 6, the resilient modulus value that correlated with the pore pressure and percent pore water transition point indicators was determined to be 0.4. Of the three EICM output parameters that were used in the SWR demonstration to assess the critical threshold related to the timing of load restrictions the resilient modulus provided the most stable characterization of the transition and became the indicator most often used to correlate likely times for the implementation and lifting of load restrictions.

The scenario illustrated in Figures 3 through 6 represents a typical thawing situation that occurred several times during the freeze–thaw period. Thaws tended to occur quite rapidly in the critical base and subgrade layers (typically, 0 to 12 in. below the base of the pavement); however, once in place, the high soil moisture, low resilient modulus conditions persisted for days or weeks as the layer of water remained trapped above the frozen layer below. Even after the frozen layer was completely thawed and gravity was able to carry the excess water downward, the resilient modulus values remained in the range of 0.2 to 0.4 and only gradually improved. Therefore, it was far easier to project when conditions might become appropriate for the institution of load restrictions than when conditions permitted lifting the restrictions. It was also easier for DOT personnel to verify the initiation of thawing in the field because the development of the layer of moisture in the base layer caused moisture to seep up through cracks in the pavement. When the EICM simulation indicated the potential for a significant thaw, the EICM research team and the DOT field personnel worked closely to verify when visual clues appeared in the field and matched these to the simulated timing. Feedback from the DOT field representatives indicated that the simulated timing of thaw conditions correlated well with their field observations.

The return of structural stability after the thaw period was a greater challenge for DOT personnel. There are no visual clues for this and most of the current testing procedures have limited ability to determine when the moisture in the subpavement profile had decreased to a point where soils regained their load bearing capacity. The EICM simulation provided a tool to visually represent what was happening in the base and top portion of the critical subgrade layer and offered what seemed to be a good method to define when conditions were adequate to lift restrictions. South Dakota and North Dakota have used a thermal index called FrezTrax since 2000 to guide load restriction implementation and removal decisions. This index is based upon the transport of heat into and out of the soil profile during the freeze–thaw period and uses the average temperature to compute a freeze index or a thaw index. The indices are accumulations of temperature differences over the season. The freeze index is used as a surrogate for the intensity of the freeze and the thaw index is used to erode the impact of the freeze. FrezTrax uses a



relationship between the freeze index and the thaw index and a measure of the soil moisture available at the beginning of the freeze cycle to compute when load restrictions should be implemented and when they should be removed. Through the use of projected average temperatures, FrezTrax is able to project best estimates of the dates for load restriction actions. Experience over the last decade in South Dakota and North Dakota indicates that this method provides reasonable guidance regarding preferable dates for load restriction actions. The FrezTrax guidance was compared to the simulation output from EICM. The resilient modulus threshold of 0.4 seemed to correlate well with guidance provided by FrezTrax, although a detailed test is needed to statistically confirm this perceived correlation.

## **FINDINGS**

Evaluation of EICM representations of pavement and sub-pavement soil conditions demonstrated that there was tremendous potential for this tool to form the basis for a seasonal weight restriction guidance tool and to serve as a mechanism for a better understanding of conditions beneath the highway infrastructure during freeze–thaw cycles. The EICM simulations showed particular promise in assessing when load restrictions should be lifted. Generally, DOT participants in the demonstration test viewed the SWR tool as another resource to support their decision process; however, participants were particularly impressed with the ability to visualize what was occurring beneath each of the specific locations in the demonstration test and felt that this capability reduced their anxiety in making tough decisions regarding load restriction announcements.

The EICM provided a method to illustrate and assess the impact of weather conditions for any location and the unique pavement and construction configuration at that site. It was possible to completely specify the existing construction profile including the characteristics of the pavement, the base materials, subgrade, native materials, and depth to the water table. The EICM had the potential to provide a better simulation of the soil profile conditions if the character of the entire profile was explicitly defined. This did pose a minor issue since all of the detail that could have been used was not available for a number of the sites selected by the DOTs. Nevertheless, the demonstration illustrated that it was possible to configure adjacent segments of a highway differently and to potentially get slightly different guidance related to each specific segment.

One of the unexpected lessons from this demonstration was the number of mid-winter thaw cycles that occurred. After frost was permanently established by late November 2010 across all three states, there were several episodes of significant intrusions of above-normal temperatures that forced thawing to a depth of 20 to 30 in. below the pavement surface. This was particularly true in Montana, but one or two episodes affected parts of North Dakota and South Dakota as well. Although each of these thaw cycles was terminated by a refreeze of the soil profile from the top down as colder conditions returned, the character of the soil profile conditions were exactly the same as the conditions that existed in what is known as the final spring thaw. Research and experience related to freeze–thaw damage indicates that much of the structural damage to the roadway is not manifest until after the thaw process is complete; that is, the effects in the modification of the structure of the subsurface soils do not show up immediately but transpire over a period of time under routine traffic loading. No load restrictions were imposed for these mid-winter thaws. The question that needs consideration is whether there

is as much potential subpavement damage due to these mid-winter events as there is in the spring thaw cycle. The EICM may provide a mechanism to help answer this question.

Verification of EICM performance was limited by the lack of sites having temperature probes at multiple depths in the demonstration area. A number of the RWIS sites had subsurface probes at a depth of 16 to 18 in. but there was only one site that had a sequence of probes at depths from the base of the pavement slab to 72 in. below the slab. These sites were used to evaluate temperature profiles and values at single depths in a profile. This limited data set did provide an indication that there was a cold bias in the EICM model and that the model reacted faster than the measured temperatures. No sensitivity tests were run to determine whether the issue might be associated with model parameterizations or with assumed values for model constants. Since these were the same findings that came out of the STWRC study, they represent an area where further investigation is needed.

The project did lead to the discovery that procedures to merge EICM output with existing SWR policies and procedures would be quite complicated and would almost require a case-by-case interface. It was decided that there was more merit in evaluating the EICM output and in determining whether the EICM SWR tool could provide an independent set of recommendations that DOT users could further evaluate as one of their SWR decision-making tools.

## RECOMMENDATIONS

The SWR demonstration pointed out a number of areas of research that could potentially improve the tool. One of the most obvious needs was the establishment of one or more research facilities to evaluate the performance of the EICM. The foremost requirement would be a network of soil temperature and moisture profile observation sites throughout a multistate area that would serve as a validation mechanism for EICM. At one or more of these test sites there is a need for a mechanism to measure the amount of ice or water in the pore space, the pore pressure, and the subgrade compression and strain.

The observation that a resilient modulus of 0.4 seems to be an appropriate threshold for instituting SWR needs further investigation. Specifically research is needed to assess whether the threshold changes for specific vehicle weight classes. The assessment of load restrictions also needs to evaluate the commercial implications of SWR—both economic and societal. What is the trade-off and what are potential ways to jointly address the impact of SWR?

The SWR demonstration looked solely at the freeze–thaw issue. Yet daily evaluation of EICM output made it evident that the information in the pictographs could be used for other situations year round. Conditions during flooding or extremely wet periods have the potential to create soil profile conditions similar to those observed during thaw periods. Soil stability concerns may be just as important when soils are saturated from non-winter sources. The EICM model offers a method to look at the impact of these saturated soil scenarios.

The website interface developed for the SWR demonstration was effective, but daily use of the site pointed out modifications that would have made the site more useful. These included more efficient navigation and display of data over a time period for a constant set of defining characteristics. For example, it would have been very helpful to define a specific start time, time step interval, and top depth for a display and to have the ability to step through each of the display formats in a manner similar to sequencing through Figures 3 through 6 in this paper without the specified conditions changing each time a new parameter was requested.

**REFERENCES**

1. Simonsen, E., and U. Isacsson. Thaw Weakening of Pavement Structures in Cold Regions. *Cold Regions Science and Technology*, Vol. 29, 1999, p. 141.
2. Isotalo, J. Seasonal Truck-Load Restrictions and Road Maintenance in Countries with Cold Climate. *Transportation, Water and Urban Development Department*, March 1993, p. 2.
3. Van Deusen, D. A., and J. L. Ovik. SPRING LOAD RESTRICTIONS, Improving Minnesota's Policy. *TR News*, No. 211, November–December 2000, pp. 36–37.
4. Canadian Strategic Highway Research Program. *C-SHRP Technical Brief No. 21: Seasonal Load Restrictions in Canada and Around the World*. September 2000, pp. 1, 3, 6.
5. Hanson, J. L. *Investigation of Atmospheric Impacts on Spring Load Restriction Limits Imposed by State Transportation Agencies*. MS thesis. University of North Dakota, 2005.

# Innovations in Winter Maintenance Equipment



## INNOVATIONS IN WINTER MAINTENANCE EQUIPMENT

## Potential Impacts of a Multipurpose Snow Removal Instrument on Snow Removal

WOO HOON JEON  
CHOONG HEON YANG  
IN SU KIM

*Korea Institute of Construction Technology*

JUN-SEOK OH  
*Western Michigan University*

**A multipurpose snow removal instrument is being developed to help effectively remove snow on the roads from urban areas. The instrument is detachable from a regular cargo truck and consists of a blower and a snow melter. The blower transports snow from the road surface to the melting tank and the water melted in the tank is drained away to sewers on the roadsides. The main purpose of the instrument is to melt away snow quickly from the road surface. The rapid snow removal is expected to recover road capacity considerably. This study is to evaluate its effectiveness by incorporating microscopic traffic simulation modeling and travel demand elasticity with respect to snowfall. The simulation analysis result shows that the multipurpose snow removal instrument helps increase traffic volume by 6% and travel speed by 13% when compared with those of ordinary snowplows.**

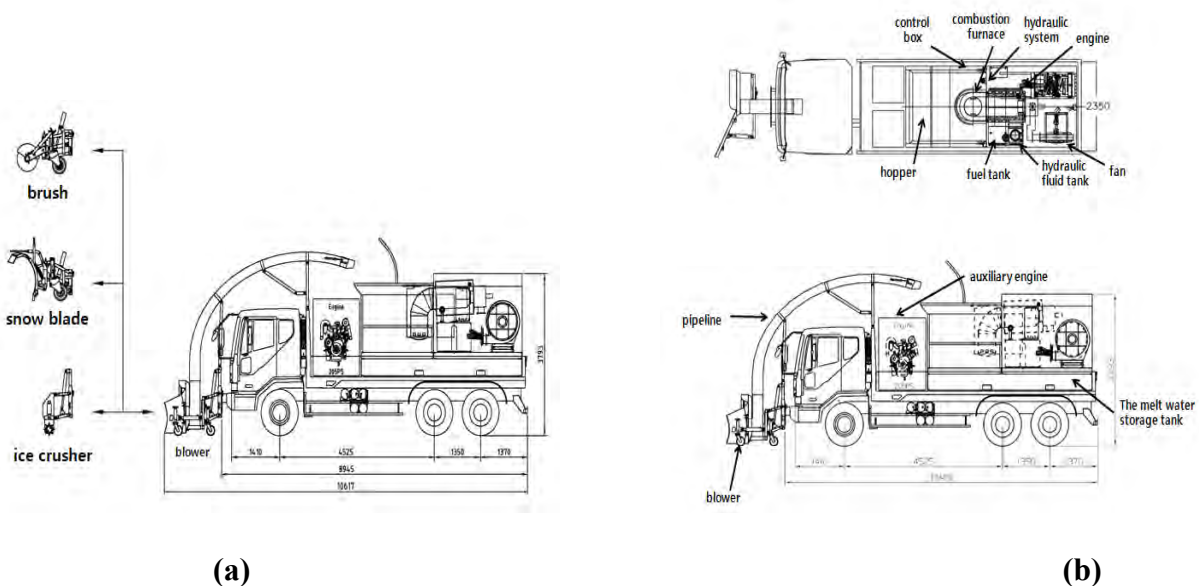
Lately in South Korea, the frequency of winter snowstorms has increased, and the resulting damage has become a major concern. The past 3 years, heavy snowstorms have hit many places in Korea including the Seoul metropolitan area, Honam (western side of Korea), Ganwon Province (eastern side of Korea), and Pohang (southeastern side of Korea). These snowstorms struck regardless of location characteristics. They were uncommon in many areas, so the resulting damage was more severe in these locations. For instance, Pohang had almost no snow in the past so the city was not ready for the heavy snowfall. These uncommon snowstorms were partly regarded as a result of recent climate changes. The unexpected heavy snowfalls completely paralyzed urban functionality in many areas due to the lack of adequate snow-removal capacity. It also required tremendous manpower to remove accumulated snow on the roads, materials for snow-removal equipment, and man-hours operations.

In general, performing snow removal after the event of snowfall is not a cost-effective method, and thus road condition recovery poses a major concern. The longer the disastrous physical conditions last, the greater the social loss is. For example, an unexpected heavy snowfall may isolate drivers for a long period and the inability to recover road conditions may cause even greater damages. Snow-removal operations have relied on deicing materials, spreaders, and snow blades; however, they have limitations in managing unexpected snowstorms effectively. Therefore, in 2010, the Korea Ministry of Land, Transport, and Maritime Affairs funded a research and development (R&D) project to develop a multipurpose snow-removal instrument in order to provide quicker and more efficient snow-removal services. One of the key

features of the instrument is the capability to melt away snow (1). This R&D project will be completed by 2013. The concept of the instrument and its operational scheme has already been achieved. Figure 1 represents a conceptual diagram of the instrument.

As shown in Figure 1, the ancillary equipment attachable to the front of the truck is designed for a variety of snow-removal functions, such as brush, snow blade, and ice crusher. If the snow melter is used, a snow blower is attached to the front of the vehicle. The snow blower transports snow on the road surface to the snow melter. For the operation of snow melter, a separate auxiliary diesel fuel tank is installed. The gas tank is designed to work for 5 h with one fill up. Instead of the snow melter, it is possible to use a deicing spreader attached to the rear of the vehicle and a snow blade or ice crusher attached in front, similar to ordinary snowplowing instruments. This study analyzes a multipurpose snow-removal instrument with a feature of a snow melter. The snow melter is basically designed to dissolve 30 tons of snow per hour and the secondary tank can store up to 5 tons of melted water (melted snow by passing through the snow melter). To expedite the melting process, screw-type agitators are installed. A collection system is also installed to remove various contaminants. While the general cargo truck with a multipurpose snow-removal instrument is in operation, its optimum operating speed is set to less than 5 km/h. The operating speed was set by considering dissolved water drainage and the density of snow. In the case it is used like ordinary snowplowing vehicles, the optimal operating speed can be between 40 and 60 km/h. Regarding snow-melting removal equipment in international practices, Japan possesses a patent for a self-propelled vehicle that can simultaneously remove and melt snow, but no actual equipment exists. In the United States, there is a patent for a vehicle that can melt collected snow by spraying pressurized hot water, but it is not classified as free technology.

The capacity of developed instruments varies depending on the treatment of the water in the auxiliary tank. If there is a risk of freezing due to weather (the temperature is below freezing point) or road conditions, the water should be discharged directly to the sewer on road shoulders



**FIGURE 1** Conceptual diagram of a multipurpose snow-removal instrument: (a) multipurpose functions and (b) multipurpose snow-removal instrument component.

through an attached hose. When discharging the melting water in an auxiliary tank, the vehicle has to stop for a minute to discharge. Doing so takes longer, but is the safer option. On the other hand, if there is no risk of freezing, the melting water can be discharged directly on the road from the snow melter while traveling. In this case, there is no need to store the melting water in the auxiliary tank, allowing for faster operating speeds. [Table 1](#) compares operating speeds for the two cases.

## LITERATURE REVIEW

In order to evaluate the effectiveness of the developed multipurpose snow-removal instrument, it is necessary to identify the relationship between snowfall and traffic volume. Baek et al. (2) has studied the impact of snowfall on traffic characteristic based on 10 years of meteorological data. Comparing weather conditions with the average daily traffic volumes and the average travel distances on Korean expressways, they showed a decreasing trend of average daily traffic with an increase of snowfall. Park et al. (3) calculated weather adjustment factors (WAF) applicable when estimating annual average traffic volume with the average traffic on snow days. Using WAF, they observed a big difference between weekdays and weekends in traffic volume changes with respect to snowfall. While it was clearly explained on weekdays, its explanation on weekends was relatively lacking. Another study on a two-lane highway has shown that the traffic volume decreases by 6.9% with a snowfall of 0.5 cm (4).

There have also been many studies in other countries on relationships between weather conditions and traffic volume. Agarwal et al. (5) tried to find causes of the reduction of traffic volume and speed due to snow, rain, and low visibility by classifying weather types by their levels of impact on speed, headway, and capacity. They identified that less than 0.5 in. of snowfall per hour lowered the road capacity and operating speed by 11% and 9.4%, respectively, and that 0.5 in. or more snowfall lowered them by 22.4% and 13.5%. In Hanbali and Kuemmel (6), in the United States, the reductions of traffic volume were measured during snowstorms on the highway in Illinois, Minnesota, New York, and Wisconsin outside of metropolitan region. Using automatic vehicle detection devices, the actual traffic counts were collected for 24 h during January, February, and March 1991. The result showed that traffic volume decreases as snowfall increases. However, less traffic was reduced during weekday peak hours than during weekend peak hours.

Previous studies have observed changes in road capacity and operating speed as an impact of snowfall. In fact, these studies include the impact of weather conditions on travel demand as well as supply (road capacity, operating speed, etc.) simultaneously. Accordingly, it is difficult to separate impact solely on travel demand or on road supply. Therefore, there are needs for further studies with more data on impacts of snowfalls on road capacity, operating speed, and travel demand.

**TABLE 1 Comparison of Operation Speeds**

Division	Snow Covered on Shoulders After Plowing		
	<30 cm	<50 cm	<100 cm
Stopping vehicles for discharging melted water to sewer (m/h)	407.06	244.23	122.12
Discharging melted water on the road while traveling (m/h)	661.52	396.91	198.46



## RESEARCH APPROACH

### Analytical Procedures for the Required Equipment

In planning for effective snow removal, the snow-removal equipment and effective operation plans should be established prior to the start of the winter season. The ideal case is to purchase all necessary snow equipment and deploy them at proper locations. However, it is literally infeasible and cost-ineffective. In order to estimate how much snow-removal equipment is needed, there are many factors to consider, such as the length of roads (vehicle kilometers), intensity and probability of precipitation, target time for snow removal, snow-removal operation speed of vehicles, as well as the efficiency of snow-removal operations. Among them, target time is one of the most influential factors. The Ministry of Land, Transport, and Maritime Affairs currently provides target times according to the road service level as shown in [Table 2](#) (7).

Empirically, when snow removal is performed with the vehicle attached to the deicing spreader on the rear and a snow blade in front, the vehicle is traveling between approximately 45 km/h and 60 km/h. In that case, the operational efficiency is assumed to be 0.7 under the total efficiency of being 1.0. The number 0.7 is considered in taking the distance from a salt storage to the vehicle of snow removal based on the farther distance, getting lower efficiency. Thus, local conditions should be properly applied to select actual operational efficiency when plowing snow on the roads.

In order to evaluate the effectiveness of the instrument, this study is basically performed on the conditions that snow accumulated on shoulders is 30 cm in height and that the melted water is drained away to the sewers with a vehicle stop as seen in [Table 1](#). In addition, it is assumed that the instrument is committed for the purpose of dealing with the snow-covered roads in downtown areas. The specific roadway section for deploying a vehicle attached the instrument

**TABLE 2 Level of Service According to Target Snow-Removal Time**

LOS	Target Time	Rural Area	Urban Area	Application Level
A	2 h	Highway	Urban highway	50% to 60% compared with normal road conditions
		Roadways with more than four lanes for each direction (over 20,000 vpd)	Major arterials	
B	3 h	Roadways with more than four lanes for each direction (over 20,000 vpd)	Minor arterials	40% to 50% compared with normal road conditions
		Roadways with more than four lanes for each direction (over 5,000 vpd)	Collected roads	
C	5 h	Roadways with more than four lanes for each direction (over 5,000 vpd)	Collected roads	Passage cleared
			Local roads	
D	—	Roadways with more than four lanes for each direction (less than 500 vpd)	Local roads	Snow removal operation later

NOTE: LOS = level of service; vpd = vehicles per day.

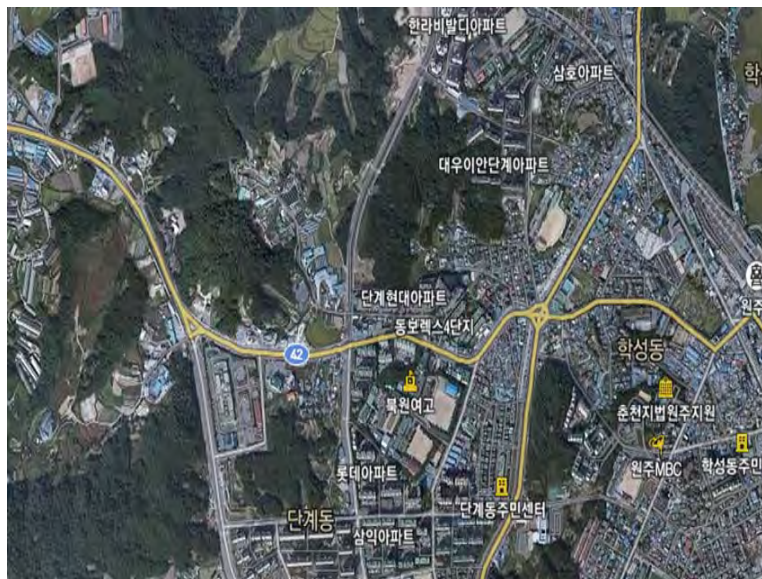
should be set up before snowstorms by the person in charge of winter operations. Target snow-removal time to reach a certain level of service is assumed to be doubled based on Table 2. With the assumptions outlined above, the number of vehicles for snowplowing and instruments can be estimated as follows:

1. Total number of vehicles for snowplowing = road extended/vehicle speed/target time for snow removal/efficiency for instrument.
2. Total number of multipurpose snow-removal instrument = road extended  $\times$  extended rate/vehicle speed/target time for snow removal/operational efficiency.

### Analysis of the Effectiveness of Instrument by Simulation Study

Paramics, the microscopic traffic simulation tool, was chosen for analyzing the effect of scenarios related to several types of snow-removal operation. Paramics is a model developed at Quadstone in Scotland; it is effectively used to portray advanced transportation facilities and public transport through its various flexible and useful elements. Paramics is a stochastic simulation model, relying on randomly generated numbers to trigger the release of vehicles, assign vehicle type, destinations, and routes, and determine driver behaviors as the vehicle moves over the simulation network. Paramics can be applied to various analyses for a large transportation network, highways, urban traffic management, intersection, advanced transportation systems, public transit, the environment, pedestrian, and so on. The most important property of Paramics is the application programming interface; it allows advanced users to easily customize many features of the underlying simulation modules. The total length of the study site is a 1.3-km section of national road route 42 in downtown areas of Dangye-dong Wonju-si, Gangwon-do, as shown in Figure 2.

Traffic conditions in this area during the winter season (January 11 and 12 and February 15 and 16, 2011) is reached, as shown in Figure 3, on the level of 2,000 vehicles per hour (vph)



**FIGURE 2** The test site for simulation runs.

in the morning peak compared to approximately 1,500 vph during the daytime.

To describe the vehicle attached to the instrument, the bus route function provided by Paramics is employed. It is also set up to stop for 1-min periods at bus stops discharging the melted water on the side of the road drainage at every 200-m interval. As for snowplowing, the feature of lane restriction according to vehicle type is used in addition to this function. Traffic signal of each intersection in the study site is assumed to the fixed signal phases. Figure 4 demonstrates the overlap aerial photo and simulation network of the study site.

Roadway capacity is not used as an input in the microscopic simulation study, but it is usually determined by the given road conditions and speed limit. Therefore, speed limit or driver behavior should be properly adjusted in order to produce roadway capacity. Since there are few

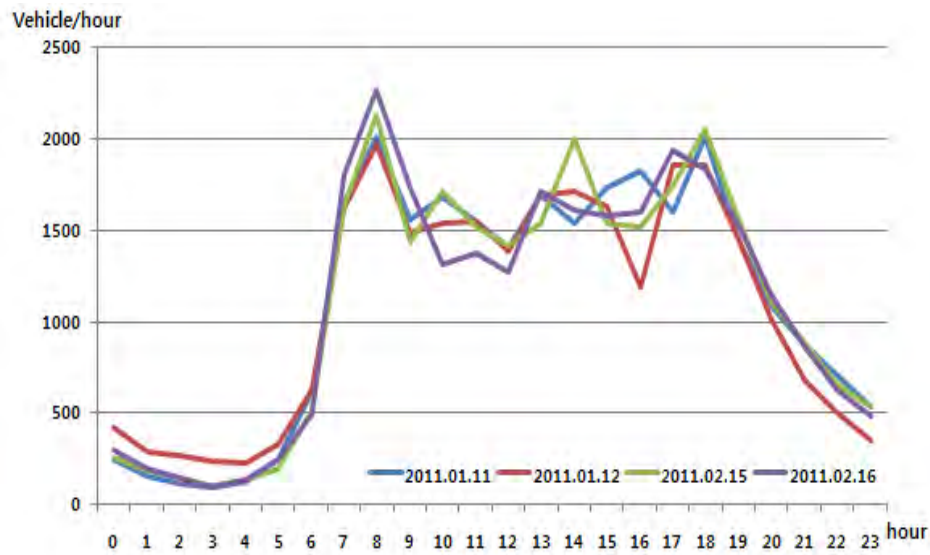


FIGURE 3 Traffic volume pattern by time period.

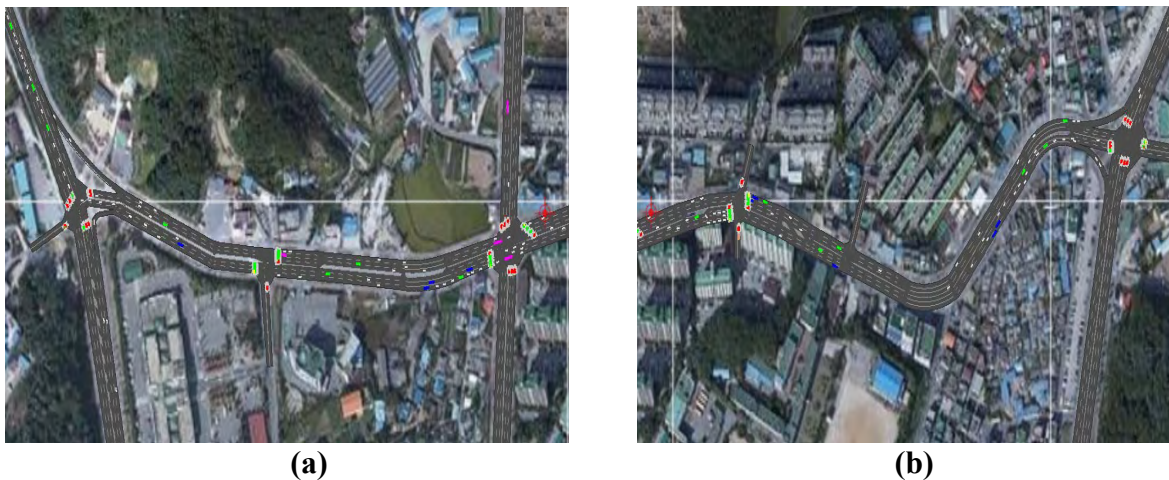


FIGURE 4 Simulation study for the test site: (a) west side of the study site and (b) east side of the test site.

studies related to driver behavior according to weather conditions, speed limit is used to produce reasonable roadway capacity. In order to perform this, the following four different scenarios were made as below.

Scenario 1: Normal conditions (three-lane for one-way and speed limit is about 50 km/h).

Scenario 2: Before snow-removal operation (do nothing and assumed a top speed of 20 km/h of in two-lane for one way).

Scenario 3: Two-lane available to pass after snow-removal operation (assumed a top speed of 40 km/h in two-lane for one-way).

Scenario 4: Three-lane available to pass (secure three-lane after plowing snow with the instrument assumed a top speed of about 45 km/h for one-way).

To estimate a reduction in traffic volume according to snowfall, *The Highway Capacity Manual 2010* and Iowa State University research reports (8) are used in the following equation.

$$R = -4.9692S - 4.4296 \quad R^2 = 0.9642$$

where  $R$  is the rate of speed reduction (%) and  $S$  is snowfall (cm).

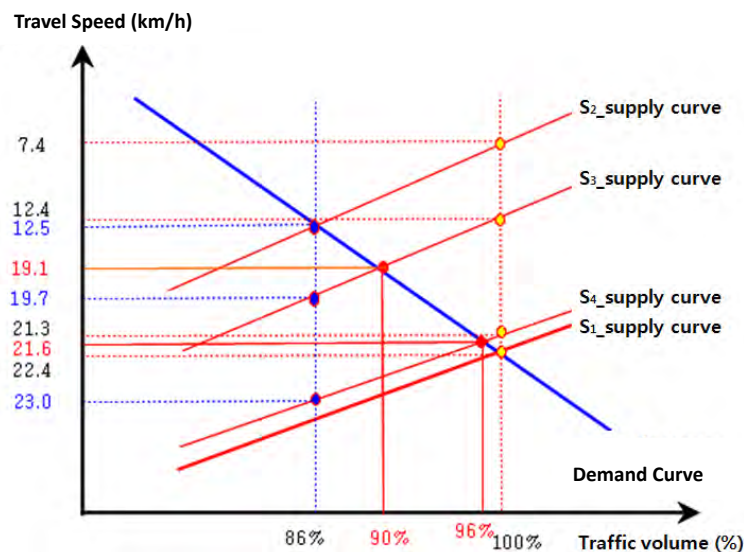
The first simulation is carried out under the assumption that traffic volume is unchanged, the second simulation are analyzed when there is a 14% reduction in traffic conditions due to 1 cm per hour in snowfall. Based on the results of the first and second simulation, reduction level in traffic volume and the balanced traffic by each scenario are estimated as represented in [Table 3](#).

Furthermore, travel demand elasticity is examined to represent demand–supply balance point by each scenario as shown in [Figure 5](#).

The supply curve of  $S_1$  represents normal conditions of the study site. In this condition, travel speed is maintained at 22.4 km/h with traffic volume at the level of 100%. The supply curve jumped up to  $S_2$  when in snowfall. If it is assumed that the traffic volume does not decrease at this time, the travel speed slowed down to 7.4 km/h. However, due to a reduction in traffic demand (14%), travel speed could be maintained at 12.5 km/h. When two-lane roadway is cleared through snowplowing, the supply curve is lowered from  $S_2$  to  $S_3$ . In this case, equilibrium is achieved when traffic volume is the level of 90% of normal traffic, and travel speed is reached at 19.1 km/h. When snow accumulated on the roads is clearly removed, enabling all three lanes to pass, travel speed can be maintained at 21.6 km/h under the level of a 4% reduction in traffic volume.

**TABLE 3 Summaries of Simulation Results**

Scenario	1st Simulation	2nd Simulation	3rd Simulation	
	Average Speed (when traffic volume is fixed)	Average Speed (with 14% traffic volume reduction)	Equilibrium Conditions	
			Average Speed	Traffic Percentage
1	22.4 km/h	—	22.4 km/h	100%
2	7.4 km/h	12.5 km/h	12.5 km/h	86%
3	12.2 km/h	19.7 km/h	19.1 km/h	90%
4	21.3 km/h	23.0 km/h	21.6 km/h	96%



**FIGURE 5 Demand-supply balance point by each scenario.**

## CONCLUSIONS

This study evaluates the effectiveness of the multipurpose snow-removal instrument by incorporating microscopic traffic simulation modeling and travel demand elasticity with respect to snowfall. The vehicle speed attached to the instrument is relatively lower than typical snowplowing, but road capacity in urban areas is expected to increase considerably because the instrument can melt snow away quickly from the road surface to the sewers on the roadside. The number of required equipment will depend on several conditions like operating speed, snow conditions, and operational efficiency, so this study has established a framework for estimation of the number for the instrument and the typical plow equipment according to several factors such as road length and operational efficiency.

From the results of the analysis, the traffic volume is decreased about 14% relative to normal conditions, and travel speed is decreased by about 44%. On the other hand, 10% of traffic volume and 12% of speed is decreased under Scenario 3. In Scenario 4, traffic volume is reduced by only 4% when the instrument is used. Finally, it appeared that traffic volume and speed is increased 6% and 13%, respectively, compared to snowplowing only.

## ACKNOWLEDGMENTS

The authors gratefully acknowledge the financial support provided by the Ministry of Land, Transport, and Maritime Affairs and Korea Institute of Construction and Transportation Technology Evaluation and Planning to fund this research project.

## REFERENCES

1. Korea Institute of Construction and Transportation Technology Evaluation and Planning.

- Development of a Multi-Purpose Snow Removal Vehicle. Publication KICTEP-01. KICTEP, Korea, 2010.
2. Baek, S. G., B. J. Kim, and Y. T. Lim. Analysis of Rain Impacts on Freeway Trip Characteristics. *Journal of Korean Society of Transportation Engineers*, Vol. 26, No. 3, 2008, pp. 119–128.
  3. Park, C. S., and J. H. Jang. A Study on Developing Weather Adjustment Factor Due to Snowfall in Estimating AADT. *Seoul Urban Study*, Vol. 5, No. 2, 2004, pp. 19–26.
  4. Hong, S. M., C. Oh, C. H. Yang, and W. H. Jeon. Estimation of Freeway Traffic Performance Deterioration Functions by Snowfall (Focus on Seohaean Freeway). Working paper, 2011.
  5. Agawal, M., T. Maze, and R. Soueyrette. Impact of Weather on Urban Freeway Traffic Flow Characteristics and Facility Capacity. Iowa State University, 2005.
  6. Hanbali, R. M., and D. A. Kuemmel. Traffic Volume Reductions Due to Winter Storm Conditions. In *Transportation Research Record 1387*. TRB, National Research Council, Washington, D.C., 1993, pp. 159–164.
  7. The Ministry of Land, Transport, and Maritime Affairs. *A Guideline for Roadway Snow Removal in South Korea*. Publication MLTM. 2001.
  8. *Highway Capacity Manual 2010*. Transportation Research Board of the National Academies, Washington, D.C., 2010.

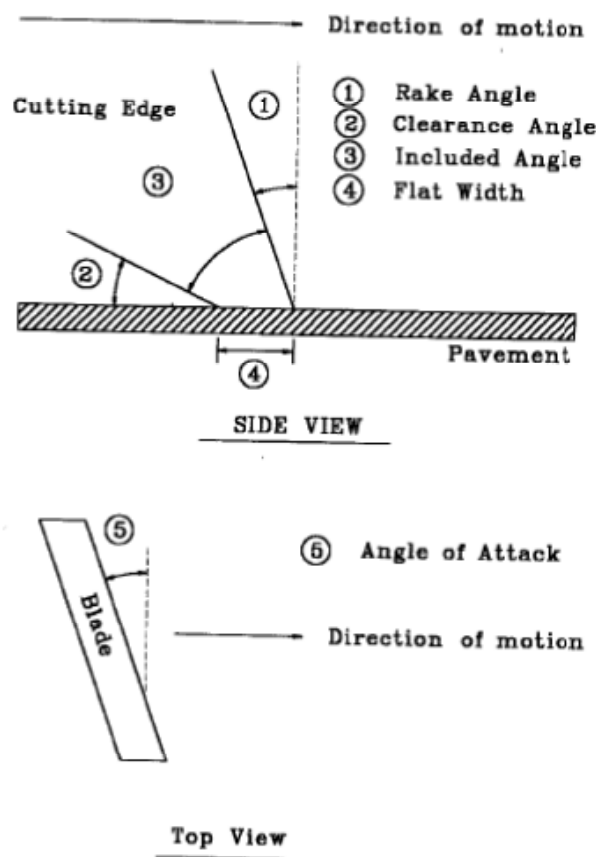
## INNOVATIONS IN WINTER MAINTENANCE EQUIPMENT

**Factors for Consideration in Selecting Snowplow Cutting Edges****WILFRID A. NIXON***University of Iowa*

The nature of cutting edges in use in winter operations in North America has changed dramatically over the past two decades, and instead of simply being a piece of high-speed steel, today's cutting edge is often a hybrid of multiple materials and may in fact include more than one blade all together. While cutting edges have not quite got to the level of razors, with five blades they are indisputably more complex and when used appropriately more effective than the cutting edges of old. With this complexity a challenge arises for agencies that handle winter operations: What sort of cutting edge is best? This paper approaches this challenge within the context of sustainability, acknowledging that the correct choice of cutting edge for an agency will reflect not only cost concerns but also environmental and societal issues. One benefit of this approach is that it avoids any sort of one-size-fits-all solution; because every agency faces different issues, the optimal solution should be different for each agency. In examining cutting-edge performance, two factors are obviously significant: the longevity of the cutting edge (how many miles or how many hours can it be used before it must be replaced) and the ability of a given cutting edge to remove snow from the road (how much snow or ice is left behind). These two factors in turn raise other issues. For example, the condition of the roads that the cutting edge will be used on is clearly of importance. If roads have significant ruts, then cutting edges need a heightened ability to conform to the road surface. If roads are particularly rough, then cutting edges must be very resistant to shock loading. If roads use any sort of raised pavement markings, then the cutting edges must not destroy these markings. An additional area that drives the selection of a cutting edge is the age and type of the truck fleet. A modern cutting edge can in many ways give an old plow new life. Additionally, some older vehicles may be more prone to vibration being transmitted from the cutting edge to the operator, in which case the ability of an edge to reduce vibration (and thus minimize plow noise) is an important factor. This paper describes a method where all these (and additional) behaviors can be incorporated into the cutting edge selection process. Various scenarios exhibit how this method works and show how changes in emphasis for different agencies can result in different selections.

The snowplow is clearly a key piece of equipment in winter maintenance and one of the most important tools in the winter maintenance toolkit. This suggests that there could be considerable benefit to be gained by examining how the performance of the snowplow could be optimized. Earlier work with regard to the performance of snowplows (1) showed the behavior of plow blades to be complex. The forces acting on the blade are dynamic and appear to depend on a number of variables.

Additional work (2–4) suggests that the shape and material in the cutting edge are as important as the dynamics of the plow itself. This earlier work indicated that the processes involved in a plow cutting edge removing snow or ice on the road were similar, *mutatis mutandis*, to the processes involved in cutting metal on a lathe or milling machine. Figure 1 is a schematic cross section of a snowplow cutting edge showing how typical concepts from metal cutting (rake angle, clearance angle) are transferable to the process of snow and ice removal.



**FIGURE 1** Schematic of snowplow cutting edge.

The work referenced above showed that there were optimal values for the rake angle, the clearance angle, and the flat width (in the latter case the value was a width that was not to be exceeded) for most efficient plowing. Such information is helpful in a background sense, but only begins to outline the problems involved in selecting a cutting edge for particular winter maintenance needs.

The choice of a cutting edge is a function of a number of variables. Key among these are price and longevity of the cutting edge, which ideally should be combined into a form of life-cycle cost analysis, and the overall performance of the cutting edge (the degree to which it clears snow and ice from the road surface) but other factors also must be considered. These include the type of pavement and pavement markings in use on the road system for which the cutting edges are being purchased. Additional factors to be considered in the selection of a cutting edge are noise and vibration and ease of installation. These factors will be discussed and compared in this paper.

## THE MATERIAL CHALLENGE

Snowplowing, at the cutting edge, involves a combination of cutting snow and ice from the road surface (physically separating the two parts: snow-ice and road surface) and then the sweeping



of this material away from the surface onto the face of the plow. This combined action places two requirements on the cutting-edge material. It must be able to withstand shock loading, because at some stage during use it will hit a discontinuity in the road surface (e.g., a bridge joint or a manhole cover); this means it must have high fracture toughness. It must resist wear or it will erode too rapidly during the scraping process; this means the cutting edge must be hard. Unfortunately, these two requirements—high-fracture toughness and high hardness—are typically mutually exclusive. Hard materials tend to be brittle and tough materials tend to be soft, all other things being equal. The typical approach to solving this sort of challenge is to develop a composite at either the macrolevel or microlevel, and it is no surprise that this approach has been taken in some cutting-edge design.

In terms of determining how best to create a suitable composite cutting edge, a key factor is the nature of the road surface being scraped. Depending on certain aspects of that surface, a composite that is more or less rigid may be required. This is considered further below.

## THE PAVEMENT SURFACE

Two aspects of the pavement surface need to be considered when selecting a type of cutting edge. First, the actual composition of the cutting surface is of importance. Some pavement surfaces include very hard aggregates and thus will wear away many cutting edges very rapidly, while others are sufficiently soft that they can themselves be damaged (gouged or scraped) relatively easily by cutting edges. This is a particular factor when pavement overlays are used (5) and should be a consideration not only in selecting the type of cutting edges to be used, but also in selecting what sort of pavement overlays should be used.

The second aspect of the pavement surface that must be considered is the issue of pavement markings. If raised pavement markings are used, then the use of hard cutting edges (steel, carbide, or other such hard materials) is not appropriate. If such hard materials are used, the raised pavement markers will be scraped off the pavement surface, along with the snow. For such circumstances, the use of rubber cutting edges is appropriate, but these tend to wear out rapidly. One approach has been to reinforce the rubber with ceramic inserts that provide additional stiffness and wear resistance. These appear to work well in terms of protecting the raised pavement markers while still scraping the snow and while also lasting much longer than unreinforced rubber blades.

## NOISE AND VIBRATION

It might be thought that noisy and vibrating snowplows are more nuisance factors rather than major concerns, but this is not the case. A vibrating or chattering blade will not only be noisy, but will also potentially damage the pavement that it is scraping. As noted above, certain pavement types can be susceptible to damage by plow blades. [Figure 2](#) shows one such pavement from Highway 927 in Iowa. The pavement received a microsurface treatment in 1999 and the photograph was taken in May 2000 (i.e., after one winter season). The average annual daily traffic on the road at that time was 4,360.



**FIGURE 2 Highway 927 in Iowa, from May 2000, showing chatter markings from plowing subsequent to a microsurface treatment in 1999.**

In addition to possible pavement damage due to blade chatter, the blade vibrations are often transmitted to the snowplow driver, causing increased fatigue, and thus diminishing safety. The challenge with noise and vibration is that such behavior is more likely with a stiff cutting edge, but that such cutting edges are more durable. Again, some sort of composite approach is needed to maintain the stiffness but reduce the vibrations.

## **TRUCK FACTORS**

As trucks and their equipment become older, wear and tear clearly increases, and the utility of the truck tends to diminish. To some degree, this utility can be increased again if some new equipment is added to the truck. In this context a new type of snowplow cutting edge can serve to give an old plow and an old truck new life or at least to diminish vibration and the concomitant noise that accompanies it. Clearly this will not work in all cases, but with a restricted budget it may be that a new cutting edge serves as a means to extend the life of plows and trucks that would otherwise be retired from the fleet.

## LIFE-CYCLE COSTING

With any issue of equipment or materials in winter maintenance, cost is a major concern. However, performance is also important. Buying something that does not work is not an efficient use of money. Cost benefit is an important tool in winter maintenance (or indeed any operations) as discussed by Veneziano et al. (6). In considering costs related to cutting edges, it is important to try to include all costs during the life cycle of a given cutting edge.

Obviously, if one cutting edge lasts longer than another, replacement will be less frequent and thus over time, the cost of the time needed to replace the blade will also be less. Some blades (especially rubber blades) may need adjustment regularly (even during storms) and those costs should be included. There may also be differences between blade types in fuel consumption. Finally, the more vibration there is from a blade, the more wear and tear is incurred on the truck (and the operator) although this is hard to quantify. [Table 1](#) shows some of the factors that should be considered and included (if valid data are available) in a life-cycle costing analysis of cutting edges.

## DETERMINING CUTTING EDGE PERFORMANCE

A concern with any equipment or materials is whether or not it will perform to the expected level. This is the case with cutting edges and is of particular importance because high-performing or longer-lived blades (which typically incorporate carbide inserts) are more expensive than regular blades. The standard approach to such issues is to develop a specification test for cutting edges which addresses this concern. However, this is not a straightforward issue.

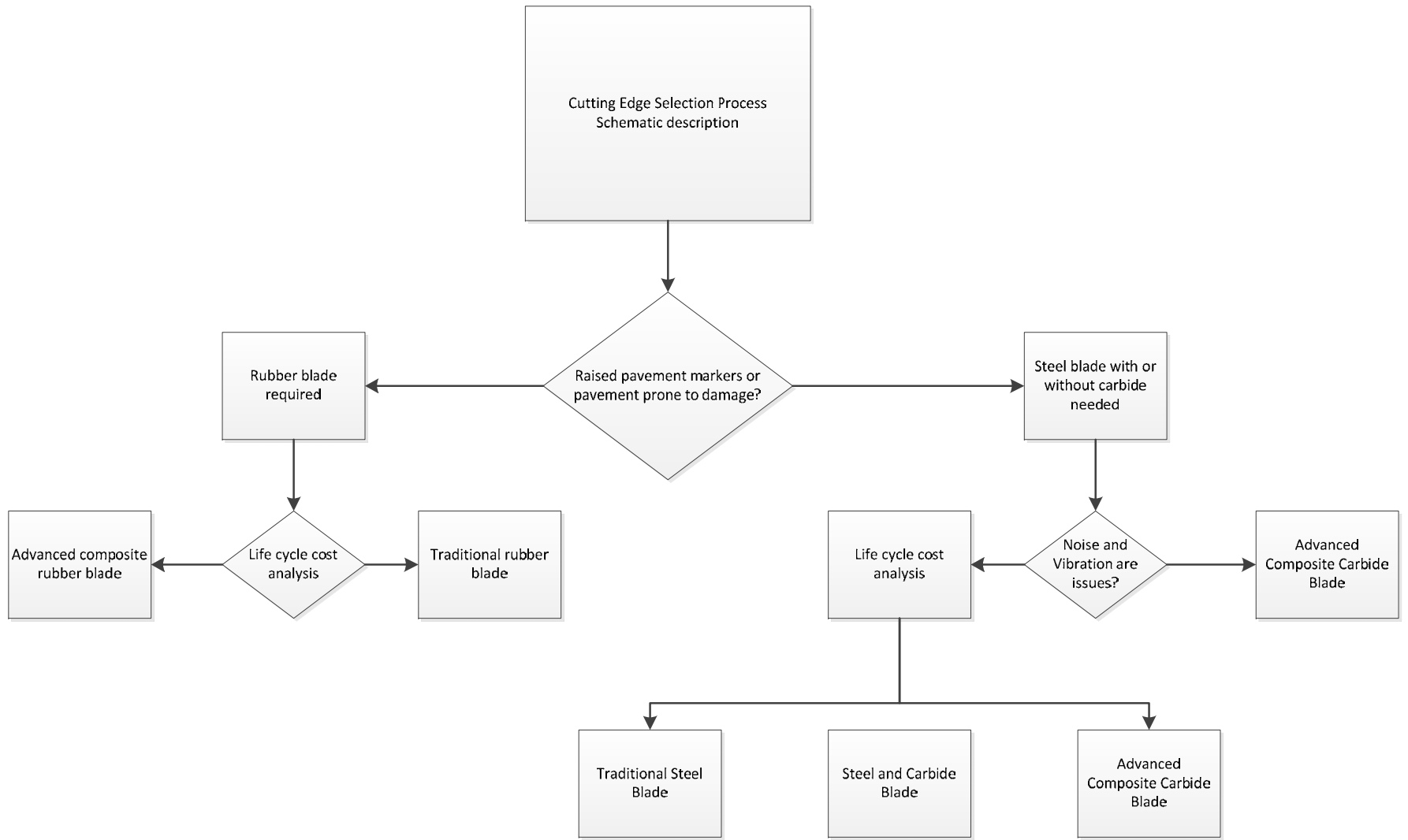
Part of the performance of a carbide insert in a cutting edge is directly related to the hardness of the insert, which means that a straightforward hardness test can be somewhat useful as a specification, and indeed many carbide inserts have a specified hardness range. However, hardness is not the same as wear resistance (although the two are related). A study in the 1990s suggested a scratch test as being a useful way of determining resistance to wear for a carbide insert (7) and more recently, the ClearRoads Consortium funded a project on carbide performance (8). This more recent work provided a framework by which a carbide insert could be accepted or rejected, but the authors noted:

However, the research identified that life expectancy is affected by many factors besides the performance of the carbide insert so it is not possible for tests to determine life expectancy under real plowing conditions.

This quote underlines the challenge of selecting a good plow blade cutting edge.

**TABLE 1 Factors to Consider in a Life-Cycle Cost Analysis for Cutting Edges**

Some Factors to Include in Life-Cycle Costing Analysis of Cutting Edges	
Overall life of cutting edge.	Replacement cost of cutting edge.
Time (and labor cost) to replace cutting edge.	Need for adjustment of edge between replacement.
Reduction in vehicle mileage with edge deployed.	Wear and tear on truck due to vibration.



**FIGURE 3 Schematic representation of the cutting edge selection process.**

## A TECHNIQUE FOR SELECTION

Determining which sort of cutting edge should be used for a given truck on a given route can be helped by a careful and logical consideration of the various factors that impact cutting edge performance. In this section, a step-by-step approach to aid in cutting edge selection is presented and discussed.

The first determination to be made is whether the type of pavement and of pavement markings will restrict the selection of cutting edges. If raised pavement markers are used, or if the pavement surface is particularly prone to being damaged by the plow, then a rubber blade of some sort should be used. Otherwise a steel blade or a carbide cutting edge can be used instead, primarily for longer life.

If a rubber blade is required, then the next step is to determine, by way of a life-cycle cost analysis, whether an advanced, composite rubber blade (which might, for example, include ceramic inserts within the rubber) is a cost-effective solution. If so, then that is the choice, otherwise a standard rubber blade is needed.

If the first decision point indicated that a steel or carbide insert blade would be suitable, two other questions arise. First, if vibration and noise are major concerns, then some sort of advanced composite construction in which the carbide insert is somehow cushioned from vibration (for example, by being sandwiched in rubber within the steel matrix) is needed. Second, if a life-cycle cost analysis is performed, then a choice can be made between a steel blade, a steel blade with inserts, and an advanced composite construction blade. This process is represented schematically in [Figure 3](#).

## CONCLUSIONS

Plowing snow from the roads is the most-effective method for returning the pavement to a safe driving condition during winter storms. Effective plowing requires a suitable cutting edge be used on the plow. The selection of the cutting edge must consider a number of factors. These factors include wear and shock resistance of the cutting edge, the nature of pavement markings on the roads being plowed, the nature of the pavement surfaces on those roads, issues with noise and vibration during plowing, and the life-cycle costs of the various cutting edge alternatives. A simple approach has been presented that allows agencies to choose what type of cutting edge will best meet the needs for a given road or plow route.

## REFERENCES

1. Nixon, W. A., Y. Wei, and A. E. Whelan. *IIHR Technical Report #388: Field Measurements of Ice Scraping Loads on Front Mounted Plow Blades*. Project HR374. Iowa Department of Transportation, October 1997.
2. Nixon, W. A., and T. R. Frisbie. *IIHR Technical Report #365: Field Measurements of Plow Loads During Ice Removal Operations*. Project HR334. Iowa Department of Transportation, November 1993.
3. Nixon, W. A. Improved Underbody Plowing. *Transportation Research Circular 447: Presentations from the 10th Equipment Management Workshop*, TRB, National Research Council, Washington, D.C., 1994, pp. 42–49.

4. Nixon, W. A., T. R. Frisbie, and C.-H. Chung. Field Testing of New Cutting Edges for Ice Removal from Pavements. In *Transportation Research Record 1387*, TRB, National Research Council, Washington, D.C., 1993, pp. 138–143.
5. Nixon, W. A. *IIHR Technical Report No. 423: Guidelines for Winter Maintenance on Thin Maintenance Overlays*, May 2002.
6. Veneziano, D., X. Shi, and L. Ballard. Development of a Toolkit for Cost-Benefit Analysis of Specific Winter Maintenance Practices, Equipment and Operations. Final report to ClearRoads Pooled Fund, November 2010.
7. Wei, Y. C., W. A. Nixon, and Z. Shi. Evaluation of Wear Resistance of Snow Plow Blade Cutting Edges Using the Scratch Test Method. *ASTM Journal of Testing and Evaluation*, Vol. 26, No. 6, 1998, pp. 527–531.
8. Kruse, C. G., and L. A. Kirchner. Development of Standardized Test Procedures for Carbide Insert Snowplow Blade Wear. Final report to ClearRoads Pooled Fund, August 2010.

## INNOVATIONS IN WINTER MAINTENANCE EQUIPMENT

**Synthesis and Best Practices for  
Performance Evaluation of Snow and Ice Plows****SOUHAIL ELHOUAR****ENAD MAHMOUD***Bradley University, Peoria, Illinois*

Removal of ice and snow from road surfaces is a critical task in the northern tier states of the United States, including Illinois. Highways with high levels of traffic are expected to be cleared of snow and ice quickly after each snowstorm. This is necessary for maintaining the safety of the public and the efficiency of the highway system. Earlier this year, the Illinois Department of Transportation (DOT) started a research project to conduct a comprehensive study to evaluate the performance of snow and ice plows. The project targets several plow performance indicators, including blade type, scraping forces, and shock acceleration. This paper will present the first part of the study in which a comprehensive literature review is conducted to summarize documented snow and ice plow performance evaluation measures. In addition to a traditional literature review through research reports and papers, the research team will conduct interviews with agency personnel, Illinois DOT engineers, and consultants actively involved in snow and ice plowing. The focus of these interviews is to collect information related to best practices and standards for plow and blade selection, installation, and maintenance. Based on the results of this review, the research team is to develop a performance evaluation procedure that would include the identification of controlling parameters for performance measures (e.g., scraping force, shock acceleration, plow design, plow angle, and speed), the development of an instrumentation plan for measuring scraping forces and shock accelerations on the plows, and the design of a test matrix for data collection. The authors will also present the experimental plan in which several plows and blades will be tested under actual snow and ice conditions using different angles, speeds, and plow designs. The testing will be conducted on Illinois Interstate highways and secondary roads during snowstorms of the 2011–2012 winter season.

## INNOVATIONS IN WINTER MAINTENANCE EQUIPMENT

## Benefits of Implementing Automatic Vehicle Location Technologies in Wisconsin for Winter Maintenance Operations

**KELVIN R. SANTIAGO-CHAPARRO**

**MADHAV CHITTURI**

**TODD SZYMKOWSKI**

**DAVID A. NOYCE**

*University of Wisconsin–Madison*

**Winter maintenance operations are a major expense for state departments of transportation (DOTs) located within the snow belt of North America. In the state of Wisconsin alone winter maintenance related expenses billed to the Wisconsin DOT by counties ranged from \$46 to \$87 million per year from 2005 through 2010, depending on the severity of the winter. During the past two winters the Wisconsin DOT implemented several technologies intended to optimize winter maintenance performance and costs. Among the technologies implemented was automatic vehicle location (AVL). AVL is a combination of systems capable of monitoring the location of a vehicle, material application rates, and road conditions from a central location. An evaluation of the AVL technology for winter maintenance operations is presented in this paper. The evaluation presented focuses on the reduction in salt usage by counties that implemented the AVL technology. Savings from increasing the efficiency of salt applications after the implementation of AVL resulted in benefit–cost ratio values that ranged from 1.05 to 1.89. Benefit–cost values were computed by considering only benefits from salt savings to create an evaluation as objective as possible, thus leaving room for an increase in the benefit–cost values if other intangible benefits are included.**

**W**eather during the winter season has a profound impact on the transportation system, and consequently on every aspect of modern society exposed to winter conditions. Snow and ice can reduce pavement friction and vehicle maneuverability, which in turn leads to slower speeds, decreased roadway capacity, and adverse effects on traffic safety. Average arterial speeds declining by 30% to 40% have been reported on snowy or slushy pavement conditions. Freeway speeds reductions of 3% to 13% in light snow and 5% to 40% in heavy snow have also been reported (1).

Winter weather factors that force motorists to operate at speeds below the intended design speed create frustration and delays. Furthermore, according to the FHWA, every year in the United States 24% of weather-related crashes occur on snowy, slushy, or icy pavement; 15% happen during snowfall or sleet, resulting in more than 1,300 people killed and more than 116,800 injured (1). In Wisconsin, winter weather-related crashes total approximately 6,000 per year (2, 3). Snow removal and ice control are therefore essential for the safety and mobility of highway users.

Safety and operational considerations are not the only concerns agencies have about winter maintenance. Monetary considerations are also important. About 20% of state departments of transportation (DOTs) maintenance budgets are spent on winter road maintenance, which translates into over \$2.3 billion spent annually on snow and ice control

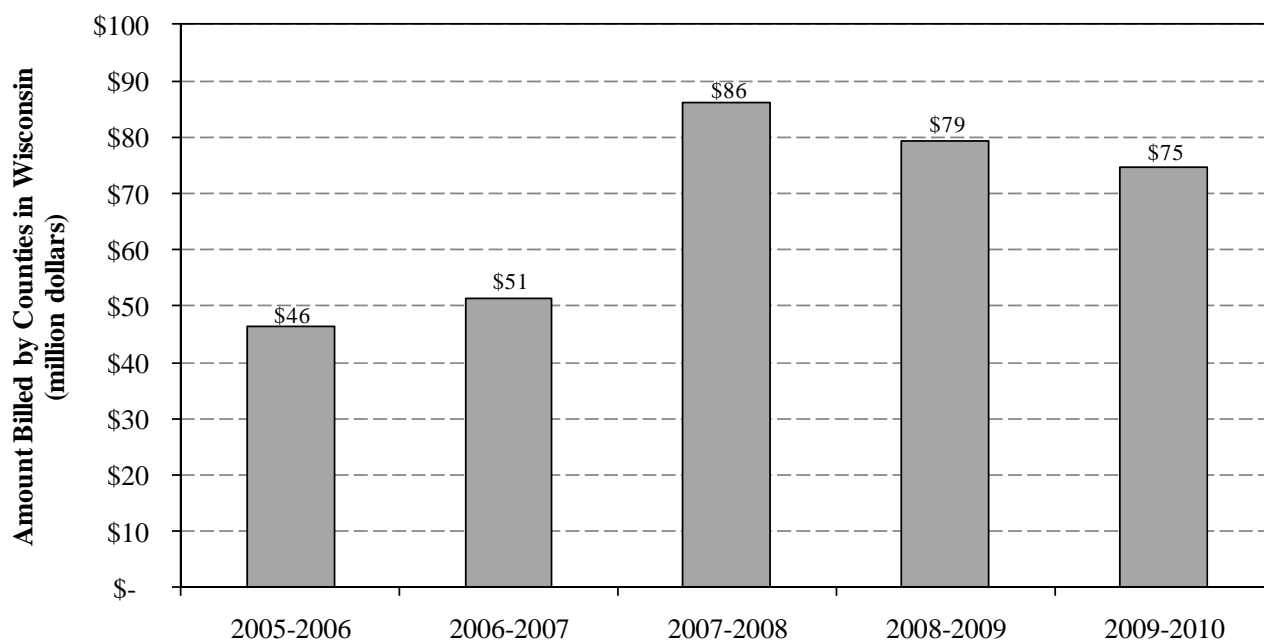


operations in the United States (1). As opposed to the maintenance practices followed by other states, the Wisconsin DOT contracts with the 72 county highway departments in the state to maintain state-owned highways. Total expenses billed by the counties to the Wisconsin DOT for winter maintenance operations ranged from \$46 to \$87 million during the 2005 through 2010 period as shown in Figure 1.

During the 2006–2007 winter season there was a significant increase in costs which motivated the Wisconsin DOT to implement new technologies for winter maintenance operations. During the 2009–2010 winter season Wisconsin DOT began implementing several new technologies to make winter maintenance operations more efficient and cost-effective. Among the technologies implemented were

1. TowPlow, which, as the name implies, is a plow towed by plow trucks that increases the total area plowed in a single pass.
2. Automatic vehicle location (AVL) for plow trucks that allows near-real time reporting of vehicle location, material use, road conditions, and actions taken by the plow operator during a maintenance operation.
3. A maintenance decision support system (MDSS) accounts for weather forecast, level of service, patrol cycle times, traffic volume, pavement type among other factors, and provides real-time treatment recommendations for winter maintenance.

This paper presents the results from an evaluation of the performance of AVL technology for plow trucks during the 2010–2011 winter season, as well as the cost and benefits associated with operating the technology.



**FIGURE 1** Costs billed by counties to the Wisconsin DOT for maintaining state-owned highways by winter season.

## AUTOMATIC VEHICLE LOCATION

AVL describes a group of technologies that when acting together enable tracking of the position of individual vehicles and, when equipped with appropriate sensors, monitor the actions and status of devices within the vehicle. For winter maintenance operations, when a plow truck is equipped with AVL technology, managers can monitor the locations of vehicles, material application rates, status of the plow, and other vehicle status indicators. Many states including Colorado, Kansas, Iowa, Maryland, Michigan, and Minnesota, and the Province of Ontario have implemented AVL technologies (4).

AVL has emerged as a technology capable of meeting the challenge of increasing productivity of winter maintenance operations along with quality and environmental stewardship while being able to maintain, and in some instances improve, the level of service of roads. Most of the literature available about the implementation of AVL technology portrays results of the implementation as favorable; furthermore, the technology appears to have matured over the years (5). There is no question about tangible benefits such as paperwork reduction and improved efficiency. However, there are many intangible benefits which if not considered and quantified properly can lead to benefit–cost evaluations inflated on the benefits or cost side of the equation. Some of the benefits that have been identified and suggested as a direct result of AVL system implementation include

- Safety improvements due to better road conditions,
- Optimization of maintenance routes,
- Better driver compliance with instructions,
- Increased accountability, and
- Faster response to incidents.

Safety-related benefits, such as expected reductions in crashes, are often the driving force behind inflated benefits. Another benefit, which has been documented in literature, includes reduced compensation costs due to the ability to monitor the position of vehicles in the past and ascertain whether claims by those seeking compensations were valid (6).

There are limited publications that present a benefit–cost evaluation of AVL implementation for winter maintenance operations. Kansas has completed the most comprehensive benefit–cost evaluation which predicts benefit–cost ratio values ranging from 2.6 to 24 depending on the aggressiveness of the implementation (7). Kansas evaluation included benefits of the implementation related to safety as well as administrative impact of the technology (7). Safety-related benefits were assumed to be a reduction of 5% in all winter storm-related crashes. Administrative benefits included a 25% reduction in total administrative costs. Evaluations by other states and countries have been limited but nevertheless the findings are reported and briefly discussed here. Colorado reported experiencing a reduction of 15% in treatment costs along with an increment in productivity of 12%. Michigan reported reductions in salt consumption, reduced removal costs, quicker response time, and reduced driver fatigue along with a reduction of approximately 3% to 4% in the miles of road, although the plow trucks were traveling through without actually treating the roads (5).

Based on previous research and considering the needs of the Wisconsin DOT the research team computed the effect that AVL implementation had on salt use and conducted a benefit–cost

evaluation considering only tangible benefits. Tangible benefits were the only cost savings considered in the evaluation in order to have an as-objective-as-possible evaluation.

## EFFECTS ON SALT USE

The research team developed a methodology to quantify possible salt savings (if any) from the implementation of AVL for winter maintenance operations: better accountability and plow operator compliance with treatment recommendations.

The methodology is based on comparison of salt use by two groups of counties (test group and control group) before and after the implementation of AVL. Although all the counties in Wisconsin had the MDSS software available during the 2010–2011 winter season, none of the counties reported following the MDSS recommendations. Therefore, change in salt use was entirely attributed to the AVL system.

The test group is composed of 13 counties (shown in [Figure 2a](#)) that significantly used the AVL technology during the 2010–2011 winter while the control group is composed of 38 counties (shown in [Figure 2b](#)) which had not implemented AVL during the 2011 winter. The remaining 21 counties (except Dane County) in Wisconsin partially implemented the technology and therefore were not considered part of the evaluation. Dane County had equipped its fleet with AVL in 2009 and was not included in either group. For both the groups included in the evaluation the before period corresponds to average salt use during the 2006, 2007, 2008, 2009, and 2010 winters and the after period corresponds to the salt use during the 2011 winter season.

Salt use by the counties is influenced by factors such as the severity of the storm events and the number of miles managed by the county, among others. To account for these two factors, salt use by counties was normalized by the severity index of the winter and the lane miles managed by the county using Equation 1, which is shown below:

$$N_U = \frac{T_S}{SI \times L_M} \quad (1)$$

where

$N_U$  = normalized salt use,  
 $T_S$  = total salt used (tons),  
 $SI$  = winter severity index (no units), and  
 $L_M$  = lane miles.

Normalized salt use values were obtained using Equation 1 for all the counties by querying the storm reports database provided by the Wisconsin DOT which included information such as winter severity index, lane miles managed by county, and salt used during each maintenance activity reported by a county. A graphical representation of the values obtained using the normalization procedure is shown in [Figure 3](#). The average normalized salt use value ( $N_U$ ) for the before period was computed for both the control group ( $\overline{N_U^C}$ ) and the test group ( $\overline{N_U^T}$ ). For the control and test groups the values reported by counties in 2011 were compared with the corresponding average values using a paired  $t$ -test and the results are shown in [Table 1](#). One of the goals of using a  $t$ -test to perform the comparison was to determine if the difference in normalized salt use between the 2011 numbers and the before period was significant for counties which implemented AVL as well as those which did

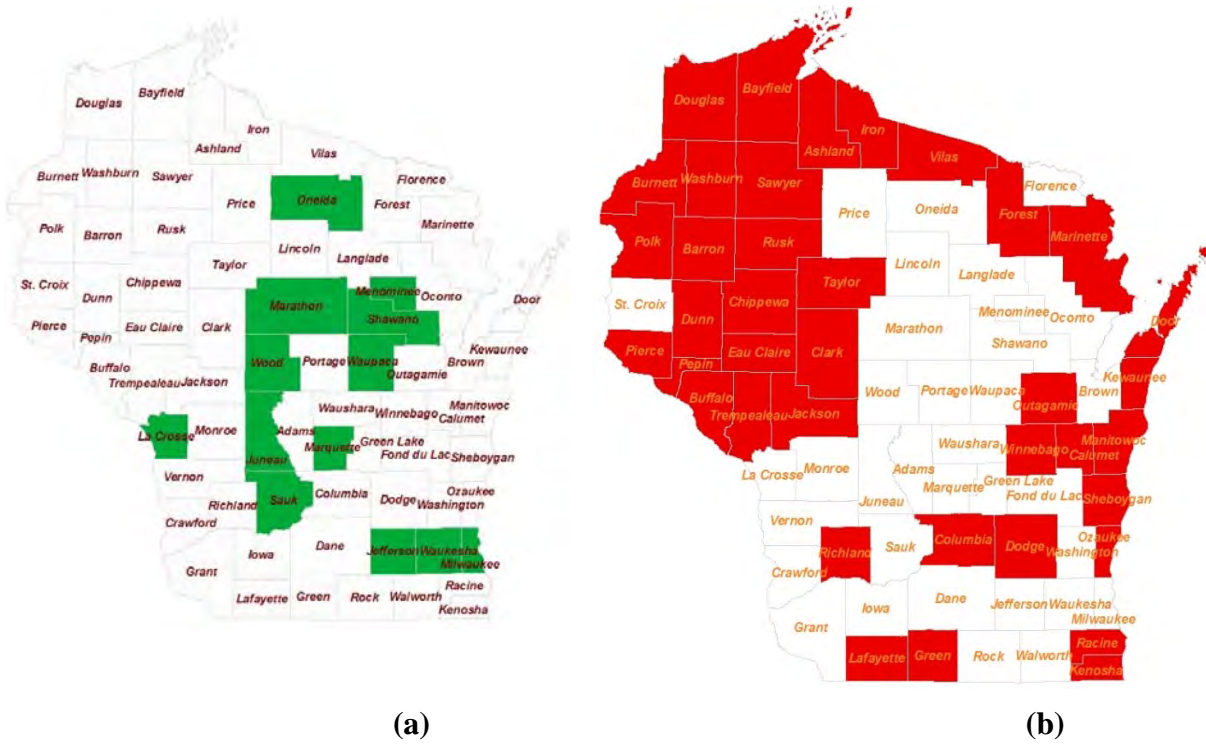


FIGURE 2 Groups of counties: (a) test group and (b) control group.

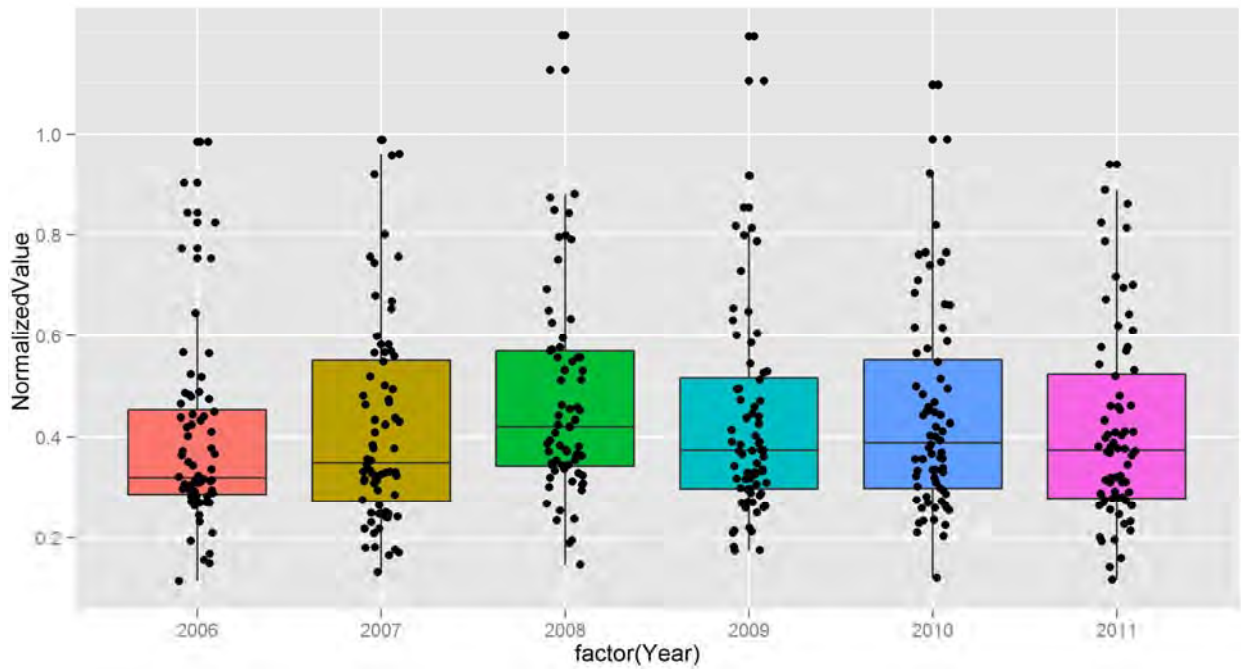


FIGURE 3 Normalized salt used value for the entire state.

**TABLE 1 Before and After Comparison**

Comparison Group	Mean Difference (After–Before)	<i>p</i> -Value	Finding
Without AVL	–2.7%	0.45	Not significant reduction
With AVL	–9.4%	0.07	Significant reduction

not implement AVL. For test purposes 90% confidence level (alpha value lesser than or equal to 0.10) was considered significant.

As Table 1 shows, the test group experienced a significant reduction of 9.4% ( $p = 0.07$ ) in the  $N_U$  value while the comparison group experienced a no significant reduction of 2.7% ( $p = 0.45$ ). In other words it can be concluded with 93% (1 to 0.07) confidence that test group of counties experienced a 9.4% reduction in normalized salt use. For the control group however, it can be concluded with 55% (1 to 0.45) confidence that normalized salt use reduced by 2.7%. A conservative interpretation of the results indicates the implementation of the AVL could have contributed to at least a 6% reduction in normalized salt use by counties. The approximate 6% reduction is obtained by subtracting the 2.7% reduction experienced by the control group from 9.4% reduction experienced by test group.

The salt savings that a county could experience due to a change in the  $N_U$  value can be computed using Equation 2. As shown in the equation 0% reduction in the  $N_U$  value returns no salt savings possible and 100% salt savings (i.e.,  $\Delta N_U = 1.0$ ) returns salt savings equal to the total average salt use by a county.

$$S_S = \Delta N_U \times \overline{SI}_B \times L_M \times \overline{N}_U^B \quad (2)$$

where

$\Delta N_U$  = change in the normalized salt use value,

$\overline{SI}_B$  = average severity index during the before period,

$L_M$  = lane miles, and

$\overline{N}_U^B$  = average  $N_U$  value during the before period.

Equation 2 shows the salt savings a county experiences given a reduction in the  $N_U$  value. In order to compute the total salt savings per year ( $T_S$ ) for the entire state Equation 3, shown below, was used. Equation 3 was applied under two different  $\Delta N_U$  values as show in [Table 2](#).

$$T_S = \sum_{i=1}^{72} \Delta N_U \times \overline{SI}_B \times L_M \times \overline{N}_U^B \quad (3)$$

**TABLE 2 Projected Salt Savings from AVL Implementation**

$\Delta N_U$	–6%	–9%
$T_S$ (tons)	16,742	25,113
Savings (\$60/ton)	\$1,025,132	\$1,537,698
Savings (\$65/ton)	\$1,110,560	\$1,665,840
Savings (\$70/ton)	\$1,195,988	\$1,793,981

As Table 2 shows, expected savings in salt converted to dollar figures, range from approximately \$1.0 million, assuming a 6% reduction in the normalized salt ( $N_U$ ) value and a cost of salt of \$60/ton, to approximately \$1.8 million assuming a 9% reduction in the normalized salt ( $N_U$ ) value and a cost of salt of \$70/ton.

## BENEFIT–COST ANALYSIS

At the basic level, a benefit–cost evaluation looks at the cost of implementing a system, the ongoing (annual) costs associated with the system, and the annual benefits obtained from the implementation through the expected life of the system. Costs and benefits are considered for the life cycle of the project and if the total benefits are greater than the total costs incurred, when properly adjusted for inflation, the benefit–cost ratio is greater than one. From a decision-making point of view, any value greater than one is justifiable, with larger values being desirable.

As previously mentioned, the main objective of the research team was to perform an evaluation that considered only tangible benefits, thus the decision to include only expected salt savings as the benefits. The authors recognize that such a conservative approach is one that certainly does not account for all the benefits previously identified as possible due to the AVL implementation and certainly does not consider all factors that have been identified in the literature (8). Annual costs considered as part of the evaluation were maintenance and communication costs associated with the technology are \$720,000 given that a total of 1,200 units were expected to be operational by the end of 2011 and assuming maintenance and communication costs of \$600 per year per unit. Implementation costs, which are expenses considered to take place at year zero totaled \$1,620,000 considering an installation cost of \$1,350 per unit. Installation costs used for the analyses are actual costs reported in Wisconsin and are consistent with what other states have reported (9).

Based on the cost and benefits discussed above and using a 2.5% discount rate (a value commonly used by the Wisconsin DOT) and 8 years for the life cycle the research team computed the benefit–cost for a range of scenarios which are shown in Table 3. Benefit–cost ratios ranged from 1.05 to 1.89 depending on the cost of salt and assumption for normalized salt usage reduction. As shown by the data, projected salt savings from the implementation of the AVL technology alone can pay for the cost and produce additional annual savings. Since the computed benefit–cost ratios are conservative by considering only benefit from savings in salt costs adding other intangible benefits reported in the literature will only increase the benefit–cost ratio further.

## CONCLUSIONS

AVL is one of the technologies implemented by the state of Wisconsin as a means to optimizing the efficiency and cost of winter maintenance operations. Savings in salt are expected due to better plow operator compliance and accountability. A before and after comparison of salt usage shows a statistically significant reduction in normalized salt use of approximately 9% for counties that implemented AVL versus a non-statistically significant reduction of approximately 3% for those counties which did not implement AVL. A conservative estimate of 6% (9% to 3%) reduction in normalized salt use can be attributed to AVL. Benefit–cost ratios computed for AVL

**TABLE 3 Range of Benefit–Cost Values**

$\Delta N_U$	–6%	–9%
Savings (\$60/ton)	1.05	1.57
Savings (\$65/ton)	1.15	1.73
Savings (\$70/ton)	1.26	1.89

range from 1.05 (6% salt use reduction, \$60/ton of salt) to 1.89 (9% salt use reduction, \$70/ton of salt) demonstrating the benefit of implementing AVL. The benefit–cost ratios reported are conservative because only savings in salt costs were considered as benefits. Accounting for other intangible benefits will increase the benefit–cost ratios further.

## REFERENCES

1. FHWA Road Weather Management. *Snow and Ice*. FHWA, U.S. Department of Transportation. [http://ops.fhwa.dot.gov/Weather/weather\\_events/snow\\_ice.htm](http://ops.fhwa.dot.gov/Weather/weather_events/snow_ice.htm). Accessed July 25, 2011.
2. Sproul, M., and M. Adams. Annual Winter Maintenance Report 2008–2009. Bureau of Highway Operations, Wisconsin Department of Transportation, Madison, November 2009.
3. Sproul, M., and M. Adams. Annual Winter Maintenance Report 2009–2010. Bureau of Highway Operations, Wisconsin Department of Transportation, Madison, November 2010.
4. Strong, C. K., N. El Ferradi, and X. Shi. *State of the Practice of Automatic Vehicle Location for Winter Maintenance Operations*. Presented at 86th Annual Meeting of the Transportation Research Board, Washington, D.C., 2007.
5. Veneziano, D., and C. Strong. Pilot Test of Automatic Vehicle Location on Snow Plows Technical Memorandum 2: Pre-Pilot Test Results. Western Transportation Institute, Helena, Mont., July 2007.
6. Racca, D. Costs and Benefits of Advanced Public Transportation Systems at Dart First State. Delaware Center for Transportation, Newark, July 2004.
7. Meyer, E. Benefit–Cost Assessment of Automatic Vehicle Location in Highway Maintenance. Presented at the 2003 Mid-Continent Transportation Research Symposium, Ames, Iowa, 2003.
8. Veneziano, D., L. Fay, Z. Ye, D. Williams, X. Shi, and L. Ballard. Development of a Toolkit for Cost–Benefit Analysis of Specific Winter Maintenance Practices, Equipment and Operations: Final Report. WisDOT 0092-09-08. Western Transportation Institute, Bozeman, Mont., November 2010.
9. Ryynanen, J. High-Tech Winter Maintenance Management. The Bridge, Local Technical Assistance Program. MichiganTech Transportation Institute, May 2009.

# **Weather Information to Improve Driver Decisions**





## WEATHER INFORMATION TO IMPROVE DRIVER DECISIONS

## Subjective and Objective Assessment of Winter Driving Environment

NAOTO TAKAHASHI

TETSUYA TAKADA

MAKOTO KIRIISHI

ROBERTO A. TOKUNAGA

*Civil Engineering Research Institute for Cold Region, Japan*

SHIGERU KAMIYAMA

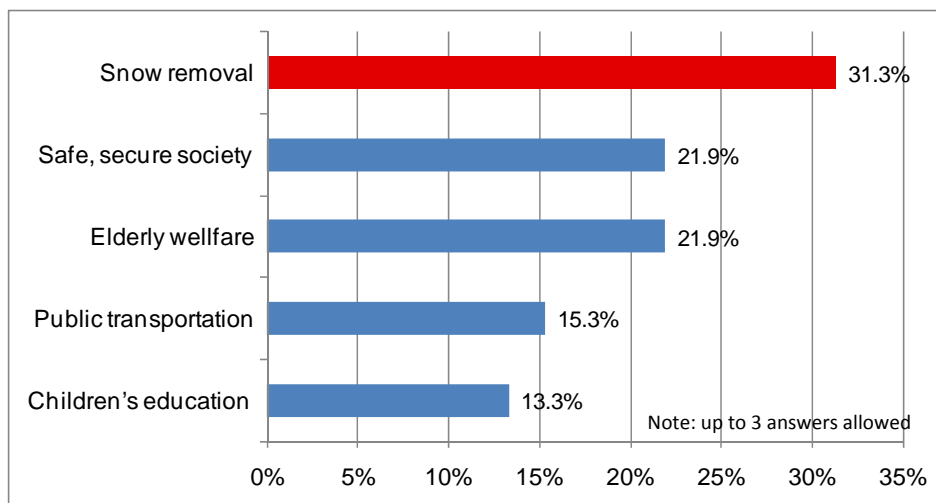
*Hokkaido Regional Development Bureau, Japan*

The deterioration of driving environments in cold, snowy regions during winter causes unfavorable traffic characteristics such as reduced travel speeds, winter-type traffic accidents, and lower user satisfaction. Road administrators work to maintain a safe, smooth flow of road traffic in winter by carrying out road maintenance. However, under the constraints of the current financial crisis, there is a need for further improvements in the appropriateness and efficiency of winter road maintenance. To achieve this, it is important to understand how the deterioration of road conditions affects user satisfaction and driving behavior. In this study, the authors sought to evaluate winter driving environments by simultaneously carrying out evaluation of road conditions, a user satisfaction survey, and a driving behavior test both in autumn and in winter. The test results indicated a tendency for driving speeds and acceleration rates to decrease in winter. However, it remained unclear whether these changes in driving behavior were caused by the deterioration of road surfaces or by the narrowing of roads due to the presence of piled snow. Meanwhile, results corresponding to the characteristics of changes in road conditions were attained in the user satisfaction survey, confirming the effectiveness of subjective assessment.

The Japanese archipelago is situated between the latitudes of 20 and 45 degrees north. Even though the islands are farther south than the majority of the world's cold, snowy countries, most of Japan's regions are affected by snow in winter. Hokkaido, the northernmost major island of Japan, is particularly cold and snowy. Many municipalities of Hokkaido experience sub-zero average temperatures from December to March, and the average annual period of snow cover exceeds 100 days. Hokkaido's capital city of Sapporo, located at the latitude of 43 degrees north has a population of approximately 1.9 million (1). The annual snowfall total there is approximately 6 m, and the maximum snow depth reaches up to 1 m.

Winter road maintenance is an indispensable part of supporting economic activity and everyday life in cold, snowy regions. Indeed, Sapporo's municipal government allocates about 11 billion yen per year to road snow removal (2). However, despite the best efforts of road administrators, the deterioration of driving environment induces unfavorable traffic characteristics such as reduced travel speeds, winter-type traffic accidents, and lower user satisfaction.

According to polls conducted by the Sapporo municipal government, snow removal ranks first in terms of measures and policies considered to need improvement (3) (Figure 1). In order to



**FIGURE 1 Measures and policies considered as needing improvement.**

enhance resident satisfaction under the constraints of the current financial crisis, there is a need to seek further improvements in the appropriateness and efficiency of winter road maintenance. To achieve this, it is important to understand how the deterioration of road conditions affects driving behavior and user satisfaction.

## LITERATURE REVIEW

A considerable amount of research on the deterioration of driving environment in winter and impact evaluation of traffic characteristics induced by such deterioration has been conducted. Evaluation of changes in winter driving environment has mainly focused on the state of pavement surfaces. One method of determining this state is to evaluate road surface friction. In the 1940s, airport authorities started monitoring surface friction to ensure that airport runways are clear of ice and free from slippery conditions (4). Nowadays, there is a growing trend toward the use of friction measurement to set standards for winter road maintenance (5). However, few studies have examined changes in road width in winter (6) and none has considered both road surface friction and road width simultaneously.

A common way of evaluating the impact of driving environment changes during winter is to observe traffic flow, weather conditions, and road conditions. Maeki (7) carried out a survey on how weather and road conditions affect driving speeds by considering factors such as wet or dry road surface conditions and the presence of ice or snow on road shoulders. The results showed that ice and snow on shoulders do not affect speed if the highway is dry, and that the presence of a layer of ice on the road reduces speed remarkably. Hanbali (8) demonstrated that snow causes a substantial reduction in traffic volume ranging from 7% to 56%. Takahashi et al. (9) used taxis operating around Sapporo with Global Positioning System units installed to analyze travel speeds throughout the year, and conducted multiple linear regression analysis to explore the effects of individual weather factors on declining travel speeds in winter. Although these methods serve to clarify the relationships between road conditions and traffic

characteristics, they cannot elucidate changes in driving behavior and individual levels of user satisfaction.

In studies focusing on individual drivers, research methods involving the evaluation of driving behavior have been employed. For instance, Tokunaga et al. (10) examined how different winter road surface management levels affect road surface friction number and driving behavior, and identified a certain relationship between friction number and acceleration. Park et al. (11) quantified the impact of icy roadway conditions on drivers' car-following behavior. However, these studies evaluated driving behavior with exclusive focus on the state of road surfaces in winter road conditions.

Many municipal governments and road agencies regularly carry out satisfaction surveys on winter roads (3, 12), and a variety of studies have been conducted to clarify the targets of user focus by applying analytic hierarchy process (13), conjoint analysis (14), and other techniques. Although subjective evaluation can verify adequacy and reliability by producing quantitative data, no research has so far involved a satisfaction survey combined with quantitative observation of winter road conditions and driving behavior.

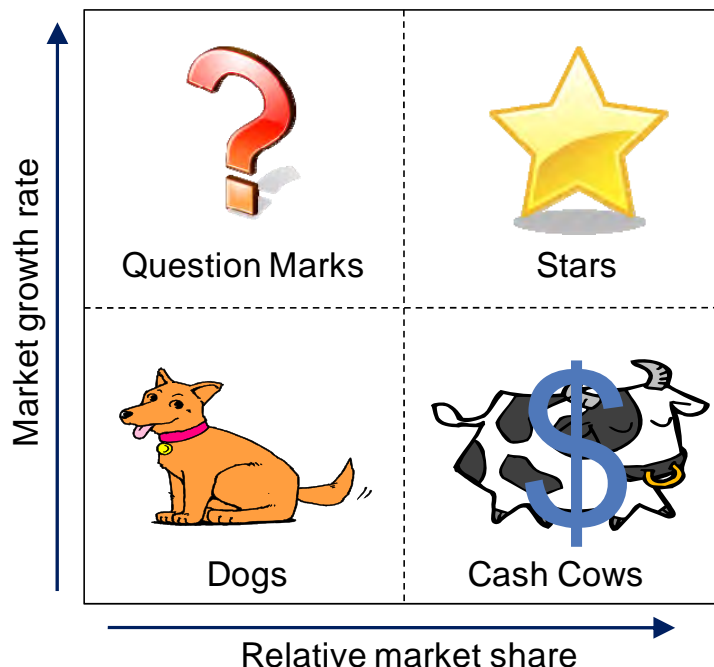
## STUDY METHOD

### Evaluation Tests and Terminology

In this research, road conditions were evaluated to determine how changes in autumn and winter driving environments affect driving behavior and driver satisfaction. Simultaneously, a user satisfaction survey and a driving behavior test were conducted. In the evaluation of winter road conditions, the dimensions of snow piles on road shoulders and friction number were measured. Additionally, to enable the simultaneous performance of the driving behavior test and the user satisfaction survey, the driving tests were conducted using a test vehicle equipped with observation instruments.

Customer satisfaction (CS) portfolio analysis was applied for the user satisfaction survey. This analysis technique is based on the product portfolio method proposed by Boston Consulting Group (BCG) and uses a scatter chart to rank business units (or products) on the basis of their relative market share and market growth rate (Figure 2). The BCG matrix is divided into the four categories of Stars, Cash Cows, Question Marks, and Dogs. Stars are high-growth businesses or products competing in markets where they are relatively strong compared with the competition. Cash Cows are low-growth businesses or products with a relatively high market share. Question Marks are businesses or products that have a low market share but operate in higher-growth markets. Finally, Dogs are businesses or products that have a low relative share in unattractive, low-growth markets.

Instead of employing the market growth rate and the relative market share, CS portfolio analysis uses a scatter chart based on user satisfaction and expectation (Figure 3). This approach has been widely used in the field of marketing and is designed to clarify user needs. In the field of civil engineering, the technique has been applied for purposes such as contributing to the improvement of safety at road works sites (15). Under this approach, to quantify satisfaction with the current situation, for example, scores on a five-point scale are totaled and averaged. Also, the degree to which each improvement influences overall satisfaction is used as an explanatory variable for multiple linear regression analysis. A partial correlation coefficient is obtained for each sub-item.



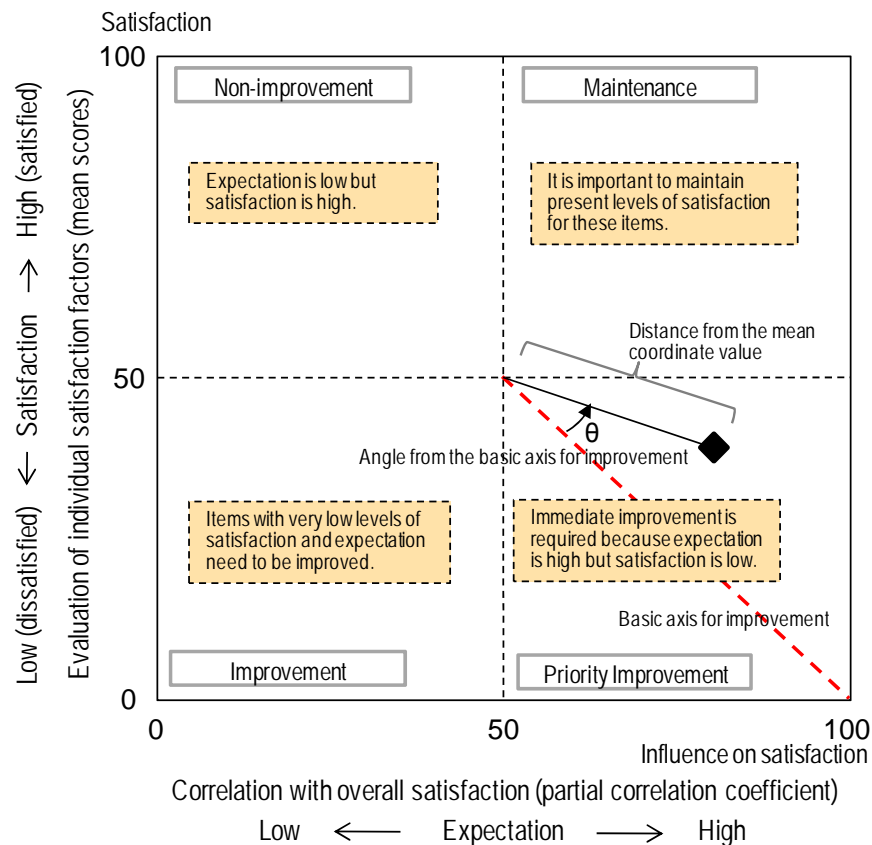
**FIGURE 2 The BCG matrix.**

The scatter chart is divided into the four quadrants of maintenance, non-improvement, improvement, and priority improvement. The maintenance quadrant contains items characterized by high levels of satisfaction and expectation, meaning that the current level of satisfaction must be maintained. The non-improvement quadrant contains items for which users' expectation is low and their satisfaction level is high, meaning that no improvement is required. The improvement quadrant contains items characterized by low levels of satisfaction and expectation, meaning that improvement is required. The priority improvement quadrant contains items that are regarded as important by users but do not satisfy their expectations, meaning that immediate improvement in related levels of service is necessary. The first step in effective enhancement of overall satisfaction is the improvement of items in this quadrant.

Next, we explain how improvement priority is determined. To deal with this consideration, improvement necessity factor (INF) is introduced in relation to both satisfaction and expectation. A line drawn from the coordinates of the mean value (50, 50) to the coordinates (100, 0) where the influence on satisfaction is the greatest and the satisfaction level is the lowest can be used as a basic axis to determine INF values. Then, the distance between the coordinates (50, 50) and the coordinates of each item, and the angle between the basic axis and the line connecting the coordinates (50, 50) with the coordinates of each item is used to calculate the INF (Equation 1). Improvement of items whose INF values are relatively large is the most effective approach for enhancing overall satisfaction.

INF = Modified exponent  $\times$  Distance from coordinates (50, 50)

$$= \left( \frac{90^\circ - \text{angle from boundary line}}{90} \right) \times \sqrt{(x - \bar{x})^2 + (y - \bar{y})^2}, \quad (\bar{x}, \bar{y}) = (50, 50) \quad (1)$$



**FIGURE 3 CS portfolio analysis based on the user satisfaction survey.**

## Driving Test

The driving test was conducted in the autumn of 2009 and the winter of 2010 to clarify changes in satisfaction related to the deterioration of driving environment. The road used was National Highway Route 230, and the two test sections were in a downtown area and a suburban area (Figure 4). Ten licensed nonprofessional drivers in their 30s and 40s were chosen as test subjects. All of them drove on a daily basis, and their annual driving distances ranged from 10,000 to 20,000 km. The tests in both seasons were carried out with the same subjects.

A typical sedan-type car with a 1,500 cc engine and front-wheel drive was used as the test vehicle. As elements of driving behavior, driving speed and longitudinal acceleration were measured at intervals of one second. The satisfaction survey was carried out immediately after the test so that drivers could record their impressions while they were still fresh.

In the satisfaction survey, the test subjects were asked to indicate their levels of satisfaction with the following considerations:

- Overall satisfaction,
- Road surface condition,
- Traffic flow,
- Road surface flatness,



**FIGURE 4 Case study route map.**

- Road width,
- Sight distance, and
- Intersections (starting and stopping).

The subjects were asked to gauge their levels of satisfaction on a five-point scale: 1 = dissatisfied, 2 = somewhat dissatisfied, 3 = neither satisfied nor dissatisfied, 4 = somewhat satisfied, and 5 = satisfied.

### Evaluation of Road Conditions

In order to assess the impact of changes in road conditions such as snow accumulation and icy road surfaces, the dimensions of snow piles on road shoulders and road surface friction were measured at the time of the driving test. The height and width of snow piles were measured using photos taken from the sidewalk so as not to interfere with traffic flow.

Road surface friction was measured using a continuous friction tester (CFT), which consists of a measuring wheel fixed to a frame towed by a vehicle (Figure 5). The measuring wheel is offset by 1 to 2 degrees from the vehicle's direction of travel to produce a lateral force that can be measured to indicate the level of road surface friction. CFT enables continuous measurement of road surface friction without braking or otherwise manipulating the measuring wheel.

Friction number measured using CFT is called Halliday friction number (HFN), which is originally determined by the device's designer. HFN scale usually ranges from 0 (no lateral force) to 100 (the lateral force on a dry road surface at  $-17.8^{\circ}\text{C}$ ).



**FIGURE 5 CFT.**

## STUDY RESULTS

### Road Conditions

The road conditions seen on the test days are shown in [Figure 6](#). Visual evaluation of road surface conditions indicated that the road surface was dry in autumn (the snow-free season), while in winter (the snowy season) there was a combination of icy, slushy, and wet surfaces in the downtown area and icy or compacted snow-covered surfaces in the suburban area.

Measurement result of the dimensions of snow piles on road shoulders showed that they were 1.1 to 1.3 m in height and narrowed the road by 1.25 to 1.45 m (1.35 m on average) in the downtown area during winter ([Figure 7](#)). This indicates that the road width was, on average, 79% of the 6.50-m value seen in autumn. In the suburban area, narrowing of roads due to snow piles was seen only on bridges.

[Figure 8](#) shows road surface conditions (HFN values) on the test dates. In autumn, the averages were as high as 93 in the downtown area and 101 in the suburban area. Meanwhile, in winter, these HFN values fell to 64 in the downtown area and 47 in the suburban area, where the road surface was particularly slippery.

### Driving Behavior

The driving speeds of the test vehicle are shown in [Figure 9a](#). The minimum speed of 0 km/h indicates stoppage at signals or other traffic signs. Compared with autumn driving speeds, the maximum values for winter were 9.6 and 6.9 km/h lower, and the average speeds were 5.8 and 7.7 km/h lower in the downtown and suburban areas, respectively. The average driving speeds in winter were 78% and 85% of those in autumn in the downtown and suburban areas, respectively.

[Figure 9b](#) illustrates the longitudinal acceleration of the test vehicle. The absolute value of acceleration was small in winter for both the downtown and the suburban areas, and the figure





	Date	Weather	Air temperature (°C)		
			Lowest	Highest	Average
Autumn	Nov. 26, 2009	Cloudy	2.9	5.8	4.1
Winter	Jan. 15, 2010	Mostly sunny	-8.7	-3.8	-6.5

FIGURE 6 Road conditions and weather conditions on the test days.

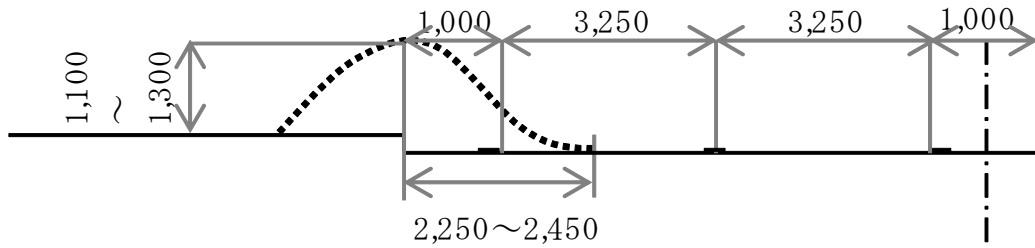


FIGURE 7 Dimensions of snow piles in the downtown area.

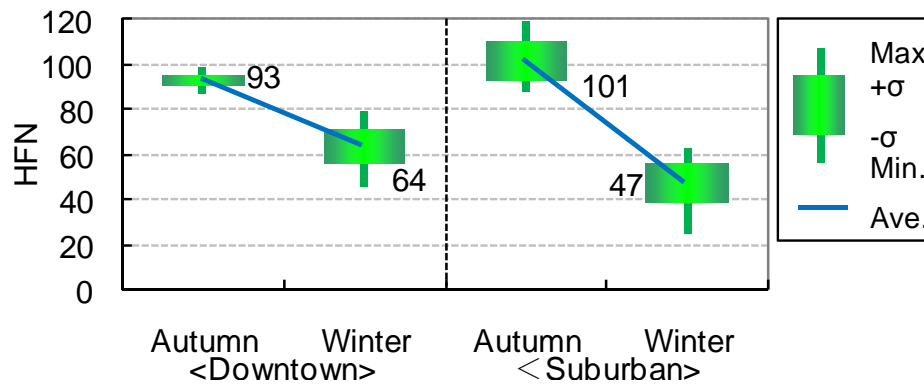
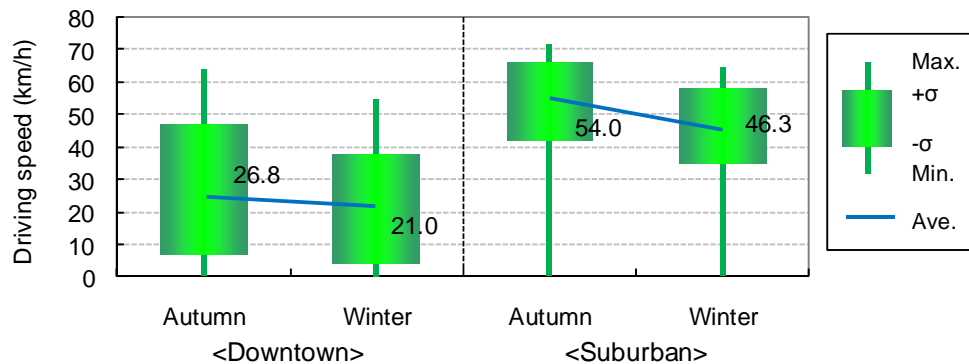
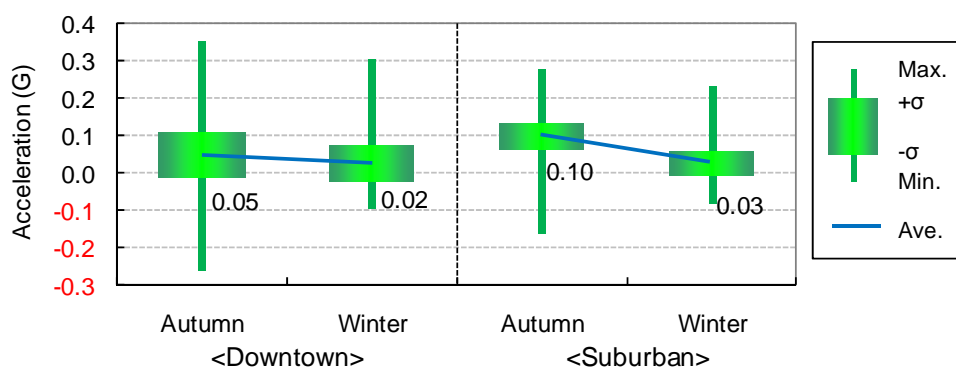


FIGURE 8 Road surface conditions (HFN values).



(a)



(b)

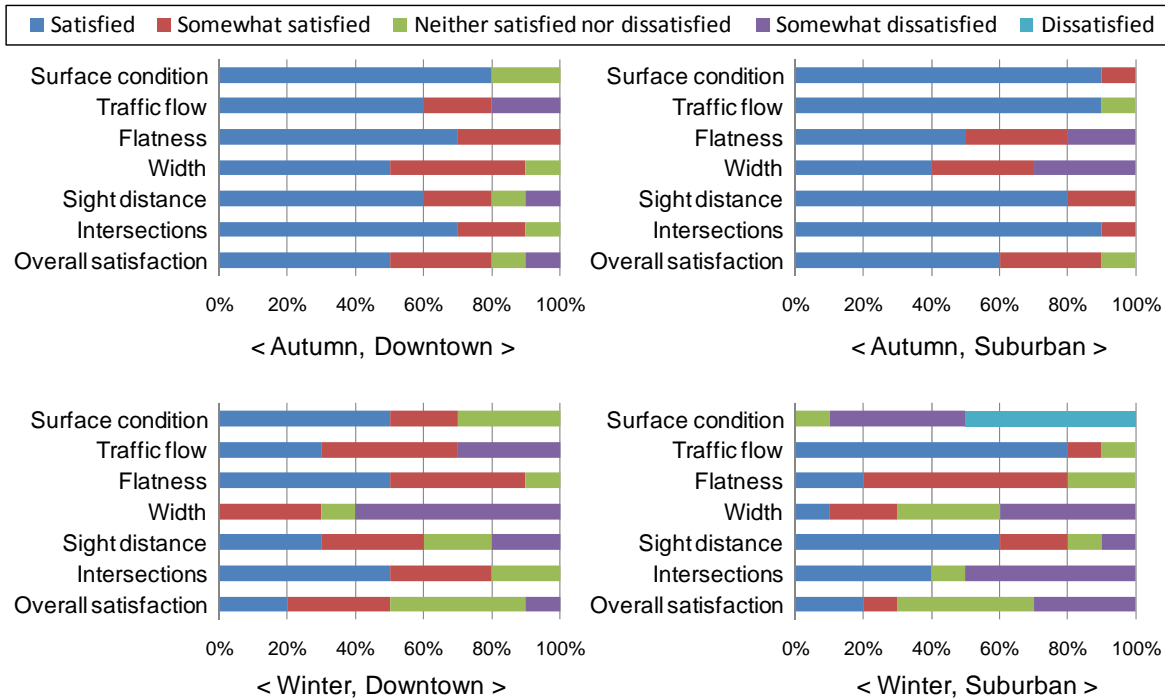
**FIGURE 9 Driving behavior: (a) driving speeds and (b) longitudinal acceleration.**

for negative acceleration was especially notable. It was confirmed that drivers accelerated and braked more carefully and paid more attention while braking, in winter than in autumn.

### Driver Satisfaction

Figure 10 shows the results of the survey on overall driver satisfaction and the six factors affecting it in autumn and winter. Although some drivers gave low evaluations for traffic flow, sight distance and overall satisfaction for autumn in the downtown area, over 80% said they were satisfied or somewhat satisfied. In autumn, some drivers in the suburban area responded that they were somewhat dissatisfied with road flatness and width, but over 90% indicated that they were satisfied or somewhat satisfied in the categories of surface condition, traffic flow, intersections, and overall satisfaction.

For the winter test in the downtown area, the percentage of drivers indicating that they were satisfied or somewhat satisfied in the category of overall satisfaction fell to 50%. No subjects responded that they were dissatisfied for any of the categories, but 50% said they were somewhat dissatisfied with road width. This is considered to stem from the reduction in road width caused by snow piles. In regard to road conditions, flatness and intersections, no respondents chose the options of somewhat dissatisfied or dissatisfied. It can therefore be inferred that the snow piles on road shoulders were not large enough to cause driver



**FIGURE 10 Satisfaction survey results.**

dissatisfaction with road conditions. In winter, satisfaction with road conditions in the suburban area decreased: 30% of respondents said they were satisfied or somewhat satisfied in the category of overall satisfaction. Surface condition received especially low ratings, with 50% of subjects saying they were dissatisfied and no subjects choosing the options of satisfied or somewhat satisfied. This is considered to be a result of slippery road surface, as the average friction number for the suburban area was as low as 47.

The CS satisfaction analysis results and calculated INF values for the downtown area are shown in Figure 11 and those for the suburban area are shown in Figure 12. The levels of satisfaction and expectation were normalized and plotted in graph form.

For autumn road conditions in the downtown area, traffic flow and sight distance are located in the priority improvement quadrant. Low travel speed in the downtown area is considered to have resulted in low satisfaction with traffic flow. In winter, however, width, traffic flow and sight distance appear in the priority improvement quadrant. It can be inferred from the evaluation of road conditions that satisfaction with traffic flow decreased due to lower sight distance and a driving speed equivalent to just 78% of that in autumn as a result of the effective road width being reduced by snow piles on road shoulders, considered to have resulted in low satisfaction with traffic flow. In winter, however, width, traffic flow and sight distance appear in the priority improvement quadrant. It can be inferred from the evaluation of road conditions that satisfaction with traffic flow decreased due to lower sight distance and a driving speed equivalent to just 78% of that in autumn as a result of the effective road width being reduced by snow piles on road shoulders.

For autumn road conditions in the suburban area, width was in the priority improvement quadrant. Low satisfaction with width is considered to result from reduced road width in tunnels

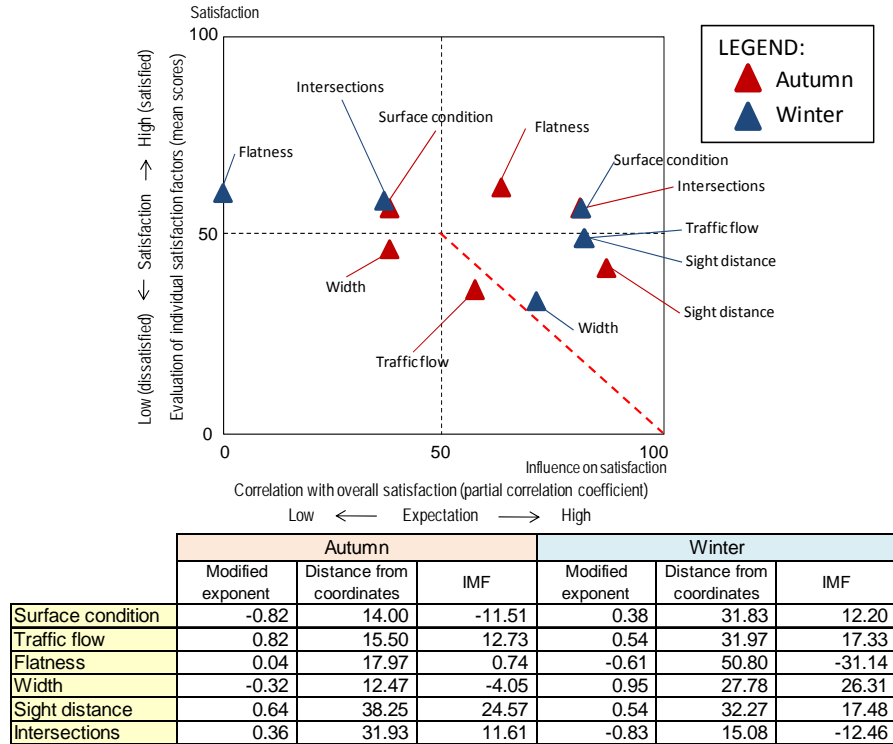


FIGURE 11 CS portfolio analysis results (downtown).

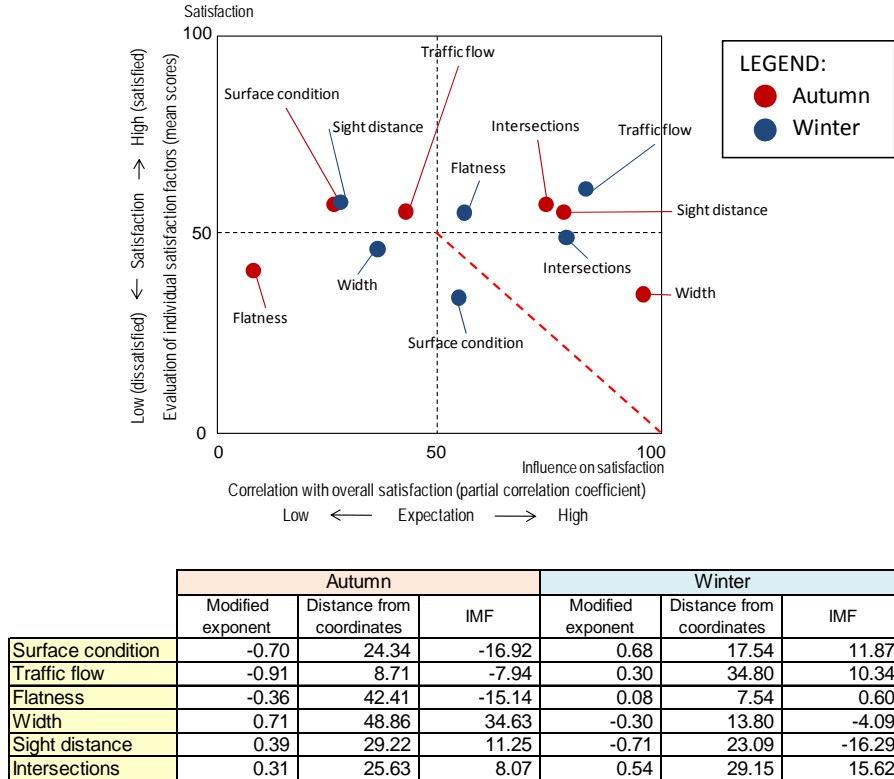


FIGURE 12 CS portfolio analysis results (suburban).

and on bridges, which is a problem with road configuration in suburban areas. In winter, surface condition and intersections were in the priority improvement quadrant. It can be inferred from the evaluation of road conditions that reduced satisfaction with these considerations was caused by low friction number. In contrast to the results for the downtown area, traffic flow was not included in this quadrant. This is considered to be because the decrease in driving speed was not as great as that in the downtown area.

Table 1 shows changes in the effects of varying winter driving environments on driving behavior and satisfaction, and also presents decrease rates (DR) for road conditions and driving behavior. To determine which improvement items need to be prioritized in relation to winter driving environment, differences in the INF between winter and autumn were established. For the downtown area, the INF difference was the greatest for width at 30.4, followed by the value for surface condition at 23.7. Although the DR for the HFN was greater than that for width, the INF difference for width was the greatest from the viewpoint of driver satisfaction. For the suburban area, the HFN showed a decrease of 53%, and the INF difference for road condition was the greatest.

## CONCLUSIONS

In this study, road conditions were evaluated and driving tests were conducted with the participation of subjects in autumn and winter to clarify how changes in winter driving environments affect driving behavior and road user satisfaction. For road condition evaluation, road surface slipperiness was determined by using CFT, and the dimensions of snow piles on road shoulders were measured to assess the changes in winter road conditions quantitatively. In the driving tests, winter driving environments were assessed based on changes in driving behavior and driver satisfaction. To examine changes in driving behavior, impacts on driving speed and acceleration in winter were clarified. However, the extent to which changes in winter driving environment affect driving behavior has not yet been elucidated by the driving tests.

In regard to changes in levels of driver satisfaction, CS portfolio analysis was performed to identify driving environments that required improvement in autumn and winter to enhance road user satisfaction. Calculation of the INF value for individual variables in autumn and winter to clarify inter-seasonal differences allowed quantitative assessment enabling the identification of winter driving environment that should be prioritized for improvement. Compared with the road condition evaluation results, the INF value was high for width in the downtown area, where there was a remarkable reduction in the effective road width, and was also high for surface condition in the suburban area, where there was a notable decrease in the road surface friction

**TABLE 1 Changes in Road Conditions, Driving Behavior, and INF in Autumn and Winter**

	Road Condition DR		Driving Behavior DR		Difference in INF					
	Width	HFN	Driving speed	Acceleration	Surface condition	Traffic flow	Flatness	Width	Sight distance	Intersections
Downtown	21%	31%	22%	60%	23.7	4.6	-31.9	30.4	-7.1	-24.1
Suburban	0%	53%	14%	70%	28.8	18.3	15.7	-38.7	-27.5	7.5

number. In this regard, subjective evaluation can be considered as an effective tool for the assessment of driving environment and the identification of factors for improvement.

Road user satisfaction with driving environment is considered to be affected by drivers' experience and their level of familiarity with the road in question. In this study, driving tests were conducted using subjects with similar characteristics in terms of age, driving experience, driving frequency and annual mileage. In this regard, there is a need to evaluate road conditions and driving behavior and conduct CS surveys involving subjects with a wider range of driving backgrounds in a variety of road environments. It is expected that this will provide a clearer understanding of how the changes in driving environment affect driving behavior and user satisfaction.

## REFERENCES

1. City of Sapporo. Population statistics. <http://www.city.sapporo.jp/toukei/jinko/jinko.html>.
2. City of Sapporo. Budget for snow and ice control measures. <http://www.city.sapporo.jp/kensetsu/yuki/jigyoubudget.html>.
3. City of Sapporo. FY 2010 municipal opinion poll results. [http://www.city.sapporo.jp/somu/shiminnokoe/sakusei/h22yoron\\_aramashi.html](http://www.city.sapporo.jp/somu/shiminnokoe/sakusei/h22yoron_aramashi.html).
4. Al-Qadi, I., A. Loulizi, G. Flintsch, D. Roosevelt, R. Decker, J. C. Wambold, and W. Nixon. Feasibility of Using Friction Indicators to Improve Winter Maintenance Operations and Mobility. *NCHRP Web Document 53*, Transportation Research Board of the National Academies, Washington, D.C., 2002.
5. Winter Maintenance Performance Measurement Using Friction Testing. Transportation Association of Canada, 2008.
6. Akimoto, S., M. Funahashi, R. Tokunaga, and M. Asano. A Study on Measurement of Traffic Flow in Winter with the Use of Image Possessing Apparatus. *Proc., Annual Conference of the Japan Society of Civil Engineers*, 2005.
7. Maeki, S. Effect of Weather and Road Conditions on Speeds. 1972.
8. Hanbali, R. M. Economic Impact of Winter Road Maintenance on Road Users. In *Transportation Research Record 1442*, TRB, National Research Council, Washington, D.C., 1994, pp. 151–161.
9. Takahashi, N., S. Miyamoto, and M. Asano. Using Taxi GPS to Gather High-Quality Traffic Data for Winter Road Management Evaluation in Sapporo. In *Transportation Research Circular E-C063: Sixth International Symposium on Snow Removal and Ice Control Technology*, Transportation Research Board of the National Academies, Washington, D.C., 2004, pp. 455–469.
10. Tokunaga, R., T. Hagiwara, Y. Onodera, A. Takahashi, and T. Matsunaga. Driving Behavior on the Winter Road Surface in Sapporo City. *Proc., 11th PIARC International Winter Road Congress*, 2002.
11. Park, S., H. Rakha, R. Alfelor, C. Y. D. Yang, and D. Krechmer. Empirical Study of Impact of Icy Roadway Surface Condition on Driver Car-Following Behavior. In *Transportation Research Record: Journal of the Transportation Research Board, No. 2260*, Transportation Research Board of the National Academies, Washington, D.C., 2011, pp. 140–151.
12. Pakkala, P., J. Olander, A. Johansson, and E. Lodenius. Sweden's "The Road to Excellence" International Benchmarking Study of Customer Satisfaction for Winter Services and Pavements. Presented at 90th Annual Meeting of the Transportation Research Board, Washington, D.C., 2011.
13. Miyakoshi, K., K. Kobayashi, and S. Matsumoto. Quantitative Evaluation of Walking Environment in Winter for the Snowy Region. *Journal of Infrastructure Planning*, Vol. 12, 1995, pp. 271–276.
14. Tokunaga, R., N. Takahashi, and M. Asano. Conjoint Approach as Customer-Based Measurement for Winter Walkway Maintenance in the Snowiest City of Japan. In *Transportation Research Circular E-*

- C063: Sixth International Symposium on Snow Removal and Ice Control Technology*, Transportation Research Board of the National Academies, Washington, D.C., 2004, pp. 237–247.
15. Hirasawa, M., A. Takemoto, M. Asano, and T. Takada. Study on Improving Worker Safety at Roadway Sites in Japan. In *Transportation Research Record: Journal of the Transportation Research Board, No. 2015*, Transportation Research Board of the National Academies, Washington, D.C., 2007, pp. 41–54.
  16. Tilley, J. S., S. S. Kroeber, J. Green, D. Clonch, and D. Halliday. Measurements of Pavement Condition and Road Weather Environment Within North Dakota Using a Tow-Hitch Mount Road Grip Tester. In *Transportation Research Circular E-C126: Surface Transportation Weather and Snow Removal and Ice Control Technology*, Transportation Research Board of the National Academies, Washington, D.C., 2008, pp. 364–378.

## WEATHER INFORMATION TO IMPROVE DRIVER DECISIONS

**Condition Acquisition and Reporting System–Common Alerting Protocol Automated Weather Reporting**

**PETER DAVIES**  
**KRISTIN VIRSHBO**  
**DANE UNRUH**  
*Castle Rock Associates*

The National Weather Service (NWS) has adopted extensible markup language standards for distributing weather alerts in a format known as Common Alerting Protocol (CAP). Following that release, Castle Rock worked with the Iowa Department of Transportation, the Idaho Transportation Department, the Louisiana Department of Transportation and Development, the Indiana Department of Transportation, and the Sacramento Area Council of Governments to develop a CAP-importing module that pulls automated weather watches and warnings into these agencies' statewide or regional 511 traveler information systems. NWS warnings are imported automatically and translated into the Traffic Management Data Dictionary (TMDD) standard for traffic reporting. The TMDD messages use a controlled set of standard phrases in order to convey the information through 511 and other public channels. NWS issues watches and warnings at the county or weather zone level. The Phase-1 system developed in this project maps those polygon-based conditions to individual stretches of roadways so that they can be announced on the 511 phone system. Zone-based weather reporting, however, does not always provide the desired level of precision, particularly when it comes to fast-moving storm systems or tornado corridors. The states and Castle Rock are now pursuing a Phase-2 deployment of the CAP importing system that pulls in gridded weather data feeds from NWS. Gridded weather data allows the display of weather events across a grid of 5-km cells. Additionally, imports of NWS polygons will be pursued under Phase 2 for reporting severe thunderstorms, flash flood warnings, and tornadoes. The size and shape of severely weather-affected areas change continually as the weather event progresses. Representing these changing conditions accurately and simply for the general public is the goal of moving beyond zoned-based CAP warnings.

Weather has an enormous impact on travel and road conditions. Drifting snow, ice, fog, and gusty winds are some of the factors that contribute to the more than 1.5 million crashes that occur each year in the United States, causing more than 7,000 deaths and 620,000 injuries. Estimates indicate that approximately 24% of crashes occur during adverse weather conditions, resulting in 21% of crash injuries and 17% of crash fatalities. Adverse weather conditions cut surface friction, impact highway capacities, and reduce accessibility. This increases operating and maintenance costs for agencies that perform winter road maintenance: traffic management centers, emergency responders, law enforcement agencies, and commercial vehicle operators. It is estimated that more than \$2.3 billion is spent on snow and ice control alone each year in the United States, accounting for roughly 20% of state department of transportation (DOT) maintenance budgets (1).

In the United States, more than 85% of all presidentially declared disasters are a result of significant weather events (2). In a typical year, the United States can expect some 10,000 severe thunderstorms, 5,000 floods, 1,000 tornados, and several hurricanes (3). Along with periods of



serious drought, heat waves, and blizzards these events translate into considerable casualties with annual property damages estimated in billions of dollars.

The public demand for better, more reliable travel weather information, together with evolving technological capabilities, is leading some transportation agencies to reconsider the ways in which they are providing intelligent transportation system-based, real-time traffic information to the public. This paper discusses some of the new approaches being taken by transportation agencies in the United States to providing enhanced weather condition information to the public.

## **THE CONDITION ACQUISITION AND REPORTING SYSTEM POOLED FUND**

The Condition Acquisition and Reporting System (CARS) platform was jointly built by 17 public transportation agencies in a pooled fund over its 14-year history. Public agencies use CARS as a public reporting tool for transportation-related event and condition reports. Examples of CARS events include traffic and travel-related situations, road condition information, special events, evacuations, homeland security alerts, and natural disasters. CARS also facilitates the sharing of traffic–travel event data with the public via 511 phone systems, the web, Twitter, and e-mail or text message notifications.

For years, CARS states struggled to find a solution to announce weather conditions and warnings on 511 phone and web systems. Until 2009, CARS did not support automated weather event importing because, historically, there had been no standards-based weather data source for CARS to import. Initially, an approach was developed that integrated rudimentary weather information onto 511 by “scraping” and parsing textual data from the National Weather Service (NWS) web pages. These reports were then announced on the 511 system. Because no standard governed the presentation of those free text reports, the result was often a choppy, difficult-to-follow report. Software errors occurred when the NWS introduced new language or descriptions, which would require revisions the scraping and parsing routines.

## **COMMON ALERTING PROTOCOL**

The Common Alerting Protocol (CAP) is an extensible markup language (XML) -based data format for exchanging public alerts and emergencies between alerting technologies. CAP allows alert messages to be disseminated simultaneously and consistently over multiple warning systems (Figure 1). A single CAP message can be used to trigger sirens, the Emergency Alert System, weather radios, telephone notification systems such as 511, state CARS web pages, and systems for people with special needs such as the deaf and hearing impaired.

The CAP protocol was designed during 2001–2002 by an international ad-hoc working group of emergency managers and technology experts based on a study on Effective Disaster Warnings published in late 2000 by the National Science and Technology Council’s Subcommittee on Disaster Reduction. After a number of field trials and demonstrations in various parts of the United States, CAP 1.0 was adopted as an international standard by the Organization for the Advancement of Structured Information Systems in April 2004.

The NWS adopted the CAP alert message protocol and began producing CAP alert messages as early as 2004 to facilitate emergency information sharing and data exchange.

**Message:** NOAA-NWS-ALERTS-  
 FL20111018201100SevereThunderstormWarning20111018211500FL.TBWSVRTBW.29adea360f363dd1a80d5f8adff80f05  
 from w-nws.webmaster@noaa.gov

**Sent:** 16:11 EDT on 10-18-2011

**Effective:** 16:11 EDT on 10-18-2011

**Expires:** 17:15 EDT on 10-18-2011

**Event: Severe Thunderstorm Warning**

**Alert:**  
 THE NATIONAL WEATHER SERVICE IN RUSKIN HAS ISSUED A

\* SEVERE THUNDERSTORM WARNING FOR...  
 WESTERN CHARLOTTE COUNTY IN FLORIDA.  
 WESTERN LEE COUNTY IN FLORIDA.

\* UNTIL 515 PM EDT

\* AT 410 PM EDT..NATIONAL WEATHER SERVICE DOPPLER RADAR INDICATED A  
 SEVERE THUNDERSTORM CAPABLE OF PRODUCING DESTRUCTIVE WINDS IN  
 EXCESS OF 70 MPH. THIS STORM WAS LOCATED NEAR CAPTIVA...OR 7 MILES  
 WEST OF SANIBEL...AND MOVING NORTHEAST AT 35 MPH.

\* THE SEVERE THUNDERSTORM WILL BE NEAR...  
 FORT MYERS BEACH.  
 CAPTIVA.  
 CAPE CORAL...FORT MYERS VILLAS.  
 WHISKEY CREEK...PAGE PARK.  
 BOKEELIA...FORT MYERS.  
 BOCA GRANDE.  
 THIS INCLUDES INTERSTATE 75 BETWEEN EXITS 143 AND 164.

**Instructions:** FOR YOUR PROTECTION MOVE TO AN INTERIOR ROOM ON THE LOWEST FLOOR OF YOUR HOME OR  
 BUSINESS. THIS STORM HAS THE POTENTIAL TO CAUSE SERIOUS INJURY AND SIGNIFICANT DAMAGE TO  
 PROPERTY. A TORNADO WATCH REMAINS IN EFFECT UNTIL 1000 PM EDT TUESDAY EVENING FOR  
 SOUTHWESTERN FLORIDA.

**Target Area:** Charlotte  
 Lee

**Forecast Office:** NWS Tampa Bay (West Central Florida)

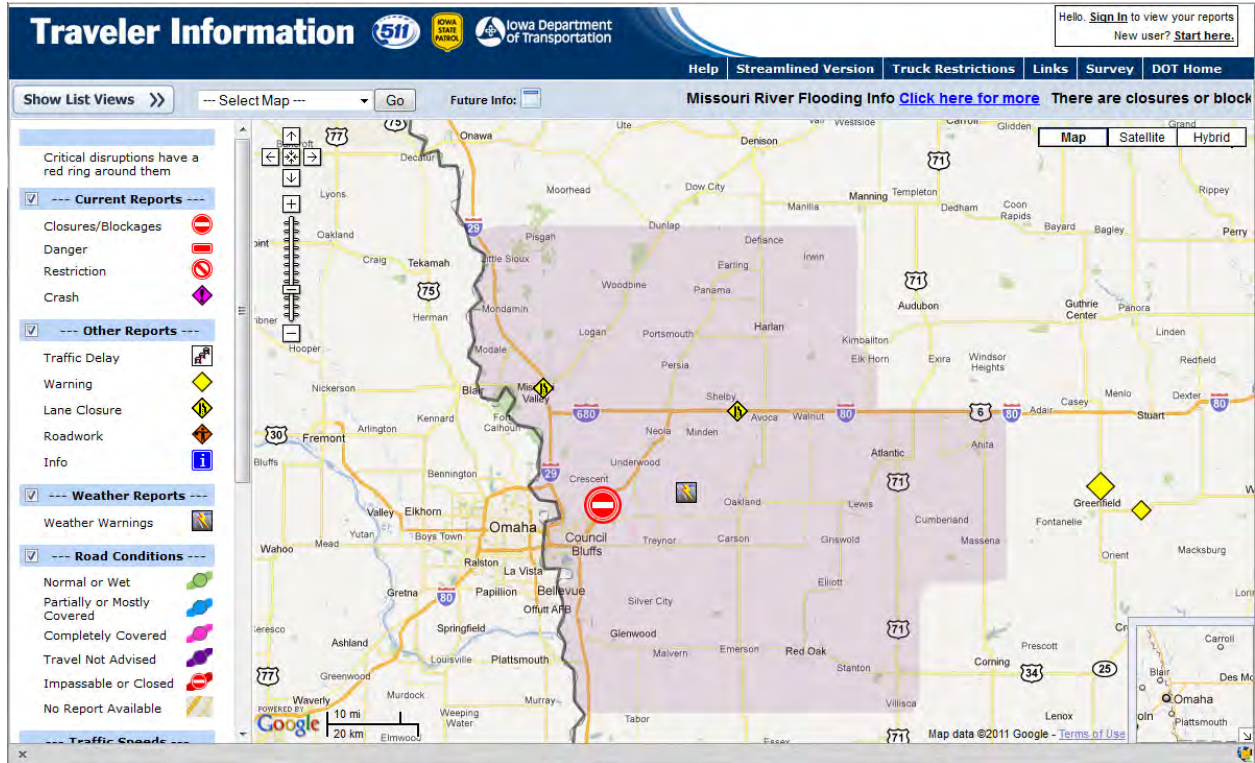
**FIGURE 1 NWS CAP Alert—Severe Thunderstorm Warning.**

## CARS and CAP

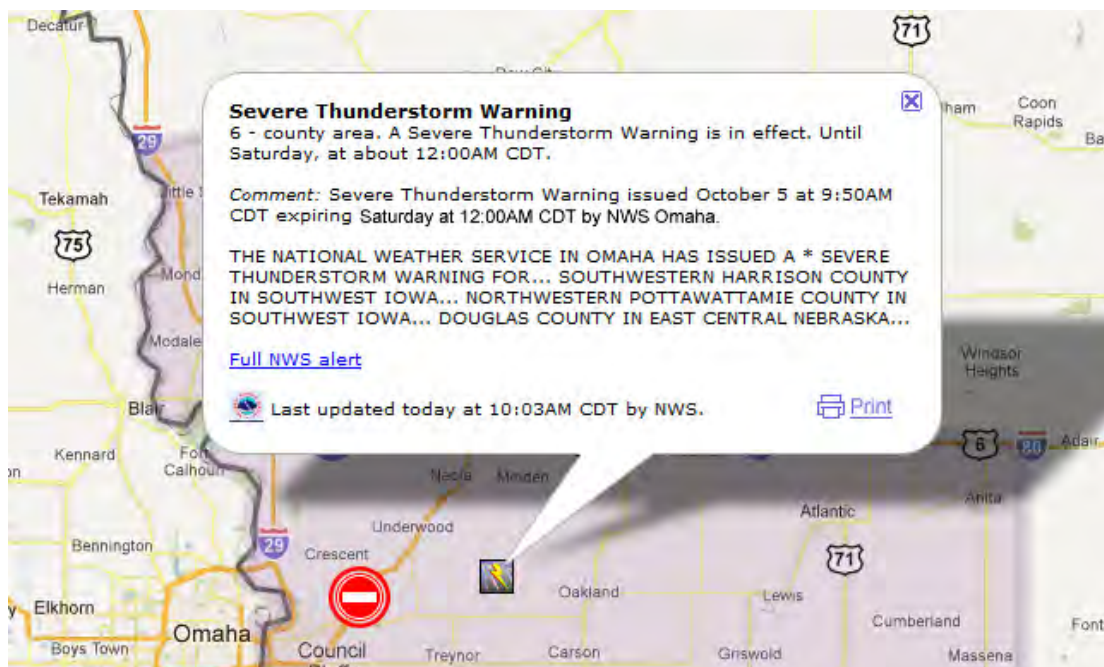
Following the NWS release of a CAP XML feed, Castle Rock worked with the Iowa DOT, the Idaho Transportation Department, the Louisiana Department of Transportation and Development, and the Indiana DOT to develop a CAP importing module called CARS–CAP. CARS–CAP is a data import system that interfaces directly with the NWS to automatically imports CAP weather warnings into CARS for conveying to the general public through 511.

NWS provides a wide range of warnings, watches, statements, and advisories, many of which are not immediately applicable to transportation information systems. Initially only warnings were imported by CARS–CAP, and those not critical to drivers were filtered out so as not to overwhelm 511 systems with uncertain or low-impact information.

The 511 system built by the CARS group afforded the opportunity to display CAP information in a more graphic, simplified format, suitable for the general public. In the Google Maps–based 511 websites, NWS CAP alerts are mapped as county–zone area events using translucent polygons, as illustrated in [Figure 4](#). Positioned at the approximate center of each polygon is a weather icon that, when clicked, opens a Google text bubble displaying the essential details of the NWS alert, including a link to the NWS alert page. [Figures 2](#) through [5](#) display a severe thunderstorm warning imported by CARS–CAP in Iowa DOT’s public 511 Traveler Information website.



**FIGURE 2** Next generation CARS web page displaying severe thunderstorm warning in Iowa.



**FIGURE 3** Severe thunderstorm warning area event details.

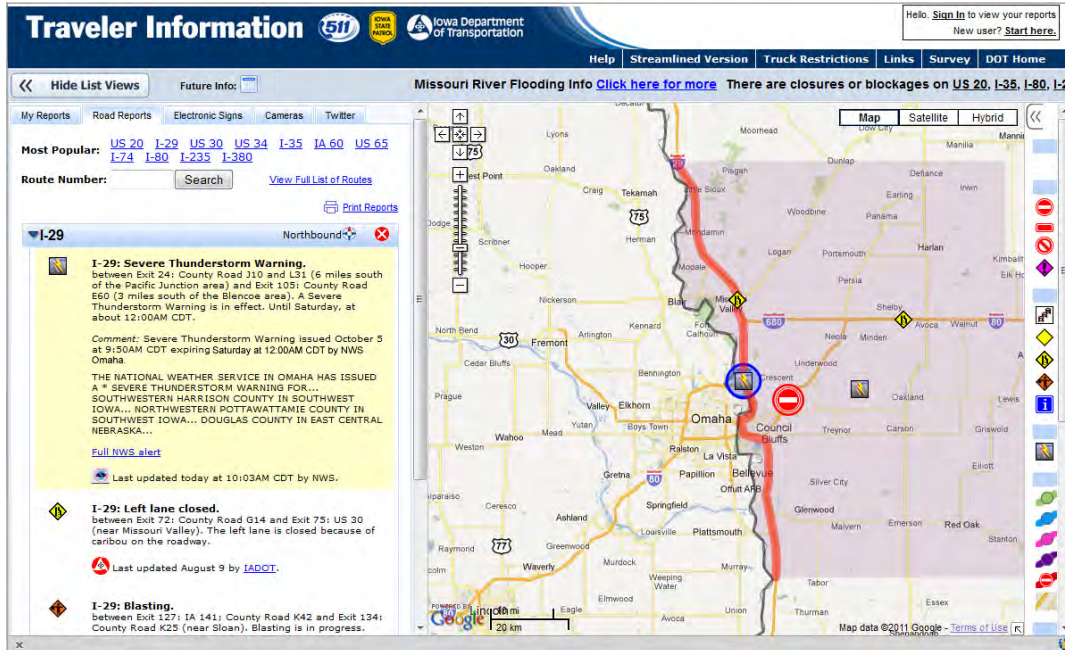


FIGURE 4 I-29 severe thunderstorm roadway event.



FIGURE 5 I-29 severe thunderstorm warning roadway event details.

Though many transportation agencies have extended their 511 systems to include web-based displays, 511 initially started as a phone system, where no maps or other graphical displays are possible. To tackle that problem, the CARS group included algorithms to map area-based CAP alerts to individual roadway sections for announcement on the 511 phone system.

Figures 4 and 5 display a section of I-29 that fall within the severe thunderstorm warning zone. The system automatically creates a severe thunderstorm warning event for this section of I-29 and reports it to the public over Iowa's 511 phone system when callers ask for information about I-29.

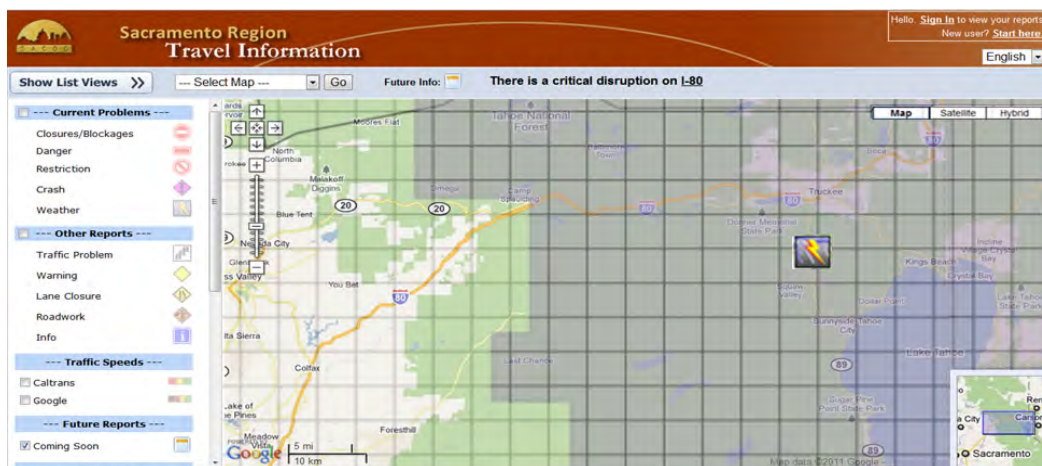
## STORM POLYGONS AND HAZARD GRIDS

The NWS recently released a new XML/Internet-based feed of its gridded weather data. Previously, these highly dense data sets were available only to those with specialized equipment by satellite download. Gridded weather data offer much more detailed and precise weather observations and forecasts than the zone-based CAP alerts that are currently imported by CARS-CAP. Castle Rock and the CARS group are now investigating a Phase 2 deployment of CARS-CAP that would take advantage of the increasingly specific and accurate data being generated by the NWS.

Hazard grids depict all active, long-duration warning and advisory hazards such as winter storm warnings, blizzards, and dense fog advisories issued by NWS weather forecast offices. Hazard grids map the extent of hazard warnings and advisories on an approximately 5 km rectangular grid covering. They are updated every hour for a forecast period of 72 h (3 days), and every 6 h for a forecast period of 120 h (5 days).

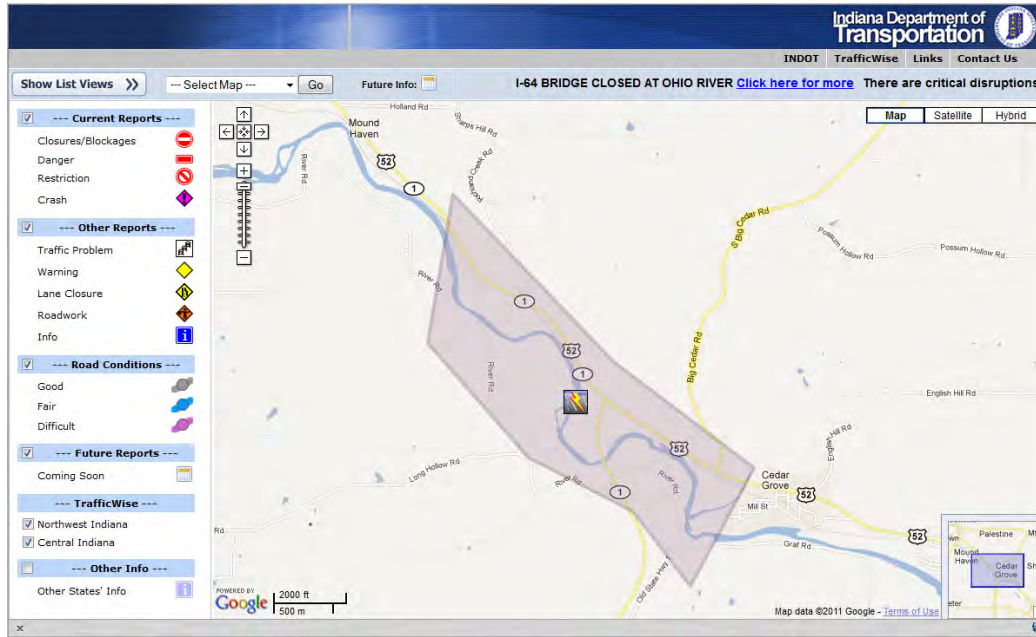
Phase 2 of the CAP data importing system will use this data to detect the intersection of active weather grid cells, or polygons, with roads on the state or U.S. highway system, and create weather events on the affected sections of roadway. Events will be automatically created, removed, updated, aggregated, and decoupled as necessary, following the path of the weather system. This offers much more precision than the CAP 1.1 alerts currently imported, which assign weather warnings along arbitrary county, or in some cases, zone boundaries.

NWS now also offers storm polygons through its XML feed. Storm polygons are latitude-longitude boxes drawn by NWS meteorologists based on where they perceive greatest threat for severe weather. As with the gridded weather data, they allow the extent of weather events such as flash floods and tornado corridors to be much more precisely represented when reporting the warning to the public, as shown in the mock-up in [Figure 6](#).

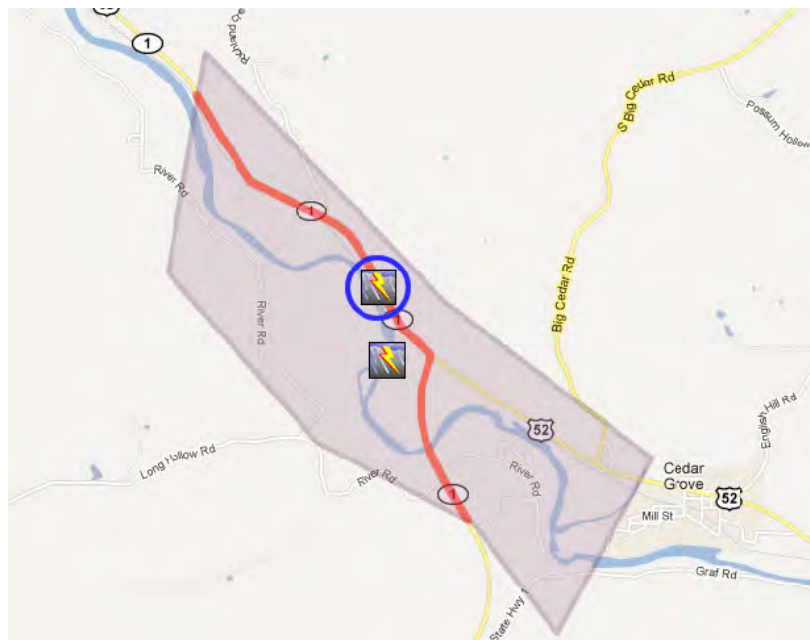


**FIGURE 6** Hazard grid concept illustration.

In **Figure 7**, a flash flood warning is mapped to the specific threat area storm polygon of the Whitewater River rather than the entirety of Franklin County, Indiana. In **Figure 8**, the warning is mapped to the specific stretches of IN-1 and US-52 that are threatened by flash floods rather than all highways in Franklin County. In addition to displaying these warnings on the 511 websites, the reports area also announced by roadway on the 511 phone system.



**FIGURE 7 Polygon flash flood warning in next generation CARS-CAP illustration.**



**FIGURE 8 Roadway event created on each highway crossing the polygon illustration.**

## CONCLUSION

As technology advances to generate forecast and warning data that are increasingly specific and accurate, the transportation industry must develop the means to parse these data and communicate relevant information to the public in as timely a fashion as possible. Zone-based weather reporting does not always provide the desired level of accuracy, particularly when it comes to fast-moving storm systems or tornado corridors. The size and shape of a severely weather-affected area change continually as the weather event progresses. Representing these changing conditions accurately is the goal of moving beyond zoned-based CAP warnings. CARS–CAP seeks to import these data automatically to inform the public through the already well-established 511 traveler information systems.

## REFERENCES

1. How Do Weather Events Impact Roads? FHWA, U.S. Department of Transportation. [http://ops.fhwa.dot.gov/weather/q1\\_roadimpact.htm](http://ops.fhwa.dot.gov/weather/q1_roadimpact.htm). Accessed October 17, 2011.
2. Presidential Disaster Declarations, January 3, 2000, to March 3, 2007. Federal Emergency Management Agency. [http://www.fema.gov/pdf/hazard/map/declarationsmap2000\\_07.pdf](http://www.fema.gov/pdf/hazard/map/declarationsmap2000_07.pdf). Accessed October 17, 2011.
3. NOAA Watch. National Oceanic and Atmospheric Administration. <http://www.noaawatch.gov>. Accessed October 17, 2011.

## WEATHER INFORMATION TO IMPROVE DRIVER DECISIONS

## Study on Provision of Winter Road Snowstorm Information to Road Users

HIROTAKA TAKECHI  
MASARU MATSUZAWA  
TOSHIROU KAWANAKA  
HIROSHI NAKAMURA  
MANABU KANEKO

*Civil Engineering Research Institute for Cold Region, Public Works Research Institute, Japan*

In recent years, Hokkaido has seen traffic hazards caused by snowstorms as a result of rapidly developing low-pressure systems even in areas where, until now, the frequency of snowstorms has been relatively low (1, 2). This fact highlights the importance of providing information on winter road driving environments such as snowstorm conditions, prompting appropriate responses from drivers to enhance the safety and reliability of winter roads. Thus, the authors conducted tests on providing information on winter road conditions, such as visibility during snowstorms, via personal computers (PCs) and mobile phones. The information provided in the test was as follows: (1) Information on visibility in each area of Hokkaido during a snowstorm (PCs and mobile phones); (2) Information on visibility on roads in each municipality during a snowstorm (PCs and mobile phones); (3) Information on driving time required according to the winter driving environment (only PCs); and (4) Snowstorm information on winter roads collected from road users (only PCs). An online questionnaire survey was also conducted on the effectiveness of the information on visibility in each area of Hokkaido during a snowstorm. The results showed that 90% or more respondents found the snowstorm visibility information of each Hokkaido area useful, confirming the effectiveness of the information. In addition, 80% or more respondents used the information on visibility conditions and driving time for routes in each municipality as reference for departure and arrival times, and approximately 50% referred to it for examining alternative routes. This showed the information was useful for road users to make driving plans.

In Hokkaido—a cold snowy region in the northernmost part of Japan—snowstorms severely hinder visibility, and road administrators take steps to install and maintain blowing-snow control facilities such as snowbreak woods and snow fences.

In recent years, Hokkaido has seen traffic hazards caused by snowstorms as a result of rapidly developing low-pressure systems even in areas where, until now, the frequency of snowstorms has been relatively low (1, 2).

For early-stage action against snowstorm-related visibility hindrance, it is also important to consider intangible measures (such as the promotion of appropriate driving behavior) by providing information on winter road visibility conditions during snowstorms.

Previous studies clarified that road users considered it important to receive information on visibility, road surfaces, and route distances and times while driving on winter roads (3).

In this study, a trial was conducted to provide the following snowstorm information to road users' personal computers (PCs) and mobile phones via the Internet to promote safe driving and route planning:



1. Visibility information relating to snowstorms in individual areas of Hokkaido (referred to here as “snowstorm visibility information”);
2. Detailed winter road information on visibility conditions on routes from departure points to arrival points, still images of roads, and data on estimated winter travel times; and
3. Posted snowstorm information highlighting conditions based on reports submitted by road users.

## COLLECTION OF VISIBILITY INFORMATION DURING SNOWSTORMS

### Tasks for Visibility Information Provision During Snowstorms

Capturing still images of roads and collecting visibility data at weather stations are considered effective in providing real-time information on visibility and road surfaces during snowstorms in winter (3, 4). However, the number of locations from which still images and weather station data can be obtained is limited and may not be sufficient to provide road users with detailed information on visibility conditions over entire routes.

Accordingly, this trial adopted a method of estimating visibility during snowstorms from easily available weather data to provide information on visibility conditions on winter roads during snowstorms.

### Method of Estimating Visibility During Snowstorms

Visibility during snowstorms has a strong correlation with the mass flux snow ( $\text{g}/\text{m}^3/\text{s}$ ), defined as the mass of snow particles passing through a unit space per unit time. Previous studies clarified that the relationship is as shown by Equation 1 (5).

$$\text{Vis} = 10^{-0.886 \times \log(Mf) + 2.648} \quad (1)$$

where

$$\begin{aligned} \text{Vis} &= \text{visibility (m); and} \\ Mf &= \text{mass flux of snow (g/m}^2/\text{s)} \end{aligned}$$

The mass flux snow is expressed by the product of the snow concentration  $N(\text{g}/\text{m}^3)$ , defined as the mass of snow particles in a unit space and the wind velocity (m/s).

In other words, visibility can be estimated by determining the snow concentration.

Matsuzawa et al. proposed a method of estimating snow concentration  $N(z)$  from snowfall intensity, wind velocity and air temperature, which can be determined relatively easily using Equation 2 (6).

$$N(z) = \frac{P}{w_f} + \left( N_t - \frac{P}{w_f} \right) \left( \frac{z}{z_t} \right)^{-\frac{w_b}{kU}} \quad (2)$$

where

- $P$  = snowfall intensity ( $\text{g}/\text{m}^2/\text{s}$ );
- $w_f$  = falling velocity of snowfall particles ( $= 1.2 \text{ m/s}$ );
- $w_b$  = falling velocity of suspended snow particles ( $= 0.35 \text{ m/s}$ );
- $z$  = height of the viewpoint of small-vehicle drivers ( $= 1.2 \text{ m}$ );
- $z_t$  = reference height ( $0.15 \text{ m}$ );
- $N_t$  = snow concentration at reference height  $z_t$  ( $30 \text{ g}/\text{m}^3$ );
- $U^*$  = friction velocity ( $= 0.036 \times V_{10}$ ), (where  $V_{10}$  is the wind velocity at a height of 10 m);  
and
- $k$  = Karman's constant ( $= 0.4$ ).

The air temperature and wind velocity in each 5-km mesh and the snowfall intensity in each 1-km mesh in Hokkaido, as reported by the Japan Meteorological Agency in real time, were used in this trial to calculate the snow concentration in each 1-km mesh from Equation 2, determine the mass flux snow and estimate visibility during snowstorms.

### Judgment of Visibility During Snowstorms

Previous studies clarified the relationship between visibility during snowstorms and driver behavior (7). If visibility is less than 200 m, driving speed begins to decrease; if it is less than 100 m, driving speed decreases significantly and vehicle speed differences increase.

Based on these findings, information was provided in this trial with visibility conditions during snowstorms divided into five levels: significantly poor visibility (less than 100 m), quite poor (100 to 200 m), poor (200 to 500 m), somewhat poor (500 to 1,000 m), and good (more than 1,000 m).

## SNOWSTORM VISIBILITY INFORMATION FOR INDIVIDUAL AREAS OF HOKKAIDO

### Overview of Snowstorm Visibility Information

The Northern Road Navi website operated by the Civil Engineering Research Institute for Cold Region provides road information for the Hokkaido area (8). In this trial, information was provided to personal computers and mobile phones as shown in Figures 1 and 2 on the Northern Road Navi website.

Hokkaido was divided into 46 areas and snowstorm visibility conditions in each area were judged based on the five levels outlined and displayed on maps in color.

Information was provided to PCs during the three winters of 2008–2009, 2009–2010, and 2010–2011 and to mobile phones during the winter of 2010–2011.

### Effectiveness of Snowstorm Visibility Information

Figure 3 shows the daily number of accesses for the winters of 2008–2009, 2009–2010, and 2010–2011—the periods during which the visibility information site for PCs was made available. It shows that the average number of accesses to the snowstorm visibility information site increased

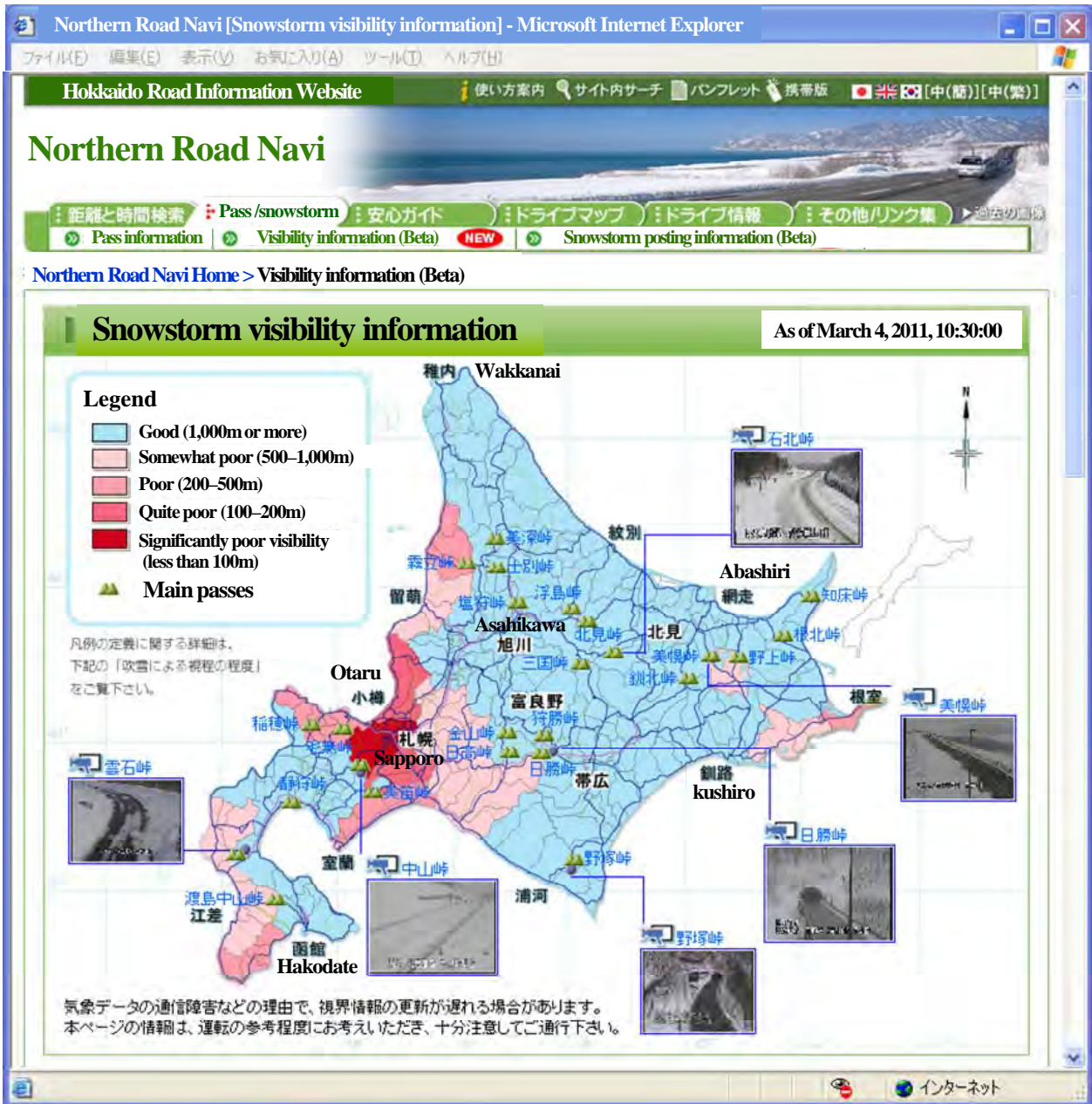
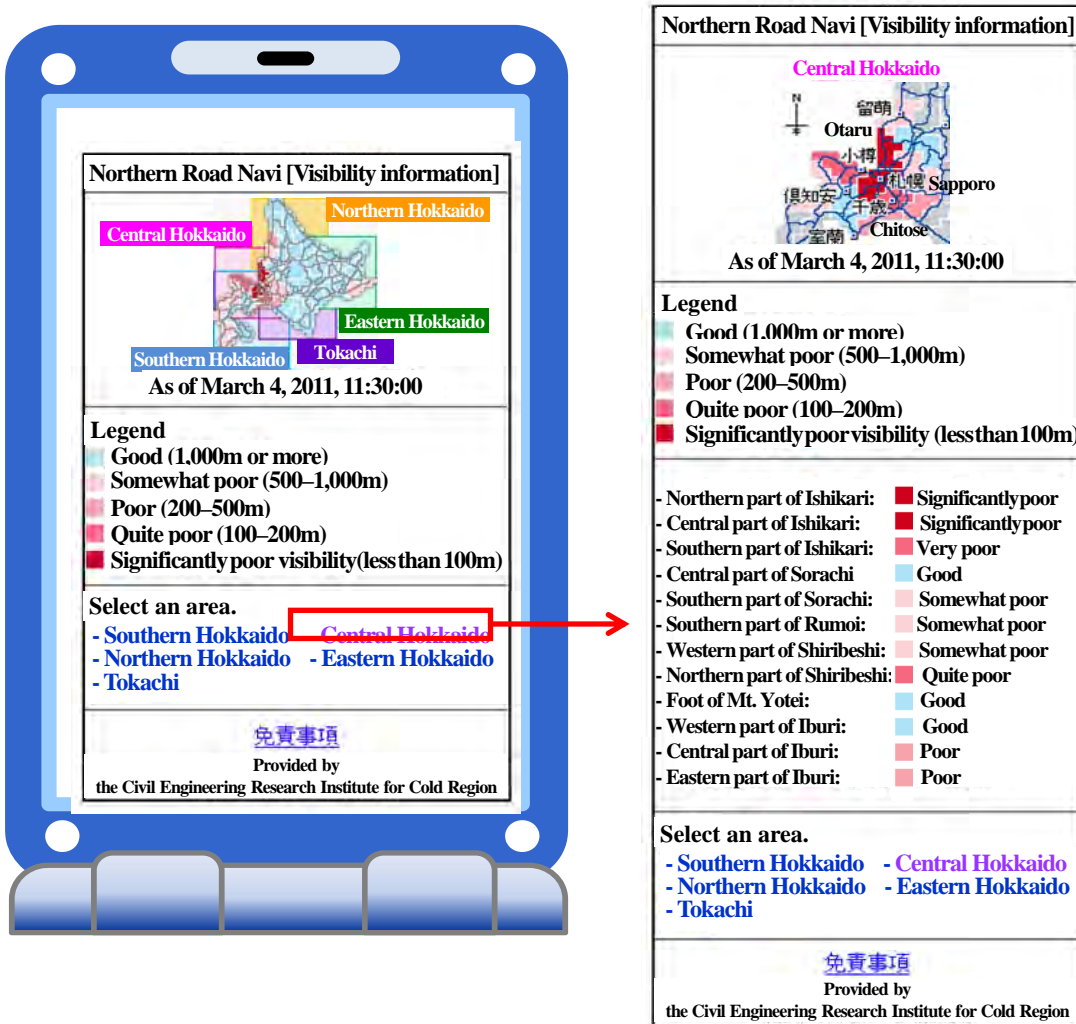


FIGURE 1 Screen showing snowstorm visibility information (for PCs).



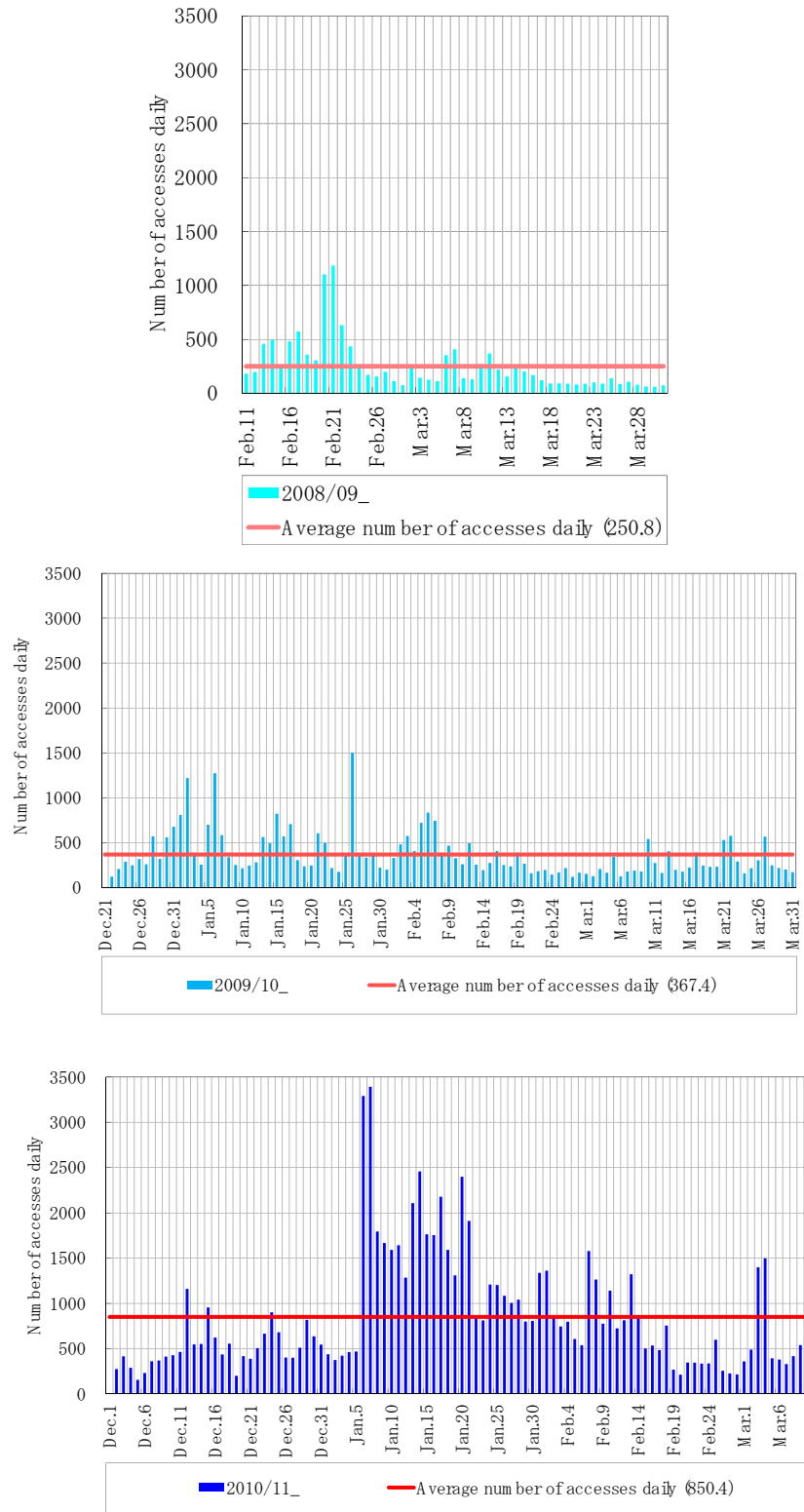
**FIGURE 2** Screen showing snowstorm visibility information (for mobile phones).

every year, exceeding 1,000 in the period from January 6 to 21, 2011, when heavy snow fell in Sapporo City. The maximum number of accesses (3,391) was recorded on January 7, 2011.

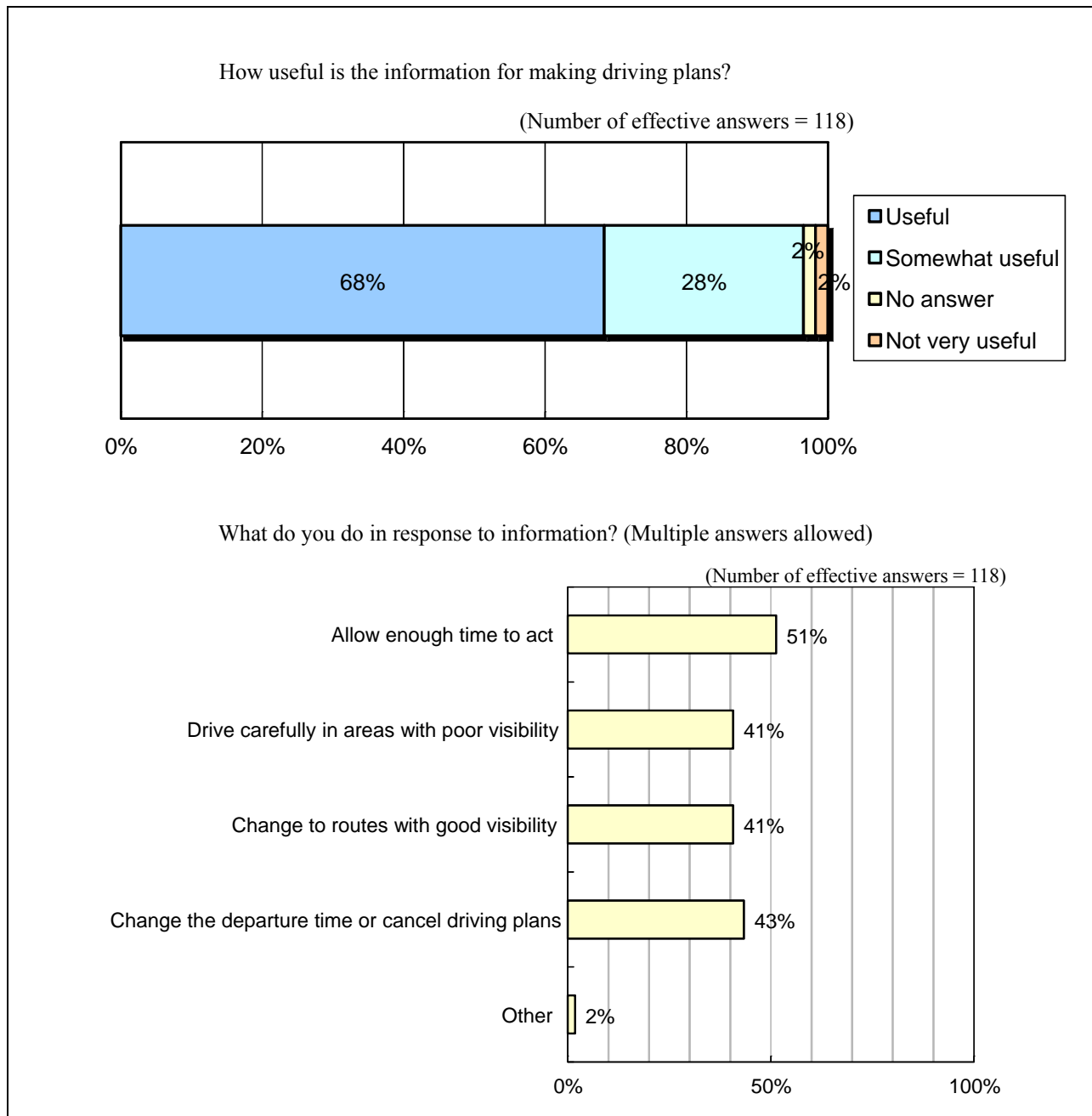
Thus, snowstorm visibility information was used the most during snowstorms and periods of snowfall.

In addition, a questionnaire survey was conducted on the effectiveness and effects of snowstorm visibility information for PCs on the Northern Road Navi website during the period from March 9 to 22, 2010. Figure 4 shows the results.

It can be seen from the figure that at least 90% of respondents answered “useful” or “somewhat useful” in response to the question “How useful is the information for making driving plans?”, indicating the value of snowstorm visibility information to road users. To the question “What do you do in response to information?” at least 50% of respondents answered “allow enough time to act;” at least 40% answered “drive carefully in areas with poor visibility,” “change to routes with good visibility.” or “change the departure time or cancel driving plans,” and snowstorm visibility information was seen as useful by drivers considering or changing driving plans.



**FIGURE 3** Number of accesses to the screen showing snowstorm visibility information (for PCs).



**FIGURE 4** Effects of snowstorm visibility information (for PCs)  
(results of questionnaire survey on the Northern Road Navi website).

## INFORMATION ON VISIBILITY DURING SNOWSTORMS IN MUNICIPALITIES ALONG ROUTES AND DATA ON TRAVEL TIMES FOR WINTER DRIVING ENVIRONMENTS

### Overview of Detailed Winter Road Information

The Northern Road Navi website provides information such as route and distance data from departure points to arrival points and travel times for snow-free conditions (referred to as the time and distance search function) (8, 9). However, travel times for periods when snow is accumulated are not provided.

The authors added data on winter travel times to route information that can be searched using the time and distance search function, created a page showing detailed winter road information that provided data on snowstorm visibility conditions in individual municipalities, still images of roads and conditions of road weather stations, and dispatched information to PCs and mobile phones during the period from February 14 to April 28, 2011 (Figure 5).

The upper part of the page showing detailed winter road information for PCs displayed the distance from the departure point to the arrival point and the travel time in snow-free conditions, while the lower part showed snowstorm visibility conditions and weather information in each relevant municipality, as shown in Figure 5. If still images of roads or information on road weather stations were available along routes, pop-up screens appeared to show the relevant data. A button to move to the page displaying the winter travel time was provided above the data on travel times in snow-free conditions, and the screen shown in Figure 5a popped up.

When the user selected visibility conditions from among “good (more than 1,000 m),” “poor (200 to 1,000 m),” and “significantly poor visibility (less than 100 m)” and road conditions from among “wet/dry road surface” and “road surface covered with snow and ice,” the travel time from the departure point to the arrival point as given by the user was estimated based on the specified conditions and displayed on this screen. Estimated winter travel times were compensated using a driving speed reduction ratio for each level of visibility and road surface conditions as shown in Table 1 (10). A simple questionnaire was provided close to the “winter travel time” button as shown in Figure 5.

Figure 6 shows the screen on detailed winter road information for mobile phones. The distance between departure and arrival points, the travel time in snow-free seasons and routes were displayed first on the page, which then changed to show snowstorm visibility information for individual municipalities along the route and still images of roads. Information on winter travel times was not provided to mobile phones.

### Effectiveness of Detailed Winter Road Information

A questionnaire survey (shown in Figure 5) was conducted to determine the effectiveness of the page showing detailed winter road information for PCs. A total of 57 people responded to the survey, and Figure 7 shows the results.

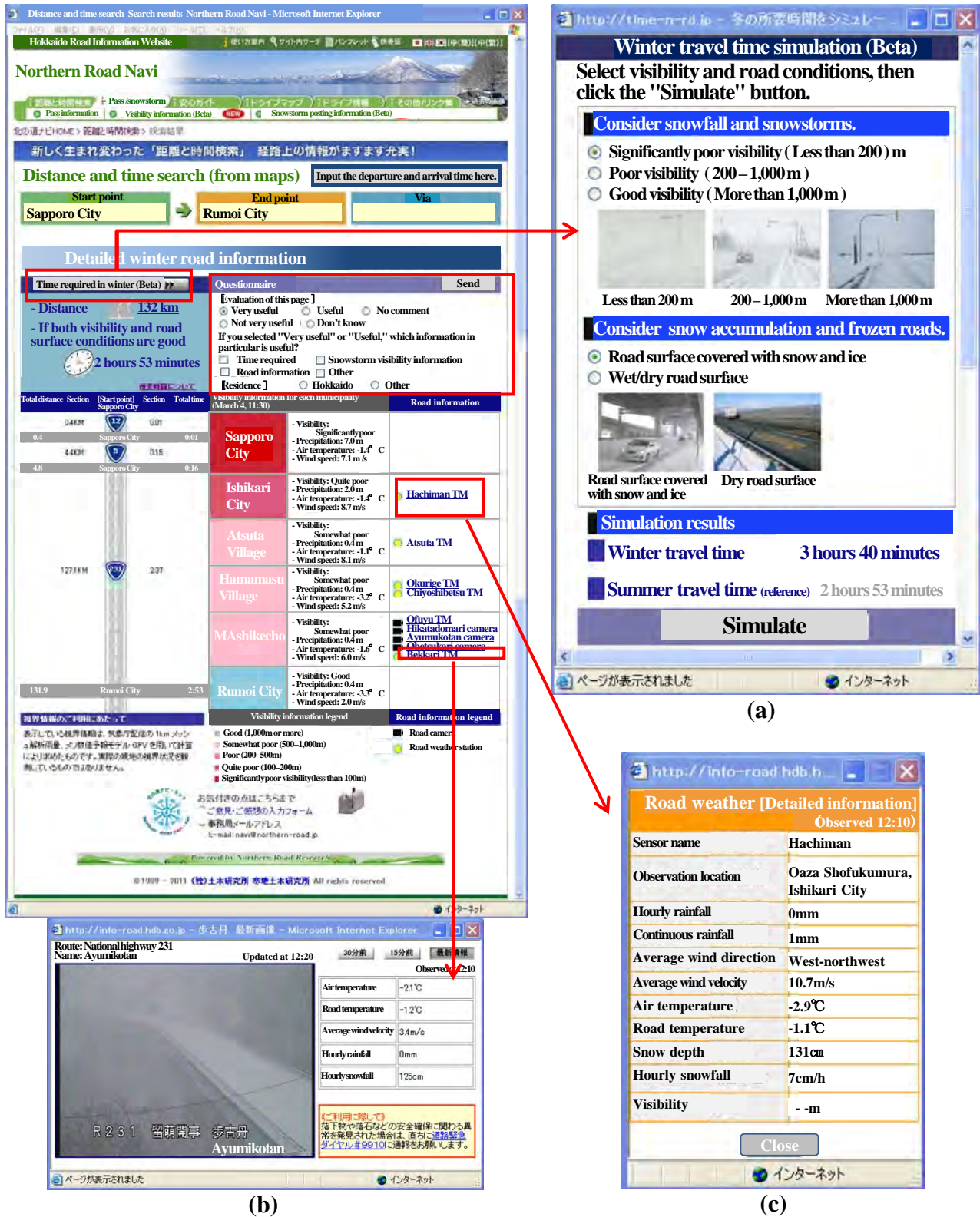


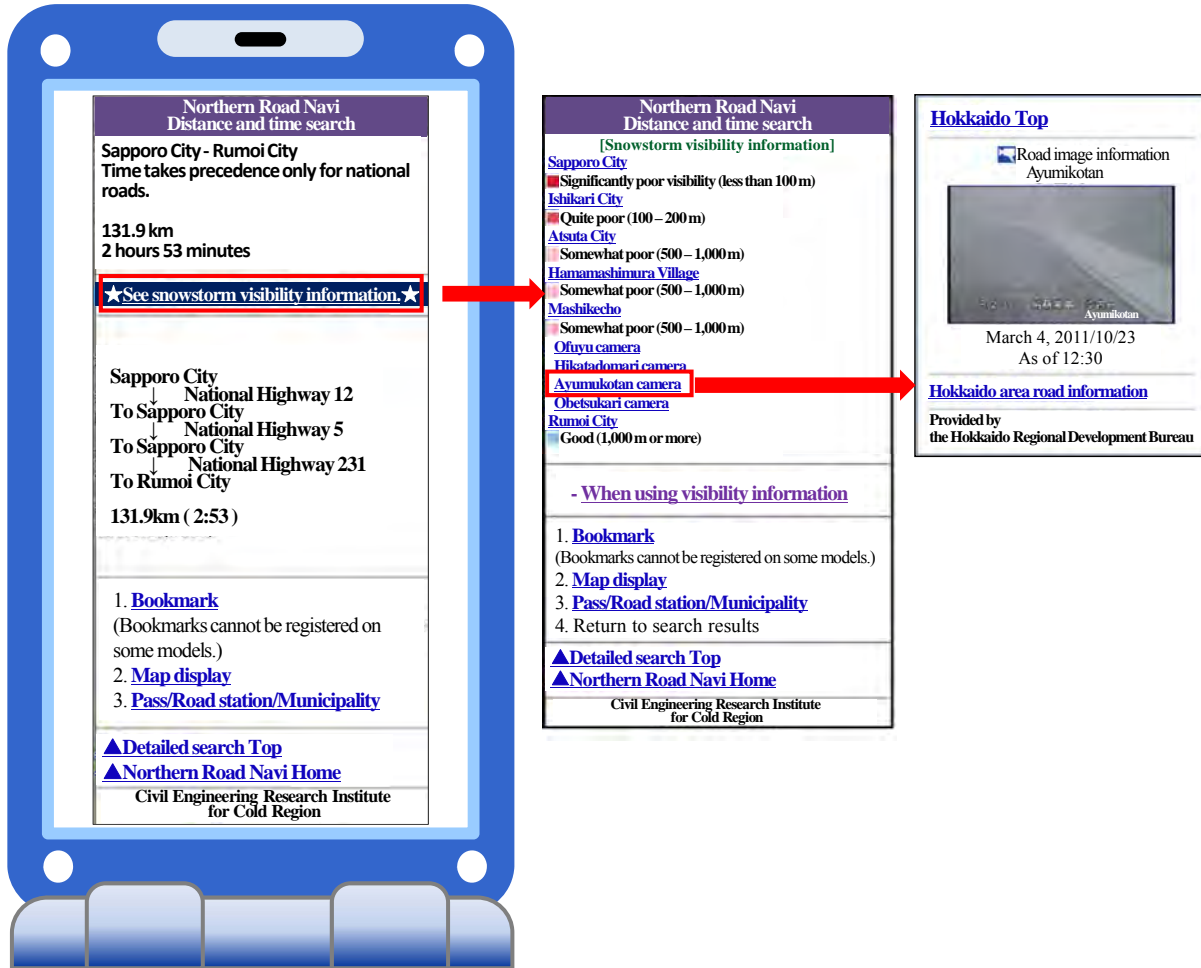
FIGURE 5 Screen showing detailed road information and popup screens for individual items (for PCs) (a) winter travel time, (b) road image, and (c) road weather station information).



**TABLE 1 Driving Speed Reduction Rates During Periods of Snow Cover (Suburban Flatlands, Straight Intervals)**

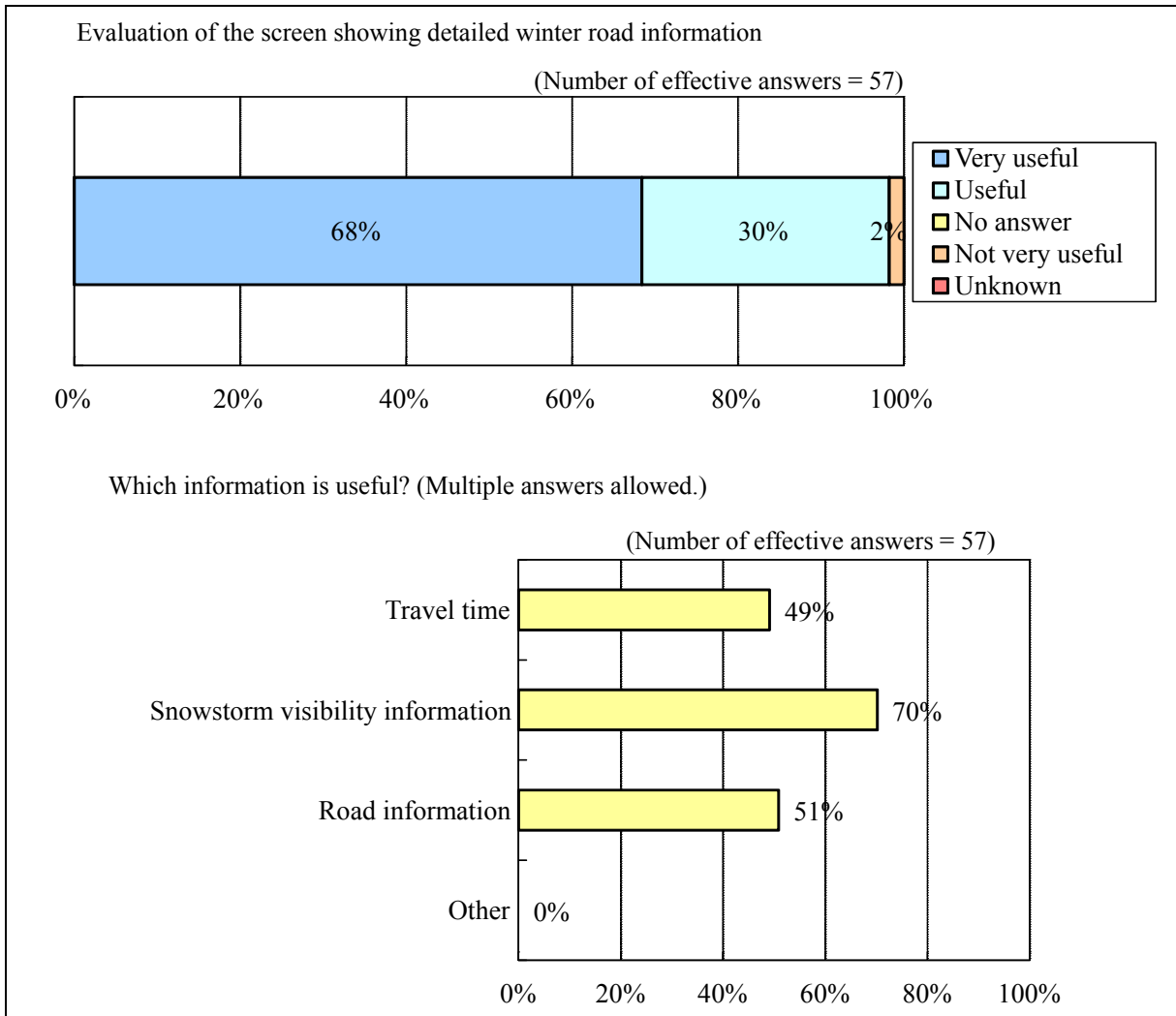
	Road Surface Covered with Snow and Ice (%)	Wet-Dry Road Surface (%)
Significantly poor visibility (less than 200 m)	27	15
Poor visibility (200–1,000 m)	15	10
Good visibility (more than 1,000 m)	12	6

NOTE: The values are rates of speed reduction for driving on a dry road with visibility of 1,000 m or more.



**FIGURE 6 Screen showing detailed winter road information (for mobile phones).**

It can be seen from the figure that at least 90% of respondents found the detailed winter road information useful, thereby confirming its effectiveness. In response to the question, “Which information is useful?” at least 70% of users identified the snowstorm visibility information (the highest score for all information provided), meaning that it was considered more

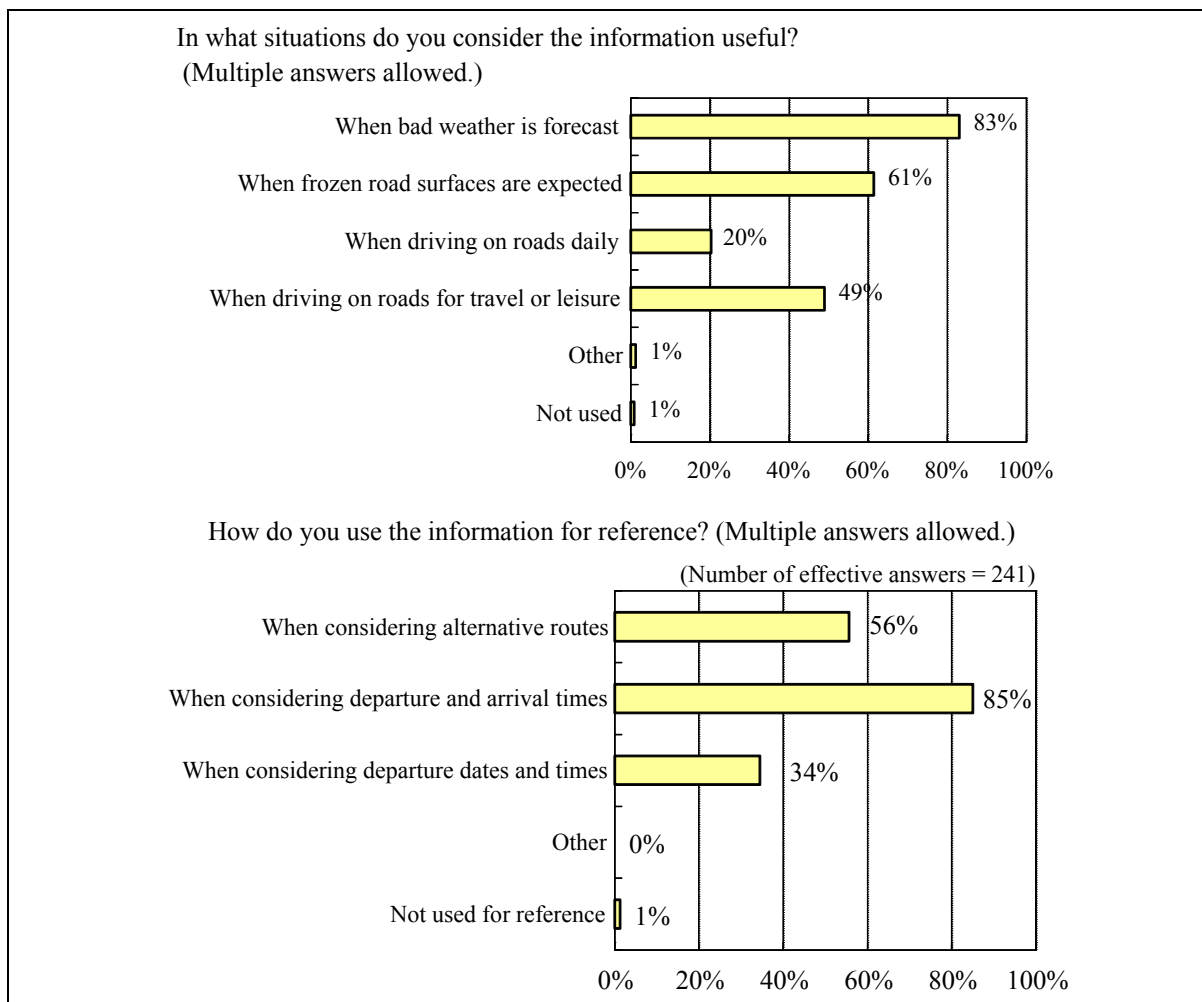


**FIGURE 7 Effects of detailed winter road information (for PCs) (results of user questionnaires).**

effective than road information.

A further questionnaire survey was conducted on the Northern Road Navi website regarding the usage and effectiveness of the page showing detailed winter road information for PCs during the period from February 18 to March 7, 2011(8). A total of 241 people responded to the survey, and Figure 8 shows the results.

In response to the question, “In what situations do you consider the information useful?” at least 80% of respondents answered “when bad weather is forecast.” In response to the question, “How do you use the information for reference?” at least 80% of respondents answered “when considering departure and arrival times” for use when considering these times and at least 50% answered “When considering alternative routes” for reference when examining alternative routes. This indicates that the detailed winter road information was useful for road users making driving plans if severe driving environments (such as those with poor visibility) were expected.



**FIGURE 8** Effects of detailed winter road information (for PCs) (results of questionnaire survey on the Northern Road Navi website).

## SNOWSTORM INFORMATION POSTED BY WINTER ROAD USERS

### Overview of Posted Snowstorm Information

Snowstorm information posted by road users was provided on the trial Northern Road Navi website to provide real-time information to road users in the event of large-scale snowstorms (8).

Trial implementation was operated during the period from January 27 to April 28, 2011, in which road users provided information such as descriptions of visibility conditions—weather and still images of roads during snowstorms using mobile phones or PCs, and this information was posted on the PC website for provision to road users.

Submitters were asked to post the municipality name, route name, visibility conditions, weather descriptions, comments and still images of roads via the posting screen (shown in Figure 9). The information collected was provided on the information page shown in Figure 10 together with submitters' user names. Positional information was obtained using the GPS function of

Snowstorm information posting - Microsoft Internet Explorer

Posted snowstorm information

Welcome, snow.

**Road condition posting**

● **Road condition input**  
Input the road condition as of 16:24.

Region (required) 道央 → Central Hokkaido

Municipality (required) 札幌市 → Sapporp city

Route (required) 国道5号 → National Highway 5

Visibility (required)

- Good (1,000 m or more)
- Somewhat poor (500 – 1,000 m)
- Poor (200 – 500 m)
- Quite poor (100 – 200 m)
- Significantly poor visibility (less than 100 m)

Weather (required)

- Fair
- Cloudy
- Snow
- Snowstorm

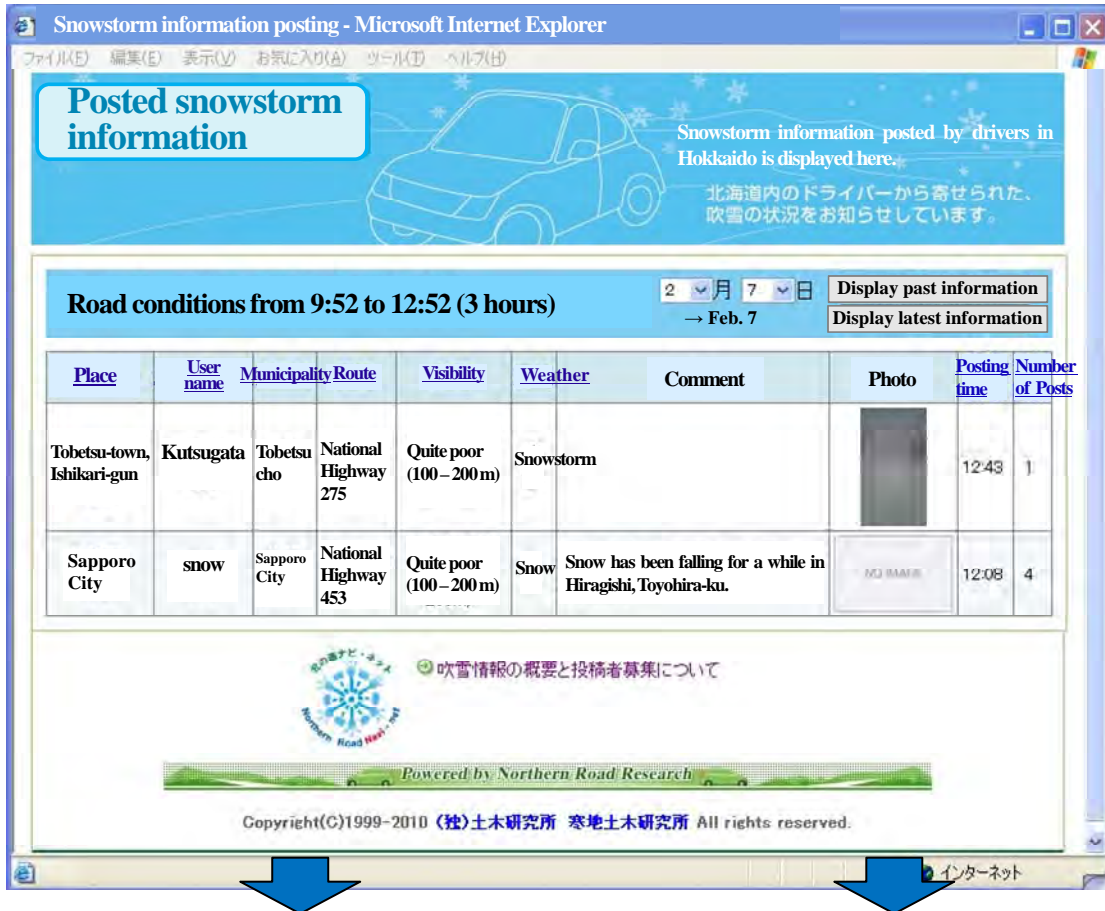
Coment (optional)

Photo (optional) 参照...  
\* Only JPEG files can be uploaded.

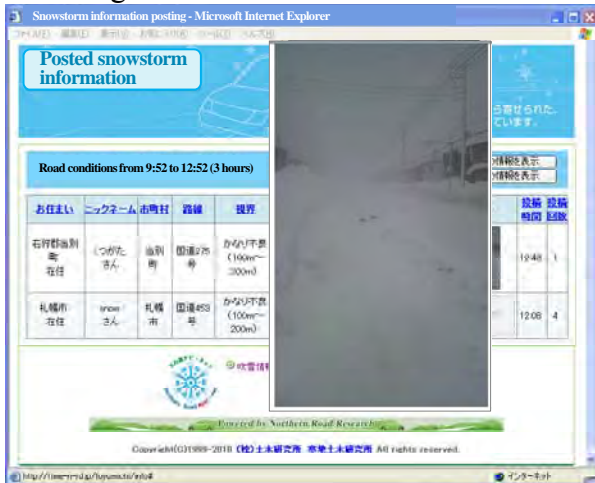
➤ To confirmation screen

ページが表示されました インターネット

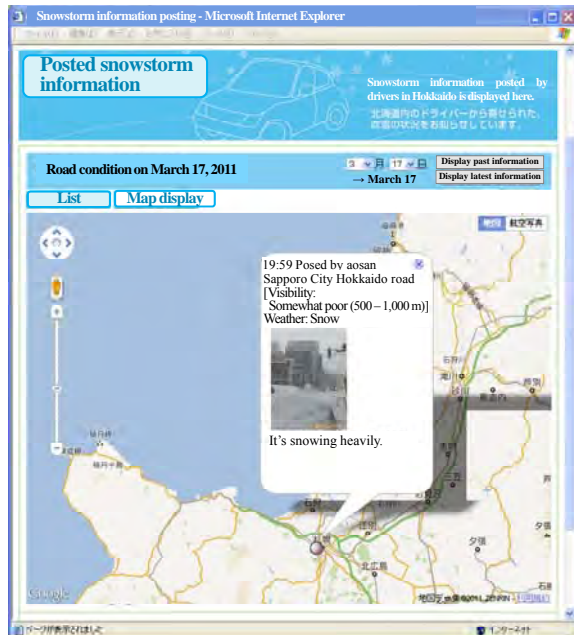
FIGURE 9 Screen for posting snowstorm information (for PCs).



Still images of roads



Location information



\* Information publicized after the completion of the questionnaire survey.

FIGURE 10 Screen showing posted snowstorm information.

mobile phones from March 8, 2011, onward, and information posted was displayed on the map along with the relevant location. Only information posted in the previous 3 h was displayed on the information page.

**Effectiveness of Posted Snowstorm Information**

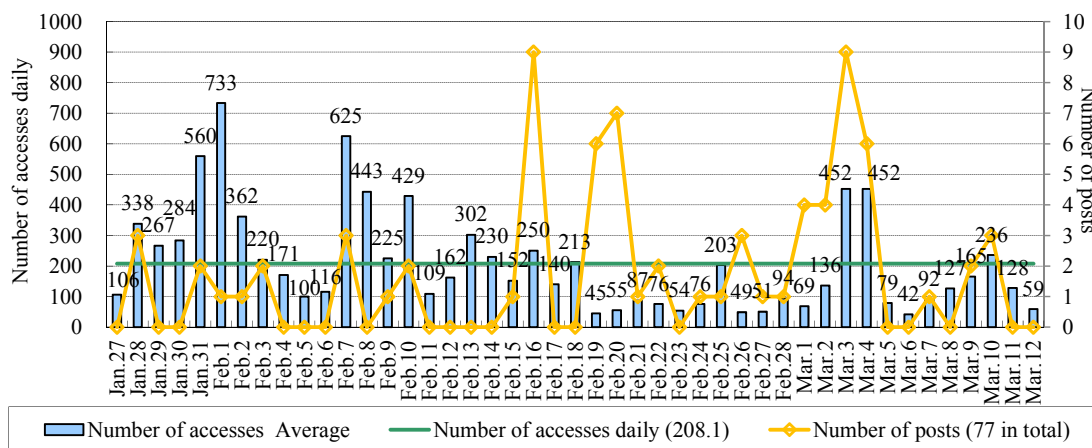
Figure 11 shows the daily numbers of posts and accesses to the information page during the period from January 27 to March 12, 2011, when the information page was made available. A total of 47 people registered, and 77 pieces of snowstorm information were posted during the period.

It can be seen from the figure that the daily average number of accesses to the posted snowstorm information page was 208. The daily number of accesses to the page was 733 on February 1, 2011, when the daily amount of snow that fell in Sapporo was relatively large, and the daily number of posts was nine (with the highest value recorded). The page was accessed 452 times on March 3, 2011, when the daily snowfall in Sapporo was at its maximum for the monitoring period.

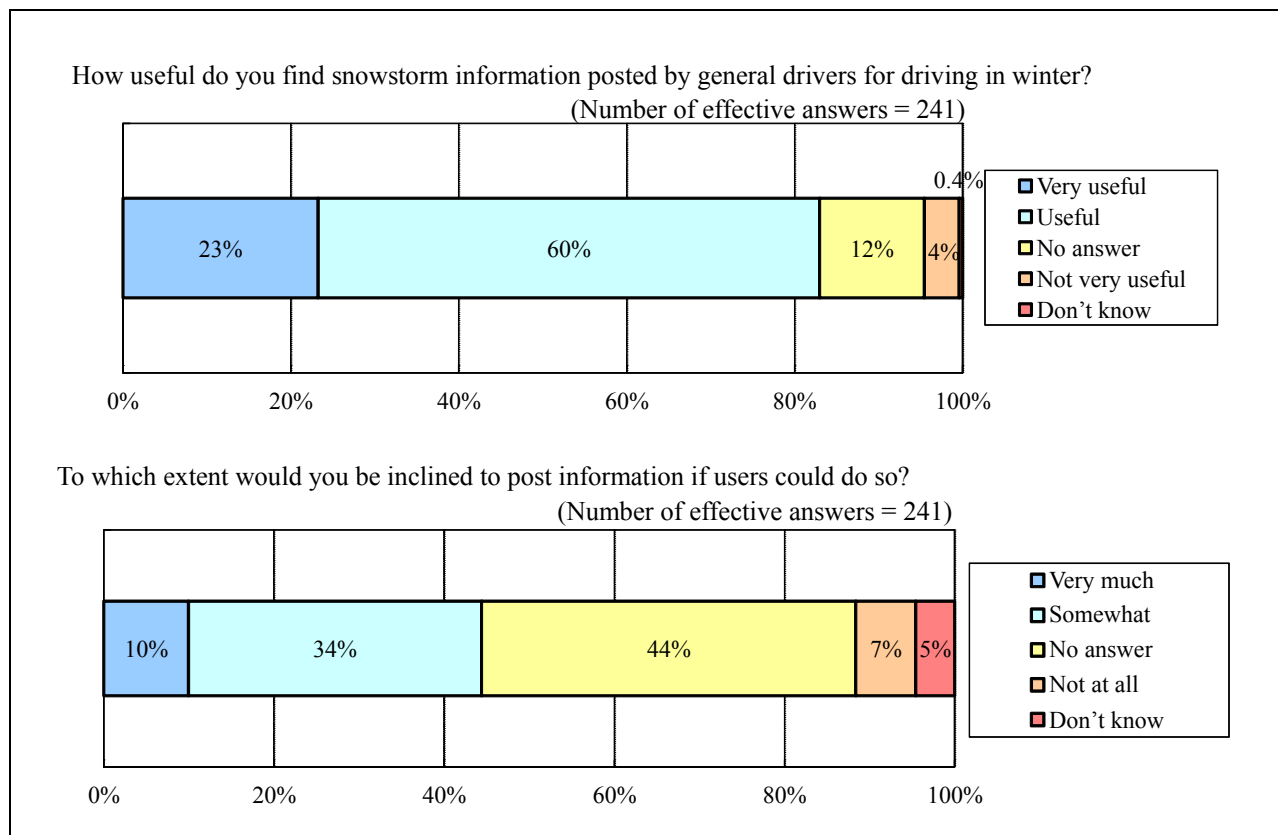
A questionnaire survey was conducted on the effectiveness and feasibility of providing posted snowstorm information in the same way as for the detailed winter road information during the period from February 18 to March 7, 2011, on the Northern Road Navi website. A total of 241 people responded to the survey, and Figure 12 shows the results.

It can be seen from the figure that in response to the question “How useful do you find snowstorm information posted by general drivers for driving in winter?” at least 90% of respondents answered “useful” or “somewhat useful,” indicating that the information was effective in the same way as snowstorm visibility information. In response to the question “To what extent would you be inclined to post information if users could do so?” at least 40% of respondents indicated that they would be inclined to post.

These results suggest that user-submitted information on snowstorm conditions can be quickly provided to road users in real time during snowstorms, and that posted information is useful as a measure to promote driving plan changes and safe driving when major snowstorms occur.



**FIGURE 11** Number of posts and accesses to the screen showing posted snowstorm information.



**FIGURE 12 Effects of posted snowstorm information (results of the questionnaire survey on the Northern Road Navi website).**

## CONCLUSION

This study involved the trial provision of snowstorm visibility information showing conditions in individual areas of Hokkaido, detailed winter road information showing information such as winter travel times (calculated in consideration of snowstorm visibility and road conditions), still images of roads, and real-time posted snowstorm information highlighting visibility conditions as submitted by road users.

The findings of the study can be summarized as follows:

- The snowstorm visibility information for PCs was evaluated as “useful” by at least 90% of questionnaire respondents. The validity of information provision to road users was confirmed by the number of page accesses, which was as high as 3,391 in 1 day.
- The detailed winter road information for PCs was evaluated as useful “when bad weather is forecast” by at least 80% of respondents and useful as a reference “when considering departure and arrival times.” The number of accesses to the information page tended to increase during periods of inclement weather and the detailed winter road information was regarded as effective for road users making driving plans.
- Of the data provided via the page showing detailed winter road information, snowstorm visibility conditions in individual municipalities along routes were evaluated as being

the most useful by users. The information was clearly more useful than data such as still images of roads that were provided together with it.

- Posted snowstorm information was evaluated as “useful” or “somewhat useful” by at least 90% of respondents, thereby confirming its value. A total of 47 people registered as authors of posts and 77 pieces of snowstorm information were posted during the trial period from January 27 to March 12, 2011. The questionnaire results showed that at least 40% of respondents would post snowstorm information if a facility to allow this was provided.

- It is therefore considered that posted snowstorm information will be an effective means of providing real-time data on snowstorm conditions if the number of post authors and users can be expanded and maintained.

## REFERENCES

1. Takechi, H., Y. Ito, H. Matsushita, T. Yamada, M. Matsuzawa, and Y. Kajiya. Snowstorm Disaster Situations and Tasks in Hokkaido in Winter 2008: Example from Near Naganuma in February. *Snow and Ice in Hokkaido*, No. 27, 2008, pp. 99–102 (in Japanese).
2. Ito, Y., H. Takechi, H. Matsushita, T. Yamada, M. Matsuzawa, and Y. Kajiya. Snowstorm Disaster Situations and Tasks in Hokkaido in Winter 2008: Examples from the Kushiro and Nemuro Regions in April. *Snow and Ice in Hokkaido*, No. 27, 2008, pp. 103–106 (in Japanese).
3. Kajiya, Y., Y. Matsuda, and T. Matsushima. Study on the Expression of Winter Road Information and Its Effects on Travelers’ Decision Making, Monthly Report. Civil Engineering Research Institute For Cold Region, August 2007 (in Japanese).
4. Matsushima, T., Y. Kajiya, and Y. Yamagiwa. Style and Behavior Changes Relating to the Provision of Winter Road Information Through the Internet. 60th Academic Lecture Abstracts. Japan Society of Civil Engineers, 2005 (in Japanese).
5. Takechi, H., M. Matsuzawa, and H. Nakamura. Relationship Between Human Perceptions of Visibility During Snowstorms and Values Measured Using Transmissometers and Drift Collectors. *Snow and Ice in Hokkaido*, No. 28, 2009 (in Japanese).
6. Matsuzawa, M. The Development and Use of Method for Estimating Visibility During Snowstorm. Civil Engineering Research Institute for Cold Region, May 2006 (in Japanese).
7. Kajiya, Y., M. Matsuzawa, T. Suzuki, K. Tanji, and Y. Nagata. A Consideration on Drivers Behavior During Reduced Visibility Condition by Falling and Blowing Snow. *Proc., 2004 Cold Region Technology Conference*, Hokkaido Development Engineering Center, 2004 (in Japanese).
8. Hokkaido Road Information website (Road and Traveler Information in Hokkaido). Northern Road Navi. Available at <http://www.northern-road.jp/navi/> (in Japanese).
9. Time and Distance Search. <http://time-n-rd.jp/> (in Japanese).
10. Takechi, H., M. Matsuzawa, H. Nakamura, M. Kaneko, and T. Kawanaka. The Effects that Visibility and Surface Conditions of Winter Roads Have on Driving Speed. Civil Engineering Research Institute for Cold Region, December 2010 (in Japanese).



## WEATHER INFORMATION TO IMPROVE DRIVER DECISIONS

**Tomorrow's Forecast**  
*Informed Drivers***SHELDON DROBOT**  
**MICHAEL B. CHAPMAN**  
**AMANDA ANDERSON**  
**BRICE LAMBI***National Center for Atmospheric Research***PAUL A. PISANO**  
**GABRIEL GUEVARA**  
*Federal Highway Administration*

The transportation community is well on its way toward the development of wireless vehicle capabilities where vehicles communicate with other vehicles and the road infrastructure to improve safety and mobility and to reduce environmental impacts. In the near future, it will be possible for millions of vehicles to anonymously collect direct (e.g., temperature) and indirect (e.g., wiper status) measurements of the road and atmospheric conditions in their immediate surroundings. This will greatly expand the current weather observation network, particularly in respect to the roadway environment. However, the volume and anonymity of vehicle-based observations, and the fact that the observations are from a moving platform, pose several challenges related to data integrity. These must be addressed before the data will be broadly usable and acceptable. With funding and support from the U.S. Department of Transportation's Research and Innovative Technology Administration and direction from FHWA's Road Weather Management Program, the National Center for Atmospheric Research is conducting research to develop a vehicle data translator (VDT) to address these vehicle-based data challenges. The main function of the VDT is to quality check individual vehicle probe data elements, such as temperature and pressure, and then combine them into "derived observations" that are valid along a given length of roadway over a given time. The objective of this paper is to provide an overview of the VDT Version 3.

The U.S. Department of Transportation's (DOT) FHWA and Research and Innovative Technology Administration are working jointly to promote safety, mobility, and the environment on the nation's surface transportation system through a new connected vehicle initiative. This initiative is a multimodal effort to enable wireless communications among vehicles, the infrastructure, and passengers' personal communication devices. It will enhance Americans' safety, mobility, and quality of life while helping to reduce the environmental impact of surface transportation.

This paper outlines work that the University Corporation for Atmospheric Research's National Center for Atmospheric Research (NCAR) has done to develop a vehicle data translator (VDT) system. The VDT ingests and processes mobile data already resident on the vehicle along with ancillary weather data (e.g., radar). Continued work on the VDT revolves around several key concepts:

- Developing the connected vehicles' role in the overall FHWA Road Weather Management Program (RWMP) goal of anytime, anywhere road weather information;
- Improving the characterization of current weather and road conditions, especially from a spatial perspective;
- Exploiting any and all vehicle-based data, including
  - Data from original equipment manufacturer (OEM) sensors (e.g., air temperature, wiper status, braking status) and
  - Data from after-market sensors (e.g., pavement temperature, plow status);
- Combining data from vehicles with data from fixed sources (e.g., *Clarus*); and
- Outputting basic and inferred segment-based weather and road conditions to support weather-related applications.

Earlier versions of the VDT were developed using nine to 11 vehicles operating in the Detroit Development Test Environment (DTE) in the winter and spring of 2009 and 2010. Additional details on this work are presented in NCAR (1, 2). Using the vehicle data, as well as standard weather observations, e.g., radar, satellite, and model analyses, NCAR developed algorithms to derive road and atmospheric hazard condition assessments as part of the VDT 2.0.

The long-term FHWA goal for connected vehicles includes the collection of vehicular and environmental status data by millions of passenger and commercial vehicles. The data will be transmitted to other vehicles and to the infrastructure to be used for safety, mobility, and environmental applications. Environmental data will include weather and road condition data, such as ambient air temperature and atmospheric pressure, road surface temperature, and road friction coefficient. Some vehicle status data will also be related to weather and road conditions, such as windshield wiper status, antilock braking system status, electronic stability, and traction control status. Ultimately, decision makers will have the benefit of decision-support tools that have access to data provided by millions of vehicles. However, the specific development of decision support tools is not a foundational platform of this project. Rather, here the FHWA RWMP desires to demonstrate how weather, road condition, and related vehicle data may be collected, transmitted, and processed. Using existing fleet infrastructures, data sets, sensors, and wireless communications technology provided by state DOTs, this project will help to determine standards and procedures by prototyping the process of integrating weather, road condition, and vehicle status data messages.

This project builds on the capabilities of the VDT to ingest mobile weather, road condition, and vehicle status data, check the data quality, and aggregate the data for use in applications. The project also features the integration of mobile weather and road condition data into the FHWA's *Clarus* system. *Clarus*, operated by Mixon Hill Inc. under contract to the FHWA, currently organizes weather and road condition data collected by stationary sensors across the United States and parts of Canada, and makes the data available over the Internet with text and graphics-based retrieval systems.

The overall objectives of this project are to

1. Determine requirements for collection and processing of weather, road condition, and vehicle status data from mobile sources;
2. Enhance the VDT tool and use it to perform quality checks and consolidate weather and road condition data;

3. Demonstrate the value of adding weather, road condition, and vehicle status data from mobile sources into management or decision-support systems and other road weather-based applications; and
4. Provide data input to the *Clarus* system, the Data Capture and Management program, and other programs.

### VDT 3.0 DATA PROCESSING

This section outlines some basic terms, discusses the three main stages in the VDT 3.0, and provides some comments on VDT-related applications and data storage.

#### Basic Terminology and Input Data

The definition of several terms will aid the reader in understanding this paper.

Input data are referred to as one of two things:

- Mobile data are all data originating from a vehicle, whether native to the Controller Access Network Bus (CANBus) or as an add-on sensor (e.g., pavement temperature sensor mounted to a vehicle).
- Ancillary data represent all other data, such as surface weather stations, model output, satellite data, and radar data.

Within the VDT, three data types are referenced:

- Point data are individual data points with a known time stamp and geographic location. An example would be a single air temperature reading from a moving vehicle.
- Gridded data represent a spatial area on the Earth, such as a 5-km<sup>2</sup> box. Gridded data can consist of a single observation (e.g., radar pixel) or a combination of data points statistically compiled within a grid cell (e.g., average temperature in a grid cell from several surface stations).
- Segment data represent a given stretch of roadway with a single data value. This data may be an average of several point data values (e.g., average speed of five vehicles over a 1-mi segment), or the fusion of several point data sources (e.g., combining wiper, brake, and temperature data to determine road slickness potential).

The VDT also contains several data formats:

- Raw data are simply geolocated data.
- Quality-checked (QC) data are raw data after some form of QC has been performed.
- Basic road segment data are individual QC data compiled via some statistical procedure. Examples include the mean air temperature along a segment or the number of wiper data points set to off. The basic road segment statistics do not combine different types of input data into a single product. For instance, a basic road segment output would never combine wipers and temperature data into a single road condition analysis.
- Advanced road segment data combine at least two types of QC data. An example is combining road temperature and brake information to generate a road slickness assessment.

## VDT Overview

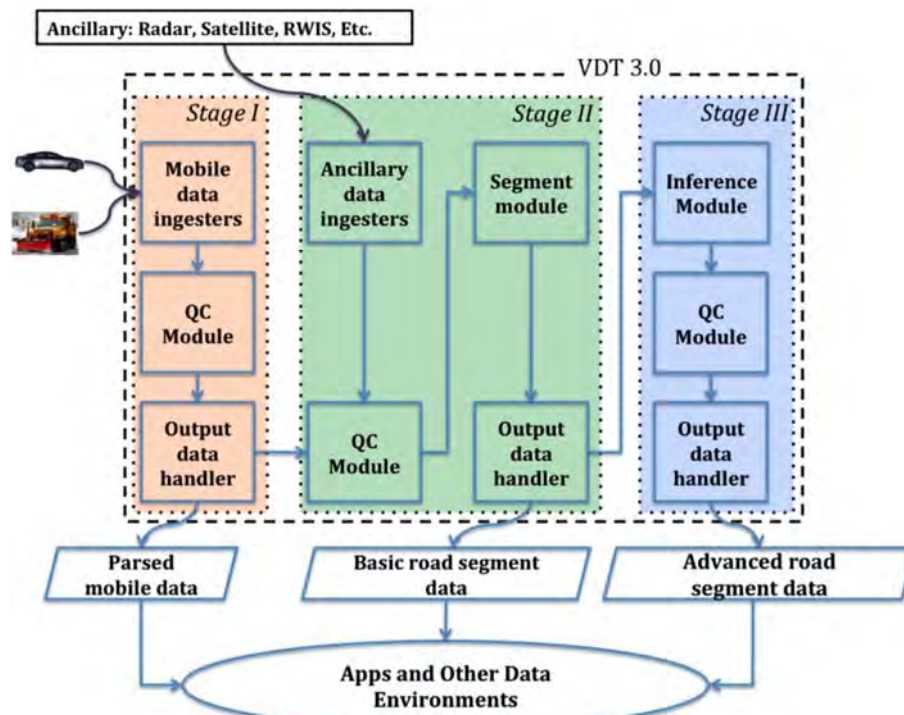
The organizational construct for how the data are processed in the VDT 3.0 is displayed in [Figure 1](#).

### *Stage I: Mobile Data Collection, Parsing, and Sorting*

The initial stage of the VDT ingests mobile data. If the data are already pre-processed in some way, such as by the *Clarus* system, then the VDT can simply read the metadata and data from the *Clarus* output. However, the VDT also has routines to directly ingest mobile data from the CANBus or a data collection and forwarding facility, parse them, and then sort them by time, road segments, and grid cells (the road segments and grid cells are user-defined via configuration files). This stage also reads any extra data sent from the vehicle that originates outside of the CANBus, such as readings from add-on sensors. These data are then passed through a QC module that tags data that contain invalid geospatial or temporal information (e.g., latitude values greater than 90°N or time of day greater than 23:59:59). All data are passed through the output data handler, which outputs the parsed mobile data for use in applications, and also for use in Stage II of the VDT. One such application has already been created, and it can display the data from this stage on a Google Map.

### *Stage II: Basic Road Segment Data*

Stage II analyses provide the road segment data using QC mobile data. The QC module examines individual mobile data (CANBus and some add-on sensors) and flags each data point for the relevant QC tests that are listed in [Table 1](#). Ancillary data, such as *Clarus* surface station data and radar data, are also ingested by the ancillary data ingesters, which perform the same



**FIGURE 1** VDT 3.0 data processing.

**TABLE 1 Comparison of Some Data and Process Changes in VDT 3.0 Versus VDT 2.0**

Module/Process	VDT 2.0	VDT 3.0
Probe data elements	External air temperature Atmospheric pressure Wiper status Headlight status accelerometer Antilock braking status Traction control Stability control Rate of change of steering Vehicle velocity Brake status Brake boost Date Time Location Vehicle heading Rain (rain sensor)	External air temperature Atmospheric pressure Wiper status Headlight status accelerometer Antilock braking status Traction control Stability control Rate of change of steering Vehicle velocity Brake status Brake boost Date Time Location Vehicle heading Rain (rain sensor) Relative humidity Pavement temperature Revolutions per minute Engine torque Exhaust diagnostics
Radar	Composite reflectivity	Composite reflectivity Echo top Velocity Precipitation Vertically integrated liquid Dual-polarization data
Gridded Weather Observations	Rapid update cycle (RUC) Surface assimilation systems (RSAS)	RUC real-time mesoscale analysis (RTMA)
Satellite	Geostationary Operational Environmental Satellite (GOES): 2- and 4-km cloud mask (present/not present)	GOES: 2- and 4-km cloud mask (Naval Research Laboratory cloud classification algorithm)
Surface stations	Automated Surface Observing System (ASOS)/Automated Weather Observing System (AWOS)	ASOS/AWOS Clarus, MADIS
Road weather forecasts	Not present	NCAR Road Weather Forecast System

functions as the Stage I mobile data ingestors module (except in this case for ancillary data), including time stamping and geolocating. These ancillary data are then used in some of the quality checking processes, but they are not QC themselves; however, the ancillary data used in the VDT 3.0 is all QC by other means before being incorporated into the VDT. All data are passed through to the statistics component, where the mobile data that pass QC are used to compute road segment statistics. Examples of these data would include the mean air temperature

over an individual road segment for a given time step, or the percentage of windshield wipers activated over an individual road segment for a given time step. All mobile data with QC flags and the statistical data for the basic road segment data are output from Stage II.

### *Stage III: Advanced Road Segment Data*

Stage III analyses provide additional value-adds for mobile data. In the inference module, fuzzy logic algorithms, decision trees, and other data mining procedures are used to produce the advanced road segment data. Examples of these include combining mobile data with radar, satellite, and fixed-surface station data to compute a derived road precipitation product over an individual road segment for a given time step. These data are then run through a QC module that assigns a confidence value to the advanced road segment data assessments.

## **Applications and Other Data Environments**

Data from the VDT will be used in applications and other data environments (Table 2). Although not part of the VDT 3.0, NCAR has built one application, the Pathfinder VDT display, which can show all data output from the VDT 3.0 (stages I, II, or III), as well as (a) National Weather Service (NWS) watches, warnings, and advisories; (b) NWS Storm Prediction Center (SPC) storm reports; (c) radar and satellite data; and (d) social media feeds, such as Twitter.

## **Data Storage**

Data are not archived in the VDT 3.0, but data sent from the VDT to other data environments, such as *Clarus*, may be archived.

## **VDT QC ROUTINES**

The QC routines are largely based on the *Clarus* QC routines, with modifications for mobile data. Only mobile data (CANBus and some add ons) are QC. This section outlines the specific QC tests in VDT 3.0. Like the *Clarus* system, all the tests are run on each sensor reading, and the test results are combined to obtain an overall confidence factor. This section describes the various QC tests.

### ***Clarus*-Based Tests**

#### *Anticipated Range Test*

The anticipated range test (ART) detects readings that fall outside the anticipated realistic range of sensor hardware specifications or theoretical limits (i.e., a maximum and minimum value). If the observation value is greater than or equal to the minimum, and less than or equal to the maximum, the sensor reading passes this quality check. If the sensor reading value is less than the minimum or greater than the maximum, the sensor reading does not pass. This test is useful in identifying observations that are likely not possible on the given sensor, particularly if the

**TABLE 2 VDT Applications and Other Data Environments**

NWS products	National Oceanic and Atmospheric Administration SPC storm reports NWS watch–warning–advisory information NWS story of the day	SPC storm reports NWS watch–warning–advisory information NWS story of the day
Social media	Twitter (#wxreport)	Twitter (#wxreport, #STwx <sup>1</sup> )
<b>QC Routines</b>		
	<i>Clarus</i> -based: anticipated range test Non- <i>Clarus</i> based: Data filtering test Neighboring station test Model analysis test Combined algorithm test Neighboring vehicle test	<i>Clarus</i> -based: Anticipated range test Persistence test Step test Spatial tests (replaces neighboring station test) Climate range test  Non- <i>Clarus</i> based: Data filtering test Model analysis test (enhanced) Neighboring vehicle test Combined algorithm test
<b>VDT Algorithms</b>		
	Precipitation Pavement condition Visibility All hazards	Precipitation (enhanced) Pavement condition (enhanced) Visibility All-hazards (enhanced)

NOTE: <sup>1</sup>ST stands for the two-letter state modifier, such as #OKwx, #COWx, etc.

sensor uses an unusual value for identifying missing observations (e.g., 167.3 instead of -999). Unlike bounds for the *Clarus* system, it is not possible to know with precision the ART bounds for some vehicle instruments. This is because the OEMs do not release this information, so we cannot know with certainty the actual limits for every sensor on the road. Additionally, due to privacy–anonymity issues, even if we knew the ranges for sensors, we will not know which sensors are being used for some vehicles.

*Time Step Test*

The time step test detects sensor readings whose values change by more than a predefined variable-specific or station-specific rate over a 30-min (past) and 5-min (future) configurable period. For example, in the *Clarus* system, an air temperature reading from 2:00 p.m. will be compared to the corresponding air temperature sensor readings from the same sensor that was recorded in the time range of 1:30 p.m. to 2:05 p.m. This test requires that the sensor can be tracked through time, so this test can only work on vehicles that can be identified, such as fleet vehicles; it will not be useful to run this on passenger vehicle data that are anonymized.

Each time this test is invoked, it is given a single sensor reading. The system then obtains all of the sensor readings that have been received over the configured time period from the same

sensor that are of the same weather parameter type. If either the current sensor reading or the prior sensor readings (a minimum of one is required) cannot be obtained, the test returns immediately with an error condition indicating that it was not able to run.

From the sensor, the system obtains configured positive and negative step threshold rates. If the difference between the current sensor value and the prior sensor value divided by the time difference in seconds  $[(\text{current} - \text{prior}) / \text{time difference}]$  falls between the negative step threshold and positive step threshold rates, then the current sensor reading passes the step quality check. If the computed rate falls outside the defined rates, then the current sensor reading does not pass the step quality check. This method assumes that the positive step threshold is specified as a positive value and the negative step threshold is specified as a negative value.

### *Persistence Test*

The persistence test (PET) detects whether sensor readings remain constant for a predefined variable-specific period of time. For example, in the *Clarus* system, if consecutive pressure sensor readings remain unchanged to the precision of the instrument for 4 h, the current sensor reading will not pass the PET. This test requires that the sensor can be tracked through time, so this test can only work on vehicles that can be identified, perhaps such as fleet vehicles; it will not be useful to run this on passenger vehicle data that are anonymized.

Each time this test is invoked, it is given a single sensor reading, which then determines the persistence time period. Consecutive sensor readings from the same sensor over that period of time preceding the current observation are then obtained. If the current sensor reading or the prior sensor reading cannot be obtained, the test returns immediately with an error condition indicating that it was unable to run.

If one or more of the consecutive sensor values are different, the current sensor reading passes the persistence quality check. If all of the consecutive sensor values over the given time period are equivalent, the current sensor does not pass the persistence quality check.

### *Spatial Tests: Air Pressure and Air and Pavement Temperature (STTa and STTp)*

In version 2.0 of the VDT, both temperature and pressure were QC using the nearest station test (NST). For the NST, a temperature observation passed if it was within 2°C of the station observation and pressure if the observation was within 5 hPa. While this test was sufficient for the smaller DTE, a more sophisticated QC method is necessary for VDT 3.0.

The pressure spatial test will compare the observations with the closest surface stations in space and time. The nearest stations are currently defined as being within a 69-mi radius (The 69-mi radius is a legacy of earlier implementations of the *Clarus* QC algorithms) and 5-min observation time from the data point; however, for the VDT 3.0, NCAR will examine other radius values and time ranges. In concept, this test mirrors the newest version of the sea level pressure test (3) performed in the *Clarus* system and is a major enhancement to the simple NST that VDT 2.0 uses for both temperature and pressure spatial QC.

The temperature spatial tests (air pressure and air and pavement temperature) mirror the newer spatial QC from the *Clarus* system as well. Where there are more than five observations within a 69-mi radius and a 5-min observation time, the interquartile range (IQR) is used as a more robust method for spatial QC. In the instance where there are fewer observations than



required for an IQR, the Barnes spatial QC method will be used. These are new tests for the VDT 3.0.

### *Climate Range Test*

The climate range test (CRT) detects sensor readings that fall outside predetermined climate range values. This test does not exist in version 2.0 of the VDT, but it does for the *Clarus* system. We propose to mirror the *Clarus* CRT. Namely, the climate range data for *Clarus* were drawn from 30 years of National Centers for Environmental Prediction-Department of Energy Reanalysis 2 data. These reanalysis data are created by running a set of historical observational data through a common model, thus ensuring that the output data are consistent over time. The reanalysis also ensures that data are available in every time period at every grid point. Bounds for the CRT test were determined by computing monthly minimum and maximum values over a 2.5-degree x 2.5-degree fixed latitude-longitude grid. In the latitude band, this equates to a grid spacing of 172.5 mi. In the longitude band, this varies from 172.5 mi at the equator, to 0 mi at the poles. Each time this QC test is invoked, it is given a single sensor reading. The appropriate climate maximum and minimum values used for the test are determined by the month of the sensor reading date and the latitude-longitude region in which the sensor reading location falls. If the sensor reading value is greater than or equal to the climate minimum, and less than or equal to the climate maximum, the sensor reading passes the climate range quality check. If the sensor reading value is less than the climate minimum or greater than the climate maximum, the sensor reading does not pass the sensor climate range quality check.

### **Non-Clarus-Based Tests**

#### *Data Filtering Test*

In some cases, data may be obviously in error, such as latitude values greater than 90°N or a time value greater than 23:59:59. In special conditions, such as tunnels, data may be misleading (e.g., headlights and wiper status may differ in a tunnel). Additionally, some research (4) indicates that at low speed, air temperature data may not be reliable, though other findings do not show this results (3). This user-configurable QC will offer the ability to filter out these kinds of data.

#### *Model Analysis Test*

The model analysis test compares the air temperature and pressure observations from the vehicles to those of a numerical weather model analysis field for the closest grid point. The VDT 2.0 is set up to use the RSAS data for the pixel closest in space to the observation. VDT 3.0 will use the more robust RTMA. These data will be ingested into the VDT 3.0 every hour.

#### *Neighboring Vehicle Test*

The neighboring vehicle test (NVT) compares the given vehicle observation to neighboring vehicles in the road segment. Specifically, the standard deviation and the mean of the observations along a 1-mi road segment during a 5-min snapshot are taken, and then each observation is checked to be sure it falls within a standard deviation, multiplied by a constant, of

the mean of the road segment. Currently, the VDT version 2.0 uses a constant of 2.5, meaning the observations are checked to see if they fall within 2.5 standard deviations of the mean of the user-defined or standard 1-mi road segment. This value was chosen based on previous tests with the Data Use and Analysis Project and the 2009 DTE experiment (DTE09) and 2010 DTE experiment (DTE10) data, which were tested with the VDT and determined 2.0 standard deviations, was too strict. For VDT 3.0, this test will mirror the spatial tests (Barnes or IQR) being performed for the *Clarus* system and also include using  $\pm 5$  min as the time period. A minimum number of vehicles are required for either the IQR or Barnes spatial tests to run in order for the NVT to be statistically sound. This may prove to be a difficult test to run until a larger vehicle dataset becomes available.

## VDT ALGORITHMS

### Precipitation

The VDT 3.0 precipitation algorithm will provide an assessment of the type and intensity (amount/hour) or accumulation rate of precipitation that is falling to the road surface by road segment. We anticipate that it will have four precipitation types: rain, snow, ice–mixed, and hail. Additionally, it will distinguish between light–moderate and heavy rates of these precipitation types. “No precipitation” will, of course, also be included.

The following minimum input vehicle data are designed for inclusion into the algorithm:

- Air temperature,
- Front wiper status,
- Headlight status, and
- Ratio of vehicle speed to road segment speed limit.

Additionally, the following ancillary data will be considered:

- Time of day,
- Date,
- Radar reflectivity,
- Satellite cloud mask,
- Naval Research Laboratory (NRL) cloud classifier, and
- Dual-polarization radar observations.

Air temperature is a useful parameter in determining the likely type of precipitation (liquid versus frozen). It can be useful for precipitation rate in that at very cold temperatures, heavy precipitation is unlikely due to the reduced amount of moisture in the atmosphere. Wiper status would, of course, indicate when the drivers needed to remove liquid or ice from their windshields. Other parameters would be useful in determining whether the wipers are removing precipitation or road splash, or if precipitation is occurring but wipers are not being used (e.g., light snow). Headlight status can give an indication of precipitation by indicating reduced visibility, as well as the common driving concept or legal requirement of turning on one’s headlights in precipitation. Low speed ratios can indicate heavy precipitation as well as snowy or

icy conditions. This would be especially helpful near the freezing point of 0°C, where lower speed ratios would indicate ice–snow and higher would indicate rain. Nonrecurring congestion is important to consider, too, and using time of day and date would help indicate if slow speed ratios are occurring during typical noncongestion times. Radar reflectivity will be useful particularly for indicating if precipitation is occurring and how heavily it is falling. For the satellite cloud mask, a sky clear of clouds can help differentiate between road splash and actual precipitation. When the NRL cloud classifier is incorporated, the cloud types can help identify storm cells (cumulonimbus) that are likely producing heavy rain or hail. This could be especially useful in areas where Doppler radar coverage is sparse, such as some areas of the high terrain in the western United States. Further into the future, when the NWS begins running dual-polarization radar operationally, radar fields aside from the reflectivity can be analyzed for their ability to infer precipitation type. This could be useful for identifying precipitation type around 0°C. Additionally dual-polarization radar should greatly improve rainfall rate estimation from the radar, useful in alerting for heavy rain and hydroplaning risk. It is important to note that the radar detects precipitation type above the ground rather than at the surface, and the further away from the radar the higher above the ground the detection. However, other parameters such as air temperature and vehicle observations can be used in conjunction with the hydrometeor identification above the ground to infer what is happening at the surface.

A variety of techniques will be examined to enhance the version 3.0 algorithm. In its current VDT version 2.0 form, the algorithm is a decision tree. Other methods such as fuzzy logic will be explored and their usefulness evaluated. Additionally, data mining procedures will be used to identify other useful vehicle observations and adjust the specific thresholds used within the algorithm. These will include, but are not limited to, developing a decision tree from a dataset of observations and linear regression models. Random forest, another type of classification and regression tree (5), is an additional option.

### **Pavement Condition**

The pavement algorithm is being developed to derive the pavement condition on a segment of roadway from the vehicle observations. Pavement conditions being considered are: dry, wet, road splash, snow, icy–slick, and hydroplaning risk. Particular effort will be focused on the slickness component.

The following vehicle data are being considered for this algorithm, although other vehicle information may also be considered:

- Air temperature,
- Road temperature,
- Front wiper status,
- Ratio of vehicle speed to road segment speed limit,
- Antilock brakes–traction control–stability control engagement,
- Latitudinal acceleration,
- Longitudinal acceleration,
- Yaw rate,
- Steering angle, and
- Steering angle rate.

Additionally, the following nonvehicle data will be considered:

- Radar reflectivity,
- Satellite cloud mask,
- Dual-polarization radar observations, and
- NRL cloud classifier.

Analysis of current data suggests that air and road temperature can help indicate whether roads are wet, snow-covered, or slick. For example, an air temperature of  $-6^{\circ}\text{C}$  would support the possibility of a road being snow covered, whereas an air temperature of  $6^{\circ}\text{C}$  would not be supportive of keeping snow or ice on the road. Front wiper status can help indicate precipitation or road splash. A low speed ratio can indicate a hazard, such a slick roadways, whereas a speed ratio near 1 would indicate roads are not very slick. Along with slickness, antilock brakes, traction control, or stability control are more likely to be engaged in such an environment than on dry pavement. Previous research shows that increased variability (i.e., larger IQR) of latitudinal and longitudinal acceleration, yaw rate, and steering angle corresponded to engagement of the antilock brakes and traction and stability control systems. This likely corresponds to a driver trying to control a swerving car, and hence the trigger to engage the systems. The rate of change of the steering angle will also be examined. For outside data sources, the presence or absence of radar reflectivity and clouds as viewed by the satellite can help distinguish between precipitation and road splash. The reflectivity is also helpful for identifying whether roadways are more likely to be dry or wet–snow covered, and this distinction could further be improved with hydrometeor identification from dual-polarization radar. Also, as mentioned in the previous subsection, the NRL cloud classification could be useful in areas outside of (or with limited) radar coverage as well as identifying areas likely to be experiencing heavy precipitation, which in turn could indicate roadways that are becoming snow covered or have a hydroplaning risk.

As with precipitation, several techniques will be explored to form the pavement algorithm. Again, decision trees and fuzzy logic will be analyzed. Additionally, work has begun in using fuzzy logic sets for the algorithm. For this method, each pavement type (e.g., slick and dry) has a set of fuzzy logic functions associated with it. There is one function for each input parameter (e.g., wiper status) in each set. The value of each function (0 to 1) is added up for all functions within the set. The “most likely” pavement type is then the type that has the highest sum. For example, suppose the slick pavement set has a sum of 7 while the dry pavement set has a sum of 2. Between the two sets, the pavement is determined to be slick. This method was chosen based on a similar method used to determine the most likely hydrometeor type using dual-polarization radar measurements.

## Visibility

The visibility algorithm is being designed to provide additional information by road segment as to both a general decrease in visibility as well as more specific visibility issues. This approach is being considered because specific visibility hazards such as blowing snow may be able to be derived, but in other cases the vehicle reports may indicate low visibility without an indication of the precise cause. In addition to reporting visibility as normal or low, possible specific hazards include dense fog, heavy rain, blowing snow, and smoke.

The following minimum input vehicle data will be considered for inclusion into the algorithm:

- Air temperature,
- Front wiper status,
- Headlight status, and
- Ratio of vehicle speed to road segment speed limit.

Additionally, the following nonvehicle data will be considered:

- NRL cloud classifier,
- Wind speed (currently from the nearest ASOS),
- Relative humidity (currently from the nearest ASOS),
- Visibility from nearest ASOS, and
- Output from the precipitation algorithm.

Analysis has determined that air temperature is a useful predictor for low visibility. This may be due to its inherent relation to relative humidity and thus haze and fog. Wiper status is a good indication of heavy precipitation or road splash causing a reduction in visibility. Headlight status can help identify both low visibility and fog. For example, drivers are likely to have their headlights on in low visibility, may turn their fog lights on, and are less likely to have their high beam lights on. Speed ratio may be useful in that drivers are likely to drive slower, especially on Interstates or other highways, when visibility is low. The NRL cloud classifier could aid in identifying low cloud (e.g., stratus) associated with reduced visibility (e.g., haze or fog). Wind speed may be useful in both identifying the potential for blowing snow as well as the likelihood of fog, with higher wind speeds making fog less likely due to the mixing of the air. In analyzing the data, relative humidity has emerged as a useful predictor, likely due to its relation to haze, fog, and precipitation. Two methods may be used in assigning the relative humidity: directly from the nearby fixed weather stations, or using the stations' dew point temperature as well as vehicle air temperature. Visibility from the nearest fixed stations, of course, will give some idea of visibility in the vicinity of the road segment, but there are many local variations that may limit its usability. Finally, output from the precipitation algorithm may be useful in assigning specific precipitation-related visibility obstructions such as heavy rain or blowing snow.

## REFERENCES

1. An Analysis of Temperature and Pressure Data from Connected Vehicles in the Developmental Testbed Environment. FHWA-JPO-10-062/NTL #14968. National Center for Atmospheric Research, 2009.
2. *Clarus* Quality Checking Algorithm Documentation Report. National Center for Atmospheric Research, 2010.
3. Vehicle-Based Data Assessment. National Center for Atmospheric Research, 2010.
4. Vehicles as Mobile Sensing Platforms for Meteorological Observations: Introductory Research During a Winter Season. Mitretek, 2006.
5. Breiman, L. Random Forests. *Machine Learning*, Vol. 45, 2001, pp. 5–32.

## APPENDIX

**Author Contact Information**

Jessica Adkins  
Cargill, Incorporated  
916 South Riverside Avenue  
St. Clair, MI 48079  
810-989-7558; Fax: 810-329-3328  
E-mail: Jessica\_adkins@cargill.com

Michelle Akin  
Western Transportation Institute  
Montana State University–Bozeman  
P.O. Box 174250  
Bozeman, MT 59717-4250  
406-994-6356; Fax: 406-994-1697  
E-mail: michelle.akin@coe.montana.edu

Shawn Allan  
AMEC  
P.O. Box 13216  
St. John's, Newfoundland  
Labrador  
A1B 4A5 Canada  
709-722-7023  
E-mail: shawn.allan@amec.com.

Roemer M. Alfelor  
Federal Highway Administration  
1200 New Jersey Avenue  
Room E84-422  
Washington, DC 20590  
202-366-9242  
E-mail: roemer.alfelor@dot.gov

Amanda Anderson  
National Center for Atmospheric Research  
3450 Mitchell Lane  
Boulder, CO 80307  
303-497-2746; Fax: 303-497-2825  
E-mail: aander@ucar.edu

Motoki Asano  
Civil Engineering Research Institute for Cold  
Region  
1-34, Hiragishi 1-3, Toyohira-ku  
Sapporo 062-8602 Japan  
+81-11-841-5198; Fax: +81-11-841-9747  
E-mail: m-asano@ceri.go.jp

Mark A. Askelson  
University of North Dakota  
Clifford Hall Room 400  
4149 University Avenue, Stop 9006  
Grand Forks ND 58202-9006  
701-777-6334  
E-mail: askelson@aero.und.edu

Namchul Baik  
Korea Institute of Construction Technology  
1190, Simindae-Ro, Ilsanseo-Gu, Goyang-Si,  
Gyeonggi-Do, 411-712  
Republic of Korea  
+ 82-31-910-0684; Fax: 82-31-919-5694  
E-mail: nc100@kict.re.kr

Kevin Balke  
TTI/TransLink Research Center  
Gibb Gilchrist Building, Room 158  
Texas A&M University System  
3135 TAMU  
College Station, TX 77843  
979-845-9899  
E-mail: k-balke@tamu.edu

Brian Bell  
Global Science & Technology, Inc.  
7855 Walker Drive, Suite 200  
Greenbelt, MD 20770  
301-474-9696; Fax: 301-474-5970  
E-mail: brian.bell@gst.com

David L. Bergner  
4024 E. Elmwood Street  
Mesa, AZ 85205  
480-669-4043  
E-mail: dlbergner@gmail.com  
Andrew Betts  
School of Engineering  
University of Guelph  
Guelph, ON, N1G 2W1  
bettsa@uoguelph.ca

Göran Blomqvist  
Swedish National Road and  
Transport Research Institute  
SE-581 95 Linköping, Sweden  
+46 13 20 40 00; Fax: +46 13 14 14 36  
E-mail: goran.blomqvist@vti.se.

Jörgen Bogren  
Klimator AB and Department of Earth Sciences  
Göteborg University  
Box 460  
SE – 405 30 Göteborg, Sweden  
E-mail: jorgen@gvc.gu.se

Brenda Boyce  
Mixon/Hill, Inc.  
12980 Metcalf Avenue, Suite 470  
Overland Park, KS 66213  
913-239-8400  
E-mail: Brenda.Boyce@mixonhill.com

Per Brandli  
Norwegian Public Roads Administration  
Åndalsnes, Norway  
+47 95 80 54 04  
E-mail: per.brandli@vegvesen.no

Amy Burlarley-Hyland  
DBi Services LLC  
100 North Conahan Drive  
Hazleton, PA 18201  
570-459-1112; Fax 570.459.0321  
E-mail: abhyland@dbiservices.com

Michael Chapman  
National Center for Atmospheric Research  
3450 Mitchell Lane  
Boulder, CO 80307  
303-497-8395; Fax: 303-497-8386  
E-mail: mchapman@ucar.edu

Madhav Chitturi  
University of Wisconsin–Madison  
1415 Engineering Drive B243  
Madison, WI 53706  
608-890-2439  
E-mail: mchitturi@wisc.edu

Chris Cluett  
Battelle  
1100 Dexter Ave North, Suite 400  
Seattle, WA 98109  
206-528-3333  
E-mail: cluett@battelle.org

Peter Davies  
Castle Rock Associates  
524 E. Burnside Street, Suite 710  
Portland, OR 97214  
646-926-7738; Fax: 623-321-8330  
E-mail: Peter.Davies@crc-corp.com

Paul Delannoy  
AMEC  
210 Colonnade Road South, Suite 300  
Ottawa, Ontario, K2E 7L5, Canada  
613-727-0658  
E-mail: paul.delannoy@amec.com

R. Mark DeVries  
McHenry County Department of Transportation  
16111 Nelson Road  
Woodstock, Illinois 60098  
815-334-4975; Fax: 815-334-4989  
E-mail: rmdevries@co.mchenry.il.us

Garrett Donaher  
University of Waterloo  
58 Roslin Avenue South  
Waterloo, Ontario, N2L 2G8 Canada  
519-781-7654  
E-mail: gdonaher@gmail.com

Sheldon Drobot  
National Center for Atmospheric Research  
3450 Mitchell Lane  
Boulder, CO 80307  
303-497-2705; Fax: 303-497-2825  
E-mail: drobot@ucar.edu

Jeremy Duensing  
 Telvent DTN  
 11400 Rupp Drive  
 Burnsville, MN 55337  
 952-882-4554; Fax: 19528824500  
 E-mail: jeremy.duensing@telventdtn.com

Johan Edblad  
 MetSense AB  
 Box 460  
 405 30, Gothenburg, Sweden  
 E-mail: edblad@mitsense.com

Souhail Elhouar  
 Department of Civil Engineering and  
 Construction  
 Bradley University  
 206 Jobst Hall  
 Peoria, IL 61625  
 309-677-3830; Fax: 309-677-2867  
 E-mail: selhouar@bradley.edu

Bonnie J. Fields  
 Pennsylvania Department of Transportation  
 400 North Street  
 Harrisburg, PA 17120  
 717-214-8686  
 E-mail: bfields@pa.gov

Daniel Fortin  
 Iowa State University  
 Department of Statistics & Statistical Laboratory  
 Snedecor Hall  
 Ames, IA 50011-1210  
 515-294-3443; Fax: 515-294-4040  
 E-mail: dfortin@iastate.edu

Liping Fu  
 Department of Civil and Environmental  
 Engineering  
 University of Waterloo  
 200 University Avenue West  
 Waterloo, ON, N2L 3G1, CANADA  
 519-888-4567 ext. 33984; Fax: (519) 725-5441  
 E-mail: lfu@uwaterloo.ca

Douglas Galarus  
 Western Transportation Institute  
 Montana State University  
 P.O. Box 174250  
 Bozeman, Montana 59717-4250  
 406-994-5268  
 E-mail: dgalarus@coe.montana.edu

Bahram Gharabaghi  
 50 Stone Road East  
 School of Engineering  
 University of Guelph  
 Guelph, ON, N1G 2W1  
 519-824-4120 ext 58451  
 E-mail: bgharaba@uoguelph.ca

Terje Giæver  
 Norwegian Public Roads Administration,  
 Trondheim  
 Postboks 8142 Dep,  
 NO-0033 Oslo  
 +47 926 19 403  
 E-mail: terje.giaver@vegvesen.no

Charles C. Goodhart  
 Pennsylvania Department of Transportation  
 400 North Street  
 Harrisburg, PA 17120  
 717-787-6899  
 E-mail: cgoodhart@pa.gov

Deepak Gopalakrishna  
 Battelle  
 100 M Street SE, Suite 250  
 Washington, D.C. 20003  
 202-479-9645  
 E-mail: gopalakrishnad@battelle.org

Tina Greenfield  
 Iowa Department of Transportation  
 800 Lincoln Way  
 Ames, IA 50010  
 515-233-7746; Fax: 515-239-1005  
 E-mail: tina.greenfield@dot.iowa.gov



Dagfin Gryteselv  
 SINTEF Road and Railway Engineering  
 P.O. Box 4760  
 Sluppen NO-7465 Trondheim  
 +47 930 96 827/ +47 7359 6829  
 E-mail: dagfin.gryteselv@sintef.no

Gabriel Guevara  
 Federal Highway Administration  
 1200 New Jersey Avenue, SE  
 Washington, DC, 20590  
 202-366-0754; Fax: 202-366-3225  
 E-mail: gabriel.guevara@dot.gov

Patrick Grover  
 4DM Inc.  
 Toronto, Ontario, Canada  
 416-410-7569  
 E-mail: pgrover@4dm-inc.com

Torbjörn Gustavsson  
 University of Gothenburg  
 Department of Earth Sciences, Box 460  
 405 30, Gothenburg, Sweden  
 +46 31 786 1964  
 E-mail: torbjorn@gvc.gu.se

Wolfgang Hafner  
 Magistrat der Landeshauptstadt Klagenfurt am  
 Wörthersee  
 A-9010 Klagenfurt am Wörthersee  
 Bahnhofstraße 35, Austria  
 +43 (0)463 537 4885; Fax: +43 (0)463 511694  
 E-mail: wolfgang.hafner@klagenfurt.at

Zachary Hans  
 Center for Transportation Research and  
 Education (CTRE)  
 Institute for Transportation  
 Iowa State University  
 2711 S. Loop Drive, Ste 4700  
 Ames, IA 50010-8664  
 515-294-2329  
 E-mail: zhans@iastate.edu

Yusuke Harada  
 Civil Engineering Research Institute for Cold  
 Region  
 Public Works Research Institute  
 1-3 Hiragishi Toyohira-ku,  
 Sapporo, Hokkaido, 062-8602, JAPAN  
 +81-11-841-1746; Fax: +81-11-841-9747  
 E-mail: harada-y@ceri.go.jp

Barbara T. Harder  
 B. T. Harder, Inc.  
 1610 Spruce Street, 3rd Floor  
 Philadelphia, PA 19103  
 215-735-2482  
 E-mail: btharder@sprintmail.com

Robert D. Hart  
 Meridian Environmental Technology, Inc.  
 4324 University Avenue, Suite B  
 Grand Forks, ND 58203  
 701-792-1800  
 E-mail: bobhart@meridian-enviro.com

Matt Haubrich  
 Iowa Department of Transportation  
 800 Lincoln Way  
 Ames, IA 50010  
 515-233-7902; Fax: 515-239-1005  
 E-mail: matthew.haubrich@dot.iowa.gov.  
 Neal Hawkins  
 Center for Transportation Research & Education  
 (CTRE)  
 Institute for Transportation  
 Iowa State University  
 2711 S. Loop Dr, Ste 4700  
 Ames, IA 50010-8664  
 E-mail: (hawkins@iastate.edu

Neil Hellas  
 4DM Inc.  
 Toronto, Ontario, Canada  
 416-410-7569  
 E-mail: nhellas@4dm-inc.com

Paul Heppner  
Global Science & Technology, Inc.  
7855 Walker Drive, Suite 200  
Greenbelt, MD 20770  
301-474-9696; Fax: 301-474-5970  
E-mail: paul.heppner@gst.com

Benjamin W. Hershey  
Meridian Environmental Technology, Inc.  
4324 University Avenue, Suite B  
Grand Forks, ND 58203  
701-792-1800  
E-mail: bhershey@meridian-enviro.com

Jennifer L. Hershey  
University of North Dakota  
501 N. Columbia Road, Stop 9037, Room 2702  
Grand Forks, ND 58202-0937  
701-777-2250  
E-mail: jhershey@rwic.und.edu

Ivar Hol  
Norwegian Public Roads Administration  
Molde, Norway  
+47 95 80 54 04  
E-mail: ivar.hol@vegvesen.no

Yasuhiko Ito  
Snow Avalanche and Landslide Research Center  
Erosion and Sediment Control Research Group  
Public Works Research Institute  
2-6-8 Nishiki-cho, Myoko-shi  
Niigata, 944-0051, JAPAN  
+81-255-72-4131, Fax: +81-255-72-9629  
E-mail: yasu-ito@pwri.go.jp

Jinhwan Jang  
Korea Institute of Construction Technology  
1190, Simindae-Ro, Ilsanseo-Gu, Goyang-Si,  
Gyeonggi-Do, 411-712  
Republic of Korea  
+82-31-910-0684; Fax: 82-31-919-5694  
E-mail: jhjang@kict.re.kr

Woo Hoon Jeon  
Korea Institute of Construction Technology  
Goyang, Korea  
E-mail: cwsoon@kict.re.kr

Mark Kaiser  
Iowa State University  
Department of Statistics & Statistical Laboratory  
Snedecor Hall  
Ames IA 50011-1210  
515-294-3443; Fax: 515-294-4040  
E-mail: mskaiser@iastate.edu

Shigeru Kamiyama  
Hokkaido Regional Development Bureau  
N8W2, Kita-Ku, Sapporo, 060-8511, Japan  
+81-11-709-2311; Fax: +81-11-757-3270  
E-mail: kamiyama-s22ab@hkdlit.go.jp

Manabu Kaneko  
Civil Engineering Research Institute for Cold  
Region  
Public Works Research Institute  
1-3 Hiragishi Toyohira-ku  
Sapporo, Hokkaido, 062-8602, JAPAN  
+81-11-841-1746; Fax: +81-11-841-9747  
E-mail: kaneko-m22ae@ceri.go.jp

Toshiro Kawanaka  
Civil Engineering Research Institute for Cold  
Region  
Public Works Research Institute  
1-3 Hiragishi Toyohira-ku  
Sapporo, Hokkaido, 062-8602, JAPAN  
+81-11-841-1746; Fax: +81-11-841-9747  
E-mail: 93170@ceri.go.jp

Paul S. Keltner  
Wisconsin Department of Transportation  
433 W. St. Paul  
Milwaukee, WI 53203  
414-227-2141  
E-mail: Paul.Keltner@dot.wi.gov

Olga Kidson  
Nova Scotia Transportation and Infrastructure  
Renewal  
P.O. Box 186  
Halifax, Nova Scotia, Canada, B3J 2N2  
902-424-3621  
E-mail: kidsonol@gov.ns.ca.

In Su Kim  
Korea Institute of Construction Technology  
Goyang, Korea  
E-mail: mriskim@kict.re.kr

Makoto Kiriishi  
Civil Engineering Research Institute for Cold  
Region  
PWRI, IAA  
1-3 Hiragishi, Toyohira-ku  
Sapporo, 062-8602, Japan  
+81-11-841-1738; Fax: +81-11-841-9747  
E-mail: kiriishi-m22aa@ceri.go.jp

Scott Koefod  
Cargill, Incorporated  
2301 Crosby Road  
Wayzata, MN 55391  
952-742-5670; Fax: 952-742-3300  
E-mail: scott\_koefod@cargill.com

Dan Koller  
Meridian Environmental Technology, Inc.  
4324 University Avenue, Suite B  
Grand Forks, ND 58203  
701-792-1800  
E-mail: koller@meridian-enviro.com

Masayuki Kumagai  
Civil Engineering Research Institute for Cold  
Region  
Public Works Research Institute  
Hiragishi 1-3-1-34  
Toyohira-ku, Sapporo, 062-8602 JAPAN  
+81-11-841-5561; FAX:+81-11-841-9747  
E-mail: kumagai-m22ab@ceri.go.jp

Jeffrey Kuntz  
Meridian Environmental Technology, Inc.,  
Grand Forks, ND  
701-792-1800  
E-mail: jkuntz@meridian-enviro.com

Brice Lambi  
National Center for Atmospheric Research  
3450 Mitchell Lane Boulder, CO 80307  
303-497-8467; Fax:-303-497-2825  
E-mail: lambi@ucar.edu

Steve Lavrenz  
Iowa State University  
Department of Statistics & Statistical Laboratory  
Snedecor Hall  
Ames, IA 50011-1210  
515-294-3443; Fax: 515-294-4040  
E-mail: slavrenz@iastate.edu)

Jing Li  
Iowa State University  
Department of Statistics & Statistical Laboratory  
Snedecor Hall  
Ames, IA 50011-1210  
515-294-3443; Fax: 515-294-4040  
E-mail: lijing@iastate.edu

Enad Mahmoud  
Bradley University  
1501 W. Bradley Avenue  
Jobst Hall 100  
Peoria, IL 61625  
309-677-2945  
E-mail: emahmoud@bradley.edu

Hiroki Matsushita  
Civil Engineering Research Institute for Cold  
Region  
Public Works Research Institute  
Hiragishi 1-3-1-34, Toyohira-ku  
Sapporo, Hokkaido, 062-8602, Japan  
+81-11-841-1746 ; Fax: +81-11-841-9747  
E-mail: hmatsu@ceri.go.jp

Masaru Matsuzawa  
Civil Engineering Research Institute for Cold  
Region  
Public Works Research Institute  
Hiragishi 1-3-1-34, Toyohira-ku  
Sapporo, Hokkaido, 062-8602, Japan  
+81-11-841-1746; Fax: +81-11-841-9747  
E-mail: masaru@ceri.go.jp

Steven McArdle  
4DM Inc.  
Toronto, Ontario  
416-410-7569  
E-mail: smcardle@4dm-inc.com

Anthony K. McClellan  
 Meridian Environmental Technology, Inc.  
 4324 University Avenue, Suite B  
 Grand Forks, ND 58203  
 701-792-1800  
 E-mail: [tmcclellan@meridian-enviro.com](mailto:tmcclellan@meridian-enviro.com)

John J. Mewes  
 Meridian Environmental Technology, Inc.  
 4324 University Avenue, Suite B  
 Grand Forks, ND 58203  
 701-792-1800  
 E-mail: [jmewes@meridian-enviro.com](mailto:jmewes@meridian-enviro.com)

Luis F. Miranda-Moreno  
 Department of Civil Engineering and Applied  
 Mechanics  
 McGill University  
 Montreal, Quebec H3A 2K6  
 514-398-6589; Fax: (514) 398-7361  
 E-mail: [luis.miranda-moreno@mcgill.ca](mailto:luis.miranda-moreno@mcgill.ca)

Hiroshi Nakamura  
 Civil Engineering Research Institute for Cold  
 Region  
 Public Works Research Institute  
 Hiragishi 1-3-1-34, Toyohira-ku  
 Sapporo, Hokkaido, 062-8602, JAPAN  
 +81-11-841-1746; Fax: +81-11-841-9747  
 E-mail: [nakamura-h22ae@pwri.go.jp](mailto:nakamura-h22ae@pwri.go.jp)

Li Ningyuan  
 Changsha University of Science and Technology  
 45 Shiling Road, Changsha  
 Hunan, China 410076  
 +86-137-20541209  
 E-mail: [nli@uwaterloo.ca](mailto:nli@uwaterloo.ca)

Anna Niska  
 Swedish National Road and Transport Research  
 Institute (VTI)  
 SE- 581 95 Linköping, Sweden  
 +46 (0) 13 20 40 48; Fax: +46 (0) 13 14 14 36  
 E-mail: [anna.niska@vti.se](mailto:anna.niska@vti.se)

Wilfrid A. Nixon  
 University of Iowa  
 4105 SC, College of Engineering  
 Iowa City, Iowa 52242  
 319-335-5166; Fax: 319-335-5660  
 E-mail: [wilfrid-nixon@uiowa.edu](mailto:wilfrid-nixon@uiowa.edu)

Inya Nlenanya  
 Center for Transportation Research & Education  
 (CTRE)  
 Institute for Transportation  
 Iowa State University  
 2711 S. Loop Dr, Ste 4700  
 Ames, IA 50010-8664  
 E-mail: [inya@iastate.edu](mailto:inya@iastate.edu)

David A. Noyce  
 Traffic Operations and Safety (TOPS)  
 Laboratory  
 Department of Civil and Environmental  
 Engineering  
 University of Wisconsin–Madison  
 1415 Engineering Drive 1204  
 Madison, WI 53706  
 608-265-1882  
 E-mail: [noyce@engr.wisc.edu](mailto:noyce@engr.wisc.edu)

Gudrun Öberg  
 Swedish National Road and Transport Research  
 Institute (VTI)  
 SE-581 95 Linköping, Sweden  
 Fax: + 46 13 14 14 36  
 E-mail: [gudrun.oberg@vti.se](mailto:gudrun.oberg@vti.se)

Jun-Seok Oh  
 Western Michigan University  
 Kalamazoo, Michigan  
 269- 276-3216  
 E-mail: [jun.oh@wmich.edu](mailto:jun.oh@wmich.edu)

Leon F. Osborne, Jr.  
 Meridian Environmental Technology, Inc.  
 4324 University Avenue, Suite B  
 Grand Forks, ND 58203  
 701-792-1800  
 E-mail: [leono@meridian-enviro.com](mailto:leono@meridian-enviro.com)

Gregory M. Ostermeier  
 Meridian Environmental Technology, Inc.  
 4324 University Avenue, Suite B  
 Grand Forks, ND 58203  
 701-792-1800  
 E-mail: grego@meridian-enviro.com

Max S. Perchanok  
 Ontario Ministry of Transportation  
 301 St. Paul Street  
 St. Catharines, Ontario L2R 7R4  
 E-mail: Max.Perchanok@ontario.ca

Nandana Perera  
 University of Guelph  
 50 Stone Road East  
 Guelph, ON, N1G 2W1  
 519-824-4120 ext 58451  
 E-mail: mperera@uoguelph.ca

Paul A. Pisano  
 USDOT/Federal Highway Administration  
 1200 New Jersey Avenue, SE  
 Washington, D.C. 20590  
 202-366-1301; Fax: 202-366-3225  
 E-mail: paul.pisano@dot.gov

Benoit Pouliot  
 AMEC  
 50 Troop Avenue, Unit 300  
 Dartmouth, Nova Scotia, B3B 1Z1, Canada  
 902-480-5434  
 E-mail: benoit.pouliot@amec.com

Jaime Rall  
 National Conference of State Legislatures  
 (NCSL)  
 7700 East First Place  
 Denver, Colorado 80230  
 303-856-1417; Fax: 303-856-2626  
 E-mail: jaime.rall@ncsl.org

Michael S. Renz  
 Vance & Renz, LLC  
 606 Wayland Place  
 State College, PA 16803  
 814-231-8155  
 E-mail: mike@vancerenz.com

Mats Riehm  
 Royal Institute of Technology  
 Land and Water Resources Engineering  
 Brinellvägen 28, 100 44  
 Stockholm, Sweden  
 +46 8 790 8987  
 E-mail: riehm@kth.se

Osamu Sakase  
 Civil Engineering Research Institute for Cold  
 Region  
 Public Works Research Institute  
 Hiragishi 1-3-1-34, Toyohira-ku  
 Sapporo, Hokkaido, 062-8602, Japan  
 +81-11-841-1746; Fax: +81-11-841-9747  
 E-mail: 94239@ceri.go.jp

Kelvin R. Santiago-Chaparro  
 Traffic Operations and Safety (TOPS)  
 Laboratory  
 Department of Civil and Environmental  
 Engineering  
 University of Wisconsin–Madison  
 1415 Engineering Drive B245  
 Madison, WI 53706  
 608-403-5302  
 E-mail: ksantiago@wisc.edu

Jung Gon Sung  
 Korea Institute of Construction Technology  
 Goyang, Korea  
 E-mail: jgsung@kict.re.kr

Todd Szymkowski  
 Traffic Operations and Safety (TOPS)  
 Laboratory  
 Department of Civil and Environmental  
 Engineering  
 University of Wisconsin–Madison  
 1415 Engineering Drive 1208  
 Madison, WI 53706  
 608-263-2684  
 E-mail: szymkowski@enr.wisc.edu

Tetsuya Takada  
 Civil Engineering Research Institute for Cold  
 Region  
 1-3 Hiragishi, Toyohira-ku  
 Sapporo, 062-8602, Japan  
 +81-11-841-1738; Fax: +81-11-841-9747  
 E-mail: t-takada@ceri.go.jp

Naoto Takahashi  
 Civil Engineering Research Institute for Cold  
 Region  
 1-3 Hiragishi, Toyohira-ku  
 Sapporo, 062-8602, Japan  
 +81-11-841-1738; Fax: +81-11-841-9747  
 E-mail: takahashi-n24k@ceri.go.jp

Hiroataka Takechi  
 Civil Engineering Research Institute for Cold  
 Region  
 Public Works Research Institute  
 1-3 Hiragishi Toyohira-ku  
 Sapporo, Hokkaido, 062-8602, Japan  
 +81-11-841-1746; Fax: +81-11-841-9747  
 E-mail: hiro-takechi@ceri.go.jp

Julie L. Theisen  
 Meridian Environmental Technology, Inc.  
 4324 University Avenue, Suite B  
 Grand Forks, ND 58203  
 701-792-1800  
 E-mail: theisen@meridian-enviro.com

Roberto A. Tokunaga  
 Civil Engineering Research Institute for Cold  
 Region, PWRI, IAA  
 1-3 Hiragishi, Toyohira-ku  
 Sapporo, 062-8602, Japan  
 +81-11-841-1738; Fax: +81-11-841-9747  
 E-mail: roberto-1097ga@ceri.go.jp

Mary W. Treisbach  
 390 Rittenhouse Boulevard  
 Norristown, PA 19403  
 610-635-0525  
 E-mail: mtreisbach@gmail.com

Masayo Ueda  
 Civil Engineering Research Institute for Cold  
 Region  
 Public Works Research Institute  
 1-3 Hiragishi Toyohira-ku  
 Sapporo, Hokkaido, 062-8602, Japan  
 +81-11-841-1746; Fax: +81-11-841-9747  
 E-mail: m-ueda@ceri.go.jp

Dane Unruh  
 Castle Rock Associates  
 524 E. Burnside Street, Suite 71  
 Portland, OR 9721  
 971-404-0333; Fax: 623-321-833  
 E-mail: Dane.Unruh@crc-corp.com

Taimur Usman  
 University of Waterloo  
 Waterloo, ON, N2L 3G1, Canada  
 519- 888 4567 ext. 31170  
 E-mail: tusman@engmail.uwaterloo.ca

Torgeir Vaa  
 Norwegian Public Roads Administration  
 Trondheim, Norway  
 +47 92 61 94 01  
 E-mail: torgeir.vaa@vegvesen.no

Robert J. Vance  
 Vance & Renz, LLC  
 606 Wayland Place  
 State College, PA 16803  
 814-231-8155  
 E-mail: bob@vancerenz.com

Kristin Virshbo  
 Castle Rock Associates  
 524 E. Burnside Street, Suite 710  
 Portland, OR 97214  
 503-246-2743; Fax : 623-321-8330  
 E-mail: Kristin.Virshbo@crc-corp.com

Wei Wang  
 Henan Vocational and Technical College of  
 Communications  
 165 Hanghai Zhong Road, Zhengzhou  
 Henan, China 450052  
 +86-371-68858012  
 E-mail: hnjyww@163.com

Takashi Watanabe  
 Civil Engineering Research Institute for Cold  
 Region  
 Public Works Research Institute  
 1-3 Hiragishi Toyohira-ku  
 Sapporo, Hokkaido, 062-8602, Japan  
 +81-11-841-1746; Fax: +81-11-841-9747  
 E-mail: 06143@ceri.go.jp

Phil Woodhams  
AMEC  
210 Colonnade Road South, Suite 300  
Ottawa, Ontario, K2E 7L5, Canada  
613-727-0658  
E-mail: philip.woodhams@amec.com

Tatsuya Yamazaki  
Hokkaido Regional Development Bureau, MLIT  
N8W2, Kita-Ku  
Sapporo, 060-8511, Japan  
+81-11-709-2311; Fax: +81-11-709-8956  
E-mail: yamazaki-t22ab@hkd.mlit.go.jp

Mr. Yuji Yanagisawa  
Civil Engineering Research Institute for Cold  
Region  
Public Works Research Institute  
Hiragishi 1-3-1-34, Toyohira-ku  
Sapporo, 062-8602 Japan  
+81-11-590-4051; Fax: +81-11-590-4054  
E-mail: y-yanagi@ceri.go.jp

Choong Heon Yang  
Korea Institute of Construction Technology  
Goyang, Korea  
E-mail: chyang@kict.re.kr

David Yohanan  
Telvent USA Corporation  
1390 Piccard Drive, Suite 200  
Rockville, MD 20850  
301-354-4664  
E-mail: David.Yohanan@telvent.com.

Duk-Geun Yun  
Korea Institute of Construction Technology  
Goyang, Korea  
E-mail: dkyun@kict.re.kr

Zhengyuan Zhu  
Iowa State University  
Snedecor Hall  
Ames, IA 50011-1210  
515-294-3443; Fax: 515-294-4040  
E-mail: zhuz@mail.adp.iastate.edu

# THE NATIONAL ACADEMIES

## *Advisers to the Nation on Science, Engineering, and Medicine*

The **National Academy of Sciences** is a private, nonprofit, self-perpetuating society of distinguished scholars engaged in scientific and engineering research, dedicated to the furtherance of science and technology and to their use for the general welfare. On the authority of the charter granted to it by the Congress in 1863, the Academy has a mandate that requires it to advise the federal government on scientific and technical matters. Dr. Ralph J. Cicerone is president of the National Academy of Sciences.

The **National Academy of Engineering** was established in 1964, under the charter of the National Academy of Sciences, as a parallel organization of outstanding engineers. It is autonomous in its administration and in the selection of its members, sharing with the National Academy of Sciences the responsibility for advising the federal government. The National Academy of Engineering also sponsors engineering programs aimed at meeting national needs, encourages education and research, and recognizes the superior achievements of engineers. Dr. Charles M. Vest is president of the National Academy of Engineering.

The **Institute of Medicine** was established in 1970 by the National Academy of Sciences to secure the services of eminent members of appropriate professions in the examination of policy matters pertaining to the health of the public. The Institute acts under the responsibility given to the National Academy of Sciences by its congressional charter to be an adviser to the federal government and, on its own initiative, to identify issues of medical care, research, and education. Dr. Harvey V. Fineberg is president of the Institute of Medicine.

The **National Research Council** was organized by the National Academy of Sciences in 1916 to associate the broad community of science and technology with the Academy's purposes of furthering knowledge and advising the federal government. Functioning in accordance with general policies determined by the Academy, the Council has become the principal operating agency of both the National Academy of Sciences and the National Academy of Engineering in providing services to the government, the public, and the scientific and engineering communities. The Council is administered jointly by both Academies and the Institute of Medicine. Dr. Ralph J. Cicerone and Dr. Charles M. Vest are chair and vice chair, respectively, of the National Research Council.

The **Transportation Research Board** is one of six major divisions of the National Research Council. The mission of the Transportation Research Board is to provide leadership in transportation innovation and progress through research and information exchange, conducted within a setting that is objective, interdisciplinary, and multimodal. The Board's varied activities annually engage about 7,000 engineers, scientists, and other transportation researchers and practitioners from the public and private sectors and academia, all of whom contribute their expertise in the public interest. The program is supported by state transportation departments, federal agencies including the component administrations of the U.S. Department of Transportation, and other organizations and individuals interested in the development of transportation. [www.TRB.org](http://www.TRB.org)

[www.national-academies.org](http://www.national-academies.org)





TRANSPORTATION RESEARCH BOARD  
500 Fifth Street, NW  
Washington, DC 20001

**THE NATIONAL ACADEMIES™**

*Advisers to the Nation on Science, Engineering, and Medicine*

The nation turns to the National Academies—National Academy of Sciences, National Academy of Engineering, Institute of Medicine, and National Research Council—for independent, objective advice on issues that affect people's lives worldwide.

[www.national-academies.org](http://www.national-academies.org)