

## LED Airfield Lighting System Operation and Maintenance

### DETAILS

---

90 pages | 8.5 x 11 | PAPERBACK

ISBN 978-0-309-37494-1 | DOI 10.17226/22076

### AUTHORS

---

John Burns, Chuck Dennie, Shady Elshetwy, Doron Lean, and Joe Vigilante; Airport Cooperative Research Program; Transportation Research Board; National Academies of Sciences, Engineering, and Medicine

BUY THIS BOOK

FIND RELATED TITLES

### Visit the National Academies Press at [NAP.edu](http://NAP.edu) and login or register to get:

---

- Access to free PDF downloads of thousands of scientific reports
- 10% off the price of print titles
- Email or social media notifications of new titles related to your interests
- Special offers and discounts



Distribution, posting, or copying of this PDF is strictly prohibited without written permission of the National Academies Press. (Request Permission) Unless otherwise indicated, all materials in this PDF are copyrighted by the National Academy of Sciences.

**AIRPORT COOPERATIVE RESEARCH PROGRAM**

---

---

**ACRP REPORT 148**

---

---

**LED Airfield Lighting System  
Operation and Maintenance**

**John Burns  
Chuck Dennie  
Shady Elshetwy**  
BURNS ENGINEERING, INC.  
Philadelphia, PA

**Doron Lean  
Joe Vigilante**  
LEAN ENGINEERING, INC.  
Irvine, CA

*Subscriber Categories*  
Aviation

---

Research sponsored by the Federal Aviation Administration

---

**TRANSPORTATION RESEARCH BOARD**

WASHINGTON, D.C.  
2015  
[www.TRB.org](http://www.TRB.org)

## AIRPORT COOPERATIVE RESEARCH PROGRAM

Airports are vital national resources. They serve a key role in transportation of people and goods and in regional, national, and international commerce. They are where the nation's aviation system connects with other modes of transportation and where federal responsibility for managing and regulating air traffic operations intersects with the role of state and local governments that own and operate most airports. Research is necessary to solve common operating problems, to adapt appropriate new technologies from other industries, and to introduce innovations into the airport industry. The Airport Cooperative Research Program (ACRP) serves as one of the principal means by which the airport industry can develop innovative near-term solutions to meet demands placed on it.

The need for ACRP was identified in *TRB Special Report 272: Airport Research Needs: Cooperative Solutions* in 2003, based on a study sponsored by the Federal Aviation Administration (FAA). ACRP carries out applied research on problems that are shared by airport operating agencies and not being adequately addressed by existing federal research programs. ACRP is modeled after the successful National Cooperative Highway Research Program (NCHRP) and Transit Cooperative Research Program (TCRP). ACRP undertakes research and other technical activities in various airport subject areas, including design, construction, legal, maintenance, operations, safety, policy, planning, human resources, and administration. ACRP provides a forum where airport operators can cooperatively address common operational problems.

ACRP was authorized in December 2003 as part of the Vision 100—Century of Aviation Reauthorization Act. The primary participants in the ACRP are (1) an independent governing board, the ACRP Oversight Committee (AOC), appointed by the Secretary of the U.S. Department of Transportation with representation from airport operating agencies, other stakeholders, and relevant industry organizations such as the Airports Council International-North America (ACI-NA), the American Association of Airport Executives (AAAE), the National Association of State Aviation Officials (NASAO), Airlines for America (A4A), and the Airport Consultants Council (ACC) as vital links to the airport community; (2) TRB as program manager and secretariat for the governing board; and (3) the FAA as program sponsor. In October 2005, the FAA executed a contract with the National Academy of Sciences formally initiating the program.

ACRP benefits from the cooperation and participation of airport professionals, air carriers, shippers, state and local government officials, equipment and service suppliers, other airport users, and research organizations. Each of these participants has different interests and responsibilities, and each is an integral part of this cooperative research effort.

Research problem statements for ACRP are solicited periodically but may be submitted to TRB by anyone at any time. It is the responsibility of the AOC to formulate the research program by identifying the highest priority projects and defining funding levels and expected products.

Once selected, each ACRP project is assigned to an expert panel appointed by TRB. Panels include experienced practitioners and research specialists; heavy emphasis is placed on including airport professionals, the intended users of the research products. The panels prepare project statements (requests for proposals), select contractors, and provide technical guidance and counsel throughout the life of the project. The process for developing research problem statements and selecting research agencies has been used by TRB in managing cooperative research programs since 1962. As in other TRB activities, ACRP project panels serve voluntarily without compensation.

Primary emphasis is placed on disseminating ACRP results to the intended users of the research: airport operating agencies, service providers, and academic institutions. ACRP produces a series of research reports for use by airport operators, local agencies, the FAA, and other interested parties; industry associations may arrange for workshops, training aids, field visits, webinars, and other activities to ensure that results are implemented by airport industry practitioners.

## ACRP REPORT 148

Project A09-09  
ISSN 1935-9187  
ISBN 978-0-309-37494-1  
Library of Congress Control Number 2015957208

© 2015 National Academy of Sciences. All rights reserved.

### COPYRIGHT INFORMATION

Authors herein are responsible for the authenticity of their materials and for obtaining written permissions from publishers or persons who own the copyright to any previously published or copyrighted material used herein.

Cooperative Research Programs (CRP) grants permission to reproduce material in this publication for classroom and not-for-profit purposes. Permission is given with the understanding that none of the material will be used to imply TRB, AASHTO, FAA, FHWA, FMCSA, FRA, FTA, Office of the Assistant Secretary for Research and Technology, PHMSA, or TDC endorsement of a particular product, method, or practice. It is expected that those reproducing the material in this document for educational and not-for-profit uses will give appropriate acknowledgment of the source of any reprinted or reproduced material. For other uses of the material, request permission from CRP.

### NOTICE

The report was reviewed by the technical panel and accepted for publication according to procedures established and overseen by the Transportation Research Board and approved by the National Academies of Sciences, Engineering, and Medicine.

The opinions and conclusions expressed or implied in this report are those of the researchers who performed the research and are not necessarily those of the Transportation Research Board; the National Academies of Sciences, Engineering, and Medicine; or the program sponsors.

The Transportation Research Board; the National Academies of Sciences, Engineering, and Medicine; and the sponsors of the Airport Cooperative Research Program do not endorse products or manufacturers. Trade or manufacturers' names appear herein solely because they are considered essential to the object of the report.

*Published reports of the*

### AIRPORT COOPERATIVE RESEARCH PROGRAM

*are available from*

Transportation Research Board  
Business Office  
500 Fifth Street, NW  
Washington, DC 20001

*and can be ordered through the Internet by going to*

<http://www.national-academies.org>

*and then searching for TRB*

Printed in the United States of America

*The National Academies of*  
SCIENCES • ENGINEERING • MEDICINE

The **National Academy of Sciences** was established in 1863 by an Act of Congress, signed by President Lincoln, as a private, non-governmental institution to advise the nation on issues related to science and technology. Members are elected by their peers for outstanding contributions to research. Dr. Ralph J. Cicerone is president.

The **National Academy of Engineering** was established in 1964 under the charter of the National Academy of Sciences to bring the practices of engineering to advising the nation. Members are elected by their peers for extraordinary contributions to engineering. Dr. C. D. Mote, Jr., is president.

The **National Academy of Medicine** (formerly the Institute of Medicine) was established in 1970 under the charter of the National Academy of Sciences to advise the nation on medical and health issues. Members are elected by their peers for distinguished contributions to medicine and health. Dr. Victor J. Dzau is president.

The three Academies work together as the **National Academies of Sciences, Engineering, and Medicine** to provide independent, objective analysis and advice to the nation and conduct other activities to solve complex problems and inform public policy decisions. The Academies also encourage education and research, recognize outstanding contributions to knowledge, and increase public understanding in matters of science, engineering, and medicine.

Learn more about the National Academies of Sciences, Engineering, and Medicine at [www.national-academies.org](http://www.national-academies.org).

---

The **Transportation Research Board** is one of seven major programs of the National Academies of Sciences, Engineering, and Medicine. The mission of the Transportation Research Board is to increase the benefits that transportation contributes to society by providing leadership in transportation innovation and progress through research and information exchange, conducted within a setting that is objective, interdisciplinary, and multimodal. The Board's varied activities annually engage about 7,000 engineers, scientists, and other transportation researchers and practitioners from the public and private sectors and academia, all of whom contribute their expertise in the public interest. The program is supported by state transportation departments, federal agencies including the component administrations of the U.S. Department of Transportation, and other organizations and individuals interested in the development of transportation.

Learn more about the Transportation Research Board at [www.TRB.org](http://www.TRB.org).

# COOPERATIVE RESEARCH PROGRAMS

## **CRP STAFF FOR ACRP REPORT 148**

**Christopher W. Jenks**, *Director, Cooperative Research Programs*

**Michael R. Salamone**, *ACRP Manager*

**Joseph D. Navarrete**, *Senior Program Officer*

**Terri Baker**, *Senior Program Assistant*

**Eileen P. Delaney**, *Director of Publications*

**Hilary Freer**, *Senior Editor*

## **ACRP PROJECT 09-09 PANEL**

### **Field of Maintenance**

**Vivek Khanna**, *KSA Engineers, Inc., McKinney, TX (Chair)*

**Frank Barczak**, *PMA Consultants, Orlando, FL*

**Somnath Mukherjee**, *Port Authority of New York and New Jersey, Eng. Department, New York, NY*

**Ed Runyon**, *ADB Airfield Solutions, Columbus, OH*

**Tracy J. Saunders**, *Delta Airport Consultants, Inc., Charlotte, NC*

**Stephen Jon Schmitz**, *Lakeland Airport, Woodruff, WI*

**Thomas Mai**, *FAA Liaison*

**Richard Marchi**, *Airports Council International - North America Liaison*

**James W. Bryant, Jr.**, *TRB Liaison*

  
FOREWORD

By Joseph D. Navarrete

Staff Officer

Transportation Research Board

*ACRP Report 148: LED Airfield Lighting System Operation and Maintenance* provides guidance for operating and maintaining light-emitting diode (LED) airfield ground lighting systems, including taxi guidance signs, elevated light fixtures, and in-pavement light fixtures. The guidebook will be of particular interest to airport operations and maintenance (O&M) practitioners seeking to maximize the potential O&M benefits that LED lighting offers as they integrate and/or replace older airfield lighting with this new technology.

---

Airports require reliable airfield lighting to ensure safety and service continuity at night or other periods with low visibility, so a significant component of an airport's operating budget is dedicated to operating and maintaining airfield lighting systems. Since LED airfield lighting offers potential for substantially reduced maintenance and utility costs, the industry is accelerating the replacement of traditional lighting technologies with this new, more efficient technology. Although LED lighting offers improved efficiencies and reliability, operation and maintenance presents challenges (e.g., potential for obstruction by snow and ice, unique maintenance training and orientation requirements, and system performance monitoring issues). Additionally, O&M factors should be considered during the design and implementation of airfield lighting systems. Research was needed to develop guidance for airports to optimize the operation and maintenance of LED airfield lighting systems.

The research, led by Burns Engineering, began with a literature review. Next, an extensive survey of nearly 50 airports produced information on the extent to which LED lighting was used on airfields and on unique O&M practices for LED systems. More detail was obtained through case studies of 12 of the surveyed airports; the case studies focused on field and shop maintenance, unique training for staff regarding LED airfield maintenance, and general lessons learned. Based on the research, the team prepared its guidance.

The guidebook begins with an overview of regulatory requirements as they relate to LED airfield lighting and a summary of the survey and case studies. *ACRP Report 148* then provides guidance on maintenance, including acceptance testing and warranty, fixture obsolescence and spare part recommendations, preventive maintenance and refurbishment/repair, maintenance practices during pavement repair, and environmental factors (e.g., vibration and moisture). The guidebook also covers operational considerations, including circuit configuration, heaters, monitoring, photometric and chromaticity analysis, and return-on-investment. The guidebook is supplemented by a list of references, bibliography, glossary, and sample system requirements and maintenance schedules.

## AUTHOR ACKNOWLEDGMENTS

The Burns Engineering research team, including Lean Engineering, would like to thank the airports who participated in this research and contributed valuable information to support the development of this guidebook.

O'Hare International Airport, Chicago, IL (ORD)	Sacramento International Airport, Sacramento, CA (SMF)
John F. Kennedy International Airport, New York, NY (JFK)	John Wayne-Orange County Airport, Santa Ana, CA (SNA)
La Guardia Airport, New York, NY (LGA)	Portland International Airport, Portland, Oregon (PDX)
Dallas/Fort Worth International Airport, Dallas/Fort Worth, TX (DFW)	San Jose International Airport, San Jose, CA (SJC)
Orlando International Airport, Orlando, FL (MCO)	Louisville International-Standiford Field, Louisville, KY (SDF)
Baltimore/Washington International Thurgood Marshall Airport, Baltimore, MD (BWI)	Piedmont Triad International Airport, Greensboro, NC (GSO)
Washington Dulles International Airport, Dulles, VA (IAD)	Portland International Jetport, Portland, ME (PWM)
Ronald Reagan Washington National Airport, Arlington, VA (DCA)	Fresno International Airport, Fresno, CA (FAT)
Philadelphia International Airport, Philadelphia, PA (PHL)	Great Falls International Airport, Great Falls, MT (GTF)
San Francisco International Airport, San Francisco, CA (SFO)	Boise Air Terminal, Boise, Idaho (BOI)
Los Angeles International Airport, Los Angeles, CA (LAX)	Spokane International Airport, Spokane, WA (GEG)
Denver International Airport, Denver, CO (DEN)	Missoula International Airport, Missoula, MT (MSO)
Las Vegas International Airport, Las Vegas, NV (LAS)	St. George Municipal, St. George, UT (SGU)
Salt Lake City International Airport, Salt Lake City, UT (SLC)	King County International Airport/Boeing Field, Seattle, WA (BFI)
Seattle Tacoma, Seattle, WA (SEA)	Aspen Airport, Aspen, CO (ASE)
Phoenix International Airport, Phoenix, AZ (PHX)	Telluride Regional Airport, Telluride, CO (TEX)
Houston-Intercontinental Airport, Houston, TX (IAH)	Metropolitan Oakland International Airport, Oakland, CA (OAK)
Minneapolis International Airport, Minneapolis (MSP)	Long Beach Airport, Long Beach, CA (LGB)
Kansas City International Airport, Kansas City, MO (MCI)	Capital City Airport, Harrisburg, PA (CXY)
Memphis International Airport, Memphis, TN (MEM)	South Jersey Regional Airport, Mount Holly, NJ (VAY)
Ted Stevens Anchorage International Airport, Anchorage, AK (ANC)	Santa Monica Airport, Madison, SD (SMX)
Raleigh-Durham International Airport, Raleigh/Durham, NC (RDU)	Naples Municipal Airport, Naples, FL (APF)
Pittsburgh International Airport, Pittsburgh, PA (PIT)	Franklin County Regional Airport, Chambersburg, PA (N68)
	McGuire Field, Wrightstown, NJ (WRI)
	Joint Base Andrews, Camp Springs, MD (ADW)
	Camp Pendleton, Camp Pendleton, CA (NAS)
	Fallon Naval Air Station, Fallon, NV (NFL)



# CONTENTS

<b>1</b>	<b>Chapter 1 Introduction</b>
1	Background
2	Purpose and Objectives
3	Guidebook Layout
<b>4</b>	<b>Chapter 2 Guidelines and Research</b>
4	Regulatory Requirements
4	Surveys and Case Studies
<b>7</b>	<b>Chapter 3 Maintenance Considerations</b>
7	Acceptance Testing and Warranty
7	Acceptance Testing
16	Warranty
18	Fixture Obsolescence and Spare Parts Recommendations
18	Fixture Obsolescence
20	Spare Parts Recommendations
22	Determining Availability
22	Available Spare Parts
23	Quantity of Spare Parts Method
24	Preventive Maintenance and Refurbishment/Repair
28	Elevated Fixtures
29	In-pavement Fixtures
31	Maintenance Practices During Pavement Repair
31	Pre/During Paving
32	Post Paving
34	Environmental Factors
35	Vibration
37	Moisture
40	Additional Factors
<b>42</b>	<b>Chapter 4 Operation Considerations</b>
42	Circuit Configuration
42	Circuit Load Calculation
43	Circuit Optimization
46	Mixed Circuits with Lights and Signs
46	Mixed Circuits with Incandescent and LED Fixtures
46	3-Step vs. 5-Step CCRs for LED Circuits
47	LED Circuit Inrush
48	Heaters in Elevated and In-pavement Fixtures
52	Monitoring



53	Photometrics and Chromaticity
53	Photometrics
56	Chromaticity
58	Return on Investment Discussion
<b>62</b>	<b>References and Bibliography</b>
<b>63</b>	<b>Abbreviations and Acronyms</b>
<b>65</b>	<b>Glossary of Terms</b>
<b>66</b>	<b>Appendix A</b> System Requirements
<b>72</b>	<b>Appendix B</b> Maintenance Schedules

# Introduction

Airfield ground lighting (AGL) is a major element of pavement visibility. Coupled with pavement markings, signage, and instrument landing systems, ground lighting provides visual guidance to pilots and airport personnel. AGL over the years has used incandescent, quartz halogen, and fluorescent technology. The use of light-emitting diode (LED) technology in AGL has become more common in the past decade and significant advances have been made toward implementing this technology on airfields.

Although LED light fixtures have been approved for use by the FAA certification program under *Advisory Circular (AC) 150/5345-53, Airport Lighting Equipment Certification Program*, and *Engineering Brief 67, Light Sources Other than Incandescent and Xenon for Airport and Obstruction Lighting Fixtures*, concerns still exist regarding best practices for installation, operation, and maintenance.

Current reference, design, and maintenance documentation for AGL fixtures provides guidance for their maintenance. However, such documentation typically refers to LED light fixtures through procedures published for incandescent light fixtures. The research performed under ACRP Project 09-09 indicates differences in the operational and maintenance practices for LED fixtures. Approximately 49% of airports surveyed stated that they have a maintenance schedule for LED different from that for incandescent light fixtures.

Operation and maintenance practices for LED fixtures are deployed by individual airports with little carryover to other locations. This results in isolated solutions that have not attained industry concurrence. This guidebook, the result of collection and review of the methods used across the nation, presents a comprehensive collection of best practices.

## Background

AGL has been in use at airports since 1930. Initially, lighting was developed for the runway edges and then taxiway edges. These systems expanded to centerline lighting, touchdown zone lighting, and approach light systems. Taxiway guidance signage became illuminated, and runway guard light systems were established. Systems have expanded to clearance bars, stop bars, and most recently runway status lights (RWSL). Appendix 3 of the FAA's *AC 150/5345-53D* now contains an entire catalog of FAA-approved lighting systems, each with unique characteristics and construction.

AGL helps pilots with situational awareness through illuminated color, spacing, and light intensity. Lights indicate where an aircraft is on the airfield and provide guidance regarding pathways where the aircraft can head. Early versions of airfield ground lights used tungsten-filament incandescent lamps. Given the short life of incandescent lamps, new lamp technologies

## 2 LED Airfield Lighting System Operation and Maintenance

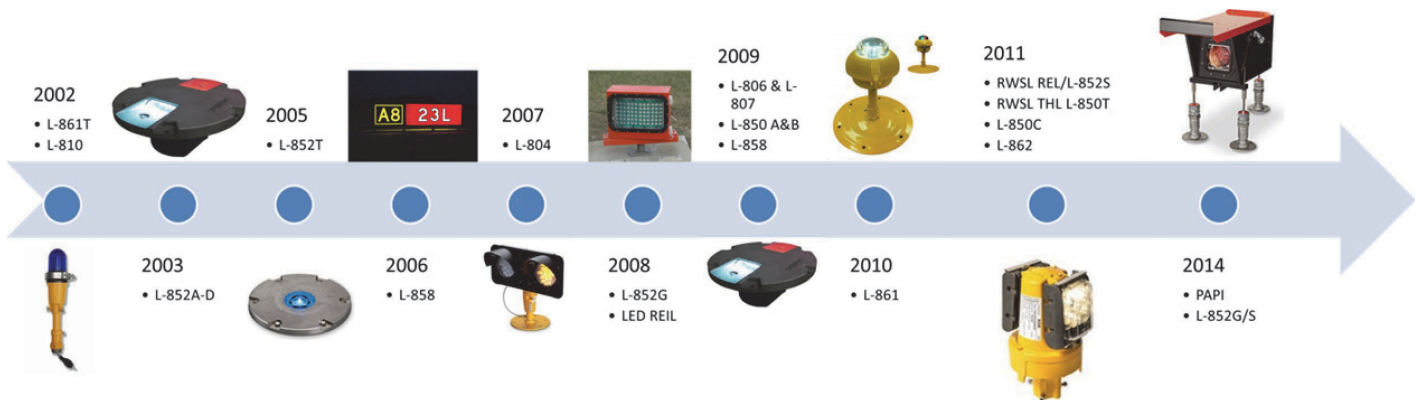

**Figure 1. Timeline of FAA approval for LED fixtures.**

were introduced. Fluorescent lamps became a popular choice for guidance signs (although they have had performance issues in colder climates), and quartz halogen incandescent lamps rose in popularity. Quartz halogen technology offers lamp life that is 3 times longer than tungsten-filament, with the added benefit of increased vibration resistance.

The next step in the evolution of AGL was the introduction of LED technology. In use on airfield since the early 2000s (see Figure 1), the newest versions bear little resemblance to the pioneer models. Though initially introduced on obstruction lighting and taxiway elevated edge lighting, LED technology has expanded to most types of AGL [excluding approach light systems such as the medium-intensity approach lighting system with runway alignment indicator lights (MALSR) and the approach lighting system with sequenced flashers II (ALSF-2) systems]. This guidebook presents the progression of LED technology and provides guidance on maintaining LED lighting systems, regardless of the version installed on the airfield.

### Purpose and Objectives

This guidebook presents typical challenges U.S. airports have encountered in implementing LED fixtures and provides guidance on maintaining and operating these systems. By interviewing airport maintenance and engineering personnel and LED fixture manufacturers, the research team collected a list of industry concerns. This guidebook summarizes potential issues and illustrates methods to optimize these systems and extract the greatest benefit from this new technology. The research findings, which include the review of standards and approaches, form the basis for the recommended approaches in this guidebook.

This guidebook, a resource for airfield electrical maintenance personnel, offers insight into the most persistent issues that arise with LED AGL. Guidance is included for continuing education and training of staff as well guidelines for a successful preventive maintenance program. Criteria are established for evaluating the various components associated with operating and maintaining LED lighting to allow the maintenance director to establish priority and protocol; insight from maintenance departments around the country is included to afford the maintenance technician with best practices for servicing these systems.

The research team prepared this guidebook for users who have already purchased LED fixtures and are using them on their airfields. This book neither weighs in on the LED versus incandescent lighting debate for an airfield, nor provides guidance on the layout of LED airfield lighting. For such information, refer to ACs which may be found at <http://www.faa.gov/airports/resources/>

advisory\_circulars/. Although incandescent lighting is mentioned in various sections, this guidebook is intended to address issues relating to the operation and maintenance of LED AGL systems and current industry practices. The survey data expresses the experiences of the individuals' surveyed who actively deal with the product. In many instances, the research team based information and recommendations on the interpretation of experiences and anecdotal information collected because hard data of a statistically relevant sample size was not available.

This guidebook does not endorse specific manufacturers. All references to specific manufacturers in this guidebook are the result of direct communication with airport personnel or interviews with manufacturers. Airports should select manufacturers based on the specific facility needs.

## Guidebook Layout

The research team based this guidebook on the knowledge, expertise, opinions, and recommendations of airport personnel and other airport industry professionals, as obtained through surveys, interviews, and case studies. In addition to a collection of maintenance material references from ACs and manufacturer's maintenance guides, this guidebook provides a comprehensive collection of best practices for the maintenance and operation of LED AGL systems.

Airport personnel should use this as a reference guide. Rather than organizing this guidebook to be read from beginning to end, the research team organized it so that readers can focus on the particular topic they need addressed. Although the research team collected similar topics in adjacent sections, this guidebook is designed so that extensive cross-referencing is not necessary.

Chapter 3 covers maintenance considerations for LED signs in general and for the following in particular:

- Acceptance testing procedures and warranty issues
- Avoiding fixture obsolescence and maintaining adequate spare parts inventories
- Preventive maintenance and refurbishment/repair
- Prior to, during, and following pavement repair
- Environmental factors, such as vibration and moisture

Chapter 4 covers operation considerations for

- Circuit configuration
- Fixture heaters
- Monitoring of AGL systems
- Photometrics and chromaticity
- Return on investment

Key takeaway summaries throughout this guidebook highlight significant points made in the discussion of each topic.



## CHAPTER 2

# Guidelines and Research

### Regulatory Requirements

Extensive guidance has been written for the proper installation and maintenance of AGL systems. In addition to local codes and ordinances, this work is subject to regulations outlined in the National Electric Code (NEC) and several forms of FAA-published material. The FAA has created ACs to help specify the manufacture, installation, and maintenance of airfield equipment. Additionally, the FAA issues Orders and Standards that outline requirements that must be met to obtain acceptance from the FAA. Further, when discussing AGL systems on military airfields, the Uniform Facility Code (UFC) must be observed. Internationally, these systems must conform to International Civil Aviation Organization (ICAO) standards. A list of pertinent FAA resources is available in References and Bibliography. A selection of the most pertinent resources includes

- *AC 150/5340-30, Design and Installation Details for Airport Visual Aids*
- *AC 150/5340-26, Maintenance of Airport Visual Aid Facilities*
- *Engineering Brief 67D, Light Sources Other than Incandescent and Xenon for Airport and Obstruction Lighting Fixtures*
- *AC 150/5345-46, Specification for Runway and Taxiway Light Fixtures*

### Surveys and Case Studies

To further understand the effect of LED lighting on airfield lighting, the research team surveyed 44 different airports of varying sizes and in different geographic regions. Responses from these airports to questions about installation, operation, and maintenance of LED lights provided a basis for further understanding of LED lighting operations and maintenance (O&M) practices. Figure 2 shows the locations and sizes of the airports that participated in the survey.

The research team carefully selected the airports to represent a cross section of the industry, considering airport size, climate, and aircraft type mix. This resulted in a broad perspective of the use and maintenance of LED AGL. Through diligent investigation, over 92% of airports requested provided data that helped to hone the research.

After collecting and interpreting the survey responses, the research team conducted extended case study interviews. These 2- to 8-hour interviews expanded on the questions in the survey and allowed for an open forum where maintenance personnel shared their experiences maintaining and operating this equipment. In total, 10 airports participated in the case study interview. These discussions revealed specific best practices in use and enabled the research team to isolate 11 specific representative elements as areas requiring additional discussion and understanding. These topics are categorized into maintenance and operations considerations, Chapter 3 and Chapter 4. The findings and best practices outlined in the following sections are a summary of data collected



**Figure 2.** Airports selected for LED lighting survey.

from subject matter experts within airport maintenance and operations personnel, manufacturers, and the design community.

The research team have summarized and presented results for many of the key survey questions throughout this document. Charts illustrate many of those findings and include the related survey question for each. Data shown represents the total responses from all airfields in the survey. The contractor's final report includes a list of the airports surveyed, the survey questionnaire, survey responses, and case studies.

Charts illustrating the responses to two key survey questions are shown in Figures 3 and 4. These figures illustrate that LED technology is far from ubiquitous; however, most airports have experience working with these systems. Additionally, many airports have had these systems in place for over 5 years, so the merits of LED longevity can begin to be evaluated.

Figure 5 presents the LED lighting systems in use at the surveyed airports.

**WHAT PERCENTAGE OF YOUR AIRFIELD UTILIZES LED LIGHTING?**

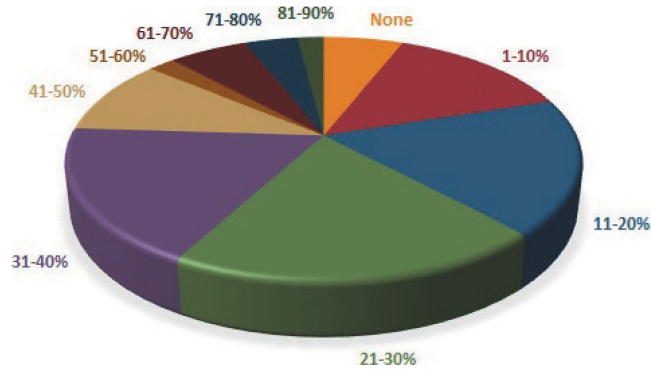

**Figure 3. Percentage of surveyed airfields using LED lighting.**

**HOW LONG HAVE YOU EMPLOYED LED LIGHT FIXTURES ON YOUR AIRFIELD?**

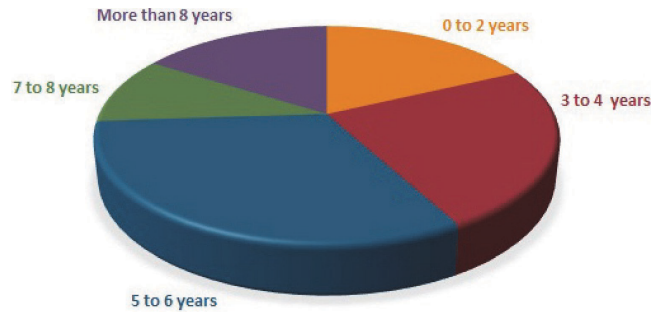

**Figure 4. Duration that LED lighting has been used on airfields.**

**WHAT TYPES OF LED LIGHT FIXTURES DO YOU CURRENTLY HAVE INSTALLED ON YOUR AIRFIELD?**

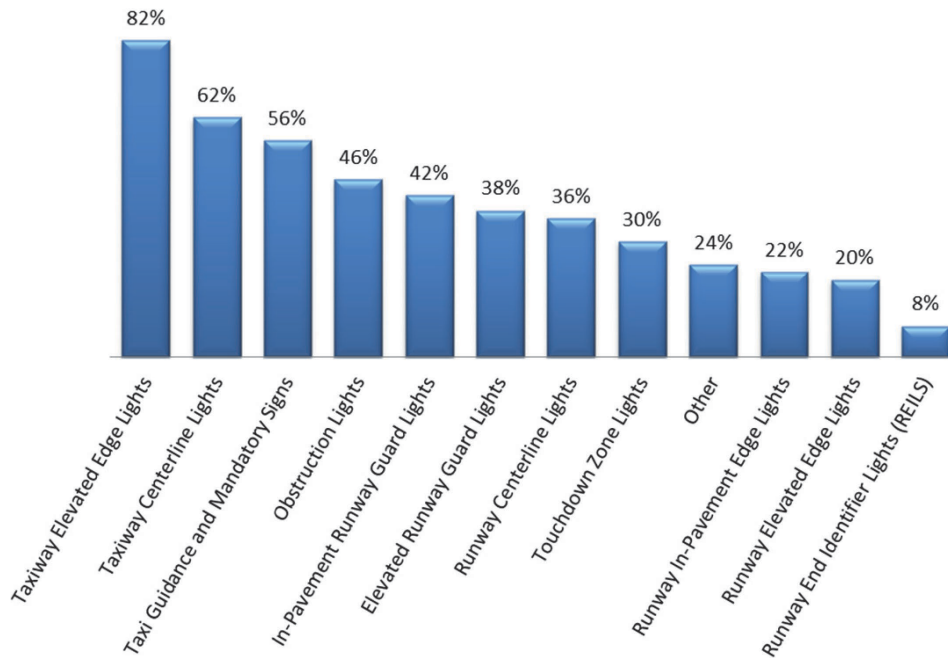

**Figure 5. Percentage of each type of fixture that are LEDs, in use at airfields.**

# Maintenance Considerations

Maintenance and care of AGL has been necessary since the first smudge pot was filled with kerosene and lit to assist pilots at night. The need to minimize maintenance and costs soon followed. Throughout the history of AGL, improvements to equipment, training, practices, and technology have moved the industry to provide and maintain systems with minimal interruptions to operations. The goal of system maintenance is to reduce or eliminate repeated visits to a particular light or system, thus allowing resources to be focused on other issues. This chapter discusses the advantages and disadvantages of LED airfield lighting technology, including the equipment itself, environmental conditions, installation, acceptance testing and warranty, spare parts, and preventive maintenance.

## Acceptance Testing and Warranty

### Acceptance Testing

An effective maintenance program starts with a well-constructed, compliant, and documented system. Commissioning and acceptance testing of AGL should be conducted in tandem with every construction project to ensure the system is performing to the specified design and to set benchmark performance metrics for the airport's lighting system before it is turned over to airport maintenance.

Operation and maintenance departments can be overburdened by accepting a new LED lighting system which was poorly installed and not thoroughly inspected to meet industry standards. The new system must operate without issues stemming from installation and equipment flaws. This is particularly critical in systems where new technology is implemented and continues to evolve. The implementation of an appropriately stringent acceptance program is vital to the long-term operation and maintenance of an LED AGL system.

FAA guidelines already exist for testing and maintaining AGL systems. This guidebook adds recommendations for LED lighting systems to those guidelines, so that maintenance departments receive a fully compliant system with proper test reports, documentation, training, and spare parts.

### Acceptance Procedure

The survey data and case studies suggest that newly installed LED lighting systems face issues similar to non-LED systems when it comes to physical installation. In addition, the survey data indicate potential issues of new LED systems in regards to light brightness and early light fixture failures. Based on this information, a recommended airfield light system's acceptance testing procedure should include the following elements:

- Visual and physical inspection
- Electrical testing



- Photometric testing
- System burn-in

### *Visual and Physical Inspection*

It is a good idea to visually and physically inspect all new AGL and guidance sign systems installed at an airport. Particular features to inspect are presented in the following subsections.

**Taxi Guidance Signs.** The research team recommends inspecting all signs for power and type, orientation, and physical condition.

- **Power and Type.** The type of power feed supplying the sign (i.e., 3-step, 5-step, or a single constant-current feed) and the nameplate data of the sign should be verified.
- **Orientation.** The field location and orientation of all taxi guidance signs should be inspected before acceptance of the system. This inspection should include the lateral and longitudinal distance of the sign from any intersecting taxiway or runway and from the defined edge of the taxiway or runway. Additionally, the angle of the sign legend directional arrows should be verified to ensure it is aligned with the intersecting taxiway centerline orientation.
- **Physical Condition.** Verify that (1) the exterior and interior signs are clean and clear of debris; (2) the power supply is in a sealed enclosure or is encapsulated for protection; (3) the sign legend and frame are free of scratches, cracks, or breaks; and (4) that all bolts and tethers are properly installed and secured.

The research team recommends checking a random sampling of 20% of signs to verify the correct installation of the power leg during installation. The research team recommends using a documented pass/fail protocol to do this check. If one sign's power leg is not installed correctly, the sign fails, and another 20% should be measured. Continue until all signs in a sample pass or all signs have been inspected. All signs that fail should be corrected and re-inspected for compliance. The installation of the power leg frangible coupling, cable clamp, and cable assembly is difficult to verify after completion of work, so these items should be inspected during installation. Visible verification that the total assembly is installed properly is recommended.

**Elevated Light Fixtures.** The research team recommends inspecting all elevated light fixtures for proper height and exterior condition.

- **Height Inspection.** Verify the height of the elevated light fixtures for conformance with *AC150/5340-30H, Design and Installation Details for Airport Visual Aids*, Figure 108, Adjustment of Edge Light Elevation for High Snowfall Areas.
- **Condition Inspection.** Inspect the elevated light fixture for any physical damage, including cracked globes; scratches; dents or abrasions on the fixture housing and stem; and damage to the base plate. Verify that the retaining ring or clips for the globe are present and secure. Verify that all bolts are installed and a base plate gasket is present. Ensure the fixture is level and plumb. Figure 6 provides exterior inspection information.
- **Light Base Interior Inspection.** Visually inspect inside the light base to verify the installation of several components and verify the state of good condition for a new installation. Components to view and verify include the following:
  - Connectors
  - Grounding connections
  - Spacers
  - Top extension or flange ring
  - Length of bolts
  - Transformer

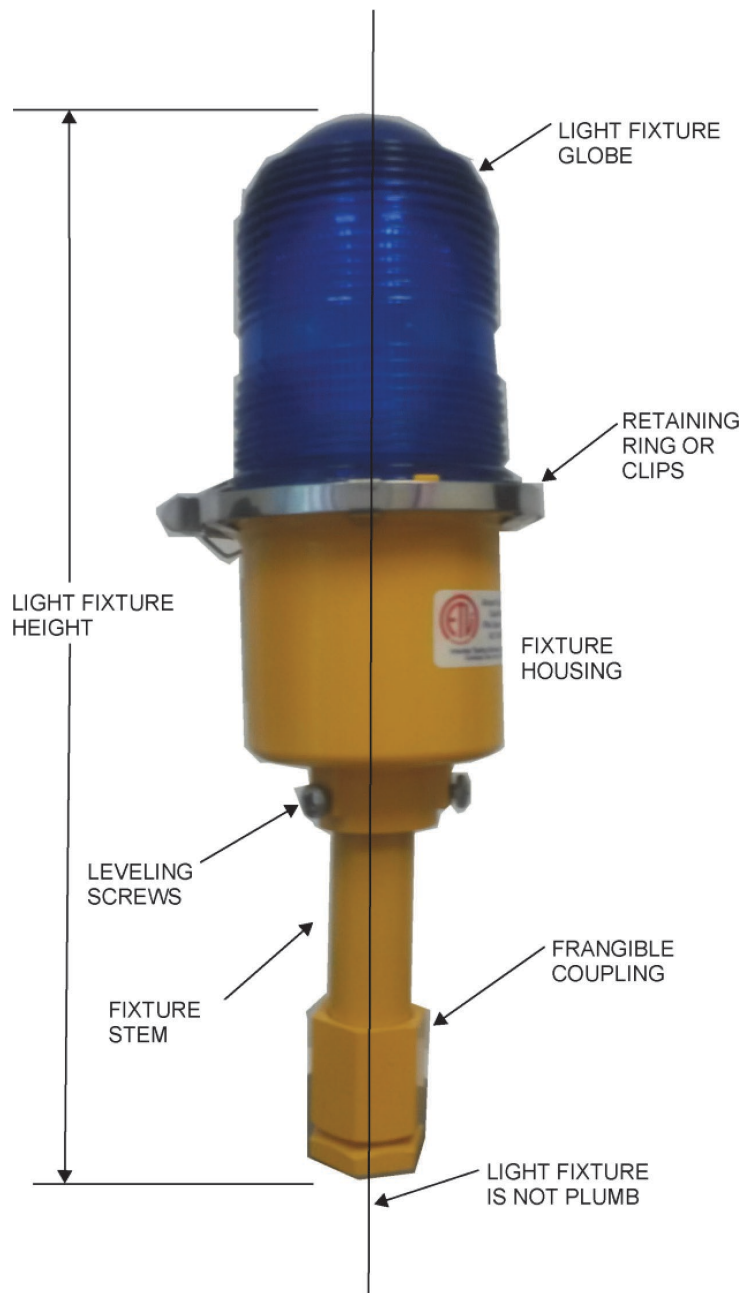

**Figure 6. Elevated light fixture exterior inspection criteria.**

- Cable length
- Conduit ends condition

In addition, inspect the LED light fixture leads for nicks, cuts, or abrasions because water can penetrate the cable jacket and be wicked into the fixture by the heating and cooling process. This water can damage the circuit board and other electronic components if they are not properly sealed.

The research team recommends checking a random sampling of 20% of fixtures. If one fixture fails, then another 20% should be opened and inspected. This should continue until all fixtures in a sample pass or all fixtures are inspected. All failed fixtures should be corrected and re-inspected.

### In-Pavement Light Fixtures

- In-Pavement Fixture Height.** Often overlooked and highly dependent on the technician's workmanship, the improper installation of an in-pavement light fixture can adversely affect the performance of a good fixture. A fixture not installed in compliance with the height requirement is susceptible to physical damage and/or noncompliant photometric performance. A fixture set too low will have the lower portion of the beam cut off, making the beam spread smaller and potentially making it noncompliant. If this fixture still meets the photometric output, as the photometric output degrades over time, this fixture will move out of compliance more quickly because of the smaller beam spread. As outlined in *AC150/5340-30H, Design and Installation Details for Airport Visual Aids*, Chapter 12, paragraph 11.c "The top of the fixture edge must be between +0 and  $-1/16$  inch from the low side of the pavement surface." This provides the requirement, but gives no guidance on how to verify the installation. To better understand the issue and a suggested measurement method, refer to *Innovative Pavement Research Foundation (IPRF) Report No. 1-G-002-03-1, Constructing In-pavement Lighting, Portland Cement Concrete Pavement*. Illustrations from that report are provided for reference in Figures 7 and 8.

The research team recommends checking a random sampling of 20% of fixtures, using this method with a documented pass/fail protocol. If one fixture fails, then another 20% should be measured. Continue until all fixtures in a sample pass or all fixtures have been measured. All fixtures that fail should be corrected and re-measured for compliance. An LED light fixture not set at the proper elevation may go out of photometric compliance more quickly than a properly set fixture. As LED light output degrades over time, fixtures at the proper elevation will continue to meet FAA output requirements, while a lower fixture that has part of the light output clipped by the pavement may fail to meet the same criteria, thus requiring poorly installed fixture locations to be addressed by maintenance sooner.

- Exterior Light Base Inspection.** The exterior inspection of the light base sealant typically indicates the overall workmanship of the light fixture installation. Visually inspect the sealant around the light base to ensure it is evenly distributed and the thickness is no more than  $3/4$  in. Verify that all bolts are installed and properly secured. Note inconsistencies among light fixtures. The light fixture installation indicated in Figure 9 is under suspicion because of two observations: the light reflection and the unevenness of the sealant installation.

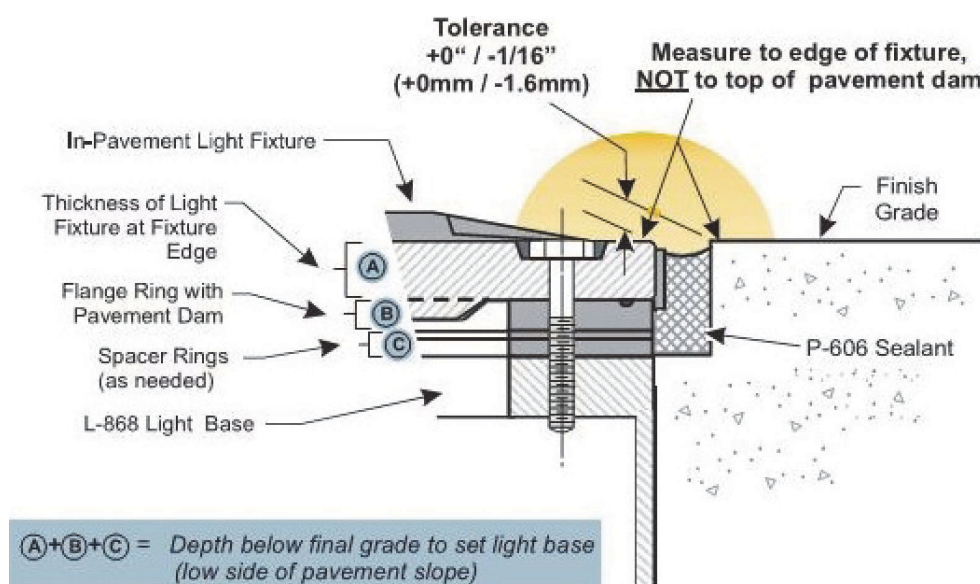
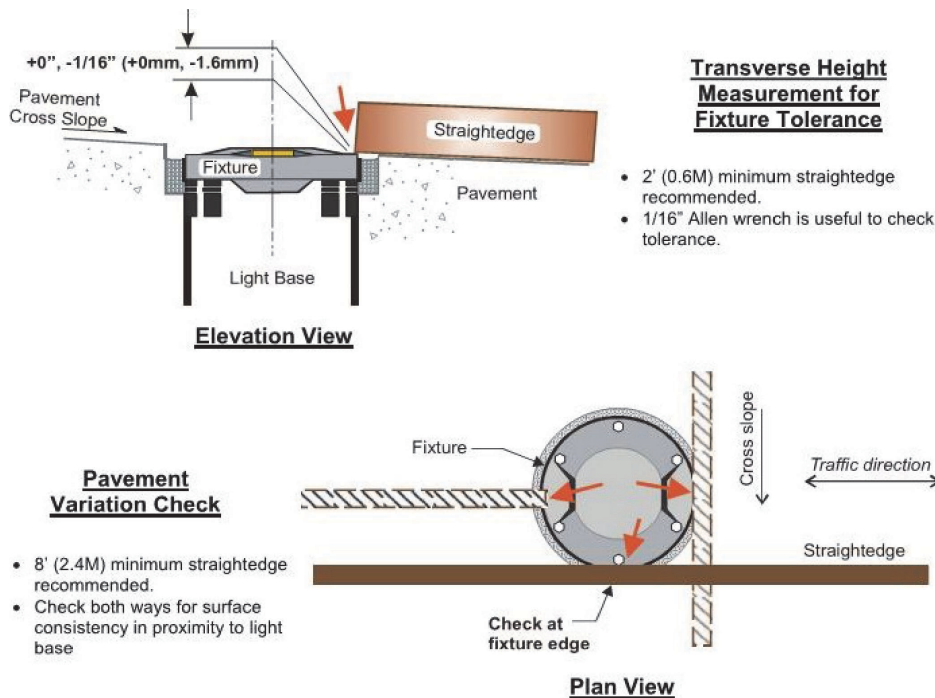
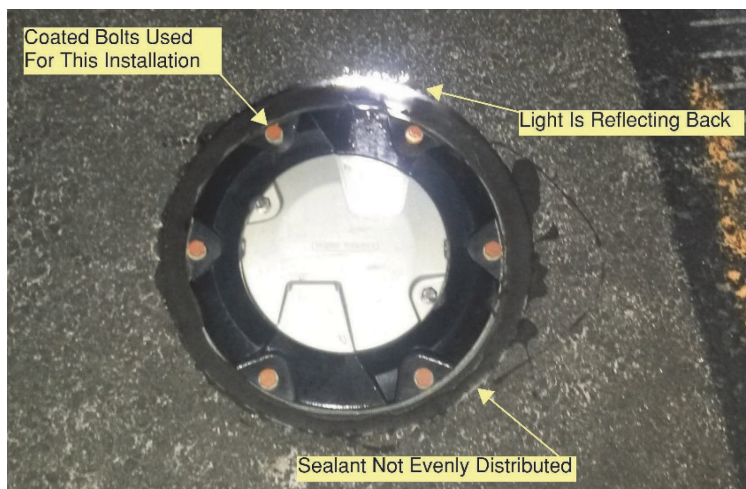

Figure 7. Height of in-pavement light fixture (IPRF 1-G-002-03-1).

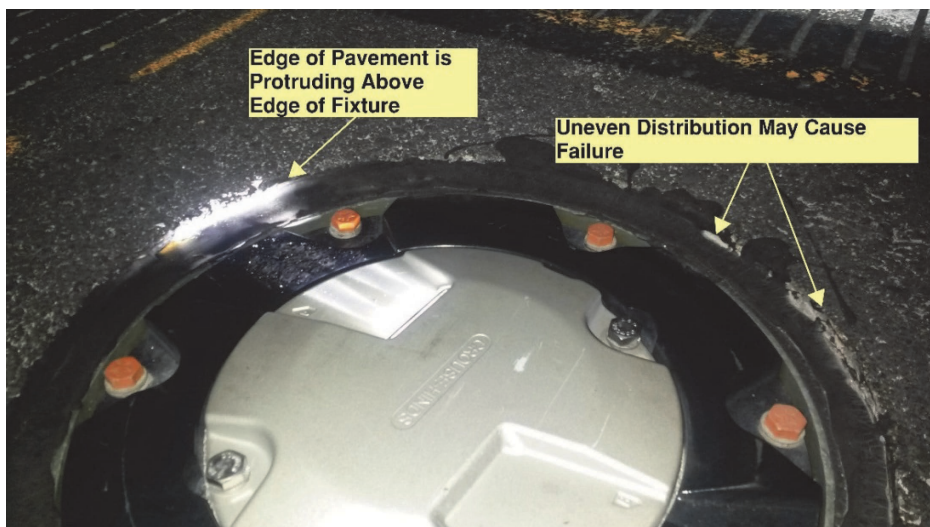

**Figure 8. Height measurement of in-pavement light fixture (IPRF 1-G-002-03-1).**

Closer examination of the same light fixture (Figure 10) reveals that the pavement is protruding above the edge of the light fixture and causing a reflection of light. This could be an indication that the fixture was installed too low or not plumb. If not verified and corrected, the light could appear to be missing from the pilot's perspective; additionally, the back reflection of the light could give the appearance that the light fixture is a bidirectional unit, thus providing false information to taxiing aircraft. The only accurate method of determining if the fixture passes is to test the photometric intensity of the fixture using mobile test equipment. Visual inspection along with photometric testing will verify the compliance of this fixture. The uneven and poor distribution of the sealant could cause premature failure of the sealant and allow water into the



**Figure 9. In-pavement light-visual inspection.**



**Figure 10.** In-pavement fixture—visual inspection 2.

fixture; therefore, the sealant should be removed and reinstalled.

The research team recommends visually inspecting the exterior of all newly installed fixtures and recording notes on an inspection form. The form should include a check of, at a minimum:

- Fixture ID, if available, or location
- Type of fixture
- Bolt installation
- Sealant inspection
- Damage to fixture
- Surrounding pavement condition
- General observations

If an issue is observed, a photograph should be taken and attached to the inspection form.

- **Mounting Bolts.** Mounting bolts are critical to the AGL system. Improper installation (i.e., loose bolts) causes a unique issue for LED light fixtures, given that LED fixtures require servicing so infrequently and loose bolts could result in bolts becoming dislodged, creating foreign object debris (FOD). Although this situation can occur with traditional incandescent light fixtures, those fixtures require re-lamping more frequently, so the risk of severely loosened bolts is less likely. Unless the fixture is clamped down properly, the LED fixture is susceptible to premature failure due to excessive vibration. Additionally, improper bolt installation can cause the fixture to disengage from the light base, potentially causing catastrophic damage. Several bolt characteristics that must be verified are the type, thread engagement, and clamping force (Figure 11). Information on these items is available in several FAA publications including

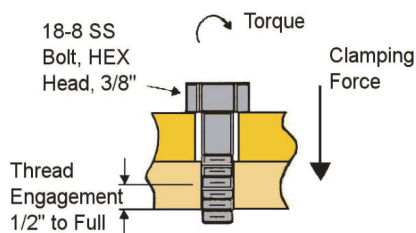

**Figure 11.** Mounting bolt parameters.

AC 150/5340-30, *Design and Installation Details for Airport Visual Aids*, AC 150/5340-26, *Maintenance of Airport Visual Aid Facilities*, FAA Engineering Brief 83, *In-pavement Light Fixtures Bolts*, and AC 150/5345-42, *Specification for Airport Light Base, Transformer Housings, Junction Boxes and Accessories*. Bolt composition varies with the specific installation and materials used; two types of bolts are approved for use, an 18-8 Stainless Steel and an SAE J429 Grade 2 bolt with a ceramic-fluoropolymer coating. Airports may deviate from using these bolts, but they must support their decision with extensive research and comparison for a different selected bolt. The torque value varies depending on bolt type and the application of anti-seize compounds. As indicated in *Engineering Brief No. 83*, the application of an anti-seize compound will result in an equivalent clamping force with less torque. A bolt should never be over-torqued, as this will lead to premature failure. Follow *Engineering Brief 83* guidelines for the proper torque value of the specific installation.

The research team recommends checking a random sampling of 20% of the fixtures, using a calibrated torque wrench set at the specified value with a documented pass/fail protocol. If one fixture fails (i.e., one bolt is not properly installed), then another 20% should be measured. This should continue until all fixtures in a sample pass testing or all fixtures have been measured. All failed fixtures should be corrected and re-measured for compliance.

- **Light Base Interior Inspection.** Visually inspect inside the light base of the elevated light fixture to verify the installation of components and verify the condition for a new installation. Components to view and verify include the following:
  - Connectors
  - Grounding connections
  - Spacers
  - Flange ring
  - Length of bolts
  - Transformer
  - Cable length
  - Conduit ends condition

In addition, inspect the LED light fixture leads for nicks, cuts, or abrasions as indicated in Figures 12 and 13 because water can penetrate the cable jacket and be wicked into the fixture by the heating and cooling process. This water can damage the circuit board and other electronic components if they are not properly sealed.

The research team recommends checking a random sampling of 20% of fixtures. If one fixture fails, then another 20% should be opened up and inspected. This should continue until all fixtures pass in a sample or all fixtures are inspected. All failed fixtures should be corrected and re-inspected. This inspection can coincide with the exterior inspection and these items be added to the inspection form.

**Electrical Testing.** Electrical testing (1) ensures minimum specified values are met and (2) provides valuable initial data that can be used to set a maintenance baseline. These measured values should, at a minimum, include

- **Circuit Insulation Resistance Measurement.** The circuit insulation resistance measurement is the resistive measurement in Ohms of the cable insulation's ability to resist the passage of stray current through the wall of the insulation to a ground source. Excessive current flow through the insulation wall is categorized as current loss and creates an inefficient electrical system. The larger the resistance value, the better the performance of the electrical system. Periodic measurement of the cable's insulation resistance will provide a "check-up" of the system. However, this one measurement will not indicate overall condition. The measurement of the cable's insulation resistance is better used as a trending and tracking measurement to determine the condition and performance of a cable, rather than a static measurement of condition. A high initial measurement reading is desirable, followed by relatively consistent

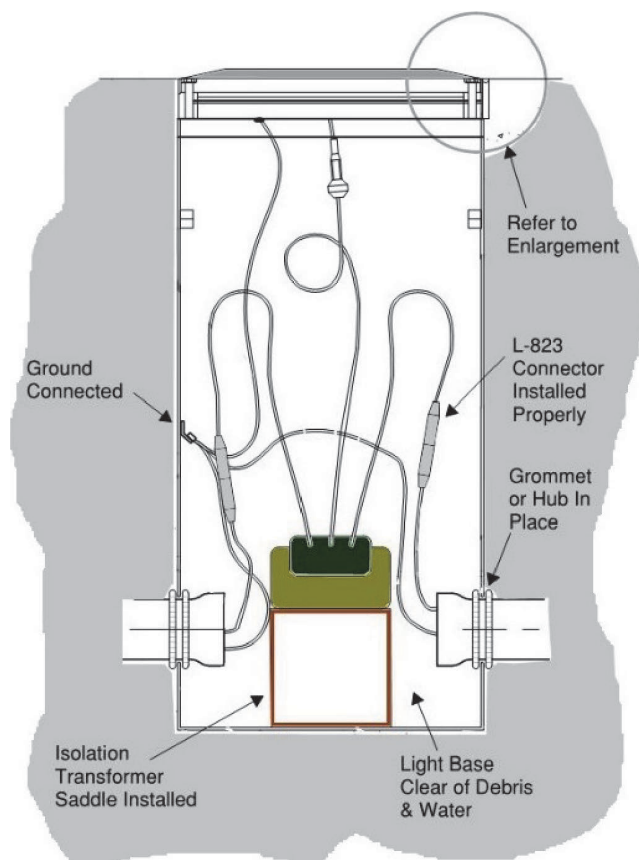

**Figure 12.** Visual inspection inside light base.

readings over the anticipated life of the cable. This indicates a steady state of performance of the cable and the circuit. A sudden drop of measured value or a slow decrease in measured values typically indicates a failed or failing cable and circuit, at which point further maintenance investigation is warranted. *AC 150/5340-30* indicates the minimum insulation resistance value of a cable to be 50 megohms ( $M\Omega$ ). Typically, higher initial values are achievable. This value should be used unless the initial value is specified in the design documents—then the

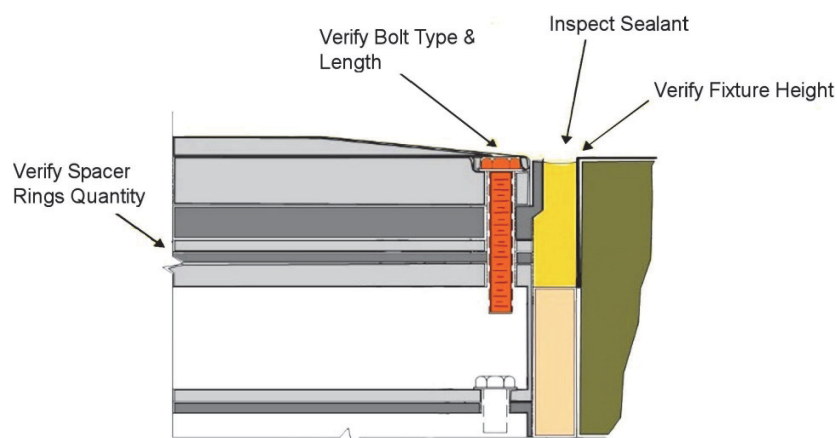

**Figure 13.** Light base enlargement.

more stringent value should be used. Regardless, it is important to obtain this startup value to establish a baseline and trend the data to ensure the health of the series lighting circuit.

- **Circuit Overall Resistance Measurement.** This measurement, which is a function of the length of the circuit and the number of light fixtures on it, is the loop resistance of the circuit after all cable, connectors, transformers, and light fixtures are installed. No specified value should be obtained but, similar to the insulation resistance, it's a value that can be taken periodically and tracked to determine the state of the circuit.
- **Circuit Load Measurement.** Circuit load is typically calculated during the design stage and is used to ensure that the series circuit is not overloaded. Taking these measurements on completion of design and before turn-over to the airport will verify the circuit is not loaded beyond its capacity. Load calculations assume ideal conditions, but the circuit load can change during installation due to as-built conditions. This load information is also important for maintenance if circuits need to be combined or placed on spare constant current regulators during a failure event.

### *Photometric Testing*

Once the AGL system is installed, it is impossible to tell by merely visual observation if it is providing the FAA-compliant photometric output required. Photometric testing evaluates light systems and identifies performance deficiencies not apparent during visual inspection and measures the light beam output distribution of a fixture, light spread, and intensity. Results can be compared with FAA criteria to determine compliance. Photometric testing equipment is a computer-based system generally composed of a light bar consisting of photometric sensors attached to a vehicle or a trailer. The photometric sensors are positioned to test the fixture's light beam. The light bar is scanned over energized light fixtures at the various intensity settings, thereby providing real-time data and feedback. Performance issues, such as those that might result from a dirty lens, can be corrected and retested in the same work cycle. Other more-involved performance issues (e.g., a defective light fixture or an improper installation) should be corrected and retested at another time.

The research team recommends that each newly installed LED lighting system have photometric acceptance testing performed as part of the project close out. Ideally, the photometric testing for acceptance should be performed by a third-party entity separate from the contractor and the airport. It is preferable that the testing agency be hired by the designer or consultant on the project, rather than directly by the airport, with the cost of the testing agency included as part of the project's construction budget. However, if no designer or consultant is involved, the airport should hire the testing agency independent of the contractor. If an airport cannot directly secure the services of the testing agency, the testing can be included as part of the contractor's scope of work. The research team recommends the airport contact the Illuminating Engineering Society, Aviation Lighting Committee (IESALC) at [www.iesalc.org](http://www.iesalc.org) for contact information of airfield photometric testing firms.

To maintain a state of good repair, the research team recommends an airport perform periodic photometric testing to track the condition and degradation of the AGL system. The research team recommends annual testing for airports with CAT III low-visibility lighting systems. The test should be performed before entering the inclement weather season, with enough time to correct any deficiencies. The research team recommends biennial (every 2 years) testing for CAT II airports with elevated and in-pavement fixtures. The research team recommends testing every 3 to 4 years for CAT I airports. The periodic testing can be performed by a third-party agency or, if the airport chooses to purchase photometric equipment, it can be performed by the maintenance team.

### *System Burn-in*

The burn-in period is an effective way to identify inferior products of state-of-the-art components that are semi-conductor based. LED light fixtures fall within this category. As indicated in



the survey data, the major source of LED light fixture failure is the electronic component. Although the survey data does not indicate the timeline of these failures, industry studies have identified infant mortality (IM) failures as the main reason for early onset system failures. IM failures are defined as early failures caused by material defects and errors in assembly. A burn-in period introduces stresses to a new system not normally encountered by the system early in its lifecycle. This allows issues to arise from defective parts or poor workmanship and for those issues to be corrected before system acceptance.

The research team recommends a burn-in period of 5 to 10 times the normal daily operating period. A normal operating period is typically 12 hours, so this would yield a burn-in period of 60 hours to 120 hours with the system set on the highest intensity setting.

Acceptance testing should be fully documented for validation and acceptance by the maintenance group. Additional items to be included with the acceptance testing documentation are as follows:

- Fixture ID numbers and locations
- Installation dates for warranty purposes
- Equipment operations and maintenance manuals
- Listing of spare parts delivered to the maintenance department

Once the testing and documentation is submitted and deemed complete and acceptable, then the maintenance of the system can shift from the construction contractor to the airport maintenance group.



### Key Takeaways

- Implement an acceptance testing program for LED lighting systems. At a minimum, perform a physical inspection and a system burn-in.
- Depending on the project size and the airport, perform testing in house by the maintenance team or by a third party. Acceptance testing should not be performed solely by the contractor.
- Log data collected from the acceptance testing in an acceptance test manual. The manual should include equipment operations and maintenance manuals, record drawings, electrical test results, photometric test results, calculations, inspection reports and photos, fixture inventory list, and manufacturer's equipment cut sheets. This information will be needed for equipment asset inventory management.

### Warranty

The first LED fixtures to gain FAA approval were the taxiway elevated edge lights. Approval occurred in the early 2000s. Shortly after, in the mid-2000s, in-pavement fixtures such as L-852A-D and L-852T also received FAA certification. Elevated taxiway edge lights (e.g., the L-861T) gained support as a result of their reliability. In one case study, a medium hub airport claimed that they installed the lights as soon as they were FAA-approved and have yet to encounter any issues with the elevated fixtures. This same airport also installed in-pavement LED fixtures.

The in-pavement fixtures did not perform nearly as well as the elevated fixtures. Because of the number of failures and unreliability of these lights, the FAA implemented a 4-year warranty requirement. This requirement has been successful in controlling unanticipated repair costs to airports, and it motivated manufacturers to identify issues quickly and significantly improve the reliability of LED fixtures. Many of the early problems with LED fixtures were eliminated by product improvements. Several airports that participated in this study and were early adopters of LED airfield lighting reported reliability issues such as electronic failure due to moisture and unprotected circuit boards inside the lights. Others reported vibration issues causing pieces of the circuit boards to break or connectors to become unplugged or dislodged. Obsolescence resulting from product upgrades also created difficulty in finding replacement parts. While manufacturers continued to upgrade fixture components, the FAA revised their standards to hold the manufacturers to a higher design requirement. Improvements included solid-state components that resist vibration, fully potted (meaning encapsulated in an epoxy resin for protection against the elements) circuit boards that protect against moisture, and enhanced adjustable electronics that protect against obsolete diodes.

In March of 2012, the FAA superseded *Engineering Brief 67C* with the release of *Engineering Brief 67D*. In the updated brief, specific language states the warranty period each manufacturer must provide to gain FAA approval and for airports to gain FAA funding for purchase of fixtures. The following excerpt is from *Engineering Brief 67D*:

#### 4.0 Minimum Warranties

4.1 All LED light fixtures with the exception of obstruction lighting (AC 150/5345-43) must be warranted by the manufacturer for a minimum of 4 years after date of installation inclusive of all electronics. The replacement criterion for light fixtures is per AC 150/5340-26.

The 4-year warranty provides the airport with assurance of a reliable product and time to acclimate maintenance personnel to the equipment. The warranty period starts from the date of installation—not the date of purchase by either the maintenance group or the construction contractor. Make sure acceptance testing documentation accurately records the installation date. If a contractor delivers spare fixtures to the airport after the completion of a construction project, and those fixtures remain in inventory for a year before installation, according to *Engineering Brief 67D*, the date of installation is when the warranty starts. However, the manufacturer cannot be expected to honor the warranty indefinitely for stockpiled fixtures. This is an important topic to discuss with the manufacturer at the time of purchase or with the contractor purchasing the lights. Warranty claims processing is simplified when an airport maintains an asset management program and can track fixture installations, among other aspects. This approach allows the airport to easily provide the manufacturer with proof of the installation date.

The process of warranty claims reviewed in the case studies consisted of airport maintenance personnel being responsible for removing and replacing a failed fixture in the field. Once the light was returned to the shop, maintenance personnel examined it for physical damage and determined whether it was covered under warranty. After it was determined that the light was insured, the light was put in a stockpile area with other failed fixtures to be shipped back to the manufacturer. Airports tended to send fixtures back in groups of 20 to 40 at a time. Once the manufacturer received the fixtures, the manufacturer decided whether to either repair the fixture or replace it—depending on what caused the failure. A repaired or replacement light was then returned to the airport. Repairs could take as long as 6 months; however, in most cases, fixtures were returned in less than 90 days, depending on the number of fixtures and the availability of components.

Airport personnel must fully understand the coverage of the warranty. A manufacturer warrants the fixture for failure under normal use and does not cover damage inflicted to the fixture due to external causes (e.g., snow plowing operations or grass cutting). Some manufacturers will warrant the electronics and the diode for 4 years but other components may only have a 1- or 2-year

warranty period. Some manufacturers also stated that they will begin the warranty start date approximately 6 months after ship date, but, in certain cases, there is flexibility to accommodate airport needs.

Interviews with airfield light manufacturers made clear that the 4 year warranty is a gray area open to interpretation. The interviewed manufacturers confirmed that only the diode and the electronics are covered for 4 years—components such as external casing, glass (lenses), or couplings are **not** covered for 4 years. A good relationship between airport and manufacturer is important in efficiently resolving LED issues on the airfield.

Most manufacturers will offer an extended warranty or a service contract to outsource fixture repairs when the base warranty expires. Service contracts reviewed in the case studies consisted of the airport removing the fixtures and sending them to the manufacturer for repair. Every airport operator must consider the different options for maintaining fixtures after the warranty period and take into account factors such as the airport's budget and the size of its maintenance department.

Extended warranties vary from manufacturer to manufacturer. One manufacturer interviewed repaired fixtures through an extended warranty or refurbishment program, using a flat rate method. Another manufacturer offered extended warranties based on an asset risk method—they collect data (e.g., the number of LED fixtures on airfield, maintenance practices, age of fixtures, and commonly failed components) and use this data to develop an extended warranty cost. This cost increases proportionately as fixtures age because risk of failure increases with time. Some manufacturers stated that they would rather train maintenance personnel to repair their own fixtures in lieu of providing an extended warranty. It was also mentioned that transport of fixtures can cause damage unknown to the manufacturer. For example, unsecured fixtures moving inside a shipping box is a common reason for cord set failure.

The 4-year warranty has been successful in enhancing the reliability of newly installed LED circuits. However, airport maintenance departments need to address repair strategies for when the warranty period expires.



### Key Takeaways

- Current LED fixtures are much more reliable than earlier generations, in part due to the FAA-mandated warranty requirement.
- Document the fixture installation date for proper warranty management.
- Develop a post-warranty strategy for fixture repairs (e.g., service contract, extended warranty, or perform in-house repairs).
- Maintain a close relationship with fixture manufacturer.
- Have an asset management program in place.

## Fixture Obsolescence and Spare Parts Recommendations

### Fixture Obsolescence

LED airfield light fixtures have improved with multiple generations of production. However, because the FAA requires fixtures meet certain photometric requirements, the manufacturer is only allowed to use light fixture components that meet standards set forth by the FAA. Early

generation fixtures are no longer being supported by manufacturers and are considered obsolete. This presents challenges to airport maintenance departments maintaining early generations of LED fixtures.

All airfield lighting manufacturers purchase their LEDs, rather than manufacturing them. Diode manufacturers are constantly working to advance their technology to meet the demand for efficiency and to remain competitive. The airfield lighting application is usually not a diode manufacturer's first concern. The lights are designed to fit and apply to various commercial, automotive, and specialty lighting applications. This means that, once an LED is no longer in production by the diode manufacturer and a replacement is available that is more efficient or requires different electronics, an airfield lighting manufacturer has to revise the design of their fixture to meet the requirements of the new diode. These technological upgrades affect not only the diode but any component of the fixture that the airfield lighting manufacturer does not manufacture in house. This is a challenge for manufacturers trying to continue to fabricate or supply spare parts and achieve backward compatibility with previous generations of fixtures. At some point, manufacturers can no longer support the obsolete fixtures. The obsolescence issue affects incandescent lighting circuits as well. In a few instances in the research, maintenance personnel complained about the difficulty in purchasing certain replacement incandescent bulbs.

Twenty-five percent of survey respondents noted obsolescence in LED fixtures as a concern. Obsolescence is a significant concern for smaller airports because they may not receive FAA funding for lighting fixture upgrades as often and typically do not have the budget to replace obsolete fixtures in a timely manner. In one case study, a medium hub airport stated "The fast-paced development of LED technology makes fixtures obsolete too quickly."

After further communication with the airport, the research team discovered that this airport was an early adopter of LED fixtures. The generation of fixtures they installed went obsolete shortly after purchase as a result of technological advancements and upgrades to the electronics. The light fixture manufacturer committed to maintaining support for an additional 5 years after purchase and did provide this support. The airport does not have an adequate budget to replace outdated fixtures and faces challenges attempting to repair the fixtures. Although this was only one case study, and was an extreme case because the lights were first generation, it demonstrates the concern with obsolescence of new technology. The fixture manufacturer offered to replace the fixtures with the newer generation fixtures at a reduced cost; however, even the reduced cost was beyond the airport's budget. The airport is replacing a few fixtures each year as the budget allows, and staff continue to look for spare parts and repair fixtures. Attending maintenance training seminars has proven beneficial in the upkeep of their LED lighting systems. This airport noted that they had no major issues with their elevated fixtures installed more than 10 years ago.

Although airfield lighting manufacturers are beginning to notice a slowing down in the pace of advancement of LED technology, no one can foresee what advancements will occur. Airfield lighting manufacturers, in most cases, attempt to maintain fixture backward-compatibility of components for 5 years. Some manufacturers, in order to maintain longer production life for their fixtures as well as provide a sense of security for their consumers, have begun to produce electronics that can work with various diode generations. The best method for ensuring support from a lighting manufacturer is to keep an open line of communication with the manufacturer to understand the production status of an airport's generation of fixtures.

Fixture obsolescence can be mitigated in several ways. One method is continuous upgrade to the latest generation by stockpiling a small number of complete light fixtures. As lights outside of the warranty period fail, they are replaced by newer units. This ensures that the airport is stocking the latest fixtures and avoids the problems of obsolescence. The FAA does not restrict having different generations of LED fixtures on the same circuit or length of pavement if they all conform

to the photometric and chromaticity requirements. For this method to work properly, the airport must maintain a meticulous asset management program to track fixture stock, including installed location and warranty periods. Unfortunately, however, this approach is more costly than repairs. In addition, if airports want to repair fixtures and have used this method, they will have multiple generations in place, which could increase their spare parts budget for stockpiling parts.

Another method is to stockpile critical spare parts and train personnel to repair the fixtures so they can maintain the equipment after the warranty has expired. This method requires the airport to keep a record of the components that experience the highest failure rates and keep those replacement components on hand. Before the manufacturer discontinues support, based on the airport's repair experience, the airport must stockpile an appropriate number of spare parts with that generation of fixtures. This method, although it is cheaper than replacing full fixtures, is not a long-term solution to obsolescence. Eventually, the components will be discontinued from production, forcing the airport to purchase the newer generation of fixtures.

Most airports require at least a 10% spare fixture stockpile whenever a lighting project is completed. This stockpile, however, should not be the only stockpile the airport carries and should include a separate inventory of components such as circuit boards, power supplies (if not part of circuit boards), and LEDs, based on repair experience. These components will come in handy if the manufacturer stops supporting the fixtures after the warranty period has expired. Manufacturers should notify airports when a fixture is going out of production. Some manufacturers post a list of obsolete fixtures and component compatibility.

As technology matures, obsolescence becomes less of an issue because manufacturers have typically solved the field problems and begun to standardize designs for greater compatibility. LED light fixtures are following this progression and the research team expects that obsolescence will be less of a concern in the future.



### Key Takeaways

- Product obsolescence is an inevitable trend with all technological advancements.
- Obsolescence is often a larger concern at smaller airports.
- Fixture obsolescence has decreased due to more adaptable electronics.
- Maintain a close relationship with the manufacturer to stay updated on manufacturer support status for fixtures.
- Asset management programs can help airports match budgets with maintenance needs.
- Airports should maintain a stock of complete fixtures along with a stock of parts that have typically failed.

## Spare Parts Recommendations

### *Developing an Inventory*

An airport should maintain an adequate number of replacement fixtures and spare parts to facilitate quick repair so as to maintain the operational status of the AGL system and the airport. *AC 150/5340-26C, Maintenance of Airport Visual Aid Facilities*, provides guidance and outlines the process in Chapter 3, Maintenance Management. The AC indicates three factors that can help

determine a sufficient inventory: effect of downtime to operations, part availability, and component failure rate.

### *Understanding LED Fixture Components*

An LED light fixture has various components. Components found in both in-pavement incandescent and LED fixtures include fixture housings, lenses, seals, gaskets, cord sets, and mounting hardware. Although components such as fixture housings, lenses, and gaskets are similar, they may not be interchangeable. The physical configuration of LED fixtures may vary from an incandescent counterpart from the same manufacturer and should be verified to determine if a separate stock of parts is needed. The major difference between an LED light fixture and an incandescent fixture is that an LED light fixture contains electronic components. Although the exact configuration of the components may vary slightly from manufacturer to manufacturer, they contain similar major components. The two major components are an LED light engine assembly and LED printed circuit board (PCB) with integral power supply (PCB/PS).

As shown in Figure 14, the top housing has been removed. The light assemblies detach from the housing and plug into the PCB. The PCB and power supply are in the bottom of the fixture. Newer generations of PCB/PS are being potted. Given the location of the electronics for LED fixtures, the bottom of the fixture may be larger than that for a standard incandescent fixture. This may cause issues when performing a direct light fixture substitution on existing shallow or overcrowded light bases. This size varies between light fixture manufacturers and should be verified before selecting a light fixture for direct replacement.

Elevated incandescent light and LED light fixtures also contain similar parts including frangible couplings, elevated stems, fixture housings, glass domes, seals, gaskets, cord sets, and mounting hardware. Again, although similar, the physical configuration of these fixtures varies from their incandescent counterparts and the potential to interchange parts should be verified with the manufacturer. As with the in-pavement fixture, the main differences between the incandescent and the LED fixtures are the LED light assembly and LED PCB/PS electronic components. Refer to the taxiway elevated edge light fixture in Figure 15 for illustration.

The components of an elevated fixture sit in the upper housing of the fixture and sometimes in an enlarged fixture stem. The light engine assembly and the PCB/PS are sometimes integrated to form one unit. This is solely a manufacturer's design preference.

Light manufacturers' websites often contain useful information on each type of LED fixture they manufacture. Typical websites provide assembly drawings, replaceable parts lists, and guidelines

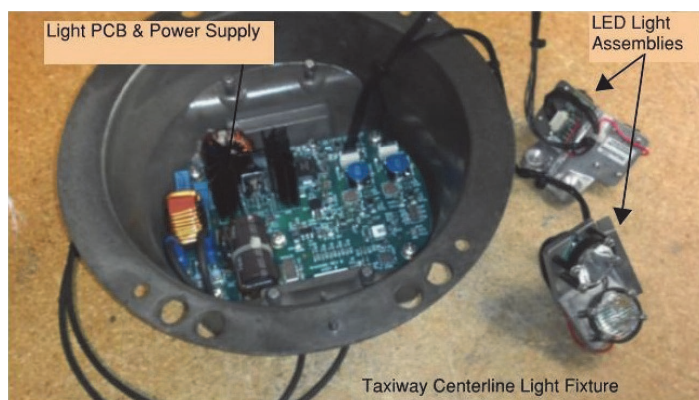

**Figure 14.** *Typical in-pavement LED fixture components.*

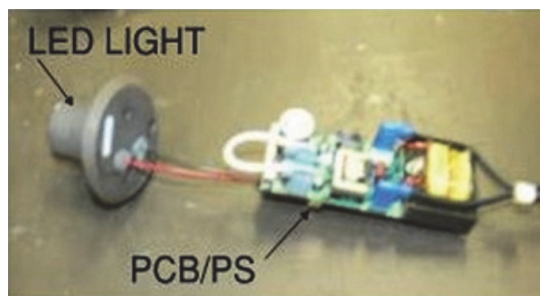

**Figure 15. Typical elevated edge light LED components.**

on how to test and replace the parts. It is important to become familiar with this information as it pertains to a particular light fixture.

### Determining Availability

Early generation LED light fixtures, through changing LED technology, have become obsolete. Spare parts may not be available for these early-generation fixtures if they were not purchased at the time of installation or before being discontinued by the manufacturer. Maintenance departments should contact the fixture manufacturer to determine the availability of LED and PCB components to determine if repair or refurbishment is an option for the light fixture. If parts are not available through the manufacturer and the manufacturer is no longer supporting the fixture, the fixture is obsolete and a complete replacement is required. Be cautious if repair parts are obtained through an exchange with another airport, because these may not be the certified parts associated with the fixture and may adversely affect the performance of the light fixture. Such exchange is not a recommended practice.

Newer generation lighting fixtures are now available with an intelligent PCB/PS that can support the light fixture through several changes of the LED technology and is interchangeable among types of light fixtures. A one-power-supply-fits-all scenario will reduce the need to stock different versions of power supplies and help reduce fixture obsolescence.

The number of available spare parts depends on the business and fabrication practices of the various manufacturers. Manufacturers maintain a supply of fabrication parts to produce light fixtures and those quantities depend on their current procurement and fabrication schedules. However, discussion with several manufacturers has revealed that a small quantity of fixtures is usually available with a delivery timeframe of 2 to 3 weeks.

### Available Spare Parts

Each lighting fixture manufacturer website indicates a list or provides drawings for the available spare parts associated with a particular light fixture and a maintenance guideline for each fixture. Spare parts that are typically available for light fixtures are as follows:

<i>In-pavement</i>	<i>Elevated</i>	<i>Signs</i>
PCB/PS	Light Assembly	Light Assembly
Light assembly	PCB/PS	PCB/PS
Cable clamp	Cable clamp	Power Cable Assembly
Cord Set	Cord set	Exterior Switch
Cord set grommet	Cord set grommet	Seals and Gaskets

<i>In-pavement</i>	<i>Elevated</i>	<i>Signs</i>
O-ring	Stem	Tether
Prism	Frangible coupling	Frangible coupling
Prism gasket	Globe	
Seal, prism keeper	Arctic kit heater	
Arctic kit heater		

Several manufacturers are moving toward standardizing parts among types of light fixtures and among the types of signs. Standardization will allow a single type of item to be used for various fixtures or signs, thus eliminating the need to carry redundant parts for all types of fixtures. Airports that refurbish fixtures and signs may continue to do so with LED fixtures and LED signs. LED fixture refurbishment tends to be more successful in a workstation environment, rather than out in the field, because electronic components can be degraded if exposed to poor environmental conditions. Additionally, it is a good practice to perform the work in a separate clean environment, rather than where the refurbishment of non-LED light fixtures is performed. L-858 Guidance signs, unlike lights, are generally repaired in the field; in this case, the work must be performed diligently to ensure components are kept clean.

Working on electronic components requires specific precautions to prevent damage from handling. Such precautions include preventing static electric discharge and preventing transfer of oil and grease to the components. Refurbishment of light fixtures and signs should follow the recommended guidelines set forth by industry standards and the manufacturers.

The survey data indicates the major reason for light-out failures of LED fixtures is the electronics/printed circuit board. The initial versions of LED light fixtures and signs contained model-specific LED components. Manufacturers have addressed this issue and are offering newer generation fixtures and signs with standardized and universal components.

### Quantity of Spare Parts Method

Regardless of the size of an airport (e.g., general aviation, regional or major hub) and the capital investment it makes to maintain an inventory of spare parts/stock, an inventory of spare parts must be maintained. The current practices established at an airport for maintenance of light fixtures can be followed for LED light fixtures, whether that practice involves full fixture replacement, refurbishment of light fixtures, or a combination of both.

There are numerous theories for determining the ideal number of spare parts for a given type of fixture. However, only the individual airport can decide what approach works best. A typical rule of thumb is 10% stock for spare parts but, with the longevity of LED fixtures, this may be reduced to 5% for an initial inventory. That percentage may be increased for elevated fixtures that are more prone to physical damage from vehicle traffic. Airports can adjust the value as they gain experience with LED lighting systems and the physical and environmental stresses of their particular location. As more LED lights are installed during rehabilitation projects, airports should use those opportunities to adjust inventory to maintain the new lights. Additionally, airports should build a relationship with their lighting manufacturer to better understand the manufacturer's parts and stock inventory practices and to develop an emergency lighting replacement plan. Spare parts inventory will vary from airport to airport, depending on the service duration of the fixtures. An airport that has been using LED fixtures for only 2 years will not have the same parts inventory as an airport that has been using them for 6 years, where the fixtures may be out of warranty. Figure 16 shows how often surveyed airports needed to replace components within LED fixtures; however, duration of service was not accounted for.



How often do you need to replace the light engine/electronics/diode of your LED light fixtures (not including premature failures)?

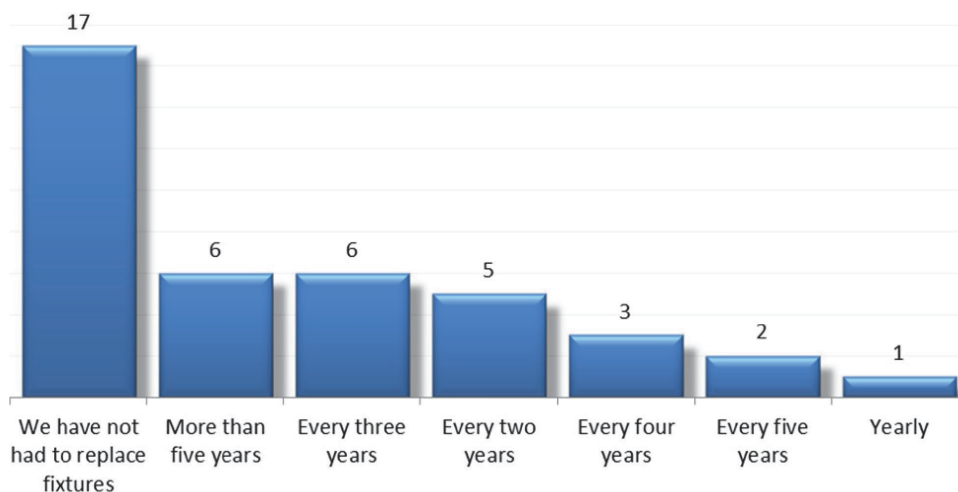

**Figure 16.** Survey results for the need to replace parts on LED fixtures.



### Key Takeaways

- Maintain an initial minimum of 5% stock items, whether full fixtures or spare parts.
- Refurbishment of LED fixtures should be conducted in a clean area, following manufacturer's guidelines and industry practices for work on electronic equipment.
- To maintain the quality of LED light fixtures, use only parts received from manufacturers for the particular light fixture.
- Maintain a relationship with a lighting manufacturer to gain knowledge of part availability and to develop an emergency lighting plan in the event of major light fixture failures.

## Preventive Maintenance and Refurbishment/Repair

Preventive maintenance is essential to maximizing the life expectancy of any AGL system. Preventive maintenance includes regular inspection and refurbishment of light fixtures to avoid failure. For an airfield to operate under safe conditions, the FAA mandates a maximum lights-out requirement for each lighting system. System requirements are provided in Appendix A. Along with lights-out requirements, the FAA also mandates a schedule for maintaining the lights. Table 1 is one of many maintenance schedules in *AC 150/5340-26, Maintenance of Airport Visual Aid Facilities*, used to guide airports in establishing a cost-effective preventive maintenance program.

Appendix A contains all the schedule tables for easy reference by maintenance personnel.

A common misconception about LED lights is that, given their claimed longer life span in comparison with their incandescent counterparts, they require little or no maintenance. However,

**Table 1. AC 150/5340-26C, Table 5-5, preventive maintenance inspection schedule for runway and taxiway elevated edge lights.**

MAINTENANCE REQUIREMENT	D A I L Y	W E E K L Y	M O N T H L Y	S E M I A N N U A L	A N N U A L	U N D E R S C R I B E D
1. Inspect for outages; repair as necessary	X					
2. Check cleanliness of lenses	X					
3. Perform photometric testing (HIRL) and check light alignment and orientation			X			X
4. Re-align lights as needed			X			X
5. Clean fixtures and sockets						X
6. Check light elevation				X		
7. Check for moisture in lights				X		
8. Inspect fixture for rust, deterioration					X	
9. Check lamp fitting and clean contacts					X	
10. Check gaskets					X	
11. Remove snow and/or vegetation from around lights						X

an LED fixture needs to be well-maintained to maximize life expectancy. From the data collected, it was evident that maintenance personnel believed that if a fixture illuminates, it needs no attention. This belief, however, conflicts with most manufacturer recommendations and the minimum requirements of AC 150/5340-26.

AC 150/5340-26 describes the minimum maintenance requirement for AIP-funded airports and provides guidance and recommendations for airports funded through other sources. The following excerpt is from the AC:

**Applicability.** The FAA recommends the guidance and specifications in this AC for the Maintenance of airport Visual Aid Facilities. In general, use of this AC is not mandatory. However, use of this AC is mandatory for all projects funded with federal grant monies through the Airport Improvement Program (AIP) and with revenue from the Passenger Facility Charges (PFC) Program.

The AC should be followed in order to maintain airfield visual equipment properly. The AC covers every visual aid system on the airfield in detail, providing requirements and intervals for maintaining the equipment. The AC also includes a table that breaks down maintenance into time

**Is the maintenance schedule identical for incandescent and LED lights?**

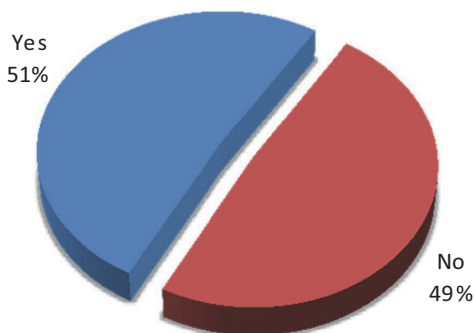

**Figure 17. Survey results for difference in maintenance schedules for LED and incandescent fixtures.**

periods (e.g., daily, weekly, monthly, semi-annually, and annually). The circular goes through step-by-step detail in each section and discusses the tasks to be completed in each timeframe. However, these requirements are set as a minimum and may require alteration in response to local airport conditions. The AC also repeatedly advises users to consult manufacturers maintenance manuals. *AC 150/5340-26* is not a replacement for manufacturers maintenance manuals.

Based on the airport and the airfield category, a specific number of lights have to be turned on and functioning for the airfield to operate safely. For example, a CAT I runway can operate with only 85% of the edge lights on. Based on the availability of maintenance personnel, labor costs, and the stockpile of spare parts or fixtures, maintenance procedures must be established for the airport that are not cost prohibitive. Such procedures may evolve over years of planning and recordkeeping of maintenance tasks and labor hours associated with each task.

As LED AGL becomes a more prominent part of the visual aid system, the preventive maintenance practices once used with incandescent fixtures will, in some cases, differ from those for LED fixtures (see Figure 17). To preserve the life of LEDs, a specific maintenance schedule has to be implemented because fixtures no longer require frequent re-lamping. Lack of attention can quickly result in a small problem becoming a bigger problem that can result in permanent failure to the fixture. For example, in one case study, a spider gained access to the housing of a fixture and created a web on the circuit board. Although the fixture continued to operate, over time the web held moisture and, ultimately, short circuited the electronics—this problem could have been avoided by periodic inspection of the fixtures.

Although preventive maintenance can reduce fixture failures, it will not eliminate them. Airports rely on their fixture failure maintenance procedures. The surveys and case studies revealed several methods for failure maintenance. Some airports found that it was best to replace fixtures as they failed. If the fixtures were within the warranty period, the fixtures were returned to the manufacturer for repair or replacement. If fixtures were out of warranty, they were replaced with new fixtures and the failed fixtures were discarded. This method reduced some of the preventive maintenance mentioned in the table above and allowed maintenance personnel to be used in other ways; it also reduced concern about retaining obsolete fixtures. Other airports repair fixtures as they fail. At almost all airports surveyed, maintenance personnel did not troubleshoot or repair any LED fixtures in the field. They replaced the fixture with a functional one in the field and brought the failed fixture back to the shop. This is also the recommended procedure as stated in *AC 150/5340-26*:

Do not disassemble LED-type light fixtures in the field—follow the manufacturer’s recommendation for maintenance if any is required.

A potential method conceived by the research team through case studies with airport personnel would be to establish a refurbishment schedule for portions of the airfield throughout the year. For example, every other June, a hypothetical airport might remove runway centerline lights and bring them to the shop for refurbishment, which would include replacing gaskets, seals, lenses or prisms, among other components that can sustain wear, and running each fixture through different tests, including photometric and chromaticity testing, pressure testing, and PCB output. Components would be repaired as needed. This refurbishment would be conducted in conformance with the maintenance manuals provided by the manufacturer.

In most cases, the diode will not fail; other components around it fail or degrade due to various reasons including moisture, vibration or simple wear and tear due to vehicular and aircraft movement and weather.

A maintenance supervisor from a medium-hub airport in a cold climate remarked:

We haven’t started yet, as most LEDs are less than 4 years old. However, we need to set up a PM plan to rebuild sections of LEDs at a time. With incandescent fixtures, we (remove and replace) them as

the lamps burn out. At that time, usually a year or so, they get an overhaul. Since the LEDs are lasting much longer, the prisms and gaskets will not be addressed in a timely manner, without a rebuild time period.

Although most airports refurbish or repair fixtures in their own shops (Figure 18), some airports use a service contract with the light fixture manufacturer for repairs or refurbishment of fixtures. These airports package the fixtures and return them to the manufacturer. The extent of in-house repairs varied from airport to airport. Some replace internal components and seal the fixture back up while others fully refurbish the fixture including the housing.

Given that LED technology is evolving, receiving proper training is necessary for the personnel who maintain these lights. Many training opportunities for airfield lighting are offered. Many airports have staff attend training courses provided by the fixture manufacturers or ask the manufacturer to conduct in-house seminars (Figure 19). These training opportunities include attending airfield conferences, classes offered by lighting manufacturers, and AAAE certification programs. Proper training ensures that maintenance personnel are handling fixtures in an approved manner and that preventive maintenance measures recommended by the manufacturer are being adhered to by the consumer. A good way to ensure airfield personnel receive training is to include training costs in the scope of large construction projects.

Although preventive maintenance routines differ, the following elements are considered the minimum essential by the FAA, as stated in *AC 150/5340-26*, in establishing a maintenance program:

- a. Document the service checks that comprise the maintenance program.
- b. Record the performance of each maintenance action, scheduled or unscheduled.

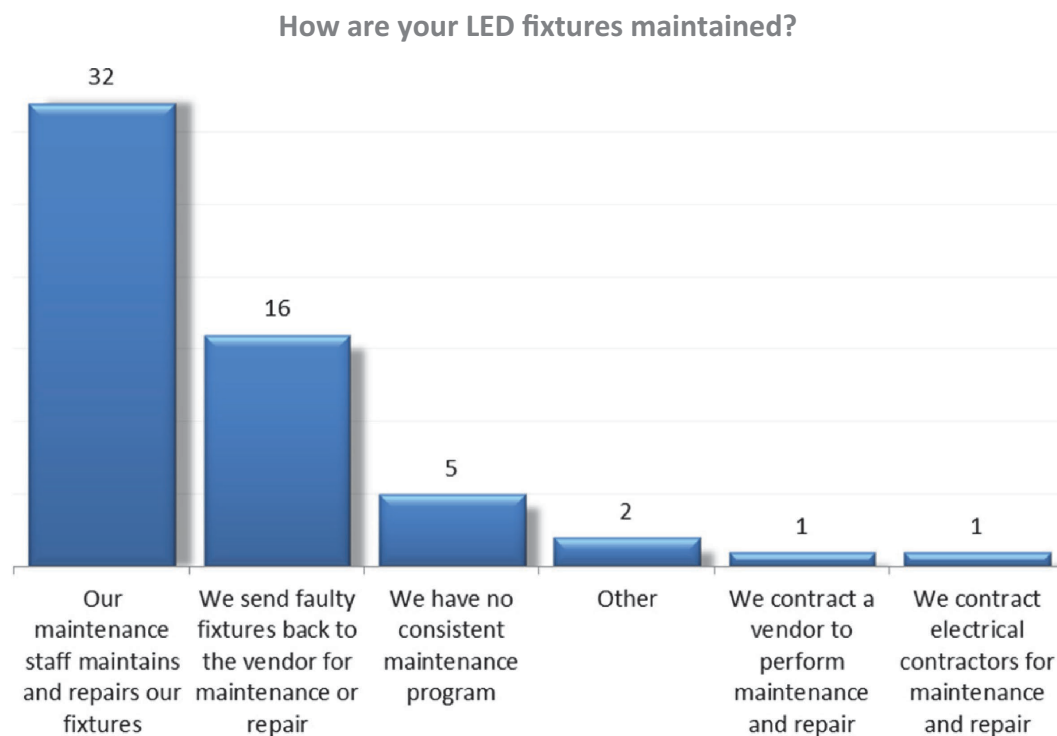

**Figure 18.** Survey results indicating how many surveyed airports use each method of fixture maintenance.



**Figure 19.** Survey results for how many airports use each type of training.

- c. Document repairs and troubleshooting performed on each piece of equipment and the results of those actions, as well as the symptoms related to the malfunction. This allows for more rapid troubleshooting of similar problems later.

The AC also states that a maintenance program is essential to the safety and reliability of the lighting system, especially if a failure occurs at a critical time. The following is a summary of paragraph 5.3, Light Fixture and Base Maintenance, which is the FAA's minimum requirement for maintaining runway and taxiway lights, including scheduled and unscheduled inspection checks:

- Airport lighting fixtures for runway and taxiway use are broken into two general categories: elevated and in-pavement.
- In-pavement fixtures typically require more maintenance than elevated fixtures.

### **Elevated Fixtures**

- Do not disassemble LED-type light fixtures in the field.
- Elevated fixtures are more likely to be damaged because of snow plowing, operation, or grass cutting. For this reason, many airfields use in-pavement edge fixtures.
- If elevated fixtures are struck, proper measures must be taken to prevent foreign object debris (FOD) hazard.
- When repairing edge lights, ensure proper aiming. The beams of runway edge lights are aimed toward the runway centerline at 3.5 degrees. The beam is also aimed up 4 degrees from horizontal. Refer to the manufacturer's manuals. If the globe is opened, gaskets/seals should be replaced.
- Control the vegetation growing around elevated edge lights.
- Never repair fixtures with the circuit energized.
- Only use parts approved by the original equipment manufacturer of the fixture.

## In-pavement Fixtures

- Rubber deposit on the lens is the main cause for poor photometric performance.
- Jet fuel, deicing fluid, and other contaminants can collect on/in a fixture, thereby causing deteriorating light output.
- When maintaining a fixture, remove and replace with a refurbished or new unit. Bring fixtures back to the shop for required maintenance.
- For maintenance purposes, maintain a quantity of spare fixtures equal to 5% of the installed quantity for each type of fixture at the airport.
- Airports are encouraged to build specially modified trailers or vehicles for fast removal and replacement of fixtures. Maintenance vehicles or trailers can be equipped with generators, air compressors, and proper tools to perform almost any task.
- Bench-test fixtures after refurbishment.
- Replace all gaskets/seals during refurbishment to avoid water intrusion.
- Some newer light fixture designs come from the factory with a Schrader valve stem attached to the bottom of the fixture. This fitting is used at the factory to pressure test the fixture during final assembly and can also be used during maintenance. Consult the fixture manufacturer for recommended air pressure settings.
- When reassembling a fixture, follow all manufacturers' instructions.
- When reinstalling the fixture, use new bolts and locking washers.

Many of the maintenance requirements can be simplified if the airport maintains an asset management system. An asset management system also allows the airport to budget properly, maintain a safe operating stock, and develop a plan for replacing outdated fixtures. Ensuring that a stock of functioning lights is always available is paramount to the safe operation of an airfield. The case studies revealed that some airports keep electronic records while others keep paper records. Manufacturers are beginning to use electronic methods to record hours of operation completed on fixtures. Airport records must be kept current and an understanding of the warranty must be established with the manufacturer. Keeping records current and understanding the warranty will help ensure that the airport maximizes its investment.

For new fixtures, the asset management database should log vital information (e.g., fixture type and serial number, date of purchase, date of installation, and fixture location). For refurbished or repaired fixtures, the database should include repair/refurbishment date, fixture location, tests, measurements conducted, and parts replaced. By documenting fixture repairs at problem areas on the airfield and noting components susceptible to higher failure rates, airports can stock more of the components they need. Other data deemed necessary by individual airfield maintenance teams should also be recorded.

To maintain efficiency on the airfield and ensure personnel are repairing equipment properly and to the standards and recommendations of the manufacturers, maintenance personnel are encouraged go through applicable training. *AC 150/5340-26* states the following:

Maintenance personnel should have a thorough knowledge of the equipment, experience with high voltage, and should be able to perform inspections and repairs. Special training is available and may be desirable, as most well-qualified electricians can be trained on-the-job if suitable supervision and instruction are provided. Qualified maintenance individuals should be present, or on-call, during the operating hours of the airport to correct any deficiencies that may develop. Airport visual aid maintenance personnel should be specialists in the field.

Conferences and tradeshow occur all over the country throughout the year. Attending these events may help keep airfield personnel current on issues, studies, and technological developments. Staff can attend these events and bring information back to their respective airfield maintenance teams.



### Key Takeaways

- Preventive maintenance is regular inspection and refurbishment of light fixtures to avoid a failure.
- *AC 150/5340-26, Maintenance of Airport Visual Aid Facilities*, describes the minimum maintenance requirements for AIP-funded airports. (All the schedule tables are in Appendix A of this guidebook.)
- To preserve the life of LEDs, a specific maintenance schedule has to be implemented given that fixtures no longer require frequent re-lamping.
- Based on the availability of maintenance personnel, labor costs, and the stockpile of spare parts or fixtures, maintenance procedures must be established for the airport that are not cost prohibitive.
- A typical rule of thumb is 10% stock for spare parts, but with the longevity of an LED fixture life, this may be reduced to 5% for an initial inventory. However, only the individual airport can decide what works best.
- Do not troubleshoot or repair any LED fixtures in the field. Replace fixtures and bring failed ones back to the shop.
- Stay ahead of fixture obsolescence by replacing failed fixtures with the latest generation or keep a stockpile of commonly failing components to allow for fixture repair after a fixture is out of production.
- Airports should maintain asset management systems to allow for proper budgeting and a safe operating stock and to help in developing a plan for replacing outdated fixtures.
- The asset management database should log in vital information (e.g., fixture type and serial number, date of purchase and date of install and fixture location) for new fixtures. For refurbished or repaired fixtures, the database should include repair/refurbishment date, fixture location, tests, measurements conducted, and parts replaced.
- Airport personnel must fully understand the coverage of the warranty.
- Fixture manufacturers may offer an extended warranty or a service contract to outsource fixture repairs when the base warranty expires.



### Key Takeaways

- To maintain efficiency on the airfield and ensure personnel are repairing equipment properly and to the standards and recommendations of the manufacturers, maintenance personnel are encouraged to go through the applicable training.
- When repairing edge lights, ensure proper aiming. Refer to manufacturers manuals. If the globe is opened, gaskets/seals should be replaced.
- Only use parts approved by the original equipment manufacturer of the fixture.
- Replace all gaskets/seals during refurbishment to avoid water intrusion and bench-test fixtures after refurbishment.
- When reinstalling a fixture, use new bolts and locking washers.
- *AC 150/5340-26* requires airports to check the torquing of in-pavement light fixture bolts bi-monthly at a minimum. If an area experiences repeated failures, that area should be checked more frequently.

## Maintenance Practices During Pavement Repair

Airfields undergo long-term construction improvement projects, such as rubber removal, striping, or full pavement rehabilitation. During such projects, fixtures may be affected. Several methods can be used to protect lights during construction.

While pavement is being rehabilitated, repaired, or newly constructed, protecting the light fixtures must be part of the project. In most cases, part of the electrical work is performed first before civil work can proceed. It is highly recommend that lights be removed, tagged, and stored or disposed of as the airport sees fit. Leaving lights in the pavement during civil work may cause severe damage to the fixtures.

Some of the issues mentioned in the airport survey and case studies for elevated fixtures occurred due to construction equipment and vehicles being close to the activities. In-pavement fixtures often get damaged during rubber removal when chemicals can enter the fixture or lenses can be scratched. In-pavement fixtures sometimes get painted over, which affects their photometric integrity. Maintenance activities can also affect fixtures. When fixtures are removed during pavement maintenance, they can be mishandled, thus resulting in damage to the fixtures or identification tags being misplaced, which ultimately affects the maintenance log.

The following steps, as illustrated in Figures 20 and 21, are general procedures for protecting fixtures during pavement overlay construction:

### Pre/During Paving

- Remove fixture, transformer(s), and top section. Remove P-606 sealer, cement compound, or epoxy around the perimeter of opening. Remove extension or top section.
- Take coordinate location (northing and easting/latitude and longitude). This will be used to locate the fixture after final paving is complete.



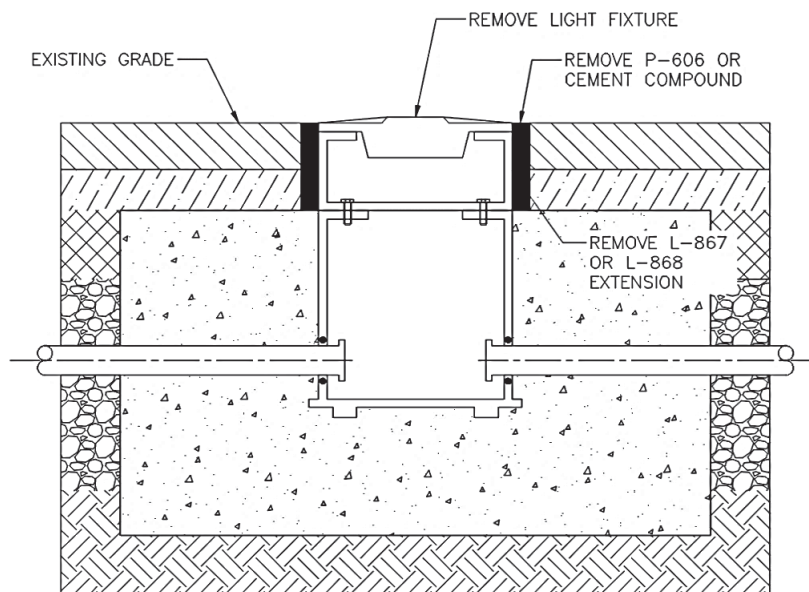

**Figure 20. Fixture to be removed prior to paving.**

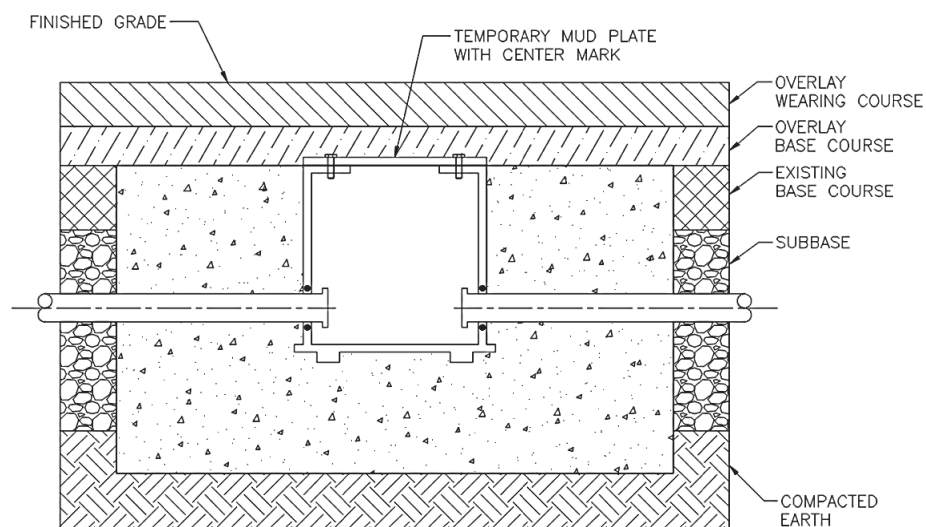

**Figure 21. Fixture removed during paving.**

- Furnish and install a temporary mud plate on the fixture. Mud plates should be  $\frac{1}{8}$ -in.-thick steel or  $\frac{5}{8}$ -in.-thick plywood.
- While paving operations are in progress, perform preventive maintenance on fixtures.
- Refurbish damaged fixtures in house or ship them to the manufacturer.
- Dispose of failed or obsolete fixtures and purchase new replacement fixtures as part of the construction budget or the airport's budget (budget dependent).

### Post Paving

- Using coordinates previously recorded, locate the light base.
- Core drill the full-size hole for the top section and fixture installation. The gap between fixture and pavement should not exceed  $\frac{3}{4}$  of an inch.
- Remove the temporary mud plate.

- After properly cleaning all debris from the light base, including the bolt holes, reinstall the extension onto light base.
- Fill the gap between the extension and pavement with appropriate materials (e.g., P-606 sealer, cement compound, or epoxy).
- Make all necessary connections and reinstall the light fixture.
- Final fixture installation will resemble the installation shown in Figure 21.

There are several ways to protect fixtures during a construction project. Elevated lights can be protected by enhancing their visibility to reduce the likelihood of vehicles or equipment hitting them. This can be done by placing construction cones around the light fixtures. If possible, ensure that edge lights are outside of the construction limits to reduce accidental damage. For in-pavement fixtures, fixtures should be removed during major paving operations. If pavement marking is being applied, fixture lenses should be masked to avoid getting paint on the lenses or light channels. The same procedure applies to rubber removal. Rubber should be removed from the fixture by separately cleaning each fixture lens after rubber removal procedures have been completed for the pavement.

Protecting the fixtures also extends to storage and inventory. The research team recommends that fixtures removed during paving be properly labeled. Fixtures should not be stacked on top of one another in large piles because this may damage the electrical leads (which could promote water infiltration).

Because most LED fixtures are more expensive than incandescent fixtures, airports tend to refurbish fixtures out of warranty. In general, if an LED fixture is opened for any kind of repair, the research team recommends that gaskets and prisms be replaced. After the fixture is repaired and reassembled, a pressure test is recommended to verify the light's assembly integrity. The research team also recommends photometrically testing the light to confirm that it meets FAA standards. Many airports are now obtaining photometric testing equipment to test lights after refurbishment or repair. Lights should also be tested through the five intensity steps using a benchtop constant current regulator to ensure proper functionality. Some airports completely rebuild fixtures, meaning that all components are either cleaned or replaced depending on condition, including sandblasting and repainting of the housing. This refurbishment can be done either by a trained contractor, trained airfield maintenance personnel, or the manufacturer of the fixtures. Once a fixture is refurbished, a maintenance log should be prepared or updated explaining what was repaired or replaced on the fixture.

Follow these general steps during refurbishment:

- Visually inspect the housing for cracks or deformities.
- Inspect the globe/prism for cracks, pitting, or other damage.
- Inspect for evidence of moisture infiltration.
- Disassemble the fixture and inspect internal components for damage or moisture.
- Replace parts as needed according to the manufacturer's recommendation.
- Reassemble the fixture and pressure test.
- Run the fixture through the five intensity steps. The fixture should be tested for an adequate period of time to ensure it will not prematurely fail in the field.
- Photometrically test the fixture on the highest step. Other steps can be tested; however, the FAA only requires testing on the highest step.

For major paving projects, the age of the fixtures should be assessed along with the generation, availability of spare parts, and failure rate. These will all help determine whether the fixture should be refurbished or replaced as a part of the rehabilitation project.

As previously stated, in-pavement fixtures should be protected during rubber removal. Enforcing this precaution is essential in touchdown zones where rubber accumulation is more severe.

**Table 2. Possible damage from rubber removal methods.**

Possible Damage	Water Blasting	Chemical Removal	Shot Blasting	Mechanical Removal
Groove damage	X		X	X
Spalling of concrete	X			
Damage to asphalt pavements	X	X	X	X
Microtexture degradation (polishing of aggregates)	X	X		
Loss of aggregate/fines	X		X	
Damage to expansion joints and crack seal	X		X	X
Damage to patches	X		X	X
Damage to equipment from caustic chemicals		X		
Damage to runway lighting	X	X	X	X
Damage to paint/markings	X	X	X	X

In 2008, TRB released *ACRP Synthesis 11, Impact of Airport Rubber Removal Techniques on Runways*. The document briefly discussed some of the effects rubber removal has on the lights. From all the different methods used for rubber removal, water blasting was deemed most harmful to lights. One of the main contributors to damage occurred when an inexperienced operator was using the equipment. *ACRP Synthesis 11* states, “However, in those cases where operator skill or experience was not adequate, damage to runway lighting, pavement markings, and crack sealant was experienced.”

Table 2, from *ACRP Synthesis 11*, shows that any method for rubber removal could damage the lighting system. It may be cost effective to remove the lights and plate their cans prior to rubber removal operations.



### Key Takeaways

- Pavement rehabilitation projects, or whenever pavement is shut down for a prolonged period, is an optimal time to perform preventive maintenance on LED light fixtures.
- Airport should have a protection plan for fixtures during pavement construction projects.
- Fixtures should be protected during pavement marking and rubber removal operations.

## Environmental Factors

Environmental factors are a greater cause of concern when comparing LED with incandescent fixtures, because LED fixtures contain electronics that can be more susceptible to environmental effects than standard lampholders and incandescent lamps. During the project, the research team noticed that, although vibration and moisture are the more common reasons for failure, other environmental aspects (e.g., insects) were also cause for concern. As the technology evolves and improves, these environmental factors are beginning to be reduced. In many cases,

manufacturers have worked closely with the airports to resolve issues and then took the necessary steps to prevent the failure from occurring in future fixtures.

## Vibration

Vibration is typically associated with the airfield operating environment due to moving aircraft and the forces they generate. As use of LED fixtures began to gain momentum in airfield applications, vibration became a concern given the various electronic components incorporated in the fixtures. The FAA requires airfield lighting manufacturers to subject in-pavement fixtures to vibration and shock tests. *AC 150/5345-46, Specification for Runway and Taxiway Light Fixtures*, states that fixtures must be subjected to a sinusoidal vibration along three mutually perpendicular axes. The first part of the test vibrates the fixture over a frequency range of 20 to 500 Hz with a maximum acceleration of 10Gs. The second part of the test vibrates the same fixture from 500 to 2,000 Hz, with a maximum acceleration of 15 times the force of gravity. Each part of the test must have a duration of 10 minutes. At the conclusion of the test, the fixture is thoroughly inspected for mechanical damage, loosened components, loss of continuity, or movement of the diode which is cause for rejection of the fixture. For shock testing, which applies to runway in-pavement lighting, the fixture is mounted to a 1-in.-thick steel plate or a 4-in.-thick concrete base. Steel or concrete must not be less than 3 square feet in size. Once assembly is complete, the fixture is set to the highest brightness level for 2 hours prior to the start of the test. With the fixtures still at highest brightness, a 5-pound steel ball is dropped on the center of the light from a height of 6 feet. This step is repeated 10 times at 5-minute intervals between drops. At the conclusion of the test, the fixture internals are inspected for failures or displaced components. Any evidence of damage or LED failure is a cause for rejection.

Vibration due to aircraft impacts is believed to be one of the causes for premature failure of LED airfield fixtures. Pinpointing the effects of vibration is difficult because clear data does not exist on what happens to fixture internals as an aircraft runs over it. Some of the airport personnel who completed the survey mentioned that vibration was a cause of LED failure on the airfield shortly after installation. In cases where lights failed due to vibration, the fixtures were typically still under warranty and issues were repaired by the manufacturer. Fixtures failing due to vibration were most commonly taxiway centerline lights at runway high-speed exits. Taxiway centerline lights are not required to comply with the rigorous impact testing that runway centerline lights are subjected to.

The following survey response from a medium-hub airport in a cold-climate environment demonstrates how vibration has affected LED fixtures:

When we first installed L-852 LEDs on a high speed taxiway, off a runway, we had a high rate of failures. We had not experienced the same issue on slower taxiways. Ultimately, we attributed this to the high number of 747s and MD11s . . . causing high rates of vibration in the fixtures. Basically, the leads were breaking off the light engines. [The lighting manufacturer] pursued the problem and repairs, under warranty. After a couple of rebuilds and product improvement, the LEDs are holding up.

A large-hub airport stated the following:

We have had a lot of runway fixtures go out in the first couple months of operations. Specifically centerlines and some touchdown fixtures.

Earlier generation fixtures were more susceptible to vibration damage. Resistors, capacitors, and other circuit board components would break away from the circuit board, causing the fixture to immediately fail. However, product improvement, for example, by potting the electronics and reducing the number of “moving parts,” has resolved many of the problems. Some light manufacturers established test beds to determine whether LED fixtures were more susceptible to vibration in comparison with their incandescent equivalents. For example, one manufacturer

installed their fixtures at a Naval Air Facility to subject them to a more severe environment than on a typical airfield. After many landings and tail-hook strikes, no fixture failures due to vibration were reported. (<http://www.adb-air.com/media/10333/ADB-Tech-Corner-Answers-High-Intensity-Airfield-Lighting.pdf>) The results showed that newer generation LED fixtures are more stable and durable in high vibration areas. By incorporating more solid-state and passive components, fixtures are now more resilient to vibration. In comparison, incandescent fixtures still incorporate a wire filament. When exposed to vibration, these filaments are susceptible to failure.

If an airfield is experiencing repeated failures in certain areas, specifically if these areas are runway centerlines, high-speed taxiways or touchdown zones, it may be due to vibration. A good practice is to discuss this topic with the airfield lighting vendor to better understand how equipment will perform in high-vibration areas. The case studies revealed that the areas mentioned above were typical areas for premature failure due to vibration and shock.

There are industry concerns regarding loosening in-pavement fixture hold-down bolts, regardless of the fixture type. Although FOD damage is the primary concern, loose bolts can amplify vibration damage. After being exposed to the various forces of aircraft movement, the bolts holding in-pavement fixtures down have been known to loosen if not fastened properly or have sheared off when fastened too tight. Whenever a fixture is not properly fastened, vibration to the fixture increases, which inherently increases the probability of damaged fixture electronics, disconnection of wiring, or loosening of components within the fixture.

*AC 150/5340-26* requires airports to check the torquing of in-pavement light fixture bolts bi-monthly, at a minimum. If an area experiences repeated failures, that area should be checked more frequently. Vibration issues were not as evident in incandescent lights because the fixtures were visited more often for re-lamping. LEDs do not require re-lamping and, therefore, are not visited as often. A good practice, especially for airfields with high LED usage, is to have a work plan and special crews assigned only to bolt torquing. Some of the airports included in the case studies stated that they have special crews that go out, usually at night, to check bolt torquing. These airports had different parts of the airfield testing scheduled at different times of the year to accommodate the work load. Although this may seem like an additional maintenance requirement for LEDs, it is not. The same amount of maintenance, if not more, is required when re-lamping an incandescent. Furthermore, *AC 150/5340-26* requires the same torquing checks for incandescent fixtures. More research is being conducted on bolt torquing issues, but a solution is yet to be determined. Maintenance records should be maintained by the airport to ensure that bolt maintenance schedules are followed.



### Key Takeaways

- Fixtures in runway centerlines, high-speed taxiway centerlines, or touchdown zones may experience greater failure rates due to vibration from more consistent high-impact aircraft movement.
- Discuss vibration with the manufacturer to better understand technological advancements and how issues can be alleviated.
- Maintain proper bolt torquing on light fixtures by creating a testing schedule and stocking the correct tools.

## Moisture

### *In-Pavement Light Fixtures*

The responses to the surveys and case study questionnaires indicated that moisture is a common issue and area of concern that airports are experiencing with LED fixtures and that the presence of moisture may result in the failure of the fixture. Moisture is not unique to LED fixtures; in fact, incandescent equivalents experience similar water infiltration. The difference is that LED fixtures use a printed circuit board (PCB) in lieu of the gas-encapsulated filament used in traditional lamps. Once water migrates into a PCB, it quickly corrodes conductive material, resulting in a circuit short that is difficult to pinpoint and impractical to repair. When water is present at the base of an incandescent lamp, corrosion is accelerated; however, due to the shorter life span of lamps in incandescent fixtures, lamps require replacement long before corrosion is an issue. Additionally, lamp replacement is far less expensive than the replacement of the PCB. The project research indicates that most airports have water in their light bases as well as conduit system. Newer LED fixtures have better coatings on the circuit boards and other electrical components to prevent corrosion; however, in older fixtures that is not the case. Other airports reported that water injected into the light fixtures as aircraft rode over them. Figures 22 through 24 show an incandescent light fixture that had been in service over 40 years and was still operational. As



**Figure 22.** *Water surging through lighting infrastructure.*



**Figure 23.** *Primary cabling flooded by storm water.*



**Figure 24.** *Accumulation of silt and corrosion on cabling.*

the fixture was removed, the research team could see the damage done to the fixture assembly and primary cabling. LED fixtures cannot be sustained in this environment. If groundwater or stormwater reaches the light fixture itself, the infrastructure should be drained or else LED fixtures will be more susceptible to failure in these locations. Many airports require their AGL systems to be drained to the nearest stormwater structure. For example, a light base will have a 2-inch PVC or HDPE pipe running from the bottom of the can. Unfortunately, as time goes on, these drainage lines may become clogged.

In addition to water being present in the lighting infrastructure, there are various reasons why moisture penetrates the actual fixture. Although fixtures leave the factory with an airtight seal that prevents water entry, the surveys and case studies revealed that water penetrates these fixtures through worn gaskets, cracked lenses, and damaged cord sets. Opportunities for water to penetrate fixtures are magnified by the longevity of LED systems.

LED fixtures require little to no re-lamping and are, therefore, visited less often than their incandescent counterparts for repair. Many airports the research team interviewed stated that as long as a light is operational, it is not touched by the maintenance team. After several years, with the fixtures having gone through the different seasons, the gaskets on the lights began to blister and crack. The lenses subjected to jet blast and aircraft tires began to get scratched and cracked. Cable insulation on cord sets began to break down. Such issues that would typically be inspected during a re-lamping phase are often left untouched, causing their effect on the LED light fixture to be amplified.

Figure 25 was taken at Portland International Jetport (PWM) in Portland, Maine by maintenance personnel. Although this fixture clearly shows moisture, other fixtures may fail before showing any signs. If a light begins to appear dimmer than surrounding fixtures, it is usually a good indication that the light requires further investigation.

Figure 26, also taken at PWM by maintenance personnel, shows a disassembled light fixture that failed because of water within the fixture. This picture was taken prior to a complete refurbishment of the fixture.

Research findings proved that the most common method of inspecting lights is with a low-speed drive-by review, noting lights that are not illuminated or are dim. Such fixtures are removed from the light base to allow staff to inspect the damage and to determine the repair or replacement protocol at the first available opportunity. This method, although effective, is substandard to some manufacturers' recommendations. Most manufacturers recommend a much more thorough inspection that usually involves pulling all fixtures out of the light bases on a schedule. This solution is difficult



**Figure 25.** *Moisture build-up inside fixture.*

to achieve because the procedure would take weeks, if not months, to complete when considering allowable runway and taxiway closures.

Although moisture is an ongoing issue, maintenance personnel had success with fixture life when they thoroughly inspected a failed light. This included replacing gaskets, testing boards, and cleaning fixtures, among other steps to ensure a fully functional, properly sealed fixture.

### ***Guidance Signs***

L-858 runway and taxiway guidance signs subject to environmental factors (e.g., jet blast, vehicle damage, and ground maintenance damage) require diligent maintenance. Based on the survey data, approximately 55% of the airports have some LED lighted taxiway guidance signs. Manufacturer documentation indicates all standard signs are available in three-step or five-step operation.



**Figure 26.** *Water inside light fixture.*



As with the LED-type AGL, the LED lighted signs offer extended lamp life, which significantly reduces re-lamping maintenance compared with non-LED signs. The survey data indicated the most common issue faced by the LED signs is exposure of the electronic power supply inside the sign structure to environmental conditions. Given that the sign housing is not sealed, the power supply is susceptible to dust and dirt. Dirt on the electronic components can cause overheating and premature failures. This condition has been indicated in case studies for the early generation of guidance signs.

Manufacturers have revised the design of the signs by either encapsulating the electronic power supply or providing a sealed box to house the power supply. Some manufacturers are using a universal power supply that can be used with both ground lighting and signs with only minor adjustments.

### Additional Factors

Figures 27 through 30 present the survey results on LED fixtures performance versus incandescent fixture performance in various conditions.

Much of the feedback the research team received reiterated the toll taken from high-impact areas, making vibration and moisture two standout factors for discussion. Additionally, the research team also learned that insects and spider webs that hold moisture have penetrated light fixtures and shorted out PCBs. Although insects typically coexist with most systems in industrial locations, unprotected PCBs are fragile and susceptible to many forms of deterioration.

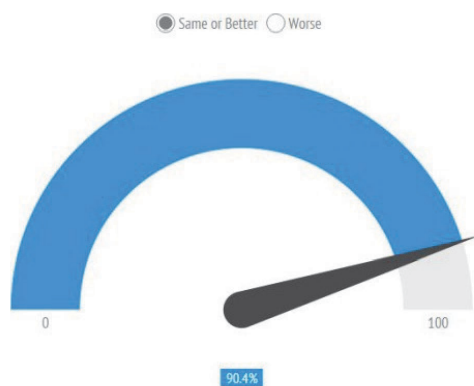

**Figure 27. Insect resistance.**



**Figure 28. Operation in snow.**



**Figure 29. Operation in extreme cold.**



**Figure 30. Operation in extreme heat.**

Although this data seems to be an overwhelming endorsement for the performance of LED systems, the reality is that decades of using incandescent fixtures were being compared to a relatively new product. Although this may skew the perception in favor of LEDs, early reports on these fixtures indicate no inherent flaw with the use of this equipment that would restrict its use in any region or climate.



### Key Takeaways

- Refer to the preventive maintenance section to develop a plan to inspect LED fixtures independent of light failures.
- Inspect all material susceptible to moisture entry during repair.
- Areas that have a higher susceptibility to moisture damage include touchdown areas, high-speed exits, deicing areas, and areas at a low elevation.
- LED PCBs are much more sensitive to environmental conditions than legacy incandescent systems.



## CHAPTER 4

# Operation Considerations

### Circuit Configuration

LED lighting systems consume less energy and have a longer life than other lighting sources. Because of their low energy consumption, there has been a tendency to increase the number of fixtures on a given circuit to optimize the capacity of the constant current regulator (CCR). Many airports have implemented LED lighting through grant-funded or capital projects where the installation is performed by electrical contractors. However, some airports replace existing fixtures with LED lights using their own maintenance staff. This chapter presents best practices for circuiting LED fixtures, with a focus on maximizing CCR capacity and optimizing maintenance practices.

LED fixtures typically require 50% to 75% less power than incandescent fixtures as shown in Figure 31. This decrease in power consumption is a tremendous savings when extrapolated across an entire airfield. To maximize the benefits of this new technology, several factors must be considered.

### Circuit Load Calculation

In reviewing what effect more efficient fixtures will have on AGL systems, the research team determined several strategies an airport can implement. LED AGL loads can realize a significant reduction in energy consumption, as illustrated below. The load calculation for any given circuit is as follows:

$$TL = (F \times (FL + XL)) + (L \times CR \times A^2)$$

where

- TL = Total Circuit Load (VA)
- F = Quantity of light fixtures
- FL = Load of Each Light Fixture (VA)
- XL = Load of Each Isolation Transformer (VA)
- L = Cable Length (Ft)
- CR = Cable Resistance ( $\Omega$ /Ft)
- A = Circuit Ampacity (High Step)

The calculation below shows that the circuit load for a taxiway centerline circuit using 100 bidirectional incandescent L-852C type fixtures and 20,000 feet of L-824 cable will be 5,980 VA. This calculation illustrates a circuit current of 6.6 Amps and the cable resistance is

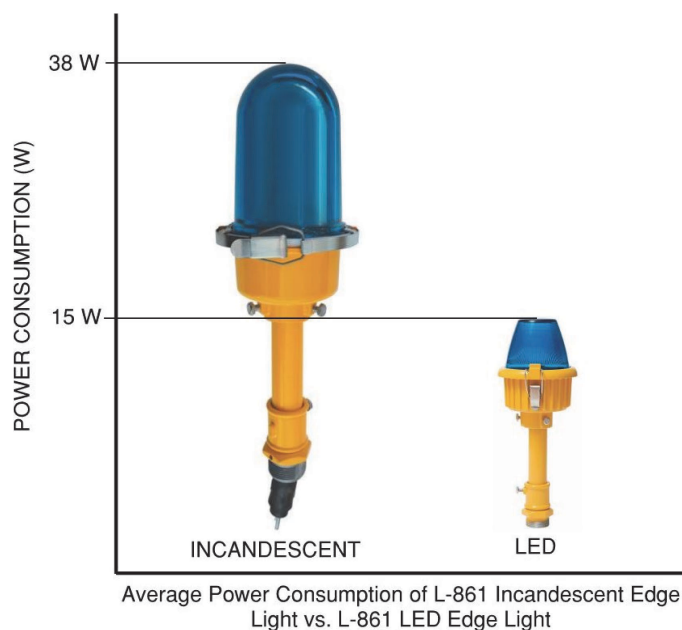

**Figure 31. Load comparison of L-861T medium-intensity elevated edge lights.**

derived from the NEC Chapter 9 Table 9 value for #8 AWG cable ( $0.78 \div 1,000$ ). The calculations are defined as follows:

$$TL = (100 \times (45 + 8)) + (20,000 \times .00078 \times 43.56)$$

$$TL = 5300 + 680$$

$$TL = 5980$$

A load this size would typically be placed on either a 7.5 kW or a 10 kW CCR. For this example, a 7.5 kW CCR has been selected because the load is roughly 80% of the capacity of the CCR. Having established the base model of a typical taxiway centerline circuit, the next step is to investigate the effect of converting to LED fixtures.

## Circuit Optimization

There are several circuit configuration and optimization strategies for direct replacement with LED lighting. These strategies address different goals for the airport and include

- Direct replacement with LED lights without any circuit modifications. (**Low cost, Low-power factor, Medium flexibility**)
- Direct replacement with a new properly sized CCR. (**High cost, High-power factor, Medium flexibility**)
- Direct replacement and combining circuits to maximize the load on the CCR. (**Low cost, High-power factor, Low flexibility**)
- 40%–50% loading of circuits to facilitate emergency repairs. (**High cost, Low-power factor, High flexibility**)

The strategy chosen depends on the available budget, energy efficiency, operational strategies, and maintenance strategies. Figure 32 addresses strategies implemented by the airports surveyed.

**When installing LED light fixtures to replace incandescent light fixtures on an existing series lighting circuit, did you:**

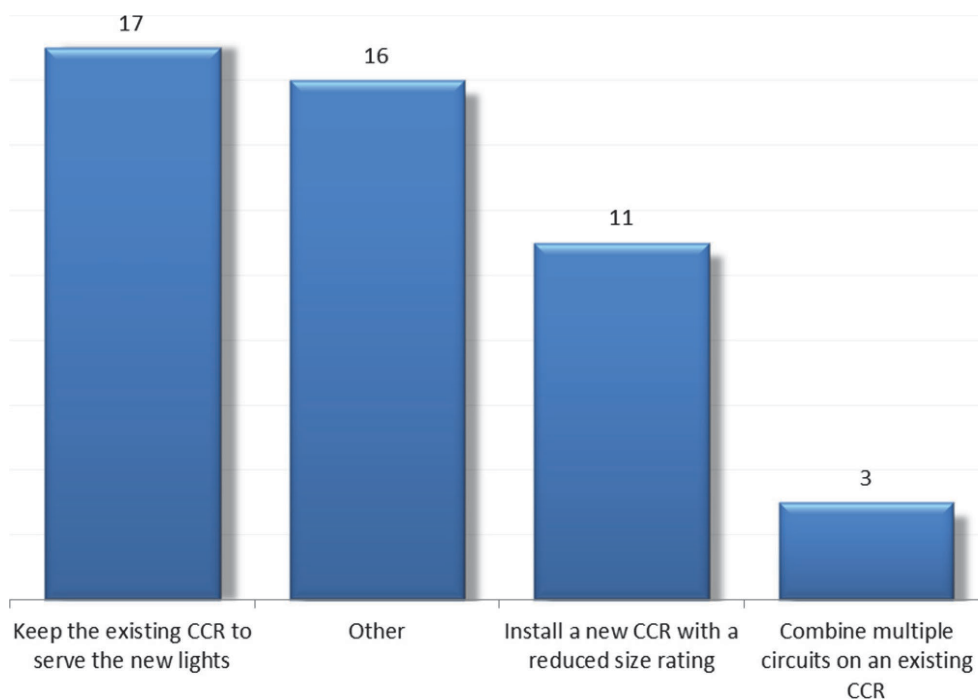

**Figure 32. Survey results for replacement of CCR when LED fixtures replaced incandescent.**

***Approach 1: Direct Replacement Without Circuit Modifications***

If the fixtures on this circuit were then converted to LED, the calculation would be as follows:

$$TL = (100 \times (17 + 3)) + (20,000 \times 0.00078 \times 43.56)$$

$$TL = 2000 + 680$$

$$TL = 2680$$

This would net a circuit load of 2,680 volt-amps. One option would be to leave the existing 7.5 kW CCR in place to service this load. The load of 2,680 volt-amps would be less than half of the consumption of the original circuit. This would result in the least effect to cost and maintenance (Figure 33), although there would be an operational concern. If this CCR were a silicon-controlled rectifier (SCR) type, the taps would have to be adjusted to the new value or else the input current draw would be nearly identical to the original incandescent load [Runyon 2013]. Whether an SCR or Ferro-resonant type CCR, the power factor would be worse when a CCR would be lightly loaded as the voltage would become more out of phase with the current. CCR manufacturers recommend a minimum loading of 60% for CCRs to minimize any power factor losses due to inefficiency.

***Approach 2: Direct Replacement With a Properly Sized CCR***

The next option would be to replace the existing 7.5 kW CCR with a 4 kW CCR. This new CCR would be matched to the new load with a capacity at 67% full. Although this method would have higher initial costs, the energy consumption would be at its lowest, and the CCR would still only

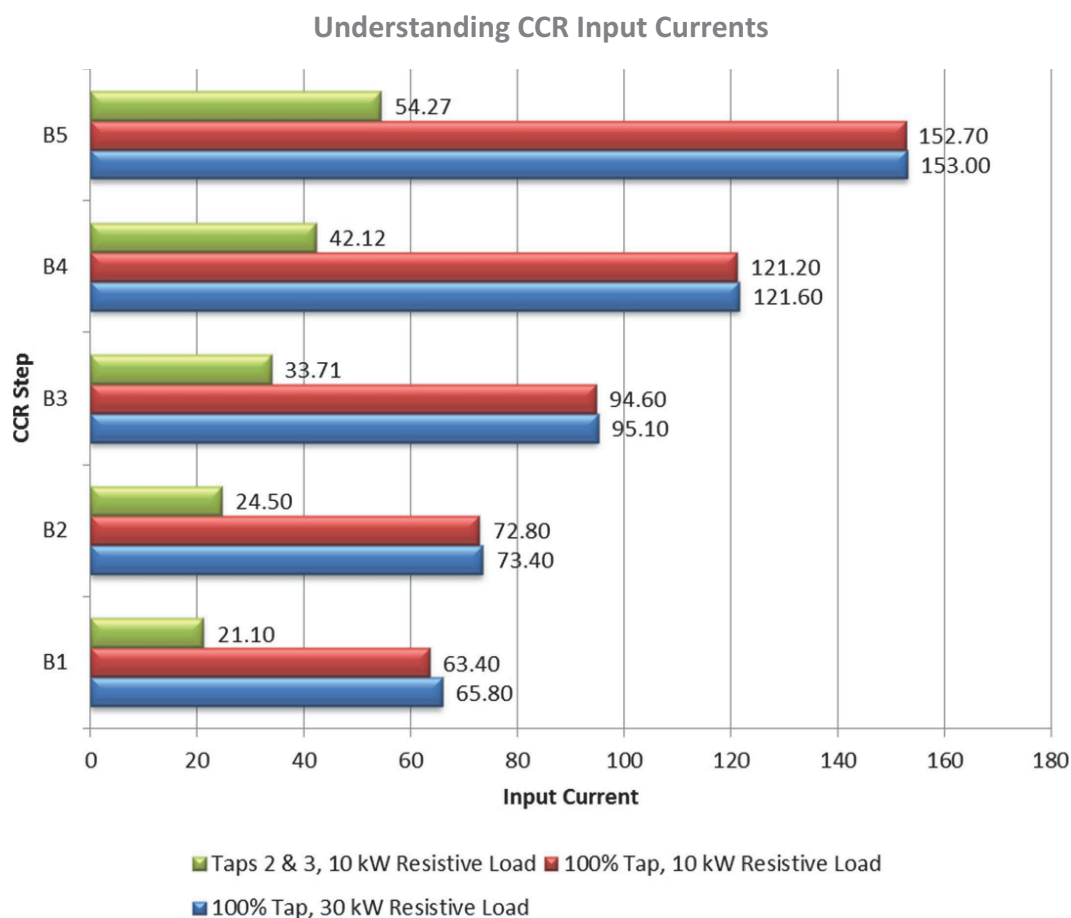

**Figure 33. Effect of CCR inefficiency.**

serve one circuit. This method would maintain the existing circuit segmentation plan which could be operationally important; however, it would have a higher cost and would not alleviate any existing space constraints within the airfield lighting vault.

### ***Approach 3: Direct Replacement and Combining of Circuits on the Existing CCR***

In the example above, where the 7.5 kW CCR would be only loaded at 36%, it would provide the opportunity to combine several circuits into one circuit. Because roughly 4,800 VA of capacity would remain on this CCR, the facility might choose to add another identical circuit to this CCR. Now, this CCR would be responsible for 200 fixtures and 40,000 feet of cable over two taxiways. This new circuit would have an improved power factor, and perhaps there would be a cost savings by not requiring an additional CCR. Combining these circuits would eliminate the need for an additional regulator, but would increase the affected area if this circuit should fail. This could affect operations and increase the time and effort to troubleshoot the circuits. It might also affect operational flexibility if the tower preferred to illuminate only those taxiways or runways in use.

### ***Approach 4: 40%–50% Loading of Circuits to Facilitate Emergency Repairs***

One of the airports interviewed for the case study indicated the maintenance department preferred to load the CCRs just under 50% to facilitate emergency repairs. By having significant spare capacity in each circuit, maintenance can temporarily jumper an adjacent circuit to it if

there are cable failures in that circuit. This approach allows them to get the lights back on quickly and perform cable repairs or replacement at a more appropriate time. This strategy is similar to Approach 1 in that it is the lowest cost when replacing LED fixtures; however, the load on the CCRs must be adequate and the CCRs must be adjusted so they perform correctly. This method does not optimize efficiency of the CCR and will result in a lower circuit power factor.

### **Mixed Circuits with Lights and Signs**

Another possible scenario on an airfield is the mixing of lights and signs on the same circuit. This is not a preferred configuration and should always be designed according to manufacturer's recommendations. The issue with placing signs on light circuits is that signs will draw the same wattage on all steps where a light fixture load varies with the step intensity. Lights will require less wattage as the steps decrease, and in turn less voltage, although the current remains constant. Because signs are required by the FAA to have a constant light output across all steps, an airfield circuit that contains both signs and lights and has a high proportion of signs, may experience CCR failure at the low steps. Therefore, the regulator must be designed to avoid a trip in the circuit due to overloading of the regulator. There are also sizable losses in the cable runs because signs are usually spaced farther apart. Placing signs and lights on separate circuits allows for better sizing of regulators. This is the preferred best practice for designing an airfield lighting system.

### **Mixed Circuits with Incandescent and LED Fixtures**

The most economical method to introduce LED fixtures to an airfield would be to replace old and damaged incandescent fixtures with their respective LED counterparts. Eventually, as all incandescent fixtures fail, the airfield will be completely replaced with LED fixtures. However, this is the exact scenario the FAA is trying to avoid. Per FAA AC 150/5340-30G:

The increasing use of airport LED light fixtures on the air operations area (AOA) has caused concerns when LED light fixtures are interspersed with their incandescent counterparts. LED light fixtures are essentially monochromatic (aviation white excepted) and may present a difference in perceived color and/or brightness than an equivalent incandescent fixture. These differences can potentially distort the visual presentation to a pilot. Therefore, LED light fixtures must not be interspersed with incandescent lights of the same type. Example: An airport adds an extension to a runway. On the existing runway, the runway centerline light fixtures are incandescent. The airport decides to install LED runway centerline fixtures on the new section of runway and retains the incandescent fixtures on the existing section. This interspersing of dissimilar technology is not approved for installation. In addition, defective incandescent fixtures must not be replaced with their LED counterparts. When replacing a defective light fixture, make certain that the replacement uses the same light source technology to maintain a uniform appearance.

This guidance indicates that incandescent lighting can be replaced with LED lighting only when replacing an entire system or when there is significant visual demarcation between the old lighting and the new. LED fixtures can be combined with incandescent fixtures on the same lighting circuit with no issue; however, the information on LED circuit inrush gives guidance as to how high to load a CCR.

### **3-Step vs. 5-Step CCRs for LED Circuits**

Now that several years' worth of data from LED AGL systems in use is available, user feedback has inspired changes to the FAA ACs on the use of these systems. AC 150/5340-30H, in Chapter 4, has determined that high-intensity LED lighting systems will be served by 5-step CCRs. The reasoning is that a 3-step CCR cannot adequately reduce the light intensity of these systems at the lowest step. A 3-step CCR has a low step current of 4.8 amps while a 5-step CCR has a low step current of 2.8 amps, nearly half of the 3-step equivalent. Although the AC does not specify

what constitutes a “high-intensity” LED system, there appears to be a shift in the industry to move LED AGL circuits to 5-step CCRs.

## LED Circuit Inrush

The FAA conducted a study to determine the effects of LED lighting on the operation of a CCR. In the study, the FAA tested five LED taxiway edge lights from different manufacturers. Each light presented a high initial peak power (VA) value then dropped off to a steady operating power (VA) value; however, not all high peak values and steady operating values were the same among the fixtures. The study recommended that light manufacturers limit the peak power and power drop values to 10% of the fixtures operating power value to ensure the CCR could adjust to the overvoltage and overcurrent condition during startup to the steady-state operation phase. Although LED taxiway guidance signs were not included as part of the test, the understanding is they, too, would have a high initial peak power value and then drop off to steady-state operation. Refer to *FAA Technical Note DOT/FAA/AR-TN08/29, Light Emitting Diode Taxiway Lighting Effects on Constant Current Regulator Stability* for more information.

The survey data from one case study indicated an ongoing issue with a CCR “tripping-out” on an LED light fixture circuit. In such cases, several factors can be reviewed to help mitigate the situation for both existing and future lighting circuits.

If an existing CCR is tripping-out, the circuit size and load should be reviewed and verified. If the circuit load is within 10% of the CCR nameplate load, remove light fixtures from the circuit until the load is 10% to 15% less than the nameplate load. Operate the circuit with the reduced load. Depending on the manufacturer of the light fixture and CCR, additional light fixtures may have to be removed. If this does not resolve the issue, further investigative testing is required to determine initial and steady-state circuit loads and overvoltage and overcurrent parameters of the CCR. This data can be used to determine if it is a circuit issue or a CCR issue.

For new designs, three factors can be implemented to help reduce the potential of overload on the CCR powering an LED light fixture circuit: (1) limit the calculated circuit load, which includes light fixtures, signs, cable, transformer losses, digital control devices losses, etc., to be 85% to 90% of the selected CCR nameplate load; (2) review the LED light fixture peak power and drop-off power value and compare to the fixture’s operating power value, a value difference close to 10% may give you a better performing system; and (3) review the adjustment capabilities and specifications of the CCR for compatibility with high initial peak power circuits.



### Key Takeaways

- Consider the needs of your airfield when evaluating circuit optimization.
- For existing circuits, verify existing circuit load and compare to CCR nameplate.
- For new circuits, the research team recommends selecting a CCR nameplate load 10% to 15% higher than the calculated circuit load.
- Review the specified operating performance of LED light fixtures, LED taxiway guidance signs, and CCR with manufacturers for proper selection of circuit components.



## Heaters in Elevated and In-pavement Fixtures

The need to provide heaters for elevated and in-pavement light fixtures in areas prone to snow, sleet, and ice has been an issue since the start of development and implementation of LED light fixtures. Ice and snow can accumulate and adhere to elevated and in-pavement light fixtures obscuring the light output. Heat, an inherent characteristic of incandescent fixtures was the source of ice and snow melting. LED fixtures produce heat at the light engine; however, this heat is transferred to a heat sink farther from the fixture surface to prolong the life of the diode. Therefore, to replicate the snow-melting capabilities of incandescent fixtures, a separate heating element was designed for both elevated and in-pavement light fixtures to mimic the lamp heating effect of an incandescent light fixture.

More than half (65%) of airports surveyed do not use heaters for their light fixtures. However, the survey was not clear on the type of precipitation experienced by these airports. To review more closely, the research team turned to the case studies which included several large hub airports in regions prone to significant amounts of frozen precipitation; with the use and non-use of heaters roughly split in half. Two of these airports, which are geographically close to each other, were split on the debate of whether to use heaters or not. The need for use of heaters is thus inconclusive.

The heating activation of incandescent light fixtures is a function of energizing the series lighting circuit. Case studies indicate that most airports do not regulate the intensity of the lighting circuit to melt snow or that they are energized to the highest intensity in anticipation of heavy snow. These light fixtures are operated based on visibility and runway visual range (RVR) in accordance with FAA Order JO 7110.65, Air Traffic Control, Section 4, Airport Lighting. However, visibility during snow events typically calls for the lights to be on the highest intensity setting.

Because the operation and intensity of the incandescent light is based on visibility, rather than ambient temperature, when evaluating the efficacy of LED light fixtures with heaters versus the heat generated by an incandescent light fixture, the heat at each intensity needs to be taken into account (Figure 34).

Heaters supplied with LED light fixtures are thermostatically controlled and are activated when the circuit is energized. According to manufacturer information, the thermostat typically activates the heaters when the ambient temperature is 40°F or less. The heating process

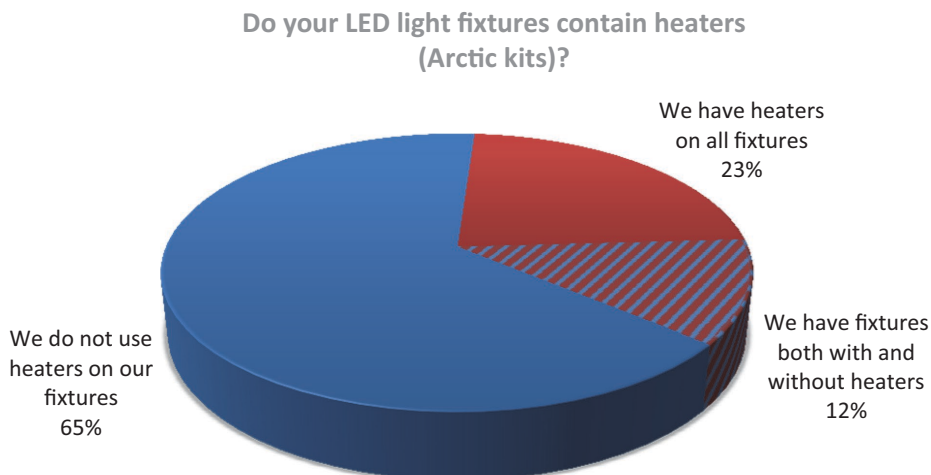

**Figure 34.** Heater usage on airfields.

for an LED light fixture is based on temperature, rather than a function of intensity setting (as is the case for an incandescent fixture). The heating process allows the heater to turn on and warm the fixture prior to the ambient temperature reaching the freezing point at any intensity setting.

The actual heating element of an in-pavement LED light fixture is next to the lens of the fixture. FAA *Engineering Brief 67, Light Sources Other than Incandescent and Xenon for Airport and Obstruction Lighting Fixtures*, indicates “. . . the main beam light emitting surface temperature must rise a minimum of 15°C after 30 minutes.” This allows for an efficient heating source concentrated in critical areas with minimal unnecessary heating of the entire fixture.

In-pavement light fixture heaters are not integrated with the LED light assembly or the power supply, but are a separate, detachable unit. The exact style and location varies, depending on manufacturer. Figure 35 depicts the heating element and thermostat components that make up an in-pavement light fixture heater. The figure shows a bidirectional two-cord set fixture. Each circuit has a thermostat and a heater associated with it.

The heaters for elevated light fixtures can be integrated into the light assembly (see Figure 36) or a separate detachable unit. The exact configuration varies among manufacturers. Heater operation is similar to that for in-pavement light fixtures as outlined in *Engineering Brief 67*. The heaters provide heat on the globe/lens of the elevated light fixture to melt snow and ice. The exact method of heating and heater should be discussed with the light fixture manufacturer for the particular light fixture.

Because the LED heater is thermostatically controlled and is concentrated on the main beam, it is more predictable than its incandescent counterpart and more effective in applying heat to the lens at a lower intensity setting. An incandescent light fixture applies an unregulated amount of heat to its entire surface area. Although the incandescent fixture melts ice and snow, this typically happens at a higher intensity setting than an LED light fixture.

Table 3 indicates the typical operating characteristics of an incandescent lamp for an airfield lighting circuit. The table shows that the power consumption of the lamp drops below half from the highest intensity setting to Step 3.

One of the objections to the use of a heater is that heaters are often the first component to fail and therefore cause a diminished MTTF to the fixture. Discussions conducted with light

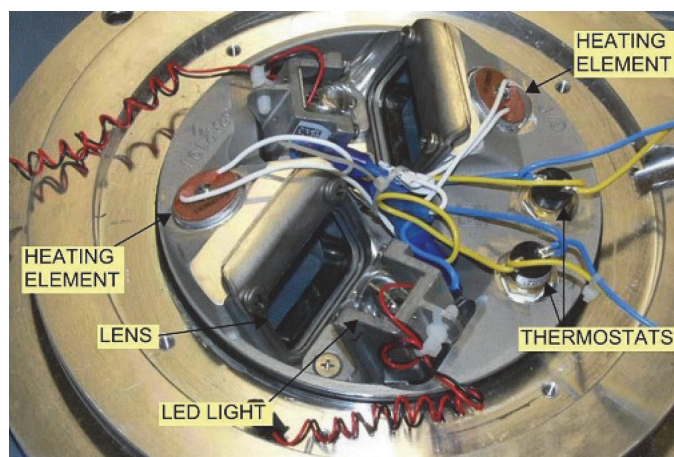

**Figure 35.** *In-pavement fixture Arctic kit.*



**Figure 36. Elevated fixture heater and light.**

fixture manufacturers and additional research have indicated the MTTF of the light fixture includes the heater. The failure tests performed by the manufacturers have been on fixtures with heaters, thus the MTTF of the light fixture is not limited by the heater. For example, adding a heater to a runway centerline light fixture does not affect the published MTTF of 150,000 hours. This eliminates the concern of affecting the life of an LED light fixture by selecting one with a heater.

Another objection to the use of heaters is the added energy consumption and increased operational energy cost. A calculation was performed using an L-852D LED light with a heater, an L-852D LED light without heater, and an L-852D quartz halogen light, to determine yearly power consumption. The research team assumed a cold-climate airport has, on average, 157 days at 40 degrees and below and 208 days at 40 degrees and above, operates its lights on the highest intensity setting an average of 12 hours per day (see Figure 37), has approximately 500 lights, and pays \$0.12 per KWH; the airport could realize energy costs as indicated in

**Table 3. Typical lamp operating characteristics for incandescent lamps.**

Lamp Characteristic for Incandescent Lamps							
Intensity Level	FLA (%)	Amps (A)	Lumens (%)	Watts (%)	RW C/L Watts	TW C/L Watts	LED Heater
Step 5	100%	6.60	100%	100%	96W	64 W	32W
Step 4	79%	5.21	23%	69%	66.24W	44.16	32W
Step 3	63%	4.16	5.7%	48%	46.08W	30.72	32W
Step 2	52%	3.43	1.73%	35%	33.60W	22.4	32W
Step 1	43%	2.84	0.53%	26%	24.96W	16.64	32W

On average, how often are your airfield lights illuminated daily?

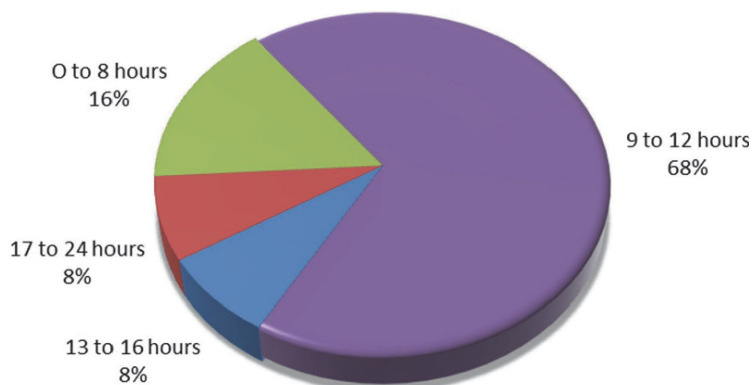

Figure 37. Amount of hours lights are on at airports surveyed.

Table 4. (This number is based on the light fixture load only and does not include transformer losses, CCR efficiency, and additional hours of operation, and the KWH cost at each airport will vary. Regardless, LED light fixtures equipped with heaters provide a substantial reduction of energy.)



**Key Takeaways**

- The use of heaters in LED light fixtures is incorporated in the MTTF of the LED light.
- Light fixtures with heaters provide a predictable and efficient heating operation with the heating element focus on the light beam area of the lens.
- Precipitation type and snow/ice removal techniques influence the need for heaters, i.e., airports with occasional ice and minimal removal equipment may benefit by having heaters vs. airports that are highly experienced with snow and ice removal.
- The study did not produce sufficient data to determine when heaters are needed.
- Airports should discuss the type, configuration, and use of heaters with the light fixture manufacturers to determine what is appropriate for use at a particular airport.

Table 4. Operational energy cost example.

Fixture	Volt-amps (VA)	Watt-Hrs/Year	Percent Difference	Energy Cost
L-850D Quartz Halogen	64	46,720	Baseline	\$2,803.00
L-850D LED W/Heaters	50.8	23,772	50% less than quartz	\$1,426.00
L-850DA WO/Heaters	18.8	13,724	70% less than quartz 43% less than heaters	\$823.00

## Monitoring

The two advisory circulars on monitoring AGL systems are *AC 150/5345-10, Specification for Constant Current Regulators and Regulator Monitors*, and *AC 150/5345-56, Specification for L-890 Airport Lighting Control and Monitoring System (ALCMS)*.

AC 150/5345-10 describes monitoring through the constant current regulator and detection of the status of the CCR and the series lighting circuit. Five conditions must be detected, four of which deal with the status of the CCR (i.e., loss of power, input over current shutdown of CCR, drop in output power to series circuit and irregular output current to series circuit). The condition that deals directly with the series lighting circuit is lamps out in the series circuit.

AC 150/5345-56 describes monitoring through a lighting control system and discusses various levels of monitoring, with each level building to the next level. The levels include control and status, basic—monitoring of circuits and feedback, and advance—monitoring of lamps out for low visibility operations. Advance monitoring indicates the quantity and location of non-operational fixtures in a particular lighting system to help ensure compliance with low-visibility requirements.

The survey data suggests issues seem to rise as a result of the calibration of CCRs for the lamps-out monitoring of light fixtures.

The initial generation of LED light fixtures had compatibility issues with the lamps-out monitoring system. Typically, for an incandescent light, a burnt-out lamp would cause an open circuit on the secondary side of the isolation transformer, thus allowing the transformer to become saturated. A saturated transformer appears as a shorted circuit in the series circuit, thus significantly reducing the impedance of the isolation transformer and the fixture. Calibrated monitoring systems can detect these changes of impedance in the series circuit, which can be used to determine the number of lamps out. When LED light fixtures, which contain electronics, fail, they typically continue to draw some current and load. This condition may not change the impedance of the circuit significantly enough, thus rendering the monitoring system unreliable.

L-829 CCR monitoring of LED light fixtures is being addressed by light fixture manufacturers. Newer generation light fixtures can mimic a burnt-out lamp indication. The newer fixtures contain intelligent power supplies equipped to create an open circuit if an LED array or an electronic component fails. The L-829 monitoring of LED light fixtures can only be accomplished if the circuit is composed of all LED lights of the same manufactured generation or ones that provide the same type of indication. Given that how this is accomplished is subject to the fixture manufacturer's design preference, airports should verify this capability for their light fixtures with the manufacturer.

The L-890 ALCMS provides more advanced monitoring required for low-visibility lighting systems. The monitoring method, configuration, and capabilities for the L-890 system vary by manufacturer, so airports should discuss specifics with the manufacturer. The control and monitoring for the L-890 system can be accomplished by adding a control and monitoring unit (CMU) to the input of a light fixture and communicating with the head-end equipment via power line signal over the circuit power feeds. Another version of the L-890 control and monitoring system uses a programmable logic controller (PLC) base system communicating via a fiber-optic cable. Both systems interface with the input of the fixture and rely on electrical measurements to provide data to the controller. The systems face similar issues because of their reliance on electrical measurements. Airports surveyed used both these systems. In general, the survey data and case studies indicated a mix of responses as to how this system works with LED light fixtures. Some airports have implemented LED light fixtures on low-visibility

lighting systems (e.g., runway guard bar lights and controllable stop bars), while others choose to use incandescent light fixtures for these systems to ensure reliability. Based on the survey, no direct conclusion can be drawn about the effective operating capability of LED light fixtures on monitored circuits.

Control and monitoring issues are being addressed with intelligent power supplies in the newer generation of light fixtures, thus allowing the use of LED light fixtures on low-visibility systems. Caution should be taken in mixing manufacturers' LED light fixtures on a monitored circuit. LED light fixtures from one manufacturer may not be compatible with the monitoring configuration of another manufacturer's L-890 control and monitoring system. Airports with lamp-out monitoring generally rely on visual inspections and have de-emphasized the use of remote monitoring solely. If L-829 or L-890 monitoring is being used and LED light fixtures are being installed, the research team recommends discussing the airport's unique monitoring needs and requirements with a light fixture manufacturer and investigating the method and capabilities of their control and monitoring system for LED light fixtures.



### Key Takeaways

- Verify with a light fixture manufacturer the capability of their light fixtures for use with L-829 and L-890 monitoring systems and calibrate accordingly.
- Be careful when performing L-829 monitoring on a circuit with various manufacturers' light fixtures installed. Verify the method of indication for each type of light fixture with the manufacturer.

## Photometrics and Chromaticity

### Photometrics

Tables 1 and 2 in *AC 150/5345-46, Specification for Runway and Taxiway Light Fixtures*, indicate the photometric output requirement for in-pavement and elevated AGL fixtures. Each type of light fixture has a specific requirement and curve for photometric output. These tables do not distinguish between LED and incandescent light fixtures and, therefore, they have the same photometric output requirement.

The requirements for in-pavement lights are based on the projection of the main beam curve and the surrounding 10% beam curve (as illustrated in Figure 38).

Using Figure 38 for an L-850A runway centerline light fixture, the main horizontal beam ranges from  $-5^\circ$  to  $+5^\circ$  and the main vertical beam ranges from  $0.2^\circ$  to  $9^\circ$ . This main beam at the highest intensity setting has a minimum average intensity of 5000 candelas measured at 1 degree intervals along the main axis. The main beam is above the horizontal axis of the light fixture and provides a complete forward projection of the light.

The photometric output has an additional FAA requirement—the 10% beam curve. The 10% beam curve for the example of a runway centerline light fixture envelopes the main beam and

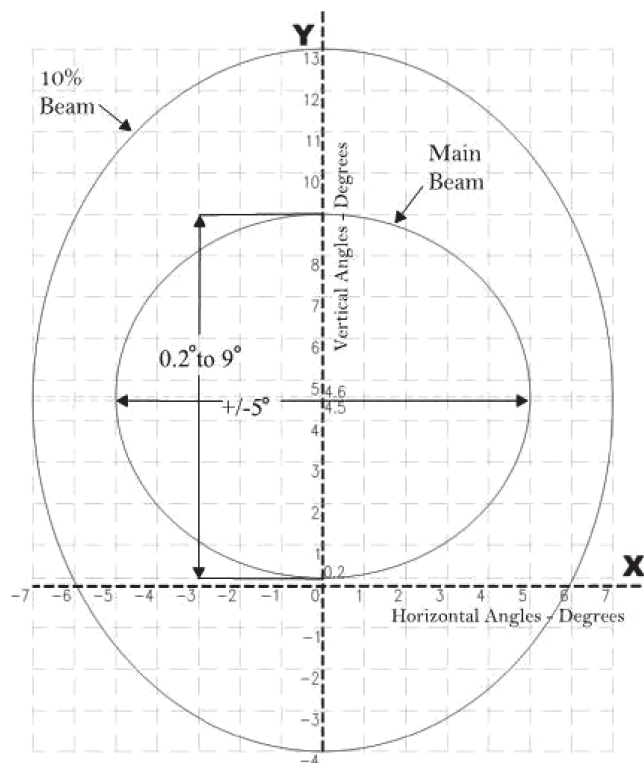

**Figure 38. Light fixture photometric ellipse.**

has a horizontal beam ranging from  $-7^{\circ}$  to  $+7^{\circ}$  and a vertical beam ranging from  $-4^{\circ}$  to  $+13^{\circ}$ . The intensity of the 10% curve must be no greater than 10% of the main beam average, or 500 candelas. Additional requirements include (1) no value inside the main beam ellipse must be less than 50% of the main beam average and (2) the maximum candela value divided by the minimum candela value must not be less than 3. These requirements are designed to eliminate a bright spot in the ellipse. The 10% beam curve indicates the beam pattern with negative values below the horizontal of the fixture—This light, seen reflecting on the horizontal surface of the fixture, is an inherent characteristic of a light beam ellipse shape.

The photometric requirement for LED light fixtures and incandescent light fixtures are the same. Different fixtures (e.g., runway edge lights, runway centerline lights, and taxiway centerline lights) have different requirements based on use.

One of the original problems with LED light fixtures was that light intensity output did not follow the compatible incandescent light fixture light intensity output at the intermediate steps. This resulted in an uneven light output among different light fixtures along the intermediate operational intensity settings. The uneven light output affected the operational capability of the light fixture during various visibility conditions that used the intermediate step settings of the circuit.

In response to this, the FAA updated *Engineering Brief 67, Light Sources Other than Incandescent and Xenon for Airport and Obstruction Lighting Fixtures*. This update supplied specific criteria for the minimum and maximum photometric intensity of the LED light fixture along each intensity setting. The new requirement demands that the intensity follow a smooth curve mimicking that of an incandescent light fixture. Figures 39 and 40 show the minimum and maximum percentage of intensity output for LED light fixtures.

Light manufacturers revised their LED light fixtures in subsequent generations with the implementation of this Engineering Brief update. *Engineering Brief 67* was developed in 2000

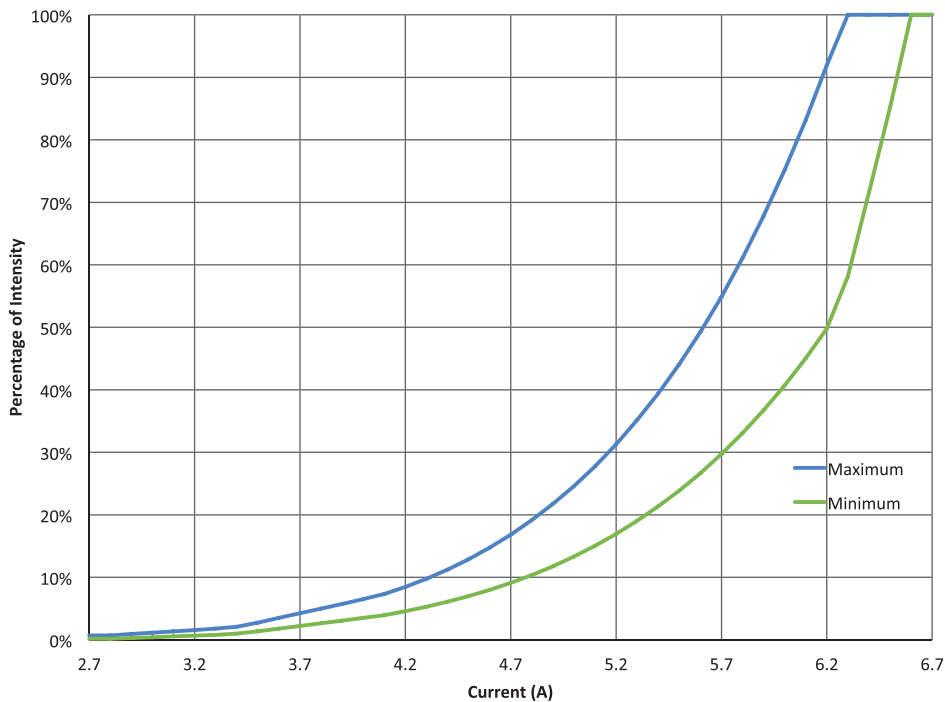

**Figure 39.** LED fixtures dimming curve for white LED.

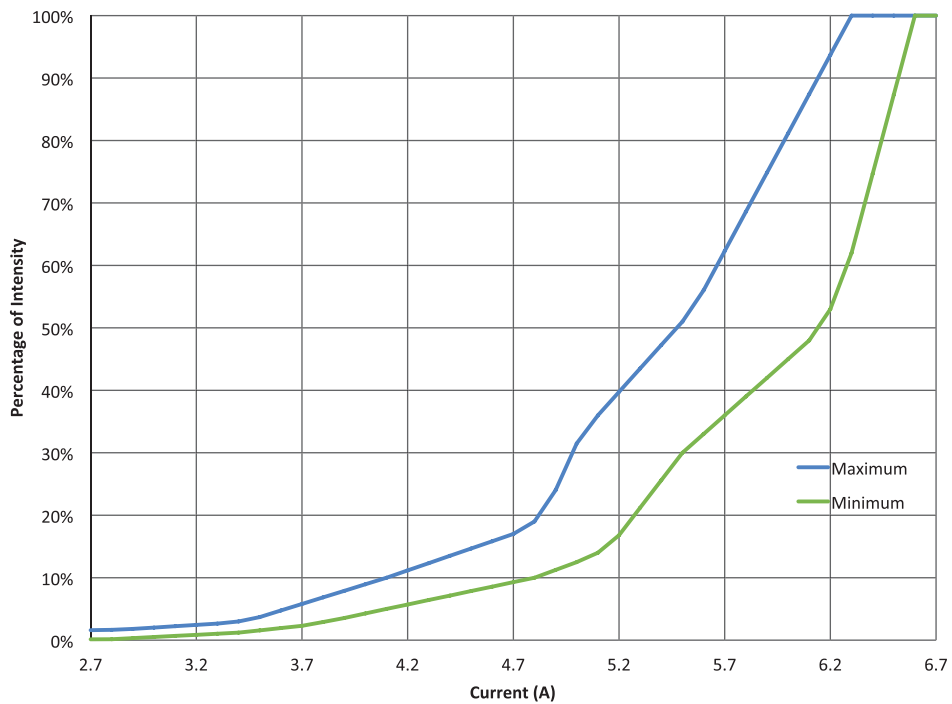

**Figure 40.** LED fixtures dimming curve for color LED.



and was updated in 2012 (revision D) to revise the dimming curve. The survey data indicates that LED lights are operating in accordance with the requirements and that this issue has been resolved.

## Chromaticity

Chromaticity is the quality of color characterized by its dominant or complementary wavelength and purity measurements. The aviation industry basis of color for lighting systems is found in *Aerospace Standard AS25050, General Requirements for Colors, Aeronautical Lights and Lighting Equipment*. Figure 30 is the International Commission on Illumination's (CIE's) mixture diagram, which indicates color limits for the aviation lights. Figure 41 illustrates the aviation color wavelength limit. The FAA has refined the boundaries as more stringent than the diagram indicates, but given the scale of the diagram it could not be displayed accurately. This diagram will serve as a representation for example purposes. The section for aviation green, which has the largest wavelength variation, any type of light that falls within this area is considered compliant. To better understand, the next step is to superimpose the color spectrum onto this figure. Refer to Figure 42.

The overlay of the color spectrum on the mixture diagram provides perspective on the allowable color range for aviation lighting. In Figure 42, a border was drawn around the aviation green and aviation blue areas. The area for aviation green is large, ranging from blue/green to pure green.

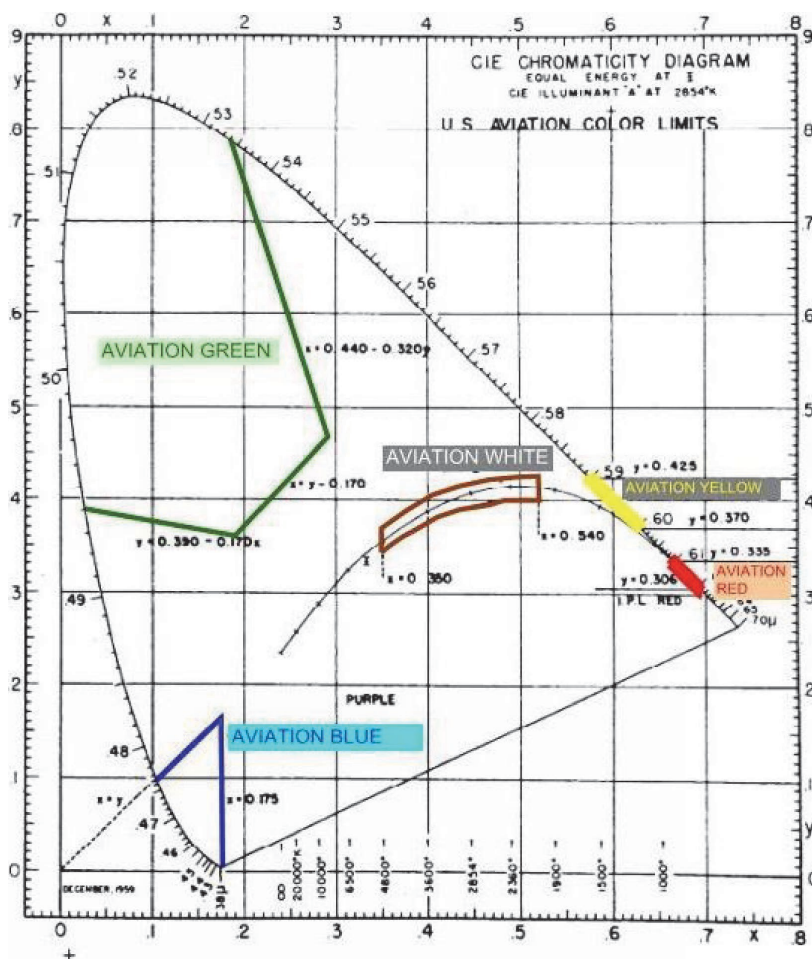
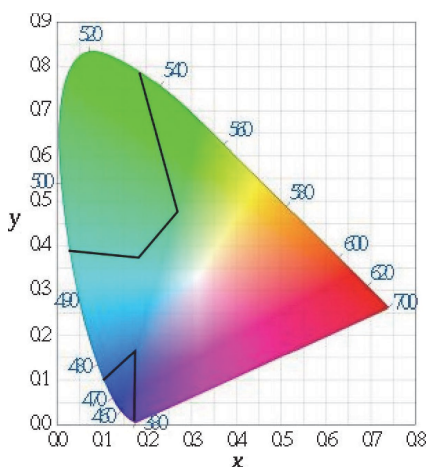

Figure 41. CIE mixture diagram.



**Figure 42. Color spectrum overlaid on mixture diagram.**

Table 5 details the color location of an LED taxiway centerline light fixture and Table 6 details the color location of an incandescent taxiway centerline light fixture. The first column in each table represents the light beam angle position of the location measurement. Referring to the ‘X’ and ‘Y’ coordinates, the color locations are relatively consistent throughout the various angles.

Taking the location of the first row for both Tables 5 and 6 and plotting this onto Figure 41 results in the color location of the taxiway light fixtures as shown in Figure 43.

The incandescent light fixture color is near the bottom of the green spectrum, where the color transitions to blue. To the human eye, the light appears greenish-blue. The LED light fixture is near the top of the green color spectrum and thus provides a truer green color.

The difference in color location of these two fixtures makes an LED light fixture appear brighter than an incandescent light fixture. This typically leads to the conclusion that the LED is not operating properly. However, based on the allowable color spectrum, both light fixtures comply with FAA requirements. The other light fixtures have a smaller color spectrum range, so their color location differences will not be as great, so the colors between the LED and incandescent light

**Table 5. LED taxiway centerline light color location.**

Position Degrees	X	Y
(-3.5,1)	0.177	0.730
(-3.5,8)	0.178	0.730
(3.5,1)	0.174	0.732
(3.5,8)	0.174	0.737
(0,4.5)	0.176	0.733

**Table 6. Incandescent taxiway centerline light color location.**

Position Degrees	x	y
(3.5L, 4.5U)	0.1622	0.3960
(0H, 4.5U)	0.1620	0.3929
(3.5R, 4.5U)	0.1626	0.3970
(0H, 1U)	0.1641	0.3940
(0H,8U)	0.1614	0.3988

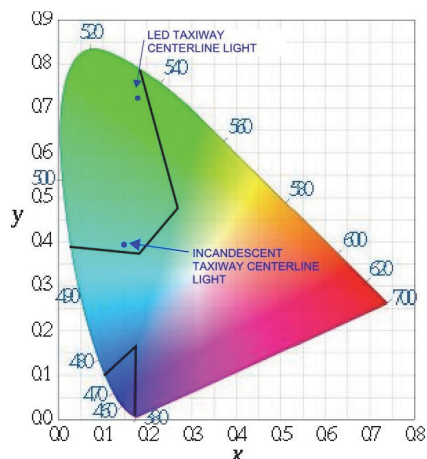

**Figure 43. Color location of the taxiway light fixtures.**

fixtures for blue, white, yellow, and red will appear similar. Because the light color locations may vary for the different types of LEDs used by the manufacturers, the color may vary among different light manufacturers light fixtures.

It has been reported that taxiway LED fixtures appear brighter than their counterparts, and pilots have requested they be set to a lower intensity setting. However, this does not suggest the fixtures are out of FAA compliance but this is just one of the differences with LED light fixtures. Ultimately, the pilots are the users of the system and the system should be operated to accommodate their needs.



### Key Takeaways

- Using a five-step intensity setting CCR for taxiway centerline LED lighting systems is recommended. This will allow lower intensity settings to be set at verbal request.
- Verify color coordinates and color spectrum among LED light fixtures of different manufacturers if adding to an existing LED light circuit or location. Colors located close to each other will provide consistency in the lighting system.
- Do not mix LED and non-LED light fixtures on straight sections of taxiway or on a runway because of chromaticity compatibility as described in AC 150/5340-30.

## Return on Investment Discussion

Among the airports surveyed, the greatest concern about LED lighting was cost. Roughly 75% indicated the cost of LED lighting prevents them from installing and/or adding LED lighting on their airfields. However, the data also suggests LED lighting on airfields accounts for 20% to 50% of total lighting at most airports.

Understanding the Return on Investment (ROI) for LED lighting compared to non-LED lighting will help airport decisionmakers select the best course of action for their airports.

Factors to consider when determining ROI compared to non-LED fixtures include

- Fixture cost
- Energy cost (with and without heaters)
- Maintenance cost (lamp replacement labor and materials)
- Refurbishment cost
- Fixture damage rates
- Failure rates

LED fixtures have a higher initial cost to purchase than incandescent fixtures (Figure 44). Airports will have a higher initial investment cost for material, requiring upfront capital and relying on ROI to balance investment. Historical energy cost data should be considered to determine if cost is a driver for the use of LED fixtures with or without heaters. Incandescent fixtures have a labor and material lamp replacement cost associated with them that should be considered. Refurbishment of light fixtures are similar for both type of fixtures and should not affect ROI. Because LED fixtures have a higher replacement cost (given damage caused by snow plow operations and vehicles), airports need to consider fixture replacement as part of their ROI. LED fixtures have a longer MTTF, thereby minimizing routine maintenance costs which could greatly affect ROI.

Energy cost and maintenance cost have a major effect on ROI. Reduced energy consumption is evident when using LED light fixtures and depends on energy costs, equipment efficiencies, operation of the system (light intensity settings), and state of repair of the system. The energy cost reduction varies from region to region and airport to airport.

The most significant issue affecting the ROI is maintenance cost. To maximize the ROI, maintenance costs must be minimized. The best way to minimize maintenance costs is to use fixtures that require less maintenance because this minimizes runway shutdowns and labor required to replace the fixtures.

The following example illustrates the factors that affect maintenance costs. Table 7 summarizes the factors affecting ROI for a 100-fixture LED Runway Guard Light (L-852G) circuit versus an incandescent light fixture. This demonstration indicates the effect lamp failure has on maintenance costs for one circuit, over the lifetime of the circuit—in this case, 15 years.

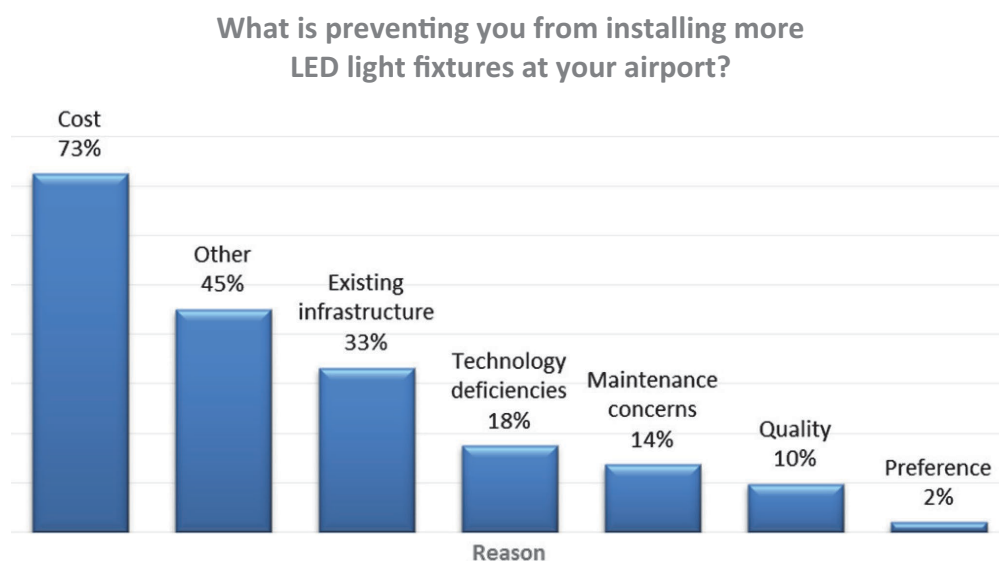

**Figure 44.** Survey results show cost as leading obstacle for acquiring more LED fixtures.

**Table 7. LED maintenance cost savings.**

Category of Cost	Percent Savings	Costs
Energy Cost	4.2%	\$3,521.52
Lamp Replacement Labor Cost	71.0%	\$60,000.00
Material Cost	24.8%	\$21,000.00

With MTTF as a large component of ROI, the defining factors that affect MTTF must be evaluated for both LED and incandescent light fixtures.

Historically, the discussion of fixture performance has centered on whether the fixture is energized and operating or not. The simplest definition of failure is that there is no light coming from the fixture. However, for in-pavement systems (and especially CAT II and III) lighting systems, a paradigm shift is warranted to understand the true definition of fixture performance. Three factors affect the operational performance of a light fixture: lamp life, photometric output, and deterioration of optical lens. The three factors are summarized in Table 8.

The MTTF for an LED fixture includes all components (i.e., LED light assembly, power supply and heater, if applicable). Taking the typical operating conditions and assuming a 10-hour operational period per day, the proposed MTTF for an LED is 20 years and that of an incandescent is almost 2 years. Once the photometric output of a fixture drops below 70% of the required output, the fixture is deemed noncompliant. For an incandescent fixture, this 70% deterioration can occur within 50% of its operating life, thus reducing its MTTF to 1 year. An LED fixture has minimum light output deterioration, allowing it to operate within the compliant range for most its life. The third factor, deterioration of the optical lens, which includes pitting, scratching, rubber removal damage, depends on the environmental condition (not the light fixture type).

So as a comparison of lights and their MTTF:

**MTTF Ignoring Photometrics:**

$$\frac{MTTF \text{ of LED Fixtures}}{MTTF \text{ of Incandescent Fixture}} = \frac{150,000}{6,000} = 25 \text{ Times}$$

The LED has a 25 times greater lamp life expectancy than an incandescent. Taking the deterioration of the photometric output into consideration, the LED has a 32 times greater overall life expectancy.

**Table 8. Operational performance factors.**

Factors	LED	Incandescent
MTTF	Average LED life of 56,000 hours under high-intensity conditions and more than 150,000 hours under typical operating conditions.	Low-energy/long-life halogen lamps are 48W with a rated life of 1,500 hours at 6.6A and in excess of 6,000 hours in practical use.
MTTF to Photometric Output Dips Below 70%	Approximately the life of the fixture.	Photometric Intensity of the Quartz lamp may drop below 70% at 50% of the life of the lamp.
Deterioration of Optical Lens and Environmental Factors	Subject to deterioration is the same for either type of fixture.	Subject to deterioration is the same for either type of fixture.

**MTTF with Photometrics:**

$$\frac{\text{MTTF of LED Fixtures (10\% Photometric Drop)}}{\text{MTTF of Incandescent Fixture (30\% Photometric Drop)}} = \frac{135,000}{4,200} = 32 \text{ Times greater}$$

However, both types of fixtures are subject to lens pitting, rubber removal damage, snow plow damage, and other environmental factors. To maximize the MTTF and get the true performance out of the LED lights, and thus the appropriate ROI from LED, the airport has to consider a maintenance approach that includes all of the above factors. Case study discussions indicated that most maintenance is performed based on whether or not a fixture is operating (light output). However, operating in this fashion provides a false sense of fixture longevity for incandescent light fixtures. Light output and lens deterioration need to be addressed as part of maintenance practice.

**Key Takeaways**

- Develop a maintenance plan that includes cleaning and inspecting the lens and performing photometric testing.
- Develop a lens cleaning and/or replacement program. Lenses will pit over time which will affect light output performance, thus reducing MTTF.
- Track fixture maintenance and replacement to help determine associated maintenance costs.
- Develop a commissioning and final acceptance plan that ensures that the elevation and alignment of the light base and fixture is correct so as to ensure that any future deterioration is the cause of environmental factors rather than poor installation.



## References and Bibliography

- |  |   |
|--|---|
| ACRP Synthesis 11  | Impact of Airport Rubber Removal Techniques on Runways  |
| AC 150/5340-26   | Maintenance of Airport Visual Aid Facilities  |
| AC 150/5340-30   | Design and Installation Details for Airport Visual Aids                                       |
| AC 150/5345-10   | Specification for Constant Current Regulators and Regulator Monitors                          |
| AC 150/5345-42   | Specification for Airport Light Base, Transformer Housings, Junction Boxes and Accessories    |
| AC 150/5345-43   | Specification for Obstruction Lighting Equipment  |
| AC 150/5345-46   | Specification for Runway and Taxiway Light Fixtures   |
| AC 150/5345-53   | Airport Lighting Equipment Certification Program  |
| AC 150/5345-56   | Specification for L-890 Airport Lighting Control and Monitoring System (ALCMS)                |
| AS25050  | General Requirements for Colors, Aeronautical Lights and Lighting Equipment                   |
| DOT/FAA/AR-TN08/29   | Light Emitting Diode Taxiway Lighting Effects on Constant Current Regulator Stability         |
| Engineering Brief 67   | Light Sources Other than Incandescent and Xenon for Airport and Obstruction Lighting Fixtures |
| Engineering Brief 83   | In-pavement Light Fixtures Bolts  |
| FAA Order JO 7110.65   | Air Traffic Control   |
| Innovative Pavement Research Foundation (IPRF) Report No. 1-G-002-03-1 | Constructing In-pavement Lighting, Portland Cement Concrete Pavement                          |



# Abbreviations and Acronyms

AC	Advisory Circular
AGL	Airfield Ground Lighting
AIP	Airport Improvement Program
ALCMS	Airport Lighting Control and Monitoring System
ALSF-2	Approach Lighting System with Sequenced Flashers II
Amps	Amperes
C/L	Centerline
CAT	Category
CCR	Constant Current Regulator
CIE	International Commission on Illumination
CMU	Control and Monitoring Unit
FLA	Full Load Amps
FOD	Foreign Object Debris
FPM	Feet per Minute
HDPE	High Density Polyethylene
HIRL	High-Intensity Runway Light
ICAO	International Civil Aviation Organization
IESALC	Illuminating Engineering Society of North America
IM	Infant Mortality
IPRF	Innovative Pavement Research Foundation
kW	Kilowatt
KWH	Kilowatt Hour
LED	Light-Emitting Diode
MALS	Medium-Intensity Approach Light System
MALSF	Medium-Intensity Approach Lighting System with Sequenced Flashers
MALSR	Medium-Intensity Approach Lighting System with Runway Alignment Indicator Lights
MTTF	Mean Time to Failure
MΩ	Megohm
NEC	National Electric Code
O&M	Operations and Maintenance
ODALS	Omni Directional Approach Lighting System
PAPI	Precision Approach Path Indicator
PCB	Printed Circuit Board
PCB/PS	Printed Circuit Board with integral Power Supply
PFC	Passenger Facility Charges
PLC	Programmable Logic Controller
PVC	Polyvinyl Chloride
PWM	Portland International Jetport



64 LED Airfield Lighting System Operation and Maintenance

REIL	Runway End Identification Light
ROI	Return on Investment
RW	Runway
RWSL	Runway Status Lights
SCR	Silicon-controlled Rectifier
TW	Taxiway
UFC	Uniform Facility Code
VA	Volt-amps
VASI	Visual Approach Slope Indicator



## Glossary of Terms

Arctic kits	Light fixture heaters
Infant mortality (IM)	The premature failure of a device, nominally within the first 4 months, that can typically be attributed to installation or manufacture error
Light engine	Comprised of the LED light assembly and PCB/PS
Normal Life	The accepted life expectancy of a device
Potted	Encapsulated in an epoxy resin for protection against the elements



## APPENDIX A

## System Requirements

This appendix is a reference guide for the minimum system requirements of the FAA under *AC 150/5340-26* for all projects funded with federal grant monies through the Airport Improvement Program (AIP) and with revenue from the Passenger Facility Charges (PFC) Program. For in-depth information, *AC 150/5340-26* has details regarding the maintenance of airfield lighting systems. The following tables are duplicated from *AC 150/5430-26C* and are included for reference.

**Table A-1. AC 150/5340-26, Table A-2, medium-intensity approach light systems (MALS, MALSF, MALSR).**

Parameter	Standard	Tolerance / Limit: Initial	Tolerance / Limit: Operating
1. Light units operational			
a. Steady burning	All	All	15% lamps out (random) – 2 lamps out; in 5-light bar – 1 light bar out
b. Flashing	All	All	1 unit out
2. Flashing rate	120 fpm	±2 fpm	±2 fpm
a. Input voltage	120V or 240V	±3%	±5%
3. Light unit alignment			
a. Vertical	Locally established	±1 degree	±2 degrees
b. Horizontal	Parallel to runway centerline	±1 degree	±2 degrees
4. Obstructions due to vegetation, etc.	No obstruction	Same as standard	Same as standard

**Table A-2. AC 150/5340-26, Table A-3, omnidirectional approach light system (ODALS).**

Parameter	Standard	Tolerance / Limit: Initial	Tolerance / Limit: Operating
1. Light units operational	All	All	1 unit out
2. Input voltage	120V or 240V	±3%	±5%
3. Flashing rate	60 fpm	±2 fpm	±2 fpm
4. Light unit alignment	Level	±1 degree	±2 degrees
5. Obstructions due to vegetation, etc.	No obstruction	Same as standard	Same as standard

**Table A-3. AC 150/5340-26, Table A-4, lead-in lights.**

Parameter	Standard	Tolerance / Limit: Initial	Tolerance / Limit: Operating
1. Light units operational	All	All	1 unit out in 3-light cluster
2. Flashing rate	Locally established	±2 fpm	±2 fpm
3. Input voltage	120V or 240V	±3%	±5%
4. Light unit alignment			
a. Vertical	Locally established	±1 degree	±2 degrees
b. Horizontal	Locally established	±1 degree	±2 degrees
5. Obstructions due to vegetation, etc.	No obstruction	Same as standard	Same as standard

**Table A-4. AC 150/5340-26, Table A-5, runway end identifier lights (REILs).**

Parameter	Standard	Tolerance / Limit: Initial	Tolerance / Limit: Operating
1. Light units operational	All	All	All
2. Flashing rate			
a. Unidirectional type	120 fpm	±2 fpm	±2 fpm
b. Omnidirectional type	60 fpm	±2 fpm	±2 fpm
3. Input voltage	120V or 240V	±3%	±5%
4. Alignment (unidirectional)			
a. Vertical			
(1) With baffles	3 degrees	±1 degree	-1 degree +2 degrees
(2) Without baffles	10 degrees	±1 degree	±2 degrees
b. Horizontal		±1 degree	±2 degrees
(1) With baffles	10 degrees	±1 degree	±2 degrees
(2) Without baffles	15 degrees (away from runway centerline)	±1 degree	±2 degrees
5. Obstructions due to vegetation, etc.	No obstruction	Same as standard	Same as standard

**Table A-5. AC 150/5340-26, Table A-6, visual approach slope indicator (VASI).**

Parameter	Standard	Tolerance / Limit: Initial	Tolerance / Limit: Operating
1. Lamps burning			
a. VASI	All	All	Not more than one lamp out per box
b. SAVASI	All	All	
2. Vertical aiming (VASI and SAVASI)			
a. Downwind bar (bar no. 1)	½ degree below established glide path angle	±2 minutes	±6 minutes
b. Upwind bar (bar no. 2)	Established glide path angle	±2 minutes	±6 minutes
3. Vertical aiming (3-bar VASI)			
a. Downwind bar (bar no. 1)	2.75 degrees	±2 minutes	±6 minutes
b. Middle bar (bar no. 2)	3.0 degrees	±2 minutes	±6 minutes
c. Upwind bar	3.25 degrees	±2 minutes	±6 minutes
4. Horizontal alignment	Parallel to runway centerline	± ½ degree	± ½ degree
5. Tilt switch	¼ to ½ degree below and ½ to 1 degree above established light bar angle	Same as standard	Same as standard
6. Lamp current (current-regulated)	Rated current of lamps	Same as regulator currents for type of regulator used	
7. Lamp voltage (voltage-regulated)	Rated voltage of lamps	±3%	±5%
8. Obstructions due to vegetation, etc.		Same as standard	Same as standard

**Table A-6. AC 150/5340-26, Table A-7, precision approach path indicator (PAPI).**

Parameter	Standard	Tolerance / Limit: Initial	Tolerance / Limit: Operating
1. Lamps burning			
a. PAPI	All	All	Not more than one lamp out per box
2. Vertical aiming <sup>1</sup>			
a. Unit D (close to runway)	3° 30'	±2 minutes	±6 minutes
b. Unit C (2nd from runway)	3° 10'	±2 minutes	±6 minutes
c. Unit B	2° 50'	±2 minutes	±6 minutes
d. Unit A (farthest from runway)	2° 30'	±2 minutes	±6 minutes
3. Horizontal alignment	Parallel to runway centerline	± ½ degree	± ½ degree
4. Tilt switch	¼ below to ½ degree above established light bar angle	Same as standard	Same as standard
5. Lamp current (current-regulated)	Rated current of lamps	Same as regulator currents for type of regulator used	
6. Lamp voltage (voltage-regulated)	Rated voltage of lamps	±3%	±5%
7. Obstructions due to vegetation, etc.	No obstruction	Same as standard	Same as standard

<sup>1</sup> Unless a different standard is established locally, angles shown are for a 3 degree glide path.

**Table A-7. AC 150/5340-26, Table A-8, runway and taxiway lighting systems.**

Parameter	Standard	Tolerance / Limit: Initial	Tolerance / Limit: Operating
1. Runway lights			
a. Threshold lights	All on	All on	75% on for VFR and non-precision IFR runways 75% on
b. End lights	All on	All on	
c. Edge lights	All on	All on	85% on except for CAT II and CAT III runways which require 95% serviceable
d. Centerline lights	All on	All on	95% serviceable
e. Touchdown Zone lights	All on	All on	90% serviceable
2. Taxiway lights			
a. Edge lights	All on	All on	85% on - see note 3 for CAT III taxi routes
b. Centerline lights	All on	All on	90% on - see note 3 for CAT III taxi routes
c. Elevated Runway Guard Lights	All on	All on	No more than one light in a fixture unserviceable
d. In-pavement runway guard lights	All on	All on	No more than three lights per location unserviceable nor two adjacent lights unserviceable
e. Runway stop bar lights	All on	All on	No more than three lights per location unserviceable nor two adjacent lights unserviceable
3. Lamp current	Amperes	Amperes	Amperes
a. 3 step, 6.6A	6.6 5.5 4.8	6.50 - 6.70 5.40 - 5.60 4.80 - 4.90	Same as initial Same as initial Same as initial
b. 5 step, 6.6A	6.6 5.2 4.1 3.4 2.8	6.50 - 6.70 5.10 - 5.30 3.98 - 4.22 3.30 - 3.50 2.70 - 2.90	Same as initial Same as initial Same as initial Same as initial Same as initial
c. 5 step, 20A	20.0 15.8 12.4 10.3 8.5	19.70 - 20.30 15.50 - 16.10 12.10 - 12.70 10.00 - 10.60 8.20 - 8.80	Same as initial Same as initial Same as initial Same as initial Same as initial
4. Lamp voltage (parallel circuits)	Lamp voltage rating	±3%	±5%





## APPENDIX B

## Maintenance Schedules

This appendix is to be used as a reference guide for the minimum preventive maintenance requirements of the FAA under *AC 150/5340-26* for all for all projects funded with federal grant monies through the Airport Improvement Program (AIP) and with revenue from the Passenger Facility Charges (PFC) Program. For in-depth information, *AC 150/5340-26* has details about the maintenance of airfield lighting systems. The following tables and figures are duplicated from *AC 150/5430-26C*, dated 6/20/2014, and are included in this appendix for reference.



**Table B-2. AC 150/5340-26, Table 5-1, preventive maintenance inspection schedule for airport lighting vaults.**

Maintenance Requirement	D A I L Y	W E E K L Y	M O N T H L Y	S E M I A N N U A L	A N N U A L	U N S C H E D
1. Check control operation	X					
2. Check general cleanliness		X				
3. Check for moisture		X				
4. Check ventilator screens or air conditioner controls		X				
5. Inspect safety boards, safety equipment and fire extinguishers			X			
6. Check insulation resistance of all field circuits*			X			
7. Check input voltage to vault				X		
8. Check ground resistance				X		
9. Inspect and clean buses				X		
10. Check relay operation				X		
11. Check oil fuse cutouts				X		
12. Check oil switches				X		
13. Operate power transfer switches			X			
14. Check control panel or computer control equipment				X		
15. Check photoelectric switch				X		
16. Check astronomic time switch				X		
17. Check radio control of lighting equipment			X			
18. Check lightning arrestors				X	X	
19. Inspect miscellaneous electrical equipment				X		
20. Test oil dielectric strength in transformers and regulators					X	
21. Paint equipment as necessary					X	X

\* Weekly insulation resistance tests may be necessary for older circuits.

**Table B-3. AC 150/5340-26, Table 5-3, 5-step CCR output tolerances.**

Output Step	Output 6.6 A Regulator	Allowable Range	Output 20 A Regulator	Allowable Range
5	6.6 amps	6.50–6.70	20.0 amps	19.70 – 20.30
4	5.2 amps	5.10–5.30	15.8 amps	15.50 – 16.10
3	4.1 amps	4.00–4.20	12.4 amps	12.10 – 12.70
2	3.4 amps	3.30–3.50	10.3 amps	10.00 – 10.60
1	2.8 amps	2.70–2.90	8.5 amps	8.20 – 8.80

**Table B-4. AC 150/5340-26, Table 5-4, preventive maintenance inspection schedule for constant current regulators.**

Maintenance Requirement	D A I L Y	W K L Y	M T H L Y	S M A N L Y	A N N L Y	U N S C H
1. Check control circuits on all brightness steps	X					
2. Check condition and operation of regulator		X				
3. Check input voltage and current			X			
4. Check output current on each brightness step			X			
5. Check output load on regulator if needed				X		
6. Check relays, wiring and insulation				X		
7. Check dielectric strength of cooling oil (if used)					X	
8. Perform a short-circuit test					X	
9. Perform an open-circuit test (only on regulators with open circuit protection).					X	
10. Clean rust spots and repaint as necessary.						X

**Table B-5. AC 150/5340-26, Table 5-5, preventive maintenance inspection schedule for runway and taxiway elevated edge lights.**

MAINTENANCE REQUIREMENT	D A I L Y	W K L Y	M T H L Y	S M A N L Y	A N N L Y	U N S C H
1. Inspect for outages; repair as necessary	X					
2. Check cleanliness of lenses	X					
3. Perform photometric testing (HIRL) and check light alignment and orientation			X			X
4. Re-align lights as needed			X			X
5. Clean fixtures and sockets						X
6. Check light elevation				X		
7. Check for moisture in lights				X		
8. Inspect fixture for rust, deterioration					X	
9. Check lamp fitting and clean contacts					X	
10. Check gaskets					X	
11. Remove snow and/or vegetation from around lights						X

**Table B-6. AC 150/5340-26, Table 5-6, preventive maintenance schedule for in-pavement runway and taxiway lighting.**

MAINTENANCE REQUIREMENT	D A I L Y	W K L Y	M T H L Y	B I M O N T H L Y	S M A N L Y	A N N L Y	U N S C H
1. Check for burned-out lamps or dimly burning lights	X						
2. Replace defective lights with refurbished units		X					
3. Clean lights with dirty lenses			X				X
4. Perform photometric testing of runway lighting systems			X				X
5. Check torque of mounting bolts				X			
6. Check for water in shallow light bases					X		
7. Remove snow from around fixtures							X
8. Check wires in saw kerfs							X

**Table B-7. AC 150/5340-26, Table 5-8, preventive maintenance schedule for lighted wind cones.**

Maintenance Requirement	D A I L Y	W K L Y	M T H L Y	B I M O N T H L Y	S E M I A N N U A L	A N N U A L	U N S C H E D
1. Check lamp operation.	X						
2. Check photocell operation.	X						
3. Check for freedom of motion of wind cone frame.			X				
4. Check condition of wind cone fabric.			X				
5. Check lamp age for scheduled replacement.				X			
6. Clean glassware.				X			
7. Check paint on segmented circle.				X			
8. Clean and grease bearings.					X		
9. Read insulation resistance.					X		
10. Check mounting bolts.						X	
11. Check wiring at hinge.						X	
12. Check grounding system resistance.						X	
13. Check paint on wind cone structure.						X	
14. Remove vegetation and check condition at foundation.							X

**Table B-8. AC 150/5340-26, Table 5-9, preventive maintenance schedule for PAPI (precision approach path indicator).**

Maintenance Requirement	D A I L Y	W K L Y	M T H L Y	Q U A R T E R L Y	S E M I A N N U A L	A N N U A L	U N S C H E D
1. Check lamps for operation.	X						
2. Check operation of controls.			X				
3. Check for damage by service vehicles or aircraft.			X				
4. Clean lamps and filters.			X				
5. Check mechanical parts for damage.			X				
6. Check lightning arresters.			X				
7. Check for water damage or insect infestation.			X				
8. Check for presence of rodents.			X				
9. Record output current and input voltage of adapter (if used).			X				
10. Check alignment and aiming of light boxes.			X				
11. Check leveling and operation of tilt switch.			X				
12. Check integrity of obstacle-free approach plane.				X			
13. Check insulation resistance of underground cables.					X		
14. Check resistance of grounding system.					X		

**Table B-9. AC 150/5340-26, Table 5-10, preventive maintenance schedule for VASI (visual approach slope indicator).**

MAINTENANCE REQUIREMENT	D A I L Y	M T H L Y	Q U A R T E R L Y	S E M I A N N U A L
1. Check lamps for operation	X			
2. Check operation of controls		X		
3. Check for damage by vehicles or aircraft		X		
4. Clean lamps and filters		X		
5. Check mechanical parts for damage		X		
6. Check lightning arrester		X		
7. Check for water damage or insect infestation		X		
8. Check for presence of rodents		X		
9. Record output current and input voltage of adapter (if used)		X		
10. Check alignment and aiming of light boxes		X		
11. Check leveling and operation of tilt switch		X		
12. Check integrity of obstacle-free approach plane			X	
13. Check insulation resistance of underground cables			X	
14. Check resistance of grounding systems				X

**Table B-10. AC 150/5340-26, Table 5-12, preventive maintenance schedule for MALSR (medium-intensity approach light system with runway alignment lights).**

Maintenance Requirement	D A I L Y	W E E K L Y	M O N T H L Y	B I M O N T H L Y	S E M I A N N U A L	A N N U A L	U N S C H E D
1. Check for burned-out lamps.	X						
2. Check system operation.		X					
3. Replace burned-out lamps.		X					
4. Check in pavement lights for cleanliness.		X					
5. Record input and output voltages of control cabinet.			X				
6. Clear any vegetation obstructing the lights.			X				
7. Check angle of elevation of lights.					X		
8. Check structures for integrity.					X		
9. Check approach area for new obstructions.					X		
10. Check photoelectric controls (if used).					X		
11. Check electrical distribution equipment.						X	
12. Check insulation resistance of cable.						X	
13. Check fuse holders, breakers, and contacts.						X	

**Table B-11. AC 150/5340-26, Table 5-15, preventive maintenance schedule for ODALS (omnidirectional approach light system).**

Maintenance Requirements	M T H L Y	Q T R L Y	S M A N L Y	A N N L Y	T R I E N N L	A S R E Q D
1. Make visual operational checks of all lights on all brightness steps.	X					
2. Check remote control functions.		X				
3. Record meter reading.		X				
4. Visually check for misaligned lights or mirrors.		X				
5. Check for approach line-of-sight clearance for the intrusion vegetation and other obstructions.		X				
6. Check all fixtures, including mirrors if installed, for alignment and elevation			X			
7. Check for cleanliness and condition of all glassware and reflectors.				X		
8. Check all structures for rot or corrosion. Check all light supports for rigidity, guy tensions, and obvious misalignment.				X		
9. Inspect and clean, if required, interior of all cabinet mounted flashing units.				X		
10. Check safety devices, ground connections, lightning arrestors, and safety conditions of power distribution equipment at terminal poles, light supports, and substation Pads.				X		
11. Check conductor and insulation resistance of all power and control cables. Record all measurements and compare them with previous readings.					X	
12. Change all ODAL lamps after 500 hours of maximum brightness.						X

*Abbreviations and acronyms used without definitions in TRB publications:*

A4A	Airlines for America
AAAAE	American Association of Airport Executives
AASHO	American Association of State Highway Officials
AASHTO	American Association of State Highway and Transportation Officials
ACI-NA	Airports Council International-North America
ACRP	Airport Cooperative Research Program
ADA	Americans with Disabilities Act
APTA	American Public Transportation Association
ASCE	American Society of Civil Engineers
ASME	American Society of Mechanical Engineers
ASTM	American Society for Testing and Materials
ATA	American Trucking Associations
CTAA	Community Transportation Association of America
CTBSSP	Commercial Truck and Bus Safety Synthesis Program
DHS	Department of Homeland Security
DOE	Department of Energy
EPA	Environmental Protection Agency
FAA	Federal Aviation Administration
FHWA	Federal Highway Administration
FMCSA	Federal Motor Carrier Safety Administration
FRA	Federal Railroad Administration
FTA	Federal Transit Administration
HMCRRP	Hazardous Materials Cooperative Research Program
IEEE	Institute of Electrical and Electronics Engineers
ISTEA	Intermodal Surface Transportation Efficiency Act of 1991
ITE	Institute of Transportation Engineers
MAP-21	Moving Ahead for Progress in the 21st Century Act (2012)
NASA	National Aeronautics and Space Administration
NASAO	National Association of State Aviation Officials
NCFRP	National Cooperative Freight Research Program
NCHRP	National Cooperative Highway Research Program
NHTSA	National Highway Traffic Safety Administration
NTSB	National Transportation Safety Board
PHMSA	Pipeline and Hazardous Materials Safety Administration
RITA	Research and Innovative Technology Administration
SAE	Society of Automotive Engineers
SAFETEA-LU	Safe, Accountable, Flexible, Efficient Transportation Equity Act: A Legacy for Users (2005)
TCRP	Transit Cooperative Research Program
TDC	Transit Development Corporation
TEA-21	Transportation Equity Act for the 21st Century (1998)
TRB	Transportation Research Board
TSA	Transportation Security Administration
U.S.DOT	United States Department of Transportation



**TRANSPORTATION RESEARCH BOARD**  
500 Fifth Street, NW  
Washington, DC 20001

**ADDRESS SERVICE REQUESTED**

*The National Academies of*  
SCIENCES • ENGINEERING • MEDICINE

The nation turns to the National Academies of Sciences, Engineering, and Medicine for independent, objective advice on issues that affect people's lives worldwide.

[www.national-academies.org](http://www.national-academies.org)

ISBN 978-0-309-37494-1



9 780309 374941

NON-PROFIT ORG.  
U.S. POSTAGE  
**PAID**  
COLUMBIA, MD  
PERMIT NO. 88