

Methods and Practices on Reduction and Elimination of Asphalt Mix Segregation

DETAILS

112 pages | 8.5 x 11 | PAPERBACK

ISBN 978-0-309-27182-0 | DOI 10.17226/22131

BUY THIS BOOK

AUTHORS

Mary Stroup-Gardiner

FIND RELATED TITLES

Visit the National Academies Press at NAP.edu and login or register to get:

- Access to free PDF downloads of thousands of scientific reports
- 10% off the price of print titles
- Email or social media notifications of new titles related to your interests
- Special offers and discounts



Distribution, posting, or copying of this PDF is strictly prohibited without written permission of the National Academies Press. (Request Permission) Unless otherwise indicated, all materials in this PDF are copyrighted by the National Academy of Sciences.

NATIONAL COOPERATIVE HIGHWAY RESEARCH PROGRAM

NCHRP SYNTHESIS 477

**Methods and Practices on
Reduction and Elimination of
Asphalt Mix Segregation**

A Synthesis of Highway Practice

CONSULTANT

Mary Stroup-Gardiner
Gardiner Technical Service
Monterey, California

SUBSCRIBER CATEGORIES

Highways • Materials

Research Sponsored by the American Association of State Highway and Transportation Officials
in Cooperation with the Federal Highway Administration

TRANSPORTATION RESEARCH BOARD

WASHINGTON, D.C.
2015
www.TRB.org

NATIONAL COOPERATIVE HIGHWAY RESEARCH PROGRAM

Systematic, well-designed research provides the most effective approach to the solution of many problems facing highway administrators and engineers. Often, highway problems are of local interest and can best be studied by highway departments individually or in cooperation with their state universities and others. However, the accelerating growth of highway transportation develops increasingly complex problems of wide interest to highway authorities. These problems are best studied through a coordinated program of cooperative research.

In recognition of these needs, the highway administrators of the American Association of State Highway and Transportation Officials initiated in 1962 an objective national highway research program employing modern scientific techniques. This program is supported on a continuing basis by funds from participating member states of the Association and it receives the full cooperation and support of the Federal Highway Administration, United States Department of Transportation.

The Transportation Research Board of the National Academies was requested by the Association to administer the research program because of the Board's recognized objectivity and understanding of modern research practices. The Board is uniquely suited for this purpose as it maintains an extensive committee structure from which authorities on any highway transportation subject may be drawn; it possesses avenues of communications and cooperation with federal, state, and local governmental agencies, universities, and industry; its relationship to the National Research Council is an insurance of objectivity; it maintains a full-time research correlation staff of specialists in highway transportation matters to bring the findings of research directly to those who are in a position to use them.

The program is developed on the basis of research needs identified by chief administrators of the highway and transportation departments and by committees of AASHTO. Each year, specific areas of research needs to be included in the program are proposed to the National Research Council and the Board by the American Association of State Highway and Transportation Officials. Research projects to fulfill these needs are defined by the Board, and qualified research agencies are selected from those that have submitted proposals. Administration and surveillance of research contracts are the responsibilities of the National Research Council and the Transportation Research Board.

The needs for highway research are many, and the National Cooperative Highway Research Program can make significant contributions to the solution of highway transportation problems of mutual concern to many responsible groups. The program, however, is intended to complement rather than to substitute for or duplicate other highway research programs.

NOTE: The Transportation Research Board of the National Academies, the National Research Council, the Federal Highway Administration, the American Association of State Highway and Transportation Officials, and the individual states participating in the National Cooperative Highway Research Program do not endorse products or manufacturers. Trade or manufacturers' names appear herein solely because they are considered essential to the object of this report.

NCHRP SYNTHESIS 477

Project 20-05, Topic 45-12
ISSN 0547-5570
ISBN 978-0-309-27182-0
Library of Congress Control No. 2015933592

© 2015 National Academy of Sciences. All rights reserved.

COPYRIGHT INFORMATION

Authors herein are responsible for the authenticity of their manuscripts and for obtaining written permissions from publishers or persons who own the copyright to any previously published or copyrighted material used herein.

Cooperative Research Programs (CRP) grants permission to reproduce material in this publication for classroom and not-for-profit purposes. Permission is given with the understanding that non of the material will be used to imply TRB, AASHTO, FAA, FHWA, FMSCA, FTA, or Transit development Corporation endorsement of a particular product, method, or practice. It is expected that those reproducing the material in this document for educational and not-for-profit uses will give appropriate acknowledgment of the source of any development or reproduced material. For other uses of the material, request permission from CRP.

NOTICE

The project that is the subject of this report was a part of the National Cooperative Highway Research Program conducted by the Transportation Research Board with the approval of the Governing Board of the National Research Council. Such approval reflects the Governing Board's judgment that the program concerned is of national importance and appropriate with respect to both the purposes and resources of the National Research Council.

The members of the technical committee selected to monitor this project and to review this report were chosen for recognized scholarly competence and with due consideration for the balance of disciplines appropriate to the project. The opinions and conclusions expressed or implied are those of the research agency that performed the research, and, while they have been accepted as appropriate by the technical committee, they are not necessarily those of the Transportation Research Board, the National Research Council, the American Association of State Highway and Transportation Officials, or the Federal Highway Administration of the U.S. Department of Transportation.

Each report is reviewed and accepted for publication by the technical committee according to procedures established and monitored by the Transportation Research Board Executive Committee and the Governing Board of the National Research Council.

Published reports of the

NATIONAL COOPERATIVE HIGHWAY RESEARCH PROGRAM

are available from:

Transportation Research Board
Business Office
500 Fifth Street, NW
Washington, DC 20001

and can be ordered through the Internet at:
<http://www.national-academies.org/trb/bookstore>

Printed in the United States of America

THE NATIONAL ACADEMIES

Advisers to the Nation on Science, Engineering, and Medicine

The **National Academy of Sciences** is a private, nonprofit, self-perpetuating society of distinguished scholars engaged in scientific and engineering research, dedicated to the furtherance of science and technology and to their use for the general welfare. Upon the authority of the charter granted to it by the Congress in 1863, the Academy has a mandate that requires it to advise the federal government on scientific and technical matters. Dr. Ralph J. Cicerone is president of the National Academy of Sciences.

The **National Academy of Engineering** was established in 1964, under the charter of the National Academy of Sciences, as a parallel organization of outstanding engineers. It is autonomous in its administration and in the selection of its members, sharing with the National Academy of Sciences the responsibility for advising the federal government. The National Academy of Engineering also sponsors engineering programs aimed at meeting national needs, encourages education and research, and recognizes the superior achievements of engineers. Dr. C. D. Mote, Jr., is president of the National Academy of Engineering.

The **Institute of Medicine** was established in 1970 by the National Academy of Sciences to secure the services of eminent members of appropriate professions in the examination of policy matters pertaining to the health of the public. The Institute acts under the responsibility given to the National Academy of Sciences by its congressional charter to be an adviser to the federal government and, upon its own initiative, to identify issues of medical care, research, and education. Dr. Victor J. Dzau is president of the Institute of Medicine.

The **National Research Council** was organized by the National Academy of Sciences in 1916 to associate the broad community of science and technology with the Academy's purposes of furthering knowledge and advising the federal government. Functioning in accordance with general policies determined by the Academy, the Council has become the principal operating agency of both the National Academy of Sciences and the National Academy of Engineering in providing services to the government, the public, and the scientific and engineering communities. The Council is administered jointly by both Academies and the Institute of Medicine. Dr. Ralph J. Cicerone and Dr. C. D. Mote, Jr., are chair and vice chair, respectively, of the National Research Council.

The **Transportation Research Board** is one of six major divisions of the National Research Council. The mission of the Transportation Research Board is to provide leadership in transportation innovation and progress through research and information exchange, conducted within a setting that is objective, interdisciplinary, and multimodal. The Board's varied activities annually engage about 7,000 engineers, scientists, and other transportation researchers and practitioners from the public and private sectors and academia, all of whom contribute their expertise in the public interest. The program is supported by state transportation departments, federal agencies including the component administrations of the U.S. Department of Transportation, and other organizations and individuals interested in the development of transportation. **www.TRB.org**

www.national-academies.org

TOPIC PANEL 45-12

CATHRINA BARROS, *California Department of Transportation, Sacramento*
FREDERICK HEJL, *Transportation Research Board*
RICHARD M. HEWITT, *Florida Department of Transportation, Deland*
BAOSHAN HUANG, *University of Tennessee, Knoxville*
GERALD A. HUBER, *Heritage Research Group, Indianapolis, IN*
GREGORY D. JOHNSON, *Minnesota Department of Transportation, Maplewood*
JEFFREY MANN, *New Mexico Department Transportation, Santa Fe*
JEFFREY S. UHLMAYER, *Washington State Department of Transportation, Tumwater*
BRAD NEITZKE, *Federal Highway Administration (Liaison)*
JOHN S. YOUTCHEFF, *Federal Highway Administration (Liaison)*

SYNTHESIS STUDIES STAFF

STEPHEN R. GODWIN, *Director for Studies and Special Programs*
JON M. WILLIAMS, *Program Director, IDEA and Synthesis Studies*
JO ALLEN GAUSE, *Senior Program Officer*
GAIL R. STABA, *Senior Program Officer*
DONNA L. VLASAK, *Senior Program Officer*
TANYA M. ZWAHLEN, *Consultant*
DON TIPPMAN, *Senior Editor*
CHERYL KEITH, *Senior Program Assistant*
DEMISHA WILLIAMS, *Senior Program Assistant*
DEBBIE IRVIN, *Program Associate*

COOPERATIVE RESEARCH PROGRAMS STAFF

CHRISTOPHER W. JENKS, *Director, Cooperative Research Programs*
CHRISTOPHER HEDGES, *Manager, National Cooperative Highway Research Program*
EILEEN P. DELANEY, *Director of Publications*

NCHRP COMMITTEE FOR PROJECT 20-05

CHAIR

BRIAN A. BLANCHARD, *Florida Department of Transportation*

MEMBERS

STUART D. ANDERSON, *Texas A&M University*
SOCORRO "COCO" BRISENO, *California Department of Transportation*
CYNTHIA J. BURBANK, *FHWA (retired)*
CYNTHIA L. GERST, *Ohio Department of Transportation*
MALCOLM T. KERLEY, *Virginia Department of Transportation (retired)*
JOHN M. MASON, JR., *Auburn University*
CATHERINE NELSON, *Salem, Oregon*
RANDALL R. "RANDY" PARK, *Utah Department of Transportation*
ROGER C. OLSON, *Minnesota Department of Transportation*
BENJAMIN I. ORSBON, *South Dakota Department of Transportation*
ROBERT L. SACK, *New York State Department of Transportation*
JOYCE N. TAYLOR, *Maine Department of Transportation*
FRANCINE SHAW WHITSON, *Federal Highway Administration*

FHWA LIAISONS

JACK JERNIGAN
MARY LYNN TISCHER

TRB LIAISON

STEPHEN F. MAHER

Cover figure: Credit: Mary Stroup-Gardiner.

FOREWORD

Highway administrators, engineers, and researchers often face problems for which information already exists, either in documented form or as undocumented experience and practice. This information may be fragmented, scattered, and unevaluated. As a consequence, full knowledge of what has been learned about a problem may not be brought to bear on its solution. Costly research findings may go unused, valuable experience may be overlooked, and due consideration may not be given to recommended practices for solving or alleviating the problem.

There is information on nearly every subject of concern to highway administrators and engineers. Much of it derives from research or from the work of practitioners faced with problems in their day-to-day work. To provide a systematic means for assembling and evaluating such useful information and to make it available to the entire highway community, the American Association of State Highway and Transportation Officials—through the mechanism of the National Cooperative Highway Research Program—authorized the Transportation Research Board to undertake a continuing study. This study, NCHRP Project 20-5, “Synthesis of Information Related to Highway Problems,” searches out and synthesizes useful knowledge from all available sources and prepares concise, documented reports on specific topics. Reports from this endeavor constitute an NCHRP report series, *Synthesis of Highway Practice*.

This synthesis series reports on current knowledge and practice, in a compact format, without the detailed directions usually found in handbooks or design manuals. Each report in the series provides a compendium of the best knowledge available on those measures found to be the most successful in resolving specific problems.

PREFACE

By Donna L. Vlasak
Senior Program Officer
Transportation
Research Board

The report documents methods and practices on reduction and elimination of asphalt mix segregation. This synthesis provides guidance on how to reduce or eliminate segregation during aggregate production, mix design, asphalt mix production, mix transport and transfer, and placement. Successful options for reducing or eliminating segregate, as well as caveats for what not to do, are included for the following topics: segregation descriptions and segregation specifications (standard sections, advantages, disadvantages, incentives/disincentives, and desired changes).

A survey was sent to members of the American Association of State Highway and Transportation Officials (AASHTO) Committee on Construction (with a 96% state response rate). The same on-line survey was submitted to state Asphalt Pavement Association (APA) representatives to collect information from the paving industry’s perspective on successful construction equipment and practices for minimizing or eliminating segregation, as well.

Mary Stroup-Gardiner, Gardiner Technical Service, Monterey, California, collected and synthesized the information and wrote the report. The members of the topic panel are acknowledged on the preceding page. This synthesis is an immediately useful document that records the practices that were acceptable within the limitations of the knowledge available at the time of its preparation. As progress in research and practice continues, new knowledge will be added to that now at hand.

CONTENTS

1	SUMMARY
5	CHAPTER ONE INTRODUCTION
	Project Background, 5
	Synthesis Objectives, 5
	Synthesis Scope, 5
	Report Organization, 5
7	CHAPTER TWO LITERATURE REVIEW
	Descriptions of Segregation, 7
	End-of-Truck Segregation, 7
	Random Segregation, 7
	Longitudinal Segregation, 7
	Temperature Segregation, 9
	Detecting Segregation, 9
	Visual Method, 9
	Surface Texture, 10
	Temperature Differences, 12
	Ground Penetrating Radar, 14
	Intelligent Compaction, 15
	Summary of Methods for Detecting Segregation, 16
	Testing, 16
	Quality Control/Quality Assurance Testing, 18
	Performance-Related Testing, 23
	How and Where Mix Segregates, 24
	Aggregate Production, 24
	Mix Designs, 25
	Asphalt Plants, 27
	Mix Transfer from Haul Truck to Paver, 33
	Paver, 38
	Pavement Distresses and Pavement Condition in Segregated Areas, 41
	Top-down Cracking, 42
	Reflective Cracking, 42
	Ride Quality, 43
	Specifications, 44
	Alberta, Canada, 44
	Texas, 45
	Research Development of Segregation Specifications, 46
47	CHAPTER THREE SURVEY RESULTS
	Descriptions, Detection, Responsibility, and Training, 47
	Descriptions, 47
	Detection, 47
	Responsibility for Detecting Segregation, 47
	Training and Certification Programs, 48
	Testing, 50
	Roadway Density Testing, 50
	Laboratory Testing, 50

- Specifications, 51
 - Incentives/Disincentives, 55
 - Advantages, 55
 - Disadvantages, 55
 - Dispute Resolution, 55
 - Desired Changes in Segregation Specification, 56
 - Summary of Segregation Specification Comments, 56
- Pavement Distresses in Segregated Areas, 56
- Reducing Segregation During Design, Production, and Placement, 57
 - Mix Designs, 57
 - Gradations and Mix Type, 58
 - Material and Mix Production, 60
 - Pavers, 63

66 CHAPTER FOUR CONCLUSIONS

74 ABBREVIATIONS AND ACRONYMS

75 REFERENCES

79 APPENDIX A ON-LINE SURVEY FORM

102 APPENDIX B RESPONDENTS

103 APPENDIX C CHECKLIST FOR REDUCING OR ELIMINATING SEGREGATION

Note: Photographs, figures, and tables in this report may have been converted from color to grayscale for printing. The electronic version of the report (posted on the web at www.trb.org) retains the color versions.

METHODS AND PRACTICES ON REDUCTION AND ELIMINATION OF ASPHALT MIX SEGREGATION

SUMMARY Mix segregation is generally described as localized concentrations of coarser aggregate and fewer fines than the surrounding areas (i.e., rough surface texture) and can be introduced into the mix at any point from aggregate production to where the mix exits the paver. Temperature segregation is localized areas of cold mix compared with the majority of mix and typically occurs between loading the haul truck and coming off the back of the paver screed. Segregation can only be reduced or eliminated when agency and contractor staff can consistently recognize and detect segregation, understand where it occurs, and know what successful practices and equipment can be used to reduce or eliminate segregation. This synthesis provides guidance on how to reduce or eliminate segregation during aggregate production, mix design, asphalt mix production, mix transport and transfer, and placement.

Information on current practices and equipment used by agencies and the paving industry was collected through a literature review and an on-line survey. The survey was sent to members of the AASHTO Committee on Construction (96% response rate) and state Asphalt Pavement Association (APA) organizations (50% response rate; however, only 38 states have APA organizations).

Successful options for reducing or eliminating segregate, as well as caveats for what not to do, are included for the following topics.

Descriptions—There are three types of mix segregation that result in coarser pavement surface textures (end-of-truck, random, and longitudinal). Mix segregation can also be described as concentrations of fine aggregates, binder-rich areas (“fatty spots”), and areas with “clumps” of other additives (e.g., fibers and polymers). Temperature segregation is frequently described as temperature differences of more than a certain threshold such as 25°F or 50°F. Survey respondents were asked to indicate which descriptions are used to describe segregation in their state. The majority of respondents frequently use descriptions for end-of-truck, random, longitudinal, and temperature segregation. About 25% to 30% of the agencies also use one or more descriptions of other types of mix segregation. Standardized segregation descriptions are essential so that field inspections, specifications, and testing for segregation are consistently and more uniformly applied.

Detection Methods—Visual detection of segregation is used by almost all agencies and a number of agencies use one or more methods for measuring temperature differences. Infrared guns and infrared cameras are each used about 20% of the time and about 10% use an infrared sensor bar system (e.g., Pave-IR).

Inspection Responsibilities—Field inspection responsibilities can be split between agency and consultant staff. How the responsibilities are split varies widely. One agency uses agency staff about 25% of the time and consultants about 75% of the time. Another agency uses staff to inspect projects 98% of the time and only uses consultants about 2% of the time. Given the subjective nature of visual detection, which is most frequently used to detect segregation, it is very important to have well-established segregation definitions and training programs for field staff, both agency and consultants, so that agency specifications are uniformly understood and applied.

Testing—Once segregation is detected, the most common action requires additional testing of the potentially segregated areas. Roadway (in-place) density testing and laboratory testing for density, aggregate gradations, and asphalt content are used for standard quality control/quality assurance. However, these test methods usually require additional roadway surface or laboratory sample preparation because of the coarser texture and higher permeability of segregated mixes. A lack of understanding of the required practices or proper selection of laboratory test methods unintentionally skews test results so that mix properties are either under- or overestimated. This leads to accepting a significant amount of mix that does not actually meet specifications or rejecting mix that is actually acceptable. Training and certification programs for field and laboratory staff would include how, when, and where test methods are to be adjusted to accurately measure segregated mix properties.

Training and Certification Programs—Training and certification programs are used by a majority of the agency and industry respondents. Interestingly, these respondents do not believe training for segregation identification is an important component. This observation conflicts with written comments from respondents that frequently identify the subjective nature of segregation detection as a disadvantage. Based on the training and certification program question responses and written comments for these questions, training and certification programs that add information on how and where segregation occurs and highlight successful equipment and practices can help reduce or eliminate segregation.

Specifications—Agency specifications for the control of segregation that were identified by the survey respondents were reviewed and summarized. In general, there is currently no consistent approach for agency specifications.

Pavement Distresses—Respondents identify the most frequently observed early pavement distresses in segregated areas as raveling (texture changes) and potholes in various stages of formation. The next most common “distress” in segregated areas is a loss of ride quality (i.e., rougher ride). Intermittent longitudinal cracking in the wheel path and intermittent fatigue cracking are also considered early distresses in segregated areas by about one-quarter of all respondents. Both types of cracking happen when the tensile strength of the mix cannot support the traffic loads. Segregated mixes lose tensile strength and the loss of strength increases with the increasing severity of segregation.

Written comments about the ability of the agency’s pavement condition survey and pavement management system to adequately detect and track cyclic early pavement distresses resulting from segregation are an indication that the methods are not currently set up to collect and track this kind of information.

How and Where Asphalt Mix Segregates—Key areas where segregation can be generated, observed, and controlled are at the mix design stage, with aggregate production, at the asphalt plant, when asphalt mix is transported, when the mix is transferred to the paver, and may be associated with the paver equipment and operation.

Mix designs—Mixes with gradations without gaps between consecutive sieves are less likely to segregate. Mixes with 9.5-mm maximum size aggregate rarely segregate. Segregation is increasingly more likely as the maximum aggregate size increases. The amount of asphalt in the mix controls the asphalt film thickness on the aggregates and an adequate asphalt film thickness is necessary to keep aggregate particles “stuck” together. When the design asphalt content is too low, the likelihood that the mix will segregate increases. When asphalt-containing recycled materials are used to contribute a portion of the effective binder content in the mix, the properties of the recycled material stockpiles are to be controlled so the effective asphalt content (i.e., asphalt film thickness) is controlled. If this is not controlled, segregation can become an issue.

Aggregate production—The majority of aggregate stockpiles are constructed with labor-intensive processes (i.e., loader operators) and fixed location conveyors. The skills of the

loader operators are important to reducing or eliminating segregation at this point in the process. Training and certification programs help highlight successful practices and skills that reduce or eliminate segregation.

Asphalt plant—The main source of segregation at a batch plant is in the #1 hot aggregate bin. Practices that keep the fines from collecting and building up on the sides of the bin are needed to keep “clumps” of fines from dropping all at once into the mixer. Segregation can be reduced or eliminated at drum mix plants by using kickback flights in the drum, a fixed plow at the discharge point, orienting the drag slat to the silo at 90° to the drum exit, maintaining an optimum amount of mix on the drag slat, using silo batchers, keeping an optimum amount of mix in the silo (about 25% to 75% full), and loading all haul trucks with multiple drops.

Mix transport and mix transfer—Insulated truck beds can help reduce temperature segregation. Baffles that form a funnel at the back of end dump haul trucks help reblend mix as it is deposited into the paver hopper. Windrow elevators help reblend mixes and reduce segregation. Material transfer units can be successful at reducing or eliminating segregation when they are operated correctly.

Paver—Segregation at the front of the paver can be reduced or eliminated by keeping the paver half full at all times, using outboard motors to move conveyors, adding paver retrofits to limit coarser aggregates from rolling off the sides of the conveyors, and using newer paver designs that use a pair of twin augers rather than conveyors to move the mix to the back of the hopper. Segregation at the back of the paver can be reduced or eliminated using kicker paddles or a reverse flow option to push mix under the gear box, keeping a constant volume of mix (and constant head of mix) supplied to both sides of the screed augers, and using auger extensions when screed extensions are used.

Suggestions—There are several gaps in the information gathered about reducing or eliminating segregation. Additional research or training program content suggested to fill these gaps are summarized here.

- Segregation definitions and descriptions could be standardized to improve consistency in the application of segregation specifications such that agency and contractor personnel have a common understanding of segregation.
- Future ground penetrating radar and intelligent compaction roller technologies research programs and pilot projects could evaluate the usefulness of this technology for detecting localized low-density areas resulting from segregation and thereby increase the durability in segregated areas.
- Recycled materials that contribute asphalt content to the mix could benefit from quality control practices for ensuring consistent effective asphalt content. This is increasingly important as the allowable recycled content increases. It is also important that successful practices to physically reblend high recycled content mixes that contribute to the effective asphalt content be identified.
- Paver equipment characteristics that have the potential to reduce or eliminate segregation would be documented. It is important that the effectiveness of pairs of twin augers in the paver hopper, outboard motors and narrower spacing of hopper conveyors, independent speed controls for hopper conveyors or augers, and using auger extensions when screed extensions are used be evaluated.
- Pavement condition surveys and pavement management systems could benefit from being adjusted to detect and track early distresses and loss of pavement life resulting from segregation. Raveling is the first distress to be seen in segregated areas. Because raveling is viewed as a noticeable change in the surface texture, longitudinal texture profiles may be useful for tracking emerging pavement distresses in segregated areas.

CHAPTER ONE

INTRODUCTION**PROJECT BACKGROUND**

Segregation is generally described as localized concentrations of coarser aggregate with fewer fines than the surrounding areas (i.e., rough surface texture). Mix properties in segregated areas are characterized by lower asphalt contents, lower densities, higher air voids, higher permeabilities, lower strengths, or lower stiffness than the design mix. Any or all of these deviations from the job mix formula mix properties can be outside of the specified mix properties and result in premature pavement distresses in the segregated areas.

Segregation seen behind the paver can be introduced into the mix at any point from aggregate production at the plant to when the mix exits the paver. Temperature segregation typically occurs between loading the haul truck and the back of the paver screed. The key to reducing or eliminating segregation is derived from knowing how and where segregation occurs and what equipment and practices can be used to solve the problem.

The main focus of this synthesis is to provide guidance on how to reduce or eliminate segregation during aggregate production, mix design, asphalt mix production, mix transport and transfer, and placement.

SYNTHESIS OBJECTIVES

The objectives of this synthesis were to compile information on:

- Descriptions of segregation
- Methods for detecting segregation
- Testing of segregated areas
- Specifications for controlling segregation
- Pavement distresses and pavement condition for pavements with evidence of segregation
- How and where mix segregates because of:
 - Aggregate production
 - Mix design
 - Asphalt plant production
 - Mix transport and transfer to paver
 - Paving operations.

SYNTHESIS SCOPE

Information was collected through a literature review and an on-line survey (Appendix A). The AASHTO Committee on Construction members were surveyed to determine agency current practices and equipment usage that can influence segregation. There was a 96% response rate (48 of 50 states) from the state agencies (Figure 1). The same on-line survey was submitted to state Asphalt Pavement Association (APA) representatives to collect information from the paving industry's perspective on successful construction equipment and practices for minimizing or eliminating segregation. Requests for survey participation were sent to the 38 states with an APA organization; not all states have associations. A total of 19 of the 38 APA organizations (50%) returned survey responses (Figure 2).

The survey questions collected information on segregation descriptions, segregation specifications (standard sections, advantages, disadvantages, incentives/disincentives, desired changes), and were answered by every respondent. Survey respondents had the option of selecting more than one choice for most of the questions and were also able to choose which questions they wished to answer. Most of the respondents answered the majority of the questions; therefore, the percentages reported in the survey result tables are based on the maximum number of survey respondents, *N*. The number of responses for each row in each question, *n*, are also shown in these tables.

REPORT ORGANIZATION

The information is organized in the following chapters:

- Chapter One—Introduction
 - Briefly outlines the study purpose, objectives, study approach, and report organization.
- Chapter Two—Literature Review
 - Contains the subject background and how mix segregation can be reduced during aggregate production, mix design, and asphalt concrete mix production. Mix transportation, transfer, and placement as well as the expected pavement distresses that can be accelerated in segregated areas are discussed.



FIGURE 1 State agencies responding to the survey (shaded) [Source: Stroup-Gardiner (2014)].

- Chapter Three—Survey Results
 - Includes the results, analysis, and conclusions based on the current experiences of agencies and industry representatives.
 - Chapter Four—Conclusions
 - Summarizes successful strategies for reducing or eliminating mix and temperature segregation and suggests needs for future research.
- References
 - Appendix A—On-Line Survey Form
 - Appendix B—Respondents

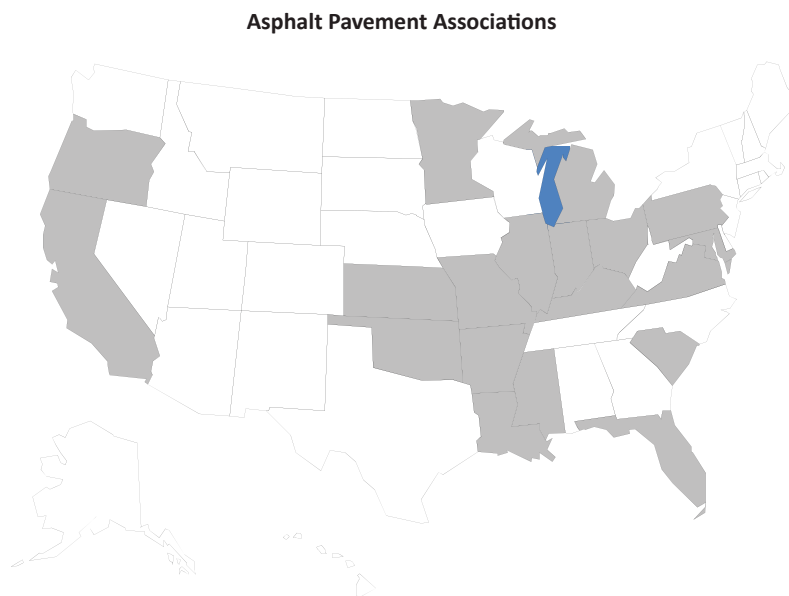

FIGURE 2 Asphalt Pavement Associations responding to the survey (shaded) [Source: Stroup-Gardiner (2014)].

CHAPTER TWO

LITERATURE REVIEW

The literature review information contained in this chapter is covered in the following sections:

- Descriptions of segregation
- Detecting segregation
- Testing in segregated areas
- Segregation specifications
- Pavement condition in segregated areas
- How and where mix segregates.

DESCRIPTIONS OF SEGREGATION

Mix segregation is usually described by the location and the pattern of the coarsely textured areas in the finished mat. Although a range of terms and descriptive phrases have been used by various agencies and consultants for specific types of segregation, the following terms will be used for consistency throughout this report:

- End-of-truck segregation
- Random segregation
- Longitudinal segregation
- Temperature segregation.

Longitudinal joint construction and segregation at the joints is not specifically covered in this synthesis. However, successful practices that reduce or eliminate longitudinal segregation are also considered successful practices for minimizing joint segregation.

End-of-Truck Segregation

End-of-truck segregation (AASHTO 1997; Scherocman 2011; Warren 2013) is described as a separation of coarse and fine aggregate fractions in the asphalt mix and appears behind the paver as two coarser textured areas in a transverse location on either side of the center of the paver (Figure 3). The pattern of the coarser areas is commonly described as a chevron.

End-of-truck segregation occurs because of improper loading of the silo, improper loading and unloading of haul trucks, running the paver hopper too low or empty, dumping left-over mix in the paver wings (i.e., “flipping” the wings), or not removing spilled mix.

Other terms that have been used to mean end-of-truck segregation include truck to truck (AASHTO 1997), truckload to truckload (Scherocman 2011), periodic segregation on each side (Brock et al. 1998), and chevrons of rough texture (Murphy 2012b).

Random Segregation

Random segregation is coarse textured areas at irregular intervals and is the least frequent type of segregation seen behind the paver (Scherocman 2011). The coarsely textured areas can be localized transverse or longitudinal in no consistent or continuing pattern (Figure 4). Random segregation with a fine texture (i.e., fine aggregate segregation) is more difficult to visually identify and can be seen under certain lighting conditions or with the aid of texture measurements.

Random segregation can occur during the formation and handling of aggregate stockpiles, asphalt plant operations, clumping of mix components, and as windrows are formed.

Other descriptions for random segregation that are related to the separation of the asphalt mix components include “clumps” (e.g., non-mixed fibers, polymers, or other additives) or “fat spots” (e.g., binder-rich areas) (Figure 5). Clumps of additives occur because of the improper location of addition during mixing or insufficient time in the batch or drum mixer. Fat spots can occur because of the binder draining off of the aggregate surface during silo storage, asphalt mix transfer, or asphalt mix placement.

Longitudinal Segregation

Longitudinal segregation is described as a stripe, or streak, of coarsely textured asphalt mix behind the paver. Coarse textured stripes can occur in the center of a lane that is usually under the gear box at the back center of the paver. Longitudinal stripes on either or both sides of the center of the lane can correspond to the outside edges of the paver conveyors, at the edges of the screed, and where screed extensions start at the edge of the fixed screed. Centerline segregation is a longitudinal strip of coarsely textured mix under the screed auger gear box located in the center of the screed.



FIGURE 3 Example of end-of-truck segregation [Source: Stroup-Gardiner and Brown (2000)].



FIGURE 6 Example of longitudinal segregation on one side [Source: Adams et al. (2001)].



FIGURE 4 Example of random segregation [Source: Stroup-Gardiner (2014)].

Longitudinal segregation (Figures 6 and 7) can occur because of improper loading of the bin batcher, under- or over-filling the silos, running the paver screed augers too slowly (“starving” the augers), and paver designs. When mix is segregated as it leaves the asphalt mix plant and is not adequately remixed before transfer to the paver, the segregation will move through the paver and appear as longitudinal segregation. One-sided longitudinal segregation can also be caused by an imbalance in the volume of mix across the width of the screed augers. The segregation can be seen on the side of the screed with the lowest volume (“starving” the augers on one side).

Longitudinal centerline segregation occurs when the coarser aggregate rolls off of the paver hopper conveyors or coarser



FIGURE 5 Example of random segregation (separation of binder and stone) in SMA [Source: Stroup-Gardiner (2014)].



FIGURE 7 Example of longitudinal segregation, both sides [Source: Murphy (2012a)].

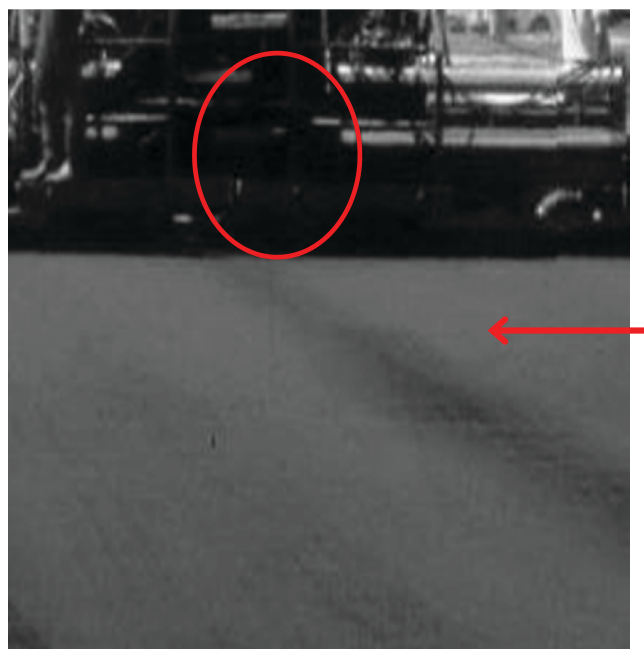

FIGURE 8 Example of centerline longitudinal segregation under gear box [Source: Stroup-Gardiner (2014)].

aggregate at the inside edges gets dropped under the gear box as the mix moves toward the screed augers (Figure 8).

Temperature Segregation

Temperature segregation is localized areas of cold mix surrounded by a majority of mix with hotter and more uniform temperatures. Temperature segregation is measured with infrared temperature “guns,” infrared camera image analysis, or infrared sensor units (e.g., Pave-IR) mounted to the back of paver.

Research by Gunter (2012) showed that the four most frequent locations to detect cold mix are at the end of each truck load of mix, when the paver stops to change haul trucks, when the paving operation stops while waiting for haul trucks to arrive, and in areas with handwork (Table 1). Hand work is typically done at the stop-start of paving operations and at the joints and edges of the fresh mat, and may or may not indicate segregated mix.

DETECTING SEGREGATION

The following five methods are currently used or have some potential to detect segregation behind the paver:

1. Visual
2. Surface texture
3. Temperature differences
4. Ground penetrating radar (density mapping)
5. Intelligent compaction.

TABLE 1 RANKING OF CAUSE OF TEMPERATURE DIFFERENCES

Cold Areas on South Carolina Projects		Ranking and Type of Non-Uniformity	
Reasons for Cold Areas	No. of Images	Mix	Temp.
<i>Mix Transfer</i>			
End of Truck	129	1	
Work Stoppages	98		2
Cold Mix Due to Waiting During Long Work Stoppages	40		3
Liquid Spills on Mat	3		9
<i>Paver Operations</i>			
Wing Dump (“flipping”)	18	7	
Streaks in the Mix	25	5	
Mechanical Problems	5	8	
Start-Up, Cold Joint, Etc.	21	6	6
<i>Miscellaneous</i>			
Hand Work	31	4	
Environmental (Weather)	2		10

Source: Gunter (2012).

Ranking: 1= largest number of infrared images with cold areas.

10 = fewest number of infrared images with cold areas.

Visual Method

Visual detection has been used the longest and is considered the benchmark against which other methods for detecting segregation are compared. One study documented the subjectivity (i.e., high variability) in visual detection of segregation. A Texas study in 1999 detailed five expert inspector’s evaluations of 5.11 miles of pavement construction (Tahmoressi et al. 1999). This length of paving was divided into nine test sections that investigated the influence of various methods of mix transfer on segregation. In the most efficient case, the number of segregated areas identified by each expert varied from 7 to 9 for a specific 1,000-ft subplot of paving. In the worst case, the number of segregated areas identified by each expert varied from three to 11 for the same section of pavement.

Because the severity of the segregation significantly impacts the loss of pavement life, there has been some effort to define the levels of segregation by visual examination. Gavin and Heath (2002) reported that slight segregation is described as “. . . matrix, asphalt cement and fine aggregate, [that] is in place between the coarse aggregate. However, there is more stone in comparison to the surrounding acceptable mix . . .” (Figure 9). Moderate segregation is described as “. . . significantly more stone than the surrounding mix; moderately



FIGURE 9 Example of slight level of segregation [Source: Gavin and Heath (2002)].



FIGURE 10 Example of moderate level of segregation [Source: Gavin and Heath (2002)].

segregated areas usually exhibit a lack of surrounding acceptable matrix . . ." (Figure 10). Severe segregation “. . . appears as an area of very stony mix, stone against stone, with very little or no matrix . . ." (Figure 11).

The major disadvantage with visual assessment is that each person assesses the mat texture based on their own experiences and interpretation of segregation (Mahoney et al. 2003). Variations in lighting, angle of view, and shadowing increase variations in the visual appearances of the mat. Differences of opinion between experts performing the visual assessments lead to discussions, arguments, and requirements for dispute resolutions, any of which delay construction, increase the time needed for lane closures, increase the project cost for the agency, generate additional testing requirements, and may result in lost revenue for the contractor (i.e., disincentives).

- *Experts visually inspecting a project for segregation can frequently disagree on the number and extent of segregation.*

Surface Texture

Quantitative measures of the surface texture are useful for eliminating the subjective nature of visual assessments of texture. Surface texture can be measured using:

- Static texture measurements,
- Longitudinal texture profiles, and
- Photographic image analysis.

Static Texture Measurements

Static texture measurements are tests that evaluate a limited area of the pavement surface either immediately after construction is completed or at some time after the roadway is opened to traffic. Once the roadway is open to traffic, traffic control is required during testing for worker safety. The simplest method of estimating the surface texture is with the ASTM E965 Standard Test Method for Measuring Pavement Macrotexture Depth Using Volumetric Technique. This method uses a known volume of fine sand that is spread in a circle on the pavement surface. The diameter of the circle and the mass and volume of the sand are used to estimate the depth of the surface voids (Figure 12). The circular texture meter uses a laser sensor to measure the texture profile of an 11.2-in. (284-mm) diameter circle according to ASTM E2157 Standard Test Method for Measuring Pavement Macrotexture Properties Using the Circular Track Meter (Meegoda et al. 2002, 2003; Applied Pavement Technology 2008). Both static measurement methods provide similar, but somewhat offset, texture measurements.

- *Static texture measurements can quantify texture changes resulting from segregation, but they only provide measurements for a small area of the overall pavement.*

Longitudinal Texture Profiles

Longitudinal texture profiles are obtained using vehicle-mounted, high-speed laser distance measurement sensors usually mounted over the right wheel path. The sensor(s) mea-

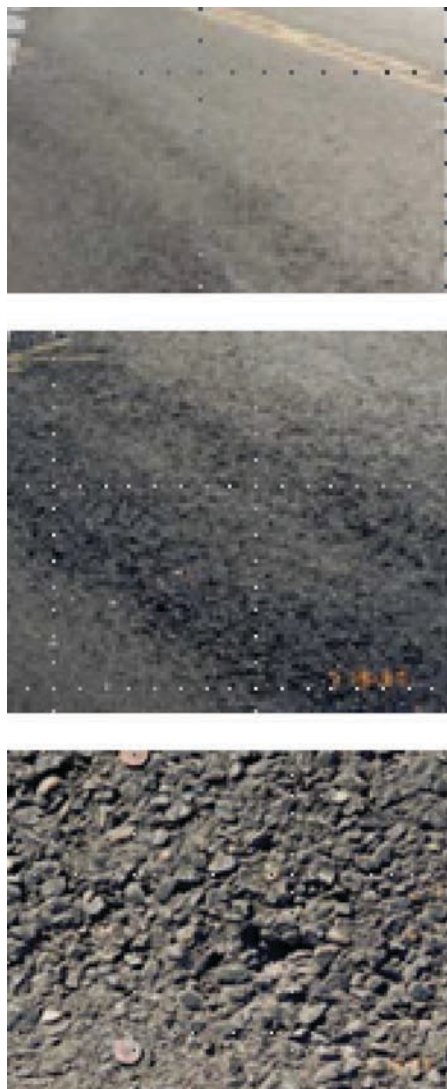

FIGURE 11 Example of severe segregation [Source: Gavin and Heath (2002)].

sures the distance from the mounted position to the pavement surface every 2 mm (0.8 in.) of longitudinal distance. The data are used to develop a longitudinal profile of the texture depth (Meegoda et al. 2002, 2003; Williams 2003).

End-of-truck segregation is typically seen as cyclic peaks in the surface texture at intervals that correspond with the length of paving completed with each haul truck (Figure 13). The use of a material transfer vehicle (MTV) can reduce segregation, but may not completely eliminate it such as when the mix is not fully reblended by the MTV. However, the cyclic peaks, although reduced in height, can still be detected with the longitudinal texture measurements.

- *Longitudinal texture profiles quantify:*
 - *Texture changed as a result of end-of-truck segregation.*

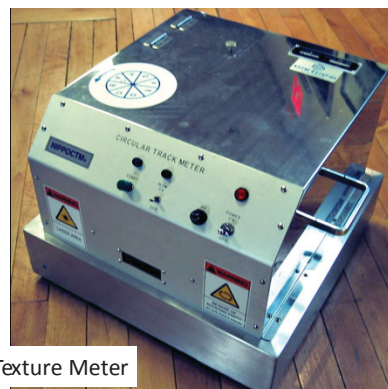

FIGURE 12 Examples of static circular area texture measurement methods [Source: Hanson and Prowell (2004); APT (2008)].

- *Effectiveness of material transfer units for reducing end-of-truck segregation.*

Photographic Image Analysis

Digital photographs can be used to record evidence of visible texture differences and various analysis methods can be used to mathematically quantify the changes in the pixel brightness (de Leon Izzepi et al. 2006; de Leon Izzepi and Flintsch 2006a, b; Zelelew and Pagagiannakis 2011). The changes in the pixel color or grey tone values indicate the consistency of the pavement texture seen in the photograph. The simplest representation of the data is a histogram of the brightness values (Figure 14), which indicates a fairly uniform distribution of pixel color and therefore a uniform texture. When the histogram is wider and more brightness values are contained in the distribution, the image captures non-uniform texture characteristics. This is still an experimental approach, as non-uniform texture areas not only locate potentially segregated areas they also identify white pavement markings, pockets of moisture, and tire marks on new pavements as having non-uniform texture. On-site visual evaluation for segregation detection is necessary for areas having high variability in the image analysis.

- *Photographic image analysis has the potential to detect textural changes resulting from segregation.*
 - *Lighting, environmental conditions (e.g., moisture, clouds, etc.), and other pavement textures such as*

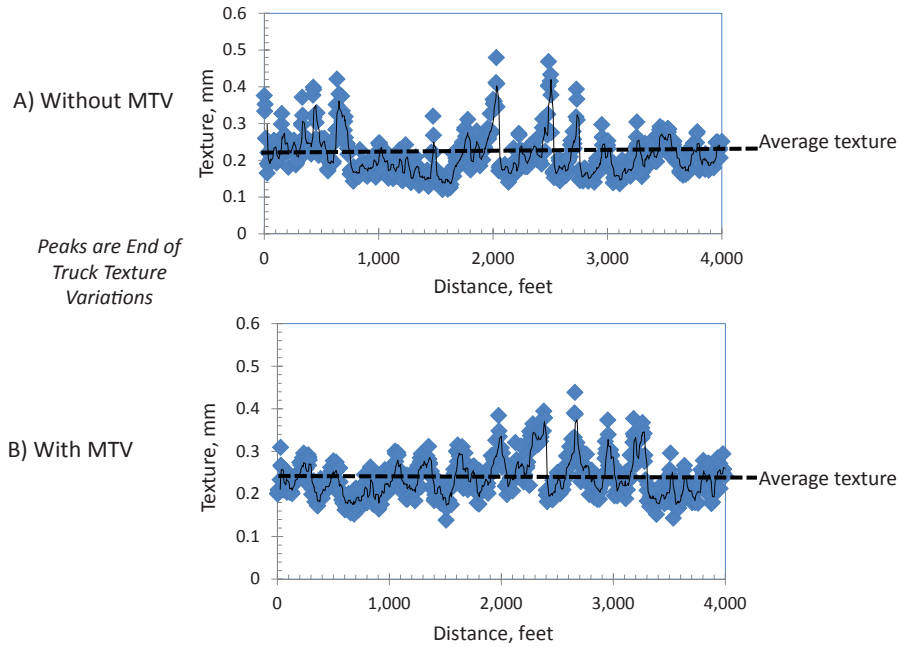

FIGURE 13 Longitudinal texture profile changes with and without MTV [Source: Williams (2003)].

striping and tire tracks can significantly influence the image analyses.

or sampled for laboratory testing to determine if the mix properties meet the specification requirements.

Temperature Differences

Temperature differences can be used to locate non-uniformity in the mix, production, and paving process. Areas with sufficiently large localized temperature differences can be tested

Temperature differences can be determined using handheld infrared sensors (“guns”), infrared cameras, or paver-mounted infrared sensors and computer systems. The simplest method for identifying temperature differences in the mix is with the infrared gun. This technology is economical, easy to use, and

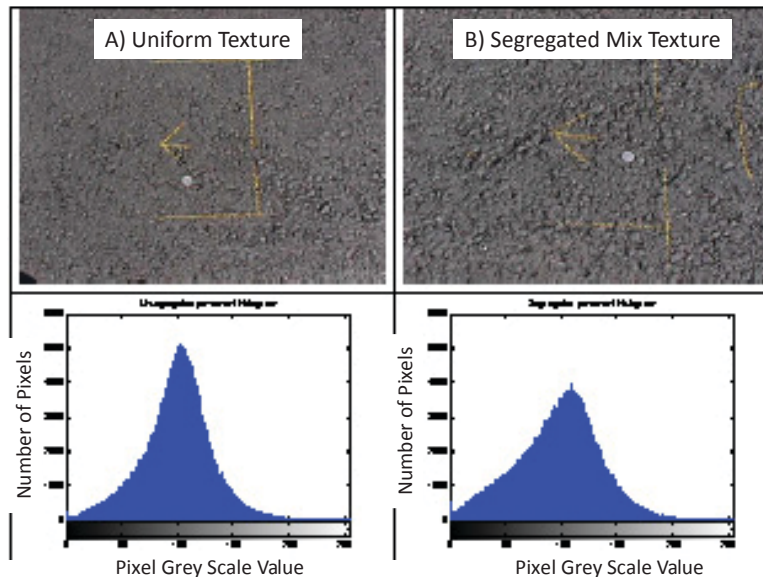

FIGURE 14 Example for the analysis of photographic images [Source: de Leon Izeppi et al. (2006b)].

numerous measurements can be taken throughout the paving process. However, the area included in the temperature reported on the device's display can change substantially owing to the distance of the gun to the area being tested and the distance to spot (D:s) characteristic of the device that defines the area averaged in the measurement. The results from these devices may also need to be hand-recorded, as most guns do not have a data collection component.

- *Temperature measurements obtained with infrared guns can vary substantially depending on the device D:s ratio and the distance of the user to the target. When these factors vary, it is difficult to accurately detect temperature segregation.*

Infrared cameras are more expensive but provide a more detailed method of “photographing” the pavement during construction. Thermal photographs, such as digital photographs, are dependent on the knowledge and experience of the person operating the camera, as well as the options available on the camera. The following is to be considered when acquiring thermal images so that temperature segregation is not over- or underestimated:

- The area of the paving included in each infrared image and analysis is to be standardized as much as possible (Gunter 2012) (Figure 15). It is important that non-paved areas or right-of-way obstructions be excluded from the analysis area
- Images are to be in focus so the color analysis of pixels can be accurately analyzed (Figure 16).
- Zooming in on one section can result in too small an area of the pavement being represented in the image and complicate subsequent analysis (Figure 17). It is difficult to assess areas of segregation when the image does not show the width of the lane.

- Temperature scale increments can be set by the user on some devices to highlight incremental temperature changes of interest. For example, the temperature scale can be set to indicate increments of 18.8°F (10°C), which helps show the larger chevron pattern of end-of-truck segregation (Figure 18).
- Newer infrared cameras can also capture a digital image at the same time the thermal image is saved so that visible evidence of segregation can be documented (Figure 19).
 - *Standardized protocol for image collection and camera scale setting are necessary to reliably detect temperature segregation.*
 - *It is essential that infrared camera images be in focus and represent a sufficient area of the pavement so that non-uniform and uniform areas can be identified in the analyses.*

Temperature differences have been directly linked to visually identifiable types of segregation (Adams et al. 2001); thermal and digital photographs that show:

- End-of-truck segregation (Figure 20),
- Longitudinal centerline segregation (Figure 21), and
- Longitudinal one-sided segregation (Figure 22).

Note that Figure 21 also includes temperature differences resulting from longitudinal ridges and depressions because of the screed settling down during a paver stop. Although some temperature differences directly indicate visibly identifiable segregation, other temperature differences indicate non-segregated textural changes.

The Pave-IR™ unit combines paver-mounted infrared sensors, a computer system for collecting and analyzing

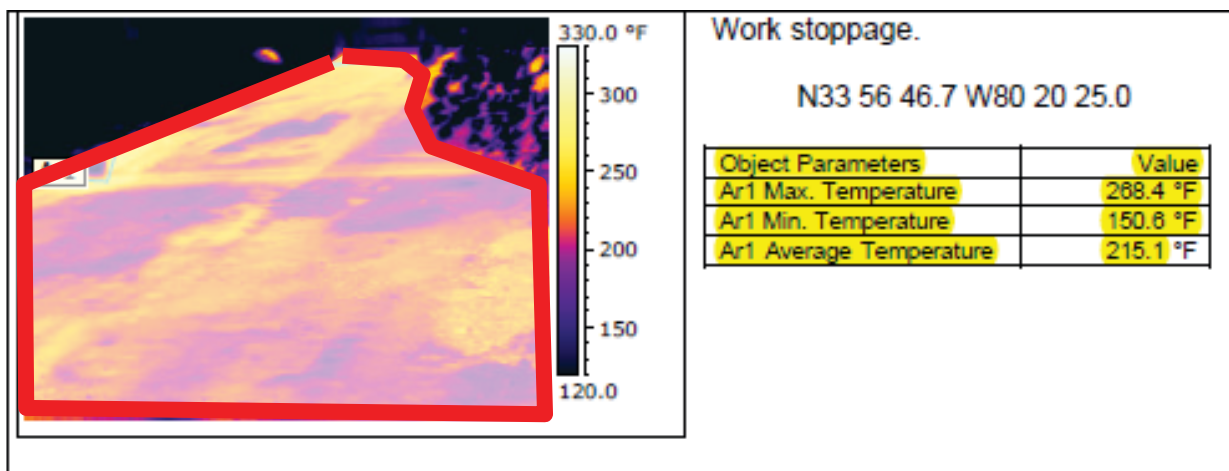
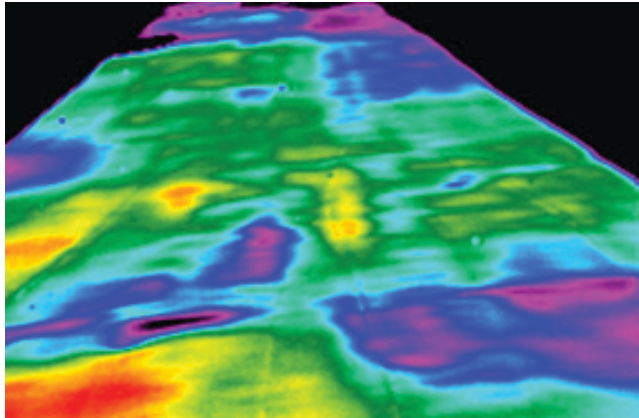

FIGURE 15 Example of standardizing thermal image for analysis by eliminating non-paving areas from the analysis [Source: Gunter (2012)].



Blurry edges in image will influence the data analysis of the image which is based on pixel color values

FIGURE 16 Example of an out-of-focus temperature image [Source: Henault et al. (2005)].

the temperature data, and a global positioning system (GPS) to provide a location reference for temperature anomalies and paver stops (Figure 23). A visual display allows the paving crew to identify when paving operations or equipment would be adjusted to improve the uniformity of the mat properties.

- Infrared temperature profiles developed using infrared sensor bars such as the Pave-IR keep the distance-to-target constant, standardize the area of the pavement included in each profile, and document the location of any non-uniform areas with the unit's GPS technology.

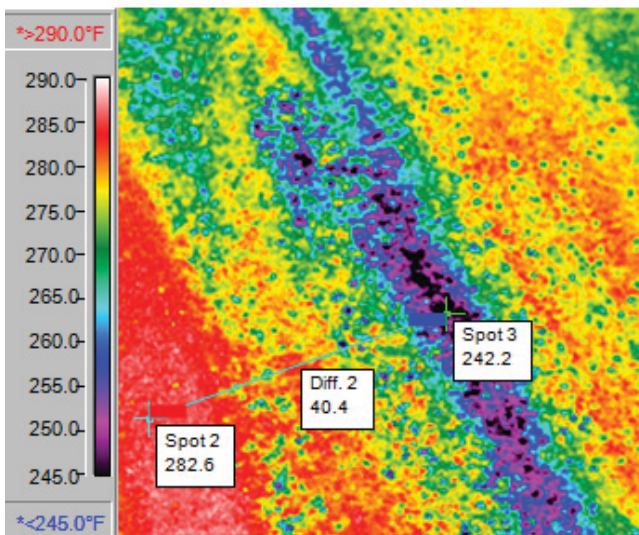

There is not enough data contained in the image to determine significant temperature changes across the width of the mat.

FIGURE 17 Example of a too-close view of a temperature anomaly [Source: Henault et al. (2005)].

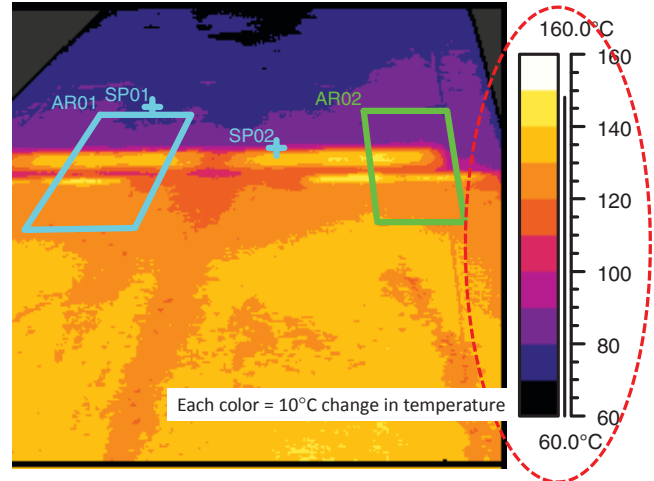

FIGURE 18 Example of setting the thermal image colors to represent increments of 10°C [Source: Gunter (2012)].

All of these features help to accurately detect any temperature segregation.

- Temperature images (infrared camera, infrared sensor bar) can help detect types of segregation that can also be seen as visibly detectable segregation.

Ground Penetrating Radar

Segregated areas of the pavement typically have lower densities and higher air voids; therefore, technologies that can evaluate these properties may have the potential to detect segregation. Several states have active ground penetrating radar (GPR) programs for the measurement of layer thicknesses, pockets of water, determination of voids, delamination on bridge decks, or moisture in or damage to asphalt pave-

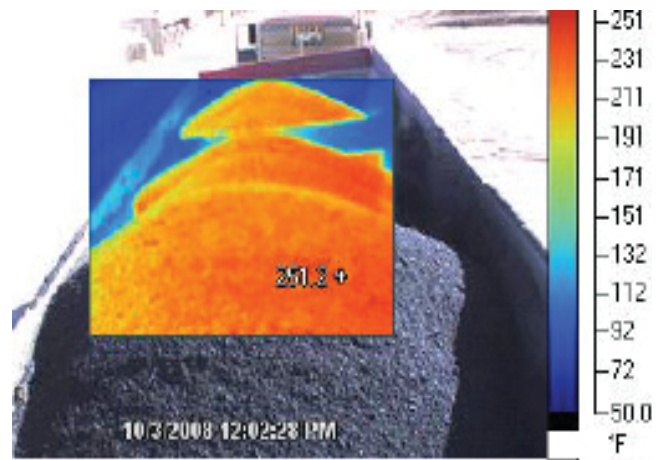

FIGURE 19 Example of image from newer infrared camera that simultaneously collects digital and infrared image [Source: Song et al. (2009)].

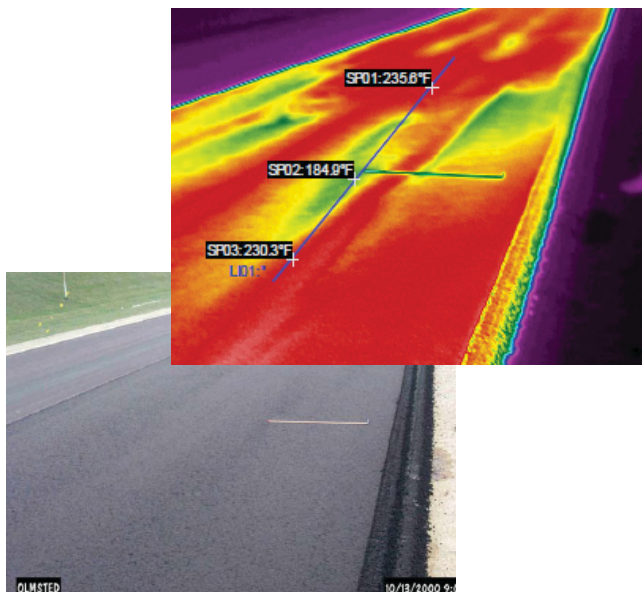

FIGURE 20 Temperature differences that reflect visible changes in texture (end-of-truck segregation) [Source: Adams et al. (2001)].

ment (Al-Qadi and Lahouar 2004). GPR measurements of the dielectric constant are correlated with densities or air voids of cores taken from the pavement to be tested. Mix properties can be obtained for a portion of a pavement lane or the entire lane width, depending on the number of GPR units that are mounted on the vehicle (Figure 24) (Sebesta and Scullion 2002, 2012; Sebesta et al. 2006, 2013).

➤ *GPR technology can be used to develop a geospatial density map, but it is unclear if the technology can*

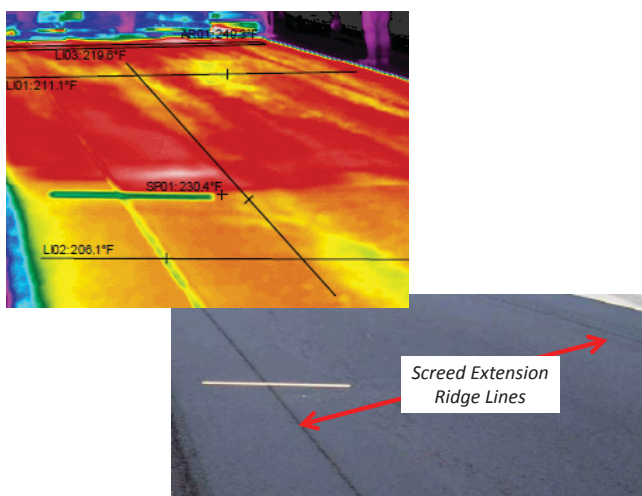

FIGURE 21 Temperature differences that reflect visible changes in texture (centerline segregation and screed extension anomalies) [Source: Adams et al. (2001)].

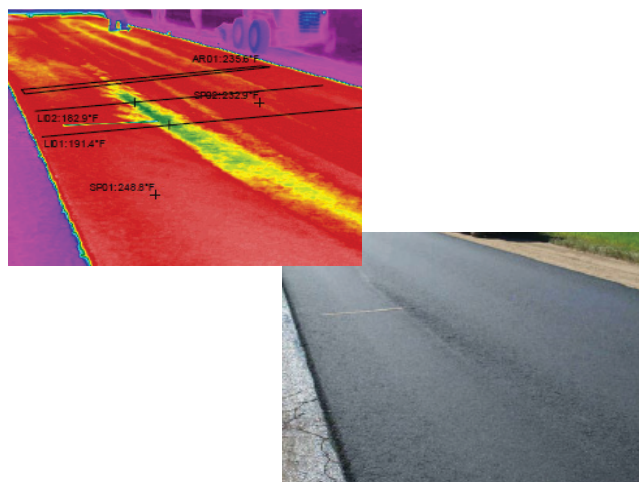

FIGURE 22 Temperature differences that reflect visible changes in texture (longitudinal one-sided segregation) [Source: Adams et al. (2001)].

detect localized areas of low density resulting from segregation.

➤ *Further evaluations of the GPR technology are important in this area.*

Intelligent Compaction

The lower densities and higher air voids in segregated areas are responsible for the loss of mix stiffness in those areas. The intelligent compaction (IC) technology uses an instrumented tandem steel wheel vibratory roller to estimate changes in freshly placed asphalt mix stiffness in the mat during breakdown rolling. The IC technology is comprised of a GPS unit, a display for the roller operator, a temperature sensor, and an accelerometer sensor mounted to the front steel drum. Changes in vibrations from the eccentric weights inside the drum are used to estimate changes in stiffness (Figure 25). Areas of the pavement with segregation-related stiffness changes may influence changes in the IC roller vibrations. It is possible this technology may be capable of detecting segregation by detecting areas with low stiffness; however, no research has yet been conducted to investigate this possibility.

Intelligent compaction technology has the potential to:

- Provide real-time feedback to the roller operator about the number of passes completed, roller speed, mat temperature, and the sensor data needed for analyses.
- Document all data collected during compaction.
- Statistically evaluate data and report information in geospatial format.
- Identify underlying “soft spots” that may be detrimental to the compaction of the new mat over these areas.

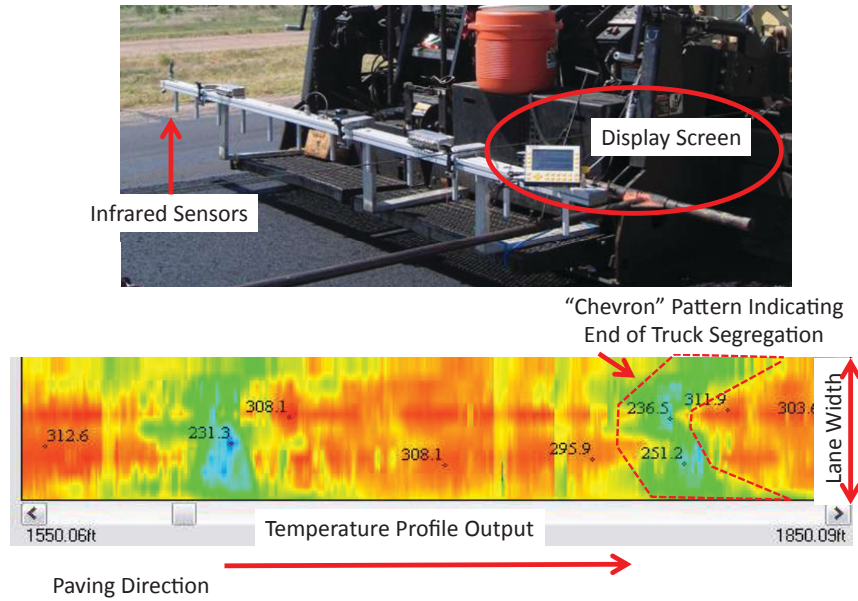

FIGURE 23 Pave-IR system for collecting and analyzing temperature data during paving [Source: Rand (2012)].

- Potentially identify areas of low stiffness in new layers that may also indicate segregated areas.
- Prevent “over-compaction,” which is detrimental to obtaining optimum stiffness.

it is unclear if the technology can identify localized areas of low stiffness resulting from mix segregation.
 ➤ *Future research programs could explore this possible use for the IC technology.*

Current barriers include:

- Uncertainty of the technology to adequately differentiate between the stiffness of each pavement layer.
- Limited availability of equipment that meets the FHWA criteria for IC equipment that requires high precision GPS, IC valves, and temperature measurement.
- Need for simplification of data collection, management, and analyses processes.
 - *While the IC technology has been used to develop geo-spatial density, modulus, and underlying support maps,*

Summary of Methods for Detecting Segregation

Each method for detecting segregation has advantages and disadvantages (Table 2).

TESTING

Over the last 20 years, a number of research and pilot projects were conducted related to different methods for detecting segregation to measureable changes in density, air voids,



FIGURE 24 GPR vehicle developed by Texas Transportation Institute [Source: Sebesta et al. (2006)].

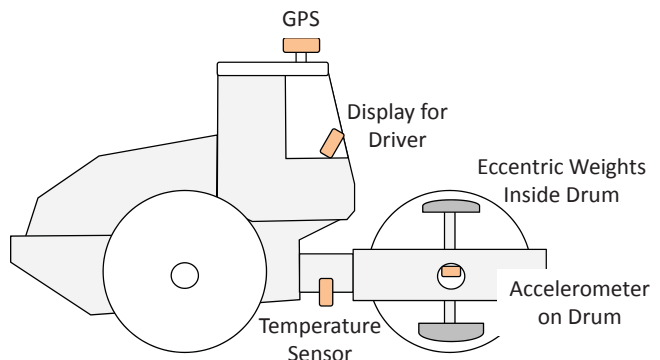

FIGURE 25 Schematic of sensors and electronics used for intelligent compactors [Source: Stroup-Gardiner after Haskell (2007); FHWA (2011)].

TABLE 2
ADVANTAGES AND DISADVANTAGES FOR METHODS FOR DETECTING SEGREGATION

Detection Method	Advantages	Disadvantages
Visual Detection	<ul style="list-style-type: none"> • Benchmark method for detection of segregation • Detects mix segregation (coarse and fine) • Locates binder-rich areas • No equipment needed • Mix can be evaluated for segregation and can be evaluated during or after construction • No cost 	<ul style="list-style-type: none"> • Subjective • Only evaluates surface anomalies • Requires experienced field staff, inspectors, contractors • Can be wide differences in detection of segregation between experts • Fails to locate localized areas of poor density not associated with mix segregation • Difficult to see texture changes during night-time paving • Does not always identify areas with significantly different mix properties
Infrared Gun	<ul style="list-style-type: none"> • Identifies areas with temperature differences • Effective during day or nighttime paving • Easy to use • Immediate results obtained • Economical 	<ul style="list-style-type: none"> • Only provides spot-specific measurements • Only evaluates surface anomalies • Measurements need to be recorded manually • Area of mat included in the measurement is device-dependent, distance-dependent, and user-dependent • Does not always identify areas with significantly different mix properties
Infrared Images or Profiles	<ul style="list-style-type: none"> • Detects areas with temperature differences • Provides record of temperature variability on entire project • Software can indicate significant temperature differences in real time so corrections to the construction process can be made immediately • Effective during day or nighttime paving 	<ul style="list-style-type: none"> • Data needs to be collected during construction • Only evaluates surface anomalies or those underlying anomalies that influence surface temperature • Technician training and standardized data collection method needed • Does not differentiate between mix segregation and temperature segregation • Moderate cost • Does not always identify areas with significantly different mix properties
Surface Texture	<ul style="list-style-type: none"> • Quantifies texture changes seen with visual detection of segregation • Data can be collected during or after construction • Data can be collected at highway speeds using an inertial profiler with a high frequency laser • Longitudinal texture profiles can evaluate the successful remixing of segregated mixes by material transfer devices 	<ul style="list-style-type: none"> • Testing can only be done after compaction is complete • Only evaluates surface anomalies • Vehicle mounted methods only provide longitudinal profile • Static texture measurement methods only provide single point measurements and may require traffic control during testing • Does not always identify areas with significantly different mix properties • Lighting and environmental conditions can influence results

(continued on next page)

TABLE 2
(continued)

Detection Method	Advantages	Disadvantages
Ground Penetrating Radar (GPR)	<ul style="list-style-type: none"> • Estimates changes in density due to changes in mix properties, which is a key factor in the pavement service life • Can provide information on densities across the full lane width of the project • Has potential for density monitoring during compaction when mounted on roller 	<ul style="list-style-type: none"> • Limited experience with this specific use of technology as a means of detecting segregation • Testing can only be done after compaction is complete • GPR measurements of dielectric constant need to be correlated with core densities (air voids) for each project • Requires significant technician training • Complicated analysis • High cost
Intelligent Compaction	<ul style="list-style-type: none"> • Estimates changes in layer stiffness • Evaluates the full lane width of layer properties during construction • Information during rolling can immediately show operator where coverage is not complete • Real time display allows the roller operator to proactively adjust rolling patterns to achieve the most uniform stiffness • Existing vibratory compaction equipment can be retrofitted with sensors and data collection/analysis devices • Retrofit only moderately expensive 	<ul style="list-style-type: none"> • Results are dependent on the underlying pavement structure stiffness and layer thicknesses • Current use focused on overall project stiffness and evaluation of the uniformity of existing pavement structure stiffness • Mixed results in linking results with density, estimated from stiffness information, of individual layers • No research has been conducted for use in detecting segregated mix

gradations, and asphalt content (Table 3). These mix properties are typically assessed during normal quality control (QC) and quality assurance (QA) testing. When segregation is detected, additional testing can be done to evaluate if the mix properties in these areas meet the specification requirements.

Quality Control/Quality Assurance Testing

Density and Air Voids

In-place densities or the densities of cores can be used to determine if the mix properties exceed the specification limits. Air voids are calculated from test results used to calculate density and the maximum specific gravity determined during the mix design. Some states specify densities in their specifications, while others specify air voids or the percent of maximum density, which is another form of controlling air voids. One Texas study found that density profiles in visually detected segregated areas only failed to meet the speci-

fication criteria 17% of the time, whereas profiles in other segregated areas failed to meet the criteria 83% of the time (Tahmoressi et al. 1999).

Most of the research reported in the literature shows that at least a moderate or high level of segregation is required before the properties fail to meet the specification requirements (Wolff et al. 2000; Adams et al. 2001; Mahoney et al. 2003; Willoughby et al. 2003).

Roadway (In-Place) Density Testing Methods Roadway

Density testing is accomplished using either a nuclear density gauge or a non-nuclear device such as the Pavement Quality Indicator (PQI) (Figure 26). The nuclear density gauges are commonly used by both agencies and contractors for QC. A few agencies allow nuclear density gauge readings for acceptance in specific cases. Pavement surfaces with a coarse or open texture require the surface voids be filled with fine sand and leveled before determining the density with a nuclear density gauge. This is necessary because the small gap caused by the

TABLE 3
SUMMARY OF FIELD PROJECTS INVESTIGATING SEGREGATION

State	References	No. Sect.	Gradation Information*	Year Constructed	Detection Method	QC/QA Properties
Alabama	Cerdas (2012)	28	OGFC (1), SMA (3), WMA (3) 100% passing 25 mm (3) 100% passing 19 mm (9) 100% passing 12.5 mm (7) 100% passing 9.5 mm (2)	2010 to 2011	Temperature	Density Mix Properties
Alabama	Stroup-Gardiner and Brown (2000)	2	100% passing 25 mm (2)	1998	Visual	Density Mix Properties
Colorado	Gilbert (2005)	20	SMA (1) 100% passing 25 mm (11) 100% passing 19 mm (8)	2004 to 2005	Temperature	Density
Connecticut	Henault (1999) Henault et al. (2005)	11	100% passing 19 mm (11)	1999	Temperature	Density Mix Properties
Connecticut	Mahoney et al. (2003)	38	100% passing 25 mm (26) 100% passing 19 mm (12)	2001 to 2003	Temperature	Density Mix Properties
Florida	Sebesta et al. (2013)	1	100% passing 19 mm (1)	2010	Temperature GPR	Density Mix Properties (no gradations)
Georgia	Stroup-Gardiner and Brown (2000)	4	SMA (1) 100% passing 25 mm (1) 100% passing 19 mm (2)	1998	Visual	Temperature Density Texture Mix Properties
Maine	Sebesta et al. (2013)	1	WMA with 100% passing 19 mm (1)	2011	Temperature GPR	Density Mix Properties (no gradations)
Michigan	Wolff et al. (2000)	22	100% passing 19 mm (22)	1998	Visual	Density Mix Properties
Minnesota	Adams et al. (2001)	63	100% passing 12.5 mm (24) 100% passing 9.5 mm (39)	2000	Temperature	Density
Minnesota	Sebesta et al. (2013)	1	WMA with 100% passing 19 mm (1)	2010	Temperature GPR	Density Mix Properties
Minnesota	Stroup-Gardiner and Brown (2000)	2	100% passing 12.5 mm (2)	1998	Visual	Density Mix Properties
Nebraska	Bode (2012) Cho et al. (2010)	18	Information not available	2007 to 2009	Temperature	Density
Texas	Stroup-Gardiner and Brown (2000)	2	100% passing 37.5 mm (2)	1998	Visual	Density Mix Properties

(continued on next page)

TABLE 3
(continued)

State	References	No. Sect.	Gradation Information*	Year Constructed	Detection Method	QC/QA Properties
Texas	Sebesta and Scullion (2002)	4	100% passing 19 mm (4)	2001	Visual Temperature GPR	Density Mix Properties
Texas	Sebesta et al. (2013)	1	SMA (1)	2009	Temperature GPR	Density Mix Properties
Virginia	McGhee et al. (2003)	8	100% passing 37.5 mm (2) 100% passing 25 mm (2) 100% passing 19 mm (2) 100% passing 12.5 mm (2)	2002	Texture	Density Mix Properties
Washington	Stroup-Gardiner and Brown (2000)	2	100% passing 25 mm (2)	1998	Visual	Density Mix Properties

*Gradation information: each state uses different mix designations and mix design methods (e.g., Marshall, Superpave). In order to make comparisons between different state studies, the largest sieve size with 100% passing is used to characterize the gradations. SMA = stone matrix asphalt; WMA = warm mix asphalt; OGFC = open-graded friction course.

surface air voids results in lower densities being reported. Small air gaps resulting from debris on the bottom of the gauge can also lead to underestimated densities.

The PQI uses measurements of dielectric constant to estimate the pavement density (McGhee et al. 2003; Flintsch

et al. 2005). Each material has its own temperature-dependent dielectric constant. When dielectric constant measurements are used to estimate the pavement density, the gauge readings represent a combined dielectric value for all of the materials. (Note: This is the same material property measured with the GPR technology.)

ASTM D2950
Nuclear Density Gauge

Surface air voids or small gaps between the gauge bottom and surface result in lower density estimates.



Non-Nuclear Density Gauge
(Pavement Quality Indicator (PQI))



PQI uses measurements of dielectric constant to estimate density.

Because of the high dielectric value of water, any moisture in or on the pavement can significantly influence density readings.

FIGURE 26 In-place density testing devices [Source: (left) Dixon (n.d.) Troxler Electronic Laboratories (right) Pavementinteractive.org (<http://www.pavementinteractive.org>)].

General dielectric constant ranges for typical asphalt mix materials are:

- Aggregates, 2.5 to 5.0
- Asphalt (unmodified or modified), 2.5 to 3.2
- Air, 1
- Water, 80.4 @ 68°F, 55.3 @ 212°F.

The low dielectric value for air, compared with those for asphalt binder and aggregates, helps identify changes in density that are linked to changes in air voids. However, because of the very high dielectric constant of water and the sensitivity of the value to temperature, any moisture content in the mix has the potential for significantly influencing the gauge readings. Because the sources, types, and combinations of materials are unique for each property, it is important to determine the dielectric value in non-segregated areas of the pavement so that any significant changes in the proportions of aggregates and air voids can be detected.

- *If the rough texture in segregated areas is not sanded prior to determining the density with a nuclear gauge, the density readings can be underestimated.*
- *It is important that non-nuclear density gauges be calibrated relative to readings in non-segregated areas so that an accurate estimate of density can be obtained.*

Roadway Density Changes and Temperature Differences
Various approaches to evaluate density changes in segregated areas such as a single point measurement, two density measurements (one in a segregated area and one in an unsegregated area), or density profiles (longitudinal, transverse, or skewed) are shown in Table 4. When density profiles are used, density changes over the profile length are evaluated by a single criterion or set of criteria (Figure 27). For example, Washington and Minnesota adopted criteria developed by Kansas using ten density measurements collected for a 50-ft length. The criteria used were:

- Density range: The difference between the high- and low-density values. The range needs to be no more than 6.0 lb/ft³.
- Density drop: The difference between the average density for the profile minus the lowest density reading in the profile. The acceptable density drop is no more than 3.0 lb/ft³.

Minnesota and Washington studies reported that at least 80% of the density profiles met both density range and density drop criteria in areas with temperature differences of less than 25°F. No more than 49% of the profiles met both requirements when the temperature differences were more than

TABLE 4
EXAMPLE OF DENSITY CHANGES DUE TO TEMPERATURE DIFFERENCES

State	Density Requirements	Results
<i>T</i> < 25°F		
Washington (Willoughby et al. 2001)	Density (high)—Density (low) in profile ≤ 6.0 lb/ft ³	80.5% met both criteria
Minnesota (Adams et al. 2001)	Density (average)—Density (low) ≤ 3 lb/ft ³	93.1% met both criteria
<i>T</i> ≥ 25°F		
Washington (Willoughby et al. 2001)	Density (high)—Density (low) in profile ≤ 6.0 lb/ft ³	10.7% met both criteria
Minnesota (Adams et al. 2001)	Density (average)—Density (low) ≤ 3 lb/ft ³	48.6% met both criteria
Texas (Rand 2010)	Criteria applied at paver stops, when using non-automated temperature measurements, visually identified mix segregation	No statistics in reports
Connecticut (Mahoney et al. 2003)	3-ft intervals, starting 15 ft in front of cold area and ending 15 ft after cold area	Average decrease in density was 5.73 lb/ft ³
Connecticut (Henault et al. 2005)		No identifiable density differences due to temperature differences
Nebraska (Bode 2012)	Single point measurements	Temperature differences explains at least 59% of changes in densities

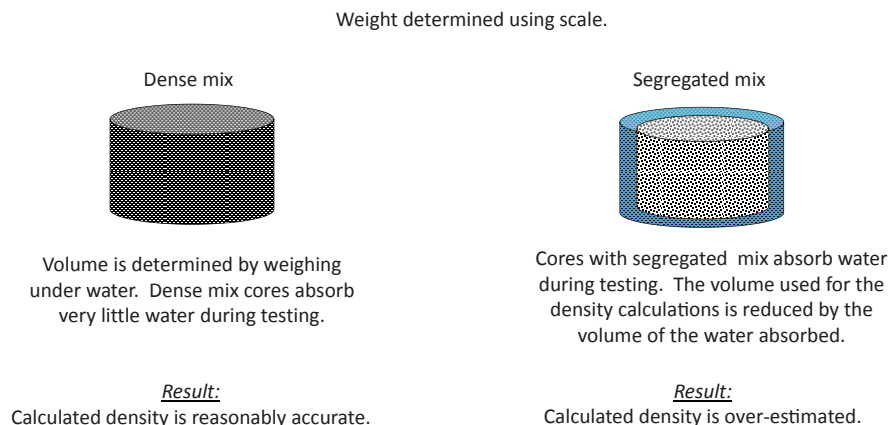

Successful laboratory density testing of segregated mix uses samples which are coated on the outside so water can't be absorbed.

FIGURE 27 Explanation of the impact of segregation on laboratory density measurements [Source: Stroup-Gardiner (2014)].

25°F. A Connecticut study reported mixed results for density changes in areas with colder temperatures and the Nebraska research found lower densities were likely when the temperature difference was more than 25°F.

- *Densities that do not meet the specification requirements are more likely to be found in areas with temperature differences of more than 25°F lower than the surrounding areas.*

Laboratory Density Testing When segregation is detected after the paving is completed, additional cores can be taken so that densities can be determined with laboratory test methods. When segregation is detected at some point before the mix is compacted, loose mix samples can be collected and compacted in the laboratory before testing. Laboratory density tests that may be specified by agencies include methods using:

- Saturated surface dry samples (uncoated; AASHTO T166)
- Hot paraffin wax-coated samples (AASHTO T275)
- Parafilm™ stretchable wax wrap coated samples (ASTM D1188)
- Samples vacuum sealed in a heavy duty plastic bag (AASHTO T331).

Samples prepared using typical dense mix that is not segregated absorbs only a minimal amount of water into the surface voids during density testing (AASHTO T166). Samples with segregated mix are likely to have large surface voids; interconnected air voids that allow water to be absorbed during testing (Figure 28). When this happens, the density is significantly overestimated and the severity of the segregation is significantly underestimated.

- *Potentially segregated mix samples are to be coated prior to laboratory density testing to prevent significantly overestimating the density and underestimating the severity of the segregation.*

Aggregate Gradations and Asphalt Content Testing

Cores or loose mix samples of segregated mix during construction are used to determine if gradations and asphalt contents are within the specification limits. Aggregates and asphalt are separated using either solvent extraction methods or with an ignition oven. Solvent extraction methods have a longer history. The asphalt is extracted from the mix using one of several approved solvents. The mix and recovered aggregate are measured before and after soaking to determine the asphalt content. When cores are tested, the cut faces on the edges of the core are to be removed before testing so that the after-extraction gradations are not skewed by the percent of cut aggregates.

The ignition oven method burns the asphalt off of the mix sample and the difference in the weight before and after burning is recorded as the asphalt content. However, some aggregates also have individual components that can burn off along with the asphalt and calibration information is needed for the specific aggregates used on the project. Gradations determined after burning may also be influenced by the high heat as some aggregates fracture at the higher temperatures. If there is any water trapped in the internal aggregate voids, the water turns to steam as the oven temperature increases and fractures the aggregate. These artificial aggregate size reductions may mask the extent of coarse aggregate segregation.

- *When the testing is done to determine changes in gradations resulting from segregation, the selection of the*

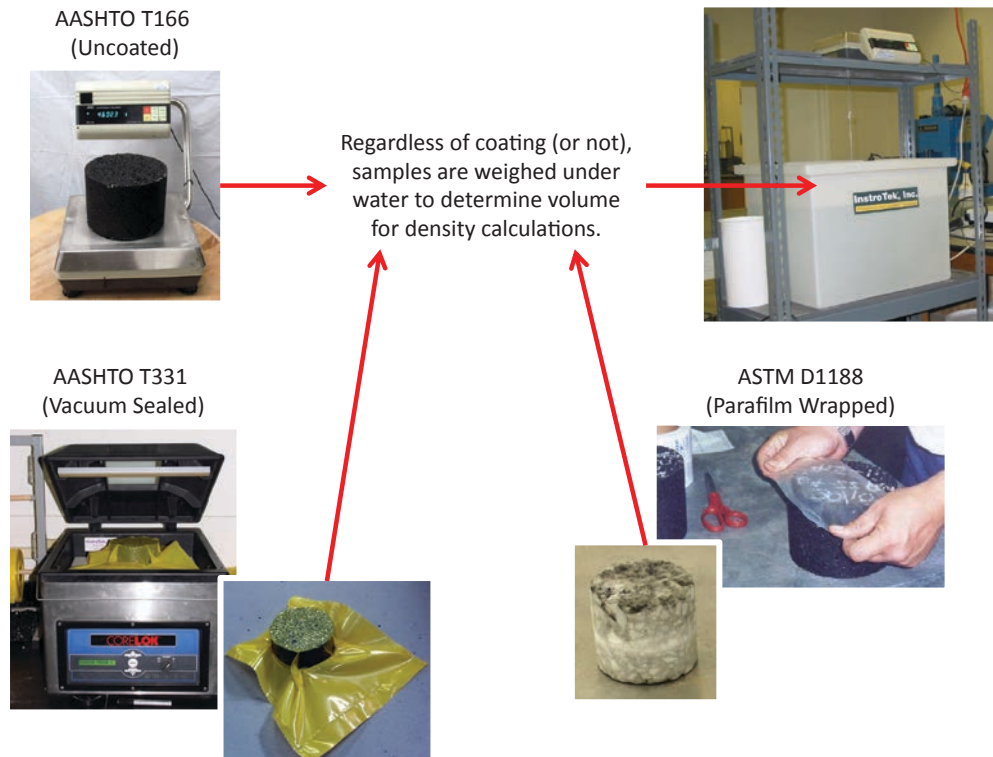

FIGURE 28 Example of methods for coating samples for density testing [Source: Stroup-Gardiner (2014)].

test method and/or test equipment may unintentionally underestimate gradation changes.

- *Laboratory methods for separating the aggregates and asphalt for cores or loose mix can mask the extent of coarse aggregate segregation. It is important to understand the limitations of gradation and asphalt content estimates once the components have been mixed together.*
- *It is important that agency field and laboratory staff understand the impact of test methods when testing segregated mixes. It is important that this information be included in any agency training programs.*

PERFORMANCE-RELATED TESTING

The literature review found various research studies that investigated the impact of segregation on performance-based mix properties such as permeability, rutting, fatigue, tensile strength, and mix stiffness. The findings from these studies are summarized by each material property.

- Permeability
 - Increases quickly when air voids are greater than 8% (Williams et al. 1996).
 - Predictive equation showed a 300% increase in permeability with every 1% increase in air voids (Willoughby et al. 2001).

- Rutting Potential
 - Severely segregated mix resulted in increases of rut depths from 69% to more than 100% (Williams et al. 1996).
 - Rut depths increased because of the increase in air voids owing to segregation (Brock and Jakob 1999).
- Fatigue Life
 - Fatigue life decreases substantially with increasing segregation. Moderate levels of segregation can reduce the fatigue life from 20% to 40% and severe segregation can reduce fatigue life from about 80% to 95% (Williams et al. 1996; Brock and Jakob 1999).
- Tensile Strength
 - Tensile strength can be reduced by 20% to 70% when the mix is moderately to severely segregated (Stroup-Gardiner and Brown 2000).
 - Decreases in tensile strength are a function of increases in air voids in segregated mix (Sebesta et al. 2013).
- Mix Stiffness
 - Resilient or dynamic modulus can be reduced by 30% to 50% when the mix is moderately to severely segregated (Stroup-Gardiner and Brown 2000).
 - *Research studies show that moderate to high levels of segregation significantly increase permeability, increase rut depths, decrease fatigue life, and decrease tensile strengths.*

HOW AND WHERE MIX SEGREGATES

Segregation can start as early in the paving process as aggregate production and can continue through the asphalt mix design phase, mix production, and paving operations (AASHTO Joint Task Force 1997; Cleaver 2012). The following sections identify equipment and practices that can reduce segregation at each step of the design and production of asphalt mix.

Aggregate Production

Aggregate particle sizes can be separated (segregated) by:

- Stockpile construction methods,
- Conveyor systems, and/or
- Loader operators.

Large stockpiles with a range of particle sizes usually have coarser aggregates that roll down the sides of the stockpile and collect around the lower edges (Figure 29). When it is necessary to form conical stockpiles, it is effective to use short drop distances (close enough so aggregates do not roll), limited ranges of particle sizes in each stockpile, and adequate separation between the stockpiles to avoid cross-contamination (Figure 30). Sufficient space between stockpiles is desirable but sometimes difficult to achieve because of space limitations, especially in urban environments.

Telescoping and/or radial conveyors (Figure 31) that drop the aggregate onto the top of the stockpile from a short distance help maintain uniformity in the aggregate gradation



FIGURE 29 Stockpiles separated to avoid overlap of materials [Source: Scherocman (2011)].



FIGURE 30 Course aggregates collect around the outside bottom edges of the stockpile [Source: Warren (2012)].

(Quality in California 2011). Layered stockpiles can be constructed with radial stackers that minimize the segregation-prone cone shape. Larger maximum size aggregate gradations benefit the most from the use of radial stackers (Cleaver 2012; Zettler 2012).

Aggregate conveyors are sometimes called slingers because they “throw” the material off the end of the belt. Vulcan Materials developed a laboratory demonstration to show how conveyors distribute different particle sizes in the stockpile. Because larger particles weigh more per particle (i.e., contain more mass), they will be “flung” the furthest and the smallest particles with the least mass per particle will tend to just drop off the end of the belt. The colors of the particles are uniformly and randomly distributed on the moving conveyor (Figure 32). Once the particles reach the end of the conveyor, the smaller white particles are concentrated at the edge nearest the conveyor and mostly covered by the larger green particles rolling down from the top of the pile. The orange particles are the

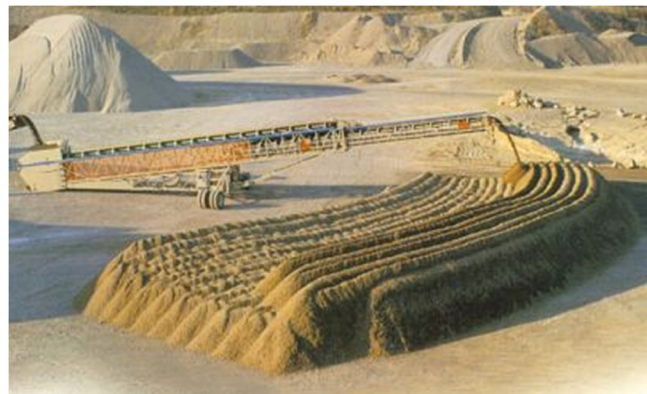

FIGURE 31 Telescoping, radial stacker used to build large scale stockpiles [Source: Sam Johnson, Vulcan Materials (n.d.)].

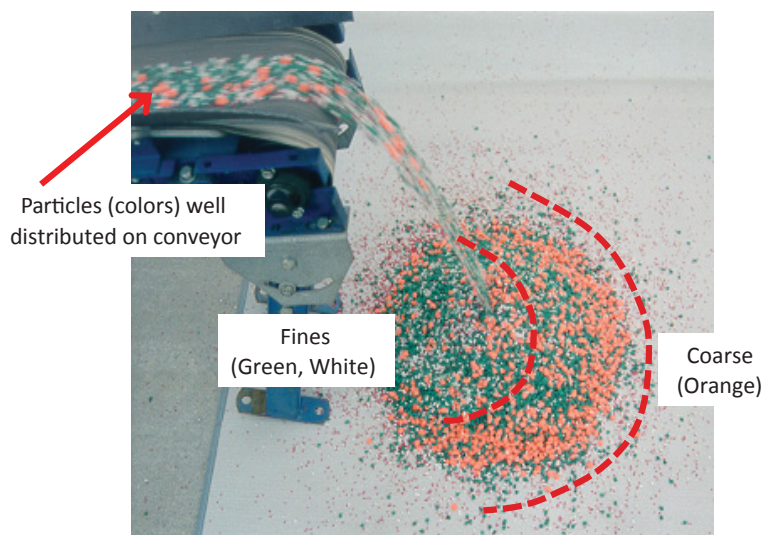

FIGURE 32 Demonstration of how different aggregate sizes are “slung” off conveyor [Source: Sam Johnson, Vulcan Materials (n.d.)].

largest and are thrown around the outer circumference of the pile.

Loader operators can help minimize aggregate segregation by blending the fine and coarse areas of the stockpile. Random segregation can be avoided by reworking the stockpile to rebundle the coarser aggregate at the bottom with the rest of the aggregate or by filling the loader bucket with non-segregated aggregate in the pile (Scherocman 2011). When stockpiles are built with dozer operations, movement of the equipment over the layers should be minimized so that the heavy equipment does not crush (degrade) the aggregate. This is especially important when working with light weight aggregates that are easier to crush.

- *Segregation is reduced when aggregate stockpiles are produced with narrow ranges of particle sizes, short drop distances, and skilled loader operators.*

Mix Designs

The segregation potential of mixes can be minimized during the design phase by the appropriate selection of the (AASHTO 1997; Brock et al. 1998):

- Aggregate gradation,
- Maximum aggregate size,
- Asphalt content (asphalt film thickness), and
- Recycled materials that contribute asphalt content.

The literature review found two potential test methods and one European standard for estimating the segregation potential of mixes during the mix design phase.

Aggregate Gradations

Aggregate gradations are to be evaluated for segregation potential using all of the Superpave sieve sizes for the gradation analysis. Gradations with the least segregation potential have percentages of aggregates about evenly distributed on each of the sieves (i.e., typical well-graded dense mixes). Gradations with low or no percentages of aggregates on one or more of the standard Superpave sieve sizes are more likely to segregate. Gap-graded or open-graded friction course gradations are much more prone to segregation during mixing, truck load out, transportation, or paving processes (Brock et al. 1998; Quality in California 2011; VDOT 2012). The Bailey method for aggregate gradation design can be a useful tool for predicting how changes in the gradation influence aggregate structure (i.e., packing). A well-packed gradation reduces the segregation potential (Marais and Pretorius 2007).

- *Segregation potential can be reduced by avoiding gaps in the aggregate gradation. If gapped gradations are used, more attention is required during construction to control segregation.*
 - *Using the full range of Superpave sieve sizes when constructing the gradation curves can help identify any gaps in the gradation.*

Maximum Aggregate Size

The segregation potential of the mix increases with the maximum size aggregate of the gradation (Brock et al. 1998; VDOT 2012). Larger aggregates are more likely to:

- Get “thrown” farther than smaller particles by conveyor systems.

- Roll to the outer edges of the mix in the silos and the edges of the mix in the haul truck bed.
- Drop off of the paver hopper conveyors and be deposited under the paver gear box.
- Move to the outer edges of the screed augers.

Typical dense-graded mixes with a maximum aggregate size of 25 mm are more segregation-prone than 12.5-mm mixes (Mahoney et al. 2003; Buncher and Rosenberg 2012). Wise (2007) recommends that the ratio between the maximum aggregate size and lift thickness be less than 1:2 to help with the compactability of the mix and decrease the potential for mix segregation. Others recommend ratios of 1:3 or 1:4 to help with compaction (USCOE 2001).

- Segregation can be reduced by using mixes with maximum aggregate sizes of 12.5 mm or less.
- Segregation potential increases with the maximum aggregate size.

Asphalt Content (Asphalt Film Thickness)

Asphalt content was identified by the AASHTO Joint Task Force (1997) as the single most important mix design criterion for segregation potential. Adequate asphalt content is necessary to provide a sufficient film thickness to hold the range of aggregate particles together and provide workability of the mix (Advanced Asphalt Technologies 2011). Low film thicknesses result in mixtures that segregate more easily and are more difficult to place. A small increase of 0.2% in the asphalt content can help reduce segregation in gapped gradations (Brock et al. 1998). The potential for segregation can be reduced by *avoiding the following*:

- Fluctuations in the aggregate gradations in general and dust in particular:
 - Decreasing the finer particles decreases the aggregate surface area that needs to be, or can be, coated.

- Aggregates with high moisture capacities:
 - Any retained moisture makes it difficult to uniformly coat the aggregates. Absorptive aggregates tend to hold moisture that may not be adequately removed during mixing.
 - Absorptive aggregates also absorb more asphalt binder that can reduce the film thickness over extended hot storage times (i.e., time in silo).
- Segregation potential is reduced when there is sufficient asphalt film thickness to hold the different aggregate sizes together.

Recycled Materials

More additives and recycled materials are added to today's mixes so that there is greater potential for additional forms of material segregation. Individual materials are to be added at the correct time and point in the mixing process so that they are fully blended with all of the other materials. Flexibility in the point-of-introduction is important so that different materials can be added for optimum distribution throughout the mix and long mixing zones provide adequate mixing time (Clever 2012).

Proper handling, preparation, and sampling of asphalt-containing recycled stockpiles is particularly important because of the potential for wide ranges of material properties in recycled materials (Figure 33). When recycled asphalt pavement (RAP) is separated into coarse and fine fractions, the asphalt content of the coarse fraction can be the most variable (Valdes et al. 2011). It is likely this will be a more significant factor in mix uniformity as agencies increase the allowable percentages of recycled materials in asphalt mixes.

Correct sampling procedures of RAP and recycled asphalt shingles (RAS) stockpiles are especially important because



FIGURE 33 Several steps may be needed to process recycled material so a uniform, consistent size is obtained [Source: National Asphalt Pavement Association (n.d.)].

improper sampling can lead to incorrectly calculating the asphalt content in the RAP (Advanced Asphalt Technologies 2011). Variability in the asphalt content of the recycled materials leads to variability in the asphalt content and asphalt film thickness. This makes it difficult to control the segregation potential of the mix.

- Segregation potential can be reduced with a sufficient and consistent asphalt film thickness.
 - Uniform preparation and proper sampling of recycled material stockpiles is required to ensure that all of the individual components are uniformly distributed throughout the mix.
 - Any component added to the mix that increases the variability in asphalt content has the potential for producing mixes that may vary between over- or under-asphalted mixes (i.e., variability in film thickness), which makes it difficult to control segregation.
 - Variability in gradations has the potential for creating more of a gap gradation that can be more prone to mix segregation.

Determining Segregation Potential During Mix Designs

Three methods for estimating the segregation potential during mix design were found in the literature (Murphy 2012a, b; Feng et al. 2013). All of the methods evaluate how hot, freshly blended asphalt mix segregates as it is dropped from a given height (Figures 34 and 35). A sample report of results from an asphalt mix known to segregate showed a significant change in the 4.75-mm (No. 4) sieve, asphalt content, and air voids (Table 5).

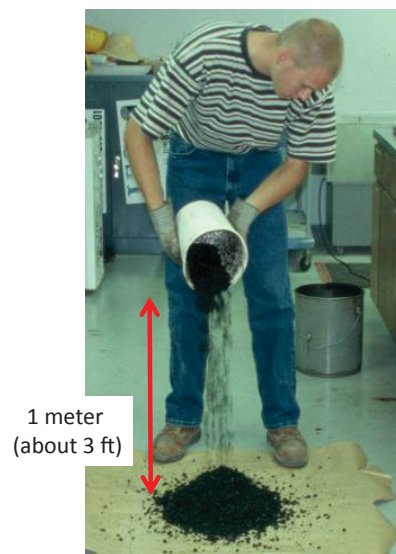

Material inside the bucket diameter is tested and compared to the results for the material outside of the bucket diameter

FIGURE 34 Laboratory test for estimating segregation potential [Source: Murphy (2012a)].

The European Standard BS EN 12697-15 2003 Hot Mix Asphalt—Segregation Sensitivity describes a test method that can be used during mix design, which is similar to the two concepts described previously.

- It may be possible to estimate the segregation potential of a mix during the design phase of a project.

Asphalt Plants

Cold Feed Bins

Cold feed bins are a source of aggregate segregation in both batch and drum mix plants. The skill of the loader operator is a major factor in minimizing any potential segregation (Brock et al. 1998; Scherocman 2011; Cleaver 2012). The loader operator is responsible for:

- Keeping the cold feed bins as full as possible. Bins that are allowed to get too low form a reverse cone, which allows the coarser particles to roll down the slope and onto the cold feed belt (Figure 36).
- Avoiding scooping the material under the stockpile along with a load from the stockpile to avoid contamination.
- Carefully reblending any coarser particles around the lower portions of the stockpiles with upper portions. Keep reworking of the stockpile to a minimum to prevent degradation of the particles.
- Filling the loader bucket with non-segregated aggregate taken from several feet above the ground level.

Each cold feed bin is loaded from a single stockpile; that is, when an asphalt plant only has three cold feed bins, the

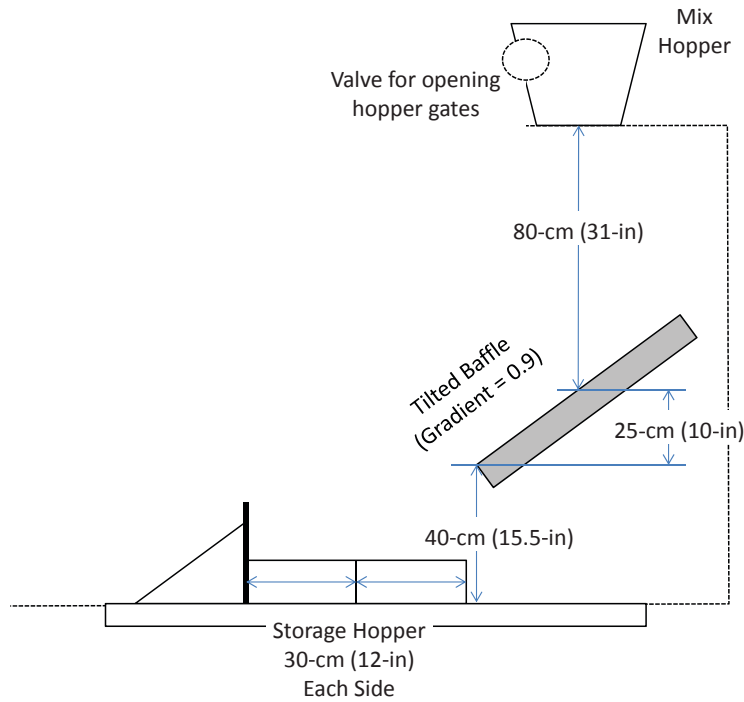

FIGURE 35 Feng's concept for a laboratory test for evaluating the segregation potential of asphalt mixes [Source: Feng et al. (2013)].

TABLE 5
EXAMPLE OF RESULTS FOR A LABORATORY TEST TO ESTIMATE THE
POTENTIAL OF A GIVEN MIX TO SEGREGATE

Property	Mix Inside Bucket Diameter	Mix Outside Bucket Diameter	Difference
12.5 mm (½ in.)	100% passing	100% passing	0%
4.75 mm (No. 4)	59%	45%	14% (coarser)
Asphalt Content	5.8%	5.5%	0.3% (lower)
Air Voids (Marshall Compaction)	3.6%	5.2%	1.6% (higher)

Source: Murphy (2012a).



FIGURE 36 Reverse “cone” formed in center of cold feed bin which has been run too low [Source: Stroup-Gardiner (2014)].

plant only needs to keep three stockpiles on site. The limited number of stockpiles implies that there is a wider range of particle sizes in each stockpile, which makes it easier for the coarse and fine aggregates to segregate. Asphalt plants with a larger number of cold feed bins allows for better control of segregation in the stockpiles.

- Segregation can be reduced by increasing the number of cold feed bins used to produce the mix.
- Well-trained and skilled loader operators responsible for loading the cold feed bins are important for reducing segregation at the beginning of mix production.

Batch Plants

Segregation occurs most frequently in a batch plant in the hot aggregate bins (Figure 37). Segregation is generated when the aggregate is loaded from the screens into the #1 bin, which receives the fine aggregate fraction (4.75-mm to 0.075-mm sizes) (AASHTO 1997; Brock et al. 1998; Figure 38). The dust tends to collect on the sloping bin wall nearest the aggregate feed drop, while the larger particles end up collecting on the opposite side. The fines pack together then drop all at once when the bin is almost empty. This produces mix with a high percentage of fines that are typically uncoated. The buildup of fines can be minimized by vibrating the side of the bin to keep the fines from accumulating in one spot.

- The No. 1 hot aggregate bin in a batch plant is the source of most segregation because of the buildup of dust or coarse aggregates on opposite sides of the bin.
- Segregation can be reduced by vibrating the sides of the bin to prevent buildup.

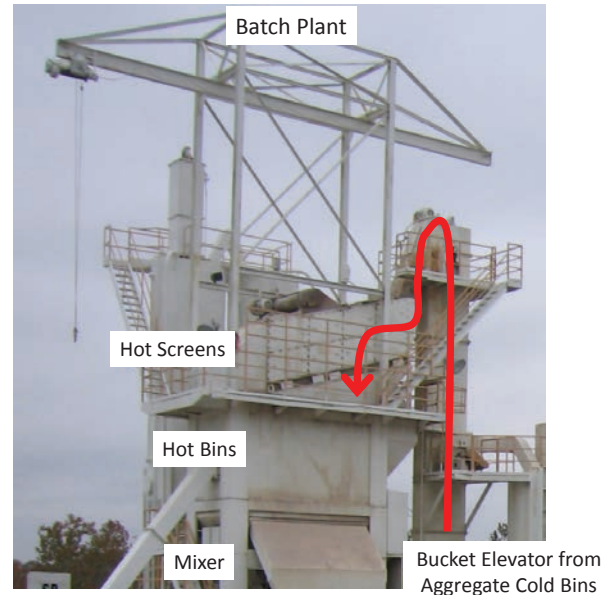
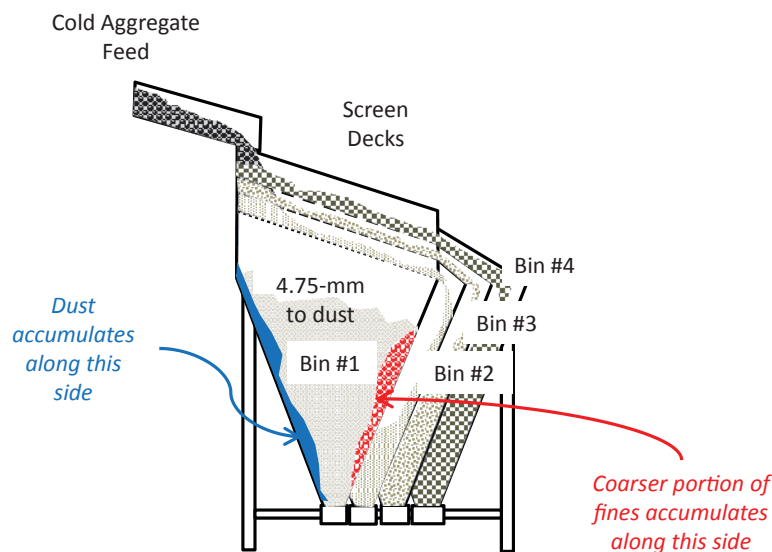

FIGURE 37 Components of a batch plant [Source: Stroup-Gardiner (2014)].

Drum Plants

Segregation can be generated at six locations during mix production (Figure 39):

1. Drum
2. Exit from the drum
3. Drag slat conveyor
4. Bin charging batcher
5. Silos
6. Load out.



Aggregate segregation happens when the build-up of either dust or coarse aggregate gets too large and drops all at once into the mixer

FIGURE 38 Schematic of aggregate bins in a batch plant [Source: Brock et al. (2003); Stroup-Gardiner after Murphy (2012a)].

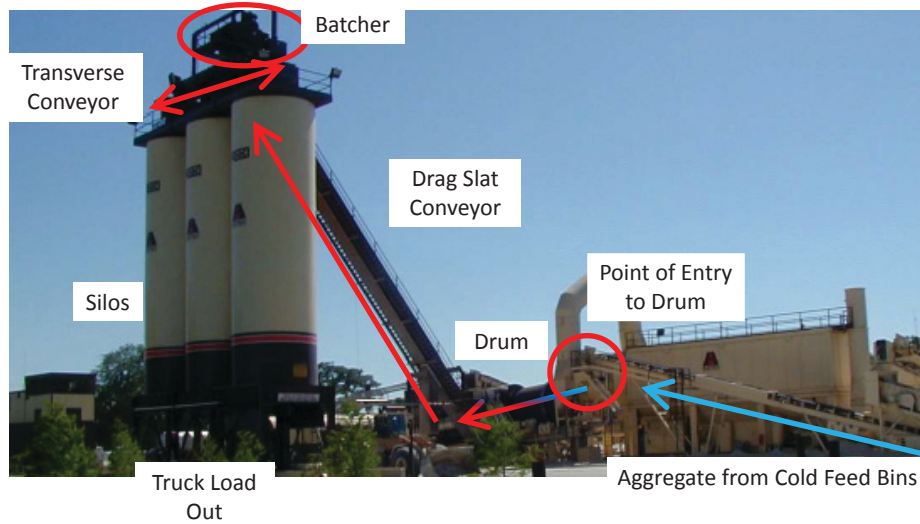

FIGURE 39 Locations in a drum mix plant where segregation can occur [Source: Stroup-Gardiner (2014)].

A more recent concern for mix segregation is in how and where materials other than aggregates and asphalt are added into the mix. RAP has been used in mix for years; however, the recent trend is to increase the amount allowed in the mix as well as comingling RAP with RAS. New additives and processes for producing warm mix asphalt may also influence the segregation potential of the mix. In some cases, new additives may reduce segregation, or in others, increase segregation. No research was found in the literature that evaluated these factors in segregation.

Drum Configurations An inadequate asphalt film thickness can increase the segregation potential of the mix. Insufficient or non-uniform asphalt film thicknesses can be the result of

short mixing times or damp aggregates. Of the two general types of drum mix plants, parallel flow and counter flow (Figure 40), the parallel flow has less time for the aggregates to dry and blend in the drum before the asphalt is introduced. Counter flow drum mix plants are better at mixing the aggregate gradation in the aggregate drying portion of the drum length.

Mixing and drying times can be increased by installing kick-back flights or dams inside the drum and/or decreasing the drum slope to slow the movement of the mix through the drum. However, decreasing the slope can decrease the production rate if the drum drive motor is too small. The preferred options for minimizing segregation during mix production are options that do not impact the production rates.

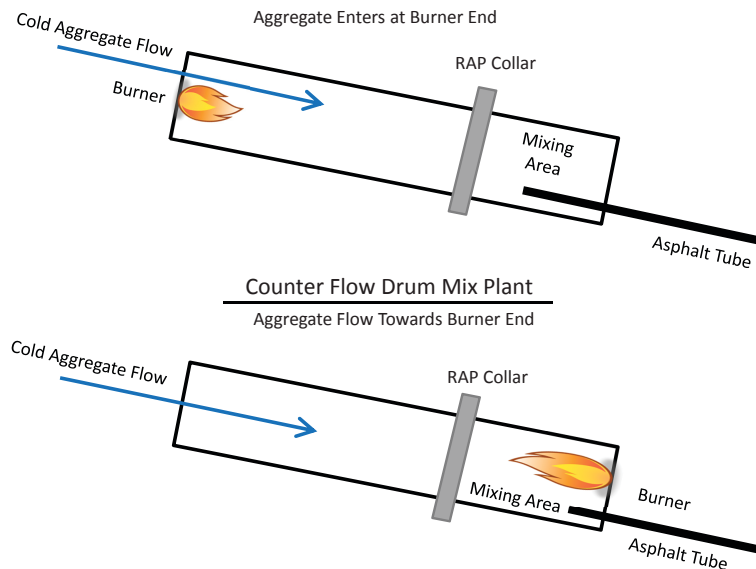

FIGURE 40 Schematics of parallel flow and counter flow drums [Source: Stroup-Gardiner after Brock et al. (2003)].

The uniformity of the film thickness also is improved by limiting the amount of the dust (0.075 mm) material to the lower specification limit. This reduces the aggregate surface area, which is to be coated during mixing.

- *Segregation is reduced by:*
 - *Kick-back flights or dams inside of the drum to help increase the aggregate drying time, which helps promote uniform asphalt coating.*
 - *Decreasing the amount of fines to the lower specification limit to help improve the uniformity of the film thickness by reducing the aggregate surface that is to be covered with asphalt.*

Point of Discharge Segregation can occur in the drum and result as segregated mix if the configuration or features of the point of discharge fail to help reblend the mix (AASHTO 1997; Brock et al. 1998). Coarser aggregates discharge to one side, while the finer aggregates collect on the opposite side at the end of the drum. Segregation can be minimized by:

- Setting the drag slat conveyor at 90° to the end of the drum (Figure 41).
- Restricting the mix as it leaves the drum so the mix is forced into the center of the conveyor (Figure 42).
 - *Segregation can be reduced as the mix exits the drum by orienting the drag slat conveyor at 90° to the drum exit or restricting the mix as it exits the drum onto the drag slat.*

Drag Slat Conveyor Segregation can happen on the drag slat conveyor when there is too much or too little mix on the conveyor. When there is an excess of mix, coarser particles

roll backward over the top of the slat and down to the next conveyor section (hydroplaning; Brock et al. 1998). Too little mix allows coarser particles to roll to the outsides of each conveyor section. Keeping the drag conveyor full, but not overly full, helps reduce segregation at this point in the process.

- *Segregation can be reduced by keeping the drag conveyor full, but not overly full.*

Bin Loading Batcher

Segregation at the asphalt plant is a function of the surge and storage bin characteristics (Astec 2010; Scherocman 2011). A bin loading batcher, also referred to as a gob hopper, is one of the most common choices for eliminating segregation in the silos. The batcher, which typically holds about three tons of mix, collects a batch of mix from the drag slat conveyor at the top of the silo and drops it as a single large mass into the silo. The impact of the mix landing in the silo distributes the mix uniformly over the surface of the mix in the silo.

Like all construction equipment, the bin loading batcher needs to be operated properly or it will promote rather than reduce segregation. Segregation can occur when the loading chute to the batcher is not positioned over the center of the silo, the batcher is not completely emptied, or the batcher gates are too slow in opening and closing. It is important that the chute be positioned in the center of the batcher; otherwise, the coarser particles will roll to the lower, outer edges of the mix (Figure 43). Insufficient emptying of the batcher lets coarser particles build up along the outside edges over time (Brock et al. 1998). The batcher gates are to be opened

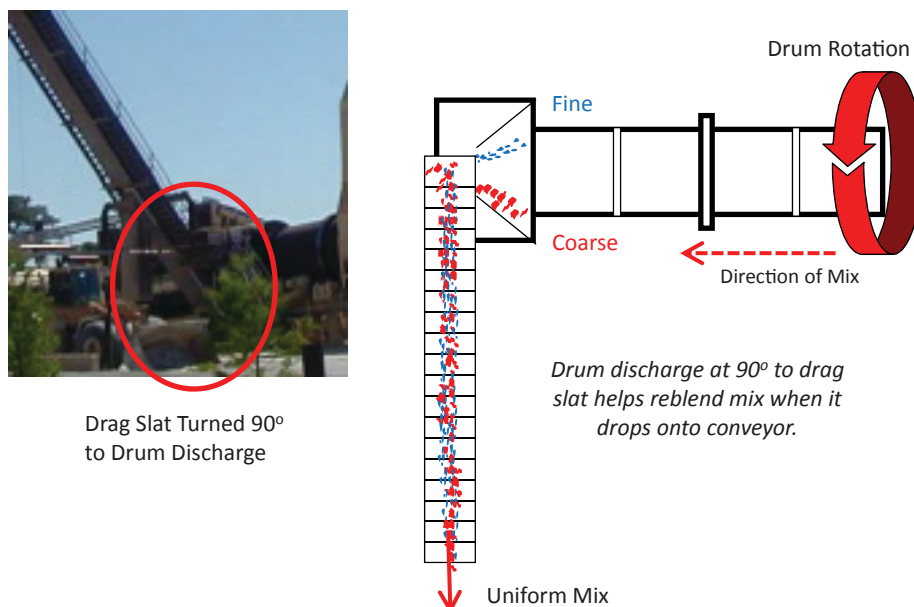

FIGURE 41 Locating the drag slat conveyor at 90° to the drum discharge helps reduce segregation [Source: Stroup-Gardiner after Murphy (2012a)].

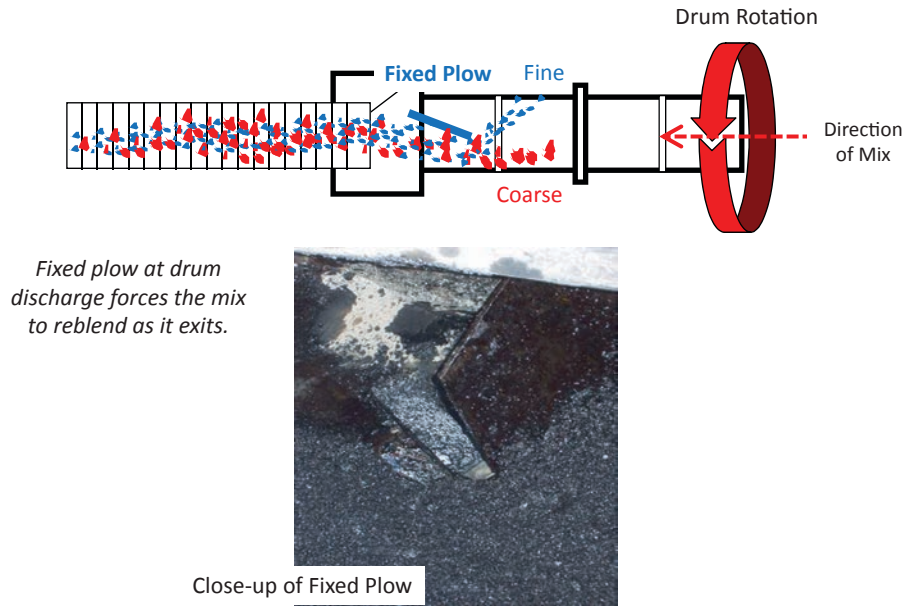

FIGURE 42 Fixed plow at the discharge helps reduce mix segregation [Source: Stroup-Gardiner after Murphy (2012a)].

quickly so the mix is dropped into the silo in a single mass. It is also important that the gates be closed quickly so the mix does not slowly dribble into the silo.

Newer storage bins equipped with batchers and steeper-sided cone-shaped bottoms can be completely emptied with little or no segregating of asphalt mixes.

- *Batchers reduce segregation when the chute is centered over the batcher, filled before dropping the mix, and the mix is dropped into the silo all at once.*

Silos

Segregation can be reduced by keeping an optimum amount of mix in the silo and by proper operation of the gates at the bottom of the silo (Figure 44). When the level of the mix is too low, any coarser particles at the outer edges collect at the bottom of the silo and are dropped all together into the next truck load. When the silo is too full there is not a sufficient drop height to flatten out the mix and a cone of mix is formed at the top of the silo that allows the coarser particles to roll down the outer edges of the silo.

Proper centering of chute over center of batcher
Minimizes Segregation

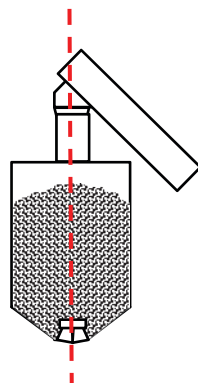

Chute not properly aligned over center of silo
Causes Segregation

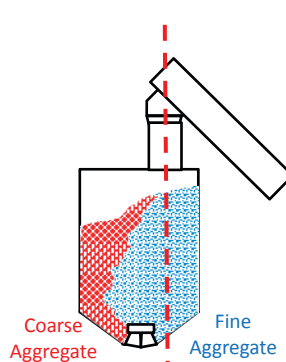

FIGURE 43 Proper use of bin charging batcher over silo [Source: Stroup-Gardiner after Murphy (2012a)].

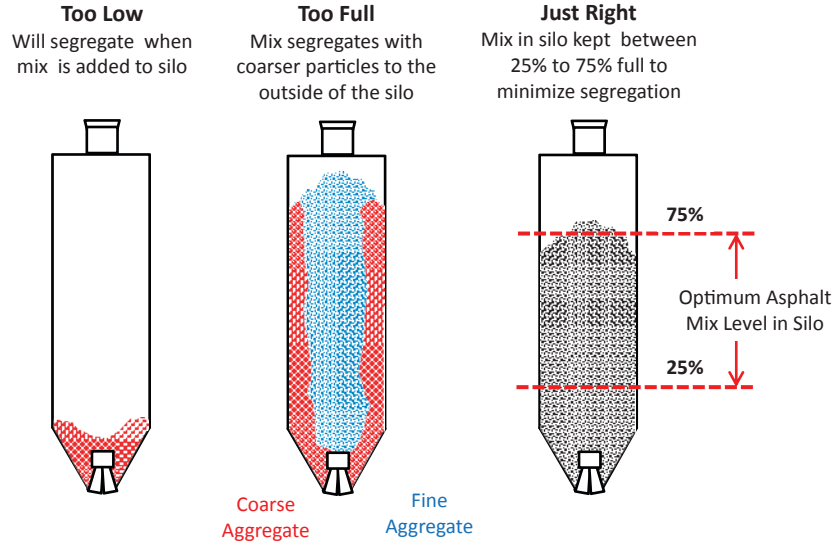

FIGURE 44 Schematic of storage silos with different volumes of mix [Source: Brock et al. (2003); Stroup-Gardiner after Murphy (2012a)].

- Segregation is reduced when:
 - The level of mix in the silo is kept between 25% and 75% full.
 - Silo gates are quickly opened and closed when loading the haul trucks.

end dump haul trucks (up to 35 cubic yards), belly dumps (18 to 20 cubic yards), and live bottom trucks (31 to 50 cubic yards) also will be loaded using multiple individual drops (Figure 46). It is important that continual loading of the truck while it slowly moves forward be avoided.

Load Out

Segregation occurs when the haul truck is loaded with a large single drop of mix, because this allows the coarser particles to roll to the outside edges of the truck bed (AASHTO 1997; Brock et al. 1998; Cleaver 2012). Proper loading of a 10 to 12 cubic yard capacity end dump haul truck can be accomplished in three drops (Figure 45), with the front third of the truck loaded first, the back loaded second, and the last drop into the center (AASHTO 1997; Scherocman 2011). Larger

- Load Out:
 - Segregation is reduced when haul trucks are loaded in multiple drops.
 - Avoid loading with a large single drop or continuously as the truck moves forward.

Mix Transfer from Haul Truck to Paver

Transferring the mix from the haul truck to the paver hopper can be a significant source of segregation. The type of trucks

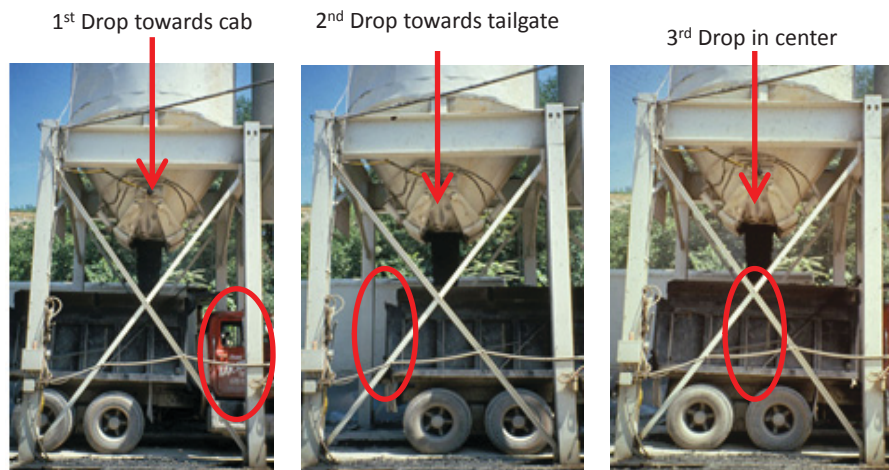

FIGURE 45 Loading with multiple drops [Source: Scherocman (2011)].



FIGURE 46 Loading large haul trucks with multiple drops [Source: Warren (2012)].

used to haul the mix determines how the mix is transferred to the paver.

End Dump Truck Mix Transfer

Segregation can be reduced when the end dump haul truck bed is raised before opening the back gate. When the gate is finally opened, the mix is discharged from the truck bed in mass into the paver hopper (FHWA 2002; Brock et al. 1998). This process rapidly fills the paver hopper and prevents the coarser particles from collecting in the paver wings.

The haul truck should not “bump” the paver as it gets ready to transfer the mix, but rather wait for the paver to make contact. The paver is equipped to push the truck forward so the transfer from the truck to the hopper is smooth and continuous (Figure 47).

Any segregation in the haul truck can be minimized by reblending the mix as it exits the bed. The end dump bed can be fitted with baffles that form a funnel at the back (Figure 48). This funnel forces any potentially segregated mix along the outside of the truck bed to reblend with the mix in the center when the mix is transferred into the paver hopper. A baffle around the hydraulic lift at the front of the bed (not pictured) can also help keep the mix from segregating as it flows around lift box.

Spills can happen when the mix is dribbled out of the end dump gate either at the start of transferring the load or when “shaking” the last of the mix out of the truck bed (Figure 49). Spills can also happen when the hopper wings are raised (i.e., flipped), and if not removed a segregated area of mix and bumps in the pavement surface can be produced (Scherocman 2011).



FIGURE 47 Transferring asphalt mix to the paver hopper [Source: Stroup-Gardiner (2014)].

- *Segregation is reduced when the*
 - *Truck bed is lifted before opening the gate so the mix is rapidly transferred to the paver hopper.*
 - *Baffles that form a funnel at the back of the truck bed are added to the back of the truck bed to help reblend the mix as it exits.*
 - *Any spills are cleaned up.*

Belly Dump Truck Mix Transfer by Windrow

Belly dump haul trucks deposit mix onto the roadway from the bottom of the truck bed and a pick-up unit (i.e., windrow elevator) is used to move the mix in the windrow into the paver hopper (Figure 50). The simplest pick-up devices use a rotating drum with paddles to push the mix onto a conveyor



Baffles which create a funnel at the tailgate helps reblend mix as it exits.

FIGURE 48 End dump bed fitted with a funnel at the back to help reblend asphalt mix [Source: Murphy (2012a); Stroup-Gardiner (2014)].



If left, spills create a bump in lane and leave mix to get cold. Cold mix can result in low densities.

FIGURE 49 Temperature segregation can result from mix spilled in front of the paver and not cleaned up [Source: Stroup-Gardiner (2014)].

that deposits the mix into the paver hopper (Figure 51). Other designs include an auger on either side of the rotating paddles to help reblend the mix and move it toward the paddles (Gilbert 2005).

As with all construction processes, when effective construction practices are not followed, a segregated mix placed in a windrow is likely to remain segregated when placed in the paver hopper (Figure 52). The segregated mix visible in the windrow likely occurred at the asphalt plant somewhere between the mixer discharge point and loading of the haul truck. The amount of mix in the windrow needs to be sufficient to keep the paver hopper full and the paver moving. The consistency of the mix in the windrow also is to be homogeneous; clumps and areas of cold mix are to be avoided (Figure 53).

- *Segregation in the windrow can be reduced when the windrow elevator (pick-up unit) helps reblend the mix.*

- *Mix in the windrow is fairly uniform.*
 - *Avoid mix that is obviously segregated, contains clumps of mix, or is “dribbled” out of the haul truck.*
- *Sufficient mix is necessary in the windrow to keep a constant supply of mix to the screed augers.*
- *The effectiveness of paddles only and augers with paddles for reducing segregation could be explored in future studies.*

Live Bottom Truck Transfer

Segregation can be reduced by the funnel-shaped inside of a live bottom haul truck. The mix slides down the sides and a conveyor at the bottom of the truck bed moves the mix horizontally out the back (Figure 54). Live bottom trucks can deposit the mix directly into the paver hopper or can place the mix in a windrow.



Belly dumps drop mix when the gates at the bottom of the truck bed deposit mix into a windrow on the exiting surface

FIGURE 50 Windrow formed as belly dump deposits mix [Source: Pavementinteractive.org (<http://www.pavementinteractive.org>)].



Pick-up devices may have only paddles to move the mix onto the internal conveyor or have a combination of augers and paddles.

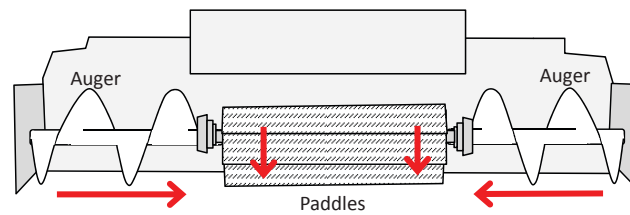

Augers move mix from the outside of the windrow towards the paddles. The paddles rotate downward and push the mix onto the internal conveyor which deposits the mix into the paver hopper.

FIGURE 51 How windrow elevators (pick-up devices) work [Source: Stroup-Gardiner (2014)].



Coarse aggregate segregation deposited in the windrow shows up in paver hopper.

Windrow elevators can't completely reblend segregated mix.

FIGURE 52 Segregated mix in the windrow can still remain segregated when it gets to the paver hopper [Source: Stroup-Gardiner (2014)].

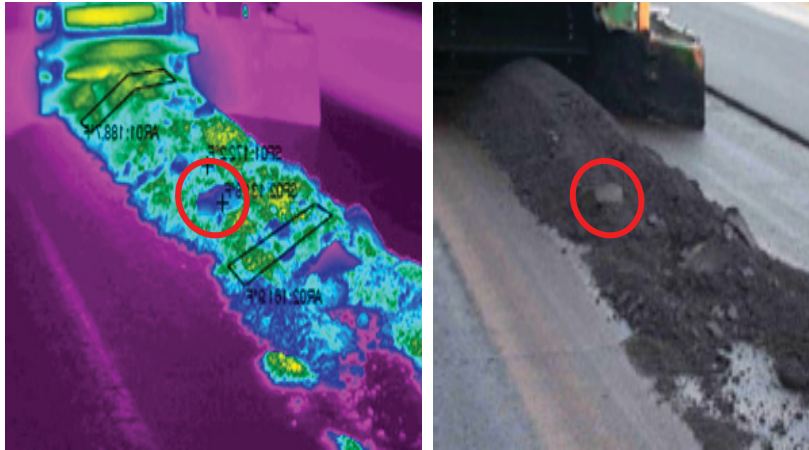

Mix “dribbled” out of haul truck and mix clumps are visible in the windrow (circled areas). Infrared image shows areas of cold mix. All of these non-uniformities will result in variations in density and ride quality of the finished mat.

FIGURE 53 Only a limited amount of mix is in the windrow; cold mix and clumps of material can be seen [Source: Adams (2001)].

- Live bottom truck bed designs help reduce segregation. The funnel-shaped sides help reblend the mix as it is pulled down and moved out the back of the bed.

Material Transfer Vehicles and Devices

Material transfer units reduce segregation by reblending mix from the haul trucks before it is transferred to the paver. Another benefit is the ability to hold larger quantities of mix,

which helps minimize paver stoppages and keeps the screed augers adequately supplied with mix (i.e., prevents “starving” the augers). The two general types of material transfer units are MTV and material transfer devices (MTD), although the terms are frequently interchanged. An MTV is a self-powered unit that is designed to receive mix from more than one haul truck. Mix is transferred from the haul truck into a surge bin with remixing augers at the bottom. As the mix is reblended, it is transferred to a surge bin that sits in the paver hopper (Figure 55).



A conveyor belt in the bottom of the truck bed to move the mix out of the back of the truck.

Mix can be transferred to the paver hopper or deposited into a windrow.

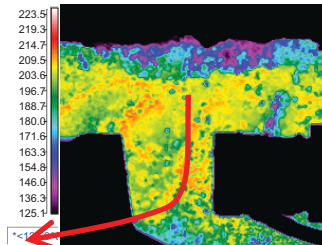

FIGURE 54 Live bottom haul trucks move mix horizontally and out the back of the truck bed [Sources: ABS Trailers (<http://www.abstrailers.com>) (upper left) and Pavementinteractive.org (<http://www.pavementinteractive.org>) (below)].

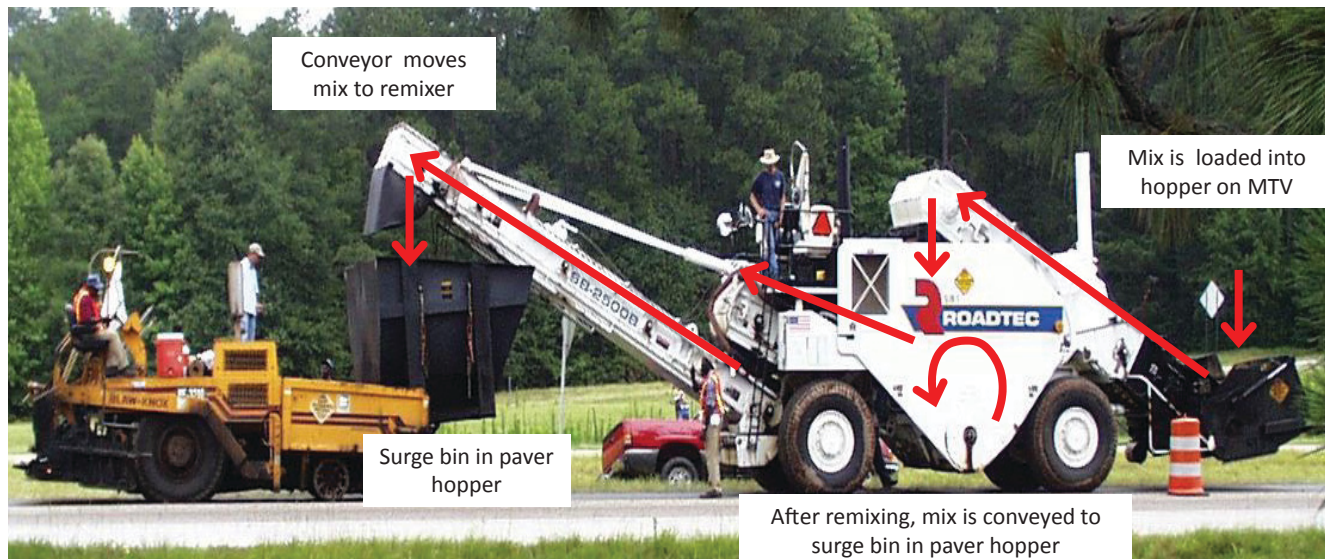

FIGURE 55 Example of remixer as a separate unit [Source: Stroup-Gardiner (2014)].

An MTD is an attachment to the paver designed to receive and hold larger loads of mix in a hopper, then convey it up and into a surge bin in the paver hopper (Figure 56). The surge bin in the paver hopper has augers in the bottom for reblending the mix as it moves toward the back of the paver.

For the greatest reduction in segregation to be achieved, it is important that material transfer units be operated properly. These units would have:

- Surge bins sized appropriately for the size of the paver hopper.
- Sufficient mix supplied to the job site so that the amount of mix in the surge bin keeps the paver operating without stopping.
- Sufficient mix supplied to the screed augers.
- *Material transfer units are very effective in reducing segregation when they:*
 - *Keep sufficient mix supplied to the screed augers.*
 - *Have enough mix to keep the paving operations moving at a continuous speed without stopping.*

Paver

Paver Hopper

Mix that is still segregated by the time it is transferred to the paver hopper will show up as segregated mix behind the paver. Any coarser mix along the edges of the end dump haul truck bed moves into the hopper and is deposited at the outer edges of the paver hopper (Figure 57). If the paver hopper is run too low before the wings are flipped, a concentrated quantity of segregated or cold mix is dropped directly onto the hopper conveyors. The segregated mix is conveyed to the screed augers as the paver moves forward and segregated mix starts to show up in the mat at the center of the screed. The end-of-truck chevron (“V” shaped) coarse texture pattern is created as the segregated mix moves along the screed auger to the outside edges of the lane.

Any segregation that is deposited in the paver hopper can be reduced by raising (flipping) the wings when the hopper is at least half full (Figure 58). This helps reblend any segregated mix in the wings with more uniform mix in the center of the



FIGURE 56 Example of a remixer in the surge bin in paver hopper [Source: Stroup-Gardiner (2014)].

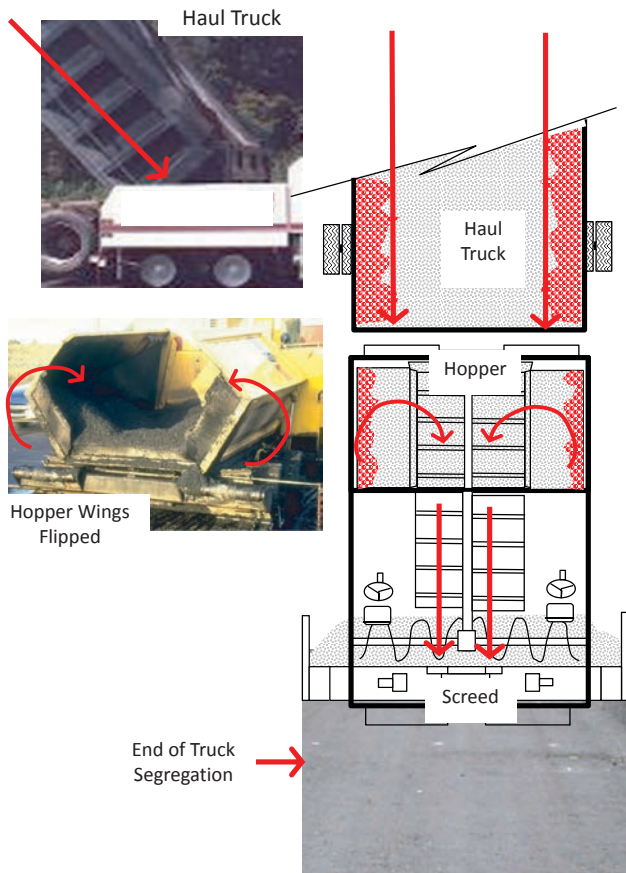

FIGURE 57 End-of-truck segregation: How segregated mix moves from the outer edges of the truck bed to the pavement [Source: Stroup-Gardiner (2014)].

hopper as the mix is pulled down and to the back of the paver. The general understanding is that flipping the wings is a bad practice, which is generally true because most paver operators run the hopper almost empty before changing out haul trucks. When haul trucks are changed while the paver hopper is at least half full, any cold mix at the outer edges can be blended

with a larger volume of mix before moving to the screed. As with all construction processes, the use of effective practices significantly reduces segregation.

Longitudinal segregation can be produced by equipment that moves the mix from the hopper to the screed augers. Older pavers move mix with drag slat conveyors, which allow coarser mix particles to roll off of the edges of the conveyors. In some cases, the aggregate can be fractured by the conveyors that can also leave a coarse texture, but not necessarily a segregated, longitudinal streak (ForConstructionPros.com 2012). Newer paver designs replace conveyor motors with outboard motors that allow the conveyors to be placed closer together, and the motors can be adjusted to balance the volume of mix delivered to each side of the screed (Figure 59). It is especially important to be able to balance the volume of mix when screeds are extended to a different width on each side. Although the reduction in longitudinal segregation is considered a benefit when outboard motors are used, no research was found that formally documents this reduction in segregation.

Segregation may be reduced by newer paver designs that replace the traditional conveyors with a pair of counter-rotating augers (Figure 60). Counter-rotating augers pull the mix from the entire hopper and the variable auger pitch aids in reblending the mix as it moves toward the screed augers. This design helps reduce aggregate fracturing that can happen with conveyors. However, these benefits have not yet been documented.

- Segregation is minimized when the hopper is kept at least half full.
- Longitudinal segregation may be minimized with the use of outboard motors to move hopper conveyors or by replacing the conveyors with a pair of twin augers. However, these benefits could be explored in future research studies.



Hopper Half Full



Hopper Almost Empty

When the hopper is at least half full, the screed augers are not starved for mix. If the paver wings are flipped with the hopper at least half full, any cold or segregated mix is blended with enough uniform mix so segregation behind the paver is minimized.

FIGURE 58 Examples of hopper half full (optimum lowest level) and a too empty hopper [Source: Murphy (2012b); Warren (2013)].

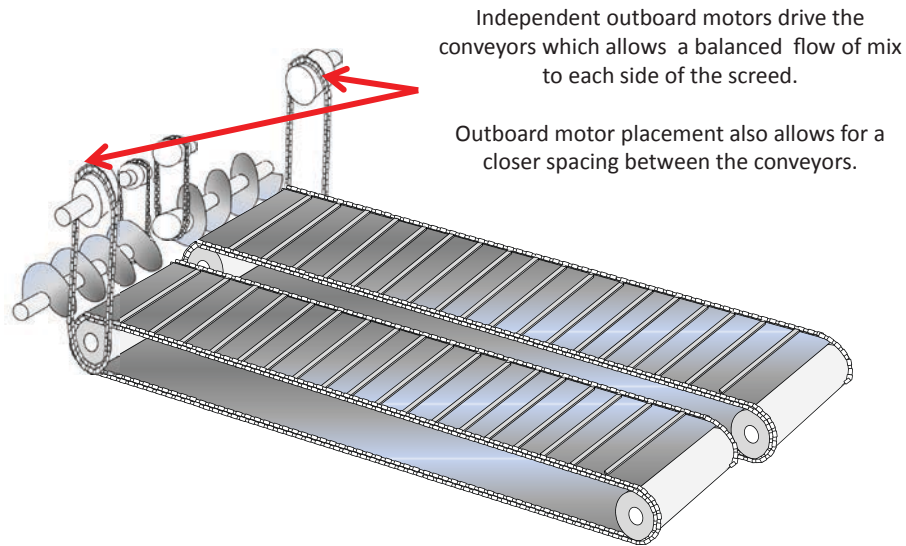

FIGURE 59 Example of outboard mounted motors and variable flow options for balancing mix to the screed augers [Source: Stroup-Gardiner (2014)].

Paver Screed

Longitudinal segregation on one or both sides of center occurs when the screed augers are operated either too slowly or too fast (Brock et al. 1998; FHWA 2002; Cleaver 2012). If the augers rotate too slowly, the larger aggregate sizes can drop off; running the augers too fast results in too little mix, and coarser mix gets delivered to the outside edges of the screed (USCOE 2001). The most effective option for the screed auger speed is moderate and continuous. Some newer designs provide options for reversing augers to force material under the housing or relying on outboard drive motors for the auger drives (Cleaver 2012).

Centerline mix segregation can occur under the auger chain drive. Kicker paddles can be installed next to the gear box to push the mix under the auger gear box (Figure 61). In some cases, the mix is gravity fed into the augers instead of using the conveyors, which may also help minimize segregation (Brock et al. 1998).

- *Centerline segregation is reduced when kicker paddles or reverse flow options are used to push mix under the gear box.*

Longitudinal segregation on one or both sides or either side of the centerline can also be caused by screed and auger extensions. The extensions are to be adjusted so that the same amount of mix is pulled from the center to the edges (Cleaver 2012). The depth of mix across the screed augers would cover about 75% of the augers across the entire width of paving (Figure 62). Auger extensions are to be used when screed extensions are used. Extending the augers ensures that the mix is pulled from the center to the outside edge of paving. If auger extensions are not used, the mix has to be pushed into the extension areas that segregate the mix in the extension areas. If a large amount of mix is allowed to accumulate in front of the screed and beyond the end of the augers, the mix gets cold (temperature segregation).

Options for variable flow help balance the amount of mix across the screed when the screed extensions are not evenly

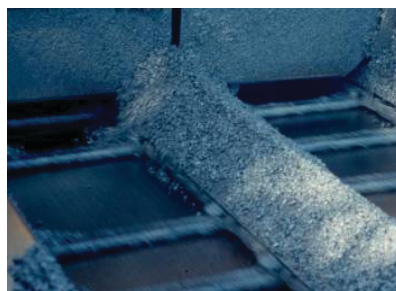

Conventional drag slat configuration can fracture aggregate which shows up behind the screed as a coarser texture.



Pair of twin augers help pull mix from entire hopper and reblend mix as it is moved towards the screed.

FIGURE 60 Examples of different methods of moving mix from hopper [Source: (left) Murphy (2012a); (right) Bateman (2009)].

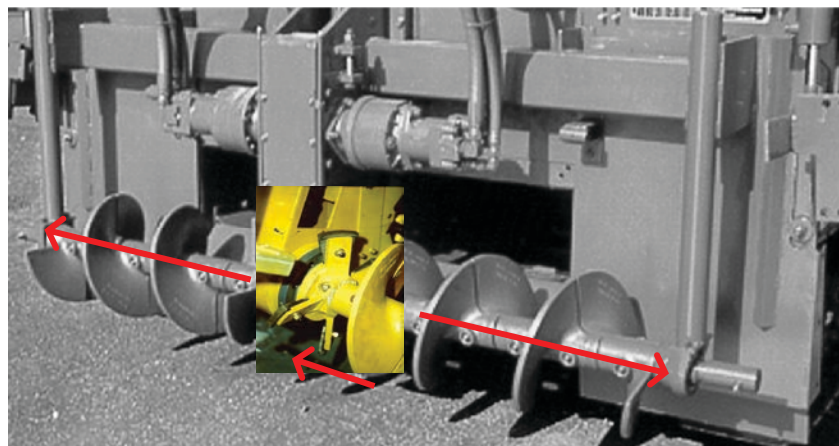

Kicker paddles, placed next to the gear box, pushes mix in the opposite direction of the augers.

FIGURE 61 Kicker paddles added to the screed augers help move mix under the gear box [Source: Combined from Murphy (2012a)].

extended on both sides of the screed. Longitudinal segregation on one or both sides of the centerline occurs when the augers are “starved” for mix. A constant head of mix keeps the angle of the screed (i.e., angle of attack) constant, so a uniformly textured non-segregated mix is placed by the paver. Keeping the paver hopper at least half full helps maintain a sufficient amount of mix in front of the screed (i.e., head of mix).

- *Longitudinal segregation (either or both sides) is reduced when:*
 - *A balanced volume of mix is supplied to each side of the screed.*
 - *Auger extensions are used with screed extensions so the mix is pulled, rather than pushed, into the extension areas.*

When a uniform amount of mix is not supplied consistently across the full width of the screed, the angle of the screed plate

(i.e., angle of attack) varies, which results in varying mat thicknesses. If the mat thickness is too thin, the screed drags larger aggregate particles and tears the mat surface (Figure 63). The coarse texture left by dragging aggregates may be interpreted as segregation; however, in reality, it is only a change in the surface texture.

- *Longitudinal coarse textured areas may be the result of the screed dragging aggregates over the top of the mat.*
 - *Keep the angle of attack consistent and uniform to prevent tearing the mat.*

PAVEMENT DISTRESSES AND PAVEMENT CONDITION IN SEGREGATED AREAS

Two studies reported on the typical pavement distresses observed in segregated areas of paving projects from 1.5 to 10 years old; raveling and potholes in various stages of

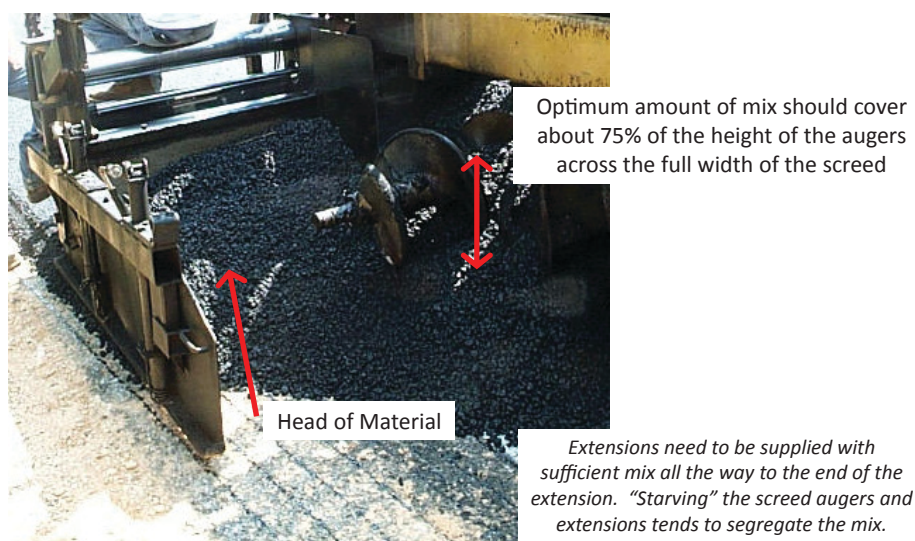

FIGURE 62 Example of depth of mix at auger [Source: Stroup-Gardiner (2014)].



Texture from Screed

FIGURE 63 Example of large aggregates leaving tears in mat from being dragged by screed [Source: (top) Warren (2012); (bottom) Stroup-Gardiner (2014)].

formation (Table 6). On older pavements, the raveling and potholes had evolved into longitudinal cracking, with more severe raveling around the edges of the cracking (Figure 64).

Top-down Cracking

Three forensic studies linked intermittent longitudinal top-down cracking very early in pavement life to areas with longitudinal segregation (Abu-Hassan 2002; De Freitas et al. 2005; Harmelink et al. 2008). Fifty percent of the cores taken from 28 Colorado projects had gradations that were at least 4% coarser on two sieve sizes than gradations from uncracked areas (Harmelink et al. 2008).

Harmelink et al. (2008) compared the cracking patterns with the configurations of the pavers used for each project (Figure 65). The longitudinal cracking occurred along the outside edges of the two slat conveyors and under the gearbox

between the conveyors. Discussions between the Colorado Department of Transportation (DOT) and the paver manufacturers resulted in the development of a retrofit system of chains and deflectors to prevent the coarser fractions of the mix from dropping off the outer edges of the conveyors or getting concentrated under the gear box.

- *Top-down longitudinal cracking can occur in locations corresponding with the gear box (longitudinal center-line segregation) and with the outside edges of the paver conveyors (longitudinal cracking on one or both sides of the centerline).*

Reflective Cracking

Several studies documented temperature differences during the construction of a number of overlay projects and periodically monitored the pavement condition over 1.5 to 5 years

TABLE 6
SUMMARY OF PAVEMENT DISTRESSES IN SEGREGATED AREAS REPORTED IN LITERATURE

Type of Pavement Distress	Stroup-Gardiner and Brown (2000)	Bode (2012)
	12 Projects/5 States 4 to 10 Years Old	18 Projects/1 State 1.5 to 2 Years Old
Raveling	100%	32%
Potholes Starting to Form	57%	37%
Intermittent Longitudinal Cracking	25%	—
Intermittent Rutting	20% (1 state)	—
Transverse Cracking	—	25%
Reflective Cracking	—	—
Intersection of Multiple Cracks	—	7%

— = no information provided.

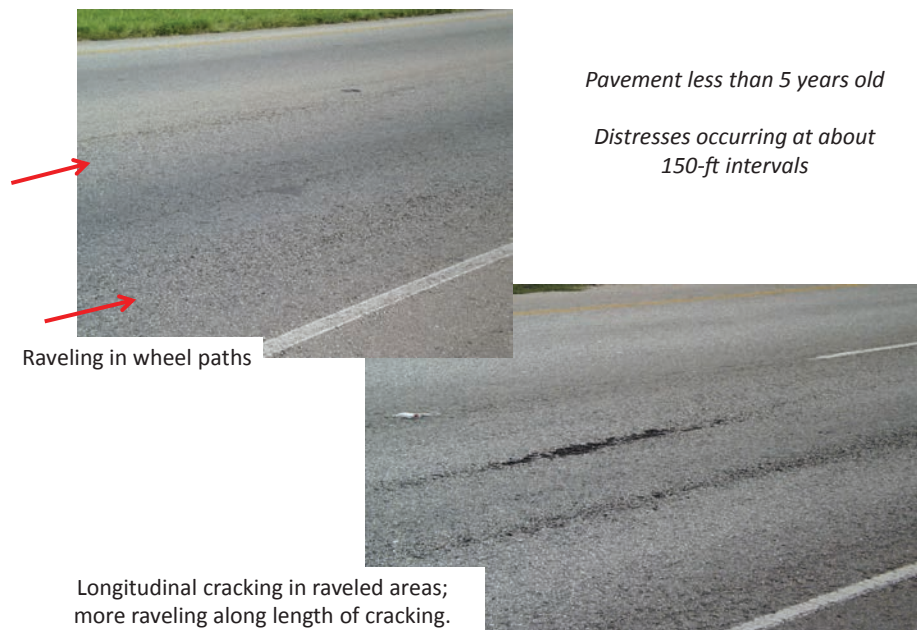

FIGURE 64 Example of how pavement distresses in segregated areas of the pavement progress with exposure to traffic and environmental conditions [Source: Stroup-Gardiner (2014)].

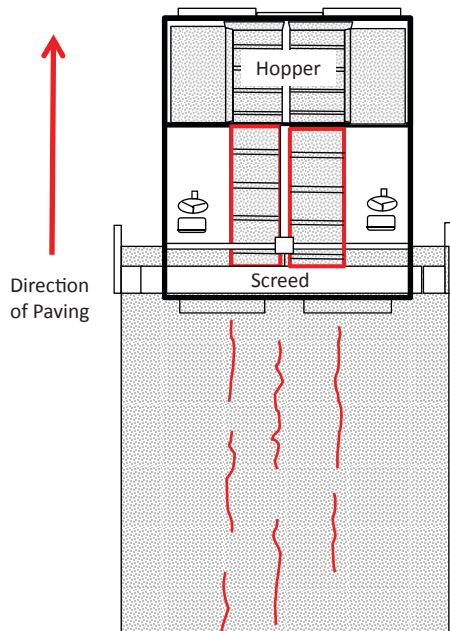

FIGURE 65 Overlay of paver conveyor slat location and the occurrence of longitudinal cracking in the center of lane and on either side of the centerline [Source: Stroup-Gardiner after Harmelink et al. (2008)].

(Henault et al. 2005; Gunter 2012; Sebesta and Scullion 2012). The most obvious pavement distress seen on these projects was reflective cracking, which is a form of cracking that is generated by cracks in the original surface propagating up to the surface of the overlay. Other types of distresses appeared to be starting; however, the researchers believed the surfaces were not old enough for the distresses to be significant.

- *Regardless of segregation, reflective cracking from the underlying layers can be the first pavement distresses seen within the first five years of traffic.*

Ride Quality

Three studies evaluated the impact of temperature segregation on ride quality. A Texas demonstration project in 1999 determined the ability of various MTVs to minimize visibly detectable segregation and improve the ride quality of the sections (Tahmoressi et al. 1999). The profilograph and inertial profiler units showed similar trends in the ride quality for each test section. However, the average number of visibly identifiable segregated areas did not correlate with the ride quality. The Present Serviceability Index, a calculation of the pavement condition, was not correlated with the segregation seen in the test sections.

Four projects (eight test sections) constructed with and without MTVs in Alabama in 2001 showed that the International Roughness Index (IRI, a measure of ride quality) was

lower (smoother) by 18 in./mi when an MTV was used and no temperature segregation was documented (Harris 2002). The ride quality in the extended screed area tended to be rougher than the ride in the right wheel path for four of the seven test sections. Five Connecticut projects also had lower IRI values in areas without temperature segregation (Nener-Plante and Zofka 2009).

- *Ride quality can be significantly improved on sections of pavement with no temperature segregation.*

SPECIFICATIONS

Alberta, Canada

Gavin and Heath (2002) reported that a Segregation Tri-Party Task Group was formed to adjust Alberta, Canada, Standard Specification 3.50, Asphalt Concrete Pavement-EPS. The main revisions to the existing edition included:

- Identifying segregation quickly so the contractor can mitigate the problem to prevent further segregation.
- Eliminating the requirement for the repair of “slight” levels of segregation.
- Repairing “moderate” to “severe” segregation only repaired during construction. This allows repairs to be made while the asphalt plant and contractor is still on site.
- Reinstating the opportunity for substantial bonuses. Penalties were increased for moderate-to-severe segregation and penalties for slight segregation and center-of-paver segregation were added.
- The contractor provides written documentation of daily changes or modifications to equipment and operations if segregation is identified at the beginning of a project, which is expected to eliminate or minimize any occurrence of segregation.

Section 3.50.4.7.2—Classifying Pavement Segregation defines segregation as an area of pavement with visually identified texture differences that are more than 0.1 m² or are

center-of-paver streaks longer than 1 m (Table 7). The specific definitions of the levels of segregation are:

- Slight segregation: The matrix, asphalt cement, and fine aggregate are in place between the coarse aggregate. However, there is more stone in comparison with the surrounding acceptable mix.
- Moderate segregation: significantly more stone than the surrounding mix; moderately segregated areas usually exhibit a lack of a surrounding matrix.
- Severe segregation: Appears as an area of very stony mix, stone against stone, with very little or no matrix.
- Center-of-paver: Appears as a continuous or semi-continuous longitudinal “streak” typically located in the middle of the paver mat.

The contractor is required to perform a daily inspection for segregation of all lifts paved. If segregation is seen, the contractor takes immediate corrective actions. A consultant(s) performs inspections during construction of all lifts. If segregation is discovered, the consultant immediately requests that the contractor take corrective action. The consultant(s) conducts a second inspection following construction, normally within 2 weeks after completion of paving, and a written assessment of the location and severity of segregation is submitted.

Slight segregation in any lift does not require repairs. Moderate segregation in lower lifts does not require repair and severe segregation in the lower lifts requires repairs only when the consultant believes the segregation will reduce the life of the wear course. Assessed penalties are based on the total number of areas with each level of segregation and only moderate, severe, or center-of-paver segregation on the top lift requires repairs.

- Moderate segregation can be repaired using slurry or a hot mix patch.
- Severe segregation can be repaired by removing and replacing or with an overlay.
- Spray seals, applied either with a distributor, by hand, by squeegeeing, etc., *is not* an acceptable repair method.

TABLE 7
INCENTIVES/DISINCENTIVES FOR SEGREGATION IN ALBERTA, CANADA, SPECIFICATION

Level of Segregation	Frequency of Segregation	Incentive/Disincentive
Slight	0	Bonus of \$1,000 per lane-km only if also no segregation of any type
	1 or 2	Bonus pay of \$500 per lane-km only if also no moderate, severe, or center-of-pavement segregation
	More than 2	Reduce pay by no. × \$100
Moderate and Severe	0	Bonus of \$1,000 per lane-km only if also no segregation of any type
	1 or more	Reduce pay by no. × \$500
Center-of-Paver	More than 1-m	Reduce pay by length × \$1.50/linear meter

After Gavin and Heath (2002).
Maximum penalty is limited to \$2,000 per lane-km.

Texas

Over the last 10 years, Texas DOT (TxDOT) has implemented thermal measurements using handheld infrared sensors, density measurements, and requirements for using MTVs to reduce segregation (Rand 2010, 2012). TxDOT, in conjunction with the Texas Transportation Institute (TTI) at Texas A&M University, developed a new specification and test method for the identification of segregation.

Three levels of segregation are based on ranges of temperature differences: no or limited segregation, $<25^{\circ}\text{F}$; moderate segregation, from 25°F to 50°F ; severe segregation, $>50^{\circ}\text{F}$. Hand-operated or automated infrared sensors can be used to obtain the temperature information (TxDOT 2011):

- Infrared guns (D:s minimum 6:1; accuracy of $\pm 2^{\circ}\text{F}$).
- Thermal imaging camera (D:s minimum 6:1; accuracy $\pm 4^{\circ}\text{F}$) and/or paver-mounted.
- Infrared sensor bar (i.e., *Pave-IR*) (10 sensors; spacing no more than 13 in. apart; maximum 3 ft above surface; D:s minimum 6:2; accuracy $\pm 2^{\circ}\text{F}$).

Hand-held infrared sensor temperature data are taken approximately five feet behind the paver and no more than 20 feet away from the operator while the paver is moving. Collect and record the maximum temperature in the base line area of the profile length (150 ft; Figure 66). The permissible lower temperature for the next 130 ft is calculated by subtracting 25°F from the baseline temperature reading. When the temperature of the mat behind the paver drops below this value the edge of the roadway is marked, the temperature is recorded, and a density profile is required. If the lowest temperature recorded for the temperature profile is more than 50°F lower than the baseline temperature, no QC/QA bonus is paid.

A minimum of one temperature and density profile is required for each subplot. Density profiles are also required when the paver stops, at locations where the temperatures are lower than 25°F of the base line temperature, and when visible segregation is identified. Density profiles consist of nuclear density testing at intervals of 5 ft over a 50-ft longitudinal section using an offset of 2 ft or more from the edge of the pavement.

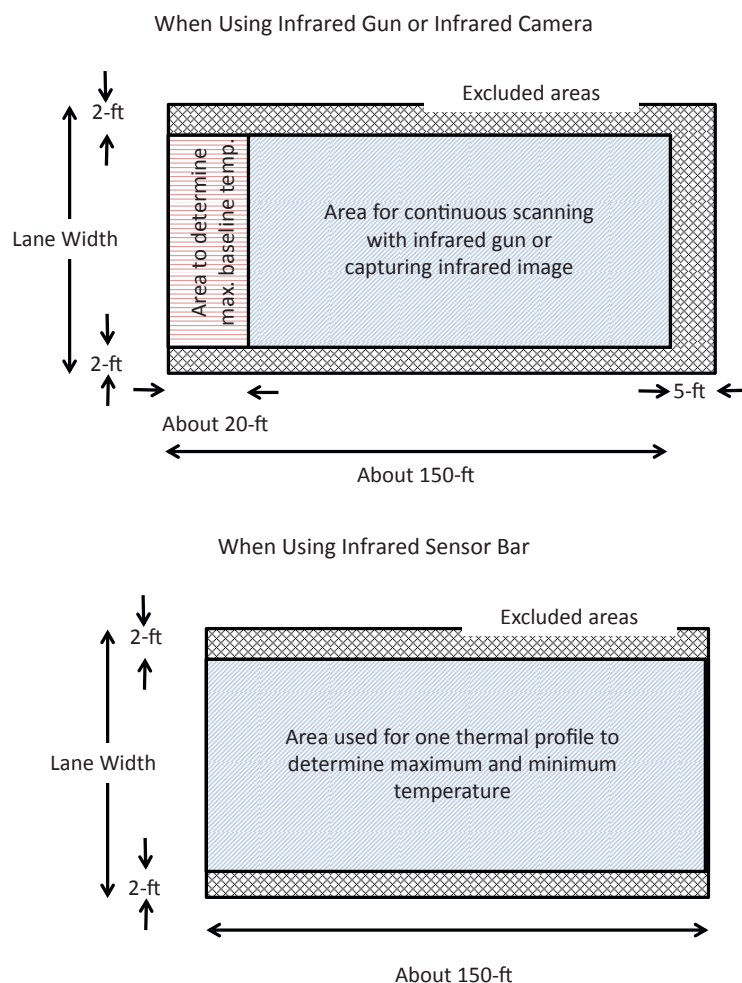

FIGURE 66 Area specified for one thermal profile [Source: Tex-244-F (TxDOT) (2014)].

TABLE 8
QUALITY ACCEPTANCE UNIFORMITY RATING SCALE

Standard Deviation of Texture, mm				Contract Unit Price Adjustment (% of pavement unit price)
9.5 mm	12.5 mm	19.0 mm	25.0 mm	
0.5 and under	0.10 and under	0.15 and under	0.20 and under	105
0.06 to 0.10	0.11 to 0.20	0.16 to 0.25	0.21 to 0.30	103
0.11 to 0.15	0.21 to 0.25	0.26 to 0.35	0.31 to 0.45	100
0.16 to 0.20	0.26 to 0.30	0.36 to 0.45	0.46 to 0.75	90
0.20 to 0.25	0.31 to 0.35	0.46 to 0.55	0.76 to 1.0	80
Over 0.25	Over 0.35	Over 0.55	Over 1.0	Corrective action required

Source: McGhee et al. (2003).

The automated data collection system continuously collects and records temperature profiles and paver stops. When the contractor uses the automated system, no density profiles are required.

Research Development of Segregation Specifications

McGhee et al. (2003) and McGhee (2004) evaluated the use of longitudinal texture profiles for improving the uniformity of Virginia's roadways. Texture was estimated for every 2 ft of project length for profiles collected with the left wheel path and between the wheel paths. Specific projects with evidence of segregation were identified, surface mixes selected from the Virginia Department of Transportation (VDOT) active maintenance schedule, and new projects were used to evaluate intermediate and base mix testing. Eight projects with both uniform and non-uniform areas were selected for the field evaluations.

The variability in the longitudinal texture profiles rather than the surface texture measurements were used to develop a possible specification framework (Table 8). Texture variability fluctuates proportionally and consistently with the maximum aggregate size. The main advantage to this approach is that information about the original mix characteristics job mix formula is not needed. One disadvantage is that any flushed

areas with unusually slick surfaces or texture anomalies in between the laser texture profiles are not captured.

Rowe et al. (2004) developed a methodology that estimates the area [i.e., volume of surface (voids) determined from longitudinal texture profiles that were divided into increments (base length)] and the area between the profile and a horizontal line extended from the maximum particle height in the increment. The areas calculated for each of the increments are summed and used to determine the level and quantity of segregation. A methodology for the acceptance or non-acceptance of a pavement section and a suggested pay scale were proposed (Table 9).

$$\text{AREA} = A_{\text{low}} (1.0) + A_{\text{medium}} (1.42) + A_{\text{High}} (2.50)$$

TABLE 9
SUGGESTED PAY ADJUSTMENT FACTOR
BASED ON TEXTURE CALCULATIONS

Range of AREA Index	Pay Adjustment Factor
0.5–5.0	105
5.0–15.0	95
15.0–25.0	85
25.0–35.0	65
35.0–45.0	25

Source: After Rowe et al. (2004).

CHAPTER THREE

SURVEY RESULTS

DESCRIPTIONS, DETECTION, RESPONSIBILITY, AND TRAINING

Descriptions

Well-defined descriptions of segregation are important so that agency field staff and contractors have a consistent basis for detecting segregation. Segregation descriptions also help narrow the list of potential areas to target for reducing segregation. The first survey question collected information about how segregation is described by each agency or industry representative (Table 10).

Question 1: Your agency considers an asphalt mix to be segregated when there are (Choose all that apply.)

The most frequently selected descriptions of segregation are those used to define end-of-truck, random, and longitudinal segregation. The majority of respondents also included the description for fine aggregate segregation. Approximately one-third of the respondents also considered the newer and less commonly used descriptions as types of segregation observed in their state.

- *Segregation is more than just localized areas of pavement with coarse texture. Other types of non-uniformity during construction include areas of cooler temperatures and evidence of poorly mixed additives or quantities of binder that have drained off of the aggregate.*
- *Clear descriptions of all forms of segregation are to be developed so that field staff can consistently detect segregation.*

Detection

Various methods can be used to detect segregation. The visual and infrared methods are the most commonly used and reported in research studies. Other methods with the potential for detecting segregation include ride quality immediately after construction and monitoring density during or after construction with GPR. Methods that are considered useful for detecting segregation were determined with Question 10 (Table 11).

Question 10: How are areas of segregation asphalt mix detected? (Choose all that apply.)

Almost all of the respondents reported using visual examination to detect segregation. In addition to visual examination,

some measurement of temperature differences using infrared guns, infrared cameras, or infrared sensor bars were also used to detect segregated areas.

“Bumps” or ride quality (i.e., profilers, profilograph) were frequently used by seven agencies. This may reflect states that have ride quality requirements for the acceptance of the final project, and ride quality is strongly influenced by construction practices that also minimize or eliminate segregation.

GPR and a combination of GPR and infrared sensor bars were not selected as methods to detect segregation.

- *Visual examination alone, or in conjunction with, temperature measurements are the most common methods for detecting segregation.*
- *Some form of ride quality measurement is considered as a method for detecting segregation by 15% of the agencies.*

Responsibility for Detecting Segregation

Field inspectors are responsible for detecting and enforcing segregation specifications. Question 2 was included in the survey to determine who performs the field inspections on behalf of the agency (Table 12).

Question 2: Does your agency typically perform field inspection of paving projects with agency staff or with consultants? (Choose all that apply.)

The majority of agency projects are inspected by agency staff, although some agencies use some combination of agency and consultant staff for field inspection. In one case, as much as 75% of the field inspections are undertaken by consultants. In another case, only 2% of the state’s projects are inspected by consultants.

- *Field inspection, which is the main method for visually detecting segregation, can be the primary responsibility of agency staff or some combination of consultants and agency staff.*
- *Training is important so all of the field inspection staff have a consistent understanding of:*
 - *What definitions of segregation are used.*
 - *What causes each type of segregation.*
 - *Where to concentrate on detecting segregation before it is returned to the back of the paver.*

TABLE 10
DESCRIPTORS OF SEGREGATION (Question 1)

Survey Choices	Description(s)			
	Agencies (N = 48)		Industry (N = 19)	
	%	n	%	n
<i>Common Descriptions for End-of-Truck, Random, and Longitudinal Segregation</i>				
Localized areas of coarse texture in the finished mat	95%	46	100%	19
Longitudinal “streaks” of coarser-texture mix in center of mat behind the paver (e.g., under gear box, at screed extensions)	88%	42	71%	13
Longitudinal “streaks” of coarser-textured mix on one or both sides of mat behind the paver	75%	36	68%	13
Localized areas of very fine texture in the finished mat (smoother surface than uniform textured areas)	68%	32	57%	11
<i>Newer and Less Common Descriptions for Temperature and Additional Forms of Mix Segregation</i>				
Localized areas of hotter or cooler temperature mix behind the paver	38%	18	45%	9
Transverse sections of cooler temperature mix (e.g., after changing trucks, paver stops)	38%	18	39%	7
Localized “clumps” of fibers and/or binder or other mix additives	30%	14	32%	6
Localized areas of binder-rich (e.g., “fat spots”) in the finished mat	28%	13	42%	8

Not all respondents answered all questions. Responses for “occasionally used,” “rarely used,” and “don’t know” not shown; multiple answers were allowed.

Training and Certification Programs

Training of the field and construction staff is important for consistent segregation detection and for identifying the most successful practices for reducing segregation. Question 19 collected information about the content of existing asphalt plant and field technician certification programs (Table 13).

Question 19: Indicate topics that are covered in asphalt plant and/or field technician certification programs (all levels) in your state. (Choose all that apply.)

Almost half of training and certification programs contain a section on the identification of segregated mix; however, less than one-third of the respondents believe this training helped reduce segregation. More respondents believe training that

TABLE 11
METHODS FOR DETECTING SEGREGATION (Question 10)

Survey Choices	Choice of Method(s)			
	Agency (N = 48)		Industry (N = 19)	
	%	n	%	n
Visual examination	98%	47	100%	19
Infrared thermometer (gun)	24%	11	57%	11
Infrared camera	21%	10	13%	2
Infrared temperature sensors (e.g., Pave-IR)	13%	6	22%	4
Inertial profiler—full size	5%	3	4%	1
Bump detection software for profiler	5%	3	4%	1
Inertial profiler—light weight	3%	1	4%	1
Profilometer (California)	0%	0	13%	2
Ground penetrating radar (GPR)	0%	0	0%	0
Combination of infrared temperature sensors and GPR	0%	0	0%	0

Not all respondents answered all questions. Responses for “occasionally used,” “rarely used,” and “don’t know” not shown; multiple answers were allowed.

TABLE 12
FIELD INSPECTION RESPONSIBILITIES (Question 2)

Survey Choices	Inspection Staffing			
	Agencies (N = 48)		Industry (N = 19)	
	%	n	%	n
Agency Staff	86%	48	97%	18
Consultant	44%	23	65%	12
<i>Percent Split When Both Agency and Staff Personnel Perform Inspections</i>				
% Agency/% Consultant Split When Both Are Used for Inspection	25%/75%	1	No information on percent split included	
	50%/50%	2		
	60%/40%	2		
	65%/35%	1		
	70%/30%	1		
	80%/20%	1		
	90%/10%	2		
	95%/5%	1		
	98%/2%	1		

Not all respondents answered all questions. Responses for “occasionally used,” “rarely used,” and “don’t know” not shown; multiple answers were allowed.

TABLE 13
TECHNICIAN TRAINING PROGRAMS (Question 19)

Survey Choices	Included in Program				Helps Reduce Segregation			
	Agency (N = 48)		Industry (N = 19)		Agency (N = 48)		Industry (N = 19)	
	%	n	%	n	%	n	%	n
<i>Aggregate Production and Handling</i>								
Stockpiling of aggregates	54%	26	45%	9	44%	21	35%	7
Loading cold feed bins	44%	21	39%	7	42%	20	34%	7
<i>Material Properties, Field Sampling, and Identification of Segregation</i>								
Properties of component materials	60%	29	45%	9	17%	8	23%	4
Random sampling	54%	26	39%	7	17%	8	19%	4
Identification of segregated mix	50%	24	45%	9	29%	14	13%	2
<i>Asphalt Plant Calibration and Quality Control</i>								
Plant calibration	44%	21	42%	8	19%	9	32%	6
Quality control charts	48%	23	32%	6	15%	7	26%	5
<i>Asphalt Plant Production</i>								
Heating	38%	18	32%	6	13%	6	23%	4
Blending	38%	18	32%	6	23%	11	26%	5
Drying	38%	18	32%	6	13%	6	19%	4
Mixing	44%	21	26%	5	23%	11	26%	5
Loading haul trucks	54%	26	39%	7	38%	18	26%	5
<i>Mix Transport, Mix Transfer, and Rolling</i>								
Transportation to job site	46%	21	32%	6	23%	11	26%	5
End dump transfer to paver	46%	22	32%	6	31%	15	29%	6
Loading material transfer device	50%	22	32%	6	38%	18	26%	5
Roller operations	50%	22	42%	8	8%	4	19%	4

Not all respondents answered all questions. Responses for “occasionally used,” “rarely used,” and “don’t know” not shown; multiple answers were allowed.

covers stockpiling aggregates, loading cold feed bins, loading haul trucks, and transferring mix from the haul trucks to the paver is more useful for reducing segregation than training on the detection of segregation.

Topics related to asphalt plant production equipment and practices tend to be less frequently included in training or certification programs, although there are a number of key areas of the production process that have a significant impact on segregation.

- *Training programs may help reduce segregation by:*
 - *Explaining how segregation occurs in each part of the production process.*
 - *Linking each topic to segregation descriptions and successful practices for reducing or eliminating segregation.*

TESTING

Once segregation is detected, additional testing may be conducted to determine if mix properties do not meet the specification requirements. Two questions were included in the survey to collect information about current practices for additional testing in segregated areas.

Roadway Density Testing

Question 12 elicited information about how any additional roadway density testing was conducted (Table 14).

Question 12: If density testing (other than standard random sampling) is conducted after segregation is identified, indicate how the testing is done. (Choose all that apply.)

Both nuclear and non-nuclear density gauges are used in a variety of ways. Single point measurements, pairs of den-

sity tests, and longitudinal density profiles are used more frequently than skewed or transverse density profile testing. Gauges are not always calibrated with core properties.

- *Both nuclear and non-nuclear gauges are used in a variety of ways for additional roadway density testing in segregated areas.*
- *Gauges are not always calibrated with cores.*

Laboratory Testing

Standard QC/QA testing can be used to determine if the mix in potentially segregated areas meets the specification requirements (Table 15). Question 13 collected information on laboratory test methods used when testing potentially segregated samples. The selection of the appropriate test method is important so that segregation is not under- or over-estimated.

Question 13: If cores and/or loose mix are obtained for laboratory testing (other than for standard random sampling) after segregation is identified, indicate the testing which is completed on the potentially segregated mix. (Choose all that apply.)

The most frequently used density test was AASHTO T166. This method is quick and simple; however, the uncoated sample can absorb significant amounts of water when testing segregated mix. When this happens densities are overestimated, which can lead to erroneously accepting a lot or subplot with out-of-specification materials. Methods that seal the samples before testing can be used to test segregated mixes; however, this was used only 13% of the time, at best.

Gradations and asphalt content are determined by separating the mix back into the individual material components (i.e., asphalt and aggregate). The method used to separate the asphalt from the aggregate portion of the mix can bias the test results. If gradations are determined after burning off the

TABLE 14
ROADWAY DENSITY TESTING (Question 12)

Survey Choices	Nuclear Gauge				Non-Nuclear Gauge			
	Agency (N = 48)		Industry (N = 19)		Agency (N = 48)		Industry (N = 19)	
	%	n	%	n	%	n	%	n
Single point on pavement	15%	7	10%	5	10%	5	6%	3
Skewed longitudinal density profile	8%	4	4%	2	4%	2	0%	0
Pair of single points, one each in uniform and non-uniform textured areas	10%	5	10%	5	8%	4	8%	4
Longitudinal density profile	13%	6	10%	5	6%	3	4%	2
Transverse density profile	4%	2	4%	2	0%	0	0%	0
One or more cores taken for gauge calibration	4%	2	13%	6	4%	2	6%	3

Not all respondents answered all questions. Responses for “occasionally used,” “rarely used,” and “don’t know” not shown; multiple answers were allowed.

TABLE 15
RESULTS FOR QUALITY CONTROL/QUALITY ASSURANCE TESTING (Question 13)

Survey Choices	Cores				Loose Mix			
	Agency (N = 48)		Industry (N = 19)		Agency (N = 48)		Industry (N = 19)	
	%	n	%	n	%	n	%	n
<i>Density Test Methods</i>								
Density testing (AASHTO T166)	27%	13	29%	6	0%	0	6%	1
Density testing, paraffin coating (AASHTO T275)	0%	0	6%	1	0%	0	6%	1
Density testing, parafilm wrapped (ASTM D1188)	2%	1	6%	1	0%	0	0%	0
Density testing, vacuum sealed (AASHTO T331)	13%	6	6%	1	0%	0	6%	1
<i>Gradation and Asphalt Content Test Methods</i>								
Gradation, after ignition oven	21%	10	10%	2	10%	5	16%	3
Gradation, solvent-extracted aggregate	6%	3	10%	2	6%	3	10%	2
Asphalt content, ignition oven (AASHTO T308)	13%	6	6%	1	6%	3	16%	3
Asphalt content, solvent extraction (AASHTO T164)	6%	3	10%	2	10%	5	6%	1
<i>Performance-Related Test Methods</i>								
Indirect tensile strength, dry (AASHTO T283)	2%	1	6%	1	0%	0	6%	1
Tensile strength ratio (AASHTO T283)	4%	2	%	1	0%	0	6%	1
Permeability	2%	1	6%	1	0%	0	6%	1
Rut testing	2%	1	6%	1	0%	0	6%	1
Fatigue testing	0%	0	0%	0	0%	0	0	0

Not all respondents answered all questions. Responses for “occasionally used,” “rarely used,” and “don’t know” not shown; multiple answers were allowed.

asphalt in the ignition oven, the heat may fracture aggregate particles, which can make the gradation appear less coarse (less segregated). Any moisture retained in the internal aggregate voids turns to steam as the oven heats up, which can also fracture the particles. Calibration samples are required to factor out aggregate damage during ignition oven testing.

It can be noted that only 35% of the respondents elected to answer this question; the lowest number of responses for any survey question. This may indicate a limited understanding of laboratory testing by construction staff and contractors. A better understanding of the limitations of test methods by field staff and, conversely, a better understanding of the impact of out-of-specification materials on test results would be useful for material engineers.

- *Laboratory density testing may need to coat (seal) samples before testing to avoid underestimating density changes resulting from segregation.*
- *When determining aggregate gradations for potentially segregated samples after ignition oven asphalt content evaluation it is important to account for any aggregate fracturing resulting from heating.*
- *Obtaining better understanding of testing limitations by field staff is important for accurate estimates of mix property changes resulting from segregation.*

Performance-related testing, such as moisture sensitivity and rutting, can be included in the mix design of the project. The most common tests evaluate the indirect tensile strength of the mix before and after moisture conditioning (AASHTO T283) and rut testing (e.g., Hamburg loaded wheel test). None of these performance tests were identified as being frequently used to assess changes resulting from segregation.

- *Performance-based testing is not frequently used to evaluate rutting, fatigue, tensile strength, or permeability of segregate mixes.*

SPECIFICATIONS

A total of 21 agency respondents documented specific segregation-related specification sections or special provisions (Table 16).

- Thirteen agencies base their detection of segregation on the visual observations of field inspectors, resident engineers, or district engineers.
- Eight agencies use visual inspection to detect segregation with no additional testing requirements outside of standard QC/QA of random samples.

TABLE 16
SUMMARY OF SURVEY RESPONSES AND REVIEW OF SPECIFICATION DOCUMENTS SPECIFICALLY IDENTIFIED BY RESPONDENTS

State	Specification	Website	Visual Inspection		Temperature		Texture	Construction Requirements		Density (in-place)	Testing (cores)						Levels	
			Measurement	Range	MTV	Remixing (general)		Other Construction Requirements	Asphalt Content		Gradation	Density	Air Voids	VMA	VFA	Fines to Binder		
AK	409.04	http://www.arkansashighways.com/standard_spec/2014/Division%20400.pdf	X	10°F SA			X			X								
AL	ALDOT 389-98	http://www.dot.state.al.us/conweb/doc/Specifications/2012%20DRAFT%20Standard%20Specs.pdf	X															
AZ	406-5	http://www.azdot.gov/docs/business/2008-standards-specifications-for-road-and-bridge-construction.pdf?sfvrsn=0	G															
CA	39-1.05	http://library.constantcontact.com/download/get/file/1101788399873-201/SS_39_D01-27-11_v6+_2_.pdf	X															
CO	401 (revision; 2-3-2011)	http://www.coloradodot.info/business/design-support/construction-specifications/2011-Specs/standard-special-provisions/sections-200-500-revisions/401ts.docx/view	X	>25°F T						X								
FL	330-9.2	http://www.dot.state.fl.us/specificationsoffice/Implemented/SpecBooks/2014/Files/2014eBook.pdf	X										X					
GA	400.3.06.E	http://www.dot.ga.gov/doingbusiness/Materials/Documents/provision400.pdf	X									X	X	X	X	X	X	Case I (Random Segregation) Case II (Regular Intervals of Segregation) Case III (Longitudinal Streaks)
IA	2.53.G.4	http://www.iowadot.gov/erl/current/CM/content/CM%202.50.htm	X								Testing cores at option of engineer						Pay factor on visual inspection	

TABLE 16
(continued)

State	Specification	Website	Visual Inspection	Temperature		Texture	Construction Requirements		Density (in-place)	Testing (cores)						Levels	
				Measurement	Range		MTV	Remixing (general)		Other Construction Requirements	Asphalt Content	Gradation	Density	Air Voids	VMA		VFA
KS	602.4.e	http://www.ksdot.org/burConsMain/specprov/2007/602.pdf						BP	X-SA								Max. density range; max. density drop
LA	502.08(b)	http://wwwsp.dotd.la.gov/Inside_LaDOTD/Divisions/Engineering/Standard_Specifications/Standard%20Specifications/2006%20Standard%20Specifications%20for%20Roads%20and%20Bridges%20Manual/09%20-%202006%20-%20Part%20V%20-%20Asphaltic%20Pavements.pdf	X				X										
ME	401.201(d)	http://maine.gov/mdot/contractors/publications/standardspec/docs/ss_combined.pdf	X							X	X		X	X	X	X	Based on QA pay factors
MI	503.03.N	http://mdotcf.state.mi.us/public/specbook/2012/	X														Heavy (based on testing cores)
MN	S-1 (Draft)	http://www.dot.state.mn.us/materials/icdocs/2016_QualityManagement_SP2014-54.1_01.03.14.pdf		X													≤25°F good >25°F and ≤50°F moderate 50°F severe
MO	403.13.2	http://www.modot.org/business/standards_and_specs/Sec0403.pdf	X						X-LP								Max. density range; max. density drop
ND	408.04.H	http://www.dot.nd.gov/manuals/environmental/2008-Vol01.pdf	X														
NJ	902.02.04	http://www.state.nj.us/transportation/eng/specs/2007/spec900.shtm	X														

(continued on next page)

TABLE 16
(continued)

State	Specification	Website	Visual Inspection	Temperature		Texture	Construction Requirements		Density (in-place)	Testing (cores)						Levels	
				Measurement	Range		MTV	Remixing (general)		Other Construction Requirements	Asphalt Content	Gradation	Density	Air Voids	VMA		VFA
OH	401.15	http://www.dot.state.oh.us/Divisions/ConstructionMgt/OnlineDocs/Specifications/2013CMS/400/401.htm	X	<25°F T			X										
OK	411.03.F	http://www.okladot.state.ok.us/c_manuals/specbook/oe_ss_2009.pdf	X	>10°F T		X											
OR	745.6	http://www.oregon.gov/ODOT/HWY/SPECS/docs/08book/08_00700.pdf	X														
PA	409.03(h) (3)	ftp://ftp.dot.state.pa.us/public/Bureaus/design/Pub408/Pub%20408%20Chg%207/Sections/409.pdf	X		X					X	X	X					Potentially segregated >0.610-mm texture difference
WA	5-04.3 (10)B2	http://www.wsdot.wa.gov/publications/manuals/fulltext/M41-10/SS2014.pdf	X	>25°F SA				X									

T = transverse; SA = surrounding area; LP = longitudinal profile; BP = best paving practices; G = general wording; VFA = voids filled with asphalt; VMA = voids in mineral aggregate.

- Six agencies use temperature measurements in their specifications:
 - Three agencies (Minnesota, Ohio, and Oklahoma) define segregation based solely on temperature difference.
- Three agencies (Arkansas, Colorado, and Washington) use temperature differences to identify areas for further testing.
- One agency (Pennsylvania) uses measureable texture changes to identify areas for further testing.
- One agency (Arizona) addresses segregation with wording to minimize segregation, but does not provide specific directions on how to identify or what to do when segregation is observed.

When further testing is required, five agencies use in-place density testing to determine if the non-uniform areas fail to meet specification-defined limits or ranges. Five other agencies require additional laboratory testing of cores.

Incentives/Disincentives

Comments from the agency respondents regarding incentives and disincentives included the following:

- Remove and replace is an effective disincentive to obtain corrective action to minimize segregation (12 agencies).
- “Suspend operations” for quick resolutions to non-uniformity (two agencies).
- Pay adjustments for less severe levels of non-uniformity with the remove/replace option for the most severe non-uniformity (two agencies).
- Use of a pay factor disincentive of 5% (one agency).

Contractor comments included similar incentives/disincentives: suspend operations, remove and replace, and percent within limits applied before remove and replace is required. One respondent indicated that the time required for identification, testing, and analysis was actually a significant disincentive because it can result in construction delays and delay penalties. Another contractor noted that its state had only a disincentive (\$10/yd²), with no opportunity for incentives; a less subjective method of segregation would be appreciated so that incentives could be included with the disincentive.

Advantages

Agency respondents noted the following as advantages to their current segregation specifications:

- Provides defined steps for the identification and testing of non-uniform mix/work (seven agencies).
- Includes the ability to reject unacceptable mix/work (six agencies).

- Allows the inspector to use a broad interpretation of “segregation” to reject non-uniform mix/work (two agencies).
- Forces contractor “best practices” (one agency).
- Length of time specification has been in use so everyone knows what to expect (one agency).

Contractors reported that the advantages of their state’s segregation specification were:

- Encourages the use of effective practices (e.g., use of MTV and no stopping).
- Ensures that everyone is aware of the (potential) problem.
- Quantifies segregation.
- Produces pavements with more uniform densities and smoother ride quality.

Disadvantages

Agency respondents reported the following disadvantages with their state’s segregation specification:

- Subjective specification (12 agencies).
- Too much time to test for segregation (four agencies).
- No severity level is included (two agencies).
- Specification may pass pavement that looks like it may be segregated (one agency).
- Cannot be used on previously constructed pavement sections (one agency).
- Required equipment not always appropriate for low-volume roadways (one agency).
- Contractor complaints about cost of equipment (one agency).

Contractors reported disadvantages such as:

- Definitions of segregation were subjective.
- Central laboratory testing of potentially segregated areas can have a turnaround time of 20 days (or more) and is not useful for daily project QC.
- Slows down production.
- Additional equipment costs for the contractor.
- Poorly trained inspectors, lack of understanding of segregation, coarse texture as a result of handwork being defined as segregation.

Dispute Resolution

Of the agency respondents who provided an answer to this question, ten indicated that very little time was spent on dispute resolution. Two agencies noted decreases in time spent on dispute resolution once the specification was amended to require the use of material transfer machines and devices. Other responses included:

- Less than 0.5% of the time
- 120 person-h/year

- 6 times/year
- 30% per week during the paving season
- Handled at the district level rather than the state level.

Contractors noted that very little time is spent on dispute resolution because most “differences of opinion” are addressed in the field.

Desired Changes in Segregation Specification

Agency respondents believed that the following segregation options would improve their current specification:

- Less subjectivity in either (or both) segregation definitions and segregation measurements (eight agencies).
- Implement temperature measurements (six agencies).
- Smaller tolerances for one or more of the following: “pattern segregation” mix property changes, air voids, and number of patches before requiring removing and/or replacing (three agencies).
- Defined levels of severity for specific corrective actions (two agencies).
- Better guidelines for removing and/or replacing, along with a better definition(s) and measurements (one agency).
- Add a segregation test method (one agency).
- Require at least one core for testing (one agency).
- Mandatory, rather than optional, testing for temperature differences (one agency).

Contractor’s indicated the following changes would be desirable:

- Less subjectivity
- Use Pave-IR technology
- Focus on incentives rather than disincentives
- Better control of mix gradations
- Enforcement of current specification(s)
- Use permeability testing in the laboratory to identify potential damage to pavement since stripping (moisture damage) and freeze/thaw cycles are major causes of deterioration.

Summary of Segregation Specification Comments

- Both agency staff and contractors agree that pay factors and requirements for removal and replacement are great motivators for minimizing segregation. However, contractors would like to see the same level of emphasis that is put on incentives placed on disincentives.
- Both agency staff and contractors agree specifications that encourage the use of effective practices in plant and placement operations are considered advantages.
- Although not stated in the same way, both agency staff and contractors noted that the use of effective practices to minimize segregation has the additional advantages

of increasing mat density uniformity and improving ride quality.

PAVEMENT DISTRESSES IN SEGREGATED AREAS

Segregation is responsible for significant loss of pavement life throughout the country. Question 25 is used to document agency and industry experience about the particular types of distresses that are seen more frequently in segregated areas compared with non-segregated areas (Table 17).

Question 25: Based on experience, indicate the type(s) of individual pavement distresses which occur in segregated areas. (Choose all that apply.)

Potholes, raveling, and longitudinal raveling are more frequently seen in segregated areas of the pavement than in the surrounding pavement. The loss of ride quality (i.e., a rougher ride) in segregated areas is frequently observed by about one-third of the respondents.

Raveling is followed in quick succession by longitudinal cracking and fatigue cracking. This concept is supported by respondents noting that longitudinal cracking and fatigue cracking either in or between the wheel paths also occurs more frequently in segregated than non-segregated areas. Reflective cracking, which is cracking initiated by underlining joints or cracks, was not influenced by segregated mix in the surface layer.

Progression of these segregated-related distresses is the source of the loss of pavement life resulting from segregation, but are also the least likely to be documented during traditional network pavement condition surveys. This is because the impact of localized areas of distress(es) are “averaged” using various pavement management system algorithms into the percentage of the roadway with each distress and the perceived impact of each distress on the useful life of the pavement.

Twenty-one agency respondents provided responses about the ability of their current pavement condition survey procedures to adequately capture the intermittent nature of segregation-related distresses and these are summarized as follows:

- Current procedures are not sensitive enough to evaluate cyclic distresses (nine agencies).
- Agency does not specifically track segregation-related distresses (four agencies).
- Not sure (four agencies).
- Texture has been used, but not routinely (one agency).
- International Roughness Index and video are used to confirm raveling (one agency).
- Formal monitoring of interstate roadways is conducted (one agency).

TABLE 17
PAVEMENT DISTRESSES IN SEGREGATED AREAS (Question 25)

Survey Choices	Frequently Higher Than Non-Segregated Areas				Same as Rest of Pavement			
	Agency (N = 48)		Industry (N = 19)		Agency (N = 48)		Industry (N = 19)	
	%	n	%	n	%	n	%	n
<i>Raveling, Stripping, Potholes</i>								
Raveling	52%	25	45%	9	0%	0	6%	1
Longitudinal raveling (e.g., at joints, auger gear box, locations of screed extensions)	35%	17	23%	4	2%	1	0%	0
Raveling along construction joints	40%	19	26%	5	2%	1	0%	0
Potholes (patched or unpatched)	46%	22	39%	7	0%	0	0%	0
<i>Ride Quality</i>								
Roughness	35%	17	39%	7	0%	0	0%	0
<i>Rutting</i>								
Depressions in wheel paths (e.g., rutting in low density areas)	8%	4	13%	2	19%	5	6%	1
<i>Cracking</i>								
Longitudinal cracking in wheel path(s)	25%	12	26%	5	6%	3	6%	1
Fatigue cracking in wheel path(s)	21%	10	19%	4	13%	6	6%	1
Longitudinal cracking, non-wheel path, non-reflective cracking (e.g., at joints, auger gear box, locations of screed extensions)	17%	8	3%	3	6%	3	6%	1
Longitudinal fatigue cracking in only one wheel path (e.g., screed extension location)	17%	8	13%	2	4%	2	6%	1
Transverse cracking	8%	4	6%	1	21%	10	13%	2
Reflective cracking	0%	0	6%	1	17%	8	13%	2
<i>Miscellaneous Distresses</i>								
Shoulder drop-off, shoving, etc.	4%	2	13%	2	15%	7	6%	1

Not all respondents answered all questions. Responses for “occasionally used,” “rarely used,” and “don’t know” not shown; multiple answers were allowed.

- Emerging distresses are evaluated as part of warranty programs (one agency).
- Walking survey is conducted for a sample 500-ft section (one agency).
- Additional monitoring is done once raveling is detected (one agency).
- *Intermittent potholes and raveling are the most frequently observed distresses in segregated areas of the pavement.*
- *Higher roughness (decreased ride quality) is frequently expected in segregated areas.*
- *Additional distresses seen in segregated areas include intermittent longitudinal and fatigue cracking.*
- *Current pavement condition survey procedures do not adequately capture the intermittent nature of segregation-related pavement distresses.*

REDUCING SEGREGATION DURING DESIGN, PRODUCTION, AND PLACEMENT

Mix Designs

Segregation can be reduced or encouraged by choices of gradations, asphalt (binder) type, and asphalt content. An additional question was included in the survey to explore the segregation potential of mixes with high recycled asphalt-containing material contents.

Recycled materials are typically more variable because of the range of sources of materials, differences in the recycled material densities, methods for pre- and post-removal processing, and the lack of consistent QC testing plans of recycled material stockpiles. All of these factors can influence the consistency of the final asphalt mix gradation and

TABLE 18
TYPICAL ASPHALT MIX GRADATION AND MAXIMUM AGGREGATE SIZES IN USE
(Question 14)

Survey Choices	Frequently Segregates				Occasionally Segregates			
	Agency (N = 48)		Industry (N = 19)		Agency (N = 48)		Industry (N = 19)	
	%	n	%	n	%	n	%	n
<i>Dense-Graded Mixes</i>								
Dense mix, 25-mm (1-in.) max. agg. size	19%	9	26%	5	15%	7	50%	10
Dense mix, 19-mm (3/4-in.) max. agg. size	15%	7	16%	3	38%	18	45%	9
Dense mix, 12.5-mm (1/2-in.) max. agg. size	0%	0	4%	1	38%	18	36%	7
Dense mix, 9.5-mm (3/8-in.) max. agg. size	0%	0	0%	0	6%	3	14%	3
<i>Other Types of Mixes</i>								
SMA gradations	0%	0	0%	0	14%	7	23%	4
Porous asphalt gradations	0%	0	6%	1	8%	4	14%	3
Ultrathin wearing course	0%	0	0%	0	4%	2	5%	1

Not all respondents answered all questions. Responses for “occasionally used,” “rarely used,” and “don’t know” not shown; multiple answers were allowed.

Max. agg. = maximum aggregate; min. agg. = minimum aggregate.

Boxed values highlight the impact of decreasing maximum aggregate size on the tendency of the mixes to segregate.

asphalt content, which also influence the segregation potential of the mix.

Gradations and Mix Type

The literature review found that segregation can be reduced by using mixes with smaller maximum aggregate sizes. Little information was found in the literature concerning the segregation potential of stone matrix asphalt (SMA), porous asphalt, and ultrathin wearing course. Question 14 collected information on these topics (Table 18).

Question 14: Based on your experience, indicate the tendency of the following aggregate gradations to segregate. (Choose all that apply.):

Agencies believe that dense mixes with maximum aggregate sizes of 12.5 mm or larger occasionally or frequently segregate. Industry representatives believe segregation decreases with decreases in the maximum size of aggregates. All respondents agree that mixes with 9.5-mm maximum aggregate size are not likely to segregate. Written comments included dense mixes with 37-mm (1.5-in.) maximum size aggregates and a generic designation of “big rock asphalt base” mixes as likely to segregate. The use of 12.5 mm or smaller maximum size gradations rarely segregate.

SMA, porous asphalt, and ultrathin wearing course gradations are considered to have some potential for segregation. SMA and porous asphalt mixes often have a larger percentage of coarser aggregates and higher asphalt contents, which implies that segregation is a separation of asphalt from the

aggregates. When there is not enough surface area to “hold” the asphalt, the asphalt drains off of the aggregate. Respondent comments indicated that they were less familiar with the segregation potential of these mixes than with dense-graded mixes.

- Segregation can be reduced by reducing the maximum size aggregate in the gradation.
 - 9.5 mm and smaller maximum aggregate size gradations are not likely to segregate.
- SMA and porous asphalt mixes occasionally segregate (asphalt drains down).

Binders (Asphalt)

Different types of binders and mixes designed for asphalt contents either with higher or lower contents can influence the ability of the binders to “stick” the aggregate particles together (i.e., asphalt film thickness) (Table 19).

Question 15: Based on your experience, indicate the impact of various binders on the tendency of mixes to segregate. (Choose all that apply.)

The only binder-related mix that frequently segregates is one with low asphalt content. Base courses or asphalt-stabilized layers are examples of mixes typically designed with low asphalt contents. In this instance, the segregation potential is related to the asphalt low film thickness that fails to provide sufficient binder to hold the aggregate particles together. Mixes with high asphalt content, and modified and unmodified binders occasionally segregate. There is a trend

TABLE 19
USE OF ASPHALT BINDER TYPES AND ASPHALT CONTENTS (Question 15)

Survey Choices	Frequently Segregates				Occasionally Segregates			
	Agency (N = 48)		Industry (N = 19)		Agency (N = 48)		Industry (N = 19)	
	%	n	%	n	%	n	%	n
High asphalt content mixes	0%	0	0%	0	10%	5	23%	4
Modified binder mixes	2%	1	1%	1	17%	8	19%	4
Unmodified binder mixes	2%	1	0%	0	13%	6	23%	4
Warm mix asphalt (WMA)	0%	0	0%	0	8%	4	13%	2
Low asphalt content mixes	15%	7	23%	4	27%	13	32%	6

Not all respondents answered all questions. Responses for “occasionally used,” “rarely used,” and “don’t know” not shown; multiple answers were allowed.

Boxed values highlight (1) WMA mixes to have less of a tendency to segregate than other mixes, and (2) the increased tendency of low asphalt mixes to have the most tendency to segregate.

for warm mix asphalt (WMA) mixes to have a somewhat lower expectation of segregation; however, agency respondents selected the “don’t know” choice from 30% to 48% of the time.

➤ *Low asphalt content mixes can frequently segregate.*

Recycled Materials

Variability in recycled material particulate sizes and asphalt content has the potential to increase the segregation potential of the asphalt mix (Table 20). Question 16 collected information about the respondent’s experiences with increasing segregation because of increasing RAP and/or RAS content.

Question 16: Based on your experience, indicate the impact of recycled materials used in your mixes to increase the tendency to segregate. (Choose all that apply.)

Mixes with recycled material contents are not likely to frequently segregate. Mixes with 10% or less RAP are considered to “occasionally segregate” by no more than 13% of the

respondents. Mixes with RAP contents of greater than 10% have more potential to occasionally segregate. It is interesting to note that industry representatives consider mixes with more than 10% RAP or with some RAS content to be more susceptible to segregation. It is likely that the lack of widespread and long-term use with high RAP and/or RAS content can skew the interpretation of the survey results.

One agency’s comment drew attention to a potential cause of segregation in mixes with a higher percentage of recycled materials:

We have done some limited production of higher RAP mixes (20%). Because we count all RAP asphalt toward the total asphalt content, we have suffered from some dry mixes with higher RAP contents. We have not realized that some RAP asphalt never remixes and that some of the RAP asphalt stays “locked-up” in the RAP and cannot contribute to the overall required asphalt content. Therefore, the measured asphalt content really isn’t the true “working asphalt” content and we end up with drier mixes that segregate easily.

That is, the low film thickness that occurs when the asphalt in the recycled material is not fully incorporated in the total

TABLE 20
USE OF ASPHALT-CONTAINING RECYCLED MATERIALS (Question 16)

Survey Choices	Frequently Segregates				Occasionally Segregates			
	Agency (N = 48)		Industry (N = 19)		Agency (N = 48)		Industry (N = 19)	
	%	n	%	n	%	n	%	n
RAP mixes, 10% or less	0%	0	0%	0	13%	6	5%	1
RAP mixes, 10% to 25%	0%	0	0%	0	27%	13	25%	5
RAP mixes, greater than 25%	4%	2	3%	1	19%	9	20%	4
Recycled asphalt shingles	0%	0	3%	1	8%	4	20%	4
Combination of RAP and shingles, 10% or less	2%	1	3%	1	4%	2	25%	5

Not all respondents answered all questions. Responses for “occasionally used,” “rarely used,” and “don’t know” not shown; multiple answers were allowed.

asphalt binder content of the mix ends up producing unintentionally lean mixes that in turn produce mixes that are more likely to segregate.

- *If higher percentages of asphalt-containing recycled materials unintentionally result in low effective asphalt contents (i.e., low film thickness), then the segregation potential of the mixes may increase.*
- *Future research studies might investigate the segregation potential of mixes with high recycled material content and allowable percentages of replacement binder ascribed to these materials.*

Material and Mix Production

Two questions (17 and 18) collected information about the frequency of use of specific equipment, operations, and training. Information was also collected about the respondent’s assessments of each option to help reduce segregation.

Aggregate Production

The selection of equipment used to move aggregate during the construction of stockpiles and the skills of the loader operator can significantly reduce segregation (Table 21).

Question 17: Indicate the typical use of aggregate pit/quarry equipment and practices and the potential impact on coarse or fine aggregate segregation. (Choose all that apply.)

Both agency staff and industry representatives agree that the use of radial, telescoping stackers helps reduce segregation when constructing aggregate stockpiles. The literature

also indicates radial stackers with telescoping capabilities are the most effective option for building stockpiles. However, radial stackers (telescoping or fixed) are typically larger-sized equipment, which are used in larger aggregate pit and quarry operations and may be a factor in the lower usage.

The more labor-intensive practice of constructing stockpiles with trucks, dozers, and fixed conveyors likely reflect stockpiles commonly built in locations with limited areas for stockpiles, such as at hot mix plants. Higher percentages of personnel-dependent processes make the skills of the loader operators more important to the overall reduction of segregation in asphalt mixes.

Slightly less than half of the agency respondents frequently use technician training, but not certification programs for equipment operators. Approximately one-third of the industry representatives believe that both training and certification programs can help reduce segregation. Because the skills of the loader operator can impact the level of segregation in the stockpiles, more emphasis on training and certification programs can be helpful for controlling segregation. Loader operator skills are particularly important if aggregate production and asphalt plant operations are combined at one location, because the same equipment operators can be responsible for both building the stockpiles and loading the cold feed bins.

- *Segregation in the aggregate stockpiles can be reduced by skilled loader operators.*
 - *Stockpiles are much more likely to be built using fixed location conveyors and truck/dozer methods, but are also methods that are more dependent on the skills of the loader operator to prevent segregation.*

TABLE 21
AGGREGATE PIT/QUARRY EQUIPMENT AND PRACTICES (Question 17)

Survey Choices	Frequently Used				Helps Reduce Segregation			
	Agency (N = 48)		Industry (N = 19)		Agency (N = 48)		Industry (N = 19)	
	%	n	%	n	%	n	%	n
<i>Equipment</i>								
Truck dumps/dozer stockpile construction	38%	18	23%	4	17%	8	10%	2
Fixed location conveyors	29%	14	26%	5	4%	2	3%	1
Radial stackers	17%	8	16%	3	17%	8	16%	3
Radial, telescoping stackers	13%	6	10%	2	25%	12	29%	6
<i>Practices</i>								
Technician certification programs	44%	21	29%	6	8%	4	29%	6
Equipment operator certification programs	6%	3	6%	1	8%	4	26%	5

Not all respondents answered all questions. Responses for “occasionally used,” “rarely used,” and “don’t know” not shown; multiple answers were allowed.

- *Loader operator certification programs are useful for reducing segregation during aggregate stockpile construction.*

Asphalt Plant Characteristics and Practices

Segregation in a batch plant can be introduced into the mix because of a build-up of fines or coarse aggregate in the #1 hot bin and introduced at several points at drum mix plants. Information on the range of options currently used for equipment and practices that can reduce segregation was collected with Question 18 (Table 22).

Question 18: Indicate the typical hot mix plant equipment and practices used in your state. (Choose all that apply.)

The number of cold bins available at the asphalt plant dictates the number of stockpiles that can be used to produce the mix gradation. More stockpiles allow for more stockpile and gradation options, stockpiles with narrower ranges

of particle sizes, tighter control of the job mix formula, and help keep the overall aggregate gradations well-blended. The majority of the respondents frequently use four or more cold feed bins. Approximately one-third of the industry respondents believe that the use of four or more cold feed bins helps reduce segregation.

Although batch plants are still in use in most states, drum mix plants are used more frequently.

Industry representatives indicated that counterflow drums are used somewhat more frequently than parallel flow drums. About one-third of these respondents also use kickback flights in the drum to help increase aggregate drying and mixing times. The lower percentage of responses from the agencies may be because this drum characteristic is not easily observed during production. Kickback flights help reduce segregation by ensuring that a uniform asphalt film thickness is obtained and help reblend the mix to minimize any segregation that may occur in the drum. Fixed plows at the discharge point are used, but not frequently.

TABLE 22
ASPHALT PLANT CHARACTERISTICS AND PRACTICES (Question 18)

Survey Choices	Frequently Used				Helps Reduce Segregation			
	Agency (N = 48)		Industry (N = 19)		Agency (N = 48)		Industry (N = 19)	
	%	n	%	n	%	n	%	n
<i>Aggregate Cold Feed Bins</i>								
Cold feed bins, 3 or fewer	19%	9	6%	1	2%	1	3%	1
Cold feed bins, 4 or more	52%	25	58%	11	19%	9	29%	6
<i>Plant Type</i>								
Batch plants	10%	5	6%	1	8%	4	0%	0
Drum mix plants	56%	27	58%	11	10%	5	20%	4
<i>Drum Characteristics</i>								
Parallel flow drums	33%	16	23%	4	4%	2	3%	1
Counterflow drums	31%	15	39%	7	6%	3	10%	2
Kick back flights in drum	13%	6	29%	6	13%	6	20%	4
Fixed plow at drum exit	6%	3	10%	2	4%	2	3%	1
<i>Silos</i>								
Silo loading batcher	38%	18	45%	9	19%	9	35%	7
Load out accomplished in multiple drops	52%	25	55%	10	29%	14	39%	7
<i>Training</i>								
Plant technician certification programs	38%	18	16%	3	13%	6	30%	6
Cold feed bin loader operator skills/training programs	4%	2	48%	9	13%	6	25%	5
Plant equipment operator certification programs	6%	3	23%	4	6%	3	20%	4

Not all respondents answered all questions. Responses for “occasionally used,” “rarely used,” and “don’t know” not shown; multiple answers were allowed.

Almost half of the industry respondents use silo batchers that help reduce segregation. Noticeably fewer agency respondents noted a frequent use of silo batchers or believe this equipment reduces segregation.

More than half of all respondents use multiple drops to load haul trucks and about one-third believe this helps reduce segregation.

More than one-third of the agencies use plant technician training programs; however, significantly fewer believe this training program can help reduce segregation. Less than 20% of the industry representatives noted that plant technician training is used; however, more than one-third believe this training helps reduce segregation. The differences between agency and industry respondents are likely the result of how technician test results are used; that is, agencies use testing for acceptance and contractors use the results for process (quality) control. One interesting observation is that industry representatives are more likely to believe training and certification programs are important for reducing segregation.

- Segregation can be reduced when
 - Four or more cold feed bins are used at the asphalt plant.
 - Drum mix plants use kickback flights.
 - Silo batchers are used.
 - Haul trucks are loaded with multiple drops.
 - Training and certification programs are used for asphalt plant technicians, loader operators, and asphalt plant operators.

Mix Transport and Mix Transfer

Segregation that occurs during asphalt mix production can be perpetuated and enhanced, or significantly reduced, by how

the asphalt mix is transferred to the paver. Asphalt mix that is segregated in the truck and deposited directly into the paver hopper appears as end-of-truck segregation in the finished pavement. Question 20 collected information about the type of haul trucks typically used on state projects and whether the respondents believed that the choice of the type of haul truck influences segregation (Table 23).

Question 20: Indicate the type(s) of haul trucks used in your state. (Choose all that apply.)

Agencies are more likely to use (see) a range of haul truck types on state projects. End dumps are the most frequently used; however, approximately one-third of the agencies see belly dumps and approximately one-sixth see live bottoms on state projects. State projects are typically larger projects that can benefit from transporting large amounts of mix at one time. Industry responses reflect more regional and local agency projects that have a wider range of project sizes, lengths, traffic levels, individual project constraints, and smaller budgets than those overseen by state agencies.

About 10% of the agency respondents believe that larger capacity haul trucks can help reduce segregation. This may be a reflection of the how the mix is transferred to the paver when either belly dumps or live bottom trucks are used. Belly dumps deposit mix in a windrow and windrow elevators can help reblend the mix as it is placed in the paver hopper. Live bottom truck bed designs that funnel the mix down and horizontally out the back can also help minimize segregation. An additional benefit from using these types of trucks is that they do not have to be raised to transfer the mix. This implies that areas with height restrictions are more easily accessed.

- Belly dumps and live bottom haul trucks may help reduce segregation, but this may actually be because of how the mix is transferred to the paver.

TABLE 23
USE OF TYPES OF HAUL TRUCK (Question 20)

Survey Choices	Frequently Used				Helps Reduce Segregation			
	Agency (N = 48)		Industry (N = 19)		Agency (N = 48)		Industry (N = 19)	
	%	n	%	n	%	n	%	n
End dumps	43%	20	58%	11	0%	0	0%	0
Transfer dumps (pups) (i.e., end dumps with extra trailer)	4%	2	0%	0	0%	0	0%	0
Bottom dumps (belly dumps)	31%	15	3%	1	10%	5	3%	1
Live bottom (flow boys)	15%	7	0%	0	13%	6	3%	1
Mixed types of trucks on single project	8%	4	10%	2	0%	0	0%	0
Quad axle dump trucks	2%	1	0%	0	0%	0	0%	0

Not all respondents answered all questions. Responses for “occasionally used,” “rarely used,” and “don’t know” not shown; multiple answers were allowed.

TABLE 24
HAUL TRUCK CHARACTERISTICS AND MATERIAL TRANSFER UNITS (Question 21)

Survey Choices	Frequently Used				Helps Reduce Segregation			
	Agency (N = 48)		Industry (N = 19)		Agency (N = 48)		Industry (N = 19)	
	%	n	%	n	%	n	%	n
<i>Haul Truck Characteristics During Transport</i>								
Tarps	50%	24	55%	10	23%	11	10%	2
Insulated truck beds	17%	8	10%	2	19%	9	10%	2
Heated truck bodies	0%	0	0%	0	0%	0	0%	0
<i>Mix Transfer from Truck to Paver</i>								
Material transfer device	31%	15	35%	7	29%	14	35%	7
Material transfer device with remixer	31%	15	32%	6	31%	15	35%	7
Windrow elevator (if windrow paving is used)	27%	13	3%	1	10%	5	10%	2
Baffle in truck bed around hydraulic lift	10%	5	3%	1	4%	2	6%	1
Removal of spillage between end dump and paver	23%	11	31%	6	25%	12	15%	3

Not all respondents answered all questions. Responses for “occasionally used,” “rarely used,” and “don’t know” not shown; multiple answers were allowed.

➤ *End dump haul trucks are the most frequently used truck types but the choice of truck type depends on the size of the project physical limitations (e.g., height constraints), and the mix of truck types in the contractor’s fleet.*

Information about mix transport practices that may reduce temperature segregation and how mix is transferred to the paver was collected with Question 21 (Table 24).

Question 21: Indicate the mix transport and transfer equipment and practices used in your state (Choose all that apply.)

Tarps are used to minimize flying debris and help slow temperature loss. At least half of the respondents frequently use tarps on haul trucks; however, fewer than one-quarter believe tarps actually help reduce (temperature) segregation. Less than 20% of the respondents use insulated truck beds.

One-third of the respondents use MTDs and also believe that this equipment helps reduce segregation. Because belly dumps are used approximately one-third of the time on state projects, about the same percentage indicated the use of windrow elevators.

At most, one-quarter of the agency respondents remove spills between the haul truck and paver, a practice that is considered likely to reduce segregation. Industry frequently removes spills, but does not always consider this a practice that can help reduce segregation.

- *Temperature segregation can be reduced by using insulated truck beds.*
 - *Tarps may help, but may more likely be used to prevent flying debris.*
- *MTDs help reduce segregation.*
 - *Windrow elevators are not considered as effective at reducing segregation.*
- *Removing spillage of mix between the haul trucks and paver is a good practice that may help reduce some forms of segregation.*

Pavers

Paver equipment and paving practices can either reduce or increase segregation, particularly longitudinal segregation (Table 25). Information about paver equipment and operations currently in use was collected with Question 22.

Question 22: Indicate the typical paver equipment and practices used in your state. (Choose all that apply.)

Front of the Paver

Older paver designs that use conveyors to move the mix from the hopper to the screed are still used on more than half of the pavers. Newer designs that replace conveyors with a pair of twin augers are now used about one-third of the time. The twin augers help pull mix from the entire paver hopper as well as rebblend the mix as it moves back to the screed. Eliminating the conveyors may help reduce longitudinal segregation when

TABLE 25
PAVER EQUIPMENT AND OPERATIONS (Question 22)

Survey Choices	Frequently Used				Helps Reduce Segregation			
	Agency (N = 48)		Industry (N = 19)		Agency (N = 48)		Industry (N = 19)	
	%	n	%	n	%	n	%	n
<i>Front of Paver</i>								
Hopper, slat conveyor(s)	65%	31	58%	11	13%	6	15%	3
Hopper, twin augers	29%	14	20%	4	15%	7	20%	4
Paver operator folds wings between each load	0%	0	3%	1	6%	3	10%	2
<i>Back of Paver</i>								
Screed extensions, front of screed	40%	19	15%	3	2%	1	10%	2
Screed extensions, back of screed	38%	18	39%	7	0%	0	10%	2
Auger extensions	38%	18	42%	8	25%	12	20%	4
Spread auger, gear box	46%	22	42%	8	6%	3	10%	2
Spread auger, outboard motor	6%	3	3%	1	2%	1	3%	1
Use of variable mix distribution to balance flow to augers	23%	11	35%	7	10%	5	10%	2
Use of mix temperature information to make adjustments to paver operation	6%	3	10%	2	17%	8	10%	2

Not all respondents answered all questions. Responses for “occasionally used,” “rarely used,” and “don’t know” not shown; multiple answers were allowed.

coarser aggregate particles roll off the edges of the conveyors or are fractured under the conveyor belts. The conveyor belt configuration has also been linked to early occurrences of top-down cracking that aligns with the edges of the conveyor belts; the newer paver designs may also reduce this type of distress.

Although none of the respondents indicated that they frequently flip the paver wings, approximately one-third noted that this practice is still occasionally used (28% to 33%). The use of material transfer units helps minimize this practice, because the surge bin in the hopper prevents this practice.

Back of the Paver

Screed extensions either front or back and with or without auger extensions are used about 40% of the time. Only the use of the auger extensions can reduce segregation. About the same percentage of pavers still have gear boxes in the center of the screed.

From one-quarter to one-third of the pavers in use can balance the flow of mix so that both sides of the screed augers receive the same volume of mix. The literature review indicated that keeping a uniform volume of mix across the screed can significantly reduce segregation and dragging of the screed because one or both augers are starved for mix. However, only

10% of the respondents believe that an option for variable flow is important to reducing segregation. The potential benefit of this equipment option could be explored more thoroughly in future studies.

There is currently a limited use of temperature differences to adjust paving operations. Agency respondents, more than industry, believe this is useful for reducing segregation.

- Segregation can be reduced with the use of:
 - A pair of twin augers to move mix from the hopper to the screed.
 - The benefit of this design could be investigated in future research studies.
 - Auger extensions are used when screed extensions are deployed.
- Additional research is essential to determine if the use of balanced mix flow across the screed augers reduces segregation.
 - The literature review identified this feature as beneficial, but the survey results do not confirm the literature.

Compaction

Several documents found in the literature review acknowledged the potential for sound compaction practices and

TABLE 26
COMPACTION EQUIPMENT (Question 23)

Survey Choices	Frequently Used				Helps Improve Durability of Segregated Mix			
	Agency (N = 48)		Industry (N = 19)		Agency (N = 48)		Industry (N = 19)	
	%	n	%	n	%	n	%	n
<i>Breakdown Rollers</i>								
Breakdown, steel drum, vibration	65%	31	55%	10	23%	11	16%	3
Breakdown, steel drum, no vibration	15%	7	10%	2	10%	5	0%	0
Breakdown, pneumatic	4%	2	0%	0	15%	7	3%	1
Intelligent compaction unit	2%	1	0%	0	6%	3	3%	1
<i>Intermediate Rollers</i>								
Intermediate, steel drum, vibration	42%	20	29%	6	10%	5	16%	3
Intermediate, steel drum, no vibration	8%	4	6%	1	8%	4	0%	0
Intermediate, pneumatic	27%	13	23%	4	25%	12	13%	2
<i>Finish Rollers</i>								
Finish, steel drum	67%	32	55%	10	6%	3	10%	2

Not all respondents answered all questions. Responses for “occasionally used,” “rarely used,” and “don’t know” not shown; multiple answers were allowed.

aggressive compaction to minimize low density in mix or temperature segregation (FHWA 2002; Gilbert 2005). However, no specific studies were found to substantiate these observations. Question 23 was included to collect information on typical compaction practices for breakdown, intermediate and finish rolling, and the possibility for improved durability with various combinations of rollers (Table 26).

Question 23: Indicate typical roller types used in your state. (Choose all that apply.)

Over half of the respondents use steel wheel vibratory rollers for breakdown rolling. Agencies use steel wheel vibratory rollers as the intermediate roller about twice as often as pneumatic rubber tire rollers. Industry representatives use both types about equally. This difference in use is likely a reflection of the wider range of project sizes and traffic volumes represented by the industry responses.

Industry representatives are slightly more convinced than the agencies that an intermediate steel wheel vibratory roller can help improve the durability in segregated areas. About one-quarter of the agencies believe that the use of intermediate pneumatic rubber tire rollers can help improve durability; however, significantly fewer industry representatives agree.

Steel wheel rollers are commonly used as the finish rollers, but are not considered to improve durability in segregated areas.

- *Steel wheel vibratory rollers are commonly used as the breakdown roller.*
 - *There is no consensus on whether they can improve the durability in segregated areas.*
- *Pneumatic rubber tire rollers are used as the intermediate rollers about one-quarter of the time.*
 - *There is no consensus on whether they can improve the durability in segregated areas.*

CONCLUSIONS

The important points identified in the literature review and survey sections are assembled here in table formats that can be used for quick guidance for:

- Descriptions, detection, and inspection responsibilities for segregation (Table 27);
- Specifications, pavement distresses, and capabilities of pavement management systems to evaluate segregation (Table 28); and
- Links between test methods, training and certification programs, and segregation (Table 29).

The conclusions are organized as individual tables for quick reference on how and where segregation occurs and how it can be reduced or eliminated:

- During mix design and aggregate production (Table 30),
- At the asphalt plant (Table 31),
- During mix transport and mix transfer (Table 32), and
- At the paver (Table 33).

The following gaps in the information were found in the literature search and in the survey responses:

- Standardized definitions and descriptions for all types of segregation where not consistently defined. Such descriptions and terms can help improve consistency in detecting segregation, particularly when visual detection is the standard detection method.
- Future research programs and pilot projects could evaluate:
 - Ground penetrating radar as a means of detecting segregated areas of the mat, and
 - Intelligent compaction roller technologies as a means of ensuring increased durability can be obtained by aggressive rolling in segregated areas of the mat.

- Recycled materials that contribute asphalt content to the mix could be evaluated:
 - Quality control practices for ensuring consistent effective asphalt content,
 - Segregation potential of high recycled material content mixes, and
 - Successful practices to physically reblend high recycled content mixes during production and placement.
- Effectiveness of paver equipment characteristics to reduce or eliminate segregation could be documented for:
 - Pairs of twin augers in the paver hopper,
 - Outboard motors and narrower spacing of hopper conveyors,
 - Independent speed controls for hopper conveyors or augers for keeping consistent mix volumes across the entire paver screed, and
 - Benefits of using auger extensions when screed extensions are used.
- The possibility of adjusting pavement condition survey practices and pavement management system analysis of data to evaluate cyclic occurrences of early pavement distresses linked to segregation could be explored.
- Texture measurements have some potential to locate and quantify end-of-truck segregation and subsequent textural changes resulting from raveling in these areas; however, these data are not currently collected during annual condition surveys.
- Pavement management systems are not currently configured to assess the impact of early distresses in segregated areas on pavement life. Changes to how individual distresses are reported may help quantify the loss of pavement life resulting from segregation.

TABLE 27
 DESCRIPTIONS, DETECTION, AND INSPECTION RESPONSIBILITIES FOR SEGREGATION

Topic	Categories	Importance
Descriptions of Segregation	Localized areas of coarse texture in the finished mat	Descriptions of segregation need to be standardized to help with consistent detection of segregation, particularly visual detection.
	Longitudinal “streaks” of coarser-texture mix in center of mat behind the paver (e.g., under gear box, at screed extensions)	
	Longitudinal “streaks” of coarser-textured mix on one or both sides of mat behind the paver	
	Localized areas of very fine texture in the finished mat (smoother surface than uniform textured areas)	
	Localized areas of hotter or cooler temperature mix behind the paver	
	Transverse sections of cooler temperature mix (e.g., after changing trucks, paver stops)	
	Localized “clumps” of fibers and/or binder or other mix additives	
	Localized binder-rich areas (e.g., “fat spots”) in the finished mat	
Detection of Segregation	Visual	Almost always used; considered the “gold standard”
	Temperature differences	Currently used in addition to visual detection, but automated sensor bars are more widely used.
	Ride quality, bump detection	Used more frequently by industry; possibly linked to ride quality specifications Early loss of ride quality occurs in segregated areas
	Texture	Not routinely used Longitudinal texture profiles can detect end-of-truck segregation and evaluate effectiveness of material transfer units in reducing this type of segregation.
	Ground penetrating radar, intelligent compaction	Have possibilities, but have not yet been evaluated for detection of segregated areas.
Responsibility for Field Inspections	Wide mix of agency staff and consultants	Well-defined definitions and understanding of segregation on how and where segregation can occur are important for everyone conducting field inspections.

TABLE 28
SPECIFICATIONS, PAVEMENT DISTRESSES, AND CAPABILITIES OF PAVEMENT MANAGEMENT SYSTEMS TO EVALUATE SEGREGATION

Topic	Categories	Importance
Specifications	Method of detection	Visual detection most used, followed by temperature differences; no consistent use of temperature differences at this time
	Disincentives	Remove and replace most frequent disincentive
		Time needed for additional testing for segregation is a good disincentive; delays construction
		Percent within limits (PWL) and level of segregation incremental pay factors not frequently used
	Advantages	Defines steps for detection, testing, quantifies segregation
		Provides ability to reject work
		Forces contractor "best practices"
	Disadvantages	Can be subjective
		Too much time needed for testing; delays construction
		Accepts lots that look segregated
Dispute resolution	Usually dealt with by the field or district level staff	
Desired changes	Less subjective	
	Use temperature measurements	
	Require cores	
	Smaller tolerances for QC/QA testing	
Pavement Distresses in Segregated Areas	Raveling, potholes	Most frequently expected distresses
	Increased roughness	Expected at least 35% more often
	Longitudinal and fatigue cracking in wheel path	Expected about 25% more often
Pavement Management System	Ability to identify pavement distresses resulting from segregation	Do not currently have the ability to assess and monitor intermittent pavement distresses

TABLE 29
LINKS BETWEEN TEST METHODS, TRAINING AND CERTIFICATION PROGRAMS, AND SEGREGATION

Topic	Categories	Importance
Roadway QC/QA Test Methods in Segregated Areas	Nuclear and non-nuclear gauges	No consistent method of use: Variations in testing include single point, pair of test points, or longitudinal, transverse, and skewed density profiles.
		<i>Nuclear density gauges:</i> Overestimates roadway density if coarse textured surfaces are not sanded prior to testing (air gaps alter readings). Clean gauge bottom also needed to keep air gaps at a minimum.
		<i>Non-nuclear density gauges:</i> Any variations in mix moisture content influence density measurements.
		Gauges not always calibrated with cores.
Laboratory QC/QA Testing for Segregated Samples	Density tests	<i>AASHTO T166:</i> Overestimates density in segregated areas because segregated samples are more permeable. Coated or sealed samples are more likely to provide more accurate density measurements.
	Gradations	<i>Ignition oven testing:</i> Aggregate fracture because of heat needs calibration factor or any increases in coarse sizes resulting from segregation are underestimated.
	Performance-related testing	Not currently used to evaluate the change in mix properties in segregated areas.
Training and Certification Programs	Field inspectors	Both agency staff and consultant are used for field inspections.
		Training is important for all field inspection staff so everyone has a consistent understanding of segregation definitions, detection, causes, and methods for reduction.
	Asphalt plant and field technicians	Topics covered in training need links between the topic and causes segregation at each step.
	Materials engineers, lab techs	Importance of using best field and laboratory practices and methods when determining mix properties in segregated areas could be included in training programs.
Equipment operator certification programs	Loader operator certification and training programs can help reduce segregation. Skills needed for constructing aggregate stockpiles, managing stockpiles at the asphalt plant, and loading the cold feed bins at the asphalt plant.	

TABLE 30
HOW AND WHERE SEGREGATION CAN BE REDUCED DURING MIX DESIGN AND AGGREGATE PRODUCTION

Location	Topics	How to Reduce Segregation	Comments
Mix Design	Gradation	Limit gaps in the gradation	Use gradation chart with all Superpave sieve sizes plotted to see any gaps that should be minimized
			Bailey method of designing gradation helps minimize gaps
	Maximum aggregate size	Use 9.5-mm maximum size aggregate mixes Physically reblend mixes with larger maximum size aggregates when transferring mix from haul trucks to paver (e.g., material transfer units, baffles at back of end dump bed to funnel mix)	12.5 mm or larger maximum size aggregate mix increasingly segregates with increases in maximum size aggregate
	SMA and porous asphalt	Increase additives to prevent drain down	Occasionally segregate; asphalt separates (drains down) from aggregate
	Asphalt content (asphalt film thickness)	Minimum voids in mineral aggregate (VMA) establish a minimum acceptable asphalt film thickness Small increase in asphalt content in gradations with some gapping (e.g., 0.2% typical dense mix)	Adequate asphalt film thickness is needed to “stick” the aggregate particles together
			Low asphalt content mixes such as base coarses and stabilized mix can frequently segregate
	Recycled materials with an asphalt content	Keep RAP content to less than 10% RAP at 10% to 25%: Reblending the mix before it starts to move through the paver can help (e.g., material transfer vehicle/device baffles at back of end dump bed to funnel mix)	Quality control testing needed to keep track of variations in the recycled material asphalt content
Higher contents of asphalt containing recycled material can result in “dry” mixes (low asphalt film thickness) when recycled asphalt content not completely used in effective asphalt content			
Variations in asphalt content in the recycled material results in variations in asphalt film thickness, which makes it difficult to control segregation			
Aggregate Production	Practices	Loader operator training and certification programs	Majority of stockpiles are constructed with labor-intensive practices with trucks, dozers, and fixed conveyors

TABLE 31
HOW AND WHERE SEGREGATION CAN BE REDUCED AT THE ASPHALT PLANT

Location	Topics	How to Reduce Segregation	Comments
Asphalt Plant	Cold feed bins	At least four or more cold feed bins are needed	More cold feed bins allow a larger number of aggregate stockpiles to be used with narrower ranges of gradations in each
	Batch plants	Actively dislodge fines that build up on the #1 hot bin	Keeps “clumps” of fines from dropping into mixer all at once
	Drum mix plants	<i>Drum:</i> Kickback flights inside the drum	Helps improve mixing and drying times, which improves asphalt film thickness
		<i>Discharge point:</i> Use fixed plow at exit	Forces mix to reblend as it exits
		<i>Discharge point:</i> Set drag slat conveyor at 90° to exit	Forces mix to reblend as it exits
	Silo batchers	Keep top chute over center of batcher	Keeps coarser aggregates from collecting on one side
		Fill batcher and drop all at once into the silo	There needs to be enough mix so it flattens out when it lands in the silo. This keeps a cone from forming that segregates mix.
		Close batcher gates quickly	Keeps mix from “dribbling” into silo
	Load out	“Build” smaller batches of mix in all haul trucks (multiple drops)	Helps keep any possible segregation blended with overall mix gradation
		DO NOT load mix in single drop	Results in coarser particles rolling to entire perimeter of haul truck bed
DO NOT load mix continuously as larger haul truck moves forward		Results in one continuous cone that allows coarser aggregates to roll down and to the outer edges of the haul truck bed	

TABLE 32
HOW AND WHERE SEGREGATION CAN BE REDUCED DURING MIX TRANSPORT AND MIX TRANSFER

Location	Topics	How to Reduce Segregation	Comments
Mix Transport	Truck types	<i>Belly dumps and live bottom:</i> May help reblend mixes with lower levels of segregation	Survey indicated these haul trucks help minimize segregation, but this benefit may be the result of remixing, which occurs during transfer rather than truck type
	Truck options	<i>Tarps:</i> Some indication they help manage temperature segregation	Widespread use most likely because they limit flying debris
		<i>Insulated truck beds:</i> Help minimize temperature segregation	Used by agencies in the colder regions of the country Used by agencies with long haul distances
Material Transfer	End dumps	Use funnel-shape baffles at back of bed	Forces mix to reblend as it flows through funnel into paver hopper
	Windrow elevators (pick-up devices)	Deposit sufficient mix in windrow to keep optimum amount of mix supplied to screed	Windrows commonly formed by belly dumps
		DO NOT “dribble” mix out in thin stream	When next truck places more mix on top of “dribble,” both mix and temperature segregation is produced.
		Minimize segregation in haul truck bed	Limited amount of segregation can be remixed by windrow elevators, but more severe levels of segregation will still be transferred to the paver hopper.
	Material transfer vehicles/devices	Keep sufficient amount of mix in holding hopper and surge bin	Keeps screed auger from being “starved” for mix
		DO NOT run surge bin with low level of mix	
		Properly size surge bin to size of paver hopper	Needed for proper operation of transfer units
Make sure remixing augers in holding hopper or surge bin are running		Easily overlooked during set up; needed for most successful reblending of mix	
	DO NOT scrape down cold mix built up on sides of holding hopper or surge bin if the mix is too low	This creates both mix and temperature segregation	

TABLE 33
HOW AND WHERE SEGREGATION CAN BE REDUCED AT THE PAVER

Location	Topics	How to Reduce Segregation	Comments
Pavers— At Front	Hopper	Keep hopper at least half full	If wings are flipped, then there is sufficient mix in the hopper to reblend any coarser aggregates deposited by haul trucks.
		DO NOT let hopper run too low before flipping wings	Creates end of truck segregation
	Moving mix	<i>Drag slats</i> : ensures that coarse aggregate stays on conveyors (may require retrofit)	Coarse aggregated rolling off conveyor edges creates longitudinal segregation that is documented to cause premature top-down longitudinal cracking.
		<i>Outboard motors</i> : allows closer spacing of conveyors	Helps minimize coarser aggregates from rolling off conveyor
		<i>Pair of twin augers</i> : newer design that helps reblend mix in hopper	May help reduce some forms of longitudinal segregation but benefits have not yet been fully documented.
		Independent operation of conveyor speed	Different speeds allow the volume of mix supplied to each side of the screed to be balanced.
	DO NOT allow variable speed operation to draw mix down too low on one side of the hopper	Can create one-sided longitudinal segregation when wings are flipped.	
Pavers— At Back	Near gear box	<i>Kicker paddles</i> : pushes mix under gear box Use reverse flow option if available on paver to push mix under gear box	Keeps coarser aggregates mixed with more uniform mix
	Screed augers	Keeps volume of mix consistent; about 75% of the auger height is about right	Lower levels “starve” augers that segregates mix
	Head of material	Keep optimum height of mix at the edge of the screed	Optimum mix level helps keep angle of attack constant, mat thickness uniform, and the screed from dragging and tearing mat.
	Screed extensions	Balance flow of mix to each side of screed	Can require independent speed controls for mix delivery from hopper when extensions are different widths on each side.
	Use auger extensions when screed extensions are used	Mix needs to be pulled from the center by the augers across the full width of paving. Segregation occurs when the mix is pushed. This happens when auger extensions are NOT used.	

ABBREVIATIONS AND ACRONYMS

APA	Asphalt Pavement Association
GPR	Ground penetrating radar
IC	Intelligent compaction
IRI	International Roughness Index
JMF	Job mix formula
MTD	Material transfer device
MTV	Material transfer vehicle
PQI	Pavement Quality Indicator
QA	Quality assurance
QC	Quality control
RAP	Recycled asphalt pavement
RAS	Recycled asphalt shingles
SMA	Stone matrix asphalt
TTI	Texas Transportation Institute
TxDOT	Texas Department of Transportation
USCOE	United States Army Corps of Engineers
VDOT	Virginia Department of Transportation
WMA	Warm mix asphalt
WSDOT	Washington Department of Transportation

REFERENCES

- Abu-Hassan, M., *Sampling Location Impact on Measuring Asphalt Content of Hot Mix Asphalt*, Report No. CDOT-DTD-R-2002-12, Colorado Department of Transportation, Denver, 2002 [Online]. Available: http://www.coloradodot.info/programs/research/pdfs/2002/asphalt_sampling.pdf [accessed July 17, 2013].
- Adams, J., R. Mulvaney, B. Reppovitch, and B. Worel, "Investigation of Construction-Related Asphalt Concrete Pavement Temperature Differentials," Office of Materials and Road Research, Minnesota Department of Transportation, Maplewood, Oct. 2001 [Online]. Available: <http://www.mrr.dot.state.mn.us/research/pdf/2001mrrdoc005.pdf> [accessed July 5, 2013].
- Advanced Asphalt Technologies, LLC, *NCHRP Report 673: A Manual for Design of Hot-Mix Asphalt with Commentary*, Transportation Research Board of the National Academies, Washington, D.C., 2011 [Online]. Available: http://www.nap.edu/openbook.php?record_id=14524 [accessed June 7, 2013].
- Al-Qadi, I.L. and S. Lahouar, "Use of GPR for Thickness Measurement and Quality Control of Flexible Pavements," *Association of Asphalt Paving Technologists*, Vol. 73, Mar. 2004, pp. 501–528.
- American Association of State Highway and Transportation Officials (AASHTO), "Segregation: Causes and Cures for Hot Mix Asphalt," Publication by the Joint Task Force on Segregation of AASHTO Subcommittee on Construction; AASHTO Subcommittee on Materials; and National Asphalt Pavement Association, AASHTO, Washington, D.C., 1997 [Online]. Available: <http://www.in.gov/indot/files/segregationAsphalt.pdf> [accessed Aug. 15, 2013].
- Applied Pavement Technology (APT), "Circular Texture Meter Overview," APT, Urbana, Ill., 2008 [Online]. Available: http://www.appliedpavement.com/techResources equipLoanProg_ctmeter.html [accessed Mar. 20, 2014].
- Astec, Inc., "Storage Bin Segregation, Chattanooga, Tenn., 2010 [Online]. Available: <http://tecspot.astecinc.com/category/products/storage-bins/> [accessed Jan. 20, 2014] and <http://tecspot.astecinc.com/2010/11/storage-bin-segregation/> [accessed June 2013].
- Bateman, A., "Tracked MTV Targets Multiple Application," *Rock to Road*, Oct.–Nov. 2009 [Online]. Available: http://www.rocktoroad.com/index.php?option=com_content&task=view&id=993&Itemid=134 [accessed May 15, 2014].
- Bode, T.A., *An Analysis of the Impacts of Temperature Segregation on Hot Mix Asphalt*, Dissertation, Construction Systems Department, University of Nebraska–Lincoln, Sept. 1, 2012 [Online]. Available: <http://commons@unl.edu/constructiondiss> [accessed June 27, 2013].
- Brock, D. and H. Jakob, "Temperature Segregation-Temperature Differential Damage," Technical Paper T-134, Astec Industries, Inc., Urbana, Ill., 1999 [Online]. Available: http://www.roadtec.com/images/uploads/productdocs/t134_techpaper_temperaturesegregation.pdf [accessed Jan. 15, 2014].
- Brock, J.D., J.G. May, and G. Renegar, "Hot Mix Asphalt Segregation: Causes and Cures," Quality Improvement Series 110/86, National Asphalt Pavement Association, Riverdale, Md., 1998 [Online]. Available: http://inti.gob.ar/cirsoc/pdf/tecnologia_hormigon/T-117_Segregation_Causes_Cures.pdf [accessed Aug. 15, 2013].
- BS EN 12697-15:2003 Bituminous mixtures—Test methods for hot mix asphalt. Part 15: Determination of the segregation sensitivity.
- Buncher, M.S. and C. Rosenberg, "Best Practices for Construction and Specifying HMA Longitudinal Joints," Asphalt Institute and Federal Highway Administration draft final report, May 2012 [Online]. Available: <http://www.asphaltinstitute.org/dotAsset/69e25ae4-a615-4e51-89d4-84e6bbbd31ac.pdf> [accessed June 27, 2013].
- Cerdas, S.F., *Thermal Segregation: Causes and Effects on In-Place Density and Fatigue Performance of Asphalt Mixtures*, Master's Thesis, Auburn University, May 2012 [Online]. Available: <http://etd.auburn.edu/etd/handle/10415/3028> [accessed Oct. 2, 2012].
- Cho, Y.K., Y.R. Kim, and T. Bode, *Infrared Thermography-Driven Flaw Detection and Evaluation of Hot Mix Asphalt Pavements*, Nebraska Transportation Center, Lincoln, Report No. SPR-PI (08) P309, Jan. 2010 [Online]. Available: <http://nlcs1.nlc.state.ne.us/epubs/R6000/B016.0145-2010.pdf> [accessed Sept. 20, 2013].
- Cleaver, L., "Longer Life for Your Mat," ForConstructionPros.com™, Mar. 20, 2012 [Online]. Available: <http://www.forconstructionpros.com/article/10658939/longer-life-for-your-mat> [accessed June 28, 2013].
- De Freitas, E.F., P. Pereira, L. Picado-Santos, and A.T. Papagiannakis, "Effect of Construction Quality, Temperature, and Rutting on Initiation of Top-Down Cracking," *Transportation Research Record: Journal of the Transportation Research Board*, No. 1929, Transportation Research Board of the National Academies, Washington, D.C., 2005, pp. 174–182.
- de Leon Izzepi, E.D., G.W. Flintsch, and A.L. Abbott, *Measuring the Uniformity of Hot Mix Asphalt Pavements with Digital Image Technology*, Dissertation, Civil and Environmental Engineering, Virginia Polytechnic Institute and State University, Blacksburg, Sept. 21, 2006 [Online]. Available: http://scholar.lib.vt.edu/theses/available/etd-10062006-011435/unrestricted/Diss_EDL.pdf [accessed July 7, 2013].
- de Leon Izzepi, E.D. and G.W. Flintsch, *Application of Digital Image Technology to Measure Hot Mix Asphalt Homogeneity*, Dissertation, Civil and Environmental Engineering, Virginia Polytechnic Institute and State University, Blacksburg, Sept. 21, 2006a [Online]. Available: http://scholar.lib.vt.edu/theses/available/etd-10062006-011435/unrestricted/Diss_EDL.pdf [accessed July 7, 2013].

- de Leon Izzepi, E.D. and G.W. Flintsch, *High-Speed, Non-Contact Imaging System for Inspection of Hot-Mix Asphalt Pavement*, Dissertation, Civil and Environmental Engineering, Virginia Polytechnic Institute and State University, Blacksburg, Sept. 21, 2006b [Online]. http://scholar.lib.vt.edu/theses/available/etd-10062006-011435/unrestricted/Diss_EDL.pdf [accessed July 7, 2013].
- Dixon, M., "Non-Destructive Density Gauge Use on Asphalt Pavement," Troxler Electronic Laboratories, n.d. [Online]. Available: http://www.apao.org/documents/NuclearGaugeUseonAsphaltPavement_Dixon.pdf [accessed June 30, 2014].
- Federal Highway Administration (FHWA), "Pavement Preservation Checklist Series 3: Thin Hot-Mix Asphalt Overlay," FP², FHWA, Washington, D.C., Sept. 2002 [Online]. Available: <http://www.wsdot.wa.gov/NR/rdonlyres/7F43DCD4-0136-4842-AC82-B0C897BB3038/0/ppcl03.pdf> [accessed June 28, 2013].
- Feng, X., S. Ye, and P. Hao, "A New Laboratory Method to Characterize Gradation and Segregation of Asphalt Mixes," *Construction and Building Materials*, Vol. 38, 2013, pp. 1199–1203.
- Flintsch, G.W., K.K. McGhee, and E. de Leon Izzepi, "Field Validation of Macrotecture-Based Hot Mix Asphalt Segregation Detection Methods," *Journal of Association of Asphalt Paving Technologists*, Vol. 74, 2005 [Online]. Available: http://scholar.lib.vt.edu/theses/available/etd-10062006-011435/unrestricted/Diss_EDL.pdf [accessed Oct. 11, 2013].
- ForConstructionPros.com, "Smooth, Consistent and Continuous," 2012 [Online]. Available: <http://www.forconstructionpros.com/article/10837622/smooth-consistent-and-continuous> [accessed Oct. 11, 2013].
- Gavin, J. and D. Heath, *Paving Guidelines and Segregation Rating Manual*, Technical Standards Branch, Highway Engineering Section, Alberta Ministry of Transportation, 2002 [Online]. Available: <http://www.transportation.alberta.ca/Content/docType233/Production/pavsegman.pdf> [accessed July 7, 2013].
- Gilbert, K., *Thermal Segregation*, Report No. CDOT-DTD-R-2005-16, Colorado Department of Transportation, Denver, Nov. 2005 [Online]. Available: <http://www.coloradodot.info/programs/research/pdfs/2005/thermal%20segregation.pdf> [accessed Sept. 1, 2013].
- Gunter, C.B., *Field Evaluation of Temperature Differential in HMA Mixtures*, Report No. FHWA-SC-12-02, South Carolina Department of Transportation, Columbia, May 2012 [Online]. Available: <http://www.clemson.edu/t3s/scdot/pdf/projects/SPR%20673%20Thermal%20Segg%20Final%20Report.pdf> [accessed June 27, 2013].
- Hanson, D. and B. Prowell, "Evaluation of Circular Texture Meter for Measuring Surface Texture of Pavements," 2004 [Online]. Available: <http://www.pavetrack.com/documents/NCAT%20Reports/04-05%20Evaluation%20of%20Circular%20Texture%20Meter%20for%20Measuring%20Surface%20Texture%20of%20Pavements.pdf> [accessed June 30, 2014].
- Harmelink, D., S. Shuler, and T. Ascenbrener, "Top-Down Cracking in Asphalt Pavements: Causes, Effects, and Cures," *Journal of Transportation Engineering*, Vol. 134, 2008, pp. 1–6.
- Harris, J.K., *The Effect of Material Transfer Device on Pavement Smoothness*, Master's thesis, Civil Engineering Department, Auburn University, Auburn, Ala., Dec. 2002.
- Haskell, B., "Intelligent Asphalt Compaction Analyzer," Highways for LIFE Technology Partnerships Program Progress Report, Haskell Lemon Construction Company, Norman, Okla., 2007 [Online]. Available: <http://www.fhwa.dot.gov/hfl/partnerships/haskell/phase1/index.cfm> [accessed July 28, 2014].
- Henault, J.W., K.R. Lane, and J.M. Sime, *Development of Guidelines for Reduction of Temperature Differential Damage (TDD) for Hot Mix Asphalt Pavement Projects in Connecticut—Construction Report*, Research Report No. 2222-1-99-5, Division of Research, Bureau of Engineering and Highway Operations, Connecticut Department of Transportation, Hartford, Nov. 1999 [Online]. <http://www.ct.gov/dot/LIB/dot/documents/dresearch/CT-2222-F-04-9.pdf> [accessed June 27, 2013].
- Henault, J., D.A. Larsen, and J.J. Scully, *Development of Guidelines for Reduction of Temperature Differential Damage (TDD) for Hot Mix Asphalt Pavement Projects in Connecticut*, Construction Report No. 2222-F-04-9, Connecticut Department of Transportation, Hartford, Dec. 2005 [Online]. Available: <http://www.ct.gov/dot/LIB/dot/documents/dresearch/CT-2222-F-04-9.pdf> [accessed Sept. 2, 2013].
- Mahoney, J., S.A. Zinke, J.E. Stephens, L.A. Myers, and A.J. DaDalt, *Application of Infrared Thermographic Imaging to Bituminous Concrete Pavements—Final Report*, Report No. 2229-F-03-7, Connecticut Advanced Pavement Laboratory, Connecticut Transportation Institute, School of Engineering, University of Connecticut, Storrs, Nov. 2003 [Online]. Available: http://www.caplab.uconn.edu/pdfs/thermal_imaging_final-rpt.pdf [accessed July 20, 2013].
- Marais, H. and D. Pretorius, "Innovative Design Methods for HMA in Gauteng," *SABITA Digest*, Southern African Bitumen Association (Publisher), Pinelands 7505, South Africa, Mar. 2007 [Online]. Available: www.sabita.co.za/documents/DIGEST-06.pdf [accessed Nov. 2013].
- McGhee, K., "Application of High Speed Texture Measurement to Traditional Hot Mix Asphalt Acceptance Testing," *Materials Evaluation*, Vol. 62, No. 7, July 2004, pp. 784–789.
- McGhee, K.K., G.W. Flintsch, and E. de León, *Using High-Speed Texture Measurement to Improve the Uniformity of Hot-Mix Asphalt*, Technical Report VTRC 03-R12, Virginia Transportation Research Council and Federal Highway Administration, Charlottesville, May 2003, p. 23 [Online]. Available: http://www.virginiadot.org/vtrc/main/online_reports/pdf/03-r12.pdf [accessed Oct. 30, 2013].
- Meegoda, J.N., G.M. Rowe, A. Jumikis, C.H. Hettiarachchi, N. Bandara, and N. Gephart, "Detection of Surface Segre-

- gation Using LASER,” CD-ROM, 82nd Annual Meeting of the Transportation Research Board, Washington D.C., Jan. 12–16, 2003 [Online]. Available: www.ltrc.lsu.edu/TRB_82/TRB2003-001764.pdf [accessed Sept. 20, 2013].
- Meegoda, J.N., G.M. Rowe, C.H. Hettiarachchi, N. Bandara, and M.J. Sharrock, *Correlation of Surface Texture, Segregation and Measurement of Air Voids*, Report FHWA-NJ-2002-026, New Jersey Department of Transportation and Abatech, Trenton, 2002 [Online]. Available: http://transportation.njit.edu/nctip/final_report/CorrelationOfSurfaceTextureSegregation.pdf [accessed June 27, 2013].
- Murphy, T., *Segregation of Hot Mix Asphalt: Observations, Evaluations, and Recommendations*, Murphy Pavement Technology, Inc., Chicago, Ill., 2012a [Online]. Available: www.murphypavetech.com [accessed Nov. 15, 2013].
- Murphy, T., *Segregation: The Cardiac Arrest of Hot Mix Asphalt Pavements*, Murphy Pavement Technology, Inc., Chicago, Ill., 2012b [Online]. Available: www.murphypavetech.com [accessed Nov. 15, 2013].
- Nener-Plante, D.J. and A. Zofka, “Long-Term Study on Asphalt Mixture Segregation in Connecticut: Preliminary Results on the Use of MTV,” *Proceedings of the 8th International Conference on the Bearing Capacity of Roads, Railways, and Airfields*, Champaign, Ill., June 29–July 2, 2009.
- Quality in California, “Stockpile Segregation,” May 24, 2011 [Online]. Available: <http://www.qualityincalifornia.com/2011/stock-pile-segregation.html> [accessed Sept. 20, 2013].
- Rand, D.A., “Thermal Segregation,” Southeastern User Producer Group Conference, Oklahoma City, Dec. 8, 2010 [Online]. Available: http://www.seaupg.org/PDF/2010/Wednesday/5%20Thermal%20Segregation_DRand_TxDOT.pdf [accessed June 27, 2013].
- Rand, D.A., “Measuring Pavement Segregation,” TxDOT Construction Division presentation, Austin, 2012 [Online]. Available: <http://www.flexiblepavements.org/sites/www.flexiblepavements.org/files/events/conferences/Measuring%20Pavement%20Segregation.pdf> [accessed June 27, 2013].
- Rowe, G.M., J.N. Meegoda, A. Jumikis, and M.J. Sharrock, “NJTxtr—A Computer Program Based on LASER to Monitor Asphalt Segregation,” *Journal of Construction Engineering and Management*, Vol. 130, Nov./Dec. 2004, pp. 924–934.
- Scherocman, J.A., *Segregation: Causes and Cures*, J. Scherocman, Consulting Engineer, Cincinnati, Ohio, Oct. 2011 [Online]. Available: http://www.oregon.gov/ODOT/HWY/CONSTRUCTION/manuals/hmac_inspector_training/14_hmac.pdf [accessed July 9, 2013].
- Sebesta, S. and T. Scullion, *Infrared Imaging and Ground Penetrating Radar to Detect Segregation in Hot Mix Overlays*, Texas Transportation Institute, Texas A&M, College Station, 2002 [Online]. Available: [cloudfront.net/tti.tamu.edu/documents/4126-1.pdf](http://d2dt15nnlpfr0r.cloudfront.net/tti.tamu.edu/documents/4126-1.pdf) [accessed Nov. 26, 2013].
- Sebesta, S. and T. Scullion, *Performance Monitoring Pavements with Thermal Segregation in Texas*, Report FHWA/TX-12/0-6080-1, Texas Transportation Institute, Texas A&M University, College Station, April 2012 [Online]. Available: <http://onlinepubs.trb.org/onlinepubs/shrp2/SHRP2prepubR06C.pdf> [accessed Aug. 3, 2013].
- Sebesta, S., F. Wang, T. Scullion, and W. Liu, *New Infrared and Radar Systems for Detecting Segregation in Hot-Mix Asphalt Construction*, Texas Transportation Institute, Texas A&M University, College Station, April 2006 [Online]. Available: <http://d2dt15nnlpfr0r.cloudfront.net/tti.tamu.edu/documents/0-4577-2.pdf> [accessed Oct. 14, 2013].
- Sebesta, S., T. Scullion, and T. Saarenketo, *Using Infrared and High-Speed Ground-Penetrating Radar for Uniformity Measurements of New HMA Layers*, SHRP2 Report S2-R06C-RR-1, Transportation Research Board of the National Academies, Washington, D.C., 2013 [Online]. Available: <http://onlinepubs.trb.org/onlinepubs/shrp2/SHRP2prepubR06C.pdf> [accessed July 1, 2013].
- Song, J., M. Abdelrahman, and E. Asa, *Use of a Thermal Camera During Asphalt Pavement Construction*, North Dakota State University Department of Civil Engineering Final Report to North Dakota Department of Transportation, Bismarck, Sept. 2009 [Online]. Available: http://www.dot.nd.gov/divisions/materials/research_project/ndsu0801final.pdf [accessed July 7, 2013].
- Stroup-Gardiner, M. and E.R. Brown, *NCHRP Report 441: Segregation in Hot Mix Asphalt Pavements*, Transportation Research Board, National Research Council, Washington, D.C., 2000 [Online]. Available: http://onlinepubs.trb.org/onlinepubs/nchrp/nchrp_rpt_441.pdf [accessed Oct. 15, 2013].
- Tahmoressi, M., D. Head, T. Saenz, and S. Rebala, *Material Transfer Device Showcase in El Paso, Texas*, DHT-47, Departmental Research, Texas Department of Transportation, Austin, 1999.
- Texas Department of Transportation (TxDOT), *Test Procedure for Thermal Profile of Hot Mix Asphalt*, TxDOT Designation: Tex-244-F, TxDOT, Austin, 2011 [Online]. Available: ftp://ftp.dot.state.tx.us/pub/txdot-info/cst/TMS/200-F_series/pdfs/bit244.pdf [accessed Jan. 15, 2014].
- U.S. Army Corps of Engineers (USCOE), *Hot-Mix Asphalt Laydown and Compaction Part III*, Report AC150/5370-14A, Appendix 1, 2001 [Online]. Available: http://www.faa.gov/documentlibrary/media/advisory_circular/150-5370-14a/150_5370_14a_app1_part_i.pdf [accessed June 27, 2013].
- Valdes, G., F. Perez-Jimenez, R. Miro, A. Martinez, and R. Botella, “Experimental Study of Recycled Asphalt Mixtures with High Percentages of Reclaimed Asphalt Pavement (RAP),” *Construction and Building Materials*, 2011, Vol. 25, pp. 1289–1297.
- Virginia Department of Transportation (VDOT), *Asphalt Field Certification Study Guide*, MCS: Asphalt Field

- Certification School, VDOT and Platinum Performance Partners, LLC, Charlottesville, 2012 [Online]. Available: <http://www.virginiadot.org/business/matschools.asp> [accessed June 28, 2013].
- Warren, J., "End of Load Segregation: Identification, Causes, and Cures," Asphalt Contractors Association of Florida, Tallahassee, 2013 [Online]. Available: <http://www.acaf.org/>.
- Williams, M.B., *The Effect of Material Transfer Devices on the Texture and Temperature Differentials of Hot Mix Asphalt Concrete*, Master thesis, Civil Engineering Department, Auburn University, Auburn, Ala., May 2003.
- Williams, R.C., G.R. Duncan, and T.D. White, *Sources, Measurements, and Effects of Segregation Hot Mix Asphalt Pavement*, FHWA/IN/JHRP-96/16, Joint Highway Research Project, Purdue University, West Lafayette, Ind., Dec. 1996 [Online]. Available: <http://docs.lib.purdue.edu/cgi/viewcontent.cgi?article=1664&context=jtrp> [accessed July 2, 2013].
- Willoughby, K.A., et al., *Construction-Related Asphalt Concrete Pavement Temperature Differentials and the Corresponding Density Differentials*, Report Number WA-RD 476.1, Washington State Transportation Center, University of Washington, Seattle, June 2001 [Online]. Available: <http://www.wsdot.wa.gov/research/reports/fullreports/476.1.pdf><http://www.wsdot.wa.gov/research/reports/fullreports/476.1.pdf> [accessed Aug. 19, 2013].
- Willoughby, K.A., J.A. Mahoney, L.M. Pierce, J.S. Uhlmeyer, and K.W. Anderson, "Construction-Related Variability in Mat Density Due to Temperature Differentials," 82nd Annual Meeting of the Transportation Research Board, Washington, D.C., Jan. 12–16, 2003 [Online]. Available: http://www.ltrc.lsu.edu/TRB_82/TRB2003-001535.pdf.
- Wise, J., "Old Habits Die Hard—Especially in Cape Town," *SABITA Digest*, CAPSA 2006 Paper Summary, Sept. 2007 [Online]. Available: www.sabita.co.za/documents/DIGEST-06.pdf [accessed Nov. 2013].
- Wolff, T.F., G.Y. Baladi, and C. Chang, *Detecting and Quantifying Segregation in Bituminous Pavements and Relating Its Effect to Condition*, Pavement Research Center of Excellence, Michigan State University, Lansing, 2000 [Online]. Available: <http://202.154.59.182/ejournal/files/Application%20of%20digital%20image%20processing%20techniques%20for%20asphalt%20concrete%20mixture%20images.pdf> [accessed Nov. 12, 2013].
- Zeilew, H.M. and A.T. Papagiannakis, "Wavelet-Based Characterization of Aggregate Segregation in Asphalt Concrete X-Ray Computed Tomography Images," *International Journal of Pavement Engineering*, Vol. 12, No. 6, Dec. 2011, pp. 553–559.
- Zettler, R., "Longer Life for Your Mat," Site-K Construction Zone, 2012 [Online]. Available: <http://www.site-kconstructionzone.com/?p=8072> [accessed June 27, 2013].

APPENDIX A

On-Line Survey Form

NCHRP Synthesis Topic 45-12 HMA Segregation

Please enter respondent's information.

First Name

Last Name

E-mail Address

Phone Number

Mobile Phone

Title

Agency or Company Name

Street Address

Apt./Suite/Office

City

State

Zip

Country

Agency Specification for Segregation in Asphalt Concrete

1. Your agency considers an asphalt mix to be segregated when there are (Choose all that apply):

Additional short descriptions can be added in the "Other" boxes at the end of the list. There is room for longer comments in the "Comments" box following this list.

- Localized areas of coarse texture in the finished mat.
- Localized areas of very fine texture in the finished mat (smoother surface than uniform textured areas).
- Longitudinal "streaks" of coarser-texture mix in center of mat behind the paver (e.g. under gear box, at screed extensions).
- Longitudinal "streaks" of coarser-textured mix on one or both sides of mat behind the paver.
- Localized areas of hotter or cooler temperature mix behind the paver.
- Transverse sections of cooler temperature mix (e.g., after changing trucks, paver stops).
- Localized areas of binder-rich (e.g., "fat spots") in the finished mat.
- Localized "clumps" of fibers and/or binder or other mix additives.
- Other
- Other
- Other

Comments

2. Does your agency typically perform field inspection of paving projects with agency staff or with consultants? (Choose all that apply.)

Agency staff

Consultant

Other

If more than one method of inspection is used, indicate the percent of each.

Comments

3. Does your agency have a ***segregation specification***? If so, what is the section number in your agency standard/manual for your segregation specification? Please provide a link to your specification and/or manual.

4. If your agency has a segregation specification, how are the level(s) of ***segregation quantified***?

5. If you have segregation specifications, please tell us what you think are the ***advantages*** of your current segregation specifications?

6. If you have segregation specifications, please tell us what you think are the ***disadvantages*** of your current segregation specifications.

7. If your agency has a segregation specification, does it include ***incentives/disincentives, monetary adjustments, or remove and replace requirements*** included in your segregation specification? If so, are they effective in improving the quality of the pavement?

8. Estimate the ***time spent on dispute resolution*** due to segregation issues. Has this time increased/decreased due to recent changes in your agency's segregation specification?

9. If you could, ***what would you change*** in your agency segregation specification?

Detection and Quantification of Segregation

10. How are areas of segregation asphalt mix ***detected***? (Choose all that apply.)

You can enter additional choices in the "Other" boxes at the end of the list.

- Visual examination
- Infrared thermometer (gun)
- Infrared camera
- Infrared temperature sensors (e.g., Pave-IR)
- Ground penetrating radar (GPR)
- Combination of infrared temperature sensors and GPR
- Profilometer (California)
- Inertial profiler - light weight
- Inertial profiler - full size
- Bump detection software for profiler
- Other
- Other
- Other

Comments

11. How is the segregated asphalt mix ***location documented?*** (Choose all that apply.)
You can enter additional choices in the "Other" boxes at the end of the list.

Marked on road or side of roadway

Measured from survey marker, mile post

GPS coordinates using hand held device

Infrared temperature software (manufacturer)

Inertial profiler (manufacturer)

Other

Other

Comments

12. If ***density testing*** (other than standard random sampling) is conducted after segregation is identified, indicate how the testing is done. (Choose all that apply.)

You can enter additional choices in the blank boxes at the end of the list.

	Don't know	Nuclear density gauges	Non-nuclear density gauges
Single point on pavement			
Pair of single points, one each in uniform and non-uniform textured areas.			
Longitudinal density profile			
Skewed longitudinal density profile			
Transverse density profile			
One or more cores taken for gauge calibration			

Comments

13. If cores and/or loose mix are obtained for ***laboratory testing*** (other than for standard random sampling) after segregation is identified, indicate the testing which is completed on the potentially segregated mix. (Choose all that apply.)

You can enter additional choices in the blank boxes at the end of the list.

	Don't know	Cores	Loose mix
Density testing (AASHTO T166)	<input type="checkbox"/>	<input type="checkbox"/>	<input type="checkbox"/>
Density testing, vacuum sealed (AASHTO T331)	<input type="checkbox"/>	<input type="checkbox"/>	<input type="checkbox"/>
Density testing, paraffin-coating (AASHTO T275)	<input type="checkbox"/>	<input type="checkbox"/>	<input type="checkbox"/>
Density testing, parafilm wrapped (ASTM D1188)	<input type="checkbox"/>	<input type="checkbox"/>	<input type="checkbox"/>
Asphalt content, solvent extraction (AASHTO T164)	<input type="checkbox"/>	<input type="checkbox"/>	<input type="checkbox"/>
Asphalt content, ignition oven (AASHTO T308)	<input type="checkbox"/>	<input type="checkbox"/>	<input type="checkbox"/>
Gradation, solvent-extracted aggregate Gradation, after ignition oven	<input type="checkbox"/>	<input type="checkbox"/>	<input type="checkbox"/>
Indirect tensile strength, dry (AASHTO T283)	<input type="checkbox"/>	<input type="checkbox"/>	<input type="checkbox"/>
Tensile strength ratio (AASHTO T283)	<input type="checkbox"/>	<input type="checkbox"/>	<input type="checkbox"/>
Permeability	<input type="checkbox"/>	<input type="checkbox"/>	<input type="checkbox"/>
Fatigue testing	<input type="checkbox"/>	<input type="checkbox"/>	<input type="checkbox"/>
Rut testing	<input type="checkbox"/>	<input type="checkbox"/>	<input type="checkbox"/>
<input type="text"/>	<input type="checkbox"/>	<input type="checkbox"/>	<input type="checkbox"/>
<input type="text"/>	<input type="checkbox"/>	<input type="checkbox"/>	<input type="checkbox"/>
<input type="text"/>	<input type="checkbox"/>	<input type="checkbox"/>	<input type="checkbox"/>

Comments

Impact of Mix Variables on Segregation

14. Based on your experience, indicate the tendency of the following aggregate gradations to segregate. (Choose all that apply.)

You can enter additional choices in the blank boxes at the end of the list.

	Don't know	Frequently segregate	Occasionally segregate	Rarely segregate	No influence
Dense mix, 25-mm (1-in.) max. agg.					
Dense mix, 19-mm (3/4-in.) max. agg.					
Dense mix, 12.5-mm (1/2-in.) max. agg.					
Dense mix, 9.5-mm (3/8-in.) max. agg.					
SMA gradations					
Porous asphalt gradations					
Ultrathin wearing course					

◀ ||| ▶

Comments

What are the most commonly used types of gradations for intermediate and wear courses in your state?

15. Based on your experience, indicate the impact of various ***binders*** on the tendency of mixes to segregate. (Choose all that apply.)

You can enter additional choices in the blank boxes at the end of the list.

	Don't know	Frequently segregate	Occasionally segregate	Rarely segregate	No influence
High asphalt content mixes					
Low asphalt content mixes					
Unmodified binder mixes					
Modified binder mixes					
Warm mix asphalt additives/technologies					

◀
▶

Comments

16. Based on your experience, indicate the impact of *recycled materials* use in your mixes to increase the tendency to segregate. (Choose all that apply.)

You can enter additional choices in the blank boxes at the end of the list.

	Don't know	Frequently segregates	Occasionally segregates	Rarely segregates	No influence
RAP mixes, 10% or less					
RAP mixes, 10% to 25%					
RAP mixes, greater than 25%					
Recycled asphalt shingles					
Combination of RAP and shingles, 10% or less					



Additional comments on recycled materials

Construction Processes - Aggregate Suppliers

17. Indicate the typical use of *aggregate pit/quarry equipment and practices* and the potential impact on coarse or fine aggregate segregation. (Choose all that apply.)

You can enter additional choices in the blank boxes at the end of the list.

	Don't know	Frequently used	Occasionally used	Rarely used	Helps reduce segregation
Truck dumps/dozer stockpile construction	<input type="checkbox"/>	<input type="checkbox"/>	<input type="checkbox"/>	<input type="checkbox"/>	<input type="checkbox"/>
Fixed location conveyors					
Radial stackers	<input type="checkbox"/>	<input type="checkbox"/>	<input type="checkbox"/>	<input type="checkbox"/>	<input type="checkbox"/>
Radial, telescoping stackers					
Technician certification programs	<input type="checkbox"/>	<input type="checkbox"/>	<input type="checkbox"/>	<input type="checkbox"/>	<input type="checkbox"/>
Equipment operator certification programs					
	<input type="checkbox"/>	<input type="checkbox"/>	<input type="checkbox"/>	<input type="checkbox"/>	<input type="checkbox"/>
	<input type="checkbox"/>	<input type="checkbox"/>	<input type="checkbox"/>	<input type="checkbox"/>	<input type="checkbox"/>

◀ ||| ▶

Comments

Construction Processes - Asphalt Plant

18. Indicate the typical *hot mix plant equipment and practices* used in your state. (Choose all that apply.)

You can enter additional choices in the blank boxes at the end of the list.

	Don't know	Frequently used	Occasion-ally used	Rarely used	Helps reduce segregation
Cold feed bins, 3 or fewer	<input type="checkbox"/>	<input type="checkbox"/>	<input type="checkbox"/>	<input type="checkbox"/>	<input type="checkbox"/>
Cold feed bins, 4 or more	<input type="checkbox"/>	<input type="checkbox"/>	<input type="checkbox"/>	<input type="checkbox"/>	<input type="checkbox"/>
Cold feed bin loader operator skills/training programs	<input type="checkbox"/>	<input type="checkbox"/>	<input type="checkbox"/>	<input type="checkbox"/>	<input type="checkbox"/>
Batch plants	<input type="checkbox"/>	<input type="checkbox"/>	<input type="checkbox"/>	<input type="checkbox"/>	<input type="checkbox"/>
Drum mix plants	<input type="checkbox"/>	<input type="checkbox"/>	<input type="checkbox"/>	<input type="checkbox"/>	<input type="checkbox"/>
Parallel flow drums	<input type="checkbox"/>	<input type="checkbox"/>	<input type="checkbox"/>	<input type="checkbox"/>	<input type="checkbox"/>
Counterflow drums	<input type="checkbox"/>	<input type="checkbox"/>	<input type="checkbox"/>	<input type="checkbox"/>	<input type="checkbox"/>
Kick back flights in drum	<input type="checkbox"/>	<input type="checkbox"/>	<input type="checkbox"/>	<input type="checkbox"/>	<input type="checkbox"/>
Fixed plow at drum exit	<input type="checkbox"/>	<input type="checkbox"/>	<input type="checkbox"/>	<input type="checkbox"/>	<input type="checkbox"/>
Silo loading batcher	<input type="checkbox"/>	<input type="checkbox"/>	<input type="checkbox"/>	<input type="checkbox"/>	<input type="checkbox"/>
Loadout accomplished in multiple drops	<input type="checkbox"/>	<input type="checkbox"/>	<input type="checkbox"/>	<input type="checkbox"/>	<input type="checkbox"/>
Plant technician certification programs	<input type="checkbox"/>	<input type="checkbox"/>	<input type="checkbox"/>	<input type="checkbox"/>	<input type="checkbox"/>
Plant equipment operator certification programs	<input type="checkbox"/>	<input type="checkbox"/>	<input type="checkbox"/>	<input type="checkbox"/>	<input type="checkbox"/>
	<input type="checkbox"/>	<input type="checkbox"/>	<input type="checkbox"/>	<input type="checkbox"/>	<input type="checkbox"/>
	<input type="checkbox"/>	<input type="checkbox"/>	<input type="checkbox"/>	<input type="checkbox"/>	<input type="checkbox"/>
	<input type="checkbox"/>	<input type="checkbox"/>	<input type="checkbox"/>	<input type="checkbox"/>	<input type="checkbox"/>

Comments

19. Indicate topics which are covered in ***asphalt plant and/or field technician certification programs*** (all levels) in your state. (Choose all that apply.)

You can enter additional choices in the blank boxes at the end of the list.

	Included in technician certification	Helps reduce segregation	No influence on segregation
Properties of component materials			
Stockpiling of aggregates			
Loading cold feed bins			
Blending			
Heating			
Drying			
Mixing			
Loading haul trucks			
Plant calibration			
Quality control charts			
Transportation to job site			
End dump transfer to paver			
Loading material transfer device			
Joint construction			
Roller operations			
Random sampling			
Identification of segregated mix			

Comments

Please indicate where technician certification program material can be obtained. Provide link(s) if possible.

Construction Processes - Mix Transport and Transfer Practices

20. Indicate the type(s) of **haul trucks** used in your state. (Choose all that apply.)
 You can enter additional choices in the blank boxes at the end of the list.

	Don't know	Frequently used	Occasionally used	Rarely used	Not used	Allowed under certain project condition
End dumps						
Transfer dumps (pups) (i.e., end dumps with extra trailer)	<input type="checkbox"/>	<input type="checkbox"/>	<input type="checkbox"/>	<input type="checkbox"/>	<input type="checkbox"/>	<input type="checkbox"/>
Bottom dumps (belly dumps)						
Live bottom (flow boys)	<input type="checkbox"/>	<input type="checkbox"/>	<input type="checkbox"/>	<input type="checkbox"/>	<input type="checkbox"/>	<input type="checkbox"/>
Mixed types of trucks on single project						
	<input type="checkbox"/>	<input type="checkbox"/>	<input type="checkbox"/>	<input type="checkbox"/>	<input type="checkbox"/>	<input type="checkbox"/>
	<input type="checkbox"/>	<input type="checkbox"/>	<input type="checkbox"/>	<input type="checkbox"/>	<input type="checkbox"/>	<input type="checkbox"/>

Comments

21. Indicate the ***mix transport and transfer equipment and practices*** used in your state.
 (Choose all that apply.)

You can enter additional choices in the blank boxes at the end of the list.

	Don't know	Frequently used	Occasionally used	Rarely used	Not used	Allowed under certain project condition
Tarps						
Baffle in truck bed around hydraulic lift	<input type="checkbox"/>	<input type="checkbox"/>	<input type="checkbox"/>	<input type="checkbox"/>	<input type="checkbox"/>	<input type="checkbox"/>
Insulated truck beds						
Material transfer device	<input type="checkbox"/>	<input type="checkbox"/>	<input type="checkbox"/>	<input type="checkbox"/>	<input type="checkbox"/>	<input type="checkbox"/>
Material transfer device with mixer						
Windrow elevator (if windrow paving is used)	<input type="checkbox"/>	<input type="checkbox"/>	<input type="checkbox"/>	<input type="checkbox"/>	<input type="checkbox"/>	<input type="checkbox"/>
Removal of spillage between end dump and paver						
	<input type="checkbox"/>	<input type="checkbox"/>	<input type="checkbox"/>	<input type="checkbox"/>	<input type="checkbox"/>	<input type="checkbox"/>
	<input type="checkbox"/>	<input type="checkbox"/>	<input type="checkbox"/>	<input type="checkbox"/>	<input type="checkbox"/>	<input type="checkbox"/>

Comments

Construction Processes - Paver and Compaction

22. Indicate the typical ***paver equipment and practices*** used in your state. (Choose all that apply.)

You can enter additional choices in the blank boxes at the end of the list.

	Don't know	Frequently used	Occasionally used	Rarely used	Not used	Helps reduce segregation
Hopper, slat conveyor(s)	<input type="checkbox"/>	<input type="checkbox"/>	<input type="checkbox"/>	<input type="checkbox"/>	<input type="checkbox"/>	<input type="checkbox"/>
Hopper, twin augers	<input type="checkbox"/>	<input type="checkbox"/>	<input type="checkbox"/>	<input type="checkbox"/>	<input type="checkbox"/>	<input type="checkbox"/>
Screed extensions, front of screed	<input type="checkbox"/>	<input type="checkbox"/>	<input type="checkbox"/>	<input type="checkbox"/>	<input type="checkbox"/>	<input type="checkbox"/>
Screed extensions, back of screed	<input type="checkbox"/>	<input type="checkbox"/>	<input type="checkbox"/>	<input type="checkbox"/>	<input type="checkbox"/>	<input type="checkbox"/>
Auger extensions	<input type="checkbox"/>	<input type="checkbox"/>	<input type="checkbox"/>	<input type="checkbox"/>	<input type="checkbox"/>	<input type="checkbox"/>
Spread auger, gear box	<input type="checkbox"/>	<input type="checkbox"/>	<input type="checkbox"/>	<input type="checkbox"/>	<input type="checkbox"/>	<input type="checkbox"/>
Spread auger, outboard motor	<input type="checkbox"/>	<input type="checkbox"/>	<input type="checkbox"/>	<input type="checkbox"/>	<input type="checkbox"/>	<input type="checkbox"/>
Use of variable mix distribution to balance flow to augers	<input type="checkbox"/>	<input type="checkbox"/>	<input type="checkbox"/>	<input type="checkbox"/>	<input type="checkbox"/>	<input type="checkbox"/>
Paver operator folds wings between each load	<input type="checkbox"/>	<input type="checkbox"/>	<input type="checkbox"/>	<input type="checkbox"/>	<input type="checkbox"/>	<input type="checkbox"/>
Use mix temperature information to make adjustments to paver operation	<input type="checkbox"/>	<input type="checkbox"/>	<input type="checkbox"/>	<input type="checkbox"/>	<input type="checkbox"/>	<input type="checkbox"/>
	<input type="checkbox"/>	<input type="checkbox"/>	<input type="checkbox"/>	<input type="checkbox"/>	<input type="checkbox"/>	<input type="checkbox"/>
	<input type="checkbox"/>	<input type="checkbox"/>	<input type="checkbox"/>	<input type="checkbox"/>	<input type="checkbox"/>	<input type="checkbox"/>
	<input type="checkbox"/>	<input type="checkbox"/>	<input type="checkbox"/>	<input type="checkbox"/>	<input type="checkbox"/>	<input type="checkbox"/>

◀
▶

Comments

23. Indicate typical **roller types** used in your state. (Choose all that apply.)

While the type of rollers won't actually influence segregation, it may be possible to minimize localized poor performance in these areas with appropriate choice(s) of equipment. This question will hopefully obtain more information on this topic.

You can enter additional choices in the blank boxes at the end of the list.

	Don't know	Frequently used	Occasionally used	Rarely used	Not used	Helps improve durability segregation mix
Breakdown, steel drum, no vibration	<input type="checkbox"/>	<input type="checkbox"/>	<input type="checkbox"/>	<input type="checkbox"/>	<input type="checkbox"/>	<input type="checkbox"/>
Breakdown, steel drum, vibration	<input type="checkbox"/>	<input type="checkbox"/>	<input type="checkbox"/>	<input type="checkbox"/>	<input type="checkbox"/>	<input type="checkbox"/>
Breakdown, pneumatic	<input type="checkbox"/>	<input type="checkbox"/>	<input type="checkbox"/>	<input type="checkbox"/>	<input type="checkbox"/>	<input type="checkbox"/>
Intermediate, steel drum, no vibration	<input type="checkbox"/>	<input type="checkbox"/>	<input type="checkbox"/>	<input type="checkbox"/>	<input type="checkbox"/>	<input type="checkbox"/>
Intermediate, steel drum, vibration	<input type="checkbox"/>	<input type="checkbox"/>	<input type="checkbox"/>	<input type="checkbox"/>	<input type="checkbox"/>	<input type="checkbox"/>
Intermediate, pneumatic	<input type="checkbox"/>	<input type="checkbox"/>	<input type="checkbox"/>	<input type="checkbox"/>	<input type="checkbox"/>	<input type="checkbox"/>
Finish, steel drum	<input type="checkbox"/>	<input type="checkbox"/>	<input type="checkbox"/>	<input type="checkbox"/>	<input type="checkbox"/>	<input type="checkbox"/>
Intelligent compaction unit	<input type="checkbox"/>	<input type="checkbox"/>	<input type="checkbox"/>	<input type="checkbox"/>	<input type="checkbox"/>	<input type="checkbox"/>
	<input type="checkbox"/>	<input type="checkbox"/>	<input type="checkbox"/>	<input type="checkbox"/>	<input type="checkbox"/>	<input type="checkbox"/>
	<input type="checkbox"/>	<input type="checkbox"/>	<input type="checkbox"/>	<input type="checkbox"/>	<input type="checkbox"/>	<input type="checkbox"/>
	<input type="checkbox"/>	<input type="checkbox"/>	<input type="checkbox"/>	<input type="checkbox"/>	<input type="checkbox"/>	<input type="checkbox"/>

◀
▶

Comments

Construction Process - Joint Construction

24. Indicate *joint construction practices* used and the impact on mix and/or temperature segregation. (Choose all that apply.)

You can enter additional choices in the blank boxes at the end of the list.

	Don't know	Frequently used	Occasionally used	Rarely used	Not used	Minimize mix segregation at joint
Hot joint	<input type="checkbox"/>	<input type="checkbox"/>	<input type="checkbox"/>	<input type="checkbox"/>	<input type="checkbox"/>	<input type="checkbox"/>
Semi-hot joint	<input type="checkbox"/>	<input type="checkbox"/>	<input type="checkbox"/>	<input type="checkbox"/>	<input type="checkbox"/>	<input type="checkbox"/>
Cold joint	<input type="checkbox"/>	<input type="checkbox"/>	<input type="checkbox"/>	<input type="checkbox"/>	<input type="checkbox"/>	<input type="checkbox"/>
	<input type="checkbox"/>	<input type="checkbox"/>	<input type="checkbox"/>	<input type="checkbox"/>	<input type="checkbox"/>	<input type="checkbox"/>
Cold joint cut back	<input type="checkbox"/>	<input type="checkbox"/>	<input type="checkbox"/>	<input type="checkbox"/>	<input type="checkbox"/>	<input type="checkbox"/>
Butt joint	<input type="checkbox"/>	<input type="checkbox"/>	<input type="checkbox"/>	<input type="checkbox"/>	<input type="checkbox"/>	<input type="checkbox"/>
Notched wedge joint	<input type="checkbox"/>	<input type="checkbox"/>	<input type="checkbox"/>	<input type="checkbox"/>	<input type="checkbox"/>	<input type="checkbox"/>
Wedge or tapered joint	<input type="checkbox"/>	<input type="checkbox"/>	<input type="checkbox"/>	<input type="checkbox"/>	<input type="checkbox"/>	<input type="checkbox"/>
Overlap material at joint	<input type="checkbox"/>	<input type="checkbox"/>	<input type="checkbox"/>	<input type="checkbox"/>	<input type="checkbox"/>	<input type="checkbox"/>
Echelon paving	<input type="checkbox"/>	<input type="checkbox"/>	<input type="checkbox"/>	<input type="checkbox"/>	<input type="checkbox"/>	<input type="checkbox"/>
Joint matcher	<input type="checkbox"/>	<input type="checkbox"/>	<input type="checkbox"/>	<input type="checkbox"/>	<input type="checkbox"/>	<input type="checkbox"/>
Ski	<input type="checkbox"/>	<input type="checkbox"/>	<input type="checkbox"/>	<input type="checkbox"/>	<input type="checkbox"/>	<input type="checkbox"/>
Roll from cold side	<input type="checkbox"/>	<input type="checkbox"/>	<input type="checkbox"/>	<input type="checkbox"/>	<input type="checkbox"/>	<input type="checkbox"/>
Roll from hot side	<input type="checkbox"/>	<input type="checkbox"/>	<input type="checkbox"/>	<input type="checkbox"/>	<input type="checkbox"/>	<input type="checkbox"/>
	<input type="checkbox"/>	<input type="checkbox"/>	<input type="checkbox"/>	<input type="checkbox"/>	<input type="checkbox"/>	<input type="checkbox"/>
	<input type="checkbox"/>	<input type="checkbox"/>	<input type="checkbox"/>	<input type="checkbox"/>	<input type="checkbox"/>	<input type="checkbox"/>
	<input type="checkbox"/>	<input type="checkbox"/>	<input type="checkbox"/>	<input type="checkbox"/>	<input type="checkbox"/>	<input type="checkbox"/>

◀
▶

Comments

Pavement Performance

25. Based on experience, indicate the type(s) of individual pavement ***distresses which occur in segregated areas.***

You can enter additional choices in the blank boxes at the end of the list.

	Don't know	Frequently higher than non-segregated areas	Occasionally higher than non-segregated areas	Rarely higher than non-segregated areas	Same as rest of pavement
Roughness	<input type="checkbox"/>	<input type="checkbox"/>	<input type="checkbox"/>	<input type="checkbox"/>	<input type="checkbox"/>
Potholes (patched or unpatched)					
Raveling	<input type="checkbox"/>	<input type="checkbox"/>	<input type="checkbox"/>	<input type="checkbox"/>	<input type="checkbox"/>
Depressions in wheel paths (e.g., rutting in low density areas)					
Longitudinal cracking in wheel path(s)	<input type="checkbox"/>	<input type="checkbox"/>	<input type="checkbox"/>	<input type="checkbox"/>	<input type="checkbox"/>
Longitudinal raveling (e.g., at joints, auger gear box, locations of screed extensions)					
Longitudinal cracking, non-wheel path, non-reflective cracking (e.g., at joints, auger gear box, locations of screed extensions)	<input type="checkbox"/>	<input type="checkbox"/>	<input type="checkbox"/>	<input type="checkbox"/>	<input type="checkbox"/>
Fatigue cracking in wheel path(s)					
Longitudinal fatigue cracking in only one wheel path (e.g., screed extension location)	<input type="checkbox"/>	<input type="checkbox"/>	<input type="checkbox"/>	<input type="checkbox"/>	<input type="checkbox"/>
Raveling along construction joints					
Transverse cracking	<input type="checkbox"/>	<input type="checkbox"/>	<input type="checkbox"/>	<input type="checkbox"/>	<input type="checkbox"/>
Reflective cracking					
Shoulder drop-off, shoving, etc.	<input type="checkbox"/>	<input type="checkbox"/>	<input type="checkbox"/>	<input type="checkbox"/>	<input type="checkbox"/>

<input type="text"/>	<input type="checkbox"/>	<input type="checkbox"/>	<input type="checkbox"/>	<input type="checkbox"/>	<input type="checkbox"/>
<input type="text"/>	<input type="checkbox"/>	<input type="checkbox"/>	<input type="checkbox"/>	<input type="checkbox"/>	<input type="checkbox"/>

Comments

If report(s) are available, please indicate the report title, web links, and/or contact person(s)

26. Please comment on the ability of your agency's pavement condition survey program to adequately capture the intermittent nature of early segregation-related pavement distresses.

Pilot Projects

27. Indicate any ***pilot projects*** which have or will be constructed to investigate these topics.

(Choose all that apply.)

You can enter additional choices in the blank box at the end of the list.

	None planned	In planning stages	Constructed 2012-2013	Constructed 2010-2011	Constructed 2008-200
Impact of construction practices on segregation	<input type="checkbox"/>	<input type="checkbox"/>	<input type="checkbox"/>	<input type="checkbox"/>	<input type="checkbox"/>
Infrared guns or infrared cameras for detecting segregation	<input type="checkbox"/>	<input type="checkbox"/>	<input type="checkbox"/>	<input type="checkbox"/>	<input type="checkbox"/>
Pave-IR for detecting and locating segregation	<input type="checkbox"/>	<input type="checkbox"/>	<input type="checkbox"/>	<input type="checkbox"/>	<input type="checkbox"/>
Combined use of Pave-IR and GPR to detect, locate and quantify segregation	<input type="checkbox"/>	<input type="checkbox"/>	<input type="checkbox"/>	<input type="checkbox"/>	<input type="checkbox"/>
Surface texture measurements to detect segregation	<input type="checkbox"/>	<input type="checkbox"/>	<input type="checkbox"/>	<input type="checkbox"/>	<input type="checkbox"/>
Intelligent compaction technology	<input type="checkbox"/>	<input type="checkbox"/>	<input type="checkbox"/>	<input type="checkbox"/>	<input type="checkbox"/>
	<input type="checkbox"/>	<input type="checkbox"/>	<input type="checkbox"/>	<input type="checkbox"/>	<input type="checkbox"/>
	<input type="checkbox"/>	<input type="checkbox"/>	<input type="checkbox"/>	<input type="checkbox"/>	<input type="checkbox"/>
	<input type="checkbox"/>	<input type="checkbox"/>	<input type="checkbox"/>	<input type="checkbox"/>	<input type="checkbox"/>

◀
▶

Comments

Contact information for person(s) familiar with pilot project(s).

Pilot Project Title

First Name

Last Name

E-mail

Phone

Cell Phone

Web link for report.

APPENDIX B

Respondents

Agency*
Alabama Department of Transportation
Alaska Department of Transportation
Arizona Department of Transportation
Arkansas State Highway and Transportation Department
Caltrans (California Department of Transportation)
Colorado Department of Transportation
Connecticut Department of Transportation
Delaware Department of Transportation
Florida Department of Transportation
Georgia Department of Transportation
Hawaii Department of Transportation
Illinois Department of Transportation
Indiana Department of Transportation
Iowa Department of Transportation
Kansas Department of Transportation
Louisiana Department of Transportation and Development
Maine Department of Transportation
Maryland Department of Transportation
Massachusetts Department of Transportation Research and Materials
Michigan Department of Transportation
Minnesota Department of Transportation
Missouri Department of Transportation
Montana Department of Transportation
Nebraska Department of Roads
Nevada Department of Transportation
New Mexico Department of Transportation
New Hampshire Department of Transportation
New Jersey Department of Transportation
North Carolina Department of Transportation
North Dakota Department of Transportation
Ohio Department of Transportation
Oklahoma Department of Transportation
Oregon Department of Transportation
Pennsylvania Department of Transportation
Rhode Island Department of Transportation
South Carolina Department of Transportation
South Dakota Department of Transportation
Tennessee Department of Transportation
Texas Department of Transportation
Utah Department of Transportation
Vermont Agency of Transportation
Virginia Department of Transportation—Materials Division
Washington State Department of Transportation
West Virginia Department of Highways—Materials Control, Soils & Testing Division
Wisconsin Department of Transportation
Wyoming Department of Transportation

APPENDIX C

Checklist for Reducing or Eliminating Segregation

The important points identified in each of the literature review and survey sections are assembled in table formats, which can be used for quick guidance in this appendix.

- Descriptions, detection, and inspection responsibilities for segregation (Table C1)
- Specifications, pavement distresses, and capabilities of pavement management systems to evaluate segregation (Table C2)

- Links between test methods, training and certification programs, and segregation (Table C3)

The conclusions are organized as individual tables for quick reference on how and where segregation occurs and how it can be reduced or eliminated:

- During mix design and aggregate production (Table C4)
- At the asphalt plant (Table C5)
- During mix transport and mix transfer (Table C6)

TABLE C1
DESCRIPTIONS, DETECTION, AND INSPECTION RESPONSIBILITIES FOR SEGREGATION

Topic	Categories	Importance
Descriptions of Segregation	Localized areas of coarse texture in the finished mat.	Descriptions of segregation need to be standardized to help with consistent detection of segregation, particularly visual detection.
	Longitudinal “streaks” of coarser-texture mix in center of mat behind the paver (e.g., under gear box, at screed extensions).	
	Longitudinal “streaks” of coarser-textured mix on one or both sides of mat behind the paver.	
	Localized areas of very fine texture in the finished mat (smoother surface than uniform textured areas)	
	Localized areas of hotter or cooler temperature mix behind the paver.	
	Transverse sections of cooler temperature mix (e.g., after changing trucks, paver stops)	
	Localized “clumps” of fibers and/or binder or other mix additives	
Detection of Segregation	Localized binder-rich areas (e.g., “fat spots”) in the finished mat.	
	Visual	Almost always used; considered the “gold standard”
	Temperature differences	Currently used in addition to visual detection, but automated sensor bars are being more widely used.
	Ride quality; bump detection	Used more frequently by industry; possibly linked to ride quality specifications Early loss of ride quality occurs in segregated areas
	Texture	Not routinely used Longitudinal texture profiles can detect end-of-truck segregation and evaluate effectiveness of material transfer units in reducing this type of segregation
Responsibility for Field Inspections	GPR, Intelligent Compaction	Have possibilities, but have not yet been evaluated for detection of segregated areas
	Wide mix of agency staff and consultants	Well-defined definitions and understanding of segregation on how and where segregation can occur are important for everyone conducting field inspections.

TABLE C2
SPECIFICATIONS, PAVEMENT DISTRESSES, AND CAPABILITIES OF PAVEMENT MANAGEMENT SYSTEMS TO EVALUATE SEGREGATION

Topic	Categories	Importance
Specifications	Method of detection	Visual detection most used followed by temperature differences; no consistent use of temperature differences at this time.
	Disincentives	Remove and replace most frequent disincentive
		Time needed for additional testing for segregation is a good disincentive; delays construction
		Percent within limits (PWL) and level of segregation incremental pay factors not frequently used
	Advantages	Defines steps for detection, testing, quantifies segregation
		Provides ability to reject work
	Disadvantages	Forces contractor "best practices"
		Can be subjective
Too much time needed for testing; delays construction		
Dispute resolution	Accepts lots that look segregated	
	Usually dealt with by the field- or district-level staff	
Desired changes	Less subjective	
	Use temperature measurements	
	Require cores	
Pavement Distresses in Segregated Areas	Smaller tolerances for QC/QA testing	
	Raveling, potholes	Most frequently expected distresses
	Increased roughness	Expected at least 35% more often
	Longitudinal and fatigue cracking in wheel path	Expected about 25% more often
Pavement Management System	Ability to identify pavement distresses resulting from segregation	Do not currently have the ability to assess and monitor intermittent pavement distresses

TABLE C3
LINKS BETWEEN TEST METHODS, TRAINING AND CERTIFICATION PROGRAMS, AND SEGREGATION

Topic	Categories	Importance
Roadway QC/QA Test Methods in Segregated Areas	Nuclear and non-nuclear gauges	No consistent method of use: Variations in testing include single point, pair of test points, or longitudinal, transverse, and skewed density profiles.
		<i>Nuclear density gauges:</i> Overestimates roadway density if coarse textured surfaces are not sanded prior to testing (air gaps alter readings). Clean gauge bottom also needed to keep air gaps at a minimum.
		<i>Non-nuclear density gauges:</i> Any variations in mix moisture content influence density measurements; gauges not always calibrated with cores.
Laboratory QC/QA Testing for Segregated Samples	Density tests	<i>AASHTO T166:</i> Overestimates density in segregated areas because segregated samples are more permeable. Coated or sealed samples are more likely to provide more accurate density measurements.
	Gradations	<i>Ignition oven testing:</i> Aggregate fracture because of heat needs calibration factor or any increases in coarse sizes as a result of segregation are underestimated.
	Performance-related testing	Not currently used to evaluate the change in mix properties in segregated areas.
Training and Certification Programs	Field inspectors	Both agency staff and consultant are used for field inspections. Training is important for all field inspection staff so that everyone has a consistent understanding of segregation definitions, detection, causes, and methods for reduction.
	Asphalt plant and field technicians	Topics covered in training need links between the topic and cause segregation at each step.
	Materials engineers, lab techs	Importance of using best field and laboratory practices and methods when determining mix properties in segregated areas needs to be included in training programs.
	Equipment operator certification programs	Loader operator certification and training programs can help reduce segregation. Skills needed for constructing aggregate stockpiles, managing stockpiles at the asphalt plant, and loading the cold feed bins at the asphalt plant.

TABLE C4
HOW AND WHERE SEGREGATION CAN BE REDUCED DURING MIX DESIGN AND AGGREGATE PRODUCTION

Location	Topics	How to Reduce Segregation	Comments
Mix Design	Gradation	Limit gaps in the gradation	Use gradation chart with all of Superpave sieve sizes plotted to see any gaps which can be minimized Bailey method of designing gradation helps minimize gaps
	Maximum aggregate size	Use 9.5-mm maximum size aggregate mixes	12.5 mm or larger maximum size aggregate mix increasingly segregate with increases in maximum size aggregate
		Physically reblend mixes with larger maximum size aggregates when transferring mix from haul trucks to paver (examples: material transfer units; baffles at back of end dump bed to funnel mix)	
	SMA and porous asphalt	Increase additives to prevent drain down	Occasionally segregate; asphalt separates (drains down) from aggregate
	Asphalt content (asphalt film thickness)	Minimum voids in mineral aggregate (VMA) establish a minimum acceptable asphalt film thickness	Adequate asphalt film thickness is needed to “stick” the aggregate particles together
		Small increase in asphalt content in gradations with some gapping (example: 0.2% typical dense mix)	Low asphalt content mixes such as base courses and stabilized mix can frequently segregate
Recycled materials with an asphalt content	Keep RAP content to less than 10%	QC testing needed to keep track of variations in the recycled material asphalt content	
	<i>RAP at 10% to 25%: Reblend the mix before it starts to move through the paver can help (examples: material transfer vehicle/device baffles at back of end dump bed to funnel mix)</i>	Higher contents of asphalt containing recycled material can result in “dry” mixes (low asphalt film thickness) when recycled asphalt content not completely used in effective asphalt content Variations in asphalt content in the recycled material results in variations in asphalt film thickness, which makes it difficult to control segregation	
Aggregate Production	Practices	Loader operator training and certification programs	Majority of stockpiles are constructed with labor intensive practices with trucks, dozers, and fixed conveyors

TABLE C5
HOW AND WHERE SEGREGATION CAN BE REDUCED AT THE ASPHALT PLANT

Location	Topics	How to Reduce Segregation	Comments
Asphalt Plant	Cold feed bins	At least four or more cold feed bins are needed	More cold feed bins allow a larger number of aggregate stockpiles to be used with narrower ranges of gradations in each
	Batch plants	Actively dislodge fines that build up on the #1 hot bin	Keeps “clumps” of fines from dropping into mixer all at once
		<i>Drum: Kickback flights inside the drum</i>	Helps improve mixing and drying times, which improves asphalt film thickness
	Drum mix plants	<i>Discharge point: Use fixed plow at exit</i>	Forces mix to reblend as it exits
		<i>Discharge point: Set drag slat conveyor at 90° to exit</i>	Forces mix to reblend as it exits
	Silo batchers	Keep top chute over center of batcher	Keeps coarser aggregates from collecting on one side
		Fill batcher and drop all at once into the silo	There needs to be enough mix so it flattens out when it lands in the silo. This keeps a cone from forming, which segregates mix
	Load out	Close batcher gates quickly	Keeps mix from “dribbling” into silo
		“Build” smaller batches of mix in all haul trucks (multiple drops)	Helps keep any possible segregation blended with overall mix gradation
		DO NOT load mix in single drop	Results in coarser particles rolling to entire perimeter of haul truck bed
	DO NOT load mix continuously as larger haul truck moves forward	Results in one continuous cone, which lets coarser aggregates roll down and to the outer edges of the haul truck bed	

TABLE C6
HOW AND WHERE SEGREGATION CAN BE REDUCED DURING MIX TRANSPORT AND MIX TRANSFER

Location	Topics	How to Reduce Segregation	Comments
Mix Transport	Truck types	<i>Belly dumps and live bottom:</i> May help reblend mixes with lower levels of segregation	Survey indicated these haul trucks help minimize segregate, but this benefit may be due to remixing, which occurs during transfer rather than truck type
	Truck options	<i>Tarps:</i> Some indication they help manage temperature segregation	Widespread use most likely because they limit flying debris
		<i>Insulated truck beds:</i> Help minimize temperature segregation	Used by agencies in the colder regions of the country Used by agencies with long haul distances
Material Transfer	End dumps	Use funnel-shape baffles at back of bed	Forces mix to reblend as it flows through funnel into paver hopper
	Windrow elevators (pick-up devices)	Deposit sufficient mix in windrow to keep optimum amount of mix supplied to screed	Windrows commonly formed by belly dumps
		DO NOT “dribble” mix out in thin stream	When next truck places more mix on top of “dribble,” both mix and temperature segregation is produced
		Minimize segregation in haul truck bed	Limited amount of segregation can be remixed by windrow elevators but more severe levels of segregation will still be transferred to the paver hopper
	Material transfer vehicles/devices	Keep sufficient amount of mix in holding hopper and surge bin DO NOT run surge bin low of mix	Keeps screed auger from being “starved” for mix
		Properly size surge bin to size of paver hopper	Needed for proper operation of transfer units
Make sure remixing augers in holding hopper or surge bin are running DO NOT scrape down cold mix built up on sides of holding hopper or surge bin if the mix is too low		Easily overlooked during set up; needed for most successful reblending of mix This creates both mix and temperature segregation	
Pavers— At Front	Hopper	Keep hopper at least half full	If wings are flipped, then there is sufficient mix in the hopper to reblend any coarser aggregates deposited by haul trucks
		DO NOT let hopper run too low before flipping wings	Creates end of truck segregation
	Moving mix	<i>Drag slats:</i> ensure coarse aggregate stay on conveyors (may require retrofit)	Coarse aggregated rolling off conveyor edges creates longitudinal segregation that is documented to cause premature top-down longitudinal cracking
		<i>Outboard motors:</i> allow closer spacing of conveyors	Helps minimize coarser aggregates from rolling off conveyor
		<i>Pair of twin augers:</i> newer design, which helps reblend mix in hopper	May help reduce some forms of longitudinal segregation, but benefits have not yet been fully documented
		Independent operation of conveyor speed	Different speeds allow the volume of mix supplied to each side of the screed to be balanced
	DO NOT allow variable speed operation to draw mix down too low on one side of the hopper	Can create one-sided longitudinal segregation when wings are flipped	
Pavers— At Back	Near gear box	<i>Kicker paddles:</i> pushes mix under gear box Use reverse flow option if available on paver to push mix under gear box	Keeps coarser aggregates mixed with more uniform mix
	Screed augers	Keep volume of mix consistent; about 75% of the auger height is about right	Lower levels “starve” augers, which segregates mix
	Head of material	Keep optimum height of mix all the way to the edge of the screed	Optimum mix level helps keep angle of attack constant, mat thickness uniform, and keeps the screed from dragging and tearing the mat
	Screed extensions	Balance flow of mix to each side of screed	Can require independent speed controls for mix delivery from hopper when extensions are different widths on each side
		Use auger extensions when screed extensions are used	Mix needs to be pulled from the center by the augers across the full width of paving. Segregation occurs when the mix is pushed. This happens when auger extensions are NOT used.

Abbreviations used without definitions in TRB publications:

A4A	Airlines for America
AAAE	American Association of Airport Executives
AASHO	American Association of State Highway Officials
AASHTO	American Association of State Highway and Transportation Officials
ACI-NA	Airports Council International-North America
ACRP	Airport Cooperative Research Program
ADA	Americans with Disabilities Act
APTA	American Public Transportation Association
ASCE	American Society of Civil Engineers
ASME	American Society of Mechanical Engineers
ASTM	American Society for Testing and Materials
ATA	American Trucking Associations
CTAA	Community Transportation Association of America
CTBSSP	Commercial Truck and Bus Safety Synthesis Program
DHS	Department of Homeland Security
DOE	Department of Energy
EPA	Environmental Protection Agency
FAA	Federal Aviation Administration
FHWA	Federal Highway Administration
FMCSA	Federal Motor Carrier Safety Administration
FRA	Federal Railroad Administration
FTA	Federal Transit Administration
HMCRP	Hazardous Materials Cooperative Research Program
IEEE	Institute of Electrical and Electronics Engineers
ISTEA	Intermodal Surface Transportation Efficiency Act of 1991
ITE	Institute of Transportation Engineers
MAP-21	Moving Ahead for Progress in the 21st Century Act (2012)
NASA	National Aeronautics and Space Administration
NASAO	National Association of State Aviation Officials
NCFRP	National Cooperative Freight Research Program
NCHRP	National Cooperative Highway Research Program
NHTSA	National Highway Traffic Safety Administration
NTSB	National Transportation Safety Board
PHMSA	Pipeline and Hazardous Materials Safety Administration
RITA	Research and Innovative Technology Administration
SAE	Society of Automotive Engineers
SAFETEA-LU	Safe, Accountable, Flexible, Efficient Transportation Equity Act: A Legacy for Users (2005)
TCRP	Transit Cooperative Research Program
TEA-21	Transportation Equity Act for the 21st Century (1998)
TRB	Transportation Research Board
TSA	Transportation Security Administration
U.S.DOT	United States Department of Transportation

TRANSPORTATION RESEARCH BOARD
500 Fifth Street, NW
Washington, DC 20001

ADDRESS SERVICE REQUESTED

THE NATIONAL ACADEMIES™

Advisers to the Nation on Science, Engineering, and Medicine

The nation turns to the National Academies—National Academy of Sciences, National Academy of Engineering, Institute of Medicine, and National Research Council—for independent, objective advice on issues that affect people's lives worldwide.

www.national-academies.org

ISBN: 978-0-309-27182-0



9 780309 271820

NON-PROFIT ORG.
U.S. POSTAGE
PAID
COLUMBIA, MD
PERMIT NO. 88